

**BUILD YOUR OWN HANDI-TALKIE!**

48783

# **Radio** **Electronics**®

OCTOBER 1992

Combined  
with **Electronics**  
**NOW**®

Build this  
high-efficiency  
**HANDI-TALKIE**  
for business or amateur  
communications

Build our  
**REFLEX TESTER**  
and find out just  
how fast you are!

How to use the  
**555 TIMER CHIP**  
to build  
oscillator circuits

Build a  
**250-WATT**  
**POWER INVERTER**  
to supply 120 volts AC  
from 12 volts DC!

Use our  
**PC-BASED**  
**TEST BENCH**  
to identify and test  
digital IC's

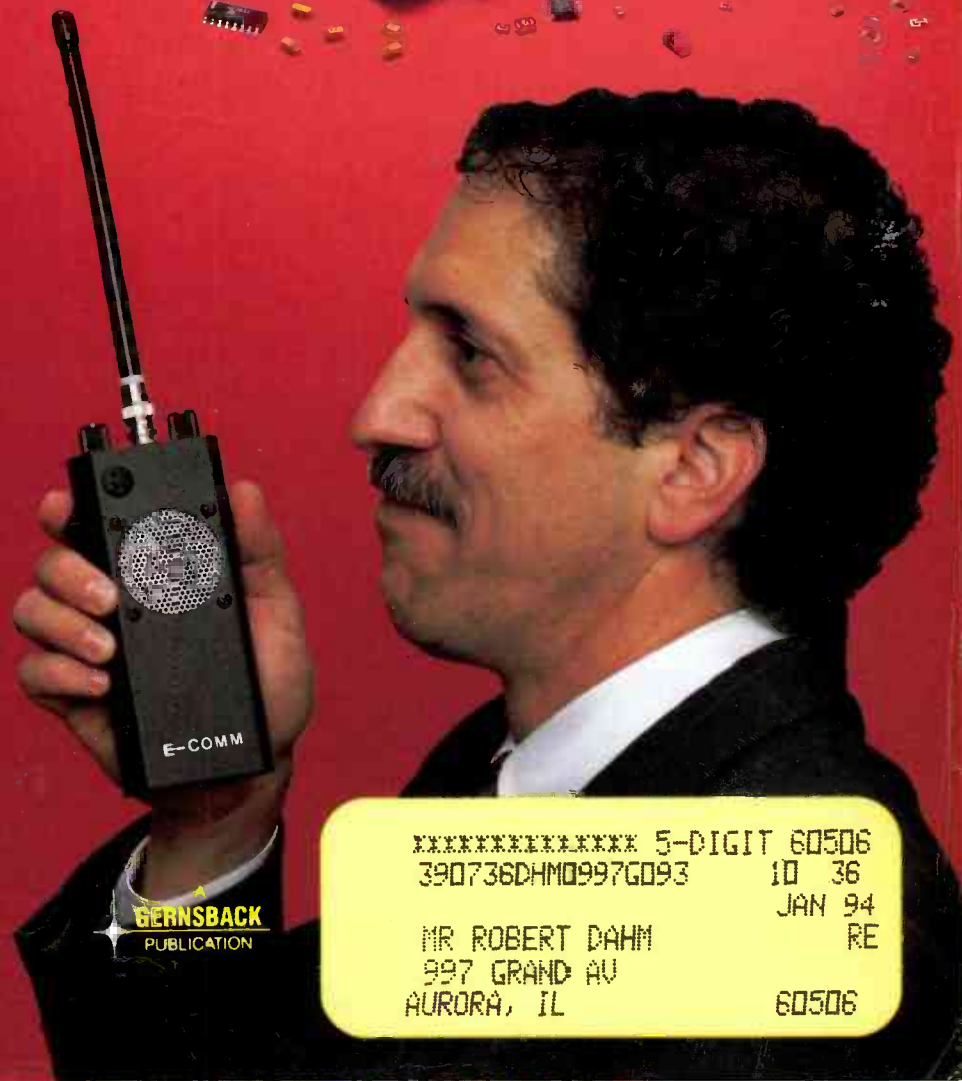
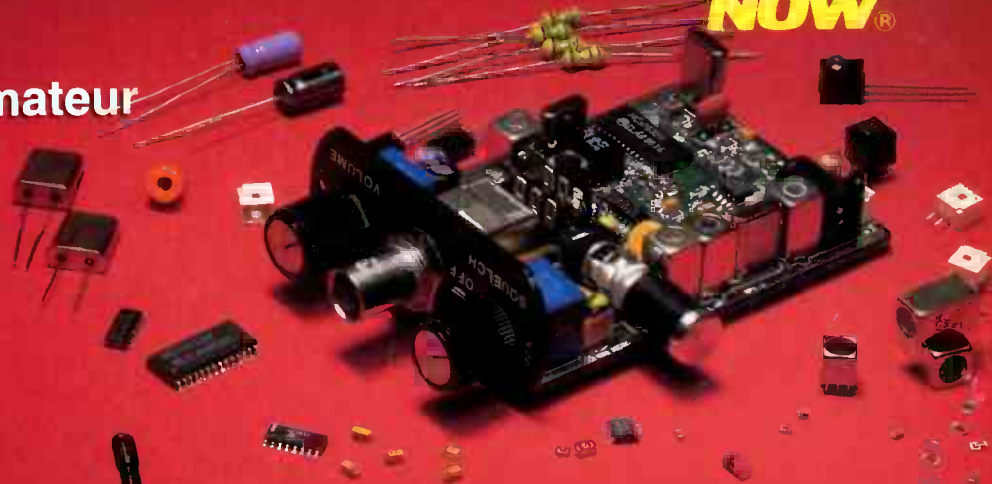

\$2.95 U.S.  
\$3.75 CAN

**GERNSBACK**  
PUBLICATION

XXXXXXXXXXXX 5-DIGIT 60506  
390736DHMO997G093 10 36  
JAN 94 RE  
MR ROBERT DAHM  
997 GRAND AV  
AURORA, IL 60506

**FLUKE**



**PHILIPS**

# Introducing SCOPEMETER™

There's More Than One Reason to Reach for It.

In fact, there's *every* reason to reach for ScopeMeter™. Because only ScopeMeter combines the expertise of Fluke and Philips to bring you a dual-channel digital scope along with everything you've come to expect from Fluke digital multimeters.

The result: an integrated scope-and-multimeter that lets you see a waveform and digital meter display at the same time from the same input. Or switch between dedicated high-performance Scope and Meter functions with the touch of a key. That makes it faster and easier than ever to capture, store and analyze precisely what you're looking for. At a price that looks good, too.

To get your hands on a ScopeMeter, contact your Fluke sales office or your nearest Fluke distributor. For more product information, call 1-800-44-FLUKE.

**SCOPEMETER. Now there's only one to reach for.**



## Built to Take It.

- Completely sealed against water, dust and contaminants.
- EMI protected and measures up to 600 volts rms.
- Rugged construction with shock-resistant holster.
- Three-year warranty from Fluke.

## Simply Easy.

- Intuitive front panel layout for simple, straightforward operation.
- Pop-up menus and five function keys for easy control.
- Autoset automatically sets voltage, time and trigger functions.
- Safety-designed BNC connectors and probes simplify floating measurements.

## Double Duty.

- 50 MHz digital storage scope and 3000-count digital multimeter in one handheld package.
- Precision Min Max Record and 40 ns Glitch Capture make it easy to troubleshoot intermittent failures.
- Simultaneous waveform and digital display on a backlit screen you can read across the room.

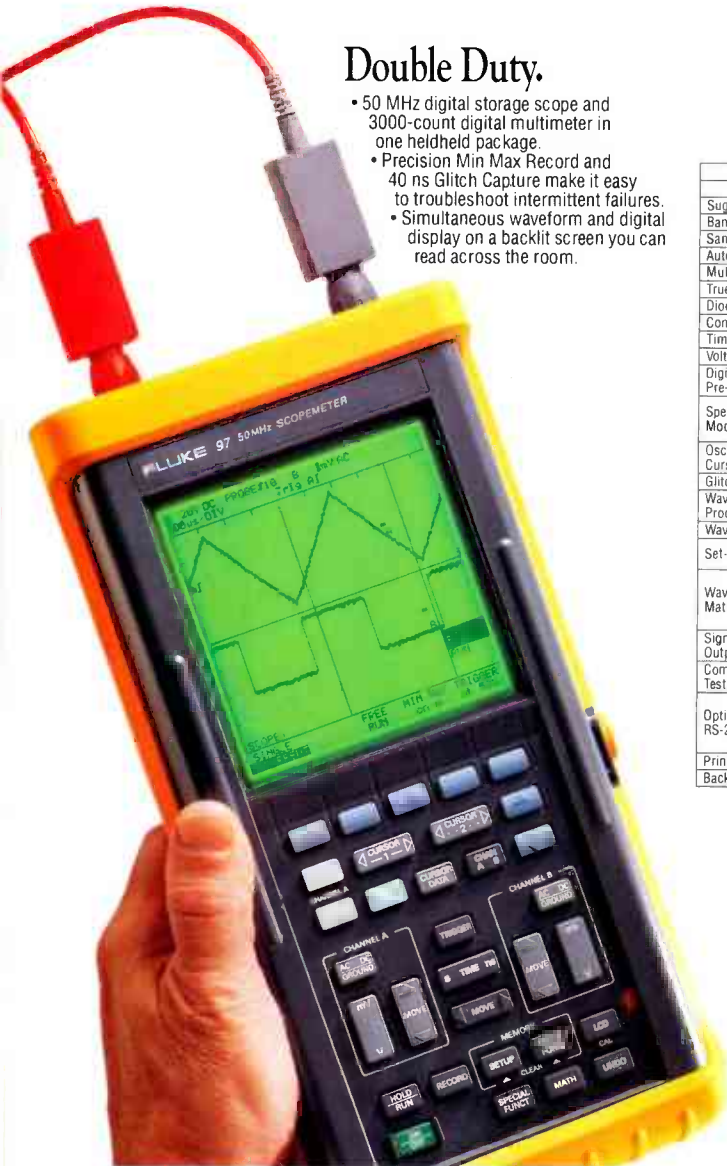

FLUKE 90 SERIES SCOPEMETER SELECTION GUIDE			
	FLUKE 97	FLUKE 95	FLUKE 93
Suggested List Price	\$1795	\$1495	\$1195
Bandwidth	50 MHz Dual Channel		
Sample Rate	25 Megasamples/second		
Autoset	Automatically sets Voltage, Time and Trigger		
Multimeter Display	3 1/2 digits (>3000 Counts)		
True RMS Volts	AC or AC+DC up to 600V (1700V Pk-Pk)		
Diode Test	Up to 2.8V		
Continuity Beeper	Yes		
Time/Division	10 ns/div to 60 sec/div		
Volts/Division	1 mV/div to 100V/div		5 mV/div to 100V/div
Digital Delay or Pre-Trigger	By Number of Cycles, Events, Time, or Zoom Mode		By Time
Special Multimeter Modes	Min Max Average Record, Relative (zero), dBm, dBV, dBW, Audio Watts, % Scale, Frequency, Smoothing, Change Alert™		Frequency, Smoothing™, Change Alert™
Oscilloscope Cursors	12 Measurements, Display 5 Simultaneously		
Glitch Capture	≥40 ns		
Waveform Processing	Average, Variable Persistence, Min Max Record		
Waveform Memory	Store and Recall 8 Waveforms		
Set-Up Memory	Store and Recall 10 Front Panel Set-Ups		
Waveform Mathematics	Add, Subtract, Multiply, Invert, Filter or Integrate Waveforms		
Signal Generator Output	Sinewave or Squarewave		
Component Tester Output	Voltage or Current Ramp		
Optically Isolated RS-232-C Interface	Full Operation by Remote Control via optional PM 9080 cable		
Printer Output	Serial		
Backlit Display	Electroluminescent		



## Goes Wherever You Go.

- Runs on rechargeable NiCad Batteries, standard C-cells or the included line voltage adapter/battery charger.
- Adjustable tilt-stand/hanger.
- Compatible with a wide range of Fluke multimeter accessories.

©1992 John Fluke Mfg. Co., Inc. Ad No. 00224.

**FLUKE**

CIRCLE 121 ON FREE INFORMATION CARD

# October 1992 **Electronics NOW**

Vol. 63 No. 10

## BUILD THIS

### 35 HANDI-TALKIE

Use this efficient mini FM transceiver for business or amateur communications.

**Don Wray**

### 43 REFLEX TIMER

Find out just how fast your reflexes are!

**Dan Kennedy**

### 61 DIFFERENTIAL PROBE

Make safe measurements in ungrounded systems.

**Walter Dorfman**

## COMPUTERS

### 47 PC-BASED TEST BENCH

Build the T1003 digital logic IC tester.

**Steve Wolfe**

### 75 250-WATT POWER INVERTER

Use it to power small appliances from your car.

**James Melton**

## TECHNOLOGY

### 55 NOT WORKING TO NETWORKING

Case histories of some problem LAN's.

**Gary McClellan**

### 69 THE 555: A VERSATILE OSCILLATOR

Learn to use the 555 IC in circuits that wail, warble, and honk!

**Ray M. Marston**

## DEPARTMENTS

#### 8 VIDEO NEWS

What's new in this fast-changing field.

**David Lachenbruch**

#### 16 EQUIPMENT REPORT

Computer monitor checker.

#### 78 AUDIO UPDATE

Syndicated reviewers, AM stereo, and consumer fraud.

**Larry Klein**

#### 79 HARDWARE HACKER

Histogram equalization.

**Don Lancaster**

#### 88 DRAWING BOARD

Video scrambling.

**Robert Grossblatt**

#### 97 COMPUTER CONNECTIONS

Miniature multimedia.

**Jeff Holtzman**



**BUILD THIS REFLEX TIMER**

How fast are your reflexes? The reflex timer will show you.

**DAN KENNEDY**

Your reaction time is a good indicator of your overall health. A reflex timer is a simple circuit that measures your reaction time. It consists of a 555 timer, a speaker, and a light bulb. When the timer is triggered, the speaker emits a tone and the light bulb turns on. The time between the tone and the light turning on is your reaction time. This circuit is simple to build and can be used to test your reflexes at any time.

PAGE 43



Power small appliances from your car or any other 12-volt source with our 250-watt inverter.

**250 WATT POWER INVERTER**

**JAMES MELTON**

PAGE 75

## AND MORE

106 Advertising and Sales Offices

106 Advertising Index

97 Buyer's Market

4 Editorial

14 Letters

32 New Lit

22 New Products

12 Q&A

6 What's News

## ON THE COVER



Whether you need a handheld transceiver for business or for amateur-radio—or just want to build one for the fun of it—our Handi-Talkie has a lot to recommend it. The small, light-weight transceiver is powerful and efficient, offers narrow-band FM modulation and can be designed to operate anywhere from 27 to 32 MHz—and even up to 60 MHz with minor parts changes! That configuration allows the Handi-Talkie to work both the six- and ten-meter amateur-radio bands. Thanks to the use of surface mount technology, the whole device, including a rechargeable nickel-cadmium battery pack, is housed in a case less than six inches long. Turn to page 35 for all the details!

## COMING NEXT MONTH

### THE NOVEMBER ISSUE GOES ON SALE OCTOBER 6.

#### PHOTO SOUND STROBE

This project brings the worlds of electronics and photography together to capture exciting, astounding images on film.

#### SOLAR EVENT MONITOR

Keep track of magnetic-field anomalies that can disrupt—or enhance—communications.

#### CIRCUIT COOKBOOK

A variety of astable- and monostable multivibrator circuits based on the 555 timer.

#### AUTOMOTIVE POWER RELAY

This "smart" switch is perfect for controlling such high-current devices as auxiliary lights and high-power audio amplifiers.

As a service to readers, ELECTRONICS NOW publishes available plans or information relating to newsworthy products, techniques and scientific and technological developments. Because of possible variances in the quality and condition of materials and workmanship used by readers, ELECTRONICS NOW disclaims any responsibility for the safe and proper functioning of reader-built projects based upon or from plans or information published in this magazine.

Since some of the equipment and circuitry described in ELECTRONICS NOW may relate to or be covered by U.S. patents, ELECTRONICS NOW disclaims any liability for the infringement of such patents by the making, using, or selling of any such equipment or circuitry, and suggests that anyone interested in such projects consult a patent attorney.

ELECTRONICS NOW, (ISSN 0033-7862) October 1992. Published monthly by Gernsback Publications, Inc., 500-B Bi-County Boulevard, Farmingdale, NY 11735. Second-Class Postage paid at Farmingdale, NY and additional mailing offices. Second-Class mail registration No. R125166280, authorized at Toronto, Canada. One-year subscription rate U.S.A. and possessions \$19.97, Canada \$27.79 (includes G.S.T. Canadian Goods and Services Tax Registration No. R125166280), all other countries \$28.97. All subscription orders payable in U.S.A. funds only, via international postal money order or check drawn on a U.S.A. bank. Single copies \$2.95. © 1992 by Gernsback Publications, Inc. All rights reserved. Printed in U.S.A.

POSTMASTER: Please send address changes to ELECTRONICS NOW, Subscription Dept., Box 55115, Boulder, CO 80321-5115.

A stamped self-addressed envelope must accompany all submitted manuscripts and/or artwork or photographs if their return is desired should they be rejected. We disclaim any responsibility for the loss or damage of manuscripts and/or artwork or photographs while in our possession or otherwise.

# Electronics NOW

Hugo Gernsback (1884-1967) founder

Larry Steckler, EHF, CET,  
editor-in-chief and publisher

#### EDITORIAL DEPARTMENT

Brian C. Fenton, editor

Marc Spiwak, associate editor

Neil Sclater, associate editor

Teri Scaduto, assistant editor

Jeffrey K. Holtzman  
computer editor

Robert Grossblatt, circuits editor

Larry Klein, audio editor

David Lachenbruch  
contributing editor

Don Lancaster  
contributing editor

Kathy Terenzi, editorial assistant

#### ART DEPARTMENT

Andre Duzant, art director

Injae Lee, illustrator

Russell C. Truelson, illustrator

#### PRODUCTION DEPARTMENT

Ruby M. Yee, production director

Karen S. Brown  
advertising production

Marcella Amoroso  
production assistant

Lisa Rachowitz  
editorial production

#### CIRCULATION DEPARTMENT

Jacqueline P. Cheeseboro  
circulation director

Wendy Alanko  
circulation analyst

Theresa Lombardo  
circulation assistant

Michele Torriolo  
reprint bookstore

Typography by Mates Graphics  
Cover photo by Diversified Photo  
Services

Electronics Now is indexed in  
*Applied Science & Technology Index*,  
*and Readers Guide to Periodical Literature*,  
*Academic Abstracts*, and  
*Magazine Article Summaries*.

Microfilm & Microfiche editions are  
available. Contact circulation department  
for details.

Advertising Sales Offices listed  
on page 102.

Electronics Now Executive and  
Administrative Offices  
1-516-293-3000.

Subscriber Customer Service:  
1-800-288-0652.

Order Entry for New Subscribers:  
1-800-999-7139.



Audit Bureau  
of Circulations  
Member



# HOME-WORK

## For Electronics

MADE IN  
U.S.A.

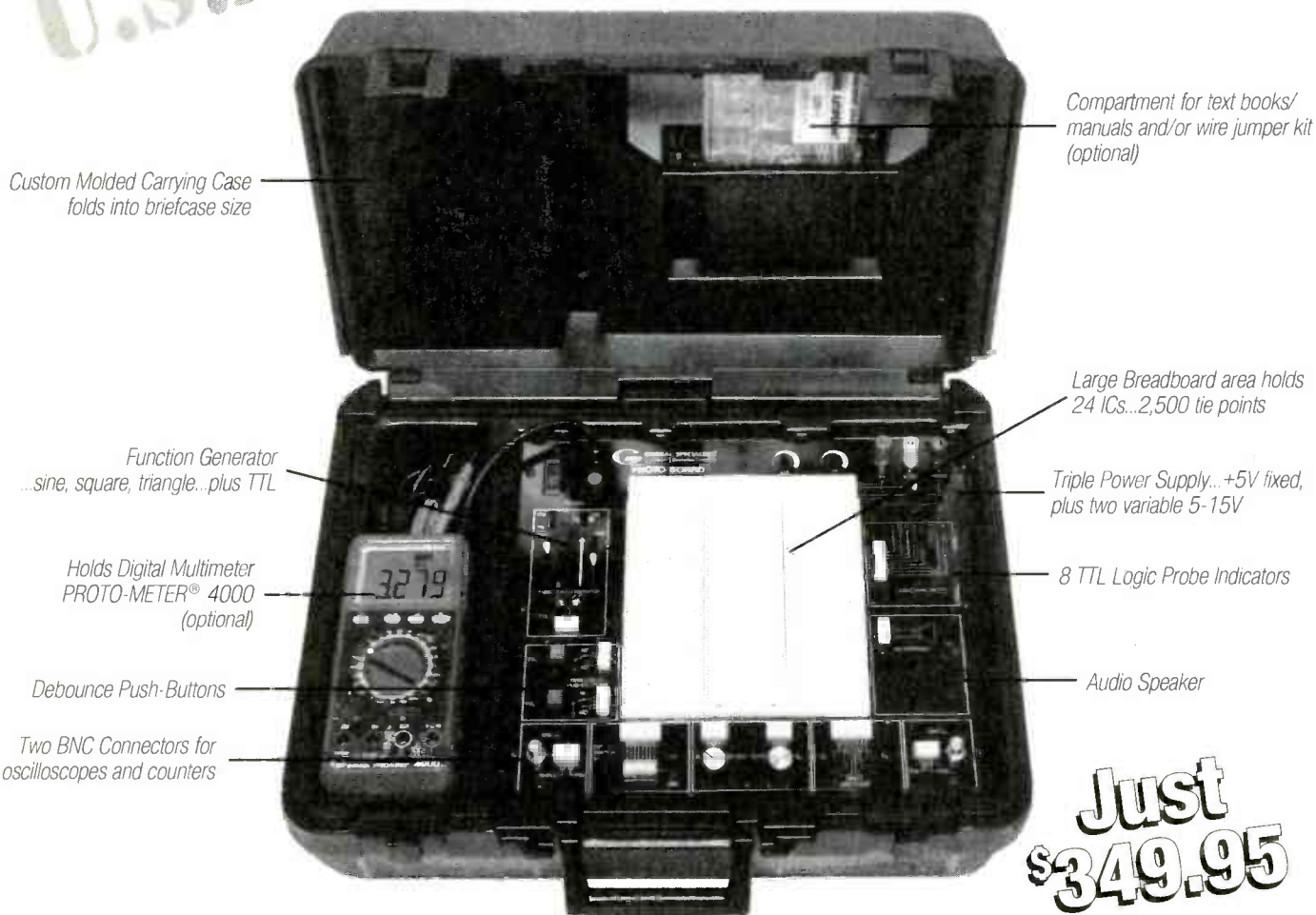

Custom Molded Carrying Case  
folds into briefcase size

Compartment for text books/  
manuals and/or wire jumper kit  
(optional)

Function Generator  
...sine, square, triangle...plus TTL

Large Breadboard area holds  
24 ICs...2,500 tie points

Holds Digital Multimeter  
PROTO-METER® 4000  
(optional)

Triple Power Supply...+5V fixed,  
plus two variable 5-15V

Debounce Push-Buttons

8 TTL Logic Probe Indicators

Two BNC Connectors for  
oscilloscopes and counters

Audio Speaker

Just  
\$349.95

Here's PB-503-C. It has every feature that our famous PB-503 offers, but we added one more, portability. Work on your projects at the office or school, take it home at night... it's for the engineer or student who wish to take their lab with them. **Instrumentation**, including a function generator with continuously variable sine, square, triangle wave forms and TTL pulses. **Breadboards** with 8 logic probe circuits. And a **Triple**

**Power Supply** with fixed 5VDC, plus two variable outputs (+5 to +15VDC). Throw-in 8 TTL compatible LED indicators, switches, pulsers, potentiometers, audio experimentation speaker... plus a life-time guarantee on all breadboarding sockets! And, because it's portable you will always have everything you need right in front of you! PB-503-C, one super test station for under \$350! Order yours today!!



**FOR MORE INFORMATION  
CALL 1-800-572-1028**



**GLOBAL  
SPECIALTIES®**

CIRCLE 182 ON FREE INFORMATION CARD

Global Specialties®, 70 Fulton Terrace, New Haven, CT 06512  
Tele: 203-624-3103/Fax: 203-468-0060 - ©1990, Interplex Electronics  
All Global Specialties® breadboarding products are made in the U.S.A.  
Proto-Board is a registered trademark of Global Specialties® **A033**

an  
**Interplex  
Industries**  
company

# EDITORIAL

## NOW'S THE TIME

*Now*, according to Webster's New World Dictionary, means "at the present time; at this moment." **Electronics Now** is just what its name implies: a compilation of what is happening in electronics at this moment!

**Electronics Now** brings you the latest news, the newest products, the most useful training, the most exciting projects, the newest how-to information. We help you learn how it works, how to keep it working, and, of course, how to make your own. We even show you what may happen tomorrow.

Above all else, we remain *your* electronics magazine. We know that the great majority (89%) of you earn your living in electronics. But you are the engineers and technicians to whom being an electronics professional is more than just a job. In your spare time—your leisure time—your personal time—you still want to know and learn more about electronics.

You want to know how Caller ID works. You want to know how digital audio tape compares to digital compact cassettes. You need to know about cellular telephone services and the personal communication networks of tomorrow. You need to know what microprocessor your next computer will have. You have to know what the next generation IC's will be like.

Bringing you information on those and other subjects is our forte. We work and strive to stay on top, to learn, to explore, and follow late-breaking developments in electronics. And we do it *now!* That's where our new name—**Electronics Now**—comes from. That's what we bring to you —today and tomorrow—**Electronics Now!**

Stay with us as we evolve and grow to meet the ever growing challenge of the electronics revolution. Stay with us as we continue our quest for the most exciting, most revolutionary, and most daring developments of today and tomorrow. Become, through our pages, a part of the most important and influential segment of our modern world. Come with us as we become **Electronics Now.**



Larry Steckler, EHF/CET  
Editor-in-Chief and Publisher

FROM

\$19<sup>95</sup>

Standard



\$199<sup>95</sup>

High Performance

GREAT VALUE!

**Standard Features - Models 100, 150, 200 & 400**

- AC & DC VOLTAGES ● DC CURRENT ● RESISTANCE
- CONTINUITY TESTER - Buzzer ● DIODE TEST ● 3 1/2 Digit LCD
- LOW BATTERY INDICATOR ● ACCURACY +/- 0.5% RDG

Kelvin Meters backed by a 2 Yr Warranty - Parts & Labor

PRO 400



100 Basic



150 Basic+



200 Advanced



KELVIN PRO 400

- |                          |                             |  |   |
|--------------------------|-----------------------------|--|---|
| BATTERY TEST             | TRANSISTOR hFE BATTERY TEST | TRANSISTOR hFE CAPACITANCE AC/DC CURRENT | 20MHz FREQ COUNTER AC/DC CURRENT CAPACITANCE LOGIC TEST TRANSISTOR hFE LED TEST - VERIFY GOOD/BAD |
| <b>KELVIN # 990087</b>   | <b>KELVIN # 990090</b>      | <b>KELVIN # 990091</b>                   | <b>KELVIN # 990092</b>  |
| <b>100 Basic</b>         | <b>150 Basic+</b>           | <b>200 Advanced</b>                      | <b>PRO 400</b>  |
| <b>\$19<sup>95</sup></b> | <b>\$29<sup>95</sup></b>    | <b>\$39<sup>95</sup></b>                 | <b>\$69<sup>95</sup></b>  |

**Protective Cases**

- For Models 100, 150, 200 ..... \$4.<sup>95</sup> (990088)
- Case For Model Pro 400 ..... \$9.<sup>95</sup> (990094)



Model 92 PERFORMANCE PLUS



Model 93 DIAGNOSTIC PLUS



Model 95 ENGINE ANALYZER PLUS

**Standard Features - Models 92, 93, 94 & 95**

- DC/AC VOLTMETERS ● AC/DC CURRENT ● OHM METER
- FREQUENCY COUNTER to 4 MHz ● AUDIBLE CONTINUITY TESTER
- DIODE TESTER ● MAX/MIN AVERAGE MEMORY RECORD
- RELATIVE MODE ● 10A HIGH-ENERGY FUSE PROTECTION
- DATA HOLD ● AUTO SLEEP & AUTO POWER OFF

**PERFORMANCE PLUS**

Model 92 # 990109  
**\$119<sup>95</sup>**

Complete with above **Standard Features** plus WATER RESISTANT (92 & 94 Models only), 2 YEAR WARRANTY, YELLOW HOLSTER, PROBES, BATTERY, FUSE, STAND

**DIAGNOSTIC PLUS**

Model 93 # 990110  
**\$149<sup>95</sup>**

Complete with **Standard & Model 92 Features** plus LOGIC PROBE, CAPACITANCE TESTER, TRANSISTOR TESTER, TEMPERATURE TESTER & K-TYPE PROBE, HIGH VOLTAGE WARNING BUZZER

**ENGINE ANALYZER PLUS**

Model 95 # 990112  
**\$199<sup>95</sup>**

Complete with **Standard & Model 92 Features** plus TEMPERATURE, TACHOMETER & DWELL ANGLE TESTER, DUTY CYCLE, 10 MEGA OHM IMPEDANCE, ANALOG BAR GRAPH, K-TYPE TEMP PROBE, ALLIGATOR CLIP TEST LEADS, INDUCTIVE PICKUP CLIP, 6' TEST LEADS & CARRY CASE

10 HUB DRIVE  
MELVILLE, NY  
11747

**KELVIN**

M/C & VISA

(800) 645-9212  
(516) 756-1750

Established 1945  
(516) 756-1763/FAX

**The Ultimate Meter**  
TRUE RMS - LCR - Hz - dBm



12 INSTRUMENTS IN ONE - DC VCLTMETER, AC VOLTMETER, OHMMETER, AC CURRENT, DC CURRENT, DC DIODE TESTER, AUDIBLE CONTINUITY TESTER, dBm, FREQ COUNTER, CAPACITANCE METER, INDUCTANCE METER, LOGIC PROBE

0.1% ACCURACY on DC Voltages Water Resistant

**\$199<sup>95</sup>** MODEL 94 #990111

COMES COMPLETE WITH YELLOW HOLSTER, PROBES, BATTERY, FUSE, STAND

10 MEGA OHM IMPEDANCE  
RELATIVE MODE / DATA HOLD  
MAX/MIN AVERAGE MEMORY RECORD  
10A HIGH-ENERGY FUSE PROTECTION  
AUTO SLEEP & AUTO POWER OFF with Bypass

Freq Counter to 20 MHz

**Cases for 90 Series Meters**

- Regular Added Zipped ... \$9.<sup>95</sup> (#9901-6)
- Deluxe Added Zipped ... \$14.<sup>95</sup> (#9901-5)

This meter is designed in accordance with relevant safety requirements as specified in IEC-348, UL-1244 and VDE-0411.

# WHAT'S NEWS

*A review of the latest happenings in electronics.*

## **64-megabyte memory chip**

A computer memory chip jointly developed by engineers at IBM (Essex Junction, VT) and Siemens can store more than 64-million bits of data—four times the capacity of the most advanced memory chip in computers today.

The new dynamic random access memory (DRAM) chip can store the equivalent of about 6000 pages of double-spaced typewritten text, and can "read" more than 64-million bits on the chip in a fraction of a second. The chip measures 10.7mm by 18.1mm (approximately  $\frac{3}{8}$ -inch by  $\frac{3}{4}$ -inch).

The chip was developed with an advanced CMOS technology process. Its smallest conductive traces are 0.4 micrometers wide, about one two-hundredth of the thickness of a human hair. The transistor's gate insulator, a nonconducting layer that separates conducting layers on the chip, measures only 10 nanometers in thickness.

The electrical charges that make up each bit of information are stored in a buried-plate trench cell. A con-

ductive region in this cell is diffused from the bottom part of the trench into the substrate. That region serves as the common buried-plate contact to all the cells. The trench's sidewalls are covered with an insulating material, and the trench is then filled with conductive silicon. Information is stored in the material inside the trench.

The entire trench area occupies only 1.5 square micrometers. The cell is so small that nearly one million of them can fit on the head of a pin.

The 64-megabit chip, which operates from a single 3.3-volt power supply, has borderless contacts that eliminate the necessity for providing a border around the metal that forms electrical contacts to specific areas of the chip. Borderless contacts reduce the area of the chip.

IBM and Siemens began their joint development on the chip in January 1990. Their goal is to have the chip ready for mass production by the middle of the decade.

In July IBM announced that it is

joining with Siemens and Toshiba to develop 256-megabit DRAMS.

## **Faster silicon circuits**

Westinghouse Electric Corp. (Pittsburgh, PA) has received a government contract to develop silicon transistors that operate at higher speeds than today's devices. The new technology is expected to extend the use of low-cost silicon substrates into the higher-frequency regions of radar, cellular telephones, digital radio, and ultra-high-speed computing.

The \$624,000 U.S. Navy Research Laboratory contract, which extends through the end of 1993, supports further development of the silicon-on-insulator technology—called Microx. The technology will be used for applications in which both microwave radio and digital functions are built into the same monolithic chip.

Experimental microelectronic chips fabricated from Microx have operated at the microwave frequencies of 30 GHz and they are expected to achieve 40 GHz, smoothing the way to a new generation of low-cost, mixed function RF/digital silicon monolithic circuits whose speeds are comparable to those attained by gallium-arsenide devices. Westinghouse believes these to be the highest frequencies ever reported for linear MOS silicon transistors.

The key innovations are ion-implanted oxide layers produced with a high-resistivity substrate that resembles an insulator, combined with several advanced fabrication techniques. According to Michael C. Driver, manager of microelectronics at the Westinghouse Science & Technology Center, Microx can realize at least 10 decibels of power gain at 10 GHz. This performance, he said, coupled with the low cost typical of silicon MOS technology, opens up a broad range of applications.

**R-E**

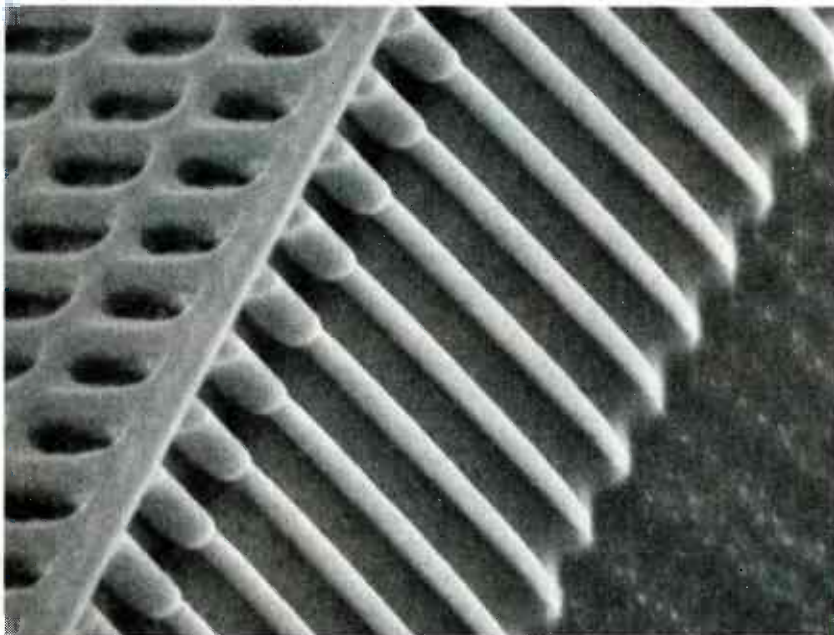

**A SERIES OF MEMORY CELLS IN THE IBM/SIEMENS 64-million-bit computer memory chip as seen with an electron microscope.**





3765 \$29.95



2800P \$16.95 Softcover

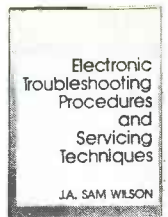

9370-XX \$38.60 Counts as 2



3279-XX \$36.95 Counts as 2

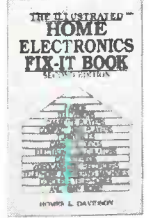

2883P \$18.95 Softcover



3107P \$18.95 Softcover



3672P \$18.95 Softcover

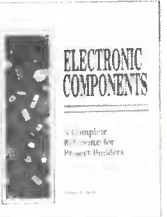

3671 \$29.95



2613P \$17.95 Softcover



3258 \$28.95



2925P \$10.95 Softcover



3804P \$19.95 Softcover

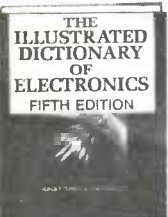

3345P \$26.95 Softcover



2867P \$18.95 Softcover



2996P \$14.95 Softcover



3627P \$19.95 Softcover

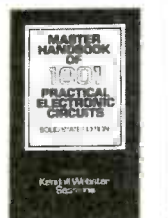

2980P \$19.95 Softcover

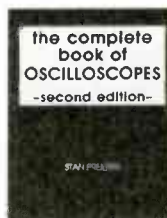

3825 \$26.95



3777-XX \$32.95 Counts as 2

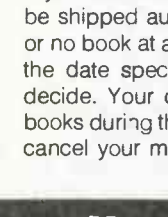

3589 \$27.95

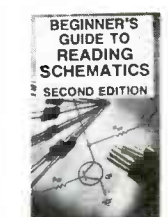

3632P \$10.95 Softcover



3438-XX \$39.95 Counts as 2

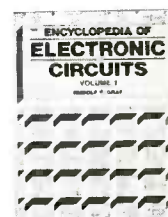

1938-XXX \$60.00 Counts as 3

**Your most complete and comprehensive source for the finest electronics books**

**As a member of the Electronics Book Club . . .**  
 . . . you'll enjoy receiving Club bulletins every 3-4 weeks containing exciting offers on the latest books in the field at savings of up to 50% off of regular publishers' prices. If you want the Main Selection do nothing and it will be shipped automatically. If you want another book, or no book at all, simply return the reply form to us by the date specified. You'll have at least 10 days to decide. Your only obligation is to purchase 3 more books during the next 12 months, after which you may cancel your membership at any time.

(Publishers' Prices Shown) ©1992 EBC

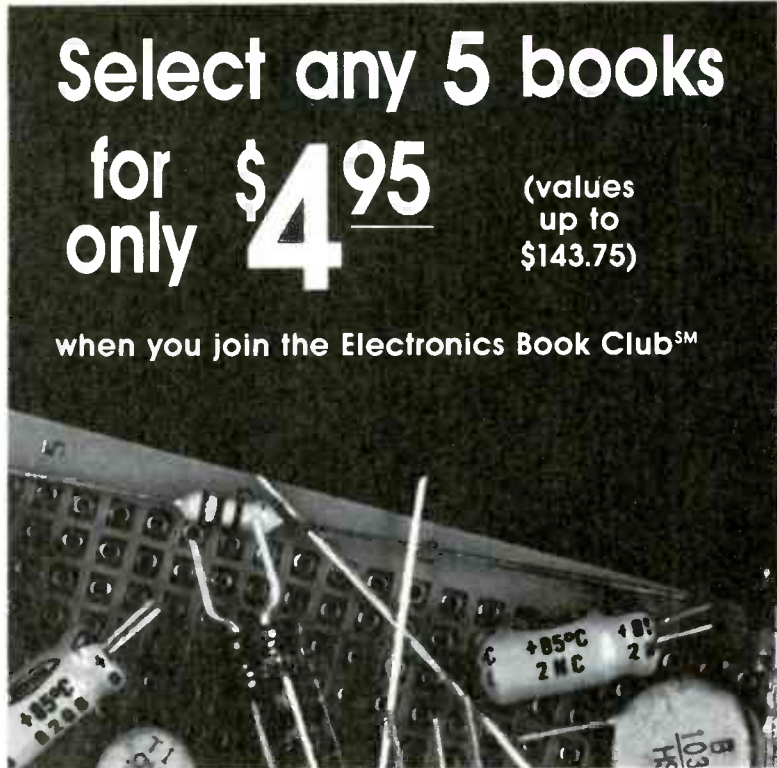

Select any 5 books  
 for only \$4.95  
 (values up to \$143.75)

when you join the Electronics Book Club<sup>SM</sup>

If coupon is missing, write to: Electronics Book Club, Blue Ridge Summit, PA 17294-0810

# ELECTRONICS BOOK CLUB<sup>SM</sup>

Blue Ridge Summit, PA 17294-0810

**YES!** Please send me the books listed below, billing me for just \$4.95 plus shipping/handling & tax. Enroll me as a member of the **Electronics Book Club** according to the terms outlined in this ad. If not satisfied, I may return the books within 10 days without obligation and have my membership cancelled. A shipping/handling charge & tax will be added to all orders.

--	--	--	--	--

If you select a book that counts as 2 choices, write the book number in one box and XX in the next.  
 If you select a Counts as 3 choice, write the book number in one box and XXX in the next 2 boxes.

Name \_\_\_\_\_  
 Address \_\_\_\_\_  
 City/State \_\_\_\_\_  
 Zip \_\_\_\_\_ Phone \_\_\_\_\_

Valid for new members only, subject to acceptance by EBC. Canada must remit in U.S. funds. Applicants outside the U.S. and Canada will receive special ordering instructions. All books are hardcover unless otherwise noted. RPE1092

# VIDEO NEWS

What's new in the fast-changing video industry.

DAVID LACHENBRUCH

● **Digital TV gains.** There has been a notable shift in the direction of the world HDTV winds in the last few months. Despite the fact that both Europe and Japan are theoretically committed to analog systems, the United States suddenly has assumed unquestioned leadership in the HDTV field. Progress here in digital HDTV—and proof that digital systems actually can work—has sent shock waves through Japanese and European television circles. Now, for the first time, engineers in both regions are looking seriously at digital systems, and predicting that their countries "ultimately" will go digital.

*Japan.* In Japan, where the analog MUSE Hi-Vision system is actually being broadcast by satellite for eight hours daily, engineers are beginning to forecast an eventual switch over to a digital compressed system. Japan's commercial broadcasters have always been slightly ill at ease over the publicly supported, non-commercial NHK network's espousal of Hi-Vision, but for direct satellite broadcast only. The Hi-Vision system is now almost 20 years old and it ignores some of the newer technologies employed in other HDTV systems. Prices of HDTV receivers have been coming down—but from the rarefied level of \$30,000 to the still high \$10,000—and sales have been extremely slow.

*One manufacturer's view.* Digital HDTV is "quite likely to be the wave of the future" in Japan, said Hiroyuki Mizuno in the keynote address to the International Conference on Consumer Electronics (ICCE) in June, the annual meeting of America's consumer-electronics engineers in Chicago. The statement is significant because Mizuno is executive vice president of Matsushita Electric, the world's largest producer of consumer electronics. Mizuno called the analog Hi-Vision

system a "bird in the hand," giving the Japanese people and TV set manufacturers experience in high definition.

But Mizuno said digital HDTV will "inevitably fuse" the TV and the computer, making TV a "digital multimedia broadcast station which can process, store, create, and transmit video images." Conceding that "we are experiencing temporary technical difficulties" in supplying practically priced HDTV receivers and VCR's in Japan, he said that these problems eventually will be solved, but he didn't say whether the solution would be digital or analog.

*Europe.* Europe's Eureka project, designed to develop an HDTV system different from Japan's, envisions a two-stage move to HDTV. The first stage would be broadcasting in a widescreen improved system called D2-MAC, followed by a move to HD-MAC, a high-definition system. However, neither system is compatible with the existing PAL and SECAM broadcasts in Europe, and both systems were designed for direct satellite transmission. Europe's satellite broadcasters are having financial difficulties, and generally have refused to adopt MAC broadcasting, preferring to continue to use PAL, which is compatible with TV sets there. Despite tremendous pressure by TV manufacturers and proposals to issue large government subsidies for a changeover, MAC's adoption has been sluggish. Europe's broadcast authorities, with a nervous eye on the HDTV research in the United States, have been quietly working on digital systems for Europe. With the MAC structure coming under increasing criticism (for instance, it ignores terrestrial broadcasting, which produces 90% of the broadcast ad revenues in Europe and has more than 90% of the audience), demands for a change to digital terrestrial HDTV have been sounded

more frequently in recent months, and research toward a digital system has come out of the closet and is being discussed openly.

Just a few years ago, it was popular to say that the United States was far behind Japan and Europe in HDTV. Today, it is accepted that digital broadcasting is the wave of the future, and that the United States is in the vanguard. Officially, Japan might be very proud that it was first and that its system has been under development for 20 years—but that makes it a 20-year-old system, in contrast to America's up-to-the-minute approach to HDTV.

*HDTV set availability.* When will HDTV receivers be widely available in the United States? The Advanced Television Advisory Committee (ATAC) to the FCC recently set out to get the answer, so it sent questionnaires to all major TV manufacturers serving the United States market—a total of 14. It received 12 replies. ATAC specifically asked for "time of general availability to consumers from multiple sources"—not for the time of shipment of "one set per showroom."

The replies indicated that HDTV sets would be plentiful 2½ to three years after the FCC approves a transmission system. That event is tentatively scheduled for late 1993. However, some respondents replied that sets could be available sooner if manufacturers take a chance and start developing them as soon as the advisory committee makes its recommendation to the FCC. That is expected in February 1993. And the survey showed that HDTV system proponents that also manufacture TV sets—Philips, Thomson, and Zenith—might have a six- to nine-month advantage over their competitors. Other manufacturers that develop their own IC's might have a three-month advantage over those that buy chips from others, the survey revealed. **R-E**

# Graduate as a Fully Trained Electronics Professional!

If you want to learn about electronics, and earn a good income with that knowledge, then CIE is the best educational value you can receive.

CIE's reputation as the world leader in home study electronics is based solely on the success of our graduates. And we've earned our reputation with an unconditional commitment to provide our students with the very best electronics training.

Just ask any of the 150,000-plus graduates of the Cleveland Institute of Electronics who are working in high-paying positions with aerospace, computer, medical, automotive and communications firms throughout the world.

They'll tell you success didn't come easy...but it did come...thanks to their CIE training. And today, a career in electronics offers more rewards than ever before.

## CIE'S COMMITTED TO BEING THE BEST...IN ONE AREA...ELECTRONICS.

CIE isn't another be-everything-to-everyone school. CIE teaches only one subject and we believe we're the best at what we do. Also, CIE is accredited by the National Home Study Council. And with more than 1,000 graduates each year, we're the

largest home study school specializing exclusively in electronics. CIE has been training career-minded students like yourself for nearly sixty years and we're the best at our subject...ELECTRONICS...BECAUSE IT'S THE ONLY SUBJECT WE TEACH!

## CIE PROVIDES A LEARNING METHOD SO GOOD IT'S PATENTED.

CIE's AUTO-PROGRAMMED® lessons are a proven learning method for building valuable electronics career skills. Each lesson is designed to take you step-by-step and principle-by-principle. And while all of CIE lessons are designed for independent study, CIE's instructors are personally available to assist you with just a toll free call. The result is practical training...the kind of experience you can put to work in today's marketplace.

## LEARN BY DOING..WITH STATE-OF-THE-ART EQUIPMENT AND TRAINING.

CIE pioneered the first Electronics Laboratory Course and the first Microprocessor Course. Today, no other home study school can match CIE's state-of-the-art equipment and

training. And all your laboratory equipment, books and lessons are included in your tuition. It's all yours to use while you study and for on-the-job after you graduate.

## PERSONALIZED TRAINING...TO MATCH YOUR BACKGROUND.

While some of our students have a working knowledge of electronics others are just starting out. That's why CIE has developed twelve career courses and an A.A.S. Degree program to choose from. So, even if you're not sure which electronics career is best for you, CIE can get you started with core lessons applicable to all areas in electronics. And every CIE Course earns credit towards the completion of your Associate in Applied Science Degree. So you can work toward your degree in stages or as fast as you wish. In fact, CIE is the only school that actually rewards you for fast study, which can save you money.

## SEND FOR YOUR CIE COURSE CATALOG AND WE'LL SEND YOU A FREE 24-PAGE CIE ELECTRONIC SYMBOLS HANDBOOK.

# FREE!

SEND FOR YOUR CIE HOME STUDY COURSE CATALOG AND RECEIVE A FREE 24 PAGE CIE ELECTRONIC SYMBOLS HANDBOOK!

Includes hundreds of the most frequently used electronic symbols. Published exclusively by CIE for our students and alumni. Yours free when you request a CIE Course Catalog.

electronics



**YES!** I want to get started. Send me my CIE course catalog including details about the Associate Degree Program. (For your convenience, CIE will have a representative contact you - there is no obligation.)

AE43

Please print clearly

Name \_\_\_\_\_

Address \_\_\_\_\_

City \_\_\_\_\_ State \_\_\_\_\_

Zip \_\_\_\_\_ Age \_\_\_\_\_

Phone No. (\_\_\_\_) \_\_\_\_\_

Check box for G.I. Bill Benefits

Veteran  Active Duty



1776 East 17th Street  
Cleveland, Ohio 44114

A School of Thousands.  
A Class of One. Since 1934.

## Q & A

Write to Q & A, *Electronics Now*, 500-B Bi-County Blvd., Farmingdale, NY 11735

### LOCAL BUS

I've been hearing a lot about local-bus computers, but I can't seem to find a clear definition of exactly what they are and why they're supposed to be so terrific. Several computers in the mail-order advertisements tout the feature, and each one that does is quite a bit more expensive than similar ones without a local bus. Can you explain to me in simple terms what a local bus is, and whether it's worth the extra money?—F. Geeben, Anawana, NY

All the peripheral cards that plug into your computer, such as the video card and others, get their basic clock speed from a single pin on the bus. The clock speed comes from

the master oscillator on the motherboard, which is usually the one that's clocking the microprocessor.

For reasons buried deep in the corporate vaults at IBM, the bus clock was usually limited to a maximum of 6 or 8 MHz—that was the speed of the last of the original AT's that had a standard bus. With the introduction of the PS/2 series of computers, IBM abandoned the old standard bus and began using the Microchannel Bus—a different thing altogether.

That change left the compatible and clone manufacturers in a bit of a quandary since they no longer had a developing standard from IBM. The original AT had a 16-bit bus because that was the internal bus size of the 80286 (the last microprocessor

IBM used in the AT). IC's such as the 386 and 486 are 32-bit microprocessors, but IBM's new 32-bit Microchannel Bus was a proprietary bus. The result was a lack of an accepted standard for a 32-bit bus.

With the exception of IBM, computer manufacturers have recently agreed on the EISA (Extended Industry Standard Architecture) 32-bit bus that has shown up in a lot of newer PC-compatibles. The genesis of the local bus is similar.

While some cards that plug into the slots at the back of the motherboard have to run at speeds slower than the microprocessor, a few others are perfectly happy to run at microprocessor speeds. A good example of this is the video adapter, which can easily be designed to run

# The dirtiest part of your

Clean Without CFCs  
or 1,1,1-Trichloroethane  
With New HCFC Blend

Tech Spray has developed a fast-acting and highly effective cleaner called Envi-Ro-Tech™ 1677 (1677) that uses a formulation of HCFCs and other non-CFC chemicals.

This extremely pure product is non-corrosive, making it safe for use on most electronic equipment. Envi-Ro-Tech 1677 is effective in removing oils, greases, dirt, silicone, fluxes and similar soils.

Although Envi-Ro-Tech 1677 has universal cleaning power, its low surface tension makes it ideal for precision and microscopic cleaning.

For a sample of this, or any Tech Spray cleaner, defluxer, duster or freeze spray, contact our Technical Assistance Department toll free at 1-800-858-4043.



Envi-Ro-Tech™ 1677 (1677)

Use Envi-Ro-Tech™  
Precision Duster™ For Pure  
Cleaning with No CFCs

To remove particles from sensitive equipment without harmful solvents, use Tech Spray's CFC-free Envi-Ro-Tech™ Precision Duster™.

Envi-Ro-Tech Precision Duster (1668-OFS) is a moisture-free inert gas, which is quad-filtered for ultimate purity. It is odorless and non-abrasive, and is safe for use on most surfaces to remove microscopic contaminants, lint, dust, metallic oxide deposits and similar soils.

The Precision Duster Kit (1668-OFK) comes with a Chrome Trigger Sprayer 22 for precise dusting. The Chrome Trigger Sprayer is a convenient and safe attachment that can be removed and replaced without loss of product.

Tech Spray also offers a totally new dusting gas formulated with HFCS, Envi-Ro-Tech™ Duster 1671 (1671), which has an ozone depletion potential of zero.

For a sample of Envi-Ro-Tech Precision Duster (1668-OFS), contact our Technical Assistance Department toll free at 1-800-858-4043.



Envi-Ro-Tech™ Precision Duster™ Kit (1668-OFK)

at speeds higher than those available with the standard bus clocks.

Along with the adoption of the EISA bus, the local bus is a system in which a separate bus is provided for certain peripheral cards that don't have to be limited to standard bus-clock speeds. The result is much faster operation, and for something such as video, the difference is astounding.

Deciding if something is worth spending money on is a personal decision, so I won't answer that part of your question. However, because this is a recent development, manufacturers are just starting to produce local-bus peripherals so you might want to wait and see what develops over the next few months and whether a standard takes hold.

#### AUDIO CROSSTALK

**I've been getting a lot of crosstalk between audio channels and, after eliminating every other possibility, I've come to the conclusion that the signals are leaking through the power supply. There doesn't seem to**

**be anything on the circuit boards to take care of the problem so I guess I'll have to do it myself. Could you tell me what the basic circuit setup is for power-supply decoupling?—A. MacDonnell, Mill Hill, NY**

If you're sure that the power supply is the source of your problem, and it turns out that you're right, you can consider yourself lucky because it's easy to take care of.

The basic design for power-supply decoupling is shown in Fig. 2 and, as you can see, there isn't much to it. You can get a lot more involved when you're dealing with very high frequencies, but because you're only concerned with audio stuff, the layout in Fig. 2 will be fine.

The resistor values should be calculated by looking at the maximum current draw of the equipment and applying Ohm's law. Remember that the resistors will be carrying all the current needed by the circuit, so you should pay proper attention to their wattage as well. In general, as long as you're dealing only with line-level stuff, you can use quarter-watt

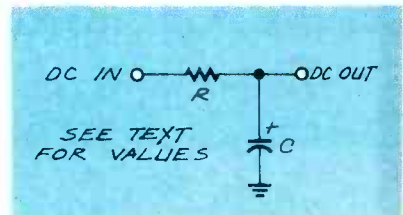

**FIG. 1—POWER-SUPPLY DECOUPLING CIRCUITRY.** These circuits can get a lot more complicated, but for audio frequencies, this is more than enough.

resistors and everything will be OK.

Once you calculate the needed resistance (supply voltage/maximum current), add another fifty percent to the value just to be on the safe side. Audio levels can vary all over the place, and if you're listening to something with a really wide dynamic range, too low a value on the resistor will cause the signal to clip.

There's nothing magical about the choice of the capacitor value either, and I've used everything from 10 to 100  $\mu$ F without any noticeable difference. You would think that the circuit would call for a non-polarized capacitor.  
*continued on page 15*

# job just got cleaner

Every Cleaning Task Made Easier with New Brushes, Swabs & Wipes

Whether you're tackling the dirtiest job, or cleaning a precision piece of equipment, Tech Spray has a cleaning product that makes the task easier.

Tech Spray has expanded its line of brushes, swabs and wipes to cover the wide variety of cleaning and maintenance needs in the electronic industry.

All TechBrushes™, Techswabs™ and Techclean™ Wipes are precisely manufactured under Tech Spray's rigid specifications.

Tech Spray takes special care throughout the manufacturing process and in its packaging to maximize cleanliness and protection against electrostatic discharge.

For a sample of these, or any Tech Spray product, contact our Technical Assistance Department toll free at 1-800-858-4043.



A sampling of TechBrushes™, Techswabs™ and Techclean™ Wipes

The makers of Blue Shower are bringing you a sophisticated line of new formulations and accessories to make your cleaning and defluxing jobs easier.

Tech Spray has expanded its proven line of cleaners and defluxers by adding the non-CFC Envi-Ro-Tech™ series, new products formulated with HCFCs, HFCs and other non-CFC chemicals. These innovative formulas have been engineered to clean quickly and thoroughly, matching and in some cases surpassing the performance of comparable CFC-based products.

In addition, Tech Spray has added to its line of brushes, swabs and wipes to accommodate the wide variety of cleaning tasks found in the electronics service industry today.

Ask for a sample of these or any Tech Spray product or a copy of Tech Spray's full-line catalog by contacting our Technical Assistance Department toll free at 1-800-858-4043.



**TECH SPRAY**  
P.O. Box 949  
Amarillo, TX 79105-0949  
(806) 372-8523

# LETTERS

Write to Letters, *Electronics Now*, 500-B Bi-County Blvd., Farmingdale, NY 11735

## EQUIPMENT REPORT UPDATE

Thank you for the wonderful *Equipment Report* on our CompuScope LITE IBM PC-based oscilloscope (**Electronics Now**, August 1992). We wholeheartedly agree with you that "PC-based instruments are the leading edge of growth for test and measurement." Gage has been a major contributor to the buildup of that industry for the past five years.

In the same article, three valid criticisms were made by your reviewer. Because those points have also been raised by some of our customers around the world, we have been working to solve the problems. In July 1992 we released a new software package called GageScope for our complete line of CompuScope cards.

First, we have drastically improved the hardware installation procedure. We have rewritten the entire documentation and software supplied with the CompuScope LITE card with special emphasis on installation. The 112-page manual has a 15-page section on board installation, full of examples and charts on how to configure a new I/O address even if the user does not know hexadecimal mathematics.

Second, to improve the description of the menus in the manual, we included a detailed description of each menu entry, as well as a 13-page tutorial that guides the user through the most often-used menu commands.

Finally, to satisfy the needs of more sophisticated customers, we offer other products: CompuScope 220, a 40-MHz card with up to 8 megabytes of memory, and CompuScope 250, which samples at 100 MHz. Our products are being used by major organizations such as NASA, IBM, Honeywell, and Motorola, and hundreds of smaller less well known companies and individual customers.

We think that, overall, your review was very positive about the importance of PC-based instruments in general, and CompuScope LITE in particular. We are very excited about our coverage in **Electronics Now**.

MUNEEB KHALID

Vice President

Gage Applied Sciences Inc.  
Montreal, Quebec, Canada



## SURFMAN DIODE REVERSAL

An error appeared in our SurfMan sound generator article (**Electronics Now**, August 1991). Diode D2 was incorrectly drawn reversed in the parts placement diagram, Fig. 2 on page 35. However, it is drawn correctly in the schematic, Fig. 1 on page 34.

## IC SUBSTITUTION

Mr. Caristi is to be congratulated for his article "Digital Altimeter" (**Radio-Electronics**, May 1992).

There is one point that concerns me, however. IC3 gives a full-scale reading for a 100-millivolt input change (from 2.5 to 2.4 volts at pin 30), which is an effective sensitivity of 20 feet per millivolt. My concern is the choice of the LM324 as IC1. While it is a very useful chip indeed, it does not exhibit low off-set drift with temperature. Prospective constructors who think that shortcoming could be a problem might want to consider replacing the LM324

with four devices such as OP-07's, which have impressively low drift.

D.M. BRIDGEN

Reading, Berks., U.K.

## CLASSIC VIDEO AMPS RE-REVISITED

I enjoyed seeing my article, "Classic Video Amps Revisited," published in the June issue of **Radio-Electronics**. Thanks!

However, in the editing process some errors crept in. The first one occurs in the second paragraph on page 60. The wording implies that the 733 is the better choice for use in filters; that's not so. The 592 provides the greatest attenuation of the unwanted signal. I tried to say that the the 592 will provide zero voltage gain with a high impedance across the gain control pins (G1A and G1B), the desired design objective at those points for those signals. In fact, the 733 would be a bad choice for this application because it provide a minimum 20-dB theoretical gain for the unwanted input signals.

Paragraph four implies that D1 through D4 are forward biased. Diodes D1 and D2 are reversed biased and D3 and D4 are not biased at all or only forward biased when an overvoltage signal is applied to the circuit. That is necessary for input protection.

Also on page 60, Fig. 7 shows S1 with a shorting bar across the two wipers. That connection is incorrect. There should only be an insulated mechanical connection.

On page 61, Q1 in Fig. 9 should be a PNP device and it should be labeled 2N4959/2N3906 rather than 2N4959/2N3904. Also in Fig. 9, Q3 should be a PNP device. Figure 8 can be used to illustrate the proper configuration.

Overall, the article fulfills its objective of stating that both the 592 and 733 video amplifiers are still recommended for new designs.

EDGARDO PEREZ

R-E

## Q&A

continued from page 13

capacitor, but my experience is that polarized capacitors work just as well. Remember that you're not dealing with high current and voltage levels here, and that gives you a considerable amount of leeway.

### LINE-LEVEL DIFFERENCE

I've noticed that there's a considerable difference in the audio level that comes out of my CD, tuner, cassette player, and other equipment. When I switch my amplifier from one source to another I can often hear a dramatic difference in the levels. Is there some way to buffer those signals between the equipment and the inputs to my power amp so the levels presented to the amp are all the same?—D. Gould, Michigan City, IN

You can call them buffers, but as far as I can see, what you really need is a preamp on each line so you can adjust the level from each device before it gets to the power-amp inputs. A lot of the consumer audio equipment on the market really cheats out when it comes to the output level. The cassette and CD players on my shelf, for example, are top of the line units, but neither of them has a convenient front panel control for adjusting the output level.

There are really three ways you can handle this problem. The first, and easiest, is simply to drop all the levels to that of the lowest one with simple resistor pads. Once you've done that, you can set the power-amp level and not have to change it every time you switch from one source to another.

The second way to deal with this involves a bit more work, but is not really all that difficult. Although there's no front-panel control for the output level, you can bet your new pair of white tennis shoes that there's a trimmer somewhere inside each of the players that sets the output level. Just get yourself a screwdriver, take the cover off, and start exploring. It's a good idea to have the service manual around

when you do this, but most of the consumer audio stuff I've seen has the function of the trimmer silkscreened on the printed-circuit board.

The last approach to the problem is to build a bunch of preamps with line-level inputs and outputs. You can put them between the equipment and the power amp and adjust the levels that way. I'd do that only as a last resort. It's a lot more work

because you'll need two preamps for each piece of equipment (assuming, of course, that you're dealing with stereo). Besides the extra work, I've never been convinced that it's a good thing to have more electronics on the line than the bare minimum required. That's because any extra electronics is a potential noise generator, and also a potential entryway for externally produced noise.

R-E

## Economic Choice for High Quality from GOLDSTAR

### OSCILLOSCOPE

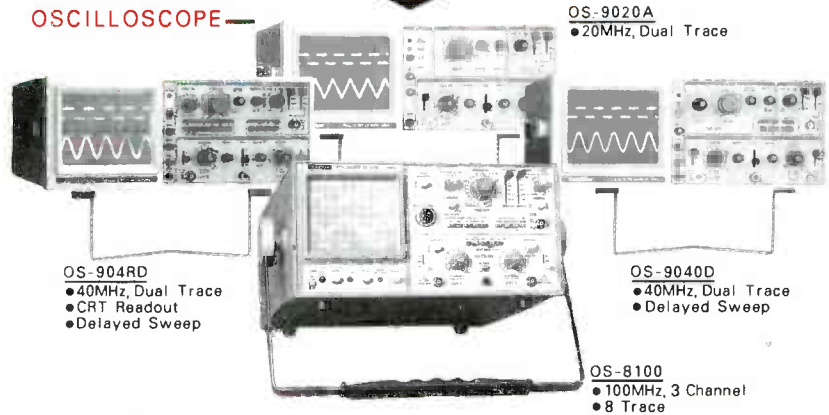

OS-904RD  
● 40MHz, Dual Trace  
● CRT Readout  
● Delayed Sweep

OS-9020A  
● 20MHz, Dual Trace

OS-9040D  
● 40MHz, Dual Trace  
● Delayed Sweep

OS-8100  
● 100MHz, 3 Channel  
● 8 Trace

### DIGITAL MULTIMETER



DM-9055S

- 3 1/2 Digits
- Pen Type DMM
- Auto and Manual Range
- Logic tester
- Current

DM-9183

- 3 1/2 Digits
- Manual Range
- Diode Check
- Continuity
- Large LCD Display

DM-6335

- 3 1/2 Digits
- Auto Range
- Memory
- Data Hold
- Diode Check
- Continuity

DM-8135

- 3 1/2 Digits
- Auto Range
- Bar Graph
- hFE Check

DM-7333

- 3 1/2 Digits
- Manual Range
- hFE Check
- Capacitance Check
- Freq., Counter

DM-8433

- 3 1/2 Digits
- Manual Range
- hFE Check
- Temperature Check
- Capacitance Check

### FREQUENCY COUNTER FUNCTION GENERATOR

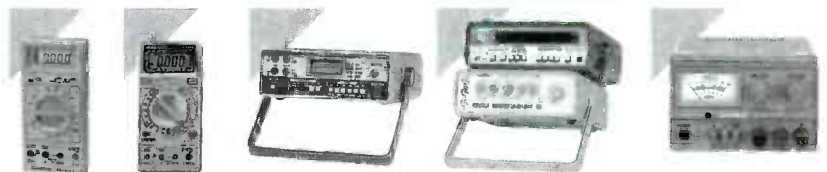

DM-7143

- 4 1/2 Digits
- Manual Range
- Data Hold Function

DM-8243

- 4 1/2 Digits
- Manual Range
- Data Hold Function
- hFE Check
- Capacitance Check
- Freq., Counter

DM-7241

- 4 1/2 Digits
- Bench Type
- Manual Range
- Measuring Unit Display with LCD
- Function Indication

FC-7012: 100MHz

FC-7052: 550MHz

FC-7102: 1GHz

- 0.02 Hz To 2MHz
- Sweep

GP-103: 18V/1.0A

GP-105: 30V/0.5A

GP-235: 18V/1.0A

30V/0.5A

**GoldStar Precision Co., Ltd.**

13013 East 166th Street, Cerritos, Ca. 90701 U. S. A.  
TEL: (310) 404-0101 FAX: (310) 921-6227

CIRCLE 189 ON FREE INFORMATION CARD

# EQUIPMENT REPORTS

## The Checker Computer Monitor Tester

Get a quick go/no-go indication of computer monitor operation.



CIRCLE 10 ON FREE INFORMATION CARD

Computer monitors and standards have certainly changed dramatically in the last decade. We've moved from composite video monitors through the MDA, CGA, HGC (Hercules), EGA, VGA, and SVGA standards. And there are yet other standards in

use, and more in the wings. One thing that hasn't changed, however, is that computers monitors eventually need service.

The Checker, a new product from Computer and Monitor Maintenance, Inc (6669 Peachtree Ind. Blvd, Suite B, Norcross, GA 30092)

was designed with that in mind. Although The Checker is a rather simple service tool, it can make things easier for any monitor repair technician, or for anyone who manages or maintains computer equipment in an office environment.

The Checker is packaged in a rectangular plastic box that measures about 6 x 3½ x 1¼ inches. The face of the unit has a single control that serves as the power switch as well as an output-mode control. Two video connectors, one a nine-pin and the other a fifteen-pin connector, are provided on one edge of the device. The Checker can be powered by a standard 9-volt battery for portable operation; a wall-adaptor is also provided to run the unit from the AC lines.

The Checker provides three out-

# SMALL WONDER



Small size to fit your pocket. Small price to fit your pocketbook. Large functionality to fit your work. The Pocket Series. A small wonder.

from **\$39.95**



CIRCLE 193 ON FREE INFORMATION CARD



## Your Ticket To SUCCESS

Over 28,000 technicians have gained admittance worldwide as certified professionals. Let your ticket start opening doors for you.

ISCET offers Journeyman certification in Consumer Electronics, Industrial, Medical, Communications, Radar, Computer and Video. For more information, contact the International Society of Certified Electronics Technicians, 2708 West Berry Street, Fort Worth, TX 76109; (817) 921-9101.

Name \_\_\_\_\_  
 Address \_\_\_\_\_  
 City \_\_\_\_\_  
 State \_\_\_\_\_ Zip \_\_\_\_\_

Send material about ISCET and becoming certified.  
 Send one "Study Guide for the Associate Level CET Test." Enclosed is \$10 (inc. postage).



put modes: CGA (color graphics adapter), EGA (enhanced graphics adapter) and VGA (video graphics array). Only standard VGA resolution (640 × 480) is supported.

Using the Checker is straightforward: Turn the unit on, set the proper mode, and connect the monitor. In the CGA mode, you'll see two sets of color bars: high-intensity on the top half of the screen, low-intensity on the bottom. In EGA mode, three sets of color bars are presented. In VGA mode, the Checker generates a single set of eight color bars.

Even though the Checker is rather simple, we can come up with many uses for it. Around the **Electronics Now** offices, for example, we could use it for quick checks of monitor problems. When someone reports a monitor problem, the usual first check is to swap out the suspect monitor with one that is known to be good. (Of course if its the graphics card that is bad, then another swap is required.) That first step is basic, simple troubleshooting to narrow down the problem.

Unfortunately, that simple method has its own problems. First is the time and trouble to move heavy monitors around. Second is the limited space that is available at the computer—there's usually not enough room to work conveniently. The handheld Checker weighs less than a pound, and permits a monitor check to be done in just a minute or two.

For anyone who maintains an inventory of computer monitors, the Checker could also come in handy. Is the monitor that is to be installed for that new employee working? The Checker lets you find out *before* you haul a non-working monitor over to the installation site.

The Checker also has a place in professional service shops. It can be used, for example, to "burn in" a monitor without tying up special test equipment or a computer (with, of course, the correct graphics card installed.) When a customer comes in to pick up his monitor, the Checker makes an ideal way to demonstrate that the repair was successful and that the monitor is now

working properly. It can also be used as an aid in setting vertical and horizontal size controls correctly.

The Checker does not support Hercules-type monochrome monitors. That's an unfortunate oversight in our opinion. Although such monitors are not popular sellers these days, there are an awful lot of older units in circulation, and older equipment is more likely to develop problems. We would also have preferred to see an SVGA (super VGA) mode and test patterns more useful than the non-standard color bars that are provided.

With a price of \$229.95, the Checker is far too expensive for casual use. However, the speed and ease with which the Checker can provide a go/no-go indication would be welcome by anyone who spends a lot of time checking a lot of monitors. When you consider the amount of time that the device could potentially save, and the headaches it could help prevent, the Checker could prove to be a worthwhile purchase. **R-E**

## The World is Talking!



### Shortwave Listening Guidebook

by Harry Helms

Here's your guide to getting the most from a shortwave radio! In clear, nontechnical language, Harry explains how, when, and where to listen in. Its 320 heavily-illustrated pages are packed with advice on:

- antennas
- selecting the right radio
- accessories
- reception techniques

Learn how to hear the BBC, Radio Moscow, ham operators, ships, even spies and "pirate" radio stations! Includes hundreds of station frequencies and the times you can hear them.

Only \$16.95 at radio equipment dealers, or order direct from HighText! Add \$3 shipping (\$4 Canada, \$5 elsewhere). CA add sales tax. U.S. funds only please.

**HighText**  
publications Inc.

7128 Miramar Road, Suite 15L  
San Diego, CA 92121

# NO WONDER

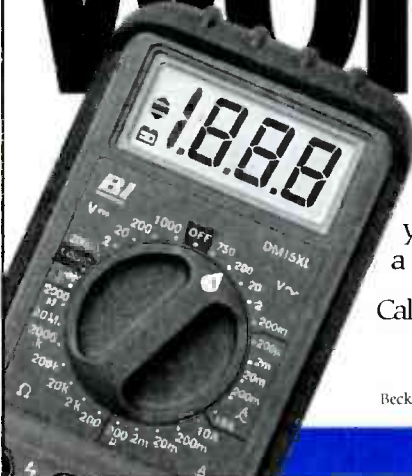

Because it's from Beckman Industrial. The new Pocket Series from the people who have proven you don't have to pay a fortune for a top quality meter.

Call (800) 854-2708, (800) 227-9781 in CA.

**Beckman Industrial™**  
An Affiliate of Emerson Electric Co.  
Beckman Industrial Corporation, San Diego, CA 92123-1898.

# No other training to troubleshoot computers

Only NRI walks you through the step-by-step assembly of a powerful 386sx computer system you train with and keep—giving you the hands-on experience you need to work with, troubleshoot, and service today's most widely used computer systems. Only NRI gives you everything you need to start a money-making career, even a business of your own, in computer service.

No doubt about it: The best way to learn to service computers is to actually build a state-of-the-art computer from the keyboard on up. Only NRI, the leader in career-building at-home electronics training for more than 75 years, gives you that kind of practical, real-world computer servicing experience.

Indeed, no other training—in school, on the job, *anywhere*—shows you how to troubleshoot and service computers like NRI.

**Get inside the West Coast 386sx computer system... and experience all the power and speed of today's computer technology!**

With NRI's exclusive hands-on training, you actually build and keep the powerful new West Coast 386sx/20 MHz mini tower computer system.

You start by assembling and testing your computer's 101-key "intelligent" keyboard, move on to test the circuitry of the main logic board, install the power supply and 1.2 meg high-density floppy disk drive, then interface your high-resolution monitor.

What's more, you now go on to install and test a powerful 40 meg IDE hard disk drive—today's most-wanted computer peripheral—included in your course to

**NEW!**  
386sx/20 MHz  
Mini Tower  
Computer!

#### DIAGNOSTIC HARDWARE AND SOFTWARE

R.A.C.E.R. plug-in diagnostic card and QuickTech menu-driven software, both from Ultra-X, give you hands-on experience with today's professional diagnostic tools

#### DISCOVERY LAB

Complete breadboarding system lets you design and modify circuits, diagnose and repair faults

#### LESSONS

Clear, illustrated texts build your understanding of computers step by step

#### MONITOR

High-resolution, nonglare, 14" TTL monochrome monitor with tilt and swivel base

#### DIGITAL LOGIC PROBE

Simplifies analyzing digital circuit operation

#### DIGITAL MULTIMETER

Professional test instrument for quick and easy measurements

#### SOFTWARE

Train with MS-DOS, GW-BASIC, and popular Microsoft Works applications software

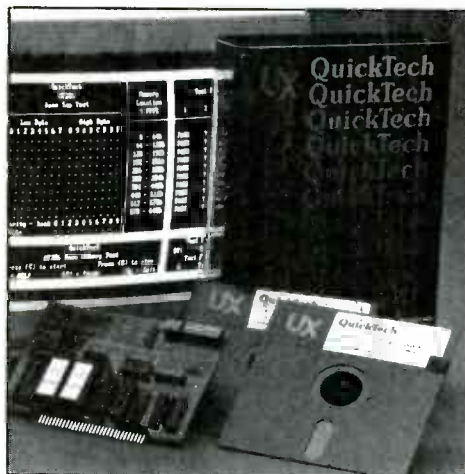

dramatically increase your computer's data storage capacity while giving you lightning-quick data access. But that's not all!

**Professional diagnostic hardware and software makes troubleshooting fast and accurate**

Your NRI training now includes a remarkable diagnostic package that allows you to quickly locate and correct defects in IBM XT, AT 80286/80386, and

# shows you how and service like NRI!

**NEW! 40 MEG HARD  
DISK DRIVE!**

You install this 40 meg IDE hard disk drive internally, for greater data storage capacity and data access speed

**NEW! 386sx/20 MHz  
MINI TOWER COMPUTER!**

Features 32-bit 80386sx CPU, 1 meg RAM, 64K ROM, 1.2 meg high-density floppy disk drive



NRI gives you the confidence and the know-how to step into a full-time, money-making career as an industry technician, even start a computer service business of your own!

**No experience necessary...  
NRI builds it in**

With NRI, you learn at your own pace in your own home. No classroom pressures, no night school, no need to quit your present job until you're ready to make your move. And all throughout your training, you have the full support of your personal NRI instructor and the NRI technical staff, always ready to answer your questions and give you help whenever you need it.

**FREE catalog tells more. Send today!**

Send today for NRI's big, free catalog that describes every aspect of NRI's innovative computer training, as well as hands-on training in TV/video/audio servicing, telecommunications, industrial electronics, and other high-growth, high-tech career fields.

If the coupon is missing, write to NRI School of Electronics, McGraw-Hill Continuing Education Center, 4401 Connecticut Avenue, NW, Washington, DC 20008.

IBM is a registered trademark of International Business Machines Corp. QuickTech and R.A.C.E.R. are registered trademarks of Ultra-X, Inc. West Coast is a member of the Syntax Group.

compatible computers.

You'll use your Ultra-X QuickTech diagnostic software to test the system RAM and such peripheral adapters as parallel printer ports, serial communications ports, video adapters, and floppy and hard disk drives. You'll go on to use your R.A.C.E.R. diagnostic card, also from Ultra-X, to identify individual defective RAM chips, locate interfacing problems, and pinpoint defective support chips.

This ingenious diagnostic package is just one more way

**NRI School of  
Electronics**

McGraw-Hill Continuing Education Center  
4401 Connecticut Avenue, NW  
Washington, DC 20008



For career courses approved  
under GI Bill  
 check for details

Check one FREE catalog only

- MICROCOMPUTER SERVICING
- TV/Video/Audio Servicing
- Industrial Electronics & Robotics
- Telecommunications
- Basic Electronics

- Computer Programming
- Security Electronics
- Electronic Music Technology
- Desktop Publishing
- Programming in C++ with Windows

Name \_\_\_\_\_ (Please print) \_\_\_\_\_ Age \_\_\_\_\_

Address \_\_\_\_\_

City/State/Zip \_\_\_\_\_ Accredited Member, National Home Study Council 3-102

# NEW PRODUCTS

Use the Free Information Card for more details on these products.

**LOGIC PROBE.** Beckman Industrial's LP50 is an inexpensive, small 50-MHz logic probe that can detect pulses as short as 10 nanoseconds. The pen-sized logic probe is intended for troubleshooting high-speed, microprocessor-controlled circuits and the detection of extremely fast pulses. According to Beckman, the probe measures TTL, DTL, and RTL logic levels at frequencies up to 50 MHz.

The LP50 is powered from the circuit under test through an alligator clip that provides a secure connection to circuit ground. The mini-hook clips onto the circuit's positive voltage points. When the probe tip is touched to the



CIRCLE 16 ON FREE INFORMATION CARD

signal test point, the probe simultaneously lights an LED and generates a tone to make it easy for the user to understand what is happening at the test point.

The LP50 logic probe is priced at \$45.—Beckman Industrial Corporation, 3883 Ruffin Road, San Diego, CA 92123-1898; Phone: 619-495-3218.

**CABLE/TV SIGNAL-LEVEL METER.** Leader Instruments' Model 951 RF signal-level meter is intended for broadcast and cable TV measurements. It features auto-channel search to measure the store level data for up to 32 channels. The LED bargraph display is arranged in groups of eight channels and it provides readout of the selected channel in dBmV or other user-selectable engineering units.

Autoranging is featured but manual ranging can be selected. The Model 951 also operates in the single-channel mode with a combination bargraph and digital readout of level in selected engineering units. The meter's operation can

be programmed for video or sound-carrier levels of channels selected by the operator.



CIRCLE 17 ON FREE INFORMATION CARD

Frequency data for the USA and other countries are stored. Up to 32 channel readings can be stored. DC and AC voltages on the cable can also be read. The portable instrument measures  $8\frac{3}{8} \times 4\frac{3}{4} \times 7\frac{7}{8}$  inches and it weighs 10½ pounds. Powered by D

cells, it has an auto-off feature that extends operating time.

The Model 951 CATV/TV signal level meter has a price of \$1695.—Leader Instrument Corporation, 380 Oser Avenue, Hauppauge, NY 11788; Phone: 1-800-645-5104 or 516-231-6900 in New York.

**KEYBOARD-CONTROLLED POWER SUPPLIES.** Kepco's DPS Series of keyboard-controlled power supplies provide 75 watts of DC power in four ranges from 0 to 125 volts. Each power supply is controlled by a keypad that commands a built-in microprocessor to set voltage, current limit, range, over voltage protection (OVP), displays, and

over-current protection.

Remote talk-listen control can be exercised with an RS-232C connection that can be addressed in Basic and most common computer languages. Keypad slew controls permit continuous adjustment of voltage up and down for fine tuning while the output is enabled. Separate LED displays provide voltage and current readout.



CIRCLE 18 ON FREE INFORMATION CARD

DSP power supplies are priced at \$429.—Kepco, Inc., 131-38 Sanford Avenue, Flushing, NY 11352; Phone: 718-461-7000; Fax: 718-767-1102.

**MULTIFUNCTION OUTLET TESTER.** Polytronics Sure-Test Pro Multifunction Outlet Tester is said to be able to provide a higher level of assurance of power delivery than conventional voltage meters in situations where the power source is critical.

The meter test for current capability by creating a 12-ampere load on the line. Applied in short intervals, the 12-ampere power draw can reveal the presence of a faulty circuit breaker or a sag in power delivery (greater than 5%) due to poor contacts or improper wiring.



# A MUST FOR OEMs AND MROs!

## THE NEW NTE PARTS CROSS REFERENCE AND TECH GUIDE IS MORE USEFUL THAN EVER!

NTE's parts catalog just keeps getting better! Our new 1992-93 edition features:

- Over a quarter of a million U.S., Japanese and European devices cross-referenced to NTE's 3,500 quality replacement semiconductors — available off the shelf!
- Easier to read, thumb-through format
- Divided sections

Order your copy direct or through your local NTE distributor. For your nearest one, call NTE toll-free 1-800-631-1250 (including Canada) or (201) 748-5089. FAX: (201) 748-6224.

YES PLEASE SEND ME THE FOLLOWING NUMBER OF COPIES OF NTE'S 1992 CROSS REFERENCE:

\_\_\_\_\_ Copies @ \$4.95 ea.

Enclosed please find my check or money order

for \$ \_\_\_\_\_  
(U.S. funds only)

ALSO SEND ME INFORMATION ABOUT NTE'S QUICKCross™ SOFTWARE!

Name \_\_\_\_\_

Company \_\_\_\_\_

Address \_\_\_\_\_

City \_\_\_\_\_

State \_\_\_\_\_ Zip \_\_\_\_\_

Attach this coupon to your letterhead and mail to:  
NTE, 44 Farrand St., Bloomfield, NJ 07003 RE 1092

NTE's new PC-based software allows you access to the NTE cross reference of over 250,000 parts in about one second. Check the coupon box to receive more information.



**NTE**  
NTE ELECTRONICS, INC.  
A WORLDWIDE REPUTATION FOR QUALITY SERVICE AND VALUE

QUICKCross™ software runs in MS-DOS on any IBM PC or compatible with 640K of RAM, a small hard drive, and a 5 1/4" or 3 1/2" floppy drive. NTE's database occupies only 2.1 Mbytes of hard disc space when loaded. It is a public domain release. MS-DOS is a registered trademark of Microsoft Corporation. IBM is a registered trademark of International Business Machines.

CIRCLE 71 ON FREE INFORMATION CARD



**CIRCLE 19 ON FREE INFORMATION CARD**

The *SureTest Pro* tests seven outlet parameters: miswires and incorrect wiring, proper voltage and current capability, ground faults (6-milliampere trip current), ground/neutral voltage latch, ground/neutral short, and high ground impedance. The unit is plugged into an outlet, and LED indicators provide go/no-go readouts for all tests.

The *SureTest Pro* multi-function outlet tester (Part No. 413B200) is priced at \$179.—**Jensen Tools Inc.**, 7815 South 46th Street, Phoenix, AZ 85044; Phone: 602-968-6231.

**HEAVY-DUTY CABLE TEST CLIP.** *ITT Pomona's Model 5784* test clip permits the probing of insulated wires or cables without stripping the insulation. It is intended for use in laboratories, auto service shops and factory maintenance facilities. The clip is said to assure positive electrical contact and true readings, and it provides safe high-voltage lead testing with operator protection of up to 1000 volts AC.

The spring-loaded test



**CIRCLE 20 ON FREE INFORMATION CARD**

probe has a heavy-duty, stainless-steel needle point set within a clamp-type jaw, allowing the clip to pierce the insulation of a cable up to 0.14-inch (3.5mm) in diameter without damaging the insulation. The insulated tip assures that the desired wire or cable is safely and firmly grasped, and it avoids contact and shorts to adjacent machinery. A socket for a sheathed test lead connection is located in the plunger handle.

*Model 5784* clips are priced at \$12.30 each—**ITT Pomona Electronics**, 1500 East Ninth Street, P.O. Box 2767, Pomona, CA 91769; Phone: 714-469-2900; Fax: 714-629-3317.

**SMT PROTOTYPING BOARD.** The *SMT-1000* protoboard from *Precision Circuit Technologies* allows for the placement of more than one IC on the board. Measuring 2.9 x 4.75 inches, it permits the prototyping of circuits with many IC's.

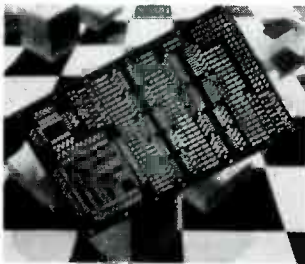

**CIRCLE 21 ON FREE INFORMATION CARD**

Each SMT pad is connected to a plated-through hole that interconnects it to other points on the board with wire links. Two power busses simplify power connections. Most of the board's part footprints will accommodate more than one part size. The SOIC-16's will accommodate 8-, 14-, or 16-pin SOIC's; the SOIC-20W will

accommodate a 16- or 20-pin wide-body SOIC or an 8-, 14-, or 16-pin SOIC; and the SOIC-24W will accommodate a 16-, 20-, or 24-pin wide-body SOIC or an 8-, 14-, or 16-pin SOIC.

Two PLCC areas permit great selection of PLCC sizes (20- to 100-pin PLCC's). A small section with through-hole pads spaced at 0.1-inch is available for combined AMD and leaded assembly.

*SMT-1000* protoboards are priced at \$18.95 each.—**Precision Circuit Technologies**, 10378 Fairview Ave., Suite 152, Boise, ID 83704; Phone: 208-327-0300, Ext. 2200.

**SELF-PULSATING LASER DIODE.** The *RLD Series* of self-pulsating, single-longitudinal-mode, AlGaAs laser diodes from *Rohm Electronics* can, according to the manufacturer, reduce the cost of fiber-optic transmission in LAN's and WAN's. The double-heterostructure laser diodes can be modulated at frequencies of 1.2 GHz.

The high modulation frequencies are achieved through the low junction capacitance of the die's active area. They are manufactured by the molecular beam epitaxy (MBE) process which permits atomic-layer control in the growth of the structure. This, according to ROHM gives better control than is obtained with either liquid-phase epitaxy (LPE) or metalorganic chemical vapor deposition (MOCVD).

*RLD Series* laser diodes typically operate at a threshold current of only 32 milliamperes, significantly lowering power consumption, increasing switching speed, and giving longer operating life. Recent accelerated life tests of the

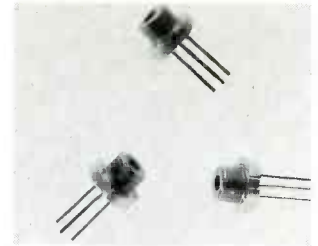

**CIRCLE 22 ON FREE INFORMATION CARD**

laser diodes by ROHM on one sample lot at 50° C with a constant 3 milliwatt optical output showed a mean time to failure of 240,000 hours. This figure compares with the 20,000 hours typical for laser diodes in compact and video disk players.

*RLD* laser diodes are priced below \$30 each in volume.—**Rohm Corporation**, address, Antioch, TN.

**COMMUNICATIONS RECEIVER.** According to its manufacturer, the *Lowe HF-150* communications receiver puts the entire radio spectrum from 30 kHz to 30 MHz at your fingertips. That gives the listener access to international shortwave bands, amateur, ship and aircraft bands, and time signals. The tuning rate is variable according to the rotation speed of the main tuning knob.

This rugged portable receiver is made with solid hard alloy casings, metal panels and machined parts. It measures only 7.3 x 3.2 x 6.3 inches and weighs only 2.9 pounds. It can be operated from an AC to DC adaptor (supplied), an external 10 to 15-volt DC source, or eight internal nickel-cadmium rechargeable AA cells for 150 milliamperere drain.

Reception modes are AM, upper sideband (USB), and lower sideband (LSB), which also allows reception of CW/RTTY/Fax. A phase-locked AM

**More lessons!**

**More Services!**

# A Shocking Offer!

Now you don't have to be enrolled at CIE to receive our introductory Electronic and Electricity Lesson Modules. This program is available for a limited time to non-students for the shockingly low price of only \$99.50.

With CIE's patented AUTO-PROGRAMMED method of learning you will quickly learn and then master the basics of electronics and electricity and then move on to... DC/AC circuit theories, fundamentals of bi-polar junction transistors (BJT), field effect transistors (FET), wiring, diagram and schematic readings, component identification, soldering techniques... and much, much, more. This introductory offer includes the first 39 lessons in CIE's Associate in Applied Science in Electronic Engineering Technology Degree.

Your commitment to CIE ends with your payment, but CIE's commitment to your success just begins when you receive your lessons, exams, binder and equipment. This special introduc-

tory price includes all the benefits and assistance CIE normally extends to its full time students. You'll be entitled to unlimited access to CIE's faculty and staff to assist you in your studies via a toll free 800 number six days a week, 24-hour turnaround on grading your submitted exams, CIE bookstore privileges, a patented learning method, reference library, access to CIE's electronic bulletin board and a free issue of CIE's school newspaper The Electron.

**And best of all, when you decide to continue your electronics education in any of CIE's programs you'll receive full academic credit for successful lessons submitted and a \$100.00 Tuition Credit Certificate.**

All this knowledge and support will put you on the road to understanding digital electronics, automotive and industrial electronics, microprocessing principals, computer systems, telecommunications and much, much, more.

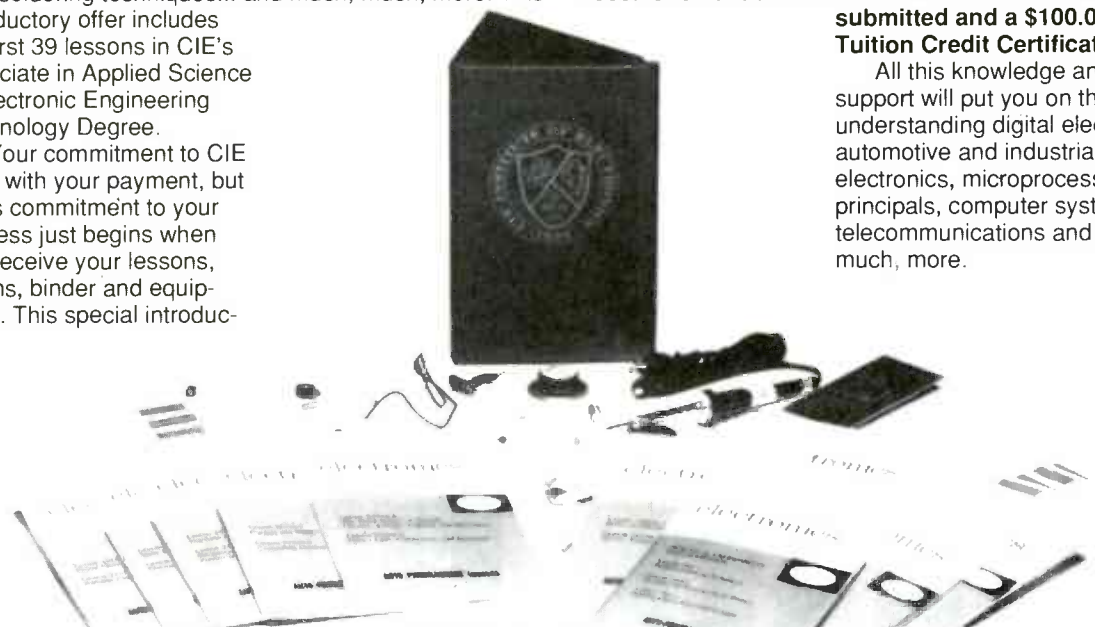

**All This For Only!**

# \$99.50

- \$100.00 Tuition Credit
- Academic Credit
- Free issue of The Electron
- Build your personal burglar alarm
- Toll Free Instructor Assistance
- 24-hour grading
- CIE bookstore privileges

- 39 theory and hands-on training lessons and exams.
- Patented learning method
- CIE electronic bulletin board privileges

**Yes! Send me CIE's Introductory Electronic and Electricity Lessons and Equipment.** A7314

Name: \_\_\_\_\_  
 Street: \_\_\_\_\_ Apt#: \_\_\_\_\_  
 City: \_\_\_\_\_  
 State: \_\_\_\_\_ Zip: \_\_\_\_\_  
 Age: \_\_\_\_\_ Phone: (\_\_\_\_) \_\_\_\_\_

Total Merchandise: \_\_\_\_\_ \$99.50  
 Ohio Residents add 7% Sales Tax: \_\_\_\_\_  
 California Residents add 6 1/2% Sales Tax: \_\_\_\_\_  
 Total This Order: \_\_\_\_\_  
 Shipping and Handling Charge: \_\_\_\_\_ \$5.00  
 Method of Payment/Amount Enclosed: \_\_\_\_\_ \$  
 Personal Check or Money Order  
 Master Card     Visa     Discover  
 \_\_\_\_\_  
 Card Expiration Date: \_\_\_\_\_  
 Signature: \_\_\_\_\_



**BOOKSTORE**  
1776 East 17th Street  
Cleveland, Ohio 44114



**CHARGE BY PHONE!**  
9 AM to 4:30 PM Eastern Time;  
1-800-321-2155 ext. 7314

October 1992, Electronics Now



**CIRCLE 23 ON FREE INFORMATION CARD**

system allows reception of selection of either synchronous lower sideband or synchronous upper sideband, and synchronous double sideband. That arrangement obtains the best reception from weak shortwave signals.

In the dual-conversion design, the IF bandwidths of 2.5 kHz and 7 kHz are selectable, and the master oscillators are quartz crystals. Tuning frequency is displayed on a 5-digit LCD that also shows modes,

memory information, and other important operating functions. Sixty memory channels, each storing frequency and mode, are provided.

The loudspeaker is internal. Provision is made for external connections to headphones, external loudspeaker, and output for a tape recording. The receiver can accept three different antennas: 600-ohm long wire, 50-ohm coaxial feed, or a high-impedance whip. The rear panel has a socket for an optional keypad, which allows direct frequency entry and instant direct memory access.

The HF-150 receiver is priced under \$600.—**Electronic Equipment Bank**, 323 Mill Street N.E., Vienna, VA 22180; Phone: 703-368-3270; Fax: 703-938-6911.

**AUTORANGING DIGITAL MULTIMETERS.** The Tektronix DM2510 and DM2510G digital multimeters, designed for benchtop use, offer full programmability with 4½-digit accuracy, an integral power supply, and autoranging or manual operation. Functions provided by both units include voltage, current, or resistance measurement, true RMS AC voltage measurement (200-millivolts to 500-volt range), dB calculation, and

temperature measurements.

The meters measure DC volts from 200 millivolts to 1000 volts with 0.03% basic DC voltage accuracy and DC amperes from 100 microamperes to 10 amperes with 0.06% basic DC amperes accuracy. Both units are programmable, and the DM2510G offers full programmability with its IEEE-488.1 interface.

Front-panel keys simplify the selection of function and range, and permit the setting of GPIB address and termination parameters. The TM2500 Series DMM's can be stacked together with other products in the Tektronix TM250 or TM2500 Series to save bench space. Besides design, manufacturing, and service applications, The DMM's are said to have



**CIRCLE 24 ON FREE INFORMATION CARD**

# SIMPLE

The RMS225 was built around simplicity. Instead of a barrage of buttons to push, you simply scroll through a menu of special functions. Minimums,



maximums and automatic reading hold are simple functions with Beckman Industrial's RMS225. It's simply the best meter for the money.



**CIRCLE 194 ON FREE INFORMATION CARD**

## ADVANCE YOUR ELECTRONIC INTERESTS



**WITH A NEW SUBSCRIPTION TO: THE SPEC-COM JOURNAL!**

Getting your FCC Amateur Radio License is easier than ever before (NO-CODE requirement - see R.E. April 91 issue, pages 27-28). SCJ is an 80-page per issue HAM RADIO magazine that covers ALL the specialized modes. Modes like HAM-TV, Radioteletype, Satellites, WXFAX and Computer Data Transmissions. Current issue - just \$3.75 ppd.

Annual Subscriptions (6 issues):  
\$20 USA \$25 Canada/Mexico  
\$30 Foreign (Surface)

**The SPEC-COM Journal**  
P.O. Box 1002,  
Dubuque, IA 52004-1002  
(319) 557-8791  
BBS (319) 582-3235



have broad applications in design manufacturing and service as well as training.

The *DM2510* is priced at \$595 and *DM2510G* is priced at \$695.—**Tektronix**, Test & Measurement Group, P.O. Box 1520, Pittsfield, MA 01202; Phone: 1-800-426-2200.

**AUTOMATIC RCL METER.**

Fluke's *PM 6303A* automatic RCL meter is said to determine the value, dimension, and equivalent circuit of passive components accurately over a wide range. The component is connected to the four-wire test fixture on the front panel of the instrument and the backlit LCD display shows the dominant component values with an accuracy of better than 0.25%. It also provides the user with an elec-



**CIRCLE 25 ON FREE INFORMATION CARD**

trical dimension and one of the seven equivalent circuit diagrams.

In addition its **AUTO MODE**, the RCL meter permits users to select from nine different variables: series and parallel resistance, impedance, capacitance and inductance, phase-angle, plus dissipation, C with a 2-volt DC bias, and Q-factor. Each function can be directly accessed with a front-panel button. A press of the **TRIM** button eliminates any errors intro-

duced by either a test cable or a test fixture.

The *PM 6303A* automatic RCL meter, equipped with a four-wire test fixture, an operating manual, and a line cord, is priced at \$1500.—**John Fluke Mfg. Co., Inc.**, P.O. Box 9090, M/S 250E, Everett, WA 98206-9090; Phone: 800-44-FLUKE.

**RF DETECTOR OSCILLOSCOPE PROBE KIT.**

This kit is for an RF-detector oscilloscope probe with a bandwidth of 800-MHz. Intended for use with any oscilloscope having a 10-megohm input, *Pomona Electronics' Model 5815* kit contains interchangeable oscilloscope probes and accessories for the professional oscilloscope user. The RF detector oscilloscope probe kit is



**CIRCLE 26 ON FREE INFORMATION CARD**

packaged in a reusable plastic case, and replacement parts are readily available. The probes' modular design permits maximum flexibility and interchangeability of tips and various types of interface connections.

The *Model 5815* RF-detector oscilloscope probe kit is priced at \$70.50.—**ITT Pomona Electronics**, 1500 East Ninth Street, P.O. Box 2767, Pomona, CA 91769; Phone: 714-469-2900; Fax: 714-629-3317. **R-E**

**WE'RE  
THE  
#1  
HOPE  
FOR  
THE  
#3  
KILLER:  
LUNG  
DISEASE**

**AMERICAN  
LUNG  
ASSOCIATION®**  
The Christmas Seal People®

Space contributed by the publisher as a public service.

**TRUTH**

If your meter doesn't have True RMS, it's lying to you. Those nasty nonsinusoidal and noisy sinusoidal wave forms fool even the best "averaging" meters. The problem was, True RMS used to be expensive. Good news. The RMS225 is half the price of similar meters.

Call (800) 854-2708, (800) 227-9781 in CA.

**Beckman Industrial™**  
An Affiliate of Emerson Electric Co.

Beckman Industrial Corporation, San Diego, CA 92123-1898.



**CIRCLE 194 ON FREE INFORMATION CARD**

# Take **3** PROFESSIONAL BOOKS for \$**9.95** only

when you join the **ELECTRONICS ENGINEERS' BOOK CLUB**

Values to \$129.40



**3258** **\$28.95**  
This book offers up-to-date instructions for troubleshooting and repairing all major brands of equipment, with hundreds of diagrams, specs, and schematics. Covers TVs, VCRs, CD players, and much more. 310 pp.



**3991** **\$39.95**  
Engineers and technicians will find full coverage of standard power supply sources. Covers new frequency devices including insulated-gate bipolar transistor (IGBT), mos-controlled thyristor (MCT). 464 pp., 365 illus.



**9255-XXX** **\$105.00**  
"Outstanding, extensive reference to current technology of electronics. Covers everything from principles to applications." —Computer Book Review  
2,528 pp., 1,800 illus.  
*Counts as 3*

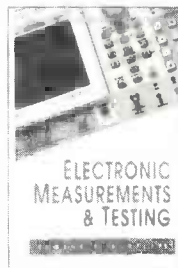

**003961** **\$39.95**  
Here's your guide to basic electrical measurements, component measurements, system tests, and performance verification. Most of the methods and procedures you'll find here use available off-the-shelf test equipment. 224 pp., 180 illus.

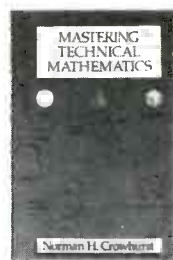

**3438** **\$39.95**  
Promotes true understanding by explaining how and why mathematics principles work. Step-by-step instructions and alternative techniques are provided for solving problems in basic arithmetic, algebra, geometry, trigonometry, and calculus. 512 pp., 481 illus.

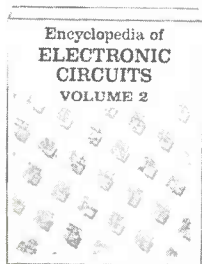

**3138-XX** **\$60.00**  
A GIANT "Circuit Book" of over 700 of the most widely-used, state-of-the-art electronic and integrated circuits ever compiled in a single source! The perfect sourcebook for all levels of electronics practitioners. 738 pp. *Counts as 2*



**3147-XX** **\$38.95**  
Provides a ready source of basic information on using programmable controllers to achieve a wide variety of manufacturing goals. You'll find flowcharts and step-by-step explanations to develop, improve, and monitor process control. 304 pp., 187 illus. *Counts as 2*

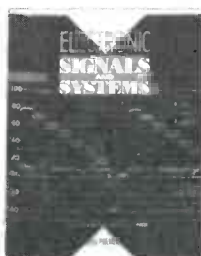

**3557** **\$29.95**  
A detailed study of signal analysis as it applies to the operation and signal-generating capabilities of today's devices. Explains the composition and use of test instruments, transmission media, satellite systems, broadcast and reception facilities, and more. 272 pp.

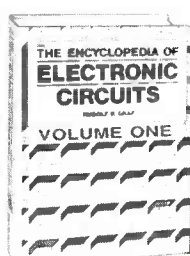

**1938-XX** **\$60.00**  
For quick-reference and on-the-job use, this sourcebook puts over 1,300 state-of-the-art designs at your fingertips. From A (alarm circuits) to Z (zero crossing detector circuits) this compendium excels in content, scope, and design. 768 pp. *Counts as 2*

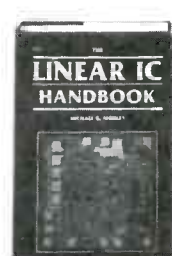

**2672** **\$49.50**  
This "one-stop" sourcebook bridges the gap between data books and the designer's search for the right component. Covers how linear ICs are fabricated, how they work, what types are available, and techniques for designing. 624 pp.

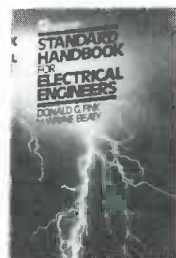

**020975-XXX** **\$104.50**  
The essential reference for all electrical engineers. Completely revised and updated, this classic handbook covers the generation, transmission, distribution, control, conservation, and application of electrical power. 2,416 pp., 1,388 illus., 430 tables. *Counts as 3*



**3540** **\$26.95**  
This guide brings you up-to-date on today's most advanced power supply circuits, components, and measurement procedures. Covers switching rates up to 3-MHz and higher as well as the 20-kHz standard. 176 pp.



**3837** **\$27.95**  
Focuses on the specific digital circuits used in electronic power applications. Presents state-of-the-art approaches to analysis, troubleshooting, and implementation of new solid-state devices. An excellent sourcebook and a valuable edition to an engineer's library. 272 pp.



**003957-XX** **\$49.95**  
Written for technical personnel, engineers, managers, and operators, this is a practical guide to design, implementation, and maintenance of cable TV systems. Includes an overall introduction to standard NTSC and HDTV systems. 400 pp. *Counts as 2*

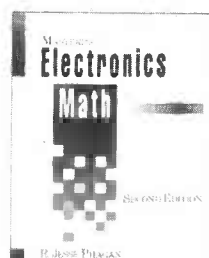

**3589** **\$27.95**  
A practical toolbox reference for anyone in the electronics field. Phagan guides you through the practical calculations needed to design and troubleshoot circuits and components. 352 pp., 270 illus.



**053570-XX \$64.95**  
This is a "one-stop" guide to the theory and design of communications receivers: short-wave, broadcast, radar, military, broadcast (AM-FM), radar, aeronautical, marine, and directions finding. 608 pp., 402 illus. *Counts as 2*

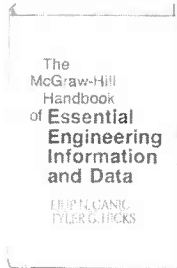

**022764-XX \$92.50**  
Packed with information for solving on-the-job design, operation, and analysis problems this is the most complete collection of engineering facts, figures, techniques, and methods ever assembled into a single source. 1,072 pp., 400 illus. *Counts as 2*

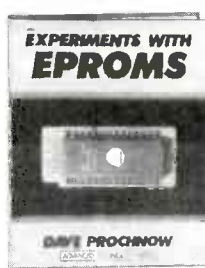

**2962P \$17.95**  
This complete EPROM instruction manual provides a detailed explanation of underlying theory, plus 15 different projects, including programmers, erasers, and EPROM-based circuits. 240 pp. *Softcover*



**3321P \$16.95**  
Prospective CETs can use this all-around reference source to study the basic subject matter they will encounter on the Industrial Electronics Option Test. 350 pp., 200 illus. *Softcover*



**050806-XX \$54.95**  
This book emphasizes circuit, transformer, and magnetics design. Provides worked-out examples of transformers, currents, power levels, and more. 550 pp., 250 illus. *Counts as 2*

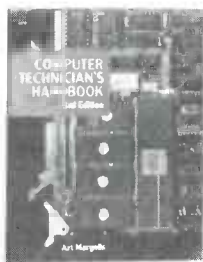

**3279 \$36.95**  
Perform routine maintenance, and diagnose and repair any kind of computerized device. This popular reference covers large dynamic RAMs, 32-Bit processors, 80286, 80386, and Z8001-Z8002 processors. 570 pp.

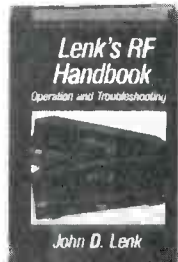

**037504 \$39.95**  
Packed with simplified, circuit-by-circuit troubleshooting examples, this handbook provides the practical know-how you need to operate and troubleshoot modern RF equipment. 352 pp., 150 illus.

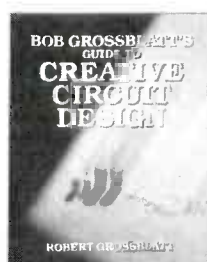

**3610 \$28.95**  
Emphasizing the importance of scientific method over technical knowledge, Grossblatt walks you through the circuit design process—from brainwork to paperwork to boardwork—and suggests ways for making your bench time as efficient as possible. 248 pp., 129 illus.

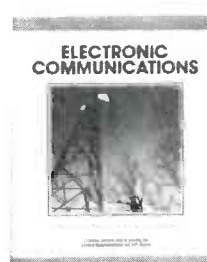

**3365P \$24.95**  
Both a professional reference and a study guide for the aspiring technician, this is a well-illustrated introduction to modern communications. Use it to prepare for your FCC General Radiotelephone Operator License or CET exam. 704 pp. *Softcover*



**9290-XX \$36.00**  
This book provides the practical approaches and innovative, easy-to-perform troubleshooting techniques you need to pinpoint symptoms and effectively evaluate the cause of electronic malfunctions. 318 pp., Illus. *Counts as 2*

**Your source for quality, affordable and timely authoritative engineering books.**

## As a member of the Electronics Engineers' Book Club<sup>SM</sup> . . .

. . . you'll enjoy receiving Club bulletins every 3-4 weeks containing exciting offers on the latest books in the field at savings of up to 50% off of regular publishers' prices. If you want the Main Selection do nothing and it will be shipped automatically. If you want another book, or no book at all, simply return the reply form to us by the date specified. You'll have at least 10 days to decide. Your only obligation is to purchase 3 more books during the next 2 years, after which you may cancel your membership at any time.

©1992 EERC

All books are hardcover unless otherwise noted. Publishers' prices shown.

If card is missing, write to:  
Electronics Engineers' Book Club, Blue Ridge Summit, PA 17294-0860

## ELECTRONICS ENGINEERS' BOOK CLUB

Blue Ridge Summit, PA 17294-0860

**YES!** Please rush me the books indicated below for just \$9.95 plus shipping/handling & applicable sales tax. Enroll me as a member of the **Electronics Engineers' Book Club** according to the terms outlined in this ad. If not satisfied, I may return the books within 10 days without obligation and my membership will be cancelled. A shipping/handling charge and sales tax will be added to all orders.

--	--	--

If you select a book that counts as 2 choices, write the book number in one box and XX in the next.  
If you select a Counts as 3 choice, write the book number in one box and XXX in the next 2 boxes.

Name \_\_\_\_\_

Address \_\_\_\_\_

City/State \_\_\_\_\_

Zip \_\_\_\_\_ Phone \_\_\_\_\_

Offer valid for new members only, subject to acceptance by EERC. Canada must remit in U.S. funds. Applicants outside the U.S. and Canada will receive special ordering instructions.

DRE1092AC

# NEW LIT

Use The Free Information Card for fast response.

**ENCYCLOPEDIA OF ELECTRONIC CIRCUITS: Volume 4;** by Rudolf F. Graf and William Sheets. TAB Books, Division of McGraw-Hill Inc., Blue Ridge Summit, PA 17294-0850; Tel. 1-800-822-8138; \$29.95.

Hundreds of schematics for up-to-date electronic circuits, straight from the drawing boards of industry leaders such as Motorola, Texas Instruments, General Electric, and National Semiconductor, are included in the 700-plus



CIRCLE 27 ON FREE INFORMATION CARD

pages of this book. Tightly organized and extensively indexed, the book includes complete descriptions of automotive, audio, video, ultrasonic, alarm and security, and computer-related circuits. The book's index includes not only the circuits presented in Volume 4, but also those that appear in the first three volumes. The circuits are arranged in 104 chapters, with circuit titles listed at the beginning of each chapter for easy reference. Almost every circuit is accompanied by a brief written explanation; those who require more details can order the original sources, which are listed in the back of the book.

**BUILD YOUR OWN SPECTRUM ANALYZER;** by Murray (WA2PZO) and Bruce (WA2DRO) Barlowe. Science Workshop, Box 310, Bethpage, NY 11714; Phone: 516-731-7628; \$24.95.

A spectrum analyzer is a valuable—and expensive—piece of test equipment with dozens of applications. But professional models, costing thousands of dollars, are beyond the means of most electronics hobbyists and many professionals. This book shows how to build the "Poor Man's Spectrum Analyzer" for a fraction of the cost. The instrument does "almost everything the professional models do," but requires "a little more effort and ingenuity" on the part of the user when it comes to making precise measurements. The analyzer can use almost any standard oscilloscope for its display. The Poor Man's Spectrum Analyzer is packaged as a kit, available separately.

The book includes a tutorial covering theory of operation, layout drawings and photographs, and magazine articles about the spectrum analyzer, reprinted from *Ham Radio*

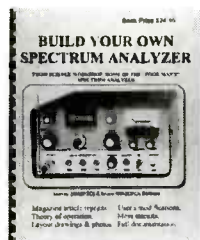

CIRCLE 28 ON FREE INFORMATION CARD

and *Communications Review*. In addition, it features a chapter titled "User Feedback" in which actual user modifications are presented and explained in detail. The final chapter includes copies of the instructions, schematics, and parts layouts for each of the modules used in the spectrum analyzer.

**MOBILE-ANTENNA WALL CHART;** from The Antenna Specialists Co., 30500 Bruce Industrial Parkway, Cleveland, OH 44139-3996; Phone: 216-349-8400; Fax: 216-349-8407; free to dealers, distributors, service shops, RF-design labs, and service professionals.



CIRCLE 29 ON FREE INFORMATION CARD

This full-color wall chart is intended to help readers choose the right mobile antenna for every vehicular installation requirement. The 54 x 38-inch chart presents pictures of almost 150 professional mobile-antenna models, grouped by frequency range from low-frequency band through 800 to 900 MHz. The antennas are cross-referenced to various vehicular mounting schemes, such as On-Glass, conversion mounts, 3/4- and 3/8-inch hole mounts, trunk lid, magnetic, and other temporary mounts. The chart also presents antenna so-

lutions for special applications including those on motorcycles and railroads. Each antenna is depicted in a photograph with its components identified by part number.

**HIGH PERFORMANCE PC/AT DATA ACQUISITION PRODUCTS;** from Analogic Corporation, 360 Audubon Road, Wakefield, MA 01880; Phone: 508-977-3000; Fax: 617-245-1274; free.

This 64-page catalog features data acquisition products with a broad range of capabilities, from those with 12- to 16-bit accuracies at 50 kHz throughput to those providing true 16-bit accuracies at acquisition speeds up to 1 MHz. Many of the acquisition boards contain analog output capabilities, counter-timers, and digital input/output. The catalog also features expansion boards, analog-output boards, and signal-con-



CIRCLE 30 ON FREE INFORMATION CARD

ditioning boards, as well as PC-based frame grabbers. In addition to hardware products, the catalog offers high level language (HLL) drivers, set-up and demo routines, and interfaces to many third-party software packages. **R-E**

48 HOUR SHIPPING

# ELENCO & HITACHI PRODUCTS AT DISCOUNT PRICES

TO ORDER  
CALL TOLL FREE  
1-800-292-7711  
1-800-445-3201 (Can.)

## Hitachi RSO Series

- (Portable Real-time Digital Storage Oscilloscopes)
- VC-6023 - 20MHz, 20MS/s \$1,695
  - VC-6024 - 50MHz, 20MS/s \$1,995
  - VC-6025 - 50MHz, 20MS/s \$2,195
  - VC-6045 - 100MHz, 40MS/s Call
  - VC-6145 - 100MHz, 100MS/s Call

RSO's from Hitachi feature roll mode, averaging, save memory, smoothing, interpolation, pretriggering, cursor measurements. These scopes enable more accurate, simpler observation of complex waveforms, in addition to such functions as hardcopy via a plotter interface and waveform transfer via the RS-232C interface. Enjoy the comfort of analog and the power to digital.

## 25MHz Elenco Oscilloscope

### \$349

#### S-1325

- Dual Trace
- 1mV Sensitivity
- 6" CRT
- X-Y Operation
- TV Sync

• (2) 1x, 10x Probes included

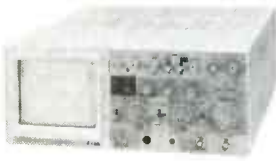

## SPECIAL BUY

### V-212 - 20MHz Scope \$409

## Hitachi Portable Scopes

### DC to 50MHz, 2-Channel, DC offset function, Alternate magnifier function

- V-525 - CRT Readout, Cursor Meas. \$995
- V-523 - Delayed Sweep \$975
- V-522 - Basic Model \$875
- V-422 - 40MHz \$775
- V-223 - 20MHz delayed sweep \$695
- V-222 - 20MHz deluxe \$625

## PRICE BREAKTHRU

- ### 20MHz Digital Storage Oscilloscope
- Analog/Digital Scope
  - 2K word per channel memory **DS203**
  - 10MS/s sampling rate
  - State-of-art technology **\$775**
  - Includes probes
  - **S-1360 60MHz Delay Sweep \$775**

## HITACHI COMPACT SERIES SCOPES

This series provides many new functions such as CRT Readout, Cursor measurements (V-1085/1065A/665A), Frequency Ctr. (V-1085), Sweeptime Autoranging, Delayed sweep and Trigger Lock using a 6-inch CRT. You don't feel the compactness in terms of performance and operation.

- V-660 - 60MHz, Dual Trace \$1,149
- V-665A - 60MHz, DT, w/cursor \$1,345
- V-1060 - 100MHz, Dual Trace \$1,395
- V-1065A - 100MHz, DT, w/cursor \$1,649
- V-1085 - 100MHz, QT, w/cursor \$1,995
- V-1100A - 100MHz, Quad Trace \$2,195
- V-1150 - 150MHz, Quad Trace \$2,695

## Elenco 40MHz Dual Trace

Good to 50MHz **\$495**

### S-1340

- High luminance 6" CRT
- 1mV Sensitivity
- 10KV Acceleration Voltage
- 9ns Rise Time
- X-Y Operation
- Includes (2) 1x, 10x Probes

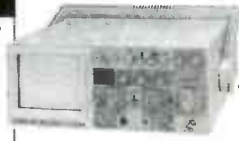

All scopes include probes, schematics, operators manual and 3 year (2 yrs for Elenco scopes) world wide warranty on parts & labor. Many accessories available for all Hitachi scopes. Call or write for complete specifications on these and many other fine oscilloscopes. **1x, 10x Scope Probes: P-1 65MHz \$17.95, P-2 100MHz \$21.95**

## Digital Capacitance Meter

### CM-1550B



**\$58.95**

- 9 Ranges
- 1pF-20,000uF
- .5% basic accy.
- Zero control w/ Case
- Big 1" Display

## Digital LCR Meter

### LC-1801



**\$125**

Measures:  
Coils 1uH-200H  
Caps 1pF-200uF  
Res .01-20M

## Multimeter with Capacitance & Transistor Tester



**\$55 CM-1500B**

Reads Volts, Ohms  
Current, Capacitors,  
Transistors and  
Diodes / with case

## FLUKE MULTIMETERS

Scopemeters	(All Models Available Call)
Model 93	\$1,095.00
Model 95	\$1,395.00
Model 97	\$1,695.00
10 Series	
Model 10	\$62.95
Model 12	\$79.95
70 Series	
Model 70II	\$65.00
Model 77II	\$145.00
Model 79II	\$169.00
80 Series	
Model 87	\$289.00

## Quad Power Supply XP-580



**\$69.95**

- 2-20V @ 2A
- 12V @ 1A
- 5V @ 3A
- 5V @ .5A

Fully regulated and short circuit protected

## Triple Power Supply XP-620



**Assembled \$75**  
**Kit \$50**

- 2 to 15V @ 1A,
- 2 to -15V @ 1A
- (or 4 to 30V @ 1A)
- and 5V @ 3A

All the desired features for doing experiments.  
Features short circuit protection, all supplies

## AM/FM Transistor Radio Kit with Training Course

**Model AM/FM 108**  
**\$26.95**

14 Transistors • 5 Diodes  
Makes a great school project

## True RMS 4 1/2 Digit Multimeter



**M-700T**  
**\$135**

.05% DC Accuracy  
1% Resistance with Freq. Counter  
Data Hold

## GF-8016 Function Generator with Freq. Counter



**\$249**

Sine, Square, Triangle  
Pulse, Ramp, .2 to 2MHz  
Freq Counter .1 - 10MHz  
Int/Ext operation

GF-8015 without Freq. Meter \$179

## Function Generator Blox



**#9600**  
**\$28.95**

Provides sine, triangle, square wave from 1Hz to 1MHz  
AM or FM capability

## Learn to Build and Program Computers with this Kit

Includes: All Parts, Assembly and Lesson Manual

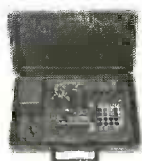

**Model**  
**MM-8000**  
**\$129.00**

Starting from scratch you build a complete system. Our Micro Master trainer teaches you to write into RAMS, ROMs and run a 8085 microprocessor, which uses similar machine language as IBM PC.

## Wide Band Signal Generators



**SG-9000 \$129**

RF Freq 100K-450MHz AM Modulation of 1KHz Variable RF output  
**SG-9500 w/ Digital Display & 150 MHz built-in Counter \$249**

## LASER KITS

Build your own laser. This great kit includes all parts needed to build a class II laser. Safe to use, output is under one milliwatt. Kit includes a new He-Ne 1.125 dia x 5.75" long laser tube. Comes with building instructions, schematic and all parts.

**Model LK-1 \$79.95**

Specifications LK-1:  
Input voltage 12VDC @ 1.25 amp  
Output voltage 2-3KV @ 3-4.5MA  
Trigger voltage 6-8KV  
Laser power 1 milliwatt  
Laser tube type helium - neon  
Laser tube size 1.125" dia x 5.75" long

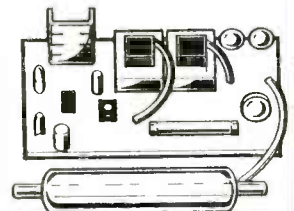

## Mirror & Motor Kit

This unique kit allows you to project laser patterns on the ceiling or walls. You change the patterns by varying the speed of the motors. The kit comes complete with 2 motors, 2 front surface mirrors, 2 motor brackets and 1 power rheostat control to vary speed of the motor.

**Model LM-1 \$19.95**

WE WILL NOT BE UNDERSOLD  
UPS SHIPPING: 48 STATES 5%  
IL RES 7.5% TAX (\$3 min \$10 max)  
OTHERS CALL

**C&S SALES INC.**  
1245 ROSEWOOD, DEERFIELD, IL 60015  
FAX: 708-520-0085 • (708) 541-0710



**15 DAY MONEY BACK GUARANTEE**  
**2 YEAR WARRANTY**  
**WRITE FOR FREE CATALOG**  
PRICES SUBJECT TO CHANGE

CIRCLE 109 ON FREE INFORMATION CARD

# 47st. Photo<sup>®</sup>

The latest in electronics is only a phone call away! **1-800-221-7774**

In N.Y. or if busy call: 1-718-722-4750. Please mention code ES892.



**NEW!**  
**AIWA CSD-EX1**  
**PORTABLE LCD**  
**RADIO CASSETTE CD PLAYER**  
• High power output  
• Power saving switch plus auto stop  
• 20-selection random programmable memory CD  
• AM wide/FM stereo tuner  
(AIW-427)  
Our Price **\$139<sup>95</sup>**  
Sugg. Retail \$179.95



**NEW!**  
**AIWA NSX-330**  
**30W/ch HI-FI MINI COMPONENT**  
**SYSTEM WITH SURROUND SOUND**  
• Super T-bass  
*Includes:*  
• 3-preset graphic equalizer  
• 5-band spectrum analyzer  
• Wireless remote  
• FM/AM tuner with 32-station random preset  
• Dual auto reverse cass. w/Dolby B NR  
• Optical digital output terminal  
• 3-way speaker  
(AIW-424)  
Our Price **\$399<sup>95</sup>**  
Sugg. Retail \$560.00



**NEW!**  
**AIWA XP-7**  
**PORTABLE CD PLAYER**  
**WITH IN CAR USE**  
• 1-bit dual D/A converter  
• 8-times oversampling digital filter  
• Optical digital output terminal  
• 24-random programmable memory  
• Heat-resistant for in car use  
• Random play with 3-way repeat  
*Includes:* Rechargeable battery BP-50, stereo headphones with remote control, AC adaptor recharger and connection cord.  
(AIW-420)  
Our Price **\$249<sup>95</sup>**  
Sugg. Retail \$280.00



**BONUS!**  
Free case with purchase of E-63  
**\$59 Value!**  
**CANON E-63**  
**8mm CAMCORDER WITH**  
**8:1 POWER ZOOM**  
• High speed shutter  
• 180° FlexiGrip  
• 2-lux low light  
• Sports finder  
• Wireless Remote (CAN-6300)

**Super Value!**



**NEW!**  
**PANASONIC RQ-535V**  
**AM/FM STEREO CASSETTE**  
**PLAYER WITH AUTO REVERSE**  
• Ultra compact size  
• Digital synthesizer tuner with 7AM/7FM presets  
• S-XB5 & Dolby NR  
• LCD tpae/radio display  
• Dual clock/alarm functions  
• One button wired remote  
*Includes:*  
Rechargeable battery and charger.  
(PAN-275A)  
Our Price **\$169<sup>95</sup>**  
Sugg. Retail \$209.95



**NEW!**  
**SONY WM-WX50**  
**WALKMAN®**  
**STEREO CASSETTE**  
**PLAYER**  
**WIRELESS HEADSET!**  
• Broadcasts up to 9 ft.  
• Auto reverse Mega Bass  
• 2x sound system with variable control  
• Dolby NR  
(SON-3483)  
Our Price **\$179<sup>95</sup>**  
Sugg. Retail \$249.95



**SHARP IO-8400**  
**ELECTRONIC ORGANIZER**  
• 256 KB memory  
• Typewriter style keyboard  
• Hi-contrast 40 char. by 8 line screen  
• Month/week & day calendar  
• 3 phone directories  
• Business Card function  
(SHA-8400)  
Our Price **\$319<sup>95</sup>**  
Sugg. Retail \$499.95



**SONY XVT-600**  
**ADD PRO STYLE SUPERIMPOSED**  
**TITLES TO YOUR VIDEOS!**  
• 15 color picture computer superimposes picture title or background to video  
• Draw lines, add color—endless possibilities!  
(SON-409)  
Our Price **\$109<sup>95</sup>**  
Sugg. Retail \$600

**SALE!**

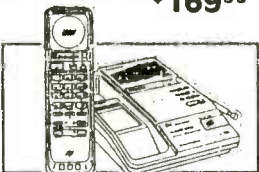

**PANASONIC KX-T4300**  
**CORDLESSPHONE WITH**  
**ANSWERING MACHINE**  
• 10 channel access • Rubber antenna  
• Tone/pulse • 2-way paging  
• 10-number speed dial • Message alert  
• LED readout  
• 11-function tone remote  
• Auto logic operation.  
(PAN-4300)  
Our Price **\$159<sup>95</sup>**  
Sugg. Retail \$199.95

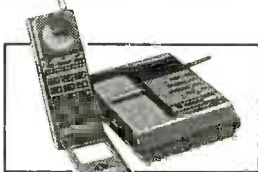

**PANASONIC KX-T9000**  
**900MHz POCKET-SIZED FOLDING**  
**CORDLESSPHONE**  
• Operates on 902/928Mhz  
• Sound Charger technology  
• 30ch auto scan • Auto Intercom  
• 2 Interchangeable batteries  
• 2-way paging & auto intercom  
• 10, 20 digit no. auto dial  
• Handset Auto switch to 'talk' mode  
(PAN-9000)  
Our Price **\$399<sup>95</sup>**  
Sugg. Retail \$499.95



**NEW!**  
**CASIO BP-100**  
**BLOOD PRESSURE**  
**MONITOR WATCH**  
• Water resistant to 50 meter  
• 12/24-hour formats  
• 3 multi-function alarms  
• Altimeter, Depth meter & Barometer  
• Countdown alarm  
• 1/100 stopwatch  
(CAS-826)  
Our Price **\$129<sup>95</sup>**  
Sugg. Retail \$169.95

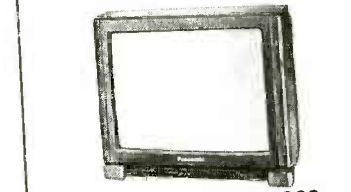

**PANASONIC CTP-2066S**  
**20" STEREO MONITOR-RECEIVER**  
**WITH S-VHS INPUT (Over 500**  
**lines horizontal resolution)**  
• Audio/Video Input jacks  
• Unified TV/VCR remote  
• Clock, Sleep-timer & on-timer  
(PAN-2796)  
Our Price **\$357<sup>95</sup>**  
Sugg. Retail \$499.95

**SALE!**

- Cameras
- Darkroom Supplies
- Video Equipment
- Televisions
- Hi-Fi Stereo Equipment
- Portable/Personal Audio
- Telephones
- Cellular Phones
- Computer Equipment
- Business Machines
- Calculators/Organizers
- Electronic Games
- Watches/Sunglasses
- Small Home Appliances
- Jewelry

Visit our superstores at:

**67 West 47th Street**    **115 West 45th Street**  
Bet. 5th & 6th, NYC CA. LIC. #800189-691860    Bet. 6th & B'way, NYC CA. LIC. #800191-81628

**1-212-921-1287**

Sun. 10:00-5:00, Mon-Thurs. 9:30-6:00, Fri. 9:30-2:00, Closed Saturday

**A New York Landmark for over 26 years!**

Toll-free line is open  
SUN. 10-5, DAILY 8-7, FRI. 8-2  
Local lines are open  
SUN. 10-5, DAILY 9:30-6, FRI. 9:30-2

**OVERNIGHT DELIVERY**  
to any point in the  
continental USA  
**AVAILABLE**  
at additional cost

Mall Order Dept.:  
455 Smith Street, Brooklyn, N.Y. 11231

EN1092

# BUILD THIS HANDI-TALKIE

DON WRAY

*Build this efficient, miniature FM handheld transceiver and start your own private communications network.*

IF YOU EVER WANTED TO BUILD A small powerful handheld transceiver and, at the same time learn surface-mount technology (SMT), this is the project for you! The E-Comm frequency-modulated (FM) transceiver is housed in a rugged yet attractive aluminum case less than six inches long. It is one of the most unusual transmitter-receivers ever designed for its power level and operating frequency range. The case includes a rechargeable nickel-cadmium power pack that will save you the cost of periodically replacing eight AA alkaline cells.

The E-Comm receiver has a respectable 0.3-microvolt sensitivity (12-dB SINAD) for high quality reception, and its transmitter boasts at least a 90% efficiency. E-Comm owes its efficiency to its innovative Class-E final amplifier which exhibits high power gain. It offers a continuous output of 3 watts rms into a 50-ohm antenna or dummy load. The efficient receiver and the rechargeable power supply make it possible to keep E-Comm on the air in the *squelch* mode for 80 hours without recharging the power pack.

Intended for narrow-band FM, E-Comm has a usable carrier frequency range of 27 MHz to 32 MHz with only crystal and alignment changes. The subject of this article is a version designed for 27.145-MHz operation. With modifications to the transmit and receive filters (component value changes) operation up to 60 MHz is possible. This allows the transceiver to work both the six- and ten-meter amateur radio bands. Note: This transceiver has not

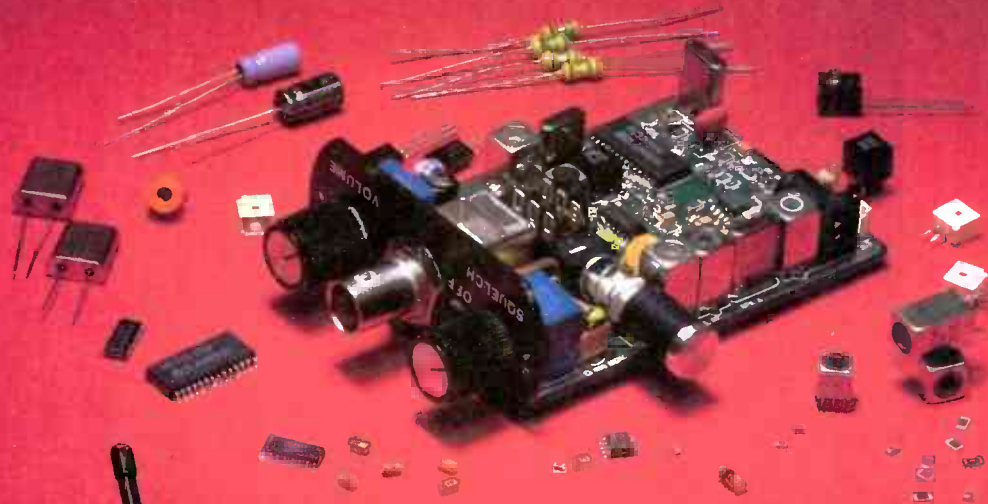

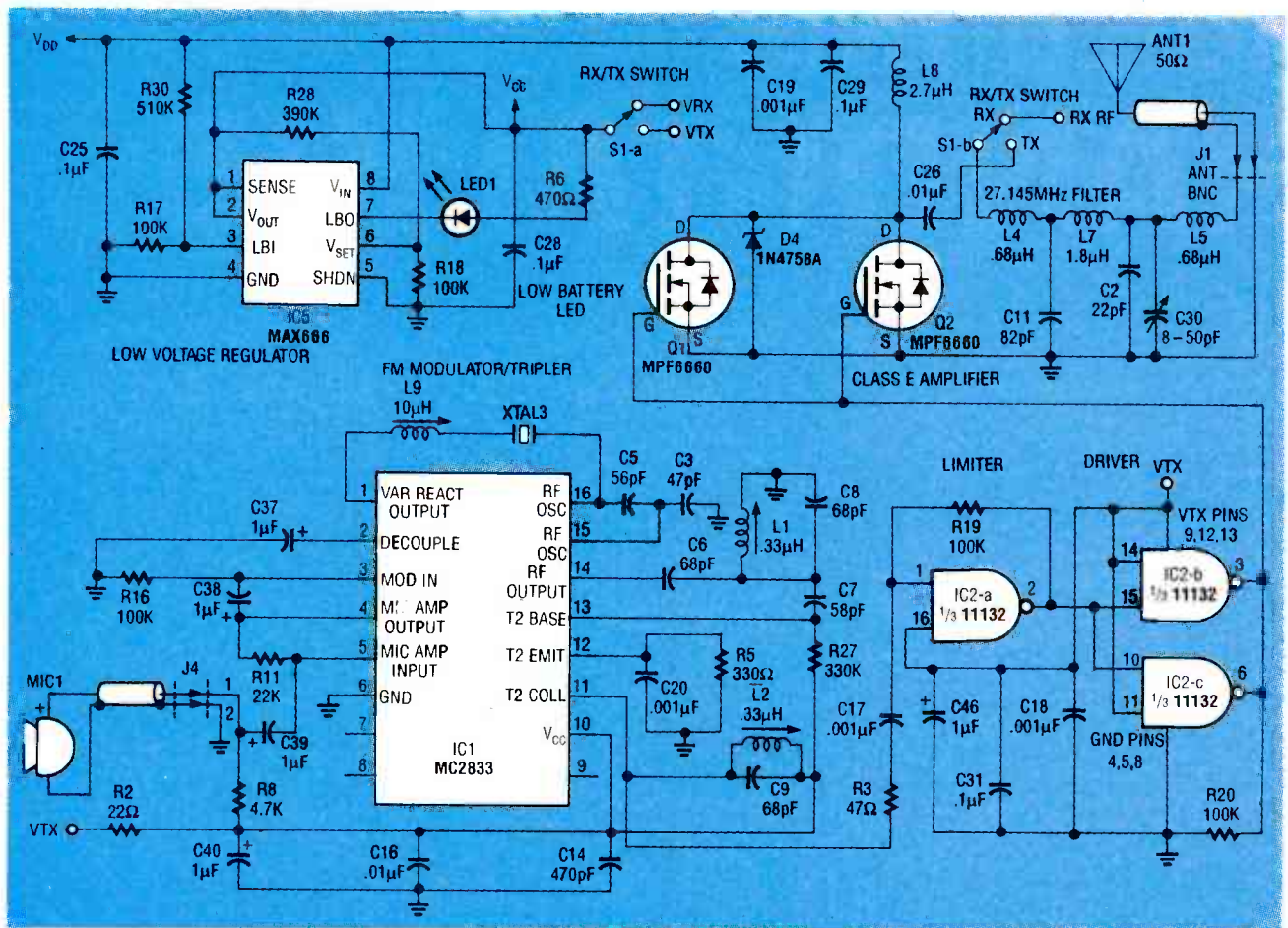

FIG. 1—SCHEMATIC SHOWING THE MODULATOR/TRIPLER, Class-E amplifier, limiter, driver and low-voltage regulator sections of the E-Comm transceiver. The key device is IC1, the FM transmitter chip.

been submitted for FCC approval, and its operation on certain frequencies may not be allowed and/or may require licensing.

The top panel controls of E-Comm include an ON-OFF switch, VOLUME and SQUELCH knobs and an LED power-pack status indicator. The removable flexible seven-inch antenna is coupled to the transceiver with a 50-ohm bayonet-style BNC connector plug. All the components except the battery pack, microphone, and speaker are mounted on the double-sided PC board. Extensive use of integrated circuits and surface-mounted components allows the circuitry to fit on a PC board that measures only 2.25 × 3.1 inches.

#### How it was designed

The transceiver has three main sections: transmitter, re-

ceiver, and power supply. (Refer to Figs. 1 and 2.) The transmitter is designed around Motorola's MC2833, a low-power FM transmitter IC whose pinout and functional block diagram are given in Fig. 3. The receiver is designed around Motorola's MC3363, a low-power, dual-conversion FM receiver IC whose pinout and block diagram are given in Fig. 4.

Received signals picked up by the antenna are preselected by the five-pole transmit bandpass filter consisting of inductors L4, L7, and L5 and capacitors C11, C2, and C30 as shown on the right side of Fig. 1. The received signal is then fed through the receive/transmit switch S1-b to an impedance-matching stage consisting of C10 and L3 shown on the left side of Fig. 2. That stage provides an additional two poles of preselection.

Diodes D1 and D2 prevent

overloading and the possible destruction of the RF amplifier transistor if it is subjected to overdriving at the front end. The preselected signal is then amplified by the IC3 (MC3363) internal common-emitter RF amplifier stage and fed to the first mixer stage on pin 1.

The RF amplifier provides a gain of approximately 20 dB. The first local oscillator (LO) takes a third overtone from a crystal, and drives the first mixer through an internal cascode amplifier. Downconversion makes the first LO frequency (the first IF frequency) 10.7 MHz greater than the carrier. For example, if a 27.145 MHz carrier were present, the crystal frequency would be 27.145 MHz plus 10.7 MHz or 37.845 MHz.

The mixer is a doubly balanced multiplier that provides about 18 dB of conversion gain. The output of the mixer is an emitter-follower stage with an output impedance of 330 ohms to match the ceramic filter. Fil-



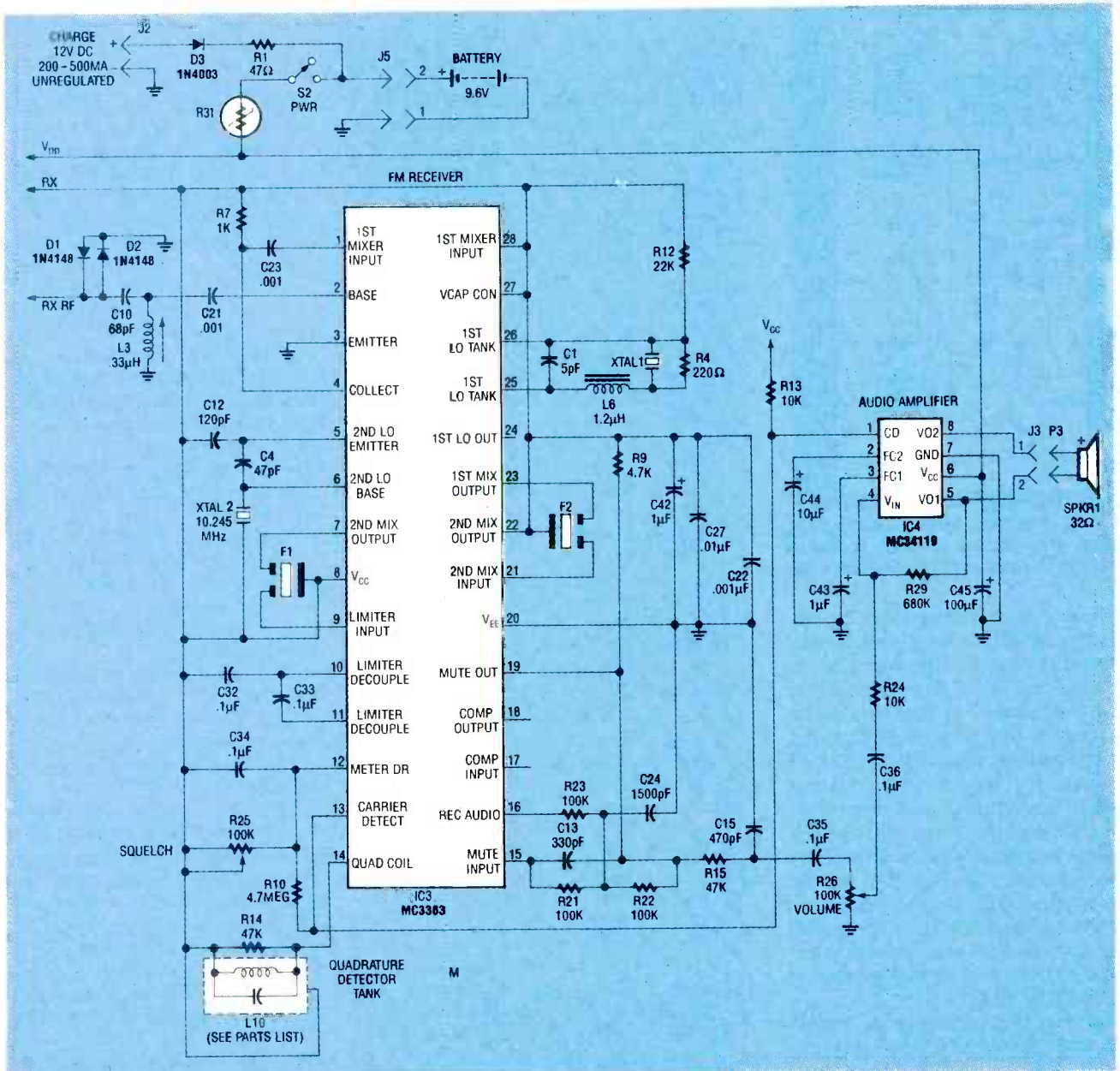

FIG.2—SCHEMATIC SHOWING FM RECEIVER, audio filter, and audio amplifier sections of the E-Comm transceiver. The key device here is IC3, the dual-conversion FM receiver chip.

ter F2, a 10.7-MHz ceramic bandpass filter, removes unwanted out-of-band harmonics from the output of the first mixer. The second mixer takes a signal from the 10.245-MHz fundamental mode crystal-controlled oscillator XTAL2 whose output is mixed with the 10.7-MHz first IF to generate the 455-kHz second IF with a conversion gain of approximately 21 dB.

The 455-KHz ceramic filter F1 (left side of IC3 in Fig. 2) provides narrow-band filtering for the limiter amplifiers within

IC1, the MC2833 FM transmitter chip. The limiters clip the 455-kHz second IF signal to remove unwanted amplitude-modulated signals and feed the audio detector. A quadrature detector within IC3, the MC3363, detects the modulated signal. The parallel quadrature detector tank, L10, in the detector is tuned to 455 KHz.

The demodulated (audio) signal on pin 16 of the FM transmitter IC1 is then filtered by an active filter stage that includes an op-amp within IC3, the FM

receiver chip in Fig.2. This active filter, connected at pins 15 and 19 of IC3 and consisting of capacitors C13, C24, and C15 and resistors R21, R22, R23, and R15, has a rolloff at 3 kHz

Squelch is performed by the carrier-detect function on pin 13 of the FM transmitter chip, IC1 in Fig. 1. Resistor R10 (between pins 12 and 13) provides hysteresis in the squelch circuit to prevent unwanted "break through." This squelch circuit is unusual: its output both enables and disables IC4, a Motorola MC34119D low-power audio amplifier with a CHIP DISABLE pin 1 (CD).

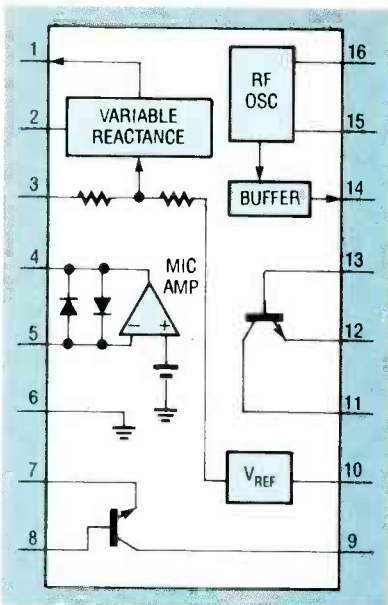

FIG. 3—PINOUT AND FUNCTIONAL block diagram for IC1, the Motorola MC2833 low-power FM transmitter chip.

Power consumption is reduced by disabling the audio amplifier when the receiver is squelched, and it is also kept low because it is run from the unregulated power supply in combination with the 32-ohm speaker. This arrangement holds receiver consumption down to only 7 milliamperes from the battery pack when the receiver is in the squelch mode. The gain of the audio amplifier is set by resistor R29 (between pins 4 and 5) and nearby resistor R24, and is expressed as  $(2 \times R29/R24)$ .

The transmitter is a 3-watt narrow-band FM Class E circuit with efficiency greater than 90%. The front end of the transmitter is based on IC1 (Fig. 1), the low-power FM transmitter chip. The voice signal is picked up by the microphone and fed to the MIC AMP INPUT on pin 5 of IC1. Resistor R11 (between pins 4 and 5) sets the gain of the amplifier, and the output of the amplifier drives the FM modulator.

A variable reactance in the modulator "bends" the frequency of the crystal-controlled oscillator. Because the crystal frequency cannot be deviated by more than a few kilohertz by the variable reactance circuit, a multiplication scheme derives the proper carrier and modulation frequencies. In the E-

Comm, a crystal frequency equal to one-third of the carrier frequency was chosen. Inductor L9 (in series with XTAL3 between pins 1 and 16 of IC1) centers the oscillator frequency

when no modulation is applied. The buffered output of the oscillator on RF OUTPUT pin 14 then feeds a tank circuit made up of inductor L1 and capacitor C8, which is tuned to the third har-

## PARTS LIST

### Resistors (All 1206 SMD chip resistors are 1/8-watt, 5%, unless otherwise specified)

- R1—47 ohms, 1/2-watt, 5%, radial-lead
- R2—22 ohms, 1206, SMD
- R3—47 ohms, 1206, SMD
- R4—220 ohms, 1206, SMD
- R5—330 ohms, 1206, SMD
- R6—470 ohms, 1206, SMD
- R7—1000 ohms, 1206, SMD
- R8, R9—4700 ohms, 1206, SMD
- R10—4.7 megohms, 1206, SMD
- R11, R12—22,000 ohms, 1206 SMD
- R13, R24—10,000 ohms, 1206 SMD
- R14, R15—47,000 ohms, 1206 SMD
- R16-R23—100,000 ohms, 1206 SMD
- R25, R26—100,00 ohms potentiometer, Bourns 51CADD12A20, or equivalent
- R27—330,000 ohms, 1206 SMD
- R28—390,000 ohms, 1206 SMD
- R29—680,000 ohms, 1206 SMT
- R30—510,000 ohms, 1206 SMT
- R31—current variable resistor, polymer-based, Raychem Polyswitch RXE040 or equivalent

### Capacitors

- C1—5 pF NPO 805 SMD ceramic, Tayio-Yuden UMK212CH0R5D-B or equivalent
- C2—22 pF NPO ceramic disc, 100-volt, Panasonic ECC-F2A220JCE or equivalent
- C3, C4—47 pF NPO 805 SMD ceramic, Tayio-Yuden UMK-212CG470K-B or equivalent
- C5—56 pF NPO 805 SMD ceramic, Tayio-Yuden UMK212CG560K-B or equivalent
- C6-C10—68 pF NPO 805 SMD ceramic, Tayio-Yuden UMK-212CG680K-B or equivalent
- C11—82 pF NPO ceramic disc, 100-volt, Panasonic ECC-F2A820JCE or equivalent
- C12—120 pF NPO 805 SMD ceramic, Tayio-Yuden UMK-212CG121K-B or equivalent
- C13—330 pF NPO 805 SMD ceramic, Tayio-Yuden UMK-212CG331K-B or equivalent

- C14, C15—470 pF NPO 805 SMD ceramic, Tayio-Yuden UMK-212CG471K-B or equivalent
- C16, C26, C27—0.01 $\mu$ F Y5V 805 SMD ceramic, Tayio-Yuden UMK212F103Z-B or equivalent
- C17-C23—1000 pF NPO 805 SMD ceramic, Tayio-Yuden UMK212SL102K-B or equivalent
- C24—1500 pF X7R 805 SMD ceramic, Tayio-Yuden UMK-212B152K-B or equivalent
- C25, C29, C31-C36—0.1 $\mu$ F Y5V 805 SMD ceramic, Tayio-Yuden UML212F104Z-B or equivalent
- C28—designation not used
- C30—8-50 pF trimmer capacitor, Sprague-GM GKG50011 or equivalent
- C37-C40, C42, C43, C46—1 $\mu$ F 1206 SMD tantalum, 16-volt
- C41—designation not used
- C44—10 $\mu$ F electrolytic, 16-volt, 5-mm, Panasonic ECE-A1CGE100 or equivalent
- C45—100 $\mu$ F electrolytic, 16-volt, 6.3 mm, Panasonic ECE-A1CGE101 or equivalent

### Semiconductors

- D1, D2—DL4148 switching diode, 1206 SMD,
  - D3—DL4003 silicon rectifier, SMD
  - D4—1N4758A 56-volt Zener diode
  - LED1—HLMP-1503-101 (Hewlett-Packard) green light-emitting diode right-angle indicator or equivalent
  - Q1, Q2—MPF6660 power FET, (Motorola) or equivalent
  - IC1—MC2833 (Motorola) low-power FM transmitter system, SMD
  - IC2—74ACL11132 (Texas Instruments) quad NAND gate, Schmitt trigger, SMD or equivalent
  - IC3—MC3363DW (Motorola) low-power dual-conversion FM receiver, SMD package
  - IC4—MC34119 (Motorola) low-power audio amplifier, SMD
  - IC5—MAX666CSA (Maxim) voltage regulator, SMD package
- ### Inductors
- L1-L3—0.33  $\mu$ H, adjustable coil, Toko, 292KNAS-T1034Z or equivalent

## PARTS LIST

L4, L5—0.68  $\mu$ H, axial-leaded inductor, Taiyo-Yuden, LAL04NAR68M or equivalent

L6—1.2  $\mu$ H SMD inductor, 2.5  $\times$  3.2mm or equivalent

L7—1.8  $\mu$ H axial-leaded inductor, Taiyo-Yuden LAL04NA1R8M or equivalent

L8—2.7  $\mu$ H axial-leaded inductor, Taiyo-Yuden LAL04NA2R7M or equivalent

L9—10  $\mu$ H adjustable inductor, Toko F292CNS-T1052Z or equivalent

L10—quad coil, Toko 5SVLC-0637BJT or equivalent

### Switches

S1—DPDT pushbutton switch, (Schadow) F2UOA or equivalent

S2—SPDT slide switch, C&K, 1101M2S3AQE2 or equivalent

### Connectors

J1—50-ohm BNC bayonet-style, PC-board-mount jack with two hex ring nuts

J2—charging jack, Cui Stack PJ-002A or equivalent

J3 to J5—sockets, 2-pin 2mm, Molex 53014-0210 with three 2-pin plugs, 2mm, Molex 51004-0200 and six pins, Molex 50011-8100 or equivalent

### Crystals

XTAL1—37.845-MHz third-overtone crystal, Toyocom, HC-49 or equivalent

XTAL2—10.245-MHz parallel-mode crystal, 32 pF, Toyocom, HC-49 or equivalent

XTAL3—9.0483-MHz parallel-mode crystal, 32 pF, Toyocom, HC-49 or equivalent

### Filters

F1—455-kHz ceramic filter, Murata CFUM455E or equivalent

F2—10.7-MHz ceramic filter, Toko SK107M5-A0-10 or equivalent

### Other Components

MIC1—microphone, Panasonic WM-54BT or equivalent

SPKR1—speaker, 2-inch square, 32-ohm, Regal, SA-200 or equivalent

ANT1—flexible coil antenna with BNC bayonet-style plug.

**Miscellaneous:** PC board, custom-made battery pack with eight rechargeable nickel-cadmium AA cells, No. 24 AWG wire; one 120-volt AC to 12-volt DC adapter for charging the power pack; custom-made extruded case with bottom panel and silk-screened top panel; one custom made speaker grill; two knobs, Keystone, 8580 or equivalent with two hex ring nuts each; four No. 440  $\times$  3/8-inch Philips-head screws, black; four No. 6-32  $\times$  5/16-inch Philips-head screws, black; four No. 6-32 internal-tooth lock washers, four No. 6-32 hex nuts, one perforated hole plug, Hayco 2637 or equivalent; six-inch length of shielded wire; 12-inch length of No.24 AWG wire; fine solder wire; tools and accessories as specified in the text.

**NOTE: The following parts are available from Micro Advancement Products, Inc., P.O. Box 8505, Hollywood, FL 33084 800-358-8545**

- Printed circuit board only—\$12.00
  - Kit with printed circuit board and all components—\$97.00
  - Enclosure including all hardware, microphone, speaker, knobs and transmit button—\$38.00
  - Battery pack—\$17.95
  - AC to DC adapter for charging power pack, wall outlet mount—\$7.85
  - Flexible "rubber ducky" seven-inch 27-MHz antenna with BNC bayonet-style plug—\$17.95
  - Complete kit for one E-Comm transceiver—\$168.00
  - Complete kit for two E-Comm transceivers—\$297.00
  - One E-Comm transceiver assembled and tested—\$229.00
- Please add \$4.95 for shipping and handling to all orders. Free frequency modification sheet and crystal list with each order.

monic of the oscillator.

The signal is multiplied by a factor of three to obtain the carrier frequency in this tank circuit. Both the carrier and the modulation signal are multi-

plied to obtain the 5-kHz deviation required by the receiver. Next the signal is passed through a tuned common-emitter amplifier to amplify and smooth the carrier.

Next the signal is clipped by the quad NAND Schmitt trigger, IC2, a 74AC1132 high-speed CMOS logic gate. Two sections of IC2 (IC2-b and IC2-c) provide drive to turn a parallel-connected pair of enhancement-mode MPF6660 power MOSFETs, Q1 and Q2, on and off. Class E operation is obtained with the fast switching as well as the low ON resistance of the power MOSFETs.

Theoretically, if no power were required by the switch for activation (driver power), and if it were lossless, E-Comm would be nearly 100% efficient. Although the FETs do not form a perfect switch, they offer several useful characteristics: The input power required to drive the FETs is very low (drawn principally in switching the gate input capacitance on and off at high speed (less than 6 nanoseconds), and their switching speed is very high.

Those characteristics give the transmitter an efficiency of about 90%, measured as the ratio of rms RF power (delivered to the 50-ohm load) to the DC supply. A five-pole filter matches

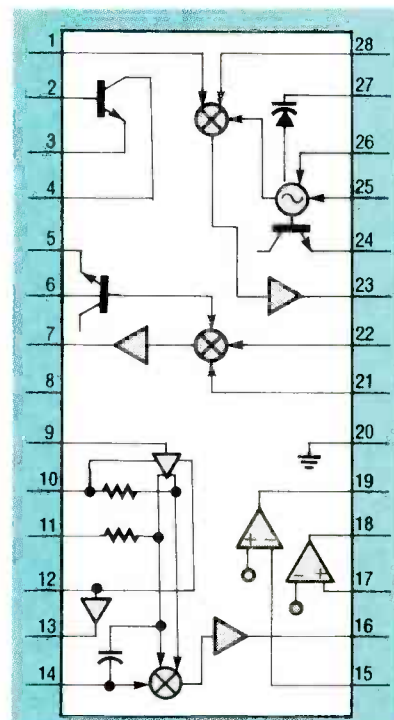

**FIG. 4—PINOUT AND FUNCTIONAL block diagram for IC3, the Motorola MC3363DW low-power, dual-conversion FM receiver chip.**

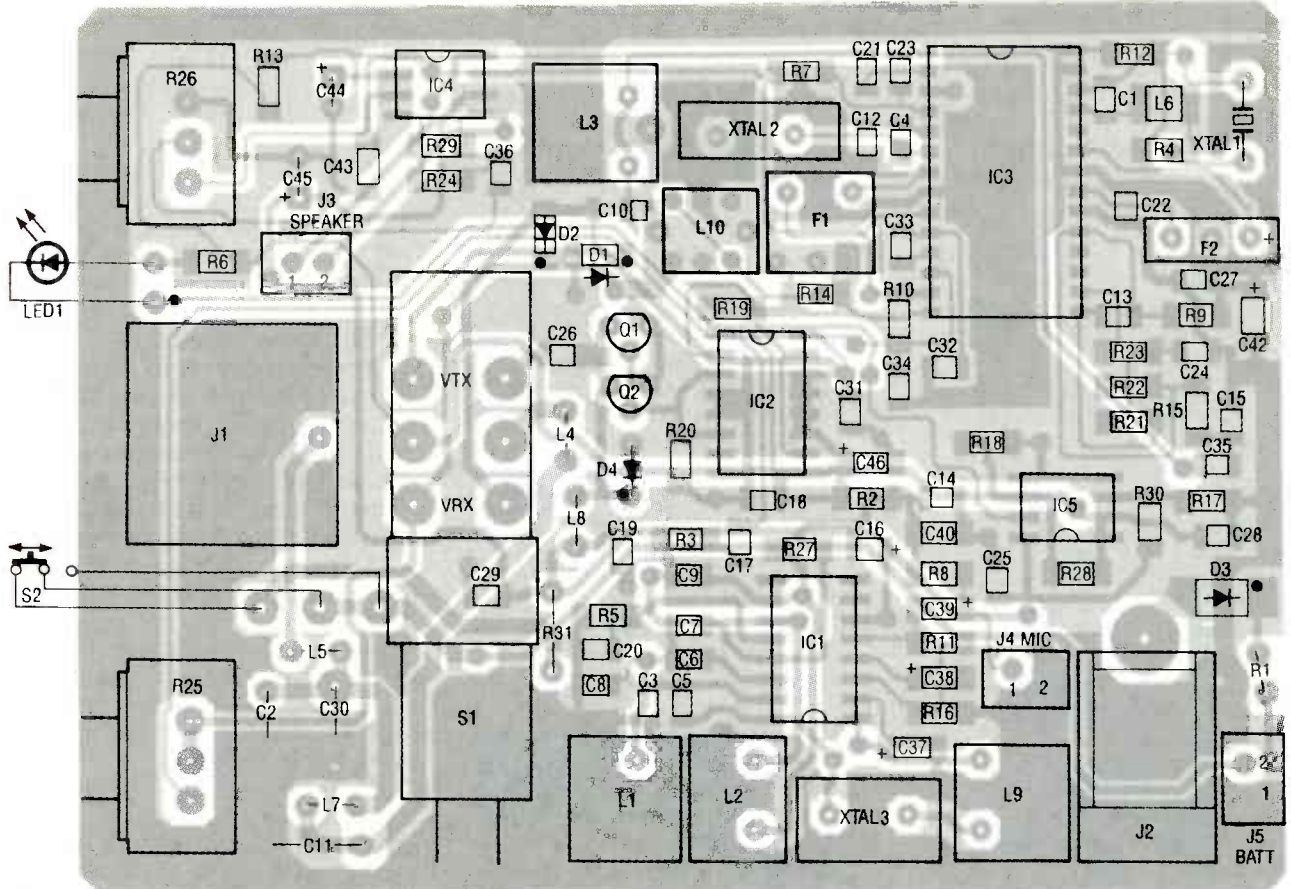

FIG. 5—PARTS PLACEMENT DIAGRAM for the E-Comm transceiver. Note radial leaded components C2, C11, R30 and F2. Axial leaded components R1, L4, L5, L7, L8 and D4 are vertically mounted.

the output of the MOSFET switches to the antenna impedance while also filtering.

Variable capacitor C30 fine tunes the output stage to match the antenna or dummy load. Notice that to obtain class E operation, both the load and the multiplier stages must be tuned in accordance with instructions in the Calibration and Tuneup section of this article. Mismatch and overload protection are provided by Zener clamp D4 (Fig. 1, between Q1 and Q2) as well as the Poly-switch protective resistor R31 (Fig. 2, upper left) in the power supply.

The low-voltage regulator shown in Fig. 1 includes a CMOS voltage regulator IC5, a Maxim MAX666, which conserves power and provides two features: low quiescent current of about 15 microamperes and a built-in low-battery detect function. The regulated output is set by resistor R18 (pin 6) and R28

to be 6.4 volts. This voltage level was chosen to provide enough gate voltage to switch power MOSFET's Q1 and Q2 on hard without exceeding the maximum voltage specification of the quad NAND gate IC2.

The low-battery detect circuit is set by resistors R17 and R30 at LBI pin 3 of IC5 to about 8 volts. Because the voltage regulator is a CMOS device, high resistor values are placed in the feedback loops for further reduction of power consumption. Pin 7 of IC5 LBO has an open-drain output that drives the low-battery indicator LED1.

The receive/transmit switch S1-a turns the receive and transmit sections of the transceiver on and off for further power conservation. The power pack consists of eight AA nickel-cadmium rechargeable cells, each with a rating of 1.2 volts at 500 milliampere hours. The pack is charged through connector J2 (Fig. 1, upper left) by a

120-volt AC to 12-volt unregulated DC adapter plugged into the AC line.

### Building the transceiver

Surface mount devices (SMD) were chosen for E-Comm because they permit the construction of a miniature transceiver, and their small component dimensions help to keep PC board traces short. Therefore, by building this transceiver you'll get a leg up on the whole process of surface-mount technology (SMT) because you will gain hands-on experience in picking and placing the miniature components and an awareness of both the benefits and drawback to SMT. However, *do not* attempt to construct this transceiver unless you are an accomplished project builder.

### Transceiver assembly

Many SMD components are not marked with values or ratings because of the limited

space on their cases. This means that you must be extremely careful to avoid mixing up chip components before and during construction.

Specialized tools should be used in picking and placing SMD components. They should be suitable for grasping small, hard-to-handle parts. Recommended are stainless steel needle-point curved-end jeweler's tweezers for picking and placing small parts such as chip resistors, capacitors and diodes on the circuit board. Fine jeweler's pliers will be useful for straightening stub leads on surface-mount IC's.

Do all soldering with a fine-tipped 10- to 15-watt pencil-type soldering iron. A lighted magnifying glass will be helpful, preferably one that mounts on the edge of a bench. Use only high-quality fine (0.01- to 0.02-inch) diameter solder wire and a suitable liquid flux. Keep fine solder-removing braid on hand to correct any mistakes that you might make.

Anyone building E-Comm should be mentally prepared for the surprisingly small size of the SMD components and their close spacing. Working with SMD components calls for near professional quality soldering skills and a lot of patience. Set up for building E-Comm on a well lighted desk or bench and sit in a comfortable chair. Do not start this fine work unless you are rested and relaxed; mistakes can be costly and frustrating to correct!

Refer to the parts placement diagram, Fig. 5. Be sure to observe all conventions when mounting polarized components such as diodes and capacitors. Dots on the PC board denote polarity. Position all polarized capacitors so the positive lead is nearest the dot, and position all diodes and rectifiers so their cathodes are nearest the dot. Be sure to find the markers indicating pin 1 on all SMD packages. It is typically a white dot.

Do not attempt to build this circuit on any PC board except one that has been specifically designed for this circuit. Failure

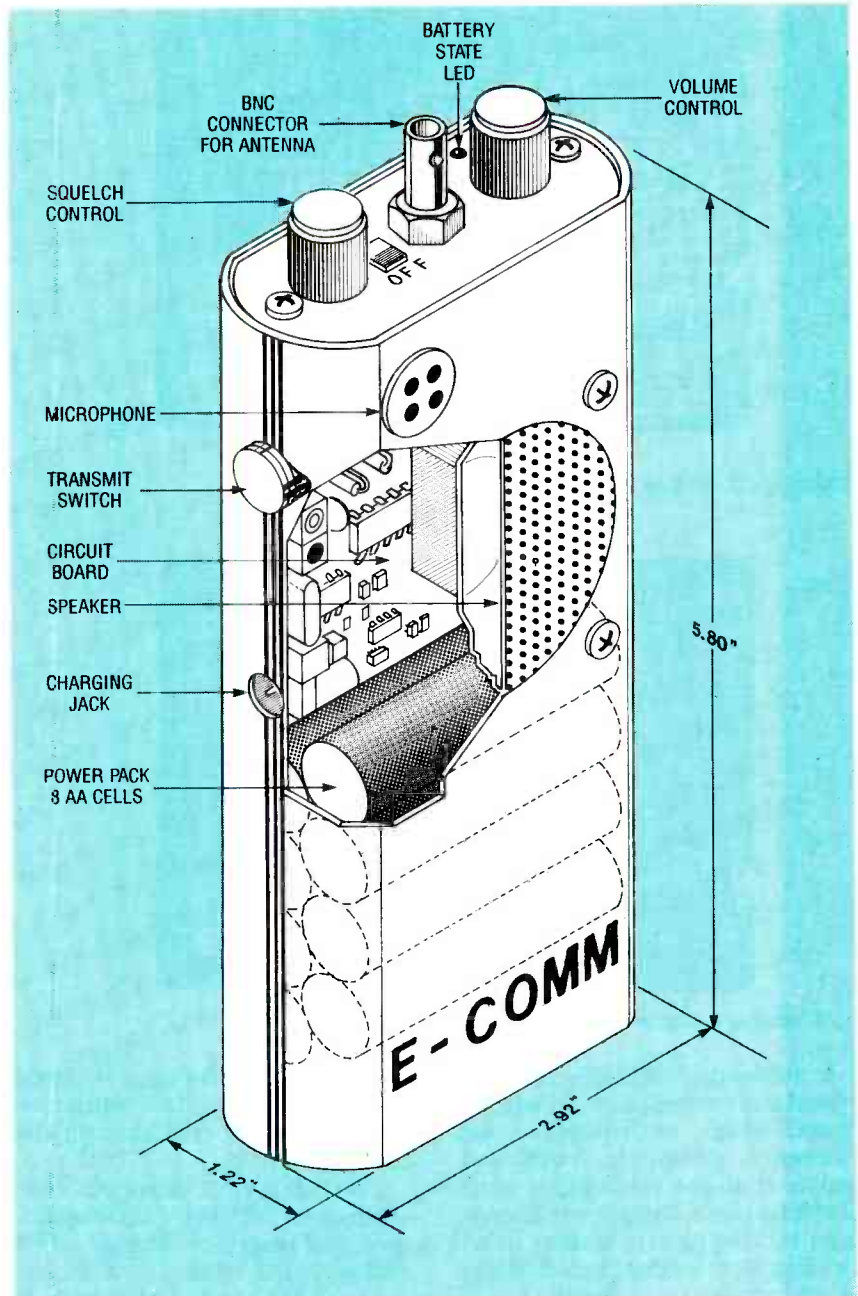

FIG. 6—CUTAWAY VIEW OF ASSEMBLED E-Comm TRANSCEIVER showing the positions of the controls and the locations of the microphone, speaker, loaded circuit board and power pack.

to observe this will result in a poor performing transceiver. A proper PC board for RF circuitry needs an adequate ground plane and short interconnects to prevent inadvertent oscillations, loss of sensitivity, and noise-related problems.

The accurate and effective mounting of SMD components requires a solder mask on the PCB because of the cramped lead spacing. A double-sided board with plated-through

holes and solder mask is available from the source given in the Parts List. It can be purchased as a single item or as part of the options listed.

An orderly assembly procedure is recommended because of the cramped PC board layout and the mixture of small and large components on the board. Solder all surface-mount IC's to the board first. *This is the most time-consuming and tedious part of the project!*

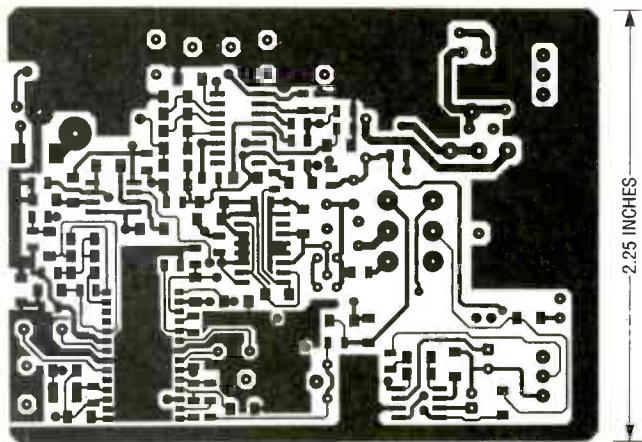

COMPONENT SIDE of E-Comm transceiver circuit board

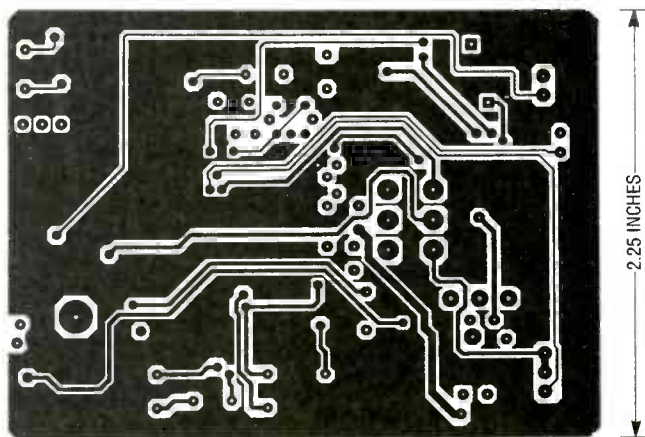

WIRE SIDE of E-Comm transceiver circuit board

In soldering SMD IC's, first tin one of the corner pads on the PC board. Then, with needle-nose tweezers, grasp the part and center it so the leads align with all of the pads. Solder the corner lead to the pad that has been tinned. Next solder the pin diagonally across from the first pin, making sure that the case is still centered on the pads. Before soldering the remaining pins, refer to Fig. 5 and verify that the IC is in the correct position; then double check to be sure that pin 1 is in the correct location.

Be careful not to apply too much solder at each pad, and try to avoid making inadvertent bridges with the molten solder between intended connections and adjacent pins. If bridging occurs, use a solder-removing braid and flux to remove it. Also avoid holding the soldering pencil at any connection point

for more than the time required to cause the molten solder to flow to prevent overheating the component.

The next step is to position and solder all SMD chip capacitors and resistors. *Install all resistors and capacitors of the same value at the same time to avoid mixing values!* Tin one pad of two-terminal components, place the component in the correct position, and hold it with tweezers while soldering it to the tinned pad. Next, solder the other end.

As in soldering the IC's, use only as much solder as is necessary to form a fillet between the component and the PC board pad. Be sure that the components are positioned flush against the board.

After all SMD components are mounted, clean the entire PC board with flux remover, and inspect all of the soldered connec-

tions with a magnifying glass. If all of the SMD soldering appears satisfactory, mount all of the leaded through-hole components with the exception of inductor L8 and solder them in position. (Inductor L8 is to be installed after the multiplier stages are aligned.)

Take care when soldering the connectors because their leads are off-centered. The axial-lead inductors and resistor R1 are mounted through holes. Use the silkscreened pattern on the PC board as a guide. Be sure to mount the switches and potentiometers so they lie flush against the PC board.

Now assemble the battery pack, microphone and speaker. Assemble the connector plugs for J3 to J5 by crimping and soldering them to the battery pack, microphone and speaker wires. Solder two six-inch lengths of insulated 26 AWG wire to the speaker and twist them together. Next solder pins to the ends of the speaker wires, being careful not to let solder flow into contact area. Then push the pins into the mating plastic plug housing. Each pin should snap into place if it is assembled correctly.

The assembly work on the battery pack subassembly is limited to twisting the wires and attaching the connector plug. *Note that this connector is polarized and can only plug in one way.* Verify that the battery connector polarity is correct because reversed polarity will destroy the transceiver!

Solder a four-inch length of shielded coaxial cable to the microphone with the shield connected to the negative side of the microphone. Then connect the cable to the polarized connector, again observing polarity.

Fasten the microphone into the plastic snap-in bushing with a room-temperature vulcanizing (RTV) silicone adhesive. *Mask the front surface of the microphone with masking tape to prevent the entry of any adhesive in the microphone or it could be ruined.* Be sure that the wire side of the microphone is flush with the back of the

*continued on page 60*

# BUILD THIS REFLEX TIMER



***How fast are your reflexes?  
The reflex timer will show you.***

DAN KENNEDY

HOW LONG DOES IT TAKE YOU TO close a switch after you hear a buzzer? When driving, how long does it take to hit the brakes after you see an obstacle? What we're really asking is, "How quick are your reflexes?" Our reflex timer will show you.

Testing your reflexes is a two-person job. To use it, one person secretly starts the timer, which sounds a buzzer. Upon hearing the buzzer, the person whose reflexes are being tested turns the timer off as fast as he can. (That also turns off the buzzer.) The person's reflex time can then be determined by observing a 10-LED display.

Figure 1 is a schematic diagram of the reflex timer, which consists of a 555 timer (IC1) and three 74LS193 4-bit binary counters (IC4-IC6). The 555 timer outputs a pulse about twice every millisecond, or 2000 times a second. The timer is se-

cretly activated by S1 which then turns on piezo buzzer BZ1 via Q1, and connects the clock output from the 555 to the binary counters through one NAND gate (IC3-d), as shown in Fig. 2. The person being timed turns S2 off, which disconnects the 555 output from the counters and turns off the buzzer. Quad NAND gate IC2 is configured as two separate latches, also as shown in Fig. 2, to prevent the contacts of S1 and S2 from bouncing.

Depending on how long it takes the person to shut off the timer, a certain number of LED's light up. The numbers next to each illuminated LED (1, 2, 4, 8, 16, 32, etc.) are then added together to give the person's reflex time in milliseconds. If all the LED's are lit, the total elapsed time is 511 milliseconds or 0.511 seconds. The indicated time can be multiplied

by a correction factor to give a more precise measurement, but that's not necessary for relative measurements or "contests" to determine who has the fastest reflexes. We'll talk more about the correction factor later.

A 7805 voltage regulator (IC7) provides +5-volts DC for the circuit from a 9-volt battery. Two 5.1K resistors (R1 and R2) and a 0.047  $\mu$ F capacitor (C1) give the 555 a clock frequency of approximately 2000 Hz, or 2 cycles per millisecond. Try using a few different 0.047- $\mu$ F capacitors for C1 to get the frequency as close to 200 Hz as possible. Closing switch S4 puts C2 (a 47  $\mu$ F capacitor) in parallel with C1. That slows down the timer to demonstrate how a binary counter works. The numbered LED's will count the number of times that LED1 turns on. The formula  $1440/(R1 + 2R2)C1$  gives the timer frequency in Hz.

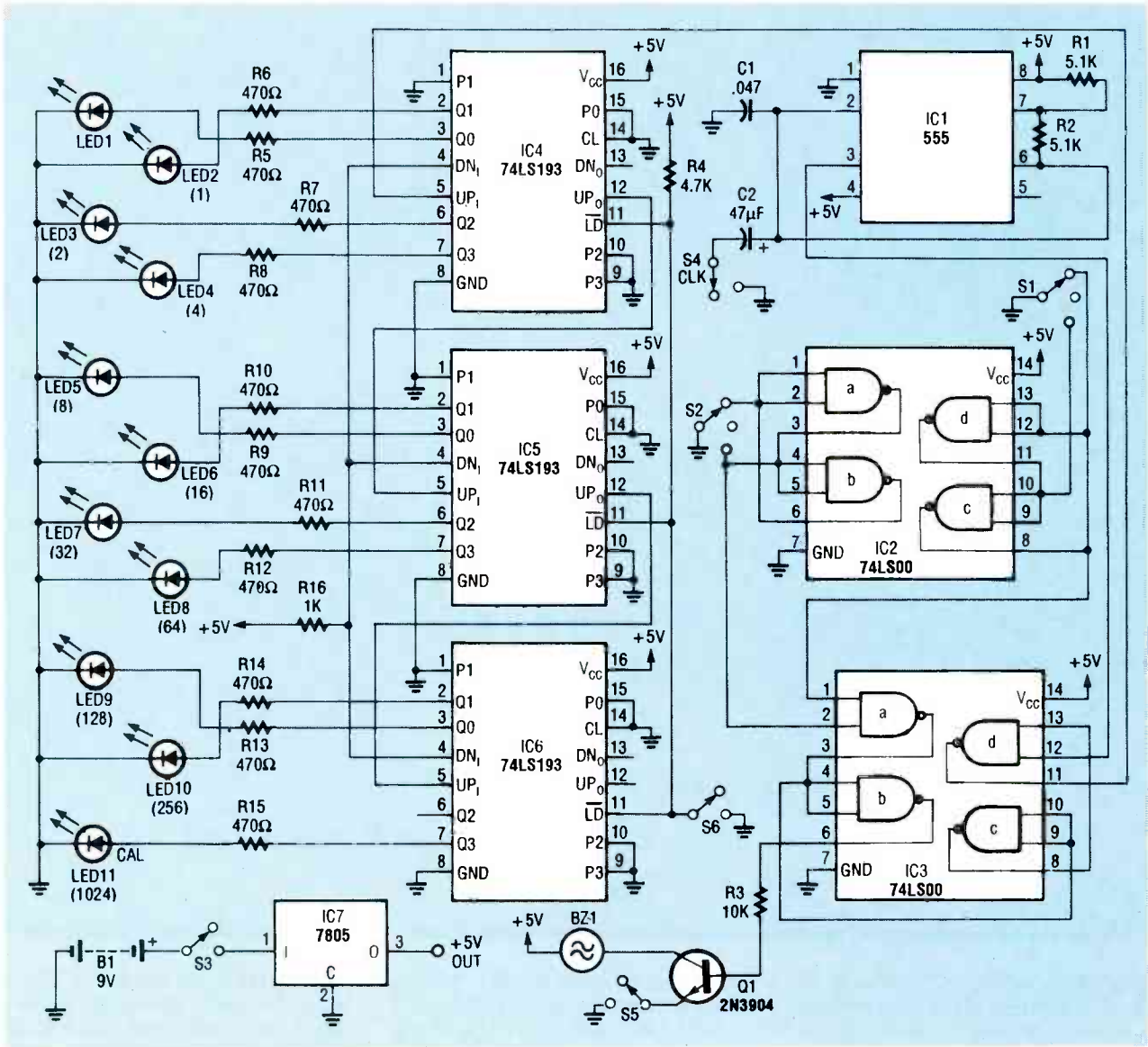

FIG. 1—SCHEMATIC OF THE REFLEX TIMER. It consists of a 555 timer and three 74LS193 4-bit binary counters.

when R1 and R2 are in kilohms and C1 is in microfarads. Switch S5 lets you turn off the buzzer when demonstrating the counters with the lower clock speed.

**The 74LS193 counters**

The 74LS193 is a 4-bit up/down binary counter that can operate at clock speeds up to 25 MHz. Data input pins P0-P3 allow a 4-bit binary number to be loaded into the counter before counting begins. The LOAD input (LD, pin 11) must be pulsed low to load the 4-bit number. Notice that the data inputs (P0-P3) of all three counters are grounded and that the LOAD pins are held at +5 volts through R4. Momentarily clos-

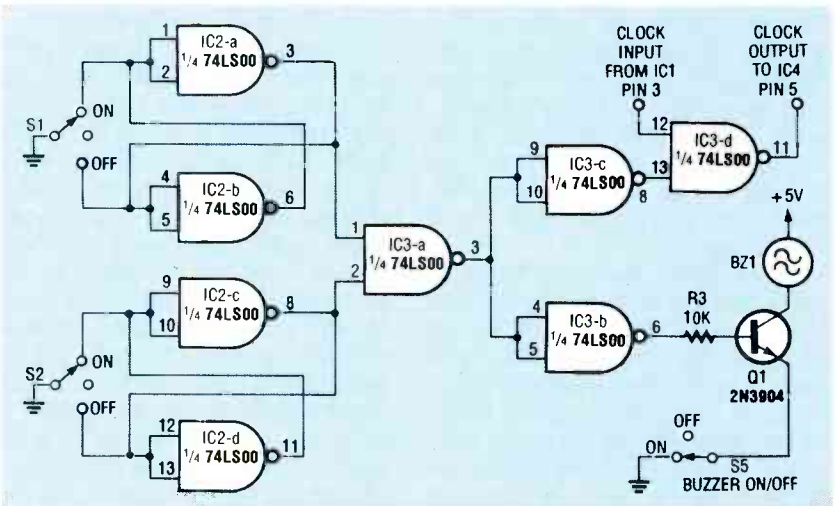

FIG. 2—QUAD NAND GATE IC2 is configured as two separate latches to prevent the contacts of S1 and S2 from bouncing. The clock output from the 555 is connected to the binary counters through one gate of IC3.



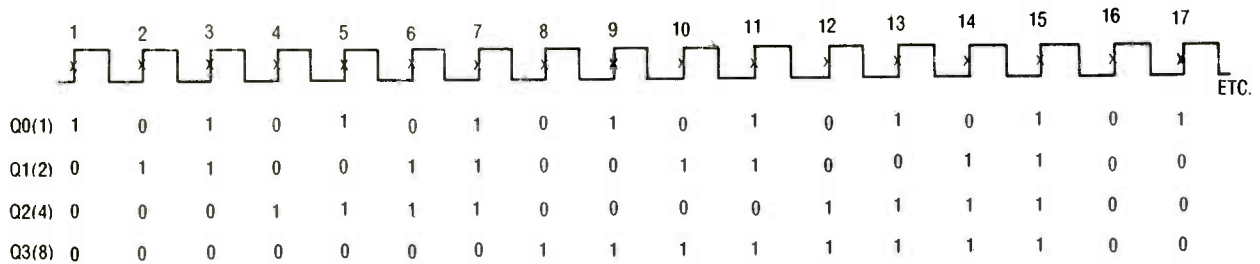

FIG. 3—WHEN ONE COUNTER FINISHES counting up to 15, it sends a carry pulse to the next counter. Here's how a counter responds to 17 clock cycles.

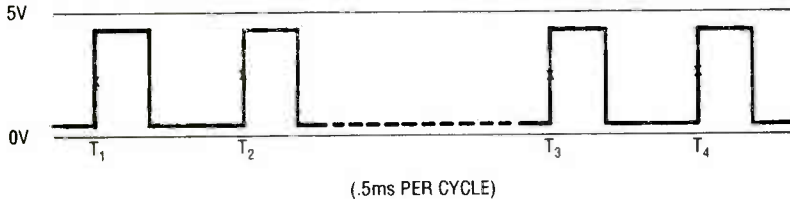

FIG. 4—THE COUNTERS ADVANCE one count on each low-to-high transition of the clock (point "X" on each rising edge).

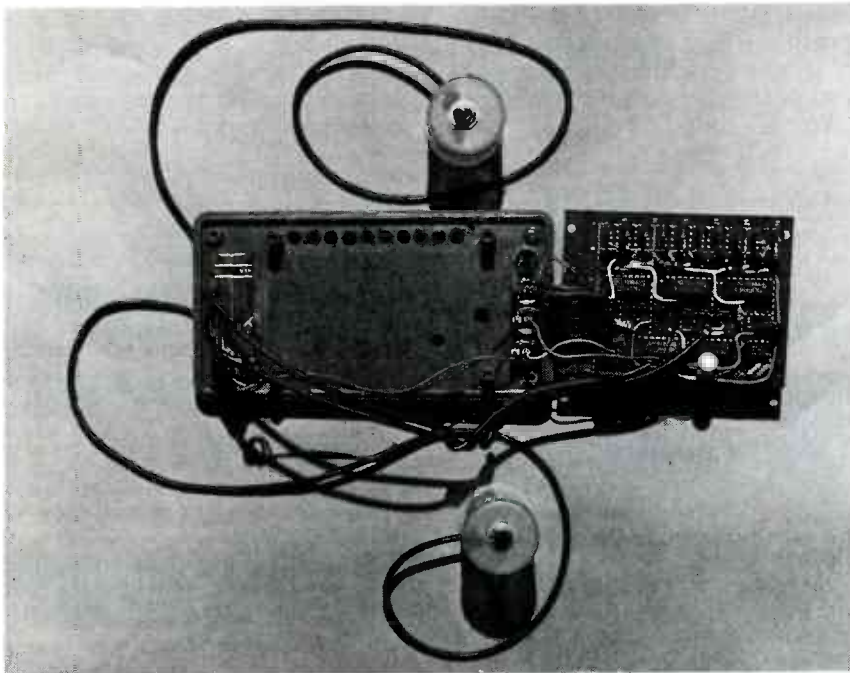

FIG. 5—THE REFLEX TIMER PROTOTYPE was built using perforated construction board and point-to-point wiring. Switches S1 and S2 are housed in plastic 35mm film canisters and connected to the main board with three-conductor wire.

ing switch S6 grounds the  $\overline{LD}$  pins and sets all three counters to zero. Although the CLEAR inputs (CL) are permanently grounded, pulsing them to +5 volts would also reset the circuit's counters.

The COUNT DOWN inputs (dn<sub>1</sub>, pin 4) are held at +5 volts through R16. The clock signal from pin 3 of the 555 is applied to pin 5 on the first counter, IC4.

When IC4 finishes counting up to 15, it sends a carry pulse from its UP<sub>O</sub> (pin 12) to the count up input (UP<sub>1</sub>, pin 5) of the second counter, IC5. Likewise, when the second counter reaches a count of 15, it sends a carry pulse from its UP<sub>O</sub> pin to the third counter, IC6. Figure 3 shows how a counter responds to 17 clock cycles. A low-to-high transition triggers the counter.

When a counter reaches 15, it starts counting again at zero.

### Accuracy

Figure 4 shows the clock signal that is fed to the counters, which advance one count on each low-to-high transition of the clock (point "X" on each rising edge). We can start and stop the count anywhere in the clock cycle. Suppose we start at T<sub>1</sub> (just after a low-to-high transition); the timer will advance one count when T<sub>2</sub> is reached, which will correctly indicate 0.5 milliseconds have elapsed. However, we don't know exactly where in the clock cycle the timer will be started. Suppose the timer is started at T<sub>2</sub> and stopped at T<sub>3</sub>. The timer would read 0.5 milliseconds more than the actual elapsed time because the timer started at T<sub>2</sub> and immediately registered one count.

A similar situation occurs at the stop time. If we start the timer at T<sub>1</sub> and stop at T<sub>3</sub> the count will be correct. But if we start the timer at T<sub>1</sub> and stop at T<sub>4</sub>, the timer would read 0.5 milliseconds less than the actual elapsed time since we stopped the counters just before a low-to-high transition. That means that the accuracy of our timer is limited to  $\pm 0.5$  milliseconds when we use a 2000-Hz clock. (That is also plus or minus the least significant bit (LSB) of our counters, which is the LED without a number next to it.)

Another factor that determines the accuracy of the reflex timer is the clock frequency. If you have a frequency counter you can measure the clock output from IC1 directly. If a frequency counter is not available, you can measure the clock frequency using a stopwatch and

## PARTS LIST

All resistors are 1/4-watt, 5%.

R1, R2—5100 ohms

R3—10,000 ohms

R4—4700 ohms

R5—R15—470 ohms

R16—1000 ohms

### Capacitors

C1—0.047  $\mu$ F, ceramic

C2—47  $\mu$ F, 10 volts, electrolytic

### Semiconductors

IC1—555 timer

IC2, IC3—74LS00 quad NAND gate

IC4—IC6—74LS193 4-bit binary counter

IC7—LM7805 5-volt regulator

Q1—2N3904 NPN transistor

LED1—LED10—red LED

LED11—yellow LED

### Other components

BZ1—Piezo buzzer

S1, S2—SPDT switch with center off

S3—S5—SPST switch

S6—SPST normally-open push-button switch

**Miscellaneous:** Perforated construction board, standoffs, project case, IC sockets, wire, solder, etc.

the calibration LED (LED11). If the clock frequency is exactly 2000 Hz, then it would take 40.96 seconds for LED11 to turn on twenty times. The author measured 41.5 seconds for LED11 to light twenty times. To calculate the frequency, multiply  $2000 \times 40.96/41.5$ ; that comes to 1974 Hz. (A frequency counter measured it at 1979 Hz.) With a clock frequency of less than 2000 Hz, the indicated reflex time would be slightly less than the actual reflex time. Multiplying the indicated time by a factor of  $2000/1974$ , which is equal to 1.013, would give the reflex time correct to the nearest millisecond.

### Construction

No PC board is required to build the reflex timer. Instead you can use perforated construction board and point-to-point wiring. The photo in Fig. 5 shows how the author's prototype was built and installed in a plastic case.

The author used plastic 35mm film canisters to house switches S1 and S2, although other mounting schemes can certainly be used. Three-conductor wire must be used to connect S1 and S2 to the main board.

It's a good idea to mount the IC's in sockets. That way you can easily exchange the 74LS193's with 74LS192's to see how a decade counter works. The 74LS192 has the same pin-out as the 74LS193 but counts only to nine before generating a carry pulse and repeating. Using those chips, the timer would display up to  $399/2 = 199.5$  in binary-coded decimal (BCD). If you wanted to read the time directly in milliseconds (from BCD) you would have to change the clock frequency to 1000 Hz.

The reflex timer is sure to be a smash hit at your next party—with it, you will be able to see for yourself who has the absolute fastest reflexes. R-E

# Train at HOME to be an Electronics Technician!

As the demand for computers and microprocessors in business, manufacturing and communications continues to grow, so does the need for qualified technicians. It's not unusual for experienced technicians to earn from \$30,000 to more than \$40,000 a year.\* Now through Peoples College of Independent Studies you can train for this exciting field without interrupting your job or home life.

### Choose From Five Programs of Study

- Electronics & Microprocessor Technology
- Industrial Electronics & Microprocessor Technology
- Communications Electronics with Microprocessor Technology
- Computer Servicing & Electronics Technology
- Specialized Associate Degree In Electronics Technology

### Professional Equipment Is Included

Depending on the program you select, you'll perfect your skills using this advanced equipment, included in the price of tuition:

- IBM-Compatible Personal Computer
- Digital Multimeter
- Digital Logic Probe
- Elenco Oscilloscope
- Portable Cellular Telephone

(\* Source: U.S. Bureau of Labor Statistics)



### Exclusive Extras That Enhance Your Training

Peoples College introduces some training firsts to make your learning experience more complete:

- Accelerated Learning System — a scientifically proven study system that helps you learn faster and easier than ever before.
- Video Tutor Training Tapes — give you a permanent, visual record of informative lectures and close-up demonstrations.
- Experience Labs — professionally designed experiments that give you hands-on "bench" experience.
- Industry Certification Training Guide — provided with four of our programs. Prepares you for examinations you may take for your professional license or certification.

### Easy Payment Plans — No Finance Charges

To help you get started on your education, Peoples College has reduced tuition rates and offers low monthly payment plans with no finance fees. So don't delay, call or write for more information today!

### For COLOR CATALOG Mail Coupon or Call TOLL FREE 1-800-765-7247

Programs offered only in United States, Canada, Puerto Rico and Virgin Islands. No Obligation. No sales person will call.

Our programs are accredited by the Accrediting Commission of the National Home Study Council

YES! I would like to know more about your training programs. Send a catalog to:

Name \_\_\_\_\_

Address \_\_\_\_\_

City \_\_\_\_\_

State \_\_\_\_\_

Zip \_\_\_\_\_

Phone # \_\_\_\_\_



**PEOPLES COLLEGE**  
OF INDEPENDENT STUDIES

233 Academy Drive • P.O. Box 421768  
Kissimmee, FL 34742-1768

Member, D.I. Peoples Group

R1092

# PC-BASED TEST BENCH

THIS MONTH WE CONTINUE our PC-based test-equipment series by building the T1004 digital logic IC tester and identifier. It is capable of testing 7400, 5400, and 4000 series IC's. In fact, the T1004 should be able to test any digital IC family that has the standard  $V_{CC}$  (+5V) and ground configuration ( $V_{CC}$  on the upper left corner of the IC package and ground on the lower right). On a 14-pin DIP that would mean that  $V_{CC}$  would be pin 14 and ground would be pin 7. The T1004 will accept 14-, 16-, 18-, 20-, 22-, and 24-pin DIP's.

The T1004 performs the following tests: Truth table, positive-going input threshold, negative-going input threshold, input hysteresis, output source capability under load, and an open-collector test. Additionally, the T1004 predicts (based on a best-guess analysis) what type of IC you are testing (HC, HCT, TTL, etc.). From now on, you'll find grab bags of unknown IC's very appealing because the T1004 has a feature that can help you identify those unknown digital IC's. If the IC being tested matches any of the IC's already in the IC database, the T1004 will find and display the names of those IC's. Running a complete test on one or all of those names will, in many cases, provide you with a comprehensive picture of the IC under test. The T1004 also lets you add IC's to the database. As we expand our IC support library we will make updated files available on the RE-BBS (515-293-2283, 1200/2400, 8N1).

## General operation

Figure 1 shows the T1004 block diagram. The chip-select section is driven by the Front End section which we discussed in detail in our June



**The T1004 digital logic IC tester and identifier can handle 7400-, 5400-, and 4000-series IC's.**

STEVE WOLFE

1992 issue; it selects and de-selects every other section in the T1004. The reference-voltage section provides a 2.5-volt reference for the analog-to-digital converter (ADC) section and also for the digital-to-analog converter (DAC) section. The pull-up or pull-down section (PUPD) is capable of providing a 10-kilohm pull-up or a 200-ohm pull-down to any or all of the test-socket pins (except the  $V_{CC}$  pin).

The DAC section produces a voltage (in 20-millivolt steps between 0 and 5 volts) which is fed to the DAC multiplexer (MUX)

section. The DAC MUX can apply the DAC voltage to one of pins 1 through 23 of the zero insertion force (ZIF) test socket. The DAC multiplexer can also disconnect the DAC voltage from the test socket. The ADC multiplexer can select a single voltage from one of pins 1 through 24 of the test socket and feed that voltage to the input of the ADC section. The socket-ground section supplies ground to one of six test-socket pins (pins 7-12) to connect the ground pin of the IC under test to ground.

## Tests performed

### • Truth-table test

During this description we'll use a 7432 quad 2-input OR gate as an example device. Because the 7432 is a 14-pin device, the socket-ground section grounds pin 7 of the test socket. The DAC section is disconnected from the socket. The device is looked up in the database and an input/output (I/O) mask is stored as three variables (or three 8-bit bytes). The I/O mask differentiates inputs from outputs. During subsequent testing, the I/O mask protects outputs from being inadvertently grounded. Next, a line of the truth table is

read into the three variables from the data base. The portions of those three variables which correspond to inputs are sent to the IC under test via the PUPD section. At this point the ADC multiplexer and ADC sections scan every test socket pin for the resultant voltage. Voltages found to be greater than 2.4 volts are converted to highs, and those less than 2.4 volts are converted to lows. The highs and lows are converted to three 8-bit bytes that are compared to the bytes that were read in from the truth table. If they match, the IC has

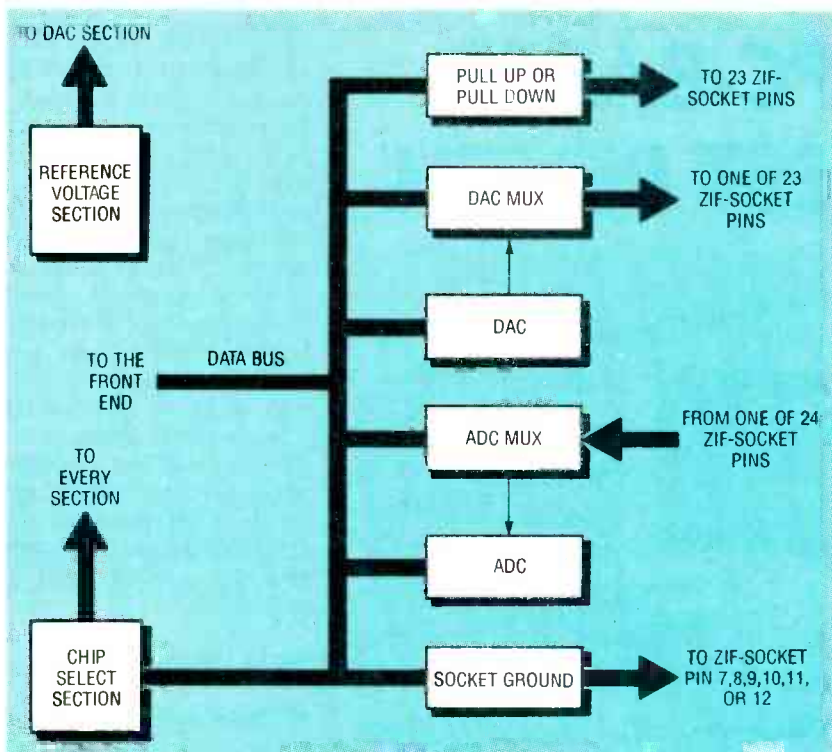

FIG. 1—T1004 BLOCK DIAGRAM. The Front End drives the chip-select section, which selects and deselects every other section in the T1004.

passed the first line of the truth table.

• **Low-to-high input test**

In this section three bytes are again sent to the test socket. The bytes are selected based on the following criteria: A known input pin on the IC under test is being held low. Additionally, when the pin being held low is taken high, a known output pin will change state. Working together, the DAC and DAC multiplexer sections take control of the input pin and slowly ramp its voltage from zero to the voltage level needed to cause the output pin to toggle. The voltage on the input pin is then read back and displayed on-screen next to the label "VT+ :."

• **High-to-low input test**

In this section three bytes are again sent to the test socket. The bytes are selected based on the following criteria: A known input pin on the IC under test is being held high. Additionally, when the pin being held high is taken low, a known output pin will change state. The DAC and DAC multiplexer sections take control of the input pin and slowly ramp its voltage from +5 volts to the voltage level needed to cause the output pin to toggle.

The voltage on the input pin is then read back and displayed next to the label "VT- :."

• **Hysteresis**

Input hysteresis is the difference between the trigger point of an input being taken high and the trigger point of the same input when it is taken low. IC's such as a 7414 intentionally have a large amount of hysteresis to give them increased noise immunity. The T1004 calculates the hysteresis and displays it on the screen next to the label "HYS:." The T1004 calculates hysteresis as follows:

$$(VT+) - (VT-) = (\text{Hysteresis})$$

• **TTL input compatibility**

A TTL-compatible input must trigger when fed a voltage not larger than 2.4 volts. If VT+ is greater than 2.4 volts then the IC under test fails the test.

• **Output-load test**

The output-load test is performed by taking an output high and loading it with 200 ohms to ground for a very brief period. During the time that the load is present, the ADC reads the loaded voltage. This test will reveal weak or damaged gates, help to identify the gate type, and test for an open-collector condition.

Any of the tests described above may be omitted from the testing procedure. The testing process is defined by a *script*, which is a set of test instructions for a particular IC. Each IC has its own script which TSW or the end user writes to suit a particular IC. IC scripts are compiled using a program supplied by TSW.

**Script tutorial**

IC's not presently supported by the T1004 can be added to the existing database by the user. Each script contains the IC's name, whether the IC is an open-collector device, and its truth-table information. Scripts can be written using any ASCII text editor.

The easiest way to create a new script is to copy an existing script and edit it as needed. Once a script has been created, it can be compiled and added to the appropriate database. You can compile a script simply by selecting that option from the software menu. You will be asked to give the name of the script (example: S7400.TSW). The compiler will then open the script and get the IC name. Next, it checks to see if the target IC already exists in the database. If it already exists, then the previous version of the IC script will not be overwritten.

The delete function lets you remove any IC from the database. If the target IC does not exist in the database, then the compiler will compile the target script file and add the results to the database. The original script is written in a form that is easy for a person to follow. Once compiled, the script takes on a more compact form that can be used by the main testing program. Scripts for 14-pin IC's must be located in the directory "\TSW\ICTEST-D14\SCRIPTS." Similarly, scripts for 20-pin IC's must be located in the directory "\TSW\ICTEST-D20\SCRIPTS," and so on.

Take a look at Listing 1. The top line (TUTORIAL SCRIPT NUMBER 1) and the numbers down the left side (1-14) are not part of the script file. They have

been added for reference only, and should not appear in scripts that you write.

The symbols in the beginning of each line tell the software what kind of function is to be performed. A "?" tells the software that the two following variables are the IC's name and whether or not it is an open-collector device, respectively. A "#" tells the software that the letters "I," "O," "V," and "G" designate inputs, outputs,  $V_{CC}$ , and ground, respectively. "V" and "G" always represent  $V_{CC}$  and ground, respectively. The numbers "1" and "0" always represent a logic high and a logic low, respectively.

An "\*" tells the software that following symbols designate the truth table of the IC under test, and that the data should be sent and the results should be read back. A "%" indicates that the following symbols designate the truth table of the IC under test, and that the data should be sent but not read back. A "/" tells the software that the following symbols designate the truth table used for the "low-to-high input threshold test" of the IC under test. A "|" says that the two following numeric variables designate the "low-to-high input threshold test" input and output pins, respectively. A "\" indicates that the following symbols designate the truth table used for the "high-to-low input threshold test" of the IC under test. A "-" means that the following symbols designate the truth table used for the "output load test" of the IC under test. An "=" means that the following numeric variable designates the "output load test" output pin.

Let's take a closer look at the script in Listing 1. Line (1) must contain three string variables separated by commas. The first variable in the line must be a "?" which tells the software that the next character is the name of the IC. The IC name can contain nine characters. In this case the name is "7400." The next character on line (1) tells the software whether or not the IC being tested is an open-collector part; "Y" for open-collector parts

or "N" for parts without an open collector.

Line (2) represents the pin numbers of the IC being scripted. In this case the IC is a 14-pin package. Line (3) is the first line of the truth-table section. From that line the test software is able to determine whether to treat any given pin as an input or as an output. The line must be correct for the lines that follow to work correctly. If the IC being scripted has more than one input/output mode (a

### LISTING 1 TUTORIAL SCRIPT NUMBER 1

```

-----
                                IC NAME
-----
(1) ? , 7400 , N

-----
                                PIN NUMBERS
-----
(2)  0 0 0 0 0 0 0 0 0 1 1 1 1 1
     1 2 3 4 5 6 7 8 9 0 1 2 3 4

-----
                                MAIN TRUTH TABLE
-----
(3) # , I , I , O , I , I , O , G , O , I , I , O , I , I , V
(4) * , 0 , 0 , 1 , 0 , 0 , 1 , G , 1 , 0 , 0 , 1 , 0 , 0 , V
(5) * , 0 , 1 , 1 , 0 , 1 , 1 , G , 1 , 0 , 1 , 1 , 0 , 1 , V
(6) * , 1 , 0 , 1 , 1 , 0 , 1 , G , 1 , 1 , 0 , 1 , 1 , 0 , V
(7) * , 1 , 1 , 0 , 1 , 1 , 0 , G , 0 , 1 , 1 , 0 , 1 , 1 , V

-----
                                LOW TO HIGH INPUT TEST
-----
(8) / , 1 , 0 , 1 , 1 , 0 , 1 , G , 1 , 1 , 0 , 1 , 1 , 0 , V
(9) | , 2 , 3

-----
                                HIGH TO LOW INPUT TEST
-----
(10) \ , 1 , 1 , 0 , 1 , 1 , 0 , G , 0 , 1 , 1 , 0 , 1 , 1 , V
(11) | , 2 , 3

-----
                                OUTPUT LOAD TEST
-----
(12) - , 0 , 0 , 1 , 0 , 0 , 1 , G , 1 , 0 , 0 , 1 , 0 , 0 , V
(13) = , 3

-----
(14) TSW ELECTRONICS
     14 PIN IC TEST SCRIPT
-----

```

74245, for example), you should give a new "#" line just prior to the IC's mode change. You can use as many "#" lines as needed, and you can use them in any section of the script. In this case pin 1 is an input, pin 2 is an input, and pin 3 is an output. Pins 4-6 follow the same pattern and pin 7 is ground. Pin 8 is an output, pin 9 is an input, and pin 10 is an input. Pins 11-13 follow the same pattern and pin 14 is  $V_{CC}$ . If you check your data book you will see that this accurately describes the I/O of a 7400.

Line (4) begins with an "\*." That means that any "1's and "0's corresponding to inputs should be sent to the IC and that the "1's and "0's corresponding to outputs should be read back from the IC. If the "1's and "0's read back do not match the those predicted by the script then a fail condition exists. A 7400 is a quad 2-input NAND gate. The line tests all four gates at the same time. In line (4), pins 1, 2, 4, 5, 9, 10, 12, and 13 are all taken low. Each functioning NAND gate must respond by outputting a high. The results are read back and compared to the script. (Any error within the script will cause good IC's to fail the test). Lines (5) through (7) send and test the remaining truth-table conditions. An "\*" can be used only in the truth-table section. Within that section, you can use as many "\*" lines as you like.

Line (8) begins with a "/." That character causes the "low-to-high input test" (LHT) to be performed. The LHT is used to determine the voltage that an input considers a high, or logic-1. The "1's and "0's corresponding to inputs are sent to the IC. Line (9) contains the character "|," which precedes the input and output pins to be used during the test. In this example pin 2 is used as the input and pin 3 is used as the output. When pin 2 is taken from low to high, pin 3 changes state. It is not important whether pin 3 goes from high to low or low to high, but only that a change of state occurs. The T1004 increases the voltage present at pin 2 (in 20-millivolt steps) until pin 3 changes states. The voltage on pin 2 is read back and displayed.

Lines (10) and (11) contain the character "\" and "|." They work in the same way except that the input voltage is swept from high to low. This test is used to determine  $V_{T-}$ . Line (12) contains the character "-" which sends a truth table that must produce a high on one of the outputs. The next line contains the character "=" which tells the software which output pin is presently high. We could have chosen any

one of four outputs since they are all high. In this instance pin 3 is chosen, and loaded with 200 ohms to ground. The load test determines the sourcing capabilities of the gate, whether the part is open-collector or not, and provides clues that the software uses to predict the IC's family. The prediction of family or type should be considered a best guess (not absolute). Line (14) contains the text "TSW ELECTRONICS," which is there as an end-of-file marker for the compiler.

Listing 2 shows "TUTORIAL SCRIPT NUMBER 2." Line (1) indicates that the device is a 4040 and that it is not an open-collector device. Line (2) indicates that a 4040 is a 16-pin device. A 4040 is a 12-bit ripple counter. Line (3) indicates that pins 1-7 are outputs, pin 8 is ground, pin 9 is an output, pins 10 and 11 are inputs, pins 12-15 are outputs, and pin 16 is  $V_{CC}$ . Pin 10 is a falling-edge triggered clock input. Pin 11 is used to reset the counter, and is active only when high. Line (4) introduces the "%" command, which is similar to the "\*" command, except that no test is performed; "%" should be used whenever you wish to send a byte to the IC without testing for a result.

In line (4) the RESET line (pin 11) and clock line (pin 10) are taken high. On that same line all of the outputs are shown low, which is an accurate representation of the effect that a reset would have on the outputs. Because line (4) is a "%" line, we do not actually test the outputs. On line (5) the reset line is released. On line (6) the clock is taken low activating the first output line (Q0). Because line (6) uses an "\*" instead of a "%," the outputs will be tested for accuracy. The "%" command allows you to configure a device before you begin to test it. It can be used in any section and as often as you like. In the low-to-high input test, it is used to reconfigure the 4040 before we sweep the input. In this case, we are using the RESET input to determine the low-to-high threshold ( $V_{T+}$ ).

The only pin that could be

used for the high-to-low input test is the CLOCK pin. Because clock input pins require fast transition times, they are not suitable for use in threshold tests. For that reason, the high-to-low input test is omitted for the 4040 IC. You can omit any section except the "?" section and the "TSW ELECTRONICS" section. A "#" must precede truth-table, threshold, or output-load tests. It must appear at least once or as often as needed.

## LISTING 2 TUTORIAL SCRIPT NUMBER 2

```

-----
                        IC NAME
-----
(1) 7,4040,N
-----
                        PIN NUMBERS
-----
(2)  0 0 0 0 0 0 0 0 0 1 1 1 1 1 1 1
    1 2 3 4 5 6 7 8 9 0 1 2 3 4 5 6
-----
                        MAIN TRUTH TABLE
-----
(3) #,0,0,0,0,0,0,0,0,G,0,I,I,0,0,0,0,V
(4) %,0,0,0,0,0,0,0,0,G,0,1,1,0,0,0,0,V
(5) %,0,0,0,0,0,0,0,0,G,0,1,0,0,0,0,0,V
(6) *,0,0,0,0,0,0,0,0,G,1,0,0,0,0,0,0,V
(7) *,0,0,0,0,0,0,0,0,G,1,1,0,0,0,0,0,V
(8) *,0,0,0,0,0,0,1,G,0,0,0,0,0,0,0,V
(9) *,0,0,0,0,0,0,1,G,0,1,0,0,0,0,0,V
(10) *,0,0,0,0,0,0,1,G,1,0,0,0,0,0,0,V
(11) *,0,0,0,0,0,0,1,G,1,1,0,0,0,0,0,V
(12) *,0,0,0,0,0,1,0,G,0,0,0,0,0,0,0,V
(13) *,0,0,0,0,0,1,0,G,0,1,0,0,0,0,0,V
(14) *,0,0,0,0,0,1,0,G,1,0,0,0,0,0,0,V
(15) *,0,0,0,0,0,1,0,G,1,1,0,0,0,0,0,V
(16) *,0,0,0,0,0,1,1,G,0,0,0,0,0,0,0,V
(17) *,0,0,0,0,0,1,1,G,0,0,0,0,0,0,0,V
(18) *,0,0,0,0,0,1,1,G,1,0,0,0,0,0,0,V
(19) *,0,0,0,0,0,1,1,G,1,1,0,0,0,0,0,V
-----
                        LOW TO HIGH INPUT TEST
-----
(20) %,0,0,0,0,0,0,0,0,G,0,1,1,0,0,0,0,V
(21) %,0,0,0,0,0,0,0,0,G,0,1,0,0,0,0,0,V
(22) /,0,0,0,0,0,0,0,0,G,1,0,0,0,0,0,0,V
(23) |,1,1,9
-----
                        OUTPUT LOAD TEST
-----
(24) %,0,0,0,0,0,0,0,0,G,0,1,1,0,0,0,0,V
(25) %,0,0,0,0,0,0,0,0,G,0,1,0,0,0,0,0,V
(26) -,0,0,0,0,0,0,0,0,G,1,0,0,0,0,0,0,V
(27) =,9
-----
(28) TSW ELECTRONICS
    16 PIN IC TEST SCRIPT
-----

```

### Detailed operation

We will use BASIC as an example language. As we've seen with previous peripherals, the first step in controlling the T1004 is to establish a base address and select the desired peripheral. The first bit of code will be:  $BAS = 768 : OUT BAS + 31,4$  768 (hex 300) is the factory-preset base address of the I1000. As noted earlier, this address is

DIP-switch selectable. Next, we have an "OUT TO BAS + 31." As you may recall, that address is reserved for peripheral selection. The T1004 has a unit, or peripheral address of "4." Consequently, if we send an "OUT TO BAS + 31" with a data byte of "4," the T1004 will be readied for full I/O operation.

The T1004 schematic has been split into two halves and shown in Figs. 2 and 3. Address lines  $A_0-A_4$  (32 bytes) are used by the T1004 (or any other peripheral) to address its IC's, and  $A_0$  is the LSB of the address lines. (Lines  $A_5-A_9$  are used by the I1000 only.) The chip-select section shown in Fig. 2 (IC23-IC25) contains two 74HCT138's (IC23 and IC24). Whenever their  $\overline{G2A}$  and  $\overline{G2B}$  lines are low and  $G_1$  is high, one of eight outputs will go low depending on the address present on the A, B, and C inputs. IC23 is active when BEN is high,  $\overline{SEND}$  is low, and RD is low. IC24 is active when BEN is high,  $\overline{SEND}$  is low, and WR is low. All but one of IC24's output lines drive the load line of the 74HCT573 latches. Because the load line of a 74HCT573 must see a high to store data, IC25 inverts the active lows produced by IC24.

The voltage-reference section, also in Fig. 2, is composed of IC26, R21, R1, IC9-a, and IC9-b. Trimmer R21 is adjusted for 2.5 volts at TP1. That provides the ADC section with a precise reference voltage. The reference voltage also passes through IC9-b and used by the DAC section.

An "OUT TO BAS + 7" will load a data byte into IC15 (a latch). DAC IC16, in combination with IC17-a, will produce between 0 and 5 volts which is proportional to the byte stored in IC15. The voltage produced will be a function of  $n \times (5/255)$ , where  $n$  is equal to the number loaded into the latch (IC15). A 500-ohm potentiometer (R22) is used to set the full-scale output voltage. If IC15 contains a value of 255, then R22 should be adjusted for 5 volts at IC17-a pin 1. The DAC multiplexer section is composed of IC18 through IC22. A latch (IC18) used to hold the DAC multiplexer address. The

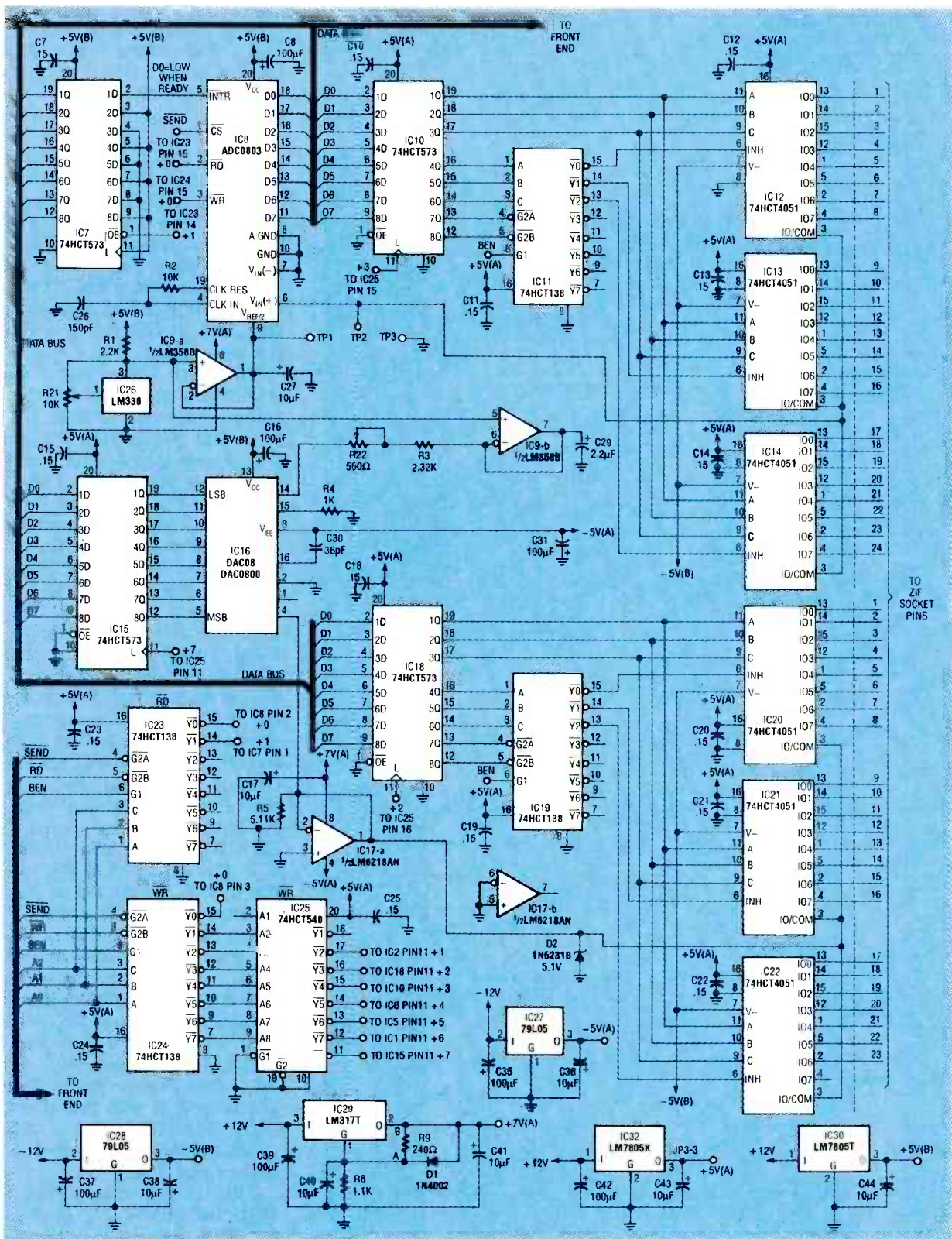
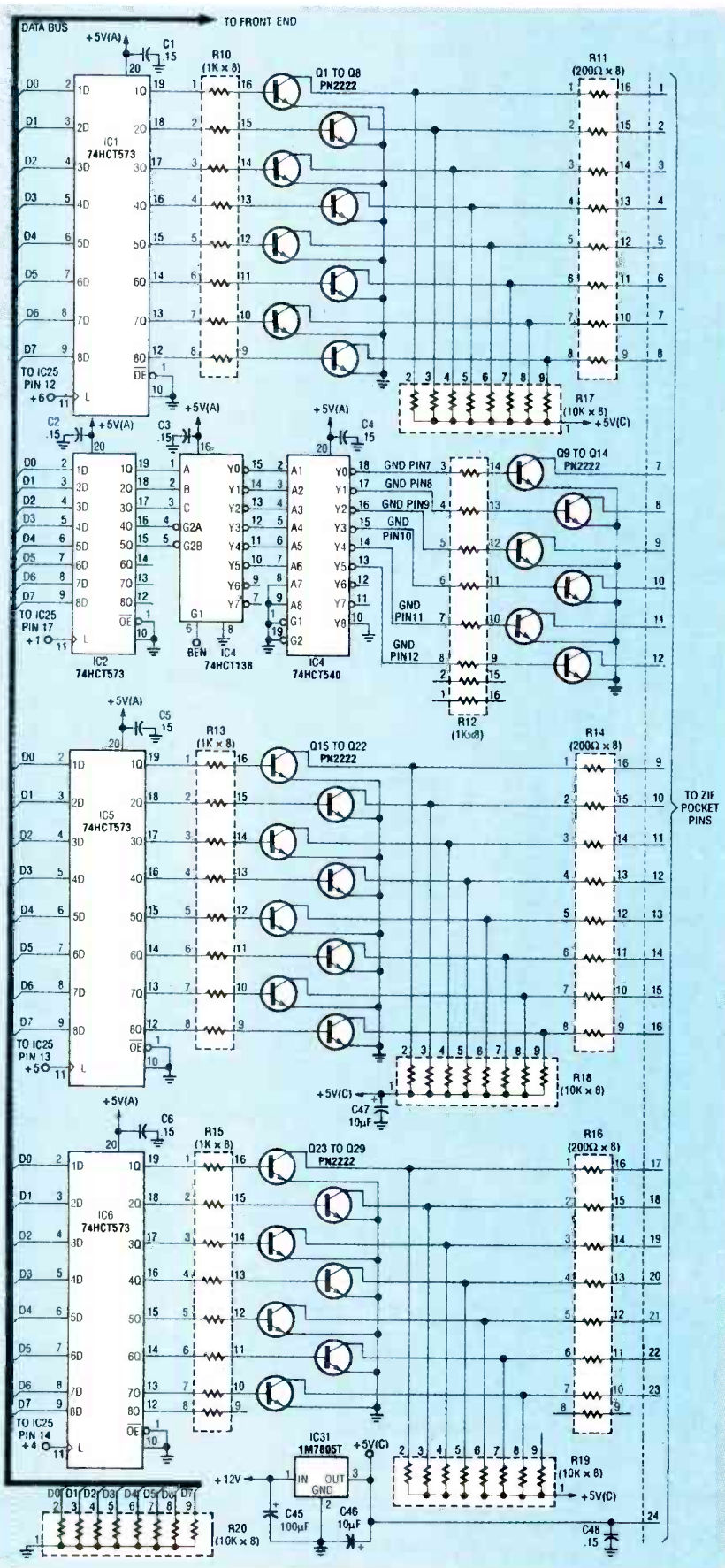

FIG. 2—IN THIS PORTION of the T1004 schematic, address lines A0–A4 are used to address IC's.

least significant three bits of the address are fed to each of three 8-bit multiplexers (74HCT4051). The remaining data lines are fed to IC19 (a

74HCT138), which activates only one of the multiplexer IC's (IC20–IC22). Assuming that the address byte sent to IC18 was less than 23, the DAC voltage is

then passed through to the test socket. If the address byte is 23 or greater, then the DAC voltage is disconnected from the test socket.



Latch IC10 is used to hold the ADC multiplexer address. The least-significant three bits of the address are fed to each of three 8-bit multiplexers. The remaining data lines are fed to IC11, a 74HCT138, which activates only one of the multiplexer IC's (IC12-IC14). Assuming that the address byte sent to IC10 was less than 24, the ADC receives voltage from only one of the test socket pins. If the address byte is 24 or greater, then the ADC is disconnected from the test socket.

The pull up or pull down (PUPD) section, shown in Fig. 3, is composed of IC1, IC5, IC6, R10, R11, R13-R16, R17-R19, Q1-Q8, and Q15-Q29. This section pulls any or all of the test socket pins high or low as needed. The PUPD section is primarily responsible for truth-table functions. Three bytes are used to control the PUPD section. Byte-A controls test socket pins 1-8, Byte-B controls pins 9-16, and Byte-C controls pins 17-23. Pin 24 is reserved for  $V_{CC}$  only and is not affected by the PUPD or DAC sections. The sections controlled by Byte-A, Byte-B, and Byte-C are functionally identical, so we'll describe the Byte-A section only.

We'll assume that the number 85 (01010101) has been sent to IC1. The OUTPUT ENABLE line on IC1 ( $\overline{OE}$ ) is grounded so the "Q" outputs must follow the "D" inputs. Pin 1 of DIP R10 will receive a high, pin 2 a low, pin 3 a high, and so on. Resultantly, the base of Q1 will be taken high connecting ground to R11 pin 1. That causes pin 1 of the test socket to be pulled low through 200 ohms. Because the base of Q2 is low, it will not conduct. That allows R17 pin 3 to pull R11 pin 2, and subsequently the test socket pin 2, high.

The IC ground section consists of IC2-IC4, R12, and Q9-Q14. Any byte latched into IC2 is passed directly to IC3. Byte values ranging from 0 to 5 transition to a low one of IC3's output lines. IC4 inverts the signals which are then fed through R12 to the bases of Q9-Q14. Only one line is active at a time, thus ensuring that

FIG. 3—THE PULL UP OR PULL DOWN section pulls any or all of the test socket pins high or low as needed.



only one transistor is conducting at any given moment. Transistor Q9 is selected when driving a 14-pin device and Q14 would be used when driving a 24-pin device.

Regulator IC27 and its associated components produce -5 volts, which is used by the DAC (IC16). Regulator IC28 and its associated components produce -5 volts for the multiplexers (IC12-IC14 and IC20-IC22). Regulator IC29 and its associated components produce +7 volts, which the op-amps require in order to produce a full 5-volt output swing. Regulator IC31 and its associated components produce +5 volts for the IC being tested. Regulator IC30 and IC32 and their associated

components produce +5 volts for all the remaining IC's. Regulator IC31 produces +5 volts and is dedicated to supplying  $V_{CC}$  to the test socket and +5 volts to the pull-up resistors R17-R19.

### Construction

To build the T1004 peripheral, a PC board is recommended. You can either buy a PC board from the source mentioned in the Parts List or make your own from the foil patterns we've provided. Note that the parts for the Front End are contained on the T1004 board shown with a dark line around them in the Parts-Placement diagram of Fig. 4. There is a separate Parts List for the Front

End, which was discussed in detail in the June issue. Do not confuse the two lists of parts, or where they go on the board. Also, for many of the capacitors, notice that there are three holes on the board, with two of them electrically the same. The holes accommodate capacitors with different lead spacing. Use whichever pair of holes on the printed-circuit board that best fits the capacitors you intend to use for the project.

One of the voltage regulators (IC32) is in a TO-3 case that must be mounted on the back panel of the T1004 case. Mount the regulator, along with an appropriate heatsink, on the back panel and hardwire it to the board. Figure 5 shows the com-

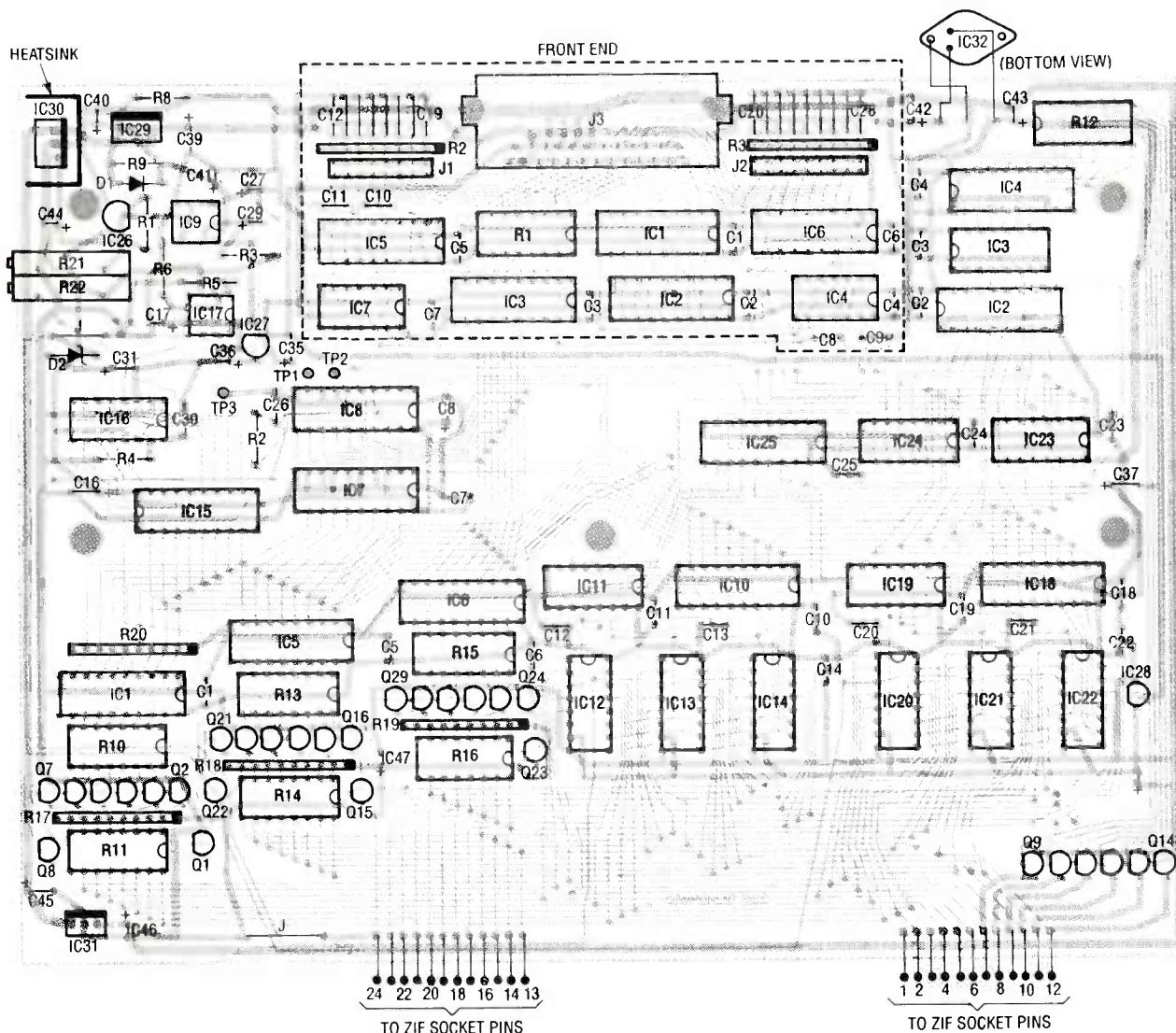
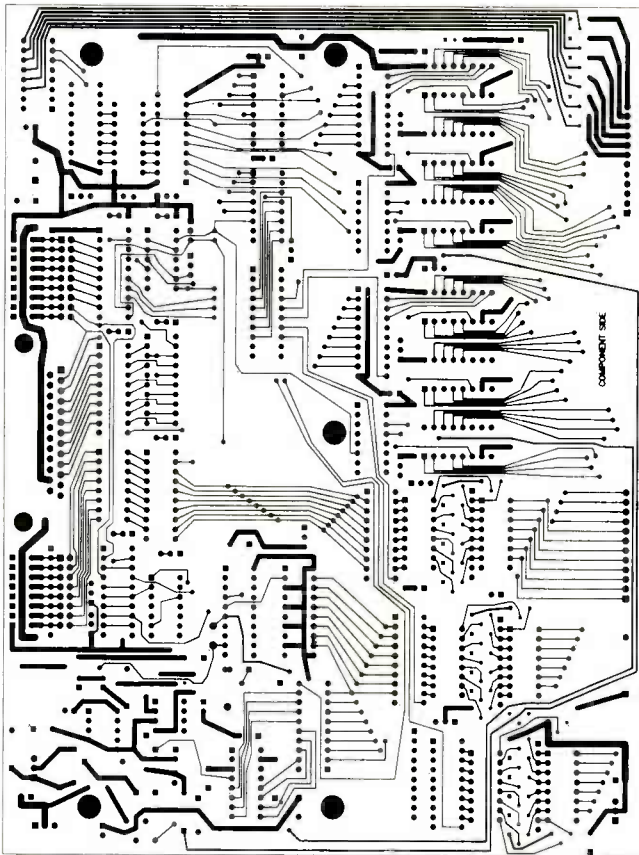
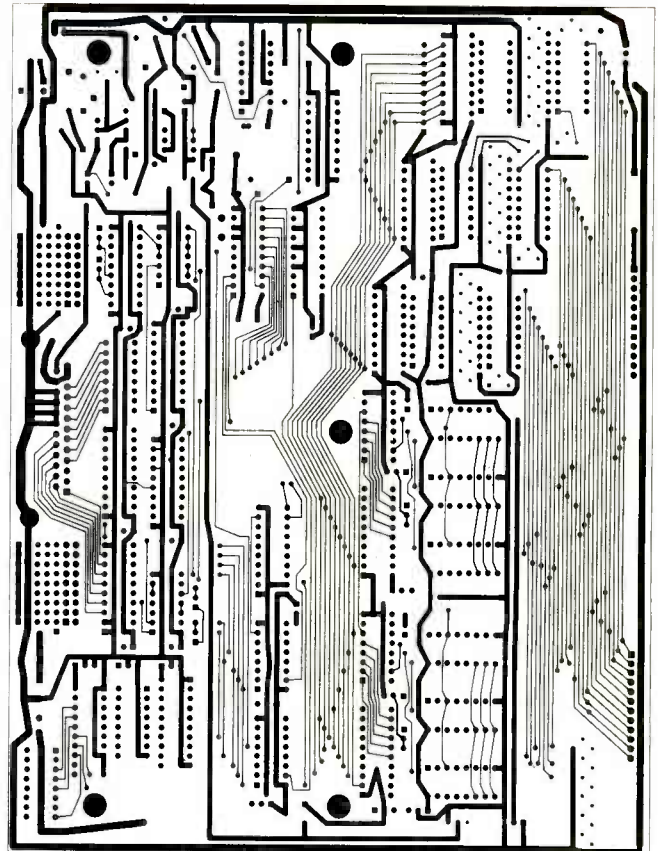

FIG. 4—PARTS-PLACEMENT DIAGRAM. The parts for the Front End are shown with a dark line around them. There is a separate Parts List for the Front End, so don't confuse the two lists of parts, or where they go on the board.



6 11/16 INCHES

T1004 COMPONENT SIDE.



6 11/16 INCHES

T1004 SOLDER SIDE.

### T1004 PARTS LIST

All resistors are 1/4-watt, 5%, unless otherwise noted.

- R1—2200 ohms
- R2—10,000 ohms
- R3—2320 ohms, 1%
- R4—1000 ohms
- R5—5110 ohms, 1%
- R6—2050 ohms, 1%
- R8—1100 ohms
- R9—240 ohms
- R10, R12, R13, R15—1000 ohms, 16-pin DIP

- R11, R14, R16—200 ohms, 16-pin DIP
- R17—R20—10,000 ohms, 10-pin SIP
- R21—10,000 ohms, multiturm trimmer potentiometer
- R22—500 ohms, multiturm trimmer potentiometer

#### Capacitors

- C1—C7, C10—C14, C18—C25, C48—0.15  $\mu$ F, polystyrene
- C8, C16, C31, C35, C37, C39, C42, C45—100  $\mu$ F, electrolytic
- C9, C15, C28, C32, C33, C34—not used
- C17, C27, C36, C38, C40, C41, C43, C44, C46, C47—10  $\mu$ F, electrolytic
- C26—150 pF, mica

- C29—2.2  $\mu$ F, electrolytic
- C30—36 pF, mica

#### Semiconductors

- IC1, IC2, IC5, IC6, IC7, IC10, IC15, IC18—74HCT573 octal latch
- IC3, IC11, IC19, IC23, IC24—74HCT138 demultiplexer
- IC4, IC25—74HCT540 octal buffer
- IC8—ADC0803 8-bit A/D converter
- IC9—LM358 dual op-amp
- IC12—IC14, IC20—IC22—74HCT4051 8-bit multiplexer

- IC16—DAC0800 or DAC08 D/A converter

- IC17—LM6218AN op-amp
- IC26—LM336 voltage reference
- IC27, IC28—79L05 voltage regulator
- IC29—LM317T voltage regulator
- IC30, IC31—LM7805T voltage regulator
- IC32—UA7805K voltage regulator (TO-3 case)

- D1—1N4002 diode
- D2 1N5231 5.1-volt Zener diode
- Q1—Q29—PN2222 NPN transistor

- Miscellaneous: 24-pin ZIF socket, TO-220 heatsink, TO-3 heatsink, PC board, instrument case, wire, solder, etc.

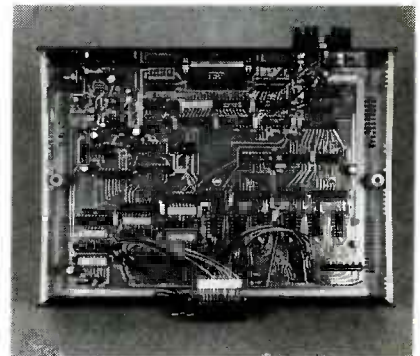

FIG. 5—THE COMPLETED T1004. One of the voltage regulators, IC32, must be mounted on the back panel of the T1004 case.

end up in one directory as you add more peripherals. Software for the I1000 and the entire series of peripherals, including the T1004, can be downloaded from the RE-BBS (516-293-2283, 1200/2400, 8N1) as a self-unarchiving zip file called T1004.EXE. Both compiled and uncompiled software is included. Software is included free with the purchase of any peripheral from the source that is mentioned in the Parts

pleted T1004 board. When you use the T1004, position the IC's you want to test as shown in Fig. 6.

#### Software

Each peripheral has its own software program to control its operation. All of the programs

# Earn Your B.S. Degree in ELECTRONICS or COMPUTERS



## By Studying at Home

Grantham College of Engineering, now in our 42nd year, is highly experienced in "distance education"—teaching by correspondence—through printed materials, computer materials, fax, and phone.

No commuting to class. Study at your own pace, while continuing on your present job. Learn from easy-to-understand but complete and thorough lesson materials, with additional help from our instructors.

Our Computer B.S. Degree Program includes courses in BASIC, PASCAL and C languages — as well as Assembly Language, MS DOS, CADD, Robotics, and much more.

Our Electronics B.S. Degree Program includes courses in Solid-State Circuit Analysis and Design, Control Systems, Analog/Digital Communications, Microwave Engr, and much more.

An important part of being prepared to *move up* is holding the right college degree, and the absolutely necessary part is knowing your field. Grantham can help you both ways — to learn more and to earn your degree in the process.

Write or phone for our free catalog. Toll free, 1-800-955-2527, or see mailing address below.

Accredited by  
the Accrediting Commission of the  
National Home Study Council

**GRANTHAM**  
**College of Engineering**  
Grantham College Road  
Slidell, LA 70460

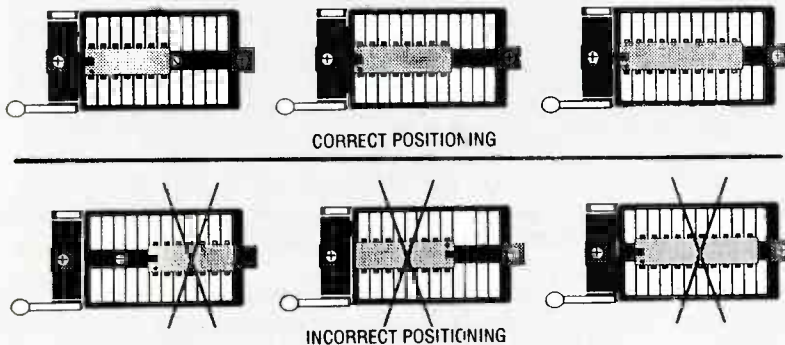
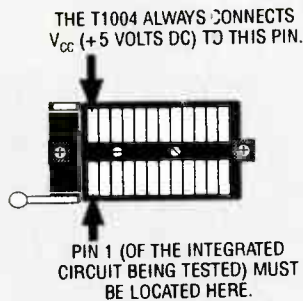

FIG. 6—BE SURE TO POSITION the IC's you want to test in the test socket as shown here.

### FRONT-END PARTS LIST

#### Resistors

- R1—33 ohms, 16-pin DIP resistor
- R2—2200 ohms, 10-pin SIP resistor
- R3—1000 ohms, 10-pin SIP resistor

#### Capacitors

- C1—C7—0.15  $\mu$ F, 50 volts, monolithic or polystyrene
- C8—C11, C20—C28—1500 pF, 63 volts, polystyrene
- C12—C19—220 pF, 100 volts, ceramic disc

#### Semiconductors

- IC1—74LS573D octal latch
- IC2—74LS688D 8-bit magnitude comparator
- IC3—74LS245D octal transceiver
- IC4—74LS02D quad 2-input NOR gate
- IC5, IC6—octal buffer
- IC7—74LS08D quad 2-input AND gate

#### Other components

- J1—16-pin male header
- J2—18-pin male header
- J3—male PC-mount DB25 connector

Miscellaneous: 17 shorting blocks (for J1 and J2)

Note: The following items are available from TSW Electronics Corp., 2756 N. University Drive, Suite 168, Sunrise, FL 33322 (305) 748-3387:

- I1000 kit—\$65.00
- I1000 PC board only—\$35.00
- I1000, assembled and tested—\$77.00

- 6-foot interface cable (DB-25-6)—\$12.95

- T1001 kit (includes PC board, all listed parts, project case, and pre-assembled front and rear panels)—\$149.00

- T1001 PC board only—\$49.00
- T1001, assembled and tested—\$179.00

- T1001 software (included free with T1001 order)—\$10.00

- Capacitor kit (unmeasured)—\$21.00

- Capacitor kit (measured to within 1%)—\$26.00

- T1003 kit (includes PC board, all listed parts, project case, and pre-assembled front and rear panels)—\$159.00

- T1003 PC board only—\$59.00
- T1003, assembled and tested—\$189.00

- T1003 software (included free with T1003 order)—\$10.00

- T1004 kit (includes PC board, all listed parts, project case, and pre-assembled front and rear panels)—\$239.00

- T1004 PC board only—\$79.00
- T1004, assembled and tested—\$249.00

- T1004 software (included free with T1004 order)—\$10.00

Add \$5.00 S&H to any order. Check or money order only.

List. (Software can also be purchased from that same supplier if you're not buying anything else from them and you have no

way of downloading it from the RE-BBS.) With the T1004, you are on your way to automatic troubleshooting. R-E

## HANDI TALKIE

continued from page 42

bushing to provide a gap between the top of the microphone and the holes in the face of the bushing. (that permits sound to enter unimpeded.)

It is recommended that the bushing be snapped into the extrusion before performing the microphone bonding step or the plastic snaps will interfere with the microphone.

Refer to the mechanical layout drawing Fig. 6 as a guide for mechanical assembly. Attach the front panel to the PC board. First attach hex ring nuts to the front of both SQUELCH potentiometer R25 and VOLUME potentiometer R26, and coaxial BNC connector J1. Be sure that the PC board abuts the front panel and is fastened with hex ring nuts on the outside of the threaded barrels of the potentiometers and BNC connector. *Avoid placing excessive torque on the potentiometers by holding the hex ring nuts behind the panel with pliers or wrench while tightening the front nuts with another wrench.*

To complete the assembly of the transceiver, place the speaker and grill inside the aluminum housing extrusion and fasten it with four No. 6-32  $\times$  5/16-inch Philips-head screws, internal tooth lock washers, and nuts. Connect all cables to their proper jacks on the PC board, and slide the assembly into the housing. Depress the transmit switch S1 shaft so that it slides into the housing. *(The transmit switch button cannot be attached until the board is inserted in the extrusion.)*

Attach the end panels with No. 440 self-tapping screws. Slide the knobs on the 0.125-inch diameter squelch and volume potentiometer shafts (R25 and R26) and lock them in position with a 0.050-inch Allen wrench.

### Calibration & troubleshooting

Charge the power cells by connecting them to the wall outlet-

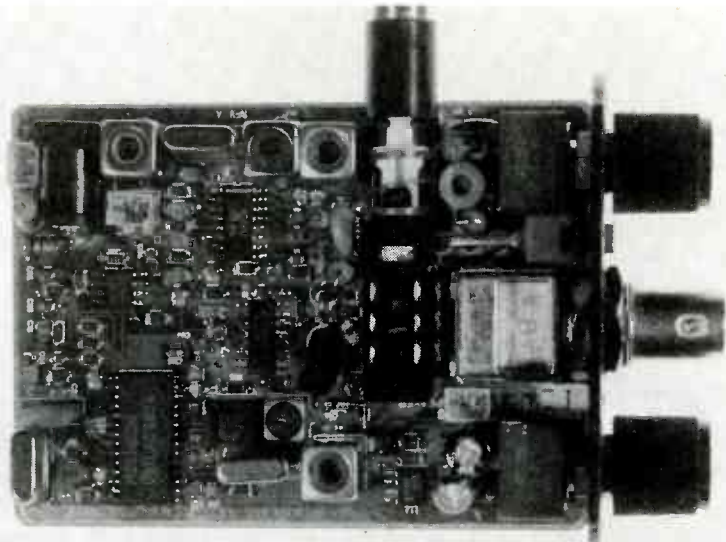

FIG. 7—COMPLETED E-Comm CIRCUIT BOARD shown actual size. Note vertically mounted axial-leaded components R1, L4, L5, L7, L8 and D4.

mounted AC to 12-volt DC adapter for 24 hours. *Be sure the power switch is OFF while the power pack is being charged.* The following test equipment is required to calibrate the E-Comm transceiver:

- Oscilloscope (one that is 50 MHz or faster)
- Frequency counter
- Digital multimeter
- Plastic coil-tuning sticks
- A 50-ohm dummy load

An FM-modulated RF source is helpful but is not a requirement for calibrating the transceiver. The 50-ohm dummy can be made by wiring ten 470-ohm resistors in parallel with short leads. *Be sure that inductor L8 is not installed before starting the procedure!*

First tune the transmitter. Note: *while adjusting the transmitter avoid touching any of the output circuit components because some high voltages are developed there.* Turn on the power switch and connect the oscilloscope leads to pin 1 of IC2, the quad-NAND Schmitt trigger and observe the waveforms while pressing the transmit switch. Tweak inductors L1 and then L2 until a clean sinusoidal waveform is observed. (The frequency should be about 27.145 MHz.)

Disconnect the oscilloscope and attach a frequency counter to pin 1 of IC2 through the high impedance input of the counter.

and adjust inductor L9 to set the frequency to 27.145 MHz. Reconnect the scope again and fine tune inductors L1 and L2 to get the best looking waveform. The waveform amplitude should be between 3 and 6 volts peak-to-peak. If the waveform is satisfactory, solder inductor L8 into the circuit board and attach the 50-ohm dummy load to the BNC antenna jack.

Attach a current meter in series with the power pack or the DC supply to adjust the final RF amplifier. Hook up the output pin of J1 to the oscilloscope and set it to 10 volts per division. While observing the current meter, press the transmit switch and look at the waveform. Quickly tweak capacitor C30 so that the current is less than 400 milliamperes and the output voltage across the dummy load is about 35 volts peak-to-peak.

To obtain maximum efficiency, fine tune inductors L1 and L2 and capacitor C30 to set the output power as close as possible to the optimum value. That value is expressed as  $(V_{out\ peak} \times 0.707)^2 / 50$  divided by the input power  $(V_{in\ DC} \times I_{in\ DC})$ . (This is a "trial and error" step that calls for patience.) *Do not try to set the output to maximum power!*

If the 400-milliamper maximum input current is exceeded-

continued on page 94

# Differential Probe

WALTER DORFMAN\*

**A** differential probe is an oscilloscope accessory that permits you to take measurements from two points in a circuit without reference to ground. That enables the oscilloscope to be safely grounded without the need for optoisolators or isolation transformers. The probe can also make accurate measurements of small signal differences even in the presence of very high common-mode voltage.

The probe, in effect, moves the input terminals from the front panel of the scope to the end of the probe. The inputs of a differential probe with appropriate input ratings can, for example, measure power semiconductor circuits because no reference to ground is needed. Both positive and negative sides of the balanced input offer high impedance to ground. High-impedance differential probes increase the input resistance and reduce the effective input capacitance of the oscilloscope.

The low-cost differential probe shown in Fig 1 was designed primarily for industrial electronic maintenance applications where AC voltages up to 500 volts rms are present. Table 1 gives the leading specifications of that instrument. It has selectable attenuation ratios of 20:1 and 200:1.

Figure 3 is a simplified schematic of the differential probe showing how it is connected between the circuit under test and the scope. A built-in differential amplifier converts the high-voltage differential input signal to a low-voltage single-ended output for a general purpose oscilloscope.

Electronic test labs that perform a wide variety of measurements are likely to own one or more differential probes. But until recently differential probes have been quite expensive (more than \$2000). As a result, you might still see oscilloscopes "floated" above ground while tests of ungrounded circuits are made. While it is never recommended, it can be done safely only if low voltages, say 1 to 28 volts, are involved—and proper safety precautions are taken. Some use a battery-powered portable scope, others remove the ground pin from the scope's AC line plug or find other ways to "un-ground" the scope's chassis.

However, if one is to measure hundreds of volts in ungrounded circuits, the case of the oscilloscope and any metal parts touching that case are at a lethal potential. The scope operator could be electrocuted! That is why demand is increasing for low-cost, industrial-strength differential probes that can make accurate measurements safely on the factory floor with a conventional grounded general purpose oscilloscope.

**Learn how to use the active differential probe to make measurements in ungrounded systems—safely**

\*Walter Dorfman is a Senior Electrical Engineer at Avex Probes, Inc.

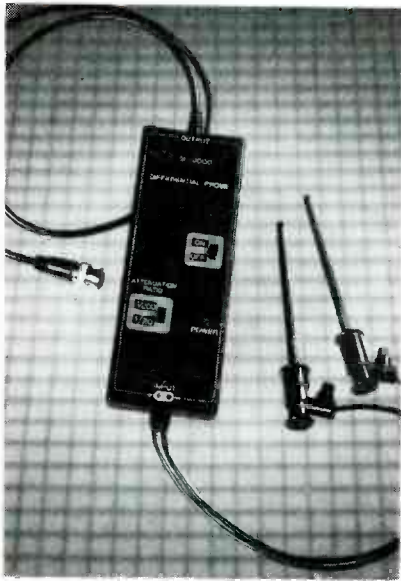

FIG. 1—API MODEL SI-900 ACTIVE DIFFERENTIAL PROBE suitable for making measurements to  $\pm 1000$  volts DC.

### High-voltage application

The best way to explain the value of a differential probe in an industrial setting is to review a problem that occurred in an ungrounded closed-loop control system and that was solved in a safe and timely manner with the probe.

A conveyor belt in a manufacturing plant was exhibiting radical speed fluctuations; it would alternately slow almost to a halt and then speed up to a rate that endangered nearby personnel. Solving this control problem was important because, unless it was corrected promptly, the production line would be shut down.

Figure 3 is the schematic for the belt drive in a control system closed around a programmable logic controller (PLC). The belt-drive DC motor is driven by a single-phase, full-wave SCR bridge that is electrically isolated from the PLC by four isolating SCR gate trigger modules. The motor is electrically isolated from a tachometer that sends velocity signals back to the PLC, and both bridge and motor are electrically isolated from the 220-volt AC line by a 1:1 power isolation transformer.

When the belt was running, persons close to it could hear the sound of the drive motor change pitch as they observed

the erratic belt speed. In attempting to trace the cause of the problem, the first step was to connect a conventional digital multimeter across the motor's armature terminals to verify that the belt speed changes corresponded with motor voltage changes. Then the conveyor belt was disconnected from the drive motor sheave to verify that the the motor's speed variations were not due to variations in belt loading.

### Troubleshooting plan

A troubleshooting plan was formulated to rule out possible faults and isolate the cause to one or more of the system elements. Figure 3 shows that the PLC is referenced to Earth ground. But the rest of the circuit is isolated from ground to prevent a build-up of damaging or hazardous potentials, due to an insulation failure, within the motor-driven conveyor-belt system. The maximum peak-to-peak voltage that could appear in the bridge is about 622 volts, based on the characteristics of a sine wave for 220-volt AC. (The rms voltage must be multiplied by a

factor of 2.83 to obtain the peak-to-peak voltage.) Examination of the control diagram showed that differential measurement techniques were needed to make accurate and safe measurements of this "floating" system.

It would be necessary to check logic-level SCR gate signals riding on the 220-volt AC line. Any differential probe suitable for making those measurements had to be capable of cancelling the large peak-to-peak AC waveform, leaving only the desired logic-level signals, estimated at 3 and 12 volts DC, for analysis.

The differential probe was first connected to Earth ground with the oscilloscope (BNC) connector. Then the probe was connected to the oscilloscope. In this case, the internal power supply was used so the probe could then be turned "on."

Knowing that voltages in excess of 622 volts AC peak-to-peak would be present, a probe attenuation range of 200:1 was selected. (Table 1 shows that for the probe used, the maximum working voltage to ground and between inputs is 500 volts rms, and the maximum non-destructive input is 700 volts AC rms or 1000 volts DC.)

The 622 volts is divided by 200 to become a 3.11-volt sig-

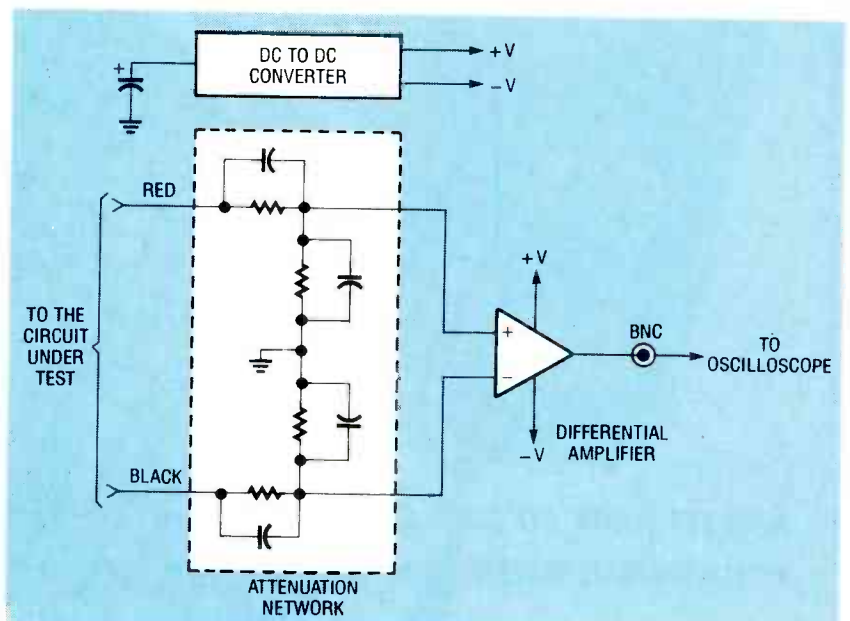

FIG. 2—A SCHEMATIC OF AN ACTIVE DIFFERENTIAL PROBE that can be internally powered by four 1.5-volt cells or an AC to DC converter.

**TABLE 1—LEADING SPECS OF API PROBE**

Bandwidth	DC to 15 MHz
Accuracy	±2% (nominal)
Attenuation ratio	20:1 and 200:1 (selectable)
Input resistance	2 Megohms
Input capacitance	25 pF (each side grounded)
Input range	±700 V DC + peak AC (200:1 attenuation) ±70 V DC + peak AC (200:1 or 20:1 attenuation)
Max. common mode input	500 V rms
Common mode rejection ratio	70 dB @ 1 kHz
Max. output	±3.5 V into 1 Megohm
Output offset	±5 mV (10°C to 40° C)
Power requirements	Four 1.5 V AA cells or 6 V DC, 50 m A adapter

motor's armature, and the periodic high-frequency oscillations shown in Fig. 4-c were seen. Their occurrence matched the motor's speed variations. Next the probe was connected across the anode (+) and cathode (-) terminals of each of the four SCR's in the bridge, and their waveforms were observed.

As shown in Fig. 5, all the SCR's exhibited some waveform distortion, but one of them, Fig. 5-c exhibited more severe distortion than the others.

As the next step, the probe was connected across the gate (+) to cathode (-) terminals of each of the three SCR's that showed lower anode-to-cathode noise voltages. The differential probe successfully cancelled the 622 volts peak-to-peak AC on which the gate-to-cathode voltages were riding. The result was clean, normal gate trigger waveforms with nominal 3-volt peaks, as shown in Figs. 6-a, 6-b, and 6-d.

However, the remaining SCR's gate-to-cathode voltage waveform, Fig. 6-c, showed time-varying gate-trigger pulses. (It was the same SCR that had shown the highest anode-to-cathode jitter in Fig. 5-c.) Some pulses in Fig. 6-c started earlier and others start-

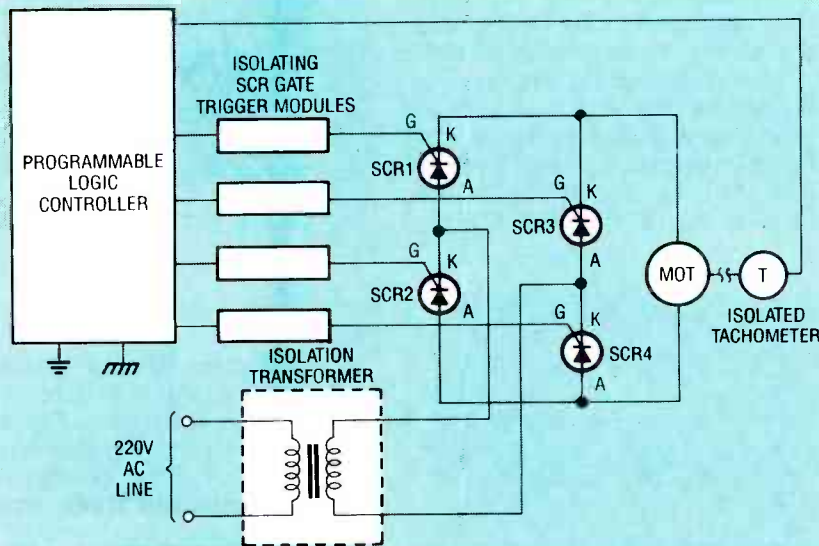

**FIG. 3—A CONVEYOR BELT SPEED CONTROL system, isolated from Earth ground, includes a programmable logic controller (PLC), a full-wave, single-phase SCR bridge, DC motor with isolated tachometer, and four isolating SCR gate-triggering modules.**

nal. (The displayed output voltage had to be kept within the ±3.5 volts limit of the probe.)

The two probe input leads were then carefully connected across the 220-volt AC line feeding the 1:1 isolation transformer. The oscilloscope displayed the 3.11-volts peak-to-peak sine wave shown in Fig. 4-a. The regularity of the scaled-down sine wave showed that there were no faults in the line voltage.

Both probes were moved to the secondary of the isolation

transformer and a waveform essentially the same as the 622-volt peak-to-peak sine waveform of Fig. 4-a appeared; it is shown as Fig. 4-b. However, small distortions and amplitude changes were seen on the negative peaks, and they were in synchrony with motor-speed variations. The electrical noise in the waveform was believed to be due to the reflected loading effects of the motor's power and speed changes.

The differential probe leads were then connected across the

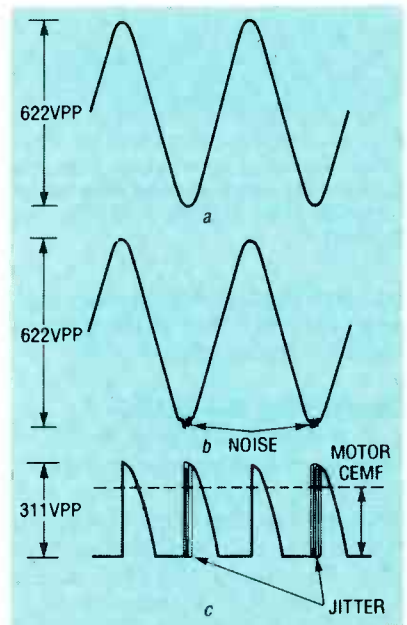

**FIG. 4—VOLTAGE WAVEFORMS viewed at 220-volt AC input: transformer primary a, transformer secondary b, and motor armature (load) c.**

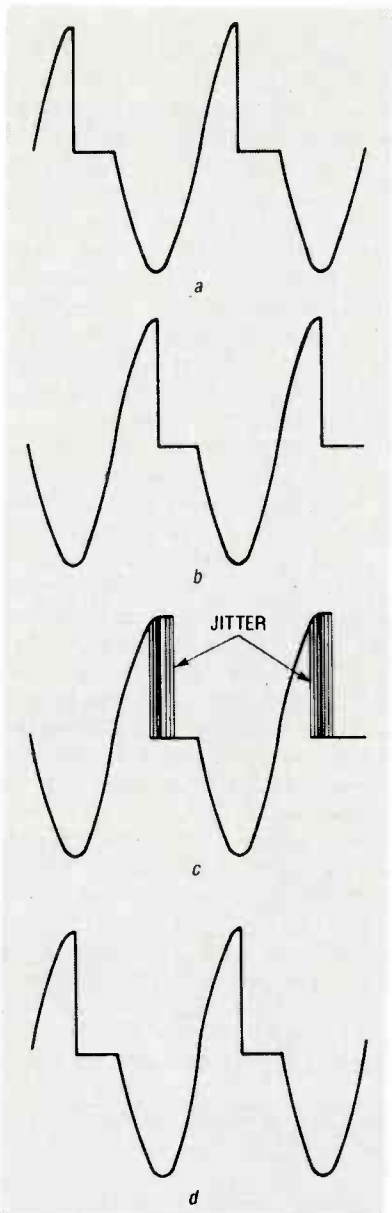

FIG. 5—ANODE-TO-CATHODE VOLTAGES viewed at each bridge SCR (triggered at 90° into a positive peak supply voltage): SCR1 a, SCR2 b, SCR3 c, and SCR4 d.

ed later than the nominal times seen for the other three gate-to-cathode waveforms.

### Identifying the culprit

A pattern had now been established linking the trouble to one SCR channel. It was next decided to determine the quality of the output signals from the PLC. To observe the PLC output lines, which are referenced to system/Earth ground, the black (-) lead of the differential probe was connected to system ground. Because 12-volt logic

signals were to be viewed, the differential probe's attenuator was switched to 20:1 (12 volts/20 = 0.6 volt), and the oscilloscope's vertical sensitivity of 0.1 volt/division was selected.

Three of the four 12-volt logic signals from the PLC to the SCR gate-trigger lines appeared normal, as shown in Fig. 6-e, 6-f, and 6-h. However, the Fig. 6-g waveform was distorted by low-level reflected noise that tracked with the motor's speed variations. It was the same SCR channel that had shown gate-to-cathode electrical noise in Fig. 5-c.

That finding narrowed the cause of the problem down to one SCR channel and it was thought to be either a faulty PLC-to-SCR gate isolating trigger module or a malfunctioning SCR. A new plug-in module was then substituted for the one that appeared to be faulty, and the problem was quickly solved.

The differential probe discussed in this article is sold in the United States by three different suppliers: Avex Probes Inc. (API) as the SI-9000; Test Probes, Inc. (TPI) as the ADF15,

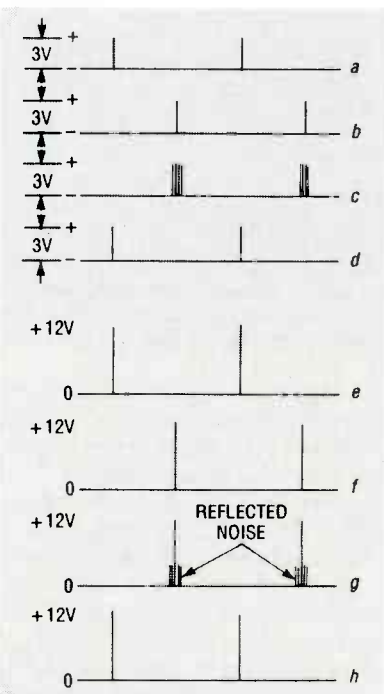

FIG. 6—GATE-TO-CATHODE VOLTAGES viewed at the input of gate terminals of SCR1 to SCR4 a, b, c, and d, and output signals from the PLC a, b, c, and d.

### PROBE SUPPLIERS

#### Avex Probes Inc. (API)

PO Box 1026  
Bensalem, PA 19020  
215-638-3300  
CIRCLE 316 ON FREE INFORMATION CARD

#### Hewlett-Packard

PO Box 612350  
San Jose, CA 95161-2350  
800-452-4848  
CIRCLE 317 ON FREE INFORMATION CARD

#### ITT Pomona

1500 East Ninth St.  
Pomona, CA 91769  
714-469-2900  
CIRCLE 318 ON FREE INFORMATION CARD

#### Jensen Tools, Inc.

7815 South 46th St.  
Phoenix, AZ 85044-5399  
602-968-6231  
CIRCLE 319 ON FREE INFORMATION CARD

#### Probe Master Inc.

4898 Ronson Court  
San Diego, CA 92111  
800-772-1519  
CIRCLE 320 ON FREE INFORMATION CARD

#### Tektronix

PO Box 50  
Beaverton, OR 97077  
503-627-7111  
CIRCLE 321 ON FREE INFORMATION CARD

#### Test Probes, Inc. (TPI)

9178 Brown Deer Road  
San Diego, CA 92121  
(616) 552-2090  
CIRCLE 322 ON FREE INFORMATION CARD

and Probe Master as the PM4230.

For purposes of comparison, consider two other differential probes, the Tektronix P6046 and the Hewlett-Packard HP 1141A/1142A. The Tektronix system consists of three separate cable-connected units: a probe head, an amplifier, and an AC-line operated power supply. It has a common-mode rejection ratio (CMRR) of 10,000:1, an input resistance of 1 megohm, and an input capacitance of 10 picofarads. Its maximum bandwidth is 100 MHz, and its maximum DC plus peak AC is  $\pm 250$  volts.

The HP 1141A differential probe is a 1x FET differential probe with a 200-MHz bandwidth and a CMRR of 3000:1. The probe has an input resistance of 1 megohm and an input capacitance of 7 picofarads. It must be used with the HP 1142A probe control and power module system.

R-E



# FROM NotWorking To NETWORKING

*Bring your knowledge to bear  
on several tough LAN case histories.*

GARY McCLELLAN

PARTS 1 AND 2 OF THIS THREE-PART series on troubleshooting LAN's presented technical background on network technologies (in Part 1), and on tools and test equipment (in Part 2). This time we put our knowledge to work in diagnosing and solving network problems of varying difficulty.

In each case, we will describe the type of LAN, symptoms manifested, fault isolation techniques, use of test equipment, and repair methods. To follow the discussion, it is important to have at least a basic understanding of LAN technologies and test equipment as described in parts 1 and 2. So if you are unsure about anything discussed so far, reread those parts before continuing.

## **The computer ate my work!**

This one happened at a local metal fabrication shop; the symptoms drove the company's finance people up the wall! That shop had five XT clones communicating with an IBM PC-AT file server via Ethernet. For a long time, the network had been reliable, but after several years of use, it began to run slower and slower whenever users ran order entry and accounting programs off the file server. Error messages began to appear, and sometimes users had to repeat the process. Troubleshooting began when several people in the order entry department

complained of trashed data.

Several users were affected, so it seemed unlikely that their computers were at fault. That left the Ethernet backbone cable and the file server as suspects. The backbone cable could have been the problem, but it didn't seem likely. Then someone discovered that a seldom-used word-processing program ran fine, so we ruled out the possibility of cable fault. That left the file server and hard disk as a possible culprit.

That evening we shut down the network and ran a "disk doctor" program on the file server. Those programs are available from several sources, including Symantec (Norton Utilities), Central Point Software (PC Tools), and Gibson Research (SpinRite). What these programs do is perform a non-destructive low-level format of a disk drive. Typically, such programs work by reading a track of data from the drive, formatting that track, and rewriting the data. Any bad sectors detected along the way get mapped out, and the data gets moved elsewhere, if possible. Figure 1 shows a sample screen from the Calibrate utility included with versions 6.x of the Norton Utilities.

A related function often goes by the name of *disk defragmenting*, which attempts to group logically related segments of a file together physically in con-

secutive sectors of a disk. Doing so can dramatically increase the speed with which DOS reads files. A disk becomes fragmented because, when a file is erased, DOS subsequently adds the now-unused sectors to a pool of sectors that might subsequently be reused. A particular group of erased sectors might not contain enough space to hold an entire file, so DOS puts parts of the file in non-adjacent areas across the disk. The result is that when loading the program or data file, DOS sends the read/write head all over the surface of the disk, rather than lapping up sectors one by one. That jerky head motion can really slow things down. It is not unusual for overall operation to be speeded up by 10–20% or even more simply by "doctoring" the hard disk. Norton and Central Point both include disk defraggers as well.

Anyway, running a disk doctor program on the fabrication shop's server solved the problem. To avoid that type of problem, run a disk doctor program a minimum of every six months to catch bad cylinders and prevent data loss. If you encounter many bad cylinders, say 5% or more, you should replace that hard disk before a catastrophic failure occurs!

## **The dead PC**

Many LAN problems go like this: A user cannot log onto the

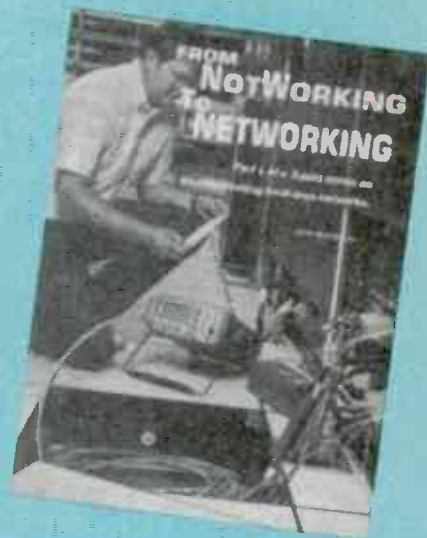

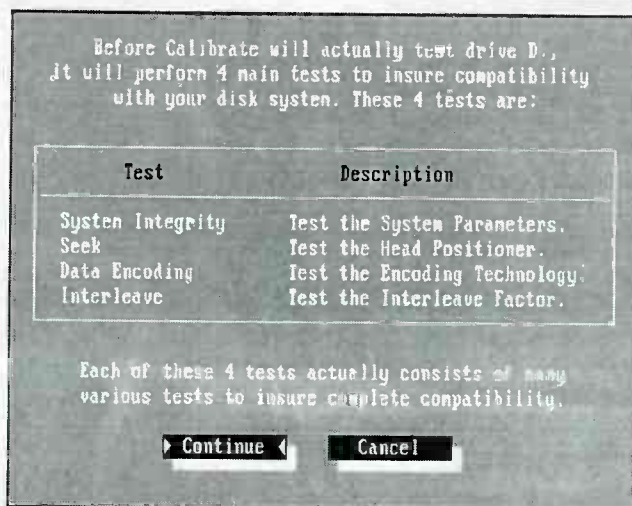

FIG. 1—SOMETIMES NETWORK FAULTS aren't network faults at all, but faults with hard-disk drives. In an MS-DOS environment, Norton's Calibrate utility can help to locate and lock out bad sectors.

network, or a PC suddenly drops offline—but other users remain unaffected. Following are two examples of this type of problem, along with corresponding solutions.

Example one occurred in a parts distributor's office. The LAN consisted of five clone PC's and a generic 80286 file server tied together via ARCnet. ARCnet operates over RG-58 thin coaxial cable that runs from computer to computer.

First, we tested the sick PC off-line and found it to be functional. That left the Network Interface Card (NIC) and LAN cabling as suspects. First we inspected the coax cables and they looked good. But a gentle tug on a loose BNC cable connector caused it to come off. Replacing the connector brought the computer back to life.

Generally speaking, connector faults are a major problem on LAN's. Most BNC connectors are crimp-on types, and if installed improperly, eventually they fail—but not before becoming intermittent and causing lots of grief! Connector problems usually develop several years after their initial installation; often they're caused by oxidation of contacts. For problem installations, we prefer soldered to crimp-on BNC con-

nectors. They take 5 to 10 minutes longer to install, but are far more reliable.

Many connector problems are caused by users who accidentally damage cables by crushing them under chair legs, or dropping equipment on them. Our troubleshooting kit includes a collection of 10-foot cables which have coaxial BNC connectors, triple twisted-pair RJ-11 connectors, and quad twisted-pair RJ-45 connectors. The cables are for on-site substitution of questionable cables.

Example two in this category concerned a dead computer in a medical billing office. The company used five IBM PC's linked by telephone-type unshielded twisted pair (UTP) cabling into a Compaq 386 configured as a hub. The hub serves as both a file server and as a central point to which all cabling returns.

We tested the problem PC, and it appeared to be working. It just wouldn't log onto the network. We substituted a different drop cable between computer and wall outlet; the new cable worked for a while and then quit. Next we substituted a PC from the office of a vacationing user, but without success.

At that point the problem could have been anywhere, in-

cluding the computer, its NIC, the cable plugged into the wall outlet, or even the wiring back to the hub.

First, we checked the old wall cable with the Paladin PatchCheck tester (discussed in the last article). PatchCheck checks cables in seconds, if you can access the modular plugs on both ends. Pin 2 showed a dim indication on the tester, suggesting high resistance. We didn't know which end was bad, so we replaced the connectors at both ends. The cable then tested good, so we reinstalled it and were able to log onto the network briefly. But then trouble developed again. On a hunch, we pushed and held the modular connector in the wall outlet. The user could log onto the network and work normally—until we let go of the connector. Then the PC crashed. Replacing the wall outlet solved the problem.

In general, most twisted-pair cable problems are caused by bad crimps or by users pulling individual strands out of the connectors. In the present case, the initial installer used cheap connectors that probably were not crimped fully, which in turn caused resistance to increase over time. As for the wall outlet, close inspection showed that the pins were partly covered by a greenish film, probably caused by moisture in the wall corroding the faulty gold plating on the pins.

If you want to avoid a career in connector replacement you should always use quality cable and wall-socket connectors.

### Warehouse madness

The problems described so far represent roughly 80% of the faults you will encounter on computer LAN's. But there are other kinds of problems that will tax your troubleshooting abilities, and that also require specialized test equipment. Our next case is a good example.

A firm relocated to a new headquarters 100 miles away, leaving behind a warehouse. The new system used an IBM midrange computer (at headquarters) and CRT terminals and printers (in the ware-

house), all connected via modems and a dedicated telephone line. The purpose of this arrangement was to generate customer shipping orders. One day all the terminals and printers in the warehouse stopped cold. The data processing manager (DPM) of the company found that his equipment was not working properly, and he blamed the telephone line. The local telephone company checked its line and pronounced it good! So where was the problem?

One possibility was that the fault was somewhere in the warehouse, between the modem and the outside line connections. With permission, we inspected the modem wiring in the telephone cable closet. It looked good, but then we measured the line voltage with a DMM. It read zero! We had expected 2 to 10 millivolts of AC noise, typical on a terminated line. A quick resistance check showed 7 ohms. There was a short in the wiring!

We then spent several hours walking between modem and cable closet, disconnecting wiring, and eliminating various suspects. One look at the huge bundles of wiring on the wall of the building was enough to discourage fault finding by visual inspection!

The solution was to use a time domain reflectometer (TDR), which can locate faults along the cable. After making sure the outside telephone line and modem cable were still disconnected, we attached a MicroTest Cable Scanner handheld TDR to the line in the closet. The TDR indicated some irregularity about 70 feet away, which put the fault near the modem. Then we made another measurement near the modem end, and the cable scanner indicated a dead short.

Then we traced the wiring into a storage closet where the red and white twisted-pair cable ran through a hole in a steel riser and up the wall. Close inspection of the wires running through the hole revealed that a sharp edge had cut through the insulation and shorted the ca-

ble. Insulating the wires with electrical tape brought the network back on-line.

The problem of different or-

#### NETWORK BACKGROUND

The following are reference materials, equipment suppliers, and network-related standards organizations.

##### References:

- *The Practical Guide to Local Area Networks*, Rowland Archer, Osborne-McGraw Hill. Good introduction to cable types, topologies, and access methods.
- *Networking IBM PCs*, Michael Durr, Que Corporation. Chapter 14 contains good overview of bridges, routers, and gateways.

- *LAN Magazine*, 600 Harrison Street, San Francisco, CA 94107 (415) 905-2200.

##### Suppliers:

- Black Box Corporation, P.O. Box 12800, Pittsburgh, PA 15241, (412) 746-5530.
- Cable Express Corporation, 500 East Brighton Avenue, Syracuse, NY 13210, (315) 476-3100.
- Contact East, 335 Willo Street South, North Andover, MD 01845, (508) 688-7829
- JDR Microdevices, 2233 Samaritan Drive, San Jose, CA 95124, (800) 538-5000.
- Jensen Tools, Inc., 7815 S. 46th Street, Phoenix, AZ 85044, (602) 958-6231.

##### Standards Organizations:

- American National Standards Institute, 1430 Broadway, New York, NY 10018, (212) 642-4900.
- IEEE Headquarters, 345 E. 47th Street, New York, NY 10017-2394, (212) 705-7900.

#### RESOURCES

The following are addresses of manufacturers whose products were discussed in this series of articles. Contact those companies for current pricing and more information.

- Paladin Corporation, 3543 Old Conejo Rd., Newbury Park, CA 92123, (800) 272-8665.
- MicroTest, Inc., 3519 E. Shea Blvd. Suite 134, Phoenix, AZ 85028, (800) 526-9675.
- *Radio Amateur's Handbook*, American Radio Relay League, Newington, CT 06111.
- Tektronix, Inc., Redmond Division, 625 S. E. Salmon Dr., Redmond, OR 97756, (800) 833-9200.
- AMP, Inc., P.O. Box 3608, Harrisburg, PA 17105, (717) 561-6168.
- Gibson Research, 22991 La Cadena Dr., Laguna Hills, CA 92653, (714) 830-2200
- Symantec Corp., Norton Utilities, 10201 Torre Ave., Cupertino, CA 95014-2132, (408) 253-9600.

ganizations blaming each other for faults neither can trace is common, because most LAN's consist of different products from different vendors, including computers, terminals, printers, modems, NIC's, cables, and more. The solution is to learn about your LAN equipment and service it yourself, or find a trustworthy service firm that can do it for you.

#### Cloak and dagger

We saved the most fascinating LAN servicing case for last. After this case was resolved, someone must have answered some interesting questions about his late-night activities.

Here's what happened: A software development firm became highly distressed when several of its workstations performed intermittently in the middle of a rush project. The firm promptly called its regular service company, which in turn concluded that there was a bad cable connecting those machines and the rest of the LAN. The service company recommended tearing the old cable out of the wall and replacing it. After considering the cost of a new cable installation, the firm asked that it be repaired instead.

At this point we were called in to provide a second opinion. Wisely, the service company had bypassed the bad cable with a temporary one; thus we could test the bad cable without shutting down the LAN. This network used a series of high-end workstations tied together via an ARCnet system into a mini-computer. A 60- to 100-foot length of coaxial cable connected the LAN with the last two workstations in the chain. We knew that the cable between them and the LAN was at fault.

We started troubleshooting by making continuity checks on the wiring. Instead of an open circuit, our DMM showed 10 ohms between the shell and center conductor of one of the BNC connectors extending from the wall.

There was definitely a short in the cable. But where was it located? Our initial response was to confirm the service compa-

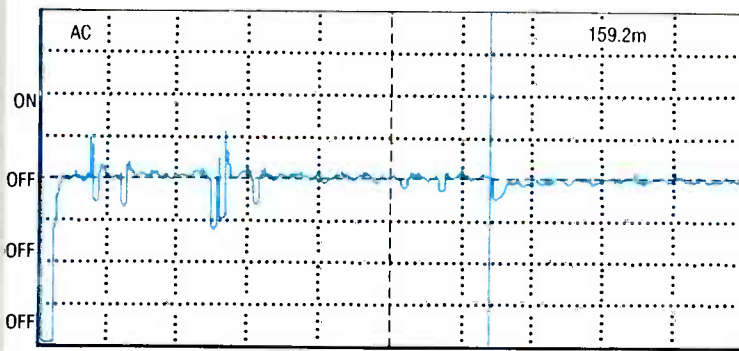

a

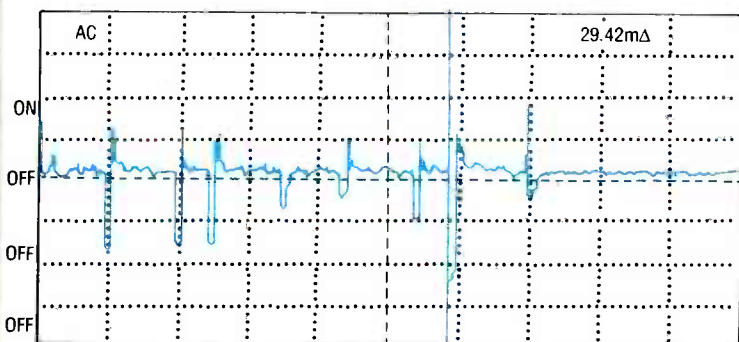

b

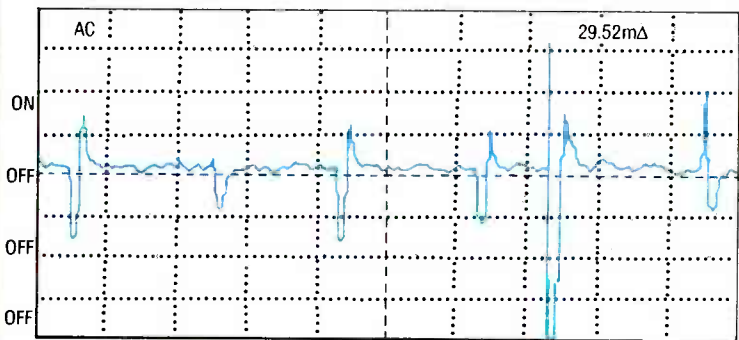

c

**FIG. 2—A GOOD ETHERNET CABLE** appears like this on a time domain reflectometer (TDR), which shows impedance vs. distance. The vertical line in *a* marks the end of the cable. In *b*, the vertical line represents a bad cable tap. The TDR can “zoom” into the display, and *c* shows an expanded view of the bad tap.

ny's assessment, and to recommend tearing out the old cable. However, we first decided to do some troubleshooting.

We rented a Tektronix model 1502C analog TDR from a local instrument rental company. (Rental is recommended anytime you need an expensive piece of equipment for just a few

days.) We chose this premiere TDR because it displays minor faults that digital TDR's often miss. In the past we have located rusty connectors, loose connectors, and water-soaked cable sections with the 1502C, all of which were missed by a digital TDR. The downside of an analog TDR is that it re-

quires more skill to use.

The 1502C displays distance vs. impedance on an LCD screen. The display shows, along the entire length of the cable, a continuous “snapshot” of impedance, which in our case was supposed to be about 50 ohms. Shorts cause the trace to drop to 0 ohms, and opens cause the trace to rise off the display. In operation, you look for suspect drops and rises, read the distance directly off the display, and start troubleshooting at the specified location. Figure 2 shows several examples of TDR displays.

After connecting the TDR to the cable, we checked the display, which showed the expected 50-ohms, but with a sharp drop about 29 feet away. A company manager, who had been looking over our shoulders, suggested that we check the ceiling. We lifted ceiling panels and located the cable. Since we had no idea of distance in the ceiling space, we guessed at the location and inspected cable for some distance each way from our access point. Above a service closet we found the culprit. Someone had sliced the cable open and crudely spliced another cable to it.

Upon closer inspection, we noticed that the added cable was pulled taut, causing strands from the uninsulated connections to touch. That, in turn, reduced signal levels to the workstations, causing intermittent problems. With excitement, we traced the second cable into a closet where we found a computer and a printer hidden behind a row of shelves.

We showed our findings to the manager. He said he would watch the closet and determine the identity of the eavesdropper. A week later he called the service company and had them remove the splice and replace it with a crimp-on BNC connector and a barrel adapter. Later we heard that the computer had been removed from the closet, but the manager would not say whether he had caught the guilty person. If it hadn't been for the short, we might never have discovered that illegal tap! **R-E**

THIS ARTICLE LOOKS AT THE VERSATILE 555 monolithic integrated timing circuit as an astable multivibrator, the flip-side of its capabilities as a monostable multivibrator in time-delay circuits. A recent article (September R-E, pg. 58) explored the role of the 555 in the monostable mode.

Now you'll find out how to build many different kinds of circuits with the 555 configured as a self-triggering oscillator. You will want to build the circuits that can generate a variety of square or rectangular waveforms. wail like a police car, imitate the jarring he-haw sound of European emergency vehicles, or reproduce the Klaxon alarm of the Star Treks' starship Enterprise.

The last article on the 555 as a monostable multivibrator included a functional block diagram and an electrical schematic of the chip. You might want to refer back to those figures if you want more detailed information about how the 555 is organized. Figure 1 is a pin-out diagram of the 555 as packaged in the most common 8-pin DIP. It was pointed out in the last article that, although a mature device, the 555 remains one of the most popular IC's available today.

At least five major semiconductor firms in the U.S. and Japan make the 555. There is also a dual version, the 556, that has two identical 555's on a single chip. The device is usually packaged in a 14-pin DIP. A quad version, the 558, has four identical 555's on a single chip, and it is packaged in a 16-pin DIP. The alternate source suppliers usually include the numerals 55, 56 or 58 in their own designations for those devices.

The 555 occupies a strange position in the universe of integrated circuits. Classed as a linear IC because it can be triggered either by linear or digital signals, its output is always digital—in the form of rectangular or square waves or pulses.

The 555 in a *monostable* multivibrator circuit (also called a timer, time delay, or one-shot)

# THE 555: A VERSATILE OSCILLATOR

**Learn how to build the 555 IC into oscillator circuits whose frequency you can change so they'll wail, warble, and honk.**

RAY M. MARSTON

generates a fixed-length output pulse for each trigger pulse at its input. This can be demonstrated with the circuit in Fig. 2. By contrast, the 555 in an *astable* multivibrator circuit is shown in Fig. 3. It has no stable output states and no external

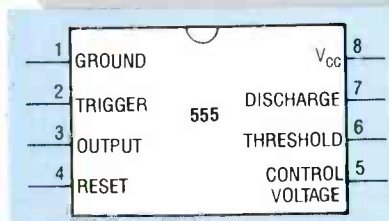

FIG. 1—PINOUT DIAGRAM OF THE 555.

trigger is necessary to start circuit oscillation; it is said to be self-triggering. This circuit configuration is also called an *oscillator*, *signal generator*, *pulse generator*, or a *rectangle-wave generator*.

As long as power is applied to the astable circuit, the output continually switches back and forth between the high and low states at a regular rate or frequency. The time in the high state (pulse width) and the time in the low state (space length) depend on the selection of external resistors and capacitors. Because of its relatively high output, the 555 in an astable circuit can drive LED's, speakers, and meters directly.

## Astable operation

In the monostable multivibrator circuit in Fig. 2, OUTPUT pin 3, DISCHARGE pin 7, and THRESHOLD pin 6 are held low when the circuit is quiescent. A monostable timing period can be started by driving TRIGGER pin 2 low with pushbutton switch S1. That causes OUTPUT pin 3 to switch high, while DISCHARGE pin 7 is released and free to follow the voltage across C1. Voltage rises exponentially through R1 toward the supply

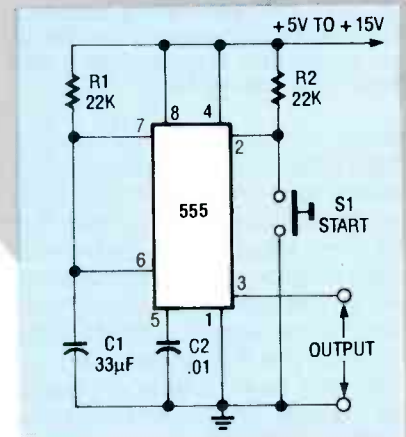

FIG. 2—MONOSTABLE MULTIVIBRATOR TIMING CIRCUIT based on the 555.

voltage. Eventually the voltage at pin 7 rises to two-thirds of the supply voltage, and monostable action ceases with pins 3,

6 and 7 grounded by the internal circuitry of the 555.

Examine the astable circuit shown in Fig. 3-a. In this circuit TRIGGER pin 2 is shorted to THRESHOLD pin 6, and timing resistor R2 is wired between pin 2 and DISCHARGE pin 7. When power is applied to the circuit, capacitor C1 charges exponentially (as it did in Fig. 1) through resistors R1 and R2 until the voltage on C1 reaches two-

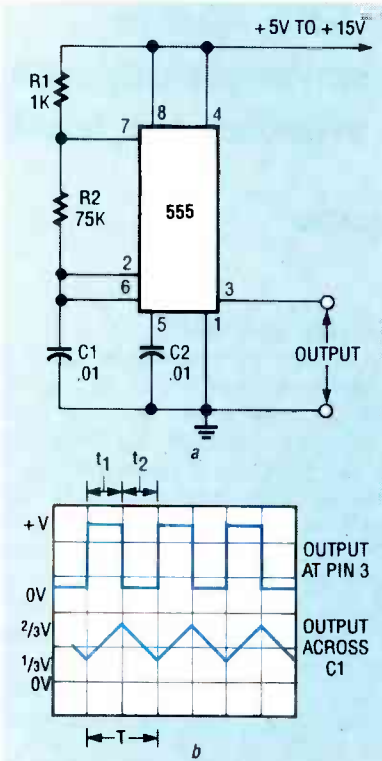

FIG. 3—A ONE-KILOHERTZ ASTABLE MULTIVIBRATOR based on the 555, a, and waveforms at output pin 3 and across C1 are shown in b.

thirds of the supply voltage. At that time, monostable action ceases and DISCHARGE pin 7 returns to its low state. Capacitor C1 then discharges exponentially into pin 7 through R2 until the voltage on C1 falls to one-third of the supply voltage, and TRIGGER pin 2 is activated.

At that time, a new monostable timing sequence is started and C1 recharges to two-thirds of the supply voltage through resistors R1 and R2. The whole sequence then repeats itself over and over with C1 alternately charging to two-thirds of the supply voltage through R1 and R2, and then discharging

to one-third of that voltage through R2 only.

Notice that in Fig. 3-a, the value of R2 is very large with respect to the value of R1. It turns out that the oscillation frequency of the circuit is largely determined by the values of R2 and C2. Figure 3-b shows the nearly symmetrical square output waveform that appears between OUTPUT pin 3 and ground while a nearly linear triangle waveform is simultaneously generated across C1.

The graph of Fig. 4 shows the relationship between the free-running frequency of the circuit in Fig. 3-a and the capacitance values of C1 with the range of R2 values shown on the diagonal lines. In this graph the contribution of resistor R1 is neglected because it is a fraction of the R2 value.

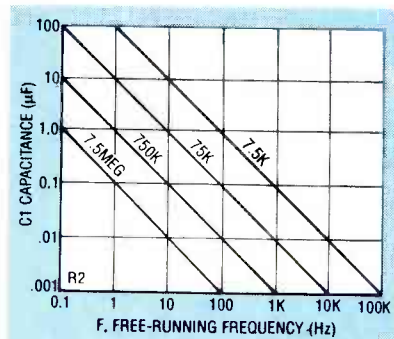

FIG. 4—THE FREE-RUNNING FREQUENCY OF OSCILLATOR in Fig. 3 as a function of capacitance values for C1 and the resistance value of R2 (when large with respect to R1).

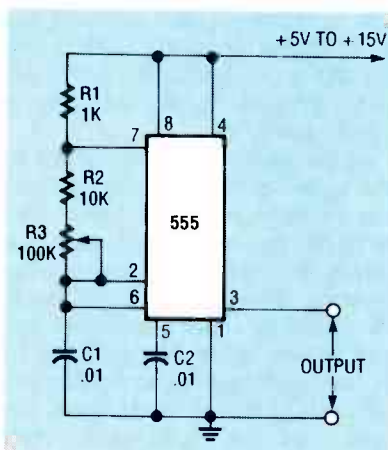

FIG. 5—THIS SQUARE-WAVE GENERATOR produces a variable frequency of 650 Hz to 7.2 kHz.

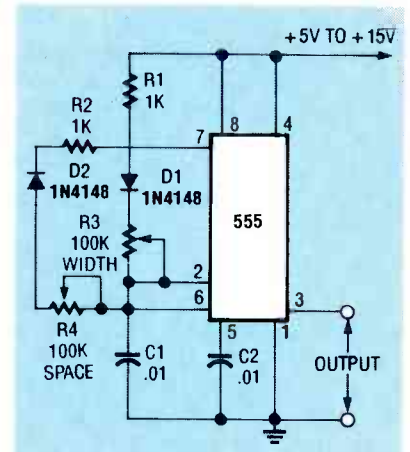

FIG. 6—AN STABLE MULTIVIBRATOR with independent pulse width and space periods variable from 7 to 750 microseconds.

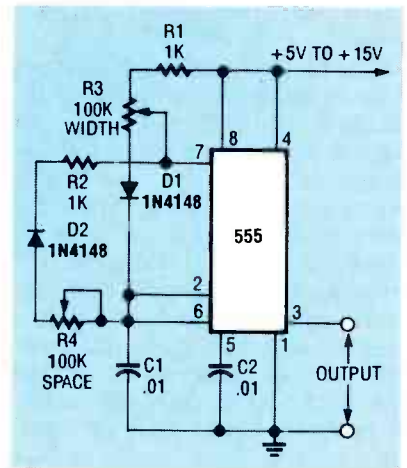

FIG. 7—ALTERNATE VERSION OF OSCILLATOR shown in Fig. 6.

The values of R1 and R2 can be varied from 1 kilohm up to tens of megohms. Resistor R1 can, however, have a significant effect on the total circuit current consumption because pin 7 is essentially grounded during half of the oscillation cycle. The duty cycle or pulse width-to-space ratio of the circuit can be preset at a nonsymmetrical value, if desired, by the choice of R1 and R2 values.

The high time (pulse width) and low time (space length) in this circuit must be calculated separately. The pulse width calculation includes the values for the timing capacitor C1 and both timing resistors R1 and R2. By contrast, the space length formula includes only the values of timing capacitor C1 and resistor R2.

Refer to Fig. 3-b. Pulse width (or time to charge capacitor C1 is:

$$t_1 = 0.7 C1 (R1 + R2)$$

Space length or time to discharge capacitor C1 is:

$$t_2 = 0.7 C1 R2$$

The total cycle time is:

$$T = t_1 + t_2$$

The ratio of pulse width to the total cycle time is the *duty cycle*. In a 555-based oscillator, the duty cycle is defined by the relative values of the two timing resistors R1 and R2:

$$\text{Duty cycle} = R2 / (R1 + 2R2)$$

Frequency in hertz (Hz) is the reciprocal of total cycle time:  $F = 1/T$ .

The circuit in Fig. 3-a can be modified in many different ways. Figure 5, for example, shows how it can be made into a variable-frequency square-wave generator by replacing R2 with a fixed resistor and potentiometer in series. The frequency can be varied over a range of about 650 Hz to 7.2 kHz with the values of the resistor and potentiometer R3 shown. If required, the frequency span can be further increased by switch-selecting alternative values of C1.

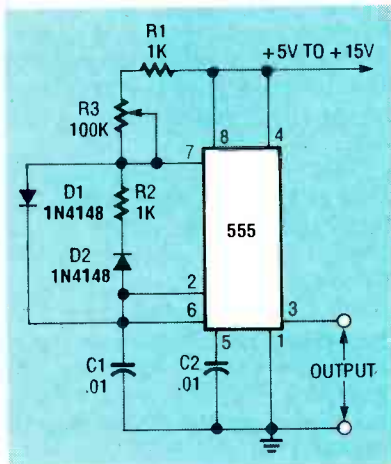

FIG. 8—A 1.2 kHz OSCILLATOR with a duty cycle variable from 1 to 99%.

### Width-space control

The circuit in Fig. 3-a can generate a fixed-frequency output waveform with any desired pulse width-to-space length ratio by selecting the appropriate values for R1 and R2. In each operating cycle, C1 alternately charges through R1 and R2.

and discharges only through R2. For example, if R1 and R2 have equal values, the circuit will generate a 2:1 width-to-space ratio.

The width-to-space periods can be independently controlled with either the Figs. 6 or 7. In Fig. 6, C1 alternately charges through R1, diode D1, and potentiometer R3, and it discharges through potentiometer R4, diode D2, and R2. In Fig. 7, C1 alternately charges through R1, potentiometer R3, and diode D1, and it discharges through potentiometer R4, diode D2, and R2. In both Fig. 6 and 7 circuits, R2 protects the 555 if potentiometer R4 is shorted.

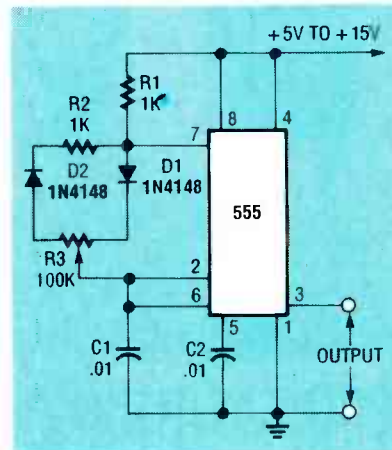

FIG. 9—AN ALTERNATE VERSION OF OSCILLATOR shown in Fig. 8.

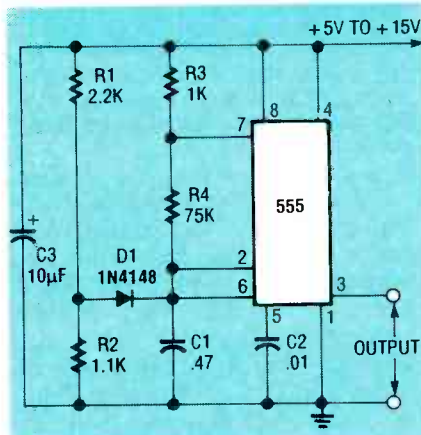

FIG. 10—A PRECISION LOW-FREQUENCY OSCILLATOR with a frequency of about 20 Hz.

In the circuits of Figs. 6 and 7, the width-to-space periods can be independently varied over about a 100:1 range, en-

abling the width-to-space ratio to be varied from 100:1 to 1:100. The oscillation frequency varies as the ratio is altered.

Figures 8 and 9 show alternate ways of connecting the 555 in the astable mode so that the width-to-space ratio can be varied without altering the oscillating frequency. In those circuits, the pulse width period automatically increases as the space length period decreases, and vice versa. Therefore, the total period of each operating cycle is constant. In those circuits, the feature of interest is the duty cycle. In Figs. 8 and 9, the duty cycle can be varied from 1% to 99% with potentiometer R3.

In the circuit of Fig. 8, C1 alternately charges through R1, the upper half of R3, and D1, and it discharges through D2, R2, and the lower half of potentiometer R3. In Fig. 9, C1 alternately charges through R1 and D1 and the right-hand half of potentiometer R3, and it discharges through the left-hand half potentiometer R3, D2, and

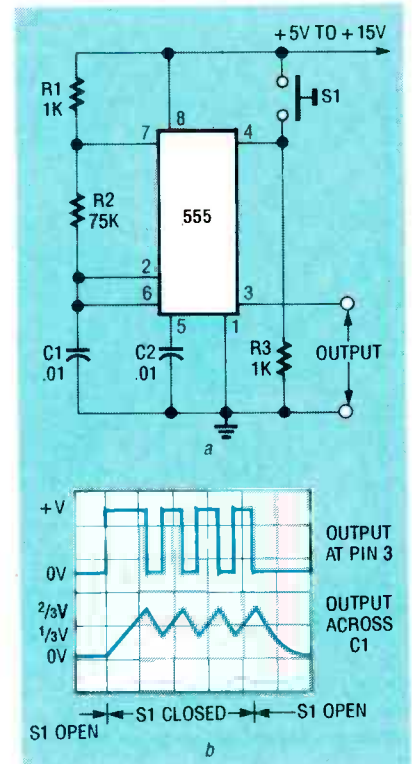

FIG. 11—GATED 1-kHz OSCILLATOR offering "press-to-turn-on" operation, a, CFHB and waveforms at output of pin 3 and across C1, b.

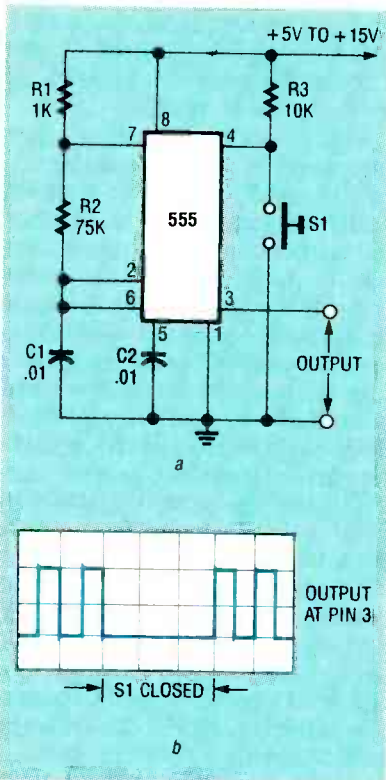

FIG. 12—GATED 1-kHz OSCILLATOR offering "press-to-turn-off" operation, a, and waveforms at output of pin 3 and across C1, b.

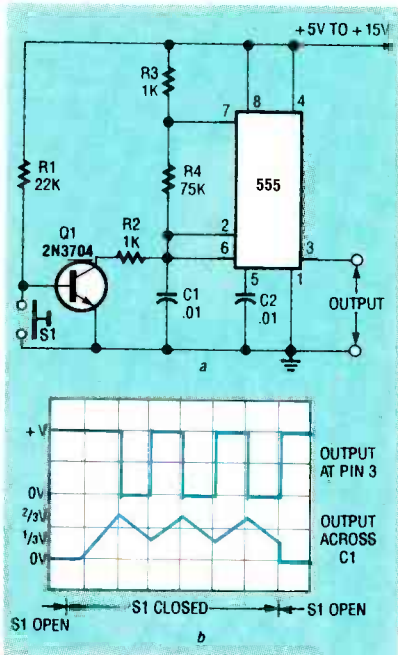

FIG. 13—ALTERNATIVE GATED 1-kHz OSCILLATOR offering "press-to-turn-on" operation, a, and waveforms at output of pin 3 and across C1, b.

R2. Both circuits oscillate at about 1.2 kHz with the value of C1 shown.

### Precision astable circuit

In the description of astable multivibrator operation given earlier in this article, it was stated that in the first half cycle of oscillation timing capacitor C1 charges from zero volts to two-thirds of the supply voltage, but in all subsequent half-cycles it either discharges from two-thirds to one-third of the supply voltage or charges from one-third to two-thirds of that voltage. Consequently, the first half cycle of oscillation has a far longer period than all subsequent half cycles.

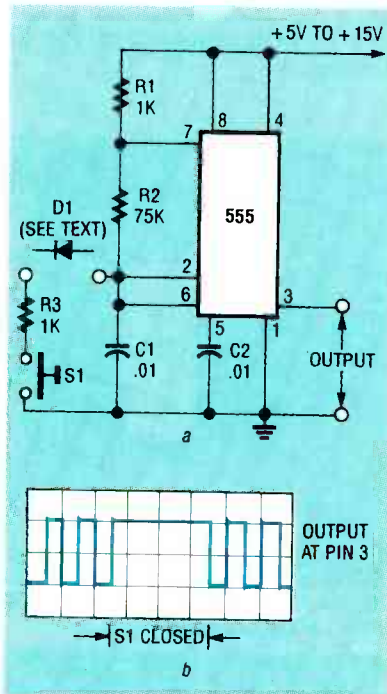

FIG. 14—ALTERNATIVE GATED 1-kHz OSCILLATOR offering "press-to-turn-off" operation, 1a and waveforms at output of pin 3, b.

In applications calling for a low-frequency clock signal, this large differential in period can cause a timing problem. However, this problem can be averted by adding an external voltage divider and diode as shown in Fig. 10. Those components bias C1 to a point slightly below one-third of the supply voltage (rather than zero volts) at the moment of switch-on. Here, R1 rapidly charges C1 to one-third of the supply voltage through D1 at switch-on, and all of the C1 charge is subsequently controlled by R3 and/or R4 only.

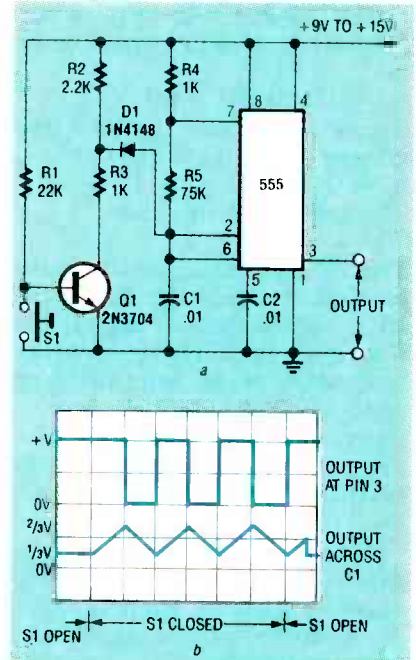

FIG. 15—PRECISION VERSION OF THE OSCILLATOR in Fig. 13, a, and waveforms at output of pin 3 and across C1, b.

### Astable gating

The 555 in the astable multivibrator mode can be triggered ON and OFF in many different ways with either an electromechanical switch or an electronic signal. The most popular way to trigger the 555 is through RESET pin 4. Figures 11-a and 12-a show alternative ways of triggering the 555 with this pin and pushbutton switch S1.

The 555 is organized so that if pin 4 is biased above about 0.7 volts, the astable mode is enabled. But if it is biased below 0.7 volts by a current greater than 0.1 milliamperes (by grounding pin 4 with a resistance less than 7 kilohms, for example) the astable mode is disabled, and the 555's output is biased low.

For example, the circuit in Fig. 11-a is normally turned off by R3, but it can be turned on by closing pushbutton switch S1, which biases pin 4 high. Figure 12-a shows an astable circuit that is normally on, but it can be turned off by closing pushbutton switch S1, which shorts pin 4 to ground. The circuits in Figs. 11 and 12 can also be triggered by applying suitable electronic signals directly to their



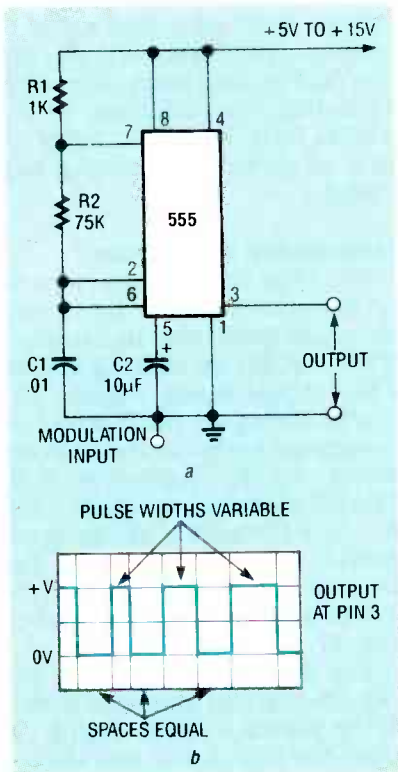

FIG. 16—CIRCUIT FOR APPLYING AC-COUPLED FM or PPM to a 555 configured as an oscillator, a, and waveforms at output of pin 3, b.

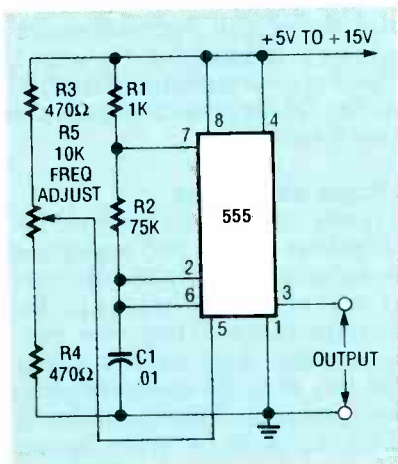

FIG. 17—CIRCUIT FOR APPLYING A DC-COUPLED FM or PPM to a 555 configured as an oscillator.

**RESET pins.**

In Fig. 11-b, the precise circuit waveforms at OUTPUT pin 3 and across C1 are shown. It can be seen that the duration of the first half-cycle of oscillation is considerably longer than the succeeding half cycles because of the time for C1 to charge to two-thirds of the supply voltage. Also, note that when the astable mode is turned off, the C1 volt-

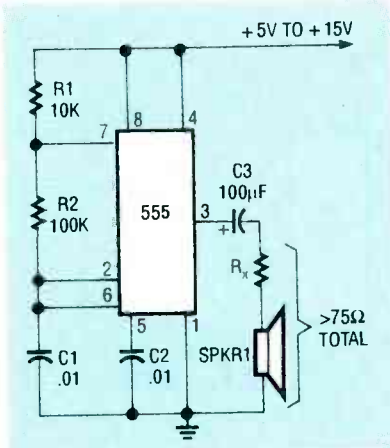

FIG. 18—CIRCUIT GENERATES 800-Hz MONOTONE ALARM that operates from 750-milliwatts.

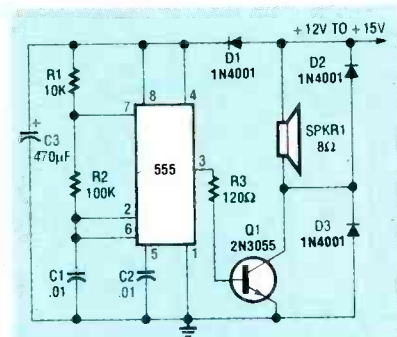

FIG. 19—CIRCUIT GENERATES 800-Hz MONOSTABLE ALARM.

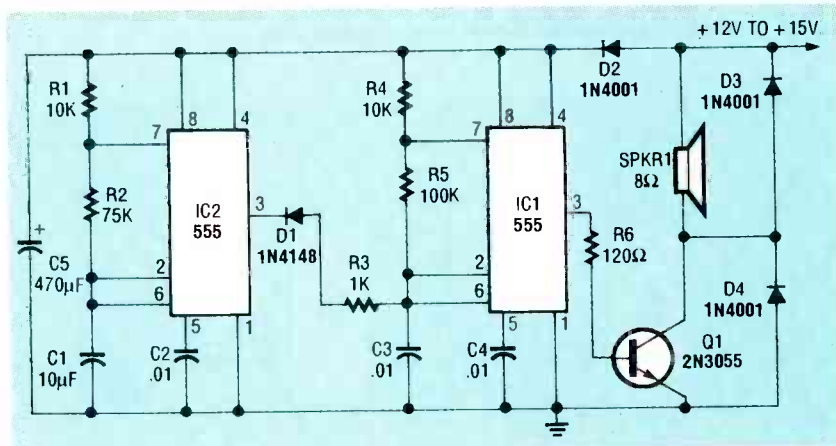

FIG. 20—CIRCUIT GENERATES 800-Hz PULSED-TONE ALARM.

age decays slowly to zero; the output at OUTPUT pin 3 is zero volts in the OFF condition. The waveform characteristics of Fig. 12-a are similar as shown in Fig. 12-b.

Figure 13-a shows an alternative method for triggering the 555 in the astable mode. Here transistor Q1 is normally biased ON by R1, so it acts like a closed switch, which pulls the junc-

tion of C1 and R4 close to zero volts through R2 preventing oscillation. When pushbutton switch S1 is closed, Q1 is biased off, and the astable circuit is free to oscillate normally.

Refer to Fig. 13-b for the waveforms of the circuit in Fig. 13-a. When the astable response is triggered on, the first half cycle is again considerably longer than in succeeding half cycles, and that the voltage on C1 decays rapidly to nearly zero volts when the trigger is off. Also notice that OUTPUT pin 3 is high in the OFF state.

Figure 14 shows how the circuit in Fig. 13-a can be modified to give *press-to-turn-off* oscillation simply by replacing Q1 with a pushbutton switch. A digital signal can trigger this circuit if a diode is connected as shown in the diagram and the pushbutton S1 is deleted. With S1 removed, the circuit will be turned off when the input signal voltage is reduced below one-third of the supply voltage. The waveform is shown in Fig. 14-b.

Finally, to complete this look at triggering techniques, Fig.

15-a shows how the Fig. 13-a circuit can be modified so that the duration of its first half-cycle is almost equal to that of all succeeding half-cycles, thus giving precision operation. In the Fig. 15-a circuit, when pushbutton switch S1 is open, Q1 is saturated, so the voltage divider made up of R2 and R3 pulls the junction of R5 and C1 to slightly below one-third of the supply

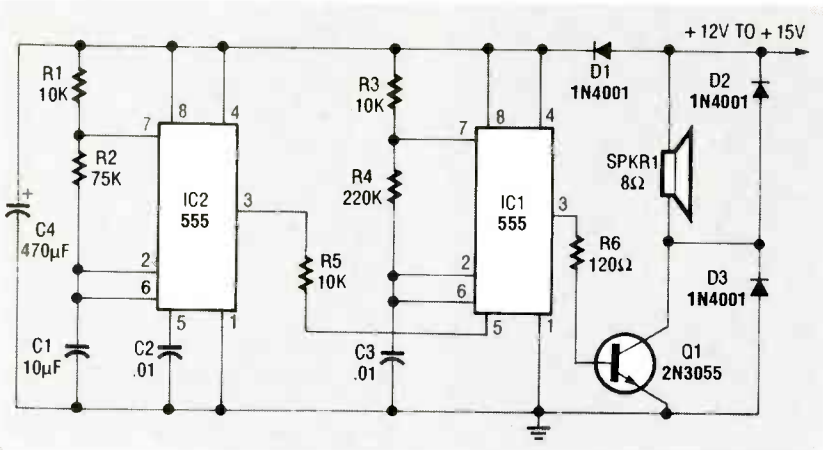

FIG. 21—CIRCUIT GENERATES WARBLE ALARM of European emergency vehicles.

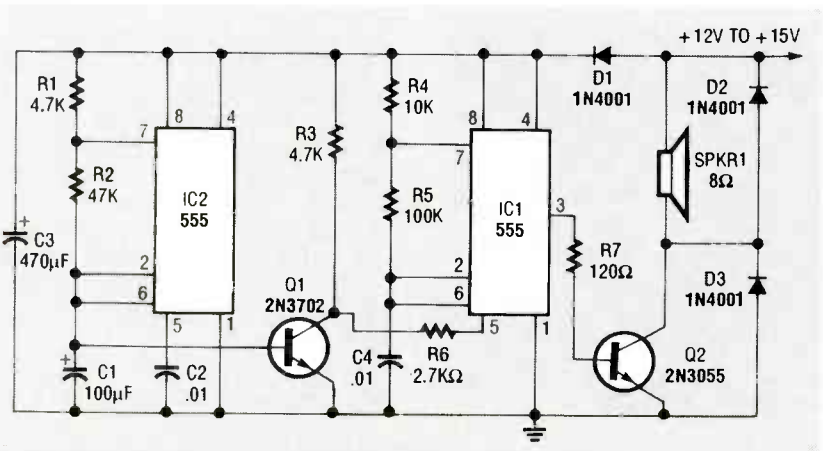

FIG. 22—CIRCUIT GENERATES SIREN WAIL of police cars.

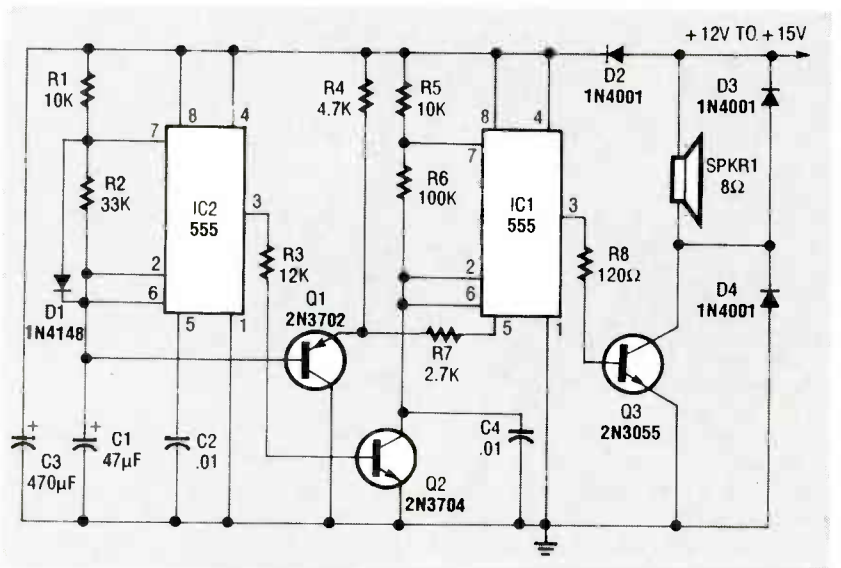

FIG. 23.—CIRCUIT GENERATES PENETRATING ALARM of Star Trek spaceship.

voltage through diode D1, thus turning the circuit off. When S1 is closed, Q1 turns off, D1 is reverse biased through R2, and

the circuit is then free to oscillate normally.

Notice in Fig. 15-b that when S1 is first closed, C1 starts to

charge from an initial value of almost a third of the supply voltage rather than from zero volts. Therefore, the duration of the initial half cycle is similar to that of all the succeeding half cycles.

### Modulation techniques

All of the 555 astable circuits reviewed so far can be frequency or pulse-position modulated (FM or PPM) by feeding a suitable modulation signal to CONTROL VOLTAGE pin 5, which is connected to part of the internal voltage divider chain of the 555. The AC modulation signal is fed to pin 5 through a blocking capacitor, as in Fig. 16-a, or the DC modulation signal can be fed directly to pin 5, as shown in Fig. 17.

The voltage on pin 5 of the Fig. 15-a circuit alters the width of the pulses in each timing cycle of the 555, but it has almost no effect on the space duration. The signal at pin 5 changes the PPM pulse width position, affecting the total cycle period so it also influences the output frequency, as shown in Fig. 16-b. In so doing, pin 3 provides a frequency-modulated signal. Those characteristics of the 555 are useful for generating special waveforms.

### Alarms and sirens

Some of the most popular applications for the 555 organized as an astable multivibrator are as waveform generators for loudspeakers. They can produce alarm and siren sounds. Figures 18 to 23 show different ways to create those sounds. All of the circuits in those figures are triggered by making or breaking their supply-voltage connections.

Figure 18 shows an 800-Hz monotone alarm-call generator circuit, which can be powered by any 5- to 15-volt DC supply. The speaker SPKR1 can have any impedance value. Note, however, that  $R_x$  must be wired in series with any speaker whose total impedances is less than 75 ohms. Select a resistor to give a total series resistance with the speaker of 75 ohms.

*continued on page 94*

## JAMES MELTON

DO YOU EVER NEED TO POWER 120-volt ac equipment when there is no AC outlet available? Our affordable power inverter was designed to supply up to 250 watts to power line-operated equipment a fraction of the cost of commercially built units.

The inverter described here has been used to power flood lamps, soldering irons (both resistance and transformer types), fans, televisions, and portable computers. It has even powered an air pump for the author's asthmatic son. The inverter will power almost any device that runs on 120 volts AC. Some motorized devices won't work well, however. A variable-speed drill may work, but only at one speed. Fans and other purely inductive loads seem to run at about  $\frac{2}{3}$  normal speed with the inverter. Synchronous motors will run at normal speed but will be a little "noisy."

### Power FET's to the rescue

Power FET (field effect transistor) devices have gotten more versatile over the last few years and, at the same time, the prices for them have plummeted. Nothing can match a FET in its ease of interfacing with logic signals, and for the ease in which it can work in parallel with similar devices without the need for any extra components. To parallel the FET's, all you have to do is tie the source leads together. When they get warm, FET's exhibit a positive temperature characteristic, which means as the temperature goes up, so does the resistance; as the resistance goes up, the current through the device is lowered. That makes FET's self-limiting when working in parallel.

FET's are now being produced with power ratings that can often make parallel operation unnecessary. The ratings for the IRFZ30's that are used in this project are amazing; they can handle a 30-amp load with 50 volts across the source-drain leads and 75-watt power dissipation, all in a TO-220AB

plastic package—for less than two bucks each when purchased in small quantities.

### Operation

Figure 1 shows the schematic of the inverter. A 555 timer, IC1, along with R3, R2, and C2, generates a 120-Hz ( $\pm 2$  Hz) signal, as set by the value of potentiometer R3.

The output of IC1 at pin 3 is fed to the clock input of a CD4013BE dual D-type flip-flop, IC2-a, which is wired to divide the input frequency by two; that generates the 60-Hz clocking for the FET array (Q1-Q6). The

output from flip-flop IC2-a at pin 1 has a 50% duty cycle, which is necessary for the output transformer. The flip-flop also provides an inverted output ( $\bar{Q}$ , pin 2), which saves us from having to add additional components to invert the  $\bar{Q}$  output. The second half of IC2 (IC2-b) is not used, so all of its input pins are grounded.

The  $\bar{Q}$  and  $\bar{Q}$  outputs from IC2-a are each fed, via R5 and R4, to three inputs of IC3, a CMOS CD4050BE hex buffer. Each group of three buffer outputs drives one bank of FET's in the power stage.

***Power small appliances from your car or any other 12-volt source with our 250-watt inverter.***

# 250 WATT POWER INVERTER



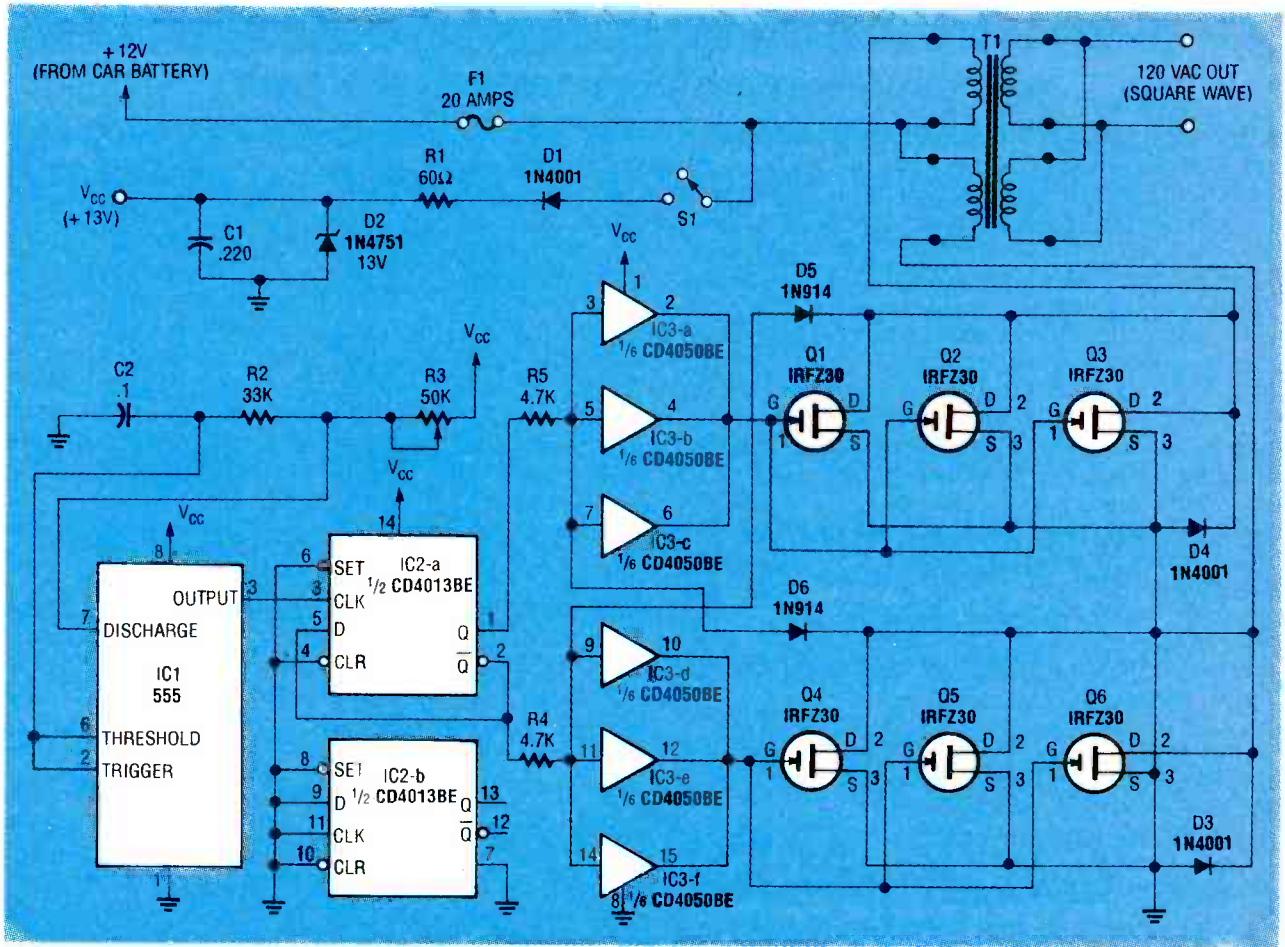

FIG. 1—INVERTER SCHEMATIC. A 555 timer (IC1) generates a 120-Hz signal that is fed to a CD4013BE flip-flop (IC2-a) which divides the input frequency by two to generate a 60-Hz clocking frequency for the FET array (Q1-Q6).

The inputs to the buffers are also controlled by D5 and D6, which are connected to the drains of the FET's so that the array that is turned-on essentially has control of the drivers of the opposite array. When one side is turned on and its drain is at ground potential, the other side cannot turn on because the input to the buffer for that array is also being held at ground. It stays that way until the controlling array has completely turned off and the drain voltage has gone above about 6 volts. That is necessary because the turn-off time for a FET is longer than its turn-on time. If the diodes were eliminated, both arrays of FET's would be turned on simultaneously during each transition, which creates tremendous spikes on the battery, the equipment tied to the output of the inverter, and to the FET's themselves.

The FET array can be made as big or as little as your application requires. The author needed at least 250 watts, and used two IRFZ30's in parallel for each array. However, to play it safe, use three in parallel (or however many you need) for each array as we've shown in the schematic. Diodes D4 and D3 dampen inductive kickback from the transformer winding that would likely cause overheating and premature transistor breakdown.

Power-supply conditioning circuitry (D1, R1, D2, and C1) eliminates spikes, overloads, and other noise from a car's 12-volt supply. Even though the 555 can handle up to a 15-volt supply, power-supply spikes will surely damage it.

If the transformer you use has a center tap, the center tap must be connected to the 12-volt line and the two 12-volt windings

must be connected to the drains of their respective driving transistors. The author used a Jefferson buck/boost transformer that's normally used to reduce or increase the line voltage for AC devices. If you are going to buy a transformer, you can use any center-tap 24-volt or dual-winding 12-volt transformer. It is important to use a transformer that can supply the amount of current that your application requires.

### Construction

Some of the components mount on a small PC board, for which we've provided the foil pattern. The parts-placement diagram is shown in Fig. 2. We recommend that you use sockets for the IC's. After soldering all components on the board, apply 12 volts and measure the frequency on the pads marked J4 and J2. Adjust R3 for a read-

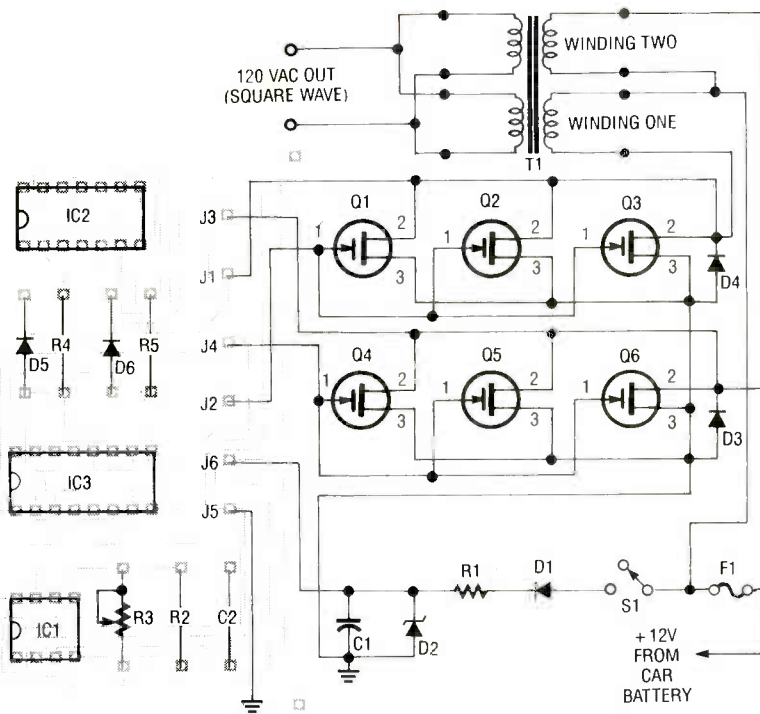
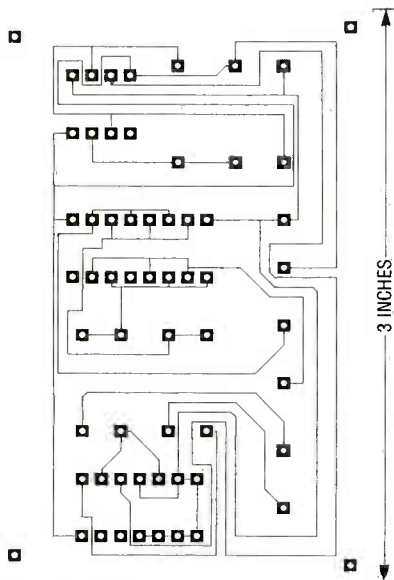

FIG. 2—MOST OF THE COMPONENTS mount on a small PC board. The off-board components can be mounted on a terminal strip or perforated construction board.

ing of 60 Hz, and make sure the voltage is very close to  $\frac{1}{2}$  of the supply voltage on each pad. That tells you that your duty cycle is 50%.

Now connect the rest of the components. The small off-board components can be mounted on a terminal strip. However, be sure to mount the FET's on a heatsink. If the heat-sink is at ground potential, also be sure to insulate the FET's from it.



FOIL PATTERN for the inverter board.

#### PARTS LIST

All resistors are  $\frac{1}{8}$ -watt, 5%, unless otherwise noted.

R1—60 ohms, 1 watt, 10%

R2—33,000 ohms

R3—50,000 ohms, 10-turn potentiometer

R4, R5—4700 ohms

#### Capacitors

C1—220  $\mu$ F, 35 volts, electrolytic

C2—0.1  $\mu$ F, 50 volts, ceramic disk

#### Semiconductors

IC1—LM555 timer

IC2—CD4013BE CMOS dual D-type flip-flop

IC3—CD4050BE CMOS hex buffer

D1, D3, D4—1N4001 diode

D2—1N4751 13-volt Zener diode

D5, D6—1N914 diode

Q1-Q6—IRFZ30 30-amp, 60-volt FET

#### Other components

T1—Jefferson #216-1121 buck/boost transformer (contact WW Granger, Inc., 1250 Busch Pkwy, Buffalo Grove, IL 60015, 708-459-5445) or other 12- or 24-volt center-tapped transformer (see text)

S1—SPST switch

F1—20-amp fuse (or use value according to desired output current and transformer used)

**Miscellaneous:** fuse holder, cabinet, mounting hardware, AC outlet, car cigarette lighter plug, wire, solder, etc.



FIG. 3—THE PROTOTYPE INVERTER. The author used a car cigarette lighter plug on the end of the power-input lead and an AC outlet for plugging appliances into.

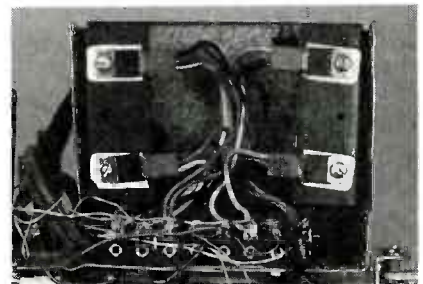

FIG. 4—THE FET'S ARE MOUNTED on metal plates used as heatsinks. If the heatsink is at ground potential, insulate the FET's from the heatsink.

The author used a car cigarette lighter plug on the end of the power-input lead, but you are free to use alligator clips or whatever is most convenient for you. A standard AC outlet was mounted on the front panel of the unit. The prototype was installed in an old, rugged metal case, but you can use whatever you have on hand. Figure 3 shows the prototype inverter and how everything is assembled. Figure 4 shows a close-up view of the FET's and how they are mounted on metal plates used as heatsinks.

#### Operation

To operate the unit, plug the input power into your cigarette lighter socket, turn on the power switch, and turn on the appliance that's plugged into the inverter. When you are not using the inverter, be sure to turn it off, since the transformer will draw about 2 amps even with no load. That will drain your car battery fairly quickly!

## Syndicated Reviewers, AM Stereo, and Consumer Fraud

LARRY KLEIN

I've frequently been distressed by the writings of the syndicated audio columnists, the pundits whose opinions appear weekly in large and small local newspapers. I've met many of them over the years and, by and large, they are nice people, but I just don't like the job they do. What's wrong? Several things.

I feel strongly that a writer should not express his opinion in print on the audio qualities of a borrowed product listened to under uncontrolled conditions in a home environment. Such home evaluations without lab test backup are, in general, untrustworthy. They actually tell you far more about the writer's mood, health, and relationship with the manufacturer than they do about the product. This is not to say that some of the recommended products aren't topnotch, but the reader has no way—sound unheard—of confirming the reviewer's opinions.

Am I being too harsh in my judgment? I think not. The temptation to say nice things about a product becomes intense when a writer has been personally wined, dined, junketed, and brainwashed by a company's public relations agency.

I can say that in the 35 years or so that I've been writing about audio I've kept my skirts relatively clean. Despite temptations to do otherwise, I have never confused my subjective opinions with objective facts and never praised a hi-fi component in print without a lab test backup. I should admit that as the technical director of the world's largest circulation audio magazine, I found it easy to be holier than almost anybody. I regularly received such manufacturer-supplied perks as all-expense-paid annual trips to audio shows and factories in Japan, Europe, and elsewhere, and all the

long-term-loan audio equipment I could use without extolling the virtues of anyone's products. Freelance writers, on the other hand, inevitably find themselves in a *quid pro quo* situation. The amount of laudatory "ink" they give to products in their columns correlates directly with the frequency of invites to press junkets. Their columns and comments are reprinted by gratified manufacturers, and they are on the "A" lists for goodies.

Once I left *Stereo Review* for the freelance life, my invitations slowly dwindled as the various PR agencies became aware of my new unexalted status. I could have reversed the situation somewhat by taking the same product review route as my syndicated contemporaries, but I chose not to do so. In any case, to reaffirm my point: Be careful before committing your dollars on the basis of any opinions unsupported by laboratory testing. It's just too easy to be misled.

### AM stereo

Remember AM stereo? It's an idea that won't die—but won't come fully to life either. Perhaps a dozen years ago, when AM stereo was first introduced as a new broadcast technology, I wrote that because of the lack of consumer interest the format would probably never fly. The letters of disagreement that subsequently reached my desk were mostly from station owners, broadcast engineers, and companies with investments in AM-stereo technology.

For years there was no visible progress on the AM-stereo front, possibly because the FCC in its wisdom (ha!) decided to let the competing formats fight it out in the marketplace. True, there was an occasional press release telling of this or that company's home or car re-

ceiver's having AM-stereo reception facilities, usually Motorola's system.

A mini breakthrough almost occurred in June 1990 when the National Association of Broadcasters (NAB) and Denon announced a "comprehensive component broadcast monitor tuner that does it all." The "all" included the now-defunct FMX FM noise-reduction system, AM stereo (Motorola's C-Quam), and the newly promulgated NRSC AM standard. The new standard included an extension of the AM tuning range (520 to 1710 kHz), a pre-emphasis/de-emphasis curve, and a wider, tightly specified audio bandwidth. The tuner was promised for "early 1991."

I recently called the Denon technical rep to ask what, if anything, had happened to the tuner. He faxed me a copy of a press release dated May 1992 announcing a revised tuner that no longer had FMX but did have AMAX, which seems to be the NRSC parameters under a new name (See **Radio-Electronics**, February 1992 for more details). The AM bandwidth can be switched to wide or narrow, providing either the broadest audio-frequency response or the lowest noise. Helping to reduce AM impulse noise is a noise-blanking circuit from Sprague/Allegro Microsystems.

I found the tuner's technical spec sheet, which was printed in Japan, to be somewhat puzzling. The audio frequency response of the AM tuner set to wide is given as 50 Hz to 7.5 kHz, +1.5 -3 dB. Certainly that's better than what one finds in most AM/FM receivers, but it falls far short of CD quality.

The claim has been made that good AM stereo is frequently indistinguishable from FM. That may well be, given the aging ears of the clas-

*continued on page 96*

# HARDWARE HACKER

**Histogram equalization, alternate action latches, gamma curve correction, digital image processing, and semiconductor IC houses.**

**DON LANCASTER**

**S**top the presses. *Murata* has just announced a *Gyrostar* piezo gyroscope. Which, if it is as great as it looks, could easily become *the* hacker component of the decade. All I've got on this so far is that brief note in the June 8th *Design News* and a promise for more technical information. Needless to say, the hacker potential of a \$5 navigation gyro would be truly revolutionary.

Be sure to stay tuned on this one.

Things are also starting to happen fast and furious on that direct-toner printed circuit board front. Since my last report, the new water-soluble decal-based *Toner Transfer System* offered by *DynaArt* has been further improved. The new *Printed Circuit Board Transfer Film* from *Techniks* looks even more promising.

What *Techniks* did was take their old differential transfer system and add a new blue polymeric release coating. The polymeric release coating can dramatically improve the transfer; it actually becomes an important part of your resist pattern.

## Faster than light?

Every week or so I get at least one letter or helpline call from people who feel they have clearly broken some physical law. Maybe they have proof that the speed of light is not a constant. Or that those three laws of thermodynamics just do not apply to them. Or that perpetual motion can be possible using magnetic repulsion. Or they have tapped the zero point scalar energy from the fabric of space. Or that their latest pet theory proves the cold-fusion process.

Usually, they'll also complain that they've sent their theory everywhere and have gotten no replies. Or that they are getting ignored because they are outsiders.

Very often, their inquiries will be

self-defeating. How? They will include totally irrelevant religious or political contexts. Or they'll be super secretive. Or written and submitted in such a way that they scream "Hey, kick me, for I'm not even computer literate."

If it likes water, looks like a duck, and quacks like a duck...

But consider who is receiving those letters. Based on past experience, the editors or the publishers know that the probability is 0.99+ that the lab work (if any) is just plain wrong. Or, more typically, *not even wrong*. And 0.99+ that the sendee is clearly a few chips shy of a full board. Why *should* they believe you?

The sad thing is that needle in the haystack. I'm going to be generous and claim that one letter in 500 in fact *does* have the germ of a new theory or a developable product or a fresh look at a solvable problem. And, yes, newer ideas often will get ignored or vehemently attacked.

What can you really do if you have genuinely beaten those overwhelming odds and your controversial idea is in fact both new and for real?

There are two possible routes you could take to get your ideas accepted. The first or *real science* method is to *thoroughly try and prove that you are wrong*. Be sure to use lots of careful research, especially through *Dialog* and those *UMI* reprints. Be certain to subscribe to *all* of the relevant insider trade journals and go

## NEED HELP?

Phone or write your **Hardware Hacker** questions directly to:  
Don Lancaster  
**Synergetics**  
Box 809  
Thatcher, AZ 85552  
(602) 428-4073

out of your way to study the scholarly publications in the field. Learn all the lingo. Attend conferences and trade shows. Find a patient and knowledgeable industry insider that is willing to look at your idea and comment honestly on it.

*Be absolutely certain that you have a simple experiment that can be independently duplicated and verified by disinterested outsiders.*

Hire some competent engineering or physical science consultants to study and add credibility to all your claims. Take enough college and university level courses to make sure you do thoroughly understand at least the fundamentals of the field—along with the needed math to back it up.

And finally, present the ideas clearly identified as a possible new theory in some professional context totally free of religious, political, or any conspiracy mumbo jumbo.

The second route is to publish via a *pseudoscience* press. There are quite a few underground and alternate life publications that welcome material of this type. Every now and then, *Whole Earth Review* gives you a list and rundown of all the magazines of that genre. Let me know if you want to see a resource sidebar on those.

One leading bookstore that does specialize in selling and distributing pseudoscience topics is *High Energy Enterprises*. Many of their offerings are utterly fascinating. Those folks also sponsor several yearly forums where controversial pseudoscience topics are strongly encouraged.

Several very important tips when publishing your own pseudoscience tracts: Be sure to use cut-and-paste Xerox-of-a-Xerox and lots of poorly printed sloppy layouts. Smear ink on cheap paper is a must. Freely quote obscure rural newspapers as

your prime data sources. Include illegible artwork. Extensively refer to unheard-of and unavailable journals. Use plenty of irrelevant inference and innuendo.

Use only 20–200 year old references, especially in any rapidly changing field. Misquote and drop some big names, even if totally out of context and they never heard of you. "Billions and billions of Carl Sagan's ago..." *Never* offer any succinct and easily verified experiment.

Always use ten words where one will do. Make all of your paragraphs unbearably wide and long. Then run them all together in haphazard order. *Never* come right out and state your key points. Work Tesla in somehow, and be sure to include plenty of obscure religious and/or political references. Show how your theory is now being suppressed by a federal conspiracy headed by the Trilateral Commission and secretly funded through both the WCTU and the SPCA.

Ignore all the personal computers entirely. They are only a passing fad that never will catch on. Finally, do

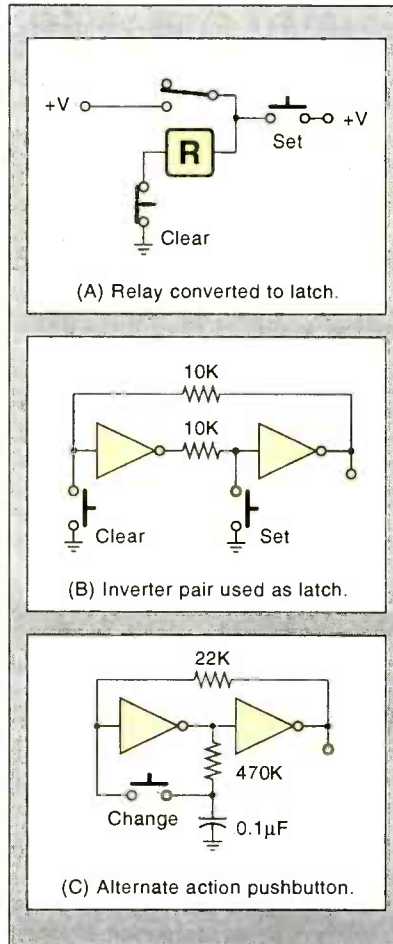

FIG. 1—SOME SIMPLE LATCHES and alternate action circuits.

not ever, under any circumstances, use any new desktop publishing tools and techniques.

### Alternate action switches

I got a helpline call the other day asking for a circuit to convert any old ordinary relay into an alternate-action on-off device. Well, as the caller has found out on his own, that gets a little trickier than it sounds.

Figure 1-a shows how to convert a regular relay into a latching relay. Press normally open button A and your relay pulls in. The pull in closes a relay contact that *holds* the relay engaged. To reset the relay, press normally closed button B. The relay drops out, opening its latching contact. This is a simple example of a *latch*, or a *set-reset* flip-flop.

In Fig. 1-b we've used a pair of digital logic inverters instead. An inverter outputs a one for any zero input and vice versa. Assume the left inverter happens to be outputting a one. The right inverter sees

this one as an input, and outputs a zero. The zero in turn reaches around and holds the left inverter in its present state. We are thus latched and stable. Press button A to set your latch. Press button B to clear your latch.

It turns out that any alternate-action circuit has to consist of two distinct storage elements. One is for "Where am I?" and one is for "Where was I?" If you don't provide two storage devices, you will get into major reliability, oscillation, or preferred state hassles.

In most integrated circuits, the two needed storage elements are done with a *pair* of separate latches. One is called the *master* flip-flop. The other is the *slave* flip-flop. Often they are combined into a single more complex logic block, forming a *type-D clocked flip-flop* or some similar device.

Check carefully, and you will even find that the button on a retractable ball-point pen consists of two distinct storage devices.

The simplest alternate-action pushbutton I know of appears in Fig. 1-c. The "Where am I?" storage consists of that pair of back-to-back inverters. The "Where was I?" storage is the capacitor.

Here's how it works: Some brief time after that latch changes, the capacitor will charge up to hold the

The **VALUE** at each PEL or picture element determines the brightness for that pel; the **LOCATION** of that pel in the array sets the pel position in your actual image.

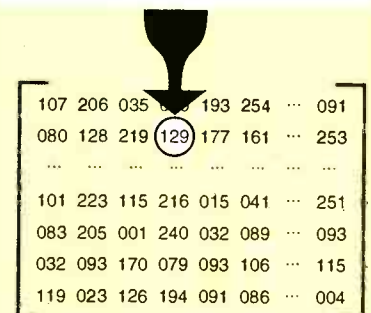

FIG. 2—A **DIGITAL IMAGE** is nothing but an array of numbers. Digital image processing takes those numbers and replaces them with other numbers, following a rule or set of rules. While there is a stunning variety of uses for digital image processing tricks and techniques, two of the most important involve gamma correction and histogram equalization.

**NEW FROM  
DON LANCASTER**

**HARDWARE HACKER STUFF**

Hardware Hacker Reprints II or III	24.50
Midnight Engineering Reprints	18.50
Incredible Secret Money Machine	18.50
CMOS Cookbook	24.50
TTL Cookbook	24.50
Active Filter Cookbook	19.50
Micro Cookbook vol I or II	19.50
Lancaster Classics Library	119.50
AppleWriter Cookbook	19.50

**POSTSCRIPT STUFF**

Ask The Guru Reprints I, II or III	24.50
LaserWriter Secrets (IIe/Mac/PC)	29.50
PostScript Show & Tell	39.50
Intro to PostScript VHS Video	39.50
PostScript Beginner Stuff	39.50
PostScript Cookbook (Adobe)	16.50
PostScript Ref. Manual II (Adobe)	28.50
PostScript Program Design (Adobe)	22.50
Type I Font Format (Adobe)	15.50
LaserWriter Reference (Apple)	19.50
Real World PostScript (Roth)	22.50
PostScript Visual Approach (Smith)	22.50
Thinking in PostScript (Reid)	22.50
Undst PS Pgrmmg (Holtzgang)	29.50
The Whole Works (all PostScript)	349.50

**BOOK-ON-DEMAND STUFF**

Book-on-demand resource kit	39.50
GENIE PSRT sampler (IIe/Mac/PC)	39.50

FREE VOICE HELPLINE      VISA/MC

**SYNERGETICS**  
Box 809-RE  
Thatcher, AZ 85552  
(602) 428-4073



- (A) Typical Gamma curve of a CRT electron beam display or a "white write" laser printer will wash out many of the lighter whites.
- (B) Properly gamma corrected display or printer treats all gray levels equally. Some available gray levels may be lost in the process.
- (C) Typical Gamma curve of a "black write" laser printer (such as a Canon SX) will muddy the darker grays.

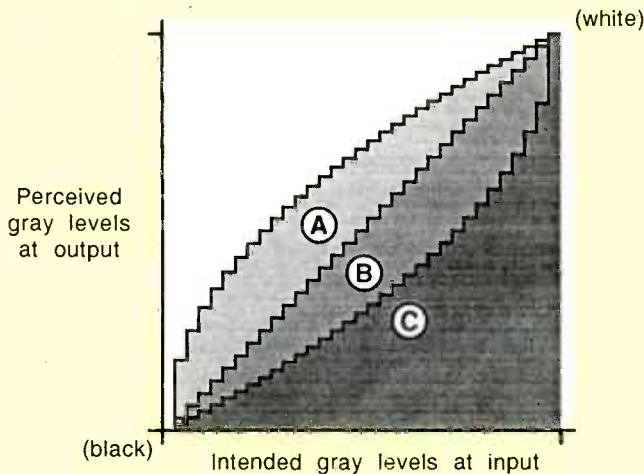

FIG. 3—THE GAMMA CURVE for any display or printer relates how the brightness levels are viewer perceived compared to how they are input. A non-linear gamma either "muddies the lows" or "washes out the highs." Gamma correction attempts to make each gray equally significant to the end viewer.

"Where was I?" one or zero. Pressing the button forces the "Where was I?" value back onto the input of the first inverter, and the latch quickly flips.

That happens because the charge on a capacitor cannot change immediately. Thus, at the instant the switch is closed, the capacitor acts as a very low impedance which "force feeds" its value to the inverter input. As soon as the inverters flip, positive feedback reinforces and holds the new value.

Releasing the button will let the "Where am I?" pair of inverters work normally. A short interval later, the capacitor will charge up (or down) to its new "Where was I?" value, and the cycle can repeat.

The circuit can also be used as a relay driver. It's the fastest and best way I know of to make a mechanical relay reliably alternate its states. While any old CMOS gates could be used, my favorite here would be a 74HC13 hex Schmidt trigger. Much more technical information on

counters, latches, and state alternation appears in my *CMOS Cookbook*.

### Digital image processing

I never cease to be amazed at how stunningly versatile that PostScript general-purpose language is. I've recently used PostScript to create a group of rapid, easy, and fun digital image processing tools. The tools and a few test images to go with them have been posted to my *GENie* PSRT RoundTable as IMAGE-KIT.PS.

What I'd like to do here is give you a brief introduction to digital image processing. We'll limit ourselves to high-quality gray-scale images.

We will also try to zero in on doing both a *gamma correction* and a *histogram equalization*. Those are both highly important and little understood crucial uses for serious digital image processing. Fail to understand either one and your images will all end up as disasters waiting to happen.

## DIGITAL VIDEO STABILIZER

ELIMINATES ALL VIDEO COPYGUARDS



While watching rental movies, you will notice annoying periodic color darkening, color shift, unwanted lines, flashing or jagged edges. This is caused by the copy protection jamming signals embedded in the video tape, such as Macrovision copy protection. THE DIGITAL VIDEO STABILIZER: RXII COMPLETELY ELIMINATES ALL COPY PROTECTIONS AND JAMMING SIGNALS AND BRINGS YOU CRYSTAL CLEAR PICTURES.

### WARNING

THE DIGITAL VIDEO STABILIZER IS INTENDED FOR PRIVATE HOME USE ONLY. IT IS NOT INTENDED TO COPY RENTAL MOVIES OR COPYRIGHTED VIDEO TAPES THAT MAY CONSTITUTE COPYRIGHT INFRINGEMENT.

### FEATURES

- Easy to use and a snap to install
- State-of-the-art Microchip technology
- 100% automatic
- Compatible to all types of VCRs and TVs
- The best and most exciting Video Stabilizer in the market
- Light weight (8 ounces) and compact (1x3.5x5")
- Uses a standard 9 Volt battery (last 1-2 years)
- Fast UPS delivery
- Air shipping available
- UNCONDITIONAL 30 day money back guarantee
- 1 year warranty

(Dealers Welcome)  
**FREE 20P Catalog**

To Order: \$59.95 ea + \$4 for p & h  
Visa, M/C, COD Mon-Fri: 9-6 EST

**1-800-445-9285**

ZENTEK CORP. DEPT. CRE10

3670-12 WEST OCEANSIDE RD. OCEANSIDE, NY 11572

CIRCLE 191 ON FREE INFORMATION CARD

## CABLE TV DESCRAMBLERS

How You Can Save Money on  
Cable Rental Fees

### Bullet Proof

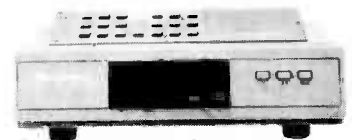

1 Unit 5+

BEST Super Tri-Bi Auto/  
Var. Gain Adjustment \$119.95...\$85  
Jerrold Super Tri-Bi... \$109.95...\$79  
Scientific Atlanta... \$109...\$79  
Pioneer... \$109...\$79  
Panasonic TZPC145... \$99.95...\$79  
Stargate Converter... \$95...\$69  
Digital Video Stabilizer... \$59.95...\$29  
Wireless Video Sender... \$59.95...\$49.95

**US Cable'll Beat  
Anyone's Price  
Advertised in  
this Magazine!**

**30 Day Money Back Guarantee**  
**FREE 20 page Catalog**

Visa, M/C, COD or send money order to:  
**U.S. Cable TV Inc. Dept. KRE10**  
4100 N. Powerline Rd., Bldg. F-4  
Pompano Beach, FL 33073

**1-800-772-6244**

### For Our Record

I, the undersigned, do hereby declare under penalty of perjury that all products purchased, now and in the future, will only be used on Cable TV systems with proper authorization from local officials or cable company officials in accordance with all applicable federal and state laws. FEDERAL AND VARIOUS STATE LAWS PROVIDE FOR SUBSTANTIAL CRIMINAL AND CIVIL PENALTIES FOR UNAUTHORIZED USE.

Date: \_\_\_\_\_

Signed: \_\_\_\_\_

**No Florida Sales!**

CIRCLE 192 ON FREE INFORMATION CARD

We'll first note that good old silver halide "slopping-in-the-slush" photo work is both incredibly versatile and highly forgiving—besides having an enormous dynamic range.

Instead, electronic digital displays, printers, and any photosteters demand data which is always "right on." If anything misses at all, you will get lousy to useless results. That's why digital image processing has become so important. And so hackable.

Hmmm. To do some digital image processing, you have to start with a digital image. You can borrow one of mine off of GENIE PSRT, or grab one from a scanner, off a satellite, a fax machine, or a video-capture board. Such a digital image is made up of picture elements, or pels. Note that a pel may or may not be the same size as the final pixel on your output device. A pel is simply the minimum resolvable data value found in your numbers within the digital image.

In a gray scale image, a pel gets defined by three parameters. The

pel luminance value will tell you how bright this tiny portion of your scene will be. Its X position value will tell you how far over in the picture this pel sits, while its Y position tells you how far up and down.

For instance, in the LENA.PS file #463 on up PSRT, we use 256 possible grays (ranging from PostScript's 0 = black smoothly up on through a 1 = white). These pels are arranged as an image 256 bytes wide by 192 bytes high. That size was picked to be big enough to be useful and interesting, yet small enough, short enough, and fast enough to have lots of fun with. PostScript, of course, can handle any image size and resolution you want.

The first byte in your data file contains the 8-bit luminance value for the upper lefthand pel. The second byte is for the next pel to the right, and so on. After 256 horizontal pels, the data starts over again at the left pel of the next line down. This repeats for a total of 192 lines

## SEMICONDUCTOR RESOURCES

### Actel

955 East Arques Avenue  
Sunnyvale, CA 94086  
(408) 739-1010

CIRCLE 323 ON FREE INFORMATION CARD

### Advanced Linear Devices

1180 F Miraloma Way  
Sunnyvale, CA 94086  
(408) 720-8737

CIRCLE 324 ON FREE INFORMATION CARD

### Advanced Micro Devices

PO Box 3453  
Sunnyvale, CA 94088  
(800) 222-9323

CIRCLE 325 ON FREE INFORMATION CARD

### Allegro/Sprague

70 Pembroke Road  
Concord, NH 03301  
(603) 224-1961

CIRCLE 326 ON FREE INFORMATION CARD

### Altera

2610 Orchard Parkway  
San Jose, CA 95134  
(408) 984-2800

CIRCLE 327 ON FREE INFORMATION CARD

### Analog Devices

PO Box 9106  
Norwood, MA 02062  
(617) 329-4700

CIRCLE 328 ON FREE INFORMATION CARD

### AT&T

555 Union Blvd  
Allentown, PA 18103  
(800) 372-2447

CIRCLE 329 ON FREE INFORMATION CARD

### Brooktree

9950 Barnes Canyon Road  
San Diego, CA 92121  
(800) 843-3642

CIRCLE 330 ON FREE INFORMATION CARD

### Burr-Brown

6730 South Tucson Blvd  
Tucson, AZ 85706  
(602) 746-1111

CIRCLE 331 ON FREE INFORMATION CARD

### California Micro Devices

215 Topaz  
Milpitas, CA 95035  
(408) 263-3214

CIRCLE 332 ON FREE INFORMATION CARD

### Catalyst Semiconductor

2231 Calle de Luna  
Santa Clara, CA 95054  
(408) 748-7700

CIRCLE 333 ON FREE INFORMATION CARD

## SUPER 12 HOUR RECORDER CALL TOLL FREE

Modified Panasonic Slimline,  
6 hrs per side  
120 TDK tape furnished.  
AC/DC Operation.  
Quality Playback.  
Digital Counter.  
Durable Lightweight Plastic.



\$119.00\*

### PHONE RECORDING ADAPTER

Starts & Stops Recorder  
Automatically When  
Hand Set is Used.  
Solid State!



FCC Approved

\$28.50\*

### VOX VOICE ACTIVATED CONTROL

Solidstate Adjustable  
Sensitivity. Voices &  
Sounds Activate Recorder  
Adjustable Sensitivity  
Provisions for Remote  
Mike



\$28.50\*

\* Add for ship. & handling. Phone Adapter & Vox \$2.00 each, Recorders \$5.00 each. Colo. Res add tax. Mail Order, VISA, M/C, COD's OK. Money Back Guar. Qty Disc. available. Dealer inquiries invited. Free data on other products.

AMC SALES INC. 193 Vaquero Dr.  
Boulder, CO. 80303  
Phones (303) 499-5405 1-800-926-2488  
FAX (303) 494-4924  
Mon-Fri 8-5 MTN. TIME

CIRCLE 108 ON FREE INFORMATION CARD

## BIG PROFITS IN VIDEO REPAIR!

### WORK FROM HOME-EARN \$85 HR!

With the tens of millions of VCRs and Camcorders in use, there currently is a **serious shortage** of trained techs to perform cleaning and repair jobs on these popular devices...

Learn how you can start your own **highly profitable, Home-Based** video servicing business...

And since up to 95% of all VCR and Camcorder malfunctions are due to a simple **mechanical or electro-mechanical** failure, you need not spend months or even years of complicated study before starting **paid, professional service work!**

Let Viejo's Training Program show you how!

**1-800-537-0589**  
or mail coupon today!

CALL TOLL-FREE

Train at Home in your Spare Time!

### VIEJO PUBLICATIONS, INC.

4470-107 Sunset Blvd., Suite 600  
Dept. VK Los Angeles, CA 90027

Yes! Rush me your **FREE OPPORTUNITY KIT** today!  
(Check appropriate box)

- VCR Repair
- Camcorder Repair
- Advanced VCR Repair
- Fax Machine Repair

Name \_\_\_\_\_

Address \_\_\_\_\_

City/State \_\_\_\_\_ Zip \_\_\_\_\_

Dept. RE

CIRCLE 190 ON FREE INFORMATION CARD

## SEMICONDUCTOR RESOURCES

### Cherry Semiconductor

2000 South County Trail  
East Greenwich, RI 02818  
(401) 885-3600  
CIRCLE 334 ON FREE INFORMATION CARD

### Cirrus Logic

1463 Centre Pointe Drive  
Milpitas, CA 95035  
(408) 945-8300  
CIRCLE 335 ON FREE INFORMATION CARD

### Crystal Semiconductor

PO Box 17847  
Austin, TX 78760  
(512) 445-7222  
CIRCLE 336 ON FREE INFORMATION CARD

### Cybernetic Micro Systems

3000 Highway 84  
San Gregorio, CA 94074  
(415) 726-3000  
CIRCLE 337 ON FREE INFORMATION CARD

### Cypress Semiconductor

3901 North First Street  
San Jose, CA 95134  
(408) 943-2600  
CIRCLE 338 ON FREE INFORMATION CARD

### Dallas Semiconductor

4401 South Beltwood Pkwy  
Dallas, TX 75244  
(214) 450-0400  
CIRCLE 339 ON FREE INFORMATION CARD

### EG&G Reticon

345 Potero Avenue  
Sunnyvale, CA 94086  
(408) 738-4266  
CIRCLE 340 ON FREE INFORMATION CARD

### Elantec

1996 Tarob Court  
Milpitas, CA 95035  
(408) 945-1323  
CIRCLE 341 ON FREE INFORMATION CARD

### Exar

PO Box 49007  
San Jose, CA 95161  
(408) 732-7970  
CIRCLE 342 ON FREE INFORMATION CARD

### Exel

2150 Commerce Drive  
San Jose, CA 95131  
(408) 432-0500  
CIRCLE 343 ON FREE INFORMATION CARD

### Fujitsu

3545 N First Street  
San Jose, CA 95134  
(800) 642-7616  
CIRCLE 344 ON FREE INFORMATION CARD

or 49152 bytes. Or 48K for short.

As Fig. 2 shows us, digital image processing simply consists of taking this large array of digital bytes and then creating a second array of new digital bytes. The bytes in the second array are related to the bytes in the first array by some rule or set of rules. And your processed new image should somehow be "better" for whatever you are trying to do.

For instance, we might just take each individual data value and make it larger. That would brighten your display and give you *lighter* values. Make each data value smaller, and you will instead *darken* your display, favoring darker values.

Should there be any defect in the picture, you can "retouch" by looking at adjacent pel values and working out some type of average. Carried to extremes, this sort of digital image processing can remove telephone poles from pictures, rear-range trees, and literally leap tall buildings with a single bound.

A digital image processing *anti-aliasing* trick lets you remove the jaggies from black and white lines. For anti-aliasing, gray values should get substituted equal to the expected average value at each pel. From any reasonable viewing distance, your jaggies will magically disappear.

Calculating new pel values based upon values of neighbor pels opens up all sorts of powerful digital image processing opportunities. For instance, if you average or low-pass filter against nearby pels, you can soften or *soft focus* your image. If you emphasize differences, you can crisp or *sharpen* your final image. Carried to extremes, a crispening or sharpening becomes *edge detection*, where only outlines remain. A magic algorithm called a *Laplacian* is often used for high-quality edge detection.

What if your original picture is out of focus or blurry? Well, you can go to a rather fancy *Fourier* or wavelet transform into a *transform plane*

## Be an FCC LICENSED ELECTRONIC TECHNICIAN!



No costly school. No commuting to class. The Original Home-Study course prepares you for the "FCC Commercial Radiotelephone License." This valuable license is your professional "ticket" to thousands of exciting jobs in Communications, Radio-TV, Microwave, Maritime, Radar, Avionics and more...even start your own business! You don't need a college degree to qualify, but you do need an FCC License.

**No Need to Quit Your Job or Go To School**  
This proven course is easy, fast and low cost! **GUARANTEED PASS**—You get your FCC License or money refunded. **Send for FREE facts now. MAIL COUPON TODAY!**

**COMMAND PRODUCTIONS**  
FCC LICENSE TRAINING, Dept. 90  
P.O. Box 2824, San Francisco, CA 94126  
Please rush FREE details immediately!

NAME \_\_\_\_\_  
ADDRESS \_\_\_\_\_  
CITY \_\_\_\_\_ STATE \_\_\_\_\_ ZIP \_\_\_\_\_

## Cable TV Article Parts

We stock the exact Parts & PC Board for an article published in Radio Electronics Magazine on building a Snooper Stopper.

**Snooper Stopper Kit.....\$19.95**  
Includes all the original Parts & Etched, Drilled Silk-Screened PC Board.

**Snooper Stopper.....\$39.00**  
This is an assembled and tested fixed frequency 106.5Mhz. Snooper Stopper for most Jerrold systems.

**Protect yourself from descrambler detection and stop the Bullet with one of our Snooper Stoppers.**

**Macrovision..now you see it, now you don't.**  
**Macrovision Kit.....\$29.00**  
Includes all the original Parts & Etched, Drill Silk-Screened PC Board. Originally Published in Radio Electronics Magazine.

**Call Toll Free 1-800-886-8699**

Visa, MasterCard or COD

**Northeast Electronics, Inc.**  
PO Box 3310  
N. Attleboro, Ma. 02761

CIRCLE 181 ON FREE INFORMATION CARD

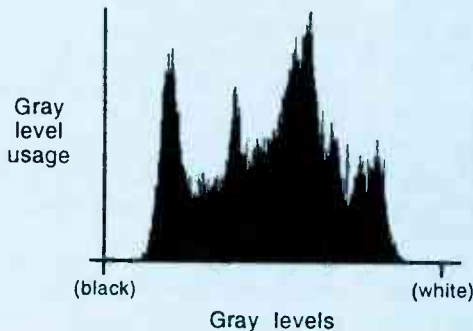

FIG. 4—THIS STOCK "LENA" DIGITAL IMAGE appears rather "weak" or "low in contrast." A glance at the histogram clearly shows why. There are no dark blacks, no lighter whites, and the few remaining grays cluster around the two peaks.

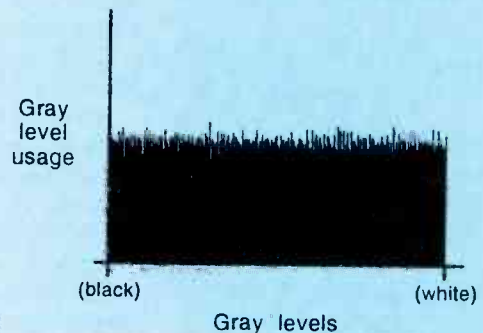

FIG. 5—HISTOGRAM EQUALIZED "LENA" DIGITAL IMAGE has much higher contrast. The histogram shows all gray values are in full use. A full histogram equalization is the equivalent of a perfect photo darkroom "dodge and burn."

and extract a *deblurring function*. Which can cancel out much (but not all) of such things as camera motion. And perform such tricks as reading those license plates on speeding cars.

There are now zillions of exciting techniques which use digital image processing. We may look at some of these in future columns. But the first of the two techniques I feel are by far the most important involves...

### Gamma correction

The eye acts as a log, rather than a linear device. And deep down inside, most display schemes are also quite nonlinear. As Fig. 3 shows us, the *Gamma* curve for any imaging system relates how the *expected* input gray levels actually *appear* to your eye at the output.

The process of "fixing" a gamma curve is called *Gamma Correction*. On a video display, nonlinearities are *purposely* introduced to attempt to cancel out such nonlinearities as the square law response of most electron beams to a control voltage. In color work, the strengths of each

individual beam are also carefully adjusted to make each color appear to be equally bright. Even if the color phosphors used have different sensitivities. As does your eye.

If at all possible, you want to do your gamma correction in some way that does *not* cut into the number of grays you have available. But if it simply can't be helped, digital image processing can be applied to gamma correct your display. It can do that by redefining gray levels, trading off a lot of nonlinear grays for fewer and more linear ones.

All of today's laser printers have inherently nonlinear gamma curves. This happens because a round dot is used which has to be *larger* than the intended square pixel it is supposed to completely and flawlessly cover. Thus, in a *black write* system (such as the Canon SX) where the laser places down black dots, typical gray levels usually end up *darker* than you asked for.

The *PhotoGrade* system used on the Apple *LaserWriter G* uses digital image processing to trade off its gray levels for a more linear gamma.

We saw some details on the *PhotoGrade* halftoning process last month. At 106 DPI, Apple's *PhotoGrade* system has 128 gray levels available. A total of 61 of these are often used for gamma correction. The gamma correction redefines lots of really dark grays and a few of the mid range grays. The net result is the remaining 67 distinct and fully Gamma corrected grays.

The *PhotoGrade* system offers you three calibration options. The options compensate for your particular choice of toner, density settings, humidity, and so on. On a calibration, a coarse and a finer halftone square are put down for typical gray levels. This is done for three different pages. You then pick the page you like the best. The internal code does a predefined Gamma correction for you.

Additional details on *PhotoGrade* processing appear in my *GENie* PSRT #451 LASGCAL.PS and over in #388 LASGNOTE.TXT. Also quite handy is a #R02311/A *LaserWriter IIg Printers Developer Notes* from APDA.

## NAMES AND NUMBERS

### APDA

20525 Mariani Avenue 33G  
Cupertino, CA 95014  
(800) 282-2732  
CIRCLE 345 ON FREE INFORMATION CARD

### Dialog Information Service

3460 Hillview Avenue  
Palo Alto, CA 94304  
(415) 858-2700  
CIRCLE 346 ON FREE INFORMATION CARD

### DynaArt Designs

3535 Stillmeadow Lane  
Lancaster, CA 93536  
(805) 943-4746  
CIRCLE 347 ON FREE INFORMATION CARD

### GENie

401 N Washington Street  
Rockville, MD 20850  
(800) 638-9636  
CIRCLE 348 ON FREE INFORMATION CARD

### Geo-Monitor

65 Washington Street #400  
Santa Clara, CA 95050  
(408) 749-6770  
CIRCLE 349 ON FREE INFORMATION CARD

### High Energy Enterprises

PO Box 5636  
Security, CO 80931  
(719) 475-0918  
CIRCLE 350 ON FREE INFORMATION CARD

### Hitachi

2000 Sierra Point Pkwy  
Brisbane, CA 94005  
(415) 589-8300  
CIRCLE 351 ON FREE INFORMATION CARD

### KMC

PO Box 348  
Port Washington, WI 53074  
(414) 284-3424  
CIRCLE 352 ON FREE INFORMATION CARD

### Murata

2200 Lake Park Drive  
Smyrna, GA 30080  
(404) 436-1300  
CIRCLE 353 ON FREE INFORMATION CARD

### Outwater Plastics

4 Passaic Street  
Wood-Ridge, NJ 07075  
(800) 526-0462  
CIRCLE 354 ON FREE INFORMATION CARD

### Quality Technologies

610 North Mary Avenue  
Sunnyvale, CA 94086  
(408) 720-1440  
CIRCLE 355 ON FREE INFORMATION CARD

### Sigretics/Philips

PO Box 3409  
Sunnyvale, CA 94088  
(800) 227-1817  
CIRCLE 356 ON FREE INFORMATION CARD

### Synergetics

Box 809  
Thatcher, AZ 85552  
(602) 428-4073  
CIRCLE 357 ON FREE INFORMATION CARD

### Techniks, Inc

45 J Ringo Road  
Ringoes, NJ 08551  
(908) 788-8249  
CIRCLE 358 ON FREE INFORMATION CARD

### UMI

300 North Zeeb Road  
Ann Arbor, MI 48106  
(800) 521-3044  
CIRCLE 359 ON FREE INFORMATION CARD

### WeatherSat Ink

4821 Jessie Drive  
Apex, NC 27502  
(919) 362-5822 FAX  
CIRCLE 360 ON FREE INFORMATION CARD

## Histograms

Those photo darkroom technicians and artists have lots of secret tricks they use to explore the incredible dynamic range of photo film. By lengthening or shortening all their exposures, they can make all of their prints darker or lighter. By printing on a "soft" paper, they can reduce their dynamic range and contrast. Or increase it by using a "hard" paper. Or eliminate it entirely with a "litho" photo paper.

Even more sneaky is *dodging* and *burning*. With dodging, you put your moving and out-of-focus hand or a

*dodging paddle* between the enlarger and the area being printed. That *holds back* your light in a selected area and makes that area *lighter* than normal. Which lets you pull details out of any dark or "muddy" areas of your negative.

With burning, you hold an opaque mask having a small, ragged, out of focus, and rapidly moving hole in it between your enlarger and the print paper. Burning lets you darken your highlights and extract details from underexposed areas.

By now, most of you have seen those spectacular Navajo slot can-

yon photos. Most any southwest calendar should include at least one example. And *Arizona Highways* will be happy to sell you bunches of them. These incredible prints carry dodging and burning to an extreme, using multiple exposures and twenty or more very precisely aligned dodging masks to bring out the subtleties of color and texture.

Digital image processing can be used to imitate these darkroom tricks. And getting things right on gets even more important with digital images, because you will always be severely limited by both the dynamic range and laser resolution.

The first step in correcting a digital image is to find out what was wrong with it in the first place. To do this, you run a *histogram*. A histogram is simply a vote on how many of the grays get used how often. Figure 4 shows us the stock and well-known *Lena* digital image, which should appear slightly "weak" or low in contrast.

That histogram underneath *Lena* clearly shows us why. Those lightest and darkest grays are not used at all. And most of the rest fill two clearly defined peaks.

A digital image processing method known as *histogram equalization* will let you perform a magic dodging and burning that can often dramatically improve your results. In Fig. 5 you see a much higher contrast and greatly improved *Lena* with lots more "snap."

To do your histogram equalization, you try to spread all of your pels around such that *each gray gets used nearly as often as any other*. You can then selectively replace each pel with a lighter or a darker gray, adjusting your accumulated sum to spread out the total number of pels per gray.

In short, you'll do an absolutely perfect dodge and burn.

For instance, if you have 49152 pels in your image and use 256 gray levels, you redefine your grays to get about 192 or so pels per gray level. A simple accumulated running average does the job for you. Full code details in my digital image tools on *GENie* PSRT, especially *IM-AGEKIT.PS*. As you can see in Fig. 5, nearly all of those available grays are fully and uniformly used.

By doing a histogram equalization, you can print "auto shopper" quality images on any unenhanced 300 DPI laser printer.

Figures 4 and 5 are available as PSRT files #463 LENA.PS and my #468 LENA.HIST.PS.

### Semiconductor chip houses

I have been meaning to do some resource sidebars that give you most integrated circuit manufacturers, or at least the more hacker-friendly ones. Since there's so many of them, we'll need several sidebars to do the job right. So, *Actel* through *Fujitsu* will appear this month, and I'll show you the rest of them as we get to them.

Some data books are free. Others have "optional" pricing depending on whether the sales person likes you or whether any of the covered chips are currently being promoted. For others, just about everybody has to pay the going rate.

Your best bet is to first request a short form catalog, a price list, and

their technical literature and application note index. These are all usually both free and immediately available.

Be sure to use your laser-printed letterhead or a professional sounding telephone request.

### New tech lit

Data books include the *Optoelectronic Products Catalog* from *Quality Technologies*. This used to be the old *GE/Harris* opto line.

*Advanced Linear Devices* has a *Product Databook* on linear timers, op-amps, and comparators.

From *Signetics/Philips*, there's a new data book on *CMOS Sequencer Solutions*. And from *Hitachi*, there's a *Semiconductor Devices for Communications* data book. Included are lots of telco and cellular radio devices.

Our two brand new labor-of-love newsletters include *WeatherSat Ink* and the *Geo-Monitor*. The first is on weather satellite image reception; the second on earthquake monitor-

ing and prediction.

Over in our neat mechanical stuff department, a free sample of a laser machined plastic is available from *KMC*. And an incredible catalog from *Outwater Plastics*. These folks are laboring under the delusion that they are now in the store display fixtures business. In reality, they offer lots of useful new electronic and prototyping hardware at unbeatable prices. Not to mention off-the-wall ideas. They even stock Grecian urns for writing odes on.

For the two key books on all of the fundamentals of digital integrated circuits, try my *CMOS Cookbook* and *TTL Cookbook*, either by themselves or as part of my *Lancaster Classics Library*.

As usual, we've gathered many of the resources mentioned together into either the *Names & Numbers* or the *Integrated Circuit Manufacturers* sidebars. Check these out before you use our no-charge technical helpline or call for your free hacker secrets brochure. **R-E**



**\$429**

## AN ECONOMICAL KEYBOARD-CONTROLLED KEPCO BENCH POWER SUPPLY 75 WATTS

Choose from four Digital Power Supplies: 0-12.5V @ 6A, 0-24V @ 3A, 0-40V @ 2A or 0-125V @ 0.5A. Each one offers precise, repeatable voltage control with two current ranges. Fully protected for overvoltage or overcurrent.

**Bonus:** You can program the output from your PC's serial port (RS232 software included) and read back too!

The DPS is an affordable professional instrument and belongs on your bench.

Want more info? Ask for "DPS" brochure, 146-1768. Call-write-fax: Dept. MXS-87, Kepco Inc. 131-38 Sanford Avenue, Flushing, NY 11352 USA • Tel: (718) 461-7000 • Fax: (718) 767-1102. Use your VISA or MASTERCARD. Immediate delivery, 5-year warranty.



# 39.504

## ELECTRONIC COMPONENTS

Whether you order 1 part or all 39,504...MOUSER stocks and...can ship today!!

CALL...  
(800) 992-9943

for your  
FREE  
CATALOG

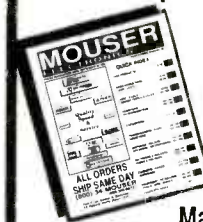

2401 Hwy 287 N.  
Mansfield, TX 76063

# MOUSER ELECTRONICS

Sales & Stocking Locations Nationwide

CIRCLE 117 ON FREE INFORMATION CARD

Try the  
**Electronics  
NOW**

bulletin board  
system

(RE-BBS)  
516-293-2283

The more you use it the more useful it becomes.

We support 1200 and 2400 baud operation.

Parameters: 8N1 (8 data bits, no parity, 1 stop bit) or 7E1 (7 data bits, even parity, 1 stop bit).

Add yourself to our user files to increase your access.

Communicate with other R-E readers.

Leave your comments on R-E with the SYSOP.

RE-BBS  
516-293-2283



### ELEVEN-PIECE RACHET TOOL KIT

Includes reversible ratchet handle, extension bar, six bits, two precision screwdrivers, and a cutter. Comes in fitted case. Get one for your shop, another for your car, another for your tool kit. To order send **\$11.75** USA shipping only. **ELECTRONIC TECHNOLOGY TODAY INC., PO Box 240, Massapequa Park, NY 11762-0240.**

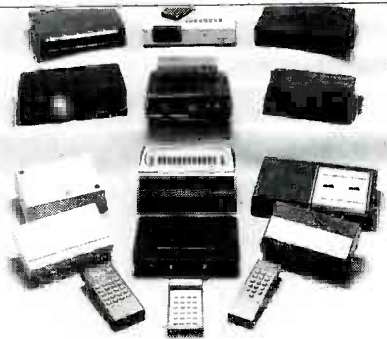

**CABLE TV CONVERTERS AND DE-SCRAMBLERS** SB-3, TRI-BI, MLD, M35B, DRZ-DIC. Call for catalog and price list. Special combos available. We ship COD. Quantity discounts. Call for pricing on other products. Dealers wanted. **FREE CATALOG.** We stand behind our products where others fail. One year warranty. **ACE PRODUCTS, 1-800-234-0726.**

CIRCLE 75 ON FREE INFORMATION CARD

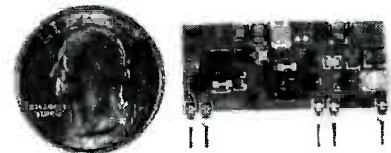

### TWO TRANSMITTERS IN ONE! 5 MINUTE ASSEMBLY! MONEYBACK GUARANTEE!

New Law Enforcement grade device on a single chip is the most sensitive, powerful, stable room transmitter you can buy. Uses any 3V-12V battery. Or attach to telephone line to monitor all telephone conversations over 1 mile away without batteries! 100mW output! 80-130MHZ. Receive on any FM radio or wideband scanner. VT-75 microtransmitter. **\$49.95 + 1.50 S&H. VISA, MC, MO. COD's add \$4.00. DECO INDUSTRIES, Box 607, Bedford Hills, NY 10507. 1-800-759-5553.**

CIRCLE 127 ON FREE INFORMATION CARD

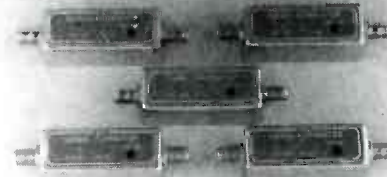
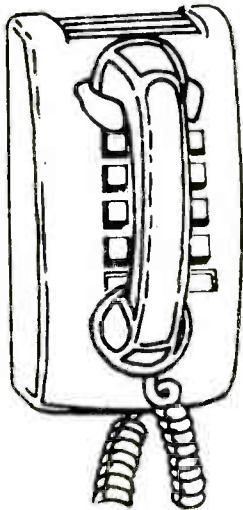

### TUNABLE 50dB NOTCH FILTERS—for TV.

Can be tuned precisely to required frequency. Model 23H-Ch's 2-3 (50-66 Mhz) Model 46FM-Ch's 4-6 plus FM (66-108 Mhz) Model 713-Ch's 7-13 (174-216 Mhz) Model 1417-Ch's 14-17 (120-144 Mhz) Model 1822-Ch's 18-22 (144-174 Mhz) **\$30** each, includes shipping. Visa, MC, or check. (C.O.D. \$5 extra). Fast delivery, 30 day money back. Quantity prices to **\$16. STAR CIRCUITS, P.O. Box 94917, Las Vegas, Nevada 89193, 1-800-535-7827.**



### GET YOUR RECHARGE CATALOG FREE...EARN BIG \$\$ IN YOUR SPARE TIME—All supplies and Do-It-Yourself kits with complete instructions available.

Supplies cost from **\$9.95** in qty and you can sell recharged toner cartridges for **\$40.00** to **\$55.00** each. Printers include HP LaserJet and Series II, Apple LaserWriter, QMS, etc. Canon PC-25 Copier also. **CHENESKO PRODUCTS, 2221 Fifth Ave., Suite #4, Ronkonkoma, NY 11779, 516-467-3205. FAX 516-467-3223, 1-800-221-3516**

## CALL NOW AND RESERVE YOUR SPACE

- 6 x rate \$940.00 per each insertion.
- Fast reader service cycle.
- Short lead time for the placement of ads.
- We typeset and layout the ad at no additional charge.

Call **516-293-3000** to reserve space. Ask for Arline Fishman. Limited number of pages available. Mail materials to: mini-ADS, ELECTRONICS NOW, 500-B Bi-County Blvd., Farmingdale, NY 11735.

FAX: 516-293-3115



### \$495 FOR A PROGRAMMABLE DC POWER SUPPLY IS NOW A REALITY!

• GPIB Interface Standard • Output Voltage/Current Programming & Readback • Local & Remote GPIB Operations • Remote Sense Function • Programmable Overvoltage and Overcurrent Protection • Software Calibration • Superior Line/Load Regulation • Output Enable/Disable • 3 Year Warranty. FREE Orientation Video available. For details, call: **AMERICAN RELIANCE INC. 800-654-9838 FAX: 818-575-0801.**

CIRCLE 187 ON FREE INFORMATION CARD

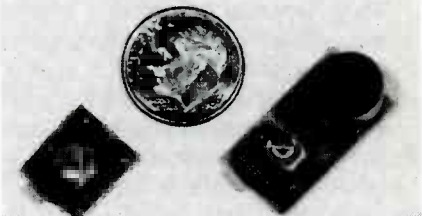

### WORLD'S SMALLEST FM TRANSMITTERS! New Surface Mount Technology (SMT) makes all others obsolete!

XST500 Transmitter—powerful 3 transistor audio amplifier, transmits whispers up to 1 mile. XSP250 Telephone Transmitter—line powered, transmits conversations up to ¼ mile. Both tune 88-108 MHz. Easy to assemble **E-Z KITS** (SMT components pre-assembled to circuit board)! XST500—**\$39.95, XSP250—\$29.95, VISA/MC. COD add \$5. XANDI ELECTRONICS, 201 E. Southern Ave., Suite 111, Tempe, AZ 85282. 1-800-336-7389.**

CIRCLE 195 ON FREE INFORMATION CARD

## Let's see what's involved in descrambling a SSAVI signal.

ROBERT GROSSBLATT

**F**ooling around with the simple video stuff we've been building is a nice alternative to hanging around on street corners, but it's not really all that terrific if your ultimate goal is to figure out what to do with the junk that shows up on certain channels on your TV. Suppressed sync is the Model-T version of video scrambling, and you can bet your bottom dollar that things have gotten a lot more complicated. Enter the digital age.

Since the suppressed-sync scrambling system was so simple, it wasn't long before people with only moderate electronic skills figured out what was being done and how to beat it. Even the simple stuff we put together over the last couple of months could—with some minor additions—do the job. As the cable business grew, so did the complexity of their scrambling methods.

As I told you when we first started out on this trip into cable video land, ripping the video signal apart is easy—putting it back together successfully is something else entirely. The amount of messing up that's done to the standard video signal is directly proportional to the cost. More intense scrambling is more expensive. Cable operators have to balance their degree of security against the cost of the equipment. Also, the larger the customer base, the less expensive the scrambling system has to be. In New York City (and other large areas), the cable companies have a lot of subscribers, each of whom needs a cable box. The more boxes the cable company has to buy (they don't make them themselves), the more money it has to keep tied up in its inventory.

The old suppressed-sync system was a one-way deal. If you got a box that could descramble one channel,

it could descramble any channel. Which channels would be unscrambled was determined by one of the wafers on the channel selector dial. A position would be either jumped or open, which was a major cable company headache for two reasons. The first was that they had to open the boxes and solder or cut traces to configure the box for a given customer. The second was that some enterprising people realized what was going on, opened up their cable boxes, and reconfigured it themselves.

The only way the cable companies could guard against that was to use screws with oddball shaped heads to hold the box together. When that didn't work, they started using screws that had a left-hand thread. But enough history.

What the cable companies needed was a way to talk to each of the boxes individually, while they were in customer's homes. Making such addressable boxes also meant that several scrambling methods could be used; the boxes could be told which method was in use at any one time. Since that information could be sent to the box during the vertical blanking interval (while the beam was off the screen), the cable operator could change the scrambling method from field to field—up to sixty times a second. The boxes

could also keep a serial number in an EPROM or some other storage device, which meant that boxes could be addressed individually and the descrambling circuitry could be turned on and off for separate channels from the main cable company office. The cable companies loved it.

Understanding that kind of stuff is a bit more difficult than the old suppressed-sync system, but if you take the pieces one at a time, it all gets cut down to manageable, bite-sized chunks. Although the cable company's scrambling delivery system became much more sophisticated, it was still faced with the same cost restrictions when it had to decide which of the available scrambling techniques to use.

One of the most popular choices was the so called SSAVI system. That's an acronym for Sync Suppression Active Video Inversion. It allows the video to be delivered to your doorstep in one of four flavors:

- Suppressed horizontal sync and normal video (Fig. 1).
- Suppressed horizontal sync and inverted video (Fig. 2).
- Normal sync and suppressed video (Fig. 3).
- Normal sync and normal video (we can forget this one).

Before we get into the nitty gritty of the SSAVI system, there are a

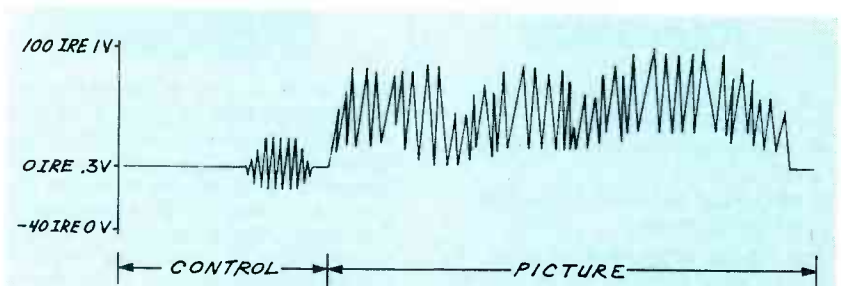

FIG. 1—THE SSAVI SYSTEM can deliver video with suppressed horizontal sync and normal video.



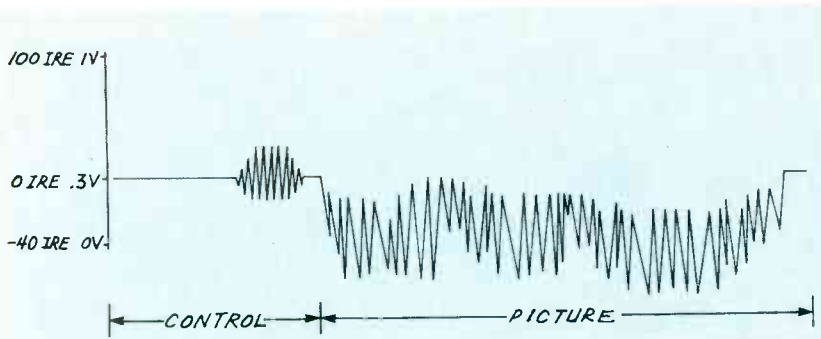

FIG. 2—SUPPRESSED HORIZONTAL SYNC and inverted video is also possible with the SSAVI system.

This isn't as strange as it might seem. In a normal video signal, the reference for color is the burst signal that follows horizontal sync. The colorburst signal lasts only a bit longer than 2 microseconds, but it's used as a reference for the whole video line, which is about 63 microseconds long. As far as color correction is concerned, that means there's no real reference signal available for more than 95% of the line! The color phase for the rest of the

few basic things you should know, because they tell you some interesting things about how the system works.

The first is that horizontal sync is never inverted—even if the picture is inverted. This means that any circuit designed to descramble it has to separate the two basic parts of the video line (control and picture first). We have to be able to turn the picture right side up (if needed) without inverting the control section as well.

The SSAVI system seems even more complex when you realize that the job of separating control and picture has to be done on lines that might very well have no horizontal sync pulse that can be used as a reference mark. In the older suppressed-sync system, the sync could be recovered from the gating signal that was buried in the audio; with the SSAVI system, there's nothing like that available.

The key to regenerating the video signal is based on the fact that all aspects of it are tied together in a strict mathematical relationship. If you can locate one part of the signal, you can determine where everything else has to be.

The broad picture for a descrambler, therefore, is to design a circuit that can identify one part of the signal, and then use the repetition of that signal as a reference for restoring the rest of the video. You should realize by now that we're talking about a phase-locked loop, or PLL. Even if the identifiable component of the video occurs only once a field (or even once a frame), that's still often enough to control the frequency of a voltage-controlled oscillator, or VCO, and lock the PLL to the received video.

## INTRODUCTORY OFFER

# Genuine Coin Jewelry

*Attracts attention!*



## Breath-taking designs!

**E**xquisite jewelry made from government-minted coins. Each coin pendant has its background cut away by hand with saws as thin as 16 thousandths of an inch leaving the coin's figure floating inside its rim. Each hand-crafted coin is cleaned and polished before 24K gold and silver is added artfully to selected portions of the coins. Finally, the coin is protected from wear and discoloration by a super-clear impervious plastic micro-coating that will not crack, chip or peel. Each coin pendant is packaged in a Shimmerlite jewelry box complete with 24-inch chain layered in 14K gold.

Each coin pendant complete with chain and jewelry box is priced at **\$39.95** which includes postage and handling. Please be sure to indicate coin(s) desired and quantity.

### Order Your Coin Pendant Today!

Please send my order of Coin Pendant(s) as indicated in the order form below.

No.	Pendant Description	Quantity
101	US Walking Liberty Half Dollar	
118	US Statue of Liberty Half Dollar	
120	Bahama 50-cent Blue Marlin	

Total Number of Pendants \_\_\_\_\_ at \$39.95 each. Total amount of Order \$ \_\_\_\_\_

Check or Money Order enclosed made payable to CLAGGK Inc.

Charge my  Visa  MasterCard

Account No. \_\_\_\_\_ Exp. Date \_\_\_\_/\_\_\_\_/\_\_\_\_

Credit Card Signature \_\_\_\_\_

Print Name \_\_\_\_\_

Address \_\_\_\_\_

City \_\_\_\_\_ State \_\_\_\_\_ Zip \_\_\_\_\_

No telephone orders or C.O.D. Signature required on credit card orders. All prices include postage and handling. Payments in U.S.A. funds only. New York residents must include local applicable sales taxes. No foreign orders.

Mail orders to CLAGGK Inc. Pendant Offer, P.O. Box 4099, Farmingdale, NY 11735. Telephone orders to 1-516-293-3751. FAX orders to 1-516-293-3115.

# FREE Heathkit

Educational Systems

Electronics & Computer Software  
Education Catalog

- \*Fast-Track Individual Learning Programs
- \*State-of-the-Art Classroom Courses
- \*The Best Values in Electronics Education Today

New

Computer Aided Instruction

DC Electronics  
AC Electronics  
Semiconductors  
Electronic Circuits

The stunning animations, hypertext glossary, and easy-to-understand text make learning the concepts of electronics a breeze...and fun!

Learn Electronics the easy and affordable way from the Masters in Electronics Training - Heathkit Educational Systems. From Basic Electricity and Electronics to Advanced Microprocessor Applications and much more, Heathkit will provide you will an unparalleled learning experience at a fraction of the cost of other programs.

For your FREE Catalog, call  
**Toll-Free 1-800-44-HEATH**  
please mention this code when calling 020-001

CIRCLE 86 ON FREE INFORMATION CARD

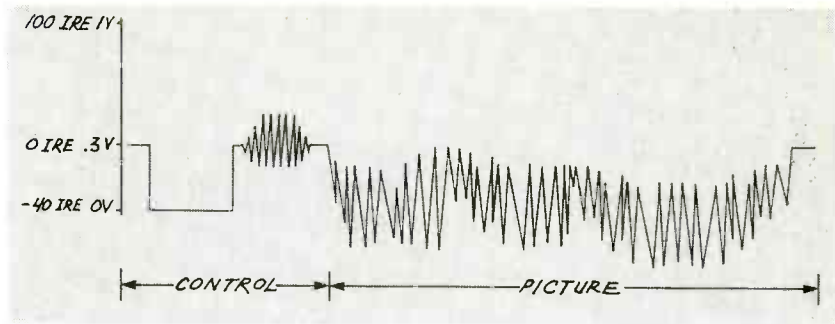

FIG. 3—HERE'S WHAT NORMAL SYNC and suppressed video look like.

line is based on the stand-alone 3.58-MHz generator that's a normal part of the TV set.

Building a SSAVI descrambler isn't as easy as building one to take care of suppressed sync, but it's not as difficult as you might think. Before we start to work out the details of the circuitry, we have to draw up a comprehensive list of exactly what we want the circuit to do. A circuit designed to descramble the SSAVI system needs the following basic features:

- A means of knowing if the picture will be normal or inverted.
- The ability to generate horizontal sync pulses.
- A way to identify a definite point in the received video.
- A circuit to place horizontal sync pulses at the right point.

Some SSAVI systems also play games with the audio, but the methods used to hide the audio have been around for a long time. The audio is usually buried on a subcarrier that's related, in some mathematical way, to the IF component of the TV signal. We'll get into that briefly when we take care of restoring the picture.

Although we'll be working out the details of the circuitry next time, you should already have some ideas of what it has to be like. The SSAVI system uses digital signals for security and access rights—the stuff that cable executives lie awake all night thinking about (instead of less-important things such as improving picture quality, increasing channel services, and widening the audio bandwidth. Because the first step in handling SSAVI scrambled signals is to locate a known point in the signal, we'll be using counters and other standard digital logic to keep track of where everything is sup-

posed to be. That's right people, most of the guts of a SSAVI descrambler are made of the same standard digital stuff we've been using in this column since the beginning.

In the future we'll take apart a typical frame of SSAVI-encoded video and see how we can put it back together again correctly. It's not as complicated as you think and, to tell you the truth, I wouldn't be a bit surprised if a bunch of you readers beat me to it. In the meantime, to help you appreciate what's involved in scrambling a video signal, next month we'll work on some circuitry that will scramble a perfectly good video signal.

R-E

# SALE!

## CABLE TV DESCRAMBLERS

WE'LL BEAT  
ANY PRICE!

CALL TOLL-FREE  
**1-800-284-8432**

- JERROLD • TOCOM • ZENITH •
- OAK • PIONEER • HAMLIN •
- SCIENTIFIC ATLANTA •

24 HOUR SHIPMENTS!  
QUANTITY DISCOUNTS!  
MONEY BACK GUARANTEE!  
FREE CATALOG & INFORMATION



MasterCard • American Express • Visa • C.O.D.  
HAVE MAKE AND MODEL NUMBER OF EQUIPMENT USED IN YOUR AREA

**1-800-284-8432**

FOR ORDERS ONLY

For technical & customer service: 305-749-3122  
ALL SHIPPING & HANDLING FEES AT CUSTOMER'S EXPENSE

**CABLE WAREHOUSE**

10117 WEST OAKLAND PARK BLVD., SUITE 515, SUNRISE, FL 33351  
NO FLORIDA SALES

CIRCLE 185 ON FREE INFORMATION CARD

Try the  
**Electronics  
NOW**

bulletin board  
system

(RE-BBS)  
516-293-2283

The more you use it the more  
useful it becomes.

We support 1200 and 2400 baud  
operation.

Parameters: 8N1 (8 data bits, no  
parity, 1 stop bit) or 7E1 (7 data  
bits, even parity, 1 stop bit).

Add yourself to our user files to  
increase your access.

Communicate with other R-E  
readers.

Leave your comments on R-E with  
the SYSOP.

RE-BBS  
516-293-2283

## Miniature multimedia machines.

JEFF HOLTZMAN

**A**pple has indeed announced a second miniature multimedia machine (MMM), as rumored here last month. Newton, the first MMM, will be designed and produced in conjunction with Sharp Electronics, and is more computer than gadget. Sweet Pea, the second, will be designed and produced in conjunction with Toshiba, and is more gadget than computer. Whereas Apple has publicly shown the hand-wired Newton prototype, Sweet Pea appears to exist only at the conceptual level. Nonetheless, the implications and technology behind Sweet Pea are enormous.

Newton has no keyboard, but uses a stylus for input. Connectivity to other Newtons, and to PC's and Macs, is also strong. The point is to service students, executives, factory workers, and others who need on-the-go computing that integrates smoothly and cleanly with desktop systems and networks.

Sweet Pea, on the other hand, appears to be aimed squarely at the consumer market, in particular, a segment that some are calling by the awkward term *infotainment*, which attempts to combine learning and entertainment. Sweet Pea will play specially prepared CD's containing text, graphics, audio, and video. According to one Toshiba official, it may connect to a TV set for home use, or it may be portable. It should hit the shelves in summer of 1993, and should be priced under \$1000.

The software technologies behind Sweet Pea are mighty interesting. Kaleida, the joint venture in multimedia between IBM and Apple, will supply these technologies. One is called Script X; it is an authoring language that developers can use to create multimedia titles that will run on multiple platforms, including Intel and Motorola CPU's, and

RISC devices. It will also run on special operating systems used by MMM's. In fact, Kaleida is developing one such operating system, the Consumer Operating System (COS) that will, of course, support Script X. Script X is also slated to support Apple's multimedia standard, QuickTime.

Apple has signed deals with Warner New Media and Paramount Communications to supply titles; Claris, Apple's software subsidiary, will also develop new titles.

Kaleida got off to a slow start, and has been partially eclipsed by other more immediately apparent benefits of the historic 1991 accords between IBM and Apple. However, the recent appointment of a board of directors, along with Nat Goldhaber as head of Kaleida, not to mention the Sweet Pea technology announcements, all indicate that Kaleida is likely to be the vortex of some fascinating and industry-shaking new developments.

Less technologically advanced, but likely to have some market impact, are new pen-based pocket organizers that will be introduced by Sharp and a joint effort between Tandy and Casio. At an estimated \$300, the Tandy/Casio unit aims to undercut initial pricing on Newton and Sweet Pea devices. The Tandy/Casio will use the GeoWorks graphical environment, will have built-in handwriting recognition, and will have a PCMCIA slot for memory and telecommunications. Look for it sometime in 1993. The Sharp unit adds pen input to the Wizard line, and includes an extensive pushbutton/menu-based interface. Pricing was unclear as of press time; the device is scheduled for release this year. Also scheduled from Sharp is an 8088-based palmtop that should sell for about \$1000.

Microsoft is hankering after this

market as well. Lately there has been discussion about a CD-ROM based machine that would run a ROM-based subset of Windows, connect to a TV set, and provide *infotainment*. Apparently designed to compete in the video-game market, the device is currently going by the name *Wintendo*.

### Upheaval in the PC business

In the beginning was the PC, which meant an 8088 and one or two 360K floppies. Then came the XT, which added a hard disk and bumped memory up to 640K. Next came the AT, which added a full 16-bit processor and peripheral interface. Then came the 386, which brought 32-bit processing and unheard-of performance. For a good four or five years, the boundaries between those four divisions were clear. However, in the past two years, the introduction of new CPU's by both Intel and its rivals has almost completely obliterated those bounds. Now there is a smooth spectrum of often overlapping price/performance choices ranging from lowly 386SX's to 50-MHz 80486DX's. It's nearly impossible to keep in mind all the variations among CPU's, including speed, bus width, power management, cache size, math coprocessor, and system support components. Choosing a complete system is no longer a choice among four well-defined categories.

Against that backdrop, manufacturers find it difficult to make their offerings stand out. In the past year, intense price wars have forced system costs to absurdly low levels. At first, the price wars were conducted almost exclusively among clone manufacturers, but Compaq recently joined the fray. IBM has promised to do so by this fall, and second-tier suppliers like Dell have

already retaliated. One industry analyst has stated that there are some 500 PC suppliers, of which 450 shouldn't exist. Another analyst suggests that within a few years, the vendor base will be reduced to a dozen multinational corporations that supply 95% of industry needs.

Another trend is that toward increasingly dense integration, both at the chip and the system level. For example, the original PC used 16K DRAM's. Today's standard is 4 megabits, an increase of 256 times. Back then, system logic was built from hundreds of discrete TTL components. Today, three or four VLSI IC's do the same job. At the system level, many motherboards today contain built-in serial and parallel ports, hard- and floppy-disk controllers, and expansive memory—16 megabytes or more. By contrast, original IBM motherboards seldom held more than 512K of memory, and contained nothing but the required system logic.

Together, price wars and the larger trend of increasing integration lead to the necessity of *product differentiation*, or some means of making your product stand out in the customer's mind from that of your competitor. Price cutting is one way, but it can only go so far. The other

way is to add features, and that's what we'll start seeing this fall.

Look for systems with built-in networking and sound capabilities. Look for systems from IBM and others with preinstalled operating system software (OS/2, DOS/Windows). Look for systems with tons of bundled applications. Look for creative marketing schemes. (For example, DAK, a mail-order house, now gives away a 386DX/33 with purchase of \$1500 worth of software—and quality stuff at that, including current versions of Windows, Word for Windows, Norton Desktop, Adobe Type Manager, Paradox, and more). Look for pre-assembled networks supporting anywhere from 2 to 250 users. Look for hard-drive upgrades from Seagate and others with preinstalled software (Windows). Look for laser-printer upgrades that include RAM with font and emulation cartridges. Look for operating systems (Windows and OS/2) to include more and more features traditionally assumed to be part of the applications realm, e.g., networking and E-mail.

The following are several trends to watch:

### CPU Wars

Intel continues to try to fend off attacks on its 386 business—AMD

expects to take 50% of the market by the end of this year—but both AMD and Cyrix are mounting new offensives on the 486. Cyrix will introduce 25-, 33-, and 40-MHz versions of its 486 clone at about half the price Intel charges. Meanwhile, AMD plans similar introductions, but a recent legal setback could stall its efforts. IIT is also entering the race; the company stated recently that it is developing a 486 clone with integrated video display and image compression hardware, paralleling Intel's efforts to combine an X86 CPU with IBM's XGA graphics and Intel's own Digital Video Interactive (DVI), a digital system for compressing and playing back video on standard PC's. Timely introduction of the latter could be the breakthrough PC-based multimedia has been waiting for.

Intel's P5 (sometimes known as the 586, although reports indicate that Intel is searching for a new name) contains two CPU's, a 486-compatible unit, and a Reduced Instruction Set Computing (RISC) unit. What's the value of sticking a RISC chip in a PC? On the other hand, what would be the value of sticking a 486 in a workstation (normally powered by a RISC chip)? In a PC, let the 486 do PC things (DOS, Windows, OS/2), and let the RISC unit run the video system or a dedicated compression/decompression unit. In a workstation, let the RISC unit do Unix things, and let the 486 provide PC compatibility.

### Power Play

Power consumption is becoming a hot topic not only among notebook PC vendors, but among desktop system vendors as well. Consumers demand longer battery life from their notebooks—a minimum of eight or ten hours. Desktop vendors need to cut power consumption for reasons of energy conservation. Significantly reducing energy consumption by computers would save \$1 billion per year, plus reduce CO<sub>2</sub> emissions by the equivalent of 5 million automobiles during the same period. Achieving these reductions is not wishful thinking; a recently formed industry/government coalition that includes the EPA, Apple, Compaq, DEC, HP,

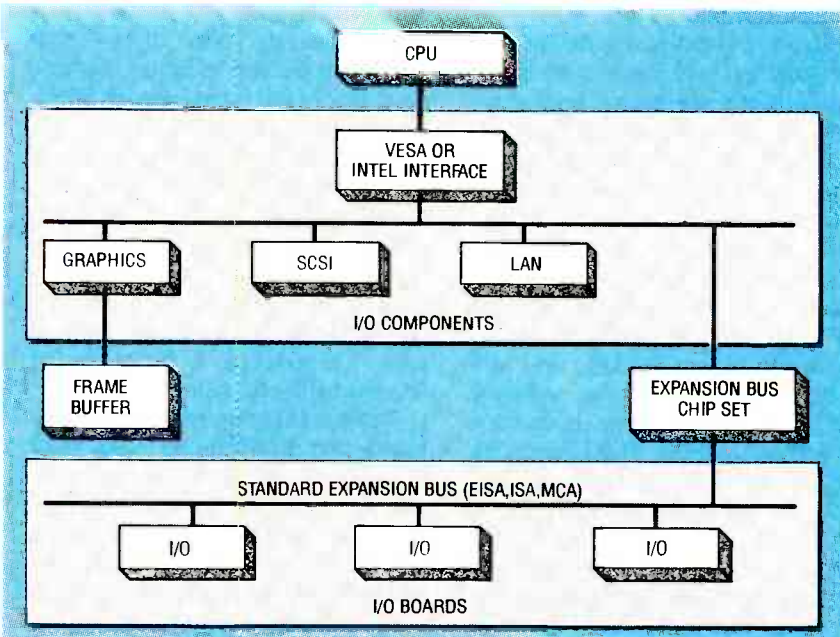

FIG. 1—LOCAL BUS ARCHITECTURES supplied by Intel and the Video Electronics Standards Association (VESA) promise to provide a high-bandwidth channel between the CPU and fast peripherals including video and network adapters, and mass-storage interfaces.

# E-N Computer Admart

Rates: Ads are 2 1/4" x 2 7/8". One insertion \$995 each. Six insertions \$950 each. Twelve insertions \$925 each. Closing date same as regular rate card. Send order with remittance to Computer Admart, Electronics Now Magazine, 500-B Bi-County Blvd., Farmingdale, NY 11735. Direct telephone inquiries to Arline Fishman, area code-1-516-293-3000. FAX 1-516-293-3115. Only 100% Computer ads are accepted for this Admart.

## HOW TO EXPAND, MODERNIZE AND REPAIR PCs AND COMPATIBLES



**BP271**—Includes PC overview, memory upgrades, adding a hard disc, adding floppy drives, display adapters and monitors, installing a co-processor, preventive maintenance, repairs, do it yourself PCs and more. To order your copy send \$7.75 plus \$2.00 for shipping in the U.S. to **Electronic Technology Today Inc., P.O. Box 240, Massapequa Park, NY 11762-0240.**

## PRACTICAL ELECTRONIC DESIGN DATA

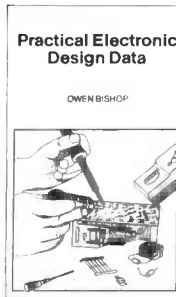

**BP316**—A comprehensive ready-reference manual for electronics enthusiasts, be they hobbyists, students or professionals. To order your copy send \$8.95 plus \$2.50 for shipping in the U.S. to **Electronic Technology Today Inc., P.O. Box 240, Massapequa Park, NY 11762-0240.**

## PCB / Schematic CAD - \$195

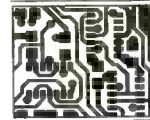

**EASY-PC** - For single sided and multilayer boards to 17"x17" with up to 1500 IC's including surface mount parts. Phenomenally fast and easy to use. Over 13,000 copies sold. Needs PC/XT/286/386, HERC/CGA/EGA/VGA. Output to laserjet/injet/dot matrix printers, pen-plotter, photo-plotter and NC Drill. Extra libraries available. Not Copy Protected.

## Logic Simulation - \$375

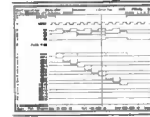

**PULSAR** - Full featured digital logic simulator for the PC/XT/AT/386, EGA/VGA allows you to test your designs quickly and inexpensively without the need for sophisticated test equipment. **PULSAR includes the 74LS and CMOS 4000 Series libraries.** Other libraries available. Not copy protected.

## Analogue Simulation - \$375

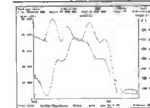

**ANALYSER III** - NEW powerful Linear Circuit Simulator has full graphical output. Handles R's, L's, C's, Bipolar Transistors, FET's, Op-Amp's, Tapped Transformers and Transmission Lines etc. Plots Input and Output Impedances, Gain, Phase and Group Delay. Covers 0.001 Hz to > 10GHz. Not copy protected.

For info, write, fax, call or use Inquiry #

**Number One Systems Ltd.**   
REF: REUS, HARDING WAY, ST. IVES, HUNTINGDON, CAMBS., ENGLAND, PE17 4WR.  
Telephone: 011-44-480-61778 Fax: 011-44-480-494042  
AMEX, VISA and MASTERCARD welcome.

CIRCLE 186 ON FREE INFORMATION CARD

IBM, NCR, Zenith, and other manufacturers announced a set of design parameters centered around several types of "sleep" modes and 3.3-volt system components. The goal is to reduce power consumption of the average PC to 30 watts.

AMD is promoting 3-volt system design guidelines, and it says that a complete PC chip set will be available this summer, with product introductions (probably centered around notebooks) scheduled for fall COMDEX. To support this burgeoning market, Intel has announced a 3.3-volt version of the 386SL that includes a fully static CPU, cache controller, bus and memory controllers, that can interface with both 3.3- and 5-volt peripherals. Cirrus Logic has introduced a dual-voltage video controller.

### Just Add Water

Networking is not yet fully pervasive. However, new chip designs promise low-cost system additions that will further spread the ability to link up. One study shows steady growth in units shipped per year during the period 1989 (2.2 million) through 1995 (6.7 million). AMD has introduced a single-IC Ethernet adapter that (along with similar devices from National, SMC, and

others) is going to further increase the availability and use of networks. The chip will be a built-in component on many new motherboards; several influential PC systems houses (Apple, Compaq, Dell, HP, Northgate) have already introduced (or will shortly) systems with built-in network adapters. Couple that with increasingly aggressive marketing by Novell, plus built-in network capabilities of the next version of Windows—and you've got instant networking.

### The Magic Bus

Windows and OS/2 demand fast, high-performance computers. As clock speed increases, getting data in and out of the CPU becomes more critical to maximizing system performance. Our trusty old system buses (ISA, EISA, MCA) simply aren't up to the task. In recent months, computer manufacturers have added a local bus that provides a direct path between the CPU and some other component, usually a special video adapter. So far, however, these efforts have been hampered by a lack of standards.

In response, Intel and an industry consortium called the Video Electronics Standards Association (VESA) have each devised its own local bus standard (see Fig. 1).

Some published reports have claimed that the two standards will compete with each other; however, Intel officials have stated publicly that the two efforts are complementary. Both share throughputs in the 120–130 megabytes-per-second range. The VESA spec includes a connector design (based on a Micro Channel bus connector) that the Intel spec currently lacks. On the other hand, the Intel spec includes a special interface IC that helps isolate the CPU from I/O subsystems—and that presumably allows for transparent CPU upgrades via the company's Over-Drive technology. Due to bus-timing and signal-reflection issues, local bus slots will most likely be limited to three, e.g., one each for video, network, and hard-disk control; the latter could be a SCSI host adapter for connecting multiple devices. The regular expansion bus would then be limited to slow-speed devices.

In short, the next few years will see many PC vendors dropping out; the ones that remain will be fighting tooth and nail to establish their products with increasingly dense integration of hardware and software components. Price wars are already raging; feature wars are just about to break out. This is going to be one heck of an interesting battle. **R-E**

## HANDI TALKIE

*continued from page 60*

ed, variable Polyswitch resistor R30 could trip and/or the output power MOSFET's could overheat.

When using the flexible "rubber ducky" antenna, it might be necessary to fine tune capacitor C30, taking care to keep the antenna away from people or large metal objects.

After tuning the transmitter, set up the receiver. Turn the power ON and set the SQUELCH control fully counterclockwise (OFF). With the 32-ohm speaker connected, increase the volume until the background noise is audible. Using the oscilloscope, look at the output from RECOVERED AUDIO pin 16 of the FM receiver chip IC3, and adjust inductor L10 so that the signal reaches a maximum level.

If an FM-modulated RF source is available, connect it to the antenna jack and set it to a 1 microvolt output level. Set the audio signal to 1 kHz and the deviation to 4 kHz. Adjust L10 for a symmetric waveform on pin 16 of IC3. The tone should be audible in the speaker. Set the input level to 0.3 microvolts and adjust L3 for minimum noise level. (This adjustment is optional.)

The range of the transceiver with the specified antenna is one to three miles, depending on background noise and the proximity of buildings or geographical obstructions. The range can be increased with a citizen band (CB) base station antenna, or if its transmission frequency is set for the 10-meter amateur radio band and a suitable antenna for that frequency range is connected.

To change the transceiver's frequency from 25 MHz to 31 MHz, change crystals 1 and 3 (XTAL1 and XTAL3) and tune the transceiver according to the instructions given earlier. (See the Parts List for the crystal specs.) To operate the transceiver outside of the 25-MHz to 31-MHz bands, the transmit filter as well as the multiplier components must be changed. **R-E**

## VERSATILE OSCILLATOR

*continued from page 74*

That resistance value will keep the peak speaker currents within the 200-milliampere output limit of the 555. The output power of this alarm circuit depends on speaker impedance and supply voltage, but it can be as high as 750 milliwatts with a 75-ohm speaker and a 15-volt supply. Notice that C3 is an electrolytic capacitor.

Figure 19 shows how the output power of the circuit in Fig. 18 can be boosted to several watts with buffer transistor Q1. The resulting high speaker output current can introduce a significant ripple voltage to the power source. Diode D1 and electrolytic capacitor C3 protect the 555 from the effects of that ripple. Diodes D2 and D3 clamp the inductive switching spikes from the speaker and protect Q1 against damage. The circuits in Figs. 20 to 23 have a similar output stages.

Figure 20 shows how a pair of 555's organized as a stable multivibrators form an 800-Hz pulsed-tone alarm generator. In this circuit IC1 is wired as a 500-Hz alarm generator, and IC2 is wired as a 1-Hz oscillator that triggers IC1 on and off through diode D1 once per second, thus generating the pulsed-tone alarm.

The circuit in Fig. 21 generates the penetrating two-tone "he-haw" sound of European emergency vehicles. Here, IC1 is also wired as an alarm generator, and IC2 is wired as a 1-Hz oscillator. But in this case the output of IC2 frequency modulates IC1 through resistor R5. The output frequency of IC1 alternates symmetrically between 500 Hz and 440 Hz in one-second alternating cycles.

Figure 22 shows a circuit that generates the wailing noise of a police siren. Here IC2 is wired as a low-frequency oscillator with a cycle period of about 6 seconds. The slowly varying ramp waveform of IC2, buffered by emitter follower transistor Q1, frequency modulates alarm generator IC1 through resistor R6. In this

circuit IC1 has a natural center frequency of about 500 Hz. The alarm output signal starts at a low frequency, rises for three seconds to a high frequency, then decays over a period of three seconds to a low-frequency before repeating itself as long as power is applied.

Finally, the circuit in Fig. 23 generates an alarm that simulates the "Red Alert" that is often heard in the Star Trek TV series. The sound starts at a low frequency and rises to a high frequency in about 1.15 seconds, ceases for about 0.35 seconds, and then starts rising again from a low frequency. Here again, the sound pattern repeats as long as power is applied to the circuit.

The 555 labeled IC2 is wired as a non-symmetrical oscillator. Capacitor C1 alternately charges through R1 and diode D1, and discharges through R2. The result is a rapidly rising and slowly falling "sawtooth" waveform across C1. After buffering by Q1, this waveform frequency modulates pin 5 of IC1 through R7, causing the output frequency of IC1 to rise slowly during the decay part of the sawtooth waveform and to collapse rapidly during the rising part of the sawtooth waveform.

The rectangular waveform at pin 3 of IC2 turns IC1 off through common-emitter amplifier Q2 during the decay phase of the alarm. Therefore, only the rising parts of the sound pattern are heard which sound very much like the Star Trek Red Alert.

The outputs of most of the circuits in this article have been taken from output pin 3, but many of the figures haven't shown triangular waveforms developed across the timing capacitor (e.g. Figs. 3b, 11b, 13b and 15b). There might be occasions when you will find those sawtooth (or ramp) waves useful. You can obtain a sawtooth by tapping the charge voltage across the timing capacitor. By charging the capacitor with a constant-current source instead of a simple resistance, the ramp can be made quite linear. **R-E**

# Countersurveillance

**Never before has so much professional information on the art of detecting and eliminating electronic snooping devices—and how to defend against experienced information thieves—been placed in one VHS video. If you are a Fortune 500 CEO, an executive in any hi-tech industry, or a novice seeking entry into an honorable, rewarding field of work in countersurveillance, you must view this video presentation again and again.**

*Wake up!* You may be the victim of stolen words—precious ideas that would have made you very wealthy! Yes, professionals, even rank amateurs, may be listening to your most private conversations.

*Wake up!* If you are not the victim, then you are surrounded by countless victims who need your help if you know how to discover telephone taps, locate bugs, or “sweep” a room clean.

There is a thriving professional service steeped in high-tech techniques that you can become a part of! But first, you must know and understand Countersurveillance Technology. Your very first insight into this highly rewarding field is made possible by a video VHS presentation that you cannot view on broadcast television, satellite, or cable. It presents an informative program prepared by professionals in the field who know their industry, its techniques, kinks and loopholes. Men who can tell you more in 45 minutes in a straightforward, exclusive talk than was ever attempted before.

## Foiling Information Thieves

Discover the targets professional snoopers seek out! The prey are stock brokers, arbitrage firms, manufacturers, high-tech companies, any competitive industry, or even small businesses in the same community. The valuable information they filch may be marketing strategies, customer lists, product formulas, manufacturing techniques, even advertising plans. Information thieves eavesdrop on court decisions, bidding information, financial data. The list is unlimited in the mind of man—especially if he is a thief!

You know that the Russians secretly installed countless microphones in the concrete work of the American Embassy building in Moscow. They converted



**CALL NOW!**

**1-516-293-3751**

**HAVE YOUR  
VISA or MC CARD  
AVAILABLE**

what was to be an embassy and private residence into the most sophisticated recording studio the world had ever known. The building had to be torn down in order to remove all the bugs.

## Stolen Information

The open taps from where the information pours out may be from FAX's, computer communications, telephone calls, and everyday business meetings and lunchtime encounters. Businessmen need counselling on how to eliminate this information drain. Basic telephone use coupled with the user's understanding that someone may be listening or recording vital data and information greatly reduces the opportunity for others to purloin meaningful information.

**CLAGG INC. P.O. Box 4099 • Farmingdale, NY 11735**

Please rush my copy of the Countersurveillance Techniques Video VHS Cassette for a total cost of \$53.95 each (which includes \$4.00 postage and handling).

No. of Cassettes ordered \_\_\_\_\_  
 Amount of payment \$ \_\_\_\_\_  
 Sales tax (N.Y.S. only) \_\_\_\_\_  
 Total enclosed \_\_\_\_\_  
 Bill my  VISA  MasterCard  
 Card No. \_\_\_\_\_  
 Expire Date \_\_\_\_/\_\_\_\_/\_\_\_\_  
 Signature \_\_\_\_\_  
 Name \_\_\_\_\_  
 Address \_\_\_\_\_  
 City \_\_\_\_\_ State \_\_\_\_\_ ZIP \_\_\_\_\_

All payments in U.S.A. funds. Canadians add \$4.00 per VHS cassette. No foreign orders.

The professional discussions seen on the TV screen in your home reveals how to detect and disable wiretaps, midget radio-frequency transmitters, and other bugs, plus when to use disinformation to confuse the unwanted listener, and the technique of voice scrambling telephone communications. In fact, do you know how to look for a bug, where to look for a bug, and what to do when you find it?

Bugs of a very small size are easy to build and they can be placed quickly in a matter of seconds, in any object or room. Today you may have used a telephone handset that was bugged. It probably contained three bugs. One was a phony bug to fool you into believing you found a bug and secured the telephone. The second bug placates the investigator when he finds the real thing! And the third bug is found only by the professional, who continued to search just in case there were more bugs.

The professional is not without his tools. Special equipment has been designed so that the professional can sweep a room so that he can detect voice-activated (VOX) and remote-activated bugs. Some of this equipment can be operated by novices, others require a trained countersurveillance professional.

The professionals viewed on your television screen reveal information on the latest technological advances like laser-beam snoopers that are installed hundreds of feet away from the room they snoop on. The professionals disclose that computers yield information too easily.

This advertisement was not written by a countersurveillance professional, but by a beginner whose only experience came from viewing the video tape in the privacy of his home. After you review the video carefully and understand its contents, you have taken the first important step in either acquiring professional help with your surveillance problems, or you may very well consider a career as a countersurveillance professional.

## The Dollars You Save

To obtain the information contained in the video VHS cassette, you would attend a professional seminar costing \$350-750 and possibly pay hundreds of dollars more if you had to travel to a distant city to attend. Now, for only \$49.95 (plus \$4.00 P&H) you can view *Countersurveillance Techniques* at home and take refresher views often. To obtain your copy, complete the coupon or call.

# E-N Engineering Admart

Rates: Ads are 2¼" × 2⅞". One insertion \$995 each. Six insertions \$950 each. Twelve insertions \$925 each. Closing date same as regular rate card. Send order with remittance to Computer Admart, Electronics Now Magazine, 500-B Bi-County Blvd., Farmingdale, NY 11735. Direct telephone inquiries to Arline Fishman, area code-1-516-293-3000. FAX 1-516-293-3115. Only 100% Computer ads are accepted for this Admart.

## DR. "CHIP" MUNK SAYS



6805/68HC05/68HC11  
DEVELOPMENT TOOLS  
QUALITY + SERVICE  
AFFORDABILITY  
TECI

"Chip" experts agree with Dr. Munk. TECI's PC based microcontroller development tools are the most cost effective for veterans or beginners.

6805 PRIMER FOR BEGINNERS . . . . . \$195.00  
6805/68HC05/68HC11 CROSS ASSEMBLERS . . . . . \$99.00  
6805/68HC05 SIMULATOR / DEBUGGERS . . . . . \$99.00  
68705P3,P5,U3,U5,R3,R5 PROGRAMMERS FROM \$349.00  
68HC705/68HC805 PROGRAMMERS FROM \$395.00  
COMPLETE PC BASED DEV. SYSTEMS FROM \$449.00  
68HC05/68HC11 REAL TIME EMULATORS FROM \$895.00



CALL TOLL FREE 1-800-336-8321  
The Engineers Collaborative, Inc.  
Rt #3 Box 8C, Barton, VT 05822 USA  
TEL:(802)525-3458 FAX:(802)525-3451

CIRCLE 179 ON FREE INFORMATION CARD

## MIDI PROJECTS

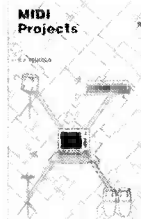

BP182—MIDI interfacing enables any so equipped instruments, regardless of the manufacturer, to be easily connected together and used as a system with easy computer control of these music systems. Combine a computer and some MIDI instruments and you can have what is virtually a programmable orchestra. To order your copy send \$6.95 plus \$2.50 for shipping in the U.S. to Electronic Technology Today Inc., P.O. Box 240, Massapequa Park, NY 11762-0240.

## HIGH POWER AUDIO AMPLIFIER CONSTRUCTION

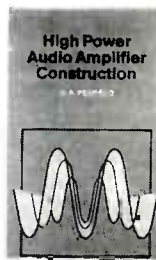

BP277—Here's background and practical design information on high power audio amplifiers capable of 300 ± 400 watts r.m.s. You'll find MOSFET and bipolar output transistors in inverting and non-inverting circuits. To order your copy send \$6.25 plus \$2.50 for shipping in the U.S. to Electronic Technology Today Inc., P.O. Box 240, Massapequa Park, NY 11762-0240.

## AUDIO UPDATE

continued from page 78

sical-music audience and the poor audio quality of most FM broadcasts. In any case, the question remains: Is the listening public really interested in AM stereo?

I don't relish raining on anyone's parade, but I suspect that (to mix a metaphor) the AM-stereo bandwagon will never get off the ground.

### Consumer fraud?

One of the panel discussions at last fall's Audio Engineering Society convention was titled "New Cable Designs: Innovation or Consumer Fraud?" The organizer of the event was strongly anti-cable and had stacked the panel accordingly. One of the surprising guests was Wilfredo Lopez, a non-audio person from the New York City Department of Consumer Affairs. He presented his department's view about what constituted fraudulent advertising, and suggested that most audio components are "blind" items, meaning that the average consumer is not in a position to judge the validity of advertising claims. Deceptive practices include "false implica-

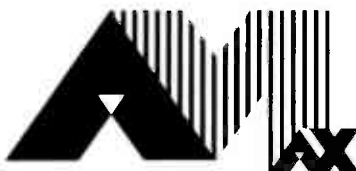

The AMAX logo will identify AM receivers that meet the NRSC requirements.

tions of quality or characteristics of the item." Mr. Lopez went on to say that if his agency finds stores trying to sell a speaker cable that is heavier but not better—but they are nevertheless claiming it is—it might take action against them.

I would caution Mr. Lopez to tread carefully. In any area where consumers are being sold "dreams"—products that purport to make them slimmer, younger, more beautiful, or their equipment better-sounding—they don't want to be told that they are being deluded. For example, the cosmetic industry would seem ripe for such an investigation with its cellulite removal creams, skin rejuvenators and other such products. Is it a defense or justification for the manufacturer to say that the consumer "thinks" the product works, notwithstanding objective evidence to the contrary?

In truth, it had never occurred to me that the absurd claims made by

many high-end cable and accessory manufacturers could be legally defined as fraudulent. In the years that I've been dealing with audio equipment claims, I never became very upset by the sometimes technically off-the-wall—or at least unproven—pronouncements of the various manufacturers. As a matter of fact, I even had a hand in writing some ads and technical papers for various companies promulgating their sometimes strange technological points of view.

Because the literature was aimed at a high-end audience, I felt no guilt at providing the kind of nonsense they loved to hear. After all, I rationalized, it wasn't as though the outrageously priced equipment was depriving anyone's wife and children of food.

My ultimate conscience-clearing maneuver was to editorialize under my own name against some of the properties (ultra-wide bandwidth, olefin cable insulation, dual-power supplies, etc.) that I had extolled in the ads. In any case, I took (and still take) none of this very seriously, and I regarded my jabs and jibes at audiophile nonsense as editorially interesting but not really powerful blows for truth, justice, and the American Way.

R-E



# BUYER'S MART

## FOR SALE

**TUBES:** "oldest," "latest." Parts and schematics. SASE for lists. **STEINMETZ**, 7519 Maplewood Ave., R.E., Hammond, IN 46324.

**TUBES**, new, up to 90% off, SASE, **KIRBY**, 298 West Carmel Drive, Carmel, IN 46032.

**T.V. notch filters**, phone recording equipment, brochure \$1.00. **MICRO THINC**, Box 63/6025, Margate, FL 33063. (305) 752-9202.

**SPEAKER** repair. All makes — models. Stereo & professional. Kits available. Refoaming \$18.00. **ATLANTA AUDIO LABS**, 1 (800) 568-6971.

**RESTRICTED** technical information: Electronic surveillance, schematics, locksmithing, covert sciences, hacking, etc. **Huge selection. Free brochures.** **MENTOR-Z**, Drawer 1549, Asbury Park, NJ 07712.

**ENGINEERING** software and hardware, PC/MSDOS. Circuit design and drawing, PCB layout, FFT analysis, mathematics, circuit analysis, etc. Data acquisition, generation, I/O PCB's, etc. Call or write for free catalog. (614) 491-0832, **BSOFT SOFTWARE, INC.**, 444 Colton Rd., Columbus, OH 43207.

**CABLE TV Equipment.** Most type available. Special: Oak M35B \$39.95. No catalog. COD orders only. 1 (800) 822-9955.

## CLASSIFIED AD ORDER FORM

To run your own classified ad, put one word on each of the lines below and send this form along with your check to:

**Electronics Now Classified Ads**, 500-B Bi-County Boulevard, Farmingdale, NY 11735

**PLEASE INDICATE** in which category of classified advertising you wish your ad to appear. For special headings, there is a surcharge of \$25.00.

( ) Plans/Kits ( ) Business Opportunities ( ) For Sale  
( ) Education/Instruction ( ) Wanted ( ) Satellite Television  
( )

Special Category: \$25.00

### PLEASE PRINT EACH WORD SEPARATELY, IN BLOCK LETTERS.

(No refunds or credits for typesetting errors can be made unless you clearly print or type your copy.) Rates indicated are for standard style classified ads only. See below for additional charges for special ads. **Minimum: 15 words.**

1	2	3	4	5
6	7	8	9	10
11	12	13	14	15 (\$46.50)
16 (\$49.60)	17 (\$52.70)	18 (\$55.80)	19 (\$58.90)	20 (\$62.00)
21 (\$65.10)	22 (\$68.20)	23 (\$71.30)	24 (\$74.40)	25 (\$77.50)
26 (\$80.60)	27 (\$83.70)	28 (\$86.80)	29 (\$89.90)	30 (\$93.00)
31 (\$96.10)	32 (\$99.20)	33 (\$102.30)	34 (\$105.40)	35 (\$108.50)

We accept MasterCard and Visa for payment of orders. If you wish to use your credit card to pay for your ad fill in the following additional information (Sorry, no telephone orders can be accepted.):

Card Number

Expiration Date

Please Print Name

Signature

**IF YOU USE A BOX NUMBER YOU MUST INCLUDE YOUR PERMANENT ADDRESS AND PHONE NUMBER FOR OUR FILES. ADS SUBMITTED WITHOUT THIS INFORMATION WILL NOT BE ACCEPTED.**

**CLASSIFIED COMMERCIAL RATE:** (for firms or individuals offering commercial products or services) \$3.10 per word prepaid (no charge for zip code). **MINIMUM 15 WORDS.** 5% discount for same ad in 6 issues; 10% discount for same ad in 12 issues within one year; if prepaid. **NON-COMMERCIAL RATE:** (for individuals who want to buy or sell a personal item) \$2.50 per word, prepaid...no minimum. **ONLY FIRST WORD AND NAME** set in bold caps at no extra charge. Additional bold face (not available as all caps) **55¢ per word additional.** Entire ad in boldface, \$3.70 per word. **TINT SCREEN BEHIND ENTIRE AD: \$3.85 per word. TINT SCREEN BEHIND ENTIRE AD PLUS ALL BOLD FACE AD: \$4.50 per word. EXPANDED TYPE AD: \$4.70 per word prepaid.** Entire ad in boldface, \$5.60 per word. **TINT SCREEN BEHIND ENTIRE EXPANDED TYPE AD: \$5.90 per word. TINT SCREEN BEHIND ENTIRE EXPANDED TYPE AD PLUS ALL BOLD FACE AD: \$6.80 per word. DISPLAY ADS:** 1" x 2 1/4"—\$410.00; 2" x 2 1/4"—\$820.00; 3" x 2 1/4"—\$1230.00. **General information:** Frequency rates and prepayment discounts are available. **ALL COPY SUBJECT TO PUBLISHERS APPROVAL. ADVERTISEMENTS USING P.O. BOX ADDRESS WILL NOT BE ACCEPTED UNTIL ADVERTISER SUPPLIES PUBLISHER WITH PERMANENT ADDRESS AND PHONE NUMBER.** Copy to be in our hands on the 5th of the third month preceding the date of the issue. (i.e., Aug. issue copy must be received by May 5th). When normal closing date falls on Saturday, Sunday or Holiday, issue closes on preceding working day. Send for the classified brochure. Circle Number 49 on the Free Information Card.

**Quality Microwave TV Antennas**

**WIRELESS CABLE - IFTS - MMDS - Amateur TV**  
Ultra High Gain 50db(+) • Tuneable 1.9 to 2.7 Ghz.

- 55-Channel Dish System \$199.95
- 36-Channel Dish System \$149.95
- 20-Channel Dish System \$124.95
- Yagi Antennas Components, Custom Tuning Available
- Call or write (SASE) for "FREE" Catalog

**PHILLIPS-TECH ELECTRONICS**  
Dish System P.O. Box 8533 • Scottsdale, AZ 85252  
LIFETIME WARRANTY (602) 947-7700 (\$3.00 Credit all phone orders)  
MasterCard • Visa • American Express • COD's • Quantity Pricing

**80C52**-Basic microcontroller board. Basic interpreter, 32K RAM, 16K Eprom, Eprom programmer, RS232, expansion connector. Bare board with manual, schematics \$22.95. **80C52**-Basic microprocessor chip \$25.95. Assembled and tested \$124.95. **PROLOGIC DESIGNS**, PO Box 19026, Baltimore, MD 21204.

**JERROLD, Tocom and Zenith "test" chips.** Fully activates unit. \$50.00. Cable descramblers from \$40.00. Orders 1 (800) 452-7090. Information (310) 867-0081.

**TOCOM-Jerrold Impulse-Scientific Atlanta Converters.** two year warranties, also test modules for your converters. Contact **NATIONAL CABLE**, (219) 935-4128 full details.

## FREE CATALOG

**FAMOUS "FIRESTIK" BRAND CB ANTENNAS AND ACCESSORIES. QUALITY PRODUCTS FOR THE SERIOUS CB'er. SINCE 1962**

**FIRESTIK ANTENNA COMPANY**  
2614 EAST ADAMS  
PHOENIX, ARIZONA 85034

**OSCILLOSCOPE** 50 MHz, Hewlett-Packard, solid state calibrated, manual \$290.00. 1 (800) 835-8335 X-159.

**SECRET cable descramblers!** Build your own descrambler for less than \$12.00 in seven easy steps. Complete instructions \$10.00. Radio Shack parts list and free descrambling methods that cost nothing to try included. **HARRYWHITE**, PO Box 1790, Baytown, TX 77520.

**DESCRAMBLERS**, converters, all name brands in stock, lowest prices, examples DPV-5 \$189.00, VIP \$250.00, Oak \$99.00, add on descramblers TVT or SA3-B 5 @ \$49.00 ea. Guaranteed. COD orders OK. free catalog. **KABLE KONNEKTION** (702) 433-6959.

**CABLE TV** equipment, wholesale to all, Oak, Jerrold, Zenith, Tocom, S.A., example Starcom-6 with volume \$189.00. Quantity prices available. C.O.D. orders OK. Free catalog. **ULTIMATE CABLE PRODUCTS**, (702) 646-6952.



**BARE** bones Eprom programmer. Plans/MS-DOS disk \$15.00. Also parts/kits/assembled. **SERGEANT**, 809 W. San Antonio, San Marcos, TX 78666.

**CABLE TV DESCRAMBLERS**  
**BEST BUYS BEST SERVICE**  
 BULLET PROOF TV TESTED  
 WANT TO BUY:  
 TOCOM, SA 8590,DPV7212  
 Must be reasonable price.  
**FREE Catalog** Dealers Wanted  
 Multi-Vision (402)331-3228 800-835-2330  
 Electronica™ 2730 SO.123rd Cl.#126 Omaha, NE 68144

**WANTED**

**INVENTIONS!** new products/ideas wanted: call TLCI for free information/inventors newsletter. 1 (800) 468-7200 24 hours/day - USA-Canada.

**INVENTORS:** We submit ideas to industry. Find out what we can do for you. 1 (800) 288-IDEA.

**FORMAL** blueprints from sketches and scratches - reasonable - confidential - mech/elec drafting. **MICROCHIP THEATRE** (718) 398-1163. Leave message.

**INVENTORS**

**INVENTORS!** Can you patent and profit from your idea? Call **AMERICAN INVENTORS CORP.** for free information. Serving inventors since 1975. 1 (800) 338-5656.

**SATELLITE TV**

**SATELLITE TV** — Do it yourself — major brands discounted, we'll beat everyone's price. **DISCOUNT LARRY** (609) 596-0656.

**VIDEOCIPHER II, descrambling manual.** Schematics, video, and audio. Explains DES, Eprom, CloneMaster, 3Musketeer, Pay-per-view (HBO, Cinemax, Showtime, Adult, etc.) \$16.95, \$2.00 postage. Schematics for Videocypher Plus, \$20.00. Schematics for Videocypher 032, \$15.00. Collection of software to copy and alter Eprom codes, \$25.00. **CABLETRONICS**, Box 30502R, Bethesda, MD 20824.

**CABLE TV DESCRAMBLERS**  
**1-800-582-1114**  
**FREE CATALOG**  
 GUARANTEED BEST PRICES • IMMEDIATE SHIPPING  
**M.K. ELECTRONICS**  
 VISA 8362 Pines Blvd. Suite 276 Pembroke Pines, FL 33024 MasterCard

**PAY TV AND SATELLITE DESCRAMBLING**  
**ALL NEW 1992 EDITION ALL NEW**  
 1992 Edition updates latest Circuits, Turn-ons, Bypasses, Buffers, Bags, Black-ciphers, VCII Plus and B-Mac Fixes. Only \$15.95. VCII Wizard Hacker's Bible includes Plus, Tellis All, \$15.95. Pay TV and Satellite Descrambling Vol. 1 (Basics), \$9.99. 1991 Editions are all different. \$14.95 each. MOS Handbook \$9.95. Satellite Systems under \$600. \$12.95 (52) Any 3/\$29.95 or 5/\$49.95. Scrambling News Monthly will keep you up to date on Plus breaks. \$24.95/yr. Special Everything we have including video. \$10.95. New Catalog \$1.  
 Scrambling News, 1552 Hertel Ave., Buffalo, NY, 14216. Voice/Fax (716) 874-2088  
 CDD'S ARE OK. ADD \$5

**Cable TV DESCRAMBLERS**  
**30-day Money Back Guarantee**  
  
 > The Most Complete Line of Descramblers  
 > Friendly, professional service  
 > **FREE Catalog**  
**ORDER NOW!**  
 VISA MC DISCOVER C.O.D.  
**1-800-228-7404**  
 Go to the Source  
**NU-TEK ELECTRONICS**  
 3250 Hatch RD  
 Cedar Park TEXAS 78613

**BUSINESS OPPORTUNITIES**

**YOUR** own radio station! Licensed/unlicensed AM, FM, TV, cable. Information \$1.00. **BROADCASTING**, Box 130-F10, Paradise, CA 95967.

LET the government finance your small business. Grants/loans to \$500,000. Free recorded message: (707) 449-8600. (KS1).

**Is Bad Service Driving You Nuts?**



Business gets crazy enough without your electronic parts supplier driving you up the wall. That's why **MCM Electronics** dedicates itself to customer service. We'll answer and service your calls in just thirty seconds. We'll also answer your questions and give you advice. Whatever you need. Then we'll use our computerized order entry and inventory control systems to speed your order to you within 24 hours. Of course, you get more than quality service. You get quality parts and components; more than 17,000 of them, all available in our huge distribution center.

**MCM ELECTRONICS**  
 Save Up To 80% On Select Video Heads  
 • Weekday Hours: 7:00a.m. - 8:00p.m. EST  
 • Saturday Hours: 9:00a.m. - 8:00p.m. EST  
 • Technical Assistance Available  
 • Reprogrammable Videotape Disposables  
 • All Products Are Stocked  
 • Expanded Line Of Diodes And Rectifiers  
**CALL TOLL FREE 1-800-543-4330**  
 TO ORDER BY FAX DIAL 1-513-434-6959

**So don't crack up. Call MCM Electronics. toll free, at 1-800-543-4330 or fax 1-513-434-6959. We'll send you our free catalog. And show you how sane excellent service can be.**



**MCM ELECTRONICS**  
 650 CONGRESS PARK DR.  
 CEN. ERVILLE, OH 45459-4072  
 A PREMIER Company

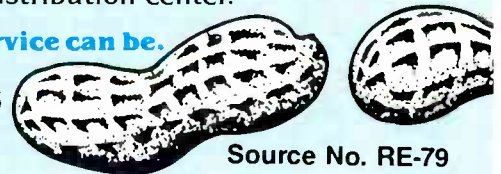

# 1-800-831-4242 Your Resource for

## Test/Measurement and Prototype Equipment

### Jameco Solderless Breadboards

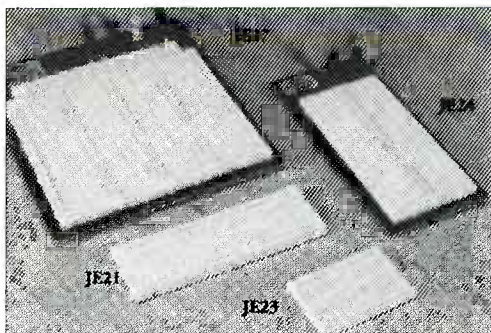

Jameco's long-lasting breadboards feature screen-printed color coordinates and are suitable for many kinds of prototyping and circuit design. Larger models feature a heavy-duty aluminum backing with voltage and grounding posts.

Part No.	Product No.	Dim. L" x W"	Contact Points	Binding Posts	Price
20600	JE21	3.25 x 2.125	400	0	\$4.95
20722	JE23	6.50 x 2.125	830	0	6.95
20757	JE24	6.50 x 3.125	1,360	2	12.95
20773	JE25	6.500 x 4.25	1,660	3	17.95
20790	JE26	6.875 x 5.75	2,390	4	24.95
20811	JE27	7.250 x 7.50	3,220	4	32.95

### GoldStar 20MHz Dual Trace Oscilloscope



The perfect unit for today's testing and measurement needs! Features include a 6" CRT display, and bandwidth from DC to 20 MHz. The GoldStar oscilloscope comes with two 40MHz probes, two fuses, power cord, operation manual, schematics and block and wiring diagram. It's lightweight and portable with a two-year warranty.

Part No.	Product No.	Description	Price
18551	GS7020	Oscilloscope	\$399.95

### Additional GoldStar Oscilloscopes

Part No.	Product No.	Description	Price
66051	GS904RD	40MHz 2 channel oscilloscope ...	\$799.95
66077	GS8100	100MHz 3 channel oscilloscope ...	1349.95

Call for additional Goldstar test equipment



24 Hour Toll-Free Order Hotline  
1-800-831-4242



Please refer to Mail Key 002 when ordering



### National and Intel Databooks

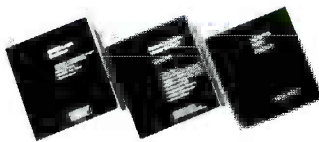

Part No.	Product No.	Description	Price
41224	400026	National General Purpose Linear Devices Databook	\$19.95
41259	400039	National Logic Databook	19.95
41208	400015	National Data Acquisition Linear Devices Databook	11.95
41304	400104	National Special Purpose Linear Devices Databook	11.95
41275	400044	National LS/S/TTL Databook	14.95
39280	230843	Intel Memory Databook	24.95
39870	270645	Intel Embedded Controller Processors Databook	24.95

Additional databooks available!

### Metex Digital Multimeters

- Handheld, high accuracy • Measures AC/DC voltage, AC/DC current, resistance, diodes, continuity, and transistor current gain (except M3900)
- Manual ranging w/overload protection
- Comes with probes, batteries, case and manual

M3650 & M4650 only:

- Also measures frequency and capacitance

Part No.	Product No.	Description	Price
27115	M3800	3.5 digit multimeter ...	\$39.95
27078	M3610	3.5 digit multimeter .....	59.95
27140	M3900	3.5 digit multimeter with tach/dwell .....	59.95
27086	M3650	3.5 digit multimeter w/frequency & capacitance .....	74.95
27158	M4650	4.5 digit w/ frequency & capacitance & data hold switch .....	99.95

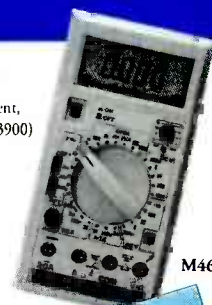

24 Hour Toll-Free Order Hotline!  
1-800-831-4242

### Jameco IC Test Clip Series

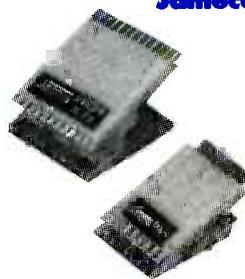

- Test clips are designed for temporary connections to DIP components
- Heavy-duty spring loaded hinge provides positive contact

Part No.	Product No.	Description	Price
22103	JTC16	16-pin (for 8, 14 & 16-pin ICs).....	\$5.95
22120	JTC20	20-pin (for 18 & 20-pin ICs).....	6.95
22146	JTC24	24-pin.....	7.95
22162	JTC28	28-pin.....	8.95
22189	JTC40	40-pin.....	11.95

### EPROMs - for your programming needs

Part No.	Product No.	Price	Part No.	Product No.	Price	Part No.	Product No.	Price
33566	TMS2516	\$4.25	40248	2764A-25	\$3.49	65904	27C256-12	\$6.49
33603	TMS2564	5.95	39829	27C64-15	3.95	39714	27C256-15	5.95
33611	TMS2716	5.95	39845	27C64-25	3.49	39722	27C256-20	5.49
37647	1702A	3.95	39853	27C64-45	2.95	39731	27C256-25	4.95
39909	2708	4.95	39992	27128OTP	2.49	40184	27512OTP	4.95
40002	2716	3.95	39925	27128-20	7.95	40150	27512-20	6.75
40011	2716-1	4.25	34933	27128-25	7.75	40168	27512-25	5.95
39706	27C16	4.25	39950	27128A-15	4.95	39773	27C512-12	7.49
40096	2732	4.95	39968	27128A-20	4.75	39781	27C512-15	6.95
40109	2732A-20	4.49	39984	27128A-25	3.75	39790	27C512-20	6.49
40125	2732A-25	3.49	39677	27C128-15	5.75	39802	27C512-25	5.95
40133	2732A-45	2.95	39685	27C128-25	7.95	39651	27C010-15	9.95
39765	27C32	4.95	40070	27256OTP	4.19	65699	27C020-15	17.95
40192	2764-20	3.95	40037	27256-15	5.49	65681	27C020-20	15.95
40205	2764-25	3.75	40045	27256-20	5.29	43692	68766-35	4.95
40230	2764A-20	3.75	40061	27256-25	4.89			

### A.R.T. EPROM Programmer

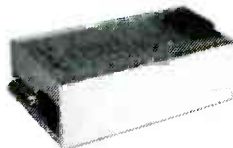

- Programs all current EPROMs in the 2716 to 27512 range plus the X2864 EEPROM
- RS232 port
- Software included

Part No.	Product No.	Description	Price
16686	EPP	Programmer....	\$199.95

### UVP EPROM Eraser



- Erases all EPROM's
- DE4 erases 8 chips every 21 minutes
- DE1 erases 1 chip every 7 minutes

Part No.	Product No.	Description	Price
15712	DE4	Eraser .....	\$89.95
66042	DE1	Portable Eraser.....	49.95

• Partial Listing • Over 4000 Electronic and Computer Components in Stock! • Call for quantity discounts.

# Value. Only a Phone Call Away.

## Computer Upgrade Products and Electronic Components

Upgrade your existing computer system! Jameco will help you upgrade easily and economically.

### 101-Key Enhanced Keyboard



This keyboard features 12 function keys, separate cursor and numeric keys.

- IBM PC/XT/AT and compatible computers
- Automatically switches between XT or AT
- LED Indicators for Num, Caps, and Scroll lock keys.

### Jameco 80386SX Motherboard

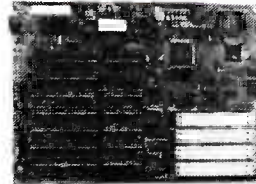

- 16MHz processing speed
- Baby motherboard (8.5" x 13")
- Zero or one wait state operation
- Supports up to 16MB of RAM
- Intel 80387SX/compatible math coprocessor socket
- AMI BIOS
- Six 16-bit and two 8-bit expansion bus slots
- One-year warranty

Part No.	Product No.	Description	Price
67432	K101	Keyboard.....	\$49.95

Part No.	Product No.	Description	Price
53882	JE3616SN	Motherboard .....	\$209.95

### Toshiba 1.44MB 3.5" Internal Floppy Disk Drive

- IBM PC/XT/AT and compatibles
- Compatible with DOS versions 3.3 or higher
- Includes all necessary installation hardware
- 1.44MB formatted high density mode
- 720KB formatted low density mode
- Size: 1"H x 4"W x 5.9"D (actual drive size)
- One-year manufacturer's warranty



Part No.	Product No.	Description	Price
40774	356KU	Disk Drive.....	\$99.95

Many more upgrade products available!

### Jameco IBM Compatible Power Supplies

JE1030:

- Output: +5V @ 15A, -5V @ 0.5A, +12V @ 5.5A, -12V @ 0.5A
- 150 watts output power
- Switchable between 110/220V
- Built-in fan
- Size: 9.5"L x 5.5"W x 4.625"H
- One-year warranty
- CSA approved

JE1036:

- Output: +5V @ 20A, -5V @ 0.5A, +12V @ 8A, -12V @ 0.5A
- 200 watts output power
- Switchable between 110/220V
- Built-in fan
- Size: 6.5"L x 5.88"W x 6"H
- One-year warranty
- CSA approved

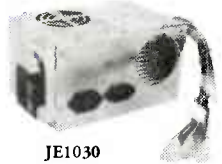

JE1030

Additional power supplies available!

Part No.	Product No.	Description	Price
19465	JE1030	150 watt PC/XT power supply.....	\$69.95
19545	JE1036	200 watt AT power supply.....	\$89.95

### Integrated Circuits\*

Part No.	Product No.	1-9	10+
48979	7400	\$.29	\$.19
49015	7402	.29	.19
49040	7404	.29	.19
49091	7406	.35	.25
49120	7407	.35	.25
49146	7408	.35	.25
49189	7410	.29	.19
49728	7417	.35	.25
50008	7420	.29	.19
50235	7432	.35	.25
50420	7447	.89	.79
50551	7474	.39	.29
50593	7476	.45	.35
50665	7486	.45	.35
50681	7489	2.95	2.75
50690	7490	.59	.49
49322	74121	.49	.39
49912	74192	.79	.69
49939	74193	.79	.69

### Linear ICs\*

Part No.	Product No.	1-9
33241	TL082CP	\$.59
23579	LM317T	.59
23683	LM324N	.35
23771	LM336Z	1.09
23851	LM339N	.45
27422	NE555V	.29
24328	LM556N	.49
24467	LM723CN	.49
24539	LM741CN	.29
23131	LM1458N	.39
23157	LM1488N	.45
23181	LM1489N	.45
34278	ULN2003A	.69
24230	LM3914N	2.49
27385	NE5532	1.19
51262	7805T	.45
51334	7812T	.45

\* Name brand IC's in stock

### IC Sockets

Part No.	Product No.	Description	Price
51570	8LP	8-pin low profile	\$.10
37161	14LP	14-pin low profile	\$.11
37372	16LP	16-pin low profile	\$.12
39335	24LP	24-pin low profile	\$.19
40301	28LP	28-pin low profile	\$.22
41110	40LP	40-pin low profile	\$.28

### Connectors

Part No.	Product No.	Description	Price
15114	DB25P	Male, 25-pin	\$.65
15157	DB25S	Female, 25-pin	.75
15085	DB25H	Hood	.39
15106	DB25MH	Metal Hood	1.35

### Miscellaneous Components\*

#### Transistors And Diodes

Part No.	Product No.	Description	Price
28628	PN2222	TO-92 case	\$.12
28644	PN2907	TO-92 case	.12
35991	1N4004	DO-41 case	.10
38236	2N2222A	TO-18 case	.25
36126	1N4735	DO-41 case	.25
38359	2N3904	TO-92 case	.12
36290	1N751	DO-35 case	.15
38421	2N4401	TO-92 case	.15
36038	1N4148	DO-35 case	.07
38308	2N3055	TO-3 case	.69

### Switches

Part No.	Product No.	Description	Price
21936	JMT123	SPDT, on-on (toggle) ...	\$1.15
38842	206-8	SPST, 16-pin (DIP)	1.09
26622	MS102	SPST, momentary (push-button)	.39

\*Additional components available

### Memory

Part No.	Product No.	Function	Price
41398	41256-120	256K DIP 120ns	\$1.69
42251	511000P-80	1MB DIP 80ns	5.99
41523	41256A9B-80	256K SIMM 80ns	16.95
41718	421000A9A-80	1MB SIPP 80ns	54.95
41769	421000A9B-80	1MB SIMM 80ns	54.95

### LEDs

Part No.	Product No.	Description	Price
34761	XC556G	T1 3/4, (Green)	\$1.16
34796	XC556R	T1 3/4, (Red)	.12
34825	XC556Y	T1 3/4, (Yellow)	.16



Mention Mail Key 002

Call or write for your 1993 Annual Catalog: 1-800-637-8471

24-Hour Toll-Free Order Hotline:

**1-800-831-4242**

**JAMECO**<sup>®</sup>  
ELECTRONIC COMPONENTS  
COMPUTER PRODUCTS  
1355 Shoreway Road  
Belmont, CA 94002

\$30.00 Minimum Order  
FAX: 1-800-237-6948 (Domestic)  
FAX: 415-592-2503 (International)  
Jameco ServiceLine™ :  
1-800-831-8020 (Computer Repair)  
Technical Support: 1-800-831-0084  
BBS Support: 415-637-9025

For International Sales, Customer Service, Credit Department and all other inquiries: Call 415-592-8097 between 7AM-5PM P.S.T.

CA Residents please add applicable sales tax. Shipping, handling and insurance are additional.

Terms: Prices subject to change without notice. Items subject to availability and prior sale. Complete list of terms/warranties is available upon request.

© 1992 Jameco 10/92 All trademarks are registered trademarks of their respective companies.

# CABLETRONICS

## CONVERTERS

1-4Units 5 Units 10 Units

PANASONIC TZP 145	\$88.00	\$75.00	\$70.00
STARGATE 2000	\$79.00	\$69.00	\$65.00
*HAMLIN MCC 3000	\$25.00	\$19.00	\$15.00

## ADD-ON DECODERS

SB-3 (NEW)	\$50.00	\$45.00	\$43.00
*SB-3 FACTORY	\$45.00	\$39.00	\$35.00
SA-3	\$56.00	\$50.00	\$45.00
DTB-3	\$65.00	\$55.00	\$50.00
KNI2A-2 or 3	\$49.00	\$45.00	\$40.00
*HAMILIN MLD 1200-3	\$49.00	\$40.00	\$35.00
*ZENITH SSAVI	\$165.00	\$149.00	\$125.00
SA-DF	\$159.00	\$139.00	\$125.00

## COMBOS

JERROLD DPV7	\$299.00	\$149.00	\$239.00
JERROLD DPBB	\$319.00	\$259.00	\$249.00
SA8580 COMBO	\$299.00	\$225.00	\$215.00
*JERROLD DRX-3-DIC	\$165.00	\$105.00	\$89.00
JERROLD DRZ-3-DIC	\$175.00	\$115.00	\$99.00
*OAK M35B	\$45.00	\$35.00	\$30.00
HAMLIN SPC 4000 3M	\$50.00	\$44.00	\$44.00

ADD \$10.00 FOR VARISYNCH

\*Refurbished as New

QTY	ITEM	OUTPUT CHANNEL	PRICE EACH	TOTAL PRICE

California Penal Code #593-D Forbids us from shipping any cable descrambling unit to anyone residing in the state of California. Prices subject to change without notice.

SUB TOTAL	
Shipping Add	
5.00 Per unit	
COD/CreditCard	
Add 5%	
TOTAL	

### Please Print

Name \_\_\_\_\_  
 Address \_\_\_\_\_ City \_\_\_\_\_  
 State \_\_\_\_\_ Zip \_\_\_\_\_ Tel: ( ) \_\_\_\_\_  
 Cashier's Check     Money order     COD  
 Visa     MC    CC# \_\_\_\_\_ Exp. Date \_\_\_\_\_

DECLARATION OF AUTHORIZED USE - I, the undersigned, do hereby declare under penalty of perjury that all products purchased, now and in the future, will only be used on TV systems with all applicable federal and state laws. FEDERAL AND VARIOUS STATE LAWS PROVIDE FOR SUBSTANTIAL CRIMINAL AND CIVIL PENALTIES FOR UNAUTHORIZED USE.

Date \_\_\_\_\_ Signed \_\_\_\_\_

### Cabletronics

9800 D Topanga Canyon Blvd., Suite 323,  
 Chatsworth, CA 91311  
**For Free Catalog, or to place an order call**  
 (800) 433-2011 • FAX (818) 709-7565

**FREE CATALOG!**  
**1-800-648-7938**  
**JERROLD HAMLIN OAK ETC**  
**CABLE TV**  
**DESCRAMBLERS**

- Special Dealer Prices!
- Compare our Low Retail Prices!
- Guaranteed Prices & Warranties!
- Orders Shipped Immediately!

**REPUBLIC CABLE PRODUCTS, INC.**  
 4080 Paradise Rd. #15, Dept RE1092  
 Las Vegas, NV 89109  
 For all other information (702) 362-9026

EASY work! Excellent pay! Assemble products at home. Call toll free 1 (800) 467-5566 Ext. 5192.

HOME assembly work available! Guaranteed easy money! Free details! **HOMEWORK-R**, Box 520, Danville, NH 03819.

**MONEYMAKERS! Easy!** One man CRT rebuilding machinery. \$6,900.00 rebuilt. \$15,900.00 new. CRT, 1909 Louise, Crystalake, IL 60014. (815) 477-8655. FAX (815) 477-7013.

**MAKE \$75,000.00 to \$250,000.00 yearly** or more fixing IBM color monitors. No investment, start doing it from your home (a telephone required). Information, USA, Canada \$2.00 cash for brochure, other countries \$10.00 US funds. **RANDALL DISPLAY**, Box 2168-R, Van Nuys, CA 91404 USA. FAX (818) 990-7803.

**FREE CATALOG**

- CABLE T.V. BOXES - ALL TYPES •
- LOW PRICES - DEALER PRICES •

**ACE PRODUCTS**  
 1-800-234-0726

CONTINGENCY patent licensing. No fees anytime. Three decades experience: law, technology, negotiations. **PROPAT INTERNATIONAL CORPORATION**, 441 Summer Street, Stamford, CT 06901. (203) 325-3344.

LEARN gold, silver, platinum scrap recycling business. (Free) information. Write: **RECYCLING**, Box 11216PE, Reno, NV 89510-1216.

**ELECTRONICS dealers:** Expand your product line. **Make \$\$\$!** Become an **AMERICAN ELECTRONICS** dealer! Profit opportunities since 1965. Call Scott Pruet, 1 (800) 872-1373.

\$ Millions on inventions secrets. Send S.A.S.E. and \$5.00 payable Carl Humphreys, to **INVENTION MILLIONS**, 3012 Flax, El Paso, TX 79925.

★★★★ PRESENTING ★★★★★  
**CABLE TV**  
**DESCRAMBLERS**  
 ★★★★★ STARRING ★★★★★  
**JERROLD, HAMLIN, OAK**  
 AND OTHER FAMOUS MANUFACTURERS

- FINEST WARRANTY PROGRAM AVAILABLE
- LOWEST RETAIL / WHOLESALE PRICES IN U.S.
- ORDERS SHIPPED FROM STOCK WITHIN 24 HRS.
- ALL MAJOR CREDIT CARDS ACCEPTED

**FOR ALL INFORMATION**  
 1-800-345-8927

**PACIFIC CABLE CO., INC.**  
 7325 1/2 Reseda Blvd., Dept. 2119  
 Reseda, CA 91335

## BEST BY MAIL

Rates: Write National, Box 5, Sarasota, FL 34230

### BUY IT WHOLESALE

BUY 30% - 90% Below Wholesale: Apparel - Electronics \$5.95 - BOULOS, Box 55027, Sherman Oaks, CA 91413.

### MONEYMAKING OPPORTUNITIES

\$1500.00 A WEEK AT Home. For Free Information Send A Stamped Envelope To: American Dream, PO Box 1533-1, North Wales, PA 19454.

NEED SECOND INCOME??? Details \$9.98: Thomas, Box 16801, Jacksonville, FL 32245-6801.

### ASTROLOGY

CHINESE HOROSCOPE 1-900-448-0611 \$2.00 Per Minute 18+ LH Services, Ft. Lauderdale, FL 33308 (305)564-3022.

## EDUCATION & INSTRUCTION

F.C.C. Commercial General Radiotelephone license. Electronics home study. Fast, inexpensive! "Free" details. **COMMAND**, D-176, Box 2824, San Francisco, CA 94126.

**ELECTRONIC engineering**. 8 volumes complete. \$109.95. No prior knowledge required. Free brochure. **BANNER TECHNICAL BOOKS**, 1203 Grant Avenue, Rockford, IL 61103.

**PATENT** it yourself. Eliminate huge fees. Complete practical instructions \$9.95: **PATENT GUIDE**, PO Box 654, Gurnee, IL 60031.

**LEARN electronics** and digital basics. Programmed courses. \$17.00 each, both \$29.00. Satisfaction guaranteed. **TEK SOURCES**, 6050 NW 68th St., Parkland, FL 33067.

**SAVE \$** importing radios, electronics... directly from manufacturers. For business/hobby. Guaranteed easy! \$2.00. **MINTER ENTERPRISES**, Box 8002-R, Westchester, OH 45069.

FULL- OR PART-TIME JOB/BUSINESS:

## Learn VCR repair!

Professional-level home study program. Master easy-to-learn, high-profit repairs *without* investing in costly high-tech instruments. Send or call today.



**Free career kit: 800-223-4542**

Name \_\_\_\_\_  
Address \_\_\_\_\_  
City \_\_\_\_\_ State \_\_\_\_\_ Zip \_\_\_\_\_

The School of VCR Repair, Dept. VL342  
2245 Perimeter Park, Atlanta, GA 30341

**MUSICIANS**, build a high quality digital delay, \$10.00, very high quality duophonic synthesizer — \$10.00. Kits also available. **GEBHARDT**, Box 754, Anaconda, MT 59711. (406) 563-7506.

**BUILDING A Robot: A Straightforward Approach**. 152 pages fully illustrated. Instructions how you can easily construct a robot. Check or money order. \$19.95 plus \$3.00 shipping. **HUMANFORM ROBOTICS**, PO Box 158486, Nashville, TN 37215.

## BUY BONDS

MC / COD / VISA  
NO FLORIDA SALES

## CABLE TV DESCRAMBLERS

### WORLDWIDE CABLE

- BASE BAND
- TOCCOM
- SCIENTIFIC ATLANTA
- JERROLD
- PIONEER
- ZENITH
- OAK
- HAMLIN

**1 800-772-3233**

1291 A POWERLINE ROAD, SUITE 109  
POMPANO BEACH, FL 33069

## CABLE TV DESCRAMBLERS

★ **CONVERTERS** ★  
and ACCESSORIES.

**SAVE MONEY. DON'T RENT!**

PANASONIC, JERROLD, OAK,  
PIONEER, SCIENTIFIC ATLANTA  
AND MORE. LOWEST PRICES. FREE CATALOG.

**CABLE READY (800) 234-1006**  
COMPANY

### Technician's Turntable

Turntable to speed repair of VCRs, TVs and more. Lets technician easily turn unit for convenient repair. 20" diameter. White color. Net weight: 5 lbs.

#RH-360-425 **\$19<sup>95</sup>** Each

### Super Horn Tweeter

The original piezo tweeter manufactured by Motorola. Sensitivity: 94 dB. 2.83V/1M. 25-30 volts (approximately 50 watts) power handling capability. Produces crisp, clean highs.

Frequency response: 4 KHz-27 KHz. Dimensions: 3-3/8" x 3-3/8" x 2-5/8". 3" hole. Motorola #KSN1005A.

#RH-270-010 **\$5<sup>30</sup>** **\$4<sup>50</sup>** **\$3<sup>95</sup>**  
(1-9) (10-79) (80-up)

### 8" In-Wall Subwoofer

8" paper cone subwoofer with polymer resin coating. Dual voice coils with 8 ohm impedance per coil. Ported plate speaker with integral crossover. Frequency response: 30-500 Hz. 50 watts RMS, 100 watts maximum power handling capability. Sensitivity: 90 dB 1W/1M. Dimensions: 10-5/8" (W) 14-5/8" (L) x 3" (D). Hole dimensions: 9" (W) x 13" (L). Net weight: 8 lbs.

#RH-300-430 **\$192<sup>95</sup>** **\$85<sup>50</sup>** **\$79<sup>90</sup>**  
(1-3) (4-up)



340 E. First St., Dayton, Ohio 45402  
Local: 1-513-222-0173  
FAX: 513-222-4644

### Piezo Super Tweeter

This extremely small tweeter incorporates all the advantages of piezo tweeters into a small package that can be mounted almost anywhere. Frequency response: 5K-20KHz. SPL: 97 dB 1W/1M. Power handling: 80 watts RMS, when used with a 4.7 microfarad capacitor. Sold in pairs. Net weight: 1/2 lb.

#RH-265-267 **\$24<sup>00</sup>** **\$22<sup>50</sup>**  
(1-3) (4-up)

### 12 Ga. Speaker Wire

Extra large gauge speaker wire for use with very high power stereo systems and for use in extremely long cable runs. Over 250 strands of 36 ga. wire. Extra thick, clear PVC insulation. Please order in multiples of 5 feet.

#RH-100-151 **39<sup>c</sup>**  
(per foot)

### BBC 12" Dual Voice Coil Subwoofer

Super quality Italian made cast frame dual voice coil subwoofer. Paper cone with foam surround. 2" dual voice coil. fs= 45 Hz. Frequency response: 45-4KHz. Sensitivity: 96.69 1W/1M. VAS= 3.73 cu ft. QTS= .338. BBC #SW321/FB. Net weight: 9 lbs.

#RH-294-130 **\$139<sup>90</sup>** **\$128<sup>60</sup>**  
(1-3) (4-up)

### 8 Ga. In-Line Fuse Holder

Screw together Bakelite fuse holder with 8 ga. wire. For use with AGU type fuses or regular AGC fuses when spring spacer is used. 50 amp max at 12 volts.

#RH-070-800 **\$3<sup>20</sup>** **\$2<sup>75</sup>**  
(1-9) (10-up)

### High Voltage Cap Kit

This 85 piece kit contains a selection of 250, 350, and 450 volt electrolytic capacitors. 5 pieces each of 1, 2, 3, 4, 7, 8, 10, 22uf and 2 pieces each of 33, and 47uf, 250V radial caps. 5 pieces each of 1, 2, 2.2, 3.3, 4.7, 10uf and 2 pieces each of 22, 33uf, 350V radial caps. 5 pieces each of 1, 2.2, 4.7uf and 2 pieces of 10uf, 450V radial caps. Over \$62.00 wholesale cost if purchased individually. Net weight: 1 lb.

#RH-020-950 **\$49<sup>95</sup>** Kit

FREE CATALOG

CALL TOLL FREE  
**1-800-338-0531**

### VCR Parts Assortment

Convenient assortment of clips, washers, springs, and screws. 10 pieces each of 4 sizes of "E" clips, 10 pieces of 2 sizes of retaining rings, 10 pieces of 14 sizes of washers, 2 each of 8 sizes of tension and compression springs and 24 assorted screws. Total of 246 pieces.

#RH-430-315 **\$6<sup>50</sup>** **\$5<sup>95</sup>**  
(1-3) (4-up)

### Suction Cup Mount Cellular Antenna

The ideal antenna for portable phones. Suction cup grip mounts on inside of car. Never have your car vandalized again. Antenna comes with 9 feet of RG-58 with TNC connector. 3 dB gain. Made in the U.S.A. 9" overall height.

#RH-265-200 **\$14<sup>95</sup>** Each

• 30 day money back guarantee • \$20.00 minimum order • We accept Mastercard, Visa, Discover, and C. O. D. orders. • 24 hour shipping • Shipping charge = UPS charge + \$1.00 (\$3.50 minimum charge) • Hours 8:30 am - 7:00 pm EST, Monday - Friday • 9:00 am - 5:00 pm Saturday. Mail order customers, please call for shipping estimate on orders exceeding 5 lbs. • Foreign destination customers please send \$5.00 U.S. funds for catalog postage •

CIRCLE 56 ON FREE INFORMATION CARD

# AMAZING ELECTRONIC PRODUCTS and KITS

Remember those Martian Space Ships in HG Wells War of the Worlds?



## MYSTERY Levitating Device

Objects float on air and move to the touch. Defies gravity! Amazing gift, conversation piece, magic trick or great scientific project.

ANT1K Easy-Ass'y Kit/Plans \$19.50



## 3 MILE FM Wireless Microphone!

Crystal clear, ultra-sensitive pickup transmits voices, sounds to any FM radio. For security, monitoring children, invalids. Be the local DJ!

MVP1 Plans ..... \$7.00  
MVP1K Kit/Plans ..... \$39.50



## 3 MILE Telephone Transmitter!

Automatically transmits 2 sides of phone conversation to any FM radio. Tunable, easy-assembly PC board. Operates only when phone is in use.

VWPM7 Plans ..... \$7.00  
VWPM7 Kit/Plans ..... \$39.50

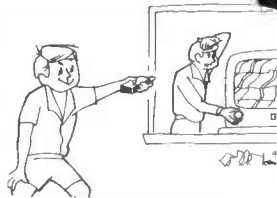

## TV & FM Joker/Jammer

Pocket size device lets you remotely disrupt TV or radio reception. Great gag! Discretion required. Easy-build electronic kit. EJK1KM .... \$19.50

## 100,000 V - 20' Range Intimidation Device!

Electronic module, may be enclosed for handheld, portable, or fixed uses. ITM2 Plans (creditable to kit) \$10.00  
ITM2K Kit & Plans ..... \$49.50

## READY-TO-USE, AUTOMATIC Phone Recording System

Complete with extended play tape recorder & line interface switch. Automatically records both sides of conversation. Check Local Laws on Proper Use! Ready-to-Use System. TAP20X System ..... \$149.50

## Laser Pen

Pen sized laser, great for movies, drive-ins, pointer. Ready to use, with batt's. LAPN1 Laser Pen . \$149.50

## Pocket Laser Kit

3mw or 5mw kits, with solid state 670nm diode. Caution, Class IIIa item. VRL3KM 3mw Laser Kit . . . \$99.50  
VRL5KM 5mw Laser Kit . . \$119.50

## MORE Laser Kits!

LAS1KM 1mw Laser, 632nm, HeNe Easy to Build Kit ..... \$69.50  
LAS4KM 3mw Version, Kit \$99.50

LAT05 Low Cost HeNe Laser Tube! .5mw Tube & Plans . . . only \$24.50

Other parts available separately. Great Low Budget Science Project!

## Shocker Force Field Vehicle Electrifier



Make hand shock balls, shock wands electrify objects, charge capacitors. Great pay back for those wise guys! SHK1KM Easy-Assembly Kit \$24.50

## CATALOG!

with many more items!  
FREE with order, or send \$1 P&H

## INFORMATION UNLIMITED

Dept RE-4 Box 716, Amherst NH 03031  
Phone 603-673-4730 FAX 603-672-5406  
MC, VISA, COD, Check Accepted. ADD \$5 S&H.

Order by Mail, or by  
24 Hr Order Phone:  
800-221-1705

# CABLE DESCRAMBLERS

Converters, Remote Controls, Descramblers, more



#EX192

All major brands carried

- \*JERROLD, \*TOCOM, \*ZENITH
- \*GENERAL INSTRUMENTS
- \*SCIENTIFIC ATLANTA, \*OAK
- \*HAMLIN, \*EAGLE, \*PIONEER

7th Year in business. Thank You  
Member of Omaha Chamber of Commerce  
1 Year warranty on new equipment  
30 Day money back guarantee  
Orders shipped from stock within 24 hours

CALL TODAY FOR A FREE CATALOG  
**1-800-624-1150**



C.O.D.



**M & G ELECTRONICS**  
875 SO. 72nd St.  
Omaha, NE 68114

# Cable TV Descrambler Kits

Universal Kit.....\$55.00

Includes all parts and PC Board. Not included is the ac adaptor or enclosure.

Tri-Mode Kit.....\$39.00

Includes all parts. PC Board and AC Adaptor. Not included is the enclosure.

SB-3 Kit.....\$29.00

Includes all parts, PC Board and AC Adaptor. Not included is the enclosure.

Universal Tutorial.....\$9.95

Includes an in depth study of the technology used and has troubleshooting hints.

Tri-Mode Tutorial.....\$9.95

Includes a gate by gate study of the circuit and has troubleshooting hints.

Snooper Stopper.....\$39.00

Protect yourself from descrambler detection and stop the "bullet".

Call Toll Free

1-800-258-1134

C.O.D.

M & G Electronics, Inc.  
301 Westminister Street  
Providence, RI. 02903

# TOURISM

A VISION OF AMERICA

Nothing matches the excitement of America's cities. Being there, traveling from one place to another, and experiencing America's many wonders is what tourism is all about.

We benefit from travel in so many ways. Tourism is a \$350 billion\* industry that creates 5.85 million\* jobs and produces a \$73.7 billion annual payroll. Tourism works for America and for you.

\*U.S. Department of Commerce, Bureau of Economic Analysis, 1991 Estimates, Bureau of Economic Analysis, Travel & Tourism Center



TOURISM WORKS FOR AMERICA

BUCK, The Tourist

The National Travel and Tourism Awareness Council

©1990, National Travel and Tourism Awareness Council



# ALL ELECTRONICS CORP.

## Small Neodymium Magnet

Small, powerful neodymium magnet. Irregular shape approx. 0.64" X 0.7" X 0.1" thick. Strong for its size. CAT# MAG-5 \$1.50 each



## Digital Voice Module

Ming# DVM-108. Digital recording module especially suited for reproducing verbal messages. Ideal for HAM contesting, memo recorder, verbal alarm system etc. Requires a minimum of external wiring. Up to 8 different phrase channels. Built-in 200 mW audio amp. 1 Megabit of DRAM memory, for up to 32 seconds of recording. Condenser or dynamic mike input. Board size: 3 3/4" X 2" X 1" high. Includes memory chips which require installation. Microphone and other external components not included. CAT# DVM-108 \$25.00 each



## A.C. Line Cord

6' Black 18/2 A.C. power cords. SPT-1 insulation. Polarized plug. CAT# LCAC-7 2 for \$1.00 • 100 for \$45.00 • 1000 for \$400.00

## Car Lighter Coil Cord



Automotive cigar lighter plug with replaceable 5 amp fuse. Quality, retractable coil cord extends to approximately 6 feet. Terminates with a 5 pin DIN plug which can be cut-off. Ideal for battery charger or running 12 Volt devices from car battery. CAT# CLP-18 \$1.50 each • 10 for \$12.50

## D.C. Wall Transformers (120 Vac INPUT)

Volts	Amps	Plug Style	Center negative	Cat#	Price
4 Vdc	70 ma.	2.5 mm co-ax	negative	DCTX-470	\$2.00
6 Vdc	300 ma.	2.1 mm co-ax	positive	DCTX-632	\$2.75
8.3 Vdc	10 ma.	battery snap		DCTX-8310	\$1.50
9 Vdc	300 ma.	2.1 mm co-ax	positive	DCTX-832	\$3.00
12 Vdc	100 ma.	2.1 mm co-ax	negative	DCTX-1210	\$2.50
12 Vdc	500 ma.	2.1 mm co-ax	negative	DCTX-125	\$4.50
12 Vdc	800 ma.	2.5 mm co-ax	positive	DCTX-1281	\$5.25
12 Vdc	1 Amp	none		DCTX-121	\$6.50
14 Vdc	700 ma.	1.3 mm co-ax	negative	DCTX-1470	\$5.25
15 Vdc	400 ma.	2.5 mm co-ax	negative	DCTX-1540	\$4.50

## VERY SPECIAL DEAL 17 Vdc 210 ma. WALL TRANSFORMERS

New 17 Vdc, 210 ma wall transformers. 6 ft. cord. Unusual co-axial device on end of cord can be cut off and used for another application. Large quantity available. CAT# DCTX-1721 \$1.50 each 100 for \$1.25 each 1000 for \$1.00 each



## 110 WATT SWITCHING POWER SUPPLY

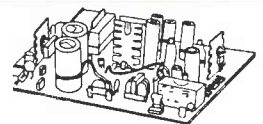

50 WATT Computer Products # XL40-8301 Input: 115/230 Vac Output: -12 Vdc @ 0.2A 12 Vdc @ 2.0 A 5.1 Vdc @ 3.5 A Switching power supply. Regulated. 6.30" X 3.93" X 1.9" high. CAT# PS-51 \$15.00 each

76 WATT Computer Products # XL50-8601 Input: 115/230 Vac Output: -12 Vac @ 1.0 A 12 Vdc @ 1.0 A 5 Vdc @ 6.0 A Regulated switching power supply. 7.75" X 4.25" X 1.78" high CAT# PS-76 \$20.00 each

## 12 VDC STEPPER MOTOR



Airpax # AB3712-M1 12 Vdc, 36 ohm coil, 15 degree/step. 2.25" dia. X 0.95" thick. 0.25" shaft X 0.6" long. CAT# SMT-9 \$6.00 each

## ELECTROLUMINESCENT BACKLIGHTS

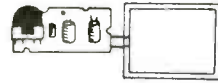

At last! A low cost electroluminescent glow strip and inverter. These brand-new units were designed to backlight small LCD TVs made by the Citizen Watch company. The inverter circuit changes 3 or 6 Vdc to approximately 100 Vac, the voltage required to light the glowstrip. Luminescent surface area is 1.7" X 2.25". The strip is a salmon color in its off state, and glows white when energized. The circuit board is 2.2" X 1". Glow strip and circuitry can be removed easily from plastic housing. Ideal for special lighting effects.

Citizen# 92TA operates on 3-6 Vdc CAT# BLU-92 \$3.50 each LARGE QUANTITY AVAILABLE 10 for \$32.00 • 100 for \$275.00

## Monoral Equalizer

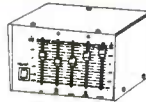

Five band graphic equalizer. Allows use of one source for background music and music-on-hold. Allows you to equalize and adjust the volume of one without changing the other. Useful in any application where equalization of a monoral source is desirable. RCA jack inputs and outputs. Removable metal control cover to prevent tampering. 6.75" X 5.75" X 3.125" high. CAT# EQ-1 \$15.00 each

## LCD Display • 40 Character X 2 Line



Optrex # DMC40218 or Hitachi # LMO18L Built-in controller and drivers. 4 or 8 bit operation. 5 Vdc power. Display size: 6.05" X 0.7" Module size: 7.12" X 1.34". Character size: (5 X 7 dots) 3.2mm X 4.85 mm. Data sheets and instructions available. CAT# LCD-3 \$15.00 each

## Piezo Element

3 Wire Piezo Element. Taiyo Yuden Co. # CB35BBKR4. Self-excited piezo electric diaphragm. 1.40" diameter x 0.021" thick. Resonant resistance: 400 ohms. 5" color-coded leads. CAT# PE-12 \$1.00 each 10 for \$6.50 • 100 for \$65.00



## L.E.D.'s

Surface mount LED chip. Clear when off, green when lit. Very tiny - whole unit is 0.115" X 0.055" X 0.05" thick. 1mm (0.04") lens diameter. Gold-plated mounting surfaces for superior conductivity. CAT# SMLED-2 10 for \$2.00 100 for \$18.00 1000 for \$140.00



## Standard JUMBO

Diffused T 1-3/4 size (5 mm) RED CAT# LED-1 10 for \$1.50 • 100 for \$13.00 GREEN CAT# LED-2 10 for \$2.00 • 100 for \$17.00 YELLOW CAT# LED-3 10 for \$2.00 • 100 for \$17.00

## REDUCED PRICES FLASHING LED

W/ built in flashing circuit 5 volt operation. T 1-3/4 (5mm)



RED 50c each CAT# LED-4 10 for \$4.75 GREEN 75c each CAT# LED-4G 10 for \$7.00 YELLOW 75c each CAT# LED-4Y 10 for \$7.00

## LED HOLDER

Two piece holder. CAT# HLED 10 for 65c



## Flash Units

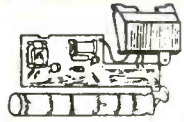

NEW compact flash assemblies from a camera manufacturer. Operates on 3 Vdc. Measures 2 1/2" X 1 1/4". Ideal for use as a strobe, warning light or attention getter. Includes a hook-up diagram. CAT# FSH-1 \$3.75 each • 10 for \$35.00 100 for \$325.00

## 12 Volt 2 Amp Transformer

Same as Mouser # 41FG020. 12 VCT, 2 Amp power transformer. 2" X 2.35" X 2.10". 2.90" mounting centers. Pigtail leads. CAT# TX-122A \$5.00 each

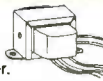

## Rechargeable Batteries (nickel-cadmium)

Size	Volt	Amp	Case	1-8	10
AAA	1.20	180 mAh	NCB-AAA	\$1.50	\$13.50
AA	1.20	500 mAh	NCB-AA	\$2.00	\$18.50
AA w/ Solder Tabs	1.20	500 mAh	NCB-SAA	\$2.20	\$20.00
Sub C w/ Solder Tabs	1.20	1200 mAh	NCB-SC	\$4.25	\$40.00
C	1.20	1200 mAh	NCB-C	\$4.25	\$40.00
C Heavy Duty	1.25	1800 mAh	HDNCB-C	\$5.25	\$42.50
D	1.20	1200 mAh	NCB-D	\$4.50	\$42.50
D Heavy Duty	1.25	4000 mAh	HDNCB-D	\$7.00	\$65.00

# ORDER TOLL FREE 1-800-826-5432

Call Or Write For A Free 64 Page Catalog Outside the U.S.A. send \$2.00 postage.

FAX (818) 781-2653 • INFORMATION (818) 904-0524

Minimum Order \$10.00 • All Orders Can Be Charged To Visa, Mastercard Or Discovercard • Checks and Money Orders Accepted By Mail • California, Add Sales Tax • No C.O.D. • Shipping And Handling \$3.50 for the 48 Continental United States - All Others Including Alaska, Hawaii, P.R. And Canada Must Pay Full Shipping • Quantities Limited • Prices Subject to change without notice.



MAIL ORDERS TO: ALL ELECTRONICS CORP • P.O. BOX 567 • VAN NUYS, CA 91408

# "CABLE BOXES" BELOW WHOLESALE GUARANTEED STOCK - COD'S

## DESCRAMBLERS

(QTY)	(10)	(20)	(40)
NEW TBI-3	70	55	CALL
TB 2 or 3	45	40	CALL
SA-3B	45	40	CALL
OAK N-12	43	38	CALL
SB 2 OR 3	43	38	CALL

## COMBINATION UNITS

DRX-DIC	89	CALL
SYL DIC	59	CALL
PIONEER	295	275 CALL

## CONVERTERS W/REMOTES

PANASONIC		
TZPC145	65	60 CALL
STARQUEST		
E-Z550	65	60 CALL
E-ZY550	75	65 CALL

THEFT OF SERVICE IS A CRIME. INSTALLING ANY DEVICE WITHOUT PERMISSION MAY SUBJECT YOU TO CIVIL OR CRIMINAL PENALTIES. YOU MUST CHECK WITH YOUR LOCAL CABLE COMPANY AND PAY FOR ALL SERVICE YOU USE. IT IS NOT THE INTENT OF LAKE SYLVAN TO DEFRAUD ANY TELEVISION OPERATOR AND WE WILL NOT ASSIST ANY COMPANY OR INDIVIDUAL IN DOING THE SAME.

LAKE SYLVAN SALES, INC.  
SORRY NO MINNESOTA SALES

CALL FOR A CATALOG NOW!!  
**800-800-4582**

CIRCLE 176 ON FREE INFORMATION CARD

# ADVERTISING INDEX

Electronics Now does not assume any responsibility for errors that may appear in the index below.

Free Information Number	Page	
	181	Northeast Electronics ..... 83
108	82	AMC Sales ..... 186
75	87	Ace Products ..... 180
107	105	All Electronics ..... 56
—	104	Amazing Concepts ..... 184
187	87	American Reliance Inc. .... 87
193	16, 17	Beckman Industrial ..... 179
194	26, 27	Beckman Industrial ..... 179
98	CV4	Beckman Industrial ..... 177
109	33	C & S Sales ..... 26
—	11, 25	CIE ..... 192
185	90	Cable Warehouse ..... 190
—	102	Cabletronics ..... 195
—	87	Chenesko Products ..... 191
—	83	Command Productions ..... 83
127	87	Deco Industries ..... 87
188	106	Electronic Goldmine ..... 106
—	7	Electronics Book Club ..... 7
—	28	Electronics Engineers B.C. .... 28
121	CV2	Fluke Manufacturing ..... CV2
—	34	47th Street Photo ..... 34
182	3	Global Specialties ..... 3
189	15	Goldstar Precision ..... 15
—	59	Grantham College ..... 59
86	90	Heathkit ..... 90
—	17	HighText Publications, Inc. .... 17
—	16	ISCET ..... 16
114	100, 101	Jameco ..... 100, 101
183	5	Kelvin ..... 5
178	86	Kepec Power Supply ..... 86
176	106	Lake Sylvan Sales, Inc. .... 106
197	104	M&G Electronics ..... 104
87	99	MCM Electronics ..... 99
53	104	MD Electronics ..... 104
93	98	Mark V. Electronics ..... 98
117	86	Mouser ..... 86
—	18	NRI Schools ..... 18
71	23	NTE Electronics ..... 23

## ADVERTISING SALES OFFICE

Gernsback Publications, Inc.  
500-B Bi-County Blvd.  
Farmingdale, NY 11735  
1-(516) 293-3000  
President: Larry Steckler

For Advertising ONLY  
516-293-3000  
Fax 1-516-293-3115  
Larry Steckler  
publisher

Christina Estrada  
assistant to the President  
Arline Fishman  
advertising director  
Denise Mullen  
advertising assistant  
Kelly McQuade  
credit manager

Subscriber Customer Service  
1-800-288-0652

Order Entry for New Subscribers  
1-800-999-7139

7:00 AM - 6:00 PM M-F MST

## ADVERTISING SALES OFFICES

EAST/SOUTHEAST  
Stanley Levitan, Eastern Advertising Sales Manager

Electronics Now  
1 Overlook Ave.  
Great Neck, NY 11021  
1-516-487-9357, 1-516-293-3000  
Fax 1-516-487-8402

MIDWEST/Texas/Arkansas/Oklahoma  
Ralph Bergen, Midwest Advertising Sales Manager

Electronics Now  
One Northfield Plaza, Suite 300  
Northfield, IL 60093-1214  
1-708-446-1444  
Fax 1-708-559-0562

## PACIFIC COAST/Mountain States

Arline Fishman  
500-B Bi-County Blvd.  
Farmingdale, NY 11735  
1-(516) 293-3000  
Fax 1-516-293-3115

EN Shopper  
Joe Shere, National Representative  
P.O. Box 169  
Idyllwild, CA 92549  
1-714-659-9743  
Fax 1-714-659-2469

## THE ELECTRONIC GOLDMINE



The Electronic Goldmine has one of the greatest selections of unique electronic kits available in the world! We have over 65 kits and over 1,400 unique, bargain priced, components in our catalog!



### INFRARED DETECTOR KIT

Great for testing and verification of infrared output. 9V battery not included.  
C6441 \$5.95



### INEXPENSIVE GEIGER COUNTER KIT

Detects both Beta and Gamma Rays. 9V battery not included.  
C6447 \$39.95



### PRECISION HIGH SPEED MOTOR

Great for Robots, mini-ature fans, etc. Size: 1 1/8" x 9/16". Operates from 1.0VDC up to 9VDC.  
G2846 1.00 ea 10.80

### BURGLAR/FIRE ALARM KEYBOARD CONTROL PANEL

These are actual late model control panels made for use on home/business, burglar/fire alarms. They contain 6 bright LEDs, a 12-key control keypad with 2" cable and connector. These are brand new and the LEDs can be ignited with just the addition of a 9V battery to several points on the connector (we show you which ones) to provide you with the most realistic looking "fake" burglar alarm. The average burglar is going to think that you have a very sophisticated alarm system installed! Size: 4 9/16" square, 1/2" thick with 3 nicad standoffs under panel. These are a great flea market items that can be sold for \$10.00 or more! Order fast to avoid disappointment!

### LCD WATCH MODULE

These were the heart of a high quality LCD watch which they are brand new and are shipped with a good battery. You must remove a tiny screw (with a jeweler's screwdriver) to remove the protective plastic covering the battery compartment. These can display date, time, and even have an alarm, but if you wish to make use of the alarm feature you have to connect any 2 lead piezo (you supply the piezo) to the tiny gold springs on the back of the module. Size: 1 1/8" diameter. Complete ready to use - but no case.  
G2741 \$1.25



### MUSIC MODULE

Try this music module made for a greeting card company. These are brand new and play a pleasant tune each time activated. The song is "Let me call you Sweetheart". Features large flat piezo disk, actuator, even music IC and battery holder all on a small PCB board! Battery not included but operates from any 1.5V tiny hearing aid cell (you can just about choose any cell and it will work).  
G2744 89c



### BURGLAR/FIRE ALARM KEYBOARD CONTROL PANEL

These are actual late model control panels made for use on home/business, burglar/fire alarms. They contain 6 bright LEDs, a 12-key control keypad with 2" cable and connector. These are brand new and the LEDs can be ignited with just the addition of a 9V battery to several points on the connector (we show you which ones) to provide you with the most realistic looking "fake" burglar alarm. The average burglar is going to think that you have a very sophisticated alarm system installed! Size: 4 9/16" square, 1/2" thick with 3 nicad standoffs under panel. These are a great flea market items that can be sold for \$10.00 or more! Order fast to avoid disappointment!

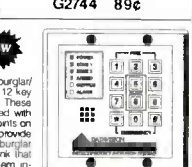

MINIMUM ORDER: \$10.00 plus \$3.50 shipping and handling.

We accept MC, Visa and Money Orders.  
SEND ORDERS TO: The Electronic Goldmine  
P.O. Box 5409 Scottsdale, AZ 85261  
PHONE ORDERS (602) 451-7454 FAX ORDERS (602) 451-9495

CIRCLE 188 ON FREE INFORMATION CARD

# NO PROBLEMO

You want a bargraph & a full range counter – Optoelectronics can deliver!

**\$199.**

Don't Wait,  
This Offer Can't Last!  
No discounts, No trade-ins.

Now for a limited time only, \$160. off the list price. for our Full Range Model 2810 with bargraph – plus:

- Full range -10Hz to 3GHz.
- LCD display (daylight visibility).
- True state-of-the-art technology with the high speed ASIC.
- NiCads & Charger included.
- Ultra-high sensitivity.
- 4 fast gate times.
- Extruded metal case.
- Compatible with MFJ207.

#### Suggested options

##### TA100S:

Telescoping Whip Antenna.....\$ 12.

##### CC30

Vinyl Carry Case.....\$ 15.

##### BL28:

EL Backlight for use in roomlight and low light.....\$ 45.

##### TCXO 30:

Precision  $\pm 0.2$ ppm 20 to 40°C temp. compensated time base .....\$100.



Universal Handi-Counter™ Model 3000, \$375. and Bench Model 8030, \$579. Both offer frequency, period, ratio and time interval.

**Made in the USA**

## OPTOELECTRONICS

Call for free catalog - Factory Direct Order Line:

# 1-800-327-5912

FL (305)771-2050 • FAX (305)771-2052

5821 NE 14th Ave. • Ft. Lauderdale, FL 33334  
5% Ship/Handling (Max. \$10) U.S. & Canada.  
15% outside continental U.S.A.  
Visa and Master Card accepted.

CIRCLE 180 ON FREE INFORMATION CARD

# The DMM our customers designed.

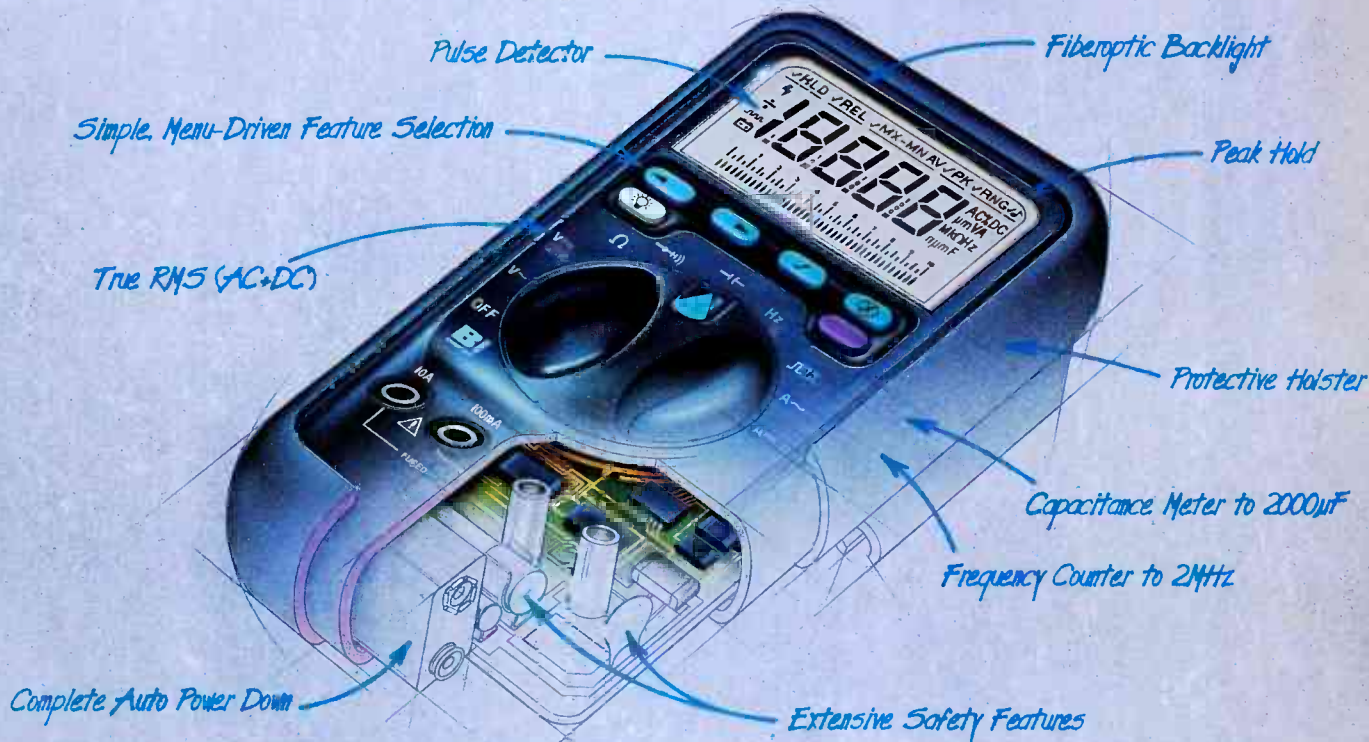

Before we built the new generation Beckman Industrial Series 2000 DMMs, we asked people like you what you *really* want.

You want more. More test and measurement capabilities. More troubleshooting features. All in an affordable hand-held DMM. The Series 2000 features the widest range Frequency Counter in any professional DMM, a full-range Capacitance Meter, True RMS measurements, Intermittent Detection, 50ns Pulse Detection, and Peak Measurement capabilities. Plus, the Series 2000 is the only meter to offer autoranging Min/Max recording and relative modes.

You want a DMM that's easier to use. The Series 2000's display is 25% larger, with bigger digits and backlighting for easier reading, even in the worst light. Plus the fast 4 digit display provides the high resolution needed for adjusting power supplies and generators down to 1mV. And only the Series 2000 features a menuing system for fast, simple feature access.



Made in the USA

The Beckman Industrial Series 2000, priced from \$209 to \$279 offers you the best performance for your dollar. Look again at these features:

- 4 Digit, 10,000 Count Resolution
- Basic Accuracy to 0.1%
- True RMS, AC or AC on DC
- 0.01Ω Resolution
- Automatic Reading Hold
- 1ms Peak Hold
- Fully Autoranging Relative and Min Max Modes
- Intermittent Detector
- UL1244, IEC1010 Design
- Three Year Warranty

The Series 2000 offers the most solutions for your everyday test and measurement needs. The only DMMs designed by the people who use them. You.

For more information on these new DMMs call (outside CA) 1-800-854-2708 or (inside CA) 1-800-227-9781. Beckman Industrial Corporation, 3883 Ruffin Rd., San Diego, CA 92123-1898.



**Beckman Industrial™**

An Affiliate of Emerson Electric Co.

CIRCLE 98 ON FREE INFORMATION CARD

Specifications subject to change without notice.  
© 1992 Beckman Industrial Corp.