

48783

Radio- POCKET TV ROUNDUP

\$1.95 JULY 1986
IN CANADA \$2.50

Electronics®

TECHNOLOGY - VIDEO - STEREO - COMPUTERS - SERVICE

A
GERNSBACK
PUBLICATION

**BUILD THIS 1.2-GHz
FREQUENCY COUNTER**

For less than \$60!

TV DESCRAMBLING

Here's how it works.

THE EARLY DAYS OF RADIO

Early crystal radios.

**BUILD A UNIVERSAL
BATTERY CHARGER**

Keep your rechargeables
in peak condition.

BUILD A STEREO AMPLIFIER

100 watts per channel of FET power.

OSCILLATORS

Our new back-to-school series.



PLUS:

★ Ask R-E

*S42R*****5-DIGIT 95014
303092 DRK 6450M091 14 R DEC86
LLOYD DARKNELL
645D MYRTLEWOOD DR
CUPERTINO CA 95014 07*CK

★ Designer's Notebook



100 MHz scope, counter, timer, multimeter: All one integrated system.

100 MHz dual time base scope. 3.5 ns risetime; sweeps from 0.5 s to 5 ns/div; alternate sweep; $\pm 2\%$ vertical/horizontal accuracy; vertical sensitivity to 2 mV/div @ 90 MHz.

9-digit fluorescent display. Digitally accurate readouts accompany the CRT waveform. Error messages and prompts also appear on the display.

Dc volts and ac coupled true RMS volts. Measured through the Ch 1 scope input.

Gated measurements. Use the scope's intensified marker to measure frequency, period, width and to count events within specified portions of the signal.

Auto-ranged, auto-averaged counter/timer. Frequency, period, width, delay time, Δ -time, plus totalize to more than 8 million events—with 7 digits plus exponent displayed.

Auto-ranged DMM. Use floating DMM side inputs with up to 5000-count resolution. Get precise readouts of average dc and true RMS voltage. Measure resistance from milliohms to gigohms.

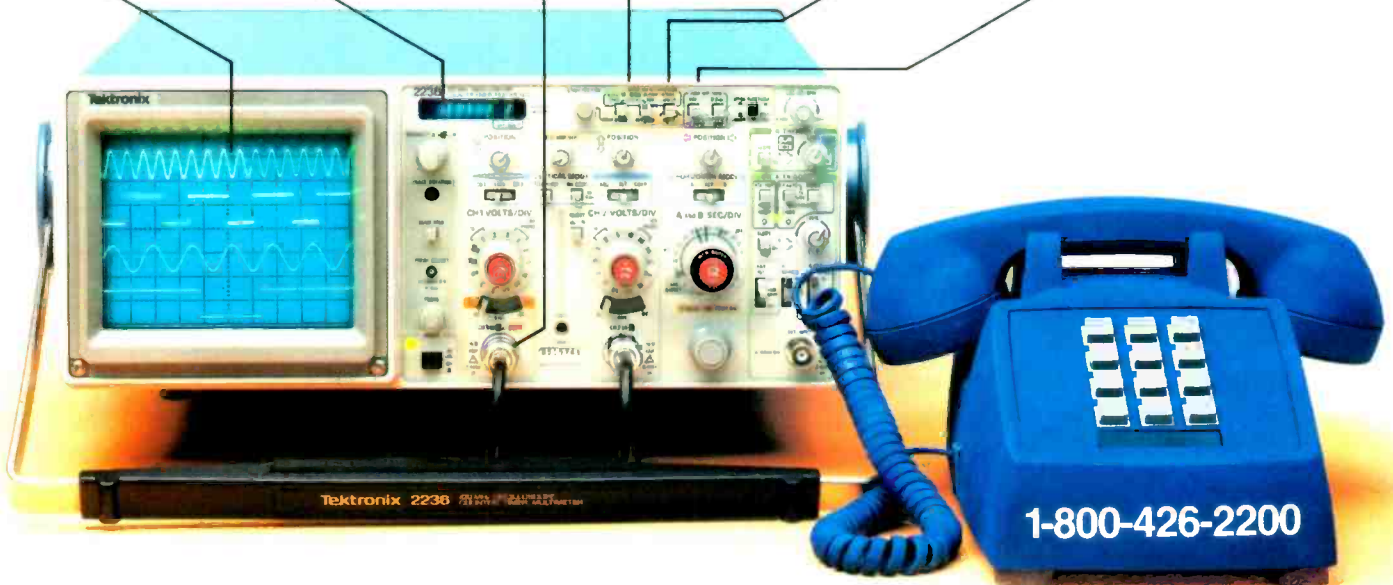

Now make measurements faster, easier, with greater accuracy and user confidence. The Tek 2236 makes gated counter measurements, temperature, time, frequency, resistance and voltage measurements push-button easy. You see results concurrently on the 9-digit numeric readout and CRT display.

Its complete trigger system includes pushbutton trigger view, plus peak-to-peak auto, TV line, TV field, single sweep and normal modes.

At just \$2650*, the 2236 includes the industry's first 3-year warranty on all parts and labor, including the CRT.

Integrated measurement system. 3-year warranty. 15-day return policy. And expert advice. One free call gets it all! You can order, or obtain literature, through the Tek National Marketing Center. Technical personnel, expert in scope applications, can answer your questions and expedite delivery. Direct orders include probes, operating

manual, 15-day return policy, full warranty and worldwide service back-up.

**Order toll-free:
1-800-426-2200
Extension 57**

In Oregon call collect:
(503) 627-9000 Ext. 57
Or write Tektronix, Inc.
P.O. Box 1700
Beaverton, OR 97075

Tektronix
COMMITTED TO EXCELLENCE

SPECIAL FEATURE	39 POCKET TELEVISION RECEIVERS Here's a round-up of the pocket-TV market. We show you what's available, for how much, and the performance you can expect. Fred Blechman	RADIO	61 THE EARLY DAYS OF RADIO A nostalgic look back at the original solid state radios. Martin Clifford
BUILD THIS	47 1.2 GHz FREQUENCY COUNTER High frequency at a low price. Fred Hufft 56 HIGH-POWER FET STEREO AMP Here's an excellent way to upgrade your outdated system! 67 UNIVERSAL BATTERY CHARGER Keep your rechargeable batteries in tip-top condition by safely recharging them with our inexpensive circuit. Michael R. Wright 75 PC SERVICE Use our exclusive direct-etch foil patterns to make circuit boards for your frequency counter.	86 ANTIQUE RADIOS Tuning eyes and other "advances." Richard D. Fitch 89 COMMUNICATIONS CORNER Amateur packet switching. Herb Friedman	
TECHNOLOGY	6 VIDEO NEWS Inside the fast-changing video scene. David Lachenbruch 44 TV SIGNAL DESCRAMBLING Part 2. We continue our series with a look at some rather complex scrambling schemes. William Sheets and Rudolf F. Graf 78 SATELLITE TV The issues of scrambling. Bob Cooper, Jr. 80 ROBOTICS Give arms to the robotics. Mark J. Robillard	COMPUTERS Following page 88 COMPUTER DIGEST Touch screens, modems, and more!	
CIRCUITS AND COMPONENTS	52 RADAR SIGNAL DETECTOR An easy-to-build circuit that can detect signals from 50 MHz to 500 GHz. Gregory Hodowanec 65 HOW TO DESIGN OSCILLATOR CIRCUITS Our our new back-to-school series. Joseph J. Carr 82 SERVICE CLINIC Servicing a dead set. Jack Darr 83 SERVICE QUESTIONS Solutions to servicing problems. 84 DRAWING BOARD More on memory management. Robert Grossblatt	EQUIPMENT REPORTS 23 Radio Shack Telephone Tester 26 OK Industries Model 205 Function Generator	
		DEPARTMENTS 112 Advertising and Sales Offices 112 Advertising Index 8 Ask R-E 113 Free Information Card 12 Guest Editorial 14 Letters 92 Market Center 30 New Products 4 What's News	

COVER 1



Who says that good test instruments have to be expensive? The subject of this month's cover can be built for under \$60 if you're willing to overlook the case. But that low price doesn't mean low performance. For example, our counter features an accuracy of ± 1 PPM ± 1 count and a sensitivity better than 150 mV over the entire measurement range from 1 Hz to 1200 MHz. For more details and complete instructions on how to build the counter, turn to page 47.

NEXT MONTH

THE AUGUST ISSUE IS ON SALE JULY 1

BUILD AN INFRARED POWER SWITCH

Control your electrical appliances from your easy chair!

TV SIGNAL SCRAMBLING

Our series continues

POCKET TV ROUNDUP

Set-by-set descriptions.

THE 4007

An indepth look at one of the most versatile CMOS IC's.

Radio- Electronics

Hugo Gernsback (1884-1967) founder
M. Harvey Gernsback,
editor-in-chief, emeritus

Larry Steckler, EHF, CET, editor-in-chief
and publisher

EDITORIAL DEPARTMENT

Art Kleiman, editorial director
Brian C. Fenton, managing editor
Carl Laron, WB2SLR, associate editor
Jeffrey K. Holtzman,
assistant technical editor
Robert A. Young, assistant editor
Julian S. Martin, editorial associate
Byron G. Wels, editorial associate
M. Harvey Gernsback,
contributing editor
Jack Darr, CET, service editor
Robert F. Scott,
semiconductor editor
Herb Friedman,
communications editor
Bob Cooper, Jr. satellite-TV editor
Robert Grossblatt, circuits editor
David Lachenbruch,
contributing editor
Richard D. Fitch,
contributing editor
Mark J. Robillard, robotics editor
Teri Scaduto Wilson, editorial assistant
Judith Kaplan, editorial assistant

PRODUCTION DEPARTMENT

Ruby M. Yee, production director
Robert A. W. Lowndes,
editorial production
Andre Duzant, technical illustrator
Karen Tucker, advertising production
Geoffrey S. Weil, production traffic

CIRCULATION DEPARTMENT

Jacqueline P. Cheeseboro,
circulation director
Wendy Alanko,
circulation analyst
Theresa Lombardo,
circulation assistant

Cover photo by Robert Lewis

Typography by Mates Graphics

Radio-Electronics, Gernsback Publications, Inc., Executive Offices, 500-B Bi-County Blvd., Farmingdale, NY 11735, 516-293-3000

Radio-Electronics is indexed in *Applied Science & Technology Index* and *Readers Guide to Periodical Literature*.

Microfilm & microfiche editions are available. Contact circulation department for details.

Advertising Sales Offices listed
on page 112.

As a service to readers, RADIO-ELECTRONICS publishes available plans or information relating to newsworthy products, techniques and scientific and technological developments. Because of possible variances in the quality and condition of materials and workmanship used by readers, RADIO-ELECTRONICS disclaims any responsibility for the safe and proper functioning of reader-built projects based upon or from plans or information published in this magazine.

Since some of the equipment and circuitry described in RADIO-ELECTRONICS may relate to or be covered by U.S. patents, RADIO-ELECTRONICS disclaims any liability for the infringement of such patents by the making, using, or selling of any such equipment or circuitry, and suggests that anyone interested in such projects consult a patent attorney.



NEW! Lower Price Scanners

Communications Electronics™, the world's largest distributor of radio scanners, introduces new lower prices to celebrate our 15th anniversary.

Regency® MX7000-EA

List price \$699.95/CE price \$399.95/SPECIAL
10-Band, 20 Channel • Crystalless • AC/DC
Frequency range: 25-550 MHz, continuous coverage and 800 MHz, to 1.3 GHz, continuous coverage. The Regency MX7000 scanner lets you monitor military, F.B.I., Space Satellites, Police and Fire Departments, Drug Enforcement Agencies, Defense Department, Aeronautical AM band, Aero Navigation Band, Fish & Game, Immigration, Paramedics, Amateur Radio, Justice Department, State Department, plus thousands of other radio frequencies most scanners can't pick up. The Regency MX7000 is the perfect scanner for intelligence agencies that need to monitor the new 800 MHz, cellular telephone band. The MX7000, now at a special price from CE.

Regency® Z60-EA

List price \$299.95/CE price \$179.95/SPECIAL
8-Band, 60 Channel • No-crystal scanner
Bands: 30-50, 88-108, 118-136, 144-174, 440-512 MHz. The Regency Z60 covers all the public service bands plus aircraft and FM music for a total of eight bands. The Z60 also features an alarm clock and priority control as well as AC/DC operation. Order today.

Regency® Z45-EA

List price \$259.95/CE price \$159.95/SPECIAL
8-Band, 45 Channel • No-crystal scanner
Bands: 30-50, 118-136, 144-174, 440-512 MHz. The Regency Z45 is very similar to the Z60 model listed above however it does not have the commercial FM broadcast band. The Z45, now at a special price from Communications Electronics.

Regency® RH250B-EA

List price \$613.00/CE price \$329.95/SPECIAL
10 Channel • 25 Watt Transceiver • Priority
The Regency RH250B is a ten-channel VHF land mobile transceiver designed to cover any frequency between 150 to 162 MHz. Since this radio is synthesized, no expensive crystals are needed to store up to ten frequencies without battery backup. All radios come with CTCSS tone and scanning capabilities. A monitor and night/day switch is also standard. This transceiver even has a priority function. The RH250 makes an ideal radio for any police or fire department volunteer because of its low cost and high performance. A UHF version of the same radio called the RU150B covers 450-482 MHz, but the cost is \$449.95. To get technician programming instructions, order a service manual from CE with your radio system.

NEW! Bearcat® 50XL-EA

List price \$199.95/CE price \$114.95/SPECIAL
10-Band, 10 Channel • Handheld scanner
Bands: 29.7-54, 136-174, 406-512 MHz. The Uniden Bearcat 50XL is an economical, hand-held scanner with 10 channels covering ten frequency bands. It features a keyboard lock switch to prevent accidental entry and more. Also order part # BP50 which is a rechargeable battery pack for \$14.95, a plug-in wall charger, part # AD100 for \$14.95, a carrying case part # VC001 for \$14.95 and also order optional cigarette lighter cable part # PS001 for \$14.95.

NEW! Regency® XL156-EA

List price \$239.95/CE price \$129.95/SPECIAL
6-Band, 10 Channel • No-crystal Scanner
Search • Lockout • Priority • AC/DC
Bands: 30-50, 144-174, 440-512 MHz. Cover your choice of over 15,000 frequencies on 10 channels at the touch of your finger. Display messages. External speaker jack. Telescoping antenna. External antenna jack. AC/DC.

NEW! Regency® R1060-EA

List price \$149.95/CE price \$92.95/SPECIAL
6-Band, 10 Channel • Crystalless • AC only
Bands: 30-50, 144-174, 440-512 MHz. Now you can enjoy computerized scanner versatility at a price that's less than some crystal units. The Regency R1060 lets you in on all the action of police, fire, weather, and emergency calls. You'll even hear mobile telephones.

Bearcat® DX1000-EA

List price \$649.95/CE price \$349.95/SPECIAL
Frequency range 10 KHz. to 30 MHz. The Bearcat DX1000 shortwave radio makes tuning in London as easy as dialing a phone. It features PLL synthesized accuracy, two time zone 24-hour digital quartz clock and a built-in timer to wake you to your favorite shortwave station. It can be programmed to activate peripheral equipment like a tape recorder to record up to five different broadcasts, any frequency, any mode, while you are asleep or at work. It will receive AM, LSB, USB, CW and FM broadcasts.

There's never been an easier way to hear what the world has to say. With the Bearcat DX1000 shortwave receiver, you now have direct access to the world.

NEW! Regency® HX1200-EA

List price \$369.95/CE price \$214.95/SPECIAL
8-Band, 45 Channel • No Crystal scanner
Search • Lockout • Priority • Scan delay
Sidelit liquid crystal display • EAROM Memory
New Direct Channel Access Feature
Bands: 30-50, 118-136, 144-174, 406-420, 440-512 MHz. The new handheld Regency HX1200 scanner is fully keyboard programmable for the ultimate in versatility. You can scan up to 45 channels at the same time including the AM aircraft band. The LCD display is even sidelit for night use. Order MA-256-EA rapid charge drop-in battery charger for \$84.95 plus \$3.00 shipping/handling. Includes wall charger, carrying case, belt clip, flexible antenna and nicad battery.

NEW! Bearcat® 100XL-EA

List price \$349.95/CE price \$203.95/SPECIAL
8-Band, 16 Channel • Priority • Scan Delay
Search • Limit • Hold • Lockout • AC/DC
Frequency range: 30-50, 118-174, 406-512 MHz. The world's first no-crystal handheld scanner now has a LCD channel display with backlight for low light use and aircraft band coverage at the same low price. Size is 1 1/2" x 7 1/2" x 2 1/2". The Bearcat 100XL has wide frequency coverage that includes all public service bands (Low, High, UHF and "T" bands), the AM aircraft band, the 2-meter and 70 cm. amateur bands, plus military and federal government frequencies. Wow...what a scanner! Included in our low CE price is a sturdy carrying case, earphone, battery charger/AC adapter, six AA nicad batteries and flexible antenna. Order your scanner now.

Bearcat® 210XW-EA

List price \$339.95/CE price \$209.95/SPECIAL
8-Band, 20 Channel • No-crystal scanner
Automatic Weather • Search/Scan • AC/DC
Frequency range: 30-50, 136-174, 406-512 MHz. The new Bearcat 210XW is an advanced third generation scanner with great performance at a low CE price.

NEW! Bearcat® 145XL-EA

List price \$179.95/CE price \$102.95/SPECIAL
10 Band, 16 channel • AC/DC • Instant Weather
Frequency range: 29-54, 136-174, 420-512 MHz. The Bearcat 145XL makes a great first scanner. Its low cost and high performance lets you hear all the action with the touch of a key. Order your scanner from CE today.

TEST ANY SCANNER

Test any scanner purchased from Communications Electronics™ for 31 days before you decide to keep it. If for any reason you are not completely satisfied, return it in original condition with all parts in 31 days, for a prompt refund (less shipping/handling charges and rebate credits).

NEW! Bearcat® 800XLT-EA

List price \$499.95/CE price \$317.95
12-Band, 40 Channel • No-crystal scanner
Priority control • Search/Scan • AC/DC
Bands: 29-54, 118-174, 406-512, 806-912 MHz. The Uniden 800XLT receives 40 channels in two banks. Scans 15 channels per second. Size 9 1/2" x 4 1/2" x 1 1/2".

OTHER RADIOS AND ACCESSORIES

Panasonic RF-2600-EA Shortwave receiver ... \$179.95
RD95-EA Uniden Remote mount Radar Detector ... \$128.95
RD55-EA Uniden Visor mount Radar Detector ... \$98.95
RD9-EA Uniden "Passport" size Radar Detector ... \$239.95
BC 210XW-EA Bearcat 20 channel scanner SALE ... \$209.95
BC-WA-EA Bearcat Weather Alert™ ... \$49.95
DX1000-EA Bearcat shortwave receiver SALE ... \$349.95
PC22-EA Uniden remote mount CB transceiver ... \$99.95
PC55-EA Uniden mobile mount CB transceiver ... \$59.95
R1060-EA Regency 10 channel scanner SALE ... \$92.95
MX3000 EA Regency 30 channel scanner ... \$198.95
XL156-EA Regency 10 channel scanner SALE ... \$129.95
UC102-EA Regency VHF 2 ch 1 Watt transceiver ... \$124.95
RH250B EA Regency 10 ch 25 Watt VHF trans ... \$329.95
RH600B EA Regency 10 ch 60 Watt VHF trans ... \$454.95
RU150B EA Regency 10 channel UHF transceiver ... \$449.95
RP410 EA 10 ch handheld no-crystal trans ... \$399.95
LPH10 EA Carrying case for RP410 transceiver ... \$34.95
MA181-EA Ni-cad battery pack for RP410 trans. ... \$34.95
P1405-EA Regency 5 amp regulated power supply ... \$69.95
P1412-EA Regency 12 amp reg. power supply ... \$164.95
BC10-EA Battery charger for Regency RP410 ... \$84.95
MA256-EA Drop-in charger for HX1000 & HX1200 ... \$84.95
MA257-EA Cigarette lighter cord for HX1200 ... \$19.95
MA917-EA Ni-Cad battery pack for HX1200 ... \$34.95
EC10-EA Programming tool for Regency RP410 ... \$24.95
SMRH250-EA Service man. for Regency RH250 ... \$24.95
SMRU150-EA Service man. for Regency RU150 ... \$24.95
SMRPH410-EA Service man. for Regency RP410 ... \$24.95
SMMX7000-EA Svc man. for MX7000 & MX5000 ... \$19.95
SMMX3000-EA Service man. for Regency MX3000 ... \$19.95
B-4-EA 1.2 V AAA Ni-Cad batteries (set of four) ... \$9.95
FB-EA Frequency Directory for Eastern U.S.A ... \$12.95
FB-W-EA Frequency Directory for Western U.S.A ... \$12.95
TSG-EA "Top Secret" Registry of U.S. Govt. Freq ... \$14.95
TIC-EA Techniques for Intercepting Comm ... \$14.95
RRF-EA Railroad frequency directory ... \$10.95
CIE-EA Covert Intelligenc. Elect Eavesdropping ... \$14.95
A60-EA Magnet mount mobile scanner antenna ... \$35.00
A70-EA Base station scanner antenna ... \$35.00
USAMM-EA Mag mount VHF/UHF ant. w/ 12 cable ... \$39.95
USAK-EA 3/4" hole mount VHF/UHF ant w/ 17 cable ... \$35.00
USATLM-EA Trunk lip mount VHF/UHF antenna ... \$35.00
Add \$3.00 shipping for all accessories ordered at the same time
Add \$12.00 shipping per shortwave receiver
Add \$7.00 shipping per scanner and \$3.00 per antenna.

BUY WITH CONFIDENCE

To get the fastest delivery from CE of any scanner, send or phone your order directly to our Scanner Distribution Center™. Michigan residents please add 4% sales tax or supply your tax I.D. number. Written purchase orders are accepted from approved government agencies and most well rated firms at a 10% surcharge for net 10 billing. All sales are subject to availability, acceptance and verification. All sales on accessories are final. Prices, terms and specifications are subject to change without notice. All prices are in U.S. dollars. Out of stock items will be placed on backorder automatically unless CE is instructed differently. A \$5.00 additional handling fee will be charged for all orders with a merchant disc total under \$50.00. Shipments are F.O.B. Ann Arbor, Michigan. No COD's. Most products that we sell have a manufacturer's warranty. Free copies of warranties on these products are available prior to purchase by writing to CE. Non-certified checks require bank clearance.

Mail orders to: Communications Electronics™, Box 1045, Ann Arbor, Michigan 48106 U.S.A. Add \$7.00 per scanner for U.P.S. ground shipping and handling in the continental U.S.A. For Canada, Puerto Rico, Hawaii, Alaska, or APO/FPO delivery, shipping charges are three times continental U.S. rates. If you have a Visa or Master Card, you may call and place a credit card order. Order toll-free in the U.S. Dial 800-USA-SCAN. In Canada, order toll-free by calling 800-221-3475. Telex CE anytime, dial 810-223-2422. If you are outside the U.S. or in Michigan dial 313-973-8888. Order today.

Scanner Distribution Center™ and CE logos are trademarks of Communications Electronics Inc.

† Bearcat is a registered trademark of Uniden Corporation.
‡ Regency is a registered trademark of Regency Electronics Inc. AD #040186-EA

Copyright © 1986 Communications Electronics Inc.

For credit card orders call
1-800-USA-SCAN

**COMMUNICATIONS
ELECTRONICS INC.**

Consumer Products Division
P.O. Box 1045 □ Ann Arbor, Michigan 48106-1045 U.S.A.
Call 800-USA-SCAN or outside U.S.A. 313-973-8888

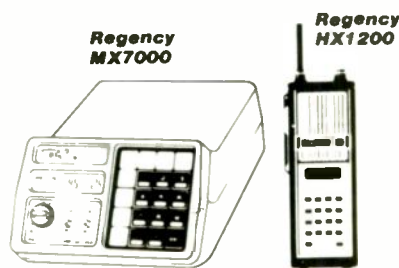

CIRCLE 79 ON FREE INFORMATION CARD

WHAT'S NEWS

Science-research budgets holding up under cuts

Federal budgets for science and research are not fairing too badly, in spite of budget cutting for many services due to Gramm-Rudman and other factors, reports the Institute of Electrical and Electronics Engineers (IEEE).

Under the fiscal 1987 budget requests, says Dr. John McTague, acting science advisor to the President, the number of Department-of-Defense-sponsored engineer-

ing-research centers would increase from 23 to 35, and it is possible that the Departments of Agriculture and Energy may sponsor such centers in the future. The science and technology budgets of the Department of Defense also showed growth in 1986 over the previous fiscal year.

The National Science Foundation expects a nine percent budget increase in fiscal 1987—about \$184 million. The National Aeronautics and Space Administration (NASA)

is requesting 7.8 billion in fiscal 1987, roughly the same as in 1986. Only the Department of Energy's R&D activity would decrease in fiscal 1987, dropping from \$4.87 billion to \$4.5 billion.

Electronics technicians honored by Reagan

Electronics technicians were honored nationally on March 4, 1986 with the inauguration of the first National Electronics Technicians Day. That special day recognized both the twentieth year of the certification program that is sponsored by the International Society of Certified Electronics Technicians and the certification of the 20,000th electronics technician.

In his proclamation announcing National Electronics Technicians Day, President Ronald Reagan saluted the high standards of performance and excellence maintained by professional technicians and by ISCET in its 20 years of distinguished service to the electronics industry. He paid tribute to the vital part that electronics technicians play in helping to ensure our country's continued technological and economic leadership as a formidable international competitor. In extending his warm personal congratulations to technicians who have met the demanding criteria for certification, President Reagan recognized the individual skills, talent, and expertise that make electronics technicians one of our country's most important technological resources.

To make National Electronics Technicians Day an official commemorative holiday, persons involved in the electronics industry are asked to contact their senators and congressmen to request their support for House Joint Resolution 507 (HJRes507).

R-E

Magnetic-resonance imaging solves mysteries of growth

Scientists of the General Electric Co. and the U.S. Department of Agriculture have adapted the recently-discovered technology of magnetic-resonance imaging to help unravel the mysteries of plant growth.

In magnetic-resonance imaging, the object being studied is positioned in an extremely strong magnetic field and probed with high-frequency radio signals from a special type of antenna. Under the field's influence, those signals can excite atoms of selected substances in the object. Radiation from those atoms is picked up by another antenna and sent to a special-purpose computer that constructs a "map" showing the location and concentration of the excited atoms.

The scanner used for the plant studies uses a large, doughnut-shaped superconducting magnet capable of producing a field of 1.5 tesla—30,000 times the strength of the earth's field—within its 1-meter bore.

In this first application of magnetic-resonance imaging of intact root systems, the researchers used hydrogen imaging (looked at hy-

drogen atoms in the root system) to study water transport, root pathology, seed growth, and other factors.

Since magnetic-resonance imaging has no known effect on plants it can be used repeatedly to monitor plant development. It also opens the door to more accurate studies of plant responses to light, carbon-dioxide levels, and nutrients.

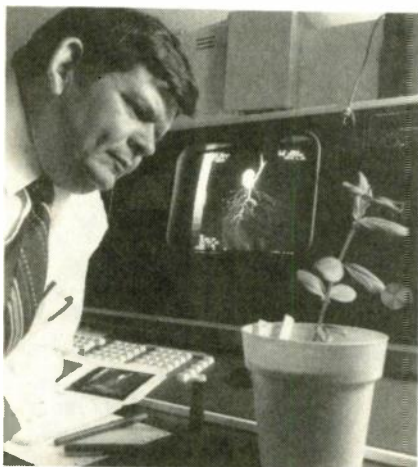

MAGNETIC-RESONANCE IMAGING, AN ADVANCED MEDICAL TECHNOLOGY, is being used by scientists of the General Electric company and the U.S. Department of Agriculture to unravel the mysteries of plant growth.



ELECTRONICS, INC.

New and Used Electronic Test Equipment
Sales • Service • Rental • Leasing

HITACHI 3.5 Digit DMM *Free* With Scope Purchase



FEATURES:

- AC DC voltage
- AC DC current
- Resistance
- Diode test
- Audible Continuity check
- Temperature (Type K, 3510 & 3525)
- Data hold
- Manual or autoranging
- Overload protection
- LCD display
- Built-in stand
- Battery included
- Test leads included

Special!

MODEL	BASIC DC VOLTAGE ACCURACY	QTY 1 PRICE	QTY 3+ PRICE	One With Any Scope Purchased From RAG
3550	±.5% ±2 digits	\$49.00	\$42.00	FREE
3525	±.25% ±2 digits	\$64.00	\$54.00	\$19.95
3510	±.1% ±2 digits	\$79.00	\$67.00	\$29.95

2 year warranty plus carrying case included!

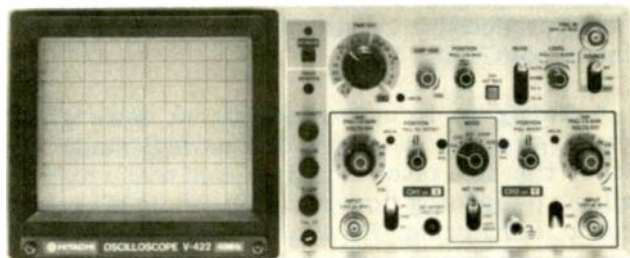

Model V-422 shown

MODEL V-222 \$536.00
DC to 20 MHz, 1 mV/div, Dual Trace, D.C. offset for DMM Output, Vertical Mode Trigger, 6" CRT (w/two X1/X10 probes).

MODEL V-422 \$694.00
DC to 40 MHz, other features same as V-222 (w/two X1/X10 probe).

MODEL V-1050F \$1,276.00
DC to 100 MHz, 5 mV/div, Quad Trace, Delayed Sweep, Full T.V. Triggering, alternate time base (w/two X1/X10 probes).

MODEL V-212 \$461.00
DC to 20 MHz, 1 mV/div, Dual Trace, Features 6" Rectangular CRT (w/two X10 probes).

MODEL V-650 \$956.00
DC to 60 MHz, 1 mV/div, Triple Trace, Delayed Sweep, Full T.V. Triggering, variable trigger hold-off (w/two X1/X10 probes).

NEW! 3 year warranty parts and labor on above scopes!
RAG Electronics is a factory authorized Hitachi repair center.

CIRCLE 126 ON FREE INFORMATION CARD

CALL US TOLL FREE
1-800-732-3457
IN CALIFORNIA TOLL FREE
1-800-272-4225

- Master Charge
- VISA ■ COD
- Money Order
- Check



ADD FOR SHIPPING AND INSURANCE

\$0 to \$250.00	\$4.50
\$251.00 to \$600.00	\$6.50
\$501.00 to \$750.00	\$8.50
\$751.00 to \$1000.00	\$12.50
over \$1000.00	\$15.00

Prices subject to change without notice.

RAG ELECTRONICS, INC. / 21418 Parthenia Street / Canoga Park, CA 91304 / 1-818-998-6500

VIDEO NEWS



DAVID LACHENBRUCH
CONTRIBUTING EDITOR

● **What kind of stereo?** Although broadcast stereo-sound TV is relatively new, the transmission of stereo audio with the video has long been an accepted practice—for example, in PBS simulcasts and on cable, with such services as MTV. Many cable-TV systems provide an FM-stereo service to their subscribers at a small additional monthly charge that includes FM channels in stereo plus stereo sound for such special cable channels as MTV, as well as special closed-circuit audio-only channels in some cases. With the advent of broadcast multichannel-TV-sound (MTS), cable systems have a new option—and new problems. Most cable systems are capable of passing along to their subscribers TV programs that are broadcast in the new stereo-sound system. The question now is whether they should also continue carrying the sound of such satellite-delivered cable programs as MTV and HBO as extra-cost FM channels or to use the standard MTS transmission systems; equipment is now available to let cable systems convert the sound of such programs to MTS.

When a consumer buys a stereo-TV set, he expects to be able to receive all stereo programs on it; in the case of simulcast programs on the FM band, for which cable systems usually add an extra charge, it creates ill will among cable subscribers when they buy “stereo-TV” receivers and can’t receive cable stereo on them. As a result, HBO is currently urging its affiliated cable systems to add the standard MTS system, and to continue simulcasting as well, in order to gather the largest possible stereo audience. But MTV says it is making no recommendations and letting its affiliates use any stereo system they wish. Meanwhile, a new “super-stereo” system is being offered to cable companies. Called *Stereo-Track II*, the system is claimed to provide “digital quality sound,” with 88–90-dB signal-to-noise ratios and 90-dB stereo separation. The audio is carried as two discrete tracks above and below the standard FM band, and the cable system provides special receiving equipment to its subscribers choosing to pay extra for the stereo-audio service.

● **Disc-continued.** The CED videodisc has reached the end of the road. RCA announced it is ending production of CED discs at its Indianapolis plant June 27 because of declining demand. The company announced the end of disc-player production in April 1984 and at that time said it would continue output of the discs for three years or as long as there was “reasonable demand.” However, RCA now says the market for the discs has collapsed, with sales this year about five percent of the 1984 rate. CBS, the only other manufacturer of CED discs, ended production in the summer of 1984. RCA introduced the videodisc player in March 1981. RCA is being sold to General Electric, which once backed the competing VHD videodisc system developed by JVC. Disc players using that system are currently being produced in Japan, but have never been introduced in the U.S.

● **Going up.** In most products, it's news when prices go down. In electronics, news is made when there's a price increase—and that's just what's happening now. A steady string of price reductions in color TV, almost since their introduction in the 1950's, has come to an end. And the even more dramatic decline in VCR prices is being reversed. Price increases so far have been relatively minor. Actually, color-TV prices have not so much risen as bottomed out. VCR prices, however, are up from the rock bottoms they reached late in 1985, with retail prices some \$10 to \$20 higher than at that point. The rise in VCR prices is due almost entirely to the increase in the value of the Japanese yen against the American dollar—by more than 25 percent since last September—which has caused price hikes in most Japanese products here. The yen/dollar relationship also has contributed to the rise in the cost of television sets made in Japan or using Japanese components. Another factor in the leveling-off of the downward TV price-spiral is the fact that most television manufacturers have been operating at a loss or sharply curtailed profits as a result of climbing costs in a hotly competitive market.

R-E

CALL TOLL FREE

CALIFORNIA 800-772-1519
OTHER STATES 800-854-1519

IN SAN DIEGO CALL
619-560-9676

FREE CATALOG!

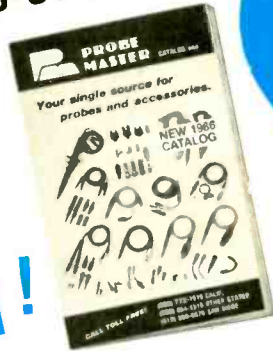

PROBE MASTER

YOUR SINGLE SOURCE FOR PROBES AND ACCESSORIES

**HIGH PERFORMANCE
MINIATURE SCOPE PROBES
60 MHz TO 250 MHz**

ACTUAL SIZE

REPLACEMENT PROBES & TEST LEADS FOR FLUKE, TEKTRONIX, H.P. & OTHERS

\$30 TO \$55

OTHER PRODUCTS

- TEST LEADS
- TERMINATIONS
- ATTENUATORS
- BNC CABLES
- BNC ADAPTERS
- RUGGED AND RELIABLE
- REPLACEABLE TIP & GROUND LEAD
- ADJUSTABLE LF & HF RESPONSE
- COMPENSATION FOR MOST SCOPES

The Probe Master 2900 series oscilloscope probes combine the characteristics of high performance, and fast rise time pulse response, with a slender design to meet the needs of today's micro electronics. The miniature tip is ideal for accessing high density boards and hard to reach test points. By locating the high and low frequency compensation circuits in the BNC end of the cable, the design of the probe has become light weight and slender for easy handling.

Other features of the 2900 series probes include a replaceable probe tip, replaceable ground lead and a Readout Actuator option (RA).

The Readout Actuator option (permanently attached) is available on the 10x fixed attenuation probes only. This option provides the necessary resistor circuit to change the range factor on the model 465, 475, 485 and 7000 series Tektronix scopes.

The Standard Accessories included with each probe are the sprung hook, trimmer tool, BNC adapter, tip insulator, IC tip cover, spare probe tip, 6" ground lead, and a handy storage pouch. The Engineers Accessory Kit (\$12.00 option) includes a wire wrap adapter tip, wire wrap adapter ground lead, alligator tip, micro sprung hook, and a 12" ground lead.

**IMMEDIATE DELIVERY
CALL FOR NEAREST DISTRIBUTOR**

READOUT ACTUATOR (RA) OPTION



SWITCHES READOUT ON TEKTRONIX 465, 475, 485 & 7000 SERIES SCOPES. (FOR 10x probes only.)



STANDARD BNC

REPLACEABLE TIP

CHARACTERISTICS

MODEL	ATTENUATION	CABLE TERMINATION	BANDWIDTH (MHz)	RISE TIME (ns)	LOADING CAP. (PF)	*RES. (M-OHM)	DC MAX	PRICE	
FIXED ATTENUATION									
2903	1X	STD	25	11	40	1	600V	\$25.00	
2960	10X	STD	60	5.8	16	10	500V	\$30.00	
2960 RA	10X	RA	60	5.8	16	10	500V	\$40.00	
2904	10X	STD	100	3.5	17	10	600V	\$35.00	
2904 RA	10X	RA	100	3.5	17	10	600V	\$45.00	
2905	10X	STD	250	1.5	17	10	600V	\$45.00	
2905 RA	10X	RA	250	1.5	17	10	600V	\$55.00	
2906	100X	STD	70	5.0	6	100	1.2KV	\$55.00	
SWITCHED									
2901	10X, 1X, GND	STD	10X/1X 100/5	3.5-70	17/100	10/1	600V	\$39.00	
2902	10X, 1X, GND	STD	250/5	1.5-70	17/100	10/1	600V	\$49.00	
1064	Engineers Accessory Kit								\$12.00

* RA = Readout Actuator, STD = Standard BNC • Cable length 5 1/2 ft.
• On switched probes, probe tip is grounded thru a 9 Meg OHM resistor, when switch is in the GND position • 10X compensation range, 15 to 50 PF



PROBE MASTER 4898 RONSON CT.
SAN DIEGO, CA 92111

ASK R-E

WRITE TO:

ASK R-E
Radio-Electronics
500-B Bi-County Blvd.
Farmingdale, NY 11735

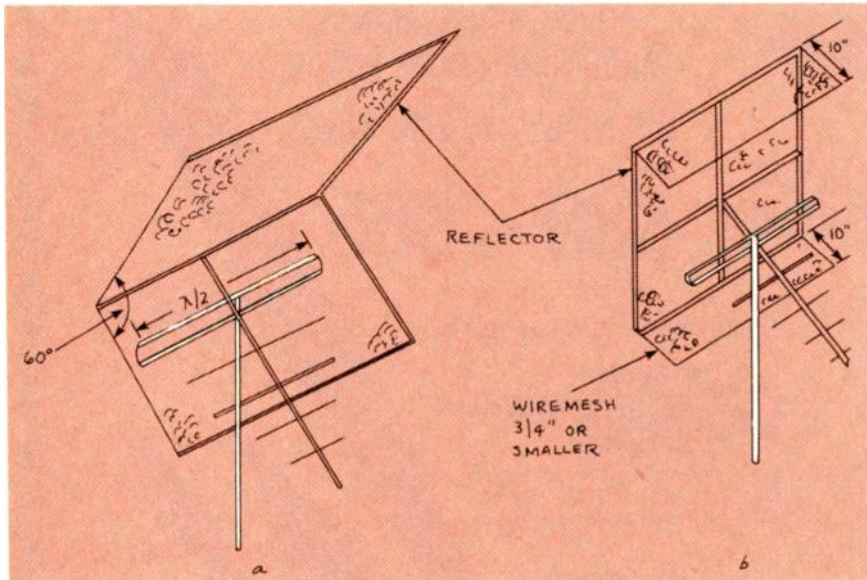

FIG. 1

POWER-LINE TV INTERFERENCE

My TV reception is being ruined by high voltage power transmission lines that run behind my apartment. My antenna is about eight to ten feet below, and 75 feet away from, those power lines. The interference is in the form of horizontal streaks and noise on channel 3, snow on channel 11, ghosts on channel 23, and extreme snow on channels 32 and 41. Sound is clear on all channels except 3. I've tried "ghost eliminators" and AC in-line filters without success. What can I do?—S. G., Elizabethtown, KY.

We're not sure that all of your problems, (ghosts, snow and noise) are caused by the power lines. We assume that all the stations you want to view are in the same general direction and that the power lines are *not* between the antenna and the desired signals. The snow indicates that your antenna is not pointed directly at the station, or that the station is

located far away. The snow can probably be cleared up by installing an antenna rotator for accurate antenna orientation, and by installing a good all-channel booster for a boost in received signal strength.

In Fig. 1 are shown two ways we have found of reducing or eliminating power-line interference. In both cases, we use a high-gain antenna, but we replaced the single-element reflector with one that screens interference from behind and from above. In each case, the screen is as wide as the original reflector, and it extends approximately $\frac{1}{4}$ wavelength above and below the plane of the antenna.

We built ours from hard-drawn $\frac{1}{4}$ -inch copper tubing used as the frame for the corner-reflector. We covered it with copper screen wire and soldered the mesh all around. The billboard-reflector was framed with $\frac{1}{4}$ -inch bamboo salvaged from inexpensive fishing poles

and covered with hardware cloth. The mesh should be three-quarter inch or smaller.

We found that the ratio of received signal to interference varied with antenna height. In fact, raising or lowering the antenna as little as three feet made an appreciable difference in the signal-to-interference ratio.

AIRCRAFT RADIO ON THE FM BAND

I live near a very active airport. FM reception is frequently marred by chatter from pilots in planes leaving or approaching the airport. Who should I complain to—the local airport authorities or the FCC?—H. McD., New Smyrna Beach, FL.

Neither; your complaint is invalid. The interference you are experiencing is due to an FM receiver with insufficient selectivity. Common FM receivers, which cover the 88- to 108-MHz band, have IF's of 10.7 MHz, so their local oscillators operate 10.7 MHz above the desired signal. To cover the broadcast band, that oscillator runs from 98.7 to 118.7 MHz. As you know, the 88- to 108-MHz band is assigned exclusively to FM broadcast stations, but, as you may not know, the 108- to 135-MHz band is allocated to aeronautical mobile services, including air traffic control.

So, if you are listening to an FM station on 100 MHz, the local oscillator is actually tuned to 110.7 MHz. Now suppose that a nearby plane is transmitting on 121.4 MHz. That signal is 10.7 MHz higher than the local oscillator signal, so it will also develop a 10.7-MHz IF signal. The signals developed by the FM broadcast station and the aircraft radio will both be amplified by the

**FORDHAM WILL BEAT
ANY ADVERTISED**

**B&K
LEADER
HITACHI
AW SPERRY
NON-LINEAR
BBC**

OSCILLOSCOPE PRICE

by \$**25**⁰⁰

No ifs, ands or buts.

Copyright © Fordham 1985

Must be a currently advertised price.
This offer may be withdrawn at any time without prior notice.

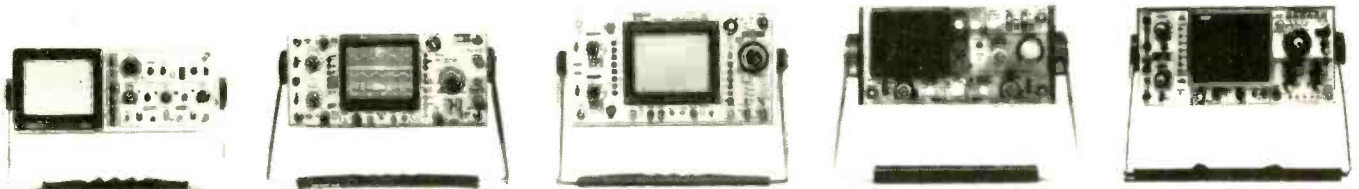

ASK FOR FREE CATALOG.
Money orders, checks accepted. C.O.D.'s require 25% deposit.



Fordham Toll Free
800-645-9518

260 Motor Parkway, Hauppauge, NY 11788

In NY State 800-832-1446

**Service & Shipping Charge Schedule
Continental U.S.A.**

FOR ORDERS	ADD
\$25-\$100	\$4.50
\$101-\$250	\$6.00
\$251-\$500	\$8.00
\$501-\$750	\$10.50
\$751-\$1,000	\$12.50
\$1,001-\$1,500	\$16.50
\$1,501-\$2,000	\$20.00
\$2,001 and Up	\$25.00



MEGURO
MADE IN JAPAN

3 1/2-DIGIT AUTORANGING MULTIMETERS

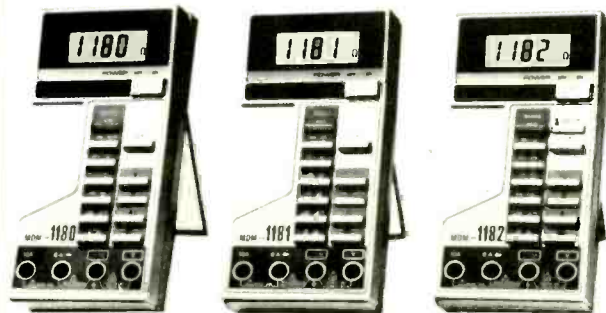

MDM-1180

~~\$45.04~~
\$39.95

MDM-1181

~~\$69.45~~
\$65.95

MDM-1182

~~\$66.55~~
\$53.95

FEATURES:

- Automatic and Manual Ranging Selectable (except current measure.)
- Large and High Contrast LCD
- Custom and Power Saving ICs:
500 hours on just two AA-Batteries
- Accuracy (DC Volt): MDM-1181 0.1%,
MDM-1182 0.25%, MDM-1180 0.7%
- Data Hold Function (MDM-1182 only)
- 9 Measurement Functions
- 2 AA-size Batteries, Safety
Measurement Leads and Fuse Included
- ONE YEAR WARRANTY
- QUANTITY LIMITED

■ PLEASE ADD FOR SHIPPING AND INSURANCE

• MULTIMETER:

\$39.00-\$250.00: \$4.50/\$251.00-\$600.00: \$6.50
\$601.00-\$750.00: \$8.50/\$751.00-\$1,000.00: \$12.50
\$1,000.00 and more: \$15.00

■ WE ACCEPT ONLY MONEY ORDERS OR CHECKS TO SAVE YOUR COST.

■ PLEASE ADD 6.5% FOR TAX (CA ONLY)

HI-SHURE CORP.
TOLL FREE 1-800-222-7798
1050 E. DOMINGUEZ ST.
CARSON, CA 90746
(213) 637-1863

RE 5

IF amp and converted into interfering audio signals.

That type of interference is called "image" interference. It develops any time a receiver picks up a signal whose frequency is twice the frequency of the IF above the frequency of the desired station. To eliminate it you must increase the selectivity of your receiver by installing additional stages of pre-selection or image traps that discriminate against the unwanted signal.

AUDIO DISTORTION FILTER

I am in the process of designing a 10-watt power booster and distortion filter for my portable stereo system. I have the booster amplifier all laid out, but I don't know how to get rid of the distortion. At full output the portable has 10% total harmonic distortion, and that is quite high. Can you tell me how to reduce that interference to a tolerable level?—D. P., Los Altos, CA.

I don't know anything about your portable stereo, but I'll bet that the distortion you find objectionable is caused by overloading its small speakers. Unless you have "golden ears," 10% THD is not so bad when heard through good hi-fi speakers that are not being overdriven.

Be sure that you design your booster amplifier so that it can be driven to the desired output level by the portable stereo when it is just "loading along." Then the set-up should sound fine as long as you don't try to get every last watt out of the booster amp.

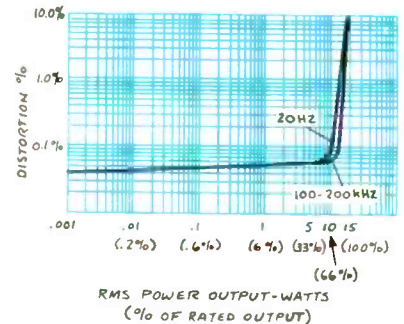

FIG. 2

Distortion curves for a typical 15-watt amplifier are shown in Fig. 2; as you can see, distortion increases drastically when you drive such an amplifier beyond about 66% of its rated output—in this case, about 10 watts. R-E

PERFORMANCE

THAT IS OUT OF THIS WORLD...



\$389⁰⁰

**MODEL 2000 20MHz
DUAL TRACE**

\$549⁰⁰

**MODEL 3500 35MHz
DUAL TRACE DELAYED SWEEP**

...AT A DOWN TO EARTH PRICE

At last! Truly affordable test equipment with no compromise in design, and features you would expect to find only on oscilloscopes costing hundreds of dollars more! JDR Instruments presents two, new, high-performance models backed by a two year warranty and technical support which is only a phone call away. Perfect for the technician or advanced hobbyist, both models feature Dual Trace capability and a variety of operating and triggering modes, including CH-B Subtract and X-Y operation.

MODEL 2000 has a 20 MHz bandwidth and 20 calibrated sweeps ranging from .2s to .2 μ s. A convenient built-in component tester provides additional diagnostic power.



INCLUDES TWO HIGH QUAL TY
1x, 10x TEST PROBES

CIRCLE 59 ON FREE INFORMATION CARD

MODEL 3500 features a 35 MHz bandwidth and exceptional 1mV/DIV sensitivity. Delayed sweep and variable holdoff allow stable viewing of complex waveforms.

ORDER TOLL FREE
800-538-5000
800-662-6279 (CA)

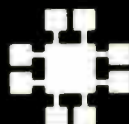

JDR INSTRUMENTS
1224 South Bascom Avenue
San Jose, California 95128 (408) 995-5430

Learn micro-processing with the new
MICRO-PROFESSOR 1P

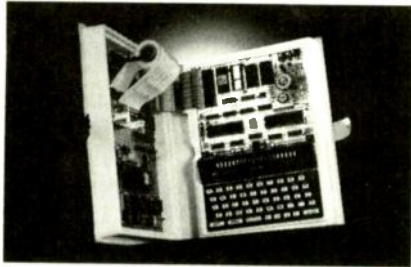

Students, engineers or technicians—
upgrade your micro-processing skills
with the new Micro-Professor 1P.

The MPF-1P features:

- extensive software support
- more built-in memory
- improved keyboard
- larger display

Three tutorial guides help cover all capabilities. The ideal training tool! MPF-1P will deliver you into the growing world of micro-processing. Invest now!

Plus—FREE GIFT Only **\$199.95**

Check this box for FREE Z-80 Microprocessor Programming and Interfacing textbook when you order within 7 days. \$12.95 value. (Include \$5.00 postage & handling)



Dept RE0786
5326 9th Ave. N.E.
Seattle, WA 98105-3617

For immediate action call TOLL FREE:

1-800-426-1044

Full money back guarantee.



CIRCLE 111 ON FREE INFORMATION CARD

LEARN TV/VCR REPAIR



No Previous Experience Necessary

Now you can train at home in spare time for a money-making career as a TV/VCR Repair Specialist. No need to quit your job or school. We show you how to troubleshoot and repair videocassette recorders and TV sets, how to handle house calls and shop repairs for almost any make of television or VCR. You learn about TV receivers, tuners and antennas, x-ray emission, the characteristics of sound, how electrical impulses are converted into a TV picture, and much, much more. Tools are included with your course so you can get "hands-on" practice as you follow the lessons step by step. Send for free facts about opportunities in TV/VCR Repair and find out how you can start making money in this great career.

Experts show you what to do, how to do it...guide you every step of the way!

Everything is explained in easy-to-understand language with plenty of drawings, photos and diagrams. But if there is ever anything in your lessons you don't understand, you can write or phone your instructor and you can count on getting an authoritative answer. Send for free facts and color brochure. No cost. No obligation. No salesman will visit you. MAIL COUPON TODAY!

SCHOOL OF TV VCR REPAIR, Dept. DE066
Scranton, Pennsylvania 18515

Please send me free facts on how I can learn TV/VCR Repair at home in my spare time. No salesman will visit.

Name _____ Age _____

Address _____

City/State/Zip _____

Phone () _____

EDITORIAL

Guest Editorial— Scrambling: Another View.

Satellite television is a vital, billion-dollar industry, and one that is growing. Ill-conceived quips that dishes "are good only for scrambling eggs" reflect a total ignorance of reality—satellite technology is now the prime delivery system for TV signals.

Industry leaders, including satellite-dish-system manufacturers and cable-TV programmers and operators, must share the blame for consumer confusion about satellite-signal scrambling. Rather than treating each other with disdain and mistrust, home satellite-TV-system manufacturers and dealers, and cable-TV operators, should cooperate to provide consumers with the free choice in programming that they desire. Instead, many in both camps are in fantasy land, trying to wish each other out of existence.

The lack of hard information that has resulted from that has left the typical consumer totally baffled. To many, the clear and important distinction between legal home satellite-TV and illegal signal piracy has become blurred. Protecting their own special interests, some, knowing better, have told satellite-system buyers that there would be little scrambling. For the same reasons, others, knowing better, have claimed that with scrambling the sky will go dark. Shallow news reports in the media, often based on half-truths or presented by those not truly familiar with satellite and cable TV, have only compounded the confusion, endangering the livelihood of those who have put their faith in exciting new technologies.

Cable-TV programmers and operators, and satellite-dish and -receiver manufacturers are all part of one industry. It is called television: an educational, entertainment, and data-transfer medium that depends on satellite technology—whether signals eventually get to the home by dish, cable, or some other means. Encoding has and will not do anything to substantially change that. It is merely a means to ensure that all party's (programmers, cable operators, home-satellite-TV-system manufacturers and dealers, and home viewers) interests are protected.

Satellite TV, with signal encoding and all of the possibilities that that entails (direct pay-per-view, for instance), offers the greatest numbers of viewers the widest choice of programming options. For millions, it is the only alternative for those wishing to take advantage of what television has to offer.

Hans Giner
President
Luxor North America Corp.

For the Field Service Professional Who Doesn't Have Everything... Rackable, Stackable and Portable Instruments From



Bench Portable



Model 202
200 KHz
Function

Model 203
2 MHz
Function

Model 204
5 MHz Pulse

Generators

These extremely compact, space saving generators do not sacrifice performance for size. The models are easily operated and have outstanding specs at unbelievably low prices.

Micro/Miniature



Model 1010
10 MHz

Oscilloscope

Designed and built for field service, this micro/miniature scope weighs only 2lbs. Made for your tool kit, it's the lightest most compact, most complete scope you'll ever buy.

Compact and Complete



Model 2324-R

Oscilloscope

Function
Generator

Multi Frequency
Counter

3 1/2 Digit DMM

The Bench Rack

When your bench is crammed for space and you are short on budget there is a superior alternative: Model 2324-R Bench Rack System. The Test Solution.

Accurate and Affordable



Model 510
200 MHz Multi Function

Model 511
600 MHz

Model 512
200 MHz

Counters

Whether you need 8 digit accuracy on the bench or in the palm of your hand precision and reliability does not cost a fortune.

For more information about O.K. Electronics Division's full range of Test Instruments contact:
 \$20 Minimum Order - U.S. Funds Only California Residents: Add 6% or 6 1/2% Sales Tax Spec. Sheets - 30¢ each
 Shipping: Add 5% plus \$1.50 Insurance Prices Subject to Change

Send stamped,
self-addressed envelope
to receive a Quarterly
Sales Flyer - FREE!
7/86



Send \$1.00 Postage for a
FREE
1986 JAMECO
CATALOG

1355 SHOREWAY ROAD, BELMONT, CA 94002 • PHONE ORDERS WELCOME 415-592-8097 Telex: 176043
CIRCLE 199 ON FREE INFORMATION CARD

LETTERS



MODEL AIRCRAFT FREQUENCIES

I noted your response to B. G. of Evergreen Park, IL in the "Ask-RE" department, **Radio-Electronics**, April 1986, page 14. I wonder if he gave you enough information. Would your answer have been the same if you had known that the channel separation is 40 kHz? Channel 42 is 40 kHz below and channel 46 is 40 kHz above his frequency. In 1991, the odd-numbered channels will come into use and separation will decrease to 20 kHz. Those model-aircraft frequencies are in the 72-MHz re-

gion, along with many commercial services.

One solution to his problem is to use a down-converter working through an automobile radio to get selectivity. I designed one, added an RF preamp, and got a 0.25-microvolt receiver that tunes the band—not really a simple project, but not too complex.

I have two suggestions for B. G. He could replace the motor in a servo with a small speaker, and with his receiver on and his transmitter off, he would hear if there were another transmitter on his

frequency. Second, he should inquire at his hobby shop about local clubs affiliated with the Academy of Model Aeronautics, 1810 Samuel Morse Drive, Reston, VA 22090. Or he could write directly to them for information. Safety procedures used by those clubs are designed to avoid simultaneous channel usage.

Here are a few suggestions for **Radio-Electronics**. I think it is time that you did a comprehensive article on radio-controlled model aircraft. The impact of solid-state
continued on page 20

So You've wiggled into an impossible position and found the problem! BUT YOUR TOOLS ARE BACK ON THE BENCH!



CHAPMAN TOOLS ARE MADE FOR THE TIGHT SPOTS

Complete pocket sized kits contain 17 different bits (Slotted, Hex or Phillips) plus Screw Driver Handle with Extension and the "World's Mightiest" Midget Ratchet (torque strength 200 in lbs.). Fix it on the spot with Chapman.
No. 6320 KIT

Only **\$22.94**
(Include \$2.00 for Handling)
Send Check or M.O.

MasterCard & Visa accepted
Write for industrial brochure



THE CHAPMAN MANUFACTURING CO.
P.O. Box 250, Rt. 17, Dept. RE-7
Durham, Connecticut 06422 (203) 349-9228

CIRCLE 179 ON FREE INFORMATION CARD

NOISE REDUCTION FOR UNDER \$10.

MIXING CONSOLES
SWITCHES
MICROPHONE CONNECTORS
SNAKE CABLES
BATTERY CONTACTS
ALL PLUGS & JACKS (XLR, PHONE, PHONO, DIN, MIDI, ETC.)
PATCHBAYS
FADERS, POTS
TERMINAL STRIPS
SPEAKER TERMINALS



CRAMOLIN®

Even the finest equipment in the world cannot guarantee noise-free operation. One "dirty" connection anywhere in the electrical path can cause unwanted noise or signal loss.

"MORE THAN A CONTACT CLEANER"

CRAMOLIN® is a fast-acting, anti-oxidizing lubricant that cleans and preserves all metal surfaces, including gold.

When applied to metal contacts and connectors, **CRAMOLIN®** removes resistive oxides as it forms a protective molecular layer that adheres to the metal surfaces and maintains maximum electrical conductivity.

CRAMOLIN® - USED BY THOSE WHO DEMAND THE BEST:

Bell & Howell	Hewlett Packard	MC(Sony)	Nakamichi
Capitol Records	John Fluke Mfg.	Motorola	RCA
Dolby Laboratories	McIntosh Labs	NASA	Switchcraft

SINCE 1956

CAIG LABORATORIES INC.

1175-O Industrial Ave., (P.O. Box J) - Escondido, CA 92025-0051 U.S.A. • (619) 743-7143

CIRCLE 183 ON FREE INFORMATION CARD

the fourth law of robotics

A robot shall make learning fun for man and thereby improve the quality of life for mankind.



A robot is a robot is a robot... was a robot. Until HERO 2000.

HERO 2000 is much more than a robot. It's a walking, talking 16-bit computer. With 64K ROM and 24K RAM expandable to more than half a megabyte. And a fully articulated arm with five axes of motion. Yours to program. Command. Modify and expand. Total system access and solderless experimenter boards provide almost limitless possibilities. Its remote RF console with ASCII keyboard gives total control. Available with three self-study courses. Backed by Heath Company, world leader in electronic kits.

Build your own HERO 2000. Or buy it assembled. Have fun learning skills that translate directly to the world of work.



HERO[®] 2000

the
knowledge
builder

FREE. Send today for latest Heathkit Catalog.



Mail coupon today to receive a **FREE** Heathkit Catalog featuring HERO 2000.

Mail to: Heath Company
Dept. 020-438
Benton Harbor, Michigan 49022

Name _____

Address _____

City _____ State _____

Zip _____

RO-141D

Heathkit[®]
Heath
Company

A subsidiary of Zenith Electronics Corporation.

CIRCLE 86 ON FREE INFORMATION CARD

NEW!

Satellite Communications Training from NRI!



Move into commercial satellite communications and home satellite TV with NRI's latest training breakthrough!

Explore Every Aspect of Satellite Transmission and Reception As You Assemble, Install, and Train With the Complete TVRO System Included in Your Course

Back in 1964, great excitement surrounded the launching of Syncom 2, the true forerunner of today's satellites. But not even the most hopeful of scientists believed that in less than 25 years, communications satellites would have such a tremendous impact on the professional and personal lives of millions of people around the globe.

Today, thanks to the rapid development of satellite technology, a call to Paris is as clear and as easy to make as a call to your next door neighbor . . . executives from multi-national corporations and even small businesses use video conferencing to "meet" without leaving their offices . . . simultaneously a billion people witness a single event (a soccer game, an inauguration, a benefit rock concert) . . . global weather maps transmitted from satellites allow meteorologists to forecast weather trends weeks

in advance . . . and scientists now explore and investigate the mysteries of outer space without leaving their labs.

And, not surprisingly, these amazing applications of satellite technology have opened up exciting new opportunities for the technician trained to install, maintain, troubleshoot and repair satellite communications equipment.

Home Satellite TV Is Just at the Start of Its Explosive Future

You've seen them in suburban backyards and alongside country farmhouses. Home satellite TV systems are springing up all across the country.

Already there are over a million TVRO (Television Receive-Only) systems in place in the U.S. alone, and experts predict that by 1990, a remarkable 60% of U.S. homes will have a satellite dish. Contributing to the field's phenomenal growth are the support of the FCC and Congress, steady improvement in product quality, the development of smaller dishes, and a growing consumer enthusiasm for satellite TV.

New Jobs, New Careers for the Trained Technician

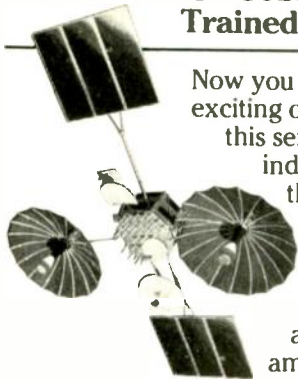

Now you can take advantage of the exciting opportunities opening up in this service- and support-intensive industry. NRI's new breakthrough training prepares you to fill the increasing need for technicians to install, adjust, and repair earth station equipment, such as dishes, antennas, receivers, and amplifiers.

As an NRI-trained technician, you can concentrate your efforts on consumer-oriented TVRO equipment. Or you can use your NRI training to build a career servicing larger commercial or military equipment used both to transmit and receive voice, data, and video signals. You'll also find opportunities in sales and system consulting, a role some expect to increase tenfold within the next five years on both the corporate and consumer levels.

NRI Brings Satellite Technology Down to Earth

Only NRI has the resources and the skills necessary to transform today's most sophisticated technology into understandable, step-by-step training.

NRI's new course in Satellite Communications gets you in on the ground floor of this booming technology. You are thoroughly trained in the necessary basic electronics, fundamental communications principles, and television transmission and operation.

Using the remarkable NRI Discovery Lab®, you demonstrate first-hand many important points covered in your lessons. You perform critical tests and measurements with your digital multimeter. And, using your NRI Antenna Applications and Design Lab, you assemble and test various types of antennas and matching sections.

Then you concentrate on both commercial and consumer satellite earth station equipment, putting theory to practice as you assemble and install the 5' parabolic dish antenna system included in your course.

Your Home Satellite TV System Brings Theory to Life!

The Wilson TVRO system included in your course comes complete with 5' parabolic dish antenna system, low-noise amplifier (LNA), down converter, receiver, low-loss coaxial cable, and even a permanent polar mount.

By training with an actual TVRO system, you'll come to understand the function and operation of a satellite earth station—knowledge that you can apply to both consumer and commercial equipment. And once you have completed your TVRO system, you'll have access to the best television entertainment available—direct from the satellite to your home.

At-Home Training the Uniquely Successful NRI Way

It's hands-on training, at home... designed around the latest state-of-the-art electronic equipment you work with as part of your training. You start from scratch and "discover by doing" all the way up to the level of a fully qualified professional. You conduct key experiments... perform vital tests... install your own system... and you do it at the pace that suits you best.

But, most important to your success, you don't do it alone. Built into your NRI training is the enormous experience of our development specialists and instructors, whose long-proven training skills and personal guidance come to you on a one-to-one basis. They are always available for consultation and help.

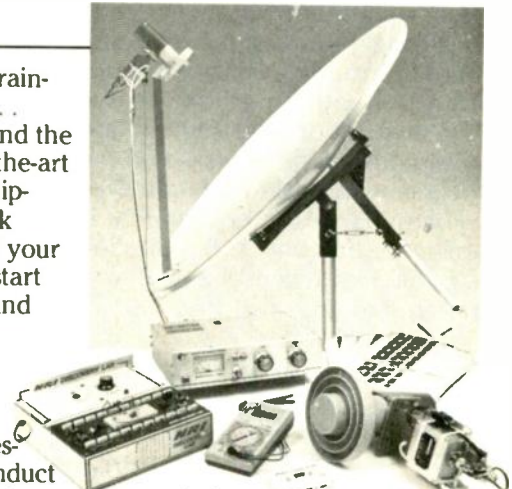

Make Your Move Into the Future Today! Send for Your FREE NRI Catalog

Only NRI can train you at home for an exciting and rewarding career as a satellite communications technician. The knowledge and know-how you gain from your NRI training provide you with the soundest possible foundation for further growth with the industry. But now is the time to act. Return the post-paid card to us today. You will receive your 100-page catalog free. It's filled with all the details you'll want to know about our training methods and materials and our more than 70 years of successful

innovation in at-home, hands-on career training—the kind of experience that enables NRI to provide the most effective training possible to prepare you for today's, and tomorrow's, high-tech opportunities. (If the card is missing, write to us at the address below.)

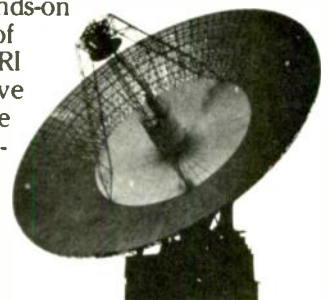

NRI SCHOOL OF ELECTRONICS

McGraw-Hill Continuing Education Center
3939 Wisconsin Avenue, NW
Washington, DC 20016

We'll give you tomorrow.



technology on the hobby has been incredible. Some very sophisticated equipment is now in use at surprisingly modest prices, compared to 10 or 15 years ago. Besides AM pulse-width modulation, we now have FSK (they call it FM); and pulse-code modulation is coming into use with systems of up to 7 or 8 channels. Most equipment is Japanese, but one U.S. supplier, ACE R/C in Higgensville, MO offers equipment in kit form.

C. R. AHERN

President,

District of Columbia Radio Club

SECRETS

I couldn't help but be angered at the lament in one of your product-review columns that schematics were not given out freely for new products—especially in "enthusiast type" equipment.

Perhaps the design of an elegant, manufacturable, and cost-effective product seems a minor exercise to that writer, but in fact it is not. Often, the only way a small company can prevent or at least slow down larger companies with volume advantage (or the Japanese) from sliding in and seizing a market is to keep as many circuit details as secret as possible for as long as possible.

That way, at least, you have a chance of selling enough of the product to recover development costs before someone else muscles in. And never mind "proprietary" circuits; the protection provided is negligible. A small company can be destroyed before the court gets around to looking at your case. A large company can patent a product before a ruling is reached, and you are left up the creek without a paddle.

NAME WITHHELD

OOOOPS!

I have received some letters from **Radio-Electronics** readers in regard to my article on the TV Stereo Adapter that appeared in the March 1986 issue. Those letters complained that the Adapter does not operate.

Reviewing the schematic presented, I understood the reason for the complaints: there is an omission in the schematic. Pin 1 of

the MC1310 IC should be connected to +12 volts. Without that connection, the Adapter certainly will not operate.

STEVE SOKOLOWSKI

RELAYS IN ROBOTICS

I enjoy your magazine, but one thing that bothers me is the use of electromechanical relays, especially in robotics projects. For example, in "Building Your Own Robot," (**Radio-Electronics**, March

1986) Mark Robillard states: "First of all, you're going to need relays if your motors are small DC types." He goes on to say that transistors sometimes don't provide full power.

My objection is that, with MOSFETS having R_{DS} 's of 0.05Ω and less commonly available, why use a relay? It's best these days to reduce the number of unreliable mechanical parts as much as possible. I have worked with relay sys-

Build Circuits Faster and Easier With Our \$20 Solderless Breadboard



...and do even more with our \$40 breadboard

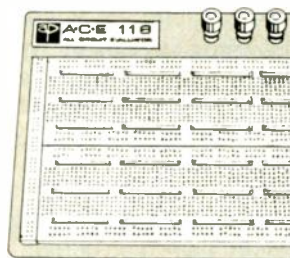

Introducing the plug-in world of AP Product's versatile, low cost breadboards.

Now you can design, build and test prototype circuits just like the professionals ... and make changes in seconds. No messy soldering or desoldering. No more twisted leads or damaged devices.

With our ACE 109 and 118 blue breadboards, you simply plug in components and interconnect them with ordinary hook-up wire. All sizes of DIPs and other discrete components up to 22 gauge lead diameters snap right into the 0.1" x 0.1" matrix of the solderless tie points ... anywhere on the layout. You don't need expensive sockets or special tools. Buses of spring clip terminals form a distribution network for power, ground and clock lines.

AP Products 100 series breadboards give you all the functions and flexibility of more expensive circuit evaluators. The spring terminals have mechanically independent contact fingers to accom-

modate most DIPs and discrete components (see diagram).

The ACE 109 has two terminals for separate voltages plus a ground connection. The larger ACE 118 offers the same three terminals, plus an additional terminal which can be used for clocking or another voltage. The backplates are heavy steel to keep the boards stationary.

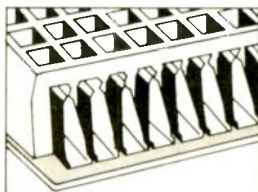

Don't wait. These low prices won't last forever. See your local AP Products dealer today, or send for a list of dealers in your area. Free information on request.

AP PRODUCTS/3M
9325 Progress Parkway
P.O. Box 540
Mentor, Ohio 44060
800-321-9668
(Ohio, 216/354-2101)

CIRCLE 76 ON FREE INFORMATION CARD

Simpson Electric Co.
Introduces

mercer

The Ultimate in Low-Cost Test Equipment

At last! Here is your opportunity to take your pick from a new test equipment line that has all the features you need and more... and at a price that's unbelievably low.

MODEL 9340

Pocket size, 3 1/2-digit DMM with 20 megohm range and 10 megohm input resistance

\$44⁰⁰

MODEL 9670

Digital capacitance tester covering 0.1 pF to 20,000 μ F

\$99⁰⁰

MODEL 9101

Compact VOM with 27 ranges, including a 100 megohm range

\$29⁰⁰

MODEL 9301

3 1/2-digit, hand-held DMM with 0.25% basic accuracy and 2,000-hour battery life

\$69⁰⁰

MODEL 9120

Analog VOM with 12 A DC range and output jack

\$39⁰⁰

MODEL 9401

4 1/2-digit, full function, hand-held DMM with .05% accuracy and data hold

\$129⁰⁰

MODEL 9701

digi-clamp™ compact AC clamp-on volt-ohm-ammeter with data hold

\$69⁰⁰

MODEL 9370

3 1/2-digit autoranging DMM with a memory mode and 0.5% basic DC accuracy

\$59⁰⁰

mercer

ELECTRONICS

Division of Simpson Electric Company

859 Dundee Avenue, Elgin, IL 60120-3090
(312) 697-2265 • Telex 72-2416

Mercer Electronics products reflect the design and quality standards established by Simpson Electric Company, an industry leader for over 50 years and known worldwide for its integrity and product excellence.

In Stock... Available Now! Stop in at your nearest distributor and see this new, complete line of Mercer test instruments. For the name of the MERCER distributor in your area, call (312) 697-2265, or send for our new line catalog.

CIRCLE 177 ON FREE INFORMATION CARD

tems, and, believe me, they waste power and they are prone to failure with age. They are also slow and they induce transients. Their only redeeming feature is that they provide simultaneous multiple-contact closure. But even that can be circumvented by using logic and semiconductor devices.

You fellows who write for the magazines: Please try to dump the old mechanics and keep it state-of-the-art.

Let me repeat that I enjoy your magazine and hope that you won't succumb to computer mania. Not that computers aren't wonderful, but a steady diet of them bores me. Let's face it: If you can't interface them with the real world, then they are limited.

As far as I am concerned, you are the last remaining good electronics magazine.

CLYDE H. HYDE
Tenino, WA

HELP NEEDED

Help! I need an operator/service manual for the Leader

LBO-511 single trace oscilloscope. Can you give me an address so that I can obtain that manual? Thanks.
PETER A. MELVILLE
Mt. Sterling, KY
Leader Instruments Corp. is located at 380 Oser Ave., Hauppauge, NY 11788.

INFORMATION NEEDED

I recently acquired an Astrocom/Marlux Solid State Tape Deck. It is a rugged, 3-motor deck, the model 407, made in Japan. It is a 1/4-track reversible reel-to-reel deck.

Unfortunately, it is in need of some minor repairs, and I have no information or schematic. If any of your readers could help me out, I would be glad to pay a reasonable compensation for their time.

ROLF K. TAHLOR
2692 Mayfield Road, apt. 2
Cleveland Hts, OH 44106
(216) 321-8716

SERVICE AND INFO NEEDED

I have an Akai model X-IV tape recorder and I need service information, or at least a schematic. The

Akai Company's response to my request for a manual was that they no longer have any information. Sams lists it in their T-111 manual, but that manual is no longer available. Therefore, I will appreciate any information your readers could provide.

E. W. HOFFHINE
P.O. Box 252
Kihei, HI 96753

RESTORING AN OLD MARCONI

I am trying to restore an old Marconi TV set (TV 500 chassis) to its original working condition, but I am unable to find a schematic or repair manual from the usual sources. The chassis appears to have a problem in the horizontal phase detector circuit, which is a type I have not encountered before. I would appreciate any help you or your readers could give me in locating information about that chassis.

P.G. DODD
18 Lakeland Cres.,
Scarborough, Ontario,
Canada M1G 2L3

Nobody Beats Us!

\$69⁹⁵

JERROLD CORDLESS CABLE T.V. CONVERTER
Model DRX3-105/400 (58 CHANNELS)

ALSO AVAILABLE TEKNICA - Model 6510 with volume control *139⁹⁵

Send Purchase Order
Check, Money Order, or C.O.D.
or Call Toll Free

800-223-0826

in N.Y. State (212) 865-5580



CO-AXIAL CABLE

Braided bare
Copper Shield

Bare Copper
Conductor

Foam
polyethylene
dielectric

RG 59/u
\$44⁵⁰/1000'

RG-6/u 69⁹⁵ 1000
Add \$5.00 per Roll for Shipping



SANYO
2SC1308K
ORIGINAL

TOSHIBA
2SC1172B
ORIGINAL

1.49

100 up
10-29 *1.99 30-99 *1.69



\$10⁹⁹

each

RCA
Triplers

SK3306/Equivalent to ECG-523
ECG-526

SK3304/Equivalent to ECG-500A

2 WAY - 75 ohm u/v
Splitter

49¢/100 lot
99¢ each



MT-2

21¢/100 lot

MATCHING
TRANSFORMER

MT-1

"F" - FITTINGS

F-59ALM with attached
1/2" ring for RG-59/u cable
12¢/100 9¢/1000



7¢/5000

F-56ALM with attached
1/2" ring for RG-8/u cable
15¢/100 10¢/1000

8¢/5000

WELLER

WTCPR CONTROLLED OUTPUT
SOLDERING STATION



Model
WTCP-R

\$69⁹⁵

HITACHI 20 Mhz Dual
Trace Scopes



V-212 *439⁹⁵ Probes
V-222 *489⁹⁵ included
V-223 *539⁹⁵ DELAYED SWEEP

MASTER CARD VISA

OMNITRON

ELECTRONICS

770 Amsterdam Ave., New York, NY 10025

SHIPPING CHARGES

For Orders	Add
\$25-100	\$6.50
\$100-500	\$8.50
\$500-750	\$10.50
\$750 and up	\$20.00

Write for
FREE CATALOG
136 page

CIRCLE 110 ON FREE INFORMATION CARD

RADIO-ELECTRONICS

22

EQUIPMENT REPORTS

Radio-Shack Telephone Tester

Now anyone can
troubleshoot a telephone.

CIRCLE 5 ON FREE INFORMATION CARD



IN THE "GOOD OLD DAYS" (BEFORE THE breakup of AT&T), getting your telephone fixed was easy. All you needed to do was call the phone company and they would come out and give you a new one. There were no extra charges, no questions to answer, and no arguments.

Now it's like playing a game of Truth or Consequences. First, you've got to figure out if it's the phone itself that's broken, or whether the problem is in the telephone line. Guess wrong and you could add a hefty, needless bill to your woes. That's because your friendly neighborhood telephone company now regards the telephone instrument itself as an alien object—they won't touch it with a ten foot pole. If they make a service call and determine that the problem is not in their lines, the only thing they are now responsible for, they'll bid you adieu, after they advise you that the bill is in the mail. Assuming that you own your own phone, as many of us now do, getting the phone fixed is your headache.

One way to cure that headache is with Radio-Shack's (Ft. Worth, TX 76102) aptly named *Telephone Tester* (catalog number 43-114). One of Radio-Shack's newest

products, that microprocessor-controlled unit makes troubleshooting a telephone so easy even a child could do it.

By the numbers

The unit is capable of testing either pulse- or tone-dialed telephones. It can also be used to test answering machines, and cordless telephones.

The tester, as supplied, is designed for use with single-line telephones. It can be adapted for use with two-line telephones via a two-line coupler. An appropriate coupler is available from Radio-Shack (catalog number 279-401).

The layout of the *Telephone Tester* is reminiscent of the self-service TV- and radio-tube testers that used to be all over the place; they are still around, but now you might have to search a bit more. All instructions are printed in a flow-chart-like format on the unit's front panel. By following the steps in sequence, the user is able to test for most common telephone and answering machine malfunctions, including defective plugs and cords, in a systematic manner.

The unit is entirely self-contained; there are no probes, accessories, etc. required. Sockets are provided on the tester for the

Scan and record temperatures from freezing to scorching.



The new Fluke 52 goes to great extremes to outperform any other handheld thermometer.

At the touch of a button, it sequentially scans the readouts of two temperature inputs and their difference. Or records the minimum and maximum from any one of these three channels for up to 1,200 hours.

You can measure extreme temperatures with 1/10th of a degree resolution, using standard K or J type thermocouples probes.

Prices for the Fluke 50 Series are surprisingly low... starting at just \$119 for the single-input Fluke 51. Order yours today.

For the name of your local supplier and a free brochure call toll-free 1-800-227-3800, Ext. 229.

FROM THE WORLD LEADER IN
HANDHELD TEST INSTRUMENTS.

FLUKE 51/52 THERMOMETERS

Measurement range	
K-type	-200°C to +1370°C (-328°F to +2498°F)
J-type	-200°C to +760°C (-328°F to +1400°F)
Accuracy	
K-type is	±(0.1% of reading + 0.7°C or 1.3°F)
J-type is	±(0.1% of reading + 0.8°C or 1.4°F)
°C or °F Selectable • Hold Mode	
Scan, Differential, and Min/Max Recording Modes (52 only)	
Standard mini-connector input	
1200 hour 9V battery life • 3-year warranty	
General-purpose K-type bead probe included (two with 52)	

© 1986 Fluke



CIRCLE 121 ON FREE INFORMATION CARD

Check Digital IC's in-circuit Fast!

In the field or on the bench. B&K-PRECISION gives you the answers for TTL or CMOS



Model 550 (for TTL) \$395
Model 552 (for CMOS) \$395

New B&K-PRECISION IC Comparator Testers/Logic Monitors put you on the fast track to digital troubleshooting. IC's are tested by comparison to a known good device, allowing you to test hundreds of types with one simple operation.

As logic monitors, they simultaneously indicate the logic states of up to 20 IC pins. No need to check pins singly with a logic probe.

Tests most 14 to 20 pin, 54 and 74 Series TTL (Model 550) or 4000 and 74C Series CMOS (Model 552) devices.

- Convenient one button testing
- Reverse polarity and overvoltage protection
- Uses power from equipment under test
- Memory stores short duration pulses and intermittent events
- Zero insertion force reference IC socket
- LED at each IC pin identifies where fault exists
- Includes 16 and 20 pin DIP clips
- Compact hand-held size

Available from stock at your local B&K-PRECISION distributor. For more information contact your distributor or:

BK PRECISION
DYNASCAN
CORPORATION

6460 West Cortland Street
Chicago, Illinois 60635 • 312/889-9087

International Sales, 6480 W. Cortland St., Chicago, IL 60635
Canadian Sales, Atlas Electronics, Ontario
South and Central American Sales,
Empire Exporters, Plainville, NY 11803

telephone itself, and for the line and handset cords. There are also two AC outlets for telephones or answering machines that require an outside source of power.

Results of all tests are conveyed via two LED's using a simple pass-fail system. In addition a small readout is used to display further information in two of the tests: In the cord test, it is used to display the number of conductors in the cable; in the dial test, it is used to verify the number dialed. Tests are selected using a row of pushbuttons; which test has been selected is indicated by a lighted LED.

In all, the unit is capable of testing nine different parameters. It has both LONG LOOP and SHORT LOOP modes that simulate connections to distant and nearby Central Offices.

OVERALL PRICE	1	2	3	4	5	6	7	8	9	10
EASE OF USE	1	2	3	4	5	6	7	8	9	10
INSTRUCTION MANUAL	1	2	3	4	5	6	7	8	9	10
PRICE/VALUE	1	2	3	4	5	6	7	8	9	10
	Poor		Fair			Good			Excellent	

The CORD TEST checks the number of conductors in the handset or line cord, and verifies the condition of either cord, including plugs.

When the handset is off-hook, the telephone company's Central Office should see a DC resistance of between 57 and 600 ohms. The function of the unit's LOOP TEST is to verify that parameter.

The DIAL TEST checks for correct dialing. Each digit output by the phone is displayed on the readout for verification. That test will work for both pulse- and tone-dialed telephones.

The TRANSMIT TEST and the RECEIVE TEST check the functioning of the telephone microphone and earpiece, respectively. In the TRANSMIT TEST, if everything is functioning normally, the PASS LED flickers in response to the output of the microphone. In the RECEIVE TEST, the user listens at the earpiece for a tone that is output by the tester.

The unit will also test ringer operation at low and high voltages, simulating distant and nearby Central Offices, and it will test telephone answering machines.

Limitations

The tester is not without its limitations. First of all, its troubleshooting capabilities are quite basic. It will tell you that the telephone is defective, and will more-or-less tell you which functions have failed, but that's all. Pinpointing the fault any further must be done using appropriate equipment and standard troubleshooting techniques. Also, the tester will not test electronic key systems or PABX key sets reliably.

The manual is pretty much what you would expect from Radio-Shack—operating instructions, some specifications, and a schematic, but little else. As to the schematic, in our copy of the manual, the hand-lettering was exceptionally difficult to read; in some cases the printing was so blurred that figuring out a part number or value was reduced to educated guesswork. (A note indicated that the schematic was subject to change and advised contacting Radio-Shack for the latest schematic and parts.) The operating instructions were a fleshed out version of the front-panel instructions.

Obviously, the tester is not something that's a must for every workbench. But without a doubt, it is a unit that will find plenty of use in the appropriate application. The tester would perhaps be at its best on a counter in a telephone store, were customers could troubleshoot their own telephones with ease. It's professional, yet, non-threatening layout and sturdy grey-steel case seem to indicate that the tester will lend itself particularly well to such an application. In service departments, the tester could be used to do initial troubleshooting, and final check-out. Since the work could be done by a non-technical individual, expensive bench time could be saved.

The Telephone Tester, which is covered by a one-year limited warranty, is available at Radio-Shack stores. It sells for \$299.95. **R-E**

continued on page 26

Two of our best Performers

14 day full money back guarantee

HM205

an outstanding Oscilloscope with digital storage

This new oscilloscope offers all the features of a state-of-the-art **20MHz** realtime instrument. In addition it provides digital storage capability for signals between **50s** and **0,3ms** duration, with a max. sampling rate of **100kHz**. Especially when working with comparatively slow phenomena, the **HM205** can easily replace considerably more expensive digital storage scopes.

2 Probes x1/x10 incl. **\$ 820⁰⁰**

HM208

the high tech Storage Scope with 20MHz sampling rate

The **HM208's** high sampling rate of max. 20MHz facilitates storing of relatively fast single shot events. Max. memory is **4096x8** bit, conveniently divided into two independent blocks. **XY-storage** capability enables easy viewing and recording of characteristic curves and Lissajous figures. An XY-recorder output and the optional **GPIB-Interface** allow full integration in automatic measurement systems. With more than **5000** units sold, this is one of Europe's bestselling digital storage scopes.

2 Probes x1/x10 incl. **\$ 2380⁰⁰**

Write or call

HAMEG® Inc.

88-90 Harbor Road
Port Washington, N.Y. 11050

☎ (516) 883.3837

TWX (510) 223.0889

2 year warranty

STUN GUN

39.95



EQUALIZER

- The ultimate non-lethal defense weapon.
- In five seconds can immobilize your attacker, even through heavy clothing.
- Discharges over forty thousand volts of electricity from a nine volt nickel-cadmium battery.
- \$39.95, Mass 5% sales tax, \$3.00 shipping and handling.

1-800-522-2636
FOR ORDERS ONLY
617-871-5611
FOR INFORMATION

Cameo Enterprises, Inc.
P.O. Box 63, Accord, MA 02018

CIRCLE 89 ON FREE INFORMATION CARD

SEE YOUR DEALER TODAY

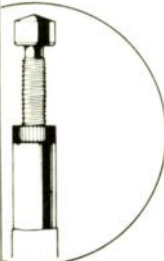

FROM



HERE'S A TIP
THAT'S PERFECT!

AM/FM AUTO RADIO
AND CB

'Firestik' II

GOLDEN SERIES

BARE-HANDS TUNABLE
"NO TOOLS NEEDED"
HIGH PERFORMANCE ANTENNAS

ALSO ANTENNAS FOR
CORDLESS TELEPHONES
MONITOR SCANNERS

Dealer & Distributor Inquiries Invited
SEND FOR FREE CATALOG

'Firestik' Antenna Company
2614 East Adams Phoenix, AZ 85034

Name _____
Street _____
City _____
State _____ Zip _____

Serving the CB and
Communications Market Since 1962.

5-YEAR REPLACEMENT WARRANTY

CIRCLE 100 ON FREE INFORMATION CARD

OK INDUSTRIES MODEL 205 FUNCTION GENERATOR

A 5-MHz, no-nonsense
function generator.

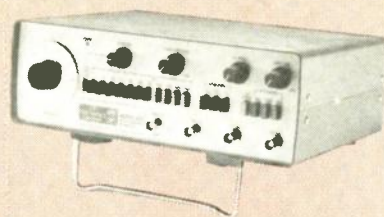

CIRCLE 6 ON FREE INFORMATION CARD

AS YOUR TEST AND MEASUREMENT needs become more sophisticated, one instrument you're sure to need is a function generator that offers sinewave, squarewave, and triangle wave outputs. We recently examined one such instrument, the model 205 from the Electronics Division of OK Industries Inc. (3455 Conner Street, Bronx, NY 10475).

We'll start our description of the 205 with its physical characteristics. It measures about 12 x 4 x 9 inches and weighs 7½ pounds thanks, in part, to a well shielded steel housing. All circuitry and switches, with the exception of front-panel potentiometers and BNC input and output jacks, are mounted on a single well laid-out circuit board.

The 205 has a frequency range of 0.005 Hz to 5 MHz in seven overlapping ranges. The output frequency is chosen by using a vernier dial (calibrated from 0.005 to 5) and a group of pushbutton MULTIPLIER switches that are arranged in decade multiples from 1 to 1 million.

Although the 205 does not offer an internal sweep generator, it does provide a SWEEP IN jack that allows the generator's frequency to be controlled by an external voltage. The sweep input sensitivity is 0 to 4 volts for 1000:1 sweep, and a maximum allowable input of ± 10 volts.

Operating modes

The 205 has 3 basic operating modes: free-run, triggered, and gated. In the free-run mode, the generator runs continuously at the selected frequency.

In the triggered mode, the generator outputs one complete cycle of the selected signal after it receives a trigger. That trigger signal

can vary from DC to 5 MHz and from TTL-compatible levels up to 20 volts. Alternatively, the MANUAL button can be used to trigger the generator. The phase of the output signal can be selected by the START/STOP PHASE control, which offers a full ±90-degree range of adjustment at output frequencies up to 500 kHz.

The gated mode is similar to the triggered mode except that the output runs for the duration of the gate signal (instead of only one cycle). As you would expect, the starting and stopping phase at the output can be set by the START/STOP PHASE control.

Outputs

The model 205 has two outputs jacks: TTL OUT and 50Ω OUT. The TTL output is at a fixed amplitude level at the frequency and symmetry of the main (50-ohm) output. It has a fan-out of 20 standard TTL loads.











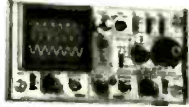

OK Industries		205									
OVERALL PRICE											
EASE OF USE											
INSTRUCTION MANUAL											
PRICE/VALUE											
		1	2	3	4	5	6	7	8	9	10
		Poor		Fair			Good			Excellent	

The 50-ohm output has a maximum output voltage (into 50 ohms) of 10 volts peak-to-peak. The AMPLITUDE control allows you to vary the output more than 20 dB. Additional attenuation is available from three pushbutton switches (0, -20, and -40 dB), and a DC OFFSET control is featured to further tailor the output signal to suit your needs.

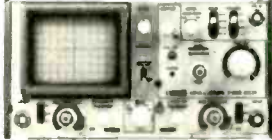
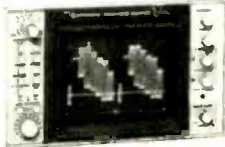
saving you money for over 45 years

WM. B. ALLEN

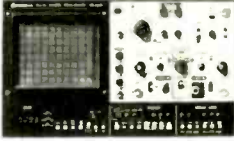
slashes prices on the new oscilloscopes from
 **HITACHI**

<p>V089 Vector Scope/3.5" CRT/AC Operated/Optional Battery Pack/ External DC Source</p>  <p>\$1390 SAVE \$200!</p>	<p>V509 50MHz/Dual Channels Mini Portable/Delayed Sweep</p>  <p>\$1199 SAVE \$200!</p>	<p>V134 10 MHz/Dual Trace/Bi-Stable Storage</p>  <p>\$1395 SAVE \$225!</p>
<p>V1100A 100MHz/Quad Channels/8-Trace/Delayed Sweep/ CRT Readout/Digital Measurement</p>  <p>\$2190 SAVE \$300!</p>	<p>VC6020 Digital Storage Scope/1MHz Dual Channel/ 20MHz Real Time/ GPIB Option/ 1K Words Memory per Channel</p>  <p>\$1700 SAVE \$250!</p>	<p>V1070A 100MHz Quad Channels 8-trace Delayed Sweep CRT Readout</p>  <p>\$1595 SAVE \$355!</p>
<p>V680 60MHz/3 Channels/6 Traces/Delayed Sweep/Cursor Measurement/ CRT Readout</p>  <p>\$1340 SAVE \$150</p>	<p>— THE 928 PAGE — WM. B. ALLEN ELECTRONICS CATALOG A \$15.00 VALUE FREE WITH EVERY PURCHASE</p>	<p>V209 20MHz/Dual Channels/AC-DC Operation/Mini Portable</p>  <p>\$795 SAVE \$150!</p>
<p>V079 Waveform Monitor/2Loop-through Inputs/AC-DC Input Coupling/ Video Output IRE Pos. IEEE 205/Half-rack Width/6" CRT</p>  <p>\$1800 SAVE \$300!</p>	<p>VC6041UG 40MHz Digital Storage 1mV Dual Trace 6" CRT 4k Words per Channel GPIB Option</p>  <p>\$5100 SAVE \$850!</p>	<p>V099 Waveform Monitor 3.5" CRT AC Operated Optional Battery Pack External DC Source</p>  <p>\$1050 SAVE \$200!</p>
<p>V1150 150MHz/Quad Channels/ 8 Traces/ Delayed Sweep/ Digital Measurement/CRT Readout</p>  <p>\$2550 SAVE \$400!</p>	<p>VC6041UX 40MHz Digital Storage 1mV Dual Trace 6" CRT 4k Words per Channel</p>  <p>\$4350 SAVE \$600!</p>	<p>V069 VectorScope/6" CRT w/Internal Graticule/AC/Power/ 100-120-220-240v/50-60Hz</p>  <p>\$2090 SAVE \$300!</p>

— and still making waves —

<p>V1050F 100MHz/Quad Channels/ 8-Trace/Delayed Sweep</p> <p>SAVE \$300! \$1245</p>	<p>V650F 60MHz/Triple Channels/ Delayed Sweep</p> <p>SAVE \$250! \$945</p>	<p>V423 40MHz/Dual Channels/ Single Time Base Delayed Sweep</p> <p>SAVE \$250! \$745</p>	<p>V422 40MHz/Dual Channels</p> <p>SAVE \$250! \$675</p>	<p>V223 20MHz/Dual Channels/ Single Time Axis Delayed Sweep</p> <p>SAVE \$200! \$595</p>	<p>V222 20MHz/Dual Channels</p> <p>SAVE \$200! \$515</p>	<p>V212 20MHz/Dual Channels</p> <p>SAVE \$150! \$465</p>
---	--	---	---	---	---	---

WM. B. ALLEN SUPPLY COMPANY

ALLEN SQUARE

300 BLOCK NORTH RAMPART, NEW ORLEANS, LA 70112

NEW ORLEANS 504 525-8222 **800 535-9593** LOUISIANA 800 462-9520

24 HOUR ANSWERING TO EXPEDITE YOUR ORDER

CIRCLE 103 ON FREE INFORMATION CARD

LOWEST EVER

SMART BUY

from
MEGURO
(JAPAN)

20 MHz Dual Trace Oscilloscope



\$299⁰⁰
2-FREE Probes Included

- Built-in Component Tester
- 6" Square Internal Graticule CRT
- Sensitivity: 5mV ~ 20V/div ±3%
- Rise Time: 17ns or less
- Sweep Time: 0.2µs ~ 0.5s/div ±3%
- X-Y and Z Axis Operation
- 110/220 Volt Operatibn
- One Year Parts & Labor Warranty

35 MHz Scope/Delay Trigger \$499.⁰⁰

Add 12.⁰⁰ Per Unit for UPS & C.O.D. Charges

TO ORDER CALL COLLECT:

(213) 624-3757

Diplomat International, 453 South Spring St.,
Suite 1224 Los Angeles, CA 90013

CIRCLE 192 ON FREE INFORMATION CARD

Radio-Electronics mini-ADS



THE MODEL WTT-20 IS ONLY THE SIZE OF A DIME, yet transmits both sides of a telephone conversation to any FM radio with crystal clarity. Telephone line powered - never needs a battery! Up to ¼ mile range. Adjustable from 70-130 MHz. Complete kit \$29.95 + \$1.50 S+H. Free Shipping on 2 or more! COD add \$4. Call or send VISA, MC, MO. **DECO INDUSTRIES, Box 607, Bedford Hills, NY 10507. (914) 241-2827.**

CIRCLE 127 ON FREE INFORMATION CARD



APPLIANCE REPAIR HANDBOOKS—13 volumes by service experts; easy-to-understand diagrams, illustrations. For major appliances (air conditioners, refrigerators, washers, dryers, microwaves, etc.), elec. housewares, personal-care appliances. Basics of solid state, setting up shop, test instruments. \$2.65 to \$5.90 each. Free brochure. **APPLIANCE SERVICE, PO Box 789, Lombard, IL 60148. 1-(312) 932-9550.**

CIRCLE 84 ON FREE INFORMATION CARD

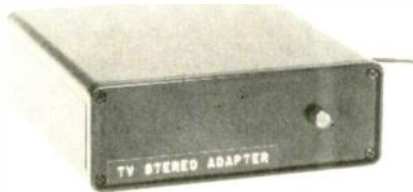

MTS STEREO ADAPTER. Add the dramatic, new dimension of MTS STEREO to virtually any TV or VCR using the Audio Output Plug and your stereo system. So versatile it even simulates extra ordinary stereo sound on non-stereo broadcast. Assembled \$81.00, also available in kit form, \$52.00. N.Y. Residence add tax. **DEL-PHONE INDUSTRIES, Box 150, Elmont, New York 11003.**

CIRCLE 180 ON FREE INFORMATION CARD

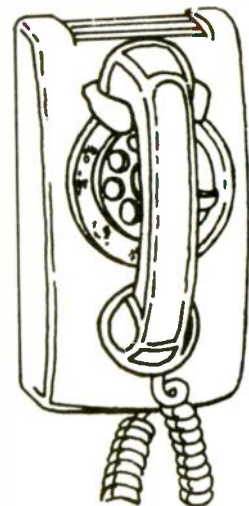

CALL NOW AND RESERVE YOUR SPACE

- 6 x rate \$745.00 per each insertion.
- Reaches 229,044 readers.
- Fast reader service cycle.
- Short lead time for the placement of ads.
- We typeset and layout the ad at no additional charge.

Call 516-293-3000 to reserve space. Ask for Arline Fishman. Limited number of pages available. Mail materials to: mini-ADS, RADIO-ELECTRONICS, 500-B Bi-County Blvd., Farmingdale, NY 11735.

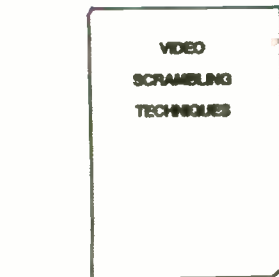

SUBSCRIPTION TV MANUAL. This information packed book details the methods used by subscription TV companies to scramble and descramble video signals. Covers the Sinewave, Gated Pulse, SSAVI system, and the methods used by most cable companies. Includes circuit schematics, theory, and trouble shooting hints. **Only \$12.95 plus \$2.00 first class P&H. ELEPHANT ELECTRONICS, INC., Box 41865-R, Phoenix, AZ 85080**

CIRCLE 120 ON FREE INFORMATION CARD

Get in on ...
ELECTRONICS!



TRAIN TODAY for an exciting money-making career in:

- Electronics Engineering Technology
- Computer Programming • Data Processing
- Information Systems • Drafting with C.A.D.

NATIONAL EDUCATION CENTERS has 50 campuses nationwide, so there's a Center near you. In as little as 9 months, you can train for a high-tech career. In a state-of-the-art environment.

ASK ABOUT OUR BENEFITS! Day and Evening classes. Financial Aid to those who qualify, and Job Placement Assistance! Many of our schools are Approved for Veterans Training, and all are accredited members of either N.A.I.T.S. or A.I.C.S.

SO DON'T DELAY! For information send in the handy coupon today. Or call 7 days a week — TOLL-FREE:

National Education Centers

1-800-722-7337
Ext. 210

National Education Centers — Headquarters
1732 Reynolds - Irvine, CA 92714

The program I am interested in is: _____

Year of High School Graduation or G.E.D. _____

NAME: _____

ADDRESS _____

CITY/STATE/ZIP _____

PHONE: _____

RE-786

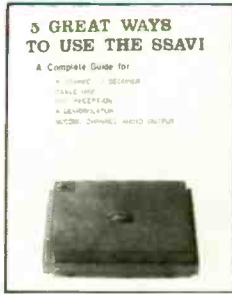

NEW PUBLICATION, "5 Great Ways to Use the SSAVI": a complete guide for all uses, including conversion to a stereo TV decoder **\$6.50** ppd. ZENITH SSAVI Descramblers only **\$169**. Gated pulse **\$199**. Reconditioned original equipment for UHF chs. 27,48,51 & 60, etc. Quantity discounts. Surplus TV equipment: Oak N-12, Hamlin MLD-1200, SB-3, etc. Warranty. Catalog **\$1**. AIS SATEL-LITE, P.O. Box 1226-A, Dublin, PA, 18917. 215-249-9411.

CIRCLE 81 ON FREE INFORMATION CARD



GN DELUXE UNIVERSAL BATTERY CHARGER & TESTER METER (new item) UL approved can test battery power and charging rechargeable ni-cd batteries D, C, AA, AAA, N, button cells and 9v batteries one time. Special **\$15.00**. CA residents add (6.5%) tax. Shipping **\$2.00**. Money Orders, Checks. **GENTLE WAYER ELECTRIC INC.** 324 S. Palm Ave. #D, Alhambra, Ca 91803 (818-289-2050) TELEX 3717727 Wayeer US.

CIRCLE 194 ON FREE INFORMATION CARD



NEW JERROLD CS 68 CHANNEL CABLE TV CONVERTER with volume control & descrambler loop (Port). Programmable clock turns TV on/off & changes channel. Audio mute kills commercials. Programmable channel scan. Instant channel recall. Automatic fine tuning with manual override. Video & audio outputs. Friendly to all descramblers. Specify output. 1 year warranty. **\$169**. Free delivery. (Dealer Inquiries Invited) **514-739-9328**. **CROSLY ELECTRONICS**, Box 840, Champlain, N.Y. 12919.

CIRCLE 198 ON FREE INFORMATION CARD

CALL NOW AND RESERVE YOUR SPACE

- 6 x rate \$745.00 per each insertion.
- Reaches 229,044 readers.
- Fast reader service cycle.
- Short lead time for the placement of ads.
- We typeset and layout the ad at no additional charge.

Call 516-293-3000 to reserve space. Ask for Arline Fishman. Limited number of pages available. Mail materials to: mini-ADS, RADIO-ELECTRONICS, 500-B Bi-County Blvd., Farmingdale, NY 11735.

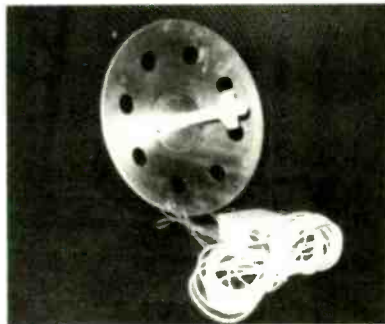

MICROWAVE ANTENNAS \$69.95 + shipping, lifetime warranty. We repair all types of downconverters. Satellite Dishes and parts complete 9" dish with block system, 80" LNA by arcfinder **\$995.00**. Coax cable T.V. parts, accessories connectors, T.V. amplifiers. Write for free catalog or call for prices. **BLUE STAR IND.**, Dept. RE7-86, 4712 Ave. N, Brooklyn, N.Y. 11234 (718)338-8318 Ext. 105.

CIRCLE 85 ON FREE INFORMATION CARD

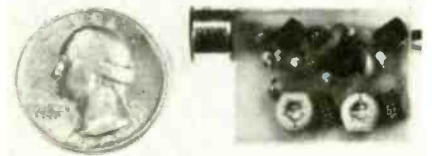

SIMPLY SNAP THE WAT-50 MINIATURE FM TRANSMITTER on top of a 9v battery and hear every sound in an entire house up to 1 mile away! Adjustable from 70-130 MHz. Use with any FM radio. Complete kit **\$29.95** + \$1.50 S + H. Free shipping on 2 or more! COD add \$4. Call or send VISA, MC, MO. **DECO INDUSTRIES**, Box 607, Bedford Hills, NY 10507. (914) 241-2827.

CIRCLE 127 ON FREE INFORMATION CARD

103 PROJECTS FOR ELECTRONICS EXPERIMENTERS



103 PROJECTS FOR ELECTRONICS EXPERIMENTERS. Soft cover, 308 pages of practical, proven plans for the electronics hobbyist...circuits, converters, amplifiers, synthesizers, optoelectronics, power supplies and more. Written and designed by Forrest M. Mims, III. 1249I \$11.50 plus \$1 postage in USA. **ELECTRONIC TECHNOLOGY TODAY INC.**, PO Box 240, Massapequa Park, NY 11762-0240.



TV STEREO-SAP-ADAPTER: \$79.00 for composite video input type or input from CATV CNVTR type. **\$59.00** for SAP only type (speaker built-in). **\$149.00** for tuner built-in type. Allow 6-8 weeks delivery. **INTEK ELECTROICS**, PO Box 76417, Los Angeles, CA 90076. (213) 739-1664.

CIRCLE 186 ON FREE INFORMATION CARD



FREE CATALOG OF HARD-TO-FIND TOOLS is packed with more than 2000 quality items. Your single source for precision tools used by electronic technicians, engineers, instrument mechanics, schools, laboratories and government agencies. Also contains Jensen's line of more than 40 tool kits. Send for your free copy today! **JENSEN TOOLS INC.**, 7815 46th St., Phoenix, AZ 85044. (602) 968-6231.

CIRCLE 115 ON FREE INFORMATION CARD

EQUIPMENT REPORT

continued from page 26

A SYMMETRY control can be used to vary the duty cycle of the output. So, for example, you can produce sawtooth waveforms from the triangle output or you can produce pulse waveforms from the squarewave output in the symmetry mode.

The instruction manual for the 205 should be adequate for most users. It includes a list of specifications, instructions on how to change the operating voltage from 110 volts to 220 volts, and basic operating information. It also includes a nomograph that can be used to determine the output frequency based on the vernier setting and the externally applied sweep voltage.

We would have liked the manual to include calibration instructions, especially since the circuit board has more than thirty trimmer potentiometers. However, a service manual (which we did not see) is available separately.

The model 205 seems like a rugged unit that offers the most-often-needed features in an attractive package. It is priced at \$545.

R-E

No previous experience necessary

LEARN PROGRAMMING



Master computers in your own home at your own pace in your spare time. Learn even before you decide on a computer.

BE YOUR OWN COMPUTER EXPERT

Programming is the best way to learn to use computers, and we can show you the best—and most economical—way to learn programming!

Send today for your free information package. No obligation. No salesman will call.

HALIX INSTITUTE
CENTER FOR COMPUTER EDUCATION DEPT 497
1543 W OLYMPIC, #226
LOS ANGELES, CA 90015-3894

YES! Send me free information on how I can learn about computers and programming at home!

Name _____
Address _____
City _____ State/Zip _____

NEW PRODUCTS

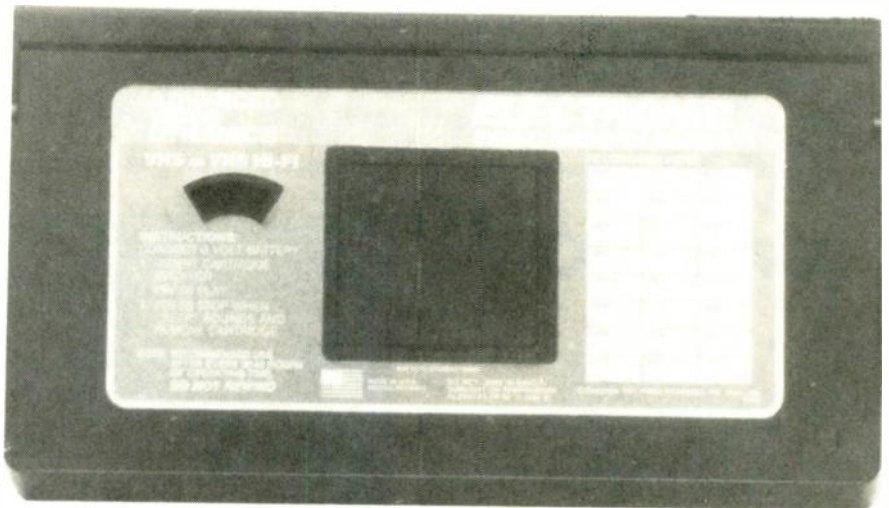

CIRCLE 21 ON FREE INFORMATION CARD

VIDEO HEAD CLEANER, the model CJ-58, is an electronic head cleaner that doesn't require the user to estimate either the length of the cleaning cycle or the amount of fluid to supply. The device automatically calculates both items.

The automatic dispensing system in the cartridge also makes the product easy to use—no spraying, swabbing, or pouring the cleaning fluid; no other paraphernalia to keep track of. The user inserts the cartridge into the VCR and presses

the PLAY button. It takes about 15 seconds to clean the video heads and other components thoroughly; then the cartridge stops and emits a beep. The user then presses the STOP button and removes the cartridge.

The head cleaner lasts for about 25–30 cleanings. It comes complete with a 9-volt alkaline battery and has a suggested retail price of \$18.95.—**Video Dynamics, Inc.**, 6525 Oxford Street, St. Louis Park, MN 55426.

DISK SYSTEM, the *EquiDisk +*, is a subsystem for the Apple II+ and IIe that increases data storage to 737 kilobytes on each 5.25-inch floppy disk and allows CP/M users to access foreign formats.

The *EquiDisk +* is a complete package. It includes an *EquiDisk +* controller card, software, and instruction manual, plus two (or optionally one) disk drives. The half-height, high-capacity disk



CIRCLE 22 ON FREE INFORMATION CARD

drives are enclosed in a slimline case that fits neatly between the computer console and the

ELENCO PRODUCTS AT DISCOUNT PRICES!

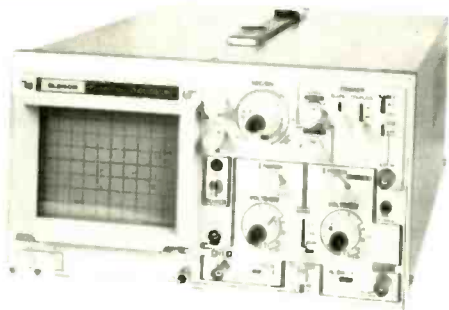

20 MHz DUAL TRACE OSCILLOSCOPE
\$336 MO-1251

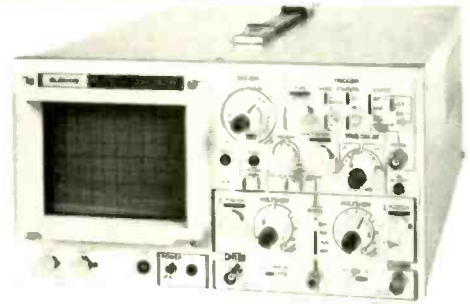

35 MHz DUAL TRACE OSCILLOSCOPE
\$545 MO-1252

Top quality scopes at a very reasonable price. Contains all the desirable features. Elenco's 2 year guarantee assures you of continuous service. Two 1x, 10x probes, diagrams and manual included. Write for specifications.



MULTI METER with CAPACITANCE and transistor tester
\$65 Model CM-1500

Reads Volts, Ohms, Current, Capacitors Transistors & Diodes



TRUE RMS 4 1/2 DIGIT MULTIMETER
\$135 Model M-7000

.05% DC Accuracy
.1 % Resistance with Freq. Counter & Deluxe Case



3 1/2 DIGIT MULTIMETER
\$25 Model M-1600

1% DC Accuracy
1% Resistance
Reads 10A DC

GF-8016 Function Generator with Freq. Counter
\$219



- Sine, Square, Triangle,
- Pulse, Ramp, .2 to 2 MHz
- Frequency .1 thru 10 MHz

GF 8015 without Freq. Meter \$169

Quad Power Supply

Including 2-20V Variable Supply



Model XP-575

Fully Regulated, Short Protect Specifications

\$59.95
3 @ **\$49.95**

Volts	AMP	Reg	Max Ripple
2-20V	2A	.10V	.005V
12V	1A	.05V	.003V
5V	3A	.10V	.005V
-5V	.4A	.05V	.005V

Triple Power Supply XP-660

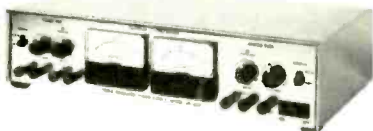

\$149.50

0-20V @ 1A
0-20V @ 1A
5V @ 5A

Fully Regulated, Short Circuit Protected with 2 Limit Cont. 3 Separate Supplies.

3 Amp Power Supply XP-650



\$119.50

0-40V @ 1.5A
0-20V @ 3A

Fully regulated, short circuit protected current limit control



DIGITAL LCR METER

Model LC-1800
Measures: Inductors
Capacitors, Resistors

\$148

Inductors .1μH to 200 H
Capacitor .1Pf to 200μf
Resistor .01Ω to 20M Ω
Ranges 6 Ind, 7 cap, 7 res

C&S SALES, 8744 W. North Ter. Niles, IL 60648
800-292-7711 (312) 459-9040



15 DAY MONEY BACK GUARANTEE ASK FOR CATALOG

2 Year Limited Guarantee! Add 5% for Postage (\$10 max.), IL Res., 7% Tax

CIRCLE 109 ON FREE INFORMATION CARD

Capacitance, logic and more. For less.

Now, a fully-loaded DMM combines a capacitance meter, logic probe, and an hFE meter, all for the price of a DMM.

TTL Logic Probe: 20 MHz

Hi/lo/off indications

Detects 25nS pulse width

Capacitance: 5 ranges (2nF to 20 μ F)

hFE (NPN or PNP): 1 range (1000)

DMM: DCV-5 ranges (.2V to 1kV)

ACV-5 ranges (.2V to 750V)

DCA-4 ranges (200 μ A to 10A)

ACA-3 ranges (20mA to 10A)

Ohms-7 ranges (200 Ohms

to 2000 Megohms)

Continuity beeper

Diode check

Built-in bail

Anti-skid pads

See one now at your local Beckman Industrial distributor.

DM25L... \$89⁹⁵*

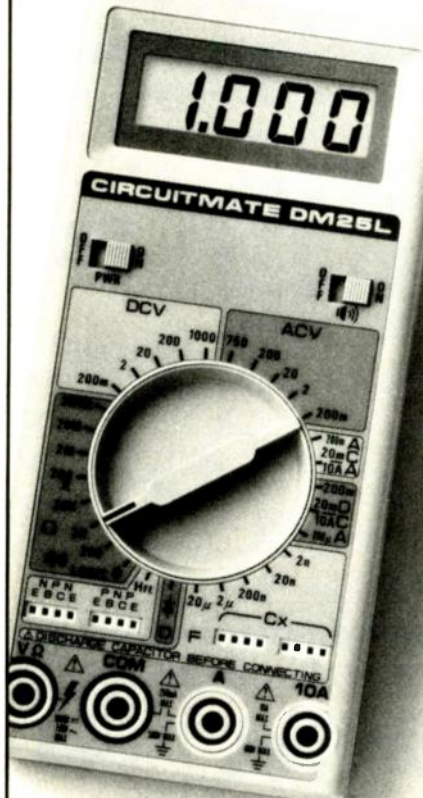

*Suggested list price (\$US) with battery, test leads and manual.

Beckman Industrial™

Beckman Industrial Corporation
A Subsidiary of Emerson Electric Company
630 Puenta Street, Brea, CA 92621
(714) 671-4800

© Copyright 1985 Beckman Industrial Corporation

CIRCLE 98 ON FREE INFORMATION CARD

monitor. The case, with built-in surge suppressor, is equipped with three AC outlets, and allows the user to control power to the computer, monitor, and printer with the unit's front-mounted ON/OFF switch.

The *EquiDisk+* is priced at \$679.00 for the two-drive system, \$579.00 for the one-drive system.—**H&M Disk Drive Services, Inc.**, 1101 East Pacifico Avenue, Anaheim, CA 92805.

DC POWER SUPPLY, the model 1630, features regulated outputs for volts and amperes; built-in metering; two current ranges for full or half output; a pre-regulator to limit internal dissipation; an isolated output so either polarity may be floated or grounded; and reverse-polarity protection. It is a 0-30 volt, 3-ampere device with low ripple.



CIRCLE 23 ON FREE INFORMATION CARD

The model 1630 has fully adjustable current limiting (from 5% to 100% of maximum output current) that protects both the circuit under test and the power supply. It can be hooked up in series or in parallel with another model 1630 for 0-30 volt, 6-ampere or 0-60-volt, 3-ampere operation. It is designed for use in service shops, engineering labs, production testing, school labs, and by hobbyists. The model 1630 is priced at \$225.00, and comes with test leads, spare fuse, schematic and parts list, and a complete instruction manual.—**B&K Precision, Dynascan Corporation**, 6460 West Cortland Street, Chicago, IL 60635.

HOME SATELLITE RECEIVER, the *Zenith Home Satellite Receiving*

System, is available with a 10-, 8-, or 6-foot-diameter perforated dish; the full system includes a micro-processor-based receiver with *Space Command* remote control and an electronic antenna positioner.

The design of the perforated aluminum dish provides high gain and interference rejection—important when receiving signals from satellites that are more than 22,300 miles away and spaced together closely. To receive signals from different satellites, the system features a motorized actuator that moves the antenna. Also mounted on the antenna is an LNB (low-noise block downconverter) and feed assembly for optimum reception.

Indoors, the system is built around a satellite receiver that can feed up to 24 channels through to a television set or videocassette recorder. The *Space Command* remote control operates channel selection and audio tuning, and can be used to change antenna positions. Because information is programmed (during installation) into a non-volatile memory inside the antenna positioner, the unit will retain programmed information during a power loss.

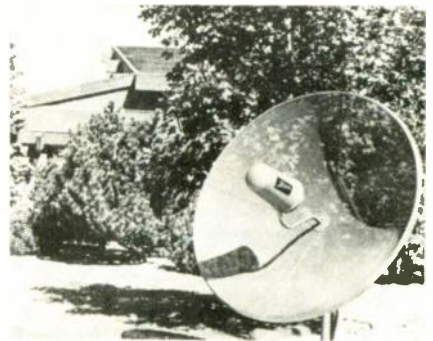
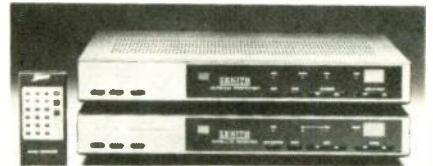

CIRCLE 24 ON FREE INFORMATION CARD

The *Zenith Home Satellite Receiving System* has a range of prices from \$1495 for a 6-foot manual system to \$2549.00 for a 10-foot motorized system, plus installation.—**Zenith Electronics Corporation**, 1000 Milwaukee Avenue, Glenview, IL 60025. **R-E**

Where's Your **ELECTRONICS** Career Headed?

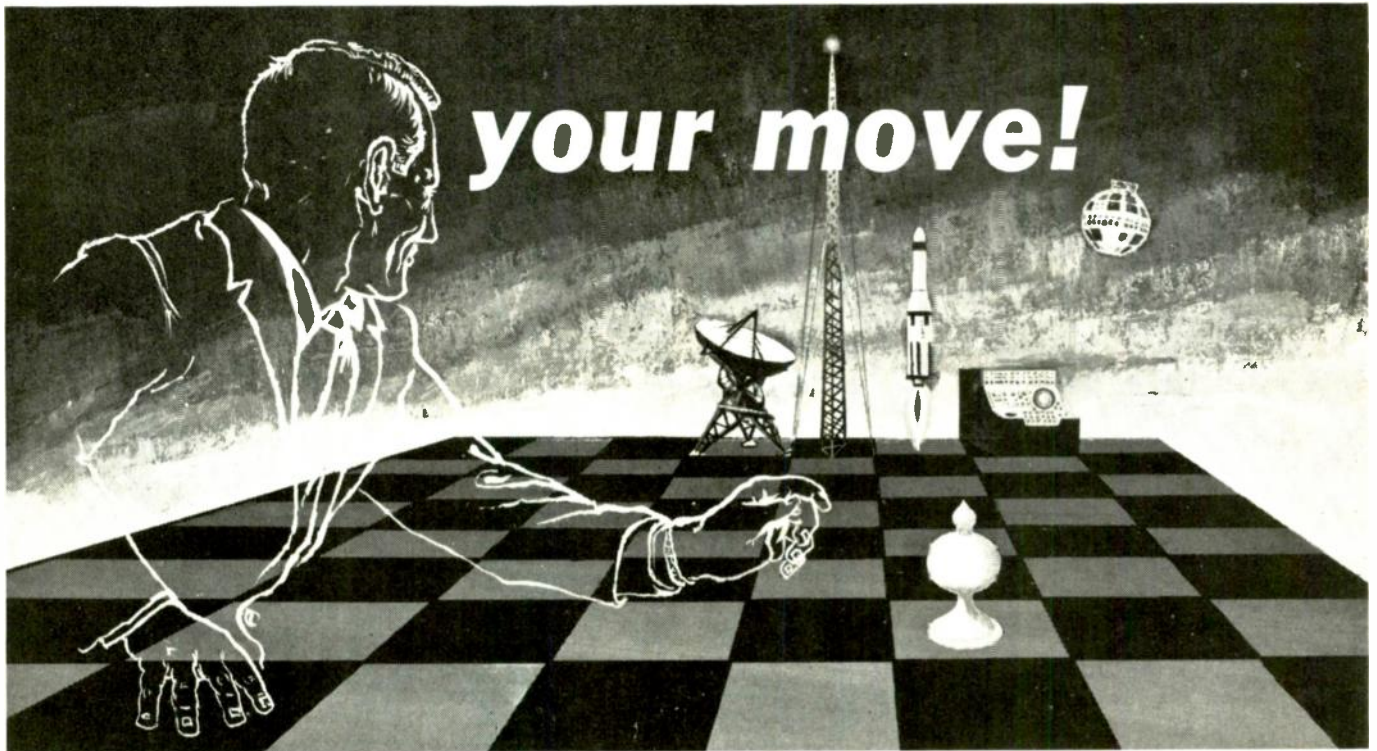

The Move You Make Today Can Shape Your Future

Yes it's your move. Whether on a chess board or in your career, you should plan each move carefully. In **electronics**, you can *move ahead* faster and further with a

B. S. DEGREE

Put professional knowledge and a **COLLEGE DEGREE** in your electronics career. Earn your degree through independent study at home, with Grantham College of Engineering. No commuting to class. Study at your own pace, while continuing your present job.

The accredited Grantham non-traditional degree program is intended for mature, fully employed workers who want to upgrade their careers . . . and who can successfully study electronics and supporting subjects through

INDEPENDENT STUDY, AT HOME

Free Details Available from:

Grantham College of Engineering
10570 Humbolt Street
Los Alamitos, California 90720

Independent Home Study Can Prepare You

Study materials, carefully written by the Grantham staff for independent study at home, are supplied by the College, and your technical questions related to those materials and the lesson tests are promptly answered by the Grantham teaching staff.

Recognition and Quality Assurance

Grantham College of Engineering is accredited by the Accrediting Commission of the National Home Study Council.

All lessons and other study materials, as well as communications between the college and students, are in the English language. However, we have students in many foreign countries; about 80% of our students live in the United States of America.

Grantham College of Engineering R-0786
10570 Humbolt Street, Los Alamitos, CA 90720

Please mail me your free catalog which explains your B.S. Degree independent-study program.

Name _____ Age _____

Address _____

City _____ State _____ Zip _____

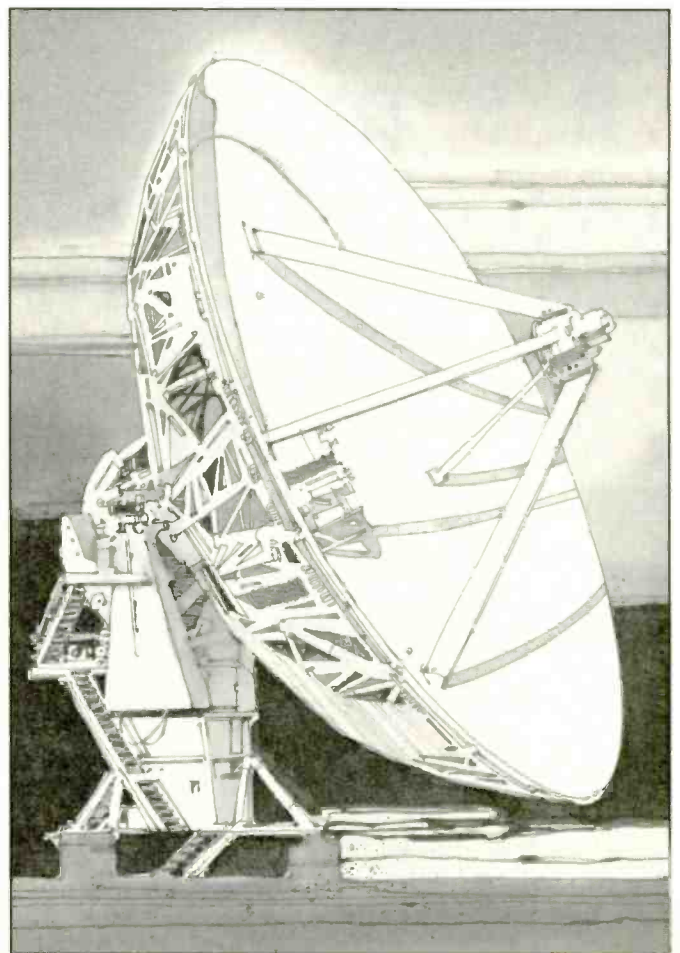
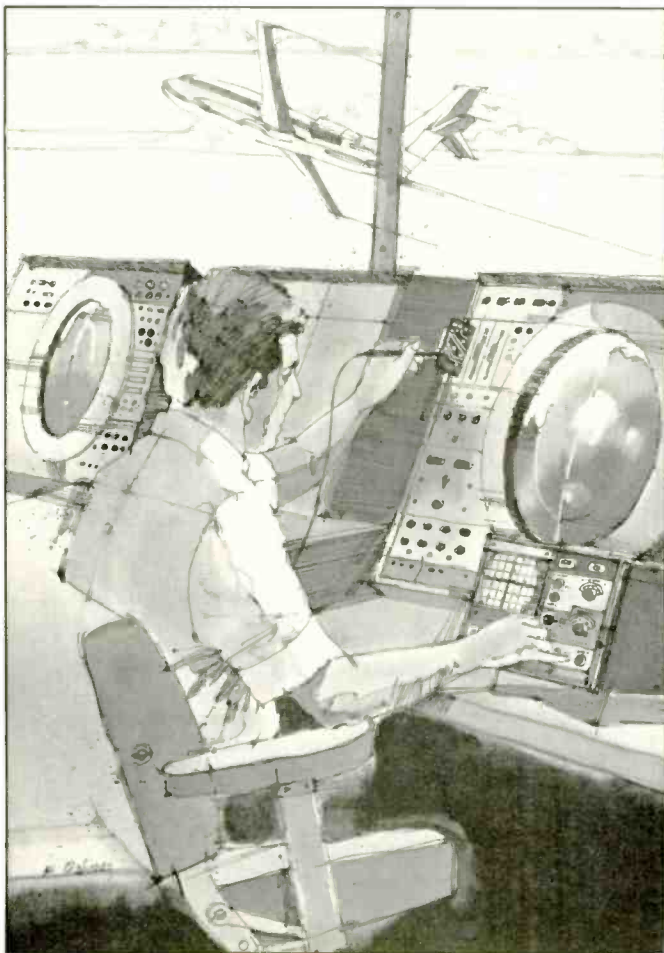
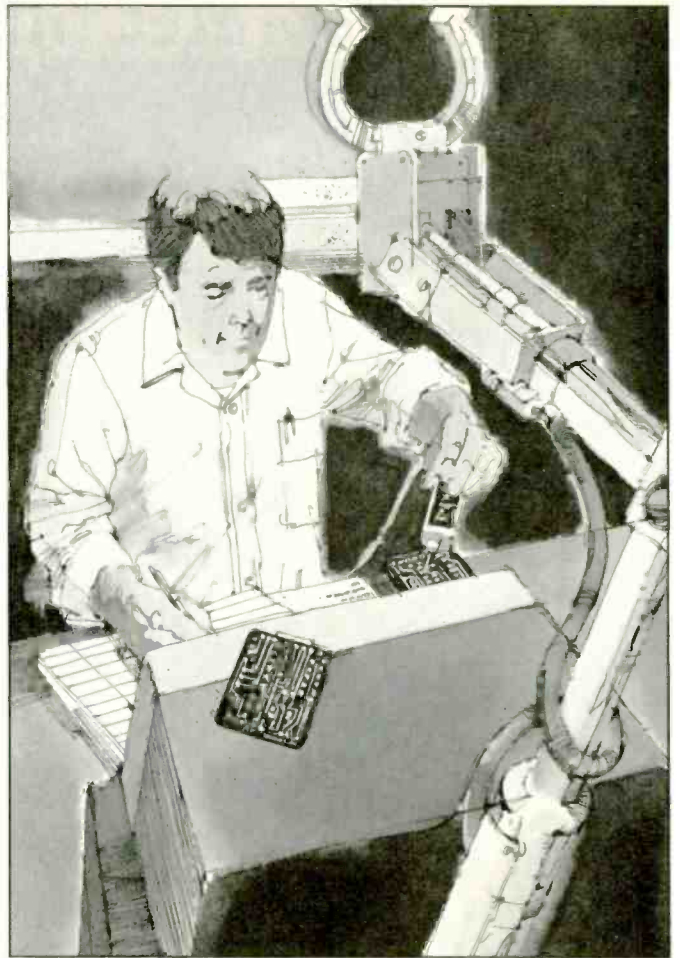
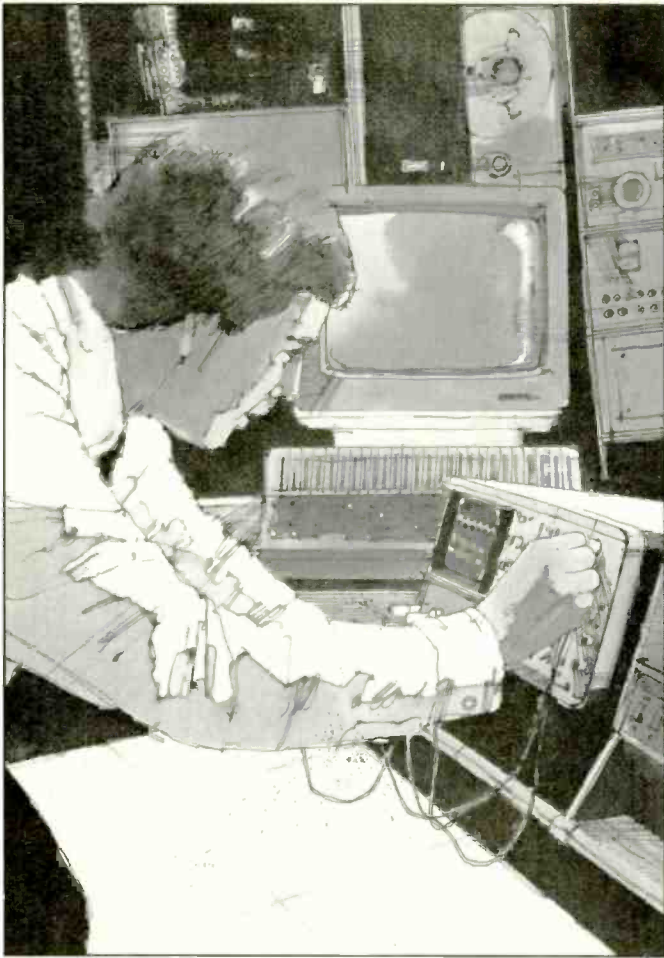

CIE MAKES THE WORLD OF ELECTRONICS YOURS.

Today's world is the world of electronics. To be part of it, you need the right kind of training, the kind you get from Cleveland Institute of Electronics, the kind that can take you to a fast growing career in business, aerospace, medicine, science, government, communications, and more.

Specialized training.

You learn best from a specialist, and that's CIE. We're the leader in teaching electronics through independent study, we teach only electronics and we've been doing it for over 50 years. You can put that experience to work for you just like more than 25,000 CIE students are currently doing all around the world.

Practical training.

You learn best with practical training, so CIE's Auto-Programmed® lessons are designed to take you step-by-step, principle-by-principle. You also get valuable hands-on experience at every stage with sophisticated electronics tools CIE-designed for teaching. Our 4K RAM Microprocessor Training Laboratory, for example, trains you to work with a broad range of computers in a way that working with a single, stock computer simply can't.

Personalized training.

You learn best with flexible training, so we let you choose from a broad range of courses. You start

with what you know, a little or a lot, and you go wherever you want, as far as you want. With CIE, you can even earn your Associate in Applied Science Degree in Electronics Engineering Technology. Of course, you set your own pace, and, if you ever have questions or problems, our instructors are only a toll-free phone call away.

The first step is yours.

To find out more, mail in the coupon below. Or, if you prefer, call toll-free 1-800-321-2155 (in Ohio, 1-800-523-9109). We'll send a copy of CIE's school catalog and a complete package of enrollment information. For your convenience, we'll try to have a representative contact you to answer your questions.

CIE Cleveland Institute of Electronics
1776 East 17th St. Cleveland, Ohio 44114

YES! I want to get started. Send me my CIE school catalog including details about the Associate Degree Program. I am most interested in:

- | | |
|--|---|
| <input type="checkbox"/> computer repair | <input type="checkbox"/> television/high fidelity service |
| <input type="checkbox"/> telecommunications | <input type="checkbox"/> medical electronics |
| <input type="checkbox"/> robotics/automation | <input type="checkbox"/> broadcast engineering |
| <input type="checkbox"/> other _____ | |

Print Name _____

Address _____ Apt _____

City _____ State _____ Zip _____

Age _____ Area Code Phone No _____

Check box for G.I. Bulletin on Educational Benefits

Veteran Active Duty **MAIL TODAY!**

OR CALL TOLL FREE
1-800-321-2155
(In Ohio, 1-800-523-9109)

RE-40

Buy a Hitachi Scope from Joseph's... Get FREE DELIVERY* and a FREE DMM!

*To UPS-shippable destinations only



V1100A 100MHz
Quad Channel/8 Trace

Pocket Calculator-Size DMM Yours FREE with Each Hitachi Scope



- 3 1/2-Digit LCD ■ Autoranging
- Continuity Beeper
- AC/DC Volts ■ Resistance
- Test Leads, Battery ■ Case
- 4 1/4" H x 2 1/4" W x 0.4" D

V1100A 100 MHz Quad Channel/8 Trace

Reg. \$2490⁰⁰ Price **Joseph's \$2235⁰⁰** Free Delivery!
Free DMM!

- CRT Readout ■ Built-in Computer ■ Cursors
- Built-in DVM and Frequency Counter
- Digital Measurement ■ Delayed Sweep
- 6" CRT ■ 18KV Acceleration
- 1 mV/Division Sensitivity
- 2 ns/Div. Max. Sweep ■ High 2% Accuracy
- Probes, Dustcover included

V1050F 100 MHz 4 Channel w/ Delayed Sweep

Reg. \$1595⁰⁰ Price **Joseph's \$1175⁰⁰** Free Delivery!
Free DMM!

- 6" CRT ■ Alt. Time Base ■ 5 mV/Div Sensitivity
- 2% Accuracy ■ Full TV Triggering
- Probes, Dustcover included

V650F 60 MHz Triple Trace w/ Delayed Sweep

Reg. \$1195⁰⁰ Price **Joseph's \$885⁰⁰** Free Delivery!
Free DMM!

- Our Best Seller! ■ 6" CRT ■ Auto-Focus
- 1 mV/Div Sensitivity ■ 3% Accuracy
- Trigger View ■ Probes, Dustcover included

V423 40 MHz Compact Dual Trace w/ Delayed Sweep

Reg. \$995⁰⁰ Price **Joseph's \$675⁰⁰** Free Delivery!
Free DMM!

- 6" CRT ■ 1 mV/Div ■ DC Offset ■ 3% Accuracy
- 20 ns/Div Sweep ■ Only 12.2 x 5.1 x 14.6", 15 1/2 lbs.
- Probes included

V222 20 MHz Dual Trace w/DC Offset

Reg. \$715⁰⁰ Price **Joseph's \$535⁰⁰** Free Delivery!
Free DMM!

- 6" CRT ■ Vert. Trigger Mode ■ 1 mV/Div
- 100 ns/Div Sweep w/ 10x mag. ■ 14.3 lbs.

V212 20 MHz Dual Trace Scope

Reg. \$615⁰⁰ Price **Joseph's \$475⁰⁰** Free Delivery!
Free DMM!

- Same as V222 above, less DC Offset



Famous HITACHI Scopes at Joseph's Low Discount Prices!

Hurry! Quantities limited at sale prices!

Joseph electronics

8830 N. Milwaukee Ave Niles, IL 60648

VISA, MASTERCARD & DISCOVER
Phone Orders Welcome

Call 1-800-323-5925

In Illinois: 312-297-4200

ROUND UP

THE CONCEPT BEHIND POCKET-TV IS NOT NEW; ITS origins can be traced to the science-fiction pulps and comic strips of the first part of this century and beyond. Science fiction became science fact in January, 1977 when Sir Clive Sinclair, that English genius of micro-miniaturization, introduced and sold the *Microvision* "pocket" TV through his company, which was called Sinclair Radionics at that time. The *Microvision* was a black-and-white TV set; it used a CRT with a 2-inch (diagonal measure) screen. Despite having some interesting features, that set's price (about \$300) and size (pocketbook size would have been more accurate) contributed to its eventual demise.

The reasons behind both the high cost and the relatively large size of the *Microvision* could be traced to the CRT (specifically, its manufacturing

costs and long neck). Realizing that, Sinclair launched research aimed at producing a "flat" CRT. His efforts, and those of his competitors, have led to the birth of a whole new branch of consumer electronics—pocket-TV sets

This report

As we stated, Sinclair is not the only player in this field. In developing products, various manufacturers have embraced new technologies, and have added colors as well. Sony's *Watchman* line, originally offered in 1982, recently passed the one-million-unit production mark.

In this report we will look at 24 pocket-TV sets that are either available now or about to be introduced. For quick reference, the features of each set are summarized in Table 1. More details on each set

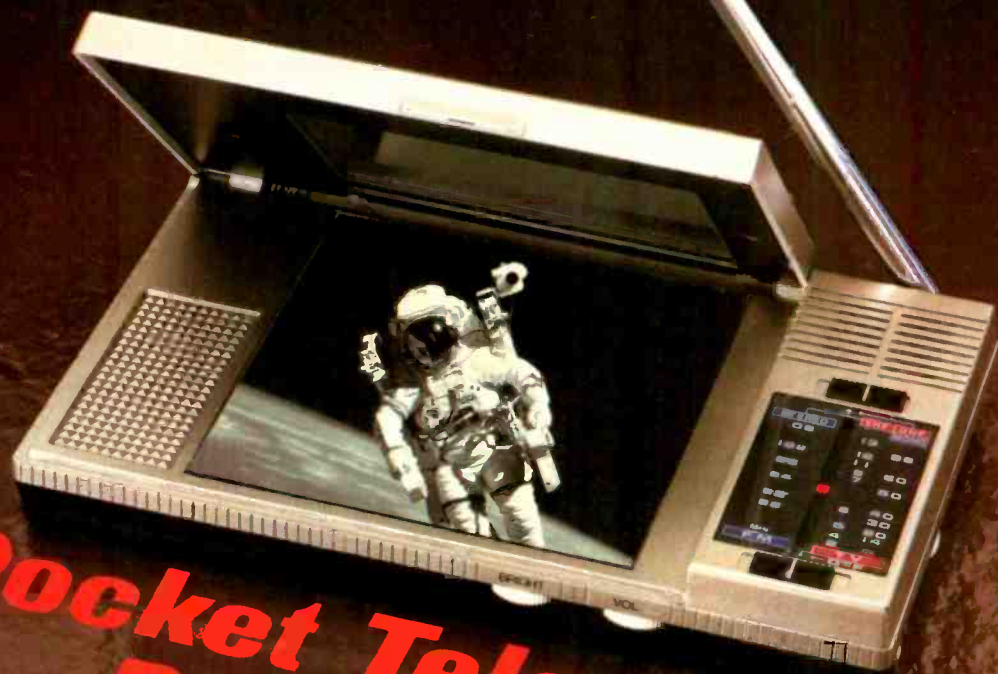

Pocket Television Receivers

FRED BLECHMAN

Here's a no-punches-pulled look at pocket TV, one of the hottest segments of the consumer-electronics market.

Manufacturer	Model	Price	Size	Weight	Power	Battery	Display	Controls	Features	Accessories	Other	Availability
Epson America, Inc. 2780 Lomita Blvd Torrance, CA 90505	ELF ET-20	\$199	2 1/4	4 1/2	1 1/4		2 LCD 13	240 220	52800	G G		
	ELF ET-12	\$350	6 1/4	3 1/4	1 1/4		LCD 13	240 220	52800	G G		
Magnavox MAP Consumer Electronics Corp. Interstate 40 S. Springline Pike Knoxville, TN 37914-1810	BF 39008K	\$160	3	6 1/2	1 1/4		2 CRT N/A	N/A	N/A	7 ?		
	BF 39018K	\$220	3 3/4	6 3/4	1 1/4		2 CRT N/A	N/A	N/A	E E		
Panasonic Company One Panasonic Way Secaucus, NJ 07094	TR-1030P	\$180	3 1/4	1 1/2	6		1.5 CRT	N/A	N/A	E E		
	CT-101	\$450	4 3/4	1 3/4	7 1/4		1.5 CRT	?	?	E E		
Radio-Shack, Div of Tandy Corp. 1700 One Tandy Center Fort Worth, TX 76102	POCKET-VISION -2 (16-152)	\$100	4 3/4	2 1/2	1 3/4		2 LCD 139	110	15290	F P		
	POCKET-VISION -3 (16-153)	\$160	5 1/4	3	3/4		2.7 LCD 10	148 122	18056	?		
	POCKET-VISION -20 (16-154)	\$300	6 3/4	3 1/4	1 1/4		2.6 LCD 3	144 108	46656	?		
Consumer Electronics Division Hattori Corp. of America 1330 W Walnut Parkway Compton, CA 90220	SEIKO LDV012	\$199	2 1/4	4 1/2	1 3/4		2 LCD 13	240 220	52800	G G		
	SEIKO LDV202	\$349	3 3/4	6	1 1/2		2 LCD 13	240 220	52800	G G		
Sindair Research Limited One Sinclair Plaza Nashua, NH 03061	FTV2	\$100	5 1/2	3 1/2	1 1/4		2 CRT N/A	N/A	N/A	G E		
Sony Consumer Products Co Sony Drive, Park Ridge, NJ 07656	FD-2A	\$180	2 1/2	6 1/2	1 1/4		2 CRT N/A	N/A	N/A	E E		
	FD-30A	\$240	3 3/4	6 3/4	1 1/4		2 CRT N/A	N/A	N/A	E E		
	FD-40A	\$200	4 3/4	8 3/4	2 1/4		4 CRT N/A	N/A	N/A	E E		
Zenith Electronics Corp. 1000 Milwaukee Ave. Glenview, IL 60025	BT 044S	\$199	4 3/4	8 3/4	2 1/4		4 CRT N/A	N/A	N/A	G G		

LEGEND:

? = "Unknown" or "Not tested"; ✓ = "yes" or "included"; E = Excellent; G = Good; F = Fair; P = Poor.
 X = Not usable, N/A = Not applicable, N/R = Not required; O = Optional

REMARKS:

A Not tested B Discontinued, but may still be available at retailers C Seek tuning D Fancy book-like case
 E High-resolution, reflective LCD F Sunhood G Dual earphone jacks H AC adapter uses non-standard plug I Antenna included J Removable LCD alarm clock K TV-Audio-only capability L Magnifier with sunshade included M Optional car antenna available

NOTES:

1 2 hours with backlight 2 Earphone only 3 Earphone wire is antenna 4 Mirror provides viewing angle
 5 Radio only 6 For speaker location F=Front, T=Top, B=Back, S=Side 7 Fluorescent backlight built in
 8 Slide controls for volume and brightness 9 3 hours with backlight 10 Manufacturer claims 5:1 contrast using black matrix LCD 11 6 hours with backlight 12 Stereo headphones included 13 TFT (Thin-film-transistor) technology 14 Backlight not required 15 2.5 hours with backlight 16 28 hours radio only
 17 Stereo headset included 18 Rechargeable battery pack included 19 On-screen tuning bar indicator
 20 Viewing screen hits upward 21 Polaroid P-500 lithium battery included 22 Available from Radio-Shack. See text 23 35 hours TV sound only

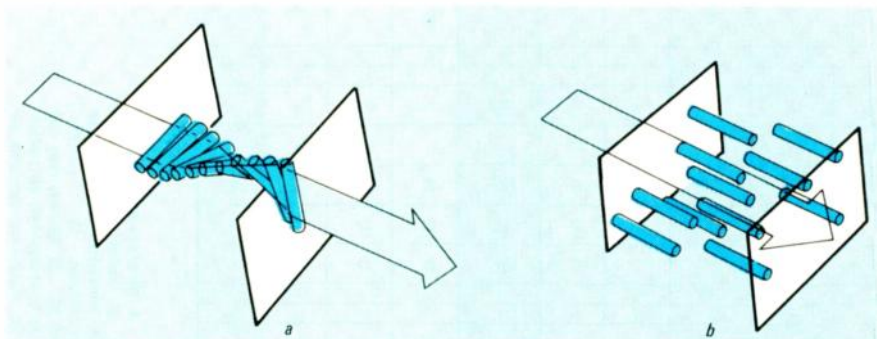

FIG. 1—IN THE ABSENCE of an electric field, liquid-crystal molecules twist the light 90°, allowing it to pass through the display (a). When an electric field is present, that twisting does not take place and the light is absorbed by the top polarizer (b).

By contrast, the circuitry required with LCD's is compact and lightweight. Therefore, the *Elf* and similar units easily can be held in the palm of the hand. Moreover, the low power consumption of an LCD eases the drain on the unit's batteries. Because the electrodes in a liquid crystal display can be made of transparent materials, the screen can be lit from behind (backlighted) with ambient light or from a built-in source.

In developing the Epson liquid-crystal color TV, Suwa Seikosha's scientists and engineers had to overcome some formidable obstacles. For one thing, the liquid crystals commonly used in watch and calculator displays respond slowly to electrical signals. That is unacceptable for video displays, where the liquid crystals must be turned on and off many times a second. Also, most liquid-crystal displays are low in contrast and limited to black images on a light background.

To solve the problems of slow response times and low contrast, Suwa Seikosha's research team turned to TFT's to turn on and off each of the 52,800 pixels in the *Elf* display. The transistors, deposited on a glass substrate, are made of polycrystalline silicon, a material known for its stability and reliability.

To understand how the TFT's improve performance, it is necessary to know a little about how liquid-crystal displays operate. In the type of LCD used in watches, calculators, and the Epson *Elf*, liquid-crystal material, which is composed of long, organic molecules, is sandwiched between two polarizers; for our discussion, let's designate those the top and bottom polarizers. The polarizers are placed in the display so that their transmission axes are separated by 90 degrees. When no electric field is present, the liquid crystal molecules have their long axes parallel to the top and bottom polarizers and the

in-between layers gradually twist through the 90 degrees between top and bottom. Light entering through the bottom polarizer gradually gets twisted through a 90-degree angle by the liquid-crystal layers and exits through the top polarizer as shown in Fig 1-a. A person viewing the display sees a light spot.

In the presence of an electric field, however, the molecules stand up on their ends, parallel to the direction of the field. In that state, they can no longer rotate light. Therefore, light entering the bottom does not get twisted; instead it gets absorbed by the top polarizer as shown in Fig. 1-b. To a person viewing the display, that spot appears dark.

To create the hundreds or thousands of pixels needed to form an image in a complex liquid-crystal display suitable for use as a video screen, the earlier (and still widely used) approach is "multiplexing." In multiplexing, rows of electrodes are deposited on one side of the liquid-crystal layer, and columns of electrodes are deposited on the other side. The pixels are created at the junctions of rows and columns.

To simulate the scanning processes of a CRT, electric pulses are fed to the row electrodes in succession; during that interval, all of the column electrodes are pulsed simultaneously. Whenever the voltage at a row-column junction exceeds a threshold value, the liquid crystals respond. In that way, every field of a standard TV signal can be displayed.

Multiplexing has its problems, however. Because many rows must be addressed in a short time by a single electric pulse, the time-weighted average on/off ratio of black to white is very low, and that results in poor contrast.

Those problems were solved by resorting to an approach called *active-matrix addressing*. In that system, the 240 row and 220 column electrodes of the display are deposited on a single glass substrate. On the opposite side of the display is a common electrode. The TFT's, placed at each row and column junction, are turned on whenever a pixel is to be activated. Driver circuitry controls which pixels are activated at what times.

With the TFT's, each pixel receives the full voltage needed to turn it on, not a time-weighted average, as in multiplexed devices. The result is a very high on/off ratio and good contrast.

Color is added through the use of thousands of microscopic red, blue, and green primary-color filters; one filter is placed over each pixel electrode. When a red spot is to be created, the TFT's at the blue and green filters in the appropriate region are turned on, blocking out light there and letting light through only the red filters. If blue is desired, the red and green TFT's are turned on. If green is to be displayed, the red and blue TFT's are activated.



PANASONIC CT-101

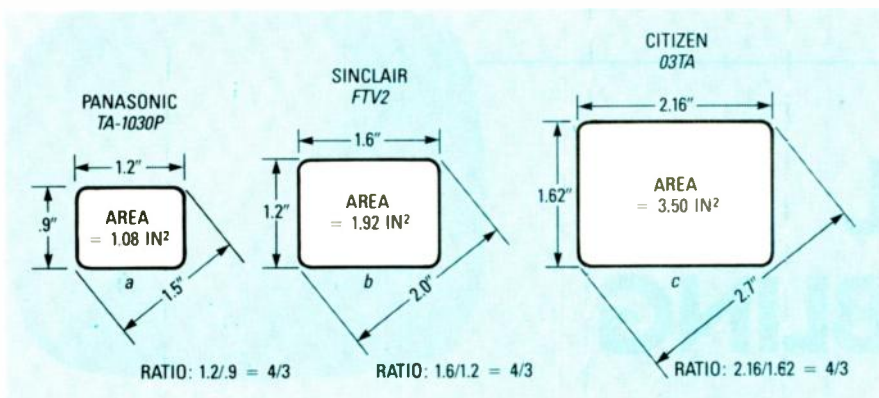

FIG. 2—DIAGONAL MEASURE versus viewing area for three popular pocket-TV sets. The Panasonic TA-1030P is shown in a, the Sinclair FTV2 is shown in b, and the Citizen 03TA is shown in c.

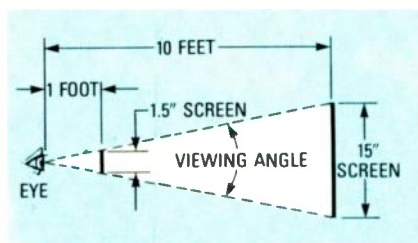

FIG. 3—A 1.5-INCH SCREEN, viewed at a distance of 1 foot, will yield the same viewing angle as a 15-inch screen viewed at a distance of 10 feet.

Other shades are created by turning on various mixtures of the primary-color pixels. If all the TFT's in a region are turned on, no light gets through and the image appears black. If none of them are turned on, all the primary colors get through and the image appears white.

Charting the sets

While the meaning of many of the entries in Table 1, our comparison chart, are obvious, some require further explanation. So, before discussing the individual TV sets, we'll first explain each of the chart headings. The notes and the remarks at the end of the chart provide much additional information.

Manufacturer or source: Most pocket TV sets are still relatively hard to find in local retail stores. Large electronics stores that carry many brands of TV and video equipment are the most likely sources. If you can't find a set you are interested in locally, you may wish to write the manufacturer for assistance. Also, some luxury catalogs, such as those available from Markline and The Sharper Image, frequently offer pocket-TV sets.

Model: It's not unusual for some pocket TV sets to look alike and yet be different in performance. Some are made by one manufacturer for another, but specifications may not be the same although appearance is identical. For example, the Citizen 03TA and the Radio Shack *Pocket-vision-3* look almost identical, but use a different screen technology and include

different accessories. Therefore, when shopping with our chart, look for specific model numbers.

Price: The prices shown are the manufacturer's suggested retail prices in effect at the time this article was compiled. As with most other types of consumer-electronics products, substantial discounts are usually available, either from dealers or from mail-order houses.

Size: The dimensions, given in inches, are approximate, and may not include minor protrusions such as switches or retracted antennas. The intention is to give you an idea of relative size. The designations of wide, high, and deep are made with the assumption that the user is looking at the surface of the unit that contains the viewing screen.

Screen characteristics: Some sets offer color but, with the exception of the Panasonic CT-101, you'll be disappointed if you expect picture quality that rivals your home color-TV set. That's because all of the color sets, except the CT-101, use an LCD instead of a CRT. While some LCD sets are surprisingly good, most have a way to go before they will equal the performance of conventional CRT's.

The screen sizes are given in inches measured diagonally, as is the convention with TV-screen specifications. However, that can be very deceptive when dealing with small-size sets. For example, the 1.5-inch Panasonic sets have a viewing area that is only about 50% of a 2-inch screen (that's probably why both Panasonic sets come with magnifiers). Figure 2 shows how diagonal measure relates to viewing area for three popular screen sizes. Note that the TV-standard 4:3 aspect ratio is maintained for all sets.

That is not to say that a 1.5-inch screen is too small. It depends upon how far it is from your eye. Figure 3 shows that a 1.5-inch diagonal screen one foot from your eye subtends the same viewing angle as a 13-inch diagonal television screen 10 feet away.

Probably the most important screen characteristic in determining the accept-

ability of the picture is the type of display. Subjectively speaking, a black-and-white CRT offers the highest levels of resolution and contrast. On the other hand, LCD screens, with their limited pixel counts and often poor contrast ratios, are the worst performers.

The clarity and contrast rating provided in the table are strictly the author's judgments, and are based on his comparisons between sets.

Adjustments: The trend by manufacturers in recent years has been to delete some of the traditional user controls from their TV sets. Among the controls that have slowly begun to disappear are vertical hold, contrast, and brightness. One reason for that is that modern integrated circuitry can control many of those parameters automatically, thereby eliminating the need for user override. Another is cost. The elimination of seldom-used controls does make the set a little less formidable to operate, but it also reduces your control over what you watch.

Speaker: If you don't expect much in the way of good sound from these sets, you won't be disappointed. Speaker location plays a role in the sound quality, with the worst performing units being those with the speakers mounted at the rear. Further, some sets are barely audible at maximum volume in noisy surroundings, such as a fast-food restaurant. Earphones are provided or available with all units, if you can tolerate typical earphone quality. The best sound was provided with the stereo earphones included with the Sony FD-30A and the Magnavox BF390IBK. Where quality ratings are provided (only on those sets tested), the rating was relative to other pocket TV's.

Computer monitor: Because of those TV set's small size, their use as a computer monitor is obviously marginal. However, the set's ability to display a 32- or 80-column computer screen is useful as a benchmark in determining its resolution capabilities. For all sets, the computer signal was coupled via a UHF modulator (channel 15) with a stub antenna. Where available, displays coupled via a video or external-antenna input were also evaluated.

Accessories: The large range of included and optional items are shown in this section of the chart. Most are self-explanatory, but further information can be found in the discussion of each individual set.

Next time

Of course, there's a lot more to be said for the various TV's than can be summarized in a chart. Next time, we'll provide in-depth, no-punches-pulled evaluations of many of the pocket-TV set currently available. If you are contemplating purchasing one of those sets, it is a round-up you won't want to miss. R-E

TV SIGNAL DESCRAMBLING

Learn all about what might be the ultimate scrambling system in this month's article.

WILLIAM SHEETS and RUDOLF F. GRAF

Part 2 LAST TIME WE LOOKED at several of the simpler scrambling techniques that are currently in use. All of those rendered the picture unwatchable by either reversing the video polarity or altering the sync in such a way that the receiver's sync circuitry could not lock onto the video signal.

However, all the methods discussed thus far have one major fault: They are "static." By that we mean two different things. First of all, the scrambling algorithm does not change over time. Once the scrambling technique has been determined, it is relatively simple to come up with a circuit that will unlock it. Further, nothing has been done to alter the order in which the video information is transmitted. The video signal is still transmitted line by line, frame by frame, in the same order as it was scanned. The audio is usually unaltered, though it may be hidden on a subcarrier.

Let's expand on that a bit. The static scrambling systems used on most pay-TV and cable-TV systems are not difficult to decode because of the following:

- There is a horizontal sync pulse (or hole) every 63.5 microseconds, and a new field every 16.68 milliseconds.
- The video signal at every instant has a fixed relationship with the scene that was scanned to produce that picture.
- All necessary decoding or unscrambling information is present in the video signal, or on another frequency or channel in a cable pay-TV system.
- Changes in picture content between adjacent frames is generally insignificant.

Thus, if the sync pulses were stripped

from a video signal (currently a very popular scrambling technique), the resulting signal would drop to zero at regular intervals. Those regions of zero signal, or "holes," would occur at the points where the sync pulses would be found normally. As we've previously seen, it is a simple matter to restore the normal sync pulses using a locally generated sync signal.

Scrambling the picture

Here's a thought to ponder for a moment: All of the previously discussed "scrambling" techniques in fact *do not scramble the picture*. All they do is disrupt the normal video waveform in such a way that a conventional TV receiver can not reproduce a watchable image.

But what if we could actually *scramble* the picture? Normally, a scene is scanned by the video camera and broken up into pixels. Those pixels are transmitted to the receiver one by one. At the receiver, the pixels are reassembled in the order in which they are received to recreate the original picture.

However, in theory there is no reason to scan the picture elements in any particular order. The picture could be thought of as a jigsaw puzzle, with each piece represented by a pixel. The puzzle could be put together in any order without affecting the final image that results. In a conventional TV system, scanning is done from left to right and top to bottom, but that is not the only scan sequence that is possible.

What would happen if we reversed the scan process? That would cause the TV picture to be inverted top to bottom, left to right. A quick "descrambler" for that

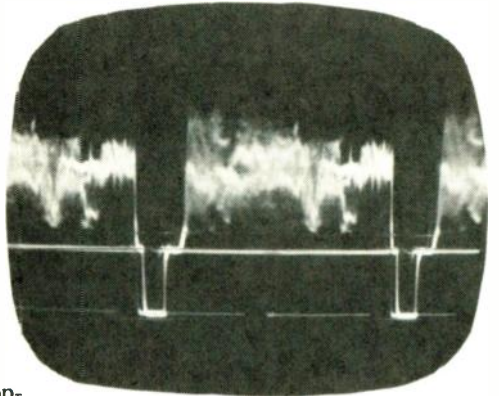

Over the next few months, **Radio-Electronics** will be presenting a series of articles describing the techniques used by pay-TV and cable companies to scramble their signals. While specific circuits for specific scrambling systems will be discussed, they are presented for *informational and experimental purposes only*. Therefore, parts lists, parts suppliers, and additional technical support will *not be available* for those circuits.

would be to turn the TV set upside down.

But suppose we began the scan at the midline of the picture. Then the bottom half would appear above the top half and things would appear to be cut in two. By now you of course realize where we're heading. We could cut the picture into four strips and scan them in 2, 4, 3, 1 order. The result would be a nearly unrecognizable picture.

Continuing on, suppose we scanned the 262½ lines per field in any random order. The resulting picture would be unrecognizable—like an unassembled jigsaw puzzle.

Finally, we could break up each line into random segments and scan them in random sequence in each line. All the pixels would still be there, but the picture would look like nothing more than colorful confetti. It would be as if someone tore the picture into tiny pieces and threw it on the floor.

Of course, there is a significant dif-

ference between what is theoretically possible and what is practical. For instance, at the receiving end, conventional, magnetic-deflection CRT's are simply incapable of displaying a picture generated by complex scanning satisfactorily. Further, the sweep circuitry in conventional TV receivers is not capable of generating the type of high-speed, high-precision waveforms needed to properly drive the CRT. It is, of course, possible to redesign the sync circuits and the CRT so they are capable of providing the appropriate drive signals; but the TV set that would result would be prohibitively expensive.

Introducing digital scrambling

There is, however, another approach—use digital technology. Thanks to modern VLSI techniques, the cost of a digital scrambling system is rapidly becoming affordable. Let's see what's involved.

It is a relatively simple task to represent the luminance and chrominance information of each pixel in digital form. Each pixel could, for example, be represented by sixteen different luminance levels and sixteen different chrominance levels. If that were done, any pixel could be described by one of the 256 possible combinations that would result. Further, if our digital system used 8-bit "words," any pixel could be completely described by one byte of data.

A standard TV set, one with a bandwidth of 3.5- to 4-MHz, has a resolution of about 250 vertical lines. That translates to a resolution of 250 pixels per line. (On a 25-inch set, which would have a screen width of about 20 inches, such resolution would allow you to see details that were as small as about $\frac{1}{10}$ inch.) Thus, all of the information contained in a line could be stored in a 256-byte memory.

If we wished, even more video information could be stored easily. For instance, each field has 262.5 lines. However, only 249.5 to 241.5 lines are actually displayed; the rest are lost to vertical retrace. That means that a complete field of video can be stored in a $256 \times 256 = 64K$ memory.

Of course, once that data is stored, we will need to retrieve that data at a fairly high rate if a usable video image is to be displayed. For instance, if we are storing our data by field, remember that 60 such fields are displayed per second. Thus our access rate must be $60 \times 64K = 3.84$ megabytes per second. Those of you familiar with the capabilities of current digital technology will realize that the hardware needed to implement such a system is available, but not inexpensive.

Now the fun begins. Once the data is safely in memory, there are few rules to

restrict the order in which that data is retrieved. Thus, the order of the pixels within a line may be scrambled (called line dicing), the order of the lines in a field may be scrambled (called line shuffling), or both.

Let's expand on that thought. The pixels of video data stored in memory could be thought of as pieces of a jigsaw puzzle stored in a box. If we could assign a numerical code to each piece, and if we had a map or chart showing where each piece should be placed, the puzzle could be assembled without wondering where each piece fits or having to figure out what part of the picture it represents.

That code could be assigned in one of several ways. One would be to break up each line into eight segments. Using a binary numbering scheme, the segments would be numbered from 000 at the extreme left to 111 at the extreme right. The ordering of the line could then be altered during transmission. At the receiver end, the segments would be placed in memory in the order in which they are received.

The proper sequence of segments could be relayed to the receiver in many ways. For instance, it could be hidden in the horizontal blanking interval, put on a sub-carrier, etc. Once the receiver has the proper segment sequence, it is easy enough to pull the stored segments out of memory in the proper order.

What makes such a scrambling system so hard to break is that the encoding can be changed at any time. Each line could be scrambled in a different manner. Or all the lines in one field or frame could be scrambled in one way and all the lines in the next field or frame in another.

If line shuffling is used, the lines can be sent to the receiver in any order. If that is done, the decoding algorithm can be sent

prior to each field during the vertical blanking interval. For maximum security both line dicing and line shuffling can be used with changing algorithms.

To give you a better idea of the level of security that those systems could provide, let's stop and consider the number of possible combinations of segments that line dicing and line shuffling can give us. If we were to dice a line into 8 segments, there would be $8!$ (read 8 factorial) possible combinations. For those unfamiliar with factorial computations, $8! = 8 \times 7 \times 6 \times 5 \times 4 \times 3 \times 2 \times 1 = 40,320$.

Now consider the number of lines in a field—rounding down, there are 262. If all of the lines in a field were shuffled, there would be $262!$ different possible combinations. (If you don't mind, we'll leave the actual computation as an exercise for an adventurous reader.) And that's just for one field; there are some 60 such fields per second, 3,600 per minute, and 108,000 per half hour. Add a constantly changing algorithm and *addressability* into the equation and you have a video "pirate's" nightmare.

For those unfamiliar with the concept, addressability allows you to send certain signals—such as descrambling algorithms—only to those decoders that have been registered as belonging to paying subscribers. Addressable decoders are now being used by many of this country's largest pay-TV distributors.

A block diagram of a system capable of carrying out the scrambling we've just described is shown in Fig. 1. In that system data stored in memory is first read out, then incoming data is read in. The result is a delay of one field (or line or frame, depending on the system). Because of the times involved (remember, 60 fields are displayed per second), the effect

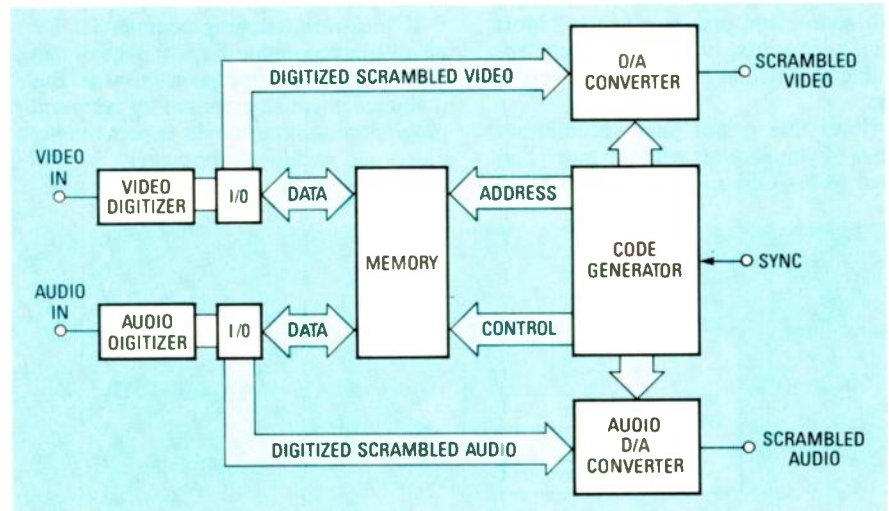

FIG. 1—A DIGITAL-SCRAMBLING SYSTEM is shown here in block diagram form. An unauthorized viewer would find that descrambling that signal is a near impossible task.

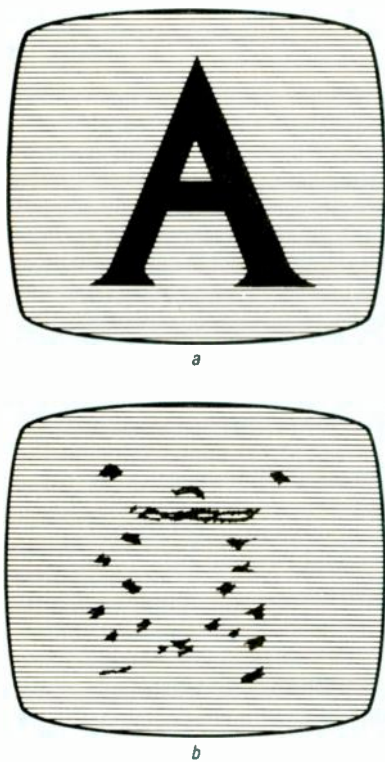

FIG. 2—IF A DIGITAL-scrambling technique such as line shuffling were used, a normal video image (a) would be reduced to colorful confetti (b).

of that delay is nonexistent. Of course, the data is read in in the sequence in which it is received, but is read out in the order determined by the code generator. The code generator establishes the order of the scrambling under direction of the "sync" signal. Note that that sync signal is the scrambling algorithm that we spoke about previously. The result is that a normal picture, like the one shown in Fig. 2-a will become completely scrambled, like the one shown in Fig. 2-b.

As indicated in Fig. 1, there is no reason that digital scrambling need be limited to just video. In fact, the task is much easier with audio, and just as effective. Most movies, concerts, etc., are not very enjoyable if they can't be heard as well as seen.

All of this is not pure speculation. Those of you familiar with the much heralded M/A-COM *Linkabit* system know

that the age of affordable digital scrambling has arrived. That system is used by HBO and other satellite programmers to limit access to their uplinked signals. The video scrambling method used by M/A-COM is rather primitive, and easily unlocked. The audio is another matter. It is scrambled using a sophisticated digital technique, one that makes use of a constantly changing algorithm and the addressability of the *Linkabit* decoders. Breaking that system should prove to be a formidable task.

Another scrambling method

Before we leave the area of theory, let's look at one more possible approach to scrambling the video. That system introduces a switchable time delay that alters the spatial relationship between successive horizontal lines.

A block diagram of the system is shown in Fig. 3. As you can see in that figure, the technique makes use of one or more delay lines. That allows for various amounts of delay, or no delay at all, to be selected for each horizontal line. The result is that a normal signal, like the one shown in Fig. 4-a, becomes one with severe ghosting and distortion, like the one shown in Fig. 4-b.

Scrambling and picture quality

One consideration with any scrambling system is how it affects the quality of the picture seen by paying subscribers. Gated sync and sinewave, and related methods, introduce deliberate interference into the video signal. While decoders do a good job of removing the interference, they are not perfect. There is always some residual video noise or interference left over. On a good quality, large-screen receiver or video monitor the effect is noticeable and may be objectionable. Further, with the use of audio subcarriers, the bandwidth of the audio that is received is somewhat reduced, resulting in less than optimum audio quality.

If you were watching commercial TV on a 19-inch portable TV set, none of that may be of great consequence to you. But if you are paying a premium for premium programming, you would expect quality video and audio. Unfortunately, scrambling may make that expectation unre-

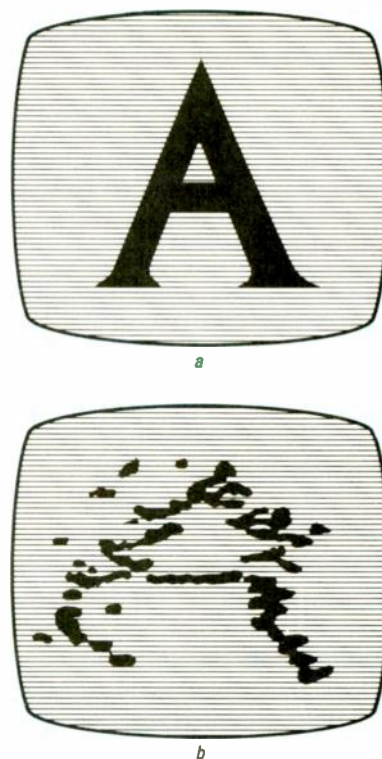

FIG. 4—DELAYING THE VIDEO INFORMATION can turn a normal video image (a) into one with severe distortion and ghosting (b).

alistic. It is something that should be considered when deciding whether or not you wish to receive a scrambled premium system.

However, digital scrambling may affect video quality in a very different way. Higher resolution, reduced video noise, and reduced interference problems are just some of the improvements possible with digital-TV technology. That's why digital TV is currently such a hot topic.

All of those advantages could also be passed on to the viewer of a digital-scrambling system, especially if the video were viewed on a high-quality, high-resolution monitor. Just as the order of assembly does not affect the way a completed jigsaw puzzle appears, the scrambling/descrambling process would have no detrimental effect on the way the displayed video would appear. In fact, one proponent of a digital video-scrambling system claims that the improvement in the signal-to-noise ratio over that of the baseband video would be about 2 dB.

Next time

So far we've seen some of the many different ways that programmers could scramble their signals to prevent access by unauthorized viewers. And we've examined those systems at the block-diagram level. But what about the circuitry necessary to implement those scrambling/descrambling systems? That's our topic for next time.

R-E

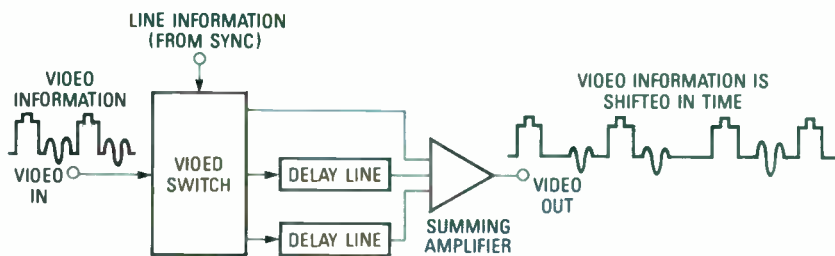

FIG. 3—IN THIS ANALOG scrambling system, adding varying amounts of delay to the video will result in spatial displacement of the horizontal lines. The result is a video image with severe distortion.

BUILD THIS

1.2 GHz FREQUENCY COUNTER

Who says a frequency counter must be big and expensive? Our little counter can measure signals into the gigahertz range, and it can be built for under \$60!

FRED HUFFT

THE PRICES OF VARIOUS TYPES OF TEST instruments have been dropping like ducks in a shooting gallery the past few years. The latest victim is the frequency counter. When digital frequency counters first appeared in the early 1950's they were very large, very expensive, and, by today's standards, very limited. However, inexpensive LSI frequency-counter IC's and high-speed ECL prescalers have been developed in the past few years.

Those IC's allow us to offer you a high-performance, hand-held frequency counter for under \$60. It can measure the frequency of signals ranging from 1 Hz to 1200 MHz, and it has sensitivity under 25 mV throughout most of its useful range. In fact, using a 19-inch telescopic antenna, we can measure the output of a $\frac{1}{10}$ -watt, 146-MHz handie-talkie that is located more than 20 feet away! Our frequency counter has many other features rivalling units selling for several times its price. Complete specifications are shown in Table 1.

Design Philosophy

Our main design objectives were to produce a 1-GHz counter with good sensitivity, and with minimal size and cost. To meet those objectives we selected two key parts: Intersil's LSI frequency counter, the 7216D (IC1 in Fig. 1), and RCA's ECL prescaler, the CA3179 (IC2).

The Intersil IC was chosen because it

contains all the circuitry necessary to count, generate gate signals, latch data, and drive a multiplexed LED display. It also has an MIP (Measurement In Progress) output, and control inputs for decimal-point placement and gate time.

The second key part is the RCA CA3179 amplifier/prescaler. It is an ECL part with an exceptional bandwidth of 1200 MHz and with excellent sensitivity. As you can see in Fig. 2, the CA3179's 500-MHz input has a sensitivity of about 10 mV rms above 100 MHz. Below that frequency, sensitivity is inversely related to frequency, rising to 125 mV at frequencies below about 2 MHz. As you can see in Fig. 3, the CA3179's 1200-MHz input is about 25 mV over the 300-1000-MHz range.

The CA3179 requires a single five-volt supply, and it runs barely warm to the touch. That makes it the only IC of its kind we know of that does not run hot in normal operation. Last, it is inexpensive and easy to find.

A few other inexpensive components round out our frequency counter. Refer-

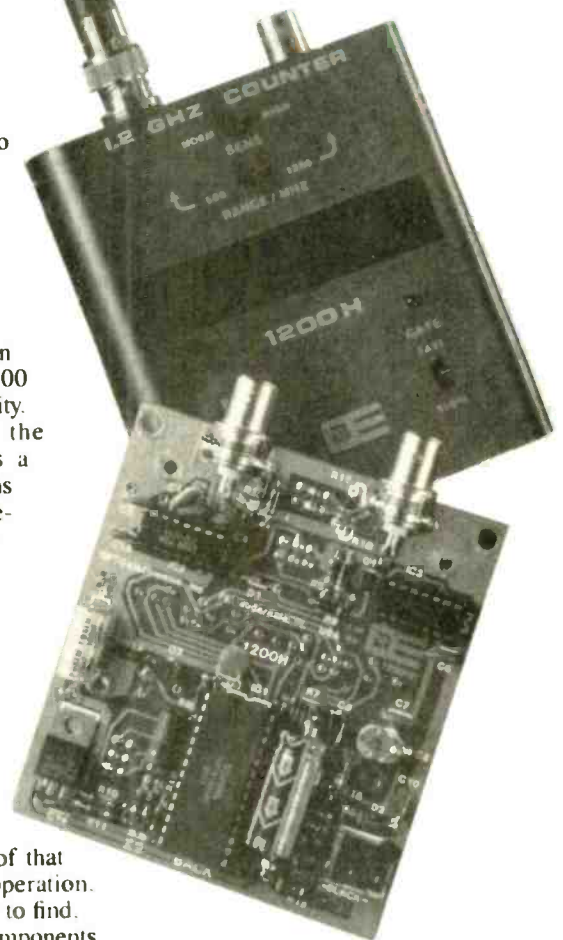

TABLE 1—FREQUENCY COUNTER SPECIFICATIONS

Range	1–1200 MHz
Gate time (fast)	0.25 second
(slow)	2.5 seconds
Resolution	100 Hz (fast gate time) 1000 Hz (slow gate time)
Display	Eight 0.28-inch high, 7-segment LED displays, common-cathode. Decimal point indicates MHz. Leading zero blanking.
Sensitivity (1–10 MHz)	100–150 mV rms
(10–1000 MHz)	1–35 mV rms
(1–1.2 GHz)	10–150 mV rms
Accuracy	± 1 PPM RTX0 timebase, ± 1 count in LSD
Timebase aging	0.1 PPM/month
Input impedance	50 ohms
Gate LED	Illuminates during count
Input connectors	2 BNC female jacks
Input power	9–14 VDC, 150 mA, internally regulated
Optional battery pack	Six AA Ni-Cd cells (7.2 volts)
AC adapter and battery charger	9 VDC, 300–500 ma
Input power connector	1/8-inch jack, center positive
Case	0.060-inch anodized aluminum
Size	3.9 × 3.5 × 1.5 (inches)
Weight	8.5 oz, 13 oz with battery pack

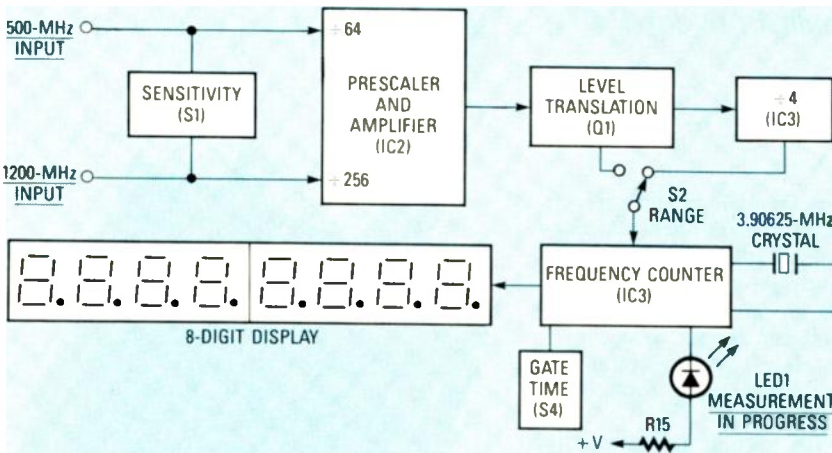

FIG. 1—BLOCK DIAGRAM OF THE FREQUENCY COUNTER reveals that only three IC's and a few discrete components are needed to produce a high-performance 1-GHz counter.

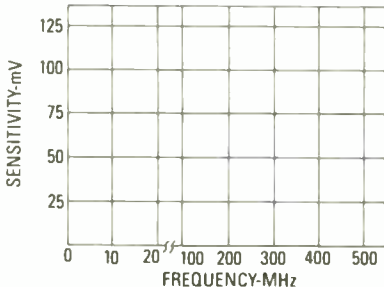

FIG. 2—RMS SINEWAVE SENSITIVITY of the CA3179's 500-MHz input is a flat 15 mV from 100 to 450 MHz.

little power. RANGE switch S2 allows you to select either the divide-by-four output or the direct output from the pre-scaler. Your chosen signal is then passed on to IC1, which processes it for output on the LED displays, two four-digit, common-cathode, multiplexed displays with 0.28-inch high digits.

The circuit is powered by an external AC adapter or an optional built-in Ni-Cd battery pack (which is trickled charged by the adapter). Separate switches are

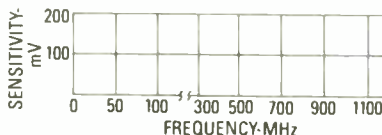

FIG. 3—RMS SINEWAVE SENSITIVITY of the CA3179's 1200-MHz input is a fairly flat 25 mV from 300 to 950 MHz.

ring back to Fig. 1, the output of the pre-scaler is fed through a level translator and then to two "D" flip-flops configured as a divide-by-four counter. We use a 74LS74 dual-D flip-flop because it is inexpensive and readily available, and because it uses

provided to control SENSITIVITY (S1) and GATE TIME (S4).

Circuit Description

Referring now to the complete circuit diagram in Fig. 4, you can see that the output of the CA3179 is fed through the D1/Q1 circuit. Those components serve to boost the 1-volt output of the CA3179 to a standard TTL level. Then, depending on the position of RANGE switch S2-b, the signal is passed directly to the 7216, or through the divide-by-four circuit built from the two "D" flip-flops in IC3.

The other half of the RANGE switch (S2-a) controls the voltage at pin 3 of the CA3179. When pin 3 is high, the signal applied to pin 9 is fed through an extra internal divide-by-four stage before it is amplified and output on pins 4 and 5. When pin 3 is low, the signal on pin 13 is simply processed for output without being divided internally.

We use a 3.90625 MHz crystal for our time base; the crystal yields a fast gate time of 0.256 second. The displayed frequency equals the input frequency divided by 1000 in the fast mode. In slow mode, gate time is 2.56 seconds. The displayed frequency equals the input frequency divided by 100 in the slow mode.

Switch S4, GATE TIME, performs two functions. First it selects the appropriate gate time according to which digit output of IC1 the RANGE input is connected to. Another of the 7216's inputs is also controlled by S4: the DP SELECT input. The decimal point of the digit output to which that pin is connected will be the one that lights up. In our case, the correct decimal point illuminates, according to the position of S4, to provide a reading in MHz.

Self-oscillation

Due to the high gain, balanced-input amplifiers in the CA3179, self-oscillation can occur with no input signal present. The result is a random, constantly-changing count. Although that does not affect the performance of the counter, it can be distracting.

To settle the display we added SENSITIVITY switch S1 and the associated resistors and capacitors. When the switch is on, the RC networks eliminate display bobble. The difference in sensitivity varies with frequency. For example, at 150 MHz, normal sensitivity is typically 15 mV rms, and high sensitivity is about 6 mV rms. But at 850 MHz, normal sensitivity is typically 40 mV rms and high sensitivity is about 25 mV rms.

The output of IC1 drives Q2, which in turn drives LED1. When it is illuminated, a measurement is in progress. The LED goes out for a fraction of a second between measurements.

For greatest accuracy, trimmer C8 can be adjusted so that the output of the oscillator is exactly 3.906250 MHz. For

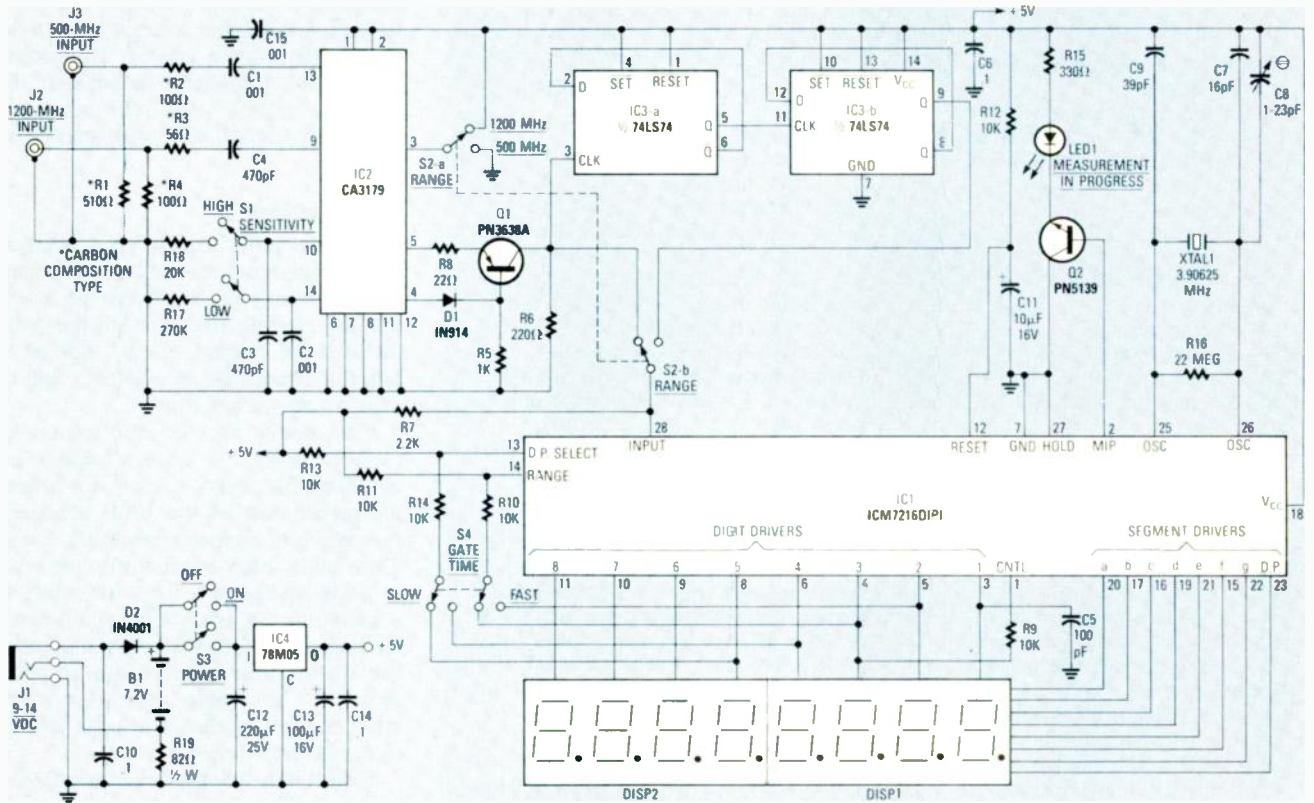

FIG. 4—SCHEMATIC DIAGRAM OF THE FREQUENCY COUNTER is a model of design simplicity. Transistor Q1 and associated discrete components translate IC2's ECL output into a TTL level for IC3 and IC1.

greatest frequency stability, C7 should be an NPO type, and C9 an N750. In case you're wondering, temperature causes almost no change in capacitance in an NPO capacitor; the capacitance of an N750 capacitor will decrease 750 parts per million for each 1°C increase in temperature.

The power supply is a standard 7805 circuit. Input voltage can range from 9–14 volts DC; input should never exceed 14 volts. Diode D2 protects the circuit from an accidental reversed-voltage input.

Power input jack J1 has a switch contact. When no plug is present, the contacts are closed, so the negative terminal of the battery is grounded. When a plug is present, R19 appears in the battery's ground circuit; that resistor is what provides trickle-charging. With a 9-volt input, a charge current of 25–45 mA will be provided. Charging occurs even when POWER switch S3 is off. You should ensure that charge current never exceeds 45 mA; adjust the value of R19 if necessary.

The Ni-Cd battery pack specified in the Parts List is rated at 45 mA. This means that a charge current of 45 mA will fully charge a completely discharged pack in about 14 hours, and that the batteries won't be harmed by continuous charging at that rate (or less). For maximum battery life and capacity, Ni-Cd's should occasionally be "deep cycled" several times by completely discharging and then fully

recharging them. That should prevent a discharge "memory" from forming at less than the full rated output voltage.

Voltage regulator IC4 provides a regulated five-volt DC output when S3 is closed. Regulated voltage is especially important to the timebase oscillator, because, as the battery's voltage varied throughout its life, so would the frequency of the timebase. Erroneous measurements would result. With a good source of

regulated voltage, however, the timebase circuit should maintain ± 1 -PPM stability at room temperature. Both temperature stability and accuracy are almost totally dependent upon the crystal used.

The counter circuitry by itself draws about 120 mA; in combination with the battery charger, about 150 mA will be drawn. The optional Ni-Cd battery pack should give up to 5 hours of continuous operation, which is more than adequate for most portable requirements. In any case, we recommend that your DC source be able to supply at least 300 mA for safe and reliable operation.

That's about all there is to the circuit—so let's build a frequency counter!

PC board

For ease of construction, we recommend use of a double-sided PC board. You can buy an etched, plated, labeled, and solder-masked board from the source mentioned in the Parts List, or you can etch your own board using the foil patterns shown in "PC Service."

For flexibility, the PC layout has a number of extra pads and holes to accommodate capacitors of various sizes and shapes. That applies to C2, C3, and C4, and to trimmer C8. We designed a partial micro-strip layout for the input connectors (J2 and J3) to simplify assembly and to approximate a 50-ohm input impedance.

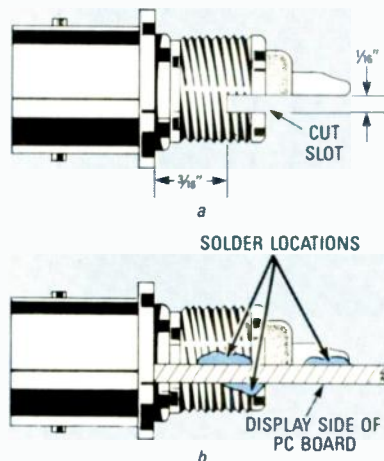

FIG. 5—A BNC CONNECTOR must be modified as shown in a so that it can be soldered to the PC board as shown in b.

PARTS LIST

All resistors are 1/4-watt, 5% unless otherwise noted.

R1—510 ohms, carbon composition
 R2, R4—100 ohms, carbon composition
 R3—56 ohms, carbon composition
 R5—1000 ohms
 R6—220 ohms
 R7—2,200 ohms
 R8—22 ohms
 R9—R14—10,000 ohms
 R15—330 ohms
 R16—22 megohms
 R17—270,000 ohms
 R18—20,000 ohms
 R19—82 ohms, 1/2 watt, 10%

Capacitors

C1, C2, C15—0.001 μ F ceramic disc
 C3, C4—470 pF ceramic disc
 C5—100 pF ceramic disc
 C6, C10, C14—0.1 μ F ceramic disc
 C7—16 pF ceramic disc, NPO
 C8—1-23 pF trimmer
 C9—39 pF ceramic disc, N750
 C11—10 μ F, 16 volts, electrolytic
 C12—220 μ F, 25 volts, electrolytic
 C13—100 μ F, 16 volts, electrolytic

Semiconductors

IC1—ICM7216DIP1 universal frequency counter (Intersil)
 IC2—CA3179 ECL pre-scaler (RCA)
 IC3—74LS74 dual "D" flip-flop
 IC4—7805 5-volt regulator (TO-220 case)
 Q1—PN3638A transistor (ECG159)
 Q2—PN5139 transistor (ECG108)

DISP1, DISP2—DL-4770, four-digit, seven-segment, common-cathode multiplexed display (Litronix)

LED1—standard red LED
 D1—1N914 switching diode
 D2—1N4001 rectifier

Other Components

S1—S4—subminiature DPDT slide switch
 J1—1/8-inch power jack with switch
 J2, J3—BNC connector, female, bulkhead mount, modified (see text)
 XTAL1—3.906250 MHz crystal, parallel resonant, 22 pF, HC-18 case.

Miscellaneous 3/16" high by 1/4" OD nylon spacer, IC sockets, PC board, case, power pack, etc.

Note: The following items are available from Optoelectronics, Inc., 5821 N.E. 14 Ave., Ft. Lauderdale, FL. 33334: PC board (no. PCB-1200H), \$16; Kit including PCB and all parts less cabinet (no. 1200HK), \$59.95; Anodized cabinet with red lens (no. CAB-1200H), \$20; Power adapter/charger (no. AC-1200), \$7.50; Ni-Cd battery pack (no. NiCd-1200), \$20; Telescoping RF antenna (no. TA-100), \$12; Vinyl zipper case (no. CC-70), \$10; 50-ohm 1 \times probe (no. P-100), \$18; Wired, tested and calibrated counter (no. 1200H), \$110. Individual components also available. Florida residents add 5% sales tax. All orders add 5% for shipping and handling.

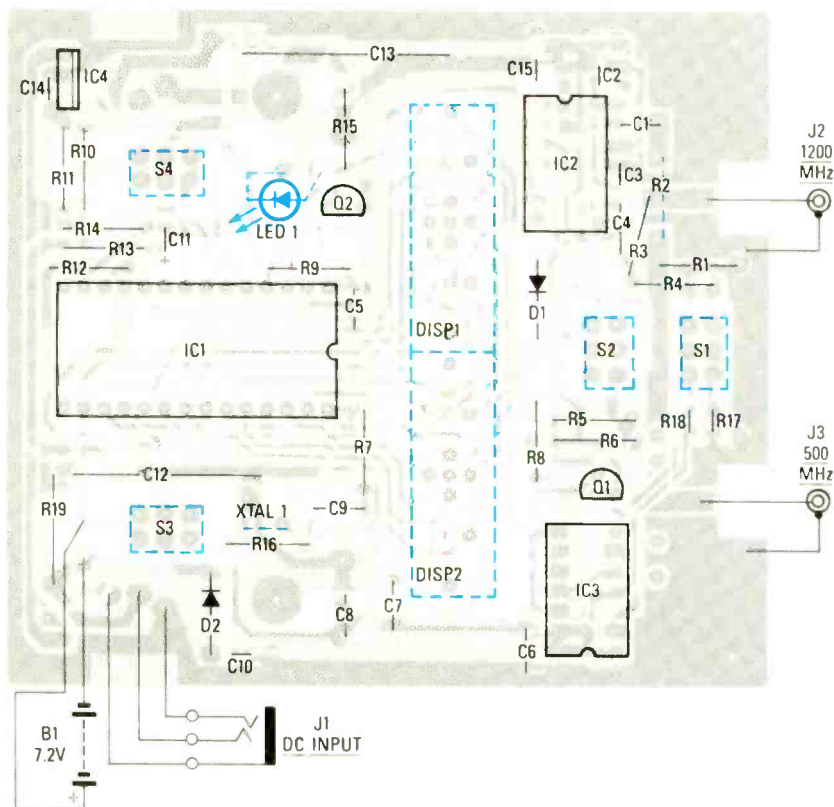

FIG. 6—PARTS PLACEMENT DIAGRAM. Most components mount on the bottom of the board. The switches, displays, R2 and LED1 are shown in dashed lines; they should be mounted on the opposite side of the board. The leads to the battery attach to the bottom side; BNC jacks J2 and J3 should be soldered to both sides of the board.

In addition, the PC board has two notches at the top to accept modified BNC connectors, and another notch along one side for the power-input jack J1. The notches for the BNC connectors should be 0.365" wide and 0.250" deep. The power-jack notch should be 0.430" wide and 0.150" deep.

Construction

Our frequency counter was designed for quick and easy assembly; by following the directions you should have no trouble building, testing, or calibrating the instrument. We'll call the "front" side of the board the side that the switches and the displays are mounted on.

First modify the two BNC connectors as shown in Fig. 5-a. Using a hacksaw or a modeling file, cut a 1/16-inch slot beneath the center post of the BNC connector, leaving 3/16 of an inch beneath the flange. Then solder each connector to the board as shown in Fig. 5-b. The connectors are soldered to the adjoining ground planes on both sides of the PC board; that makes the installation both strong and well grounded. The center conductors of the BNC connectors should also be soldered to the PC board now.

Next, on the back side of the board, as shown in Fig. 6, install the low-profile components (the diodes and resistors), followed by the IC sockets, then the capacitors, etc. Be certain to observe proper polarity when installing the diodes, the electrolytic capacitors, the IC sockets, the battery connector, and, on the front of the board, LED1 and the displays. By the way, we found almost no difference in performance with and without sockets, but using them makes servicing easier.

Since the counter will be dealing with rather high frequencies, R1-R4 and C1-C4 should be installed with minimum lead length. Also, resistors R1-R4 should be the non-inductive, carbon-composition type; the other resistors may be either carbon composition or film types. Capacitors C1-C4 should be small ceramic disk or monolithic ceramic types. All input components should be installed as neatly as possible.

To complete the back side of the board, install the voltage regulator (IC4), trimmer capacitor C8, and all small capacitors. Bend the leads of the regulator so that its body is parallel to the PC board. A heatsink is unnecessary. Next install power jack J1 and transistors Q1 and Q2.

Clean flux off the front side of the board, and then install the switches, DISP1 and DISP2, XTAL1, LED1, and R2, according to Fig. 6. The LED should be mounted above a spacer 3/16 inch in length. The displays should be mounted flush against the board. When installing the displays, the IC sockets, and any other components with numerous solder connections, it's best to solder two or three

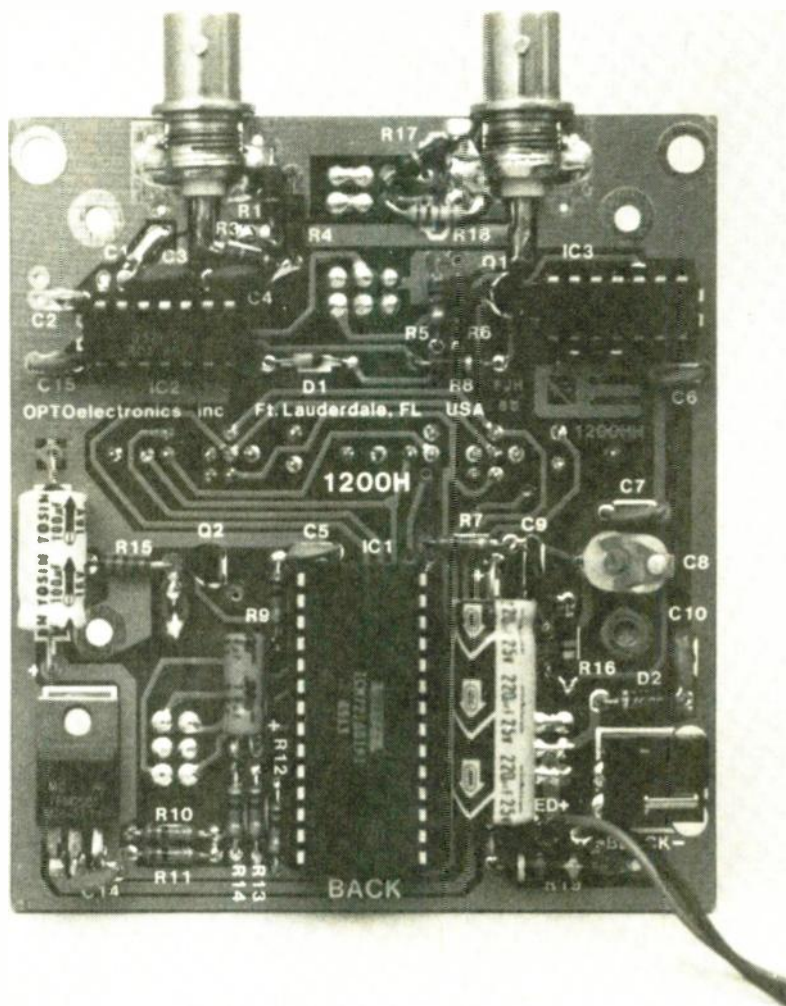

FIG. 7—ONCE ALL COMPONENTS are in place, clean the board and check your work for any shorts or opens.

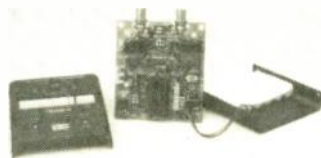

FIG. 8—ONCE INSTALLED IN ITS CASE, the counter makes a neat, compact, and easily transportable test instrument.

pins, check for alignment, correct if necessary, and only then solder the remaining pins. A small piece of double-sided foam tape should be placed under the crystal to insulate its case and to provide a shock mount. Finally, install the electrolytic capacitors, C12 and C13, on the rear side of the board.

Now clean the board and check it thoroughly for solder shorts and opens. When

you're satisfied that the board is in good shape, install the IC's. Your board should now appear as in Fig. 7.

Initial check-out

Set the SENSITIVITY switch to NORM and the GATE switch to FAST. With the RANGE switch in either position, apply power. The GATE LED should blink and the display should indicate .000 with leading digits blanked. Move the GATE switch to the SLOW position. The display should now read .0000, and the GATE LED should blink at a slower rate. Now move the SENSITIVITY switch to HIGH; the display should show a random, changing count on both ranges.

If the display is dim or blank, remove power, and make sure all IC's are installed correctly. If so, check the orientation of all the diodes and electrolytic capacitors. Re-check the PC board for shorts and opens if necessary. Finally, your power source may be weak or dead, or a switch may be bad.

Calibration and final assembly

To calibrate the counter, let it warm up for at least ½-hour, connect a stable signal of known frequency to the proper input jack, and then adjust trimmer capacitor C8 for proper display. Use the highest frequency you can and the slow gate time in order to get maximum resolution and accuracy.

Remember that a counter's accuracy is specified in PPM (Parts Per Million), and if a reading is 1 PPM high at one frequency, the counter will read 1 PPM high at all frequencies. At 1 MHz a 100 PPM error would, in many applications, be insignificant. But a 100 PPM error at 1 kHz would be quite significant. So calibrate the counter carefully!

When it is calibrated, you can mount it in its case, see Fig. 8. If you use the case mentioned in the Parts List, the PC board just slips into it. The BNC connectors and the power jack should line up with the holes in the case perfectly. Drop a red plastic filter over the displays and then screw the case together. You're ready to start using your 1.2-GHz frequency counter now!

Usage hints

Keep in mind that the counter requires only a few millivolts to make an accurate reading—seldom more than about 50 mV. Inexperienced users commonly overdrive the frequency counter—and that could cause erroneous readings or circuit damage. Signals of several volts or more should be loosely coupled by a small capacitor or picked up inductively by a loop-type probe or antenna. When connecting the frequency counter directly to a circuit, use a 10K series resistor to reduce ringing and to lighten the load on the test circuit. Other than following those simple precautions, you should have no trouble using the counter.

Since the the price-to-performance ratio of this circuit is so good, you may want to install one permanently in a piece of equipment such as a ham rig or a commercial radio transmitter. That way you could have a continuous indication of output frequency, and any drift could be corrected before it caused interference to stations transmitting on nearby frequencies.

Or, for a very handy and versatile piece of test gear, you could combine our circuit with an inexpensive function generator in a single cabinet. Also, it would be easy to adapt our circuit for automotive or marine use. If you do, be sure to wire a ¼- to ½-amp fuse in series with the counter's power input line.

As you can see, our frequency counter is so inexpensive and so easily adaptable that new applications for it seem to suggest themselves! You'd better start building several—you'll use 'em before you know it!

R-E

RADAR SIGNAL DETECTOR

If you think that a sensitive radar detector is a complicated and expensive piece of equipment, have we got a surprise for you!

GREGORY HODOWANEC

RADAR DETECTORS ARE USUALLY COMPLICATED and expensive devices, but a simple, yet effective, detector can be built in a small plastic case for less than ten dollars! The circuit, which can be tuned to respond to signals between 50 MHz and 500 GHz, is a modified version of the author's gravity-wave detector presented in April's issue. We'll actually present two different circuits, an "economy" and a "deluxe" model.

How they work

The economy model's schematic is shown in Fig. 1, and the deluxe model's schematic is shown in Fig. 2. The main difference between the two circuits is that the economy model simply drives a piezo-electric transducer directly from an op-amp, while the deluxe model uses an LM386 audio power amplifier to drive a small speaker. Doing that allows the extra

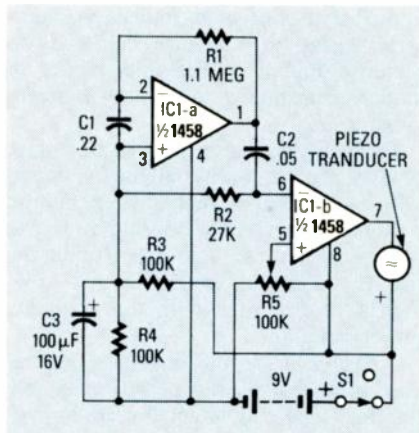

FIG. 1—THE ECONOMY RADAR DETECTOR needs only one IC and a few discrete components.

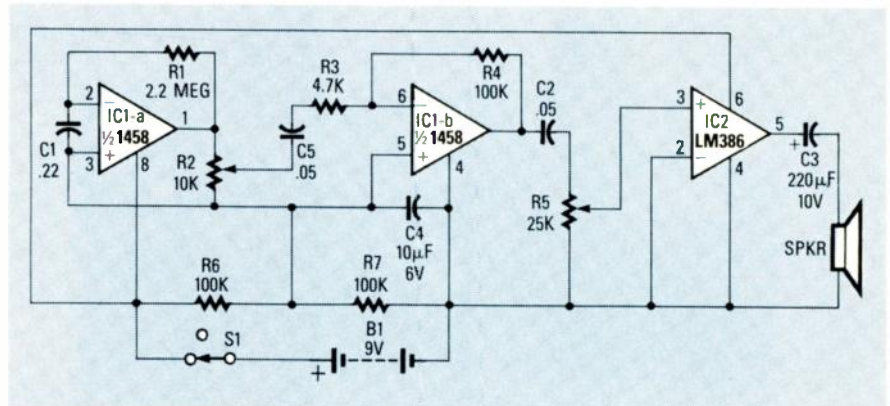

FIG. 2—DELUXE RADAR DETECTOR adds a buffer amplifier and an audio power amp to drive a speaker.

op-amp stage to be used for additional buffering, and that makes for a more sensitive detector.

The first op-amp in each circuit (IC1-a) functions as a current-to-voltage converter. Then, in the economy model (Fig. 1), IC1-b buffers the output to drive the piezo buzzer. Potentiometer R5 sets the switching threshold of IC1-b; normally it is adjusted so that the circuit barely triggers on background noise, then it's backed off a bit. That should provide plenty of sensitivity to incident RF.

Resistors R3 and R4, and capacitor C4, serve to "split" the supply voltage. To get more sensitivity from the detector, those components could be eliminated and two series-connected nine-volt batteries used instead. In that configuration, the junction of the batteries would be connected to the point where R3, R4, and C4 now meet. Alternatively, for mobile operation, twelve volts could be tapped from your car's cigarette-lighter jack.

The deluxe model functions in a similar manner, except that IC1-b is configured as a $\times 20$ buffer amplifier to drive the LM386. Potentiometer R2 adjusts threshold here, and potentiometer R5 functions as a volume control.

In both circuits, input capacitor C1 functions as a "transmission-line" that intercepts both electrical and magnetic components of incident radar signals. While it is a low-Q circuit (it is very broadband), the response may be further optimized by trimming C1's lead lengths for the desired frequency, as shown in Fig. 3. To detect typical road-radar systems, the input capacitor's leads should be about 0.5–0.6 inches long.

In both circuits the detector provides a "ringing," or slowly-decaying output with a resonance of about 400–600 Hz for the component values shown. Feedback resistor R1 may be adjusted for another "ring" frequency, if desired.

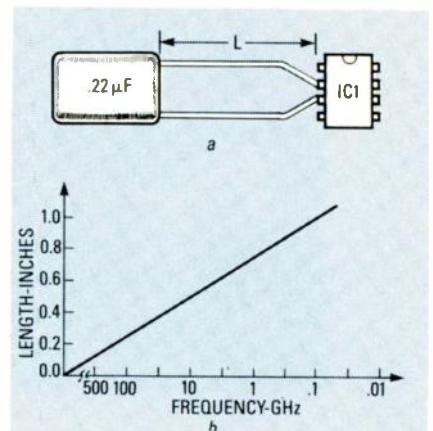

FIG. 3—VARY THE LEAD LENGTHS OF C1 to tune the input circuit.

Construction hints

Whichever detector you choose, build it in a non-metallic case so that incident RF won't be blocked. However, make sure that only R1 provides feedback to the detector's input. Since the gain of the detector is so high, unwanted feedback can force the input stage into continuous oscillation, rather than the "ringing" oscillation that decays in time. Should unwanted feedback become a problem, a small capacitor (0.005–0.01 μF) across resistor R4 may help, as may a 200–500 μF capacitor across the battery.

Perfboard construction is preferable to PC-board construction because reduced wiring capacitance and the absence of a ground plane will reduce the chance of unwanted feedback. Likewise, it's better to use a small shielded speaker for output because magnetic (and gravitational) energy from the speaker could feed back to the input. So keep C1 as far from the speaker as possible.

The detector should perform properly with little adjustment. After applying

continued on page 97

Heathkit



A completely mobile, programmable, electromechanical robot, HERO® 2000 is capable of interacting with its environment free of external control.



Home! Get the latest in amateur radio technology including high-speed Packet Radio Communication.



Powerful new IBM-PC compatible Heathkit computers are yours to build easily and save with, or to buy assembled.



Build from our full line of precision test instruments and see how they can increase your troubleshooting effectiveness.



New Digital Rain Gauge records rainfall accurately and reads out inside your home in 100ths of an inch.

Your guide to everything that's new in electronics, computers and technical education. Over 400 items. Discover fascinating kits to build, enjoy and learn with, as well as assembled high tech products for home, business and hobby.

Get our famous High Tech Catalog

FREE

Heathkit[®]
Heath
Company

Heath Company
Dept. 020-434
Benton Harbor, Michigan 49022

MAIL COUPON TODAY and receive the latest issue of the Heathkit Catalog free of charge

Name

Address

City State

CL-7E3BR3 Zip

A subsidiary of Zenith Electronics Corporation

CIRCLE 86 ON FREE INFORMATION CARD

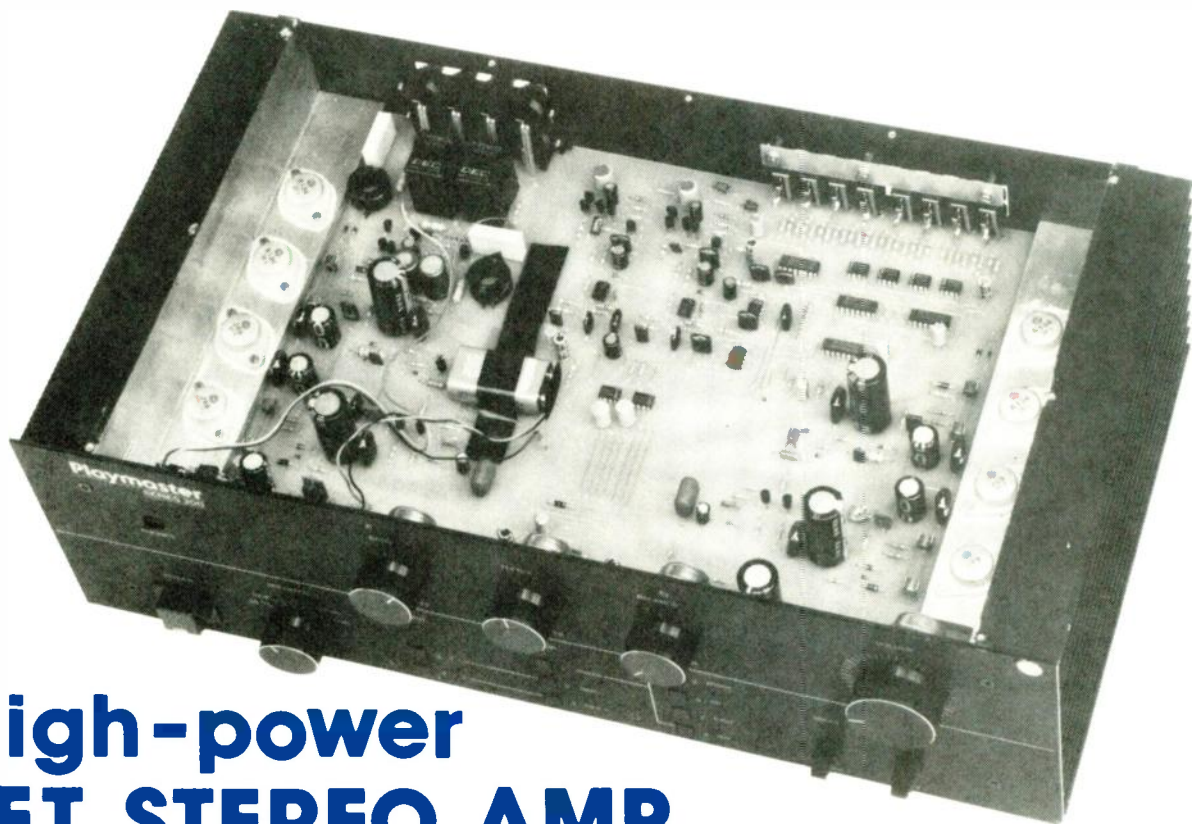

High-power FET STEREO AMP

Our amp's high-power output, low distortion, and easy construction make it a must for audiophiles who demand the very best!

LEO SIMPSON AND JOHN CLARKE*

Part 2 LAST MONTH WE DISCUSSED how the phono preamp and the analog switching sections of our amplifier work. Let's go on now and examine the volume/tone/balance circuit, the power amps, the speaker switching circuit, and the power supply.

Volume/tone control circuit

Whichever source is chosen to drive the amplifier, the signals from that source go through several stages of processing. Let's look at each in turn.

The output of analog switch IC2 is fed to IC105, shown in Fig. 5, which functions simply as a high-impedance, unity-gain buffer that drives the volume control, R110, and the STEREO/MONO switch, S11.

The wiper of the volume control is fed to IC106, another NE5534A, that is connected, in this case, as a non-inverting amplifier with a gain of 5.7. In addition to that gain, the op-amp provides a low-impedance source to drive the tone-control circuit.

We use yet another NE5534A in the tone-control stage; that op-amp is configured as a negative-feedback unity-gain amplifier when the BASS (R108) and TREBLE (R109) tone controls are set to their flat (mid-position) settings. Both BASS and TREBLE controls operate with a "constant-turnover, variable-slope" characteristic. Slope refers to the amount of boost or cut the circuit applies, and is a maximum of 6dB/octave for our circuit. Turnover refers to the frequency at which boost or cut occurs; our circuit uses a turnover frequency of 1 kHz for both bass and treble control circuits. When the wiper of the BASS control is rotated toward the input side of the op-amp, gain below 1 kHz is increased; similarly, the TREBLE control causes the gain of frequencies above 1 kHz to increase.

The tone-control amplifier drives the BALANCE and MUTE controls via a 6.8 μ F non-polarized electrolytic capacitor. The mute circuit is a 20-dB attenuator composed of R141 (680 ohms) and R142 (68 ohms). The attenuator is switched into the circuit by S3, MUTE.

By the way, the NE5534's are bipolar

op-amps that have higher input offset voltages than FET-input types like the TL071. Since we are using the NE5534's in gain stages, offset error is multiplied and therefore appears as a large DC offset at the output of the IC. The same problem occurs with the phono preamplifier. That's why we use non-polarized DC-blocking capacitors following each NE5534A.

Power amp

Moving on to the power amplifier, shown in Fig. 6, let's discuss a little of our design philosophy before getting into the actual circuit details. Our design, which is based on Hitachi application notes, did not come easily. Indeed, most of the development of the amplifier as a whole revolved around the power amplifier.

We tried many different circuits in many different configurations. Some were completely symmetrical designs with double-differential input stages and so on. We tried cascode driver stages and source degeneration in the MOSFET output stages. We also tried varying the driver stage currents to obtain the best overall distortion and slew rate.

*Adapted from material published by *Electronics Australia*

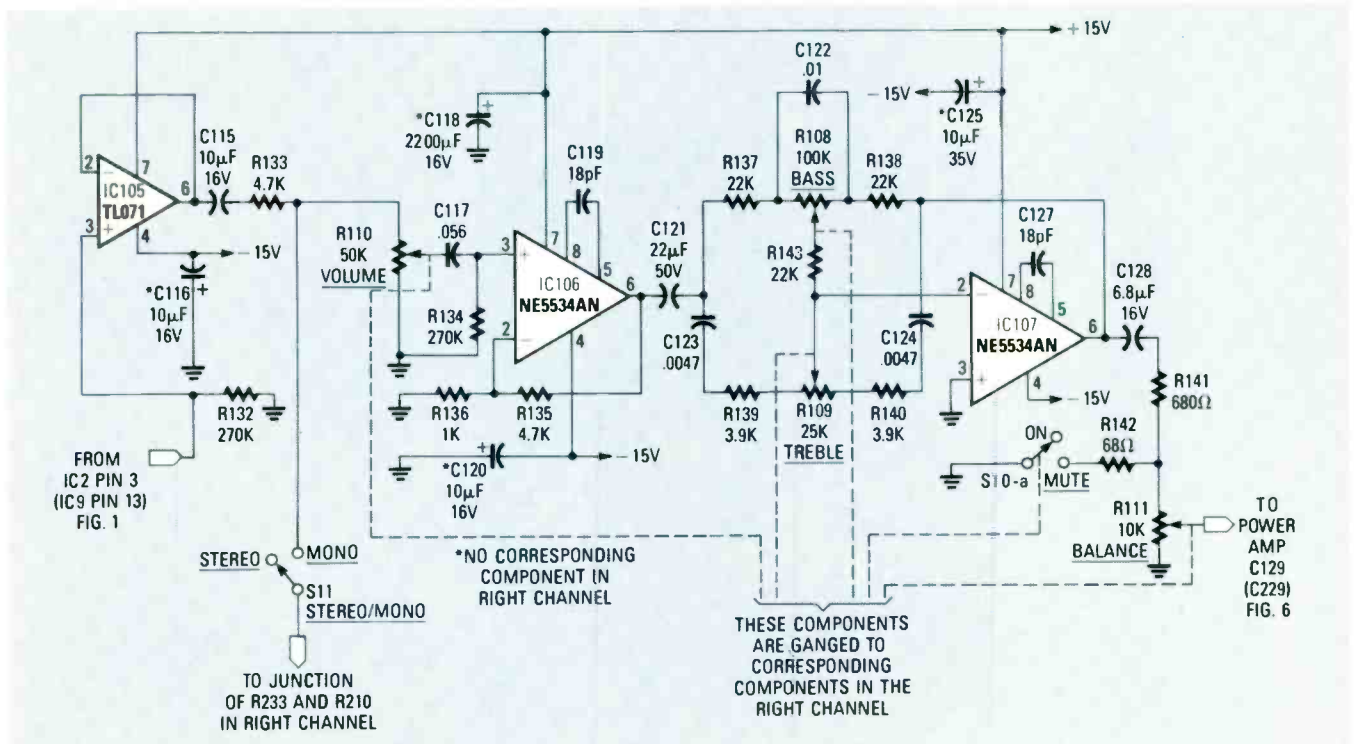

FIG. 5—THE VOLUME/TONE/BALANCE-CONTROL CIRCUITRY allows for ± 6 dB of treble or bass boost or cut, volume and balance control, muting, and stereo/mono selection.

After all that we concluded that Hitachi's design was the best overall for both simplicity and performance. And we discovered one rather surprising fact: performance of the power amps is quite dependent on the layout of the printed circuit board. In fact, even subtle changes in layout made quite dramatic reductions in distortion. We'll present what we believe is the best layout next time. But for now, let's see how the power amplifier works.

The BALANCE control (shown in Fig. 5) is coupled to the power amplifier via a 1- μ F non-polarized capacitor. Strictly speaking it should be possible to omit that capacitor because C128 (the 6.8- μ F capacitor at the output of IC107) should block residual DC across the balance control. However, if C129 were eliminated, Q105's bias current could flow through the balance control as well as through R145. Q105's 22K base-bias resistor.

By itself that would be harmless, but the signal presented to the power amplifier would vary as the BALANCE control was rotated. In addition, whatever DC offset was present at the input would be amplified, and would lead to an increase in the residual DC voltage at the output of the power amplifier. Hence, the output of the push-pull amplifiers composed of Q111-Q112 and Q113-Q114 would become unbalanced, so output distortion could result.

Also, C129, R144 and C130 function as a low-pass filter that removes signals in the

RF region. Resistor R144 functions as a "stopper" that reduces any tendency, on the part of the amplifier, to oscillate super-sonically. For full power output the input to the power amplifier should be about 1.5 volts rms.

Transistors Q105 and Q106 form a differential pair, and Q107 acts as a constant-current "tail." By virtue of diodes D101 and D102, the base-bias applied to Q107 is about 1.3 volts. That sets the current through Q107 at about one milliamp; that current is shared equally by Q104 and Q106. And, as in the R1AA preamp circuit, the constant-current source improves the PSRR of the amplifier.

The balanced output signals from the collectors of transistors Q105 and Q106 are coupled to a second differential amplifier, consisting of Q109 and Q110, which forms a "current mirror," a circuit often used in IC op-amps. The current mirror helps us obtain higher gain from the stage, as well as better linearity over the full range of output voltage. In fact, the current mirror gives a greater voltage swing than could be obtained with a simple class-A driver stage with a boot-strapped collector load.

Transistors Q108, Q109, and Q110 each has a maximum collector voltage rating of 250 volts; they are intended for use as class-B video-driver stages in television receivers. That voltage rating in conjunction with their 100-Mhz gain-bandwidth product and good beta linearity over a

wide range of operating currents makes them ideal for use in a low-distortion audio driver stage.

Those two discrete differential amplifiers provide all the voltage gain of the power amplifier; the MOSFET output transistors are operated in source-follower mode, which gives slightly less than unity voltage gain. No source degeneration resistors are used in the output transistors. We found that we were able to dispense with those resistors and thus gain lower distortion.

Nor does there appear to be any need to take measures to ensure current sharing between the parallel-connected MOSFETs (by using small source resistors). In practice, if one MOSFET becomes warmer than its partner, its transconductance (gain) is reduced accordingly; thus it is temperature-compensated automatically.

The 500-ohm trimpot, R156, connected between the collectors of Q108 and Q110 sets the bias applied to the MOSFET gates; that bias determines the quiescent output current. The amount of current is a compromise between minimum distortion and output-stage power dissipation. Since the power amplifier employs a ± 65 -volt power supply, even a small current results in high power dissipation. So quiescent current must be set carefully.

Zener diodes D106 and D107, in combination with D104 and D105, determine the maximum voltage that can be deliv-

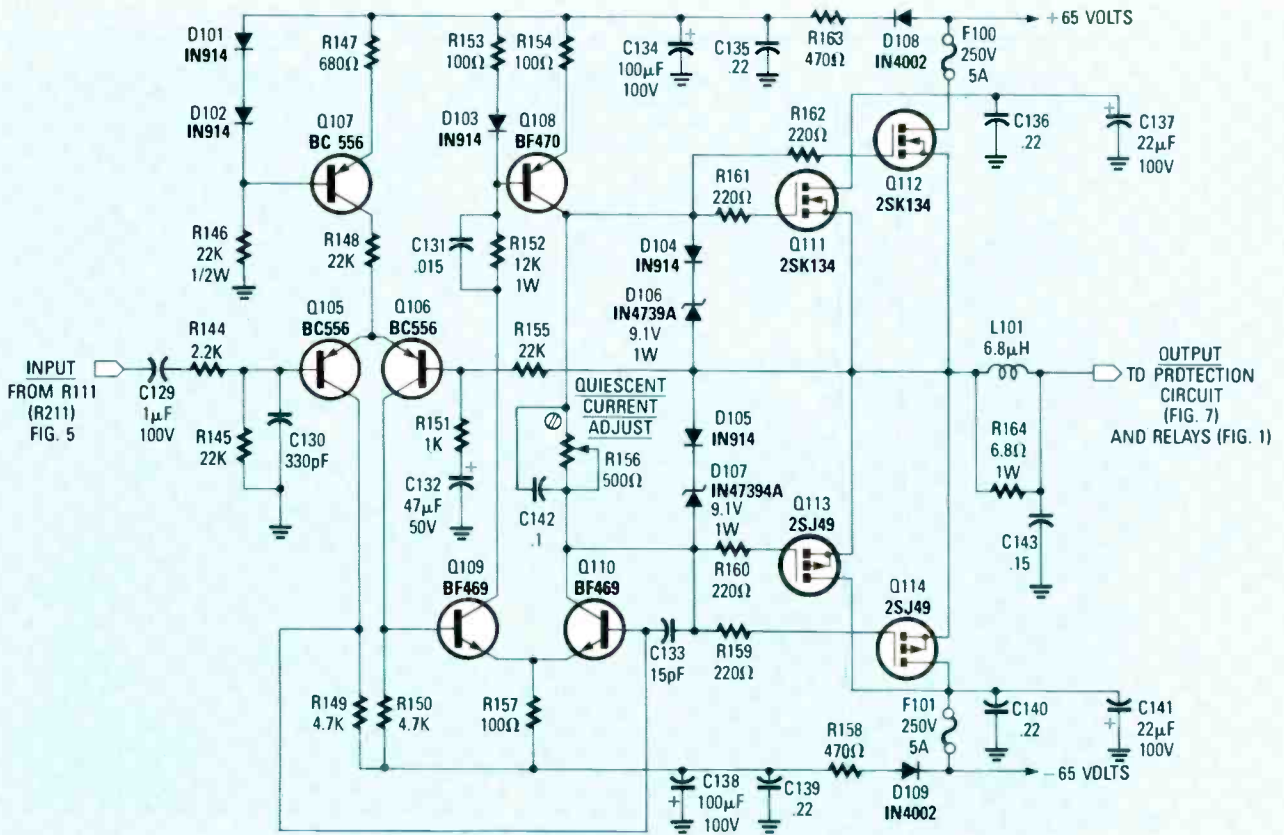

FIG. 6—THE POWER AMPLIFIER is built around two discrete bipolar differential amplifiers and power MOSFETS for output drive.

ered to the output transistors. Any signal in excess of ± 10 volts will be clipped. In that way the diodes form an effective overdrive circuit and prevent excessive power dissipation in the event of a short circuit. The gate of each output transistor has a series-connected 220-ohm resistor that functions as a "stopper" to prevent RF oscillation. Fuses are included in the output-transistor supply lines to protect the speakers should the output transistors fail. The fuse clips also provide a convenient way of measuring current (or voltage, when they are replaced by resistors) for trouble-shooting or setting the quiescent current.

Voltage gain of the power amplifier is determined by the ratio of the 22K and the 1K resistors (R155 and R156) at the base of Q106. The lower cutoff-frequency of the circuit is determined by 47 μ F capacitor C132; that capacitor is in series with 1K resistor R151.

A final refinement involves the RLC network (L101, R164, and C143) in the output circuit. That network is used to render the amplifier unconditionally stable. We use a toroidal air-core inductor in that network, as a solid ferrite core can give rise to distortion, particularly when the amplifier is delivering a great deal of power.

It is necessary to use a special capacitor in the output network. We originally installed metallized polyester capacitors for

C143 and C243, but found that high power operation of the amplifier caused them to fail quickly; they developed short-circuits. However, we found that dual dielectric (mixed paper and polyester) capacitors, normally specified for power-line interference suppression, work fine in that circuit. See the Parts List for more information.

Speaker switching

The main and remote loudspeakers are controlled with two relays rather than an expensive, high-current 4-pole switch. The relays also simplify wiring requirements, as we don't need to run heavy loudspeaker wiring to and from the front-panel SPEAKER SELECTOR switch, S12. Instead, S12 controls the coils of the relays, so only low-current wiring is required for that connection.

The DC supply for the relay coils is supplied by the loudspeaker protection circuitry discussed below. When no fault is present, the output of that circuit goes high, and that energizes the coils of both relays, through resistors R4 and R5. Diodes D2 and D3 quench the EMF spike that is generated when the relay coil is de-energized.

The moving contacts of the relays connect to the loudspeakers while the unused stationary contacts are grounded. The reason for this is that, if a large DC voltage is generated in the amplifier by a fault con-

dition, an arc is likely to result as the moving contact opens the circuit. So, as the contact moves to the "de-energized" position, that arc will be more likely to flow to ground than back into the circuit causing damage.

However, because of the high supply voltage used in our amplifier, an arc could be maintained even if the relay contacts were fully open. If that does occur, the power amplifier fuses will blow. There is a very slight chance that the amplifier itself could be damaged, but it is cheaper to repair an amplifier than to replace a loud-speaker.

Headphones

One small drawback to using the relays for loudspeaker control is that the headphones are permanently connected to the amplifier. They are not muted at power-on, but they are protected from DC faults by the 330-ohm feed resistors (R112, R212), which will limit any fault current to a safe amount.

The lack of muting is a problem since the phono preamplifier takes a little while to stabilize. During that time the amplifier is liable to emit some unpleasant sounds via the headphones if the volume control is advanced.

We solved that problem with the network attached to IC2 (shown in Fig. 1 last time), the analog switch that controls tape monitoring. That IC has an INHIBIT pin

PARTS LIST

All resistors ¼-watt, 5% unless otherwise stated.

R1, R3—10,000 ohms
 R2—220,000 ohms
 R4, R5—47 ohms, ½ watt
 R6—R9, R11—R14, R16, R18—100,000 ohms
 R10, R15, R17, R19, R100, R102, R104, R158, R163, R165, R167, R200, R202, R204, R258, R263, R265, R267—470 ohms
 R20, R21, R22, R23, R146—22,000 ohms, ½ watt
 R24, R25, R101, R103, R105, R166, R168, R201, R203, R205, R266, R268—56,000 ohms
 R26, R121, R129, R132, R134, R229, R231, R232, R234—270,000 ohms
 R27, R128, R130, R144, R228, R230, R244—2200 ohms
 R28, R159—R162, R259—R262—220 ohms
 R29—130 ohms
 R30, R31, R136, R151, R236, R251—1000 ohms
 R32—1500 ohms
 R33—R99, R169—R199, R269—R299—unused
 R106, R206—150,000 ohms
 R107, R207—300,000 ohms
 R108, R208—100,000 ohms, potentiometer
 R109, R209—25,000 ohms, linear potentiometer
 R110, R210—50,000 ohms, logarithmic potentiometer
 R111, R211—10,000 ohms, linear potentiometer
 R112, R212—330 ohms
 R113, R213—150 ohms
 R114, R214—180,000 ohms
 R115, R215—68,000 ohms
 R116, R117, R216, R217—820 ohms
 R118, R123, R218, R223—39 ohms
 R119, R219—1200 ohms
 R120, R220—2700 ohms
 R121, R221—390 ohms
 R122, R222—82 ohms
 R124, R224—3900 ohms, 1%, metal film
 R125, R225—47,000 ohms, 1%, metal film
 R126, R226—10 ohms
 R127, R227—4300 ohms
 R133, R135, R149, R150, R233, R235, R249, R250—4700 ohms
 R137, R138, R143, R145, R148, R155, R237, R238, R243, R245, R246, R248, R255—22,000 ohms
 R139, R140, R239, R240—3900 ohms
 R141, R147, R241, R247—680 ohms
 R142, R232—68 ohms
 R152, R252—12,000 ohms, 1 watt
 R153, R154, R157, R253, R254, R257—100 ohms
 R156, R256—500 ohms, trimmer
 R164, R264—6.8 ohms, 1 watt

Capacitors

C1, C14—C22, C116, C120—10 μ F, 50 volts, electrolytic

C2, C3—0.047 μ F, polyester
 C4, C5—47 μ F, 50 volts, non-polarized
 C6—100 μ F, 16 volts, electrolytic
 C7—0.01 μ F, 250 volts, polyester
 C8—C11—8000 μ F, 75 volts, electrolytic
 C12, C13—1000 μ F, 25 volts, electrolytic
 C23—C99, C144—C199, C214, C225, C226, C244—C299—unused
 C100, C200—0.082 μ F, polyester
 C101, C107, C113, C142, C201, C207, C213, C242—0.1 μ F, polyester
 C102, C202—47 μ F, 25 volts, electrolytic
 C103, C203—100 pF, ceramic
 C104, C204—0.0033 μ F, polyester
 C105, C205—220 μ F, 16 volts, electrolytic
 C106, C112, C206, C212—100 μ F, 25 volts, electrolytic
 C108, C208—10 pF, ceramic
 C109, C209—0.018 μ F, 2%, polyester
 C110, C210—0.068 μ F, 2%, polyester
 C111, C211—2.2 μ F, 50 volts, non-polarized
 C112, C212—100 μ F, 25 volts, electrolytic
 C114—10 μ F, 25 volts, electrolytic
 C115, C215—10 μ F, 50 volts, non-polarized
 C117, C217—0.056 μ F, polyester
 C118—2200 μ F, 16 volts, electrolytic
 C119, C127, C219, C227—18 pF, ceramic
 C121, C221—50 μ F, 50 volts, non-polarized
 C122, C222—0.01 μ F, polyester
 C123, C124, C223, C224—0.0047 μ F, polyester
 C128, C228—6.8 μ F, 16 volts, non-polarized
 C129, C229—1 μ F, 100 volts, non-polarized
 C130, C230—330 pF, ceramic
 C131, C231—0.015 μ F, 250 volts, polyester
 C132, C232—47 μ F, 25 volts
 C133, C233—15 pF, ceramic
 C134, C138, C234, C238—100 μ F, 100 volts, electrolytic
 C135, C136, C139, C140, C235, C236, C239, C240—0.22 μ F, polyester
 C137, C141, C237, C241—22 μ F, 100 volts, electrolytic
 C143, C243—0.15 μ F, 250 volts, dual-dielectric (Philips type PKT-P)

Semiconductors

IC1, IC2—4052 4PDT analog switch
 IC3—IC6—4011 CMOS NAND gate
 IC7—74C14 CMOS hex Schmitt trigger
 IC8—4013 CMOS dual D flip-flop
 IC9—7815 15-volt positive regulator
 IC10—7805 5-volt positive regulator
 IC11—7915 15-volt negative regulator
 IC12—IC99, IC105—IC199, IC205—IC299—unused
 IC100, IC102, IC103, IC105, IC200, IC202, IC203, IC205—TL071 low-noise op-amp
 IC101, IC106, IC107, IC201, IC206, IC207—NE5534AN bipolar op-amp
 IC104, IC204—4053 CMOS triple SPDT analog switch
 BR1—400-volt, 10-amp bridge rectifier

D1, D4—D17, D23, D101—D105, D201—D205—1N914
 D2, D3, D18—D22, D108, D109, D208, D209—1N4002
 D24—D99, D110—D199, D210—D299—unused
 D100, D200—1N752A, 5.6-volt, ½-watt Zener diode
 D106, D107, D206, D207—1N4739A, 9.1 volt, 1-watt Zener diode
 LED1—LED9—Standard red LED
 Q1, Q3, Q4—BC547
 Q2—BC557
 Q5—BC327
 Q6—Q99, Q115—Q199, Q215—Q299—unused
 Q100—Q103, Q200—Q203—2SC2545
 Q104, Q204—2N5485
 Q105—Q107, Q205—Q207—BC556
 Q108, Q208—BF470
 Q109, Q110, Q209, Q210—BF469
 Q111, Q112, Q211, Q212—2SK134
 Q113, Q114, Q213, Q214—2SJ49

Other components

B1, B2—Size AA Ni-Cd battery
 F1, F2—Fuse, 250 volts, 5 amps
 J1—Stereo headphone jack
 J100—J103, J200—J203, J104—J107, J204—J207—RCA Phono jack
 J108—J111, J208—J211—speaker connectors
 L100, L200—see text
 L1C1, L201—6.8 μ H
 P1, P2—9-pin SIP plug, 0.1" centers
 RY1, RY2—DPDT relay
 S1—S9—SPST normally open, momentary contact
 S10—DPST toggle
 S11—SPST toggle
 S12—2P4T rotary
 S13—SPST toggle switch, 250 volts AC
 T1—117 VAC primary, dual secondaries: 90 VCT and 30 VCT

Miscellaneous: Battery holder for B1 and B2, PC-mount fuse clips, Ferrite beads, 11-mm \times 25-mm coil forms

Note: The following components are available from Dick Smith Electronics, Inc., P.O. Box 8021, Redwood City, CA 94063; 800-332-5373 (orders) 415-368-8844 (inquiries). Complete kit of all parts (No. K-3516) including PC boards, heatsinks, screened front and rear panels, and transformer T1, \$299 plus \$10 shipping. Separate components: set of two PC boards (No. KH-0106), \$49.00; 2SC2545 transistor (No. KZ-1683), \$0.39 each; 2SK134 transistor (No. Z-1815), \$4.50; 2SJ49 transistor (No. Z-1816), \$4.50; transformer T1 (No. KM-2000), \$57.00; case including panels and heatsinks (No. KH-2700), \$115. All component orders must add \$1.50 for handling plus 5% of total price. California residents must add 6.5% sales tax. Orders outside U.S. must include U.S. funds and add 15% of total price for shipping.

that opens all switches. The network connects to that pin and simply prevents signals from the preceding stages from passing on for a second or two at power-on.

The muting network works as follows.

At power-on C1 is a virtual short-circuit. This means that pin 6 is pulled high, so all the switches in the IC are open. Then, as the capacitor charges, pin 6 is pulled low, and signals can pass on to succeeding stages. The delay that results makes for

more pleasant headphone listening.

Loudspeaker protection circuit

A portion of the signal from each channel's power amplifier is fed to the speaker protection circuit shown in Fig. 7. The

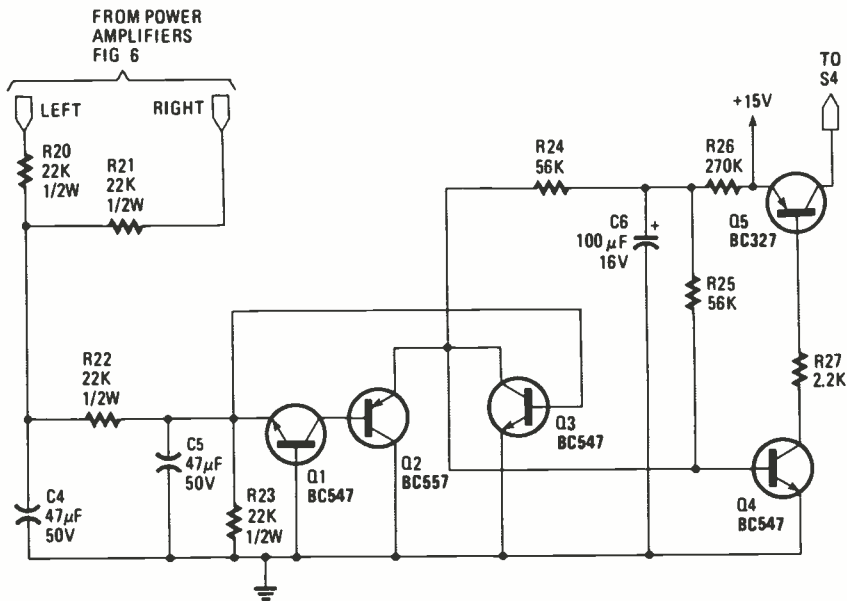

FIG. 7—THE SPEAKER PROTECTION CIRCUIT will disable the the output control relays (RY1 and RY2—shown in Fig. 1 last time) whenever the voltage produced by the output transistors becomes excessive.

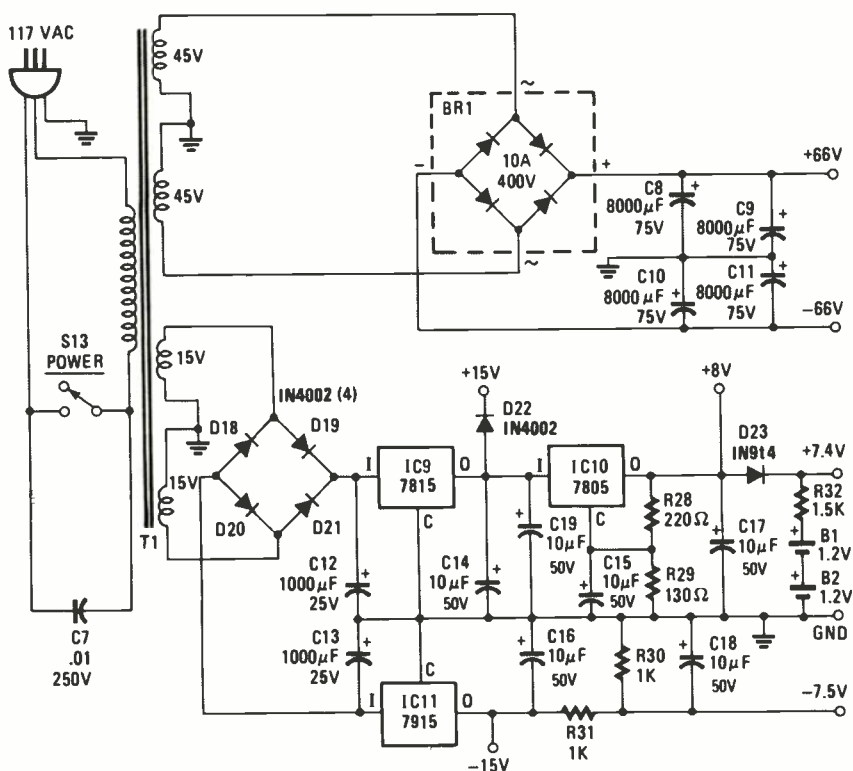

FIG. 8—THE AMPLIFIER'S POWER SUPPLY is built around a toroidal power transformer and it includes a trickle-charger for the CMOS-memory batteries, B1 and B2.

protection circuit does not protect the amplifier—it protects the loudspeakers. If a fault occurs in the amplifier that results in a large DC voltage at an output, a loudspeaker could be severely damaged. The loudspeaker protection circuitry prevents that from happening by de-energizing the relays that control the loudspeakers whenever an excessive DC voltage is sensed at the output of a power amplifier. The protection circuit also de-energizes the relay

if a large low-frequency signal is presented to the circuit for an extended period of time. That could happen for a variety of reasons; for example, if the amplifier became unstable and began to motorboat.

Both power amplifier outputs are monitored via a low-pass network consisting of the four 22K-ohm resistors (R20–R23) and the two 47-µF non-polarized capacitors (C4 and C5). The two capacitors render the protection circuit

immune to normal output voltages. But if one of the amplifiers develops an excessively negative DC voltage, Q1 will turn on. That turns on Q2 and removes the bias voltage from Q4; that in turn switches off Q5 so that no power can be fed through S4 (shown in Fig. 1), the speaker-selector switch that controls the coils of the relays. By the same token, if one of the power amplifiers develops an excessively positive DC voltage, Q3 will be forward biased. That again removes the bias from Q4 and Q5, preventing power from reaching the switch that controls the operation of the relays.

Note that the protection circuit is effectively fail-safe. If a malfunction prevents the relays from operating, the loudspeakers will be disconnected from the amplifier, so they will be safe from any potential damage.

Muting

The loudspeakers are muted (i. e., the relays are disconnected) for three seconds after power-on. That works as follows. When power is first applied, the 15-volt supply to Q5 is available almost instantly, but Q5 is unable to turn on because the base of Q4 is at ground potential, so it, too, is off.

The reason Q4 can't turn on is that its base is supplied via 56K resistor R25. That resistor is supplied by 100 µF capacitor C6, which is a short circuit at power-on. After power-on, C6 charges slowly via 270K resistor R26. Eventually Q4 turns on, so Q5 can turn on and energize the relays.

Switch-off thump

Another problem we faced was a loud thump from the loudspeakers whenever the amplifier was turned off. After investigation, we discovered that the problem was caused by the rapid collapse of the ±15V supply, which supplied the op-amps in the preamplifier stages enough juice to give a thump before the output relays released. If uncorrected, such thumps could eventually damage the speakers.

The solution was to isolate the op-amp supply. We did that by installing a 1N4002 diode (D22, shown in Fig. 8) in series with the +15-volt supply line, and by increasing the value of decoupling capacitor C18 by IC106 (the tone-control driver in Fig. 5) from 10 to 2200 µF. That large capacitor keeps the op-amp energized until the relays open. Hence, no switching transient can get through to the speakers, preventing the switch-off thump.

Power supply

The schematic of our power supply is shown in Fig. 8. In order to reduce induced hum, AC is provided by a dual-secondary toroidal transformer, shown in Fig. 9.

continued on page 74

HISTORY

MARTIN CLIFFORD

In this, the first installment of our new, occasional series about the early days of radio, we look at the original "solid-state" receivers.

DID YOU KNOW: THAT SOLID-STATE ELECTRONICS can trace its roots back to 1835? That radio signals can be demodulated using sulfuric acid or nitric acid? That oil-filled variable capacitors were once used in radio receivers? That a single crystal detector can be used as a radio receiver? That there are some radio receivers that never need to be turned off, have no on/off switch, and do not require battery or AC power? Or that lenzite, zincite, bornite, tellurium, and chalcopyrite are all semiconductors?

Most of us believe that the age of solid-state electronics began with the invention of the transistor; Bardeen and Brattain of Bell Laboratories produced that first crystal triode in 1948. However, lost in the mists of history is the fact that true solid-state receivers have been with us since about 1918.

In more recent times, the term solid-state has been so firmly associated with germanium, and subsequently with silicon, that no one should be blamed for thinking that those are the only materials

The Early Days of RADIO

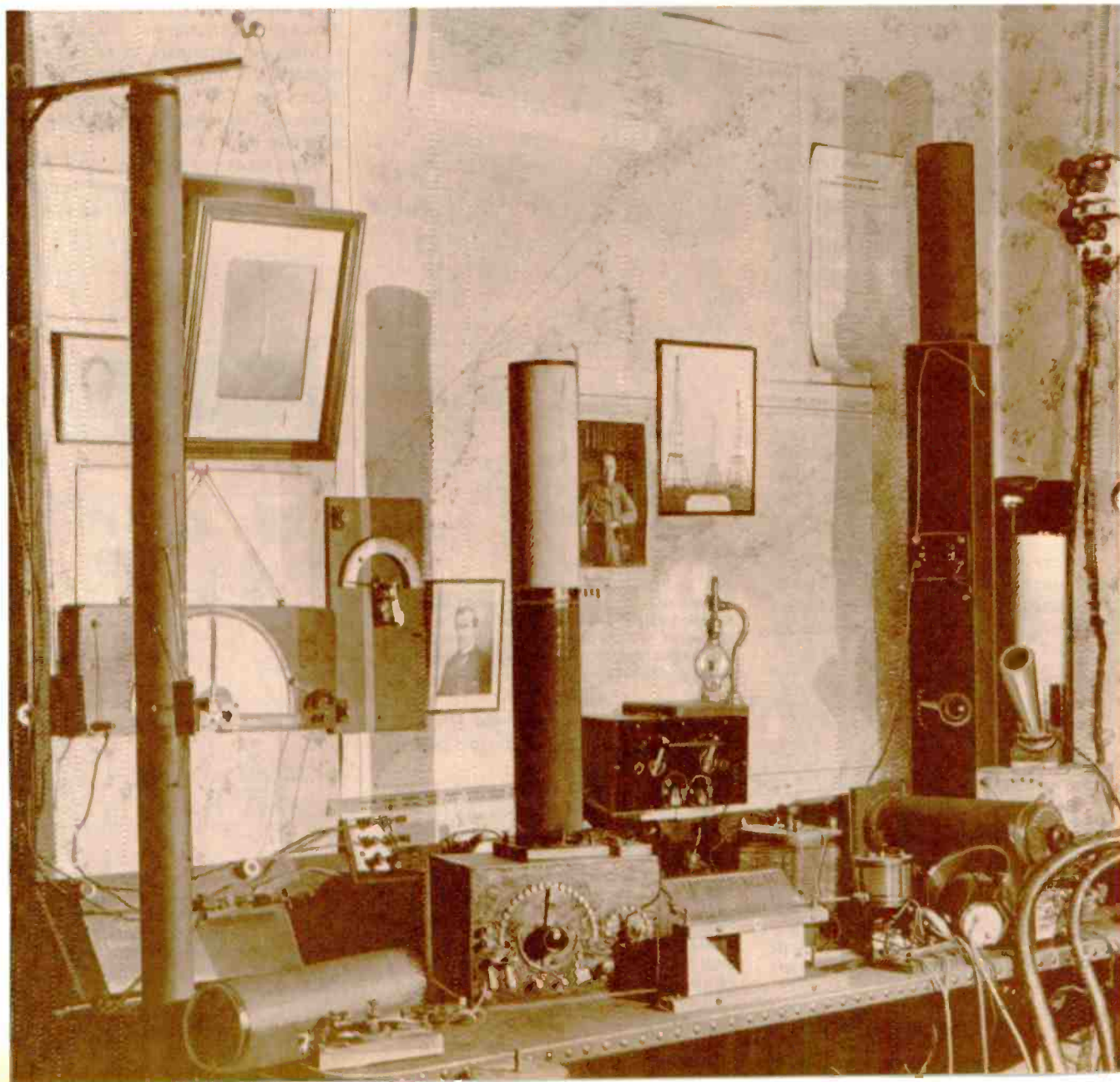

suitable for use in semiconductors. Yet there are numerous materials that are just as suitable. Among them are carborundum (silicon carbide); galena (a crystal sulphide of lead); molybdenum; lenzite; zincite (an oxide of zinc); tellurium; bornite (a sulphide of iron and copper); chalcocite (also known as copper pyrites); and cerusite. Except for carborundum, a manufactured material also used as an abrasive, all are materials that are found in nature.

Early solid state

The fact that certain materials have rectifying properties (that is, they allow current to flow in one direction only) has been known since 1835, thanks to the research of one Munk Af. Rosenshold. At the time a laboratory curiosity, his discovery was largely forgotten until it was unearthed again by F. Braun in 1874.

However, a practical use for that discovery was not found until many years later. It came at a time when interest in radio was heating up and many early experimenters had radio setups in their attic or basement workshops.

Rectifiers are key components in simple radio detectors. Along with vacuum tubes, early experimenters turned to solid-state rectifiers made from one of the substances that exhibit natural rectifying properties. Since most of those substances are crystalline in nature, such rectifiers were called *crystal detectors*; radios that used such detectors were called *crystal radio sets*, or simply crystal sets.

The simplest radio

Early vacuum-tube rectifiers, such as the UX-201A and UV-199 triodes, cost about \$15. Since \$15 a week was considered good pay for a workman back then, and since crystal detectors cost only a small part of that amount, many experimenters turned to crystal sets. Such radios were among the simplest possible, consisting of just a crystal detector and a headset. See Fig. 1.

The crystal set of Fig. 1 has its virtues, but it also has plenty of faults. Selectivity is non-existent; after all, that radio has no tuning circuits. So whatever the radio re-

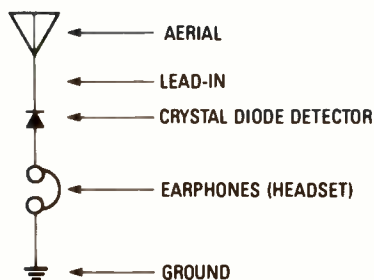

FIG. 1—THE SIMPLEST CRYSTAL RECEIVER consists of an antenna, a detector, headphones, and a ground.

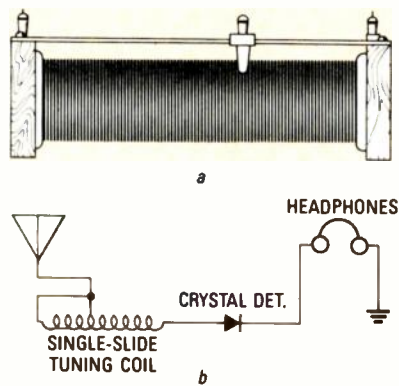

FIG. 2—TO IMPROVE SELECTIVITY a slide-tuned coil can be used (see a). The schematic of a crystal set that used such a coil is shown in b.

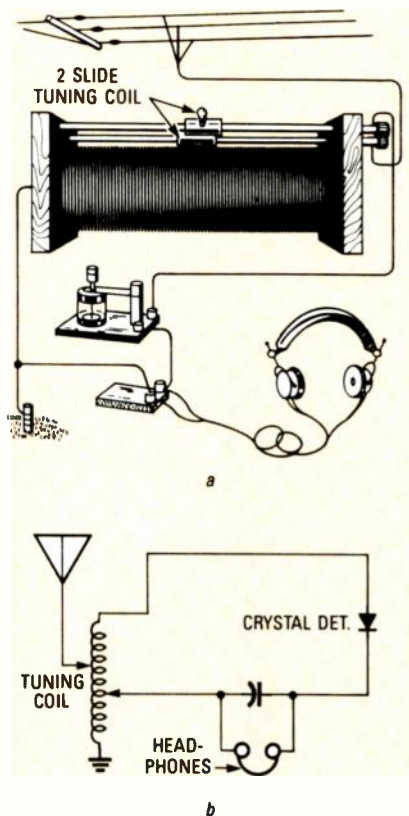

FIG. 3—FOR EVEN GREATER selectivity, receivers with double-slide-tuned coils were developed (a). The schematic of such a set is shown in b. Note the inclusion of a capacitor across the headphones. Its purpose was to bypass the RF carrier.

ceives is what you hear—the strongest signal dominates, and all the rest provide background noise.

The earliest effort at improving selectivity was to add a tuning coil like the one shown in Fig. 2-a. That coil consisted of enamel insulated wire wound on a round form; experimenters often used cylindrical oatmeal boxes as the coil form. The amount of inductance could be selected using a metal slider. The tuning method was crude, but the radio circuits that included that coil (see Fig. 2-b) did offer at

least some improvement over those with no tuning at all.

Another problem was that the output of the crystal detector consisted of both an audio signal and an RF carrier; both were passed directly to the headphones. Subsequently, a small capacitor was placed across the headphones to bypass the RF carrier.

Also, it was found that selectivity could be further improved by adding a second slider to the tuning coil. The radio shown in Fig. 3-a incorporates both those improvements; the schematic for that circuit is shown in Fig. 3-b.

Improved designs

As time went on, various methods were used to improve tuning. In one arrangement, shown in Fig. 4-a, the single-slide tuner was used as the primary of an RF transformer. The secondary winding, which was tapped, was wound on a form that could travel into the primary by means of a pair of rods. That resulted in triple tuning. The primary was tuned by the single slider; coupling was adjusted by moving the secondary in or out of the primary, and finally, the appropriate secondary tap could be switch selected by the operator. The schematic for the circuit is shown in Fig. 4-b.

Since most crystal radio receivers are "powered" by the radio signal itself, they require no voltage supply or battery. (They

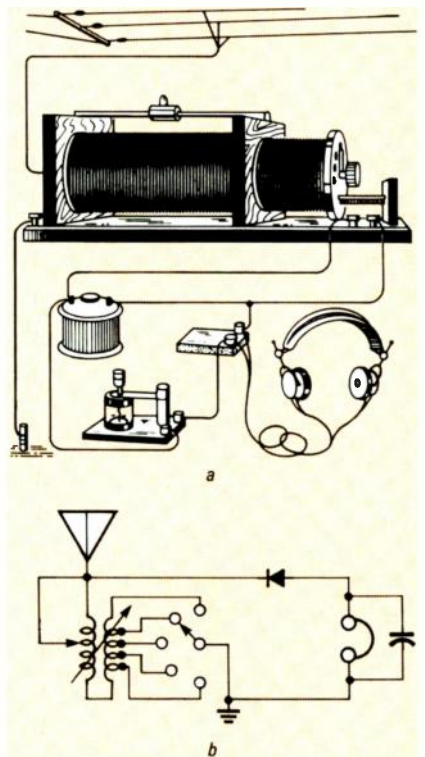

FIG. 4—IN THE CRYSTAL SET SHOWN in a the slide-tuned coil is used as the primary of an RF transformer; the secondary had multiple taps and was wound on a form that could be moved in to or out of the primary. The schematic of the circuit is shown in b.

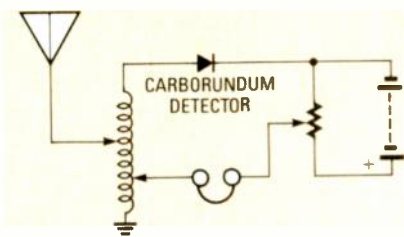

FIG. 5—BATTERY POWER was needed in crystal sets that used carborundum detectors.

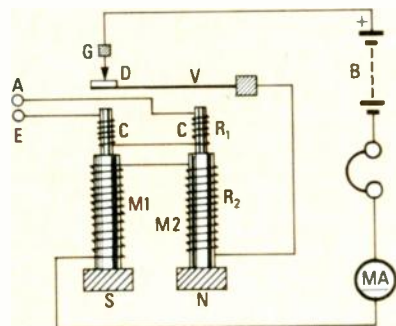

FIG. 6—BECAUSE OF THEIR LOW OUTPUT, some sort of amplification was often used with carborundum sets. Here, a popular mechanical amplifier of the time is shown.

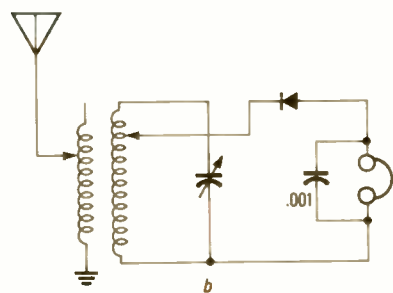
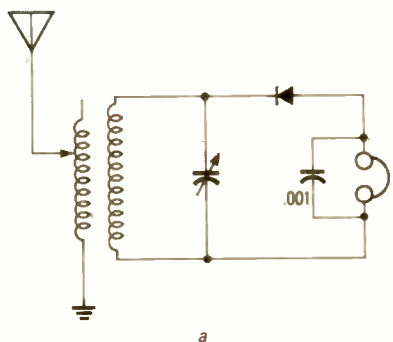

FIG. 7—THE SELECTIVITY OF CRYSTAL SETS was further improved by the addition of a variable capacitor. Here two designs, one (a) using a single-slide-tuned coil, the other (b) a double-slide-tuned coil, are shown.

also require no on/off switch.) However, that is not always the case.

One detector that was popular for a while was made from carborundum. As you can see in Fig. 5, a receiver design using that detector required a voltage source. Further, the output of the detector

was weak. Those two factors eventually caused the carborundum detector to fall out of favor, but not before it gave rise to some interesting circuit innovations.

One of those was the concept of the amplifier. The early amplifier shown in Fig. 6 was a mechanical one known as the Brown amplifying relay. The leads identified as A and B were connected to the output of the detector. The signal current through relay coil M_1 caused relay armature v to vibrate, thus varying the magnetic field around winding R_2 of the second relay. That caused the current supplied by the battery to be varied at an audio rate. That current flowed through the headphones, producing sound. In some instances a series arrangement was used; the current from the battery drove still another mechanical amplifier.

The need for clumsy tuning coils was finally eliminated through the use of a variable capacitor, then known as a condenser. For a while, however, variable capacitors were used in conjunction with single- and double-slider variable coils. Two examples of capacitor-coil-tuned circuits are shown in Fig. 7.

In some of the more advanced sets, a vario coupler, sometimes called a variometer (see Fig. 8), was used. That consisted of a pair of coils mounted in such a way that one could be rotated within the other.

Ordinarily, the variable capacitors used were air types; that is, the dielectric between the stator and rotor plates was air. Air, though, has a dielectric constant of 1. To increase the capacitance without adding more plates, one design had the variable capacitor positioned in a leak-proof, transparent case, filled with oil. Oil has a dielectric constant of five, so the capacitance of such a capacitor is five times that of one with an air dielectric (assuming all other variables to be the same). One such capacitor had 17 plates and a total maximum capacitance of $0.0004 \mu\text{F}$, while another had 43 plates and a maximum capacitance of $0.001 \mu\text{F}$.

Anyone who has had any contact with radio knows that the antenna plays an important role in determining the quality of the received signal. Antennas were even more important in the days of the crystal set. That's because that design made no provision for amplification. Thus, the strength of the signal heard was wholly dependent on the strength of the signal delivered by the antenna. Some of the schemes devised were quite elaborate; others were quite simple. For apartment dwellers, a bedspring was a popular alternative to an outdoor design; the ground connection was made to a cold-water or radiator pipe.

The crystal detector

So far, we've spoken about how crystal detectors were used in early radios. But

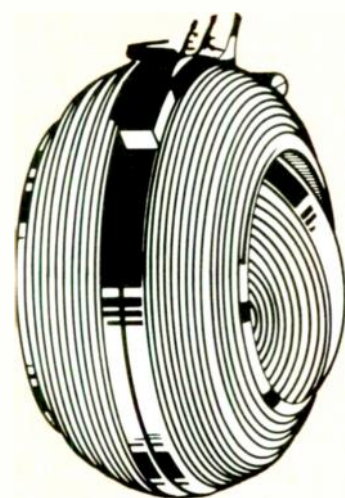

FIG. 8—A VARIO-COUPLER, or variometer, consisted of two coils mounted in such a way that one could be rotated within the other.

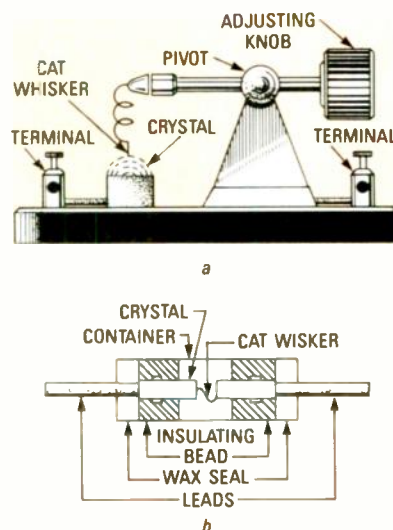

FIG. 9—TWO CATWHISKER DETECTORS. A variable contact type is shown in a; a sealed, fixed unit is shown in b.

we've not looked at the detector itself and how it was made. It is time now to correct that oversight.

Crystal detectors were available in two basic forms: contact and combination. Of those, the contact detector was cheaper and more popular.

A single crystalline substance was used in the contact detector. A small bit of spring wire, called a *catwhisker*, was placed so that it made contact with a point on the crystal. In early detectors, the catwhisker was designed to be variable because finding the most sensitive spot on the crystal was a trial-and-error procedure. See Fig. 9-a.

The catwhisker was usually made from stiff phosphor bronze, but in more expensive detectors silver or 18-karat gold was used. The wire was coiled, with a small straight extension ending in a blunt point—an arrangement much like that

used in the first point-contact transistors many years later. There were two connections to the crystal detector: one to the catwhisker and another to the cup holding the crystal.

Later on, fixed-position catwhiskers in sealed containers became available. See Fig. 9-b.

The combination crystal detector consisted of two different crystals in close contact. Various combinations of minerals were tried, including bornite and either zincite or copper pyrites. Another combination detector used tellurium and

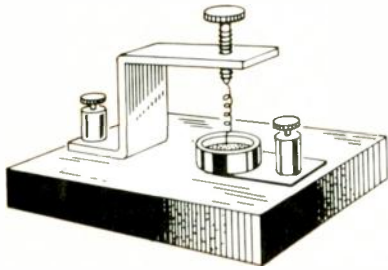

a

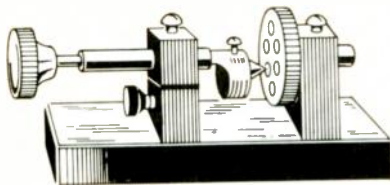

b

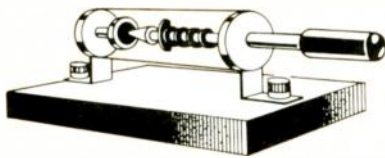

c



d

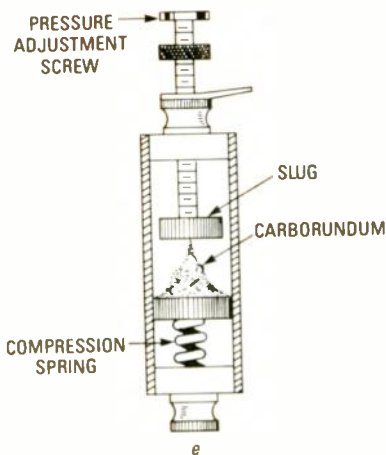

e

FIG. 10—FIVE POPULAR DETECTORS: Variable-contact catwhisker (a), Perikon (b), combination crystal (c), fixed-contact catwhisker (d), and carborundum (e).

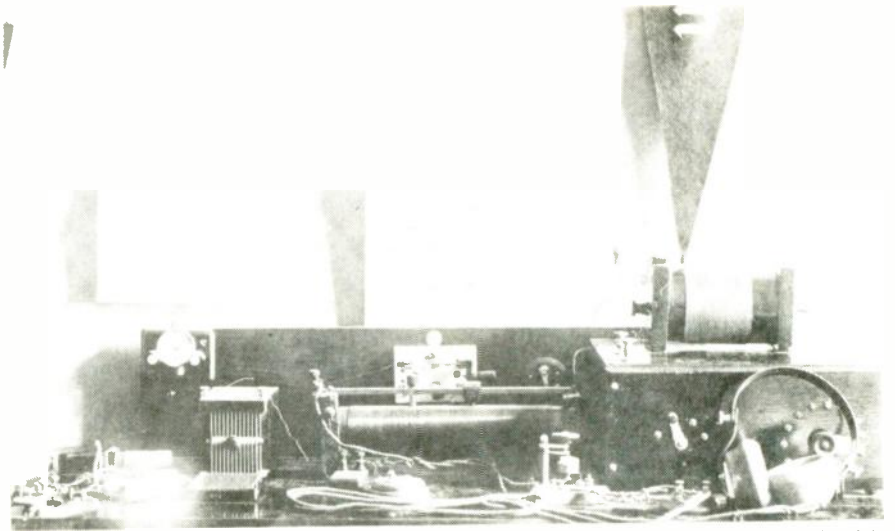

AN EARLY WIRELESS RECEIVER. With this set-up, which was part of amateur station 1-WP, Warwick, RI, circa 1913, the operator was able to log stations from Maine to Florida. Note the variable-contact catwhisker crystal detector, 23-plate tuning capacitor, and double-slide-tuned coil.

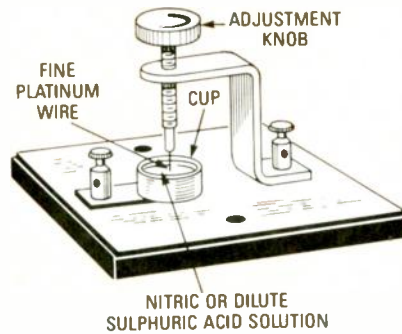

FIG. 11—IN AN ELECTROLYTIC DETECTOR the rectifying material was nitric acid or diluted sulphuric acid.

chalcopyrite (copper pyrites). The chief advantage of the combination detector was that it was less susceptible to vibration than the catwhisker type.

Some of the many different types of crystal detectors are shown in Fig. 10. We've so far looked at all of those save one—the Perikon detector, invented by Pickard in 1906, and shown in Fig. 10-b. That detector used a small, cone-shaped piece of zincite. The zincite could be positioned so that it contacted one of several segments of chalcopyrite located on a circular plate. By selecting which segment of chalcopyrite was used, the detector could be "tuned."

As we stated earlier, most detectors were made using a crystalline material. However, "most" is not "all." One detector that was at least briefly popular was the electrolytic detector, shown in Fig. 11. The design of that detector was similar to that of the catwhisker, but nitric acid, or a dilute solution of sulphuric acid, was used in place of the crystal. Despite that detector's high sensitivity, it had disadvantages. One was that the wire tended to curl away from the acid—so the wire fre-

quently had to be repositioned or replaced. Secondly, the detector used exposed acid, which is dangerous.

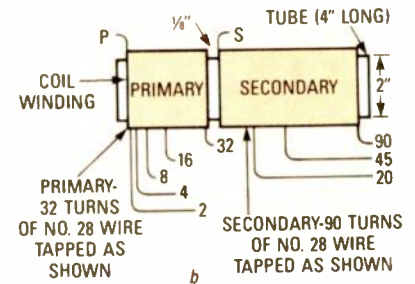
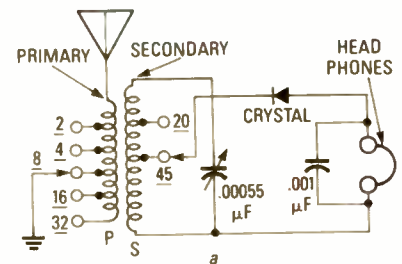

FIG. 12—YOU CAN BUILD this crystal set (a) using modern components. Winding details for the coil are shown in b.

Building your own

We hope this article has aroused your interest in the electronics of days gone by. If you want to recapture some of the flavor of the early experimenters, perhaps you'd like to try building your own crystal receiver. If so, the circuit shown in Fig. 12-a can be built using modern parts.

In that circuit we've replaced the slide-tuned coil with a tapped one. (Finding a slide-tuned coil these days would be nearly impossible.) Full details of the coil are given in Fig 12-b. Just about any diode can be used for the detector. For best results, plan on using an outdoor antenna that's at least 75 feet long.

R-E

How to

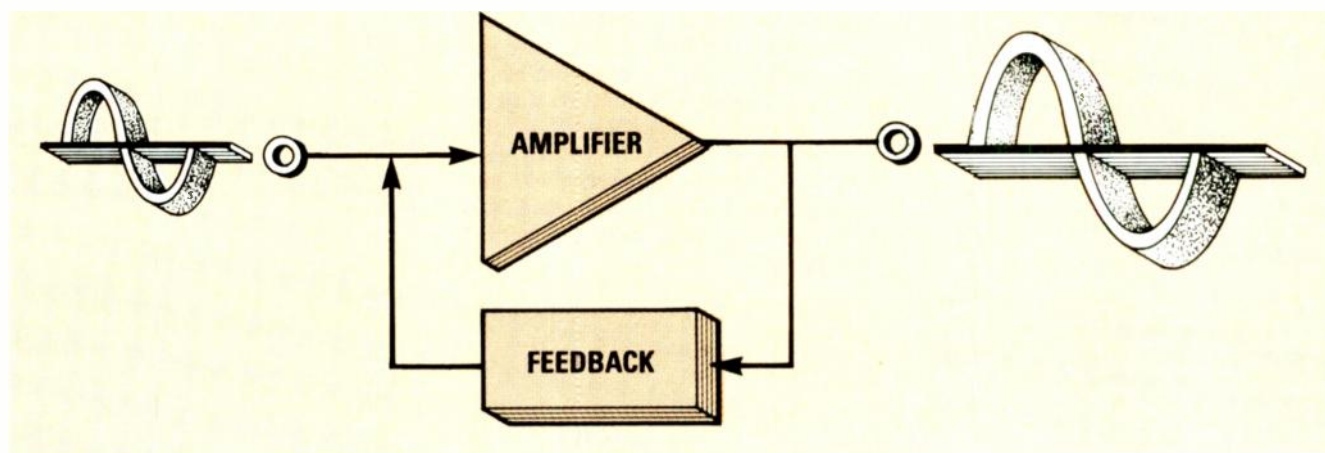

Design OSCILLATOR Circuits

JOSEPH J. CARR

Here's the first installment of our new back-to-school series that teaches you all about oscillators, multivibrators, and digital clocks.

OSCILLATORS OF ONE SORT OR ANOTHER are at the heart of all kinds of devices ranging from radio transmitters to digital computers. So, at one time or another, everyone involved in electronics—both hobbyist and professional—must build an oscillator, a multivibrator, or a digital-clock circuit. A simple oscillator, for example, might be used to generate the carrier frequency in a radio transmitter. A multivibrator that produces squarewaves might be the heart of a test instrument such as a function generator. A digital clock is a special multivibrator that is used in most digital logic and computer circuits.

In this series we'll examine the two major types of oscillator circuits in detail. We'll start off this time discussing relaxation oscillators; then we'll go on to the basic theory of feedback oscillators. And, because they are more commonly used than relaxation oscillators, we'll spend the bulk of our remaining installments discussing feedback oscillators. In particular, we'll talk about LC and RC sine-wave oscillators of all types, one-shots, crystal oscillators, and digital clocks built from both TTL and CMOS IC's. Along the way we'll give many practical circuit examples that you should have no trouble adapting to your needs. We have a lot to do, so let's get started.

Basic definitions

There is some overlap between the terms oscillator, multivibrator, and clock, and in conversation people have a tendency to blur the distinctions between those terms even further. But for our purposes let's use "oscillator" to refer to all three kinds of circuits. In fact, let's define oscillator to mean *any* circuit that produces a periodic waveform—one that produces similar outputs at regular intervals of time. That output could be a sine wave, a square wave, a triangle wave, a sawtooth wave, a pulse train, or some other wave shape. The important point is that it repeats at a regular interval.

As we said, there are two basic types of oscillators: relaxation oscillators and feedback oscillators. The basic difference between the two is that the feedback oscillator is built from active circuit elements—those that provide gain, whereas the relaxation oscillator is built from passive devices—those that do not provide gain.

Some relaxation oscillators are built from electronic devices that pass little or no current at voltages below some threshold, and that pass a relatively large current at voltages above that threshold. Examples of that sort of device are neon lamps and UJT's (UniJunction Transistors). Other relaxation oscillators use a nega-

tive-resistance device such as a tunnel diode. If you're unfamiliar with any of those devices or terms, hold on—we'll discuss each below.

A feedback oscillator uses an active device (a transistor or an op-amp, for example) as an amplifier; a special network connected to the amplifier provides a controlled amount of positive feedback. That allows the circuit to work regeneratively. By way of contrast, filters of various types (lowpass, highpass, notch, bandpass, etc.) work degeneratively. In other words, in a filter, feedback components are used to decrease the amplitude of a frequency or a range of frequencies; in an oscillator, those components are used to increase the amplitude of a frequency or a range of frequencies.

With those basic distinctions in mind, let's discuss relaxation oscillators now; we'll catch up with feedback oscillators below.

A neon-lamp oscillator

A simple neon-lamp relaxation oscillator is shown in Fig. 1. The lamp contains a low-pressure inert gas—neon—in a glass envelope with a pair of electrodes. When the voltage across the electrodes exceeds the ionization potential of neon (V_T in Fig. 2), the gas will glow. It will continue to glow as long as the voltage

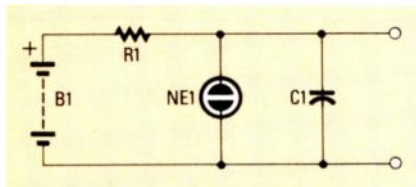

FIG. 1—THE NEON-BULB OSCILLATOR is a classic relaxation oscillator.

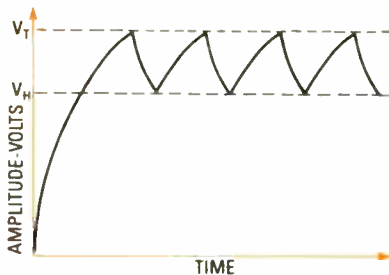

FIG. 2—VOLTAGE BUILDS UP across a neon bulb until V_T is exceeded. The bulb then begins to conduct, and voltage begins to fall. When it goes below V_H , conduction ceases, so the cycle can begin again.

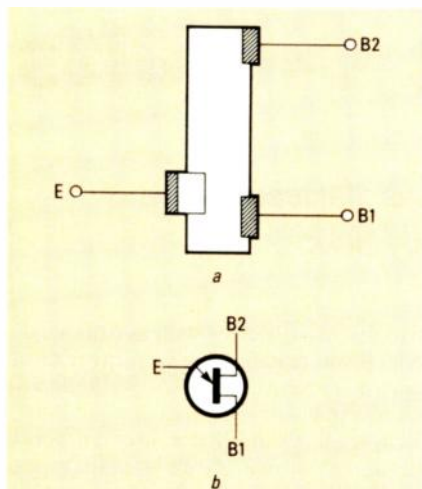

FIG. 3—THE UJT'S INTERNAL STRUCTURE is shown in a, and its symbol is shown in b.

across the lamp's electrodes exceeds the holding voltage, V_H in Fig. 2. When the lamp is not ionized, it conducts no current. That is the situation at all potentials below V_H . The popular NE-83 lamp has a V_T of 60 to 100 volts, and a V_H of 60 volts.

The circuit works like this: When power is applied to the circuit, C1 begins to charge. When the voltage across it exceeds V_T , the lamp ionizes and its resistance drops to a very low value. A series resistor may be necessary to prevent the lamp from being destroyed by the sudden onrush of current. Anyway, that low-impedance path allows C1 to begin discharging. Discharge continues until the voltage across the lamp falls below V_H . At that point the lamp de-ionizes and reverts to its high-resistance state. Then C1 begins charging again, and the cycle repeats. Hence, the voltage across C1 varies between V_H and V_T . The circuit's frequency of oscillation is determined by both V_T

and V_H , as well as by the RC time constant.

The unijunction transistor

The UJT is a special semiconductor device that has one emitter, two bases, and no collector. Its basic structure is shown in Fig. 3-a, and its schematic symbol is shown in Fig. 3-b. The UJT is built from a single chunk of silicon; the bases are just the electrodes at the ends of the block. The emitter forms a PN junction with the block. Like most other PN junctions, the UJT's PN junction will not conduct when it is reverse biased. However, it will conduct when it is forward biased; usually 0.6 to 0.7 volts is sufficient to get current flowing.

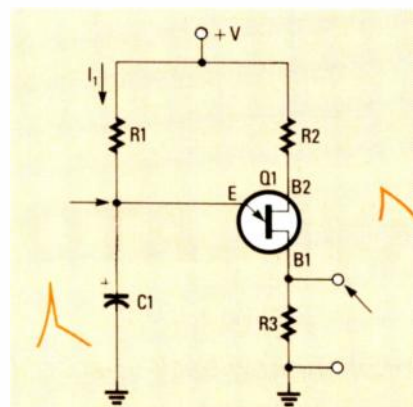

FIG. 4—THE CLASSIC UJT OSCILLATOR is a relaxation type; it provides a narrow spike at the B1 terminal.

A UJT relaxation oscillator is shown in Fig. 4. Its frequency of oscillation is set by R1 and C1 in conjunction with the characteristics of the UJT. When the circuit is turned on, the B1-emitter junction is unbiased, so no current flows through R3. Capacitor C1 begins charging through resistor R1. When the UJT's threshold voltage is exceeded, the UJT turns on. Capacitor C1 is quickly discharged by the low-impedance PN junction, so the UJT quickly turns off. A narrow pulse thereby appears across R3.

Typical UJT's need very little turn-on current (0.4–12 μ A), and that makes them useful in high-impedance circuits for detecting very small amounts of current. Also, oscillators with frequencies ranging from 1 Hz to 1 MHz may be built from UJT's.

The third major type of relaxation oscillator is built from a negative-resistance device, the tunnel diode. Let's find out what negative resistance is, and then let's see a practical example of how a tunnel diode may be used.

Negative resistance

What is negative resistance? Let's approach that question in a roundabout way. A garden-variety resistor functions according to Ohm's law. When voltage

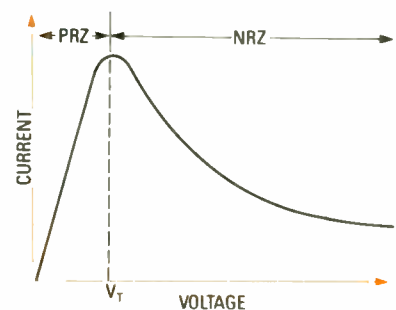

FIG. 5—TUNNEL DIODE'S CHARACTERISTIC curve reveals that, below V_T , current increases as voltage increases. Voltages above V_T cause current to decrease—and that allows oscillation to occur.

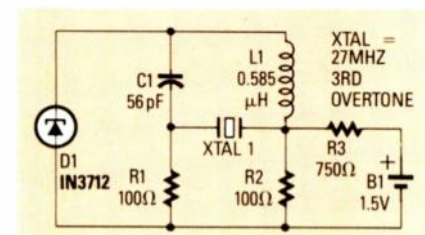

FIG. 6—THIS 27-MHZ OSCILLATOR can be used as a low-power citizen's-band signal generator.

across the resistor increases, current flowing through the resistor will also increase. A device with negative resistance, however, operates in the inverse manner. In other words, as voltage across the device increases, the current that flows through the device decreases.

The tunnel diode (also called an Esaki diode after its inventor) is a negative-resistance device; its characteristic curve is shown in Fig. 5. Note that, in the region labeled PRZ (for Positive Resistance), the device functions in the normal manner—increased voltage causes increased current. However, in the NRZ (Negative Resistance) region beginning at V_T , the opposite is true—increased voltage causes decreased current.

A tunnel-diode oscillator is shown in Fig. 6. That circuit was popular in the 1960's for tuning up citizen's-band gear, and for other uses at frequencies near 27 MHz. With the component values shown, the circuit will oscillate in the 27-MHz region using a 27-MHz 3rd overtone crystal. A similar circuit can be used to cause a tunnel diode to oscillate in the UHF and microwave regions. In that type of application, strip-line tuners and cavities are used to establish the resonant frequency.

In general, as you can see, relaxation oscillators are simple, so they're good for getting a quick-and-dirty periodic waveform, and for specialized uses. However, feedback oscillators built with active devices are much more flexible, and, therefore, much more widely used. So now let's take a look at the theory behind feedback oscillators.

continued on page 74

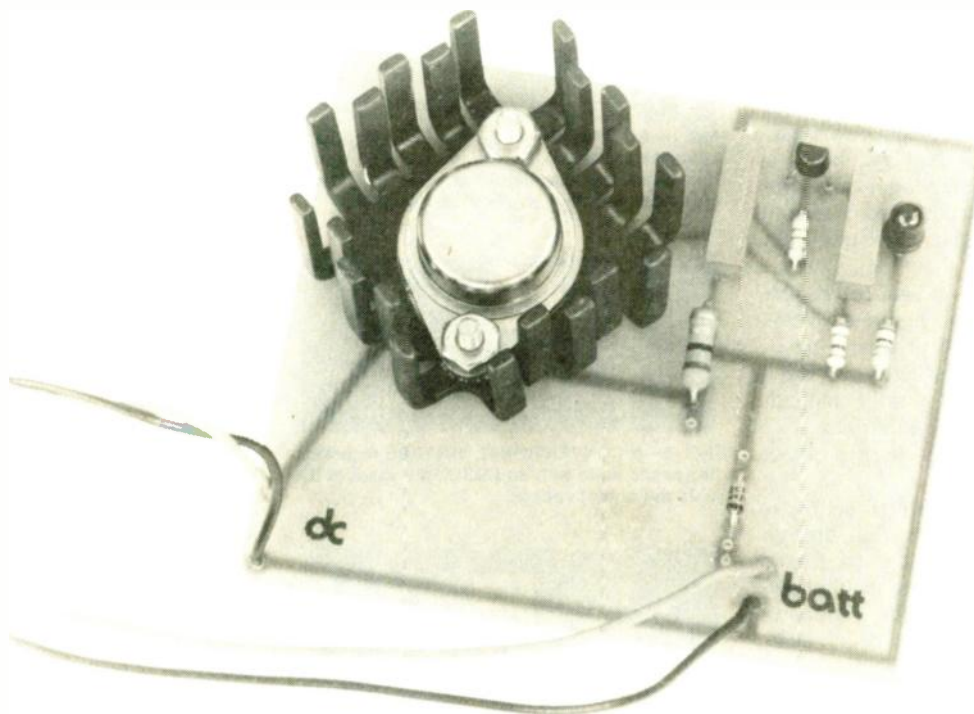

Universal Battery Charger

*Don't let your battery-powered portables run out of energy unexpectedly!
Keep your batteries fully charged with this inexpensive circuit.*

MICHAEL R. WRIGHT

ONE COROLLARY TO MURPHY'S LAW states that things always go wrong at the worst possible moment. One example familiar to electronics enthusiasts is the way that batteries tend to go dead just when you need them most. In addition, if you use many portable devices—a Walkman, a "boom-box," a portable TV, a portable computer, flashlights, and toys—the cost of batteries can become excessive.

One way to cut costs is to use rechargeable batteries. And if your portable battery-eater has a DC INPUT jack, you've got an easy way to save some cash and to go longer between recharges. All you have to do is wire up a cable that connects a high-current-capacity battery-pack of the proper voltage to your portable.

The problem is that the price of a commercial charger may cause you to think twice about converting from conventional non-rechargeable cells. However, with the circuit presented here, there's no longer an excuse. Not counting a case, the total cost of the few easy-to-obtain components in our circuit shouldn't exceed \$10. And that's for all new parts; by using spare parts you could reduce your cost to nothing!

The circuit can easily recharge batteries

with a wide variety of voltages and current capacities. The circuit was specifically designed to recharge gel-cells, but it can also be used to recharge Ni-Cd's and any other type of battery that needs a constant-current source, a constant-voltage source, or both. The values of a few resistors need to be altered to accommodate batteries of various voltages and currents. The simple design equations used for resistor selection are presented below, but first let's talk about gel-cells.

The low-down on gel-cells

Before we get started, it's worth pointing out that the term "battery" really refers to any collection of two or more single "cells," although the term is loosely applied to single-cell power sources like AA cells. The gel-cell battery is a relative newcomer to the world of rechargeable batteries; its name is really a shortened form of "gelled-electrolyte battery cell."

Basically, the gel-cell is very similar to a modern automotive battery. The gel-cell provides high power density in a sealed, multi-cell, maintenance-free, lead-acid battery. Gel-cells are not manufactured in small cases like those that enclose the

familiar AA, C, and D cells. However, they *are* manufactured in larger cases that range in size from a cigarette-pack to an automobile battery, and even larger. Gel-cells are made by (among others) Panasonic (Battery Sales Division, Division of Matsushita, P. O. Box 1511, Secaucus, NJ 07094), Globe (P. O. Box 591, Milwaukee, WI 53201), and Saft (P. O. Box 1886, 711 Industrial Blvd., Valdosta, GA 31603-1886).

Common gel-cell batteries come with voltage ratings that range from 2 to 24, and in current capacities ranging from 1.2 to 20 AH (Amp-Hours). The AH rating refers to the amount of current that can be delivered over a period of time; 20 hours is usually the specified period of time. For example, a battery might be rated at 2 volts and 30 AH. That means that the battery should be able to deliver a current of 1.5 amps (30/20) continuously for a period of twenty hours.

A properly treated battery should last for years, but an improperly treated one may last only a few months, or even weeks. For example, the author's first gel-cell battery lasted only about six weeks, because he was ignorant of how to take care of it. After uncovering and applying

the information related here, his second one is already more than a year old and still going strong.

The most common means by which a gel-cell battery is abused is "deep-cycling;" that term refers to the practice of discharging a battery deeply and then over-charging it. That practice is sometimes appropriate for Ni-Cd's, but it is definitely inappropriate for gel-cells. Our charger can't repair a damaged or abused gel-cell battery; it's up to you to treat your batteries with care.

The number of cells in a gel-cell battery is equal to the battery's nominal voltage divided by two. A 12-volt battery therefore has six (12/2) cells. Each cell has a 2.3-volt output when it is fully charged, so a 6-cell battery, nominally rated at 12 volts, actually has a fully-charged output of 13.8 volts.

You can tell when a gel-cell battery is nearly discharged by the fact that, under a no-load or low-load condition, it will have an output voltage that is near its full rated output. However, when the battery is placed under a moderate to heavy load, voltage drops by about 4.6 volts.

The reason for the two-cell drop is that a discharged cell actually reverses polarity and acts as a load that "cancels" the voltage of a good cell. So you might measure only about 9.2 volts (13.8 - 4.6 = 9.2) across a 12-volt battery that needs to be recharged. And speaking of charging, let's find out how to do it now.

Charging methods

Gel-cell batteries from different manufacturers are made in different ways, and they have different charging requirements. Many batteries can be charged using the circuitry described here, but you should check with the manufacturer of your battery to be sure.

A common and reliable method of charging is as follows. First, a regulated, constant current that is equal to 10% of rated output is applied to the battery. For example, a 12-volt 1-AH battery would start off with a charging current of 100 mA. Voltage must be monitored; when it reaches 90% of rated output, the circuit removes the constant-current source and applies a regulated voltage to complete charging. The switchover is necessary to prevent over-charging in case a battery is left connected to the charger for a long period of time. The battery can float-charge in that way indefinitely.

You may be able to use a charging current different than 10%—for example, for "fast-charging." However, if you use a different current, follow the manufacturer's recommendations carefully.

To determine the voltage the charger will have to supply, you'll have to multiply the number of cells in your battery by 2.3 and then add 5, to allow for circuit losses. To charge our example 12-volt battery,

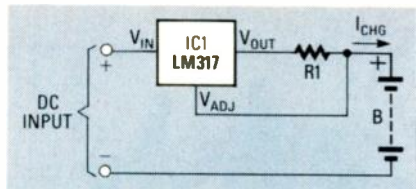

FIG. 1—A CONSTANT-CURRENT charger can be built from an LM317. The value of R1 is what determines the charging current. See the text for information on how to calculate its value.

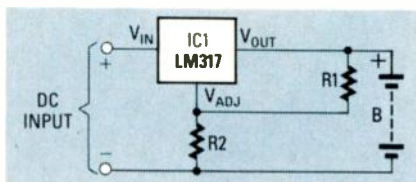

FIG. 2—A CONVENTIONAL VOLTAGE regulator is easy to build with an LM317; the value of R2 sets the output voltage.

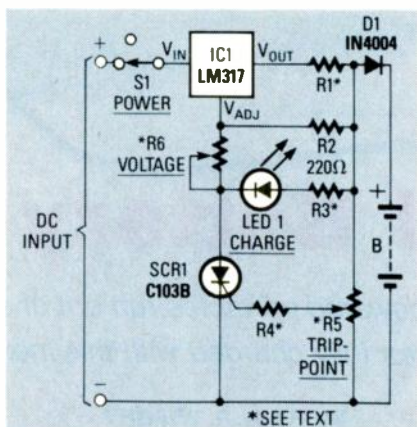

FIG. 3—THE COMPLETE CHARGER is a hybrid of the previous circuits. When the SCR is off, the circuit functions as a constant-current source; when the SCR is on, the circuit functions as a voltage regulator.

we'll actually need an unregulated DC supply of about 19 volts.

Circuitry

The constant-current charger is right out of the manufacturer's data book. As shown in Fig. 1, the heart of the charger is an LM317 adjustable regulator. An LM317K can supply as much as 1.5 amps of current if it has proper heatsinking; it can also handle as much as 37 volts. If your battery requires a higher charging voltage, you can substitute an LM317HV, which can handle as much as 57 volts. To increase current, you could use an LM338, which can provide five amps of current at a maximum of 32 volts. Calculate the value of R1 from the charge current (I_{CC}) you need, and from the 1.25-volt bias required by the LM317:

$$R1 = 1.25/I_{CC}$$

For a 1-AH battery, $I_{CC} = 0.1$ A, so $R1 = (1.25/0.1) = 12.5$ ohms. R1's wattage is determined in the usual manner: 0.1 A \times

1.25 V = 0.125 W. Just to be safe, use a $\frac{1}{2}$ -watt flame-proof resistor.

That takes care of current, but what about voltage? Take a look at Fig. 2. There an LM317 is configured as a conventional constant-voltage regulator. In normal applications, the manufacturer recommends that R1 have a value of 240 ohms. The value of R2 is what determines the output voltage, and its value may be arrived at by a fairly complex equation. It's usually simpler to wire up the circuit with a 5K or a 10K potentiometer, set the output voltage, and then substitute the closest standard fixed resistor for the potentiometer.

We've got a current regulator and a voltage regulator now. But how do we put them together? See Fig. 3.

The complete charger

Let's discuss the overall operation of the circuit and then show how to calculate resistor values. When power is applied to the circuit, SCR1 is off, so there is no bias-current path to ground; thus, the LM317 acts as a current regulator. The LM317 is connected to the battery through steering diode D1, limiting resistor R1, and bias resistor R2. That portion of the charger is similar to the circuit shown in Fig. 1 above. The steering diode was added to prevent the battery from discharging through the LED and the SCR when power is removed from the circuit.

As the battery charges, the voltage across TRIP-POINT potentiometer R5 rises and at some point turns on the SCR. At that point, current from the regulator can flow to ground, so the regulator now functions in the voltage mode. When the SCR turns on, it also provides LED1 with a path to ground (through R3). So, when LED1 is on, the circuit is in the voltage-regulating mode; when LED1 is off, the circuit is in the current-regulating mode.

Calculating resistor values

Now let's find out how to calculate the resistor values. Assume that we're still talking about a 12-volt, 1-AH battery. Let's start with the VOLTAGE adjustment potentiometer, R6. First we have to calculate a multiplication factor, F; that can be found from:

PARTS LIST

All resistors are $\frac{1}{4}$ -watt, 5% unless otherwise noted.

R1, R3, R4, R6—see text

R2—220 ohms

R5, R6—ten-turn trimmer potentiometer, see text

Semiconductors

IC1—LM317 variable-voltage regulator

D1—1N4004

LED1—standard LED

SCR1—C103B, 800 mA, 200-volt SCR

Miscellaneous

SPST toggle switch, PC board, input and output connectors

TABLE 1—EVERREADY Ni-Cd CHARGE CURRENT

Number	Size	Current	Voltage
CF15	AA	50 mA	1.50–1.60
CH15	AA	50 mA	1.35–1.45
CH35	C	120 mA	1.35–1.45
CH50	D	120 MA	1.35–1.45

$$F = (V_{CC}/1.25) + 1$$

In that equation V_{CC} is the battery's full-charge output voltage; in our case, $V_{CC} = 13.8$, so $F = (13.8/1.25) + 1 = 12.04$. Then we calculate the value of R6 as:

$$R6 = F(R1 + R2)$$

We already saw that R1 has a value of 12.5 ohms; R2 has a value of 220 ohms, so $R6 = 12 \times (220 + 12.5) = 2800$ ohms. That value is approximately what is required to obtain the end-of-charge voltage we need. The value is an approximation because it does not take into account the voltage drop across the SCR. So we simply round up to the next highest value, and use a 5K potentiometer for R6. That will allow you to adjust the circuit for use with batteries having different voltages.

The manufacturer recommends that R2 have a value of about 240 ohms. The series combination of R1 and R2 is within 5% of 240 ohms, and that's close enough. You may have to adjust the value of R2 to accommodate a different charge current, voltage, or both, or if you use the high-current LM338. See the 1982 *Voltage Regulator Handbook* by National Semiconductor (2900 Semiconductor Drive, P. O. Box 58090, Santa Clara, CA 95052-8090) for more information.

Next we need to determine the value of TRIP-POINT potentiometer R5, which sets the voltage at which the SCR turns on. We have found empirically that, if the end-of-charge voltage is less than 20 volts, a 5K unit will work. For voltages greater than 20 volts, a 10K unit will work.

The value of the LED's current-limiting resistor, R3, is easy to calculate:

$$R3 = (V_{CC} - 2.2)/20 \text{ mA}$$

$$R3 = (13.8 - 2.2)/0.02 = 580\Omega$$

You may want to substitute a 1000-ohm 1/2-watt resistor for R3. Doing that will prevent damage to the LED when the charger is used with batteries having voltages greater than 12.

The last value we need to calculate is that of R4, which limits the current that can be applied to the gate of SCR1. That current could blow the SCR if the TRIP-POINT potentiometer were turned too far in the direction of the output of the regulator. The value of R4 may be determined thus:

$$R4 = V_{CC}/50 \text{ mA}$$

So, in our case,

$$R4 = 13.8/0.05 = 276\Omega$$

Rounding up to provide extra current limiting, the closest standard value is 300 ohms, which should work fine.

Regarding the SCR, it must be able to handle the bias current of the LM317K when the latter is in the voltage mode, and it must be able to withstand the full, no-load voltage supplied by your DC source—19 volts in our example. The SCR specified is rated to handle 200 volts at 800 mA; it should be able to handle any battery you're likely to come across.

Construction

Layout and assembly are quite simple; a foil-pattern for a printed-circuit board is shown in "PC Service." A stuffing guide is shown in Fig. 4. Stuff the board, solder the components, and then check your

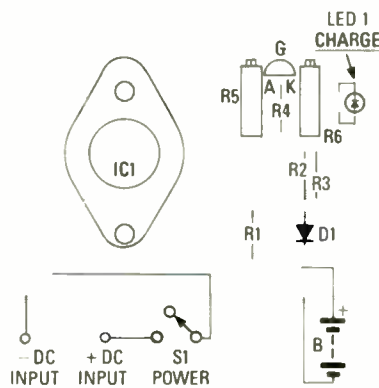

FIG. 4—PARTS-PLACEMENT DIAGRAM for the complete voltage/current charging circuit shown in Fig. 3.

work to make sure that the semiconductors are all oriented correctly.

Before applying power, set both trimmer potentiometers (R5 and R6) to the middle of their ranges; and *don't* connect the DC source or a battery to the charger yet. You must calibrate the charger first. We'll continue working with a 12-volt, 1-AH battery; substitute the appropriate values for your battery where necessary.

1. Connect an ohmmeter across the VOLTAGE adjustment potentiometer (R6). Adjust R6 so that the ohmmeter indicates the calculated set-point value—2.8K, in the example. Remove the ohmmeter from the

circuit before proceeding.

2. Apply power to the circuit and check for smoke and other signs of catastrophe. Fix any mistakes.

3. Connect a 4.7K resistor to the circuit where the battery would normally.

4. Apply power to the circuit and measure the voltage across the 4.7K resistor. That voltage should be about 13.8, or your calculated output voltage. If the measured voltage is much different from what you expect, measure the voltage across the SCR. If you don't measure about 0.7 volts, the SCR has not turned on, so adjust TRIP-POINT potentiometer (R5) until the LED turns on. If the LED won't turn on, the SCR may be bad.

5. Connect a voltmeter across the output terminals and adjust the VOLTAGE control (R6) so that the meter indicates your calculated V_{CC} —19 volts, in our case.

6. De-energize the circuit and connect an ohmmeter between the wiper of the TRIP-POINT potentiometer (R5) and ground. Adjust R5 so that the meter reads zero ohms. That will disable the current-to-voltage shift. Remove the ohmmeter and the 4.7K resistor.

7. Connect a partially-discharged gel-cell battery to the output terminals of the charger. *Be careful to observe proper polarity!* The LED should not light; if it does, steering diode D1 is in the circuit backward.

8. Connect a voltmeter across the battery, apply power to the circuit, and measure the voltage across the battery. If the battery is not discharged enough, V_{CC} may be reached before you have a chance to adjust R5. If your meter indicates V_{CC} now, you'll have to discharge your battery further and try again. What you want to do is adjust R5 so that the SCR trips just after V_{CC} is reached.

9. Partially discharge the battery and reset R5 several times until you're satisfied with the accuracy of the trip-point setting.

Charger use

When charging a battery, you'll want to take an occasional look at LED1. After it turns on, interrupt power for about three seconds. That allows the SCR to unlatch. Re-apply power, and, if the LED re-illuminates quickly, the battery is fully charged. If not, let the battery charge longer and then repeat the test.

You can also use this circuit to recharge lead-acid and Ni-Cd batteries. You'll have to re-calculate resistor values to provide the appropriate charging current, which can be obtained from manufacturers' data books. We show the required charge current for several common Eveready Ni-Cd cells in Table 1 as a point of reference.

When charging a (non gel-cell) lead-acid or Ni-Cd battery, power should be removed when the LED lights up, or over-charging may occur, and the battery may be damaged.

R-E

From McGraw-Hill . . . the professionals' publisher

Join the **Electronics and Control Engineers' Book Club**[®]

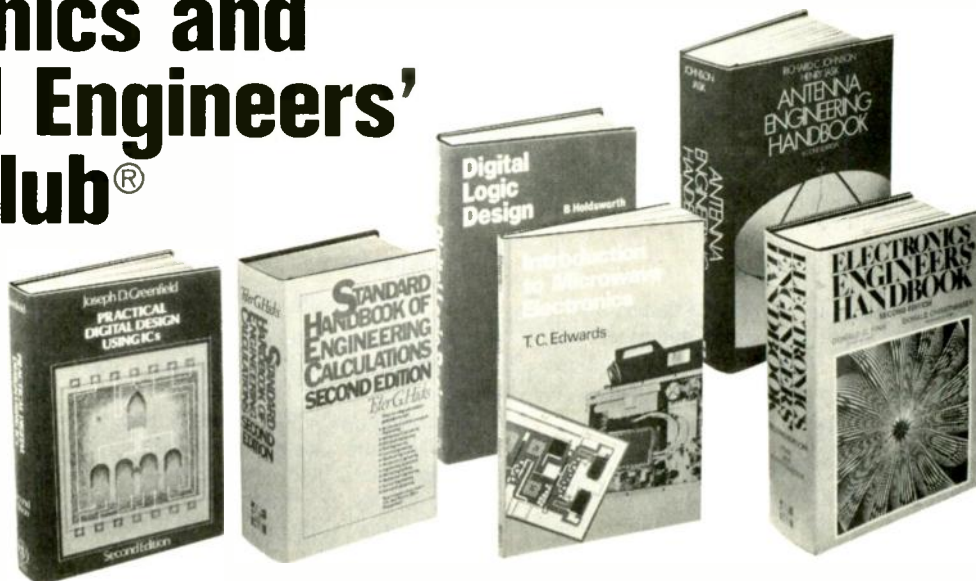

HANDBOOK OF TRANSFORMER APPLICATIONS By W.M. Flanagan. 416 pp., 132 illus. Covers virtually every facet of transformers and related ferromagnetic devices, this industry-oriented reference contains a wealth of specialized information not previously available in a single source.

212/902 Pub. Pr., \$49.50 Club Pr., \$36.75

TROUBLESHOOTING ELECTRONIC EQUIPMENT WITHOUT SERVICE DATA By R. G. Middleton. 303 pp., 162 illus. and tables. Packed with charts, diagrams, and case histories, this practical handbook shows you how to pinpoint defective electronic circuitry when no service data is available.

583134-1 Pub. Pr., \$24.95 Club Pr., \$18.50

STANDARD HANDBOOK OF ENGINEERING CALCULATIONS T. G. Hicks, Editor in Chief. 2nd Ed., 1,468 pp., 1,292 illus. and tables. Now revised, updated, and considerably expanded, this huge handbook provides more than 5,100 step-by-step procedures for solving the kinds of engineering problems you encounter most frequently in your work.

287/35X Pub. Pr., \$59.50 Club Pr., \$44.50

POWER CONTROL WITH SOLID-STATE DEVICES By Irving M. Gottlieb. 372 pages, 218 illustrations. This comprehensive book discusses every type of solid-state device and circuitry now available for power electronics. It covers both the proven-in-practice power control systems and the avant garde—as well as some promising combinations of the older and newer devices and circuitries.

583240-2 Pub. Pr., \$28.95 Club Pr., \$21.95

CONTROL SYSTEM ENGINEERING By Mohamed E. El-Hawary. 583 pages, 373 illustrations. This up-to-the-minute guide gives you the latest techniques for the design, analysis, and compensation of today's increasingly complex and sophisticated control systems. All the systems covered are closed-loop time-invariant feedback control systems.

583224-0 Pub. Pr., \$32.95 Club Pr., \$24.75

DIGITAL LOGIC DESIGN. By B. Holdsworth. 338 pp., 192 illus. All of the recent advances in digital design techniques are presented here in depth. It's both a text covering basic concepts and a practical guide to design techniques for combinational, clock-driven, and event-driven circuits.

582852-9 Pub. Pr., \$39.95 Club Pr., \$27.50

INTRODUCTION TO RADAR SYSTEMS. By M. I. Skolnik. 2nd Ed., 698 pp., 244 illus. Covering every radar fundamental and all important changes, this EE text exposes you fully to the systems themselves—and to their applications! Topics include radar equation, CW and frequency-modulated radar, MTI, pulse-doppler, tracking radar, receivers, displays, duplexers, noise, and more.

579/091 Pub. Pr., \$47.95 Club Pr., \$35.75

STANDARD HANDBOOK OF ENGINEERING CALCULATIONS SECOND EDITION
By T. G. Hicks

Digital Logic Design
By B. Holdsworth

Introduction to Microwave Electronics
By T. C. Edwards

ANTENNA ENGINEERING HANDBOOK
2/e Edited by R. C. Johnson and H. Jasik

ELECTRONICS ENGINEERS' HANDBOOK
2/e Edited by D. G. Fink & D. Christiansen

Get the competitive edge with the newest and the best information in your field . . . with books from all the leading publishers

New members!
Any one of these great professional books for only . . . **\$2⁸⁹** as a premium with your 1st selection!

Spectacular values up to **\$105.00**

THE ENCYCLOPEDIA OF ELECTRONIC CIRCUITS. By R. Graf. 760 pp., 1,256 illus. This large volume provides circuits for virtually every type of application in 98 different categories. Each has a clear and concise explanatory text accompanying it.

583265-8 Pub. Pr., \$50.00 Club Pr., \$39.95

TELEVISION ENGINEERING HANDBOOK.—By K. B. Benson. 1,478 pp., 1,091 illus. Packed with the technical information and know-how you need to design, operate and maintain every type of TV equipment in current use.

047/790 Pub. Pr., \$89.50 Club Pr., \$62.50

68000 MICROPROCESSOR. By W. A. Triebel and A. Singh. 335 pp., 129 illus. This guide to Motorola's 68000 microprocessor uses a systems approach that includes extensive coverage of the 68000, its architecture, assembly language programming, and hardware interfacing techniques.

583613-0 Pub. Pr., \$34.95 Club Pr., \$26.95

MCGRAW-HILL PERSONAL COMPUTER PROGRAMMING ENCYCLOPEDIA. Edited by W. J. Birnes. 704 pp., 48 illus. This giant reference compares the functional and operational definitions of every command used in 19 high-level computing languages as well as 8-, 16-, and 32-bit assembly languages and machine codes.

053/898 Pub. Pr., \$80.00 Club Pr., \$52.50

MCGRAW-HILL CONCISE ENCYCLOPEDIA OF SCIENCE AND TECHNOLOGY. Editor-in-Chief S. P. Parker and the Staff of the McGraw-Hill Encyclopedia of Science and Technology. 2,065 pp., 1,600 illus. This volume serves every need for understanding today's science and technology. Written by over 3,000 of the world's topmost experts, including 19 Nobel Prize winners, it covers 75 disciplines from Acoustics to Zoology.

454/825 Pub. Pr., \$95.00 Club Pr., \$66.50

HANDBOOK OF PRACTICAL ELECTRICAL DESIGN. By J. F. McPartland. 416 pp., 300 illus. This volume provides a step-by-step explanation of designing electrical systems for industrial, commercial, and residential applications.

456/95X Pub. Pr., \$44.50 Club Pr., \$33.50

INTRODUCTION TO MICROWAVE ELECTRONICS. By T.C. Edwards. 76 pp., illus., softbound. Eliminating unnecessary theory and mathematics, this book provides you with a lucid overview of microwave engineering and the devices and circuits being used today.

583030-2 Pub. Pr., \$14.95 Club Pr., \$10.95

ELECTRONICS ENGINEERS' HANDBOOK, 2/e. Edited by D. G. Fink & D. Christiansen. 2,272 pp., 2,189 illus. This updated and enlarged edition covers all the latest knowledge in the field, including new advances in integrated circuits, pulsed and logic circuits, laser technology, telecommunications, and much more.

209/812 Pub. Pr., \$89.00 Club Pr., \$50.00

ANTENNA ENGINEERING HANDBOOK, 2/e. Edited by R. C. Johnson and H. Jasik, with contributions by 57 recognized authorities. 1,408 pp., 946 illus. This widely acclaimed Handbook gives you the guidance you need to solve problems in antenna design and application.

322/910 Pub. Pr., \$105.00 Club Pr., \$62.50

GATE ARRAYS: Design Techniques and Applications. Edited by J. W. Read. 349 pp., 146 illus. Written by a team of specialists, this book describes the fundamental principles, design techniques, and uses of gate arrays.

512/868 Pub. Pr., \$35.00 Club Pr., \$24.75

ELECTRONIC COMMUNICATIONS SYSTEMS. By W. D. Stanley. 566 pp., illus. Emphasizing the signal-processing functions of modulation and demodulation operation, this book presents the essentials of electronic communications in a logical, step-by-step sequence.

582834-0 Pub. Pr., \$32.95 Club Pr., \$22.50

CONTEMPORARY ELECTRONICS CIRCUITS DESKBOOK Compiled By H. Helms. 272 pp., 442 circuit diagrams. Packed with clearly reproduced circuit diagrams, all proven-in-action, covering the entire spectrum of electronics technology. Each diagram includes a title, a brief description, type numbers or values for significant components and a citation of the original source.
279/802 Pub. Pr., \$29.95 Club Pr., \$23.50

INTRODUCTION TO RADIO FREQUENCY DESIGN. By W. H. Hayward. 383 pp., illus. This comprehensive volume prepares you to actually design HF, VHF, and UHF equipment and enables you to follow much of the current literature. Structured equation sets make it easy to write programs for small computers or calculators.
582748-4 Pub. Pr., \$32.95 Club Pr., \$27.25

MCGRAW-HILL ENCYCLOPEDIA OF ELECTRONICS AND COMPUTERS. By S. P. Parker, Editor-in-Chief. 960 pp., 1,266 illus., outsized 8 1/2 x 11 format. It's a single-volume library that covers the entire world of electronics from Edison's pioneering work in electricity right up to optical fiber communications, control systems, lasers, radar, TV receivers, artificial intelligence, and computer storage technology.
454/876 Pub. Pr., \$67.50 Club Pr., \$41.50

ELECTRONICS ENGINEERING FOR PROFESSIONAL ENGINEERS' EXAMINATIONS. By C. R. Hafer. 336 pp., more than 200 illus. Actually two books in one—a quick preparation manual to help you pass your P.E. exams on the first try and a rich source of practical electronics engineering information and know-how.
254/303 Pub. Pr., \$32.50 Club Pr., \$25.50

COMPUTER METHODS FOR CIRCUIT ANALYSIS AND DESIGN. By J. Vlach and K. Singhal. 656 pp., 148 illus. Computational methods have become an integral part of circuit analysis and design. And a solid understanding of the basics of computer-aided design is a must for engineers who want to achieve their career objectives.
582855-3 Pub. Pr., \$42.50 Club Pr., \$33.95

MODERN ELECTRONIC CIRCUITS REFERENCE MANUAL. By J. Markus. 1,264 pp., 3,666 circuit diagrams. Complete with values of components and suggestions for revisions—plus the original source of each circuit in case you want additional performance or construction details.
404/461 Pub. Pr., \$79.50 Club Pr., \$57.95

STANDARD HANDBOOK FOR ELECTRICAL ENGINEERS, 11/e. By D. G. Fink and H. Beaty. 2,448 pp., 1,414 illus. Today's most widely used source of electrical engineering information and data serves you as no other single work when you need detailed, timely, and reliable facts.
209/74X Pub. Pr., \$85.00 Club Pr., \$51.00

Be sure to consider these important titles as well!

DESIGN OF FEEDBACK CONTROL SYSTEMS. By G. H. Hostetter, C. J. Savant, and R. T. Stefani.
583206-2 Pub. Pr., \$41.95 Club Pr., \$31.45

MODERN COMMUNICATION CIRCUITS. By J. Smith.
587/302 Pub. Pr., \$43.95 Club Pr., \$32.50

MICROPROCESSOR SUPPORT CHIPS: Theory, Design, and Applications. By T. J. Byers.
095/183 Pub. Pr., \$43.50 Club Pr., \$35.25

DATA COMPRESSION: Techniques and Applications. By T. J. Lynch.
583267-4 Pub. Pr., \$44.50 Club Pr., \$31.25

TRANSDUCERS: Theory and Applications. By J. A. Allocca and A. Stuart.
582997-5 Pub. Pr., \$29.95 Club Pr., \$24.95

ANALYSIS AND DESIGN OF DIGITAL INTEGRATED CIRCUITS. By D. A. Hodges and H. G. Jackson.
291/535 Pub. Pr., \$40.00 Club Pr., \$32.50

HANDBOOK OF OPERATIONAL AMPLIFIER CIRCUIT DESIGN. By D. E. Stout & M. Kaufman.
617/97X Pub. Pr., \$48.50 Club Pr., \$34.95

ENGINEERING MATHEMATICS HANDBOOK, 2/e. By J. J. Tuma.
654/298 Pub. Pr., \$41.50 Club Pr., \$31.00

DIGITAL COMMUNICATIONS. By J. Proakis
509/271 Pub. Pr., \$42.95 Club Pr., \$31.50

CRYSTAL OSCILLATOR CIRCUITS. By R. J. Matthys.
583251-8 Pub. Pr., \$37.95 Club Pr., \$26.95

DESIGNING DIGITAL FILTERS By C. Williams.
583627-0 Pub. Pr., \$36.95 Club Pr., \$27.95

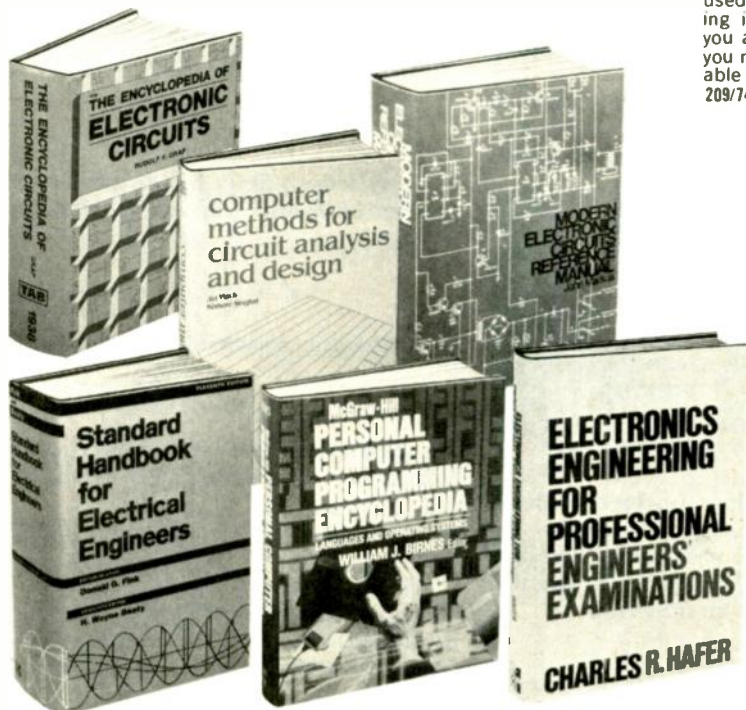

Why YOU should join now!

- **BEST AND NEWEST BOOKS IN YOUR FIELD** — Books are selected from a wide range of publishers by expert editors and consultants to give you continuing access to the best and latest books in your field.
- **BIG SAVINGS** — Build your library and save money too! Savings ranging up to 40% or more off publishers' list prices — usually 20% to 30%.

BONUS BOOKS—You will immediately begin to participate in our Bonus Book Plan that allows you savings up to 70% off the publishers' prices of many professional and general interest books!

- **CONVENIENCE**—12-14 times a year (about once every 3-4 weeks) you receive the Club Bulletin FREE. It fully describes the Main Selection and Alternate Selections. A dated Reply Card is included. If you want the Main Selection, you simply do nothing — it will be shipped automatically. If you want an Alternate Selection — or no book at all — you simply indicate it on the Reply Card and return it by the date specified. You will have at least 10 days to decide. If, because of late delivery of the Bulletin you receive a Main Selection you do not want, you may return it for credit at the Club's expense.

As a Club member you agree only to the purchase of three books (including your first selection) during your first year of membership. Membership may be discontinued by either you or the Club at any time after you have purchased the first selection plus two additional books.

Other McGraw-Hill Book Clubs:
Architects' Book Club • Byte Book Club • Chemical Engineers' Book Club
• Civil Engineers' Book Club • Mechanical Engineers' Book Club

For more information, write to:
McGraw-Hill Book Clubs, P.O. Box 582, Hightstown, New Jersey 08520-9959

MAIL THIS COUPON TODAY

McGraw-Hill Book Clubs
Electronics and Control Engineers' Book Club®
P.O. Box 582, Hightstown, New Jersey, 08520-9959

Please enroll me as a member and send me the two books indicated, billing me for the \$2.89 premium and my first selection at the discounted member's price, plus local tax, shipping, and handling charges. I agree to purchase a minimum of two additional books during my first year of membership as outlined under the Club plan described in this ad. A shipping and handling charge is added to all shipments.

Write Code No. of \$2.89 selection here

Write Code No. of first selection here

Signature _____

Name _____

Address/Apt. # _____

City _____

State _____ Zip _____

This order subject to acceptance by McGraw-Hill. All prices subject to change without notice. Offer good only to new members

E33805

FET STEREO AMP

continued from page 60

One winding feeds a 10A 400V bridge rectifier, which in turn feeds four 8000- μ F capacitors. That well-filtered supply powers the output amplifiers.

The other winding of the toroidal transformer provides a 30 VCT output that is rectified and filtered with 1000 μ F capacitors C12 and C13. Separate positive and negative three-terminal regulators, IC9 and IC11, provide fully regulated

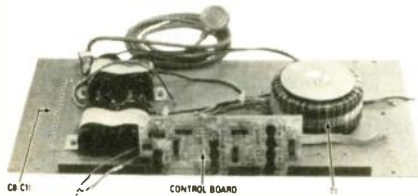

FIG. 9—THE LARGE TOROIDAL TRANSFORMER and filter capacitors provide low-ripple ± 15 -volt outputs.

+15V and -15V supplies for the op-amps. As we just stated, D22 provides an isolated positive supply for the op-amps.

The negative supply that feeds the analog switches is derived from the -15-volt supply via a simple resistive divider composed of R30 and R31. We can get away with using that simple scheme since the CMOS IC's draw only about 100 μ A of current, and that loads the resistive divider negligibly.

The positive supply must provide more current than the negative supply because the LED's are fed from the positive supply. Hence a 7805 regulator is used. The 220-ohm resistor (R28) between the output and the ground terminals of the regulator has about 23 mA of current flowing through it, and that current in conjunction with the 15 mA flowing out of the ground terminal impresses about three volts across 130-ohm resistor R29. That raises the output of the regulator from five to eight volts. The latter voltage feeds the LED's, and diode D23 isolates that voltage for the CMOS memory circuit.

Standby power

Two nickel-cadmium batteries are used to supply standby power to the CMOS IC's. The batteries provide just enough voltage so that the flip-flops retain their contents when the main power is switched off. Diode D23 ensures that the LED's don't drain the battery. Note that the minus rail is not powered by the batteries. That is because we are only interested in maintaining power in the logic circuits. Also, when the main power is on, the battery is trickle-charged via R32.

That (finally!) completes the circuit description. Start warming up your soldering iron; next time we'll go on and build an amplifier!

R-E

OSCILLATOR CIRCUITS

continued from page 66

Amplifier and feedback network

The essential components of a feedback oscillator are, as shown in Fig. 7, an amplifier and a feedback network. The amplifier could be any amplifying device—a transistor, an op-amp, even a tube. The feedback network could be built from various combinations of resistors and components such as capacitors, inductors, and crystals. A purely resistive network is seldom used in an oscillator because a network of that type is not frequency-selective. It might oscillate, but at a frequency we would have little control over.

However, we're getting a little ahead of ourselves. Before getting into the details of circuits and components, we really

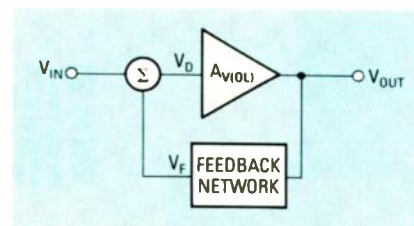

FIG. 7—THE FEEDBACK OSCILLATOR'S gain equations are based on this circuit model.

ought to approach the feedback oscillator from a more theoretical point of view. So let's see what the conditions for oscillation to occur are. We'll do that by deriving the gain equation for the circuit.

Feedback amp math

To begin with, let's simply name a few of the quantities that we'll be working with. Let's call the open-loop gain—the gain that would be obtained with no feedback—of the amplifier $A_{V(OL)}$. Gain when the feedback loop is connected is A_V —and that's the quantity we're trying to find an expression for. The circuit's output voltage is V_{OUT} , and its input voltage is V_{IN} . The output of the feedback network is V_F , and the difference between V_{IN} and V_F is V_D . In other words, $V_D = V_{IN} - V_F$.

The gain, or *transfer function*, of any circuit is simply the ratio of its output voltage to its input voltage. For the amplifier in our model circuit, we would express that relationship as:

$$A_{V(OL)} = \frac{V_{OUT}}{V_D} \quad (1)$$

In other words,

$$V_{OUT} = A_{V(OL)} \times V_D \quad (2)$$

And since the overall gain (A_V) of the circuit can be expressed as:

$$A_V = \frac{V_{OUT}}{V_{IN}} \quad (3)$$

we can substitute the right side of equation (2) into the numerator of equation (3) to obtain:

$$A_V = \frac{V_{OUT}}{V_{IN}} = \frac{A_{V(OL)} \times V_D}{V_{IN}} \quad (4)$$

As we saw above:

$$V_D = V_{IN} - V_F \quad (5)$$

So, rearranging things:

$$V_{IN} = V_D + V_F \quad (6)$$

Now we can substitute the right side of equation (6) into the denominator of equation (4) to arrive at a complete expression of the circuit's gain:

$$A_V = \frac{V_D \times A_{V(OL)}}{V_D + V_F} \quad (7)$$

Now we define a factor B that represents the ratio of feedback voltage to the output voltage:

$$B = \frac{V_F}{V_{OUT}} \quad (8)$$

By rearranging equation (8) we see that:

$$V_F = B V_{OUT} \quad (9)$$

so we can substitute the right side of equation (9) for V_F in equation (7), yielding

$$A_V = \frac{V_D \times A_{V(OL)}}{V_D + B V_{OUT}} \quad (10)$$

Our job is nearly complete; what we want to do is eliminate V_D from the preceding equation. By substituting the right side of equation (2) into equation (10) we see that:

$$A_V = \frac{V_D \times A_{V(OL)}}{V_D + B (A_{V(OL)} \times V_D)} \quad (11)$$

That allows us to eliminate V_D :

$$A_V = \frac{A_{V(OL)}}{1 + B A_{V(OL)}} \quad (12)$$

And that's we set out to find. The quantity $B \times A_{V(OL)}$ in the denominator of equation (12) is the *loop gain* of the circuit, and its value is important in determining whether a circuit will oscillate.

A feedback circuit will oscillate if two conditions are met: 1. Loop gain is unity or more, and 2. The feedback signal is in phase with the input signal. Those conditions are known as the *Barkhausen Criteria*. For the feedback signal to be in phase with the input signal we need a total phase shift of 360 degrees. And since a typical amplifier inverts the signal, or provides 180 degrees of phase shift, the feedback network must provide an additional phase shift of 180 degrees. There are many ways of providing that phase shift; next time we'll show how to do it using coils and capacitors.

R-E

PC SERVICE

One of the most difficult tasks in building any construction project featured in **Radio-Electronics** is making the PC board using just the foil pattern provided with the article. Well, we're doing something about it.

We've moved all the foil patterns to this new section where they're printed by themselves, full sized, with nothing on the back side of the page. What that means for you is that the printed page can be used directly to produce PC boards!

Note: The patterns provided can be used directly only for *direct positive photoresist methods*.

In order to produce a board directly from the magazine page, remove the page and carefully inspect it under a strong light and/or on a light table. Look for breaks in the traces, bridges between traces, and in general, all the kinds of things you look for in the final etched board. You can clean up the published artwork the same way you clean up your own artwork. Drafting tape and graphic aids can fix incomplete traces and doughnuts, and you can use a hobby knife to get rid of bridges and dirt.

An optional step, once you're satisfied that the artwork is clean, is to take a little bit of mineral oil and carefully wipe it across the back of the artwork. That helps make the paper translucent. Don't get a try on the front side of the paper (the side with the pattern) because you'll contaminate the sensitized surface of the copper blank. After the oil has "dried" a bit—patting with a paper towel will help speed up the process—place the pattern front side down on the sensitized copper blank, and make the exposure. You'll probably have to use a longer exposure time than you are probably used to.

We can't tell you exactly how long an exposure time you will need but, as a starting point, figure that there's a 50 percent increase in exposure time over lithographic film. But you'll have to experiment to find the best method for you. And once you find it, stick with it. Don't forget the "three C's" of making PC boards—care, cleanliness, and consistency.

Finally, we would like to hear how you make out using our method. Write and tell us of your successes, and failures, and what techniques work best for you. Address your letters to:

Radio-Electronics
Department PCB
500-B Bi-County Blvd.
Farmingdale, NY 11735

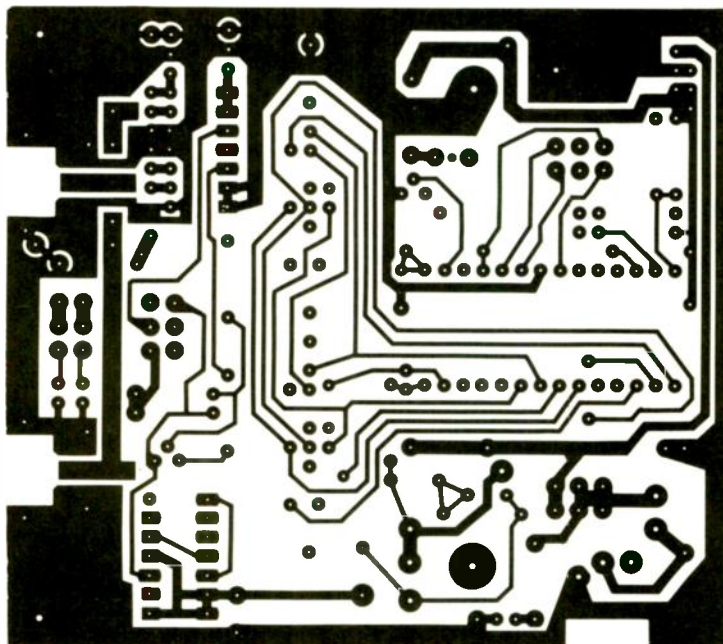

3.75 INCHES

THE COMPONENT SIDE of the frequency counter board is shown in a full-size mirror image.

PC SERVICE

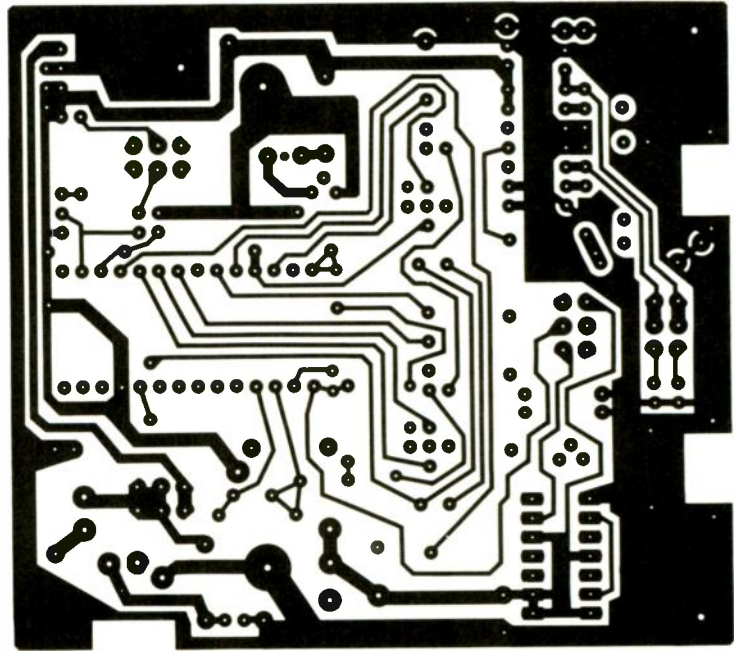

3.75 INCHES
THE DISPLAY SIDE of the frequency counter board in a full-size mirror image.

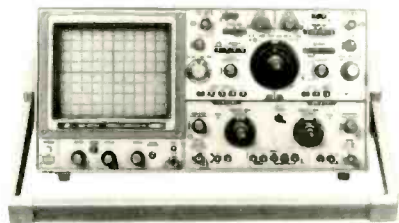

DC-60 MHz 4 Input, 8 Trace, Portable

- Typical Frequency Of From DC To 70 MHz, -3 dB (10 MHz margin over the specified frequency response)
- Reliable Time Difference Between Channels
- Built-In TV Sync Separator
- 3 Year Warranty

SS-5710 — \$1245
 SS-5710C — With Counter \$1799
 SS-5710D — With Counter/DMM \$1995

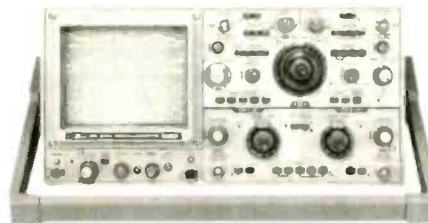

DC-100 MHz 4 Input, 8 Trace, Portable

- Typical Frequency Of From DC To 120 MHz, -3 dB (20 MHz margin over the specified frequency response)
- Reliable Time Difference Between Channels
- Jitterless Circuitry For Stable Triggering
- 3 Year Warranty

SS-5711 — \$1695
 SS-5711C — With Counter \$2295
 SS-5711D — With Counter/DMM \$2495



DC-40 MHz

SS-5705—DC-40 MHz SS-5706—DC-30 MHz

- 3 Input, 6 Trace (SS5705); 3 Input, 3 Trace (SS5706)
- Versatile Trigger Capability With TV-SYNC
- Jitter-Free Circuitry And Variable Hold-Off
- High Accuracy For V And H ($\pm 2\%$)
- Accurate Calibrator (Amplitude $\pm 1\%$ And Frequency $\pm 1\%$)

SS-5705 — \$899
 SS-5706 — \$749



DC-100 MHz Digital Storagecope

- 100 MHz Analog And Digital Bandwidth
- 40 Ms/s Sampling Rate
- Cursor Measurement (Analog And Digital)
- 4 Waveform & 7 Set-Up Memories
- GO/NO GO Judgement

DS-6121 — \$5550
 DS-6121A — With Envelope Mode \$5950

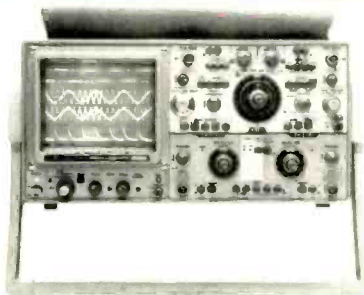

DC-200 MHz 4 Input, 8 Trace, Portable

- Reliable Time Difference Between Channels
- Freerunning Ground Facility
- High-Grade 6 Inch Quadrupole-Lens, Dome Mesh CRT
- Combination Trigger Probe (SS-0071) Optional
- 3 Year Warranty

SS-5712 — \$2999

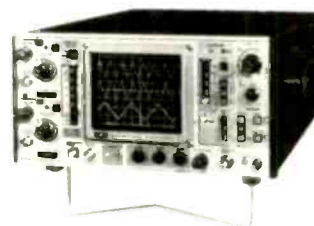

DC-10 MHz Digital Storagecope

- Built-in GP-IB (General-Purpose Interface Bus)
- High-Brightness CRT
- 3-Channel 10 MHz Oscilloscope Function
- 8-bit x 2048 Word/Channel, 1 μ s/word Digital Storage
- Both Real-Time And Digital Storage Waveforms Can Be Displayed On The CRT Simultaneously

SS-5802 — \$2750

Instruments For Your Success

SATELLITE TV



BOB COOPER, JR.,*
SATELLITE-TV EDITOR

Scrambling woes

THOSE OF YOU WHO HAVE BEEN FOLLOWING the ups and downs of the home-TVRO industry are aware that several pieces of legislation are pending before Congress. Little of that legislation is likely to be made into law this year, and, even if it should, little of it seems likely to benefit our industry.

When HBO first announced it planned to start delivering scrambled signals, there was widespread opposition to both plans and planners. M/A-Com, in particular, and other firms were crucial to the distribution of scrambling equipment; those firms have been justly criticized for their lack of preparedness. But before scrambling became official, a then-defiant trade-industry association believed that scrambling would not happen, and that it would not hurt if it did. However, it did happen, and it did hurt—badly.

Many people who hoped that scrambling would never come to pass pinned their hopes on various pieces of legislation introduced early in 1984. Had that legislation passed, it would have delayed scrambling for at least two years, and it might have gotten the FCC involved in the fray as a mediator between the disputing parties—TVRO users and program suppliers.

However, hearings regarding the pending legislation were held in early March of this year, and at least one additional round of hearings is planned. But the congressmen responsible for both the hearings and the legislation see little chance that any legislation will be enacted this year. They ac-

* Editor-in-Chief, *Coop's Satellite Digest*

Satellite	Transponder	Description
G1	12	Request TV
W5	24	The FUN Channel
	24	PPV (The pay-per-view channel)
S1	11	HSN (Hospital satellite network)
	21	BTN (Baptist telecommunications)
	21	VMT (Vanderbilt medical television)
AD1	8	CHCH (Hamilton, Ontario)
	9	WDIV (Detroit NBC affiliate)
	10	WXYZ (Detroit ABC affiliate)
	14	TCTV (Sherbrooke, Quebec)
	18	CITV (Edmonton, Alberta)
	21	WTVS (Detroit PBS affiliate)
	22	BCTV (Vancouver CTV affiliate)
	23	WJBK (Detroit CBS affiliate)
W4	11	CTNA (Catholic telecommunications)

knowledge the strength of the TVRO lobby, but they believe that differences between users and suppliers will sort itself out in the marketplace with no Congressional intervention.

The proposed legislation relates to two largely-unresolved issues: access to scrambled programming, and the price of that access. Access itself is a matter of little dispute. Virtually all cable-programming services have indicated willingness to offer services to TVRO owners.

Monopoly?

Price is a more difficult issue. For example, just what is a fair price for the TVRO owner to pay for HBO? If you subscribe directly from HBO, the price is \$12.95 per month. But some cable vendors have been offering services to cable subscribers for \$9 to \$10, and that is \$2 to \$4 per month less than the typical cable subscriber pays for the same service. And it's interesting to note that, when the dish owner buys directly from HBO, the local cable operator receives a \$5 per month "sales commission." In effect, HBO retains \$7.95 of the

\$12.95 collected, the rest is retained by the cable operator.

However, some cable operators have offered HBO to TVRO owners for as little as \$6.75 per month. As you might suspect, HBO has tried to put a halt to that sort of price-undercutting. One cable vendor (in Arkansas) offered HBO for a very low price; that company was told that HBO would no longer accept orders from subscribers living outside of the cable operator's county. That effectively shut down the company's national sales effort.

What presently galls the TVRO industry is that, to date, virtually all marketing of descrambling services has been done only by the cable programmers (e.g. HBO), and the cable franchises. But there has been no program marketing by firms involved in the satellite-TV industry. Those firms have cried "foul!" And they have claimed that prices are being set, monopoly-like, by cable-program vendors.

Price is important

Perhaps as many as 20 different program services are now sched-

uled to scramble their offerings; several are indicated in Table 1. The cost of unscrambling all of those services will amount to a fair piece of change for the consumer because possible incompatibilities between different systems may require different descrambling hardware. Consequently, many people feel that the total monthly charge for descrambling will be so high as to discourage the sale of new home-TVRO systems. In fact, there are indications that there will be 50% fewer systems sold in 1986 than were sold in 1985. The conclusion is that the price of descrambling a number of different, and very possibly incompatible systems is a key factor holding down sales of new systems.

Help from Congress?

Legislation might be able to help TVRO vendors. But key members of Congress show no interest in pushing legislation that attempts to rescue a faltering industry. The attitude, as one member of Congress noted, seems to be: "Adopting legislation to rescue home dishes will ultimately result in more legislation to rescue some other industry. There is no end to this once it starts; the marketplace must sort it out."

The problem is that the marketplace to date has not been doing a very good job of "sorting it out." Dish sales are much worse than a

year ago, inventories are excessive, and new models are not being released by manufacturers. The reason is that consumers are delaying purchases until they see who is going to scramble what, when it will be done, how compatible it will be, and how much it will cost.

Things have gotten so bad that Congressman Tauzin of Louisiana, a rare Capitol-Hill proponent of the need for legislation, is predicting that, unless the TVRO industry

gets help from federal legislation in six to eight months, the industry may go under. That's not a pretty prospect to say the least; it reminds us of the speed with which the CB-radio market suddenly collapsed some ten years ago under different circumstances.

Hopefully things won't go that route. But, in the interim, we'll continue to examine the growing amount of confusion the program scramblers are creating in the marketplace.

R-E

SATELLITE TV/

The First Five Years!

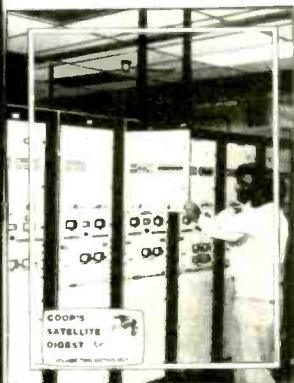

THE MOST COMPLETE report on the mushrooming home 'TVRO' industry ever compiled, written as only the 'father of TVRO' could have prepared. More than **1000 pages (!)** tracing the complete story of home TVRO, lavishly illustrated with equipment photos, schematic diagrams, equipment analysis reports. **Bob Cooper**, the first private individual to own and operate a TVRO (1976) has collected and polished hundreds of individual reports into a unique 'collector's edition' which clearly explains the TVRO phenomenon in North America. From Coop's first 20 foot 'monster' dish to the present day 5 foot 'C-band' TVROs, the fascinating growth of TVRO equipment and its legal status unfolds for you.

THIS TWO VOLUME SET totaling more than 1,000 pages is available for the first time to readers of *Radio-Electronics* at special discount pricing. **Originally sold at \$100 per two-volume set**, a limited supply is now available **ONLY** through this advertisement. **PLUS**, you will also receive a special extraordinary bonus; the 200 page (+) **October 1984 edition of CSD Coop's Satellite Digest**. This very special edition of CSD is a best-seller in the TVRO industry, with the most comprehensive collection of TVRO facts and figures ever compiled. Combined with the 1,000 page 'CSD ANTHOLOGY' report, you have instant reference to **everything** you will ever need to know about the state of the home TVRO industry. It is **MUST** reading for every person in, or thinking about 'getting into,' **any** segment of the home TVRO world.

Interested in TVRO?

For nearly two years Bob Cooper has provided a no-charge kit of printed materials that describes the challenges of and opportunities in selling TVRO systems today. With the present intense interest in scrambling systems, Coop's *CSD* has made available a new no-charge service.

The **SCRAMBLE FAX** hotline is a 24-hour-per-day telephone service that provides accurate, detailed, and hard-to-find facts concerning the changeover to scrambling in the satellite communications industry. Information describing satellite receivers tested for scrambling compatibility, sources for authorized descramblers, wholesale rates of scrambling equipment and services—all are provided on the **SCRAMBLE FAX** hotline. There is no charge for that service, other than your long-distance telephone expenses. Simply dial (305) 771-0575 for a concise and timely three-minute capsule report that covers the latest in scrambling news.



SEND CSD ANTHOLOGY 2 Vols. + CSD Bonus.
SEND CSD October '84 Special Issue ONLY.

NAME _____ COMPANY _____
ADDRESS _____
CITY _____ STATE _____ ZIP _____

Payment: \$60 US funds (Anthology + Bonus), \$15 US funds CSD Oct. ONLY; payable "CSD ANTHOLOGY." Shipping charges prepaid. Enter order to: **CSD Anthology**, Radio-Electronics Magazine, 200 Park Av. S., New York, NY 10003; or call 305-771-0505 for credit card orders ONLY.

ROBOTICS



MARK J. ROBILLARD,
ROBOTICS EDITOR

Inexpensive robotics arms

YOU DON'T HAVE TO BE INVOLVED WITH robotics for very long to understand that the vast majority of real-world applications involve a mechanical arm of sort sort. However, few affordable arms are available for hobbyist and educational purposes.

For example, at least three companies supply arm systems that are used in education. Those arms cost between one and two thousand dollars; and it is my belief that that's beyond the range of most hobbyists and many small educational institutions.

At the other end of the scale, for several years Radio Shack has been marketing an arm called *Armatron* for less than \$30. However, its purely mechanical nature makes it hard to interface to an electrical control system (but see the May 1985 issue of *Radio-Electronics* for one approach.—*Editor*). Until recently, I knew of no other arms in the under-\$100 range. Let's look at why there have been no inexpensive robot arms.

What's in an arm?

You might wonder just what makes robot arms so expensive. We are used to electronics devices being aggressively priced—after all, IC's are made of sand! However, robot arms are mostly mechanical, and mechanical linkages require expensive machining. Even inexpensive plastic parts are made from molds that are costly to make.

Motors can also be expensive, but clever design can reduce the number of motors that are required. For example, when you take apart Radio Shack's *Armatron*

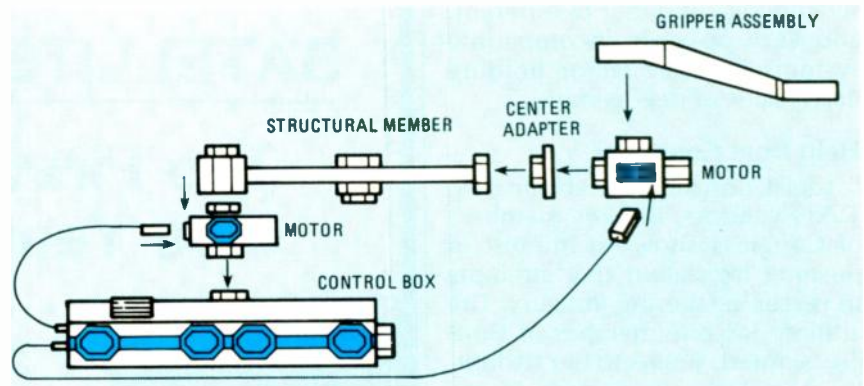

FIG. 1

(which I highly recommend as an educational exercise), the first thing that strikes you is its lack of motors—there's only one, and it can move six different joints.

The next potentially-expensive items are gears. Most arms (including Radio Shack's) are filled with gears of various sizes and configurations. And rarely can a stock catalog gear perform the desired function; thus gears must be designed and manufactured for each individual application. That makes it hard for hobbyists to find gears that are suitable for building an arm from scratch.

So, if parts are expensive or simply unavailable, how can the robotics hobbyist get an arm to experiment with?

It happens that Milton Bradley has begun marketing a kit, the *Robotix*, that will allow you to build an experimental arm for a surprisingly low price—only \$39! The kit consists of a two-fingered manipulator, a rotating base in which the battery supply is located, counterweights, and numerous other parts for construction of arms in various config-

urations. Each finger comes with two pieces of non-slip rubber for traction.

Two custom-designed motors include complex internal gearing mechanisms, and each motor can produce a torque of 50 inch-ounces. The output shaft of the motor is an octagonal male plug that fits snugly into one of several supplied structural elements. Electrically, the motors are connected to the base through specially designed cables that have easy-to-use two-pin plugs.

To give you an idea of what you can do with the *Robotix*, I built a six-jointed arm from two kits—in seven minutes! It can rotate about the vertical axis, and move at the shoulder, elbow, and wrist; and it incorporates a two-fingered gripper. Vertical-axis rotation allows the arm to transfer a part or object from one area to another along a horizontal arc. For \$78, that's impressive!

You could build a simple arm from a single *Robotix* kit by following the illustration in Fig. 1. The arm is not capable of lifting an automobile, but you could use it

learn quite a bit about the kinds of problems that robotics designers face. When you master the basics, you can extend the arm's reach by adding another structural member through a supplied coupler. But how do you master the basics?

Arm fundamentals

A device used to transport materials from one place to another is called a transfer mechanism. In its simplest form, a transfer mechanism can be a gripper and a rotary indexing table that allows the robot to grasp an object and place it on the table in another place. A rotary transfer mechanism is probably the ideal way for people on a limited budget to begin investigating robotics arms.

There are many types of grippers. Electromagnets can be used to grip ferrous metals; the advantage of an electromagnet is that it doesn't require much to control it. A small vacuum pump connected through a tube is another possibility. However, grippers with two (or more) fingers are the most common and the most popular because of their versatility.

After you've settled on the basic mechanical configuration, it's time to get the hardware wired up. The *Robotix* motor runs on three volts and draws approximately 170 mA while stalling. A simple relay arrangement (like the one shown in "Building Your Own Robot," *Radio-Electronics*, March 1986, p. 50) can be built that will allow you to reverse motor direction under computer control.

That circuit could be extended to add as many motor controls as are necessary. For simultaneous control of several motors, add an enable circuit and duplicate the direction-control circuit for each motor used.

As for interfacing, there are many brands of personal computers, so we can offer no precise guidelines about specific ways of interfacing a motor-control circuit to particular models. Suffice it to say that you must have some sort of parallel output port. Commodore *VIC's*, *C64's* and *C128's* have a "user port" that can be used. Most other brands of personal computers will require a separate parallel interface card.

Don't expect that you'll be able to use a parallel printer output port. Those ports require handshaking signals that our circuit does not supply.

For you Apple *II* owners, Crabapple Systems (118 Commercial Street, Portland, ME 04101) has a product specifically designed to drive the *Robotix* motors. For you TRS-80 *Color Computer* fans, MJR Digital (Mason Road, Milford, NH 03055) has a board with connectors that allows direct connection to the *Robotix*; software and experiments are also included.

The real problems begin only after you've got the hardware all hooked up. If you've never attempted to control an electromechanical arm before, I suggest that you start with a simple device before moving on.

One of the first lessons you'll learn is that it's hard to determine how far to move each joint when moving toward an object. There is a tremendous amount of literature available on methods of controlling mechanical arms. Most involve complex mathematics. That's another reason to start with a simple arm.

Anyway, keep in mind that the transfer mechanism moves through space in an arc, so keep the area surrounding the robot free. For a first experiment, try making your arm locate a light plastic block at location *A*. Then the arm should grasp the block and move it to a new location, *B*. Because the simple arm has no capacity for vertical motion, the block must be placed at *A* after the gripper arrives there. Otherwise, the gripper will dislodge the object as the gripper approaches it.

Your control program should flow something like this: First move the arm to *A*, and then open the gripper. Wait for a keypress from the user (that's you) to indicate that the block has been placed between the jaws of the gripper. Close the gripper, and move the arm to *B*. Finally, release the gripper.

Reader request

If you own a Heath *HERO I*, I'd like to hear from you. You don't have to say whether you like it, just that you own one.

R-E

Get A Complete Course In

ELECTRONIC ENGINEERING

8 volumes, over 2000 pages, including all necessary math and physics. 29 examinations to help you gauge your personal progress. A truly great learning experience.

Prepare now to take advantage of the growing demand for people able to work at the engineering level.

Ask for our brochure giving complete details of content. Use your free information card number, or write us directly. **\$89.95**, Postage included. Satisfaction guaranteed or money refunded.



**Banner
Technical
Books, Inc.**

1203 Grant Ave.
Rockford, IL 61103

CIRCLE 176 ON FREE INFORMATION CARD

SUPER LONG PLAY TAPE RECORDERS

10 Hour Model — \$95.00*
14 Hour Model — \$159.00*

Modified Panasonic Slimline.
high quality AC-DC
Recorders provide 5 or 7
continuous hours of quality
recording & playback on
each side of cassette for a
total of 10 or 14 hours
depending on model. Built-in
features include • Voice
level control • Digital
counter, etc. TDK DC 180
Cassette Furnished



PHONE RECORDING ADAPTER

Records calls automatically. All Solid
state connects to your telephone
jack and tape recorder. Starts
recording when phone is lifted.
Stops when you hang up. **\$24.50***
FCC APPROVED



VOX VOICE ACTIVATED CONTROL SWITCH

Solid state. Self contained. Adjust-
able sensitivity. Voices or other
sounds automatically activate and
control recorder. Uses either re-
cord or remote mike. **\$24.95***

*Add for ship & hdg. Phone Adapter & Vox \$1.50 ea.
Recorders \$4.00 ea. Cal Res. add tax. Mail order, VISA
M.C. COD's OK. Money Back Guarantee. Qty disc.
avail. Dealer Inquiries invited. Free data
AMC SALES INC., Dept. A 9335 Lubec
St., Box 928, Downey, CA
90421 (213) 869-8519

CIRCLE 108 ON FREE INFORMATION CARD

SERVICE CLINIC

Dead-set servicing

MANY PEOPLE WONDER WHERE TO start servicing a completely dead TV set. If the circuit-breaker trips as soon as you turn the set on, you've got a "crowbar short" in it. And chances are that it's in the B+ supply. So get out your ohmmeter, locate the B+ section of your chassis, and start hunting.

After you find the B+, unplug the set, discharge all large capacitors, and start measuring the resistance from various points to ground. You should always measure fairly high resistances, at least 50K, or even more. If you do find a resistance of zero (or close to it), you're in the right neighborhood. In fact, the input filter capacitor is probably shorted. But if you measure say 15–20K to ground, the short is somewhere farther down the "B+ -string." So continue measuring resistance at other points. Chances are that your problem will be due to a shorted capacitor.

Replacing capacitors

If you replace a shorted high-voltage capacitor, be sure that the replacement has a good margin of safety. For example, if a capacitor normally has 300 volts across it, use a capacitor with a rating of at least 450 volts; 600 volts is better, of course.

If you replace a shorted or leaky capacitor, and your picture improves, but still has problems, the one that you replaced may have set off a chain reaction that affected other components. Remove power and check other components in the vicinity.

A shorted filter capacitor is about the only *simple* thing that can cause the "dead-set" symp-

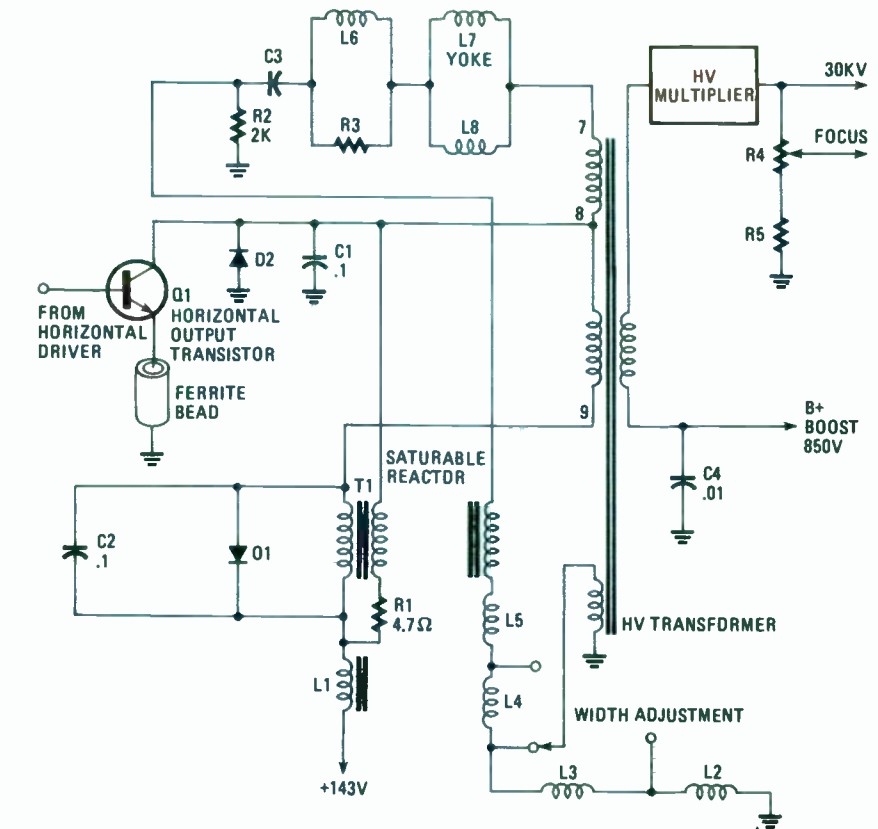

FIG. 1

tom. But if replacing that capacitor doesn't clear up the trouble, and all the nearby components seem to be OK, start checking for other problems. Things like incorrect bias on an audio-output stage or even the horizontal-output stage can wreak havoc. And check all of the high-voltage stages, like the one shown in Fig. 1, for normal operation, because trouble there can disrupt operation severely.

Of course, a dead set could be caused by other things, too—but have you ever seen *any* problem that couldn't have at least half-a-

dozen causes? So check the whole chassis very carefully for something odd—like a solder-blob in the wrong place. I worked on one set that had a dead short somewhere and I just couldn't locate it. Finally I saw a dribble of solder concealed under a terminal point. After removing it, the set worked like a charm.

So when you run into one of those monsters, take up your ohmmeter, set it on its lowest range, and start checking the resistance of the B+ string until you find the troublemaker!



JACK DARR,
SERVICE EDITOR

SERVICE QUESTIONS

OSCILLATION IN RCA CTC-107

I had several problems with an RCA CTC-107. I replaced the flyback as well as several small transistors in the voltage regulator circuit. Now I have vertical lines on the right side of the screen, and the set interferes with other sets in the vicinity! —T. M., Virgin Islands.

From the sound of it, your set is generating parasitic oscillation somewhere. Scope it out, especially the DC supply lines. Look for any sign of "fuzz" on the signal; that indicates the presence of stray or parasitic oscillation. Check all capacitors; scope the "hot" lead of each and look for fuzz, etc. If the capacitor is open you'll see garbage; there should be none with a good capacitor. Try bridging a suspect capacitor; that should show whether that one is causing the problem.

VOLTAGE PROBLEM

I replaced a blown fuse and the horizontal output transistor in my set, but the transistor still ran hot. The integrated flyback was defective, so I replaced it. But the transistor still runs too warm! What gives?—P. G., Columbia, SC.

I can think of two possible causes. Either the voltage regulator isn't working properly, or the bias on the horizontal output transistor is incorrect. Check both of those and you should solve your problem. You might also check the output drive while you're there.

FRENCH CONNECTION?

I've got a surplus chassis labeled "Morse-Electrophonic 7900." I've been looking for service data on it without any luck. It needs a power transformer with two 12-volt windings and a separate winding for the clock-chip, a 5387AA. The chassis may be Canadian because the back is marked in French.—T. S., Pahump, NV.

Non, monsieur! Pas de Francais, c'est Americain (by way of the Far East.!) That chassis was used in several brand names. Sams does not show an address for the maker, but they do list several models.

But you don't really need a schematic. Connect an external 12-volt power supply to each of the two supplies and measure the current drain. Now you can substitute a transformer with the appropriate current rating. If you really need a schematic, Sams provides details on several chassis in the 7000 series. Look at those schematics and see if one resembles yours; chances are you'll be able to find one that's close enough. That's what I used to do.

SHORTED FLYBACK?

Thanks for your suggestion about using a reduced line voltage when I was blowing new transistors. That helped a lot, but now I've got a new problem. As you suggested, I put a DC milliammeter across the fuse holder and gradually raised the line voltage. Normal current is 320 mA; at only 45-volts AC I got that much! I measure about 10 KV of HV, but nothing else. Do you think the flyback is the culprit?—H. S., Austin, TX.

I can say this: It certainly could be! If you get some HV, the flyback is trying to work, but it's drawing too much current. That indicates a possible "AC short;" that is, something that doesn't show up in an ohmmeter test, but does show up when the flyback is driven by a normal signal.

Check the flyback with the well-calibrated eyeball. See if any of the smaller windings look dark or discolored. Measure the resistance of all windings, especially the big one. If any has low resistance, look out; that may be the sign of shorted turns, and one is all you need! Digital ohmmeters, which can read as tenths of an ohm, are very handy for that type of measurement.

DC ON CRT HEATER?

Here's one I've always wondered about. Why is there a DC voltage on the CRT's filament?—B. M., Hastings, MI.

Thanks, Bill; that's one question I'm sure of the answer to! DC is applied to the heater of the CRT in order to reduce the stress between the cathode and the heater and to avoid possible heater-cathode shorts. If that happened, the tube would be inoperable. R-E

ATTENTION! ELECTRONICS TECHNICIANS



EARN YOUR
**B.S.E.E.
DEGREE**

THROUGH HOME STUDY

Our New and Highly Effective Advanced-Placement Program for experienced Electronic Technicians grants credit for previous Schooling and Professional Experience, and can greatly reduce the time required to complete Program and reach graduation. No residence schooling required for qualified Electronic Technicians. Through this Special Program you can pull all of the loose ends of your electronics background together and earn your B.S.E.E. Degree. Upgrade your status and pay to the Engineering Level. Advance Rapidly! Many finish in 12 months or less. Students and graduates in all 50 States and throughout the World. Established Over 40 Years! Write for free Descriptive Literature.

COOK'S INSTITUTE
OF ELECTRONICS ENGINEERING



347 RAYMOND ROAD
P.O. BOX 20345
JACKSON, MISSISSIPPI 39209

CIRCLE 181 ON FREE INFORMATION CARD

See Radio Electronics Magazine Constructors Project June '86

Bench Top Power Supply 0-30 Volt 1 Amp Kit

Looks so Good your Friends won't Believe you Built It!!

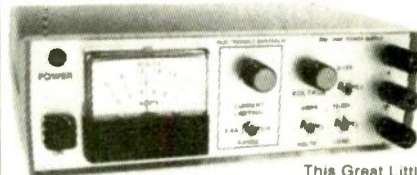

This Great Little power supply is a must for every Electronic Enthusiast and Electronic Student. Use it to power and test circuits and 1000 other uses. Very easy to build - even the beginner constructor should have no trouble - Just follow the plain English step by step instructions.

FEATURES: Output variable between 3 and 30 Volts • Short circuit Protection • Full 1 Amp output over entire voltage range • Load switching • Current limiting fully variable-twin selectable ranges • Dual Scale Meter • Separate earth terminal provided • Housed in Deluxe "ABS" instrument case

SPECIFICATIONS: • Output Voltage - 3 to 30 Volts • Output Current - 0 to 1 Amp (fully variable) • Load Regulation - Better than 0.29% from 0 to full load • Output Ripple - Less than 2mV RMS

**Save Over \$50
On Commercial Units**

**K 3210 Fantastic Value \$49.95
ADD \$4 SHIP AND DELIVERY**

PRINTED CIRCUIT BOARD ONLY

F 7530 \$4.50 Inc. Postage

IMTRONICS INDUSTRIES LIMITED
11930 31st Court, St. Petersburg
FLORIDA U.S.A. 33702
Phone 813 577 9010

CIRCLE 196 ON FREE INFORMATION CARD

DRAWING BOARD



ROBERT GROSSBLATT,
CIRCUITS EDITOR

More on memory management

ANYONE WHO HAS EVER BUILT A SYSTEM that uses memory for one thing or another should be familiar with the truth of Grossblatt's Twelfth Law: *There's no such thing as too much memory.*

No matter how much memory you design into your system, it's a foregone conclusion that you'll wind up using all of it, and when you do, you'll start looking for ways to increase it. It's like buying a new house. I know many guys who swore they'd never need more than eight rooms. Two years later they had finished the attic and the basement, and they were eyeballing the garage!

Unfortunately, it takes more than a hammer and some nails to add more memory to an electronics system. And it's slightly difficult to add memory to a system that's already using the full width of its address bus. That's the problem we started talking about at the end of last month's discussion. There are several ways to solve that problem, and each has unique advantages and disadvantages. We'll use the circuit we put together last time to examine one solution; others are certainly possible.

You'll recall that, since we're dealing with 512 bytes of memory space, the address bus is nine bits wide. We use the most significant address bit to select one of two 256-byte banks of memory automatically, and that gives us 512 bytes of continuous memory. Let's assume, for purposes of discussion, that our memory system is managed by a controller that has an eight-bit *data* bus, a nine-bit *address* bus, as well as the usual set of read, write, control, and I/O

signals. Given those parameters, let's see what we have to do to add more memory to the circuit.

Memory banking

No matter how you implement the circuit, the basic idea is to "page" or "bank" additional memory into the system. To understand the idea of bank-selecting memory, take a look at Fig. 1. Since our basic system can deal directly with

sort of problem when we assembled the demonstration circuit. This time, however, there's no handy-dandy address line to do the job for us. But, even though we have to look elsewhere for an answer, the problem is basically the same now as it was then. We need some sort of switch to toggle from one page to another.

The whole problem of getting from one bank of memory to an-

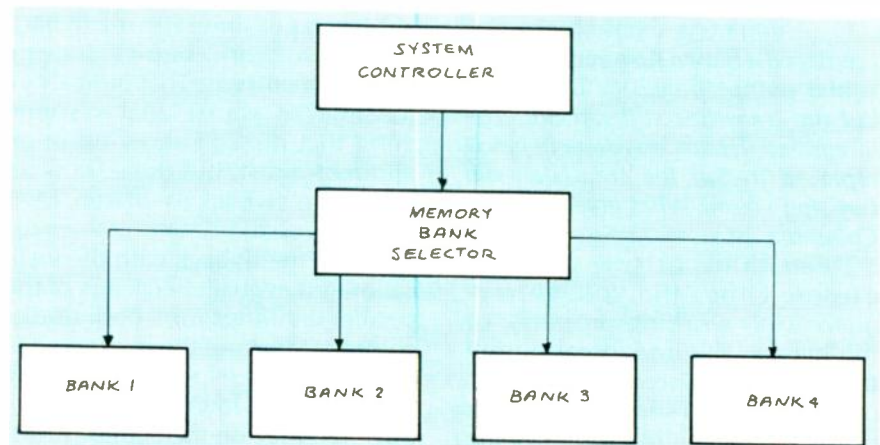

FIG. 1

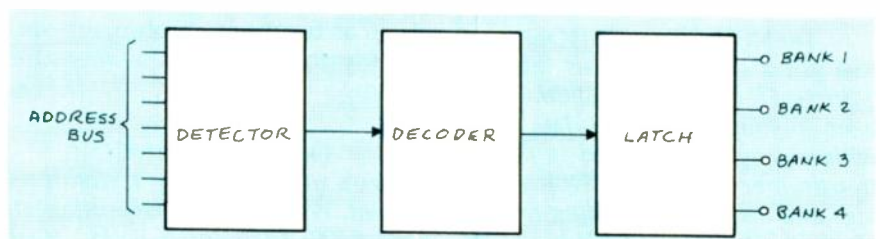

FIG. 2

only 512 bytes of memory, each page of memory will have 512 bytes. But in order for us to access different pages, we need a signal that the system can use to generate appropriate page-select signals.

We were faced with the same

other is one that computer designers face all the time. For example, any eight-bit computer that features 128K of memory uses some scheme to switch between two 64K banks.

You could always do the job with mechanical switches, but that's a

Learn the IBM PC's secrets with the
MICROPROFESSOR I/88



Students, engineers, or technicians—
Now you can learn micro-processing and
understand the technology which made
the IBM PC famous.

The MPF-I/88 features:

- extensive documentation
- 16-bit central processor
- full-size keyboard
- special options

Three tutorial guides cover all capabilities.
The ideal training tool! If the IBM PC or
micro-processing are in your future, you owe
yourself an MPF-I/88. Invest now!

Only \$349.95

Plus—

Check this box for a FREE
MPF-I/88 tutorial textbook
when you order within 7
days. \$24.95 value



Dept. RE0786
5326 9th Ave. NE
Seattle, WA 98105-3617

For immediate action call TOLL FREE:
1-800-426-1044

Full money back
guarantee.



CIRCLE 184 ON FREE INFORMATION CARD

ENABLE BANK	ADDRESS	
	HEX	BINARY
1	1FF	1 1111 1111
2	1FE	1 1111 1110
3	1FD	1 1111 1101
4	1FC	1 1111 1100

a

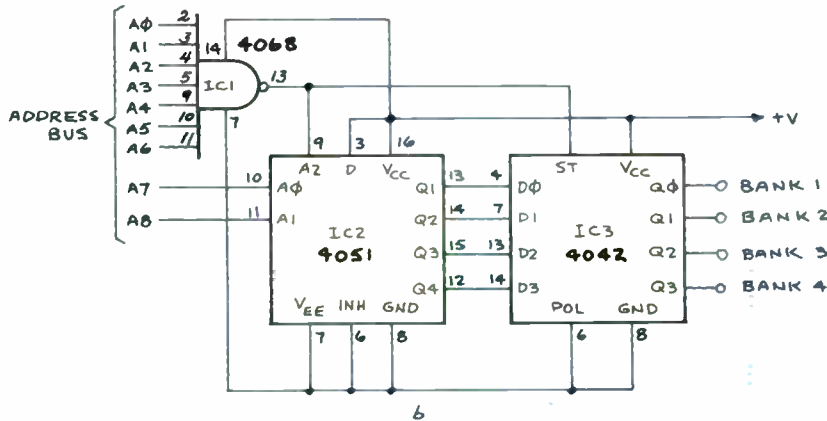

FIG. 3

bit rude and crude. A much better way is to use "soft switches" to do the toggling for us. "Soft switching" is a term that computer people use all the time; it represents a technique that we've used over and over in the circuits we've put together. All it means is that we put a decoder on the address bus and let it watch for a particular address. When that address shows up, the soft switch detects it and changes the state of its output.

As with any other problem in logic design, the first two steps are to decide exactly what you want to do and then to draw a good block diagram of the circuit. So, first, let's say that we want to piggy-back four banks of memory and have our new circuitry select the desired bank by flipping a couple of soft switches.

Second, the block diagram in Fig. 2 indicates the three basic elements we'll need: The *detector* senses the address we're looking for and causes the *decoder* to put out a signal that we can then *latch* to control our system. Now that we know what we need, let's see what we have to do to build it.

The detector is a snap—we've put together many of them during the last few years. You can use anything from a simple gates-only ap-

proach to dedicated decoder chips. Since we're just starting to find out how to build and use soft switches, let's take the most straightforward design approach. After we've got the system working, we'll see what we can do to simplify things.

Memory is addressed in our system from 000 to 1FF. We have to pick four addresses to use as our soft-switch locations. In a real-world system there would probably be circuit considerations that would dictate which locations to use. But since we're building our circuit from the ground up, we can pick any addresses we want. Let's take the four highest addresses in the system and define them according to the table shown in Fig. 3-a. As you can see, the highest address (1FF) selects the first page, 1FE selects the second page, and so on.

A starting point for the circuit we need is shown in Fig. 3-b. Since the four addresses we're looking for are all at the top of memory, the seven most significant lines will all be high when one of those addresses is accessed. That means we can use an eight-input NAND gate as the front end of our circuit. So, any time the NAND gate outputs

continued on page 90

Be an FCC LICENSED ELECTRONIC TECHNICIAN!

Earn up to \$30 an hour and more!

Learn at home in spare time. No previous experience needed.

No costly school. No commuting to class. The Original Home-Study course prepares you for the "FCC Commercial Radio-telephone License". This valuable license is your "ticket" to thousands of exciting jobs in Communications, Radio-TV, Microwave, Computers, Radar, Avionics and more! You don't need a college degree to qualify, but you do need an FCC License.

No Need to Quit Your Job or Go To School
This proven course is easy, fast and low cost! **GUARANTEED PASS** - You get your FCC License or money refunded. **Send for FREE facts now. MAIL COUPON TODAY!**

COMMAND PRODUCTIONS
FCC LICENSE TRAINING, Dept 90
P.O. Box 2223, San Francisco, CA 94126
Please rush FREE details immediately!

NAME _____
ADDRESS _____
CITY _____ STATE _____ ZIP _____

ANTIQUERADIOS



RICHARD D. FITCH,
CONTRIBUTING EDITOR

Tuning “eyes” and AVC

LAST TIME WE LOOKED AT ONE POPULAR advance in early radio circuits: the automatic tuner. This month we’ll take a look at several other, more controversial advances: tuning indicators and Automatic Volume Control (AVC) circuits. If you ever wondered how a “magic-eye” tuning indicator works, or how to troubleshoot one, you’ll find our discussion valuable.

The Truetone model D925

Our Antique of the Month, made by Western Auto, is a fine-looking radio that incorporates several of the advanced features we’ll be discussing. It has a magic-eye tuning indicator and pushbutton tuning, as well as a tone control and the ability to receive shortwave signals. To override the pushbuttons, the spring-loaded tuning knob is pushed in. The seven-tube (not counting the magic eye) superhet uses a type-80 rectifier tube, and it has an IF of 455 kHz.

Automatic tuning devices like that on the Truetone model D925 did little to hold the cost of a radio down; and cost, in the early 1930’s, was of prime consideration to manufacturers. But not all circuit improvements increased cost. In fact, one of the most important advances actually reduced cost in the final analysis. The superheterodyne circuit reduced interference and improved reception to such an extent that pounds of shielding could be eliminated.

During World War I, many engineers worked on the superheterodyne circuit, which was first



FIG. 1

patented by Major Armstrong after the war. Because of patent-right contention, superhet sets didn’t really become widely available until the early 1930’s. However, as late as 1940, TRF (Tuned Radio Frequency) receivers were still being built. But long before patent restrictions were eased, hobbyists began converting their sets from information published in radio magazines. If you come across one of those altered sets, you’ll never be able to track down an accurate schematic.

Along with circuit refinements like the superhet, accessories like tuning indicators became popular. The tuning aids we’ll discuss were, in a sense, a spin-off of AVC circuits. Of course, if a set was properly aligned, and if the dial pointer was set accurately, you could tune stations in with few problems. But manufacturers thought that it

would be a good idea to provide a *visible* indication of tuning status.

The magic eye was one popular tuning indicator. It is a tube-like device that mounts in a socket similar to a panel-light socket. A metal bracket holds the tuning eye and the socket so that the top of the tube is visible through the front of the cabinet. A fluorescent coating and a “shadow” indicate relative signal strength. The smaller the shadow, and the larger the fluorescent area, the better a station is tuned in. A tuning eye was often considered as just another of the set’s tubes, so it was tested with the other tubes when a service man repaired a set.

The magic eye is similar to a dual-triode tube that has a common cathode. One triode is connected to the set’s AVC circuit; it determines the brightness with which the fluorescent part illuminates. The other triode is really the indicator; its plate is the fluorescent target, and its grid, which is controlled indirectly by the other triode, is what actually determines brightness.

The eye works as follows. When a signal is *not* tuned in, the AVC voltage will be very positive. That will decrease the current flow through the second triode, so the “shadow” area of the fluorescent screen will increase. But as a station is tuned in, AVC voltage decreases, so more current flows, so the illuminated area increases.

Tuning-eye troubleshooting

Problems with the eye shouldn’t be difficult to diagnose, especially

if you have an antique tube tester like my NRI model 70. First test the regular triode section of the tube with the usual short and emission tests. Then check the eye section; but watch the fluorescent screen, not the meter, while making the test. Without the tube tester, only a limited continuity test can be done. If the tube tests OK, there's a good chance you've got a problem in the AVC circuit.

If your radio produces no audio, but the tuning eye still appears to operate, your set's RF stages are probably in working order. The problem is probably in the audio output stage or in a speaker. If the set is dead and the eye has a red glow, you probably have a defective power supply.

You might be baffled by a receiver that works OK, but whose eye doesn't close, especially if the eye and the AVC check out. In that case, the problem may be a resistor connected to the fluorescent plate. That resistor may be located *in* the socket of the tuning eye. Remove the eye from its socket, and carefully pry the socket open with a small screwdriver. Measure the resistor and replace it if necessary. It'll probably be a high-valued unit—100,000 ohms or so.

Other tuning indicators

In the late 1920's there were a dozen or more different kinds of tuning indicators, including a not-too-popular tuning meter. Such meters have fancy escutcheons and make fine collectables. As a station was tuned in, the pointer would swing to the right. There is also an indicator that makes an audible sound when the station isn't tuned in properly.

A popular tuning indicator in the 1930's was the *Shadowgraph*, used on Philco and other sets. By opening its case, it becomes obvious that it's really a meter-type tuning indicator. The moving vane serves to obscure light emanating from a pilot lamp inside the meter. The movement of the vane is controlled by the AVC. As the vane moves, it changes the size of the shadow from the pilot light; that shadow is then imposed on a celluloid screen. The screen is visible on the front panel, and, as with the

magic eye, the smaller the shadow, the better the signal. Here's a few hints on *Shadowgraph* troubleshooting.

If the screen is completely dark, first check the pilot lamp. If the lamp is good but the shadow doesn't change when tuning, check the AVC. If that checks out, you may have to open the case to examine the meter movement.

Tuning indicators went hand-in-hand with AVC. But so far we've been talking about AVC circuitry as if it came into existence with no birth pains at all. However, that's not the case; let's see why.

The birth of AVC

In the 1920's there was much debate in radio circles concerning the merits of AVC versus its cost. Was the added cost of an extra tube, an extra socket, a tuning indicator of some sort, and other parts worth it just to get a receiver that didn't blast or fade? As we'll see below, AVC helped to sell radios; but even so it took patience to tune in a station while watching an indicator. Later, many listeners tired of watching the tuning indicator just to be able to see what their ears were already hearing.

Most people who thought that AVC was unjustified lived in areas of good reception. Also, they attached little importance to the popular hobby of DX'ing. And they thought that programming on distant stations wasn't high quality. They were often, but not always, right. Programs originating from independent stations sometimes were amateurish, as those stations couldn't afford to hire the best entertainers.

However, even people in good signal areas sometimes suffered the effects of interference. For example, if a receiver had an antenna tuner or a loop-operated superhet, any nearby radio could be overloaded by a deafening squeal.

Those in favor of AVC usually wanted to—or could only—listen to distant stations. Not all receivers were located in the shadow of the transmitter. Also, by that time, consumer radios had to be simple to operate. Housewives, shopkeepers, and other workers wanted to listen to their radios while going about their daily rou-

PRICE/PERFORMANCE LEADER FROM NLS

\$53.30
W/CASE
& TEST
LEADS



The new NLS Model AP-105 DMM incorporates 9 functions and 23 ranges for a mere \$53.30. AC and DC volts, resistance, DC current, conductance, NPN and PNP transistor test as well as diode and battery test are all included.

Model AP-105 is the price/performance leader in the world of DMMs.

Available, locally, from Metermaster and EIL.



Non-Linear Systems

533 Stevens Ave., Solana Beach,
CA 92075 USA (619) 481-4300

CIRCLE 193 ON FREE INFORMATION CARD

MICRO-TEL A COMPACT RADIO MODEM



Microtel is a ruggedly designed portable UHF Radio/Modem suitable for a wide range of line of sight data communication.



APPLICATIONS

- Industrial System Datalinks
- Instrument to Computer Datalinks
- Warehousing & Stock Control
- Data Coms Between Fixed and Mobile Stations

FEATURES

- Available with 5 or Single Channel
- 12 Volt Operation
- RS232 Data Input/Output
- Variable Baud from 100 to 1200
- Wide Range of Accessories Available

MEASUREMENT DEVICES LTD.
11211 Richmond Ave. Suite 106
Houston, TX 77082
Tel: 558-7745

■■■■■■■■■■ MDL ■■■■■■■■■■
CIRCLE 178 ON FREE INFORMATION CARD

tine. Having to make frequent volume adjustments was a nuisance to them as it interfered with their tasks.

Audio amplifiers

After the RF and AVC stages comes the audio amplifier. Many designs were popular, but an interesting one is the push-pull amplifier, which was popular in larger, more expensive antique radios. The push-pull amplifier is also called a balanced amplifier. It has

two tubes that are operated 180 degrees out of phase with each other. In other words, one tube amplifies the positive, and the other, the negative, half-cycle of a signal.

The grids of the two tubes are connected to opposite ends of the secondary of the input transformer. The plates of those tubes are connected to opposite ends of the primary winding of the output transformer. Both transformers have center taps that are connected to AC ground.

The pentode

In the past we've discussed the origin of the diode and the triode. The screen-grid tube has also been mentioned. Now let's talk about the pentode, which was announced in the early months of 1930 by the CeCo manufacturing company. Of course, it's called a pentode because it has five elements including a cathode and a plate like a diode, a control grid like a triode, and a screen grid for the plate like a tetrode. CeCo's innovation was to add a screen grid between the cathode and the control grid.

CeCo said its five-element tube was three times as powerful as the screen-grid tube. That proclamation brought much criticism from other radio manufacturers, despite promises to share advances and circuit designs. Critics said that tube sales were already low and that a new tube was unneeded at the time. They also said that the pentode wasn't really new, as it was already in use in Europe, especially in England.

Furthermore, it was unclear how the pentode could be used. However, CeCo engineers said that the more powerful pentode would increase tube sales because radios could be made with fewer tubes; thus, radios would cost less, and more people would buy them—by the millions! And that, of course, would increase tube sales.

Of course, the pentode *did* survive. By the end of 1930 several pentodes were available: the 238 and the 247. The original pentode was probably made from a 24 screen-grid tube, a tetrode. Using the same base and envelope, the extra grid was attached to a terminal on the side of the tube base, instead of adding another prong to the tube base. In later designs, the suppressor grid was usually connected to the tube's cathode internally.

Hobbyists and other experimenters were quick to purchase the new tubes from the mail-order houses. Again, they were guided by information and circuits in the radio magazines. It's unlikely that you'll find any of those early pentodes around. If you do, consider yourself lucky. **R-E**

Radio-Electronics REPRINT BOOKSTORE

- | | |
|---|--|
| <input type="checkbox"/> 150 TV Descrambler (Jan., Feb. 1981) \$3.00 | <input type="checkbox"/> 111 Hands On Electronics #1 \$4.50 |
| <input type="checkbox"/> 151 Build Your Own Robot \$12.00 | <input type="checkbox"/> 112 Hands On Electronics #2 \$4.50 |
| <input type="checkbox"/> 152 8-Ball Satellite TV Antenna \$5.00 | <input type="checkbox"/> 113 Hands On Electronics #3 \$4.00 |
| <input type="checkbox"/> 106 Radio-Electronics back issues (1986) Write in issues desired \$3.00 | <input type="checkbox"/> 114 Hands On Electronics #4 \$4.00 |
| <input type="checkbox"/> 105 Radio-Electronics back issues (1985) Write in issues desired \$3.50 | <input type="checkbox"/> 115 Hands On Electronics #5 \$4.00 |
| <input type="checkbox"/> 104 Radio-Electronics back issues (1984) (Feb., Dec. 1984 not available) Write in issues desired \$4.00 | <input type="checkbox"/> 115A Hands On Electronics #6 \$3.50 |
| <input type="checkbox"/> 103 Radio-Electronics back issues (1983) (Jan., Feb., May 1983 not available) Write in issues desired \$4.00 | <input type="checkbox"/> 116A Hands On Electronics (Jan-Feb '86) \$3.50 |
| <input type="checkbox"/> 102 Radio-Electronics back issues (1982) (Jan., Feb., June 1982 not available) Write in issues desired \$4.00 | <input type="checkbox"/> 154 VCR Repairs \$3.00 |
| <input type="checkbox"/> 101 Radio-Electronics back issues (1981) (Jan., Feb., Mar., May, Nov., Dec. 1981 not available) Write in issues desired \$4.00 | <input type="checkbox"/> 155 IBM Typewriter to Computer Interface \$3.00 |
| <input type="checkbox"/> 153 Etch your own PC boards \$3.00 | <input type="checkbox"/> 125 Radio-Electronics Annual 1985 \$3.50 |
| | <input type="checkbox"/> 126 Radio-Electronics Annual 1986 \$2.50 |
| | <input type="checkbox"/> 156 How to Make PC Boards \$2.00 |
| | <input type="checkbox"/> 157 All About Kits \$2.00 |
| | <input type="checkbox"/> 158 Electro Importing Co. Catalog (1918) (176 pp) \$5.95 |
| | <input type="checkbox"/> 159 Low Frequency Receiving Techniques Building and using VLF Antennas \$6.00 |
| | <input type="checkbox"/> 160 New Ideas - 42 circuits for experimenters \$3.50 |
| | <input type="checkbox"/> 161 Descrambling (Feb., 1984) \$2.00 |
| | <input type="checkbox"/> 162 Build Your Own Satellite TV Receiver \$7.00 |
| | <input type="checkbox"/> 163 Receiving Satellite TV \$7.00 |
| | <input type="checkbox"/> 164 Modern Electrics (April 1908) \$3.00 |

To order any of the items indicated above, check off the ones you want. Complete the order form below. Include your payment, check or money order (DO NOT SEND CASH), and mail to Radio-Electronics, Reprint Department, 500-B Bi-County Boulevard, Farmingdale, NY 11735. Please allow 4-6 weeks for delivery.

If you need a copy of an article that is in an issue we indicate is unavailable you can order it directly from us. We charge 50¢ per page. Indicate the issue (month & year), pages and article desired. Include payment in full, plus shipping and handling charge. Make checks payable to Gernsback Publications, Inc.

ARTICLE _____		
PAGES _____	MONTH _____	YEAR _____
TOTAL PAGES _____	or 50¢ each	TOTAL PRICE _____

MAIL TO: Radio-Electronics Reprint Bookstore, 500-B Bi-County Boulevard, Farmingdale, NY 11735 All payments must be in U.S. funds

SHIPPING CHARGES IN USA & CANADA		
\$0.01 to \$5.00 \$1.00	\$30.01 to 40.00 \$4.75	OUTSIDE USA & CANADA
\$5.01 to \$10.00 \$1.75	\$40.01 to 50.00 \$5.75	Add 100% for sea mail
\$10.01 to 20.00 \$2.75	\$50.01 and above \$7.00	Add 200% for air mail
\$20.01 to 30.00 \$3.75		

Total price of merchandise \$ _____
 Sales Tax (New York State Residents only) \$ _____
 Shipping (see chart) \$ _____

Name _____ Total Enclosed \$ _____
 Address _____
 City _____ State _____ Zip _____

RB7-6

COMPUTER DIGEST

VOL. 3 NO. 7

JULY 1986

A NEW KIND OF MAGAZINE FOR ELECTRONICS PROFESSIONALS

SURFACE ACOUSTIC WAVES

Changing the face of touchscreens

MORE ON MODEMS

What you don't know CAN hurt you!

PROTOCOL CONVERTER

Build yourself some flexibility

A
GERNSBACK
PUBLICATION

COMPUTER PRODUCTS

For more details use the free information card inside the back cover

SURGE SUPPRESSOR, the *SL IV* is a multi-outlet device designed to protect computers and other microprocessor-based equipment from overvoltages.

The model *SL IV* offers non-degrading, permanent protection within operating parameters, and effectively eliminates computer downtime, component damage, and nuisance failures caused by transients. It also features a 15-amp circuit breaker with reset switch, status-indicator lights for the circuit breaker and suppression circuitry, and three high-quality grounded receptacles, which accommodate most CPU/printer/



CIRCLE 11 ON FREE INFORMATION CARD

CRT configurations and other multi-plug setups.

Any computerized equipment system drawing up to 15 amperes is appropriate for protection by the model *SL IV*; that includes microcomputers, computer terminals, intelligent photocopiers, electronic cash-register systems, memory typewriters, and medical analysis equipment.

The model *SL IV* is priced at \$224.00.—**Transtector Systems, Inc.**, 10701 Airport Drive, Hayden Lake, ID 83835.

SINGLE-BOARD COMPUTER, the model *GMX Micro-20*, combines a Motorola MC687020 32-bit microprocessor and an optional MC68881 floating-point coprocessor with 2 megabytes of 32-bit wide RAM, up to 256 kilobytes of 32-bit wide EPROM, four serial ports, an 8-bit parallel port, a 5.25" floppy disk controller, a SASI peripheral interface, and a clock with battery backup. 16-bit expansion connector allows the addition of off-the-shelf or custom I/O interfaces.

The board, measuring 8.8" x 5.75", mounts on and uses the same power connector and supply voltages as a standard 5.25" disk drive. Power requirements are +5-volts DC at 4.5A max., and +12-volts DC at 125Ma. A

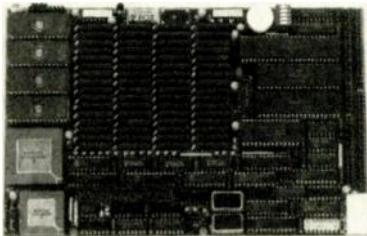

CIRCLE 12 ON FREE INFORMATION CARD.

separate board, included with the model *GMX Micro-20*, provides RS-232 level translation, and 4 DB-25 type connectors for the serial ports. A DC-to-DC converter supplies the -12 volts.

The model *GMX-Micro-20* is priced at \$27.50.—**GMX, Inc.**, 1337 West 37th Place, Chicago, IL 60609.

WORD-PROCESSING SYSTEM, is an enhanced version of Timeworks Inc., *Word Writer 128* program for the Commodore 128 computer.

The upgraded *Word Writer 128*, an 80-column professional word-processing system for home and business use, works in C-128 (128k) mode with either a 40- or 80-column monitor. Additional features now include On-screen highlighting, right-margin justification, superscript and subscript, headers and footers, and speed keys for more experienced users.

On-screen highlighting allows the printer to underline, italicize, boldface, or use all three together at the press of a key. It also allows the user to see each highlight on-screen before hard copy is printed. *Superscript* and *subscript* displays and prints numbers in superscript or subscript for fast footnote references. *Headers and footers* displays



CIRCLE 13 ON FREE INFORMATION CARD.

and prints headers and footers throughout the user's document, as commanded. *Speed keys* let the user access *Word Writer* commands quickly, using a minimum of keystrokes.

The *Word Writer 128* already includes an 85,000 word-spelling checker, a built-in 5-function calculator, "pull-down" menu technology, and a full-screen format. It can be used by itself, or interfaced with Timeworks *Data Manager 128*, *Swiftcalc 128*, and *Sylvia Porter's Personal Financial Planner*. Each of those programs carry a \$69.95 retail price. Backup disks are available for Timeworks' registered users for \$14.70.—

Timeworks, 444 Lake Cook Road, Deerfield, IL 60015.

ENHANCED KEYBOARD, *Style 3270*, has 126 keys and is designed to go with *SmartKey 5.0* Keyboard Enhancement software.

The *SmartKey* software allows the user to redefine the keyboard for specific needs. It also defines special 24 function keys to the user's use and simplifies complex commands by defining single key macros.

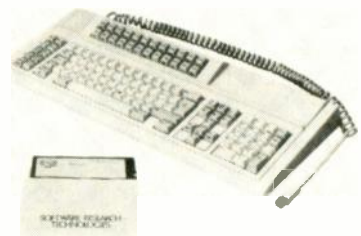

CIRCLE 14 ON FREE INFORMATION CARD.

The *Style 3270* keyboard is PC compatible. It sends IBM PC synchronous format and responds to handshake and reset signals from the IBM PC and XT. Additional features include: Cherry MX full travel gold crossbar contact configuration key module; full N-key rollover with auto-repeat and chassis ground.

The unit is 1.133" from enclosure base to center point at home row-keycap top. It also has keyboard micro with 16-deep FIFO and scanning phase in the event that FIFO is filled.

The *Style 3270* enhanced keyboard is priced at \$195.00. With *SmartKey* software included, the price is \$245.00 complete.—**Cherry Electrical Products Corp.**, 3600 Sunset Avenue, Waukegan, IL 60087.

MORE ON MODEMS

When your modem won't talk...

Herb Friedman

■A modem is the easiest peripheral to interface with a personal computer. You simply connect them together through matching plugs and everything works. But theory falls down before practice when the software becomes sophisticated, or a manufacturer has taken short cuts and left out circuits because "the average user probably won't ever need them." Unfortunately, it often works out that the circuit, wire, or signal indicator that's "missing" or unconnected is the one that's required by your software or the computer itself.

Although virtually all conventional RS-232 I/O modems utilize the 25 terminal subminiature D-connector, it takes only three connections from your computer to its modem to establish communications using a non-automatic modem. At the computer itself these connections are usually labeled as TD (transmit), RD (receive), and "common," which is always terminal #7. Although there is supposedly a "standard," TD can be terminals 2 or 3, and RD can be terminals 3 or 2. (Some manufacturers use Tx for RD and Rx for TD—and don't ask why.)

Much mumbo-jumbo has gone into describing the TD and RD connections because the original RS-232 "standard" was murky on the subject. When connecting a personal computer to a modem it's easy to keep track by remembering that TD, or transmit, means the *output* signal from the computer, while RD means the *input* signal to the computer. Unfortunately, you will find the modem's connections are probably also labeled TD and RD, so what do the connections represent at the modem? Whether at the computer or the modem TD means the computer's output signal and RD means the computer's input signal; connect the computer's TD terminal to the modem's TD terminal and the computer's RD terminal to the modem's RD terminal.

Straight-across wiring

If a computer's RS-232 I/O connections are intended for connection to a modem the wiring order of the connections is called DTE and will be what is called

"straight across," meaning computer terminal #2 connects to modem terminal #2, computer terminal #3 connects to modem terminal #3, etc.

The problem comes in when the computer's serial I/O has connections intended for a printer, the so-called DCE wiring order. The functions of DCE terminals #2 and #3, among others, are reversed; if you connect

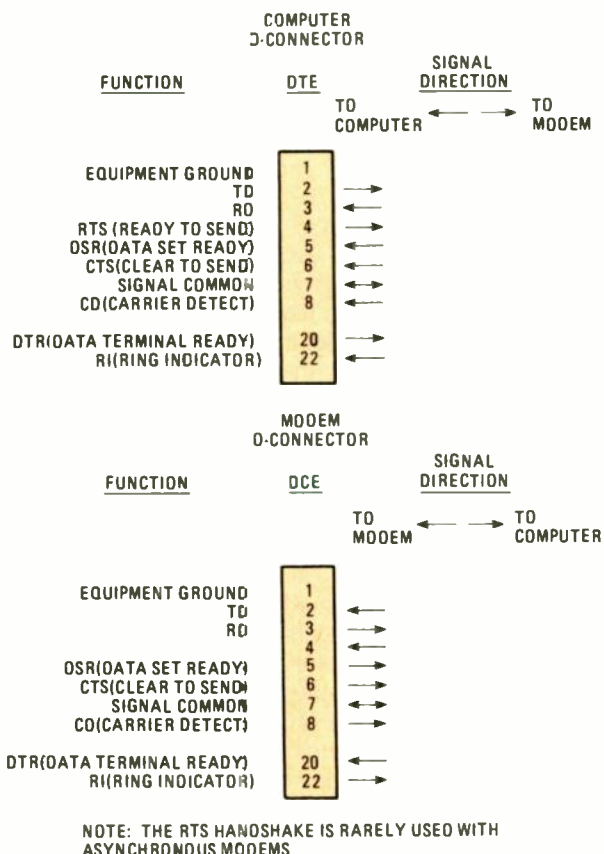

FIG. 1—ALTHOUGH THE DTE AND DCE wiring order uses the same descriptive terms for the functions, the signal direction is completely opposite.

DCE computer terminals "straight across" to the modem nothing will happen because neither the computer nor modem will know what's going on. The way out of the DCE/DTE bind (if you don't know what goes where) is to match the TD and RD terminals on the computer to the modem, which means "crossing" the connections, that is, connecting DCE computer terminal #2 to modem terminal #3 and computer terminal #3 to modem terminal #2. Make a copy of Figure 1, which shows the differences between the DCE and DTE wiring order for RS-232 D-connectors.

Modem communications would be simple if all you had to do was match the TD and RD connections, and, this is all you have to do with an acoustic modem, where you dial up the remote computer and place the telephone's handset in a pair of cups on the modem. But much modem software, and some modems, won't work with such a simple connection because they require some form of electrical "handshaking," meaning an electrical signal that informs either the modem, the computer, or both that the other device is ready to receive data. Depending on the particular software used, handshaking might be required from both acoustic and direct-connect modems—the kind that's "permanently" connected to the telephone line: and handshaking is generally needed when using an *automodem*—the kind that can automatically answer a call or dial out. For example, to prevent an automodem from answering every ring they are generally designed—or programmed by a switch—not to go "on-line" until a DTR (DATA TERMINAL READY) "handshake" is received from the computer, the DTR being a digital "high" that tells the modem that the terminal is ready to send and receive: it is usually provided by a terminal or computer's DTE wiring order on terminal #20.

Handshaking

Software intended for use with an automodem looks for a handshake from the modem that indicates the modem is turned on and ready, unfortunately, unlike the computer's DTR handshake there is no real standard for the "modem ready" handshake. Many modems create three handshakes, and only one, two, or the full three might be required by the communications software. To make certain the software receives what it considers to be a "correct" handshake the modem might internally connect several terminals on the connector so that a single modem handshake appears on the D-connector as two or three handshakes, forcing the computer to "see" the required handshake.

A modem usually outputs a "high" DSR (DATA SET READY) signal on terminal #5 when power is applied. This tells both the computer and its software that the modem is "ready for use." (Note that this is the equivalent of the DTR terminal #20 handshake signal from the computer; it's one of the connections you might have to cross-wire.)

Another modem handshake is the CTS (CLEAR TO SEND) "high" from terminal #6. This handshake can be used for just about anything, but for personal computers it is often combined with the CARRIER

DETECT (CD) "high" from terminal #8 by a simple shorting wire.

The CARRIER DETECT is the handshake that modem communications software is looking for because the CD "high" is generated only when the modem senses the "carrier tone" produced by the modem at the remote computer. Because reception of a carrier means the modem is actually "talking" to the remote computer, the CD "high" is often used as the "master handshake" for the computer, so it is often internally connected within the modem and also appears as the CTS (CLEAR TO SEND). If a carrier tone isn't being received the modem isn't talking to the remote computer, hence, it is not clear for sending data from the computer. (There really is a logic to all RS-232 connections when they concern a computer and a modem—not a printer.)

If the software is only looking for a "modem ready" handshake it might check only the the CTS and CD handshakes. However, some software intended for use with automodems won't do anything until it "sees" the DSR (DATA SET READY) handshake, the reason being that the software automatically downloads programming for the auto-modem's internal microprocessor, forces the modem to go "on-line," and causes the modem to dial only when the software sees through the DSR handshake that the modem is actually turned on. After dialing, the modem will time-out reception of the CD handshake. If it doesn't receive a CD handshake within a specified time period it will disconnect the modem or disconnect and redial.

Although software can force a Hayes-compatible automodem to go off line by transmitting a command code such as ATH0 (meaning the modem should go "on hook"), some software causes an automodem to disconnect by forcing the computer's DTR handshake "low." The modem sees the low, assumes the computer is turned off, and drops off the line. But a problem can arise when using the DTR to disconnect the modem from the telephone line because not all software and/or computers support (provide) the DTR, and not all modems which claim to be Hayes-compatible respond to the DTR; they go disconnect from the telephone line only if a direct ATH0 command is received from the computer. If either the computer or the modem don't support the DTR, and the software—or the user cannot provide an ATH0 command—the modem literally gets "stuck" and won't disconnect unless its power supply is physically turned off.

Handshake signals always appear at the same modem terminals if the modem employs a conventional 25 terminal D-connector. (The D-connector is only a general "standard" for convenience; some manufacturers of external modems employ proprietary connectors.) D-connections at the modem are always DCE and are wired as shown in Figure 1. On the other hand, computers can have either a DTE or DCE wiring order. If they are DTE the connectors are wired, as previously mentioned, "straight across." But if the computer's serial I/O is wired DCE then several wires—not just the signal pair—must be crossed if full handshaking is to be attained. Your computer or the software might not require all the handshakes provided

R-E Computer Admart

Rates: Ads are 2 1/4" x 2 7/8". One insertion \$825. Six insertions \$800 each. Twelve insertions \$775. each. Closing date same as regular rate card. Send order with remittance to **Computer Admart**, Radic Electronics Magazine, 500-B Bi-County Blvd., Farmingdale, NY 11735. Direct telephone inquiries to Arline Fishman, area code-516-293-3000. **Only 100% Computer ads are accepted for this Admart.**

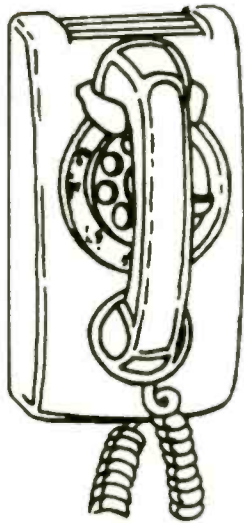

**CALL NOW
AND
RESERVE
YOUR SPACE**

- 6 x rate \$800.00 per each insertion.
- Reaches 229,044 readers.
- Fast reader service cycle.
- Short lead time for the placement of ads.

Call 516-293-3000 to reserve space. Ask for Arline Fishman. Limited number of pages available. Mail materials to: Computer Admart, RADIO-ELECTRONICS, 500-B Bi-County Blvd., Farmingdale, NY 11735.

ICs PROMPT DELIVERY!!!

SAME DAY SHIPPING (USUALLY)
QUANTITY ONE PRICES SHOWN

OUTSIDE OKLAHOMA: NO SALES TAX

640 Kbyte MOTHERBOARD MITS. Zenith 150, \$8746
IBM PC XT, Compaq Portable & Plus, hp Vectra

DYNAMIC RAM			
256K	64Kx4	150 ns	\$4.85
256K	256Kx1	100 ns	5.95
256K	256Kx1	120 ns	3.90
256K	256Kx1	150 ns	3.47
128K	128Kx1	150 ns	4.92
64K	64Kx1	150 ns	1.60
EPROM			
27512	64Kx8	250 ns	\$29.00
27C256	32Kx8	250 ns	3.15
27256	32Kx8	250 ns	3.45
27128	16Kx8	250 ns	3.90
27C64	8Kx8	200 ns	3.30
2764	8Kx8	250 ns	3.80
2732	4Kx8	450 ns	3.85
STATIC RAM			
6264LP-15	8Kx8	150 ns	\$3.45
611ELP-3	2Kx8	150 ns	2.10

8087-2 \$185.00
8087-3 \$195.00
V20 V30 8 Mhz \$17.50
80287-8 8 Mhz \$375.00

OPEN 6 1/2 DAYS: WE CAN SHIP VIA FED-EX ON SAT

MasterCard/VISA or UPS CASH CCD

Factory New, Prime Parts μ P00

MICROPROCESSOR UNLIMITED, INC

24 000 S. Peoria Ave. (918) 267-4961

BEGGS, OK 74421

Prices shown above are for April 28, 1986

Please call for current prices. Prices subject to change. Please request rights or cover prices for some parts due to supply & demand and our changing costs. Shipping & insurance extra. Cash discount prices shown. Orders received by 4 PM CST can usually be delivered to you by the next morning, via Federal Express Standard Air @ \$8.00 or Priority One @ \$13.00

CIRCLE 195 ON FREE INFORMATION CARD

A Z-80 WORKSHOP MANUAL



Starting with a review of computer principles, this book describes typical machine-code instructions followed by a detailed description of the Z-80 instruction set. Assembly language programming is also discussed with examples. Z-80 hex machine-code and assembler instructions are given in tabular form, along with in-order connections for the Z-80 and its associated devices. ... Order your copy from **Electronic Technology Today Inc., PO Box 240, Massapequa Park, NY 11762. Price is \$6.95 plus \$1.00 for shipping.**

**CALL NOW
AND
RESERVE
YOUR SPACE**

- 6 x rate \$800.00 per each insertion.
- Reaches 229,044 readers.
- Fast reader service cycle.
- Short lead time for the placement of ads.

Call 516-293-3000 to reserve space. Ask for Arline Fishman. Limited number of pages available. Mail materials to: Computer Admart, RADIO-ELECTRONICS, 500-B Bi-County Blvd., Farmingdale, NY 11735.

by the modem. If all the software wants is a "modem ready" handshake before it transmits data, then just the DSR—meaning modem power is on—would be adequate, although the CD is preferred because then the software knows for certain that it is linked up with another computer. There is much software around that appears to go on-line when it's actually working into an unconnected modem because the software is responding to the DSR handshake, which only means the modem is powered—that's all.

If it still won't work

If everything is connected together and the modem still won't work with the computer, doublecheck the modem's DSR and CTS terminal connections. Somewhere along the line the DSR and CTS got tangled and the Hayes and some Hayes-compatible modems

combine the DSR and CD handshakes, using the CTS as the "power on" handshake. It makes no difference whether DSR or CTS is connected to the CD, but usually doesn't mean *always*.

Finally, there is the modem's RI (RING INDICATOR) handshake on DCE terminal 22, which is intended for use by software that controls automodems. The RI is a "high" that indicates a telephone is ringing; it causes the software to force the modem to go "off hook" (to connect to the telephone line).

As a general rule of thumb, the more sophisticated the software the greater its use of handshaking with the modem, so when you can't get a computer to talk to its modem check that the various signal and handshakes go to the right terminals on both the modem and the computer before you start looking for glitches in the software. More often than not the problem is usually one or more "reversed" connections. ◀▶

Electronics Paperback Books

EXCITING OFFERINGS AT SPECIAL INTRODUCTORY PRICES

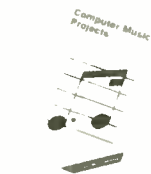

COMPUTER MUSIC PROJECTS \$7.50
Shows how to use your home computer to produce electronic music. Many circuits. Mostly set up free (NO CHARGE for shipping)

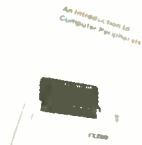

AN INTRODUCTION TO COMPUTER PERIPHERALS \$6.50
Describes and explains how to use a variety of different computer equipment in as non technical a way as possible (shipping FREE)



103 PROJECTS FOR ELECTRONICS EXPERIMENTERS FROM TAB BOOK \$11.50, by 1 over 14 Mims. More than 100 projects you'll want to build (shipping FREE)

Linear IC Equivalents and Pin Connections



LINEAR IC EQUIVALENTS AND PIN CONNECTIONS \$12.50 (shipping free) 247 pages 7 1/2 in. shows eqvs & pin connections for popular user oriented IC's



DIGITAL IC EQUIVALENTS AND PIN CONNECTIONS \$12.50 (shipping free) 312 pages 7 1/2 in. shows eqvs & pin connections for popular user oriented IC's



32 ELECTRONIC POWER SUPPLY PROJECTS \$10.95. From TAB books. Provides power supply construction info for almost any application (WE PAY for shipping)



THE PRE-BASIC BOOK \$7.50. A book on the BASIC programming for those who have not yet bought a computer as well as those who have trouble learning how to program (shipping FREE)



FIRST BOOK OF DIODE CHARACTERISTICS \$5.00. Full info on changeability data and characteristics for thousands of diodes (shipping FREE)

30 SOLDERLESS BREADBOARD PROJECTS, Reg. \$5.75. Now \$5.00.
30 SOLDERLESS BREADBOARD, Book 2, Reg. \$5.75. Now \$5.00
ELEMENTS OF ELECTRONICS, AUDIO, Reg. \$9.00. Now \$7.50
MINI-MATRIX BOARD PROJECTS, Reg. \$5.00. Now \$4.00

Save an extra \$2.00. Order both IC EQUIVALENTS editions and pay only \$23.00. We also include shipping free. You get a complete 2-volume library. (shipping FREE)

REMOTE CONTROL PROJECTS, Reg. \$5.00. Now \$4.50
PROJECTS USING SOLAR CELLS, Reg. \$5.00. Now \$4.25
DIGITAL IC PROJECTS, Reg. \$5.00. Now \$4.25
ELECTRONICS PROJECTS FOR BEGINNERS, Reg. \$5.00. Now \$4.00

Secrets of the COMMODORE 64



SECRETS OF THE COMMODORE 64 \$5.00. Masses of useful info and programming tips not found in any user's manual

An Introduction to Programming the ATARI 800 800 XL



INTRO TO PROGRAMMING THE ATARI 800 800 XL \$5.00. Perfect complement to the Atari user's manual. Even shows how to use animated graphics

Computer Terminology Explained



COMPUTER TECHNOLOGY EXPLAINED \$5.00. Explanations for computer terms often encountered. A dictionary for computer lingo

Simple Involving Circuits Book 2



INTRO TO 2-80 MACHINE CODE \$5.75. Speed up your programs. They may be harder to write, but it's worth learning how. Some demo programs are included

White's Radio Log



ANTENNA PROJECTS \$5.00. Practical radio antenna designs that deliver good performance and are relatively simple and inexpensive to build

White's Radio Log



Confidential Frequency List



WHITE'S RADIO LOG \$4.95. An up-to-date directory of AM, FM and TV stations, including a section on worldwide shortwave stations

25 Simple Amateur Band Antennas



25 SIMPLE AMATEUR BAND ANTENNAS \$5.00. All kinds of antennas for all kinds of amateur radio reception

Easy Add-on Projects for Commodore 64, VIC-20, BBC Micro & Acorn Electron



EASY ADD-ON PROJECTS FOR COMMODORE 64, VIC-20, BBC MICRO & ACORN ELECTRON \$7.50. Picture digitizer, light pen, model controller, and more

MICRO INTERFACING CIRCUITS—BOOK 1 \$5.00. Practical add-ons transform your computer into control or measurement equipment

MICRO INTERFACING CIRCUITS—BOOK 2 \$5.75. Interfacing sound and speech generators, temperature and optica sensors, motor controllers and more

Quality Paperbacks



50 FEET PROJECTS \$4.50. Projects in clude 41 amplifiers & converters, test equipment, receiver aids, tuners, receivers and more



HOW TO DESIGN ELECTRONIC PROJECTS \$5.75. How to use standard circuit elements to make custom electronic projects



HOW TO GET YOUR ELECTRONIC PROJECTS WORKING \$5.00. How to find the faults in your projects, repair them and get them working



DESIGN & MAKE YOUR OWN PC BOARDS \$5.75. Everything you need to know before you make printed circuit boards for your projects



ELECTRONIC SECURITY DEVICES \$5.00. Three basic sections. Switch activated alarms, infrared & ultra sonic systems, smoke gas, water detection



INTERNATIONAL TRANSISTOR EQUIVALENTS \$7.50. Locates possible substitutes for a popular user-oriented selection of modern transistors, Japanese, European and American types



PRACTICAL ELECTRONIC BUILDING BLOCKS, BOOK 1 \$5.75. Build the blocks and then combine them to form almost any custom project of your choice



PRACTICAL ELECTRONIC BUILDING BLOCKS, BOOK 2 \$5.75. Amplifiers of all kinds to add to the circuits from Book 1 of this series



HOW TO GET YOUR COMPUTER PROGRAMS RUNNING \$6.50. Have you ever written your own program only to find that they do not work? Help is now at hand with this book that shows you how to go about looking for errors

ELECTRONIC SCIENCE PROJECTS \$5.75. Simple to complex a group of projects with a strongly scientific flavor

CRYSTAL SET CONSTRUCTION \$4.50. A variety of crystal radio receivers for the experimenter and hobbyist

Affordable Prices



20 PROGRAMS FOR THE ZX SPECTRUM & 16K ZX81 \$5.00. All programs run on both machines. Include flow charts and info on how to modify to run on other computers



MODERN OP-AMP PROJECTS \$5.00. Includes a Slide Timer, AF Signal Gen, Make Pre amp, Scratch Filter, and much more



ELECTRONIC SYNTHESIZER PROJECTS \$4.50. How to assemble the elements of a synthesizer and then put them all together



ELECTRONIC TIMER PROJECTS \$5.00. Timing circuits to fit just about every application. Required for every experimenter



SINGLE IC PROJECTS \$4.25. All projects in this book are based on one IC and are simple to construct. Great way to get started with IC's



POPULAR ELECTRONIC PROJECTS \$4.75. A collection of a wide range of electronic projects and circuits for the experimenter



IC PROJECTS FOR BEGINNERS \$5.00. Written especially for the less experienced experimenter. Complete parts layouts and wiring diagrams



INTO THE OL ARCHIVE \$6.50. Presents the powerful database for the Sinclair OL. Step by step approach includes practical examples



POPULAR ELECTRONIC CIRCUITS, BOOK 1 \$5.00. More useful circuits. None of these projects duplicate those in Book 1 of this series

POPULAR ELECTRONIC CIRCUITS, BOOK 2 \$5.75. More useful circuits. None of these projects duplicate those in Book 2 of this series

CHECK OFF THE BOOKS YOU WANT

ELECTRONIC TECHNOLOGY TODAY INC.
P.O. Box 240, Massapequa Park, NY 11762-0240

Name _____
Address _____
City _____ State _____ Zip _____

*Canadian Shipping (\$1.50 1st two books 50c ea. additional)

Number of books ordered
Total Price of Books \$ _____
Sales Tax (NY State Residents) \$ _____
*Shipping in U.S. only (\$1.00 1st two books, 40c ea. additional) \$ _____
TOTAL ENCLOSED \$ _____

RE786

PROTOCOL CONVERTER

Allow X-on/X-off devices to interact with lead-control devices.

R. L. L. Hu

■When physical differences exist between devices, special adapters and interface converters can resolve the problems of electrical and mechanical interconnection (for example, interfacing between RS232 and RS422 circuits which differ in signal level and connector size). However, when logical differences exist, then a protocol or code converter is required. Protocol and code converters are used in situations where communication between devices cannot proceed due to lack of comprehension of each other's data. They "bridge the gap" for differences in transmission mode, transmission code, communications protocol, etc.

This article describes a protocol converter that will allow RS232 asynchronous terminals or CPU's which operate in X-on/X-off (also called DC1/DC3, Control-Q/Control-S) protocol to communicate with devices that use RS232 lead control for handshaking (e.g. RTS, CTS). Specifically, this project was developed to run a serial printer with hardware-busy handshake from an RS232

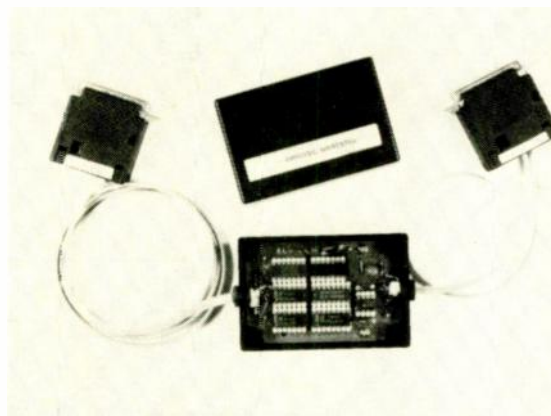

THE COMPLETED CONVERTER, ready to use. Considering the massive task it performs, it requires very little space and even less attention.

port which supported only X-on/X-off software handshake. The use of this converter has freed the host program from all timing considerations (insertion of delays or filler characters), and results in faster and

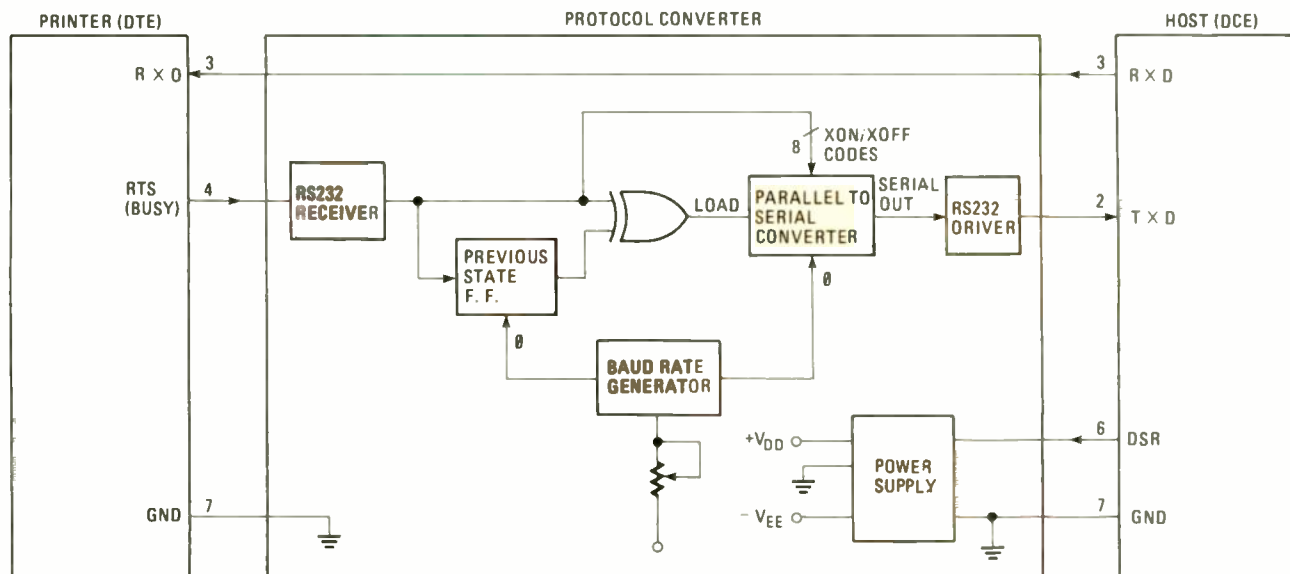

FIG. 1—BLOCK DIAGRAM provides an easy means to overview the circuit and gain sufficient grasp to make it easy to understand. See text.

more reliable operation. Notable features of this project are that it is powered by the RS232 signal lines and it does not even use a UART or ACIA chip! The whole circuit is built using standard digital CMOS chips.

Description

First, a quick overview, using host-to-printer interface as an example of the X-on/X-off protocol in operation. The printer keeps track of how many characters are in its buffer and signals the host when it can and cannot

accept more data. When the printer buffer is almost full, the printer sends the host an X-off character to stop the data transmission. Meanwhile, the printer continues to print the data in its buffer. When the buffer content is reduced below a certain threshold, the printer sends the host an X-on character to resume the data transmission. Thus, during normal printing, the printer buffer is kept nearly full by the host, resulting in maximum throughput on the printer.

Refer to the block diagram in Figure 1 to see how this

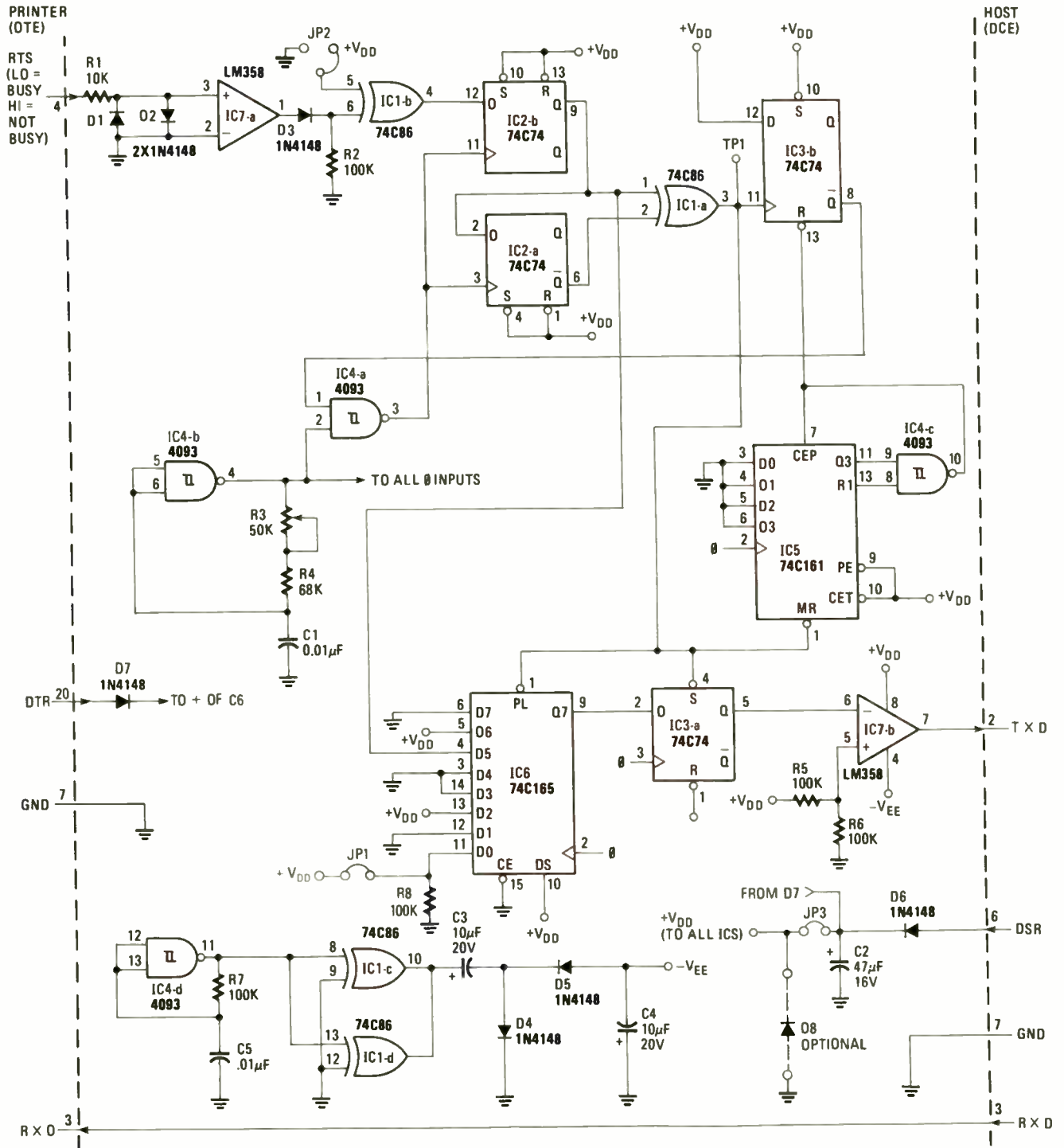

FIG. 2—SCHEMATIC DIAGRAM of converter. Note that the printer side is shown at left, the HOST at right. Text will clarify the schematic for you.

is accomplished in the converter. Serial data from the host is passed directly to the printer. The BUSY line from the printer is, however, first fed to the converter. The converter then sends the appropriate control code to the host unit, but only when there has been a change in the BUSY line state. The changes in states are detected by "remembering" the previous BUSY state and comparing it with the present BUSY state.

Now look at the schematic diagram, Figure 2, for the following detailed description. The power for this converter is derived from an active RS232 control line, the usual choices being DSR or DTR. D4, D5 and C3, C4

form a voltage inverter which is powered by the oscillator/driver combination of IC4d and IC1c and d. This generated negative supply voltage is used by the op amp IC7b, to drive the RS232 line to the host.

The baud rate clock is built using a Schmitt Trigger, IC4, making possible a simple and reliable oscillator with only a resistor and a capacitor. This eliminates the need for the more-expensive crystal and baud-rate generator chip. The baud rate clock was set to run at 2400Hz (2400 baud) in the prototype unit. This baud rate can be changed by using different values for R4 and C1. Just make sure to set the same baud rate on the

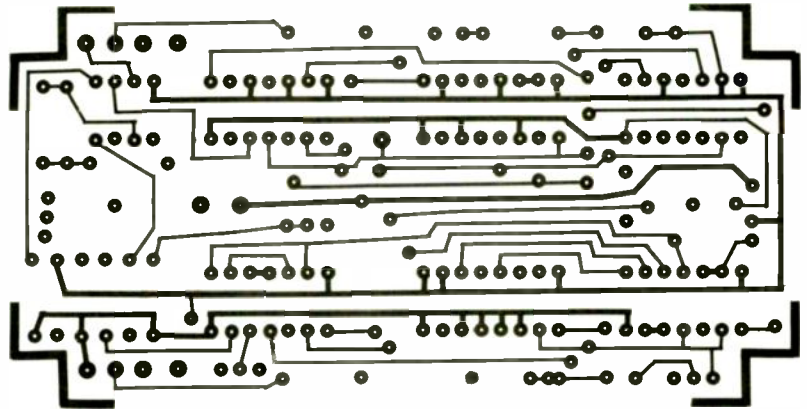

FIG. 3—THE PC BOARD is shown above (solder side, component side to left) full size for those who desire to fabricate their own boards. See parts list for name and address of source for completed circuit boards. Solder side is above, component side to the left.

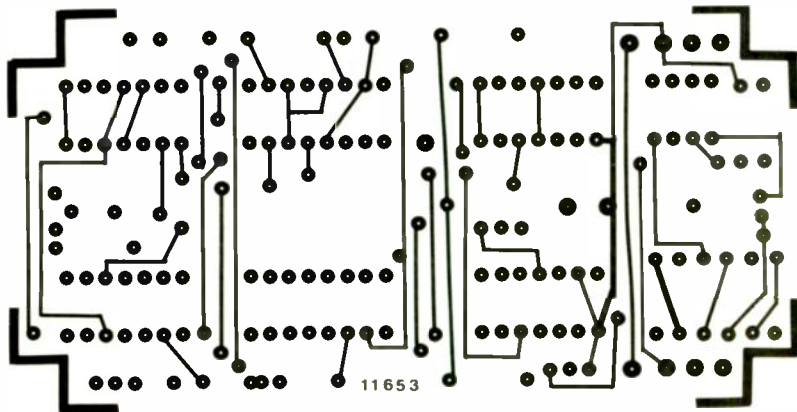
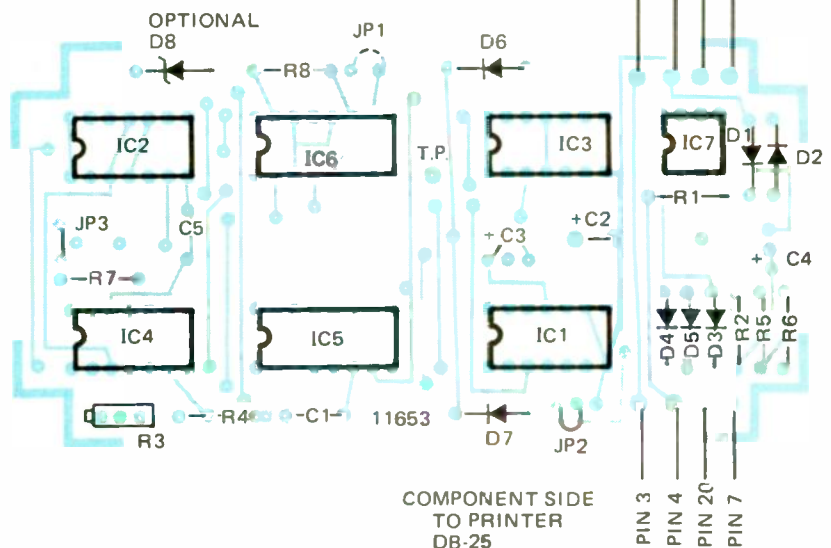

FIG. 4—PARTS PLACEMENT DIAGRAM, component side of board.



PARTS LIST

Semiconductors

D1-D7—1N4148 Diodes
D8—1N5236B Zener, 7.5V (optional)
IC1—74C86 XOR Gates
IC2, IC3—74C74 Flip-Flops
IC4—4093 Schmitt Triggers
IC5—74C161 Counter
IC6—74C165 Shift Register
IC7—LM358 Op Amps

Resistors

All resistors ¼ watt, 5% unless otherwise specified
R1—10,000 ohms
R2, R5-R8—100,000 ohms
R3—50,000 ohms, 10-turn potentiometer
R4—68,000 ohms

Capacitors

C1, C5—.01 μ F, 50V
C2—47 μ F, 16V
C3, C4—10 μ F, 20V

Miscellaneous

PC board, hardware, wire, solder, Etc.
Plastic box (Radio Shack RS 270-221)

The following are available from Capulum Ltd., 814 Proctor Avenue, Ogdensburg, N.Y. 13669: printed circuit board, double sided with plated-through holes for \$12. Assembled and tested unit, complete with connectors for \$49. Add \$2 for postage and handling. New York residents must add sales tax. Money order or Visa. (613) 726-1966.

host and the printer (while it is possible to transmit and receive at two different baud rates, nothing useful would be achieved here).

The "previous state" circuit is built using flip-flops and XOR gates. The BUSY line from the printer is sampled at each clock cycle. If it has changed from the previous time it was sampled, the output of IC1a XOR will go active low. This signal initiates the sequence necessary for transmission of X-on/X-off code. During these transmissions, the BUSY line is not sampled.

The parallel-to-serial circuitry is made up of shift register, binary counter and flip-flops. The shift register is loaded with either X-on (hex 13) or X-off (hex 11) ASCII code, depending on the present state of the BUSY line. The binary counter counts out 10 pulses (1 start, 7 data, and 2 stop bits) and upon completion, allows the "previous state" circuitry to be updated once again.

The RS232 receiver and driver are constructed using low power op amps. The op amp driver provides the bipolar output necessary to drive the host RS232 TxD input line.

Construction

The building of this converter is straightforward. There are no critical components. The prototype unit was built using a Scotchflex 3303 Breadboard Kit. However, use of the PC board is recommended to

minimize construction errors and to save time. A layout for the printed circuit board is provided full size in Figure 3. See parts-placement diagram for location of components on the PC board (Figure 4).

Calibration

Connect the converter board to the host unit. Check the voltage level of +Vdd and -Vee. Note that the magnitude of the -Vee will be about 1.2V less than +Vdd, due to the two diode drops at the inverter circuit. Make sure the RS232 voltage levels do not exceed ± 15 volts; +15 being the recommended maximum voltage for operating the CMOS chips. Install a zener diode in the circuit if necessary. Check and adjust R3 for an oscillator frequency of 2400Hz. This frequency does not have to be very accurate, since each start bit synchronizes the receiver clock of the UART/ACIA in the host. Timing errors are thus non-cumulative.

Troubleshooting

If you have problems in making the converter work properly, the best way to troubleshoot is through a terminal program on the host. Install jumper JP1. This jumper will force bit 6 of the transmitted code high, which means that DC1/DC3 control codes will now be displayed as letters 'Q' and 'S'. Then, with the converter connected between the host and the printer, take the printer offline and send enough characters to fill the printer buffer (effectively generating a BUSY signal). You should then receive a DC3 code (now displayed as letter 'S') back in your terminal program. Take the printer back online. The printer should start printing and you should receive a DC1 code (letter 'Q') as soon as the buffer empties. If the order of the received codes is reversed, invert the BUSY signal by tying jumper JP2 to ground instead of +Vdd. If you receive garbage characters, check the baud rate, word length, stop bits and parity. The host should be set up to accept baud rate of 2400, 7 data bits, 2 stop bits and no parity (same as 7 data bits, mark parity and 1 stop bit). If nothing is received at all when the printer is taken offline and online, then scope test test point TP1 on the converter. A negative-going pulse should be observed each time the printer goes busy or not-busy. Presence of pulses here indicates the fault to be in the shift register, counter, or RS232 driver circuitry. Absence of pulses here would suggest problems in the "previous state" flip-flop circuitry. Be sure to remove JP1 when you are finished. One final note: The frequency of the oscillator does change with the circuit voltage, so set the frequency at the voltage at which the converter will operate. Alternatively, you can install the optional zener diode D8, provided DSR or DTR line voltage is sufficient. This way, the frequency will not change with different line voltage. A current limiting resistor in place of jumper JP3 is needed if DSR or DTR line is powered by an external power supply and not by an RS232 line driver.

The author's manuscript was printed using WordStar with X-on/X-off protocol, the protocol converter and a lead control serial printer. ◀▶

TOUCHSCREEN TECHNOLOGY

Something new has been added...

Marc Stern

■Based on surface acoustic wave (SAW) technology, the Zenith system relies on piezoelectric elements to generate SAWs. Acoustic reflector strips on each edge of the tube face send the SAWs across the screen and an invisible matrix of touchpoints is created. (See Fig. 1)

When the matrix is broken by a touch, an amplitude dip is created. The timing and depth of the dip indicates the location and pressure of the touch.

This concept was first developed in the early 1970s in a system which used a set of parallel SAW beams, in the same manner that infrared LED touch systems are used today. Rows of transducers are placed on opposite edges of a glass panel and are cycled; one transmit-receive set is turned on at a time. In this system, transmission attenuation on one of the possible paths determines the position of the touch.

The need for transducers along a minimum of two edges imposes a cost penalty. To reduce costs, Zenith rethought the concept and borrowed from reflective array technology to complete its acoustic touchscreen. The reason it proved attractive enough for Zenith's work is its good signal-to-noise ratio and the absence of spurious reflections or transducer ringing.

Using a single transducer in the upper left corner of the touchscreen panel, a short burst of SAWs is

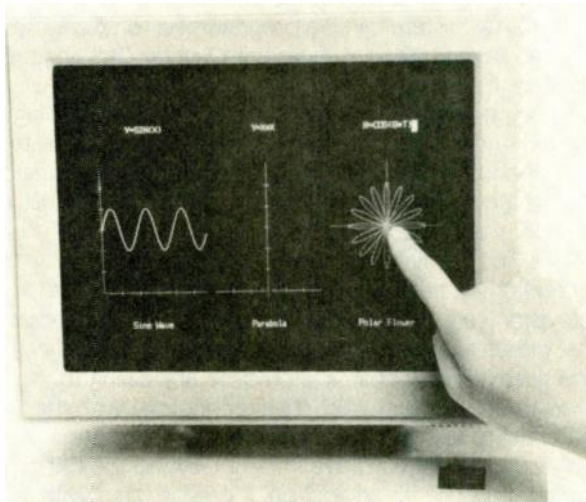

FIG. 1—THE ZENITH ACOUSTIC TOUCHSCREEN system is the first to offer three-dimensional touchpoints. It uses acoustic wave technology to create a matrix of inaudible soundwaves across the tube face, providing a depth coordinate as well as vertical and horizontal points.

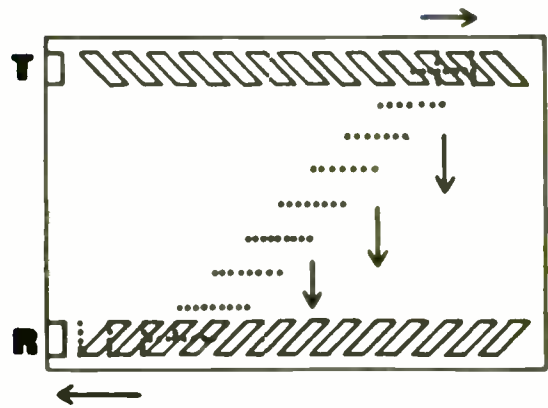

FIG. 2—USING ARRAY TECHNOLOGY, the Zenith system relies on a transmit transducer and an upside-down mirror image receiver to produce an acoustic wave system that bathes a CRT screen system with soundwaves. It is used in the horizontal and vertical plane.

emitted. Traveling along the top edge of the screen, the SAWs run into an array of partial reflectors, positioned 45 degrees to the direction of wave travel.

Wavelets

This array produces wavelets which travel vertically down the face of the screen. Because of the positioning of the reflectors, wavelets coming from reflectors farther to the right lag behind those which are reflected further to the left.

Eventually, this train of wavelets reaches an upside-down mirror image of the upper array at the bottom of the screen panel. The wavelets hitting the receive array are directed toward the receive transducer to the left. Note that the later wavelets produced to the right are further delayed by a longer return path. (See Fig. 2)

The planned delay of wavelets produces a continuous signal with a long rectangular envelope. The screen panel is covered by a continuous flow of wavelets with different transit times and each point on the time axis corresponds to a specific vertical path along the screen panel.

The attenuation dip caused by a touch appears in the output signal and indicates the position.

This system uses a fixed frequency in the 4 to 10 MHz range. The signal must be weighted so the amplitude of the signal remains constant across the screen panel, rather than decreasing exponentially over time. The designers, therefore, lowered the reflectivity of the array closest to the transmitter, where the signal is the strongest and used the highest reflectivity available at the other end.

Because of technical considerations, such as the SAW's velocity on soda-lime glass, it was found the optimum placement of the reflective elements is 0.75 mm, positioned at 45 degrees. In the perpendicular plane, spacing is 0.53 mm, or half a wavelength. A 50 percent duty factor means the strips should also be 0.27 mm wide. They are 5 microns thick. Therefore, the reflective elements can be screen printed on a panel.

Pressure dependable

A surface wave will be more deeply attenuated as a

finger is pressed harder on a screen and thus the signal's dip is deeper.

Functions can be designed in which take advantage of it. To move a cursor a user might be instructed to press lightly and to make a program choice he might be instructed to press firmly.

In operation, the Zenith SAW system is three-dimensional. It generates the usual X and Y axis points, but also a pressure point. Available in one to 16 pressure levels, it can generate a maximum resolution of 50 touch points per inch. Thus, a 14-inch CRT can have a total of 512 by 384 touchpoints.

In the acoustic touch system, the piezoelectric elements can be mounted directly on the surface of the cathode ray tube or they can also be placed on a glass overlay. When they are excited electrically, they emit SAWs, which are reflected off the reflective strip arrays mounted along each edge of the tube surface. They send the SAWs across the screen and create the invisible matrix of touchpoints.

When a finger breaks the sound waves, two or more transducers sense it and a microprocessor locates the sources of the break at its horizontal and vertical crosspoints. And, because SAWs are affected by the amount of pressure applied, this system can not only generate the traditional X and Y information common to other forms of touch systems, but also a Z or third positional input that is based on pressure.

Three-dimensional

Because it can generate an extra dimensional input, it is possible for the SAW system to be more versatile than the standard touchscreen system. Most standard touchscreen systems can generate touchpoint resolutions from 1,024 by 1,024 to nearly 4,000 by 4,000, but these are only two-dimensional (X,Y) inputs which, while they do yield good positional inputs, fail to yield any other information. Adding the pressure or Z axis allows a company to build in more functionality because a system cannot only place the touchpoint in space, but it also has a pressure reference which can serve another function.

The resistive-membrane system is the more common type. It's been used for years and relies on a grid of resistive elements. When the elements are pressed a current corresponding to the X and Y axes is generated.

Generally transparent, the typical resistive or resistive-membrane touchscreen may have a layer of dots sandwiched in its construction. Although these dots are largely for show, they help a user locate where an input is generated. The resistive element is the important piece of the sandwich and it is a transparent layer of metallic material that has been included in the membrane's construction. When this comes in contact with a second element a current from a touchpoint is generated and a microprocessor senses the input.

The drawback with is that it cuts down on the visibility of a CRT because of the number of layers that are superimposed on the glass.

A resistive system relies on the current between a fingertip and the resistive element on glass. Since it



FIG. 3—THE SAW SYSTEM is highly versatile. It can be integrated with a graphics tablet to control a personal computer or terminal.

becomes part of the glass, it can be clearer than the traditional resistive-membrane system. It is less prone to damage from sharp instruments.

The second type of touchscreen technology works in a similar manner to the acoustic wave, except that it uses banks of LEDs and infrared detectors. In this system, LED transmitters are placed along the X and Y axis and receivers are placed opposite them. The LEDs transmit vertically and horizontally, from the bezel surrounding the CRT screen, and where a fingertip interrupts the LED beams input is generated.

This type of system will generate an X-Y position, but is incapable of generating a third dimension.

More flexibility

The Zenith system is important because of the added flexibility it gives to a touchscreen system. A system can be programmed to recognize the increased pressure and can then ask if a user would like to take a new or extra action. It can be programmed to ask a user if the action sought is the correct one.

The SAW system can be programmed to take a user through several steps in a program just by pressing the screen a little harder.

Finally, because it relies on transducers surrounding the CRT, there is no diminution of the screen's visibility and since only two piezoelectric sensors are used and a corresponding number of receivers, the system has few parts and should be trouble-free.

This isn't the first time Zenith has used SAW technology. It has used this technology for years in television sets. It's the novel approach in touchscreens that makes it interesting and because of its reliability and relatively low cost, it should be appealing to broad areas of the market. It's a technology with the potential to reshape the market in its own image.

Additionally, it will have impact beyond the CRT market. Because it's an add-on, it can be used with a wide variety of products. For example, it can become part of a graphics tablet package (See Fig. 3). This will allow the user fingertip control of a computer. It's just another use of this versatile technology. ◀▶

COMMUNICATIONS CORNER



HERB FRIEDMAN,
COMMUNICATIONS EDITOR

Amateur packet switching

BECAUSE OF THE "CONGLOMERATION" of most major manufacturing firms, few if any great technological breakthroughs are now made by hobbyists in basement workshops. Aside from the enormous expense involved, the development of a highly technical communications device or system often requires assistance from persons familiar with unrelated technologies—persons usually beyond the reach of the "crazy perferesser" working alone in a damp basement or a converted garage.

But there is still one source of manpower (personpower?) skilled in many conceivable technologies: amateur (ham) radio. From its vast pool of hundreds of thousands of technically-informed hobbyists you can come up with a handful of experts on just about any technology—people who are just itching to open up new frontiers in communications. It is that spirit of adventure that has transformed many specialized technologies and obscure laboratory phenomena into viable communications systems.

The latest contribution by the amateurs is something called "packet radio." Yes, you can say that there's nothing new about packet communications. And that's true. Packet communications is used by computer networks and some megabuck communications systems, but it's the hams who are making packet radio a very popular form of communications; packet may even replace SSB, RTTY, and even FM repeaters for anything but chit-chat.

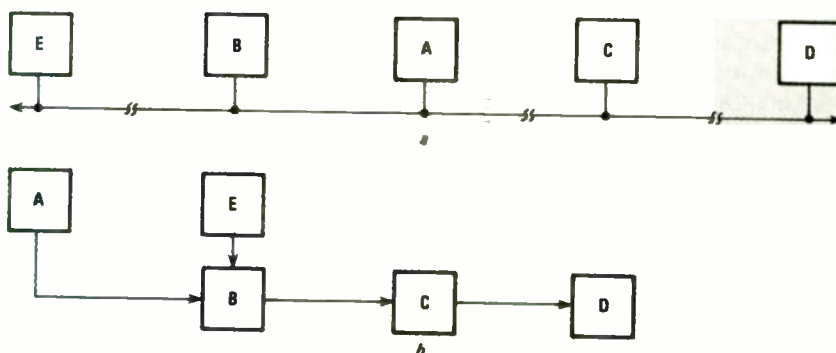

FIG. 1

How it works

The idea behind packet radio is shown in Fig. 1-a. For purposes of discussion, let's assume that data originates as entries on a keyboard, just as an actual message might originate. But that data could be chunks of a large database, programs, or just about anything else that can be represented in digital form.

Each station in a packet network is called a node, and two or more (possibly all) nodes are connected together by a simplex (single-wire) circuit. That circuit could be an actual wire, or it could be a line-of-sight radio link, a repeater, or even a satellite circuit. Or it could be any combination of those. The point is that in a simplex circuit stations send and receive on the same wire or frequency. Each node recognizes special protocol signals that switch the node from receive to transmit mode, that generate "busy" signals, etc.

For example, node A and node D might be across the room from each other, or they might be across the country from each other. In any case, to send data from node A

to node D the computer at node A assembles data until it has a block of predetermined size. When the node senses that the communications line is clear it transmits an address—where the data is going to—and then the data.

If data must be echoed through a repeater in order to reach its destination, other nodes pick it up and pass it along. As shown in Fig. 1-b, the signal might travel through nodes B and C before they actually reach node D. Obviously, then, nodes B and C must be smart enough to know that they have to pass the signal on.

Since all nodes share a single circuit something must untangle their transmissions. Again, that is part of the protocol. When A is finished transmitting to B, B attempts to retransmit that packet to C. However, suppose that, at the very moment B is ready to transmit, C sends a packet of data to D. B then gets a "busy" when it polls C, so it waits until the circuit is clear. Depending on the system, D might transmit through C and B to E even while B was storing data that is to be passed through B.

(Things *do* get complex and might get a bit confusing at first, so re-read the preceding paragraph if you find it necessary.)

While all that is going on, *A* is assembling the next block of data, which it will transmit to *B* as soon as the circuit is clear. As you can see, the data is handled in small packets which are put on the system one at a time. The destination node assembles the packets in its memory into a single file, document, or whatever. When it receives a signal that it has received the last packet, it feeds the entire file into the user's computer where it can be saved for use when needed.

As you can see, at any given time there may be bits and pieces (packets) of various data files passing through various nodes. For example, while *B* is waiting for *C* to "unbusy" so it can transmit a packet to *D*, *B* might be transmitting a packet from *E* to *A*. Since the communications protocol prevents more than one node from transmitting at a time, for all practical

purposes packet communications multiplexes a simplex communications path.

While data packets are usually a predetermined size (e. g., 256 bytes), message packets are usually a typed line; that is, all characters up to the carriage return. If you type a line and enter a carriage return, the node accepts that as a packet. If you type three lines and then a carriage return the node accepts all characters in those lines as a single packet.

The protocol includes checksum and ACK (ACKnowledge) signals which ensure that packets are received error-free. The checksum is a value that is a mathematically determined by the data in the packet. Every packet is transmitted with a checksum value. Each receiving node in the signal path calculates a checksum from the data it receives and compares that value with the checksum transmitted by the originating node. If that checksum matches the transmitted checksum, the receiving node sends an ACK signal to the ori-

ginating node. That signal informs the originating node that the packet has been properly received and that the next packet can be transmitted.

On the other hand, if something caused a reception error, the received checksum will not match the transmitted checksum, so an ACK will not be sent to the originating node. It therefore knows that it must repeat the transmission. The originating node will continuously repeat the transmission as long as necessary until it receives an ACK, or an abort signal from the receiving node. That's the way communications integrity is maintained through many nodes, thousands of miles of wire, and geographically-distant radio circuits.

Right now, hobbyist packet equipment is expensive. But, as is common in this industry, someone will probably figure out a way to put a complete node on two VLSI IC's that cost less than \$29.95. And we'll be happy to see that happen!
R-E

DRAWING BOARD

continued from page 85

a low, our circuit is addressing one of the soft switches. The two least significant bits of the address bus (A7 and A8) will determine which bank of our memory system to enable.

Since we only want to enable one bank at a time, the second part of our circuit has to be a one-of-four decoder. There are several IC's we could use, but it's always a good idea to keep the idea of system expansion in mind. The 4051 shown in Fig. 3 is a one-of-eight switch that we've used here before. It's a CMOS analog switch that can handle either analog or digital signals; the digital mode is selected by tying pin 7 low. The data presented to the *D* input at pin 3 is transferred to the output selected by the *A0*-*A2* inputs (pins 9-11). Since we're decoding four banks of memory with two inputs, we'll use the most significant select line (*A2*) to enable the IC.

The last part of the circuit is a latch. The 4042 is a four-bit latch

with a really neat feature. We can make it latch data on either a high or a low trigger by tying the *POLARITY* input (pin 6) high or low. The signal from the *NAND* gate is active low, so we'll tie the *POLARITY* pin low. So, whenever a low is presented to the *STORE* input (pin 5), the data at the latch's inputs will be stored. They'll also appear at the latch's outputs.

The circuit works like this: When one of our soft-switch addresses shows up on the system address bus, the output of the *NAND* gate goes low. That allows the 4051 to transfer that signal to the output selected by address lines *A7* and *A8*. Since a low is also presented to the *STORE* input of the 4042, the state of the four 4051 outputs are latched and transferred to the memory enable lines. The result: the selected bank is enabled and the other three banks are disabled.

Caveats

There are a few considerations you should keep in mind when using that arrangement, or a similar one, to control a banked memory system. First, you'll notice that

there's no way of predicting which states the latch's output lines will be in when the system is first powered up. Zero, one, or even several of the memory banks could be enabled when you first apply power. That last possibility exists because the 4051 can have an illegal output state—more than one high output—if much noise is present at power up.

Previously, when we were faced with that sort of problem, we used an RC network to generate a quick-and-dirty reset pulse to make sure that things were set up the way we wanted them. But if you examine our circuit, you'll see that it is, unfortunately, too complicated for that type of reset. A simple reset pulse just won't work since there are so many variables involved. A hardware reset would have to control all the circuit elements, so it would be very difficult to design.

But there are other ways to solve that problem.

However, we're out of space for now, so we'll have to wait till next time to see the solution, and also wrap up our discussion of memory management.
R-E

A \$10,000 Challenge To Escort

Let's cut through the Radar Detector Glut. We challenge Escort to a one on one Distance and Falsing 'duel to the death' on the highway of their choice. If they win, the \$10,000 check pictured below is theirs.

By Drew Kaplan

We've put up our \$10,000. We challenge Escort to take on Maxon's new Dual Superheterodyne RD-1 \$99⁹⁰ radar detector on the road of their choice in a one on one conflict.

Even Escort says that everyone compares themselves to Escort, and they're right. They were the first in 1978 to use superheterodyne circuits and they've got a virtual stranglehold on the magazine test reports.

But, the real question today is: 1) How many feet of sensing difference, if any, is there between this top of the line Maxon Detector and Escort's? And 2) Which unit is more accurate at interpreting real radar versus false signals?

So Escort, you pick the road (continental U.S. please). You pick the equipment to create the false signals. And finally, you pick the radar gun.

Maxon and DAK will come to your highway with engineers and equipment to verify the results. And oh yes, we'll have the \$10,000 check (pictured) to hand over if you beat us by more than 10 feet in either X or K band detection.

BOB SAYS MAXON IS BETTER

Here's how it started. Maxon is a mammoth electronics prime manufacturer. They actually make all types of sophisticated electronic products for some of the biggest U.S. Electronics Companies. (No, they don't make Escort's).

Bob Thetford, the president of Maxon Systems Inc., and a friend of mine, was explaining their new RD-1 anti-falsing Dual Superheterodyne Radar detector to me. I said "You know Bob, I think Escort really has the market locked up." He said, "Our new design can beat theirs".

So, since I've never been one to be in second place, I said, "Would you bet \$10,000 that you can beat Escort?" And, as they say, the rest is history.

By the way, Bob is about 6'9" tall, so if we can't beat Escort, we can sure scare the you know what out of them. But, Bob and his engineers are deadly serious about this 'duel'. And you can bet that our \$10,000 is serious.

We ask only the following. 1) The public be invited to watch. 2) Maxon's Engineers as well as Escort's check the radar gun and monitor the test and the results.

3) The same car be used in both tests. 4) We do this test during the summer when it's warm. (I'm from California, and anything below 80° will do me in.)

5) We'd like an answer from Escort no later than June 1, 1986 and 30 days notice of the time and place of the conflict. And, 6) We'd like them to come with a \$10,000 check made out to DAK if we win.

SO, WHAT'S DUAL SUPERHETERODYNE?

Ok, so far we've set up the conflict. Now let me tell you about the new dual superheterodyne technology that lets Maxon leap ahead of the pack.

It's a technology that tests each suspected radar signal 4 separate times before it notifies you, and yet it explodes into action in just 1/4 of one second.



Just imagine the sophistication of a device that can test a signal 4 times in less than 1/4 of one second. Maxon's technology is mind boggling.

But, using it isn't. This long range detector has all the bells and whistles. It has a separate audible sound for X and K radar signals because you've only got about 1/3 the time to react with K band.

There's a 10 step LED Bar Graph Meter to accurately show the radar signal's strength. And, you won't have to look at a needle in a meter. You can see the Bar Graph Meter with your peripheral vision and keep your eyes on the road and put your foot on the brake.



So, just turn on the Power/Volume knob, clip it to your visor or put it on your dash. Then plug in its cigarette lighter cord and you're protected.

And you'll have a very high level of protection. Maxon's Dual Conversion Scanning Superheterodyne circuitry combined with its ridge guide wideband horn internal antenna, really ferrets out radar signals.

By the way Escort, we'll be happy to have our test around a bend in the road or over a hill. Maxon's detector really picks up 'ambush type' radar signals.

And the key word is 'radar', not trash signals. The 4 test check system that operates in 1/4 second gives you extremely high protection from signals from other detectors, intrusion systems and garage door openers.

So, when the lights and X or K band sounds explode into action, take care, there's very likely police radar nearby. You'll have full volume control, and a

City/Highway button reduces the less important X band reception in the city.

Maxon's long range detector comes complete with a visor clip, hook and loop dash board mounting, and the power cord cigarette adaptor.

It's much smaller than Escort at just 3 1/2" wide, 4 3/4" deep and 1 1/2" high. It's backed by Maxon's standard limited warranty. Note from Drew: 1) Use of radar detectors is illegal in some states.

2) Speeding is dangerous. Use this detector to help keep you safe when you forget, not to get away with speeding.

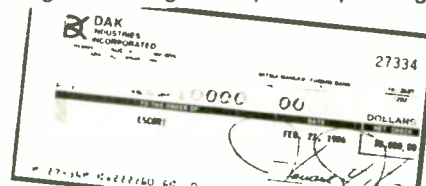

CHECK OUT RADAR YOURSELF RISK FREE

Put this detector on your visor. When it sounds, look around for the police. There's a good chance you'll be saving money in fines and higher insurance rates. And, if you slow down, you may even save lives.

If you aren't 100% satisfied, simply return it in its original box within 30 days for a courteous refund.

To get your Maxon, Dual Superheterodyne, Anti-Falsing Radar Detector risk free with your credit card, call toll free or send your check for just \$99⁹⁰ (\$4 P&H). Order No. 4407. CA res add tax.

OK Escort, it's up to you. We've got \$10,000 that says you can't beat Maxon on the road. Your answer, please?

Escort is a registered trademark of Cincinnati Microwave.

DAK INDUSTRIES INCORPORATED Dept. RE37
TOLL-FREE ORDER LINE
For credit card orders call 24 hours a day 7 days a week
CALL TOLL-FREE. . . 1-800-325-0800
8200 Remmet Ave., Canoga Park, CA 91304

MARKET CENTER

FOR SALE

RESTRICTED Technical Information: Electronic surveillance, schematics, locksmithing, covert sciences, hacking, etc. **huge selection.** Free brochure: **MENTOR-Z**, 135-53 No. Blvd., Flushing, NY 11354.

TUBES, new, unused. Send self-addressed, stamped envelope for list. **FALA ELECTRONICS**, Box 1376-2, Milwaukee, WI 53201.

LINEAR PARTS—TUBES—TRANSISTORS—MRF454 \$16, MRF455 \$12, MRF477 \$11, MRF492 \$18. Catalog. **RFPC**, Box 700, San Marcos, CA 92069 (619) 744-0728.

WHOLESALE catalog of unusual money making electronic items. Dealers wanted. **Rush \$1. CROSLY** (A), Box 840, Champlain, NY 12919.

WANTED: WESTERN ELECTRIC, RCA, Marantz, McIntosh, Telefunken, Dynaco, Altec, EV, **TUBES**, Amplifiers, Speakers. (713) 728-4343, **MAURY**, 1122 Atwell, Houston, TX 77096.

CLASSIFIED AD ORDER FORM

To run your own classified ad, put one word on each of the lines below and send this form along with your check to:

Radio-Electronics Classified Ads, 500-B Bi-County Boulevard, Farmingdale, NY 11735

PLEASE INDICATE in which category of classified advertising you wish your ad to appear. For special headings, there is a surcharge of **\$23.00**.

() Plans/Kits () Business Opportunities () For Sale
() Education/Instruction () Wanted () Satellite Television
() _____

Special Category: \$23.00

PLEASE PRINT EACH WORD SEPARATELY, IN BLOCK LETTERS.

(No refunds or credits for typesetting errors can be made unless you clearly print or type your copy.) Rates indicated are for standard style classified ads only. See below for additional charges for special ads. **Minimum: 15 words.**

1	2	3	4	5
6	7	8	9	10
11	12	13	14	15 (\$42.75)
16 (\$45.60)	17 (\$48.45)	18 (\$51.30)	19 (\$54.15)	20 (\$57.00)
21 (\$59.85)	22 (\$62.70)	23 (\$65.55)	24 (\$68.40)	25 (\$71.25)
26 (\$74.10)	27 (\$76.95)	28 (\$79.80)	29 (\$82.65)	30 (\$85.50)
31 (\$88.35)	32 (\$91.10)	33 (\$94.05)	34 (\$96.90)	35 (\$99.75)

We accept MasterCard and Visa for payment of orders. If you wish to use your credit card to pay for your ad fill in the following additional information (Sorry, no telephone orders can be accepted.):

Card Number _____

Expiration Date _____

Please Print Name _____

Signature _____

IF YOU USE A BOX NUMBER YOU MUST INCLUDE YOUR PERMANENT ADDRESS AND PHONE NUMBER FOR OUR FILES. ADS SUBMITTED WITHOUT THIS INFORMATION WILL NOT BE ACCEPTED.

CLASSIFIED COMMERCIAL RATE: (for firms or individuals offering commercial products or services) \$2.85 per word prepaid (no charge for zip code)...**MINIMUM 15 WORDS**. 5% discount for same ad in 6 issues; 10% discount for same ad in 12 issues within one year; if prepaid. **NON-COMMERCIAL RATE:** (for individuals who want to buy or sell a personal item) \$2.30 per word, prepaid...no minimum. **ONLY FIRST WORD AND NAME** set in bold caps at no extra charge. Additional bold face (not available as all caps) **50¢ per word additional (20% premium)**. Entire ad in boldface, add **20% premium** to total price. **TINT SCREEN BEHIND ENTIRE AD: add 25% premium** to total price. **TINT SCREEN BEHIND ENTIRE AD PLUS ALL BOLD FACE AD: add 45% premium** to total price. **EXPANDED TYPE AD: \$4.30 per word prepaid**. All other items same as for **STANDARD COMMERCIAL RATE**. **TINT SCREEN BEHIND ENTIRE EXPANDED TYPE AD: add 25% premium** to total price. **TINT SCREEN BEHIND ENTIRE EXPANDED TYPE AD PLUS ALL BOLD FACE AD: add 45% premium** to total price. **DISPLAY ADS:** 1" x 2 1/4"—\$310.00; 2" x 2 1/4"—\$620.00; 3" x 2 1/4"—\$930.00. **General Information:** Frequency rates and prepayment discounts are available. **ALL COPY SUBJECT TO PUBLISHERS APPROVAL. ADVERTISEMENTS USING P.O. BOX ADDRESS WILL NOT BE ACCEPTED UNTIL ADVERTISER SUPPLIES PUBLISHER WITH PERMANENT ADDRESS AND PHONE NUMBER.** Copy to be in our hands on the 12th of the third month preceding the date of the issue. (i.e., August issue copy must be received by May 12th). When normal closing date falls on Saturday, Sunday or Holiday, issue closes on preceding working day.

ENCLOSURES: Beautiful aluminum and wood. Hobbyist priced. Many sizes. Sample \$3.00 + \$2.00 shipping. Information free. **ENERGY ENGINEERING**, RT 4, Box 330, Fayetteville, AR 72701.

APPLE public domain software over 150 programs on six disks. Radio-Electronics \$52.00 payable to: **H.M. TECHNOLOGY**, Dept. 1207 Ave. U, Brooklyn, NY 11229.

FREE TRANSISTORS: Sample of **PN222** and **2N3904** with our **Catalog of Budget Priced Electronic Components** for hobbyists and industry. Send \$2.00 P&H (refundable) **BUDGET ELECTRONICS**, Box 1477, Moreno Valley, CA 92388 (714) 653-1663.

COMPLETE satellite system \$595.00. Cable converters and descramblers. Lowest prices ever. Catalog \$1.00. Dealer package \$15.95. **ED ROHWEDER LTD.**, 5785 Staghound Ave., Riverside, CA 92506.



Quality Microwave TV Antennas

Multi-Channel 1.9 to 2.7 GHz
40dB Gain True Parabolic 20 Inch Dish
Complete System \$99.95 (plus shipping)
Dealerships, Qty. Pricing, Replacement Parts

Philips-Tech Electronics
P.O. Box 8633 • Scottsdale, AZ 86262
(802) 947-7700 (\$3.00 Credit all phone orders!)
MasterCard • Visa • CDD

LIFETIME WARRANTY

CATALOG: Cable converters, both kits and assembled units. N12 minicode \$98.00 Jerrold 400 \$99.00. Pulse descrambler kit (assembles in half hour) \$74.00, built \$120.00. Satellite descrambler kit \$119, built \$190. Surplus components, hobby kits. Send \$1.00 **MJ INDUSTRY** (formerly minute kits), Box 531, Bronx, NY 10461.

BUGGING devices, long range self powered FM phone bug, \$14.95 kit. Sensitive FM mini mike kit, \$14.95. High power professional FM wireless mike kit, \$22.95. Mad blaster TV jammer kit, \$14.95 Visa. M.C. Catalog, \$2.00 **SPY STUFF**, 2575 Baird Rd., Penfield, NY 14526, (716) 586-3950.

FILM Negatives 8x10: \$8.00, positives \$12.00. Layouts by quote. **ADB GRAPHICS**, Box 24361, Vancouver V5T 4M5 Canada.

1000 photofact folders from 1940's, 1950's and 1960's. Make offer **JPB**, 115 Melrose Ave., Vicksburg, MS 39180.

ELECTRONIC surveillance: Amazing reports reveal tradecraft secrets. Details free: **A.T.I.S.**, 1107 50th, Fennville, MI 49408.

BUGGED? Wiretapped? Find out fast. Countermeasures equipment catalog \$1. **CAPRI ELECTRONICS**, Route 1R, Canon, GA 30520.

WHOLESALE car-radio, computer, telephone, audio-video accessories, antenna catalog (718) 897-0509, **D&WR**, 68-12 110th St., Flushing, NY 11375.

6ft. Antenna \$300.00, complete system \$695.00 Free catalog. **IN-X-SALES**, Box 45 Tilton, NH 03276, (603) 286-3082.



WRITE FOR
McGEE'S
SPEAKER & ELECTRONICS CATALOG

1001 BARGAINS IN SPEAKERS
toll free 1-800-346-2433 for ordering only.
1901 MCGEE STREET KANSAS CITY, MO. 64108

SB3 descrambler parts to construct project in Feb/84 Radio-Electronics, \$49.95 (Dealer inquiries invited). **CROSLEY (A)**, Box 840, Champlain, NY 12919.

WORLDS best channel 3 notch filter. \$39.95. (Dealer inquiries invite d). **CROSLEY (A)**, Box 840, Champlain, NY 12919.

NEW Jerrold Starcom-CS 60 channel, wireless, remote control cable converter. Volume and "commercial killer" mute control. Programmable time switch turns TV on/off and can change channel. Programmable favorite channel scan. Instant channel recall. Automatic fine tuning with manual override. Video and audio outputs. Works with all descramblers. 1 year warranty. \$169. Dealers wanted. **CROSLEY**, Box 840, Champlain, NY 12919 (518) 561-8700.

200 Unique circuits low cost detailed surveillance gadgets test sound and more. Experimenters gold mine US \$5.95 plus \$1.50 postage. **JSW**, 2555 Benny, Sulte 1403, Montreal H4B 2R6 Canada.

THE BEST PLACE to BUY, SELL or TRADE NEW and USED EQUIPMENT

NUTS & VOLTS MAGAZINE

BOX 1111E • PLACENTIA, CA 92670

(714) 632-7721

Join Thousands of Readers Nationwide Every Month

ONE YEAR U.S. SUBSCRIPTIONS

\$10.00 - 3rd Class • \$15.00 - 1st Class

\$35.00 - Lifetime - 3rd Class

NUTS & VOLTS

HAM GEAR
COMPUTERS
SOFTWARE
SCANNERS • OPTICS
TEST EQUIPMENT
MICROWAVE
SATELLITE
AUDIO VISUAL
NEW PRODUCTS
COMPONENTS • RITS
ANTIQUE ELECT
PUBLICATIONS
PLANS • SERVICES

OLDTIME radio programs on high quality tapes. Comedy! Adventure! Music! Free catalogue. **CARL F. FROELICH**, Heritage Farm, New Freedom, PA 17349.

T.V. tunable notch filters, free brochure. **D.K. VIDEO**, Box 63.6025, Margate, FL 33063 (305) 752-9202.

TEST equipment, reconditioned. For sale. \$1.25 for catalog. **WALTER'S**, 2697 Nickel, San Pablo, CA 94806 (415) 724-0587.

LASERS and nightvision surplus components. Free catalog. **M.J. NEAL COMPANY**, 6672 Mallard Ct., Orient, OH 43146.

TI-99/4A software/hardware bargains. Hard to find items. Huge selection. Fast service. Free catalog. **DYNA**, Box 690, Hicksville, NY 11801.

CABLE-TV converters and descramblers. Low prices. quality merchandise, we ship C.O.D. Send \$2.00 for catalog. **CABLETRONICS UNLIMITED**, P.O. Box 266, South Weymouth, MA 02190. (617) 871-6500.

CABLE TV converters-All major brands. Wireless remotes with volume, wired remotes. Cable and Video accessories. Cablemaster distributor. Lowest prices. Ship C.O.D. Catalogs \$3.00. **SONE ASSOCIATES**, 256 Broadway, Suite 201, Troy, NY 12180. (518) 274-0608.

DESCRAMBLER plans for Jerrold. Theory, schematic, parts list, waveforms. For speedy delivery send \$10.00 cash or money order. **BAY STATE ELECTRONICS**, P.O. Box 63 Accord, MA 02018.

FREE ADAPTER (Limited offer) with ASSORTMENT #103-consisting of **TOKO** Coils 144LY-120K, 520 HN-3000023, BKAN-K5552AXX (2); **PCB**; **Transistors** 2N3904 (2), BFQ85 (Sub); **IC'S** 7812, 74123, MC1330A1P; **Diodes** 1N914, 1N5231B. Only \$25.00. 10% Discount for 5 or more. Shipping \$3.00/order MC/Visa/COD. Toll Free 1-800-821-5226 Ext. 426 (orders). **Jim Rhodes, Inc.** 1025 Ransome Lane, Kingsport, TN 37660.

COLOR CODED WIRE

10 COLORS • 80 FEET EACH (11' bundled only) 10-20-22-24 • • •

500 FT ONLY \$19.95

Send Gauge and check or money order or MC or Visa # to SG Technologies, P.O. Box 278, Pittsburgh, PA 15104

CABLE-TV

WE'LL MATCH OR BEAT ANYONE'S ADVERTISED RETAIL OR WHOLESALE PRICES!

BONANZA!

ITEM	SINGLE UNIT PRICE	DEALER 10-UNIT PRICE
RCA 36 CHANNEL CONVERTER (CH. 3 OUTPUT ONLY)	29.95	180.00 ea.
PIONEER WIRELESS CONVERTER (OUR BEST BUY)	88.95	72.00 ea.
LCC-58 WIRELESS CONVERTER	92.95	76.00 ea.
JERROLD 450 WIRELESS CONVERTER (CH. 3 OUTPUT ONLY)	105.95	90.00 ea.
SB ADD-ON UNIT	109.95	58.00 ea.
BRAND NEW — UNIT FOR SCIENTIFIC ATLANTA	<i>Call for specifics</i>	
MINICODE (N-12)	109.95	58.00 ea.
MINICODE (N-12) VARISYNC	119.95	62.00 ea.
MINICODE VARISYNC W/AUTO ON-OFF	179.95	115.00 ea.
M-35 B (CH. 3 OUTPUT ONLY)	139.95	70.00 ea.
M-35 B W/AUTO ON-OFF (CALL FOR AVAILABILITY)	199.95	125.00 ea.
MLD-1200-3 (CALL IF CH. 2 OUTPUT)	109.95	58.00 ea.
INTERFERENCE FILTERS — CH. 3	24.95	14.00 ea.
JERROLD 400 OR 450 REMOTE CONTROLLER	29.95	18.00 ea.
ZENITH SSAVI CABLE READY (DEALER PRICE BASED ON 5 UNITS)	225.00	185.00 ea.
SPECIFY CHANNEL 2 or 3 OUTPUT	<i>Other products available — Please Call</i>	

Quantity	Item	Output Channel	Price Each	TOTAL PRICE
California Penal Code #593-D forbids us from shipping any cable descrambling unit to anyone residing in the state of California			SUBTOTAL	
Prices subject to change without notice			Shipping Add \$3.00 per unit	
			COD & Credit Cards — Add 5%	
			TOTAL	

PLEASE PRINT
Name _____
Address _____ City _____
State _____ Zip _____ Phone Number () _____
 Cashier's Check Money Order COD Visa Mastercard
Acct # _____ Exp Date _____
Signature _____

FOR OUR RECORDS:
DECLARATION OF AUTHORIZED USE — I, the undersigned, do hereby declare under penalty of perjury that all products purchased now and in the future, will only be used on cable TV systems with proper authorization from local officials or cable company officials in accordance with all applicable federal and state laws.
Date: _____ Signed: _____

Pacific Cable Company, Inc.

7325 1/2 RESEDA BLVD., DEPT. #R-7 • RESEDA, CA 91335
(818) 716-5914 • No Collect Calls • (818) 716-5140

IMPORTANT: WHEN CALLING FOR INFORMATION
Please have the make and model # of the equipment used in your area. Thank You

JULY 1986

ELECTRON tubes-Radio, TV & industrial types- huge inventory. Call toll free (800) 221-5802 or write Box **ESC TRANSLETRONIC, INC.**, 1365 39th St., Brooklyn, NY 11218, (718) 833-2800.

TUBES: "OLDIES," LATEST. Parts, components, schematics. SASE for list. **STEINMETZ**, 7519 Maplewood Ave., RE., Hammond, IN, 46324.

SUBSCRIPTION Television descramblers Oak built, surplus pull outs, are sinewave downconverters/descramblers. Units are untested and without AC power cords. Send \$19.95 in money order or cashiers check to: **PAMER ELECTRIC**, Surplus 12970, Branford St. Suite "M" Arlota, CA, 91331.

TUBES, name brands, new, 80% off list, **KIRBY**, 298 West Carmel Drive, Carmel, IN 46032.

INDIVIDUAL Photofact-folders #1 to #1400. \$3.00 postpaid. **LOEB**, 414 Chestnut Lane, East Meadow, NY 11554.

CABLE and Subscription TV secret manual. Build your own descramblers, converters. Instructions, schematics for Sine Wave, inband/outband gated sync, SSAVI-(HBO, Showtime, Cinemax, UHF, etc.) Send \$8.95 to **CABLETRONICS**, Box 30502R, Bethesda, MD 20814.

CORDLESS-copy phone interference? We've got the answer. Have a radar speeding ticket? We can help. Home phone extension in your car? You can have it. 50-page color catalog airmailed \$3.00. **DBE**, P.O. Drawer G, Waikiki, HI 96830.

3000 Tips color TV repairs 31 brands 116 pages \$21.00. **A FERNANDEZ**, Box 546110, Surfside, FL 33154.

\$500.00 worth. Quality Radio-TV Parts—only \$50.00! CX130, SG-274, PA-501—transistors, capacitors, others. Order from: **DEPENDABLE-TV**, Box 1645 C Sted, St. Croix, VI, USA 00820

6-DIGIT combination Frequency Counter (1Hz-100MHz), Function Generator (1Hz-1MHz) & Capacitance Meter (10pF-1mF). Tested W BNC-Probe. \$89.95 plus \$6.50 shipping. **Tugan**, 2614 W. Leland, Chicago, IL 60625.

A SINGER'S DREAM!



REMOVES VOCALS FROM RECORDS!
Now You can sing with the world's best bands! The Thompson Vocal Eliminator can remove most or virtually all of a lead vocal from a standard stereo record and leave the background!
Write or call for a free brochure and demo record.
LT Sound, Dept. R-1, P.O. Box 338, Stone Mountain, GA 30086 (404) 493-1258

DESCRAMBLER Manuals. Sinewave. Gated pulse. SSAVI, \$4.00 each, all three \$10.00. **DVE**, 6690 7 Mile, S. Lyon, MI 48178

BUSINESS OPPORTUNITIES

MECHANICALLY inclined individuals desiring ownership of small electronics manufacturing business - without investment. Write: **BUSINESSES**, 92-R, Brighton 11th, Brooklyn, NY 11235.

YOUR own radio station! AM, FM, TV, Cable. Licensed unlicensed. **BROADCASTING**, Box 130-F7 Paradise, CA 95969.

PROJECTION TV Make \$\$\$'s assembling Projectors ... Easy ... Results, comparable to \$2,500 projectors ... Your total cost less than \$30.00 ... **Plans, 8" LENS & Dealers** information \$21.95 illustrated information free ... **Macrocoma-GKX**, Washington Crossing, PA 18977. Creditcard orders 24 hours (215) 736-2880.

RECOVER silver from home and industrial junk. Free silver with my \$10.00 booklet of items that contain silver. **DON FOWLER**, Box 4401, Cleveland, TN 37311.

BIG PROFITS **ELECTRONIC ASSEMBLY BUSINESS**

Start home spare time investment knowledge or experience unnecessary. **BIG DEMAND** assembling electronic devices. Sales handled by professionals. Unusual business opportunity

FREE: Complete illustrated literature
BARTA RE-O Box 248
Wainut Creek Calif. 94597

PLANS AND KITS

CATALOG: Hobby broadcasting 1750 Meters Ham/CB: Transmitters, amplifiers, antennas, scramblers, budding devices, more! **PANAXIS**, Box 130-F, Paradise, CA 95969.

CABLE TV converters: Jerrold products include "New Jerrold TRI-MODE", SB-3, Hamlin, Oak VN-12, M-35-B, Zenith, and more. UHF Deluxe II Kits. (quantity discounts) 60-day warranty. Service converters sold here. For fast service COD orders accepted. Send SASE (60 cents postage) or call for info. (312) 637-4408. HIGGINS ELECTRONICS, 5143-R W. Diversey, Chicago, IL 60639. No Illinois orders accepted.

Hi-Fi speaker systems, kits, auto speaker systems and speaker components from the world's finest manufacturers. For beginners and audiophiles. Free literature. **A&S SPEAKERS**, Box 7462R, Denver, CO 80207. (303) 399-8609.

8" DISH \$69 fabrication cost. Polar mount, attractive, easy construction. Stock hardware items used. **COMPLETE** instructions, plans, fabrication, assembly, setup, drawings, photos. \$14.95 Plus \$2.00 shipping. **DIRIJO DISH**, Box 212, Lowell, NC 28098.

CRYSTAL radio sets, plans, parts, kits, catalog \$1.00. **MIDCO**, 660 North Dixie Highway, Hollywood, FL 33020.

BUILD this five digit panel meter and square wave generator including an ohms, capacitance and frequency meter. Detailed instructions \$2.50 refundable plus 50 cents. **BAGNALL ELECTRONICS**, 179 May, Fairfield, CT 06430.

DESCRAMBLER plans. New design decodes gated sync suppressed signals—newest pilotless method. Circuit boards, most parts from Radio Shack. Detailed theory, drawings, schematics, instructions \$14.95 plus \$2.00 shipping. **DIRIJO CORP.**, Box 212, Lowell, NC 28098.

"UNCYPHERS American and Canadian satellite or cable, latest technology available. Plans & boards. Kits or complete. Send \$5.00 for catalog. Refundable on order to **PILGRIM VIDEO PRODUCTS**, Box 203, Oak Street, Pembroke, MA 02359.

PAY TV and Satellite Descrambling.

73 pages of theory and schematics for all major systems. Fantasy and Anik-D schematics included. Most complete reference available on satellite scrambling \$12.95. MDS Handbook \$10. Stungun schematics \$5. Satellite systems under \$600. \$11.95. Printed circuits, kits catalog \$2

SHOJIKI ELECTRONICS CORP. 1327R Niagara Street, Niagara Falls, NY 14303 COD's **716-284-2163**

FREE catalog 99-cent kits—audio, video, TV, computer parts. **ALLKIT**, 434 W. 4th St., West Islip, NY 11795.

PROJECTION TV...Convert your TV to project 7 foot picture. Results comparable to \$2,500 projectors. Total cost less than \$30.00. Plans and 8" lens \$21.95. Illustrated information **FREE**. **MACROCOMA-GK**, Washington Crossing, PA 18977. Creditcard orders 24 hours (215) 736-3979.

SAVE money, energy! Circuit makes batteries last longer! Use in your own invention! State of the art. Almost anyone can build. Plans \$10.00. **WAYNE KESSLER**, Box 685, Plymouth Meeting, PA 19462.

RADIO-ELECTRONICS ALL SALES SUBJECT TO THE TERMS OF OUR 90 DAY LIMITED WARRANTY. FREE COPY UPON REQUEST.

THE NEW 65/9028 VT ANSI VIDEO TERMINAL BOARD!

★ FROM LINGER ENTERPRISES ★

A second generation, low cost, high performance, mini sized, single board for making your own RS232 Video Terminal. Use as a computer console or with a MODEM for hook up to any of the telephone-line computer services.

FEATURES:

- Uses the new SMC 9028 Video Controller Chip coupled with a 6502A CPU.
- RS-232 at 16 Baud Rates from 50 to 19,200
- On board printer port!
- 24 X 80 format (50/60 Hz).
- For 15,750 Hz (Horiz.) monitors.
- 3 Terminal Modes: H-19, ADM3A, and ANSI X 3.64-1979
- Wide and thin-line graphics.
- White characters on black background or reversed.
- Character Attributes: De-Inten, Inverse or Underline.
- Low Power: 5VDC @ .7A. · 12VDC @ 20MA.
- Mini size: 6.5 X 5 inches.
- Composite or split video.
- 5 X 8 Dot Matrix characters (U/L case).
- Answer back capability.
- Battery backed up status memory.
- For ASCII parallel keyboard.

MICRO SIZE!

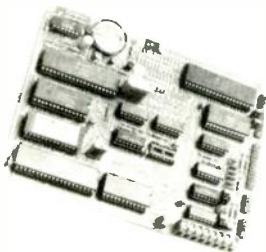

\$99⁹⁵
(Full Kit)

SOURCE DISKETTE:
PC/XT FORMAT
5 1/4 IN. \$15

ADD \$40 FOR A&T

Digital Research Computers

(OF TEXAS)

P.O. BOX 381450 • DUNCANVILLE TX 75138 • (214) 225-2309

Call or write for a free catalog on Z-80 or 6809 Single Board Computers, SS-50 Boards, and other S-100 products.

TERMS Add \$3.00 postage We pay balance. Orders under \$15 add 75c handling No C.O.D We accept Visa and MasterCard Texas Res add 5-1 8% Tax Foreign orders (except Canada) add 20 P & H Orders over \$50 add 85c for insurance



One tree can make 3,000,000 matches.

One match can burn 3,000,000 trees.



A Public Service of The Magazine of The Advertising Council

★ QUALITY PARTS ★ DISCOUNT PRICES ★ FAST SHIPPING!

SEND FOR
FREE
1986 CATALOG...
48 PAGES!

ALL ELECTRONICS CORP.

2K 10 TURN

MULTI-TURN POT
SPECTROL
#MOD 534-7161
\$5.00 EACH

SOLID STATE BUZZER

Star #SMB-06L
6 vdc
TTL compatible.
\$1.00 each
10 for \$9.00



± 12 Vdc or 24Vdc POWER SUPPLY

DELTRON MODEL QD12/15-1.7
Dual plus and minus 12Vdc open
frame power supply. Can be used as
24Vdc @ 1.5 amp. INPUT: either
115 Vac or 230 Vac
Fully regulated computer grade supply.
7" x 4 1/2" x 2 1/2"
\$12.50 each 10 for \$110.00

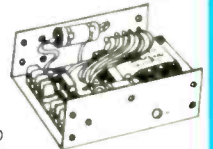

EDGE CONNECTORS

ALL ARE 1.56" SPACING.

- 22 EDGE CONNECTOR \$1.25 ea
Solder lug style 10 for \$11.00
- 22/44 EDGE CONNECTOR
\$2.00 ea PC style 10 for \$18.00
- 22/44 EDGE CONNECTOR
solder lug style \$2.50 each
- 28/56 EDGE CONNECTOR
\$2.50 ea PC style 10 for \$22.00
- 38/72 EDGE CONNECTOR
PC style \$3.00 each
- 43/86 EDGE CONNECTOR
PC style \$4.50 each

SOUND AND VIDEO MODULATOR FOR T.I. COMPUTER



T.I. # UM1381-1. Designed for use with T.I. computers. Can be used with video sources. Built-in A/B switch. Channel 3 or 4 selection switch. Operate on 12 vdc. Hook-up diagram included.
CAT# AVMOD WERE \$10.00 **REDUCED TO \$5.00 EACH**

SLIM LINE COOLING FAN



Etr # 99XM182 low noise fan. Measures 3 1/2" square x 1" deep 21 Cfm. 23 db. 1700 rpm
SPECIAL PRICE \$12.50 each

SPECIALS

1 AMP 50 VOLT DIODES (M4001) TAPE AND REEL
100 for \$4.50
1000 for \$30.00

SOLDER TAIL I.C. SOCKETS
24 PIN 10 for \$2.50
100 for \$22.00
1000 for \$200.00

SPECIAL PRICE TRANSISTOR

plastic transistor
PN3569 TO-92 N.P.N.
100 for \$8.00
1000 for \$60.00
LARGE QUANTITIES AVAILABLE

48 KEY ASSEMBLY FOR COMPUTER OR HOBBYIST



NEW T.I. KEYBOARDS. Originally used on computers, these keyboards contain 48 S.P.S.T. mechanical switches. Terminates to 15 pin connector. Frame 4" x 9"
CAT# KP-48 \$6.50 each
2 for \$11.00

MICRO-CASSETTE MECHANISM

Micro-cassette tape transport for standard MC50 or MC45 micro-cassettes. 3 Vdc operation. Contains drive motor, belt, head, capstan, pinch wheel and other components. 3 1/2" X 2 1/4" X 5/8"
CAT# MCMEC \$3.00 each 10 for \$27.50

COMPUTER GRADE CAPACITORS

- 2,000 mfd. 200 Vdc \$2.00
1 3/4" x 5" high
- 6,400 mfd. 60 Vdc \$2.50
1 3/8" x 3 3/4" high
- 9,700 mfd. 50 Vdc \$3.00
1 3/8" x 4 1/2" high
- 31,000 mfd. 15 Vdc \$2.50
1 3/4" x 4" high
- 50,000 mfd. 40 Vdc \$4.50
3" x 5 3/4" high
- 66,000 mfd. 15 Vdc \$3.00
3" x 3 3/4" high
- 60,000 mfd. 40 Vdc \$3.50
3" x 5" high
- 66,000 mfd. 15 Vdc \$3.00
3" x 3 3/4" high
- 86,000 mfd. 30 Vdc \$3.50
3" x 5 1/4" high
- 5,500 mfd. 30 Vdc \$1.00
1 3/8" x 3 1/2" high
- 5,900 mfd. 30 Vdc \$1.00
1 3/8" x 2 1/4" high
- 9,300 mfd. 50 Vdc \$1.00
2" x 4 1/2" high
- 18,000 mfd. 10 Vdc \$1.00
1 3/8" x 2 5/8" high
- 48,000 mfd. 10 Vdc \$1.00
2 1/2" x 3 1/4" high
- 100,000 mfd. 10 Vdc \$1.00
2 1/2" x 6" high
- 185,000 mfd. 6 Vdc \$1.00
2 1/2" x 4 1/2" high

RELAYS

10 AMP SOLID STATE
CONTROL 3-32 vdc
LOAD 140 vac 10 amp
SIZE 2 1/2" x 1 1/2" x 1 1/2"
\$9.50 EACH 10 FOR \$90.00

ULTRA-MINIATURE 5 VDC RELAY

Fujitsu # FBR211NE0005M20
High sensitivity
COIL 120 ohms
CONTACTS 1 amp
Mounts in 14 pin DIP socket
\$1.25 each 10 for \$10.00

MINIATURE 6 VDC RELAY

Aromat #RSO-EV
Super Small
S.P.D.T. relay
GOLD COBALT CONTACTS RAISED
1 amp @ 30 vdc. Highly sensitive
TTL direct drive possible. 120 ohm coil.
Operate from 4.3 - 6 vdc
COIL 120 ohms \$1.50 each
1 1/2" x 1 1/2" x 1 1/4" 10 for \$13.50

13 VDC RELAY

CONTACTS S.P.N.C.
10 amp @ 120 vac
Energize coil to open contact
COIL 13 vdc 650 ohms
SPECIAL PRICE \$1.00 each

4PDT RELAY

14 pin KH style
3 amp contacts
USED but fully tested \$1.70 each
Specify coil voltage desired
Either 24 vdc or 120 vac
LARGE QUANTITIES AVAILABLE

RECHARGEABLE NI-CAD BATTERIES

SOCKETS FOR KH RELAY 75¢ each

AAA SIZE 1.25V 500MAH \$1.85
AA SIZE 1.25V 500MAH \$1.85
AA with solder tab \$2.00
C SIZE 1.2V 1200MAH \$3.50
SUB-C SIZE solder tab \$3.50
D SIZE 1.2V 1200MAH \$3.50

UNIVERSAL CHARGER

Will charge 4-AA, C, D, or AAA ni-cads or one 9 volt ni-cad at one time.
\$11.00 per charger

TRANSISTORS

- 2N708 4 for \$1.00
2N2222A 3 for \$1.00
PN2222A 4 for \$1.00
2N2904 3 for \$1.00
2N2904 3 for \$1.00
2N2905 3 for \$1.00
MJ2955 \$1.50
2N3055 \$1.00
PMD 10K40 \$1.00
TIP 121 75¢
TIP 125 75¢

TRANSFORMERS

- 120 volt primaries
- 5.8 volts @ 750 ma \$3.00
6 volts @ 150 ma \$1.25
6.3 volt @ 600 ma \$3.00
12 V.C.T. @ 200 ma \$2.00
12 V.C.T. @ 400 ma \$3.00
12 V.C.T. @ 1 amp \$4.00
12 V.C.T. @ 2 amp \$4.85
12 V.C.T. @ 4 amp \$7.00
18 volts @ 850 ma \$3.50
24 V.C.T. @ 200 ma \$2.50
24 V.C.T. @ 1 amp \$4.85
24 V.C.T. @ 2 amp \$6.75
24 V.C.T. @ 3 amp \$9.50
24 V.C.T. @ 4 amp \$11.00
36 V.C.T. @ 135 ma \$3.00

WALL TRANSFORMERS

- all plug directly into 120 vac outlet
- 4 VDC @ 70 ma \$2.00
6 VDC @ 500 ma \$3.50
8 VDC @ 750 ma \$4.50
9 VDC @ 500 ma \$5.00
12.5 VDC @ 285 ma \$3.00
18 VDC @ 1.2 VA and 1.8 VA \$4.50
24 VDC @ 250 ma \$3.50
MULTI-VOLTAGE @ 500 ma \$7.00
3.4V, 6.7V, 9 or 12 VDC \$5.00

MINI-BOX

Pomona #2104
\$1.00 EACH

FUSES

3AG (AGC) SIZE
1, 1 1/2, 2, 2 1/2, 3, 4, 5, 6 AMP
GMA SIZE
1, 2, 3, 4, 5 AMP
5 of any ONE amperage 75¢

TI SWITCHING POWER SUPPLY

Compact, well-regulated switching power supply designed to power Texas Instruments computer equipment.
INPUT: 14 - 25 vac @ 1 amp
OUTPUT: + 12 vdc @ 350 ma
+ 5 vdc @ 1.2 amp
- 5 vdc @ 200 ma
\$3.50 each
SIZE 4 1/2" x 4 1/2" x 1 1/4" high

13.8 VDC REGULATED POWER SUPPLY

These are solid state, fully regulated 13.8 vdc power supplies. Both feature 100% solid state construction, fuse protection, and L.E.D. power indicator. U.L. listed.
2 amp constant, 4 amp surge \$20.00 each
3 amp constant, 5 amp surge \$27.50 each

D.C. CONVERTER

Designed to provide a steady - 5 vdc @ 240 ma. from a battery supply of 3.5 to 6.25 volts.
2 1/2" x 1 1/2" x 1 1/4"
\$1.50 each

TWIST-LOCK CONNECTOR

Same as Switchcraft #12CL5M
5 conductor in-line plug and chassis mount jack. Twist-lock style.
\$2.50/SET

ALL ELECTRONICS CORP.
LOS ANGELES, CA STORE
905 S. Vermont Ave.
213 380-8000
VAN NUYS, CA STORE
6228 Sepulveda Blvd
818 997-1806

MAIL ORDERS TO:
P.O. BOX 20406
Los Angeles, CA 90006
TXW - 51010163 ALL ELECTRONIC
EASYLINK MBX - 62887748

TOLL FREE ORDERS ONLY
1-800-826-5432
(ORDER ONLY)
(IN CALIFORNIA: 1-800-258-6666)
ALASKA, HAWAII,
OR INFORMATION
(213) 380-8000 NO C.O.D.I

QUANTITIES LIMITED
MINIMUM ORDER \$10.00
USA: \$3.00 SHIPPING
FOREIGN ORDERS:
INCLUDING SUFFICIENT
SHIPPING
CALIF. RES. ADD 6 1/2%

OMRON #C-5G3-C41
Clockwise action micro
used in coin operated
mechanisms and low torque
operations.
RATED 5 amps @ 125 Vac.
\$1.25 each 10 for \$11.00
LARGE QUANTITIES AVAILABLE

CB MODIFICATIONS

Increase channels, range, privacy! We specialize in frequency expanders, speech processors, FM converters, PLL & slider tricks, how-to books, plans, kits. Expert mail-in repairs & conversions. 16-page catalog \$2. Our 11th year!

**CBC INTERNATIONAL, P.O. BOX 31500RE,
PHOENIX, AZ 85046**

LOW cost modem, easy to build, 300 baud direct connect, simple interface. \$5.00 for plans. **OM-NISTAR DESIGNS**, Box 398, Columbus, NE 68601.

VOICE Scramblers! Telephone bugs! FM bugs! Other kits! Send stamped envelope: **XANDI**, Box 25647, Dept. 60, Tempe, AZ 85282.

ROBOTICS catalog. Specialty parts for hobbyists. \$2.00 (refundable). **ALPHA ROBOTICS INC.**, PO Box 21091, St. Paul, MN 55121.

EPROM Zapper Kit. Serial, parallel, stand alone. For information send to: **EPROM KIT**, 6910 Patter-son, Caledonia, MI 49316.

NEW! FIBER OPTIC voice link. Send your voice over a beam of light via an optical fiber. Complete kit includes microphone, speaker, fiber, PCB's and all parts. Easily assembled. Introductory offer-send \$34.95 to: **FIBER SCIENCES**, Kit-73A, PO Box 5355, Chatsworth, CA 91313-5355. CA residents add 6.5%.

VCR AMPLIFIER, transmits to any TV, FM transmitter, size of postage stamp, up to one mile range. Kits \$24.95 each. Catalog \$1.00, refundable with order. **CAS Electronics**, 1559-J Amar Rd., Suite 457, West Covina, CA 91792.

DIGITAL logic display and frequency meter kit \$30. **Vogel Enterprises**, 2020 Diamond St., #2, San Diego, CA 92109.

NEW NEW

50 dB Signal Rejection Filter

For elimination of objectionable or troublesome TV signals

MODEL 26 - Tunable from channels 2 through 6 (54-88 MHz)
MODEL 1422 - Tunable from channels 14(a) through 22(i) (120-174 MHz)
For one unit send \$30 (Refundable) HUGE discounts on quantity purchases.
STAR CIRCUITS - P.O. Box 8332 - Hollywood, Florida - 33084

KITS! Sound effects generator, eprom programmer, function generator and more. Semi-assembled and tested. Write for literature. **SERENA INDUSTRIES**, 1180-A Aster Ave., Sunnyvale, CA 94086.

BUILD CB base antenna cheap. Send \$3.00 for plans to: **RML VENDING**, 1911 West 13th Street, Grand Island, NE 68803.

PC/XT compatible three boards set, motherboard, graphic, and disc card. \$225.00 less IC version, \$115.00. Brochure available. **AMT TECHNOLOGY**, 1020 Bay Area Blvd., Suite 210, Houston, TX 77058 (713) 480-9506.

STEREO TV adapter kit easily converts any TV VCR to receive the new stereo TV sound. Contains all parts PCB and instructions to build a quality stereo decoder. For additional information send SASE to **SOKOLOWSKI**, Box 150, Elmont, NY 11003.

PRINTED CIRCUIT BOARDS

PCB 15 cents sq-in. free drilling. Quantity discounts. Professional work. **INTERNATIONAL ENTERPRISE**, 6452 Hazelcicle, Simivalley, CA 93063.

WANTED

INVENTORS! AIM wants—ideas, inventions, new products, improvements on existing products. We present ideas to manufacturers. Confidentiality guaranteed. Call toll free 1-800-225-5800 for information kit.

INVENTIONS, ideas, new products wanted! Industry presentation/national exposition. Call free 1-800-528-6050. Canada, 1-800-528-6050. X831.

CABLE-TV

DEALERS wanted: Channel 2,3, and 4 notch filters. Money back guarantee. Send \$15.00 for sample and quantity price list. Specify channel(s). **GARY KURTZ**, Box 291394, Davie, FL 33329.

REEL-TO-REEL TAPES

AMPEX professional series open reel tape. 1800-or 2400-feet on 7-inch reels. Used once. Case of 40. \$45.00. 10 1/2 x 3600 feet and cassettes available. MasterCard Visa. **VALTECH ELECTRONICS**, Box 6-RE, Richboro, PA 18954. (215) 322-4866.

DO IT YOURSELF TV REPAIR

NEW...REPAIR ANY TV...EASY Anyone can do it. Write, **RESEARCH**, R13 Box 601BR Colville, WA 99114.

INVENTORS

INVENTORS! Can you patent and profit from your idea? Call **AMERICAN INVENTORS CORPORATION** for free information. Over a decade of service. 1-800-338-5656. In Massachusetts or Canada call (413) 568-3753.

PRINTED CIRCUIT BOARDS

GUARANTEED lowest quotes, average \$.12/inch (FR-4), fast turnaround, prototype through production quantities. Send specifications, call for quotes. **-T.O.R.C.C.C. ELECTRONICS**, Box 47148, Chicago, IL 60647, (312) 342-9171.

EPROM PROGRAMMING

HOBBYISTS: Pretested EPROMs sold with your programming installed. Program listing provided. Fast Service. Write or call: **ROMULUS MICROCONTROL**, Box 8669, Rockville, MD 20856; (301) 540-8863.

cable tv

DESCRAMBLER PARTS!

We stock the exact parts, PC board and AC adaptor for Radio Electronics February 1984 article on building your own Cable TV Descrambler.

- #701 **PARTS PACKAGE** \$29.95
Includes all the original resistors, capacitors, diodes, transistors, integrated circuits, coils, IF transformers (toko BKAN-K5552AXX).
- #702 **PC BOARD** \$12.95
Original etched & drilled silk-screened PC board used in the article.
- #704 **AC ADAPTOR** \$12.95
Original (14 volts DC @ 285ma) ac adaptor used in the article.

SPECIALS

- BOTH #701 & #702 NOW \$39
- ALL THREE #701, #702 & #704 NOW \$49

Add \$2.50 shipping and handling — \$4.50 for Canadian orders
We also offer quantity Discounts on 5 or more units

FREE Reprint of Radio Electronics article (February 1984) on Building Your Own CABLE TV DESCRAMBLER with any purchase of above.

**60-CHANNEL
CABLE
CONVERTER**
WITH INFRARED REMOTE CONTROL



SC-60R CONVERTER \$69.95

Thousands of these converters sold nationally for \$119.95. We offer you this same type of converter for only \$69.95. All converters are NEW with Full manufacturer's WARRANTY.

- FEATURES**
- Full 60 Channel Capability
 - Cordless Infrared remote control
 - Ultra Stable Synthesized tuning
 - Microprocessor controlled PLL
 - Works on all TV models, channel 3 output
 - Standard HRC Switch for compatibility with all Cable Systems
 - Will work with all types of external descramblers.

Add \$3.50 Shipping and Handling
\$4.50 on Canadian Orders

**ORDER
TOLL FREE
1-800-227-8529**



inside MA 617-339-5372
VISA, MASTERCARD or C.O.D.



**J & W
ELECTRONICS, INC.**

P.O. BOX 800-D • MANSFIELD, MA 02048

CIRCLE 65 ON FREE INFORMATION CARD

SATELLITE TV

CABLE TV SECRETS—the outlaw publication the cable companies tried to ban. HBO, Movie Channel, Showtime, descramblers, converters, etc. Suppliers list included. \$8.95. **CABLE FACTS**, Box 711-R, Pataskala, OH 43062.

CABLE T.V. Source Book—a complete listing of suppliers for hard-to-find converters, descramblers, technical information, schematics and much more. Full refund if not satisfied. Send \$4.95 to **CABLE** Box 12505-R, Columbus, OH 43212.

SATELLITE Descrambler Schematics: Oak Orion PD-400C \$20.00; VideoCipherII \$20.00 VideoCipherII Patent \$15.00; actual VideoCipherII descrambler \$550.00; actual Oak Sigma descrambler \$350.00; Catalog \$5.00; send money order to **ELECTRONIC PRESS**, PO Box 10009, Colorado Springs, CO 80932.

CLOSED circuit feeds. You can watch your favorite TV shows days in advance when you know where to look. Send \$5.00 to **DOWNLINK**, 9420 Reseda Blvd., #473R, Northridge, CA 91324.

WHOLESALE prices top brands only! Decoder information. Systems from \$895.00 send \$9.95 for complete satellite TV information and product catalog. **SKYVISION**, Yartic Flats, Yantic, CT 06389.

BUILD your own satellite system and save! Instructions, schematics, parts! Send stamped envelope: **XANDI**, Box 25647, Dept. 21C, Tempe, AZ 85282.

MANUFACTURER direct! Best prices, LNAs, LNBs, receivers, kits, accessories special! Receiver kit \$69.95 plus \$4.20 shipping. Catalogue \$1.00. **RAMSEY ELECTRONICS**, 2575 Baird Rd., Penfield, NY 14526, (716) 586-3950.

PATENTED optical process satellite sound system. For information send \$3.00 to: **BEDINI ELECTRONICS**, PO Box 769, San Fernando, CA 91341.

59 degree brand name LNAs! LNBs! Ku-Band LNBs! Discount pricing! Send stamped envelope: **LNA**, 201 E Southern, Suite 100C, Tempe, AZ 85282.

SATELLITE systems \$449.00, catalog \$5.00. HBO descramblers. KU equipment **STARLINK, INC.**, 2603-16R Arrie, Huntsville, AL 35805.

"TRIPLE-X Satellite TV descrambler information. XXX - Adult Movies, ready to go - \$225.00. **NAS-SAT**, Box 5261, Long Beach, CA 90805 (213) 631-3552.

EDUCATION & INSTRUCTION

F.C.C. Commercial General Radiotelephone License. Electronics home study. Fast, inexpensive! "Free" details. **COMMAND**, D-176, Box 2223, San Francisco, CA 94126.

COMPUTER repair career training in 5 months by accredited Florida Electronics School. Lifetime placement. Financial assistance if qualified. Call **SYSTEMS TECHNOLOGY INSTITUTE** (305) 331-2840.

CRASH COURSES in digital and microcomputer fundamentals. Ideal introduction or refresher. Interactive programmed instruction with self quizzes. Everything you need for personal learning. Digital: \$19.95. Microcomputer: \$21.95. Both \$39.95. Add \$2.50 postage. **TSI**, 11915 Latigo Lane, Oakton, VA 22124.

HOBBYIST—need help? We will design, build your project, repair your kit. Unique parts found and supplied. Send your problem with **SAS** - to 3-G Engineering, PO Box 97, Littleton, MA 01460.

ATTENTION video camera owners! Learn how to do special effects w/o expensive add-ons, and earn \$\$\$ too! **FREE** info: **ORP VIDEO**, Box 2321-R, St. Louis, MO 63114-3914.

FREE EVALUATION and ADVISORY SERVICE

For professional electronic technicians by prestigious non-profit organization. Earn University Degree (Bachelors or Masters) through Home Study! Credit given for previous schooling and professional experience. Upgrade your earning power. Free Details!
CONTINENTAL EDUCATION ASSOCIATES
P.O. Box 1197 - Champlain, NY 12919-1197

BLACK BOX DE-SI-FURING THE SOLUTION TO SATELLITE SCRAMBLING VOL. II

AMERICAN AND CANADIAN

Latest Satellite Technology available. Over 100 pages of how to build. Comes with complete schematics. Parts lists and suppliers of parts & kits.



\$29.95

BLACK BOX DE-SI-FURING THE SOLUTION TO SATELLITE SCRAMBLING

CONTENTS OF MANUAL

- 4 different types of satellite scrambling
- Modes of operation
- How to build a De-Si-Fur
- Digital audio & CRT controllers
- Digital audio processors
- Schematic dia

To order Vol. II send postal money order only for \$29.95 plus \$3.00 shipping & handling. **CALL ORDER LINE (401) 333-8775. BELLRAE DIST. CO., P.O. Box 41, Warren, RI 02885.**

ELECTRONICS SUPPLIES

RESISTORS, any value (minimum 20 Ω value), 1/4 watt @ \$0.1, 1/2 watt @ \$0.2. **CAPACITORS** - 50V ceramic disk, all values @ \$0.2. **P.C.B. kits** Basic kit @ \$4.00 (materials for 2 - 3"x4" boards-included) or **SASE** for catalogs. \$1.50 shipping: all orders—**T.O.R.C.C.C.**, Box 47148, Chicago, IL 60647. (312) 342-9171.

RADAR SIGNAL DETECTOR

continued from page 52

power, background noise should be heard. You may want to vary the value of R1 slightly to get a pleasant ringing frequency. Then adjust the threshold control (R5 in Fig. 1; R2 in Fig. 2) so that received signals are just above the 1/f noise background.

You can test the detector on the work-

PARTS LIST—ECONOMY MODEL

- All resistors 1/4-watt, 5%.**
R1—1.1 megohm
R2—27,000 ohms
R3, R4—100,000 ohms
R5—100,000 ohms, panel-mount potentiometer

Capacitors

- C1—0.22 μ F
C2—0.0 μ F
C3—100 μ F 16 volts, electrolytic

Semiconductors

- IC1—1458 dual op-amp

Other components

- S1—SPST switch
Piezo-electric transducer

PARTS LIST—DELUXE MODEL

- All resistors 1/4-watt, 5%.**
R1—2.2 megohms
R2—10,000 ohms, trimmer potentiometer
R3—4700 ohms
R4, R6, R7—100,000 ohms
R5—25,000 ohms, panel-mount potentiometer

Capacitors

- C1—0.22 μ F
C2, C5—0.05 μ F
C3—220 μ F, 10 volts, electrolytic
C4—10 μ F, 6 volts, electrolytic

Semiconductors

- IC1—1458 dual op-amp
IC2—LM386 audio power amplifier

Other components

- S1—SPST switch
SPKR—8—100 ohm miniature speaker

AMAZING DEVICES

PERSONAL DEFENSE AND PROPERTY PROTECTION UTILIZE SPACE AGE TECHNOLOGY.

CAUTION: THESE DEVICES CAN BE HAZARDOUS AND MAY SOON BE ILLEGAL

PHASORS **POCKET PAIN FIELD GENERATOR — IPG50**

Assembled \$64.50

IPG5 Plans \$8.00 **IPG5K** Kit/Plans \$44.50

PHASOR PAIN FIELD CROWD CONTROLLER — PPF10

Assembled \$250.00

PPF1 Plans \$15.00 **PPF1K** Kit/Plans \$175.00

BLASTER - Provides a plasma discharge capable of puncturing a can. Produces a 100,000 WATT PULSE

BLS1C ASSEMBLED \$89.50

BLS1 PLANS \$10.00 **BLS1K** KIT/PLANS \$69.50

PLASMA STUN GUN - Very intimidating and affective 5 to 10 feet 104,000 VOLTS

ITM10 ASSEMBLED \$99.50

ITM1 PLANS \$10.00 **ITM1K** KIT/PLANS \$69.50

RUBY LASER RAY GUN - Intense visible red beam burns and welds hardest of metals. **MAY BE HAZARDOUS.**

LASERS **RUB3All Parts Available for Completing Device \$20.00**

CARBON DIOXIDE BURNING, CUTTING LASER - Produces continuous beam of high energy. **MAY BE HAZARDOUS.**

LC5 All Parts Available for Completing Device \$20.00

VISIBLE LASER LIGHT GUN - produces intense red beam for sighting, spotting, etc. Hand held complete.

LGU3 Pulsed \$10.00 (Kit & Assembled Units Available)

IR PULSED LASER RIFLE - Produces 15-30 watt infra-red pulses at 200-2000 per sec.

LRG3 All Parts & Diodes Available \$10.00

BEGINNERS LOW POWER VISIBLE LASER - Choice of red, yellow, green - provides an excellent source of monochromatic light.

LHC2 Plans \$5.00 **LHC2K** Kit \$34.50

SECURITY **SNOOPERPHONE** - Allows user to call his premises and listen in without phone ever ringing.

SNP20 Assembled \$89.50

SNP2 Plans \$9.00 **SNP2K** Plans/Kit \$59.50

LONG RANGE WIRELESS MIKE - Miniature device clearly transmits well over one mile. Super sensitive, powerful.

MFT1 Plans \$7.00 **MFT1K** Plans/Kit \$49.50

WIRELESS TELEPHONE TRANSMITTER - Transmits both sides of phone conversation over one mile, shuts off automatically.

VWPM5 Plans \$8.00 **VWPM5K** Plans/Kit \$39.50

PWMS—LONG RANGE SUPER EAR WITH WIRELESS ATTACHMENT

PWMS5 Plans \$10.00 **PWMS5K** Kit \$139.50

PWMS0 Assembled and Tested \$169.50

Our phone is open for orders anytime. Technicians are available 9-11 a.m. Mon-Thurs for those needing assistance or information. Send \$1.00 for catalog of hundreds more similar devices. Send check, cash. **MO. Visa MC. COD to INFORMATION UNLIMITED**

DEPT. RB P.O. Box 716 Amherst N.H. 03031 Tel. 603-673-4730

CIRCLE 72 ON FREE INFORMATION CARD

bench by generating a millimeter-wave microwave signal. You don't need a fancy signal generator—just "arc" a small inductor (say 500 mH) across a nine-volt battery. A properly-functioning detector should ring loudly when a signal is generated in that manner fifty feet from the detector. You may want to experiment with different inductors at different distances from the detector.

Conclusions

Both circuits pick up low-level pulsed-RF signals. The detector responds to very short pulses and will continue to ring for several milliseconds. But the circuit will respond only to the beginning and the end of a CW (continuous-wave) signal. Using either circuit, you'll soon be able to recognize various signal sources by their "signatures." Microwave towers, for example, provide lots of varied output.

Either circuit could be used for purposes other than radar detection. For example, you could use one to detect a hidden radio transmitter (provided the transmitter is a pulsed type). The detector could be used as a leakage detector at a microwave tower. The detector could also be used to detect leakage or arcing in home power lines, as well as outdoor power-transmission lines. In fact, the uses to which this circuit may be put are limited only by your imagination!

R-E

Why Pay Big Blue Prices?

Build your own IBM® PC/XT compatible & SAVE !!!

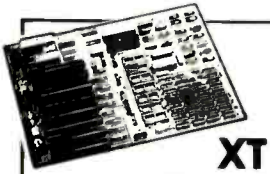

XT Compatible Motherboard

- IBM® microprocessor 8088 CPU @ 4.77 MHz
- Optional BIOS 1.33 for co-processor
- Expandable to 840 K
- 8 Channel Interrupt 8259
- 8 expansion slots
- Same power connector as physical dimensions as IBM PC/XT with Super AT
- Only 54 watt power consumption

\$149
Cat X-1001

\$39.95
Cat X-1000

\$899
Cat X-1003

Multi-function Card

- Fully socketed memory with parity checked expansion to 384 K
- IBM Parallel Printer Port
- IBM RS 232C Serial Interface Port
- One Real Time Clock Calendar with Battery Backup

\$119.95
Cat X-1005

Color Graphics Adapter Card

- For use with Color TV frequencies up to 336 MHz
- Composite Signal Monitor on-line TV uses
- Supports color and B/W modes
- 40 80 columns x 25 rows
- Graphics mode
- 320 x 200 medium res color
- 640 x 200 high res black & white

\$89.95
Cat X-1007

Floppy Disk Drive Adapter

- Drives 2 internal 5 1/4" half height, dd mini floppy drives
- Supports 2 internal floppy disk drives through a 3 1/2" B connector (optional)
- Double density mini floppy
- Write-protect compensation with check for loop data repetition

\$44.95
Cat X-1009

Monochrome Graphics Printer Card

- Text mode
- 80 column x 25 rows
- Graphic mode
- 720 x 348 pixels
- Parallel printer port
- RS 232C Serial port (optional)
- Fully compatible with IBM monochrome display printer and Hercules graphics card

\$119.95
Cat X-1012

512K RAM Card

- RAM expansion sockets from 8 K to maximum 512 K bytes increment
- Memory device
- 64K DRAM
- 16K RAM
- Switch setting hardware page number 64K Bytes

\$37.95
Cat X-1014

Multi I/O Card

- One RS232C Serial Port
- Secondary serial port (optional)
- One Centronics parallel port
- Real Time Clock Calendar with battery
- Lithium Battery backup
- Game Adapter port to connect with IBM compatible games
- 5 1/4" Diskette drive adapter (Supports two drives)

\$129.95
Cat X-1016

Winchester Disk Controller Card

- Controls 2 hard disk drives via ST-506, ST-412, disk interface 2 floppy's via SA 505
- Microprocessor based architecture with DMA transfer capability
- On board BIOS ROM in dual in-line
- Automatic format during disk access
- Split mode allows one physical drive to be split into two logical drives

\$174.95
Cat X-1018

SPECIAL DICK SMITH PACKAGE PRICE!

XT Motherboard	X-1001	\$149.00
BIOS For Motherboard	X-1000	\$39.95
64K Ram	X-1187	\$14.95
Monochrome Graphics Card	X-1012	\$119.95
Floppy Disk Controller	X-1009	\$44.95
130 Watt Power Supply	X-1110	\$89.95
IBM Style Case	X-1120	\$49.95
75 Height Disk Drive	X-7506	\$99.95
IBM compatible Mono Monitor	X-1132	\$99.95
84 Keyboard	X-1122	\$79.95
		\$786.55

only **\$659**
Save \$129.55 on Individual Prices

Every computer product carries our 14-day satisfaction guarantee AND 12-month warranty



IBM PC/XT Compatible Case

- Attractive off-white heavy duty steel case with lid
- 80 Watt Power supplied for 8 hard disk expansion & for mounting power supply
- Weight approximately 17 pounds

\$49.95
Cat X-1120

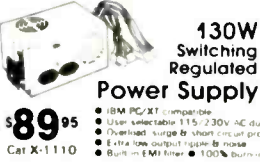

130W Switching Regulated Power Supply

- IBM PC/XT compatible
- User selectable 115-230V AC dual input
- Overload, surge & short circuit protection
- 40 Watt low output ripple & noise
- Built in EM Interlock 100% Burnin

\$89.95
Cat X-1110



12" Monochrome Monitors

- IBM compatible
 - Separated signal
 - Super D type input
 - 1000 lines resolution at center screen
 - 25 MHz x 30 MHz
 - Video amp response
- Apple Compatible
 - Composite Video
 - RCA Jack input
 - 1000 lines resolution at center screen
 - 20MHz x 30MHz
 - Video amp response

\$99.95
EACH
Cat X-1132

Disk Storage Files

- Protect those valuable disks from loss or damage!
- For 36 3 1/2" Disks (Cat # 7508) \$9.95
- For 75 5 1/4" Disks (Cat # 3509) \$8.95

High Quality Printed Circuit Boards

- Manufactured for the IBM AT Solder masked screen legend tells you where to solder each component. Comes with gold-plated edge card fingers
- Cat # 0010 8088 Motherboard for IBM AT \$29.95
- Cat # 0012 Color graphic card 80 col x 25 rows \$19.95
- Cat # 0014 Hercules monochrome graphics printer card \$29.95
- Cat # 0020 5 1/4" Ram card \$24.95
- Cat # 0026 Multi I/O Controller card \$14.95



Joystick for IBM & Apple

- Quality joystick with Apple IIe plug and two additional cables for IBM PC IIe (supplies 115 volt)
- Adjustments left & right, top and bottom buttons and auto fire button at top of the handle
- Four pairs of buttons on accommodate left and right hand players

\$19.95
Cat X-1135



Tilt & Swivel Power Command Center

- Power Control via lighted push button switches
- EM Interlocking
- Surge and spike protection
- Tilt 12.5 degrees
- Switches 360 degrees
- Minimums light improves sight angle
- Convenient front and rear markers

\$39.95
Cat X-1128

Tilt & Swivel Monitor Stand

- Now you can have your monitor facing wherever. This universal stand will suit most monitors and fits to a maximum angle of 1.2 degrees and rotates in a full 360 degree for minimal operator fatigue.

\$12.95
Cat X-1126



Desk Copy Holder

- Make computing less of a strain. This high quality metal copy holder is specially designed with adjustable, wide-angle desk clamp, large paper clip magnet and velvet arm.

\$19.95
Cat X-3503



FUJI Quality Diskettes

- 5 1/4" 5.25 DD Soft Sector 48 TP/ 80 Bytes (Cat X-3511) \$19.95
- 5 1/4" 5.25 DD Soft Sector 48 TP/ Box of 10 (Cat X-3513) \$19.95
- 3 1/2" 5.25 DD Double Track 5000K Bytes Box of 10 (Cat X-3515) \$26.95



Microcasette Cassettes

Master computer cassette tapes 5 min. with 1000 or 4000 bytes. (Cat X-3502) **95¢**



Printer Cables

- IBM Parallel Cable for IBM, Apple II, etc. F or EMI shielding
- 6 foot (Cat X-3590) \$9.95
- 10 foot (Cat X-3591) \$14.95
- IBM Serial Cable
- 25 pin male-male (Cat X-3592) \$9.95
- 25 pin male-female (Cat X-3593) \$9.95
- Apple MAC Serial Cable
- 6 foot (Cat X-3594) \$9.95
- Parallel Printer Interface Cable
- 6 foot (Cat X-3595) \$9.95
- Multi-Link Programmable Cable
- Switch selectable interface cable covers 95% of RS 232 applications.
- 12 foot (Cat X-3596) \$19.95



Keyboards

- 84-Key
 - Ergonomic design, adjustable height & tactile feel
 - Keyboard angle adjusts from 7.15 degrees
 - Mechanical key switch with strike rate 20 million (uses BQ&S)
 - LED indicator shows lock key status
 - Fully guaranteed
 - 12 month warranty
- 100-Key Enhanced
 - Similar to the 84-key model above but enhanced like the KEYTRONICS 515111 model keys include separate cursor 7 numeric key pad. Features LED indicators for power, cap lock & number lock.

\$79.95
Cat X-1122

\$99.95
Cat X-1124



Double Your Disk Capacity! Disk Notcher

- For Apple compatible systems
- Will Change a 5.25" Disk to a DS Disk

\$7.95
Cat X-3504

DICK SMITH ELECTRONICS has been selling computers since 1977. Our experience & buying power assures you the best values. Watch our ads for more great computer accessories!

Excellent REFERENCE Books

Interfacing to the IBM PC (B-8600)	\$16.95
IBM PC XT Technical Service Data (B-8601)	\$39.95
IBM PC Troubleshooting & Repair (B-8605)	\$19.95
Apple II/III Technical Service Data (B-7515)	\$19.95
Apple IIe Technical Service Data (B-7516)	\$19.95
Apple IIc Technical Service Data (B-7501)	\$22.95
Apple II Technical Service Data (B-7502)	\$22.95
Apple Programming Handbook (B-7503)	\$19.95
MAC Programming Assembly Language (B-7504)	\$16.95
Apple II/III Troubleshooting & Repair (B-8000)	\$14.95
Apple II/III Troubleshooting & Repair (B-2364)	\$19.95
Printer Connections Bible (B-2374)	\$14.95
Introduction to Turbo Pascal From Chips to Systems (B-2375)	\$19.95
Microprocessor Interfacing Techniques (B-2375)	\$19.95

DISK DRIVES

High Quality half-height drives for IBM compatibles & Apples

	X 7506	X 7507	X 7509
COMPATIBILITY	IBM PC, XT & compatibles	Apple IIc	Apple IIe
STORAGE CAPACITY	Double-sided Double-density 500 K Bytes Part Tracks 327.68 K Bytes 4096 Bytes	Single-sided Double-density 125 K Bytes 3.125 K Bytes	Single-sided Double-density 125 K Bytes 3.125 K Bytes
● Unformatted Per Media Per Tracks	5878 BPI	2,768 BPI	2,768 BPI
● Rate of Data Transfer	250 K BPS	125 K BPS	125 K BPS
● Recording Density			
● Access TIME	1 sec	1 sec	1 sec
● Search Time to Ready Time			
● Single Track Seek Time	6 msec/Track	6 msec/Track	6 msec/Track
● Average Access Time	100 msec	100 msec	100 msec
● Settling Time	70 msec	70 msec	70 msec
● Average latency	100 msec	100 msec	100 msec
● ROTATIONAL SPEED	300 rpm	300 rpm	300 rpm
● TRACK DENSITY	48 TPI	48 TPI	48 TPI
● NUMBER OF TRACKS	80	40	40
● NUMBER OF CYLINDERS	80	40	40
● NUMBER OF HEADS	2	1	1

\$99.95
EACH
Cat X-7510

10 Mega-Byte Hard Disk Drive

- 5 1/4" half height Winchester disk drive
- Low 12 watts of power consumption
- Size of the air-tighter motor design
- Access time 85 msec
- Enhanced shock resistance for portable computer applications
- On board microprocessor controlled operations
- Swing arm designed to assure integrity of transcriptions

\$389
Cat X-7510



CHALLENGER \$189

- Low Speed (10-300 bits) Frequency shift keying
- High Speed (1200 bits) Phase Shift Keying
- Auto-sense Auto-dial
- Bell System 103 212A compatible
- 8 external Status Indicators

DISCOVERY \$399

- CS/IT V.22 bis, V32
- 0-300, 600, 1200, 2400 bps
- Bell 103, 212A, Bell MultiRate Duplex
- Auto-sense Auto-dial
- RS232C Interface
- Voice Data Switching
- Receive Sensitivity 45 dbm
- Status Indicator
- Industry Standard AT Command Set
- On Card fits inside computer

MODEMS

VOYAGER 1200 B

\$169
Cat X-1100

- Auto-sense Auto-dial
- Bell 103/212A compatible
- Hayes compatible
- 0-300 1200 bps
- Receive sensitivity -45 dbm
- RS232C Port Mode Switch Selectable
- On Card fits inside computer

Apple, Apple II, III, etc. are registered trademarks of Apple Computer, Inc. IBM PC, XT, PC, AT are registered trademarks of International Business Machines Corporation. A trademark of Hercules Computer Technology. Mastercard is a registered trademark of Electronic Australia.

A new head cleaning system that's 3 times more effective than conventional products. Try it once and you'll never go back to what you were using. **\$13.95** Cat X-3517

Replacement Drays **\$6.95** Cat X-3518

RADIO ELECTRONICS Reader's Special

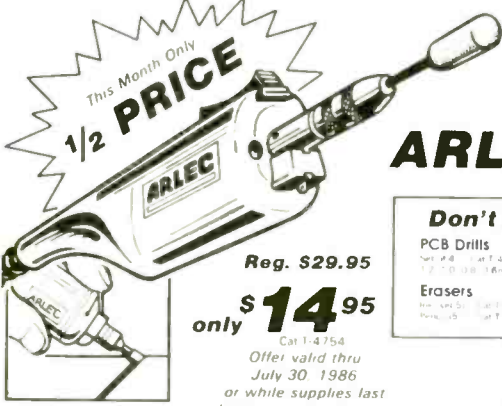

It sands, drills, polishes, cuts, mills, erases & engraves virtually everything but brushes your teeth! The fantastic 10,000 RPM supertool power head tackles any task with its various attachments. Package includes supertool, AC adapter, 2 milling cutters, wire brush grinding wheel, 4 high speed steel drills, 5 chuck collets, erasers & instructions.

ARLEC SUPERTOOL

Don't forget these Super Accessories!

PCB Drills Set #48 Cat T-4756 \$2.95 T-70 1/8" 3/64" 1/32"	Cutting Discs Set #46 Cat T-4766 \$3.95	Engraving/ Milling Bits Set #1 Cat T-4764 \$2.95
Erasers Set #45 Cat T-4748 \$2.95 Set #45 Cat T-4749 \$2.95	Wire Brushes Set #47 Cat T-4768 \$5.95	Diamond Cutter Set #1 Cat T-4768 \$3.50
Grinding Bits Set #3 Cat T-4768 \$4.50		

Reg. \$29.95
\$14.95
only
Cat T-4754
Offer valid thru
July 30, 1986
or while supplies last
Limit two per customer



DICK SMITH SOLDERING IRONS

EXCLUSIVE
1000's SOLD

Cordless 10-60 Watt Iron

\$44.95
Cat T-1600

One of the best in the world! Adjustable heat & wattage, safe fast-heating, large capacity, owner maintainable, overnight recharging with adapter. Reaches 200° within 6 seconds.

Economy Tip/Element (5 pack)	Cat T-1601 \$4.95
Cigarette Lighter Charger (12 volt)	Cat T-1603 \$10.95
AC Adaptor Charger (117 Volt)	Cat M-9505 \$8.95



Standard Tip T-1601 \$95¢
Fine Tip T-1602 \$10.95
Larger Element T-1603 \$10.95

\$29.95
Cat T-1650

12V
30-180 W
Heavy Duty
2 multi-purpose heat with adjustable wattage for temperature. Flat heating, heavy duty heat & clamps for 12V battery.

DICK SMITH ELECTRONICS FIRST CLASS PRODUCTS & SERVICE

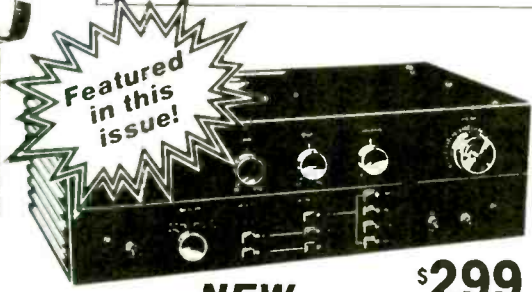

NEW from Playmaster® \$299
Cat K-3516

Build Your Own 200W Mosfet Stereo Amp!

We think this is the best build-it-yourself design available! Feature for feature, dollar for dollar, the Playmaster blows the big names (with the big prices) away. Electronic input circuitry handles moving magnet, moving coil, CD, Hi-Fi, VCR, cassette, tuner & more. Soft touch controls, die-thump, & toroidal transformers are only a few of its many features, and the step-by-step instruction manual makes it easy to build! Sorry Dick, it doesn't work - repair coupon included, but if after examination you determine the kit is beyond your skill level, simply return it intact for a full refund!

- 100W RMS/channel into 8 ohms
- Music 100dB dynamic full output
- Low Harmonic Dist. 20KHz (30dB), 20W; 65KHz (1.5dB)
- Unconditional stability into any load
- Distortion < 0.01% (1000 0 003)
- 70 Hz - 20KHz
- Sensitivity MM 2mv (80dB), m MC 200uv (75dB)
- 1000mv (90dB) CD 2V (94dB)

DSE Soldering Station

\$49.95
Cat T-2100

Continuously adjuster up to 500°C cool handle drives CB T heating, zero voltage work, may use standard soldering, stainless steel, heated by top heater, dual, ground terminal, auto, pay, mark?



20 MHz Dual Trace Oscilloscope

\$329
Cat Q-1240

A feature: LCD read-out, high brightness CRT, 1000000 counts per second, circuit wide bandwidth, high speed, 1000000 counts per second, low power consumption, regulated power supply and much more - a new low price!

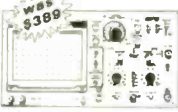

Telephone Encoder/Decoder "The Scrambler™"

\$299.95
Cat F-1009

The most compact fully self contained voice device in the world! Works on all standard communications systems that use a phone, handheld, tone or pulse cord or modem. 2 only are required to share a system.



\$199
Cat K-6315

Teletext is information by graphics transmitted as digital data between video frames. Get the latest weather, scores, stock prices & more at the touch of a button! An you need a decoder and yours is a superb performer, priced to beat the competition to shatter! Easy to build & requiring very little adjustment in features. ● Pre-adjusted/pre-assembled decoder module ● TV Teletext & TV/Teletext modes ● NewsFlash ● No user tests ● 21 button wired remote

Teletext Decoder Kit



Intro-Red Remote Control Kit

Go wireless! This sleek remote is designed just for K-6315. Requires only a handful of parts easy to build! At this price, it's not an option, it's a necessity!

\$34.95
Cat K-3425

Variable Power Supply Kit



\$39.95
Cat K-3475

This outstanding kit provides voltages from 1.3 to 30 volts, full protection, variable current limiting from 0 to 1 amp, even LED to indicate current limit mode! Plus metering of both voltage and current output.

You receive a complete kit of parts including US 117V AC transformer designed for USA plus metal case and all hardware right down to the last nut & bolt. A specially prepared & screened front panel is included for ease of operation plus instructions on your project that professional finish. (Build-it-yourself available at time of going to press.) Dick Smith Electronics price only \$39.95 for a power supply kit worth much more.

Satellite Receiver Kit

\$99
Cat R-6316

Compatible to the sat-rn & both with comprehensive instruction that makes this kit easy to build & tune. Features Siemens bandpass filter for greater selectivity & stability. Sorry Dick coupon. Requires 18V AC Power Supply (M-9558 \$7.95)



Microwave TV Receiver

\$99.95
Cat D-6380

For amateurs and enthusiasts! Receive frequencies from 1.9-2.7 GHz. WARNING: Sale of this product limited to lawful purposes reception of free transmissions only!



Radio Direction Finder Kit

\$99
Cat R-6345

● 12V ● 50,500 MHz range ● 170° calibration ● internal alignment reference ● Adjustable internal monitor speaker ● 5 stable digital circuitry ● Self-aligning commutating filters



Function Generator Kit

\$69.95
Cat K-3520

Produces sine, triangle & square waves from below 20 Hz to 170kHz! (with a wide range of output levels, top). No room to list all the specs & features here, but this kit is an incredible value!



Orders only - Call Toll Free:
Now open in L.A.!

STORES:
BERKELEY: 2474 Shattuck Ave (415)486-0755
REDWOOD CITY: 390 Conventon Way (415)368-8844
SAN JOSE: 4980 Stevens Creek Blvd. (408)241-2266
LOS ANGELES: 1830 Westwood Blvd. (213)474-0626
HEAD OFFICE: 390 Conventon Way, Redwood City, CA 94063

1-800-332-5373
Monday - Friday 7am -6pm Pacific Time
In California call 1-415-368-1066

MAIL ORDERS

P.O. Box 8024 Redwood City CA 94063
14 DAY MONEY-BACK GUARANTEE

SHIPPING & HANDLING INFORMATION

We ship UPS ground unless otherwise requested. Add 5% of order total (\$1.50 minimum) for shipping (outside USA, add 20% - \$4.00 minimum)

There is an additional \$1.50 handling fee. California residents please add sales tax.

It's Here!
The New 1986/7 DSE
CATALOG
148 Colorful Pages Packed
with Hundreds of New Products
including our exclusive 16-page data section!

YES! I MUST have a new copy of the 1986/7 DICK SMITH ELECTRONICS Catalog Enclosed is \$1 for postage & handling - send it today!

DICK SMITH ELECTRONICS
EVERYTHING FOR THE ELECTRONICS ENTHUSIAST

CIRCLE 95 ON FREE INFORMATION CARD

NAME _____ ADDRESS _____ CITY _____ STATE _____ ZIP _____ 874

Mail-Order Electronics

415-592-8097

7400			
Part No.	Price	Part No.	Price
SN7400N	19	SN7485N	55
SN7402N	19	SN7486N	35
SN7404N	25	SN7489N	1.95
SN7405N	29	SN7490N	39
SN7406N	29	SN7493N	35
SN7407N	29	SN74121N	29
SN7408N	25	SN74123N	49
SN7410N	19	SN74125N	45
SN7414N	45	SN74126N	49
SN7416N	35	SN74143N	3.95
SN7417N	35	SN74150N	1.29
SN7420N	19	SN74154N	1.25
SN7430N	19	SN74158N	1.39
SN7432N	29	SN74173N	75
SN7438N	29	SN74174N	5.9
SN7442N	45	SN74175N	59
SN7445N	69	SN74176N	89
SN7446N	79	SN74181N	1.95
SN7447N	79	SN74189N	1.95
SN7448N	79	SN74193N	69
SN7472N	39	SN74198N	1.35
SN7473N	35	SN74221N	1.95
SN7474N	39	SN74273N	1.95
SN7475N	39	SN74365N	59
SN7476N	35	SN74367N	5.9

74LS			
74LS00	19	74LS165	79
74LS02	19	74LS166	89
74LS04	25	74LS173	49
74LS05	25	74LS174	39
74LS06	95	74LS175	39
74LS07	99	74LS189	3.95
74LS08	19	74LS191	49
74LS10	19	74LS193	69
74LS14	39	74LS221	59
74LS27	25	74LS240	69
74LS30	39	74LS273N	69
74LS32	25	74LS244	69
74LS42	39	74LS245	7.9
74LS47	89	74LS259	1.19
74LS73	35	74LS273	79
74LS74	35	74LS279	79
74LS75	29	74LS279	2.95
74LS76	29	74LS365	39
74LS85	49	74LS366	39
74LS86	25	74LS367	39
74LS90	39	74LS368	39
74LS93	39	74LS373	79
74LS123	49	74LS374	79
74LS125	39	74LS393	79
74LS138	39	74LS590	5.95
74LS139	39	74LS624	1.95
74LS154	1.49	74LS629	2.49
74LS157	35	74LS640	99
74LS158	35	74LS645	99
74LS163	49	74LS670	99
74LS164	49	74LS688	1.95

74S/PROMS*			
74S00	29	74S188*	1.75
74S04	35	74S189	1.95
74S08	35	74S196	1.49
74S10	29	74S240	1.49
74S32	35	74S244	1.49
74S74	49	74S253	79
74S85	1.49	74S287*	1.69
74S86	35	74S288*	1.69
74S124	2.75	74S373	1.69
74S174	79	74S374	1.69
74S175	79	74S472*	3.49

74ALS			
74ALS00	35	74ALS138	89
74ALS02	35	74ALS174	89
74ALS04	39	74ALS175	89
74ALS08	35	74ALS240	1.79
74ALS10	35	74ALS244	1.79
74ALS27	35	74ALS245	2.49
74ALS30	35	74ALS373	1.95
74ALS32	39	74ALS374	1.95
74ALS74	55	74ALS573	1.95

74F			
74F00	59	74F139	1.29
74F04	65	74F157	1.29
74F08	59	74F193	4.95
74F10	59	74F240	2.49
74F32	65	74F244	2.49
74F74	69	74F253	1.79
74F86	89	74F373	2.95
74F138	1.19	74F374	2.95

CD-CMOS			
CD4001	19	CD4081	25
CD4011	19	CD4082	25
CD4013	35	CD4093	39
CD4016	29	CD4094	1.49
CD4017	49	CD40103	2.49
CD4018	69	CD4503	69
CD4020	59	CD4510	49
CD4024	49	CD4511	69
CD4027	39	CD4515	3.39
CD4030	39	CD4518	79
CD4040	65	CD4520	79
CD4049	29	CD4522	79
CD4050	29	CD4538	89
CD4051	65	CD4541	89
CD4052	65	CD4543	89
CD4053	65	CD4553	4.95
CD4059	3.49	CD4555	89
CD4060	89	CD4566	1.95
CD4066	29	CD4583	1.19
CD4069	29	CD4584	59
CD4070	29	CD4585	75
CD4071	25	MC14411	9.95
CD4072	25	MC14490P	4.49
CD4076	89	MC14572	89

PRICE BREAKTHROUGH!

CUSTOM COMMODORE CHIPS

for VIC-20, C-64 and C-128 Personal Computers

Part No.	Price	Part No.	Price	Part No.	Price
*6510CPU	19.95	9.95	*6526CIA	25.95	14.95
*6525TP1	29.95	9.95	*6560VIC-I	29.95	14.95
			*6567VIC-II	44.95	19.95

*Specs. Available @ \$1.50 ea. NOTE: 82S100 = U17 (C-64)



MC68701-Microcomputer with EPROM
 The MC68701 is an 8-bit single chip microcomputer unit (MIPU) which significantly enhances the capabilities of the MC6800 family of parts. On-chip resources include 2048 bytes of EPROM, 128 bytes of RAM, Serial Communications Interface (SCI), parallel I/O, and a three function Programmable Timer.

MC68701..... \$24.95

MICROPROCESSOR COMPONENTS

MICROPROCESSOR CHIPS		6500/6800/68000 Cont.		8000 SERIES Cont.	
Part No.	Price	Part No.	Price	Part No.	Price
D765AC	4.95	6843	9.95	8237-5	6.95
CDP1802CE	6.95	6845	4.95	8243	2.49
2661-3	6.95	6850	1.95	8250A	6.95
		6852	4.75	8250E (For IBM)	7.25
		68000L8	9.95	8251A	2.25
		68661	8.95	8253-5	2.25
				8254	3.95
				8254-2	11.95
				8255A-5	2.25
				8257-5	2.49
				8259-5	2.49
				8272	2.95
				8279-3	4.95
				8741	8.95
				8748	7.95
				8749	9.95
				8751	29.95
				8755	14.95

DATA ACQUISITION			
ADC0804	3.49	ADC0808	8.95
ADC0809	3.95	ADC0816	14.95
ADC0817	8.95	DAC0808	7.95
DAC1008	1.95	AY-3-0150	4.95
AY-5-1013A	3.95		

DYNAMIC RAMS			
4116N-15	16,384 x 1	(150ns)	89
4128	131,072 x 1	(200ns)	5.95
4164N-150	65,536 x 1	(150ns)	1.39
4164N-200	65,536 x 1	(200ns)	1.19
TM54416-12	16,384 x 4	(120ns)	4.95
MM5280	40,960 x 1	(200ns) 2107	1.95
8118	16,384 x 1	(120ns) (+5V Only Required)	3.95
41256-150	262,144 x 1	(150ns)	7.95
50464-15	65,536 x 4	(150ns) (4464) (41464)	7.95

STATIC RAMS			
TMM2016-12	2048 x 8	(120ns)	1.69
2102	1024 x 1	(350ns)	89
2102-2L	1024 x 1	(250ns) LP (91L02)	1.49
2114N	1024 x 4	(450ns)	1.09
2114N-L	1024 x 4	(450ns) LP	1.09
2114N-2L	1024 x 4	(200ns)	1.05
2114N-2L	1024 x 4	(200ns) LP	1.49
21014	1024 x 4	(200ns) (CMOS)	4.49
2149	1024 x 4	(450ns) CMOS	3.95
5101	256 x 4	(450ns) CMOS	1.79
HM6116P-3	2048 x 8	(150ns) LP CMOS	1.85
HM6116LP-3	2048 x 8	(150ns) LP CMOS	1.49
HM6264P-12	8192 x 8	(120ns) LP CMOS	4.69
HM6264LP-12	8192 x 8	(120ns) LP CMOS	4.79
HM6264P-15	8192 x 8	(150ns) LP CMOS	4.49
HM6264LP-15	8192 x 8	(150ns) LP CMOS	4.49
6514	1024 x 4	(350ns) CMOS (UPD444C)	4.49

PROMS/EPROMS			
1702A	256 x 8	(1us)	5.95
TMS2516	2048 x 8	(450ns) 25V	4.95
TMS2532	4096 x 8	(450ns) 25V	5.95
TMS2564	8192 x 8	(450ns) 25V	9.95
2708	1024 x 8	(450ns)	3.95
TMS2716	2048 x 8	(450ns) 3 voltage	9.95
2716	2048 x 8	(450ns)	4.95
2716-5	2048 x 8	(350ns) 25V	5.95
27C16	2048 x 8	(450ns) CMOS	4.75
2732	4096 x 8	(450ns)	9.95
2732A-20	4096 x 8	(200ns) 21V	4.95
2732A-25	4096 x 8	(250ns) 21V	4.49
2732A-45	4096 x 8	(450ns) 21V	4.25
27C32	4096 x 8	CMOS	7.95
2764-20	8192 x 8	(200ns) Single +5V	5.95
2764-25	8192 x 8	(250ns) 21V	4.49
2764-45	8192 x 8	(450ns) 21V	4.49
27C64	8192 x 8	(450ns) CMOS	3.95
27128-25	16,384 x 8	(250ns) 128K 21V	4.49
27128A-25	16,384 x 8	(250ns) 125V	5.95
27256-25	32,768 x 8	(250ns) 256K (12.5V)	9.95
27C256-25	32,768 x 8	(250ns) 256K (CMOS) (12.5V)	10.95
68176A	8192 x 8	(450ns) 25V	15.95
68176B	8192 x 8	(350ns) 25V	16.95
74S387	256 x 4	PROM TS	1.69
74S471	256 x 4	PROM TS	2.95
82S123	32 x 8	PROM TS	2.95
82S129	256 x 4	PROM TS	2.95

LOW PROFILE (TIN) SOCKETS				WIRE WRAP SOCKETS (GOLD) LEVEL #3			
Part No.	1-9	10-99	100-up	Part No.	1-9	10-99	100-up
8 pin LP	13	12	11	8 pin WW	55	49	45
14 pin LP	15	13	11	14 pin WW	69	65	59
16 pin LP	17	15	13	16 pin WW	75	69	65
24 pin LP	31	30	29	24 pin WW	119	109	99
28 pin LP	37	37	35	28 pin WW	139	129	119
40 pin LP	49	46	43	40 pin WW	179	169	159

— SOLDEXTAIL STANDARD (GOLD & TIN) AND HEADER PLUG SOCKETS ALSO AVAILABLE —

SATELLITE TV DESCRAMBLER

The MM5321 is a TV camera sync generator designed to supply the basic sync functions for either color or monochrome 525 line/60Hz interlaced and camera video recorder applications. COLOR BURST GATE & SYNC ALLOW STABLE COLOR OPERATION

MM5321..... \$9.95

DIGITALK™

DT1050 — Applications: Teaching aids, appliances, clocks, automotive, telecommunication, language translations, etc. The DT1050 is a standard DIGITALK™ kit encoded with 137 separate and useful words, 2 tones, and 5 different silence durations. The words and tones have been assigned discrete addresses, making it possible to output single words or words concatenated into phrases or even sentences. The words' output of the DT1050 is a highly intelligible male voice. The DT1050 consists of a Speech Processor Chip, MM54104 (40-pin) and two (2) Speech ROMs MM52164SSR1 and MM52164SSR2 (24-pin) along with a Master Word list and a recommended schematic diagram on the application sheet.

Part No.	Description	Price
DT1050	Digitaltalker™	\$24.95
MM54104	Processor Chip	\$12.95

DT1057 — Expands the DT1050 vocabulary from 137 words to over 250 words. Includes two (2) ROMs and specs.

DT1057..... \$11.95

INTERSL

Part No.	Price	Part No.	Price
FE0202D	12.95	7207AEV/Kit	8.49
FE0203D	12.95	7211IPL (TTL)	7.95
7106CPL	8.95	7211MIPL (Micro)	8.49
7106EV/Kit	46.95	7217IUI	10.95
7107CPL	8.95	7217API	8.95
7207AIPD	5.95	7222AEV/Kit	10.95
		7226AEV/Kit	99.95

74HC HI-SPEED CMOS

74HC00	35	74HC175	89
74HC02	39	74HC221	1.95
74HC04	39	74HC240	1.39
74HC08	39	74HC244	1.49
74HC10	39	74HC245	1.59
74HC14	59	74HC253	7.9
74HC30	39	74HC259	1.19
74HC32	45	74HC273	1.79
74HC74	45	74HC373	1.49
74HC75	69	74HC374	1.49
74HC76	69	74HC393	1.19
74HC85	1.19	74HC596	1.95
74HC86	59	74HC688	1.95
74HC123	1		

Worldwide • Since 1974

• QUALITY COMPONENTS • COMPETITIVE PRICING • PROMPT DELIVERY

Mail Order Electronics • Worldwide
Jameco
 ELECTRONICS

COMMODORE® COMPATIBLE ACCESSORIES

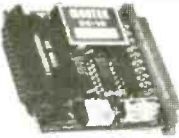

RS232 Adapter for VIC-20 and Commodore 64

The JE232CM allows connection of standard serial RS232 printers, modems, etc. to your VIC-20 and C-64 (excluding the SX-64 Portable). A 4-pole switch allows the inversion of the 4 control lines. Complete installation and operation instructions included.

Plugs into User Port • Provides Standard RS232 signal levels - Uses 6 signals (Transmit, Receive, Clear to Send, Request to Send, Data Terminal Ready, Data Set Ready)

JE232CM. \$39.95

Voice Synthesizer VIC-20 & C-64
 Plug-In - Talking in Minutes!

JE520CM. \$99.95

300 Baud Auto Modem
 Mitey-MO (For C-64). \$69.95

Parallel Printer Interface
 FREE 4K Buffer Included!

MW350 (For VIC-20, C-64 & C-128). \$69.95

TRS-80® COMPATIBLE ACCESSORIES

E-X-P-A-N-D TRS-80 MEMORY
 All kits come complete with documentation

TRS-80 MODEL I, III
 TRS-16K3 200ns (Model III). \$5.95
 TRS-16K4 250ns (Model I). \$5.49

TRS-80 COLOR AND COLOR II
 TRS-64K-2. \$11.95
 New models only -
 TRS-CoCo - Incl. 2-50464's (4164's). \$19.95

TRS-80 MODEL 4, 4P
 TRS-64K-2. \$11.95
 Expands Model 4 from 16K-64K or Model 4P from 64K-128K

TRS-64K-2PAL. \$29.95
 Expands Model 4 from 64K to 128K

TRS-80 Model 100 • NEC • Olivetti
 M1008K. \$29.95 ea. or 3 for \$79.95
 TRS-80 Model 100 Expansion

NEC8KR. \$29.95 ea. or 3 for \$79.95
 NEC Model PC-8201A Expansion

OM108K. \$29.95 ea. or 3 for \$79.95
 Olivetti Model M10 Expansion

TANDY 200
 M200R. \$99.95 ea. or 2 for \$189.95
 Tandy Model 200 Expansion

PROMETHEUS MODEMS

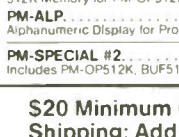

Intelligent 1200/300 Baud Modem with Real Time Clock/Calendar

The ProModem™ is a Bell 212A (1200/300) intelligent stand-alone modem. Hayes command set compatible plus an additional extended command set. Shown with alphanumeric display option. RS-232 Stand-Alone Unit.

PM1200. \$299.95

Options for ProModem 1200
 PM-COM. \$49.95
 ProCom Communications Software. Please specify Operating System - Apple: ProDOS or CP/M - IBM: PC DOS or MS DOS

PM-OP512K. \$129.95
 Communications Buffer Option
 BUF512K. \$54.95
 512K Memory for PM-OP512K
 PM-ALP. \$79.95
 Alphanumeric Display for ProModem 1200
 PM-SPECIAL #2. \$249.95
 Includes PM-OP512K, BUF512K and PM-ALP

APPLE® COMPATIBLE ACCESSORIES

All Apple Cards come complete with instructions. MADE IN THE USA!



16K RAM CARD (Language Card)
 For Apple II and II+

Expand from 48K-64K Runs AppleSoft, DOS, CP/M and Pascal (ARC-16K/MEM-1)
JE860 . . . \$39.95**



CONTROLLER CARD
 For Apple II, II+ and IIe*

Capable of handling up to two drives! Recommended drives: ADD-514 or ADD-12 (ACC-1)
JE875 \$49.95

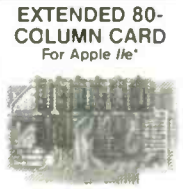

EXTENDED 80-COLUMN CARD
 For Apple IIe*

JE864 is an extended 80 column/64K RAM Card Ultra-high resolution capability
JE864 \$69.95



128K RAM CARD
 For Apple II, II+ and IIe*

Four key software programs are included: Utilities, Diagnostics, Demos, and RAM Disk Emulators for DOS 3.3, CP/M and Apple Pascal Expand-A-RAM.
JE868 \$119.95**



APPLESURANCE DIAGNOSTIC DISK CONTROLLER CARD
 For Apple II, II+ and IIe*

PREVENTS CRASHES!
 Test your RAM, ROM, CPU and Disk Drives DRV-11/Applesurance II!
JE877. \$69.95



PARALLEL PRINTER CARD
 For Apple II, II+ and IIe*

Fully compatible with Apple CP/M, Apple Pascal (or FORTRAN), and most other operating systems and software packages Available for Apple II, II+ and IIe* PRT-1
JE880. \$59.95



PARALLEL/SERIAL 64K BUFFER CARD
 For Apple II, II+ and IIe*

Using the parallel jumper cable supplied, the JE883 will attach to the JE880 (above). Parallel Card needed for operation. The JE883 includes a standard parallel input with both parallel and serial (RS232) buffered outputs. P/S Buffer.
JE883. \$79.95



PARALLEL PRINTER CARD
 For Apple II, II+ and IIe*

Fully compatible with Apple CP/M, Apple Pascal (or FORTRAN), and most other operating systems and software packages Available for Apple II, II+ and IIe* PRT-1
JE880. \$59.95



PARALLEL/SERIAL 64K BUFFER CARD
 For Apple II, II+ and IIe*

Using the parallel jumper cable supplied, the JE883 will attach to the JE880 (above). Parallel Card needed for operation. The JE883 includes a standard parallel input with both parallel and serial (RS232) buffered outputs. P/S Buffer.
JE883. \$79.95

*APPLE, APPLE II, II+ and IIe are registered trademarks of Apple Computers.
 **When using CP/M, the JE860 and JE868 will only function with Version 2.20 or earlier: PASCAL (JE868) Version 1.1 or earlier.

GENERAL APPLE® COMPATIBLE PRODUCTS

- Key: a=Apple II or II+ b=Apple IIe
- APF-1 Cooling Fan with Surge Protection - Key: (a,b) \$ 39.95
 - KHP4007 Switching Power Supply - Key: (a,b) \$ 39.95
 - JE614 Numeric/Aux. Keypad - 11 accessible functions - Key: (b) \$ 49.95
 - AMON 12" Green Monitor with Swivel Stand - Key: (a, b and IIc) \$ 99.95
 - KB-EA1 Apple Keyboard and Case - Key: (a) \$ 99.95
 - JE520AP Voice Synthesizer - Plug-In, User Ready - Key: (a,b) \$119.95
 - ADD-12 5 1/4" Half-Height Disk Drive - Key: (a,b) \$119.95
 - ADD-11c 5 1/4" Half-Height Disk Drive - Key: (IIc) \$129.95
 - ADD-514 5 1/4" Full Height Disk Drive - Key: (a,b) \$129.95
 - PM1200A Prometheus Internal Modem - 2 Cards - Key: (a,b) \$299.95
 - PM1200M Prometheus Macintosh Ext. Modem - Key: (Macintosh) \$349.95

GENERAL APPLICATION POWER SUPPLIES

Power/Mate Corp. REGULATED POWER SUPPLY
 Input: 105-125/210-250VAC @ 47-63Hz • Line regulation: 0-0.5% • 3 mounting surfaces • Overvoltage protection • UL recognized • CSA certified

Part No.	Output	Size (Inches)	Weight	PRICE
EMAS/6B	5V@3A / 6V@2.5A	4 1/4" x 4 1/4" x 2 1/4"	2 lbs	\$29.95
EMAS/8C	5V@6A / 6V@5A	5 1/4" x 4 1/4" x 2 1/4"	4 lbs	\$39.95

4-CHANNEL SWITCHING POWER SUPPLY
 Microprocessor, mini-computer, terminal, medical equipment and process control applications • Input: 90-130VAC, 47-440Hz • Output: 5VDC @ 5A - 5VDC @ 1A, -12VDC @ 1A, -12VDC @ 1A • Line regulation: 0.2% • Ripple: 30mV p-p • Load regulation: 1% • Overcurrent protection • Adjustment: 5V main output • 10% • Size: 6 1/4" x 1 1/4" x 4-15/16" H • Weight: 1 1/2 lbs

FCS-604A. \$59.95

IBM® COMPATIBLE ACCESSORIES



83-KEY KEYBOARD

Identical layout as original IBM PC Keyboard • Highly desirable case with palm rest • Complete with cable and data - JUST PLUG IN!
KE83. \$49.95

Build an IBM PC/XT™ Compatible!

- IBM-64K 64K RAM Chips (18) \$ 24.98
- KB-83 83-Key Keyboard. \$ 49.95
- IBM-FCC Floppy Controller Card. \$ 54.95
- IBM-Case Case. \$ 49.95
- IBM-MCC Monochrome Card. \$ 89.95
- IBM-PS Power Supply. \$ 89.95
- FC55B Disk Drive. \$119.95
- IBM-MON Monochrome Monitor. \$109.95
- IBM-MB Motherboard. \$199.95

Regular List \$789.58
IBM™-Special (Incl. 9 items above) . . . \$699.95

Additional Add-Ons Available!

- IBM-KB 83-Key Keyboard. \$ 79.95
- IBM-ENH Enhanced Keyboard. \$ 99.95
- IBM-ICB Integrated Color Board. \$109.95
- IBM-E384K Multifunction Card. \$169.95
- IBM-20MBK 20MB Hard Disk Drive. \$499.95

IBM is a registered trademark of IBM Computers



- FD55B Teac 5 1/4" DS 1/2-Height. \$119.95
- SA455 Shugart 5 1/4" DS 1/2-Height. \$139.95
- TM100-2 Tandon 5 1/4" DS Full-Height. \$139.95

JMR 5 1/4" DISK DRIVE ENCLOSURES

- Complete with power supply, switch, power cord, fuseholder and connectors.
- DDE-1FH 1 Full-Height 5 1/4" Floppy Drive \$69.95
 - DDE-2HH 2 Half-Height 5 1/4" Floppy Drives - Vertical \$79.95
 - HDE-1FH 1 Hard Disk Drive \$199.95

UV-EPROM ERASER



Erases all EPROMs. Erases up to 8 chips within 21 minutes (1 chip in 15 minutes). Maintains constant exposure distance of 1" • Special conductive foam liner eliminates static build-up • Built-in safety lock to prevent UV exposure. Compact - 9.00 L x 3.70 W x 2.60 H. Complete with holding tray for 8 chips.

- DE-4 UV-EPROM Eraser. \$74.95
- UVS-11EL Replacement Bulb. \$17.95

DATA BOOKS

- 30003 National Linear Data Book (82) \$14.95
- 30009 Intersil Data Book (85) \$ 9.95
- 30013 Zilog Data Book (85) \$14.95
- 30022 Nat'l. Logic Data Book Set (84) \$24.95
- 210830 Intel Memory Handbook (83/84) \$19.95
- 230843 Intel Microsystem Hndbk. (83/84) \$19.95

MUFFIN/SPRITE-STYLE FANS

- MUF60 (SPN3-15-2462) \$9.95
- SU2C7 Howard Industries (4 68" sq. 60 cfm) \$9.95
- EG&G Rotron (3 125" square, 20 cfm)

\$20 Minimum Order - U.S. Funds Only
 Shipping: Add 5% plus \$1.50 Insurance

California Residents: Add 6% or 6 1/2% Sales Tax

Spec. Sheets - 30¢ each
 Prices Subject to Change

Send stamped, self-addressed envelope to receive a Quarterly Sales Flyer - FREE!
 7/86

1355 SHOREWAY ROAD, BELMONT, CA 94002 • PHONE ORDERS WELCOME 415-592-8097 Telex: 176043

Mail Order Electronics • Worldwide®
Jameco
 ELECTRONICS

Send \$1.00 Postage for a FREE 1986 JAMECO CATALOG

DIGI KEY CORPORATION

1-800-344-4539

AK, Puerto Rico - 218 681 6674 Telex - 62827914 TWX - 910350882 DIGI KEY CORP

NATIONAL SEMICONDUCTOR • PANASONIC MACHINE • EWC, INC. • INTERSIL • AD E.C. MILLER • AVALON ELECTRONICS • JOHNSON • ATLANTIC SEMICONDUCTOR

256K (262,144 x 1) DRAM 150NS \$5.70/1; \$39.95/9
Factory Firsts

DIODES • DIAMOND TOOL • UNGAR • ESW-CW INDUSTRIES • AMDEK • G.E. • ZAP • YALOW • J.W. LEXER • TIC CHEMICALS • ARIES • PLESSEY

INTEGRATED CIRCUITS		
Part No.	Part No.	Price
7400 TTL	741564N 1.00	741569N 1.00
7401	741565N 1.00	741570N 1.00
7402	741571N 1.00	741576N 1.00
7403	741577N 1.00	741582N 1.00
7404	741583N 1.00	741588N 1.00
7405	741589N 1.00	741594N 1.00
7406	741595N 1.00	741600N 1.00
7407	741601N 1.00	741606N 1.00
7408	741607N 1.00	741612N 1.00
7409	741613N 1.00	741618N 1.00
7410	741619N 1.00	741624N 1.00
7411	741625N 1.00	741630N 1.00
7412	741631N 1.00	741636N 1.00
7413	741637N 1.00	741642N 1.00
7414	741643N 1.00	741648N 1.00
7415	741649N 1.00	741654N 1.00
7416	741655N 1.00	741660N 1.00
7417	741661N 1.00	741666N 1.00
7418	741667N 1.00	741672N 1.00
7419	741673N 1.00	741678N 1.00
7420	741679N 1.00	741684N 1.00
7421	741685N 1.00	741690N 1.00
7422	741691N 1.00	741696N 1.00
7423	741697N 1.00	741702N 1.00
7424	741703N 1.00	741708N 1.00
7425	741709N 1.00	741714N 1.00
7426	741715N 1.00	741720N 1.00
7427	741721N 1.00	741726N 1.00
7428	741727N 1.00	741732N 1.00
7429	741733N 1.00	741738N 1.00
7430	741739N 1.00	741744N 1.00
7431	741745N 1.00	741750N 1.00
7432	741751N 1.00	741756N 1.00
7433	741757N 1.00	741762N 1.00
7434	741763N 1.00	741768N 1.00
7435	741769N 1.00	741774N 1.00
7436	741775N 1.00	741780N 1.00
7437	741781N 1.00	741786N 1.00
7438	741787N 1.00	741792N 1.00
7439	741793N 1.00	741798N 1.00
7440	741799N 1.00	741804N 1.00
7441	741805N 1.00	741810N 1.00
7442	741811N 1.00	741816N 1.00
7443	741817N 1.00	741822N 1.00
7444	741823N 1.00	741828N 1.00
7445	741829N 1.00	741834N 1.00
7446	741835N 1.00	741840N 1.00
7447	741841N 1.00	741846N 1.00
7448	741847N 1.00	741852N 1.00
7449	741853N 1.00	741858N 1.00
7450	741859N 1.00	741864N 1.00
7451	741865N 1.00	741870N 1.00
7452	741871N 1.00	741876N 1.00
7453	741877N 1.00	741882N 1.00
7454	741883N 1.00	741888N 1.00
7455	741889N 1.00	741894N 1.00
7456	741895N 1.00	741900N 1.00
7457	741896N 1.00	741901N 1.00
7458	741902N 1.00	741907N 1.00
7459	741908N 1.00	741913N 1.00
7460	741914N 1.00	741919N 1.00
7461	741920N 1.00	741925N 1.00
7462	741926N 1.00	741931N 1.00
7463	741932N 1.00	741937N 1.00
7464	741938N 1.00	741943N 1.00
7465	741944N 1.00	741949N 1.00
7466	741950N 1.00	741955N 1.00
7467	741956N 1.00	741961N 1.00
7468	741962N 1.00	741967N 1.00
7469	741968N 1.00	741973N 1.00
7470	741974N 1.00	741979N 1.00
7471	741980N 1.00	741985N 1.00
7472	741986N 1.00	741991N 1.00
7473	741992N 1.00	741997N 1.00
7474	741998N 1.00	742003N 1.00
7475	742004N 1.00	742009N 1.00
7476	742010N 1.00	742015N 1.00
7477	742016N 1.00	742021N 1.00
7478	742022N 1.00	742027N 1.00
7479	742028N 1.00	742033N 1.00
7480	742034N 1.00	742039N 1.00
7481	742040N 1.00	742045N 1.00
7482	742046N 1.00	742051N 1.00
7483	742052N 1.00	742057N 1.00
7484	742058N 1.00	742063N 1.00
7485	742064N 1.00	742069N 1.00
7486	742070N 1.00	742075N 1.00
7487	742076N 1.00	742081N 1.00
7488	742082N 1.00	742087N 1.00
7489	742088N 1.00	742093N 1.00
7490	742094N 1.00	742099N 1.00
7491	742100N 1.00	742105N 1.00
7492	742106N 1.00	742111N 1.00
7493	742112N 1.00	742117N 1.00
7494	742118N 1.00	742123N 1.00
7495	742124N 1.00	742129N 1.00
7496	742130N 1.00	742135N 1.00
7497	742136N 1.00	742141N 1.00
7498	742142N 1.00	742147N 1.00
7499	742143N 1.00	742148N 1.00
7500	742149N 1.00	742150N 1.00

1 I.C. SOCKETS

SOLDER TAIL DIP SOCKETS
• Single Board
• Low Profile
• YOUR CHOICE: TIN OR GOLD!
We stock all standard gold plated sockets.

TIN PLATED SOLDER TAIL
Part No. Description Price
CS89 8-pin solder tail 1.18 184
CS90 14-pin solder tail 1.18 184
CS91 16-pin solder tail 1.18 184
CS92 18-pin solder tail 1.18 184
CS93 20-pin solder tail 1.18 184
CS94 22-pin solder tail 1.18 184
CS95 24-pin solder tail 1.18 184
CS96 26-pin solder tail 1.18 184
CS97 28-pin solder tail 1.18 184
CS98 30-pin solder tail 1.18 184
CS99 32-pin solder tail 1.18 184
CS100 34-pin solder tail 1.18 184
CS101 36-pin solder tail 1.18 184
CS102 38-pin solder tail 1.18 184
CS103 40-pin solder tail 1.18 184
CS104 42-pin solder tail 1.18 184
CS105 44-pin solder tail 1.18 184
CS106 46-pin solder tail 1.18 184
CS107 48-pin solder tail 1.18 184
CS108 50-pin solder tail 1.18 184
CS109 52-pin solder tail 1.18 184
CS110 54-pin solder tail 1.18 184
CS111 56-pin solder tail 1.18 184
CS112 58-pin solder tail 1.18 184
CS113 60-pin solder tail 1.18 184
CS114 62-pin solder tail 1.18 184
CS115 64-pin solder tail 1.18 184
CS116 66-pin solder tail 1.18 184
CS117 68-pin solder tail 1.18 184
CS118 70-pin solder tail 1.18 184
CS119 72-pin solder tail 1.18 184
CS120 74-pin solder tail 1.18 184
CS121 76-pin solder tail 1.18 184
CS122 78-pin solder tail 1.18 184
CS123 80-pin solder tail 1.18 184
CS124 82-pin solder tail 1.18 184
CS125 84-pin solder tail 1.18 184
CS126 86-pin solder tail 1.18 184
CS127 88-pin solder tail 1.18 184
CS128 90-pin solder tail 1.18 184
CS129 92-pin solder tail 1.18 184
CS130 94-pin solder tail 1.18 184
CS131 96-pin solder tail 1.18 184
CS132 98-pin solder tail 1.18 184
CS133 100-pin solder tail 1.18 184
CS134 102-pin solder tail 1.18 184
CS135 104-pin solder tail 1.18 184
CS136 106-pin solder tail 1.18 184
CS137 108-pin solder tail 1.18 184
CS138 110-pin solder tail 1.18 184
CS139 112-pin solder tail 1.18 184
CS140 114-pin solder tail 1.18 184
CS141 116-pin solder tail 1.18 184
CS142 118-pin solder tail 1.18 184
CS143 120-pin solder tail 1.18 184
CS144 122-pin solder tail 1.18 184
CS145 124-pin solder tail 1.18 184
CS146 126-pin solder tail 1.18 184
CS147 128-pin solder tail 1.18 184
CS148 130-pin solder tail 1.18 184
CS149 132-pin solder tail 1.18 184
CS150 134-pin solder tail 1.18 184
CS151 136-pin solder tail 1.18 184
CS152 138-pin solder tail 1.18 184
CS153 140-pin solder tail 1.18 184
CS154 142-pin solder tail 1.18 184
CS155 144-pin solder tail 1.18 184
CS156 146-pin solder tail 1.18 184
CS157 148-pin solder tail 1.18 184
CS158 150-pin solder tail 1.18 184
CS159 152-pin solder tail 1.18 184
CS160 154-pin solder tail 1.18 184
CS161 156-pin solder tail 1.18 184
CS162 158-pin solder tail 1.18 184
CS163 160-pin solder tail 1.18 184
CS164 162-pin solder tail 1.18 184
CS165 164-pin solder tail 1.18 184
CS166 166-pin solder tail 1.18 184
CS167 168-pin solder tail 1.18 184
CS168 170-pin solder tail 1.18 184
CS169 172-pin solder tail 1.18 184
CS170 174-pin solder tail 1.18 184
CS171 176-pin solder tail 1.18 184
CS172 178-pin solder tail 1.18 184
CS173 180-pin solder tail 1.18 184
CS174 182-pin solder tail 1.18 184
CS175 184-pin solder tail 1.18 184
CS176 186-pin solder tail 1.18 184
CS177 188-pin solder tail 1.18 184
CS178 190-pin solder tail 1.18 184
CS179 192-pin solder tail 1.18 184
CS180 194-pin solder tail 1.18 184
CS181 196-pin solder tail 1.18 184
CS182 198-pin solder tail 1.18 184
CS183 200-pin solder tail 1.18 184
CS184 202-pin solder tail 1.18 184
CS185 204-pin solder tail 1.18 184
CS186 206-pin solder tail 1.18 184
CS187 208-pin solder tail 1.18 184
CS188 210-pin solder tail 1.18 184
CS189 212-pin solder tail 1.18 184
CS190 214-pin solder tail 1.18 184
CS191 216-pin solder tail 1.18 184
CS192 218-pin solder tail 1.18 184
CS193 220-pin solder tail 1.18 184
CS194 222-pin solder tail 1.18 184
CS195 224-pin solder tail 1.18 184
CS196 226-pin solder tail 1.18 184
CS197 228-pin solder tail 1.18 184
CS198 230-pin solder tail 1.18 184
CS199 232-pin solder tail 1.18 184
CS200 234-pin solder tail 1.18 184
CS201 236-pin solder tail 1.18 184
CS202 238-pin solder tail 1.18 184
CS203 240-pin solder tail 1.18 184
CS204 242-pin solder tail 1.18 184
CS205 244-pin solder tail 1.18 184
CS206 246-pin solder tail 1.18 184
CS207 248-pin solder tail 1.18 184
CS208 250-pin solder tail 1.18 184
CS209 252-pin solder tail 1.18 184
CS210 254-pin solder tail 1.18 184
CS211 256-pin solder tail 1.18 184
CS212 258-pin solder tail 1.18 184
CS213 260-pin solder tail 1.18 184
CS214 262-pin solder tail 1.18 184
CS215 264-pin solder tail 1.18 184
CS216 266-pin solder tail 1.18 184
CS217 268-pin solder tail 1.18 184
CS218 270-pin solder tail 1.18 184
CS219 272-pin solder tail 1.18 184
CS220 274-pin solder tail 1.18 184
CS221 276-pin solder tail 1.18 184
CS222 278-pin solder tail 1.18 184
CS223 280-pin solder tail 1.18 184
CS224 282-pin solder tail 1.18 184
CS225 284-pin solder tail 1.18 184
CS226 286-pin solder tail 1.18 184
CS227 288-pin solder tail 1.18 184
CS228 290-pin solder tail 1.18 184
CS229 292-pin solder tail 1.18 184
CS230 294-pin solder tail 1.18 184
CS231 296-pin solder tail 1.18 184
CS232 298-pin solder tail 1.18 184
CS233 300-pin solder tail 1.18 184
CS234 302-pin solder tail 1.18 184
CS235 304-pin solder tail 1.18 184
CS236 306-pin solder tail 1.18 184
CS237 308-pin solder tail 1.18 184
CS238 310-pin solder tail 1.18 184
CS239 312-pin solder tail 1.18 184
CS240 314-pin solder tail 1.18 184
CS241 316-pin solder tail 1.18 184
CS242 318-pin solder tail 1.18 184
CS243 320-pin solder tail 1.18 184
CS244 322-pin solder tail 1.18 184
CS245 324-pin solder tail 1.18 184
CS246 326-pin solder tail 1.18 184
CS247 328-pin solder tail 1.18 184
CS248 330-pin solder tail 1.18 184
CS249 332-pin solder tail 1.18 184
CS250 334-pin solder tail 1.18 184
CS251 336-pin solder tail 1.18 184
CS252 338-pin solder tail 1.18 184
CS253 340-pin solder tail 1.18 184
CS254 342-pin solder tail 1.18 184
CS255 344-pin solder tail 1.18 184
CS256 346-pin solder tail 1.18 184
CS257 348-pin solder tail 1.18 184
CS258 350-pin solder tail 1.18 184
CS259 352-pin solder tail 1.18 184
CS260 354-pin solder tail 1.18 184
CS261 356-pin solder tail 1.18 184
CS262 358-pin solder tail 1.18 184
CS263 360-pin solder tail 1.18 184
CS264 362-pin solder tail 1.18 184
CS265 364-pin solder tail 1.18 184
CS266 366-pin solder tail 1.18 184
CS267 368-pin solder tail 1.18 184
CS268 370-pin solder tail 1.18 184
CS269 372-pin solder tail 1.18 184
CS270 374-pin solder tail 1.18 184
CS271 376-pin solder tail 1.18 184
CS272 378-pin solder tail 1.18 184
CS273 380-pin solder tail 1.18 184
CS274 382-pin solder tail 1.18 184
CS275 384-pin solder tail 1.18 184
CS276 386-pin solder tail 1.18 184
CS277 388-pin solder tail 1.18 184
CS278 390-pin solder tail 1.18 184
CS279 392-pin solder tail 1.18 184
CS280 394-pin solder tail 1.18 184
CS281 396-pin solder tail 1.18 184
CS282 398-pin solder tail 1.18 184
CS283 400-pin solder tail 1.18 184
CS284 402-pin solder tail 1.18 184
CS285 404-pin solder tail 1.18 184
CS286 406-pin solder tail 1.18 184
CS287 408-pin solder tail 1.18 184
CS288 410-pin solder tail 1.18 184
CS289 412-pin solder tail 1.18 184
CS290 414-pin solder tail 1.18 184
CS291 416-pin solder tail 1.18 184
CS292 418-pin solder tail 1.18 184
CS293 420-pin solder tail 1.18 184
CS294 422-pin solder tail 1.18 184
CS295 424-pin solder tail 1.18 184
CS296 426-pin solder tail 1.18 184
CS297 428-pin solder tail 1.18 184
CS298 430-pin solder tail 1.18 184
CS299 432-pin solder tail 1.18 184
CS300 434-pin solder tail 1.18 184
CS301 436-pin solder tail 1.18 184
CS302 438-pin solder tail 1.18 184
CS303 440-pin solder tail 1.18 184
CS304 442-pin solder tail 1.18 184
CS305 444-pin solder tail 1.18 184
CS306 446-pin solder tail 1.18 184
CS307 448-pin solder tail 1.18 184
CS308 450-pin solder tail 1.18 184
CS309 452-pin solder tail 1.18 184
CS310 454-pin solder tail 1.18 184
CS311 456-pin solder tail 1.18 184
CS312 458-pin solder tail 1.18 184
CS313 460-pin solder tail 1.18 184
CS314 462-pin solder tail 1.18 184
CS315 464-pin solder tail 1.18 184
CS316 466-pin solder tail 1.18 184
CS317 468-pin solder tail 1.18 184
CS318 470-pin solder tail 1.18 184
CS319 472-pin solder tail 1.18 184
CS320 474-pin solder tail 1.18 184
CS321 476-pin solder tail 1.18 184
CS322 478-pin solder tail 1.18 184
CS323 480-pin solder tail 1.18 184
CS324 482-pin solder tail 1.18 184
CS325 484-pin solder tail 1.18 184
CS326 486-pin solder tail 1.18 184
CS327 488-pin solder tail 1.18 184
CS328 490-pin solder tail 1.18 184
CS329 492-pin solder tail 1.18 184
CS330 494-pin solder tail 1.18 184
CS331 496-pin solder tail 1.18 184
CS332 498-pin solder tail 1.18 184
CS333 500-pin solder tail 1.18 184
CS334 502-pin solder tail 1.18 184
CS335 504-pin solder tail 1.18 184
CS336 506-pin solder tail 1.18 184
CS337 508-pin solder tail 1.18 184
CS338 510-pin solder tail 1.18 184
CS339 512-pin solder tail 1.18 184
CS340 514-pin solder tail 1.18 184
CS341 516-pin solder tail 1.18 184
CS342 518-pin solder tail 1.18 184
CS343 520-pin solder tail 1.18 184
CS344 522-pin solder tail 1.18 184
CS345 524-pin solder tail 1.18 184
CS346 526-pin solder tail 1.18 184
CS347 528-pin solder tail 1.18 184
CS348 530-pin solder tail 1.18 184
CS349 532-pin solder tail 1.18 184
CS350 534-pin solder tail 1.18 184
CS351 536-pin solder tail 1.18 184
CS352 538-pin solder tail 1.18 184
CS353 540-pin solder tail 1.18 184
CS354 542-pin solder tail 1.18 184
CS355 544-pin solder tail 1.18 184
CS356 546-pin solder tail 1.18 184
CS357 548-pin solder tail 1.18 184
CS358 550-pin solder tail 1.18 184
CS359 552-pin solder tail 1.18 184
CS360 554-pin solder tail 1.18 184
CS361 556-pin solder tail 1.18 184
CS362 558-pin solder tail 1.18 184
CS363 560-pin solder tail 1.18 184
CS364 562-pin solder tail 1.18 184
CS365 564-pin solder tail 1.18 184
CS366 566-pin solder tail 1.18 184
CS367 568-pin solder tail 1.18 184
CS368 570-pin solder tail 1.18 184
CS369 572-pin solder tail 1.18 184
CS370 574-pin solder tail 1.18 184
CS371 576-pin solder tail 1.18 184
CS372 578-pin solder tail 1.18 184
CS373 580-pin solder tail 1.18 184
CS374 582-pin solder tail 1.18 184
CS375 584-pin solder tail 1.18 184
CS376 586-pin solder tail 1.18 184
CS377 588-pin solder tail 1.18 184
CS378 590-pin solder tail 1.18 184
CS379 592-pin solder tail 1.18 184
CS380 594-pin solder tail 1.18 184
CS381 596-pin solder tail 1.18 184
CS382 598-pin solder tail 1.18 184
CS

THE MOST POPULAR PRODUCTS IN EUROPE & ASIA ARE COMING NOW! 50 HOT ITEMS FOR YOUR SELECTION. SEND \$1.00 FOR MARK V CATALOG, REFUND UPON ORDER

TR-100 0-15V 2A REGULATED DC POWER SUPPLY



- * Output voltage is adjustable from 0-15V DC, two current limit range are available for selection: 200mA or 2A.
- * An elaborated protection system is specially designed, a "BB" sound and a sparkle light will appear when the output is overloaded.
- * High stability and reliable resulting from employing high quality voltage regulate IC.
- * Possessing king size meter makes the reading of voltage and current more clearly and accuracy.
- * A refined case, meter and all accessory are enclosed for both kit and assembly form. Most suitable for factory, professional or even amateur.

Kit \$59.50
Ass. with tested \$69.50

CORDLESS SOLDERING IRON RECHARGEABLE

No. 620



New

The most perfect handy, lightweight soldering iron for Workshop, Home, Hobby & Outdoor work. Includes UL approval charger & cleaning sponge. With build-in solid point illumination.

Each set \$22.80

TALKING CLOCK

NEW FOR 85'



GOLDEN & BLACK ARE AVAILABLE!

1. Talk through button for voice announcement of time.
2. Read out twelve hrs system display for hour, minute, second (by color flash), AM & PM.
3. Display three display modes of time, alarm time & date.
4. Alarm on/off switch with thirty seconds voice alarm.
5. Snooze reminder voice alarm of thirty seconds after 4 minutes of first voice alarm.
6. Volume two level of voice output.
7. Language available: English.

Mynah 8504 \$25.00 NOT A KIT!

3 1/2 DIGIT MULTIMETER

YAMATO 4001



SPECIAL OFFER!

The YAMATO 4001 is a 3 1/2 DIGIT COMPACT DIGITAL MULTIMETER, it employs FE type LCD, with large figures. Its ADVANTAGES: High accuracy in measuring. High impedance assures min. measuring error. One rotary switch allows fast & convenient operation. 26 measurement range enable wider application. Over-current indication & low battery life appears on display. LSI circuit use provides high reliability and durability. Measurement possible even under strong magnetic field.

Not a KIT, assembled with tested \$33.80

TA-2400A ELECTRONIC ECHO AND REVERBERATION AMPLIFIER

REMIX records yourself!



This unit combines the most advanced computer VLSI technique with high quality Japan Made component, so it has the following FEATURES:

It can generate various reflection and reverberation effect such as that in valley and music hall. It has a 3 section effect control which includes reverberation control, delay control and depth control. Special effect can be made in your record tapes by using this model. All kinds of infield sound effect can be obtained by skilful use of this control. It has LED display to show reflection and reverberation.

Ass. with tester \$99.85

INFRARED REMOTE CONTROL UNIT

TY-41 MK3



Kit \$25.00
Ass. with tested \$30.00

60W VERSATILE STEREO POWER BOOSTER

TA-302



Ass. with tested \$60.00

0-50V/3A POWER SUPPLY W/SHORT CIRCUIT BREAK

TA-503



Kit \$12.30

LCD THERMOMETER CLOCK

NEW!



Features:
0.34" DIGITAL thermometer with Hi & Low temperature alarm function and 12 hours clock combination.
Measuring range: 0°F to 160°F or 0°C to 70°C.
Resolution reading: ±1.8°F
Dimension: 3 1/2" x 0.86" x 2.08"

T-1 with In/Out Door sensor \$29.00
T-2 with Fahrenheit/Celsius measuring \$18.00 NOT A KIT!

150MC Universal Digital Frequency Counter

SM-100



Frequency Range: 10Hz - 150MHz
Event Counter: 0 to 99999999 counts (8 Digit)
Input sensitivity: KHz range 10Hz - 10MHz 50mVrms
MHz range 1MHz - 150MHz 40mVrms
Response time: 0.2 second.
Hold Function: Hold the last input signal.
Power Supply: DC6V Battery or DC9V 250MA Adaptor
Dimension: 9 7/8" x 6 1/16" x 2 3/8"

Assembled with tested \$99.00

MULTIFUNCTIONAL LED D.P.M.

SM-43



LARGE 3 1/2 DIGIT 0.6" LED DISPLAY

MEASUREMENT RANGE:
D.C. V.C. TAGE: 1mV - 1000V
A.C. V.C. TAGE: 1mV - 1000V
DIGITAL THERMOMETER: 0°C - 100°C
D.C. CURRENT: 10A - 2A
CAPACITOR METER: 1pF - 20F
FREQUENCY COUNTER: 10Hz - 20KHz
DIMENSION: 3 3/4" x 1 7/8" x 4 1/16"

Kit \$29.23
Assembled with tested \$35.00

HIGH QUALITY MULTIPURPOSE PRE-AMPLIFIER

TA-2500

GREAT VALUE!



This specially designed pre-amplifier includes a professional GRAPH EQUALIZER TONE control system and has a gain to 12dB. Frequency response extends from 5Hz to 20KHz, so even in bad listening condition it can improve well. It can accept input from various magnetic cartridge, record deck and tuner. Its output can be connected to all kinds of power amplifier. The following combinations are good examples.

Assembled with tested \$82.00

80W + 80W DC LOW TIM PRE-MAIN AMPLIFIER

TA-800



Kit \$49.85

Model No.	Description	Kit/Assembled	Unit Price	Model No.	Description	Kit/Assembled	Unit Price
TA-001	1W Mini-Amplifier	Kit	\$3.90	TR-355 A, B	3-5A REGULATED DC POWER SUPPLY	Kit	\$10.68
TA-006	6W Mini-Amplifier	Kit	\$4.92	TR-505	0-50V 3A POWER SUPPLY WITH SHORT CIRCUIT BREAK & OVERLOAD PROTECTOR	Kit	\$12.30
TA-007	12W Stereo Power Booster	Kit	\$8.00	TR-100	0-15V 2A REGULATED DC POWER SUPPLY	Ass.	\$69.50
TA-008	AC/DC SHOULDER AMPLIFIER	Ass.	\$48.00			Kit	\$59.50
TA-10	STEREO PRE-AMPLIFIER WITH MAGNETIC MIC AMP	Kit	\$6.00	TY-1A MK4	BATTERY FLUORESCENT LIGHT	Kit	\$3.99
TA-50 A, B	MULTI-PURPOSE MELODY GENERATOR	Kit	\$10.76	TY-7	ELECTRONIC TOUCH SWITCH	Kit	\$12.30
TA-120	PURE CLASS "A" MAIN POWER AMPLIFIER	Kit	\$25.00	TY-11A	MULTI-FUNCTIONAL CONTROL RELAY	Kit	\$5.50
TA-202	20W AC DC STEREO AMPLIFIER	Ass.	\$60.00	TY-12A	DIGITAL CLOCK WITH TWO TIMER	Kit	\$3.99
TA-300	30W Multi-Purpose Single Channel Amp	Kit	\$11.07	TY-13	COLOR LED VU METER	Kit	\$13.86
TA-302	60W Stereo Power Booster	Kit	\$50.00	TY-14	ELECTRONIC SHOCK	Kit	\$17.50
		Ass.	\$60.00	TY-18	HIGH PRECISION SOUND CONTROL SWITCH	Kit	\$3.00
TA-323A	High Quality 30W-30W Stereo Amplifier	Kit	\$24.60	TY-20	SUPER SENSITIVE AUDIO LEVEL INDICATOR	Kit	\$7.68
TA-322	60W IC Stereo Pre-Amplifier & Power Amplifier	Kit	\$29.50	TY-23	COLOR LIGHT CONTROLLER	Kit	\$19.50
TA-400	40W TRANSISTORIZED MONO-AMPLIFIER	Kit	\$13.84			Ass.	\$65.00
TA-477	120W MOSFET POWER AMPLIFIER	Kit	\$55.00			Ass.	\$75.00
TA-800	160W DC LOW TIM PRE-AMPLIFIER & POWER AMP	Kit	\$49.85	TY-25	SPEAKER PROTECTOR	Kit	\$9.50
TA-802	160W PURE DC ST. POWER AMP W/SPK. PROTECTOR	Kit	\$39.95	TY-35	FM WIRELESS MICROPHONE	Kit	\$7.68
TA-820A	120W OCL DC PRE-MAIN & STEREO AMPLIFIER	Kit	\$43.00	TY-36	AC/DC QUARTZ DIGITAL CLOCK	Kit	\$7.68
TA-1000A	100W DYNAMIC CLASS "A" MAIN POWER AMP (MONO)	Kit	\$45.50	TY-38	SOUND OR TOUCH CONTROL SWITCH	Kit	\$10.00
TA-1500	200W NEW CLASS "A" DC STEREO PRE-MAIN AMP	Kit	\$67.00	TY-41 MK III	INFRARED REMOTE CONTROL UNIT	Kit	\$25.00
TA-2400A	ELECTRONIC ECHO AND REVERBERATION AMP	Ass.	\$99.85			Ass.	\$30.00
TA-2500	HIGH QUALITY MULTI-PURPOSE PRE-AMPLIFIER	Ass.	\$82.00	TY-42	BAR/DOT LEVEL METER	Kit	\$21.00
TA-2200	DC FET SUPER CLASS "A" PRE-AMPLIFIER	Kit	\$38.00	TY-45	BAR/DOT AUDIO LEVEL DISPLAY	Kit	\$34.95
TA-2800	NF CR BIFET PRE-AMP (WITH 3WAY TONE CONTROL)	Kit	\$36.80	TY-47	SUPERIOR ELECTRONIC ROULETTE	Kit	\$16.92
TA-3000	STEREO SIMULATOR	Ass.	\$30.00	YAMATO 4001	3 1/2 DIGITAL MULTIMETER	@ SET	\$33.80
		Kit	\$25.00	T1	LCD THERMOMETER CLOCK W/IN/OUT DOOR SENSOR	@ SET	\$20.00
SM-43	3 1/2 MULTI-FUNCTIONAL LED D.P.M.	Kit	\$29.23	T2	LCD THERMOMETER CLOCK W/°C MEASURING	@ SET	\$18.00
SM-48	4 1/2 HI-PRECISION D.P.M.	Kit	\$38.00	8504	TALKING CLOCK MYNAH (GOLDEN OR BLACK)	@ SET	\$25.00
		Ass.	\$43.00	NO 620	CORDLESS SOLDERING IRON RECHARGEABLE	@ SET	\$22.80
SM-100	150MC UNIVERSAL DIGITAL FREQUENCY COUNTER	Ass.	\$99.00				
TY-43	3 1/2 DIGITAL PANEL METER	Kit	\$28.00				



MARK V ELECTRONICS INC
248 E. Main Street, Suite 100,
Alhambra, CA 91801
Please mail to:
P.O. Box 7065 ALHAMBRA CA 91802
Telex: 3716914 MARK 5
Information (1-818) 282-1130
Orders (1-818) 282-1196

TERMS:
Min order: \$10.00
Charge card order: \$20.00
N.O.C.O. Cashier's check, phone orders accept.
Calif. Res Add 6.5% Sales Tax.
Prices are subject to change without notice.
TOLL FREE (ORDERS ONLY): 1-800-521-MARK

All merchandises are subject to prior sale.
Shipping & Handling: Inside L.A. 5% of total order (Min 1.50), Outside L.A. 10% of total order (Min 2.50). Outside U.S.A. 20% of total order (Min 5.00). **Shipped by UPS**

**HOURS: MON-FRI 9:30 TO 5:00
SATURDAYS 9:30 TO 1:00
(PACIFIC TIME)**

BUILD A COMPLETE 256K XT SYSTEM—\$717

STATIC RAMS

2101	256x4	(450ns)	1.95
5101	256x4	(450ns)(CMOS)	3.95
2102L-4	1024x1	(250ns)(LP)	.69
2102L-2	1024x1	(450ns)(LP)	1.45
2112	256x4	(450ns)	2.99
2114	1024x4	(450ns)	.99
2114L-4	1024x4	(450ns)(LP)	1.09
2114L-2	1024x4	(200ns)(LP)	1.49
2114L-15	1024x4	(150ns)(LP)	1.95
TMS4044-4	4096x1	(450ns)	1.95
TMM2016-150	2048x8	(150ns)	1.49
TMM2016-100	2048x8	(150ns)	1.49
HMG116-4	2048x8	(200ns)(CMOS)	1.39
HMG116-3	2048x8	(150ns)(CMOS)	1.49
HMG116LP-4	2048x8	(200ns)(CMOS)(LP)	1.49
HMG116LP-3	2048x8	(150ns)(CMOS)(LP)	1.59
HMG116LP-2	2048x8	(120ns)(CMOS)(LP)	2.99
HMG264P-15	8192x8	(150ns)(CMOS)	3.89
HMG264LP-15	8192x8	(150ns)(CMOS)(LP)	3.95
HMG264LP-12	8192x8	(120ns)(CMOS)(LP)	4.49

LP: Low power

DYNAMIC RAMS

4116-250	16384x1	(250ns)	.49
4116-200	16384x1	(200ns)	.69
4116-150	16384x1	(150ns)	.89
4116-120	16384x1	(120ns)	1.49
MK4332	32768x1	(200ns)	6.95
4164-200	65536x1	(200ns)(5v)	1.19
4164-150	65536x1	(150ns)(5v)	1.29
4164-120	65536x1	(120ns)(5v)	1.95
MC6M665	65536x1	(200ns)(5v)	1.95
TMS4164	65536x1	(150ns)(5v)	1.95
4164-REFRESH	65536x1	(150ns)(5v)(REFRESH)	2.95
TMS4416	16384x4	(150ns)(5v)	4.95
41128-150	131072x1	(150ns)(5v)	5.95
41256-200	262144x1	(200ns)(5v)	2.95
41256-150	262144x1	(150ns)(5v)	2.95

5v: Single 5 Volt Supply

REFRESH Pin 1 Refresh

★★★★HIGH-TECH★★★★

NEC V20 UPD70108 \$14⁹⁵

REPLACES 8088 TO SPEED UP IBM PC 10-40%

- HIGH SPEED ADDRESS CALCULATION IN HARDWARE
- PIN COMPATIBLE WITH 8088
- SUPERSET OF 8088 INSTRUCTION SET
- LOW POWER CMOS

8MHz V20 UPD70108-8 \$24.95

8MHz V30 UPD70116-8 \$26.95

★★★★SPOTLIGHT★★★★

EPROMS

2708	1024x8	(450ns)	3.95
2716-6	2048x8	(650ns)	2.29
2716	2048x8	(450ns)(5V)	3.49
2716-1	2048x8	(350ns)(5V)	3.95
TMS2532	4096x8	(450ns)(5V)	3.95
2732	4096x8	(450ns)(5V)	3.89
2732A	4096x8	(250ns)(5V)(21V PGM)	4.25
2732A-2	4096x8	(200ns)(5V)(21V PGM)	3.95
27C64	8192x8	(250ns)(5V)(CMOS)	5.95
2764-250	8192x8	(450ns)(5V)	3.49
2764-200	8192x8	(250ns)(5V)	3.95
TMS2564	8192x8	(450ns)(5V)	8.95
MCM68766	8192x8	(350ns)(5V)(24 PIN)	17.95
27128	16384x8	(250ns)(5V)	4.25
27C256	32768x8	(250ns)(5V)(CMOS)	12.95
27256	32768x8	(250ns)(5V)	7.49

5V Single 5 Volt Supply 21V PGM: Program at 21 Volts

ORDER TOLL FREE 800-538-5000



SPECTRONICS CORPORATION EPROM ERASERS



Model	Timer	Capacity Chip	Intensity (uW/cm ²)	Unit Price
PE 14	NO	9	8,000	\$83.00
PE 14T	YES	9	8,000	\$119.00
PE 24T	YES	12	9,600	\$175.00

8000

8035	1.49
8039	1.95
8080	2.95
8085	2.49
8087-2	169.95
8087	129.00
8088	6.95
8088-2	9.95
8155	2.49
8155-2	3.95
8748	7.95
8755	19.95
80286	129.95
80287	199.95

6500 1.0 MHz

6502	2.79
65C02	12.95
6507	9.95
6520	1.95
6522	4.95
6526	26.95
6532	6.95
6545	6.95
6551	5.95
6561	19.95
6581	34.95

2.0 MHz

6502A	2.95
6520A	2.95
6522A	5.95
6532A	11.95
6545A	7.95
6551A	6.95

3.0 MHz

6502B	6.95
-------	------

6800 1.0 MHz

6800	1.95
6802	4.95
6803	9.95
6809	5.95
6809E	5.95
6810	2.95
6821	1.95
6840	6.95
6843	19.95
6844	12.95
6845	4.95
6847	11.95
6850	1.95
6883	22.95

2.0 MHz

68800	4.95
68802	5.95
68809E	6.95
68809	6.45
68821	3.50
68845	6.75
68850	3.95
68854	7.95

CLOCK CIRCUITS

MM5369	1.95
MM5369-EST	1.95
MM58167	12.95
MM58174	11.95
M5M5832	2.95

CRT CONTROLLERS

6845	4.95
68B45	8.95
6847	11.95
HD46505SP	6.95
MC1372	2.95
8275	26.95
7220	19.95
CRT5027	12.95
CRT5037	9.95
TMS9918A	19.95

DISK CONTROLLERS

1771	4.95
1791	9.95
1793	9.95
1795	12.95
1797	12.95
2791	19.95
2793	19.95
2797	29.95
6843	19.95
8272	4.95
UPD765	4.95
MB8876	12.95
MB8877	12.95
1691	6.95
2143	6.95

BIT RATE GENERATORS

MC14411	9.95
BR1941	4.95
4702	9.95
COM8116	8.95
MMS307	4.95

UARTS

AY51013	3.95
AY31015	4.95
TR1602	3.95
Z651	4.95
IM6403	6.95
IM6403	9.95
INS8250	6.95

SOUND CHIPS

76477	3.95
76489	8.95
SSI-263	39.95
AY3-8910	12.95
AY3-8912	12.95
SP1000	39.00

CRYSTALS

32.768 KHz	.95
1.0 MHz	2.95
1.8432	2.95
2.0	1.95
2.097152	1.95
2.4576	1.95
3.2768	1.95
3.579545	1.95
4.0	1.95
4.032	1.95
5.0	1.95
5.0688	1.95
6.0	1.95
6.144	1.95
6.5536	1.95
8.0	1.95
10.0	1.95
10.738635	1.95
12.0	1.95
14.31818	1.95
15.0	1.95
16.0	1.95
17.430	1.95
18.0	1.95
18.432	1.95
20.0	1.95
22.1184	1.95
24.0	1.95
32.0	1.95

CRYSTAL OSCILLATORS

1.0MHz	5.95
1.8432	5.95
2.0	5.95
2.4576	5.95
2.5	4.95
4.0	4.95
5.0688	4.95
6.0	4.95
6.144	4.95
8.0	4.95
10.0	4.95
12.0	4.95
12.480	4.95
15.0	4.95
16.0	4.95
18.432	4.95
20.0	4.95
24.0	4.95

MISC.

TMS99531	9.95
TMS99532	19.95
ULN2003	6.95
3242	7.95
3341	4.95
MC3470	1.95
MC3480	8.95
MC3497	2.95
IC1000	13.95
2513.001HP	6.95
AY5-2376	11.95
AY5-3600 PRO	11.95

74LS00

74LS00	16	74LS165	65
74LS01	18	74LS166	95
74LS02	17	74LS169	95
74LS03	18	74LS173	49
74LS04	16	74LS174	39
74LS05	18	74LS175	39
74LS08	18	74LS191	49
74LS09	18	74LS192	69
74LS10	16	74LS193	69
74LS11	22	74LS194	69
74LS12	22	74LS195	69
74LS13	26	74LS196	59
74LS14	39	74LS197	59
74LS15	26	74LS221	59
74LS20	17	74LS240	69
74LS21	22	74LS241	69
74LS22	22	74LS242	69
74LS27	23	74LS243	69
74LS28	26	74LS244	69
74LS30	17	74LS245	79
74LS31	29	74LS251	49
74LS33	28	74LS253	49
74LS37	26	74LS256	1.79
74LS38	26	74LS257	39
74LS42	39	74LS258	49
74LS45	59	74LS259	1.29
74LS48	69	74LS260	49
74LS51	17	74LS266	39
74LS73	29	74LS272	79
74LS74	24	74LS279	39
74LS75	29	74LS280	1.98
74LS76	29	74LS283	59
74LS83	49	74LS290	89
74LS85	49	74LS293	89
74LS86	22	74LS299	1.49
74LS90	39	74LS322	3.49
74LS92	49	74LS323	2.49
74LS93	39	74LS364	1.95
74LS95	49	74LS365	39
74LS107	34	74LS367	39
74LS109	36	74LS368	39
74LS112	29	74LS373	79
74LS122	45	74LS374	79
74LS123	49	74LS375	95
74LS124	2.75	74LS377	79
74LS125	39	74LS378	1.18
74LS126	39	74LS390	1.19
74LS132	39	74LS393	79
74LS133	49	74LS541	1.49
74LS136	39	74LS624	1.95
74LS138	39	74LS640	95
74LS139	39	74LS645	95
74LS145	99	74LS649	1.29
74LS147	99	74LS670	89
74LS148	99	74LS682	3.20
74LS151	39	74LS683	3.20
74LS153	39	74LS684	3.20
74LS154	1.49	74LS688	2.40
74LS156	59	74LS783	22.95
74LS157	35	31LS95	1.49
74LS158	29	31LS97	1.49
74LS160	29	81LS98	1.49
74LS161	39	25LS251	2.80
74LS162	49	25LS259	2.80
74LS163	39	26LS31	1.95
74LS164	49	26LS32	1.95

HIGH SPEED CMOS

A new family of high speed CMOS logic featuring the speed of low power Schottky (8ns typical gate propagation delay), combined with the advantages of CMOS: very low power consumption, superior noise immunity, and improved output drive.

74HC00

74HC: Operate at CMOS logic levels and are ideal for new, all-CMOS designs

74HC00	59	74HC148	1.19
74HC02	59	74HC151	.89
74HC04	59	74HC154	2.49
74HC08	59	74HC157	.89
74HC10	59	74HC158	1.95
74HC14	79	74HC163	1.15
74HC20	59	74HC175	.99
74HC27	59	74HC240	1.89
74HC30	59	74HC244	1.89
74HC32	69	74HC245	1.89
74HC51	59	74HC257	.85
74HC74	75	74HC259	1.39
74HC85	1.25	74HC273	1.89
74HC86	69	74HC299	4.95
74HC93	1.19	74HC368	.99
74HC107	79	74HC373	2.29
74HC109	79	74HC374	2.29
74HC112	79	74HC390	1.29
74HC125	1.19	74HC393	1.39
74HC132	1.19	74HC407	1.95
74HC133	69	74HC4020	1.39

PARTIAL LISTING ONLY — CALL FOR A FREE CATALOG

CMOS

4001	19	14419	4.95
4011	19	14433	14.95
4012	25	4503	.49
4013	35	4511	.69
4015	29	4516	.79
4016	29	4518	.85
4017	49	4522	.79
4018	69	4526	.79
4020	59	4527	1.95
4021	69	4528	.79
4024	49	4529	2.95
4025	25	4532	1.95
4027	39	4538	.95
4028	65	4541	1.29
4035	69	4553	5.79
4040	69	4585	.75
4041	75	4702	12.95
4042	59	74C30	.29
4043	85	74C74	.59
4044	69	74C74	.59
4045	1.98	74C83	1.95
4046	69	74C85	1.49
4047	69	74C95	.99
4049	29	74C150	5.75
4050	29	74C151	2.25
4051	69	74C161	.99
4052	69	74C163	.99
4053	69	74C164	1.39
4056	2.19	74C192	1.49
4060	69	74C193	1.49
4066	29	74C221	1.75
4069	19	74C240	1.89
4076	59	74C244	1.89
4077	29	74C374	1.99
4081	22	74C905	10.95
4085	79	74C911	8.95
4086	89	74C917	8.95
4093	49	74C922	4.49
4094	2.49	74C923	4.95
14411	9.95	74C926	7.95
14412	6.95	80C97	.95

7400/9000

7400	19	74147	2.49
7402	19	74148	1.20
7404	29	74150	1.35
7406	29	74151	.55
7407	29	74153	.55
7408	24	74154	1.49
7410	19	74155	.75
7411	25	74157	.55
7414	49	74159	1.65
7416	25	74161	.69
7417	25	74162	.69
7420	19	74164	.85
7423	29	74165	.85
7430	19	74166	1.00
7432	29	74175	.89
7438	29	74177	.75
7442	49	74178	1.15
7445	69	74181	2.25
7447	89	74182	.75
7470	35	74184	2.00
7473	34	74191	1.15
7474	33	74192	.79
7475	45	74194	.85
7476	35	74196	.79
7483	50	74197	.75
7485	59	74199	1.35
7487	39	74221	1.35
7489	2.15	74246	1.35
7490	39	74247	1.25
7492	50	74248	1.85
7493	35	74249	1.95
7495	55	74251	.75
7497	2.75	74265	1.35
74100	2.29	74273	1.95
74123	29	74278	3.11
74125	45	74368	.65
74141	65	9368	3.95
74143	5.95	9602	1.50
74144	2.95	9637	2.95
74145	60	96S02	1.95

74S00

74S00	.29	74S163	1.29
74S02	.29	74S168	3.95
74S03	.29	74S174	.79
74S04	.29	74S175	.79
74S05	.29	74S188	1.05
74S08	.35	74S189	1.95
74S10	.29	74S195	1.49
74S15	.35	74S196	1.49
74S30	.29	74S197	1.49
74S32	.35	74S226	3.99
74S37	69	74S240	1.49
74S38	69	74S241	1.49
74S74	49	74S244	1.49
74S8E	.95	74S257	.79
74S8E	.95	74S257	.79
74S112	50	74S258	.95
74S124	2.75	74S280	1.95
74S158	79	74S287	1.69
74S140	.55	74S288	1.69
74S151	.79	74S299	2.95
74S153	.79	74S373	1.69
74S157	.79	74S374	1.69
74S158	.95	74S471	4.95
74S161	1.29	74S571	2.95

VOLTAGE REGULATORS

TO-220 CASE			
7805T	49	7905T	59
7808T	49	7908T	59
7812T	49	7912T	59
7815T	49	7915T	59
TO-3 CASE			
7805K	1.39	7905K	1.49
7812K	1.39	7912K	1.49
TO-93 CASE			
78L05	49	79L05	69
78L12	49	79L12	1.49
OTHER VOLTAGE REGS			
LM323K	5V 3A	TD 3	4.79
LM328K	Adj. 3A	TD 3	3.95
78M05K	5V 5A	TD 3	7.95
78M12K	12V 3A	TD 3	8.95
78P05K	5V 10A	TD 3	4.95

LINEAR

TL066	99	LM733	.98
TL071	69	LM741	.29
TL072	1.09	LM747	.69
TL074	1.95	LM748	.59
TL081	59	MC1330	1.69
TL082	99	MC1350	1.19
TL084	1.49	MC1372	6.95
LM301	.34	LM1414	1.59
LM309K	1.25	LM1458	.49
LM311	.59	LM1488	.49
LM311H	.89	LM1489	.49
LM317K	3.49	LM1496	.85
LM317T	.95	LM1812	8.25
LM318	1.49	LM1889	1.95
LM319	1.25	ULN2003	.79
LM320	see 7900	XR2206	3.75
LM322	1.65	XR2211	2.95
LM323K	4.79	XR2240	1.95
LM324	4.49	MPO2907	1.95
LM331	3.95	LM2917	1.95
LM334	1.19	CA3046	.89
LM335	1.40	CA3081	.99
LM336	1.75	CA3082	.99
LM337K	3.95	CA3086	.80
LM338K	3.95	CA3089	1.95
LM339	.59	CA3130E	.99
LM340	see 7900	CA3146	1.29
LM350T	4.60	CA3160	1.19
LF353	.59	MC3470	1.95
LF356	.99	MC3480	8.95
LF357	.99	MC3487	2.95
LM358	59	LM3900	.49
LM380	89	LM3909	.98
LM383	1.95	LM3911	2.25
LM386	.89	LM3914	2.39
LM393	.45	MC4024	3.49
LM394H	4.60	MC4044	3.95
TL494	4.20	RC4136	1.25
TL497	3.25	RC4558	.69
NE555	.29	LM13600	1.49
NE556	1.49	75107	1.49
NE564	1.95	75150	1.95
LM565	.95	75154	1.95
LM566	1.49	75189	1.25
LM567	.79	75189	1.25
NE570	2.95	75451	.39
NE590	2.50	75452	.39
NE592	.98	75453	.39
LM710	.75	75477	1.29
LM713	49	75492	.79

IC SOCKETS

8 PIN ST	1.99	100-	
11 PIN ST	.11	10	
14 PIN ST	.11	.09	
16 PIN ST	12	10	
18 PIN ST	15	13	
20 PIN ST	18	15	
22 PIN ST	15	12	
24 PIN ST	20	15	
28 PIN ST	22	16	
40 PIN ST	30	22	
64 PIN ST	1.95	1.49	
ST SOLDERTAIL			
8 PIN WW	59	.69	
14 PIN WW	69	.52	
16 PIN WW	69	.58	
18 PIN WW	99	.90	
20 PIN WW	1.09	.98	
22 PIN WW	1.39	1.28	
24 PIN WW	1.49	1.35	
28 PIN WW	1.69	1.49	
40 PIN WW	1.99	1.80	
WW-W REWRAF			
16 PIN ZIF	4.95	CALL	
24 PIN ZIF	5.95	CALL	
28 PIN ZIF	6.95	CALL	
40 PIN ZIF	9.95	CALL	
ZIF TEXTFOOT			
(ZERO INSERTION FORCE)			

DATA ACQ INTERFACE

ADC0800	15.55	8T26	1.26
ADC0804	3.49	8T28	1.26
ADC0809	4.49	8T95	.85
ADC0816	14.95	8T96	.85
ADC0817	9.95	8T97	.85
ADC0831	9.95	8T98	.85
DAC0800	4.49	DM8131	2.95
DAC0806	1.95	DP8304	2.25
DAC0808	2.95	D58833	2.25
DAC1020	8.25	D58835	1.99
DAC1022	5.95	D58836	.99
MC1408L8	2.95	D58837	1.65

36 PIN CENTRONICS

		MALE	
IDCEN36	RIBBON CABLE	6.95	
CEN36	SOLDER CUP	4.95	
		FEMALE	
IDCEN36 F	RIBBON CABLE	7.95	
CEN36PC	RT ANGLE PC MOUNT	4.95	

INTERSIL

ICL7106	9.95
ICL7107	12.95
ICL7660	2.95
ICL8038	4.95
ICM7207A	5.99
ICM7208	15.99

EDGECARD CONNECTORS

100 PIN ST	S-100	.125	3.95
100 PIN WW	S-100	.125	4.95
62 PIN ST	IBM PC	1.00	1.95
50 PIN ST	APPLE	1.00	2.95
44 PIN ST	STD	1.56	1.95
44 PIN WW	STD	1.56	4.95

DIP CONNECTORS

DESCRIPTION	ORDER BY	CONTACTS								
		8	14	16	18	20	22	24	28	40
HIGH RELIABILITY TDDLED ST IC SOCKETS	AUGAT _{xx} ST	.62	.79	.89	1.09	1.29	1.39	1.49	1.69	2.49
HIGH RELIABILITY TDDLED WW IC SOCKETS	AUGAT _{xx} WW	1.30	1.80	2.10	2.40	2.50	2.90	3.15	3.70	5.40
COMPONENT CARRIES (DIP HEADERS)	ICC _{xx}	.49	.59	.69	.99	.99	.99	.99	1.09	1.49
RIBBON CABLE DIP PLUGS (IDC)	IDP _{xx}	.95	.95	1.75	2.95

FOR ORDERING INSTRUCTIONS SEE D SUBMINIATURE ABOVE

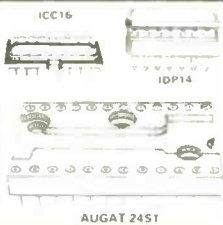

DIODES/OPTO/TRANSISTORS

N751	25	4N26	.69	
N759	25	4N27	.69	
N4148	25	1.00	4N28	.69
N4004	10	1.00	4N33	.89
N5402	25	4N37	1.19	
KB04	55	MCT-2	.59	
KB08A	95	MCT-6	1.29	
MDA99R2	35	TIL-111	.99	
ZV222	.25	2N3906	10	
2N2222	10	2N4401	.25	
2N2905	25	2N4402	.25	
2N2907	25	2N4403	.25	
2N3055	79	2N6045	1.75	
2N3904	10	TIP31	.49	

D-SUBMINIATURE

DESCRIPTION	ORDER BY	CONTACTS						
		9	15	19	25	37	50	
SOLDER CUP	MALE	DB _{xx} P	.82	.90	1.25	1.25	1.80	3.48
	FEMALE	DB _{xx} S	.95	1.15	1.50	1.50	2.35	4.32
RIGHT ANGLE PC SOLDER	MALE	IDB _{xx} PR	1.20	1.49	...	1.95	2.65	...
	FEMALE	IDB _{xx} SR	1.25	1.55	...	2.00	2.79	...
WIRE WRAP	MALE	IDB _{xx} PWW	1.69	2.56	...	3.89	5.60	...
	FEMALE	IDB _{xx} SWW	2.76	4.27	...	6.84	9.95	...
IDC RIBBON CABLE	MALE	IDB _{xx} P	2.70	2.95	...	3.98	5.70	...
	FEMALE	IDB _{xx} S	2.92	3.20	...	4.33	6.76	...
HOODS	METAL	MHODD _{xx}	1.25	1.25	1.30	1.30
	GREY	HODD _{xx}	.65	.6565	.75	.95

ORDERING INSTRUCTIONS: INSERT THE NUMBER OF CONTACTS IN THE POSITION MARKED 'x' OF THE 'ORDER BY' PART NUMBER LISTED

EXAMPLE: A 15 PIN RIGHT ANGLE MALE PC SOLDER WOULD BE DB15PR

MOUNTING HARDWARE \$1.00

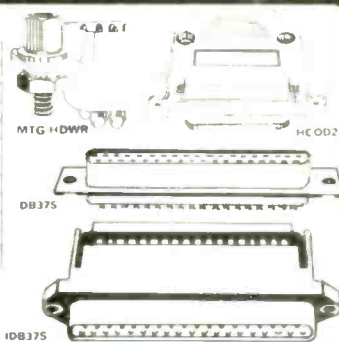

IDC CONNECTORS

DESCRIPTION

BARGAIN HUNTERS CORNER

DB25P 100/\$45 10/\$6.90
25 PIN MALE D SUB CONNECTOR

DB25S 100/\$52 10/\$7.90
25 PIN FEMALE D-SUB CONNECTOR

HOOD-25 100/\$31 10/\$6.90
PLASTIC HOOD FOR DB25

IDE34 100/\$129 10/\$14.90
34 PIN EDGE CONNECTOR

AUGAT 16WW 100/\$49 10/\$6.90
16 PIN WIRE WRAP IC SOCKET MACHINE PIN

.1uf DISC 1000/\$29.50 100/\$3.95
1uf 16 VOLT CERAMIC DISC CAPACITORS

SPECIALS END 6/30/86

PAGE WIRE WRAP WIRE PRECUT ASSORTMENT IN ASSORTED COLORS \$27.50

100ea 5.5", 6.0", 6.5", 7.0"
250ea 2.5", 4.5", 5.0"
500ea 3.0", 3.5", 4.0"

SPOOLS
100 feet \$4.30 250 feet \$7.25
500 feet \$13.25 1000 feet \$21.95

Please specify color.
Blue, Black, Yellow or Red

EMI FILTER \$4.95

MANUFACTURED BY CORCOM
• LOW COST
• FITS LC HP BELOW
• 6 AMP 120 240 VOLT

6 FOOT LINE CORDS

LC 2 2 CONDUCTOR 39
LC 3 2 CONDUCTOR 99
LC HP 3 CONDUCTOR W STD FEMALE SOCKET 1.49

MUFFIN FANS

3 1/2" SO ROTRON 14.95
3 6/32" SO ETRI 14.95
3 1/8" SO MASUSHITA 16.95

WIRE WRAP PROTOTYPE CARDS FR-4 EPOXY GLASS LAMINATE WITH GOLD-PLATED EDGE-CARD FINGERS



IBM-PR2 **IBM**
BOTH CARDS HAVE SILK SCREENED LEGENDS AND INCLUDES MOUNTING ERACKET

IBM-PR1 WITH 5V AND GROUND PLANE \$27.95
IBM-PR2 AS ABOVE WITH DECODING LAYOUT \$29.95

S-100
P100-1 BARE NO FOIL PADS \$15.15
P100-2 HORIZONTAL BUS \$21.80
P100-3 VERTICAL BUS \$21.80
P100-4 SINGLE FOIL PADS PER HOLE \$22.75

APPLE
P500-1 BARE NO FOIL PADS \$15.15
P500-3 HORIZONTAL BUS \$22.75
P500-4 SINGLE FOIL PADS PER HOLE \$21.80
7060-45 FOR APPLE IIe AUX SLOT \$30.00

SOCKET-WRAP I.D.™

• SLIPS OVER WIRE WRAP PINS
• IDENTIFIES PIN NUMBERS ON WRAP SIDE OF BOARD
• CAN WRITE ON PLASTIC, SUCH AS IC #

PINS	PART #	PCK. OF	PRICE
8	IDWRAP 08	10	1.95
14	IDWRAP 14	10	1.95
16	IDWRAP 16	10	1.95
18	IDWRAP 18	5	1.95
20	IDWRAP 20	5	1.95
22	IDWRAP 22	5	1.95
24	IDWRAP 24	5	1.95
28	IDWRAP 28	5	1.95
40	IDWRAP 40	5	1.95

PLEASE ORDER BY NUMBER OF PACKAGES (PCK OF)

FRAME STYLE TRANSFORMERS

12 6V AC CT 2 AMP 5.95
12 6V AC CT 4 AMP 7.95
12 6V AC CT 8 AMP 10.95
25 2V AC CT 2 AMP 7.95

25 PIN D-SUB GENDER CHANGERS \$7.95

SWITCHING POWER SUPPLIES

PS-IBM \$99.95
• FOR IBM PC XT COMPATIBLE
• 135 WATTS
• 5V 15A, 12V 4.2A PS IBM
• 5V 5A, 12V 5A
• ONE YEAR WARRANTY

PS-IBM-150 \$129.95
• FOR IBM PC XT COMPATIBLE
• 150 WATTS
• 12V 5.2A, 5V 16A
• 12V 5A, 5V 5A
• ONE YEAR WARRANTY PS 130

PS-130 \$99.95
• 130 WATTS
• SWITCH ON REAR
• FOR USE IN OTHER IBM TYPE MACHINES
• 90 DAY WARRANTY

PS-A \$49.95
• USE TO POWER APPLE TYPE SYSTEMS
• 5V 4A, 12V 2.5A
• 5V 5A, 12V 1A
• APPLE POWER CONNECTOR

PS-SPL200 \$49.95
• 5V 25A, 12V 3.5A
• 5V 1A, 12V 1A
• UL APPROVED
• ALUMINUM ENCLOSURE PS-SPL200

CAPACITORS

TANTALUM

1.0uf	15V	.35	.47	35V	45
6.8	15V	.70	1.0	35V	45
10	15V	.80	2.2	35V	65
22	15V	1.35	4.7	35V	85
22	35V	.40	1.0	35V	100

DISC

10uf	50V	.05	.680	50V	05
22	50V	.05	.001uf	50V	05
27	50V	.05	.0022	50V	05
33	50V	.05	.005	50V	05
47	50V	.05	.01	50V	07
68	50V	.05	.02	50V	07
100	50V	.05	.05	50V	07
220	50V	.05	.1	12V	10
560	50V	.05	1	50V	12

MONOLITHIC

.01uf	50V	14	1uf	50V	18
.047uf	50V	15	47uf	50V	25

ELECTROLYTIC

RADIAL		AXIAL			
1uf	25V	14	50V	14	
2.2	35V	15	50V	16	
4.7	50V	15	16V	14	
10	50V	15	47	50	20
47	35V	18	100	35V	25
100	16V	18	220	25V	30
220	35V	20	470	50V	50
470	25V	30	1000	16V	60
2200	16V	70	2200	16V	70
4700	25V	1.45	4700	16V	1.25
COMPUTER GRADE		44,000uf	30V	3.95	

DATASE EPROM ERASER \$34.95

• ERASES TWO EPROMS IN 10 MINUTES
• COMPACT NO DRAWER
• THIN METAL SHUTTER PREVENTS UV LIGHT FROM ESCAPING

1/4 WATT RESISTORS

5% CARBON FILM ALL STANDARD VALUES FROM 1 OHM TO 10 MEG OHM

10 PCS \$1.00/lot 05 100 PCS \$1.00/lot 02
50 PCS \$1.00/lot 025 1000 PCS \$1.00/lot 015

RESISTOR NETWORKS

SIP	10 PIN	9 RESISTOR	.69
SIP	8 PIN	7 RESISTOR	.59
DIP	16 PIN	8 RESISTOR	1.09
DIP	16 PIN	15 RESISTOR	1.09
DIP	14 PIN	7 RESISTOR	.99
DIP	14 PIN	13 RESISTOR	.99

SPECIALS ON BYPASS CAPACITORS

.01 uf CERAMIC DISC	100	\$5.00
.01 uf MONOLITHIC	100	\$10.00
.1 uf CERAMIC DISC	100	\$6.50
.1 uf MONOLITHIC	100	\$12.50

BOOKS BY STEVE CIARCIA

BUILD YOUR OWN Z80 COMPUTER	\$19.95
CIRCUIT CELLAR VOL 1	\$17.95
CIRCUIT CELLAR VOL 2	\$18.95
CIRCUIT CELLAR VOL 3	\$18.95
CIRCUIT CELLAR VOL 4	\$18.95
CIRCUIT CELLAR VOL 5	\$19.95

MICROCOMPUTER HARDWARE HANDBOOK FROM ELCOMP \$14.95

OVER 800 PAGES OF DATA SHEETS ON THE MOST COMMONLY USED ICs. INCLUDES TTL, CMOS, 74LS00, MEMORY, CPUs, MPU SUPPORT, AND MUCH MORE!

WISH SOLDERLESS BREADBOARDS

PART NUMBER	DIMENSIONS	DISTRIBUTION STRIPS	TIE POINTS	TERMINAL STRIPS	TIE POINTS	BINDING POSTS	PRICE
WBU D	3.8 x 6.50"	1	100				2.95
WBU T	1.38 x 6.50"			1	630		6.95
WBU 204-3	3.94 x 8.45"	1	100	2	1260	2	17.95
WBU 204	5.13 x 8.45"	4	400	2	1260	3	24.95
WBU 206	6.88 x 9.06"	5	500	3	1890	4	29.95
WBU 208	8.25 x 9.45"	7	700	4	2520	4	39.95

LITHIUM BATTERY AS USED IN CLOCK CIRCUITS



NEW EDITION! 1986 IC MASTER THE INDUSTRY STANDARD \$129.95

JDR Microdevices
1224 S. Bascom Avenue, San Jose, CA 95128
Toll Free 800-538-5000 • (408) 995-5430
FAX (408) 275-8415 • Telex 171-110

VISIT OUR RETAIL STORE LOCATED AT 1256 SOUTH BASCOM AVENUE IN SAN JOSE
HOURS: M-W-F, 9-5 TU-TH, 9-9 SAT, 10-3
PLEASE USE YOUR CUSTOMER NUMBER WHEN ORDERING
TERMS: Minimum order \$10.00. For shipping and handling include \$2.50 for UPS Ground and \$3.50 for UPS Air. Orders over 1 lb. and foreign orders may require additional shipping charges - please contact our sales department for the amount. CA residents must include applicable sales tax. All merchandise is warranted for 90 days unless otherwise stated. Prices are subject to change without notice. We are not responsible for typographical errors. We reserve the right to limit quantities and to substitute manufacturer. All merchandise subject to prior sale.

PARTIAL LISTING ONLY — CALL FOR A FREE CATALOG

DISK DRIVES FOR APPLE COMPUTERS

AP-150
\$99.95



- 1 1/2" HT. DIRECT DRIVE
- 100% APPLE COMPATIBLE
- SIX MONTH WARRANTY

BAL-500
\$129.95



- TEAC MECHANISM-DIRECT DRIVE
- 100% APPLE COMPATIBLE
- FULL ONE YEAR WARRANTY

AP-135
\$129.95



- FULL HT SHUGART MECHANISM
- DIRECT REPLACEMENT FOR APPLE DISK II
- SIX MONTH WARRANTY

DOUBLE SIDED!

MAC535
\$249.95



- 3 1/2" ADD-ON DISK DRIVE
- 100% MACINTOSH COMPATIBLE
- DOUBLE SIDED 800K BYTE STORAGE
- HIGH RELIABILITY DRIVE
- HAS AUTO-EJECT MECHANISM
- FULL ONE YEAR WARRANTY

AD-3C
\$139.95



- 100% APPLE IIc COMPATIBLE
- READY TO PLUG IN, W/ SHIELDED CABLE & MOLDED 19 PIN CONNECTOR
- FAST, RELIABLE SLIMLINE DIRECT DRIVE
- SIX MONTH WARRANTY

DISK DRIVE ACCESSORIES
FDD CONTROLLER CARD \$49.95
IIc ADAPTOR CABLE \$19.95
ADAPTS STANDARD APPLE DRIVES FOR USE WITH APPLE IIc

KB-1000 **\$79.95**

CASE WITH KEYBOARD FOR APPLE TYPE MOTHERBOARD

- USER DEFINED FUNCTION KEYS
- NUMERIC KEYPAD WITH CURSOR CONTROL
- CAPS LOCK
- AUTO-REPEAT



KEYBOARD-AP **\$49.95**

- REPLACEMENT FOR APPLE II KEYBOARD
- CAPS LOCK KEY, AUTO-REPEAT
- ONE KEY ENTRY OF BASIC OR CP/M COMMANDS



EXTENDER CARDS

IBM-PC	\$45.00
IBM-AT	\$68.00
APPLE II	\$45.00
APPLE IIe	\$45.00
MULTIBUS	\$86.00

APPLE COMPATIBLE INTERFACE CARDS

EPROM PROGRAMMER \$59.95

MODEL RP525



- DUPLICATE OR BURN ANY STANDARD 27xx SERIES EPROM
- EASY TO USE MENU-DRIVEN SOFTWARE IS INCLUDED
- MENU SELECTION FDR 2716, 2732, 2732A, 2764 AND 27128
- HIGH SPEED WRITE ALGORITHM
- LED INDICATORS FOR ACTIVITY
- NO EXTERNAL POWER SUPPLY NEEDED
- ONE YEAR WARRANTY

16K RAMCARD \$39.95



- FULL TWO YEAR WARRANTY
- EXPAND YOUR 48K APPLE TO 64K
- USE IN PLACE OF APPLE LANGUAGE CARD

BARE PC CARD W/INSTRUCTIONS \$9.95

IC TEST CARD \$99.95



- QUICKLY TESTS MANY COMMON ICs
- DISPLAYS PASS OR FAIL
- ONE YEAR WARRANTY
- TESTS: 4000 SERIES CMOS, 74HC SERIES CMOS, 7400, 74LS, 74L, 74H & 74S

300B MODEM \$49.95

FOR APPLE OR IBM
INCLUDES ASCII PRO-EZ SOFTWARE



• FCC APPROVED

- BELL SYSTEMS 103 COMPATIBLE
- INCLUDES AC ADAPTOR
- AUTO-DIAL
- DIRECT CONNECT

CABLE FOR APPLE IIc \$14.95

JOYSTICK CR-401 \$7.95

FOR ATARI 400, 800, 2600,
VIC 20 64 AND APPLE IIc



DISKFILE
HOLDS 70 5 1/4" DISKETTES



3.5" DISKFILE HOLDS 40 \$9.95

POWER STRIP

- UL APPROVED
- 15A CIRCUIT BREAKER



\$12.95

3-WAY SWITCH BOXES

- SERIAL OR PARALLEL
- CONNECTS 3 PRINTERS TO ONE COMPUTER OR VICE VERSA
- ALL LINES SWITCHES
- HIGH QUALITY ROTARY SWITCH MOUNTED ON PCB
- GOLD CONTACTS
- STURDY METAL ENCLOSURE



SWITCH-3P CENTRONICS PARALLEL \$99.95

SWITCH-3S RS232 SERIAL \$99.95

PRINTER BUFFERS

- FREES COMPUTER FOR OTHER TASKS WHILE PRINTING LONG DOCUMENTS
- STAND-ALONE DESIGN, WORKS WITH ANY COMPUTER OR PRINTER
- ALL MODELS FEATURE PRINT PAUSE MEMORY CHECK, GRAPHICS CAPABILITY

SP120P PARALLEL \$139.95

- 64K UPGRADABLE TO 256K
- LED INDICATOR SHOWS VOLUME OF DATA IN BUFFER

SP120S RS232 SERIAL \$159.95

- 64K UPGRADABLE TO 256K
- 6 SELECTABLE BAUD RATES, FRDM 600B-19,200B

SP110P PARALLEL \$249.95

- 64K UPGRADABLE TO 512K
- SPOOLS OUTPUT OF UP TO 3 COMPUTERS
- LED BARGRAPH DISPLAYS AMOUNT OF DATA IN BUFFER
- RESET FUNCTION CLEARS DATA IN BUFFER
- REPEAT FUNCTION CAN PRODUCE MULTIPLE COPIES OF A DOCUMENT

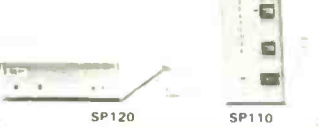

SP120 SP110

NASHUA DISKETTES DEALS

5 1/4" SOFT SECTOR
DS DD WITH HUB RINGS

\$9.90 **69c ea** **59c ea**
BOX OF 10 BULK QTY \$0 BULK QTY 250

NASHUA DISKETTES WERE JUDGED TO HAVE THE HIGHEST POLISH AND RECORDED AMPLITUDE OF ANY DISKETTES TESTED ACCORDING TO "COMPARING FLOPPY DISKS", BYTE 9-84

DISKETTES

NASHUA 5 1/4"

N-MD2D	DS DD SOFT	\$9.9c
N-MD2F	DS QUAD SOFT	\$34.9c
N-MD2H	DS HD FOF AT	\$49.9c

NASHUA 8"

N-FD1	SS DD SOFT	\$27.9c
N-FD2D	DS DD SOFT	\$34.9c

NASHUA 3.5"

N-3.5SS	3 1/2" SS DD FOR MAC	\$32.9c
---------	----------------------	---------

VERBATIM 5 1/4"

V-MD1D	SS DD SOFT	\$23.9c
V-MD2D	DS DD SOFT	\$29.9c
V-MD110D	SS DD 10 SECTOR HARD	\$23.9c

TEST EQUIPMENT FROM JDR INSTRUMENTS

DIGITAL MULTIMETER PEN DPM-1000
AUTO RANGING, POLARITY AND DECIMAL!

\$54.95

- LARGE 3.5 DIGIT DISPLAY
- DATA HOLD SWITCH FREEZES READING
- FAST, AUDIBLE CONTINUITY TEST
- LOW BATTERY INDICATOR
- OVERLOAD PROTECTION

20MHZ DUAL TRACE OSCILLOSCOPE

MODEL 2000

\$389.00

35MHZ DUAL TRACE OSCILLOSCOPE

MODEL 3500

\$549.00

FOR MORE INFORMATION ON THE OSCILLOSCOPES, SEE OUR AD ON PAGE 11

Sakata 120 CPS DOT MATRIX PRINTER

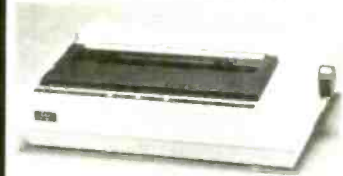

MODEL SP-1200 **\$169.95**

- EFSON IBM COMPATIBLE
- 9-PIN PRINTHEAD
- 120 CPS-BIDIRECTIONAL, 80 COL.
- EFFICIENT AND TRACTOR FEED
- PROPORTIONAL SPACING
- CENTRONICS PARALLEL INTERFACE
- 8 CHARACTER SETS AND GRAPHICS

6 FOOT IBM PRINTER CABLE \$9.95

REPLACEMENT RIBBON CARTRIDGE \$11.95

5 1/4" FLOPPY DISK DRIVES

TEAC FD-55B	1 1/2" HT DS DD (FOR IBM)	\$109.95
TEAC FD-55F	1 1/2" HT DS QUAD (FOR IBM)	\$109.95
TEAC FO-55GFV	1 1/2" HT DS HD (FOR IBM AT)	\$154.95
TANDON TM100-2	DS DD (FOR IBM)	\$99.95
TANDON TM50-2	1 1/2" HT DS DD (FOR IBM)	\$89.95
MPI B52	DS DD (FOR IBM)	\$89.95
QUME QT-142	1 1/2" HT DS DD (FOR IBM)	\$79.95

8" FLOPPY DISK DRIVES

FD 400-8	SS DD (ISA B01 EQUIV)	\$119.00
FD 400-8	DS DD (ISA B51R EQUIV)	\$159.00

DISK DRIVE ACCESSORIES

TEAC SPECIFICATION MANUAL	\$5.00
TEAC MAINTENANCE MANUAL	\$25.00
TEAC MOUNTING HARDWARE	\$2.95
MOUNTING RAILS FOR IBM AT	\$4.95
5 1/4" FDD POWER CABLE FOR 5 1/4" FDDs	\$2.95
5 1/4" FDD POWER CONNECTORS	\$1.19

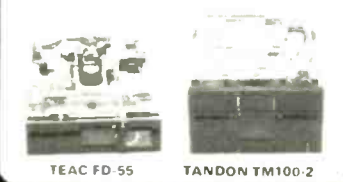

TEAC FD-55 TANDON TM100-2

DISK DRIVE ENCLOSURES

CAB-APPLE \$24.95

APPLE TYPE CABINET W/ OUT POWER SUPPLY

CAB-1FH5 \$69.95

FULL HT 5" BEIGE CABINET W/ POWER SUPPLY

CAB-2SV5 \$49.95

DUAL SLIMLINE 5" CABINET W/ POWER SUPPLY

CAB-2SV8 \$209.95

DUAL SLIMLINE 8" CABINET W/ POWER SUPPLY

CAB-2FH8 \$219.95

DUAL FULL HT 8" CABINET W/ POWER SUPPLY



CAB-2SV5 CAB-1FH5

CALL FOR VOLUME QUOTES © COPYRIGHT 1986 JDR MICRODEVICES

CIRCLE 190 ON FREE INFORMATION CARD

BUILD A COMPLETE 256K XT SYSTEM—\$717

XT COMPATIBLE MOTHERBOARD

\$159.00

- 4.77 MHz 8088 CPU, OPTIONAL 8087 CO-PROCESSOR
 - 8 EXPANSION SLOTS
 - DKM RAM INSTALLED, EXPANDABLE TO 640K ON BOARD MEMORY
 - ALL IC'S SOCKETED-HIGHEST QUALITY PC BOARD
 - ACCEPTS 2764 OR 27128 ROMS
- PRO-BIOS \$29.95**

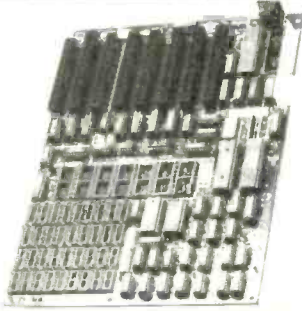

CRT MONITORS FOR ALL APPLICATIONS



LUXOR HI-RES RGB MONITOR
MODEL 190-9529

- DIGITAL RGB IBM COMPATIBLE
- 14" SCREEN
- 16 TRUE COLORS
- 25 MHz BANDWIDTH
- RESOLUTION > 640 x 262
- 31mm DOT PITCH
- CABLE FOR IBM PC INCLUDED



SAKATA COMPOSITE COLOR
MODEL SC-100

- TOP RATED FOR APPLE
- 13 COMPOSITE VIDEO
- RESOLUTION 280H x 300V
- INTERNAL AUDIO AMP
- ONE YEAR WARRANTY



CENTER SYSTEMS MONOCHROME
MODEL KLM-1211

- IBM COMPATIBLE TTL INPUT
- 12" NON GLARE SCREEN
- P39 GREEN PHOSPHORUS
- VERY HIGH RESOLUTION
- 25 MHz BANDWIDTH
- 1100 LINES (CENTER)

\$299.95

\$169.95

\$99.95

20 Mb HARD DISK SYSTEM

SEAGATE ST-225

\$489.00

INCLUDES 1/2 LENGTH HD CONTROLLER, CABLES, MOUNTING HARDWARE AND INSTRUCTIONS. ALL DRIVES ARE PRETESTED AND COME WITH A ONE YEAR WARRANTY.

IBM COMPATIBLE INTERFACE CARDS

ALL WITH A ONE YEAR WARRANTY

MULTI I/O FLOPPY CARD

\$129.95

PERFECT FOR THE 640K MOTHERBOARD



- 2 DRIVE FLOPPY DISK CONTROLLER
- 1 RS232 SERIAL PORT, OPTIONAL 2nd SERIAL PORT
- PARALLEL PRINTER PORT
- GAME PORT
- CLOCK CALENDAR
- SOFTWARE: CLOCK UTILITIES, RAMDISK, SPODLER

MULTIFUNCTION CARD

\$119.95

ALL THE FEATURES OF AST'S 6 PACK PLUS AT HALF THE PRICE



- CLOCK CALENDAR
- 0.384K RAM
- SERIAL PORT
- PARALLEL PORT
- GAME PORT
- SOFTWARE INCLUDED: PRINTER CABLE \$9.95, 64K RAM UPGRADE 9/510/71

COLOR GRAPHICS ADAPTOR

\$99.95

FULLY COMPATIBLE WITH IBM COLOR CARD



- 4 VIDEO INTERFACES: RGB, COMPOSITE COLOR, HI-RES, COMPOSITE MONOCHROME
- CONNECTOR FOR RF MODULATOR
- COLOR GRAPHICS MODE: 320 x 200
- MONO GRAPHICS MODE: 640 x 200
- LIGHT PEN INTERFACE

MONOCHROME GRAPHICS CARD

\$119.95

FULLY COMPATIBLE WITH IBM MONOCHROME ADAPTOR & HERCULES GRAPHICS



- LOTUS COMPATIBLE
- TEXT MODE: 80 x 25
- GRAPHICS MODE: 720 x 348
- PARALLEL PRINTER INTERFACE
- OPTIONAL SERIAL PORT \$19.95

MONOCHROME ADAPTOR

\$49.95

ANOTHER FANTASTIC VALUE FROM JDR!

- IBM COMPATIBLE TTL OUTPUT
 - 720 x 350 PIXEL DISPLAY
- PLEASE NOTE: THIS CARD WILL NOT RUN LOTUS GRAPHICS AND DOES NOT INCLUDE A PARALLEL PORT

FLOPPY DISK DRIVE ADAPTOR

\$49.95



- INTERFACES UP TO 4 STANDARD FDDs TO IBM PC OR COMPATIBLES
- INCLUDES CABLE FOR TWO INTERNAL DRIVES
- STANDARD DB37 FOR EXTERNAL DRIVES
- RUNS QUAD DENSITY DRIVES WHEN USED WITH JFORMAT

EASYDATA 1200 BAUD MODEM FOR IBM

INCLUDES PC TALK III COMMUNICATIONS SOFTWARE



- Hayes COMPATIBLE
- AUTO DIAL, AUTO ANSWER
- AUTO RE DIAL ON BUSY
- INCLUDES SERIAL PORT!
- ONE YEAR WARRANTY

\$169.95

BUILD YOUR OWN 256K XT COMPATIBLE SYSTEM

XT MOTHERBOARD	\$158.95
PRO-BIOS	\$28.95
256K RAM	\$26.55
130 WATT POWER SUPPLY	\$89.95
FLIP-TOP CASE	\$49.95
DKM-2000 KEYBOARD	\$79.95
1/2 HEIGHT QUME DRIVE	\$79.95
FLOPPY DISK CONTROLLER	\$49.95
MONOCHROME ADAPTOR	\$49.95
MONOCHROME MONITOR	\$89.95
TOTAL:	\$716.10

MONITOR STAND



TILTS AND SWIVELS

ONLY \$12.95

IBM PRINTER CABLE



DB25 TO CENTRONICS SHIELDED CABLE **\$9.95**

IBM STYLE COMPUTER CASE

AN ATTRACTIVE STEEL CASE WITH A HINGED LID FITS THE POPULAR PC XT COMPATIBLE MOTHERBOARDS

- SWITCH CUT OUT ON SIDE FOR PC XT STYLE POWER SUPPLY
- CUT OUT FOR 8 EXPANSION SLOTS
- ALL HARDWARE INCLUDED

\$49.95

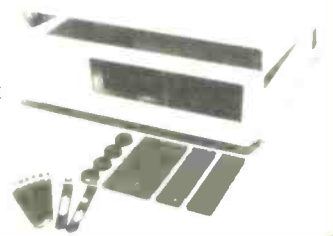

IBM COMPATIBLE KEYBOARDS

DKM-2000 **\$79.95**

IBM-5151 **\$99.95**



- "5150" STYLE KEYBOARD
- FULLY IBM COMPATIBLE
- LED STATUS INDICATORS FOR CAPS & NUMBER LOCK
- 83 KEY SAME LAYOUT AS IBM PC XT KEYBOARD



- REPLACEMENT FOR KEYTRONICS KB 5151™
- SEPARATE CURSOR & NUMERIC KEYPAD
- CAPS LOCK & NUMBER LOCK INDICATORS
- IMPROVED KEYBOARD LAYOUT

POWER SUPPLY



NOW ONLY \$89.95

- FOR IBM PC-XT COMPATIBLE
- 135 WATTS
- +5V @ 15A, -12V @ 4.2A
- -5V @ .5A, 12V @ .5A

150 WATT MODEL **\$99.95**

DISK DRIVES TANDON TM50-2

\$89.95

- 1/2 HT DS/DD
- IBM COMPATIBLE
- EXTREMELY QUIET!

TEAC FD-55B	DS/DD	\$109.95
TEAC FD-55F	DS/QUAD	\$109.95
TEAC FD-55G	DS/HD	\$154.95
QUME QT-142	DS/DD	\$79.95
MOUNTING HARDWARE		\$2.95
AT/RAILS		\$4.95

JDR Microdevices

1224 S. Bascom Avenue, San Jose, CA 95128

Toll Free 800-538-5000 • (408) 995-5430 • FAX (408) 275-8415 • Telex 171-110

TENMA

THE NAME YOU CAN TRUST IN ELECTRONIC TEST EQUIPMENT

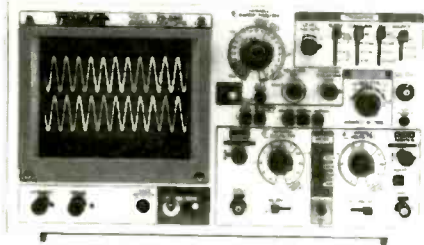

TENMA 35MHz Dual Trace Oscilloscope

- Two high quality 10:1 probes included
- For additional specification see MCM Catalog #12

#72-330
\$56900 (ea.)



NEW

TENMA 0-18V 3A Power Supply

- Regulated outputs — constant volt or constant current, both are continuously variable
- Can be connected in series or parallel for more voltage or current output
- Reverse polarity and overload protected
- Isolated output

#72-420 Available Mid May!

\$9950 (ea.)



TENMA Combination Function Generator and Frequency Counter

- 6 digit display
- Output range: 2Hz-2MHz: seven ranges
- Counter range: 1Hz-10MHz
- 5-15V TTL and CMOS output
- Wave forms: sine, triangle, square, pulse, and ramp.

#72-380

\$21990 (ea.)



NEW

TENMA Frequency Counter

- 8 digit LED display
- Measurement range: 1Hz-120MHz
- High input sensitivity of 20mV RMS

#72-375

\$18995 (ea.)



NEW

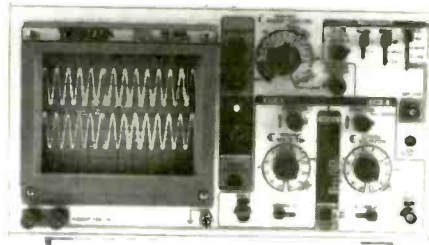

TENMA 20MHz Dual Trace Oscilloscope

- Two high quality 10:1 probes included
- For additional specification see MCM Catalog #12

#72-320

\$38995 (ea.)

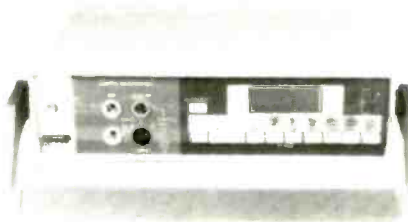

TENMA Bench Top DMM

- 3 1/2 digit
- Eight function DCV, ACV, DCA (up to 20A), ACA (up to 20A), Resistance (up to 20Mohm), Audible continuity test, diode test, capacitance test (up to 20µF)

Available Mid May!

#72-410

\$14980 (ea.)



NEW

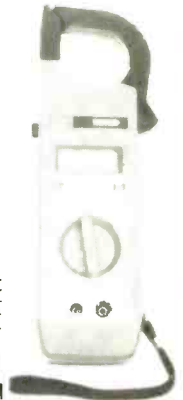

NEW

TENMA Clamp-On DMM

- 3 1/2 digit LCD display
- Rotary dial for rapid selection of functions and ranges
- AC current up to 1000A
- Audible continuity test, peak hold, data hold and diode check
- Carrying case included

#72-395

\$7995 (ea.)

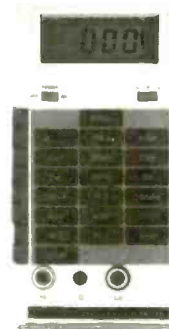

NEW

TENMA Digital LCR Meter

- Measures inductance, capacitance and resistance
- L = 1µH-200H, C = 1pF-200µF, R = 01ohm-20Mohm
- Carrying case included.

#72-370

\$14995 (ea.)



MCM ELECTRONICS
858 E. Congress Park Dr.
Centerville, Ohio 45459-4072
(513) 434-0031

SOURCE NO. RE-22

Terms:

- \$10 minimum order \$1.00 charge for orders under \$10
- \$20 minimum charge card order
- Orders shipped UPS C.O.D.
- Most orders shipped within 24 hours.
- Sales office open 8:30 am to 7:00 pm Saturdays 10:00 am to 3 pm EST
- For prepaid orders add \$2.75 for shipping and handling
- Should shipping and handling charges exceed \$2.75, the balance due will be sent C.O.D.

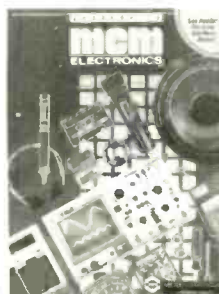

Be Sure To Call For Your FREE Catalog!
Over 6,000 Items!

We also have a full line of test equipment, computer accessories, telephone accessories, speakers, television parts, flybacks, yokes, switches, fuses, lamps, capacitors, resistors, cartridges, styli, wire, CATV equipment, the largest selection of original Japanese semiconductors in the country and more.

CALL TOLL FREE 1-800-543-4330
In Ohio 1-800-762-4315 • In Alaska and Hawaii 1-800-858-1849

CIRCLE 87 ON FREE INFORMATION CARD

Radio Shack Parts PlaceTM

START YOUR SUMMER PROJECTS AT THE SHACK[®]

Wire Wrapping! Easier and Faster Than Soldering



(1) **Wire Wrapping Tool.** Balanced 4 1/2" all-metal instrument strips, wraps and unwraps 30-gauge wire. #276-1570 5.95

(2) **30-Gauge Wire.** 50-foot spools. Use with any wrapping tool to make fast, reliable connections.

Color	Cat. No.	50-Ft. Spool
Red	278-501	2.39
White	278-502	2.39
Blue	278-503	2.39
Yellow	278-504	2.39

(3) **Wire Wrapping DIP Sockets.** Square 0.25" posts accept three levels of wire. Wire wrapping is the best way to construct experimental IC projects—making circuit changes is easy!

Pins	Cat. No.	Pkg. of 2
8	276-1988	1.19
14	276-1993	1.29
16	276-1994	1.39
28	276-1983	1.39
40	276-1984	1.99

Battery Guidebook 199

This New Book Helps You Select The Right Battery

Learn how batteries work, how to re-charge and test them, and how to choose the best values. Includes complete technical data on all ENERCELL[®] batteries. 160 pages. #62-1396

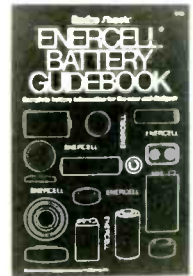

Plug-In PC Boards and Accessories

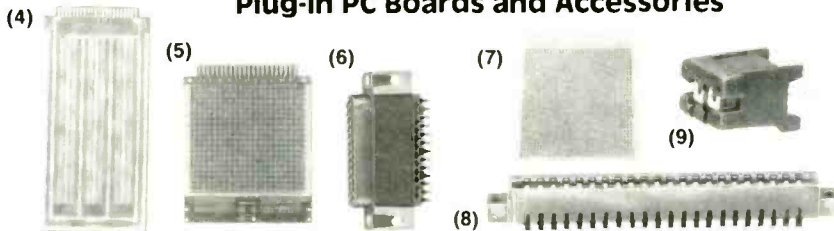

(4) **Jumbo Two-Bus Board.** Accepts up to 24 16-pin DIP sockets. 4 1/2" x 9 9/16". #276-190, 5.95

Jumbo IC/Discrete Board. Accepts up to 40 16-pin DIP ICs. #276-191 5.95

(5) **Board With RS-232 Ports.** Accepts two RS-232 connectors. 4 5/16" x 5 5/16". #276-187, 3.99

(6) **90° RS-232 Connector.** #276-1521 3.29

(7) **Multipurpose Two-Bus Board.** Predrilled DIP pattern. 4 1/2" x 4". #276-152 2.99

Three-Bus Version of Fig. 7. #276-154 2.99

(8) **44-Position Socket.** #276-1551 2.99

(9) **PCB Wire Connectors.** May be soldered to standard IC-spacing PC board. End-stackable, two-position. #276-1388 Set of 4/1.99

Special-Purchase Bargains!



(10) **Low-Voltage DC Motors.** Perfect for robotics experiments. #273-229 Pkg. of 2/1.49

(11) **Computer Keyboard.** QWERTY layout with total of 48 keys. #277-1023 3.95

(12) **Plug-In Triple-Output DC Supply.** Delivers +5 VDC up to 900 mA, -5 VDC up to 100 mA and +12 VDC up to 300 mA. UL listed. #277-1022 4.95

Panel Switch Values



(13) **SPST Push-On/Push-Off.** Rated 3 amps at 250 VAC. 1/2" mounting hole. #275-617 1.59

(14) **Momentary Switches.** Normally open. Rated 3 amps at 250 VAC. Set includes one black and one red. #275-609 Set of 2/1.69

(15) **SPST With 3/4" Brushed Aluminum Lever.** 3 amps at 125 VAC. Flush mount. #275-630 1.49

Top-Quality Capacitors

Tantalum

µF	WVDC	Cat No.	Each
0.1	35	272-1432	49
0.47	35	272-1433	49
1.0	35	272-1434	49
2.2	35	272-1435	59
10	16	272-1436	69
22	16	272-1437	79

Metal Film

µF	WVDC	Cat No.	Each
0.1	250	272-1051	39
0.47	250	272-1052	49
1	250	272-1053	59
1.0	250	272-1055	89

Prime Digital ICs

Include Pin-Out and Specs



Description	Type	Cat No.	Each
Quad 2-Input NOR Gate	4001	276-2401	99
Quad 2-Input NAND Gate	4011	276-2411	99
Dual Type-D Flip Flop	4013	276-2413	1.19
Decade Counter/Divider	4017	276-2417	1.49
Inverting Hex Buffer	4049	276-2449	1.19
Quad Bilateral Switch	4066	276-2466	1.19

Description	Type	Cat No.	Each
Quad 2-Input NAND Gate	7400	276-1801	89
Hex Inverter	7404	276-1802	99
Quad 2-Input AND Gate	7408	276-1822	1.29
BCD to 7-Segment Driver	7447	276-1805	1.69
Divide by 2/5 BCD Counter	7490	276-1808	1.19

Micronta[®] Test Instruments



(16) **21-Range LCD Multitester.** Digital precision and handy extra features! Has convenient pushbutton ohms zero adjust, special "diode-check" mode for testing semiconductor junctions and a built-in audible "beep" continuity tester. Measures to 1000 volts DC, 500 volts AC, DC and AC current to 200 mA, resistance to 20 megohms. Includes manual, probes, spare fuse. Requires 2 "AA" cells. #22-191 59.95

(17) **Dynamic Transistor Checker.** Tests PNPs, NPNs, silicon and germanium types in or out of circuit. Lamp indicates relative current gain, "opens" and "shorts." An output jack lets you connect an external meter or scope. With instructions. Requires "AA" battery. #22-025 14.95

Give Your Computer a Voice!

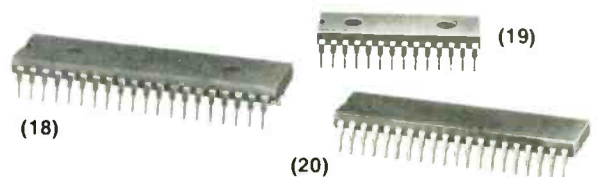

(18) **NEW! AY-3-8910A Sound Generator IC.** Only your imagination will limit the variety of sounds which can be generated by this 40-pin MOS-LSI chip and an 8 or 16-bit microprocessor. It's easily interfaced to any bus-oriented system and three simultaneous independent analog outputs are available. With data. #276-1787 9.95

(19) **SPO256-AL2 Speech Synthesis IC.** This 28-pin MOS LSI device uses a stored program to produce natural sounding speech. With circuit examples and detailed data. #276-1784 12.95

(20) **CTS256-AL2 Text-to-Speech IC.** This 40-pin device translates ASCII characters into control data for the synthesizer above. Makes it easy to add voice to most computers and terminals. With data. #276-1786, 16.95

Over 1000 items in stock: Binding posts, Books, Breadboards, Buzzers, Capacitors, Chokes, Clips, Connectors, Fuses, Hardware, ICs, Jacks, Knobs, Lamps, Multitesters, PC Boards, Plugs, Rectifiers, Relays, Resistors, Switches, Tools, Transformers, Transistors, Wire, Zeners and more!

Radio Shack[®]

A DIVISION OF TANDY CORPORATION

Prices apply at participating Radio Shack stores and dealers

CIRCLE 78 ON FREE INFORMATION CARD

RAMSEY

THE FIRST NAME IN ELECTRONIC TEST GEAR

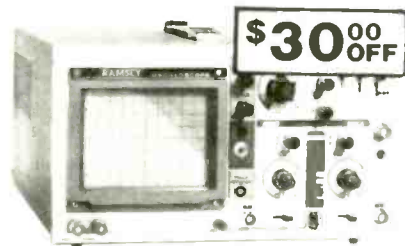

\$30⁰⁰ OFF

Save \$30 on the RAMSEY 20MHz Dual Trace Oscilloscope

Unsurpassed quality at an unbeatable price the Ramsey oscilloscope compares to others costing hundreds more. Features include a component testing circuit for resistor,

capacitor, digital circuit and diode testing • TV video sync filter • wide bandwidth & high sensitivity • internal graticule • front panel trace rotator • Z axis • high sensitivity x-y mode • regulated power supply • built-in calibrator • rock solid triggering

Was \$399.95 NOW ONLY **\$369⁹⁵** high quality hook on probes included



NEW RAMSEY 1200 VOM MULTITESTER

Check transistors, diodes and LEDs with this professional quality meter. Other features include: decibel scale • 20K volt metering system • 3/4" mirrored scale • polarity switch • 20 measuring ranges • safety probes • high impact plastic case

\$199⁹⁵ test leads and battery included



NEW

RAMSEY D-4100 COMPACT DIGITAL MULTITESTER

Compact sized reliability and accuracy. This LCD digital multimeter easily fits in your pocket, you can take it anywhere. It features full overload protection • 3 1/2 digit LCD readout • recessed input jacks • safety probes • diode check function • 2000 hours battery life

\$229⁹⁵ test leads and battery included

NEW 35 MHz DUAL TRACE OSCILLOSCOPE

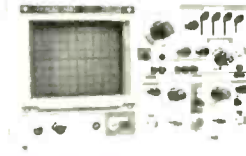

A heavy duty and accurate scope for service as well as production use. Features include • wide frequency bandwidth • optimal sensitivity • extremely bright display • delayed triggering sweep • hold off • ALT trigger • single sweep • TV sync • 5X magnification • XY or XYZ operation • HF/LF noise reduction

\$499⁹⁵ includes 2 high quality probes

ALL OSCILLOSCOPES INCLUDE 2 PROBES

NEW 15 MHz DUAL TRACE PORTABLE OSCILLOSCOPE

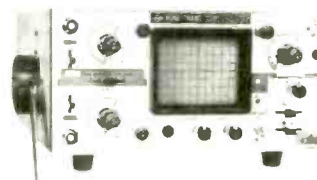

Ideal for field/bench applications, this scope can display up to 15 MHz signals. Internal battery pack allows up to 2 hours operation on a single charge. Features include • built-in battery charger • 5X horizontal magnification • high brightness CRT • front panel trace rotator • internal rechargeable battery pack

\$449⁹⁵ includes 2 high quality probes

MINI-100 FREQUENCY COUNTER

Features and capabilities of counters costing twice as much • compact • high sensitivity • low current drain • very accurate • leading zero blanking • field or shop use • 1 MHz to 500 MHz range • diode protected • 7 digit display

\$99⁹⁵ BATTERY CHARGER NICAD BATTERIES AND AC ADAPTER INCLUDED

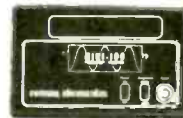

CT-70 7 DIGIT 525 MHz COUNTER

Lab quality at a breakthrough price. Features • 3 frequency ranges each with pre amp • dual selectable gate times • gate activity indicator • 50mV @ 150 MHz typical sensitivity • wide frequency range • 1 ppm accuracy

\$1199⁹⁵ wired includes AC adapter

CT-70 kit \$99.95
BP-4 nicad pack 8.95



CT-90 9 DIGIT 600 MHz COUNTER

The most versatile for less than \$300. Features 3 selectable gate times • 9 digits • gate indicator • display hold • 25mV @ 150 MHz typical sensitivity • 10 MHz timebase for WWW frequency range • 1 ppm accuracy

\$1499⁹⁵ wired includes AC adapter

CT-90 kit \$129.95
OV 1.0 1 PPM oven timebase \$9.95
BP-4 nicad pack 8.95

CT-50 8 DIGIT 600 MHz COUNTER

\$169⁹⁵ wired

CT-50 kit \$139.95
RA-1 receiver adapter kit 14.95

CT-125 9 DIGIT 1.2 GHz COUNTER

\$1699⁹⁵ wired includes AC adapter

BP-4 nicad \$8.95

MINI KITS—EASY TO ASSEMBLE, FUN TO USE BEGINNERS & PROS WILL HAVE A GREAT TIME WITH THESE KITS

FM MINI MIKE



A super high performance FM wireless mike kit! Transmits a stable signal up to 300 yards with exceptional audio quality by means of its built in electric mike. Kit includes case, mike, on/off switch, antenna, battery and super instructions. This is the finest unit available.

FM-3 Kit \$14.95
FM-3 Wired and Tested 19.95

Color Organ

See music come alive! 3 different lights flicker with music. One light each for high, mid-range and lows. Each individually adjustable and drives up to 300 W runs on 110VAC.

Complete kit, ML-1 \$8.95

Video Modulator Kit

Converts any TV to video monitor. Super stable, tunable open ch. 4 & Runs on 5 1/2V accepts VHS video signal. Best unit on the market! Complete kit, VD-1 \$2.95



Led Blinky Kit

A great attention getter which alternately flashes 2 jumbo LEDs. Use for name badges, buttons, warning panel lights, anything! Runs on 3 to 15 volts. Complete kit, BL-1 \$2.95

Super Sleuth

A super sensitive amplifier which will pick up a pin drop at 15 feet! Great for monitoring baby's room or as general purpose amplifier. Full 2W rms output, runs on 6 to 15 volts, uses 8-45 ohm speaker. Complete kit, BK-9 \$5.95

CPO-1

Runs on 3-12 Vdc 1 watt out, 1 KHz good for GPO Alarm, Audio Oscillator. Complete kit, \$2.95

FM Wireless Mike Kit



Transmits up to 300' to any FM broadcast radio, uses any type of mike. Runs on 3 to 9V. Type FM-2 has added sensitive mike preamp stage.

FM-1 Kit \$3.95 FM-2 Kit \$4.95

Whisper Light Kit

An interesting kit, small mike picks up sounds and converts them to light. The louder the sound, the brighter the light. Includes mike, controls up to 300 W, runs on 110 VAC.

Complete kit, WL-1 \$6.95

Tone Decoder

A complete tone decoder on a single PC board. Features 400-5000 Hz adjustable range via 20 turn pot, voltage regulation, 567 IC useful for touch-tone burst detection, FSK, etc. Can also be used as a stable tone oscillator. Runs on 5 to 12 volts. Complete kit, TD-1 \$5.95



Siren Kit

Produces upward and downward wail characteristic of a police siren. 5 W peak audio output runs on 3-15 volts, uses 3-45 ohm speaker. Complete kit, SK-3 \$2.95

60 Hz Time Base

Runs on 5-15 Vdc, low current (25mA), 1 min. month accuracy. TB-7 kit \$5.50 TB-7 Accy. \$9.95

Universal Timer Kit

Provides the basic parts and PC board required to provide a source of precision timing and pulse generation. Uses 555 timer IC and includes a range of parts for most timing needs.

UT-5 Kit \$5.95

Mad Blaster Kit

Produces LOUD ear shattering and attention getting siren like sound. Can supply up to 15 watts of stereo audio. Runs on 6-15 VDC.

MB-1 Kit \$4.95

30 Watt 2 mtr PWR AMP

Simple Class C power amp features 8 times power gain. 1 W in for 8 out, 2 W in for 15 out, 4 W in for 30 out. Max output of 35 W, incredible value, complete with all parts, less case and T-R relay.

PA-1 30 W pwr amp kit \$229⁹⁵

TR-1 RF sensed T-R relay kit 69⁵

Power Supply Kit

Complete triple regulated power supply provides variable 6 to 18 volts at 200 ma and -5 at 1 Amp. Excellent load regulation, good filtering and small size. Less transformers, requires 6.3V (a 1 A) and 24 VCT. Complete kit, PS-3LT \$69⁵



DM-700 DIGITAL MULTIMETER

Professional quality at a hobbyist price. Features include 26 different ranges and 5 functions • 3 1/2 digit, 1 inch LED display • automatic dermal placement • auto-matic polarity

\$1199⁹⁵ wired includes AC adapter

DM-700 kit \$99.95
MP-1 probe set 4.95



PR-2 COUNTER PREAMP

The PR-2 is ideal for measuring weak signals from 10 to 1,000 MHz • flat 25 db gain • BNC connectors • great for shifting RF • ideal receiver/TV preamp

\$449⁹⁵ wired includes AC adapter

PR-2 kit \$34.95



PS-2 AUDIO MULTIPLIER

The PS-2 is handy for high resolution audio resolution measurements, multiplies up in frequency • great for PL tone measurements • multiplies by 10 or 100 • 0.01 Hz resolution & built-in signal preamp/conditioner

\$499⁹⁵ wired

PR-2 kit \$39.95



PS-10B 1.5 GHz PRESCALER

Extends the range of your present counter to 1.5 GHz • 2 stage preamp • divide by 1000 circuit • super sensitive (50 mV typical) • BNC connectors • 1 GHz in 1 MHz out • draw only counter

\$799⁹⁵ wired includes AC adapter

PS 10-B Prescaler \$799⁹⁵

ACCESSORIES FOR RAMSEY COUNTERS

- Telescopic whip antenna—BNC plug \$ 8.95
- High impedance probe, light loading . . . 16.95
- Low pass probe, audio use 16.95
- Direct probe, general purpose use . . . 13.95
- Tilt ball, for CT-70, 90, 125 3.95

PHONE ORDERS CALL 716-586-3950

TELEX 466735 RAMSEY CI



RAMSEY ELECTRONICS, INC.
2575 Baird Rd.
Penfield, N.Y. 14626

TERMS: • satisfaction guaranteed • examine for 10 days; if not pleased, return in original form for refund • add 6% for shipping and insurance to a maximum of \$10.00 • overseas add 15% for surface mail • COD add \$2.50 (COD in USA only) • orders under \$15.00 add \$1.50 • NY residents add 7% sales tax • 90 day parts warranty on all kits • 1 year parts & labor warranty on all wired units.

CIRCLE 76 ON FREE INFORMATION CARD

ADVERTISING INDEX

RADIO-ELECTRONICS does not assume any responsibility for errors that may appear in the index below.

Free Information Number	Page	95	Dick Smith Electronics	98,99	189,190	JDR Microdevices	106,107	
81	A.I.S. Satellite	29	82	Digi-Key	102	191	JDR Microdevices	108
108	AMC Sales	81	—	Digital Research Computers	94	114,199	Jameco	13,100,101
76	AP Products	20	192	Diplomat International	28	115	Jensen Tools	29
107	All Electronics	95	124	Electronic Parts Outlet	112	—	Joseph Electronics	38
72	Amazing Devices	97	120	Elephant Electronics	28	87	MCM Electronics	109
84	Appliance Service	28	111,184	Etronix	12,85	93	Mark V. Electronics	103
77	B&K Precision	24	100	Firestik II	26	—	McGraw Hill Book Club	70
176	Banner Technical Books	81	121	Fluke Manufacturing	23	178	Measurement Devices	87
98	Beckman Industrial	32	—	Fordham Radio	9,CV4	177	Mercer	21
85	Blue Star Industries	29	194	Gentle Weyer	29	19	Microprocessors Unltd.	CD9
109	C & S Sales	31	—	Grantham College of Engineering	33	—	NRI	16
—	CIE	34	—	Halix Institute	30	—	National Education Centers	28
183	Caig Laboratories	14	62	Hameg	25	193	Non Linear	87
89	Cameo Enterprises	26	86	Heath	15,55	110	Omnitron	22
179	Chapman Tools	14	185	Hi-Shure	10	—	Pacific Cable	93
—	Command Productions	85	—	ICS Computer Training	12	96	Probestmaster	7
79	Communications Electronics	3	64	IWATSU	77	126	RAG Electronics	5
181	Cook's Institute	83	196	Imtronics Industries	83	—	RCA D&SP	CV3
—	Coop's Satellite Digest	79	186	Intek Electronics	29	78	Radio Shack	110
198	Crosley	29	197	Ishvar Technology	CD4	70	Ramsey	111
—	DAK Industries	91	65	J&W	96	92	Tektronix	CV2
127	Deco Industries	28,29	59	JDR Instruments	11	103	Wm B. Allen	27
180	Del-Phone Industries	28	187,188	JDR Microdevices	104,105.			

SUB-MINIATURE D STYLE CONNECTORS

SOLDER TYPE SUB MINIATURE CONNECTORS USED FOR COMPUTER HOOD UPS

Part No	Price
00-8 PLUG	SMDC 8P 56
00-8 SOCKET	SMDC 9S 59
00-8 HOOD	SMOH 8H 75
00-10 PLUG	SMDC 10P 64
00-10 SOCKET	SMDC 10S 69
00-10 HOOD	SMDC 10H 79
00-25 PLUG	SMDC 25P 75
00-25 SOCKET	SMDC 25S 79
00-25 HOOD	SMDC 25H 86
00-37 PLUG	SMDC 37P 1.85
00-37 SOCKET	SMDC 37S 2.45
00-37 HOOD	SMDC 37H 98

CONNECTORS

1-8 C STYLE CONNECTORS

00-25 PLUG IMD 25P 2.98

00-25 SOCKET IMD 25S 3.25

RIGHT ANGLE PC MOUNT

00-10 SOCKET SMDC 10SR 2.20

00-25 PLUG SMDC 25PR 2.70

00-37 SOCKET SMDC 37SR 4.50

DOUBLE ROW HEADERS

THESE HEADERS MATE WITH THE RIBBON CABLE CONNECTORS ABOVE

RIGHT ANGLE HEADERS

Part No	Price
20 PIN DRH 20	95
34 PIN DRH 34	98
34 PIN DRH-34	1.10
40 PIN DRH 40	1.15
50 PIN DRH 50	1.25
60 PIN DRH 60	1.35

STRAIGHT HEADERS

Part No	Price
20 PIN SH 20	95
34 PIN SH 34	1.25

RIBBON CABLE CONNECTORS

THESE CONNECTORS ARE DESIGNED TO BE PRESS MOUNTED ON STANDARD FLAT STYLE RIBBON CABLE. DOUBLE ROW CONNECTORS FIT STANDARD DOUBLE ROW HEADERS.

Part No	Price
10 PIN RDC 10	69
10 PIN RDC 16	75
20 PIN RDC 20	95
20 PIN RDC 26	1.10
34 PIN RDC 34	1.45
40 PIN RDC 40	1.75
50 PIN RDC 50	1.85
60 PIN RDC 60	1.98

CARD EDGE CONNECTORS

MATE WITH DOUBLE SIDED 1/8" PC BOARD WITH CONTACT FIBERS ON 100 CENTERS. INCLUDES BROWN CONTACT CONNECTORS SHIP FIT TO RIBBON CABLE WITH STANDARD 80 SPACING BETWEEN CONDUCTORS.

Part No	Price
20 Pin Connector Fits Card Edge with 80 Fibers on Each Side	2.75

V.20 5 5mhz NEC Speed up IBM by 30% **\$14.95**

V.20 8 8mhz NEC **\$19.95**

V.30 — Replaces 8086 in your system **\$24.95**

Basic Rom for IBM Clone Mother Board **\$ 9.95**

E-PROMS

2708 - 450ns	69	2764 - 450ns	2.20
2716 - 450ns	1.19	2764 - 250ns	2.80
2716 - 350ns	1.59	27128 - 200ns	3.95
27320A - 450ns	1.19	27256 - 250ns	7.95
27320A - 250ns	2.20		

RAMS

16K Dynamic - 200ns	32	16K Static - 200ns	1.25
16K Dynamic - 150ns	45	16K Static - 300ns	95
64K Dynamic - 200ns	1.15	64K Dynamic - 150ns	1.25
256K Dynamic - 150ns	3.35	2114 Type Static	55

ELECTRONIC PARTS OUTLET

2515 N. Scottsdale Road
Scottsdale, AZ 85257
(602) 941-9357
(602) 941-9377 (602) 941-9328, 9
(SEND FOR OUR FREE CATALOG)

MIN. ORDER \$20.00

8000-810-8200 MEMORY IC's

8000's	Price	8200's	Price
8031	3.95	8202	9.95
8035	2.95	8203	19.95
8038	2.45	8205	2.50
8080	9.95	8212	96
8080F3	9.95	8214	95
8084	7.0	8216	96
8085	3.95	8224	1.90
8085A-2	9.95	8226	1.90
8086	4.50	8228	2.20
8086-2	5.20	8237	2.90
8087-3	129.95	8238	2.30
8087-2	169.95	8243	1.25
8088	6.95	8250	3.70
8089	29.95	8251	1.75
		8251A	1.80
		8253	1.75
		8253-3	1.75
		8255	1.75
		8255-3	1.75
		8257	1.75
		8259	1.75
		8271	39.95
		8272	3.95
		8274	4.95
		8275	4.95
		8278	2.50
		8282	2.95
		8283	2.45
		8286	3.45
		8288	3.95
		8289	3.95
		8292	6.95

*Used in IBM Clone Motherboards

Z80 SERIES SPECIALS

2.5 MHz CPU CTC PIO	75	4.0 MHz (AI) CPU CTC PIO	1.50	2802TC	2MHz	45
DMA DART SID	95	2804TC	3.95	2804TC	4MHz	98
		2806CPU	2.50	2806CPU	2.5MHz	98
				2806CPU	4MHz	119

GREAT PRICES! GUARANTEED 100%

Please call for current prices. Prices subject to change. Please expect higher or lower prices on some items due to supply and demand and/or changing costs. Shipping and insurance extra.

*** NOW CREATING LOCATIONS AND MORE TO COME! ***

Gernsback Publications, Inc.
500-B Bi-County Blvd.
Farmingdale, NY 11735
(516) 293-3000
President: Larry Steckler
Vice President: Cathy Steckler

For Advertising ONLY 516-293-3000
Larry Steckler
publisher
Arline Fishman
advertising director
Shelli Weinman
advertising associate
Lisa Strassman
credit manager
Christina Estrada
advertising assistant

SALES OFFICES

EAST SOUTHEAST
Stanley Levitan
Eastern Sales Manager
Radio-Electronics
259-23 57th Avenue
Little Neck, NY 11362
718-428-6037, 516-293-3000

MIDWEST/Texas/Arkansas/Okla.
Ralph Bergen
Midwest Sales Manager
Radio-Electronics
540 Frontage Road—Suite 339
Northfield, IL 60093
312-446-1444

PACIFIC COAST/ Mountain States
Marvin Green
Pacific Sales Manager
Radio-Electronics
15335 Morrison St.—Suite 227
Sherman Oaks, CA 91403
818-986-2001

FOR FREE INFORMATION USE THESE POST-PAID CARDS

- 1 Print your name, address and Zip Code on one of the attached postage-paid cards.
- 2 Circle the number (or numbers) on the card that matches the number at the bottom of each ad or editorial item that you want information on. Advertisers' free information numbers also appear in the ad index on the facing page.

- 3 Mail the card. It's Postage-Paid.

The bottom free-information card is a BUSINESS/PROFESSIONAL CARD. If you use this card you MUST complete the spaces for Company Name, Title, and Phone Number. If these are not filled in, the card will not be processed.

NOTE: Use the postcard address for Free Product Information only. Address all editorial inquiries to Editor, Radio-Electronics, 500-B Bi-County Blvd., Farmingdale, NY 11735

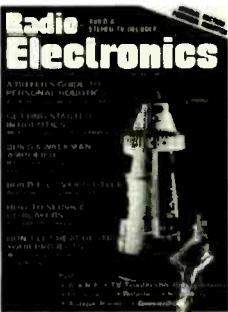

Radio Electronics.
Your favorite electronics magazine and still getting better

BUSINESS PROFESSIONAL FREE INFO CARD

Use this card if information requested is for business use. You must fill in company name and phone number.

Radio Electronics.

4-786

Name _____ Title _____
 Company _____
 Dept./MS _____ Phone () _____
 Company Address _____
 City _____ State _____ Zip + 4 _____

Unclear or incomplete mailing info will prevent our processing this request.

2 Please send me 12 issues of RADIO-ELECTRONICS for \$15.97 and bill me. (Canada \$20.97—US Funds only)

4 Please send me 6 issues of HANDS-ON ELECTRONICS for \$14.00 and bill me. (Canada \$17.00—US Funds only)

Is this your personal copy of RADIO-ELECTRONICS?
 6 Yes 8 No

19 37 55 73 91 109 127 145 163 181 199 217 235 253 271
 20 38 56 74 92 110 128 146 164 182 200 218 236 254 272
 21 39 57 75 93 111 129 147 165 183 201 219 237 255 273
 22 40 58 76 94 112 130 148 166 184 202 220 238 256 274
 23 41 59 77 95 113 131 149 167 185 203 221 239 257 275
 24 42 60 78 96 114 132 150 168 186 204 222 240 258 276
 25 43 61 79 97 115 133 151 169 187 205 223 241 259 277
 26 44 62 80 98 116 134 152 170 188 206 224 242 260 278
 9 27 45 63 81 99 117 135 153 171 189 207 225 243 261 279
 10 28 46 64 82 100 118 136 154 172 190 208 226 244 262 280
 11 29 47 65 83 101 119 137 155 173 191 209 227 245 263 281
 12 30 48 66 84 102 120 138 156 174 192 210 228 246 264 282
 13 31 49 67 85 103 121 139 157 175 193 211 229 247 265 283
 14 32 50 68 86 104 122 140 158 176 194 212 230 248 266 284
 15 33 51 69 87 105 123 141 159 177 195 213 231 249 267 285
 16 34 52 70 88 106 124 142 160 178 196 214 232 250 268 286
 17 35 53 71 89 107 125 143 161 179 197 215 233 251 269 287
 18 36 54 72 90 108 126 144 162 180 198 216 234 252 270 288

FREE INFORMATION CARD

VOID after SEPTEMBER 30, 1986

Allow 6-8 weeks for delivery of first issue

POSTAGE-PAID FREE INFORMATION CARD

Radio Electronics.

3-786

Name (please print) _____
 Company Name (if applicable) _____
 Address _____
 City _____ State _____ Zip + 4 _____

Unclear or incomplete mailing info will prevent our processing this request.

- 2 Please send me 12 issues of RADIO-ELECTRONICS for \$15.97 and bill me. (Canada \$20.97—US Funds only)
- 4 Please send me 6 issues of HANDS-ON ELECTRONICS for \$14.00 and bill me. (Canada \$17.00—US Funds only)

Is this your personal copy of RADIO-ELECTRONICS?

6 Yes 8 No

19 37 55 73 91 109 127 145 163 181 199 217 235 253 271
 20 38 56 74 92 110 128 146 164 182 200 218 236 254 272
 21 39 57 75 93 111 129 147 165 183 201 219 237 255 273
 22 40 58 76 94 112 130 148 166 184 202 220 238 256 274
 23 41 59 77 95 113 131 149 167 185 203 221 239 257 275
 24 42 60 78 96 114 132 150 168 186 204 222 240 258 276
 25 43 61 79 97 115 133 151 169 187 205 223 241 259 277
 26 44 62 80 98 116 134 152 170 188 206 224 242 260 278
 9 27 45 63 81 99 117 135 153 171 189 207 225 243 261 279
 10 28 46 64 82 100 118 136 154 172 190 208 226 244 262 280
 11 29 47 65 83 101 119 137 155 173 191 209 227 245 263 281
 12 30 48 66 84 102 120 138 156 174 192 210 228 246 264 282
 13 31 49 67 85 103 121 139 157 175 193 211 229 247 265 283
 14 32 50 68 86 104 122 140 158 176 194 212 230 248 266 284
 15 33 51 69 87 105 123 141 159 177 195 213 231 249 267 285
 16 34 52 70 88 106 124 142 160 178 196 214 232 250 268 286
 17 35 53 71 89 107 125 143 161 179 197 215 233 251 269 287
 18 36 54 72 90 108 126 144 162 180 198 216 234 252 270 288

FREE INFORMATION CARD

VOID after SEPTEMBER 30, 1986

Allow 6-8 weeks for delivery of first issue

BUSINESS REPLY MAIL
 FIRST CLASS PERMIT NO 597 BOULDER, COLORADO

Radio Electronics.
SUBSCRIPTION SERVICE
 P.O. Box 51866
 BOULDER, COLORADO 80321-1866

NO POSTAGE
 NECESSARY
 IF MAILED
 IN THE
 UNITED STATES



NO POSTAGE
NECESSARY
IF MAILED
IN THE
UNITED STATES

BUSINESS REPLY MAIL
FIRST CLASS PERMIT NO. 27346 PHILADELPHIA, PA

POSTAGE WILL BE PAID BY ADDRESSEE

**Radio-
Electronics**

FREE PRODUCT INFORMATION
P.O. BOX 13775
PHILADELPHIA, PA. 19101-9867

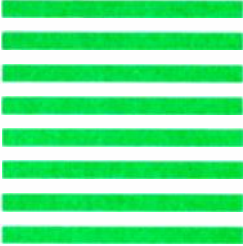

For New
Ideas
In Electronics
read **Radio-
Electronics**
every month.

During the next
12 months

Radio-Electronics will carry up to the minute articles on:

- Computers • Video
- Solid-state technology
- Outstanding construction projects
- Satellite TV • Telephones
- Radio • Stereo • Equipment Reports
- Test equipment • VCR's
- Servicing
- Industrial electronics



NEW IDEAS AND INNOVATIONS
IN ELECTRONICS APPEAR IN EVERY
ISSUE OF RADIO-ELECTRONICS

KEEP UP TO DATE! DON'T MISS
ANY ISSUES!

SUBSCRIBE TODAY!

USE THE ORDER CARD ON YOUR
LEFT!

**Hands-on
Electronics**

Formerly Special Projects

Delivers construction article after construction article....Exciting columns including Jensen on DXing, Freidman on computers, Test bench tips, Noll with Calling All Hams, New Products and more.

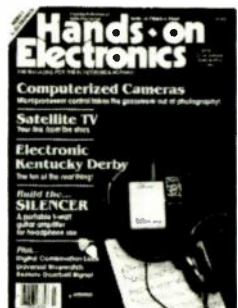

SUBSCRIBE TODAY!

USE THE REPLY CARDS ON YOUR
LEFT!

**Radio-
Electronics**

4SG62

Subscribe today to the magazine that keeps you up-to-date with the newest ideas and innovations in electronics. (If you already are a subscriber, do a friend a favor and pass this subscription card along to him.)

check offer preferred

- | | |
|--|---|
| <input type="checkbox"/> 1 Year—12 issues ONLY \$15.97
(You save \$7.43 off single copy price) | <input type="checkbox"/> 2 Years (SAVE MORE)—24 issues \$30.97
(You save \$15.83 off single copy price) |
| <input type="checkbox"/> Canada—12 issues \$20.97 | <input type="checkbox"/> Canada—12 issues \$40.97 |

ALL SUBSCRIPTIONS PAYABLE IN U.S. FUNDS ONLY.

- | | | |
|---|----------------------------------|--|
| <input type="checkbox"/> Payment enclosed | <input type="checkbox"/> Bill Me | <input type="checkbox"/> Check here if you are extending or renewing your subscription |
|---|----------------------------------|--|

Name (Please Print) _____

Company Name (If applicable) _____

Address _____

City _____ State _____ Zip _____

Allow 6-8 weeks for delivery of first issue



NO POSTAGE
NECESSARY
IF MAILED
IN THE
UNITED STATES

BUSINESS REPLY MAIL
FIRST CLASS PERMIT NO. 27346 PHILADELPHIA, PA

POSTAGE WILL BE PAID BY ADDRESSEE

**Radio-
Electronics**

FREE PRODUCT INFORMATION
P.O. BOX 13775
PHILADELPHIA, PA. 19101-9867

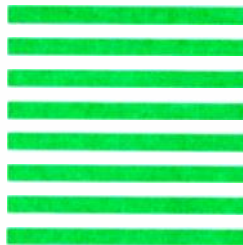

2 SIMPLE SOLUTIONS TO 227,000 PROBLEMS.

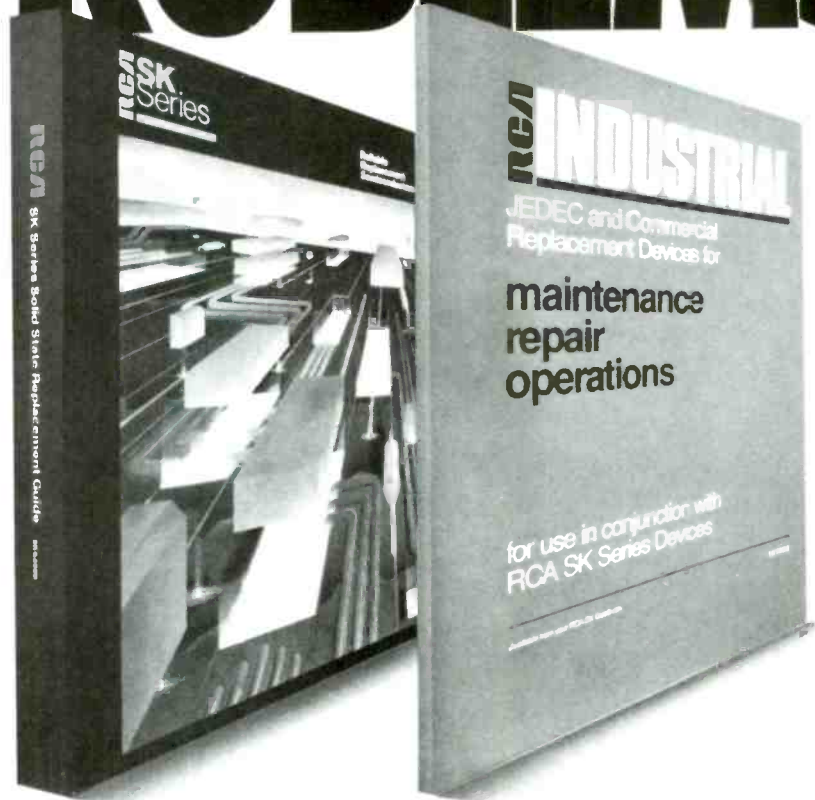

RCA's SK Series Replacement Guide (SKG202D) is your one source for over 206,000 solid state replacements using 2,500 SK and KH types. Integrated circuits, thyristors, rectifiers, transistors, microprocessors — RCA has them all.

Likewise, RCA's Industrial MRO Guide (1K7862) lists over 4,000 devices that replace more than 21,000 JEDEC* and Commercial types. The Guide also includes Power MOS/FETs, QMOS Integrated Circuits, a combined index/cross reference, and a section on high-reliability devices.

Together, these RCA Guides provide fast, easy answers for 227,000 solid state replacement problems.

For copies, see your local RCA distributor. Or write: Sales Promotion Services, RCA Distributor and Special Products Division, 2000 Clements Bridge Rd., Deptford, NJ 08096-2088.

*Joint Electron Device Engineering Council

RCA SK Replacement
Solid State



SCOPE 3½ DIGIT LCD MINI-METER WITH THE MAXI-SPECS

Small enough to fit in your shirt pocket

\$29.95
ONLY

Model
DVM-630

Model CC-30 Deluxe
Zippered Carrying Case \$4.50

- 0.5% DC accuracy
- 6 Functions, 19 Ranges
 - DC Voltage, 0.1 mV to 1000 V • DC Current, 0.1 uA to 2A • Resistance, 0.1 ohm to 2 M ohm • Diode Test • Battery Test
- Measures approx. 5 x 2¾ x 7/8 in.
- 300 hour battery life
- Automatic zero adjust
- Low battery indication
- Test leads included



SCOPE HAND-HELD DIGITAL CAPACITANCE and MULTIMETERS

- 0.5% DC Accuracy
- Highest Quality
- Highest Performance
- Lowest Prices



Model DCM-602
\$69.95

3½ Digit Capacitance Meter
8 ranges with full scale values to 2000 uF
FEATURES • Broad test range - 1 pF to 2000 uF • LSI circuit provides high reliability and durability • Lower power consumption • Crystal time base • Protected from charged capacitors • Frequency range - 800 Hz to 8 Hz

Model DVM-634
\$48.75

7 functions, 32 ranges.
Transistor measurement included.

3½ Digital Multimeters

FEATURES • DC Voltage 100 uV - 1000 V • AC Voltage 100 uV - 750 V • AC/DC Current 200 uA - 10 Amps • Resistance 20 Megohms • Capacitance (DVM 636/638) 1 pF - 20 uF • Overload Protection • Auto-decimal LCD readout • Polarity indication • 300 hour battery life with 9V transistor battery • Low battery indication

Model DVM-638
\$79.95

11 functions, 38 ranges.
Includes logic level detector,
audible visual continuity,
capacitance and conductance
measurement.

Model DVM-636
\$62.75

8 functions, 37 ranges.
Capacitance measurement
included.

ASK FOR FREE CATALOG.
Money orders, checks accepted. C.O.D.'s require 25% deposit.



Fordham

260 Motor Parkway, Hauppauge, NY 11788

Toll Free
800-645-9518
In NY State 800-832-1446

Service & Shipping Charge Schedule Continental U.S.A.

FOR ORDERS	ADD
\$25-\$100	\$4.50
\$101-\$250	\$6.00
\$251-\$500	\$8.00
\$501-750	\$10.50
\$751-1,000	\$12.50
\$1,001-1500	\$16.50
\$1,501-2,000	\$20.00
\$2,001 and Up	\$25.00