

48783

**SPECIAL
16-PAGE TEAR OUT
COMPUTER DIGEST**

**SPECIAL SECTION
SATELLITE TV
BUYERS GUIDE**

**\$1.75 OCT. 1984
IN CANADA \$2.25**

Radio- Electronics®

COMPUTERS - VIDEO - STEREO - TECHNOLOGY - SERVICE

**BUILD THIS
SATELLITE TV STEREO
DEMODULATOR.**

R-E's add-on for your satellite TV receiver tunes you into stereo audio. ➡

**ELECTRONICS
IN MEDICINE.**

How images of the human body are produced.

**RECHARGEABLE
BATTERIES.**

How to choose the one that best suits your needs.

**BUILD A
COMPUTERIZED
IC TESTER.**

With this automated tester you can quickly weed out your faulty digital IC's.



A
GERNSBACK
PUBLICATION

**SATELLITE TV
COMPONENT
BUYERS GUIDE.**

What's available if you want to piece together your satellite receiver system.

*****5-DIGIT 95014
303092 DRK 645DH091 14 9 DEC86
LLOYD DARKNELL
6450 MYRTLEWOOD DR
CUPERTINO CA 95014

Board ★ State-Of-Solid-State

★ Hobby Corner ★ New Idea

★ Service Clinic ★ Equipment Reports



Now! Tek quality and expert advice are just a free phone call away!

100 MHz dual time base scope. Easy-to-read CRT, bright, full-sized 8x10 cm, 14 kv accelerating potential complete with BEAM FIND, separate A/B dual intensity controls, FOCUS and TRACE ROTATION

Wide range vertical sensitivity. Choose from 2 mV/div (1x probe) to 50 V/div (10x probe); color-keyed for 1x and 10x probes; variable control increases scale factor by 2.5 to 1.

Two 100 MHz, high sensitivity channels. 3.5 ns risetime; dc to ≥ 100 MHz bandwidth from 5 V/div to 5 mV/div; extended sensitivity of 2 mV/div at ≥ 90 MHz.

A/B sweep selection. Calibrated A sweeps from 50 ns/div to 0.5 s/div; B sweeps from 50 ns/div to 50 ms/div; variable control for up to 2.5 to 1 reduction and 10x magnification for sweeps to 5 ns/div.

Dual time base measurements. Select either A or B sweeps, or both alternately with A intensified by B.

B trigger slope and level. Use B trigger level to select B-triggered or run-after-delay modes; use B TRIGGER SLOPE to select transitions.



Our direct order line gets you the industry's leading price/performance portables... and fast answers from experts!

The 60 MHz single time base delay 2213A, the 60 MHz dual time base 2215A and the 100 MHz dual time base 2235 offer unprecedented reliability and affordability, plus the industry's first 3-year warranty* on labor and parts, CRT included.

The cost: just \$1200 for the 2213A, \$1450 for the 2215A, \$1650 for the 2235.† Even at these low prices, there's no scrimping on performance. You

have the bandwidth for digital and analog circuits. The sensitivity for low signal measurements. The sweep speeds for fast logic families. And delayed sweep for fast, accurate timing measurements. All scopes are UL Listed and CSA approved.

You can order, or obtain literature, through the Tek National Marketing Center. Technical personnel, expert in scope applications, will answer your questions and expedite delivery. Direct orders include comprehensive 3-year warranty*, operator's

manual, two 10X probes, 15-day return policy and worldwide service backup.

Order toll free: 1-800-426-2200, Ask for Rick.

In Oregon, call collect: (503) 627-9000. Or write Tektronix, Inc. P.O. Box 1700 Beaverton, OR 97075

Tektronix
COMMITTED TO EXCELLENCE

Probably the second most important book you can turn to for guidance.

Electronics dealers and repair experts know they can depend on Philips ECG[®] Replacement Semis to fit and to work—reliably.

And they know they can depend on the new ECG Semiconductor Master Replacement Guide to save them time, money and aggravation when ordering the parts they need.

545 pages. 3,100 ECG Semiconductor types. More than 700 new products including transient voltage suppressors, micro-processor ICs, thermal cutoffs, solid state relays and more.

It's the only book of its kind you'll ever need this year, and you can get it from your nearest ECG distributor. Just call **1-800-225-8326** toll-free for his name and phone number (in Massachusetts, call 1-617-890-6107).

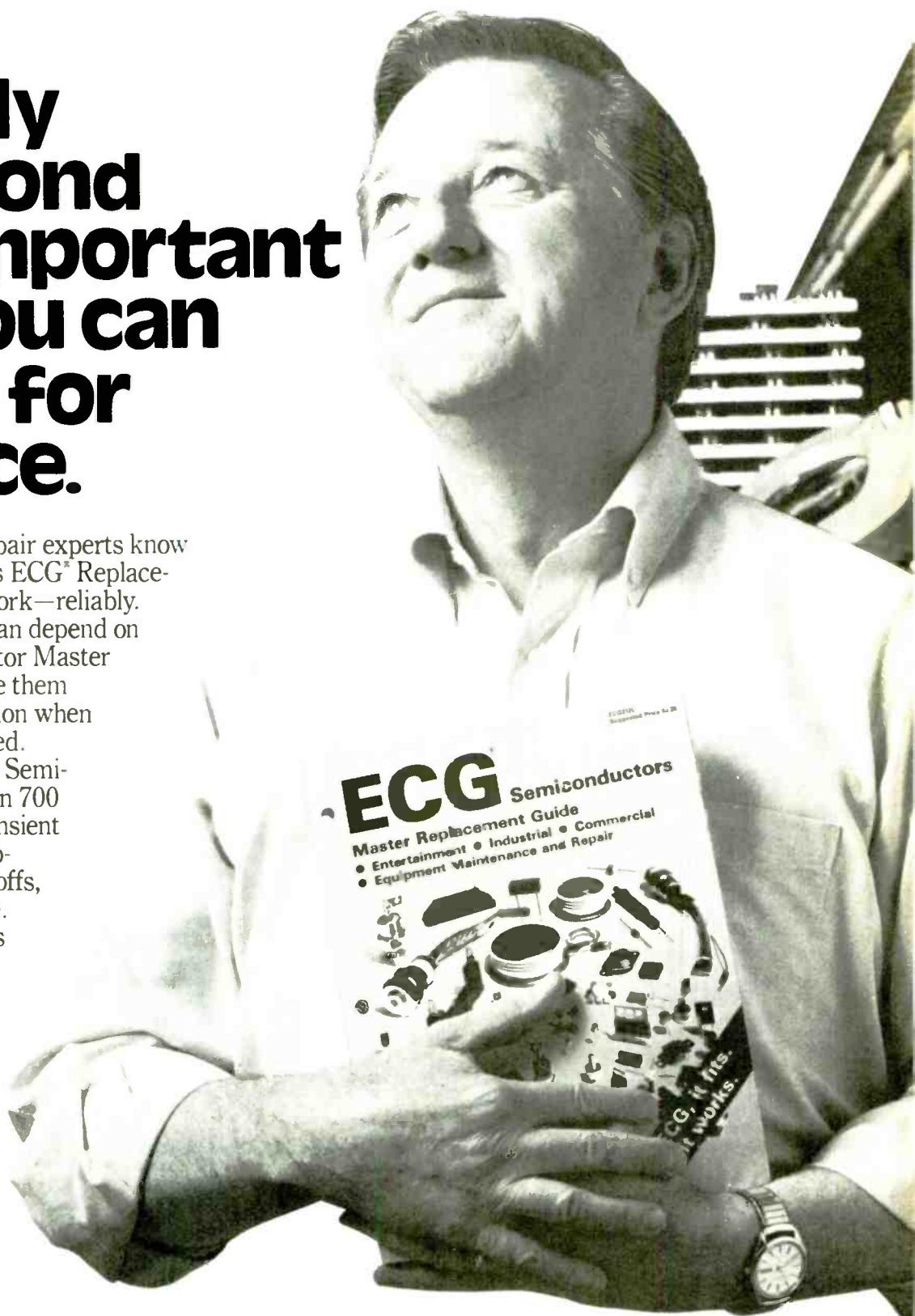

If it's ECG, it fits. And it works.

Philips ECG

A North American Philips Company

CIRCLE 47 ON FREE INFORMATION CARD

NEW!

Regency[®] Scanners

Communications Electronics,[™] the world's largest distributor of radio scanners, introduces new models with special savings on all radio scanners. Chances are the police, fire and weather emergencies you'll read about in tomorrow's paper are coming through on a scanner today.

We give you excellent service because CE distributes more scanners worldwide than anyone else. Our warehouse facilities are equipped to process thousands of scanner orders every week. We also export scanners to over 300 countries and military installations. Almost all items are in stock for quick shipment, so if you're a person who prefers fact to fantasy and who needs to know what's really happening around you, order your radio today from CE.

NEW! Regency[®] MX5000-E

List price \$599.95/CE price \$359.00
Multi-Band, 20 Channel • No-crystal scanner
Search • Lockout • Priority • AC/DC
Selectable AM-FM modes • LCD display
World's first continuous coverage scanner
Frequency range: 25-550 MHz, continuous coverage. Never before have so many features come in such a small package. The Regency MX5000 mobile or home scanner has continuous coverage from 25 to 550 MHz. That means you can hear CB, Television audio, FM broadcast stations, all aircraft bands including military and the normal scanner bands, all on your choice of 20 programmable channels.

Regency[®] MX3000-E

List price \$319.95/CE price \$179.00
6-Band, 30 Channel • No-crystal scanner
Search • Lockout • Priority • AC/DC
Bands: 30-50, 144-174, 440-512 MHz
The Regency Touch MX3000 provides the ease of computer controlled, touch-entry programming in a compact-sized scanner for use at home or on the road. Enter your favorite public service frequencies by simply touching the numbered pressure pads. You'll even hear a "beep" tone that lets you know you've made contact.

In addition to scanning the programmed channels, the MX3000 has the ability to search through as much as an entire band for an active frequency. The MX3000 includes channel 1 priority, dual scan speeds, scan or search delay and a brightness switch for day or night operation.

Regency[®] Z30-E

List price \$279.95/CE price \$169.00
6-Band, 30 Channel • No-crystal scanner
Bands: 30-50, 144-174, 440-512 MHz
Cover your choice of over 15,000 frequencies on 30 channels at the touch of your finger.

Regency[®] C403-E

List price \$99.95/CE price \$59.00
5-Band, 4 Channel • Crystal scanner
Channel indicator LED • AC only • Low cost
Bands: 30-50, 148-174, 450-470 MHz
Regency's basic scanner, the C403 gives you the excitement of police, fire and emergency calls at a budget price. It can tune in to any of five public service bands and brings the signal in loud and clear...on any of four possible channels. It comes with detachable telescope antenna and AC power cord. Order one crystal certificate for each channel you want to receive.

Regency[®] HX1000-E

List price \$329.95/CE price \$209.00
6-Band, 30 Channel • No Crystal scanner
Search • Lockout • Priority • Scan delay
Sidelit liquid crystal display • Digital Clock
Frequency range: 30-50, 144-174, 440-512 MHz.
The new handheld Regency HX1000 scanner is fully keyboard programmable for the ultimate in versatility. You can scan up to 30 channels at the same time. When you activate the priority control, you automatically override all other calls to listen to your favorite frequency. The LCD display is even sidelit for night use. A die-cast aluminum chassis makes this the most rugged and durable hand-held scanner available. There is even a backup lithium battery to maintain memory for two years. Includes wall charger, carrying case, belt clip, flexible antenna and nicad battery. Order your Regency HX1000 now.

Regency[®] R106-E

List price \$159.95/CE price \$92.00
5-Band, 10 Channel • Crystal scanner • AC/DC
Frequency range: 30-50, 144-174, 450-512 MHz.
A versatile scanner, The Regency R-106 is built to provide maximum reception at home or on the road. Rugged cabinet protects the advanced design circuitry allowing you years of dependable listening.

NEW! Regency[®] R1050-E

List price \$179.95/CE price \$109.00
6-Band, 10 Channel • Crystalless • AC only
Frequency range: 30-50, 144-174, 440-512 MHz.
Now you can enjoy computerized scanner versatility at a price that's less than some crystal units. The Regency R1050 lets you in on all the action of police, fire, weather, and emergency calls. You'll even hear mobile telephones.

Programming the R1050 is easy. Merely touch the keyboard and enter any of over 15,000 frequencies on your choice of 10 channels.

Regency[®] HX650-E

List price \$129.95/CE price \$79.00
5-Band, 6 Channel • Handheld crystal scanner
Bands: 30-50, 146-174, 450-512 MHz.
Now you can tune in any emergency around town, from wherever you are, the second it happens. Advanced circuitry gives you the world's smallest scanner. Our low CE price includes battery charger/A.C. adapter.

NEW! Regency[®] HX-650P-E

List Price \$189.95/CE price \$104.00
Now, Communications Electronics offers a special packaged price on the Regency HX-650 scanner and the following items for only \$104.00. You get the Regency HX-650 scanner, a set of 4 AAA ni-cad batteries, the MA-506 carrying case, six crystal certificates, AC adapter/charger and flexible rubber antenna for only \$104.00 per package plus \$10.00 shipping/handling. To order this special package, use CE special order number HX-650P-E.

QUANTITY DISCOUNTS AVAILABLE

Order two scanners at the same time and deduct 1%, for three scanners deduct 2%, four scanners deduct 3%, five scanners deduct 4% and six or more scanners purchased at the same time earns you a 5% discount off our super low single unit price.

NEW! Regency[®] MX7000-E

List price \$699.95/CE price \$449.00
10-Band, 20 Channel • Crystalless • AC/DC
Frequency range: 25-550 MHz, continuous coverage and 800 MHz. to 1.2 GHz, continuous coverage
In addition to normal scanner listening, the MX7000 offers CB, VHF, and UHF TV audio, FM Broadcast, all aircraft bands (civil and military), 800 MHz communications, cellular telephone, and when connected to a printer or CRT, satellite weather pictures.

The Regency Touch MX7000 provides the ease of computer controlled, touch-entry programming in a compact-sized scanner for use at home or on the road. Enter your favorite frequencies by simply touching the numbered pressure pads. You'll even hear a "beep" tone that lets you know you've made contact.

In addition to scanning the programmed channels, the MX7000 has the ability to search through as much as an entire band for an active frequency. When a call is received, the frequency will appear on the digital display.

Regency[®] Z10-E

List price \$239.95/CE price \$138.00
6-Band, 10 Channel • No-crystal scanner
Priority control • Search/Scan • AC/DC
Bands: 30-50, 140-174, 440-512 MHz.
Cover your choice of over 15,000 frequencies on 10 channels at the touch of your finger.

OTHER RADIO ACCESSORIES

B-4-E 1.2 V AAA Ni-Cad batteries (set of four) \$9.00
A-135C-E Crystal certificate \$3.00
A60-E Magnet mount mobile antenna \$35.00
A70-E Base station antenna \$35.00
Add \$3.00 shipping for all accessories ordered at the same time.
Add \$3.00 shipping per scanner antenna.

BUY WITH CONFIDENCE

To get the fastest delivery from CE of any scanner, send or phone your order directly to our Scanner Distribution Center.[™] Be sure to calculate your price using the CE prices in this ad. Michigan residents please add 4% sales tax or supply your tax I.D. number. Written purchase orders are accepted from approved government agencies and most well rated firms at a 10% surcharge for net 10 billing. All sales are subject to availability, acceptance and verification. All sales on accessories are final. Prices, terms and specifications are subject to change without notice. All prices are in U.S. dollars. Out of stock items will be placed on backorder automatically unless CE is instructed differently. A \$5.00 additional handling fee will be charged for all orders with a merchandise total under \$50.00. Shipments are F.O.B. Ann Arbor, Michigan. No COD's. Most products that we sell have a manufacturer's warranty. Free copies of warranties on these products are available prior to purchase by writing to CE. International orders are invited with a \$20.00 surcharge for special handling in addition to shipping charges. Non-certified checks require bank clearance.

Mail orders to: Communications Electronics,[™] Box 1002, Ann Arbor, Michigan 48106 U.S.A. Add \$7.00 per scanner for U.P.S. ground shipping and handling in the continental U.S.A. For Canada, Puerto Rico, Hawaii, Alaska, or APO/FPO delivery, shipping charges are three times continental U.S. rates. If you have a Visa or Master Card, you may call and place a credit card order. Order toll-free in the U.S. Dial 800-521-4414. In Canada, order toll-free by calling 800-221-3475. WUI Telex CE anytime, dial 671-0155. If you are outside the U.S. or in Michigan dial 313-973-8888. Order today.

Scanner Distribution Center[™] and CE logos are trademarks of Communications Electronics Inc.
† Regency is a federally registered trademark of Regency Electronics Inc. AD #080384-E
Copyright © 1984 Communications Electronics

Order Toll Free... call 1-800-521-4414

COMMUNICATIONS ELECTRONICS[™]

Consumer Products Division

818 Phoenix □ Box 1002 □ Ann Arbor, Michigan 48106 U.S.A.
Call TOLL-FREE 800-521-4414 or outside U.S.A. 313-973-8888

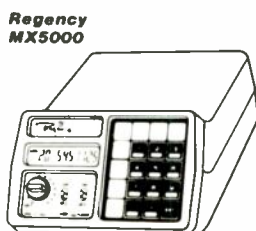
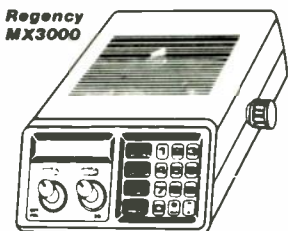

OCTOBER 84

**Radio-
Electronics**
Electronics publishers since 1908

Vol. 55 No. 10

SPECIAL SECTION

- 63 RECEIVING SATELLITE TELEVISION**
If you've been thinking of putting together your own TVRO system, let our buyer's guide help you out! **Marc Stern**
- 65 SATELLITE-TV BASICS**
- 69 SATELLITE-TV RECEIVERS**
- 73 THE DISH**
- 77 FEEDHORNS, WAVEGUIDES, AND LNA'S**
- 80 MANUFACTURER LIST**

BUILD THIS

- 51 SATELLITE STEREO DEMODULATOR**
To complement our satellite-TV buyer's guide, here's a look at an accessory that no TVRO owner should be without. **Roger Cota and Lloyd Addington**
- 83 COMPUTER-CONTROLLED IC TESTER**
Part 2. This month, we complete the tester and then improve it. **Floyd L. Oats**

TECHNOLOGY

- 14 VIDEO NEWS**
Tomorrow's news and technology in this quickly changing industry. **David Lachenbruch**
- 16 SATELLITE/TELETEXT NEWS**
What's new in communications technology. **Gary H. Arlen**
- 55 RECHARGEABLE BATTERIES**
Part 2. A look at rechargeable batteries, and how to choose the right battery for your needs. **Robert Grossblatt**
- 59 ELECTRONICS IN MEDICAL IMAGING**
A look at X-ray, CAT-scan, and other imaging techniques and the electronics behind them. **Ray Fish, Ph.D. M.D.**

CIRCUITS AND COMPONENTS

- 32 NEW IDEAS**
Improve your single-trace scope.
- 97 DESIGNER'S NOTEBOOK**
Some simple oscillator circuits. **Robert Grossblatt**
- 88 HOBBY CORNER**
Why be afraid of computers? **Earl "Doc" Savage, K4SDS**
- 94 DRAWING BOARD**
Using the 4089 binary rate multiplier IC. **Robert Grossblatt**
- 100 STATE OF SOLID STATE**
Low-power amplifier IC's. **Robert F. Scott**

RADIO

- 98 COMMUNICATIONS CORNER**
Phased antenna systems. **Herb Friedman**

VIDEO

- 105 SERVICE CLINIC**
Working with chip components. **Jack Darr**
- 109 SERVICE QUESTIONS**
Radio-Electronics' Service Editor solves readers' problems.

COMPUTERS

- 102 COMPUTER CORNER**
A look at the portable computers. **Les Spindle**
- Following **COMPUTER DIGEST**
page 108 A look at printer standards; How to use standard cassette recorders with your Commodore computer; How to use VisiCalc to determine op-amp circuit values, and more!

EQUIPMENT REPORTS

- 34 Hameg Model HM605 Oscilloscope**
- 44 Microsoft Premium Softcard IIe**

DEPARTMENTS

- 6 Advertising and Sales Offices**
- 140 Advertising Index**
- 6 Editorial**
- 141 Free Information Card**
- 22 Letters**
- 117 Market Center**
- 46 New Products**
- 12 What's News**

As a service to readers, Radio-Electronics publishes available plans or information relating to newsworthy products, techniques and scientific and technological developments. Because of possible variances in the quality and condition of materials and workmanship used by readers, Radio-Electronics disclaims any responsibility for the safe and proper functioning of reader-built projects based upon or from plans or information published in this magazine.

COVER 1



Even though much of the programming transmitted from satellites contains stereo audio, if you don't have a stereo demodulator, you won't hear it in stereo. Unfortunately the price of add-on stereo demodulators—often hundreds of dollars—can certainly rob you of the pleasure you'd otherwise gain from stereo reception.

The stereo demodulator that we'll show you how to build costs less than \$80. You can use it to listen to the stereo audio that is transmitted along with video signals. And you can use it to listen to the many audio-only programs. Either way, you don't have to wait for terrestrial TV to start stereo programming. If you have a TVRO, you can listen in stereo NOW. The story begins on page 51.

NEXT MONTH

ON SALE OCTOBER 23

COLOR-DISPLAY TECHNOLOGY

New technology will make it possible to offer color displays in many applications.

INTERFACING THE ZX81

Part 4 (which did not run this month due to space restrictions) shows how you can control a speech synthesizer with the ZX81 or Timex Sinclair 1000.

SHORTWAVE BROADCASTING CONFERENCE

A look at the Geneva Shortwave Broadcasting Conference (WARC-HFBC) and what it means to you.

AND LOTS MORE!

Radio-Electronics

Hugo Gernsback (1884-1967) founder
M. Harvey Gernsback, editor-in-chief
Larry Steckler, CET, publisher

EDITORIAL DEPARTMENT

Art Kleiman, editor
Brian C. Fenton,
technical editor
Carl Laron, WB2SLR,
associate editor
Robert A. Young, assistant editor
Julian S. Martin, editorial associate
Byron G. Wels, editorial associate
Jack Darr, CET, service editor
Robert F. Scott,
semiconductor editor
Herb Friedman,
communications editor
Earl "Doc" Savage, K4SDS,
hobby editor
Robert Grossblatt, circuits editor
Gary H. Arlen, contributing editor
David Lachenbruch,
contributing editor
Lou Frenzel, contributing editor
Bess Issacson, editorial assistant

PRODUCTION DEPARTMENT

Ruby M. Yee, production manager
Robert A. W. Lowndes,
editorial production
Dianne Osias, advertising production
Karen Tucker, production traffic

CIRCULATION DEPARTMENT

Jackie Weaver, circulation manager
Rita Sabalis, circulation coordinator
Jacqueline Allen, circulation assistant

Cover photo by Robert Lewis

Radio-Electronics is indexed in *Applied Science & Technology Index* and *Readers Guide to Periodical Literature*.

Microfilm & microfiche editions are available. Contact circulation department for details.

Advertising Sales Offices listed on page 140.

Radio-Electronics, (ISSN 0033-7862) Published monthly by Gernsback Publications, Inc., 200 Park Avenue South, New York, NY 10003. Second-Class Postage Paid at New York, N.Y. and additional mailing offices. One-year subscription rate: U.S.A. and U.S. possessions, \$14.97. Canada, \$17.97. Other countries, \$22.47 (cash orders only, payable in U.S.A. currency). Single copies \$1.75. © 1984 by Gernsback Publications, Inc. All rights reserved. Printed in U.S.A.

POSTMASTER: Please send address changes to RADIO-ELECTRONICS, Subscription Dept., Box 2520, Boulder, CO 80322.

A stamped self-addressed envelope must accompany all submitted manuscripts and/or artwork or photographs if their return is desired should they be rejected. We disclaim any responsibility for the loss or damage of manuscripts and/or artwork or photographs while in our possession or otherwise.



SUPERSALE

We will beat any advertised price

BECKMAN Circuitmate® DMM

MODEL DM73
\$63⁹⁵

- Smallest digital multimeter on the market
- Probe-style design makes it ideal for taking measurements in hard-to-reach test areas



\$64⁹⁵

- 3 1/2-digit pocket-size multimeter
- 0.8% Vdc accuracy
- diode test
- hFE test
- conductance
- 10 amps AC and DC ranges
- Auto-polarity
- Auto-Zero
- Auto-decimal

\$79⁹⁵ MODEL DM25

- 3 1/2-digit pocket-size multimeter
- 0.5% Vdc accuracy
- diode test
- capacitance
- continuity beeper
- conductance
- 10 amps AC and DC ranges
- auto-polarity
- auto-zero
- auto-decimal



B&K PRECISION

100 MHz FREQUENCY COUNTER



MODEL 1803
REG. \$169.95
OUR PRICE \$144⁵⁰

- 5 Hz to 100 MHz range
- 8 digit LED display
- Leading zero blanking
- Low pass filter
- BNC Connector input
- Overflow Indicator
- Battery or AC powered
- Charger/AC Adaptor included with Model 1803

NTSC COLOR BAR GENERATOR

MODEL 1251

REG. \$995.00
OUR PRICE \$849⁹⁵



- Generates a wide variety of test signals and patterns for comprehensive testing, servicing and adjustment of virtually all types of television and video equipment
- Video patterns include standard NTSC color bars, -1WQ, and staircase at two levels of burst phase chrominance
- A full assortment of convergence patterns, raster colors gated or full field multiburst

HITACHI PORTABLE OSCILLOSCOPES

MODEL V-222 (20 mHz)
REG. \$695.00

MODEL V-422 (40 mHz)
REG. \$895.00

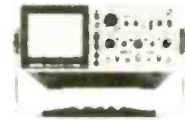
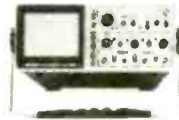

CALL FOR SPECIAL PRICING

- New series of scopes provides high performance and light weight
- Large 6-inch rectangular internal graticule CRT
- Auto-focus circuit and scale illumination
- DC offset function
- Voltage and frequency reading outputs
- High accuracy - ±3%
- High sensitivity - 1 mV/div

BP DIGITAL CAPACITANCE METER



MODEL DCM-601
REG. \$149.95

OUR PRICE \$79⁹⁵

- Digital display easy and correct readout
- High accuracy 100 PPM
- 0.5%
- LS-circuit provides high reliability and durability
- LCD display provides low power consumption

FORDHAM 550 MHz FREQUENCY COUNTER



MODEL FM-8
REG. \$199.95
OUR PRICE \$149⁹⁵

- 8-digit high frequency counter with a switch selectable input using single BNC
- Completely assembled
- Pre-Calibrated Pre-tested

LEADER NTSC WAVEFORM MONITOR



MODEL LBO-5860
REG. \$2050.00
OUR PRICE \$1850

- Permits displaying vertical interval test and reference signals by front panel line selector

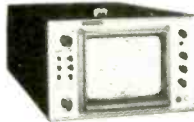

MODEL LVS-5850
REG. \$2050.00
OUR PRICE \$1850

- Convenient method for observing and measuring the relative phase and amplitude of chrominance signal components

FLUKE 70 73

- Analog Display
- Rotary Knob
- Volts AC & DC
- Resistance to 32 MΩ
- 10 Amps
- Diode Test
- 3200 Counts
- Fast Autoranging
- Function Annunciators in Display
- Power-Up Self Test
- 2000+ Hour Battery Life w/Power Down "Sleep Mode"
- New Test Leads
- VDE & UL Approval

\$74⁹⁵

- 0.7% Accuracy
- Autorange Only
- 10 Amp Only



75
\$95⁰⁰

- 0.5% Accuracy
- Manual or Autorange
- 10A + 300 mA Range
- Beeper



77
\$125⁰⁰

- 0.3% Accuracy
- Manual or Autorange
- 10 A + 300mA Range
- Beeper
- "Touch-Hold" Function



VIZ DC TRIPLE POWER SUPPLY

MODEL WP-708
REG. \$489.00

OUR PRICE \$399⁹⁵



- Dual DC Voltmeter
- Triple DC Power Supply
- Three separate completely isolated DC power supplies: two 0-20V at 0.2A, one fixed 5V at 4A

WELLER SOLDERING STATION

MODEL EC1000
OUR PRICE
\$109⁹⁵



- Identical to the EC2000 except LED Digital temperature readout
- The EC1000 is dial controlled

SOLDERING STATION

MODEL EC2000
OUR PRICE
\$139⁹⁵



- Continuously variable tip temperature from 350 to 850 F
- Positive temperature coefficient sensor inside the tip provides temperature feedback to maintain tip temperature at a set point

FORDHAM

260 Motor Parkway, Hauppauge, N.Y. 11788

- Master Charge
 - VISA
 - Money Order
 - Check
- NY State residents add appropriate sales tax.
COD's extra (required 25% deposit)

ADD FOR SHIPPING AND INSURANCE	
\$0-\$25.00	\$ 4.00
\$25.00 to \$ 500.00	\$ 6.50
\$501.00 to \$ 750.00	\$ 8.50
\$751.00 to \$ 1000.00	\$12.50
over \$1000.00	\$15.50

TOLL FREE (800) 645-9518
in N.Y. State call 800-832-1446

Free Catalog on Request

EDITORIAL



ART KLEIMAN

Satellite TV Reception— Present and Future

This is the second time this year we're presenting a special section on Satellite TV. In July, we presented the basics. This month, you will find a comprehensive buyers guide. Why are we putting forth so much effort to present Satellite TV to our readers?

It has been almost 5 years since we first presented our *Backyard Satellite TV Receiver* series by Bob Cooper. Back then, the Satellite-TV industry was in the embryo stage. Few manufactured systems existed. The majority of home satellite systems were assembled and erected by electronics enthusiasts like yourself. Information was rare and difficult to come by. Equipment and parts were hard to find—and quite expensive when you did find them. Dish antennas were large; most people were very lucky if they could get away with using a 6-foot dish. Performance from component to component varied drastically. Aligning the various components, such as a satellite-TV receiver, was genuinely a nightmare come true.

Today, the Satellite-TV industry is in its infancy. Manufactured equipment, albeit still expensive (although much cheaper by yesterday's standards), is plentiful. For \$1000-\$1500, you can own your own Satellite-TV system, including antenna, receiver, LNA, and feedhorn. For the additional cost of installation, you can own this system without the headache of setting it up. And you can be confident that the reception will be fairly decent. That's a big step forward in five years!

The Satellite-TV industry will grow into adulthood rapidly. Within the next year or two, you will see tremendous reductions in price and an increase in performance. Several factors will be responsible for

those changes: First, semiconductor manufacturers are realizing the market potential of this industry. As a result, right now they are spending large sums on R&D to produce custom IC's. They have already successfully produced a complete monolithic LNA. And they are hard at work applying this same technology to receiver design. When production lines are geared up to produce those IC's, prices will drop drastically. The IC's will obsolete the necessity for equipment alignment. Also, performance variations from component to component will be non-existent. The elimination of alignment procedures and performance variations, coupled with the newer, more powerful, satellites that have been recently launched, will result in smaller antennas. Where 6-foot dishes were once required, 4-foot dishes will provide acceptable pictures.

While this effort to produce custom IC's is going on, Japan is gearing up to produce large quantities of equipment. Within the next year or two, we will see a flood—no, a tidal wave—of imported satellite receivers and LNA's reach the market. This will exert a tremendous downward pressure on equipment prices. Within the next year or two, the price of a complete Satellite-TV system, including receiver, LNA, feedhorn, and 4-foot dish, will be in the \$300-\$400 range. With this in mind, why would a consumer consider the purchase of a DBS system? Especially when the projected cost for a DBS system is in the same price range and channel selection will be limited.

The Satellite TV industry is growing up. And in the years to come, you can bet that **Radio-Electronics** will be there covering the developments and presenting them to you, our readers.

ART KLEIMAN
EDITOR

The first no-crystal hand-held scanner.



Now you can have the one scanner you've always wanted—a no crystal, fully synthesized hand-held scanner. The incredible, Uniden® Bearcat® 100.

Push button programming.

The Uniden® Bearcat® 100 works just like the full size, no crystal Uniden® Bearcat® Scanners. Push button controls tune in all police calls, fire calls, weather warnings, and emergency information broadcasts, the split second they happen. Automatically.

All the features you want.

16 channels for storing frequencies, 8 band coverage—including high, low,

UHF and "F" public service bands; both the 70 cm and 2 meter amateur bands; plus, for the first time ever, both the military and federal government land mobile bands. Both automatic and manual search, lockout, scan delay, direct channel access. Even a liquid crystal display. Flexible antenna, earphone, AC adapter/battery charger and carry case are included.

Your Uniden® Bearcat® Dealer wants to hand you an earful.

See your Uniden® Bearcat® Dealer now for a demonstration of the amazing Bearcat® 100. Get complete information about the world's first hand-held, no crystal scanner.

SCAN's 30,000 members know what others miss! Insider news. Frequency info. Tech tips. Awards. SCAN Magazine...and more! Send \$12 for 1-year membership to the Scanner Association of North America, 240 Fenel Lane, Hillside, IL 60162.

Uniden® Corporation of America, Personal Communications Division
6345 Castleway Court, Indianapolis, IN 46250
©1984 Uniden Corporation of America

uniden®

Bearcat®

To find out more about where to buy the Uniden® Bearcat® 100 or other Uniden® Bearcat® Scanners, call 1-800-S-C-A-N-N-E-R toll free.

CIRCLE 99 ON FREE INFORMATION CARD

Learn robotics and you build this

New NRI home training prepares you for a rewarding career in America's newest high-technology field.

The wave of the future is here. Already, advanced robotic systems are producing everything from precision electronic circuits to automobiles and giant locomotives. By 1990, over 100,000 "smart" robots will be in use.

Over 25,000 New Jobs

Keeping this robot army running calls for well-trained technicians . . . people who understand advanced systems and controls. By the end of the decade, conservative estimates call for more than 25,000 new technical jobs. These are the kind of careers that pay \$25,000 to \$35,000 a year right now. And as demand continues

to grow, salaries have no place to go but up!

Build Your Own Robot As You Train at Home

Now, you can train for an exciting, rewarding career in robotics and industrial control right at home in your spare time. NRI, with 70 years of experience in technology training, offers a new world of opportunity in one of the most fascinating growth fields since the computer.

You need no experience, no special education. NRI starts you at the beginning, takes you in easy-to-follow, bite-size lessons from basic electronics right on through



key subjects like instrumentation, digital and computer controls, servomotors and feedback systems, fluidics, lasers, and optoelectronics. And it's all reinforced with practical, hands-on experience to give you a priceless confidence as you build a programmable, mobile robot.

Program Arm and Body Movement, Even Speech

Designed especially for training, your robot duplicates all the key elements of industrial robotics. You learn to operate, program, service, and troubleshoot using the same techniques you'll use in the field. It's on-the-job training at home!



You get and keep Hero 1 robot with gripper arm and speech synthesizer, NRI Discovery Lab for electronic experimentation, professional multimeter with 3½-digit LCD readout, 51 fast-track training lessons.

industrial control as

Building this exciting robot will take you beyond the state of the art into the next generation of industrial robotics.

You'll learn how your completely self-powered robot interacts with its environment to sense light, sound, and motion. You program it to travel over a set course, avoid obstacles using its sonar ranging capability. Program in complex arm and body movements using its special teaching pendant. Build a wireless remote control device demonstrating independent robot control in hazardous environments. You'll even learn to synthesize speech using the top-mounted hexadecimal keyboard.

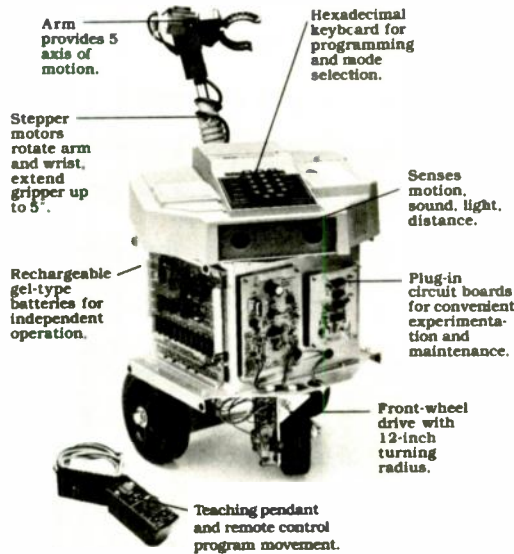

Your mobile robot duplicates functions of state-of-the-art industrial units.

reinforce your learning on a real-world basis. You get professional instruments, including a digital multimeter you'll use in experiments and demonstrations, use later in your work. And you get the exclusive NRI Discovery Lab®, where you examine and prove out theory from basic electrical concepts to the most advanced solid-state digital electronics and microprocessor technology. Devised by an experienced team of engineers and educators, your

experiments, demonstrations, and equipment are carefully integrated with 51 clear and concise lessons to give you complete confidence as you progress. Step-by-step, NRI takes you from the beginning, through today, and into an amazing tomorrow.

Send for Free Catalog Now

Send for NRI's big free catalog describing Robotics and Industrial Control plus over a

dozen other high-technology courses. You'll see all the equipment you get in detail, get complete descriptions of every lesson, find out more about career opportunities for trained technicians. There's no cost or obligation, so send today. Your action today could mean your future tomorrow. If the card has been removed, please write us today.

Training to Build a Career On

NRI training uniquely incorporates hands-on building experience to

NRI NRI SCHOOLS
McGraw-Hill McGraw-Hill Continuing Education Center
 3939 Wisconsin Ave.
 Washington, DC 20016

WE'LL GIVE YOU TOMORROW.

WHAT'S NEWS

"Out-of-this-world" technicians honored

Mission Specialists George D. Nelson and James D. van Hoften have been honored by the International Society of Certified Electronics Technicians (ISCET) with the title of Honorary Certified Electronics Technician. They are cited for outstanding technical achievements in space during the period of April 8-12, 1984, when the *Solar Max* satellite was serviced and returned to operation.

The association of professionally certified technicians honored the two astronauts for exemplifying the highest ideal of the electronics service industry by:

1. Preparing for the maintenance of high-technology elec-

tronic equipment through study, training, and retraining.

2. Personal dedication to restoring faulty equipment to a standard of performance and reliability that matches or exceeds the original.

3. Performing technically precise electronics service in the hostile environment of space.

4. Using state-of-the-art technology testing and service equipment to perform quality service.

5. Demonstrating that adequate preparation for service is essential in successful repairs.

The ISCET Board of Governors, at a special meeting, recognized the achievement of those two astronauts, working outside the space shuttle *Challenger* where the 5,000-pound *Solar Max* was

berthed. Nelson and van Hoften used power tools designed for weightless conditions to change and repair electronics instruments. This restored the satellite to operational health for the first time in three years and added years to its useful lifetime.

In congratulating the two astronauts, ISCET Chairman, John Krier CET, of Wichita, KS, cited the extremely difficult and delicate work required to repair the electronics box for the Coronagraph-Polarimeter, an instrument that was not designed to be repaired in space.

Nelson, a Ph.D. in Astronomy, and van Hoften, a Ph.D. in Hydraulic Engineering, both trained for product servicing in space in special water tanks at the Lyndon B. Johnson Space Center in Houston, TX, and the George Marshall Space Flight Center in Huntsville, AL.

New solid-state switch turns on in 1 microsecond

A new high-power switch, developed for radar transmitters, is 50 to 100 times as fast as comparable devices. Developed by Westinghouse Electric Corp's semiconductor division, the T62R is a two-terminal, four-layer reverse blocking thyristor. Its switching transition is so rapid that the device conducts a pulse current of up to 2500 amperes within one microsecond of turn-on.

The rapid transition is attained by using a high, fast-rising triggering voltage. That voltage produces a displacement current over the entire junction, activating all areas of the cathode emitter simultaneously. The required trigger impulse can be produced by capacitive discharge through a step-up transformer. R-E

NEW LITHIUM BATTERY

Matsushita Electric Co., of Osaka, Japan, has started mass production of the world's smallest pin-type lithium battery, 11 mm long and 2.2 mm wide (0.43 × .087 inch). The new 3-volt battery will have its first use in ultra-small fishing floats with light-emitting diodes (LED's) for night fishing. The unit price in Japan is 200 yen (a little less than one U.S. dollar).

The cathode material is polycarbon monofluoride and the anode, lithium. To mass-produce the battery, Matsushita has to decrease dimension tolerances to one-tenth that of previous models. The 3-volt output is twice that of silver-oxide or mercury batteries.

Expected uses are in wrist watches, calculators, microphones, and hearing aids.

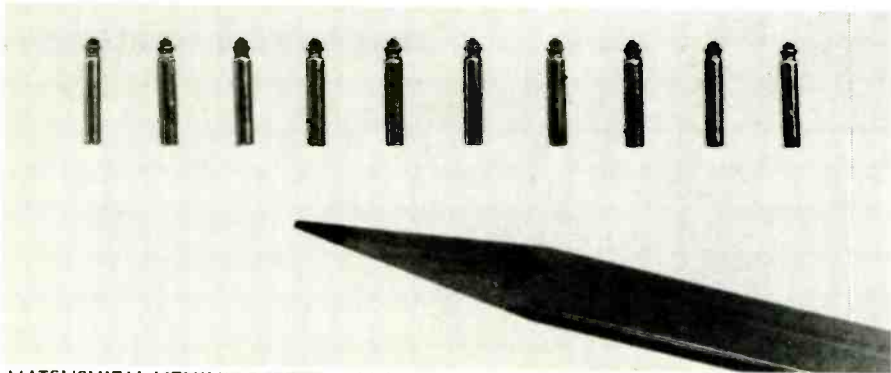

MATSUSHITA'S LITHIUM BATTERY, which measures 11 × 2.2 mm, makes a lead pencil look large.

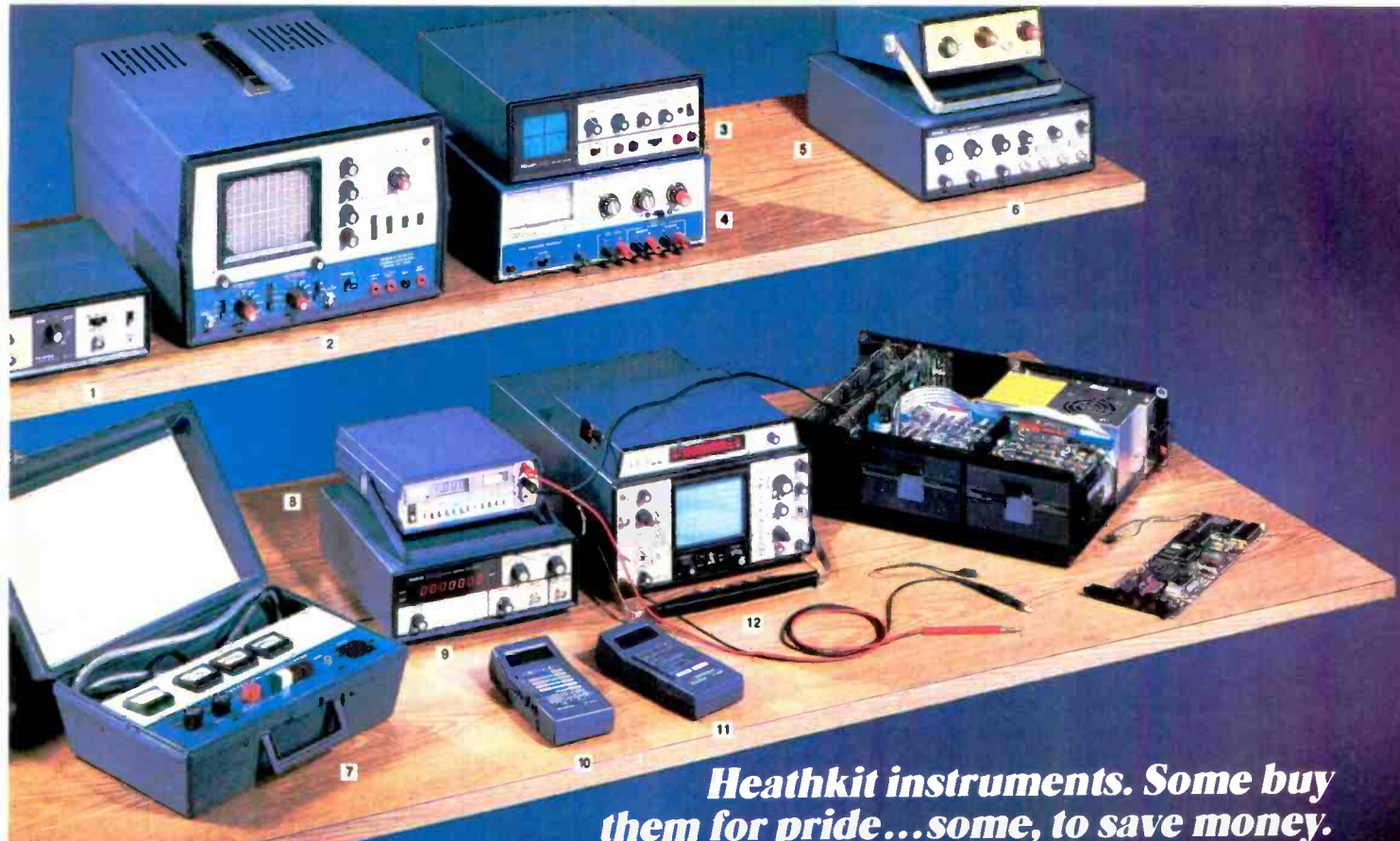

Heathkit instruments. Some buy them for pride...some, to save money.

Whether you're pursuing a proud hobby...or earning a living, don't trust the accuracy of your measurements to anything less than Heathkit instruments. Our kits are a little bigger, more rugged than "disposable" instruments that discourage self-servicing. Performance is superior, too. Just check the specs on our new IO-4360 Scope and IOA-4200 Time-Voltage Module.

Get to know our full line of instruments. They're built by experienced hands. Your hands. So they'll save money and help you do a better job. Heathkit Instruments. Don't trust your pride or money to anything less.

Professional specs for serious users

- ① IG-4244 Scope Calibrator. <1 ns rise time. 0.015% tolerance.
- ② IO-4205 Dual-Trace 5 MHz Scope. 10mV/cm sensitivity.
- ③ IT-2232 Component Tracer. Checks circuits without power.
- ④ IP-2718 Power Supply. Fixed or adjustable supply. 5 to 20 VDC.
- ⑤ IG-1271 Function Generator. Sine, square, triangle waveforms. 0.1 Hz to 1 MHz.
- ⑥ IG-1277 Pulse Generator. 100 ns to 1 sec width pulses.
- ⑦ IT-5230 CRT Tester. Tests, cleans, restores CRT's.
- ⑧ IM-2264 DMM. True RMS readings. Analog metering, too.
- ⑨ IM-2420 Frequency Counter. 5Hz to 512 MHz. Ovenized oscillator. Includes period and frequency modes.
- ⑩ IM-2215 Hand-held DMM. Five DC ranges. Accuracy: $\pm 0.25\%$ of reading +1 count.
- ⑪ IT-2250 Capacitance Meter. 199.9 pF to 199.9 mF. Auto ranging.
- ⑫ IO-4360 Scope and IOA-4200 Time/Voltage Module. Triple trace, 60 MHz, <7 ns rise time. IOA-4200 controls CRT cursor and multi-function display.

Heathkit instruments.
The professional instruments.

more measurement for your money

Heathkit
Heath
Company

A subsidiary of Zenith Electronics Corporation

Take another look at the instruments you should be building.

FREE
COLOR HEATHKIT CATALOG

Mail this coupon to:
Heath Company, Dept. 020-224
Benton Harbor, MI 49022

Name _____

Address _____

City _____

State _____ Zip _____

GX-393

VIDEO NEWS



DAVID LACHENBRUCH
CONTRIBUTING EDITOR

• **RCA's Audio-Video System.** RCA, which discontinued sale of audio products a decade ago, is coming back to sound, adding high-end audio to its high-end video in a unique system called *Dimensia*, which RCA describes as "intelligent audio-video." The heart of *Dimensia* is a new 26-inch color monitor-receiver, rack-mounted with other audio and video components, which can include a VCR, AM-FM tuner, record turntable, audio cassette-recorder, and a CD player.

The various components are designed to be connected one to the other—in series—with special connection cables. The complete system is integrated so that everything can be operated by means of one 52-button handheld infrared remote-control unit. For example, without leaving his easy chair, the user can command the audio cassette recorder to tape bands two and four from the compact-disc player, while the VCR is showing a movie. The programming is done with the aid of on-screen prompts on the TV monitor, which then confirms the commands to avoid mistakes.

The on-screen prompts include such key words AS TIME, PLAY, RECORD, STOP, FAST, REPEAT, PAUSE, BAND, PAGE, AUDIO A AND AUDIO B, SEEK, SLOW, MEMORY, CLEAR, SCAN, STATUS, ANTENNA, MUTE, VOLUME, TRACK, and PREVIOUS CHANNEL. Components may be purchased all at once or a few at a time and carry the RCA brand name but are made to RCA's specifications by Hitachi, which also manufactures RCA's VCR's.

• **Sanyo Enters 8mm.** A third company announced its entry into the American market with a VCR designed around the new 8mm video format. While the first two—Eastman Kodak and Polaroid—are photography firms making their debuts in home video with combination camera-recorders, or camcorders, the third is an old-line home-video firm.

The company is Sanyo, and its VCR is a deck without built-in camera, weighing just 2.4 pounds, which makes it the lightest VCR announced so far. Sanyo is expected to start selling the new deck here at a suggested list price of about \$1,500 in the fourth quarter of this year.

The companion to the new deck is a unique video camera that looks like a 35mm still camera and accepts standard 35mm lenses.

Sanyo, which was the first company to produce both Beta and VHS-format VCR's, now is the first to offer all three VCR formats. The company's subsidiary, Tokyo Sanyo, makes VHS recorders that are sold in the United States under Sanyo's Fisher brand name. Sanyo also is expected to be the first brand to offer camcorders in two different formats—the *Betamovie* under the Sanyo brand, and the VHS *VideoMovie* under the Fisher name.

Meanwhile, it was announced in Japan that Pioneer would enter the 8mm video field with a model of its own manufacture, which would be sold on the Japanese market, but for which the company has no export plans. It will be the first VCR to be made by Pioneer, which offers a Sony-produced Beta Hi-Fi recorder under its own name on the Japanese market.

Sony, meanwhile, announced it would manufacture 8mm videotape cassettes in Japan, but has detailed no plans on 8mm VCR hardware.

• **CBS Discontinues Videodiscs.** Three months after RCA announced it was discontinuing production of CED videodisc players (**Radio-Electronics**, July 1984), CBS said it was ending production of discs for the system. CBS had been the only source other than RCA for pressing of the capacitive discs and originally had planned to continue disc output, but noted that its volume declined sharply after RCA's announcement. RCA said it planned to continue producing the discs for at least three years and longer if the demand warrants. RCA and the movie studios continue to announce new releases in the CED format.

After the closeout of CED players here, the only videodisc players on sale in the United States will be in the Laservision format, under the brand names of Pioneer, Magnavox, and Sylvania. The VHD format, developed by JVC, is on sale in Japan by most video manufacturers there, but it has not been introduced in any other countries. R-E



Drop-proof



Overload-proof



Contamination-proof

Ooops proof.

Now there's a new breed of Beckman Industrial Corporation hand-held DMMs tough enough to withstand accidental drops, input overloads and destructive environments.

The new HD100 and HD110 DMMs are drop-proof, packed with overload protection and sealed against contamination. You won't find a more rugged meter than our HDs.

Drop Proof

Constructed of double-thick thermoplastics, the HD100 series DMMs resist damage even after repeated falls. All components are heavy-duty and shock mounted.

Contamination Proof

The HD series meters are designed to keep working even around dirt, heavy grime, water and oil. The special o-ring seals, ultrasonically-welded display window and sealed input jacks protect the internal electronics of the HD meters. The oops-proof meters are sealed so tightly, they even float in water.

Accidental Overload Protection

All DC voltage inputs are protected up to 1500 Vdc or 1000 Vrms. Current ranges are protected to 2A/600V with resistance ranges protected to 600 Vdc. Transient protection extends up to 6KV for 10 microseconds.

More Meter for Your Money

For starters you can get 2000 hours of continuous use
CIRCLE 7 ON FREE INFORMATION CARD

from a common 9V transistor battery. You can run in-circuit diode tests and check continuity. You even

get a one year warranty.

The 0.25% basic dc volt accuracy HD meters serve you with 7 functions and 27 ranges. The HD 110 also gives you 10 AMPS ac and dc. With one simple turn of the single selector switch, you can go directly to the function and range you need. There's less chance of error.

Also available is the electrical service kit. It includes the meter of your choice, a current clamp, deluxe test leads and a heavy-duty case designed to carry both meter and accessories, conveniently.

Feature for feature you can't find a more dependable meter with prices starting at just \$169 (U.S. only).

To locate your nearest distributor, write Instrumentation Products Division, Beckman Industrial Corp. A Subsidiary of Emerson Electric Company, 630 Puente Street, Brea, CA 92621 (714) 773-8111.



Beckman Industrial™

SATELLITE/TELETEXT NEWS

GARY ARLEN
CONTRIBUTING EDITOR

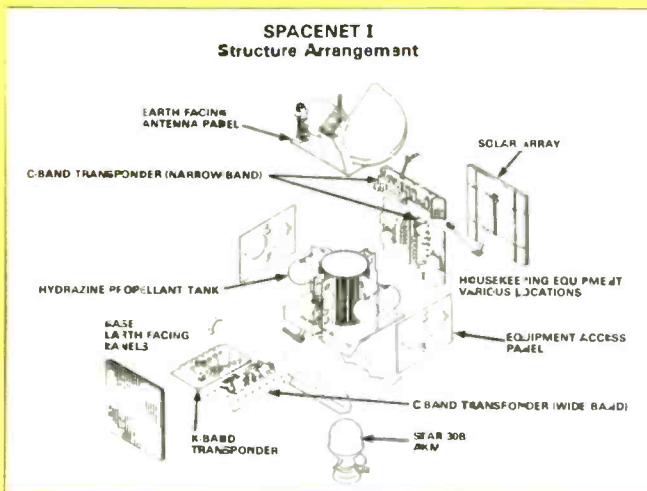

• **Spacenet I in place.** Spacenet I, GTE's first communications satellite, is now in orbit at 120° west longitude. The new satellite covers all 50 states and has dual mode C- and Ku-band capability. The bird, launched in late May aboard an Ariane rocket, is the first of three GTE satellites. Video programmers using the satellite include Bonneville Telecommunications and American Christian Television System, along with several voice and data services.

• **Satellite viewing rights.** Two legislative proposals now making their way through Capitol Hill will make it easier for satellite earth-station users to pick up whatever satellite programming they want. The "Satellite TV Viewing Rights Act of 1984," as the bills are called, would force pay TV and cable networks to deal with private dish owners.

Although Washington insiders concede that the proposed laws won't make it through Congress in this busy election year, they hope that the current examination will lay a foundation for passage of similar bills next year. The Senate version, introduced by Sen. Barry Goldwater and others, affirms the legality of TVRO reception of non-scrambled signals, allowing users to watch anything they can pick up. However, it bars the manufacture and sale of unauthorized decoders that make it possible for users to receive encrypted signals; that last point was considered

a necessary compromise to satisfy program producers. The House version of the bill wants to establish a formula of rates and terms for receiving scrambled signals—forcing pay-TV networks to deal with TVRO users.

The bills are strongly endorsed by SPACE and other private satellite groups. Supporters are encouraging TVRO owners to write to their Congressmen and Senators to support the plans, now known as HR. 5176 in the House of Representatives and S. 2437 in the Senate.

• **Teletext news bits.** The final draft of the North American Basic Teletext Specification, a 70-page technical document spelling out precise details for making teletext reception and transmission equipment, has been published. The U.S. Electronic Industries Association (2001 Eye St. NW, Washington, DC 20006) and the Canadian Videotex Consultative Committee have agreed on the engineering details spelled out in the document (EIA Interim Standard #14).

• **Motorola Semiconductor Products** has developed a Raster Memory System (RMS) a two-IC microprocessor set that can support the widely used NAPLPS videotex format; it sells for only about \$20. RMS has 640 x 500 resolution and can handle vertical or horizontal scrolling, displaying up to 32 colors simultaneously. It uses VLSI processing, which can convert a graphics program stored in memory to the video stream, producing high-resolution displays. The two-IC RMS set consists of the MC68486 raster memory interface and the MC68487 raster memory controller; it is highly programmable, and is designed to operate with three of Motorola's microprocessors.

• **Mullard**, the British-based IC-making subsidiary of Philips, will offer an NTSC version of its "computer controlled teletext" IC set. The company says the IC's, which support World System Teletext, could be built into TV sets by mid-1985, adding barely \$50 to retail prices of TV receivers. The IC's are modifications of Philips' Euro CCT IC's (SAA5240) and offer higher-resolution characters and an eight-page storage capacity, plus a new video-input processor. R-E

Meet Our New LogicScope 136. ... A True Dual Trace 10 MHz Digital Storage Scope. Only \$495.

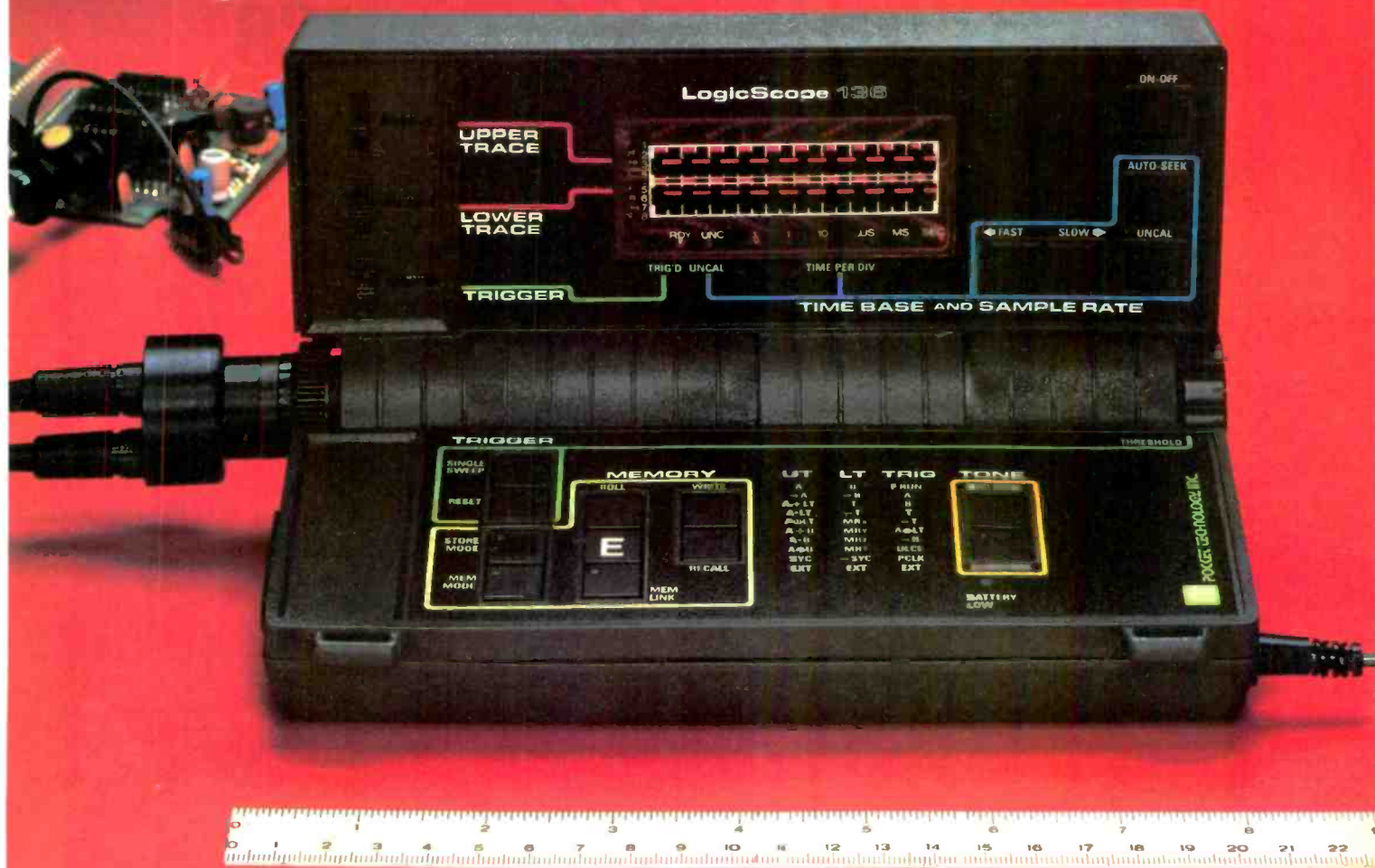

True Dual Trace • 10 MHz Real Time Bandwidth • 3 Input Channels • I/O Port
Digital Waveform Storage • Boolean Waveform Operations • Audio Functions
8.25 (L) x 4.5 (D) x 1.75 (H) Inches • 1.25 Pounds • 9 Volt Battery/AC Operation

Consider the LogicScope 136

- The LogicScope 136 is the next logical step in test instrumentation for you. It combines many of the features and capabilities of sophisticated logic analyzers and oscilloscopes... and it fits in your hand. Never before has so much technology been available in so small an instrument, at such a low price.
- The pocket-sized LogicScope 136 is made possible by a patented breakthrough in display technology. The conventional cathode ray tube has been replaced by a unique array of 400 LED's that permits simultaneous display of two digital waveforms.
- The 136 can be used for viewing single shot events, or repetitive waveforms. It can be operated in real time mode, or in memory mode which permits acquisition and storage of up to 24 128-bit waveforms. These can be recalled, logically compared (AND, OR, EXCLUSIVE OR) to other stored/input waveforms, or output to an external device via an RS 232 port.
- Its very low cost, convenience and ease-of-use make the LogicScope the ideal instrument, for designing, troubleshooting or repairing digital systems.

Consider its Engineering & Field Service Applications:

- On microprocessor-based systems, check the timing relationship of various parameters relative to the system clock and other key events. Its storage capability allows visual and logical comparison of non-repetitive waveforms to known reference signals. Output in the start-up of the digital device can be compared to reference signals to determine the operating state of the device. Questionable waveforms can be stored for analysis.
- Its light weight and small size make the LogicScope convenient to take on every service call. The 136 provides much more information for trouble shooting a digital system or peripheral than a logic probe or digital multimeter, without having to lug an oscilloscope or logic analyzer along.

Contact us for the name of your local distributor



POCKET TECHNOLOGY, INC.
7320 Parkway Drive, Hanover, MD 21076
301-796-3300

CIRCLE 32 ON FREE INFORMATION CARD

**Learning electronics
is no picnic.**

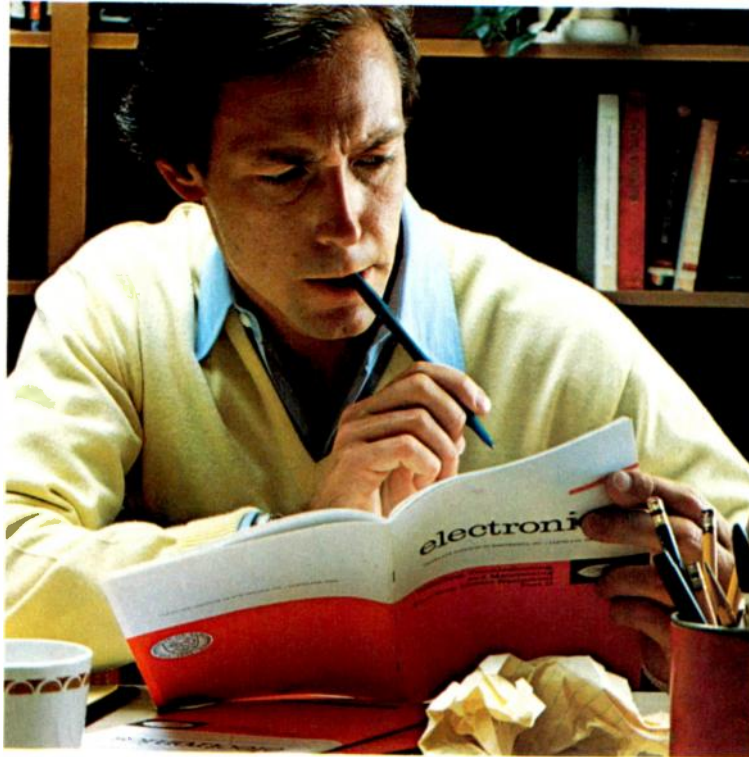

**At any level it takes
work and a few
sacrifices. But with
CIE, it's worth it.**

Whoever said, "The best things in life are free," was writing a song, not living a life. Life is not just a bowl of cherries, and we all know it.

You fight for what you get. You get what you fight for. If you want a thorough, practical, working knowledge of electronics, come to CIE.

You can learn electronics by spending some hard-working time at home. Or, would you rather go bowling? Your success is up to you.

At CIE, you *earn* your diploma. It is not handed to you simply for putting in hours. But the hours you do put in will be on your schedule, not ours. You don't have to go to a classroom. The classroom comes to you.

Why electronics training?

Today the world depends on technology. And the "brain" of technology is electronics. Every year, companies the world over are finding new ways to apply the wonders of electronics to control and program manufacturing, processing...even to create new leisure-time products and services. And the more electronics applications there are, the greater the need will be for trained technicians to keep sophisticated equipment finely tuned and operating efficiently. That means career opportunities in the eighties and beyond.

Which CIE training fits you?

Beginner? Intermediate? Advanced? CIE home study courses are designed for ambitious people at all entry levels. People who may have:

1. No previous electronics knowledge, but do have an interest in it;
2. Some basic knowledge or experience in electronics;
3. In-depth working experience or prior training in electronics.

You can start where you fit and fit where you start, then go on from there to your Diploma, an Associate Degree if you want it, and career.

Many people can be taught electronics.

There is no mystery to learning electronics. At CIE you simply start with what you know and build on it to develop the knowledge and techniques that make you a specialist. Thousands of CIE graduates have learned to master the simple principles of electronics and operate or maintain even the most sophisticated electronics equipment.

CIE specializes in electronics.

Why CIE? CIE is one of the largest independent home study schools that specializes in electronics. Nothing else. CIE has the elec-

tronics course that's right for you.

Learning electronics is a lot more than memorizing a laundry list of facts about circuits and transistors. Electronics is interesting! It is based on recent developments in the industry. It's built on ideas. So, look for a program that starts with ideas and builds on them. Look to CIE.

Programmed learning.

That's exactly what happens with CIE's Auto-Programmed[®] Lessons. Each lesson uses famous "programmed learning" methods to teach you important principles. You explore them, master them completely, before you start to apply them. You thoroughly understand each step before you go on to the next. You learn at your own pace.

And, beyond theory, some courses come fully equipped with electronics gear (the things you see in technical magazines) to actually let you perform hundreds of checking, testing, and analyzing projects.

Experienced specialists work closely with you.

Even though you study at home, you are not alone! Each time you return a completed lesson, you can be sure it will be reviewed, graded, and returned with appropriate instructional help. When you need additional individual help, you get it fast and in writing from the faculty technical specialist best qualified to answer your question in terms you can understand.

CIE offers you an Associate Degree.

One of the best credentials you can have in electronics—or any other career field—is a college degree. That's why CIE gives you the opportunity to earn an Associate in Applied Science in Electronics Engineering Technology. Any CIE career course can offer you credit toward the degree...more than half of the number needed in some cases.

You can also prepare for the government-administered FCC (Federal Communications Commission) Radiotelephone License, General Class. It can be a real mark in your favor...government-certified proof of your specific knowledge and skills.

Today is the day. Send now.

Fill in and return the postage-free card attached. If some ambitious person has removed it, cut out and mail the coupon. You'll get a FREE school catalog plus complete information on independent home study. For your convenience, we'll try to have a CIE representative contact you to answer any questions you may have.

Mail the card or the coupon or write CIE (mentioning the name and date of this magazine) at:
1776 East 17th
Street, Cleveland,
Ohio 44114.

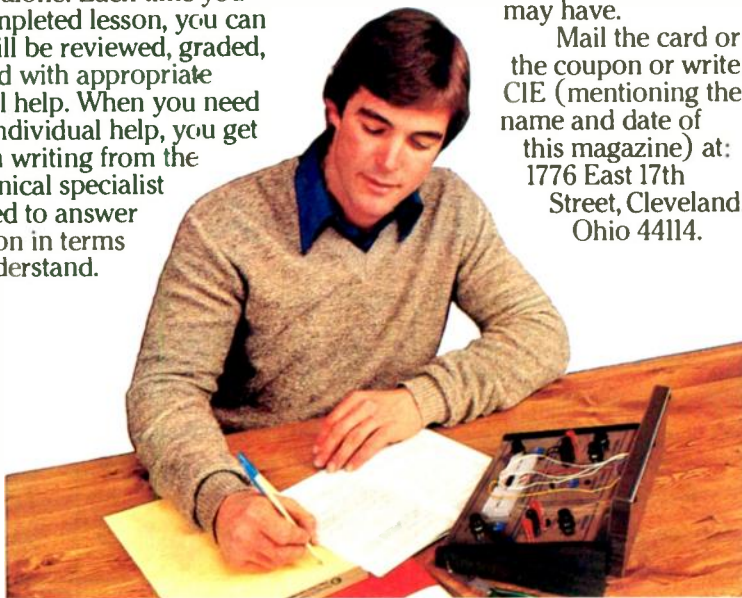

CIE Cleveland Institute of Electronics, Inc. RE-94
1776 East 17th Street, Cleveland, Ohio 44114
Accredited Member National Home Study Council

YES...I want to learn from the specialists in electronics—CIE. Send me my FREE CIE school catalog...including details about the Associate Degree program... plus my FREE package of home study information.

Print Name _____

Address _____ Apt. _____

City _____ State _____ Zip _____

Age _____ Area Code/Phone No. _____ / _____

Check box for G.I. Bill bulletin on Educational Benefits: Veteran Active Duty

MAIL TODAY!

LETTERS

WRITE TO:

LETTERS
Radio-Electronics
200 Park Ave South
New York, NY 10003

CABLE-TV DESCRAMBLING

A few comments about the Cable-TV Descrambling article published in your February 1984 issue. First, in order to obtain the correction signal shown in Fig. 8-e, the 680-ohm resistor, R10, should be connected to pin 12 instead of pin 5 of IC2. The foil pattern must be modified.

Secondly, one of the multi-vibrators of IC2 delays the correction signal. Changing R18 to a 100-kilohm trimmer potentiometer allows one to adjust the proper delay.

Finally, for those who have diffi-

culty finding the inductors T1, T2, and L2, the following seems to work fine: Replace T1, T2, and L2 with 0.1- μ H fixed inductors: Replace C1, C3, and C18 with 100, pF trimmer capacitors.

SENCER YERALAN
Columbia, MO

IRKSOME PRACTICES

I find two things done by most of the electronics, computer, and mechanic/science magazines most irksome. The first is demonstrated on page 86 of the May 1984 issue of Radio-Electronics, and relates to the use of the letters

TRS-80. By that, I assume you mean any of the several models of TRS-80 available. Yet the program doesn't work on my Color Computer, a TRS-80, and it most assuredly won't work on any of the TRS-80's that fit into the business category like the Tandy 2000, the Model 16B, or the 12, which, unless I am blind, don't even have a cassette port. If you doubt me just look at the Radio Shack computer-products catalog Number RSC-11: It's the "1984 TRS-80 Catalog". In short, then, please specify which TRS-80 you mean!







The other infuriating item,

B&K

PRECISION

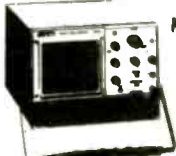
Fall Specials!

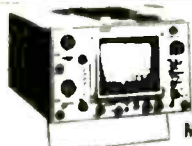
OSCILLOSCOPES

 MODEL 1590P REG \$1995.00 100 MHz 8-TRACE 4 CHANNEL DUAL TIME <i>Now \$1579⁹⁵</i>	 MODEL 1570P REG \$1395.00 80 MHz QUAD INPUT DUAL TIME <i>Now \$1095⁰⁰</i>	 MODEL 1560P REG \$1150.00 60 MHz TRIPLE TRACE <i>Now \$899⁹⁵</i>	 MODEL 1540P REG \$950.00 40 MHz DUAL TRACE <i>Now \$799⁹⁵</i>
 MODEL 1479BP REG \$795.00 30 MHz DUAL TRACE <i>Now \$635⁰⁰</i>	 MODEL EE-482 REG \$695.00 20 MHz DUAL TRACE (EICO) <i>Now \$450⁰⁰</i>	 MODEL 1476A REG \$545.00 10 MHz DUAL TRACE <i>Now \$435⁰⁰</i>	 MODEL 318-430 REG \$299.95 6.5 MHz SINGLE TRACE (KRISTA) <i>Now \$189⁹⁵</i>

OMNITRON

ELECTRONICS
770 Amsterdam Ave., New York, NY 10025

■ Write for FREE 136 page Catalog ■

SHIPPING CHARGES

For Orders	ADD
\$25 - 100	\$6.50
\$100 - \$500	\$8.50
\$500 - \$750	\$10.50
\$750 - and up	\$15.00
Parcel Post	\$20.00

MASTER CARD • VISA

Send Purchase Order, Check, Money Order or C.O.D.

or Call Toll Free
800-223-0826
in N.Y. State (212) 865-5580

Build your own IBM PC compatible and save hundreds of dollars.



Heath proudly announces the NEW HS-151 Desktop and HS-161 Portable computers.

One of the world's largest software libraries has IBM's name on it. Now you can run that software on Heath's new IBM PC compatible computers, available in easy-to-build kits.

Can you build one of these computers? 85% of our first-time customers ask the same question. And the answer is 100% yes. You can.

In fact, you *should* build one. You'll save a lot of money while learning about computers in general and the Heath PC's in particular.

Build confidence... and your new computer...one step at a time. Two main circuit boards come to you pre-assembled and factory-tested. So that you can build the three other boards, we include a test soldering board plus helpful soldering instructions to make sure you get it right.

Our instruction manuals are easy to understand, thorough and packed with cogent illustrations. And once it's built, the computer guides you

through a full range of included disk-based diagnostics.

Expert advice is only a phone call away, should you need it. You'll reach a trained consultant whose specialty is talking sense, not jargon.

We'll do whatever's necessary to make our pledge come true: "We Won't Let You Fail." Our entire business depends on that simple promise.

Experience a little wonder and a lot of pride. Save money, too, by building the highest quality personal computer. The Heath PC's have 128K RAM standard (expandable to 640K), a professional keyboard, dual 360K disk drives and optional Winchester. These machines are truly complete. Both are color capable and MS-DOS is included.

Check out the Heath PC computers today. IBM compatibility means they'll run the most popular software. And, with the money saved by building a kit, think of all the peripherals and software you can buy!

HS-151 Desktop PC with standard floppy disk drive or optional hard disk.

CIRCLE READER SERVICE CARD. Get more information on the most rewarding personal computers. The HS-151 Desktop PC and HS-161 Portable PC.

*MS is a registered trademark of Microsoft Corporation.

For computing on the go... the HS-161 Portable.



The HS-161 has the same features as the HS-151. Amber Monitor included. Convenient keyboard folds up, two disk drives fold down.



Heathkit[®]
Heath
Company

A subsidiary of Zenith Radio Corporation

CIRCLE 38 ON FREE INFORMATION CARD

CP-230

which one individual can never change, is the baloney handed out by manufacturers. Do you truly believe that when you buy a car with certain things "standard"—like the radio or air conditioner—you do not pay extra for those "standard" features as the manufacturer would have you believe? The "extra" is just incorporated into the sticker price. That same kind of hype is used in many ways by many companies. Not the least of which is Apple's claim that the

MacIntosh is a 32-bit machine when even Motorola, the IC's manufacturer, says it is a 16-bit device. If, as you indicate in your insert, you use 32-bit only as long as we remember that you are "referring to the microprocessor's internal architecture", and not make such a designation each time you refer to the MacIntosh as being a "32-bit" machine then, by the same designation you must always refer to the TRS-80 Color Computer as a 16-bit machine, because it

uses a 6809 microprocessor, as does the business/industry-oriented GIMIX system, and several other systems. The 6809 is 8/16, just as the 68000 is 16/32. You get what you pay for! Please don't continue Apple's hype; you do a disservice to those who make truthful claims, such as Radio Shack, who has at least one machine that uses the 68000.

HENRY C. GERNHARDT, Jr.
Huntington, WV

IT WASN'T OUR IDEA TO ADD TWO NEW SIZES TO OUR LINE OF ACE BREADBOARDS. IT WAS YOURS.

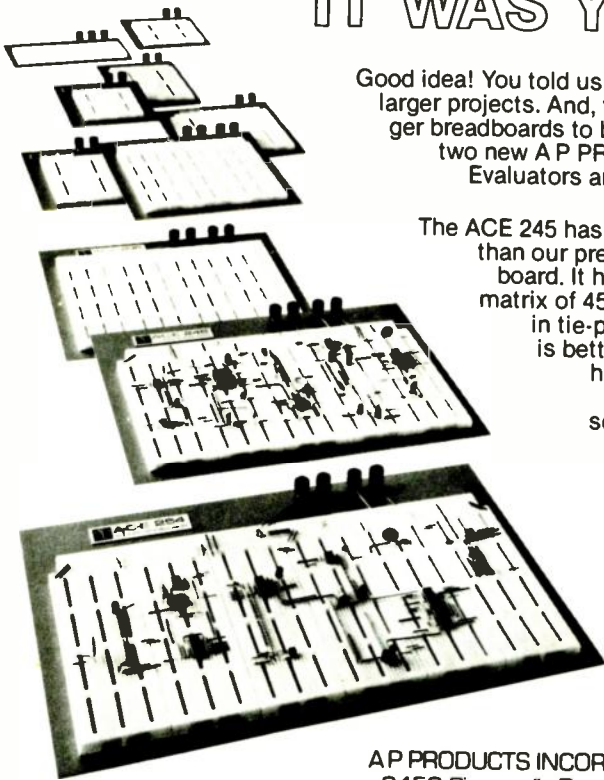

Good idea! You told us you wanted to build larger projects. And, that you needed bigger breadboards to build them. Well, our two new A P PRODUCTS All Circuit Evaluators are just what you had in mind.

The ACE 245 has 25% more capacity than our previous largest breadboard. It has a circuit building matrix of 4520 solderless, plug-in tie-points. And, if bigger is better our new ACE 254 has a circuit building matrix of 5424 solderless tie-points.

**For the
A P PRODUCTS
dealer near you
call TOLL FREE
800-321-9668.
(In Ohio, call
collect
(216) 354-2101.)**

A P PRODUCTS INCORPORATED
9450 Pineneedle Dr. • Box 540
Mentor, Ohio 44060
(216) 354-2101
TWX: 810-425-2250



In Europe, contact A P PRODUCTS • GmbH
Bäumlesweg 21 • D-7031 Weil 1 • West Germany

CIRCLE 87 ON FREE INFORMATION CARD

INVERTING OP AMPS

I have been reading Radio-Electronics for the past three years and like it very much. Since I am studying electronics in preparation for my career, I have been reading your back-to-school series of articles with great interest. The article in the May 1984 issue, which covered inverting op-amps (which was covered at school two weeks ago), was confusing in a way and I'd like to take some time to clarify

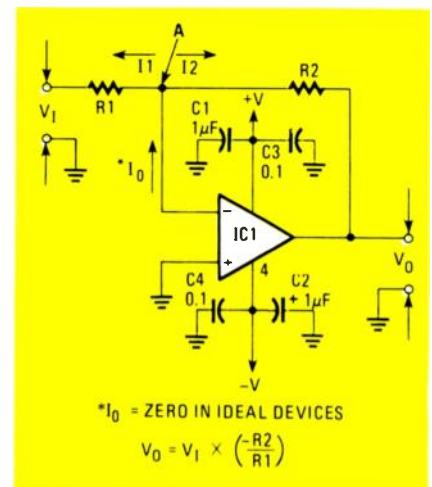

FIG. 1

the point.

The article became confusing with so many negative values being used. I thought that it should be emphasized that the gains stated in the example 5-b is not a negative gain (loss of signal), but a positive gain ($V_{OUT} > V_{IN}$) with a 180° phase shift ($+V_{IN} = -V_{OUT}$). I have found it much easier to note the fact that the signal is inverted, rather than writing a negative sign in front of the gain value.

Also, in Fig. 1, C2 is connected in a reverse polarity. It should be
continued on page 28

NEW!

uniden® Bearcat® Products

Communications Electronics,™ the world's largest distributor of radio scanners, is pleased to announce that *Bearcat* brand scanner radios have been acquired by Uniden Corporation of America. Because of this acquisition, Communications Electronics will now carry the complete line of Uniden *Bearcat* scanners, CB radios and Uniden *Bandit*™ radar detectors. To celebrate this acquisition, we have special pricing on the Uniden line of electronic products.

Bearcat® 300-E

List price \$549.95/CE price \$339.00
7-Band, 50 Channel • Service Search • No-crystal scanner • AM Aircraft and Public Service bands. • Priority Channel • AC/DC Bands: 32-50, 118-136 AM, 144-174, 421-512 MHz. The *Bearcat* 300 is the most advanced automatic scanning radio that has ever been offered to the public. The *Bearcat* 300 uses a bright green fluorescent digital display, so it's ideal for mobile applications. The *Bearcat* 300 now has these added features: Service Search, Display Intensity Control, Hold Search and Resume Search keys. Separate Band keys to permit lock-in/lock-out of any band for more efficient service search.

Bearcat® 20/20-E

List price \$449.95/CE price \$269.00
7-Band, 40 Channel • Crystalless • Searches AM Aircraft and Public Service bands • AC/DC Priority Channel • Direct Channel Access • Delay Frequency range 32-50, 118-136 AM, 144-174, 420-512 MHz. Find an easy chair. Turn on your *Bearcat* 20/20 and you're in an airplane cockpit. Listening to all the air-to-ground conversations. Maybe you'll pick up an exciting search and rescue mission on the Coast Guard channel. In a flash, you're back on the ground listening as news crews report a fast breaking story. Or hearing police and fire calls in your own neighborhood, in plenty of time so you can take precautions. You can even hear ham radio transmission, business phone calls and government intelligence agencies. Without leaving your easy chair. Because you've got a *Bearcat* 20/20 right beside it.

The *Bearcat* 20/20 monitors 40 frequencies from 7 bands, including aircraft. A two-position switch, located on the front panel, allows monitoring of 20 channels at a time.

Bearcat® 210XL-E

List price \$349.95/CE price \$209.00
6-Band, 18 Channel • Crystalless • AC/DC Frequency range 32-50, 144-174, 421-512 MHz. The *Bearcat* 210XL scanning radio is the second generation scanner that replaces the popular *Bearcat* 210 and 211. It has almost twice the scanning capacity of the *Bearcat* 210 with 18 channels plus dual scanning speeds and a bright green fluorescent display. Automatic search finds new frequencies. Features scan delay, single antenna, patented track tuning and more.

Bearcat® 260-E

List price \$399.95/CE price \$249.00
8-Band, 16 Channel • Priority • AC/DC Frequency range 30-50, 138-174, 406-512 MHz. Keep up with police and fire calls, ham radio operators and other transmission while you're on the road with a *Bearcat* 260 scanner. Designed with police and fire department cooperation, its unique, practical shape and special two-position mounting bracket makes hump mounted or under dash installation possible in any vehicle. The *Bearcat* 260 is so ruggedly built for mobile use that it meets military standard 810c, curve y for vibration rating. Incorporated in its rugged, all metal case is a specially positioned speaker delivering 3 watts of crisp, clear audio.

NEW! Bearcat® 201-E

List price \$279.95/CE price \$179.00
9-Band, 16 Channel • Crystalless • AC only Priority • Scan Delay • One Key Weather Frequency range 30-50, 118-136 AM, 146-174, 420-512 MHz. The *Bearcat* 201 performs any scanning function you could possibly want. With push button ease, you can program up to 16 channels for automatic monitoring. Push another button and search for new frequencies. There are no crystals to limit what you want to hear.

NEW! Bearcat® 180-E

List price \$249.95/CE price \$149.00
8-Band, 16 Channel • Priority • AC only Frequency range: 30-50, 138-174, 406-512 MHz. Police and fire calls. Ham radio transmissions. Business and government undercover operations. You can hear it all on a *Bearcat* 180 scanner radio. Imagine the thrill of hearing a major news event unfold even before the news organizations can report it. And the security of knowing what's happening in your neighborhood by hearing police and fire calls in time to take precautions. There's nothing like scanning to keep you in-the-know, and no better way to get scanner radio performance at a value price than with the *Bearcat* 180.

Bearcat® 100-E

The first no-crystal programmable handheld scanner. List price \$449.95/CE price \$234.00/SPECIAL!
8-Band, 16 Channel • Liquid Crystal Display Search • Limit • Hold • Lockout • AC/DC Frequency range: 30-50, 138-174, 406-512 MHz. The world's first no-crystal handheld scanner: has compressed into a 3" x 7" x 1 1/4" case more scanning power than is found in many base or mobile scanners. The *Bearcat* 100 has a full 16 channels with frequency coverage that includes all public service bands (Low, High, UHF and "T" bands), the 2-Meter and 70 cm. Amateur bands, plus Military and Federal Government frequencies. It has chrome-plated keys for functions that are user controlled, such as lockout, manual and automatic scan. Even search is provided, both manual and automatic. Wow...what a scanner!

The *Bearcat* 100 produces audio power out of 300 milliwatts, is track-tuned and has selectivity of better than 50 dB down and sensitivity of 0.6 microvolts on VHF and 1.0 microvolts on UHF. Power consumption is kept extremely low by using a liquid crystal display and exclusive low power integrated circuits.

Included in our low CE price is a sturdy carrying case, earphone, battery charger/AC adapter, six AA ni-cad batteries and flexible antenna. The *Bearcat* 100 is in stock for quick shipment, so order your scanner today.

Bearcat® DX1000-E

List price \$649.95/CE price \$489.00
Frequency range 10 kHz to 30 MHz. The *Bearcat* DX1000 shortwave radio makes tuning in London as easy as dialing a phone. It features PLL synthesized accuracy, two time zone 24-hour digital quartz clock and a built-in timer to wake you to your favorite shortwave station. It can be programmed to activate peripheral equipment like a tape recorder to record up to five different broadcasts, any frequency, any mode, while you are asleep or at work. It will receive AM, LSB, USB, CW and FM broadcasts.

There's never been an easier way to hear what the world has to say. With the *Bearcat* DX1000 shortwave receiver, you now have direct access to the world.

Uniden® PC22-E

List price \$159.95/CE price \$99.00
The *Uniden* PC22 is a 40 channel AM remote mobile CB radio. It's the answer for today's smaller cars which don't always provide adequate space for mounting. Since all the controls are on the microphone, you can stash the "guts" in the trunk. The microphone has up/down channel selector, digital display, TX/RX indicator and external speaker jack. Dimensions: 5 1/2" W x 7 1/2" D x 1 1/2" H. 13.8 VDC, positive or negative ground.

QUANTITY DISCOUNTS AVAILABLE

Order two scanners at the same time and deduct 1%, for three scanners deduct 2%, four scanners deduct 3%, five scanners deduct 4% and six or more scanners purchased at the same time earns you a 5% discount off our super low single unit price.

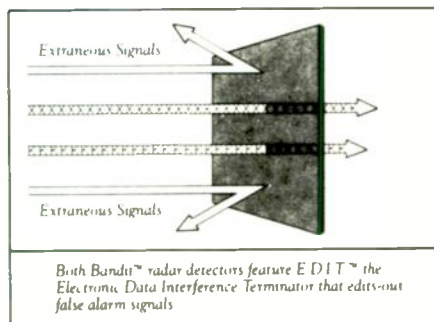

CIRCLE 26 ON FREE INFORMATION CARD

Uniden® PC33-E

List price \$59.95/CE price \$44.00
The *Uniden* PC33 boasts a super-compact case and front-panel mike connector to fit comfortably in today's smaller cars. Controls: Power & Volume, Squelch; Switches: ANL. Other features of the PC33 include Graduated LED "S"/RF Meter, Digital channel indicator. Dimensions: 6" W x 6" D x 1 1/4" H. ±13.8 VDC.

Uniden® PC55-E

List price \$89.95/CE price \$59.00
The full featured *Uniden* PC55 front-panel mike connector makes installation easier when space is a factor. It has ANL, PA-CB, Channel 9 and RF Gain switches. LED "S"/RF Meter, TX lite, PA & external speaker jacks. Dimensions: 6" W x 6" D x 1 1/4" H. ±13.8 VDC.

Bandit™ Radar Detectors

Now that everyone else has taken their best shot at radar detection, the *Uniden* *Bandit*™ has done them one better...with E.D.I.T.,™ the Electronic Data Interference Terminator that actually edits-out false alarm signals.

The *Bandit* 55, features a convenient brightness/dimmer control for comfortable day or night driving, plus a handy highway/city control for maximum flexibility wherever you drive. The *Bandit* 95 Remote, is a two-piece modular unit that lets you mount the long-range radar antenna behind the grill, out of view. The ultra-compact control unit can then be inconspicuously tucked under the dash or clipped to the visor. Order *Bandit* 55-E for \$119.00 each or the *Bandit* 95-E Remote for \$139.00 each.

OTHER RADIOS AND ACCESSORIES

FB-E-E Frequency Directory for Eastern U.S.A. ... \$12.00
FB-W-E Frequency Directory for Western U.S.A. ... \$12.00
BC-WA-E Bearcat Weather Alert ... \$35.00
A60-E Magnet mount mobile antenna ... \$35.00
A70-E Base station antenna ... \$35.00
Add \$3.00 shipping for all accessories ordered at the same time.
Add \$3.00 shipping per scanner antenna.

BUY WITH CONFIDENCE

To get the fastest delivery from CE of any product in this ad, send or phone your order directly to our Scanner Distribution Center.™ Michigan residents please add 4% sales tax or supply your tax I.D. number. Written purchase orders are accepted from approved government agencies and most well rated firms at a 10% surcharge for net 10 billing. All sales are subject to availability, acceptance and verification. All sales on accessories are final. Prices, terms and specifications are subject to change without notice. All prices are in U.S. dollars. Out of stock items will be placed on backorder automatically unless CE is instructed differently. A \$5.00 additional handling fee will be charged for all orders with a merchandise total under \$50.00. Shipments are F.O.B. Ann Arbor, Michigan. No COD's. Most products that we sell have a manufacturer's warranty. Free copies of warranties on these products are available prior to purchase by writing to CE. International orders are invited with a \$20.00 surcharge for special handling in addition to shipping charges. Non-certified checks require bank clearance.

Mail orders to: Communications Electronics,™ Box 1002, Ann Arbor, Michigan 48106 U.S.A. Add \$7.00 per scanner, radar detector or CB or \$12.00 per shortwave receiver for U.P.S. ground shipping and handling in the continental U.S.A. For Canada, Puerto Rico, Hawaii, Alaska, or APO/FPO delivery, shipping charges are three times continental U.S. rates. If you have a Visa or Master Card, you may call and place a credit card order. Order toll-free in the U.S. Dial 800-521-4414. In Canada, order toll-free by calling 800-221-3475. WUI Telex CE anytime, dial 671-0155. If you are outside the U.S. or in Michigan dial 313-973-8888. Order today.

Scanner Distribution Center™ and CE logos are trademarks of Communications Electronics.™ Ad # 070184-E
† *Bearcat* is a registered trademark of Uniden Corporation.
Copyright © 1984 Communications Electronics

Order Toll Free ... call 1-800-521-4414

COMMUNICATIONS ELECTRONICS™

Consumer Products Division

818 Phoenix □ Box 1002 □ Ann Arbor, Michigan 48106 U.S.A.
Call TOLL-FREE 800-521-4414 or outside U.S.A. 313-973-8888



- 77
- 0.3% Accuracy
 - Manual or Autorange
 - 10A + mA Range
 - Beeper
 - "Touch-Hold" Function

\$129⁰⁰

WE CARRY A FULL LINE OF FLUKE MULTI-METERS. IN STOCK NOW

FLUKE 70 SERIES MULTIMETERS

- Analog Display • Rotary Knob • Volts AC & DC • Resistance to 32 MΩ • 10 Amps • Diode Test • 3200 Counts • Fast Autoranging • Function Annunciators in Display • Power-Up Self Test • 2000+ Hour Battery Life w/ Power Down "Sleep Mode" • New Test Leads • VDE & UL Approval



\$99⁰⁰

75

- 0.5% Accuracy
- Manual or Autorange
- 10A + 300 mA Range
- Beeper

\$85⁰⁰

73

- 0.7% Accuracy
- Autorange Only
- 10 Amp Only

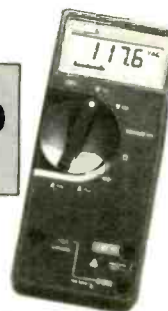

4 1/2 DIGIT MULTIMETERS

\$349⁰⁰

MODEL 8060A



- Frequency measurements to 200KHz
- dB measurements
- Basic dc accuracy 0.4%; 10 μV, 10 nA and 10 mΩ sensitivity
- Relative measurements
- True RMS
- High-speed Beeper



POWER SUPPLIES



\$299⁹⁵

MODEL 1601

- Isolated 0-50VDC, continuously variable; 0-2A in four ranges
- Fully automatic shutdown, adjustable current limit
- Perfect for solid state servicing



\$329⁹⁵

MODEL 1650

- Functions as three separate supplies
- Exclusive tracking circuit
- Fixed output 5VDC, 5A
- Two 0 to 25VDC outputs at 0.5A
- Fully automatic, current-limited overload protection



INDUSTRIAL TRANSISTOR TESTER

\$199⁹⁵



MODEL 520B

- Now with HI/LO Drive
- Works in-circuit when others won't
- Identifies all three transistor leads
- Random lead connection
- Audibly and visually indicates GOOD transistor

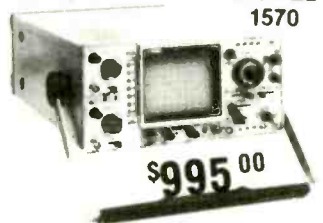

70 MHz Dual Time Base SCOPE

MODEL 1570

\$995⁰⁰

PRICE DOES NOT INCLUDE PROBES

- 1mV/division sensitivity to 70 MHz
- 500 μV/division cascade sensitivity
- Four-input operation provides trigger view on 4 separate inputs
- Alternate time base operation
- Switching power supply delivers best efficiency and regulation at lowest weight



FUNCTION GENERATORS

MODEL 3010

\$189⁹⁵

- Sine, square and triangle output
- Variable and fixed TTL outputs
- 0.1 Hz to 1MHz in six ranges
- Push button range and function selection
- Typical sine wave distortion under 0.5% from 1 Hz to 100kHz

MODEL 3020

\$319⁹⁵

SWEEP FUNCTION

- Four instruments in one package — sweep generator, function generator, pulse generator, tone-burst generator
- Covers 0.02Hz-2MHz
- 1000:1 tuning range
- Low-distortion high-accuracy outputs



MODEL 830

\$199⁹⁵

- Automatically measures capacitance from 0.1pF to 200mF
- 0.1pF resolution
- 0.2% basic accuracy
- 3 1/2 digit LCD display

CAPACITANCE METERS

\$159⁹⁵

MODEL 820

- Resolves to 0.1pF
- 4 digit easy-to-read LED display
- Fuse protected against charged capacitors
- Overrange Indication





V-222

HI-PERFORMANCE PORTABLE OSCILLOSCOPES

ALL FEATURE 6" RECTANGULAR CRT
Full 2 year parts & labor warranty.

HITACHI

~~\$599~~ **\$599⁹⁵**

V-422
DC to 40 MHz,
1mV/div, dual-trace,
DC offset function

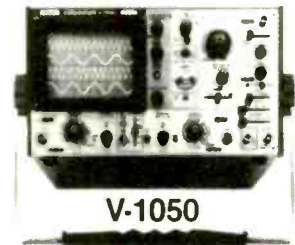

V-1050

~~\$1,249~~ **\$1,249⁹⁵**

V-1050F
100 MHz Quad Trace
w/delay sweep

~~\$499~~ **\$499⁹⁵**

V-222
DC to 20 MHz,
1mV/div, dual-trace,
DC off. func., Alt.
magnify function

~~\$439~~ **\$439⁹⁵**

V-212
DC to 20 MHz,
1mV/div, dual-trace

~~\$939~~ **\$939⁹⁵**

V-650F
60 MHz Dual Trace
w/delay sweep

PRICE DOES NOT INCLUDE
PROBES. PROBES \$50. A PAIR
WHEN PURCHASED WITH SCOPE.
\$15 SHIPPING WITHIN
CONTINENTAL U.S.

BECKMAN'S CIRCUITMATE[®] ALL UNDER \$100

AVAILABLE NOW. . . .



~~\$64~~ **\$64⁹⁵**

Circuitmate DM 20—
3½-digit, pocket-size
multimeter; 0.8% Vdc
accuracy, diode test,
hFE test, conductance,
10 amps AC and DC
ranges, auto-polarity,
auto-zero, auto-
decimal



~~\$69~~ **\$69⁹⁵**

Circuitmate DM 40 —
3½-digit multimeter;
0.8% Vdc accuracy,
diode test, auto-
polarity, auto-zero,
auto-decimal



~~\$89~~ **\$89⁹⁵**

Circuitmate DM 45 —
3½-digit multimeter;
0.5% Vdc accuracy,
diode test, continuity
beeper, 10 amps AC
and DC ranges, auto-
zero, auto-polarity,
auto-decimal



~~\$79~~ **\$79⁹⁵**

Circuitmate DM-25—
3½ digit, pocket-size
multimeter; 0.5% Vac
accuracy, diode test,
capacitance, continuity
beeper, conductance,
10 amps AC and DC
ranges, auto-polarity,
auto-zero, auto-
decimal



The DM73 is the smallest digital
multimeter on the market. Its
probe-style design makes it ideal
for taking measurements in hard-
to-reach test areas.

~~\$63~~ **\$63⁹⁵**

- Small Size
- Complete
Autoranging
- "Touch Hold"
- Audible
continuity
checking



~~\$76~~ **\$76⁹⁵**

The DM 77 gives you
the convenience of
autoranging plus 10
amps ac/dc
measurement
capability. You simply
select the function
you want, and the
DM 77 automatically
sets the required
range.

TOLL FREE HOT LINE
800-223-0474

26 WEST 46th STREET, NEW YORK, N.Y. 10036
212-730-7030

THE TEST EQUIPMENT SPECIALISTS

**ADVANCE
ELECTRONICS**



THE RIGHT STUFF.

The growth of NTE quality replacement parts has been nothing short of astronomical. And the proof is in our new 1984 Replacement Master Guide, destined to be the standard directory for technicians across the country. In excess of 3,000 quality NTE types are cross-referenced to more than 220,000 industry part numbers.

YOU'LL FIND ALL THE RIGHT STUFF FOR REPLACEMENT, MAINTENANCE AND REPAIR:

- Transistors
- Thyristors
- Integrated Circuits
- Rectifiers and Diodes
- High Voltage Multipliers and Dividers
- Optoelectronic Devices
- Zeners
- Microprocessors and Support Chips
- Memory IC's
- Thermal Cut-Offs
- Bridge Rectifiers
- Unijunctions
- RF Transistors
- Microwave Oven Rectifiers
- Selenium Rectifiers
- NEW! The Protector 6000™ Transient Voltage Protection Strip

Look for our Replacement semiconductors in the bright green polybags and cartons that list rating limits, device type, diagrams and competitive replacement right on the package. NTE quality parts are available from your local NTE distributor and come backed by our exclusive two-year warranty. Ask for your FREE NTE Replacement Master Guide and take off with NTE!



NEW-TONE ELECTRONICS, INC.

44 FARRAND STREET • BLOOMFIELD, NEW JERSEY 07003

DON'T FORGET



USE YOUR READER SERVICE CARD

LETTERS

continued from page 24

connected with the positive lead to ground.

CURT SWANSON
Maple Grove, MN

You're right about C2. However, you shouldn't assume that a negative gain necessarily indicates a signal loss. An amplifier that has an output smaller than its input has a gain (be it negative or positive) between 0 and 1. A negative gain indicates a 180° phase shift.—Editor

RADAR AND THE SPEED LIMIT

Regarding letters that concern radar and the 55-mile-per-hour speed limit—I have enjoyed reading the stimulating comments from others about those contemporary issues that are directly related to products in the consumer-electronics market.

However, might I suggest that 1984 would be an appropriate year for **Radio-Electronics** to feature articles on attempts by municipalities to ban home-satellite antennas, radar-detectors, and mobile scanners.

Many readers may also be interested in the subject of privacy and security in their telephone communications, home banking, and cable-TV viewing. Please continue offering your readers enlightening articles and challenging construction projects.

THOMAS R. CICCATERI
Santa Rosa, CA

GOOD FORMAT

I want to sincerely thank you for not selling out your excellent format. I am a totally self-taught electronic designer and I work on state-of-the-art electronics and software for industrial instrumentation. I taught myself using texts, hands-on-experiments, and magazines like yours. Thank you for keeping electronics articles that I can sink my teeth into, along with keeping up on computers and software.

MICHAEL CHRISTOPHER
Dayton, OH

R-E

SIMPLY AMAZING.

B&K-PRECISION's under \$170 100 MHz frequency counter.

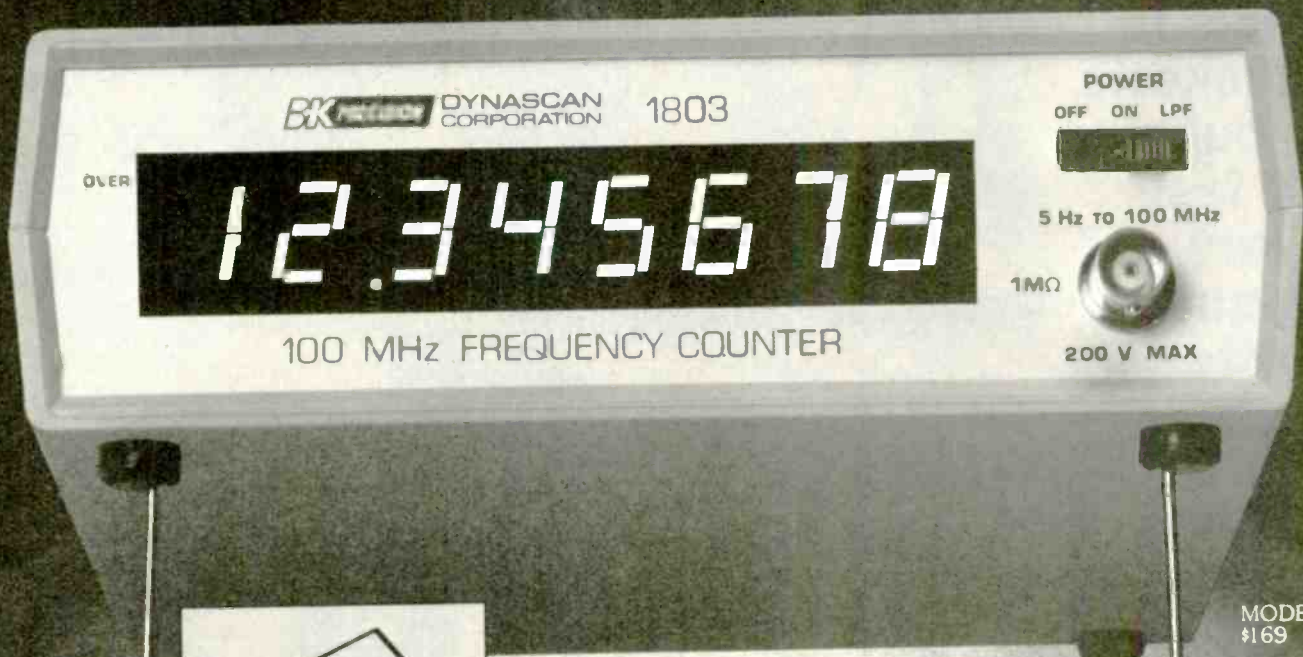

MODEL 1803
\$169

SHOWN ACTUAL SIZE

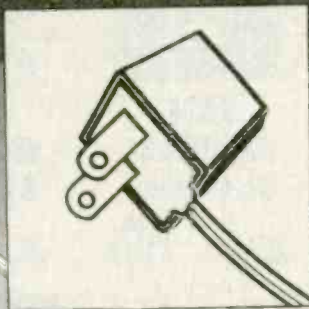

SIMPLE TO POWER.
BATTERY OR AC LINE
OPERATION
(ADAPTER INCLUDED).



EASY-TO-READ,
8-DIGIT DISPLAY
PROVIDES 1 Hz RESOLUTION

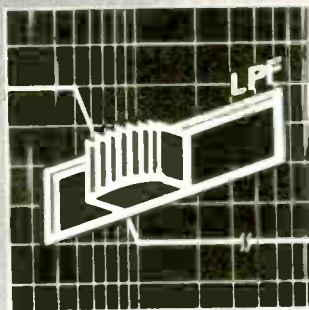

SELECTABLE LOW PASS
FILTER FOR ACCURATE
LOW-FREQUENCY
MEASUREMENTS.

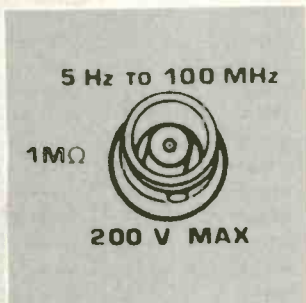

BNC INPUT CONNECTOR
SIMPLIFIES HOOK-UPS
—ELIMINATES NEED FOR
ADAPTERS.

For more details on the amazing 1803 and the full line
of new B&K-PRECISION frequency counters, see your local
distributor or call 1-312-889-9087.

B&K PRECISION DYNASCAN CORPORATION

6460 W. Cortland Street • Chicago, IL 60635 • 312/889-9087
International Sales, 6460 W. Cortland St., Chicago, IL 60635
Canadian Sales, Atlas Electronics, Ontario
South and Central American Sales, Empire Exporters, Plainville, NY 11803

CIRCLE 16 ON FREE INFORMATION CARD

Diskette Users...

When you've heard from all the animals in the diskette zoo, but you need fast delivery and high quality diskettes...

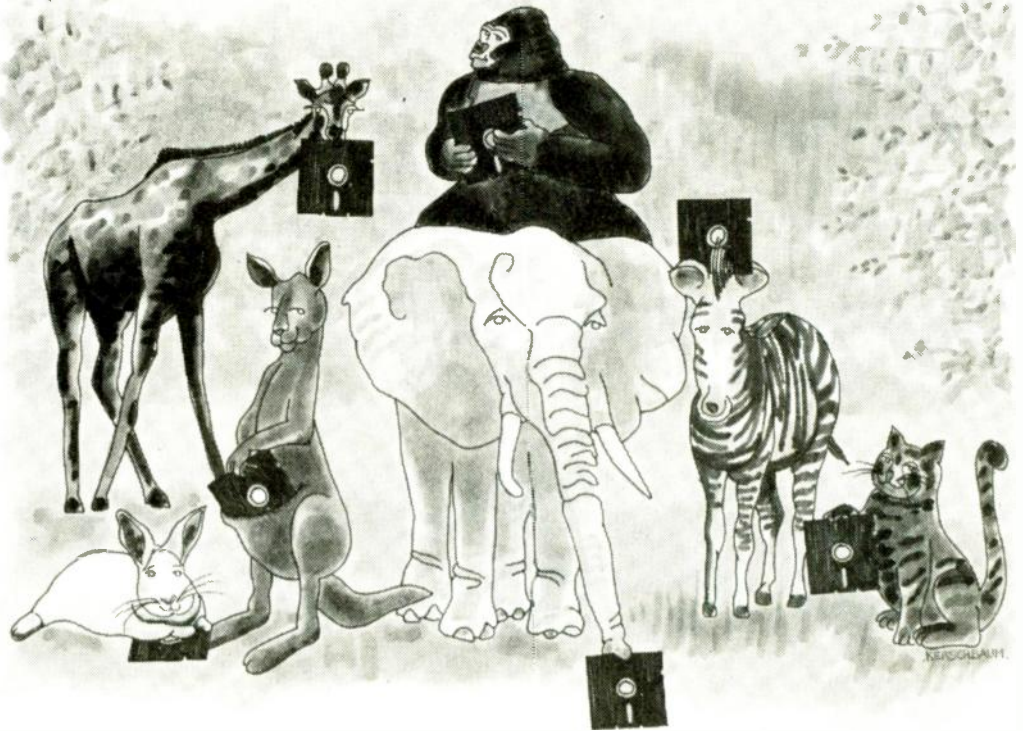

Call Communications Electronics

Diskette order desk
800-USA-DISK

In Canada 800-CA1-DISK

Choose your brand
Choose your price



Super Disk
diskettes $\frac{100}{100}$
\$0.94 each



Wabash
diskettes $\frac{100}{100}$
\$0.99 each



BASF
diskettes $\frac{100}{100}$
\$1.44 each



3M
diskettes $\frac{100}{100}$
\$1.44 each

Product Description

8" SSDD IBM Compatible 128B/S, 26 Sector	_____	_____
8" SSDD Shugart Compatible, 32 Hard Sector	_____	_____
8" SSDD IBM Compatible (128 B/S, 26 Sectors)	_____	_____
8" DSDD Soft Sector (Unformatted)	_____	_____
8" DSDD Soft Sector (256 B/S, 26 Sectors)	_____	_____
8" DSDD Soft Sector (512 B/S, 15 Sectors)	_____	_____
8" DSDD Soft Sector (1024 B/S, 8 Sectors)	_____	_____
5 1/4" SSDD Soft Sector w/Hub Ring	6431-P	1.14
5 1/4" SSDD Same as above but bulk product	6437-P	0.94
5 1/4" SSDD 10 Hard Sector w/Hub Ring	_____	_____
5 1/4" SSDD Soft Sector w/Hub Ring	6481-P	1.29
5 1/4" SSDD Same as above, but bulk product	6487-P	1.09
5 1/4" SSDD Soft Sector Flippy (use both sides)	_____	_____
5 1/4" SSDD 10 Hard Sector w/Hub Ring	_____	_____
5 1/4" DSDD Soft Sector w/Hub Ring	6481-P	1.54
5 1/4" DSDD Same as above, but bulk product	6487-P	1.34
5 1/4" DSDD 10 Hard Sector w/Hub Ring	_____	_____
5 1/4" DSDD 16 Hard Sector w/Hub Ring	_____	_____
5 1/4" DSDD Soft Sector w/Hub Ring (96 TPI)	6501-P	2.44
3 1/2" SSDD Soft Sector micro-floppy	_____	_____

Super Disk
Part #

CE quant
100 prices
per disk (\$)

Wabash
Part #

CE quant
100 prices
per disk (\$)

BASF
Part #

CE quant
100 prices
per disk (\$)

3M
Part #

CE quant
100 prices
per disk (\$)

F111-P	1.59	_____	_____	8330-P	1.94
F31A-P	1.79	_____	_____	_____	_____
F131-P	1.89	_____	_____	8330-P	2.39
F14A-P	2.09	_____	_____	8030-P	2.89
F144-P	2.09	_____	_____	_____	_____
F14B-P	2.09	_____	_____	_____	_____
F147-P	2.09	_____	_____	8030-1024-P	2.89
M11A-P	1.19	_____	_____	_____	_____
M11AB-P	0.99	_____	_____	_____	_____
M41A-P	1.19	_____	_____	_____	_____
M13A-P	1.34	54974-P	1.44	5330-RN-P	1.64
M13AB-P	1.14	_____	_____	5330-OL-P	1.44
M18A-P	1.99	_____	_____	_____	_____
M43A-P	1.34	_____	_____	_____	_____
M14A-P	1.59	54980-P	1.79	5030-RN-P	2.19
M14AB-P	1.39	_____	_____	_____	_____
M44A-P	1.59	_____	_____	_____	_____
M54A-P	1.59	_____	_____	_____	_____
M18A-P	2.49	54902-P	2.99	5030-96RH-P	3.09
_____	_____	54112-P	2.74	3330-P	3.74

Lifetime warranty

For more info on Super Disk call

800-USA-DISK
In Michigan 313-873-1111

6 year warranty

For more info on Wabash call

800-323-9868
In Illinois 312-593-8383

Lifetime warranty

For more info on BASF call

800-343-4600
In Massachusetts 617-271-4800

Lifetime warranty

For more info on 3M call

800-328-9438
In Minnesota 612-730-9624

CE...your best source for diskettes

For you the diskette buyer, it's a jungle out there. There are so many different brands to choose from, you need to go on a safari to find a good brand at a reasonable cost. Fortunately, CE has already hunted for the best diskettes and offers you an excellent choice at a CE price. To save you even more, CE also offers bulk product where 100 diskettes are packed in the same box without envelopes or labels. Since we save packaging costs, these savings are passed on to you. Diskette envelopes are also available from CE. These super strong and tear resistant Tyvek® envelopes are only \$15.00 per 100 pack. Use order # TE-5 for a 100 pack of 5¼" diskette envelopes.

Quantity Discounts Available

Our diskettes are packed 10 disks to a carton and 5 or 10 cartons to a case. The economy bulk pack is packaged 100 disks to a case without envelopes or labels. Please order only in increments of 100 units for quantity 100 pricing. With the exception of bulk pack, we are also willing to accommodate your smaller orders. Quantities less than 100 units are available in increments of 10 units at a 20% surcharge above our 100 unit price. **Quantity discounts** are also available. Order 300 or more disks at the same time and deduct 1%; 500 or more saves you 2%; 1,000 or more saves 3%; 2,000 or more saves 4%; 5,000 or more saves 5%; 10,000 or more saves 6%; 50,000 or more saves 7%; 100,000 or more saves 8%; 500,000 or more saves 9% and 1,000,000 or more disks earns you a 10% discount off our super low quantity 100 price. Almost all our diskettes are immediately available from CE. Our efficient warehouse facilities are equipped to help us get you the quality product you need, when you need it. If you need further assistance to find the flexible diskette that's right for you, call the appropriate manufacturers compatibility hotline telephone number listed at the bottom of this ad. Dealer inquiries invited.

Buy your diskettes from CE with confidence

To get the fastest delivery of your diskettes, phone your order directly to our order desk and charge it to your credit card. Written purchase orders are accepted from approved government agencies and most well rated firms at a 10% surcharge for net 10 billing. For maximum savings, your order should be prepaid. All sales are subject to availability, acceptance and verification. All sales are final. All prices are in U.S. dollars. Prices, terms and specifications are subject to change without notice. Out of stock items will be placed on backorder or substituted for equivalent product at no extra cost to you unless CE is instructed differently. A \$5.00 additional handling fee will be charged for all orders with a merchandise total under \$50.00. All shipments are F.O.B. CE warehouse in Ann Arbor, Michigan. COD terms are available, in U.S. UPS areas for \$5.00 extra, and are payable with cash or certified check.

For shipping charges add \$8.00 per 100 diskettes and/or any fraction of 100 8-inch diskettes, or \$6.00 per 100 diskettes and/or any fraction of 100 5¼-inch or 3½-inch diskettes for U.P.S. ground shipping and handling in the continental U.S. UPS 2nd day air rates are three times continental U.S. rates. For Canada, Puerto Rico, Hawaii, Alaska, or APO/FPO delivery, shipping is three times the continental U.S. rate.

Mail orders to: Communications Electronics, Box 1045, Ann Arbor, Michigan 48106 U.S.A. If you have a Visa or Master Card, you may call and place a credit card order. Order toll-free in the U.S. Dial 800-USA-DISK. In Canada, order toll-free by calling 800-CA1-DISK. If you are outside the U.S. or in Michigan dial 313-973-8888. WUI telex anytime 671-0155. Order today.

Copyright © 1984 Communications Electronics Inc.

Ad #080284



Computer Products Division

Box 1045 □ Ann Arbor, Michigan 48106-1045 U.S.A.
Call toll-free 800-USA-DISK or outside U.S.A. 313-973-8888



Verbatim diskettes **\$1.59 each**



Memorex diskettes **\$1.59 each**



Ultra diskettes **\$1.59 each**



TDK diskettes **\$1.59 each**



Fuji diskettes **\$1.59 each**



Dysan diskettes **\$1.94 each**

Verbatim Part #	CE quant. 100 price per disk (\$)	Memorex Part #	CE quant. 100 price per disk (\$)	Ultra Part #	CE quant. 100 price per disk (\$)	TDK Part #	CE quant. 100 price per disk (\$)	Fuji Part #	CE quant. 100 price per disk (\$)	Dysan Part #	CE quant. 100 price per disk (\$)
_____	_____	3062-P	1.94	01720-P	1.94	F1-S-P	2.34	F018-128H-P	1.94	000501-P	2.49
_____	_____	3015-P	1.94	_____	_____	_____	_____	_____	_____	000605-P	2.69
_____	_____	3090-P	2.39	_____	_____	F2D-S-P	2.89	F020-P	2.89	000803-P	3.14
_____	_____	3102-P	2.89	02701-P	2.89	_____	_____	_____	_____	_____	_____
_____	_____	_____	_____	02700-P	2.89	F2D-S1024-P	2.89	F02D-1024-P	2.89	000839-P	3.14
_____	_____	3104-P	2.89	_____	_____	_____	_____	_____	_____	_____	_____
28820-P	1.59	3401-P	1.59	51401-P	1.59	M1D-S-P	1.59	M01D-P	1.59	001107-P	1.94
_____	_____	_____	_____	52402-P	1.99	_____	_____	_____	_____	_____	_____
28821-P	2.54	3401-P	2.19	52401-P	2.19	M2D-S-P	2.19	M02D-P	2.19	002000-P	2.64
_____	_____	_____	_____	_____	_____	_____	_____	_____	_____	_____	_____
28823-P	3.39	3501-P	2.99	52001-P	2.99	M20X-S-P	2.99	M02D-007P-P	2.99	002007-P	3.99
_____	_____	0100-P	3.74	_____	_____	M1D-P	2.99	_____	_____	_____	_____

Lifetime warranty
For more info on Verbatim call
800-538-8589
In California 408-245-4400

5 year warranty
For more info on Memorex call
800-448-1422
Monday-Friday 9am-4pm ET

Lifetime warranty
For more info on Ultra call
408-728-7777
Monday-Friday 9 am-4 pm PT

Lifetime warranty
For more info on TDK call
800-645-6571
In New York 516-925-0100

Lifetime warranty
For more info on Fuji call
800-223-6535
In New York 212-730-3330

Lifetime warranty
For more info on Dysan call
800-552-2211
In California 408-070-0000

CIRCLE 35 ON FREE INFORMATION CARD

NEW IDEAS

Add-on scope multiplexer

HAVING A DUAL-TRACE SCOPE IS A LUXURY that many of us, unfortunately, must do without. However, with the simple circuit we'll describe, you can add dual-trace capability to your single-trace scope at a cost of less than \$5. Unfortunately, the device has one major "drawback," it only monitors logic levels (TTL and CMOS); but at that price, who cares!

How it works

Figure 1 shows the multiplexing circuit that lets you view two traces simultaneously. The operation of the unit revolves around three IC's: a 4093 quad NAND Schmitt-trigger, 4066 quad analog-switch,

and a 7555 timer (that is used to gate IC2-b and IC2-c on or off.)

The device can be powered from a supply ranging of from 4.5 to 15 volts, and draws less than 2 mA. With a supply of 5 volts, the unit may be used to monitor TTL or CMOS logic-levels. At higher supply voltages (15 volts), it may be used to check only CMOS logic signals.

To make the operation of the unit a little easier to understand, we'll first look at the two input circuits separately and then see how the switching action of the circuit is handled.

When a high is fed to PROBE 1 IN, it is inverted by IC1-a and once again

by IC1-b, so that the input to IC2-a is high. That high causes the "switch contacts" in IC2-a to close. With the "contacts" closed, a high-level output is presented to the input of IC2-b.

Meanwhile, let's suppose that a high is fed to PROBE 2 IN. That signal is then inverted by IC1-d and routed to IC2-d, causing its "contacts" to open and the unit to output a logic-level high. The output of IC2-d is then fed to IC2-c.

Unless a gating pulse is presented to both IC2-c and IC2-d, *continued on page 112*

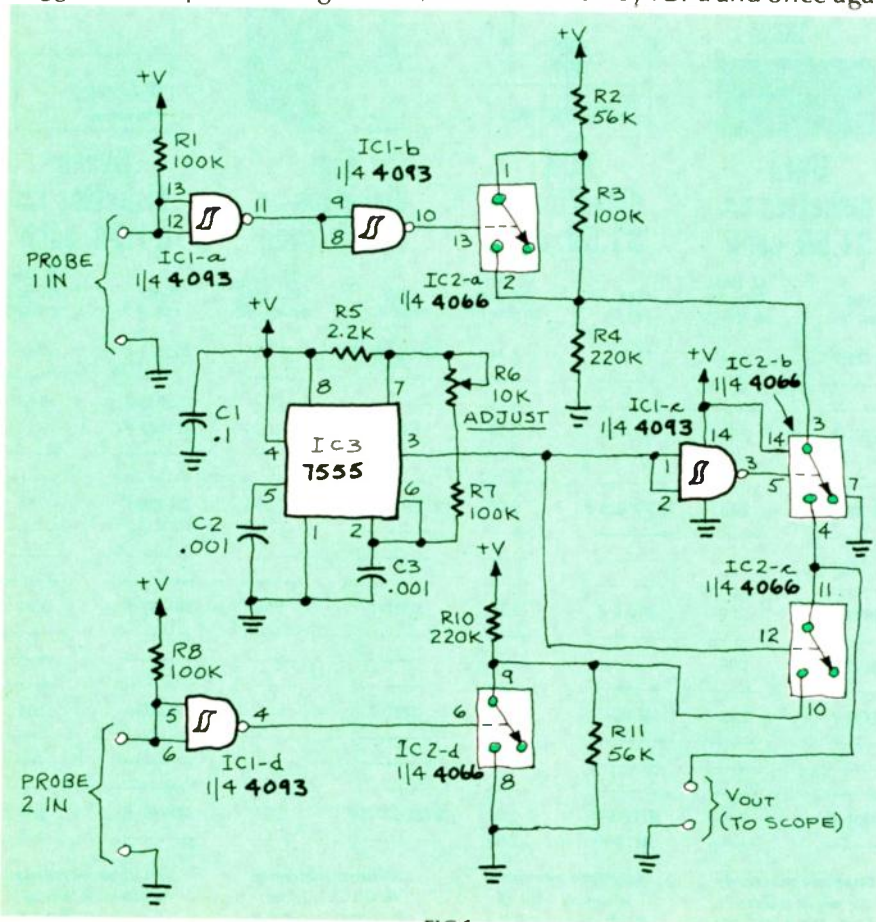

FIG.1

NEW IDEAS

This column is devoted to new ideas, circuits, device applications, construction techniques, helpful hints, etc.

All published entries, upon publication, will earn \$25. In addition, for U.S. residents only, Panavise will donate their model 333—The Rapid Assembly Circuit Board Holder, having a retail price of \$39.95. It features an eight-position rotating adjustment, indexing at 45-degree increments, and six positive lock positions in the vertical plane, giving you a full ten-inch height adjustment for comfortable working.

I agree to the above terms, and grant Radio-Electronics Magazine the right to publish my idea and to subsequently re-publish my idea in collections or compilations of reprints of similar articles. I declare that the attached idea is my own original material and that its publication does not violate any other copyright. I also declare that this material has not been previously published.

Title of Idea

Signature

Print Name

Date

Street

City

State

Zip

Mail your idea along with this coupon to: **New Ideas Radio-Electronics, 200 Park Ave. South, New York, NY 10003**

Now electronics technicians can get into VCR Servicing quickly and easily

Learn professional VCR servicing at home or in your shop with exclusive videotaped demonstrations

Today, there are more than 10 million VCRs in use, with people standing in line to have them serviced. You can bring this profitable business into your shop with NRI professional training in VCR servicing. This top-level training supports the industry's claim that the best technicians today are those who service VCRs.

Integrated Three-Way Self-Teaching Program

In one integrated program, NRI gives you a study guide, 9 instructional units, 2 hours of video training tapes accompanied by a 32-page workbook that pulls it all together. At home or in your shop, you'll cover all the basic concepts of video recording, mechanical and electronic systems analyses, and the latest troubleshooting techniques. Your workbook and instructional units also contain an abundance of diagrams, data, and supplementary material that makes them valuable additions to your servicing library.

The "How-To" Videotape

Your NRI Action Videocassette uses every modern communications technique to make learning fast and easy. You'll enjoy expert lectures and see animation and video graphics that make every point crystal-clear. You'll follow the camera eye into the heart of the VCR as step-by-step servicing techniques are shown. Both electronic and mechanical troubleshooting are covered . . . including everything from complete replacement and adjustment of the recording heads to diagnosing micro-processor control faults.

Plus Training On All The New Video Systems

Although your course concentrates on VCRs covering Beta, VHS, and 3/4" U-Matic commercial VCRs, NRI also brings you up to speed in other key areas. You'll get training in capacitance and optical video disc players, projection TV, and video cameras. All are included to make you the complete video technician. There's even an optional final examination for NRI's VCR Professional Certificate.



Covers Beta and VHS systems with actual instruction on videotape.

The Best Professional Training

This exclusive self-study course has been developed by the professionals at NRI. NRI has trained more television technicians than any other electronics school! In fact, NRI has consistently led the way in developing troubleshooting techniques for servicing virtually every piece of home entertainment equipment as it appears in the marketplace.

Satisfaction Guaranteed . . . 15-Day No-Risk Examination

Send today for the new NRI Self-Study Course in VCR Servicing for

Professionals. Examine it for 15 full days, look over the lessons, sample the videotape. If you're not fully satisfied that this is the kind of training you and your people need to get into the profitable VCR servicing business, return it for a prompt and full refund, including postage. Act now, and start adding new business to your business.

Special Introductory Offer

This complete VCR training course with two hour videotape is being offered for a limited time only, on orders received from this ad, at our low introductory price of \$179.95. Save \$20 by acting now!

NRI Training For Professionals
McGraw-Hill Continuing Education Center
3939 Wisconsin Avenue Washington, DC 20016

YES! Get me started in profitable VCR servicing. Rush me my NRI self-study course in VCR Servicing for Professionals. I understand I may return it for a full refund within 15 days if not completely satisfied.

PLEASE SPECIFY TAPE FORMAT DESIRED VHS BETA

Name (please print) _____

Company _____

Street _____

City/State/Zip _____

Enclosed is my check money order for \$179.95 (D.C. residents add 6% tax) Make check payable to NRI

Charge to VISA MasterCard _____

Interbank Number _____

Card Number _____ Expiration Date _____

Signature _____

(required for credit card sales)

2600-104



NRI Training For Professionals
McGraw-Hill Continuing
Education Center
3939 Wisconsin Avenue
Washington, DC 20016

EQUIPMENT REPORTS

Hameg Model HM605 Oscilloscope

A 60-MHz oscilloscope
with a built-in
component tester



CIRCLE 101 ON FREE INFORMATION CARD

IF YOU ARE IN THE MARKET FOR AN outstanding oscilloscope for professional or scientific applications, we recently had the opportunity to examine a unit that we feel merits your consideration. It is the model HM605 from Hameg (88-90 Harbor Rd., Port Washington, NY 11050). Its features and performance make it ideal for a wide range of demanding applications.

The HM605

The oscilloscope is a dual-trace type with a bandwidth of DC to 60 MHz. It features a rectangular CRT
continued on page 40

A.W. Sperry Instruments introduces

The 4½ digit DMM with the 3½ digit price.

Another A.W. Sperry Instruments first! Our new **AWS DM-7010** combines the precision of 4½ digit readings with all the most wanted features you've been looking for. We've even included a built-in frequency counter (up to 200KHz)! With 9 functions and 33 ranges, the **AWS DM-7010's** expanded capability can't be beat!

And that's not all! Included among the special functions built into the **DM-7010's** small, self-contained housing are: conductance, diode test and an instant audible continuity check. The **DM-7010** has a basic DC Volt accuracy of 0.05% and loads of built-in safety features.

You'd expect to pay \$300 or more for an instrument boasting this kind of performance, yet the **AWS DM-7010** can be yours for a low **\$170!** Now there's no need to pay more for the accuracy and quality you need in a DMM.

For more information, call your distributor or A.W. Sperry Instruments, Inc., P.O. Box 9300, Smithtown, N.Y. 11787. **800-645-5398** Toll-Free (N.Y., Hawaii, Alaska call collect 516-231-7050).

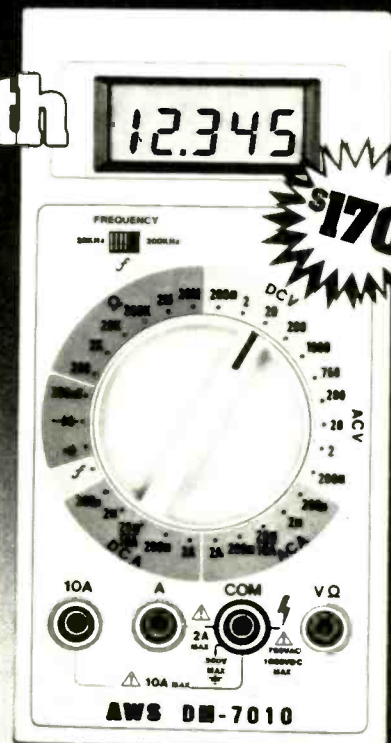

A.W. SPERRY INSTRUMENTS INC.
The Measurable Advantage.

CIRCLE 72 ON FREE INFORMATION CARD

Where's Your **ELECTRONICS** Career Headed?

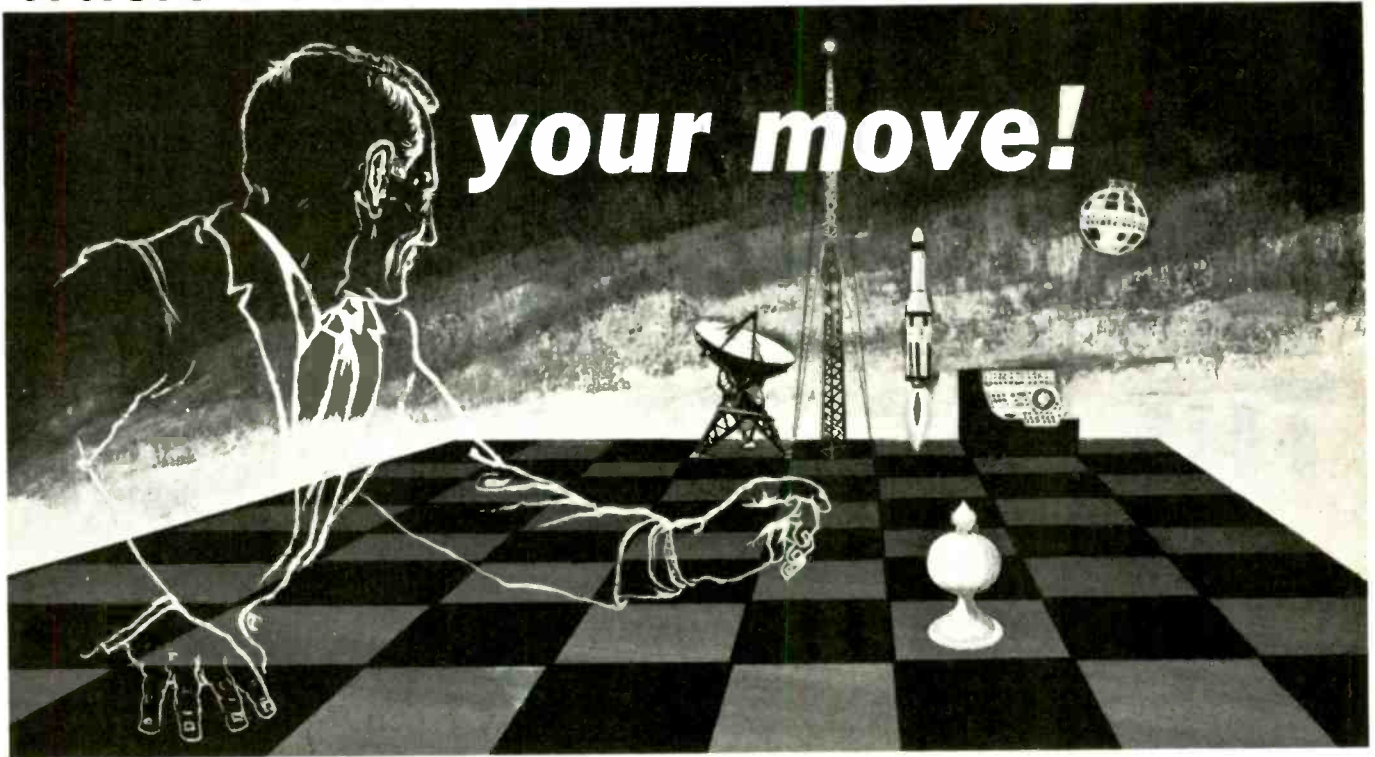

The Move You Make Today Can Shape Your Future

Yes it's your move. Whether on a chess board or in your career, you should plan each move carefully. In **electronics**, you can *move ahead* faster and further with a

B. S. DEGREE

Put professional knowledge and a COLLEGE DEGREE in your electronics career. Earn your degree through independent study at home, with Grantham College of Engineering. No commuting to class. Study at your own pace, while continuing your present job.

The accredited Grantham non-traditional degree program is intended for mature, fully employed workers who want to upgrade their careers . . . and who can successfully study electronics and supporting subjects through

INDEPENDENT STUDY, AT HOME

Free Details Available from:

Grantham College of Engineering
2500 South La Cienega Blvd.
P. O. Box 35499
Los Angeles, CA 90035

Independent Home Study Can Prepare You

Study materials, carefully written by the Grantham staff for independent study at home, are supplied by the College, and your technical questions related to those materials and the lesson tests are promptly answered by the Grantham teaching staff.

Recognition and Quality Assurance

Grantham College of Engineering is accredited by the Accrediting Commission of the National Home Study Council.

We are located at 2500 S. LaCienega Blvd., Los Angeles, California, but for faster response please use our mailing address: P. O. Box 35499, Los Angeles, CA 90035.

Grantham College of Engineering 10-84
P. O. Box 35499, Los Angeles, CA 90035

Please mail me your free catalog which explains your B.S. Degree independent-study program.

Name _____ Age _____

Address _____

City _____ State _____ Zip _____

In Computer Electronics...

NTS INTRONIC™ HOME TRAINING GIVES YOU THE EDGE

The competition for High-Technology careers is strong, and the rewards are great. Give yourself the edge you need by training with NTS.



NTS INTRONIC home training provides you with a special kind of "Hands-On" experience that prepares you better, develops your skills faster. You advance as quickly as you wish, working with actual circuits, diagrams, schematics, and state-of-the-art hardware. There are a dozen different NTS programs in electronics to help you develop and reach your potential. They range from basics to advanced areas in several fields. And the ALL-NEW NTS course catalog spells it all out. It's free, and does not obligate you in any way. Send for it today.

A GROWTH INDUSTRY

High-Technology is a growth industry. The evidence is clear, and most observers predict a steady expansion due to a relatively strong flow of investment capital into computers, electronics and precision instruments. Sales of computers alone will reach an estimated ten million units this year. This means challenges and new

employment opportunities, especially in servicing and maintenance. Computer servicing skills can best be learned by working directly on field-type equipment. NTS electronic hardware is selected and developed especially for the training program with which it is associated. You learn by doing, by assembling, by performing tests and experiments, covering principles of computer electronics, microprocessor troubleshooting, and circuitry.

MICROCOMPUTERS

NTS offers three programs in computer electronics. You will receive training covering solid-state devices, digital logic circuitry, and the fundamentals of the computer itself. Instruction includes micro-control technology and detailed operation of microcomputers. These courses will prepare you for entry-level in many facets of the computer industry such as field service and customer engineering as well as programming. In addition to written texts your course includes the NTS/HEATH disc-drive computer which you assemble as part of the training process. The assembly and use of the computer will serve to reinforce practical application of principles.

MICROPROCESSOR TECHNOLOGY

The field of industrial and microprocessor technology encompasses the application of electronic microprocessor control principles. Your course takes you from fundamentals of digital electronics and associated circuitry through the application of the microprocessor as a control device. You will learn how to move and manipulate instructions and information. The microprocessor trainer included in your course is a microcomputer system designed as a practical tool for learning the use of software and hardware techniques utilized in the linking of microprocessors to various systems.

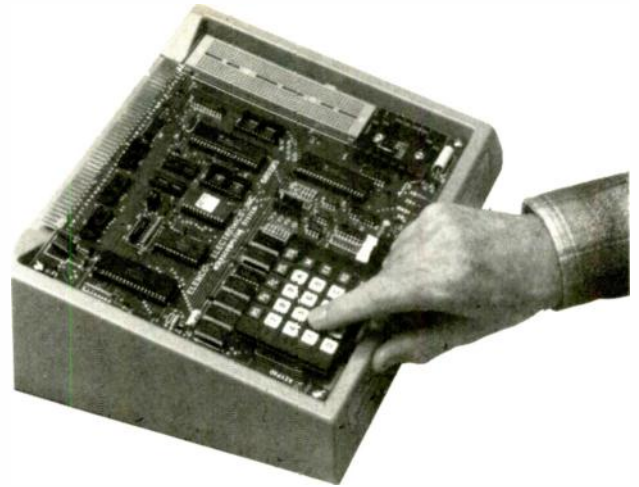

DIGITAL ELECTRONICS

The NTS Compu-Trainer is a fascinating solid-state device which you will build in order to perform over ninety logic circuit experiments. These experiments serve to emphasize an area of electronics which is essential to the understanding of state-of-the-art control equipment; they are also extremely important to those wanting to pursue a career in computer servicing. Separate courses involving the Compu-Trainer are also available in Microcomputer Servicing and Digital/Analog Electronics.

ROBOTICS & VIDEO TECHNOLOGY

Other NTS courses cover a wide range of specialization. In Robotics, the NTS/Heath Hero I is included to train you in robotic applications in

manufacturing processes. In Video technology, a new course features the advanced NTS/Heath Z Chassis "Smart Set" color TV with computer space command remote control and space phone. This is an excellent program for those interested in a career in video servicing with microcomputer basics.

EARN CEU CREDITS

America's industrial giants are turning more and more frequently to home study as an effective way to upgrade employee skills. You benefit from the experience NTS has gained in its 79 years as a leader in technical training. The skills and experience gained in the building of kits and test equipment provide you with training that cannot be duplicated. And, depending on the program you select, you can earn up to 30 CEU credits for successful completion. Complete details included in the catalog.



Use the mail-in card or fill out and mail the coupon. Indicate the field of your choice. (One, only please.) FREE full color catalog will be sent to you by return mail.

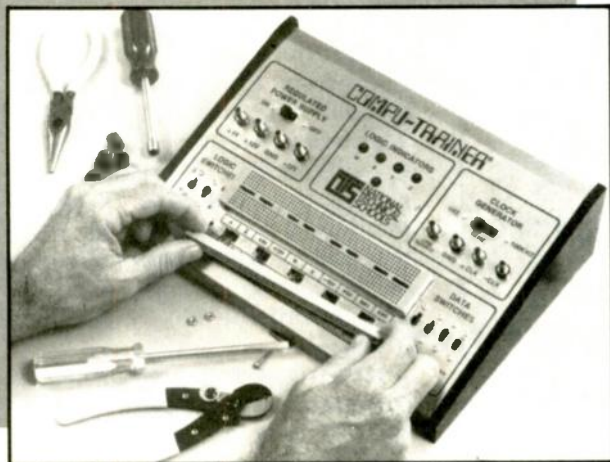

NATIONAL TECHNICAL SCHOOLS Dept 206-104
4000 South Figueroa Street, Los Angeles, CA 90037

Please send FREE color catalog on course checked below

Robotics Computer Electronics
 Digital Electronics Video Technology
 Auto Mechanics Home Appliances
 Air Conditioning / Solar Heating

Name _____ Age _____
 Address _____ Apt _____
 City _____ State _____
 Zip _____ Phone () _____

Check if interested ONLY in classroom training in Los Angeles
 Check if interested in G.I. Bill Information.

NO OBLIGATION



TECHNICAL TRADE TRAINING SINCE 1905
Resident and Home-Study Schools
4000 So. Figueroa St., Los Angeles, CA 90037

EQUIPMENT REPORTS

continued from page 34

with a 14-kilovolt acceleration potential for sharp, bright displays. The graticule is 8×10 divisions, with each division measuring 9.7 millimeters. For those who need to take photographs of the displayed patterns, the graticule can be illuminated. Two levels of illumination are provided (in addition, of course, to no illumina-

tion), with the level chosen depending on the film and camera used.

The unit boasts a variety of operating modes. Those are channel 1, channel 2, channels 1 and 2 alternated or chopped (the chopping frequency is approximately 1 MHz), sum or difference (channel-2 \pm channel-1), and X-Y mode.

Turning to the vertical (Y) amplifier, as previously mentioned, it boasts a DC to 60-MHz bandwidth

(-3dB). The risetime is 5.8 nanoseconds (ns), with a maximum overshoot of 1%. The amount of vertical deflection is set in 12 calibrated steps from 5 mV/cm to 20 V/cm. The steps are set up in the customary 1-2-5 sequence and accuracy is claimed to be $\pm 3\%$. An uncalibrated 2.5:1 variable control allows signals up to 50 volts to be displayed. In addition, a calibrated 5:1 magnifier is provided. The sensitivity of the magnifier is 1mV/cm, allowing extremely low-level signals to be displayed. The bandwidth of the scope when the 5:1 magnifier is used is DC to 20 MHz (-3dB). Finally, two LED's are used to indicate vertical overscanning, and a built-in delay-line feature allows viewing of the trigger leading edge.

Here's one phone book worth buying ...and reading.

Understanding Telephone Electronics

The powerful, positive thrust of electronics is making the telephone an ever more important communications link, bringing with it lower costs, expanded features and capabilities. Here, in an easy-to-understand book, learn what these functions are, why they are important, and how to use them. Covers analog, digital, and cellular telephony, including digital telephony, modems, and even mobile telephony. Fully illustrated. Ideal for self-paced individual learning.

By John L. Fike
George F. Frank
Texas Instruments Learning Center

Now only \$6.95

Understanding Telephone Electronics.
State-of-the-art technology is revolutionizing telephone communications. Enhancing capabilities. Lowering costs. Expanding functions.

Learn why digital systems are replacing analog. Why cordless phones are practical. How cellular mobile phones work.

Fully illustrated, *Understanding Telephone Electronics* is written in concise, nontechnical language, ideal for self-paced learning.

To order *Telephone Electronics*, or any other book in the *Understanding Series*,™ use the coupon below.

TEXAS INSTRUMENTS

Creating useful products and services for you.

™ Trademark of Texas Instruments Incorporated

RADIO-ELECTRONICS

<p>Please send me:</p> <p>Understanding Series Titles:</p> <p><input type="checkbox"/> Understanding Telephone Electronics—(LCB7141) _____ @ \$6.95</p> <p><input type="checkbox"/> Understanding Solid-State Electronics—3rd edition (LCB3361) _____ @ \$6.95</p> <p><input type="checkbox"/> Understanding Digital Electronics—(LCB3311) _____ @ \$6.95</p> <p><input type="checkbox"/> Understanding Microprocessors—(LCB4023) _____ @ \$6.95</p> <p><input type="checkbox"/> Understanding Calculator Math—(LCB3321) _____ @ \$6.95</p> <p><input type="checkbox"/> Understanding Communications Systems—(LCB4521) _____ @ \$6.95</p> <p><input type="checkbox"/> Understanding Computer Science—(LCB5471) _____ @ \$6.95</p> <p><input type="checkbox"/> Understanding Optonics—(LCB5472) _____ @ \$6.95</p> <p><input type="checkbox"/> Understanding Automotive Electronics—(LCB5771) _____ @ \$6.95</p> <p><input type="checkbox"/> Understanding Electronic Security Systems—(LCB7201) _____ @ \$6.95</p> <p><input type="checkbox"/> Understanding Electronic Control of Energy Systems—(LCB6642) _____ @ \$6.95</p> <p><input type="checkbox"/> Understanding Electronic Control of Automation Systems—(LCB6641) _____ @ \$6.95</p> <p><input type="checkbox"/> Understanding Data Communications—(LCB7981) _____ @ \$6.95</p> <p>Self Study Courses:</p> <p><input type="checkbox"/> AC Audio (LCB6651)/AC Text (LCW8168) _____ @ \$24.95</p> <p><input type="checkbox"/> DC Audio (LCB5922)/DC Text (LCW8161) _____ @ \$24.95</p>	<p>Quantity</p>	<p>Price</p>	<p>Mail to:</p> <p style="text-align: center;">Texas Instruments P.O. Box 3640, M/S 54 Dallas, Texas 75285</p> <p>Add \$1.25 per book for postage and handling. Prices subject to change without notice.</p> <p>Enclose check or money order with sales tax (except AK, DE, NH, OR). Foreign orders must be in U.S. dollars and include shipping charges. No phone orders, please.</p> <p>Name _____</p> <p>Address _____</p> <p>City _____</p> <p>State _____ Zip _____</p> <p>27-2116 ©1984 TI RE1084</p>
--	-----------------	--------------	---

HAMEG	HM605									
OVERALL PRICE	████████████████████									
EASE OF USE	████████████████████									
INSTRUCTION MANUAL	████████████████████									
PRICE/VALUE	████████████████████									
	1	2	3	4	5	6	7	8	9	10
	Poor		Fair			Good			Excellent	

The timebase is set in 23 calibrated steps from 50 ns/cm to 1 second/cm. Once again, the steps are laid out in the familiar 1-2-5 sequence. Accuracy is $\pm 3\%$. An uncalibrated 2.5:1 variable control allows the timebase to be expanded to 2.5 seconds/cm. A 10 \times magnifier allows timebases of as little as 5 ns/cm to be used. Accuracy with the 10 \times magnifier is $\pm 5\%$.

The triggering system can accommodate trigger signals up to at least 80 MHz with thresholds of 5 mm internal and 50 mV external. A variety of triggering modes are available. Among those are peak, where the sweep is triggered automatically from the peak voltage of the test signal; external; line, where the trigger signal is derived from the AC line, and single-sweep. A variable hold-off control to adjust the time between sweeps is also provided. Triggering can be selected on any point on the

LEADER

Great oscilloscopes from 15 to 35 MHz with outstanding features and new low prices.

We've designed brand new low and medium bandwidth oscilloscopes and built in many features you may never have seen in similar units. Surprising? Not any more. It's exactly the kind of innovative technology and superb quality you expect from Leader.

Ever see trigger holdoff on a 20 MHz scope? Or 500 μ V sensitivity?

Now Leader gives you these and so much more. Check it out:

LBO-524, LBO-524L:
35 MHz, \$995/\$1050

- CALIBRATED DUAL TIME BASE
- 500 μ V SENSITIVITY
- 7 kV PDA 6" CRT
- INTERNAL GRATICULE
- DELAYED SWEEP TRIGGERED FUNCTION
- VARIABLE SWEEP HOLDOFF
- ALTERNATE CHANNEL TRIGGERING
- AUTO FOCUS
- CHANNEL 1 OUTPUT

LBO-523: 35 MHz, \$895

- 7 kV PDA 6" CRT
- INTERNAL GRATICULE
- 500 μ V SENSITIVITY
- VARIABLE SWEEP HOLDOFF
- ALTERNATE CHANNEL TRIGGERING
- AUTO FOCUS
- CHANNEL 1 OUTPUT



LBO-522: 20 MHz, \$695

- 500 μ V SENSITIVITY
- 6" CRT
- INTERNAL GRATICULE
- ALTERNATE CHANNEL TRIGGERING
- VARIABLE SWEEP HOLDOFF
- AUTO FOCUS
- CHANNEL 1 OUTPUT

LBO-513A/LBO-514A:

- 15 MHz, \$470/\$595
- 1 mV SENSITIVITY
 - 0.5 μ S SWEEP SPEED
 - X-Y MODE CAPABILITY

Two-year warranty.
Evaluation units.

Our two-year warranty (even on the CRT) is backed by factory service depots on both coasts. Evaluation units are available to qualified customers.

Call toll-free
(800) 645-5104
In New York State
(516) 231-6900

Contact us for: information on 15 to 100 MHz and digital storage oscilloscopes; an evaluation unit; your nearest "Select" Leader distributor's name; and a full-line catalog.

For professionals who know the difference.

LEADER
Instruments Corporation

380 Oser Avenue
Hauppauge, New York 11788
Regional Offices:
Chicago, Dallas, Atlanta,
Los Angeles, Boston
In Canada call Omnitronix Ltd.
(514) 337-9500

CIRCLE 78 ON FREE INFORMATION CARD
CIRCLE 45 FOR DEMONSTRATION

positive or negative edge of the test signal.

The HM605 also features a rather handy sweep-delay facility. That facility allows the sweep to be started at selected delayed times after the trigger signal has been applied. That delay can be set from 1 μ s to a maximum of 1 second. The usefulness of the feature is that it allows horizontal (X) expansion of at least 1000 times.

A rather interesting feature is the unit's built-in electronic com-

ponent tester. That tester displays a test pattern that will instantly tell the user if the component is in working condition. Among the components that can be tested are resistors, capacitors, inductors, diodes, and transistors. In addition, a limited number of tests can be made on IC's. When working with resistors, capacitors, and inductors, the approximate value of the component can also be found from the pattern. With experience, precise values can be found.

Precise values can also be found by comparison with a component of known value. All components can be tested either in or out of circuit. The unit uses a test voltage of 8.5-volts rms.

For probe compensation (two $1 \times 10 \times$ probes are included with the unit) and general system checks, the unit includes a built-in squarewave generator. That generator has a switchable 1-kHz/1-MHz, selectable .2- and 2-volt (peak-to-peak) output.

As you would expect, HM605 is a ruggedly built scope. It is housed in a beige steel cabinet and is designed and tested to meet international safety standards (IEC 348).

It is intended to be used as a bench-top unit; as such, no provision for battery power has been made. It can run off any one of four selectable voltage sources. Those are 110, 125, 220, or 240 volts, all at 50-60 Hz. A carry handle, which doubles as a tilt stand, is provided.

Of course, an excellent scope deserves an excellent manual and the one provided with the HM605 is just that. It is well written and well illustrated. About the only omissions are the theory of operation and a detailed parts list, but there is a block diagram of the unit and all parts, including their industry-standard designations, are clearly identified on the schematic diagrams.

The HM605 is a well-thought-out, easy-to-use unit with an impressive array of features and specifications. It carries a suggested list price of \$965. R-E

VIEW 8 TRACES ON YOUR SINGLE OR DUAL TRACE SCOPE WITH THIS LOW COST DEVICE!!



Now you no longer have to spend thousands on an expensive multi-trace oscilloscope - our single trace Hitachi scope combined with this module will allow you to view up to 8 simultaneously occurring analog or digital (or both) signals in their real time and amplitude relationship. The MPX 101 may be used on any oscilloscope, whether single, dual or multiple traces. Its low cost makes it a particular favorite for designers, testers, hobbyists and repairmen who want to compare and analyze displayed signals in a timing diagram format. The controls on the front panel of the metal case allow you to vary amplitude and spacing of the displayed signals.

**MODEL MPX101
FULLY ASSEMBLED & TESTED!**



**NOT
A
KIT**

\$99⁸⁸

**FULL 1
YEAR
REPLACE-
MENT
WARRANTY**

- Made In The United States -

SPECIFICATIONS

Inputs: 8 signals plus ground via 9 input leads terminated with alligator clips
Bandwidth: ± 1 dB to 5 MHz
Impedance: 10.9 K
Input Voltage: ± 5 V peak (diode clamped to ± 5 Volt supplies)
Output: Staircase waveform summed with input signals, 0-800 mV full scale
Step Amplitude: Variable 0 to 150 mV/step
Signal Voltage: Variable 0 to

150 mV/step @ 5V Input
Multiplex Rate: Switch selectable, 40 KHz or 4 KHz
Impedance: 50 Ohms
Power: 105-135 VAC @ 1 V a
Dimensions: 6.25" x 3.25" x 4.75" (WxHxD)
Operating Temperature: 0-40°C
Weight: 1 lb. 10.5 oz.
Warranty: one year full replacement warranty from date of purchase
Lighted on/off power switch
Wood grain finished metal case

DISTRIBUTOR AND REPRESENTATIVE INQUIRIES INVITED



VISA, MASTERCARD, AMEX TELEPHONE ORDERS ACCEPTED!
6 Herman Drive, E. Granby, CT 06026 \square 203/651-0285



"I'd like to turn it off, father, but he's telling me to stay tuned, and he's bigger than you!"

CIRCLE 82 ON FREE INFORMATION CARD



Micro-Professor



MPF-1 PLUS

- A complete microcomputer system
- Detailed instruction manuals
- A full range of options and accessories
- For instructional use, plus a wide range of practical applications

Learn Computing! Take a Course from Micro-Professor!

You've seen it all. Fancy software, powerful hardware, and ironclad guarantees.

A Total Learning Tool

But you haven't seen a computer that offered you a comprehensive introduction to both hardware and software. One that gives you hands-on training in troubleshooting, burning chips, and developing applications while giving you a solid grounding in programming.

Versatility and Convenience

Multitech proudly presents the unique Micro-Professor MPF-IP—the most versatile Z-80*-based educational computer for its price on the market today.

For only \$199.95, you get a state-of-the-art CPU, display, and full ASCII keyboard—in a casing that easily fits on your bookshelf. And to make sure you use your Micro-Professor to its fullest, each unit comes with impressive documentation, leading you step by step through the world of microprocessors.



A Wealth of Options

But that's only the beginning. Now you can buy miniature options that fit snugly to your unit: a printer, an EPROM programming board, and a speech synthesizer, to name a few. Add to that standard assembly language programming, plus optional BASIC and FORTH chips, and you've got a total learning tool.

Learning Can Be Fun

And with the Micro-Professor, learning can be an adventure. Design an electronic clock. Or a burglar alarm. Or anything else that suits your fancy.

So don't just program. Discover what a computer *really* can do for you!

*Z-80 is a trademark of Zilog Inc.

U.S. DISTRIBUTOR LIST

LEARNING LABS, INC.
P.O. Box 122
Calhoun, GA 30701
(404) 629-1521

TECHNICAL LABORATORY SYSTEMS, INC.
P.O. Box 218609
Houston, TX 77218
(713) 463-7652

L. A. B. CORPORATION
4416 River Road
Afton, MN 55001
(612) 436-1169

ETRONIX
14803 40 St. N.E.
Redmond, WA 98052
(206) 881-0857



MULTITECH ELECTRONICS INC.
195 West El Camino Real Sunnyvale, CA
94087 U.S.A.
T.L.X: 176004 MAC SUVL FAX: (408) 749-8032
Tel: (408) 773-8400

OTHER U.S. STATES (800) 538-1542

CIRCLE 69 ON FREE INFORMATION CARD

Microsoft Premium SoftCard IIe

Adds CP/M, 64K of
additional memory, and
an 80-column display to
your Apple IIe



CIRCLE 102 ON FREE INFORMATION CARD

Watch our competition

CRINGE

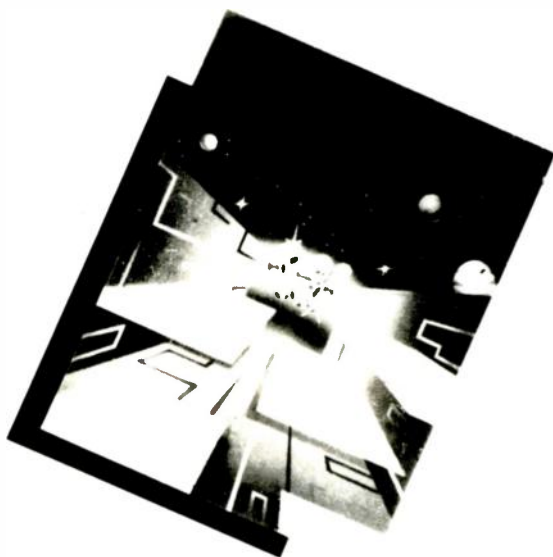

The 15th edition: CEI's 1984 fall catalog

**CALL TOLL FREE
FOR YOUR FREE CATALOG!**

1-800-543-3568
NATIONAL WATS

1-800-762-3412
OHIO WATS

IN DAYTON: (513) 252-5662 **TELEX NO.**
288-229

CEI Consolidated Electronics Inc.

705 WATERVLiet AVE, DAYTON OHIO. 45420
CIRCLE 18 ON FREE INFORMATION CARD

THE APPLE LINE OF COMPUTERS IS among the oldest and most popular on the market. One of its strongest selling points is the wide variety of software available for it. In fact, it is believed that there are more programs available for the Apple II/IIe than for any other machine.

One group of programs it can not run, however, are those written to be run under the CP/M operating system. Use of that operating system requires that your computer use a Z80/8080 microprocessor; the Apple II/IIe uses the 6502. The disadvantage of not being able to run CP/M programs is rather large, as among those are some of the best written and most useful pieces of business software.

But Apple owners are not out of luck. For years now there have been a variety of add-ons—cards that plug into one of the expansion slots inside the computer—designed to give the computer the capability of running CP/M. What those cards do is add a second microprocessor—a Z80—to the machine. When the card is activated, it is as if the Apple II/IIe were transformed into a Z80-based computer.

One of the first, and most popular of those cards, called the *SoftCard*, was developed by a Washington state firm called Microsoft (10700 Northup Way, Bellevue, WA 98004). Now, Microsoft has released the successor to that product. It is called the *Premium SoftCard IIe*, and is intended for use with Apple's IIe computer.

But that card does more than just add CP/M capability to that Apple machine—it also adds 64K of additional RAM, and upgrades the computer's 40-column display to an 80-column one. Both of those capabilities are important. Extra memory is always useful, especially if you are working with large databases or spreadsheets. Note, however, that the additional 64K can only be accessed by the computer when it is in its "6502 mode."

As for the larger display, 80 columns are absolutely essential if you intend to do any serious word processing, and come in handy for just about any other application you can name.

Microsoft	Premium softcard									
OVERALL PRICE	1	2	3	4	5	6	7	8	9	10
EASE OF USE	1	2	3	4	5	6	7	8	9	10
INSTRUCTION MANUAL	1	2	3	4	5	6	7	8	9	10
PRICE/VALUE	1	2	3	4	5	6	7	8	9	10
	1	2	3	4	5	6	7	8	9	10
	Poor		Fair			Good			Excellent	

Installation

Before we go any farther, we want to make it perfectly clear that this card will only work with the *Ile*, not with the earlier *II* or *II+*, or many of the "clones" that are based on the earlier design. One reason for that is that it installs in a special "AUXILIARY CONNECTOR" that's been added in the newer Apple machine.

If you own an Apple computer, and have ever installed a printer or modem interface, a disk controller, or any of the many other types of add-on cards available, you will have no problems installing the *Premium Softcard Ile*. The only requirements to do the job is a minimal amount of manual dexterity and some care. Since the IC's on the circuit board are, of course, sensitive to high voltages, any personal static electricity should be discharged before the unit is handled. The board also should be handled only by the edges of the board to prevent body oils from contaminating the etched traces or the edge connector. Finally, needless to say, the computer must be off before any work is done.

To install the board, the top cover of the computer must be removed to gain access to the accessory slots. That's done by simply pulling up gently on two tabs at the rear of the top cover until that cover comes off. Set the cover aside, locate the auxiliary connector-slot, and align the board's bottom edge-connector with it making sure that the component side faces the right side of the chassis (when looking into the computer from the rear). Press the board into the connector using a steady, but firm, pressure until the board seats. Re-install the top cover and the job is done.

Software and manuals

The package also includes the CP/M operating system, Microsoft Basic, and a wide variety of CP/M utility programs. Those utility programs, needed for disk formatting, file transfers, and other tasks, include just about all of those that you would expect, including PIP, STAT, COPY, and DDT.

Those of you who are familiar with computer documentation know that more often than not it is

just plain awful. Fortunately, the manuals supplied here are excellent. Included are a system installation and operation manual, a copy of *The Osborne CP/M User's Guide*, and a Microsoft BASIC reference manual. The installation and operation manual is a well-done affair that tells you everything you need to know to install and use the *Premium Softcard Ile*. It also gives a brief rundown of the
continued on page 110

The Circuitmate Family



Designed for maximum convenience and ease of use.

Special features found only on certain models include:

- full line of accessories
- tilt bale
- autoranging
- "touch hold"
- easy access battery hatch
- anti skid pads

Prices range from \$59.95 to \$89.95

All models except for the DM73, are made with a rotary dial which makes selection simple with a bright clear display.

Beckman Industrial™



The Professional Test Equipment Source

The Instrument Mart

295 Community Drive, Great Neck, New York 11021
(516) 487-7430 Outside N.Y. (800) 645-6535

Sales, Service, Rental/Leasing Programs
... and Pre-Owned Test Equipment also Available

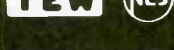

G.T.E. ELECTRONIC SUPPLY

"CAN'T FIND THAT PART?? CALL
US—OUR STOCK EXCEEDS ALL"

SAME DAY SERVICE

WE GUARANTEE WHEN WE HAVE IT IN
STOCK. IT WILL GO OUT THE SAME DAY
YOU CALL (BEFORE 3 O'CLOCK NY TIME).
IF IT DOESN'T WE TAKE 10% OFF

GE	SAMPO
HITACHI	SAMSUNG
MAGNAVOX	SANYO
MGA	SHARP
PANASONIC	SONY
PHILCO	SYLVANIA
QUASAR	ZENITH
RCA	CHANNEL MASTER

**EXACT ORIGINAL PARTS
IN STOCK**

- LOWEST PRICES ON RECEIVING TUBES
- COMPLETE MODULE HEADQUARTERS
- LARGE SAMS STOCK PHOTOFACT • VCR • CB
- CABLE CONVERTERS
- NO DESCRAMBLERS

SAMPO & SAMSUNG TV'S —
RADIO'S — FANS —
REFRIGERATORS — MICROWAVES

VCR PARTS

FLYBACKS	TRANSISTORS
YOKES	IC'S
CATV	PHONES
MATV	WATER DISTILLERS

CALL TO BE PUT ON MAILING LIST
FOR IN-HOUSE SPECIALS

ONE STOP SHOP

G.T.E. ELECTRONIC SUPPLY
2700 MIDDLE COUNTRY ROAD
CENTEREACH, N.Y. 11720
516-585-8111

NEW 14,000 SQ. FT.
WAREHOUSE/SHOWROOM
(DUE JAN 85)

G.T.E. ELECTRONIC SUPPLY
2700 MIDDLE COUNTRY ROAD
CENTEREACH, N.Y. 11720

(OUT OF STATE) (N.Y. ONLY)
800-874-1765 800-874-1764
LOCAL (516) 585-8111

CIRCLE 64 ON FREE INFORMATION CARD

NEW PRODUCTS



CIRCLE 121 ON FREE INFORMATION CARD

TECHNICIANS TOOL KIT, the model *JTK-86*, is a full-service kit in a compact zipper case. Its selection of tools includes some rarely found in a zipper case: a complete 13-piece ¼-inch drive socket set with ratchet, spinner handle and extensions; a vise-grip locking plier; a 9-blade fold-up hex-key set, and an 11-blade feeler gauge.

The model *JTK-86* is available in a vinyl, leather, or Cordura nylon case with three outside pockets for meters, test leads, or service manuals. Two pockets measure 5½ × 9 × 2¼, and the third measures 10½ × 9 × 2¼.

The model *JTK-86* is priced at \$249.00.—**Jensen Tools, Inc.**, 7815 S. 46th Street, Phoenix, AZ 85040.

PRINTER, model *LQ/2* is designed for use with a number of personal computers; it will fit into computer rooms or areas easily because of its small size.

This 12 character-per-second (CPS) letter-quality printer has standard friction feed, bi-directional continuous printing, 8½" wide carriages, is smaller and lighter and comes complete with built-in interface for all Commodore personal computers. The model *LQ/2* has a drumhead design and compatible input for IBM-PC, PCjr., TRS-80, and other personal computers with parallel Centronics-type printer output.



CIRCLE 122 ON FREE INFORMATION CARD

Optional feature: can run on battery pack. It is priced at \$349.95.—**Cardco, Inc.**, 300 S. Topeka, Wichita, KS 67202. R-E

MASTER THE NEW ELECTRONICS WITH MCGRAW-HILL'S

Contemporary Electronics Series

The fast, easy and low cost way to meet the challenges of today's electronic innovations. A unique learning series that's as innovative as the circuitry it explains, as fascinating as the experiments you build and explore.

From digital logic to the latest 32-bit microprocessor, the McGraw-Hill Contemporary Electronics Series puts you into the electronic picture one easy step at a time. Twelve unique *Concept Modules*, sent to you one every 4-6 weeks, give you a handle on subjects like optoelectronics, transistors, integrated circuits, logic circuits, and more.

Each Concept Module goes right to the heart of the matter. You waste no time on extraneous material or outdated history. It's a fast, efficient, and lively learning experience... a non-traditional approach to the most modern of subject matter.

Unique Interactive Instruction

With each module, you receive a McGraw-Hill Action Audio Cassette. Each tape is a dynamic discussion that drives home the key facts about the subject. Your learning

With your first module, you get this solderless breadboarding system. You'll use it throughout the series to build electronic circuits and bring concepts to life.

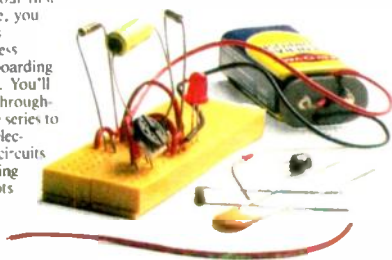

experience is reinforced through interaction with vividly illustrated text, audio cassettes, and actual electronic experiments. Indexed binders preserve backup material, notes, and tapes for convenient referral.

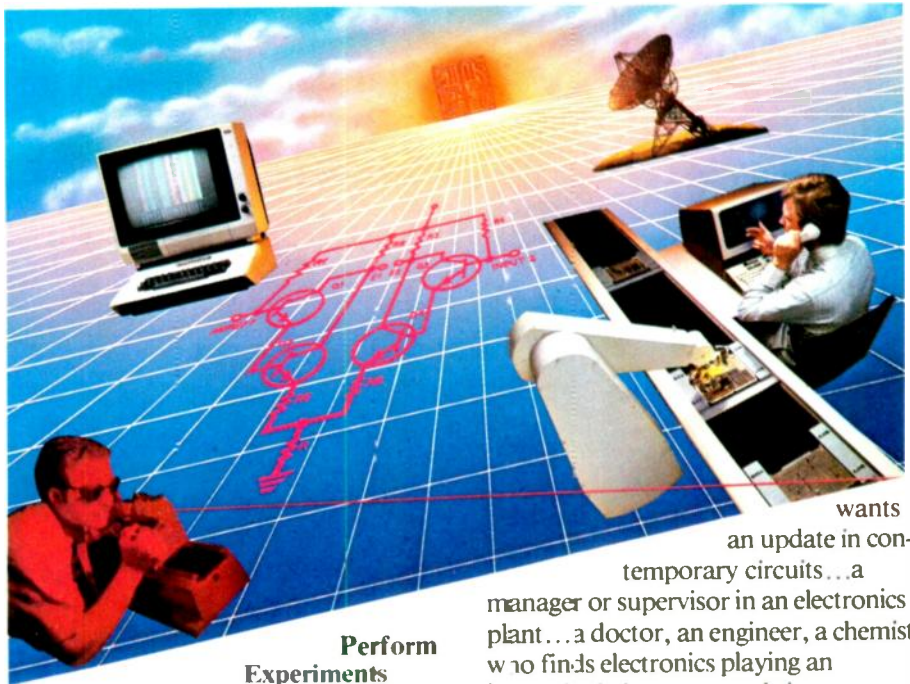

Perform Experiments in Contemporary Electronics

Throughout your series, laboratory experiments reinforce every significant point. This essential experience... dynamic, hands-on demonstrations of theory in practice... will help you master principles that apply all the way up to tomorrow's latest VLSI (Very Large Scale Integrated) circuitry.

In your very first module, you'll use integrated circuits to build a digital oscillator, verifying its operation with a light emitting diode (LED). You'll learn to identify passive and active components, understand concepts common to all electronic circuits.

For Anyone Interested in Electronics

The Contemporary Electronics Series is designed for anyone from hobbyist to professional. It's for you if you're looking for new fields of interest... if you're a teacher who

wants an update in contemporary circuits... a manager or supervisor in an electronics plant... a doctor, an engineer, a chemist who finds electronics playing an increasingly important role in your work. It's even for electronics engineers or technicians who feel their training needs freshening up. It's the quickest, most convenient, probably least expensive way to do it. And the only one that gives you hands-on experience.

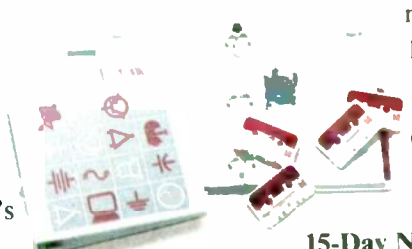

15-Day No-Risk Trial

To order your first module without risk, send the postage-paid card today. Examine it for 15 days under the terms of the order form and see how the Contemporary Electronics Series gets you into today's electronics. If card has been used, write us for ordering information.



McGraw-Hill
Continuing Education Center
3939 Wisconsin Ave.
Washington, D.C. 20016

KENWOOD

...pacesetter in amateur radio

R-11 portable receiver

R-11

Kenwood's R-11 is the perfect "go anywhere" portable receiver. It covers the standard AM and FM Broadcast bands, plus nine additional short wave bands. The R-11's selectivity is greatly enhanced by the use of double-conversion on short wave frequencies above 5.95-MHz. High sensitivity coupled with a dual antenna system (telescopic and ferrite core) allow it to

reach out and bring in those distant stations from all over the world.

Simplicity of operation is enhanced by a band-spread type tuning control. Electronic band switching, with LED band indicator, along with a tuning meter to indicate received signal strength, combine to provide you with superior listening capability. Safety Hold-Release switch prevents accidental station loss. Large front mounted speaker provides excellent sound quality. Tone switch adjusts for high, low and voice transmission.

Optional HS-7 micro-head phones allow for private listening pleasure.

All this along with a record output jack, external antenna terminal and a rugged and attractive carrying case make the R-11 portable receiver the perfect travel companion!

More information on the Kenwood receivers is available from authorized dealers of Trio-Kenwood Communications 1111 West Walnut Street, Compton, CA 90220.



R-2000 Top-of-the-line general coverage receiver • 150 kHz to 30 MHz • Ten memories • Dual 24-hr clock with timer • Scanning • 100-240 VAC (Opt. 13.8 VDC) • Opt. VHF (118-174 MHz converter).

R-1000 High performance receiver • 200 kHz-30 MHz • digital display/clock timer • 3 IF filters • PLL UP conversion • noise blanker • RF step attenuator • 120-240 VAC (Optional 13.8 VDC).

R-600 General coverage receiver • 150 kHz-30 MHz • digital display • 2 IF filters • PLL UP conversion • noise blanker • RF attenuator • front speaker • 100-240 VAC (Optional 13.8 VDC).

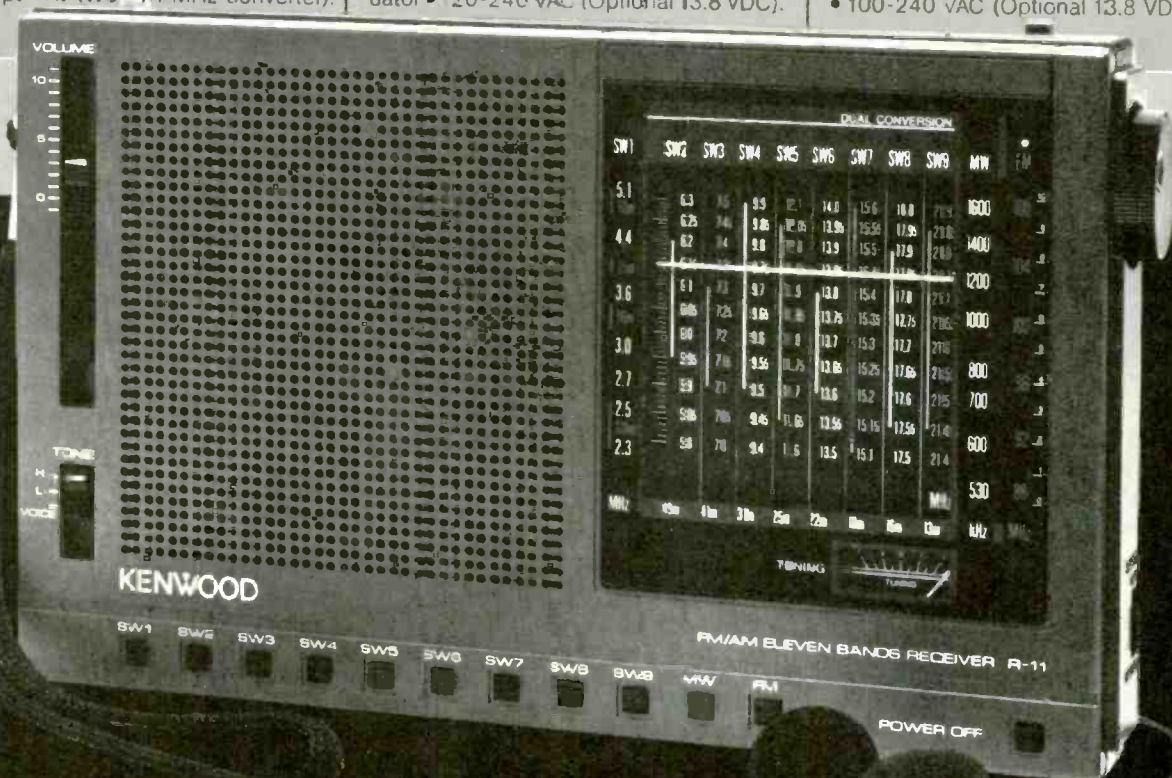

BUILD THIS

Satellite Stereo Demodulator



ROGER COTA and
LLOYD ADDINGTON

A stereo demodulator is a must for any TVRO-system owner who wants full enjoyment of his system. You can't receive stereo satellite broadcasts on your TVRO? Build this and hear what you've been missing!

ANYONE WITH A TELEVISION RECEIVE only (TVRO) home satellite system can now receive TV and audio broadcasts in stereo! If you integrate a satellite stereo demodulator into your present monaural system, you'll be able to enjoy stereo movies at home—without the hassle, expense, and crowds of a movie theater. And it won't cost any more than just a few trips out to the movies!

Much of the programming beamed to us from satellites is in stereo. That includes movies, music videos, and audio-only programming on *The Disney Channel*, *Bravo*, *The Movie Channel*, *The Nashville Network*, *MTV*, and more. In fact, stereo broadcasting is quickly becoming the norm.

Many of the more-recent satellite receivers have stereo capability built in. But if you want to add stereo capability to a monaural receiver that you already own, you can end up spending anywhere from \$300 to \$1100 for a commercially available demodulator.

But there is a less expensive alternative—you can build a stereo processor for less than \$80. And not only is the device we'll describe inexpensive, it's also easy to build and easy to operate. And it allows you to hear those movies, music videos, etc. the way that they were meant to be heard—in stereo.

We shouldn't forget to emphasize that this add-on will also let you listen—in stereo—to the many audio-only broadcast services that are present on a number of transponders on various satellites. Table 1 lists some of sources of video transmissions with stereo audio, while Table 2 lists



FIG. 1—THE TYPICAL SUBCARRIER FREQUENCIES used for audio transmissions are 5.8, 6.2, 6.8, and 7.4 MHz.

audio-only stereo services.

The satellite stereo demodulator offers both discrete and matrix capabilities, tunable left and right channels, and an input that can receive either the raw video signal or the audio subcarrier signal from a mono satellite receiver.

The stereo demodulator

The effective bandwidth of a satellite transponder is about 10 MHz. Since standard NTSC signals have a bandwidth of 6 MHz, there is ample room for audio subcarriers from 6 to 10 MHz of the transponders spectrum. Any subcarrier located above about 5.8 MHz can be used to carry additional audio programming. As shown in Fig. 1, 5.8, 6.2, 6.8, and 7.4 MHz are the most frequently used subcarrier frequencies. But in order to effectively obtain the desired stereo effect, the frequency-modulated audio subcarriers must be separated from the video. And that's why we need a stereo demodulator.

Figure 2 shows a block diagram of the satellite stereo demodulator. An incoming video or audio signal enters the first am-

plifier stages where it is filtered, amplified, and limited. The result, as shown in Fig. 3, is a hard-limited, noise-free FM signal with the video portions removed. The subcarrier signals proceed to two phase-locked loop sections.

One phase-locked loop IC is used for each stereo channel. Each is configured to cover the range from 5 to 8 MHz. A varactor diode is used to determine each center frequency. (A varactor is a voltage-variable capacitor formed from a diode in which the inherent capacitance is emphasized, instead of minimized as in a "normal" semiconductor diode.) The bias voltages for the varactor diodes are independently controlled by the front panel TUNE A and TUNE B controls. Increasing the voltage increases the frequency of the phase-locked loop.

The audio that is output by each PLL IC's is then lowpass filtered by de-emphasis circuits, applied to gain stages, and then sent to the matrix circuit, which is controlled by the front-panel-mounted DISCRETE/MATRIX selector.

Most of the stereo-audio subcarriers are

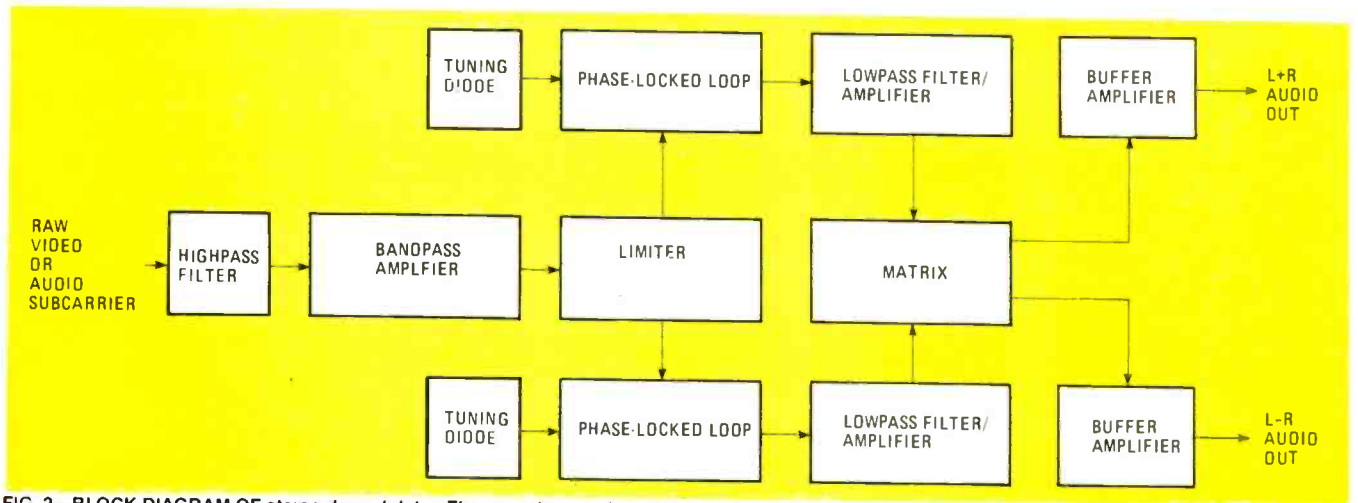

FIG. 2—BLOCK DIAGRAM OF stereo demodulator. The capacitance of each tuning diode is varied by front-panel controls.

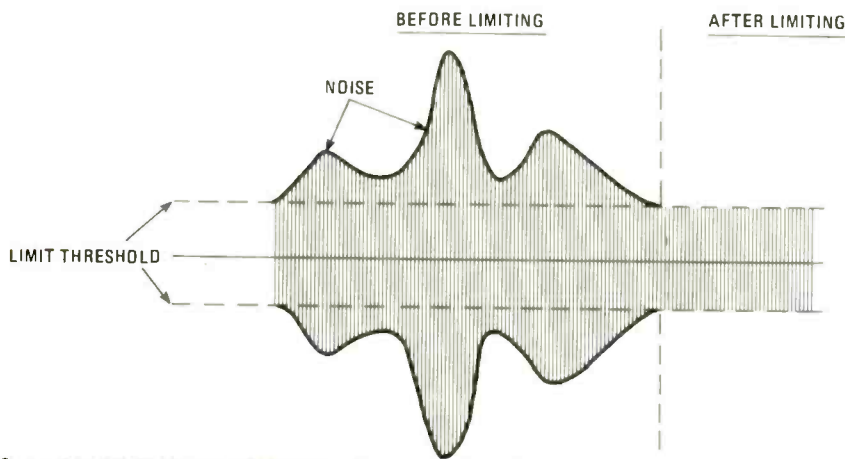

FIG. 3—THE INPUT FILTER REMOVES noise and the lower-frequency video components from the input signal.

transmitted either in *discrete* or *matrix* modes. In the discrete mode, one subcarrier contains only the left-channel information and another subcarrier contains only the right-channel information. In the matrix mode, each subcarrier contains a combination of the left- and right-channel information: One subcarrier contains the sum of the two signals (left + right or L + R) and the other subcarrier contains the difference of the two signals (left - right or L - R). The matrix circuit adds and subtracts those signals at the appropriate levels to separate out the two stereo channels. Those left- and right-channel signals are then amplified and presented at their respective output jacks.

A closer look at the circuit

Now that we've gone over the basics of what the circuit does, let's look at it in more detail. Refer to the demodulator schematic in Fig. 4.

The input to the demodulator—either the raw-video output or the subcarrier output from the satellite receiver—is fed to the VIDEO IN jack, J1. From there, the input signal passes through a highpass filter made up of C35 and R40. That leaves the audio subcarriers unattenuated but rolls off any video components that might be in the signal. The signal then enters IC2, a 10116 ECL triple line receiver. That device contains three amplifier stages that are used to amplify, filter, and limit the signal.

After passing through the first amplifier stage of the IC, the signal is filtered through L1 and C1. That series L-C circuit is tuned to 6.5 MHz, the center of the subcarrier spectrum. Resistor R38 presents a 75-ohm load for the tuned circuit (to give the appropriate Q factor).

The input to IC2 is biased up through a bias pin (pin 11) and R43. The signal then enters the next stage of the op-amp, exits at pin 15, and passes through a tuned circuit made up of C13 and L2. That circuit is also tuned to the center of the subcarrier-frequency band (6.5 MHz). At that point, the signal has been amplified and limited by IC2 to 1-volt peak-to-peak. All the

TABLE 1—STEREO VIDEO-PROGRAMMING

Satellite	Transponder Service		Subcarrier		Mode
			A (MHz)	B (MHz)	
SATCOM F3	4	Spotlight	5.8	6.2	Discrete
SATCOM F3	5	The Movie Channel	5.8	6.8	Matrix
SATCOM F3	11	MTV	5.8	6.62	Matrix
SATCOM F3	16	HTN Plus	6.8		Multiplex
SATCOM F4	6	Bravo	5.8		Multiplex
SATCOM F4	8	Entertainment Channel	5.94	6.12	Discrete
WESTAR F5	10	Disney Channel	5.8	6.8	Discrete
WESTAR F5	12	Disney Channel	5.8	6.8	Discrete
WESTAR F5	17	Nashville Network	5.58	5.76	Discrete

TABLE 2—STEREO-AUDIO PROGRAMMING

Satellite	Transponder Service		Subcarrier		Mode
			A (MHz)	B (MHz)	
SATCOM F3	3	Moody Broadcasting	5.2	7.92	Discrete
SATCOM F3	3	Country Coast to Coast	5.58	5.76	Discrete
SATCOM F3	3	Star Station	5.94	6.12	Discrete
SATCOM F3	3	WFMT-FM	6.3	6.48	Discrete
SATCOM F3	3	Bonneville Broadcasting	7.38	7.56	Discrete
SATCOM F3	3	Stardust	8.05	8.14	Discrete
SATCOM F3	3	Music in Air	5.4	5.94	Discrete
SATCOM F3	3	Music in Air	5.58	5.76	Discrete
SATCOM F3	8	Cable Jazz Network	5.94	6.12	Discrete
SATCOM F4	7	Family Radio (East)	5.58	5.76	Discrete
SATCOM F4	7	Family Radio (West)	5.94	6.12	Discrete
ANIK D1	18	CIRK	6.17		Multiplex

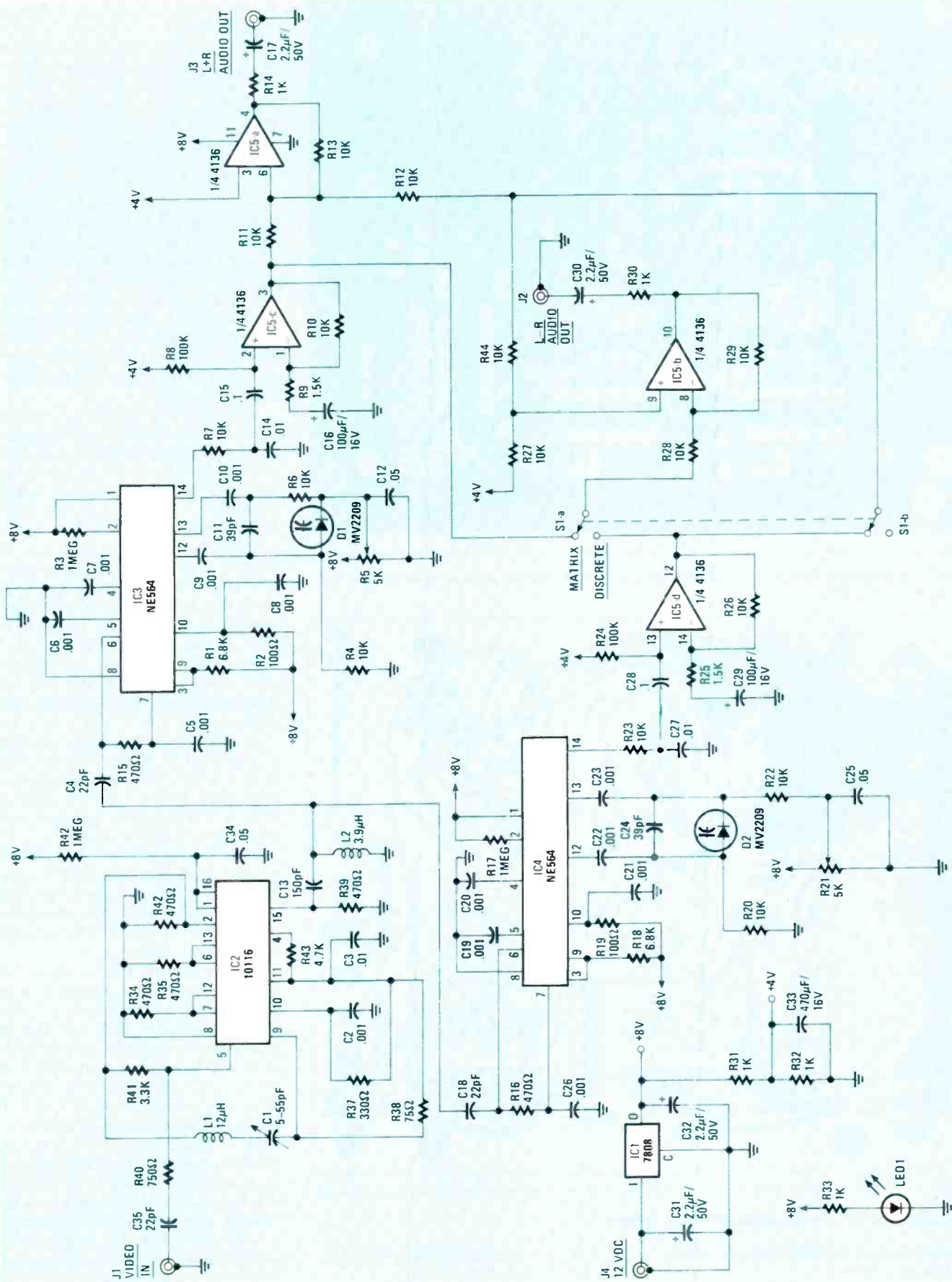

FIG. 4.—SATELLITE STEREO DEMODULATOR SCHEMATIC. The frequency of each PLL is determined by the capacitance of a varactor diode (which is controlled by R5 and R21).

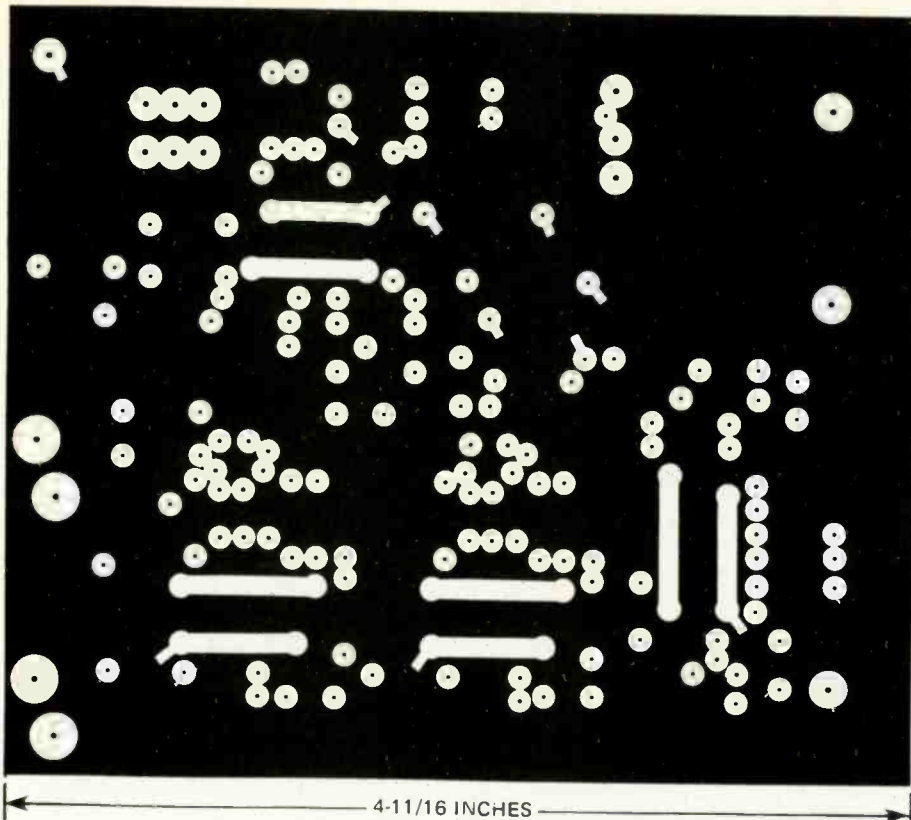

FIG. 5—COMPONENT SIDE of the demodulator's circuit board. Note that some components must be soldered on this side.

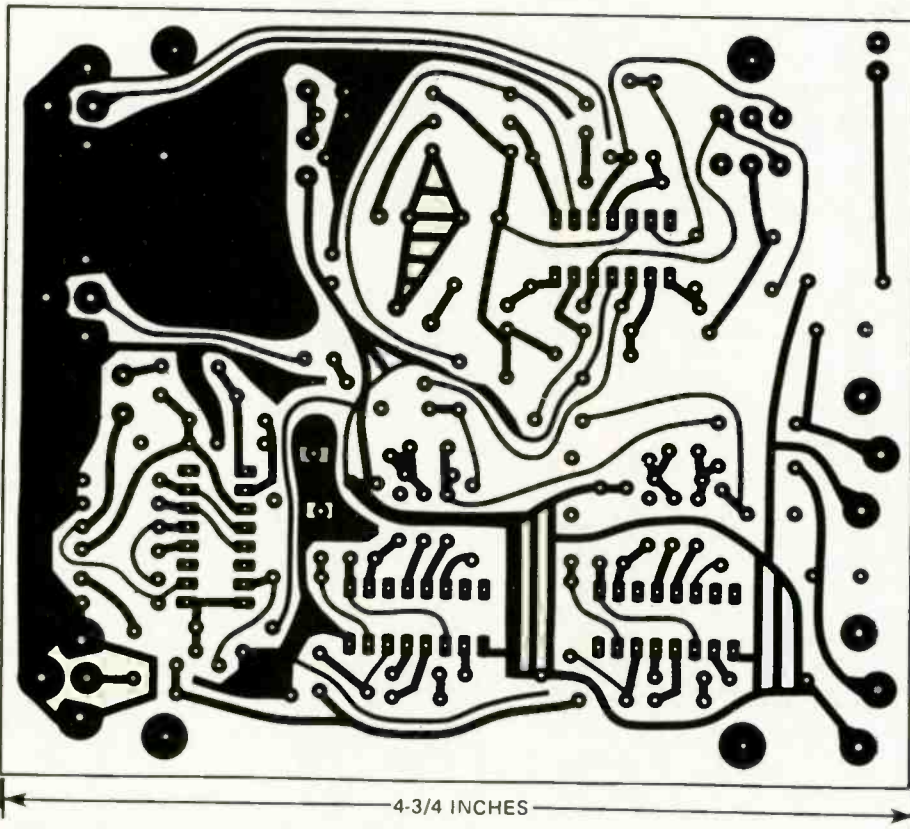

FIG. 6—SOLDER SIDE of the demodulator's circuit board.

one set of components. We will, however, list the corresponding set of components in parenthesis.

The signal from the tuned circuit passes through another highpass filter made up of C4 and R15 (C18 and R16) to roll off interfering signals prior to entering IC3 (IC4), a NE564 phase-locked loop IC. That IC then demodulates the signal. The VCO (Voltage-Controlled Oscillator) in the NE564 is controlled by the capacitance between pins 12 and 13. That capacitance is formed by C11 and D1 (C24 and D2). Note that D1 (D2) is a MV2209 varactor diode. As we mentioned previously, the capacitance of a varactor diode varies in relation to the reverse-biased voltage across it. Here, that voltage comes from a divider network made up of R4, R6, and R5 (R20, R22, and R21). Potentiometer R5 (R21) allows you to tune the proper subcarrier.

Pins 1 and 10 are the power connections on the NE564. While the voltage applied to pin 1 can be greater than 12 volts, the voltage applied to pin 10 cannot rise above 6 volts. Thus, the 8-volt power supply is dropped by R2 and filtered by C8 to give a 5-volt input to pin 10.

The demodulated output at pin 14 is lowpass filtered (or de-emphasized) via R7 and C14 (R23 and C27). At that point, we have a low-level signal that requires amplification by op-amp IC5-c (IC5-d). That op-amp is biased at one-half the power-supply voltage by the voltage divider made up of R31 and R32. That biases up the amplifier output stages to the +4-volt level.

After the de-emphasis filter, the signal is amplified by IC5-c (IC5-d), which gives it a gain of approximately 6.6, as determined by R10 and R9 (R26 and R25). At that point, the signal goes to S1, the MATRIX/DISCRETE switch.

With the switch in the DISCRETE position, the amplified output signals from the two phase-locked loop demodulators are run through the output buffer amplifiers IC5-a and IC5-b, to the two audio outputs, J2 and J3.

When the switch is in the MATRIX position, however, the amplified outputs of the two phase-locked loop demodulators are added together and subtracted from each other, then run through the IC5-a and IC5-b, which perform the matrix mixing. The output of IC5-c goes through R11 to the inverting input of IC5-a. The output of IC5-d goes through R12 and also to the inverting input of IC5-a, where they are added together. The summation of the L + R subcarrier and the L - R subcarrier (the left-channel information) is then buffered, amplified, and fed to output J3.

At the same time, the output of IC5-c goes through R28 to the inverting input of IC5-b where a subtraction is performed, giving an output of the L + R subcarrier

continued on page 114

noise and amplitude-modulated components are removed.

From the tuned circuit, the signal passes to the demodulator PLL IC's (IC3 and

IC4). As we mentioned previously, one IC is used for each stereo channel.

Note: Because the PLL circuits are essentially the same, we will discuss only

ALL ABOUT

Part 2 THIS MONTH, WE CONCLUDE our two-part look at batteries and battery technology by turning our attention to rechargeable (lead-acid and nickel-cadmium) cells, and how to choose the type you need.

Lead-acid batteries

The modern lead-acid cell is a far cry from its predecessors. Its open-circuit voltage is about 2 volts, which means that it has the second-highest energy capacity of the commercially available batteries, both disposable and rechargeable. Only a lithium-thionyl chloride cell, with an open-circuit voltage of 3.7 volts, has a higher energy-density—and it's not rechargeable! The drawbacks to lead-acid batteries—leakage, highly corrosive acid electrolyte, evaporation, and a host of other problems—have been eliminated in the designs of more modern cells. Lead-acid batteries come in a variety of sizes, voltages, and energy capacities and have characteristics that make them the ideal energy source for applications requiring

the use of rechargeable batteries.

So, you may well ask, if they're so wonderful why aren't they more available? The answer to that is... Well, I haven't the vaguest idea and would appreciate finding out why. Possibly the answer has something to do with the ready availability of nickel-cadmium batteries, the other major type of rechargeable battery. Before we start comparing the two technologies, let's take the time to find out how each is used. Once that's done, we'll list the advantages and disadvantages of both types and you'll be able to make your own decisions.

Lead-acid batteries are easy to use. Anyone who owns a car knows that those batteries can operate successfully under the most adverse conditions and are extremely forgiving when it comes to things like accidental deep discharge and constantly repeated partial discharge.

Figure 6 is a cutaway view of a typical lead-acid cell. Although there are variations from manufacturer to manufacturer, most of the batteries use the basic con-

struction shown. The electrolyte is an acid that is permanently sealed in the body of the cell. It's worth noting at this point that that technique (permanently sealing in the electrolyte) is starting to be found in car batteries as well. Some companies that make lead-acid batteries "immobilize" the electrolyte by gelling it. This means that the cell can be used in any position without any risk of the electrolyte leaking out. Even though the construction of the cell usually involves several heavy-duty seals and double-walled insulation, the acid is extremely corrosive and anything that helps maintain the integrity of the battery is a good idea.

Rechargeable lead-acid batteries are available in voltages ranging from 2 to 24 volts and they can be used in any configuration you want. Unlike some other batteries, you can either parallel them to increase the current or put them in series to increase the voltage. Since the energy density in lead-acid cells is very high, you can get really impressive amounts of power by packing together a number of

Rechargeable Batteries

We continue our look at batteries with a description of rechargeable types and how to use them.

ROBERT GROSSBLATT



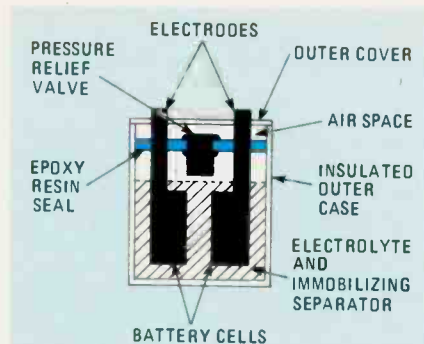

FIG. 6—CUTAWAY VIEW OF A MODERN LEAD-ACID CELL. Some batteries use a gelled electrolyte.

cells. And how much power the battery can deliver has nothing to do with how the battery was used previously.

A battery that is normally charged after only a small part of its stored energy has been used can still deliver its total power whenever the situation calls for it. That is a common scenario in applications where rechargeable batteries are used as emergency backups in case the primary power fails. Batteries that are constantly charged can similarly always be counted on to deliver their full power if the circumstances require it. In other words, lead-acid batteries have no "memory" of their previous use.

The charging circuits for these batteries can be as simple or sophisticated as you like. They are capable of being charged at extremely high rates if the proper safeguards are taken. How you charge them depends on how you plan to use them. Table 4 gives you the recommended charging rates and other information you'll need to be able to safely recharge the batteries. It's important to stay within the guidelines shown—overcharging can have catastrophic results.

Even though the chemistry of the cells is designed to be reversible (which is what makes the cells rechargeable), overcharging them carries the same sort of dangers as trying to charge the throw away batteries we discussed last month. During the charging cycle of *any* battery, gas is produced. A major function of the electrolyte is to act as a "depolarizer"—a rather fancy way of saying that it's designed to absorb the gas produced during a charge. However, and this is a really big however, the electrolyte can only absorb gas at a certain rate. If the gas is produced faster than it can be absorbed, then **BOOM!** Good-bye battery and anything else that happens to be around *and that can include you, too!* Make sure you don't exceed the recommendations for the charging rates and times given in Table 4. A lot of batteries were blown up to compile those figures.

Nickel-cadmium batteries

Nickel-cadmium (NiCd) batteries are the most popular rechargeable batteries

TABLE 4—LEAD-ACID BATTERY CHARGING PARAMETERS

Type of charge	Charging voltage (volts DC per cell)	Charging current (percent of cell capacity)	Charging time
RAPID	2.55 - 2.65	100%	1 - 3 hours
QUICK	2.50 - 2.55	20% - 50%	12 - 20 hours
STANDARD	2.45 - 2.50	10% - 40%	10 - 18 hours
TRICKLE	2.28 - 2.32	10% - 20%	Continuous

on the market today. They are packaged in all the standard sizes and the cell's open-circuit voltage is 1.25 volts (which makes them a close match for most of the applications where throw-away batteries are used.) Prices depend on where you buy them but, in general, it's safe to say that they're more expensive than alkaline and lead-acid batteries, but cheaper than lithium and silver-oxide batteries. The voltage-discharge curve is nice and flat, meaning that the battery will have a constant voltage for most of its discharge cycle. Unlike lead-acid cells, nickel-cadmium cells are not designed to be used in a parallel configuration. The normal method of use is to decide what your current requirements are and then get cells of the needed ampere-hour capacity and connect a number of them in series to build up the voltage you need for your system.

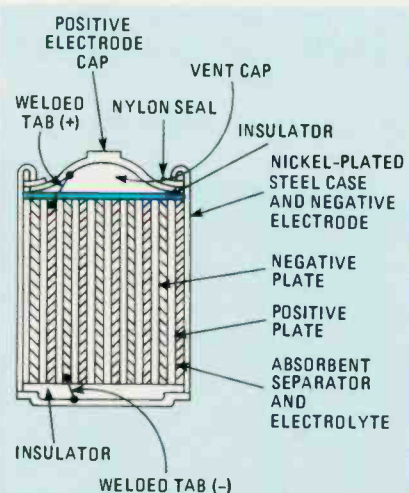

FIG. 7—A NICKEL-CADMIUM CELL consists of nickel and cadmium strips wound together and separated by absorbent nylon.

Figure 7 is a cutaway view of a typical cylindrical NiCd cell. The nickel anode and cadmium cathode are made in strips that are wound together into a coil with an absorbent nylon separator between them. The separator is used to absorb the alkaline electrolyte. It is also permeable to oxygen (the gas produced during the charge cycle). The assembled battery is packed into the outer case, usually made of nickel-plated steel, the external positive and negative contacts are welded to the electrodes, and the cell is finally sealed. The seals keep the electrolyte from drying out and are designed to act as pressure-relief valves. If the internal

buildup of gas gets excessive, the seal will open and vent the extra pressure. How well the battery functions afterward depends on how much electrolyte is lost. In any event, you can bet that the battery will be but a shadow of its former self.

The internal resistance of the average NiCd cell is very low—usually less than 100 milliohms—which means they can be used in circuits where high discharge rates are required. Some NiCd cells, however, are specifically designed with a higher internal resistance that, although lowering the maximum discharge rate, increases the cell's ability to retain a charge. Button cells and 9-volt "transistor battery" substitutes are usually manufactured like that. The internal resistance of the cell is a good guide to the charging rate: The higher the value, the lower the charging rate. The most common cause of NiCd cell failure is an improper charging rate.

A dead NiCd will be either an open or short-circuited cell. Open circuits are usually the result of electrolyte loss and this is directly caused by constant rapid discharging, constantly high charge-rates, or anything else that will make the cell blow its seal. Remember that by the time the cell parameters are exceeded enough to make the seal open, the high current rate that caused it in the first place will have made the battery heat up, and that will make the electrolyte evaporate at a greater rate. In any event, there's no way to replace the electrolyte, so if you measure the internal resistance of the battery with a multimeter and find it to be an open circuit, the battery is gone forever.

Short-circuited cells are another story. Sometimes the separator will get ruptured and metallic salts will form a small bridge that shunts the current around the rest of the plate. A high current pulse can burn out the short and the cell can then be charged, since the correct current path has been restored. Commercial "zap" circuits use this technique by charging a large capacitor and then discharging it through the cell. If you monitor the battery's voltage, you'll see the voltage start to increase as all the internal shorts are cleared out. If the separator has deteriorated in the cell, the battery is beyond salvage and should be replaced.

Recharging batteries

So now that we know everything about lead-acid and nickel-cadmium cells, let's

find out about how to charge them. The circuits needed can be as sophisticated—or as simple—as you like. Which circuit you want to use depends on which cells you use, how fast you want to charge them, and how you want to use them.

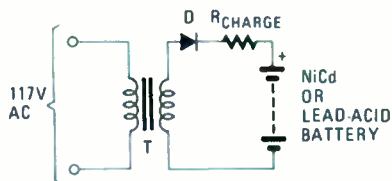

FIG. 8—A SIMPLE CHARGING CIRCUIT for nickel-cadmium or lead-acid batteries.

The simplest charging circuit you can have is illustrated in Fig. 8. Calculating the resistor value and which diode to use is simple. First, let's lay down some general guidelines. The transformer you use should have a voltage at its secondary at least twice the open circuit voltage of the battery you want to charge and the diode should have a PIV (*Peak Inverse Voltage*) rating at least twice that. The resistor has to be able to handle the charging current at the open-circuit voltage of the battery. To be on the safe side, let's use the voltage of the transformer's secondary. Now that we have those things out of the way, let's use Ohm's law to fill in the blanks.

$$V_{\text{system}} = V_{\text{transformer}} - (V_{\text{battery}} + V_{\text{diode}})$$

$$R_{\text{charge}} = V_{\text{system}} / I_{\text{charge}}$$

$$\text{WATTAGE}_R = V_{\text{transformer}} \times I_{\text{charge}}$$

The key here is deciding what you want the charging current (I_{CHARGE}) to be. The rate of current flow through a rechargeable battery is referred to in terms of the total capacity of the cell. The rate of charge or discharge for a particular battery is usually given in the C-rate. The C-rate is the current rate in amperes numerically equal to the rated minimum amp-hour capacity. If the recommended charging rate for a cell is listed as 0.1C, for example, that would tell you that the maximum current you can use to charge the battery is numerically equal to $\frac{1}{10}$ the total amp-hour capacity of the cell. If the cell was rated at 500 milliamp-hours, 0.1C would translate into a charging current of 50 milliamperes.

Table 5 shows the various rates of charge and how long it will take to fully charge a cell. It's important to remember that not all cells can be charged at the higher rates. Nickel-cadmium cells are too expensive to risk destroying by impatience. All the cells, however can withstand the standard 0.1C rate. But let's get back to our example.

If we're going to charge a 4.8 volt series of batteries that have a 1.2 amp-hour capacity at the standard 0.1C rate and are

TABLE 5—NICKEL-CADMIUM BATTERY CHARGING PARAMETERS

Type of charge	Charging voltage (volts per cell)	Charging current (percent of cell capacity)	Charging time
RAPID	Depends on Cell	Depends on Cell	1 - 3 hours
QUICK	2.50 - 3.00	20%	3 - 5 hours
STANDARD	2.50 - 3.00	10%	14 hours
TRICKLE	2.50 - 3.00	5%	Continuous

using a transformer with a 9 volt secondary:

$$V_{\text{system}} = V_{\text{transformer}} - V_{\text{battery}} \\ = 9 - 4.8 = 4.2 \text{ Volts}$$

$$I_{\text{charge}} = 0.1C = (0.1)(1.2) = 120\text{mA}$$

$$R_{\text{charge}} = V_{\text{system}} / I_{\text{charge}} \\ = 4.2 / .12 = 35\Omega$$

$$\text{WATTAGE}_R = (V_{\text{transformer}})(I_{\text{charge}}) \\ = 9 \times .12 = 1.08 \text{ WATTS}$$

Finding a resistor with a rating of 1.08 watts is going to be difficult, so let's make a general rule: we'll always bump the value up to the next available size. That means a 35-ohm, 2-watt resistor. The PIV rating of the diode has to be at least twice the transformer secondary or 18 volts and it has to be able to handle at least .12 amps. Any of the family of 1N4xxx diodes is a good choice for the circuit. In this particular case, the 1N4001 is fine. It should be noted that we did not take the voltage drop across the diode into account when we calculated the parameters of the circuit. Since the diode drop is going to be small compared to the other voltages, and our assumptions have built-in safety margins, it can reasonably be ignored. If you're building a charger for battery systems that have lower voltages and are looking for larger charging currents, the diode drop should be considered in calculating the overall system voltage. By the same token, if the charging current you need is really small, the diode's forward resistance will have to be taken into account and subtracted from the calculated value of the current limiting resistor. If the value of the calculated resistor is small enough you can do away with it altogether and let the diode serve as the current limiter.

A more efficient charger can be built using a full-wave rectifier. The math is exactly the same as in our example. Just get the values of the circuit parameters and plug them into the formulas. More elaborate chargers will monitor the state of charge of the battery and automatically switch over to trickle charging when the battery is fully charged. These circuits are used when the initial charge rate is going to be in the "quick" or "rapid" range. How the circuit is put together will depend on the batteries that are being

charged and what the initial charging rate is going to be. The actual design of these circuits is involved because it's a good idea to have several levels of protection for the battery. That way if the primary switcher circuit fails, other parts of the circuit will save the day.

The dangers here shouldn't be minimized. If you overcharge a cell at a high rate of charge, you can, of course, kiss the battery good-bye. But we've already seen that you're running the risk of explosive rupture of the cell from the accumulated gas and that can destroy a lot more than just the battery. I overcharged a 20-milliamp NiCd button cell—the smallest nickel-cadmium battery you can buy. When it exploded it blew a hole in the side of the charger's plastic case! Be warned and be careful to follow the manufacturer's recommendation.

There have been charging circuits published repeatedly in any number of magazines, data books, and so on. Look them up and decide which one you want to use in your particular application. I can offer you a few general rules and a couple of useful tips.

The overall system voltage in your charging circuit will decrease as the cell charges up and the current flowing in the circuit will, naturally enough, start to drop until it reaches a steady state. This is because a discharged cell will rapidly regain enough energy to be at its nominal voltage.

For this reason you shouldn't be alarmed if you measure the current flow in your circuit and find it a lot higher at the beginning of the charge cycle. It will soon drop to a point as close to your calculated value as your component values are close to their calculated values. If your charger is designed for the standard rate, you shouldn't have any problems.

If you use a full-wave rectifier and put the current-limiting resistor between the transformer and the rectifier, you will have a variable-current charger. Current flow will continue to decrease as the cell takes on more and more of a charge. That circuit arrangement is shown in Fig. 9. Figure 10 is a handy circuit that you can use to monitor the current flow. If it looks familiar it's because you've already seen it in the June installment of the "Designer's Notebook" and you'll find a full description of it there.

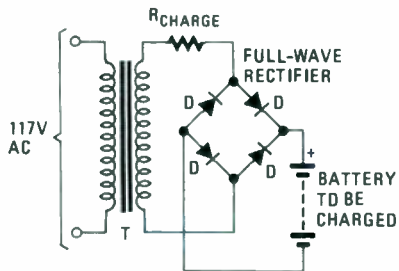

FIG. 9—AS THE BATTERY CHARGES, the current rate will decrease.

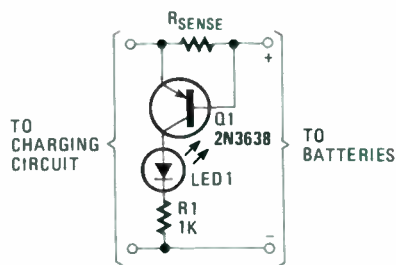

FIG. 10—YOU CAN MONITOR THE CHARGING CURRENT with this simple circuit.

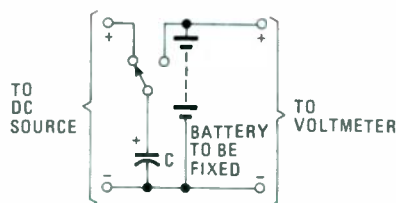

FIG. 11—YOU CAN CLEAR SMALL SHORT-CIRCUITS made up of metallic salts in NiCd batteries.

Basically the small voltage across R_{SENSE} turns on Q1 and the transistor turns on the LED. (Anything you want can be substituted for the LED. A relay, for example could put another resistor in series with the current-limiting resistor and cut the charging current down to a trickle charge.) The formula for calculating the value of R_{SENSE} is: $R_{SENSE} = 0.65/I_{CHARGE}$, where 0.65 volt is the voltage needed to turn on the transistor. If you're really a whiz at working out circuit parameters, you could get the value of R_{CHARGE} to equal R_{SENSE} and do the whole job with just one resistor. I can't work things out for you because the values for the components depend on the batteries you use, the charging rate, and many other factors. If you're careful though, you should be able to build yourself a charger that has several charging rates and can automatically switch over to over to trickle charge when a predetermined point is reached.

Rapid charging of cells should not be tried unless the cell is specifically designed to handle very high charging-currents and lots of safeguards are built into the charger. This kind of charging takes place under very controlled conditions.

Parameter

Memory
Current Capacity
Cost
Weight
Configurations
Availability
Shelf Life

Lead-acid batteries

None
Generally in Amperes
Moderate
Generally over 1 pound
Parallel or Series
Hard to Find
50% Loss in 8 Months

Nickel-cadmium batteries

Requires Reconditioning
Generally in Milliamps
High
Generally under 1 pound
Series Only
Available Everywhere
50% Loss in 3 Months

TABLE 6

The usual method of operation for this kind of charger is to monitor the *temperature* of the cell and switch to a trickle charge, (or completely off), when the temperature of the cell reaches a certain level. Thermistors and other temperature-sensing components monitor the cell and control logic that switches the charger to a lower rate.

We've already discussed how battery "zapping" can be used to try and clear out small internal shorts and revive cells that are apparently dead. Figure 11 is the basic circuit that's used. When the switch is thrown to the left, the capacitor charges, and when the switch is thrown to the right, the capacitor discharges through the theoretically dead battery and, we hope, burns out the small bridges of metallic salts that are shunting the current in the cell.

If the cell can be saved, after you blast it a few times you should see the voltage starting to rise on the meter. Once that happens, give the cell a few more hits and then charge it normally. It won't be as good as a good cell, but then again, it won't be as bad as a bad cell. You'll notice that I haven't given you any value for the capacitor. Well, the voltage rating should be *at least* as much as the largest voltage in the system, (either the battery or the source), and the capacitance should be as big as you can get. This is one of those instances where bigger is better. The more capacitance you have, the larger the blasting current is going to be and the more chance you're going to have of resuscitating the battery.

Our last helpful hint has to do with one of the most common uses for rechargeable cells: memory retention and emergency

backup. There are lots of different ways to design a circuit that will do the job, but the basic idea is shown in Fig. 12. When the DC voltage source is present, the batteries charge through R, the current-limiting resistor (because the diode is reverse biased). When the main power supply fails, the diode is forward biased and the NiCd batteries provide power to the load. The calculations for finding the value of R and the considerations for choosing the diode are exactly the same ones we discussed for our simple charger. There are other, more elaborate schemes for using rechargeable batteries like this, but they all use this approach. Diodes are used to steer the current where you want it and the

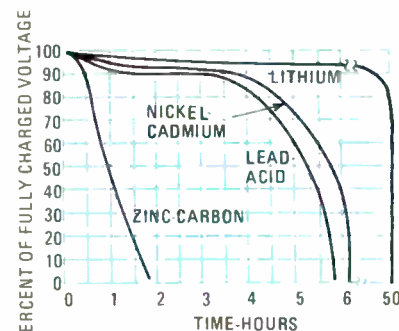

FIG. 13—VOLTAGE DISCHARGE CURVES for various types of batteries discharged at the 0.2C rate. Note the break in the hours scale.

biasing of the diodes is switched by the presence or absence of the main power supply.

We now come to the question of which battery type you should use. Well, the answer is, as we saw with disposable batteries last month, it depends. As a general rule, lead-acid batteries are used where the current draw is going to be heavy and NiCd's are used where it's not. Now I know that these are all relative terms but, like I said, it depends. For practical purposes, let's just say that if the current draw is going to be consistently in the multi-ampere range, go for lead-acid. If it's under an amp, look at NiCd cells. The relative merits of each system are summed up in Table 6 and the voltage-discharge curves for some of the various batteries are shown in Fig. 13. I've put in the curves for some of the lithium-based batteries as well as the zinc-carbon ones so you can make an overall comparison.

continued on page 113

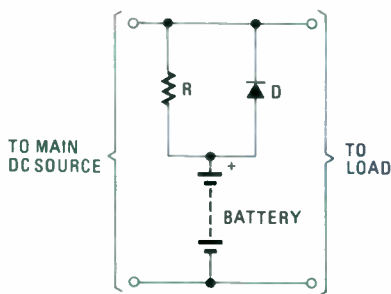
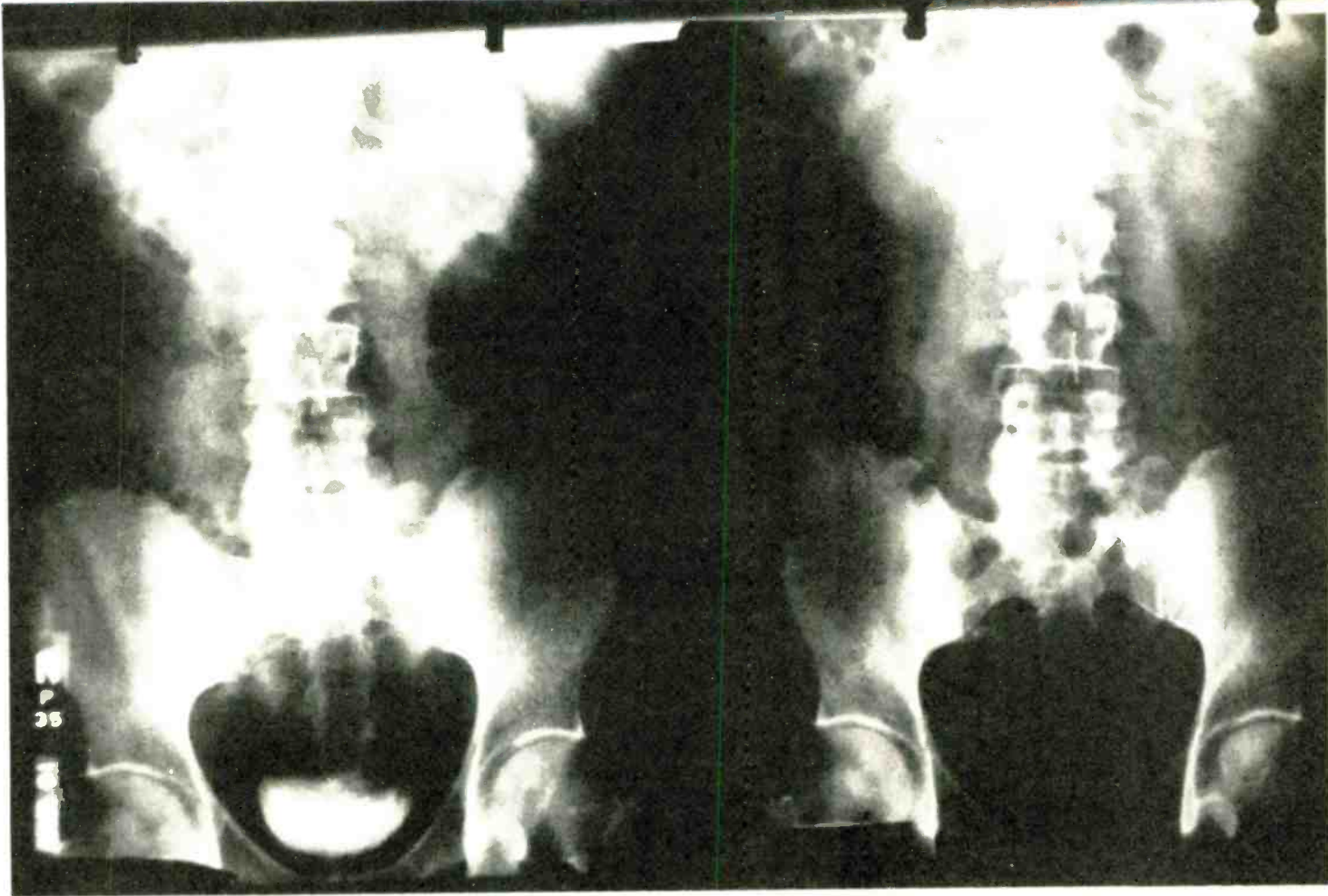

FIG. 12—ONE OF THE MOST POPULAR applications for rechargeable batteries is backing up power supplies.

Electronics In Medical Imaging



Various imaging techniques, such as X-rays and CAT scans, are commonly used in medicine. In this article, we'll take a look at those techniques and the role electronics plays in them.

Ray Fish, Ph.D., M.D.

MEDICAL IMAGING IS USED TO DISPLAY the structure and function of the body. It is used to obtain information about the status of a healing fracture, the presence of a tumor, the ability of the kidneys to remove substances from the blood, the presence of bleeding in the head, and the flow of blood through arteries and veins. Electronics has played an important role in medical imaging in the past, and that role is steadily increasing. In this article we will discuss medical imaging techniques such as conventional X-rays, fluoroscopy, linear tomography, computerized tomography, and ultrasound.

X-rays

X-rays are produced when a tungsten target is bombarded by an electron beam

of sufficient energy. In 1895, Professor Roentgen discovered that X-rays were capable of penetrating living tissue and making images of it appear on fluorescent surfaces.

Photographic film itself is relatively insensitive to X-rays. In order to overcome that, the film is placed in a "cassette" that holds a fluorescent screen close to the X-ray film. When struck by X-rays, the fluorescent screen emits light that blackens the film. If an object prevents X-rays from reaching the film and fluorescent screen, the film remains transparent (light) in appearance at such points.

Figure 1 shows the arrangement used to take a conventional X-ray picture. Exposure parameters vary according to the size of the person. A standard chest X-ray

will use an exposure time of about $\frac{1}{40}$ second, an X-ray tube voltage of 120 kilovolts, and a current of 400 milliamperes. The exact exposure time is determined automatically in many systems by an X-ray sensitive detector behind the film and screen. Note that the X-ray beam is divergent; it is cone-shaped and increases in size as it travels from its source. Therefore distances between the film, the patient, and the source of radiation will affect the size of images seen. For that reason, standardized techniques must be used when taking pictures to avoid confusion.

Figure 2 shows a conventional chest X-ray. Air permits the greatest amount of radiation to reach the film cassette. The lungs contain much air, hence they are the darkest area on the X-ray. Decreasing

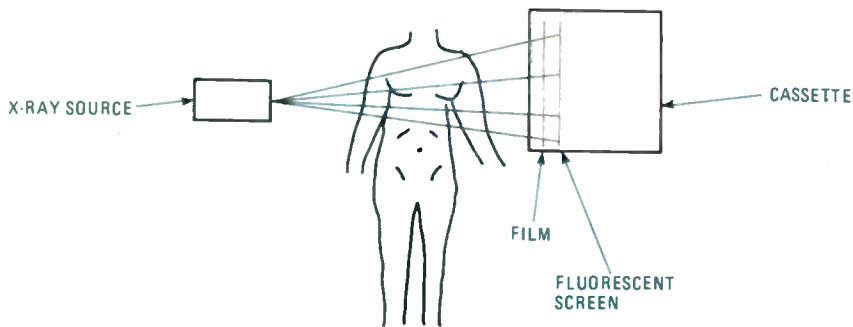

FIG. 1—ROUTINE CHEST X-RAY'S are taken using the arrangement shown. Note that the film is located in a cassette that also has a fluorescent screen.

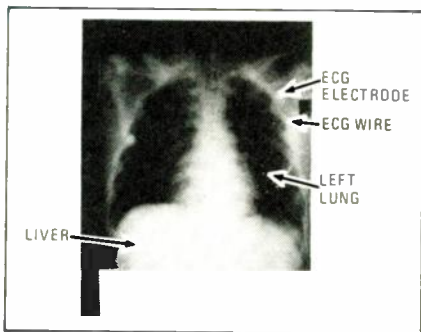

FIG. 2—A CHEST X-RAY. Since air allows the maximum amount of X-rays to reach the film, the lungs show up as a dark area.

amounts of radiation are able to penetrate soft tissues, bone, and metal. All material between the X-ray source and film contributes to the image regardless of the distance of the material from the film. For example, a rib on the front of the chest will be imaged about the same as a rib on the back of the chest.

Tomography

Figure 3 shows a method of obtaining images at a certain depth inside the body. That technique is called conventional tomography and has been in use for many years. In conventional (non-computerized) tomography, the X-ray source and film are moved simultaneously for several seconds as the picture is being taken. The geometry is arranged such that tissue densities at a certain distance from the film will remain in focus at all times during the

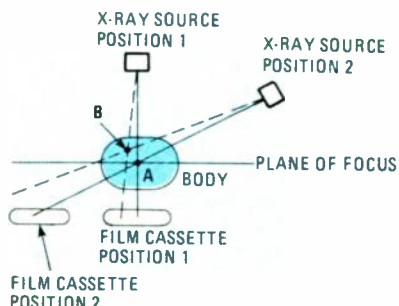

FIG. 3—CONVENTIONAL TOMOGRAPHY. In this technique, the X-ray source and the film cassette move in such a way as to keep all the structures in one plane in focus.

X-ray exposure, while tissue densities in other planes will be smeared broadly across the film. That type of tomography is relatively inexpensive and is useful even though it does not produce as clear an image as computerized tomography. Computerized tomography (which will be discussed below) is more sensitive to small differences in tissue density and has a finer resolution (smaller objects and smaller details can be seen).

Figure 4 compares images obtained by conventional tomography (Fig. 4-a) and conventional X-rays (Fig. 4-b). Different levels in the body are displayed in separate images in conventional tomography, showing detail not visible in a standard X-ray.

It is possible to put substances inside the body that strongly block X-rays. One can inject liquids called contrast agents into arteries, veins, and various body cavities. If placed into an artery, an arteriogram is obtained. Contrast agents injected into a vein will allow an X-ray to be taken that will show the vein, as seen in Fig. 5. Blockage in branches of an artery or vein can thus be seen. Blockages can occur when materials are deposited on the inner wall of an artery. Those form a relatively solid mass called a plaque. That is

especially important when the coronary arteries that supply blood to the heart muscle are involved. People often have chest pain from partial blockage of the coronary arteries. Similarly, partial blockage of the arteries supplying the legs may cause leg pain with walking. Partial blockage of the arteries supplying a kidney can cause high blood-pressure (hypertension). Blockage of arteries and veins can also occur because of blood clots, foreign bodies, or injury.

When a partial blockage of an artery is discovered, surgery can be performed to place a segment of vein in parallel with the blockage. That allows blood to bypass the blockage via the vein. Alternatively, in some cases a balloon can be placed in the partially blocked blood vessel and inflated. The material obstructing the vessel will be compressed into the walls of the vessel. Those techniques permit normal blood flow and cause relief of symptoms. In patients with certain types of coronary artery blockage, coronary bypass surgery is used to prolong life.

The kidneys normally remove many substances from the blood. Contrast agents can be injected into a vein in the arm, a simple procedure. The contrast agent will then travel through the circulatory system and eventually be concentrated and excreted by the kidneys. Kidney X-rays, also called intravenous pyelograms or IVP's can then be taken. The functioning and structure of the kidneys, ureters, and bladder can be studied using an IVP. While many kidney stones will not show on an X-ray, they can be seen in an IVP.

Fluoroscopy

Fluoroscopy is imaging that occurs when X-rays strike a surface that emits light as a result of X-ray exposure. Image intensifiers used in fluoroscopy can increase the amount of light seen and de-

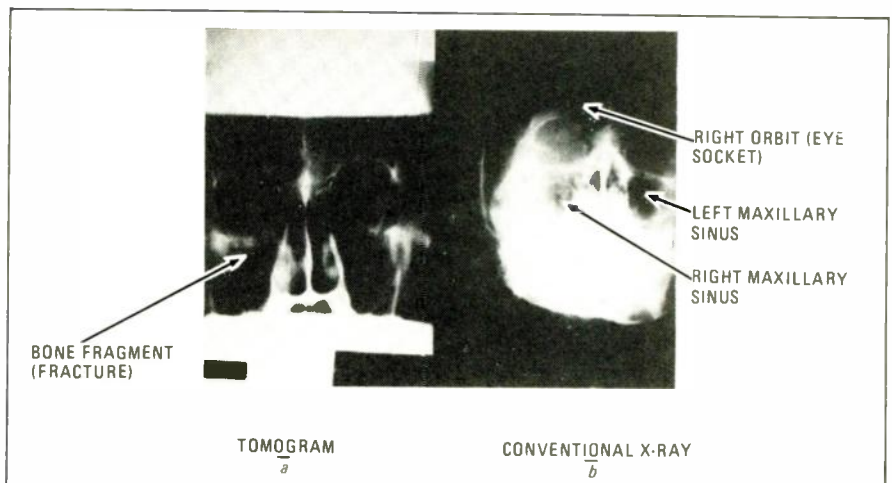

FIG. 4—A BONE FRAGMENT that shows up in the tomogram in a, does not show up in the conventional X-ray shown in b.

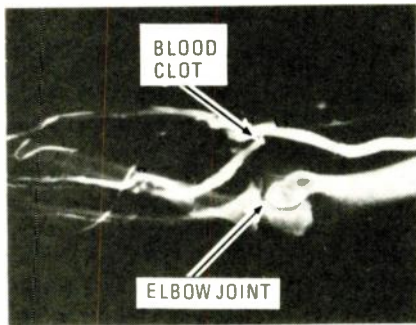

FIG. 5—IN THIS VENOGRAM, dye is injected to help pinpoint the location of a blocked vein.

crease by a factor of 1000 the amount of radiation needed to give a useful image. Image-intensifier tubes have a fluorescent screen that emits light when struck by X-rays. That light causes electrons to be emitted from a light-sensitive surface that is just behind the fluorescent screen. Those electrons are attracted to a second fluorescent screen by a high voltage, producing a brighter image than the one on the first fluorescent screen. The second fluorescent screen may be looked at directly or may be viewed by a television camera.

Use of a television camera permits magnification, image enhancement, image recording, and other image processing to be done by standard video equipment. X-ray images can be stored in a digital memory. It is possible that in the future, most X-rays will be taken with fluoroscopic equipment and be stored on videodiscs or videotape, rather than on large, expensive pieces of film. Thousands of separate X-ray pictures could be recorded on one videodisc or videotape.

Digital subtraction angiography

Digital subtraction angiography is a technique that allows imaging of arteries without injecting contrast material directly into them. Without digital-subtraction techniques, it is necessary to inject a liquid contrast material directly into an artery that is to be imaged. X-rays are taken when the contrast material is in the artery.

If the artery being studied is deep in the body, a catheter must be placed near the artery and the contrast material injected. For example, the renal (kidney) arteries are often examined. That involves placing a catheter near the kidneys by threading it through an artery, such as the femoral artery in the leg. That procedure is uncomfortable, is difficult to perform, and has the risk of complications. Complications include infection or bleeding at the site the artery is punctured. Also, the catheter may knock a plaque off the wall of any artery it passes through (such as the aorta between the groin and the kidney). A plaque knocked loose by a catheter will travel through the blood stream and eventually cause occlusion of a branch of the

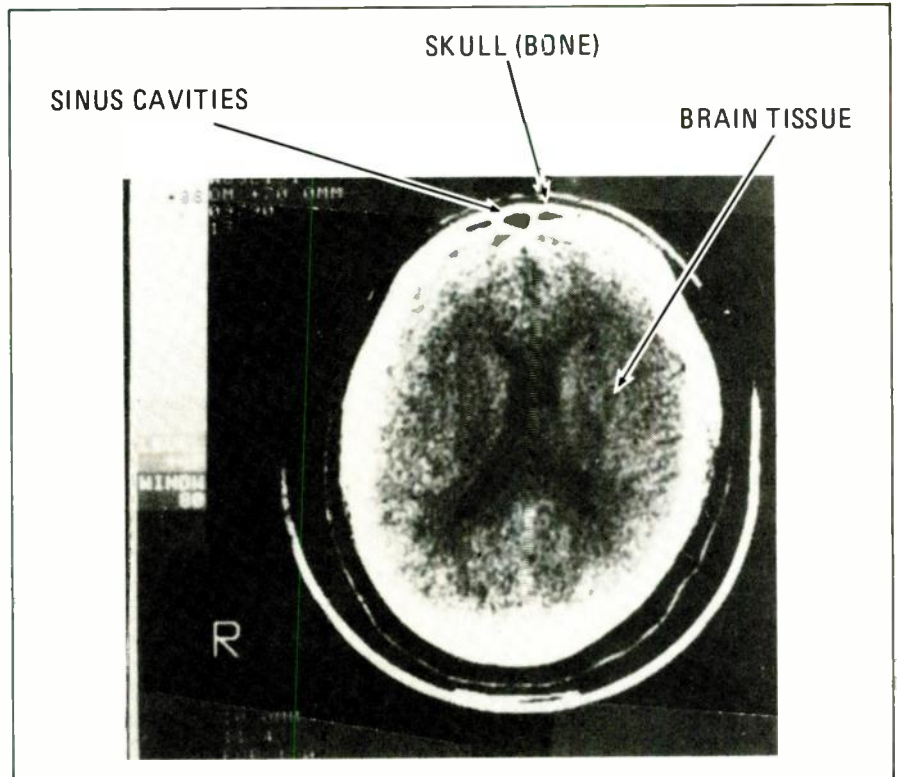

FIG. 6—A COMPUTERIZED AXIAL TOMOGRAPHY (CAT) scan of a human head. One horizontal level is shown here.

artery. That causes a lack of blood in the area supplied by the artery. If that area is in the brain, for instance, the person will have a stroke. Such complications caused by the insertion of a catheter are fortunately infrequent (about 0.1% of cases), but the cost and discomfort of arteriography do affect every patient.

With digital subtraction angiography, the need for an arterial catheter is eliminated. With the subtraction technique, an X-ray image of the area containing the artery of interest is obtained and stored in a digital memory. A contrast agent is injected into a vein in the arm, a simple, relatively safe procedure. A small percentage of the contrast agent will travel to the artery of interest, but not enough to cause an image to form on a plain X-ray. A second X-ray image is taken and stored in digital memory. The first image is then subtracted, point by point, from the second image. Structures that were the same when the two pictures were taken cancel out.

The image remaining is that caused by the circulation of the small amount of dye through the artery during the second picture. An image similar to a standard arteriogram is thus obtained without the cost, discomfort, and dangers of arterial catheterization. If there is movement between the two pictures, the images will not line up properly. Taking multiple pictures before and after the injection and choosing those that give the best image is sometimes done. Digital subtraction an-

giography is of limited use in imaging the coronary arteries because the heart moves about significantly. As digital subtraction angiography equipment becomes more refined and less expensive, it is expected that it will gradually replace conventional arteriography equipment in many applications.

Computerized axial tomography

Computerized axial tomography (CAT) is a technique that can obtain images of slices of tissue a few millimeters thick. That technique is very sensitive to differences in X-ray absorption of tissues. Conventional X-rays and tomograms are incapable of detecting the differences in X-ray absorption of soft tissues and fluids (such as blood, brain tissue, and water). Computerized axial tomography can be used to detect those differences (see Fig. 6).

If surgery is needed to correct bleeding inside the head, the CAT scan will usually show that. Arteriography was necessary to detect bleeding in the head before the CAT scan was available. The arteriography dye was injected into the carotid arteries that supply blood to the head. Arteriography is difficult, expensive, and uncomfortable. The CAT scan is safer than arteriography, without discomfort, and easy to perform. On the other hand, one drawback to CAT scans is that they are still somewhat expensive.

The CAT scan is performed by having one or more sources of X-rays and multi-

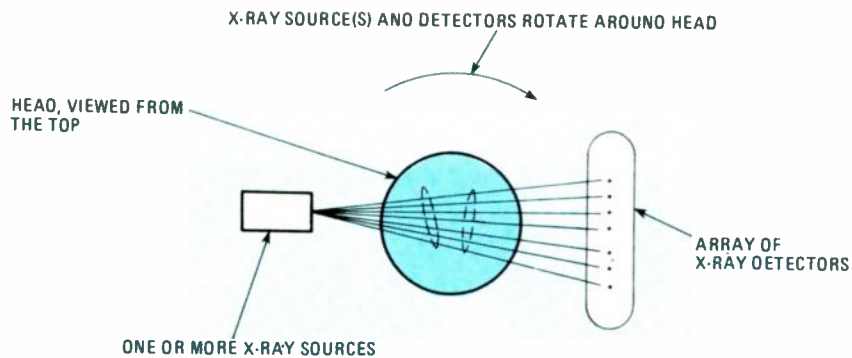

FIG. 7—SET UP USED in computerized axial tomography. Here, one or more X-ray sources rotate around the part of the body being scanned.

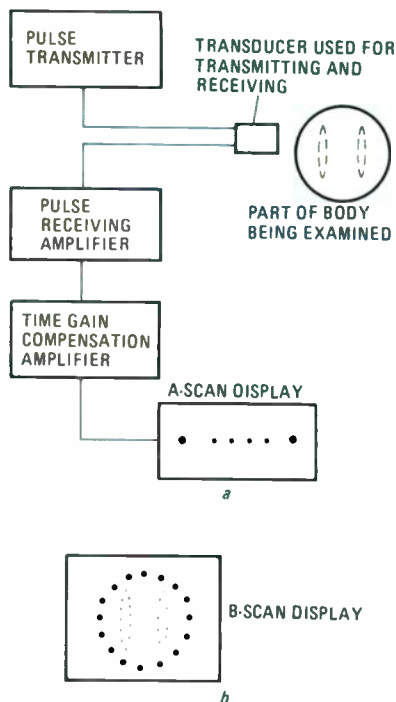

FIG. 8—BLOCK DIAGRAM of the set up used to obtain an ultrasound A-scan is shown in a. A B-scan, which is made up of a series of A-scans, is shown in b.

ple X-ray sensitive transducers positioned around the area to be examined. Figure 7 shows a simplified diagram with just one X-ray source and a few X-ray detectors. The amount of X-ray energy reaching each transducer is accurately measured. The assembly of transducers rotates around the area, taking measurements along many lines that pass through the plane being examined. Tens of thousands of measurements are made. The plane is divided into picture elements (pixels). A computer notes which lines crossed through which pixels and how much energy got through the tissue each line crossed. Having that information, the X-ray density (or the absorption) of each pixel can be calculated. In practice, the calculation of pixel density is too time-consuming, but computers can make approximate solutions and fit them to the

data. Once that task is completed, an image made up of the pixels can be displayed by the computer.

Ultrasound

Ultrasound is sound that is at a frequency too high to hear. Ultrasound used in medicine usually has a frequency of 1 to 5 MHz. Ultrasound is emitted by a crystal transducer that is placed on the skin. A jelly-like material is placed between the transducer and the skin to increase transmission. A portion of the transmitted ultrasound is reflected back to the transducer when an interface between different tissues is met. Thus, after a short pulse of ultrasound is emitted, a series of echoes is received, as shown in Fig 8-a. That tracing is referred to as an A-scan. The strength of individual echoes depends on the differences in mechanical properties of the tissues at each interface. For example, when a pulse crosses the boundary between muscle and blood, about 0.1% of the energy is reflected. The remainder of the energy continues on to image deeper structures.

The attenuation of ultrasound increases with frequency. For most soft body tissues, the attenuation coefficient is about 1 dB/cm/MHz. A structure 5 cm deep in the body will attenuate a 3.5-MHz signal 35 dB. A 10-MHz signal will be attenuated 100 dB. To compensate for the decrease in signal strength with depth, a time (or distance) gain control (TGC) system is used to pre-process the signal from the transducer. Signals received further in time after the transmitted pulse are amplified more. A series of gain switches are present on some ultrasound machine panels so the technician can set the gain at various depths to obtain a picture that continues to show tissue interface reflections despite the attenuation of the signal that occurs due to depth and various intervening structures.

Higher frequencies give a finer picture resolution because it is not possible to resolve structures smaller than about a wavelength in size. The wavelength at 1.5 MHz is about 1 millimeter. Higher frequencies are desirable unless the signal

must travel so deep into the body that it will be attenuated too much. Frequencies up to 15 MHz are used to examine the eye and other small body parts. Frequencies around 3 MHz are used for deep abdominal imaging.

The angle the tissue interface makes with the direction of the ultrasound beam may cause deflection of the beam in another direction. Successive echoes decrease in amplitude because the energy of the ultrasound is absorbed by the tissue as well as being reflected and refracted.

The mechanical properties of air and bone differ from those of soft body tissues so much that, for practical purposes, ultrasound does not penetrate air and bone. That inability to penetrate air and bone obviously limits the use of ultrasound greatly.

Despite significant absorption and refraction, useful images can be obtained using ultrasound. A two-dimensional picture, called the B-scan (see Fig. 8-b), is produced by displaying many A-scans simultaneously. Those are produced using a rapidly vibrating or rotating transducer that emits hundreds of pulses per second. That technique can be used to produce a real-time picture. Alternatively, a storage-type display can be used. In that technique, the transducer is moved manually by a technician and successive images are retained on the display, producing a picture. The quality of the picture that results from that technique can vary greatly because it depends on the skill of the technician.

B-scan ultrasound machines produce images that can be stored in a computer memory. Some commercially available machines have pictures with 16 gray levels. The images can be frozen, magnified, measured electronically, and photographed. A movable dot (cursor) can select an area to be examined for overall movement (such as a heartbeat) or for blood flow.

Some B-scan ultrasound machines have two movable dots (calipers) that can be positioned anywhere on the screen by a joystick. A digital readout of the distance between the two dots is displayed. That is useful for such things as measuring the head size (called the biparietal diameter) of fetuses. The biparietal diameter is related to the age of the fetus. Some ultrasound machines are made specifically for obstetrics. With those ultrasound machines, the heartbeat of a fetus can be monitored, for instance along with other physical data.

The screen containing the B-scan image in some machines will display the patients' name and other data so the photograph will not need further labeling or get mixed up with other patient's records. The patient's name and information about exposure settings is displayed on CAT images in a similar manner.

RECEIVING

OCT. 1984

Satellite

TELEVISION

BUYER'S GUIDE



Satellite-TV Basics

Satellite-TV Receivers

The Dish

Feedhorns, Waveguides, and LNA's

We Bring You the World

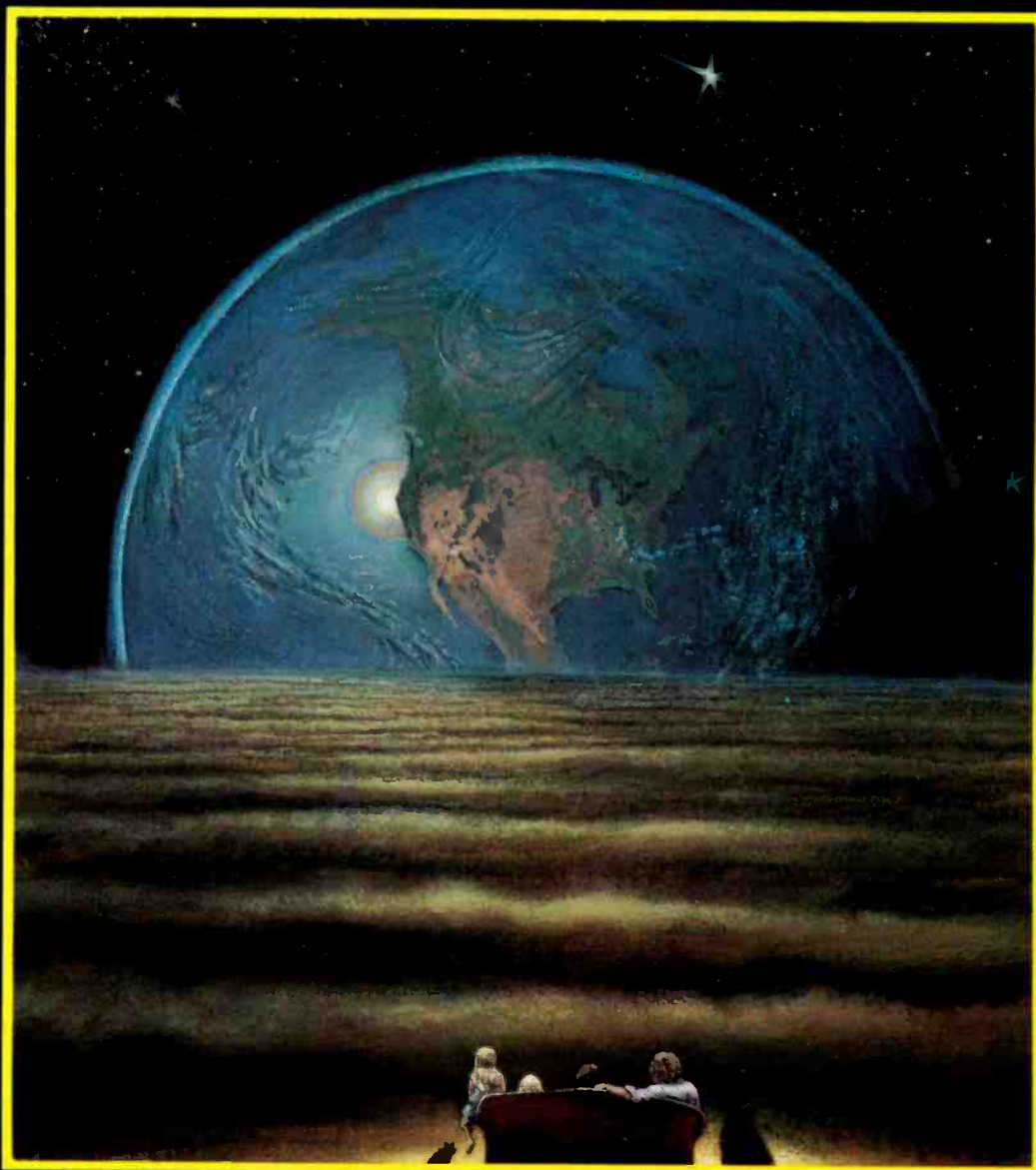

The fastest growing, most complete
video programming log for satellite television.
Satellite TV Week gets it straight —
bringing information to
industry, dealers and viewers.

 **Satellite TV Week[®]**

P.O. Box 308, Fortuna, California 95540
800-358-9997 or in CA 800-556-8787
707-725-2476

CIRCLE 9 ON FREE INFORMATION CARD

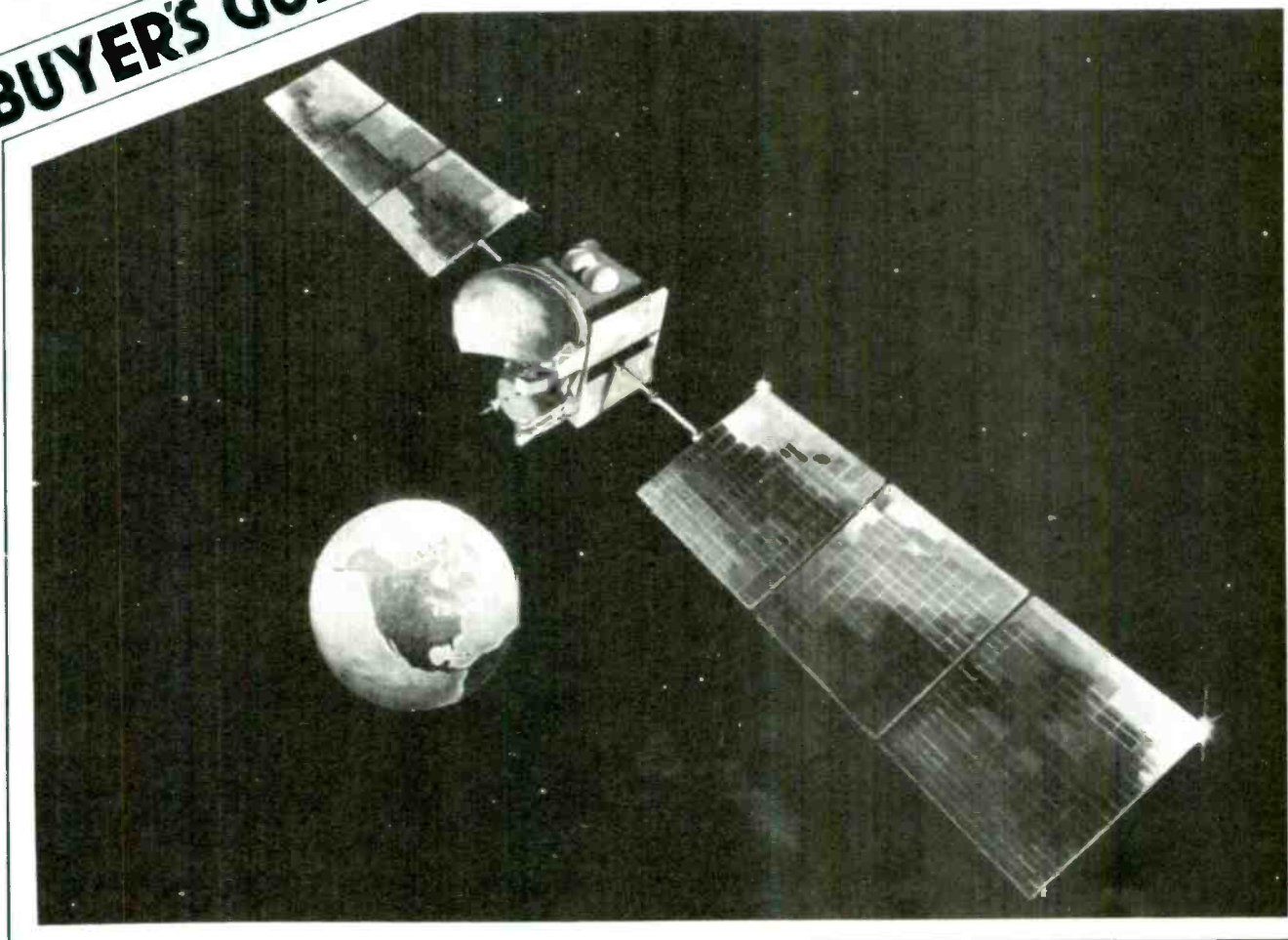
BUYER'S GUIDE

Satellite-TV Basics

By MARC STERN

Here's a quick review of some important satellite-TV basics.

THERE'S LITTLE DOUBT THAT ONE OF THE hottest areas of consumer electronics is satellite-TV reception. In this special section, we will be taking a look at the current state of the market, and what equipment is out there for the budding satellite-TV enthusiast. Before we do that, however, it might be a good idea to review some basic satellite-TV concepts and terms.

Satellite concepts

The satellites used for satellite TV are *geostationary*. That means that they are placed in an orbit 22,279 statute miles above the equator. The speed of a satellite placed into such an orbit matches the speed of the rotation of the earth and thus

appears to stand still in relation to the spot beneath it.

The purpose of satellites used for TV is to receive signals from an *earth station*, a communications facility that is capable of both reception and transmission, and retransmit them back to earth. On earth, the signals can be received by other earth stations, or by *TVRO's* (*TeleVision Receive Only*). Home setups are *TVRO's*.

Satellite-TV operates at microwave frequencies. There are two primary bands in use. The *C-band*, the one most often used by cable companies and others to distribute their programming, spans the frequencies from 3.5 to 6 GHz, while the *Ku-band* is located between 12 and 14 GHz.

The signal strength of a satellite-TV signal will of course vary with location. A chart of the signal strength at various points on the map can be made. That chart is called a *footprint*, and is shown in Fig. 1. Naturally enough, the area of maximum signal strength is located at the center of the footprint; that area is known as the *boresight point*.

As mentioned earlier, satellites orbit above the equator, in what is known as the equatorial plane. They are located in that plane between 79° and 143° west longitude (see Fig. 2). At the moment, there are 16 U.S. and Canadian satellites occupying slots in that orbit. Those slots are separated by about 4 degrees of arc, which is about 1838 miles. The reason for

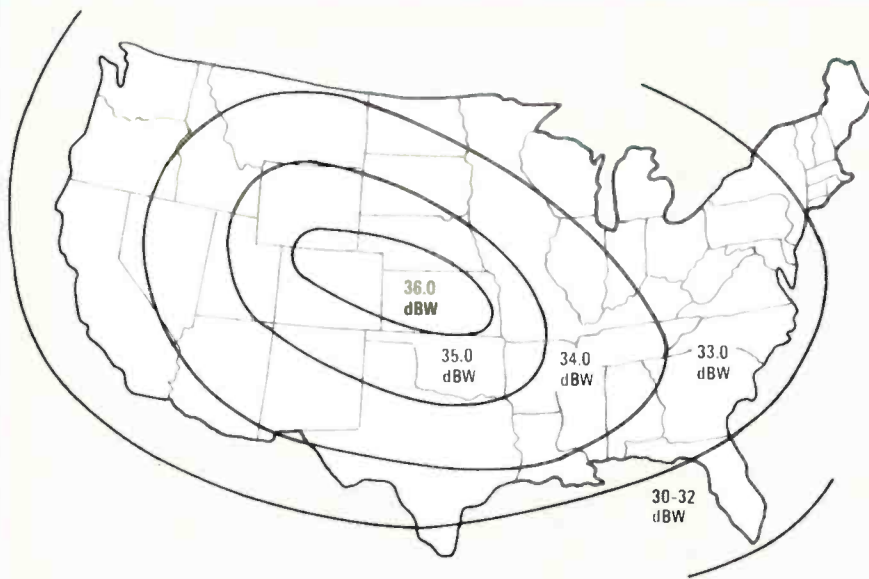

FIG. 1—A PLOT of the signal strength of a satellite transmission is called a footprint. The area of maximum strength is called the boresight point.

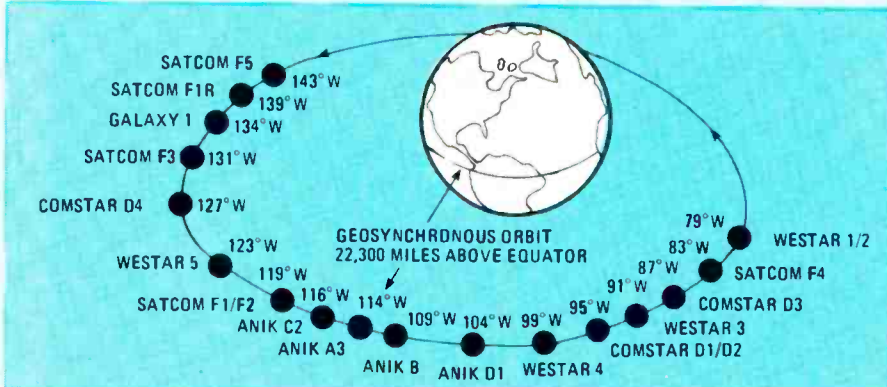

FIG. 2—ALL NORTH-AMERICAN SATELLITES orbit in the equatorial plane. They are located in that phase between 79° and 143° west longitude.

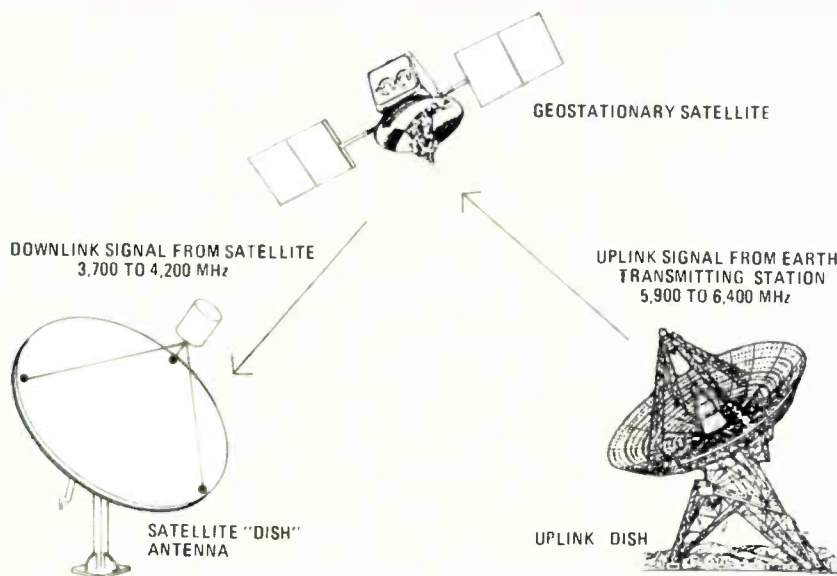

FIG. 3—C-BAND SIGNALS ARE UPLINKED at frequencies between 5.9 and 6.4 GHz, and downlinked at frequencies between 3.7 and 4.2 GHz.

that spacing is to keep the satellites far enough apart to allow each satellite to use

the same set of frequencies without interference (more on that shortly). However,

in order to accommodate more satellites, the FCC has laid down guidelines that will allow that spacing to be reduced to 2° over the next few years.

The current crop of satellites can be identified in several ways—designation, name, position, or any combination of those. Sometimes a letter or number follows the satellite's name. That indicates that the satellite is a member of a family of satellites or is a replacement for a satellite that is no longer in service. A satellite usually has a working life of about 7 to 10 years.

If you were to look at a satellite from the equator, it would appear tilted to you. That is known as the *tilt angle* of the satellite and it can be adjusted by on-board *thrusters* (rocket engines) that are controlled via sophisticated telemetry from the ground. Those thrusters are also used to compensate for any variations in the satellite's orbit.

Low-power transmitters

You might imagine that satellite transmitters would be high-powered affairs because of the great distances their signals must travel. That, however, is not the case. Instead, the average satellite *transponder*, the device that receives a signal from the ground and retransmits it back from space, has an output power of about 5 watts. Each transponder receives and sends a wide variety of video and audio information; among the types of communications handled are telephone, business data—and, of course, television and radio programming.

Power for the transponders and the satellite itself is obtained from on-board batteries. Those batteries are kept charged through solar cells mounted on wing-like panels that are deployed about the satellite. For maximum charging, the cells must be at a right angle with respect to the Sun. To maintain that orientation as the satellite travels in its orbit, the positioning of the panels is constantly being adjusted.

While low-powered transponders do draw less current than high-powered ones, conserving battery life isn't the only reason that low-powered transponders are used at C-band frequencies. On earth, that band is also used for the transmission of telephone communications. By keeping power-levels low, interference with those telephone communications is kept to a minimum. You will find higher power-output in Ku-band satellites; Canada's Anik D, for instance. That's because that particular band is not shared by any terrestrial services.

Uplink and downlink

When a signal is sent from the earth to a satellite it is being *uplinked*. And when the satellite sends it back, that signal is being *downlinked* to earth. Uplinking and downlinking take place at different fre-

quencies, with C-band signals sent to the satellite at 5.9 to 6.4 GHz, and returning signals at 3.7-4.2 GHz (see Fig. 3).

The 500-MHz uplink and downlink bands are broken up into a number of channels. Each transponder on-board a satellite is assigned one of those channels and each C-band satellite can have as many as 24 transponders.

On first inspection, that would seem to be at odds with the bandwidth requirements of the transponders. That's because each transponder needs 36 MHz for video and audio, and 4 MHz for a guard band. That would seem to limit the maximum number of transponders to 12 (12×40 is 480 MHz). But, by alternating the polarization of transponders on adjacent satellites, and by maintaining adequate satellite spacing, as many as 24 transponders can be used.

Let's take a closer look at alternating polarity. You will find if you look at two adjacent satellites that one will have its odd channels vertically polarized and its even channels horizontally polarized, while the other will use the opposite scheme. Thus, signals from adjacent transponders will be 90° out-of-phase. That allows the signals from adjacent transponders to overlap somewhat without interference. Note that alternating polarity is used only if a satellite has 24 transpon-

ders. If it has 12, then all transponders are horizontally polarized. Most U.S. satellites have either 12 or 24 transponders, although some have as few as 6. Ku-band satellites, on the other hand, have as many as 32 transponders.

Signal loss

As we've stated, a satellite signal has a long way to travel. Its round trip is about 44,600 miles and during that long trip up and down a great deal of it is lost. On a one-way trip from the satellite to the earth, about 196 dB of signal is lost and the signal that arrives at a TVRO antenna has a strength of about 0.5×10^{-20} . That signal level is less than thermal noise present at the antenna.

Even the uplink signal is affected by loss. For the most part, you will find uplink signals run from 400 watts to a kilowatt. The uplink dish affords a gain of 50 dB, or a power ratio of 100,000. Thus, the 400-watt signal effectively becomes a 40-megawatt one. But, that signal too is greatly attenuated so that it is on the order of a few microwatts by the time it reaches the satellite.

Signal improvements

Because of the extremely long distances they must travel, satellite signals greatly benefit from the use of some type

of signal processing.

In order to improve the signal-to-noise ratio of a satellite audio-signal, pre-emphasis is supplied to the audio waveform prior to uplinking. After the pre-emphasis is added, the signal is modulated onto a subcarrier in the 5 to 8 MHz frequency range. The compensation for that pre-emphasis—which emphasizes the high-frequency component of the signal—is supplied by the satellite receiver. That compensation is done before the signal is demodulated, and the task is handled by a de-emphasis network.

Video-signal processing, called *dithering*, also occurs before uplinking. In dithering, an *energy-dispersal waveform* (a triangular waveform with a frequency of 30 MHz) is added to the video signal. That process produces a more uniform dispersal of the video signal and compensates for energy concentration. Satellite receivers have a video clamping network to counter the effects of dithering.

A typical TVRO system

When you think of a home TVRO system, generally the first thing that comes to mind is the *dish*. That device acts as the reflector for the weak satellite signals and concentrates them at a focal point where the *feedhorn* is located. The feedhorn is actually the entrance to the *waveguide*.

Available NOW! The Sky Eye™ X

From KLM Electronics

Quality + Design = Performance

It's no accident that the formula to create the New Sky Eye X home satellite receiver begins with the word QUALITY. The Sky Eye X is the result of a special licensing agreement that brings state-of-the-art manufacturing and quality control techniques together with the futuristic technologies and design that has made the KLM Sky Eye receiver series a performance legend.

The Sky Eye X features include: slide rule tuning, fully tunable audio control, AFC defeat, Polarator 1 compatibility, video invert, and KLM's innovative single conversion image/reject circuitry.
Find out how you can use the KLM Sky Eye X as your formula for success. Contact your nearest KLM distributor or call toll-free 1-800-554-2478 (outside Calif.) for the name of a distributor near you.

KLM

electronics, Inc.
P.O. Box 816
Morgan Hill, CA 95037
(408) 779-7363



CIRCLE 63 ON FREE INFORMATION CARD

The waveguide acts much like the coaxial or twin-lead antenna cable with which you are familiar. It serves as the carrier for the signal from the focal point to the metal antenna probe. That device, which is usually no more than an inch long, is the actual antenna.

From the antenna probe, the signal is fed to a *Low-Noise Amplifier* (LNA). That broadband device amplifies the very low-level signals so that they are usable by the rest of the system.

At that point, the frequency of the signal is still in the 3.7-4.2-GHz range. Such frequencies require special transmission lines, however. To allow standard coaxial-cable transmission lines to be used, the frequency of the signal must be reduced to a more usable range. That task is handled by the *downconverter*.

Thus, from the LNA the signal is passed to a downconverter, which acts much like the front-end or first stage of a superheterodyne receiver. In the downconverter, the incoming 3.7-4.2-GHz signal is beat against a local oscillator and a new intermediate frequency (IF) results, typically 70 MHz. Signals of that frequency can be handled by coaxial cable with much lower loss.

As you would guess from the preceding, you will find most downconverters are located right at the output of the LNA

for minimum signal loss. Since both the LNA and downconverter are located outdoors, care must be taken to shield those devices from the elements.

After downconversion, the signal is passed via cable—typically 75-ohm RG59/U coaxial cable—to the receiver. At the receiver, the signal is again amplified and then demodulated into the original baseband audio and video. The baseband signals are then remodulated, either by a separate remodulator or one that is integrated into the receiver. (The reason demodulation and remodulation are necessary is because both video and audio are frequency modulated in a satellite system and can't be used by the television receiver. The video must be remodulated into an amplitude-modulated signal so it can be used by the television set, while the audio remains frequency-modulated.) The remodulator has an RF output, usually Channel 3 or 4, that is fed directly to the TV set.

A buyers guide

Now that we have covered some of the basic elements of a TVRO system, it's time to take a look at what is currently available in terms of satellite-receiving equipment for the home. We have tried to cover many of the major TVRO hardware suppliers, and have listed some key tech-

nical specifications to allow you to make comparisons between the various units.

A word on prices before we move on: The prices shown in the following articles are manufacturer's suggested retails. As with many other areas of consumer electronics, the actual price you may pay can vary wildly, depending on such things as demand, availability, and competition. If you are thinking about purchasing a TVRO, we suggest you do some careful comparison shopping beforehand. Now, let's move on to the guide! **R-E**

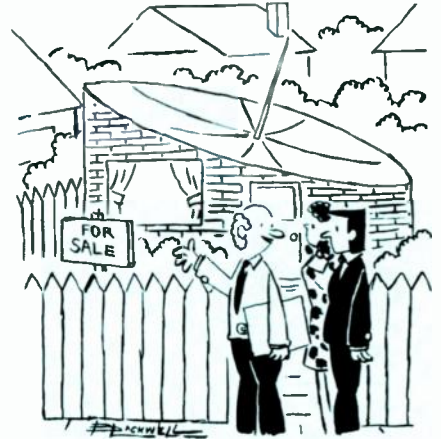

"Now if you're interested in satellite TV, this is just the house for you!"

***** 2300 MHZ VARIABLE DOWNCONVERTER *****

ANTENNA KIT

\$16.95

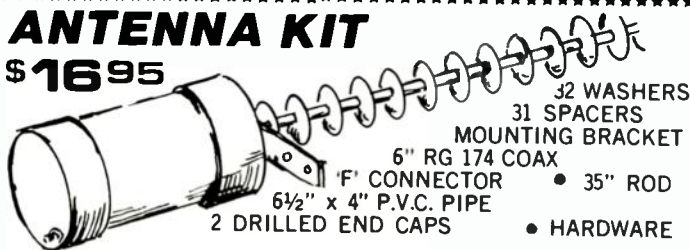

- 32 WASHERS
- 31 SPACERS
- MOUNTING BRACKET
- 6" RG 174 COAX
- 'F' CONNECTOR
- 6 1/2" x 4" P.V.C. PIPE
- 2 DRILLED END CAPS
- 35" ROD
- HARDWARE

POWER SUPPLY KIT

\$16.95

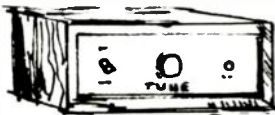

- POWER TRANSFORMER
- COURSE TUNE POT.
- FINE TUNE POT.
- 3 'F' CONNECTORS
- RESISTORS & CAPS
- LED WITH HOLDER
- TERMINAL STRIP

- P.C. BOARD
- RF CHOKE
- KNOB
- WIRE
- 2 SWITCHES
- 4 DIODES
- LM 317 REG.

WOOD GRAIN CABINET WITH SILK SCREENED front and back \$10.95 Extra

BUILT POWER SUPPLY.....\$34.95

Complete Down Converter System
INCLUDES
ANTENNA KIT
POWER SUPPLY KIT
CONVERTER KIT
SPECIAL \$49.95

QUANTITY DISCOUNTS
Any Price in Adv.
10 pcs 12% off
25 pcs 18% off
50 pcs 25% off
100 pcs 30% off
1000 pcs 35% off
No Mixing for Quantity Discount

PARTS

- Converter P.C. Board Plated through holes for stability.....\$4.95
- Power Supply P.C. Board2.95
- MRF 9012.00
- NEO21354.95
- 2835 Diodes95
- .001 Chip Caps. 10/3.95
- Choke Set of 4.....1.95
- LM 317 Regulator 1.25
- 'F' Connectors Chassis50
- Wall Transformer 12 VAC 700 MA....4.95
- 'U' Bolt95
- BALUN 75 to 300 ohm.....1.95
- BALUN for rabbit ears...2.95
- *RG 59/U COAX WITH CONNECTORS FACTORY MADE
- 100 Ft. \$17.50
- 50 Ft. 9.50
- 25 Ft. 5.75
- 3 Ft. 2.50

CONVERTER KIT

\$16.95

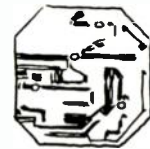

P.C. BOARD PRE-DRILLED SOLDER PLATED WITH PLATED THROUGH HOLES FOR A MORE STABLE PICTURE.

- NEW!! 2137 HOT TRANS...**
- 3 MRF 901 TRANSISTOR
 - 2 HP 2835 Diodes
 - 6 .001 Chip Caps.
 - 9 Resistors
 - 4 Prewound chokes
 - 1 Electrolytic Cap.
 - 1 Pre Made Probe

★ WIRED P.C. BOARD TESTED, READY TO CONNECT TO CAN WITH PROBE & CABLE CONNECTOR ATTACHED. **\$24.95**

We will tune converter board for \$12.50
trouble shoot add7.50
trouble shoot power supply..\$12.50
plus any parts needed.

We will accept telephone orders for Visa & Mastercard
No C.O.D. Orders

To Order Call 800-428-3500 317-291-7262
Complete Kit Weighs 10 pounds. Please add Sufficient Postage
6254 La Pas Trail
Indianapolis, Indiana 46268

ELECTRONIC RAINBOW

BUYER'S GUIDE

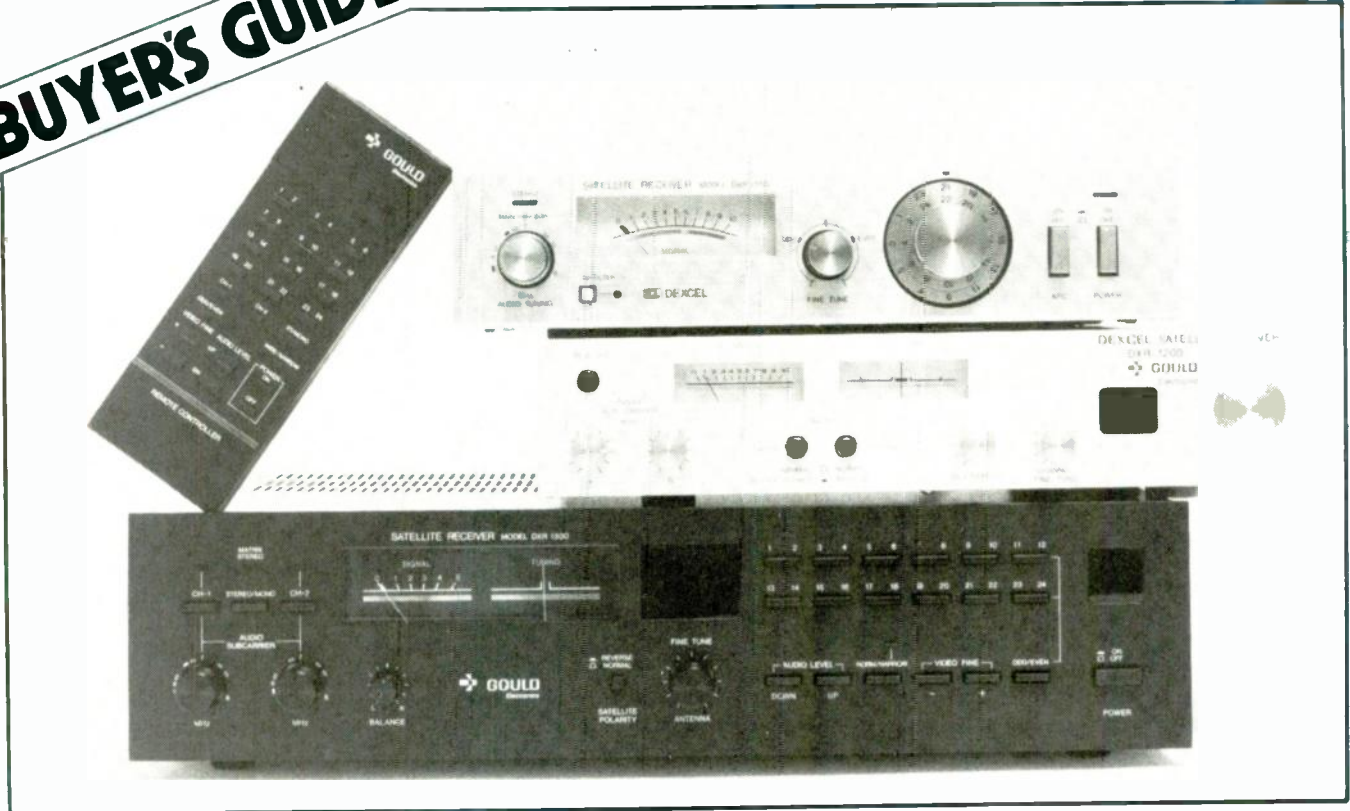

Satellite-TV Receivers

The satellite-TV receiver is the final link in a TVRO system. Learn more about those devices, including what's currently available, in this article.

MARC STERN

THE FINAL LINK IN A SATELLITE-TV SYSTEM is the satellite receiver. In some ways it is probably the most important link in the whole chain because it is the device that finally takes the signal that has been received at the antenna, amplified by the low-noise amplifier, and downconverted by the downconverter and turns it into a form that can be viewed on a home television set or monitor.

One of the few parts of the entire system that is located indoors, the best type of receiver to choose is one with 24-channel receive capability. The reason it is the best is that it gives you the ability to receive every transponder with which a satellite may be equipped. Granted, there are satellites with only 12 transponders aboard, but most of them have 24, so it makes more sense to buy a receiver with 24 channel-capability.

When you shop for a receiver, you will

find there are two basic types from which to choose: the frequency-agile receiver, described above, and the dedicated or single-channel receiver that is tuned to one particular frequency. In general, you will find, the frequency-agile receiver is what you want because it gives you the ability to tune in every possible satellite channel available. The dedicated receiver, on the other hand, is fixed to one channel and is best suited for those installations where you only want to receive one channel or service. For instance, news organizations or those companies that need only to receive information from a single source would make use of a single-channel receiver.

Receiver operation

The first step in processing a satellite-TV signal is downconversion. Receiver set-ups handle that in one of two ways.

Many use an external downconverter mounted at the dish. Others handle the downconversion process internally.

Looking first at the receivers that handle the downconversion internally, those are generally double-conversion units. The first downconversion is handled by a mixer/local-oscillator arrangement. That stage produces an IF of typically (it can, and does, vary according to the manufacturer) 1100 MHz. In addition, that stage also acts to increase the selectivity and gain of the receiver.

The 1100-MHz signal is then fed to a second mixer/local-oscillator stage. The output of that second stage is the second IF frequency of 70-MHz.

Note that only the first IF is tunable, despite the fact that two IF stages are used. That's because the output of the first stage remains the same (1100 MHz) regardless of which frequency is selected,

allowing the use of a fixed second IF stage.

A word about bandwidth: the bandwidth of the uplinked and downlinked signals is 36 MHz and normally that would be the bandwidth of the IF stages. In many receivers, however, that bandwidth is limited to only 28–30 MHz. That is done to reject noise that normally lies at the upper and lower limits of the 36-MHz signal. Narrowing the bandwidth also increases the gain of the two IF stages. There is, of course, a tradeoff; by narrowing the bandwidth, picture quality is reduced slightly.

That system has one major drawback. It requires that the microwave downlinked signal be brought some considerable distance from the outdoor LNA to the indoor receiver. Unfortunately, because of the high-frequency of those signals, cable losses can be significant if standard coaxial cable is used. Instead, heliax, which is very expensive, must be used. Because of that, receivers that use an external downconverter are far more popular.

There are two types of external downconverters—dual and single. Systems that use external dual downconversion differ little from those that use internal dual downconversion. The major difference is that the two IF stages discussed previously are housed in a separate weatherproof cabinet and are located at the dish. The output of the downconverter is, once again, 70 MHz, and signals of that frequency can be brought into the house using standard coax (such as RG-59/U).

In single-downconversion systems, all of the downconversion is handled in a single stage, as the name would imply. Once again, the circuitry is housed in a weatherproof box located at the dish and the output of the downconverter is 70 MHz. The major drawback to that scheme is that it is susceptible to the generation of image signals. To guard against that, receivers that use single-stage downconverters may be equipped with an image-rejection mixer.

Tuning and more

Satellite-TV receivers differ from other receivers in a few aspects. For one thing, a standard superheterodyne AM or FM receiver is tuned by varying the local oscillator and the RF amplifier. In a satellite-TV receiver, the RF amplifier is the LNA, which is not tunable. Instead, all tuning is handled by the local oscillator in the first IF stage (which in the case of single-conversion units, is the only one). That IF stage is either at the dish or at the receiver, depending on the location of the downconverters as previously discussed. As tuning is done by varying a DC voltage to the oscillators, the type of oscillators used are VCO's (Voltage Controlled Oscillators).

More significantly, however, a satellite-TV receiver must do at least some signal processing. The video signal, for instance, is frequency modulated, which means it is incompatible with the NTSC standard. To overcome that, the receiver must extract the original baseband video from the signal and then amplitude modulate so that it can be input to a standard TV-receiver. In addition, a video de-emphasis circuit is needed to counteract the signal processing performed on the uplink signal.

In addition to the primary frequency, each transponder may also relay a number of audio subcarriers. In order to receive those subcarriers, which are (usually) located at 5.6, 5.8, 6.2, and/or 6.8 MHz, a satellite receiver is equipped with a tunable audio demodulator. While the sound output is normally mono, stereo can be obtained if the unit is equipped with a pair of audio demodulators (one for each channel of sound). Some units are so equipped; in others, an add-on is required if stereo is desired.

Receiver features

Satellite receivers use several different tuning schemes. Many receivers feature continuous tuning with detent or click-stop tuning dials. Some use rotary dials, while others are of the slide-rule type. Still others offer digital readouts, which are, of course, much more convenient.

An important feature of any receiver is a tuning, or signal-strength meter. That meter indicates the strength of the signal being received. The tuning meter lets you know when the strength of the signal being received is at its maximum. As such, it is a valuable aid in tuning the receiver and in adjusting the position of the dish.

Many receivers use SAW (Surface Acoustic Wave) filters. A SAW filter delivers almost ideal shaping for the IF band-pass waveform and delivers a nearly flat response over the passband region. That type of filter does have a high insertion loss, around 30 dB, but that can be overcome through the use of additional IF stages.

Another feature to look for in a satellite receiver is a vertical/horizontal polarization selection switch. That allows you to set the receiver to the particular polarization used by a satellite. Of course, its use is predicated on having the proper dual-polarization antenna feed at the dish.

Here is a quick listing of other features to look for in a satellite receiver:

A video-output terminal gives you easy access to the baseband video (and sometimes audio) signals. If you have other equipment (TV, VCR, etc.) that can accept that type of signal (i.e., has a video input), its use will provide better video resolution.

A channel-calibration control, which is

usually located on the rear of the receiver, is used to assure that the tuning is correct.

Some satellite-TV programmers scramble their transmissions to prevent unauthorized viewing. While there are many scrambling schemes that may be used, one relatively simple one is simply to invert the video signal. Some receivers, however, are equipped with a video inverter that allows the viewer to defeat that (and only that!) type of scrambling.

For convenience, you might want a remote control. While frequency selection from your easy chair isn't a must, it is a nice feature.

A fine tuning control is handy for peaking the quality of the picture.

Some receivers offer a scanning feature that is used to rapidly scan through the 24 transponder channels in succession. In addition, some offer a dual-speed scanning feature that lingers at an active channel, giving the viewer time to decide if he wants to override the scan function and watch the programming at the current frequency.

Last but not least, tunable audio is a nice feature to have. That control lets you fine-tune the sound for best results.

Now that we have gone over some receiver basics, let's take a look at what is available in the marketplace.

Anderson Scientific

Supplied with an SC24 block downconverter, the dual-conversion ST1000 receiver is available for \$300. It features a built-in RF modulator, 5.5- to 7.2-MHz



ANDERSON SCIENTIFIC ST1000

audio tuning, a signal-strength meter, audio and video outputs, wide range AGC, built-in AFC, and a rotary tuning-dial. The IF bandwidth is a narrow 28 MHz, and the SC24 downconverter offers a gain of 20 dB.

Arunta

The *Challenger II* Receiver is available for \$510. It features a tuning meter, 5–8-MHz audio tuning, a polarity switch, rotary tuning and readout, built-in RF modulator, remote downconverter (single conversion), a SAW filter, a 26-MHz IF bandwidth, and composite and baseband video outputs.

The single-conversion *InVader* sells for \$815. It features a digital readout, LED-bar-graph signal-strength meter, automatic polarity-switching with skew adjustment, frequency-agile audio with auto deviation and center-tuning indicator, SAW filter, an IF bandwidth of 26 MHz, and composite- and baseband-video out-

puts.

The single-conversion \$2195 *Interceptor* contains a complete stereo processor for monaural and multiplexed, matrix, and discrete stereo. It features selectable wide or narrow audio bandwidth and dynamic noise reduction. Other features of the unit include a SAW filter, video inverter, signal-strength meter, rotary tuning-selector, polarity control, and an IF bandwidth of 26 MHz.

Automation Techniques

The *GLR-500*, priced at \$495, features full rotary tuning, tunable audio (5-8 MHz), polarity control, signal-strength meter, and a weatherproof downconverter. The *GLR-520*, priced at \$650, features pushbutton transponder selection, audio-level control, fine-tuning control, signal-strength meter, remote control, and tunable audio. The *GLR-560*, priced at \$750,

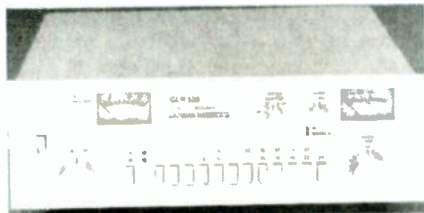

AUTOMATION TECHNIQUES GLR-500

features pushbutton transponder selection, dual audio channels for stereo with metered level controls, 30-MHz IF bandwidth, a fine-tuning control, and audio tuning-meters.

The *GLS-808*, available for \$1095, is a complete receiving system. It includes an LNA, downconverter, RF modulator, infrared remote-control, and cabling. The receiver features synthesized tuning, automatic polarity-switching, pushbutton channel-selection, LED readout, and signal-strength meter. Optional accessories include a relative-power meter for downconverter monitoring and additional remote control units. Remote control units are also available for Automation Techniques other receivers. Those feature 12-position (with detents) rotary transponder selection, polarity control, and fine tuning.

Avcom

Priced at \$1595, the rack-mounted *COM-66(T)* works with the *BDC-60* block downconverter. It features a tuning meter, rotary channel selection with scanning, audio and IF filtering control, a 30-MHz IF bandwidth, and polarity-, black-



AVCOM model COM-3

and-white-/color-, and normal-/inverted-video selectors. Also offered is a *COM-65(T)*, which is similar to the previous unit but offers only two-channel selection.

The Avcom *COM-2A* and *COM-2B* are priced at \$695 and \$663 and feature rotary channel selection, tuning meter, and automatic polarity-reversal. The *COM-2A* features a remote-tuning unit. Both units are supplied with Avcom's *RDC-10* downconverter.

Priced at \$1895, the Avcom *COM-3* and *COM3R* feature a signal-strength meter, rotary channel tuning, automatic polarity-switching, and dual video outputs. The *COM-3R* has remote tuner.

Blonder-Tongue

The \$2281 model 6007 receiver features detent tuning, signal-strength meter, remote control, automatic polarity switching, and special circuitry to aid in the reception of low-level signals.

Boman Industries

Priced at \$1199, the *SR-2000* receiver features pushbutton tuning, preset audio, time display, dynamic noise-reduction, video inversion, AFC, transponder search, and 6.8-MHz audio preset. Other features include automatic polarity-switching, east-west antenna-position tuning control (for use with Boman's antenna positioners and polar mounts), skew polarity tuning, dual-speed scanning, LED display, and tuning and signal-strength meters. Also available is a remote control that features channel selection, up and down search, standby, LED readout, 6.62- and 6.8-MHz audio presets, and audio override.

The *SR-2500*, priced at \$1364, features satellite search (a programmable feature that allows you to control the dish positioning from the receiver; for use with Boman's dish positioner and polar mounts), left-right channel variable audio-tuning controls, auto polarity selector (for use with Boman's *Polaromatic*), skew tuning, polarity reverse button, scanning, discrete stereo selector, stereo-balance control, matrix-stereo selector button, LED display, 6.8-MHz audio preset, wide/narrow audio-bandwidth selection, left-right-channel audio meters, signal-strength meter, video-inverter, AFC, fine tuning, detent volume-control, LNA/DC power remains on when unit is switched off, IF-gain control, dynamic noise-reduction, and a parental-guidance switch (for locking out certain transponders).

The *SR-800*, priced at \$599, features 24-channel detent tuning, stereo capability, fine tuning, signal-strength meter, AFC, and six preset audio channels.

Earth Terminals

Earth Terminals *Microwave Receiver*,

priced at \$1,425, features automatic AFC, remote control, automatic 5.5- to 6.8-MHz audio-subcarrier selection tuning, signal-strength and center-tuning meters, remote downconverter, continuous rotary tuning, and a 30-MHz IF bandwidth.

Gensat

The Model *CSR-1200* stereo receiver, priced at \$700, is designed to work with the *BDC-1200* block downconverter. It features polarity control, dual-audio and integral-stereo decoders, full subcarrier tuning, tuning meter, remote control, and has a 24-MHz IF bandwidth.

Gillaspie

The model 9600 is priced at \$495. It features an infrared remote-control, polarity control, pushbutton tuning, signal-strength meter, LED channel readout, built-in fine tuning, tunable 5-8 MHz audio, AFC, and scanning.



GILLASPIE model 9600

Gould (Dexcel Division)

The Dexcel satellite receiver lineup consists of the *DXR-1100*, *DXR-1200*, and *DXR-1300*, which are priced at \$1,225, \$1,255, and \$1,990, respectively. The *DXR-1100* includes among its features built-in matrix stereo decode, a standard remote control, AFC, fine-tuning control, and a signal-strength meter. The *DXR-1300* offers a built-in control for the



GOULD DXR-1300

Polarotor (a device that automatically switches antenna polarity), matrix and discrete stereo, selectable narrow and wide audio-bandwidths, digital channel-display, and signal-strength and channel-tuning meters. The *DXR-1300* offers pushbutton tuning, a digital channel-display, built-in Polarotor control, matrix or discrete stereo, infrared remote-control, selectable narrow/wide audio bandwidth, and a 35-watt audio amplifier.

KLM

Seven models are available—the *Sky Eye IV*, priced at \$635; the *Sky Eye V*, priced at \$495; the *Sky Eye VI*, priced at \$975; the *Sky Eye 7X*, priced at \$710; the *Sky Eye VIII*, priced at \$825; the *Sky Eye*



KLM Sky Eye VI

X, priced at \$550, and the *Olympiad I*, priced at \$385. The *Sky Eye IV* features a slide-rule tuning dial, 24-channel coverage, defeatable AFC, polarity switch, 5.5- to 7.5-MHz audio tuning, center-tune LED, and an LED signal-strength meter. The *Sky Eye V* features a polarity switch, signal-strength meter, 5.5- to 7.5-MHz audio tuning, slide-rule tuning dial, and a SAW filter. The *Sky Eye VI* features 5.5- to 7.5-MHz audio tuning, switchable narrow and wide audio bandwidth, AFC defeat, polarity switch, fine-tuning, two-speed scan tuning, signal-strength meter, and a remote control. The *Sky Eye 7X* features a polarity switch, polarity skew selector, AFC defeat, 5.5- to 7.5-MHz tuning, center-tune LED, and LED signal-strength meter. The *Sky Eye VIII* features 5.5- to 7.5-MHz audio subcarrier tuning, polarity-skew control, polarity switch, scanning, seek, fine tune, LED channel indicator, synthesized tuning, and signal-strength meter. The *Sky Eye X* features AFC defeat, polarity switch, and 5.5- to 7.5-MHz audio tuning. The *Olympiad I* offers a polarity control-switch, 5.5- to 7.5-MHz audio tuning, and a 30-MHz IF bandwidth.

Lowrance

Lowrance offers two receivers, the *System 70x* and the *System 70s*, priced at \$650 and \$750. The *System 70x* offers detent tuning, variable fine-tuning, AFC with defeat, variable audio-tuning, wide and narrow audio-bandwidth selection, signal-strength meter, video inverter, audio/video outputs, switchable polarity interface, and scan tuning. The *System 70s* offers all of the above and adds dual variable audio-tuning (wide or narrow band-



LOWRANCE System 70

widths), independent subcarrier tuning, and both discrete and matrix stereo capability.

Luxor/Magnum

The \$850 *9550* features dual scanning modes, video inversion, defeatable AFC, Dolby noise-reduction, 2 to 1 audio expander, outputs for composite video and audio, remote antenna control with addition of dish positioner, remote control,

mono and stereo modes with dual audio-bandwidth selection, LED channel-readout, and pushbutton tuning. A remote control is available as an option. The \$650 *9539 (Mark One)* features mono and stereo modes, polarity control, switchable audio IF, scanning, video inversion, video level-meter, pushbutton tuning, and LED channel-readout.

LSI Technologies

Priced at \$550, the *model 131* features block downconversion, tuning meter, video inversion, polarization control, continuous rotary-tuning, 5.5- to 8-MHz tunable audio, video and audio outputs, and a SAW filter.

McCullough

McCullough offers four models, the *ELC-24*, *ELX-24*, *USA-1*, and *USA-1M* which sell for \$445, \$495, \$345, and \$365. Those are tunable 24-channel satellite receivers with a remote single-conversion downconverter. Standard features include signal-strength meter, local, remote and scan tuning, wired remote control, polarity control, tunable audio, discrete and matrix stereo capability, and a baseband video/audio output.

National Microtech

National Microtech offers two models—The *Apollo Z-70*, priced at \$700, and the *Apollo Elite*, priced at \$1352. The *Apollo Z-70* offers continuous 24-channel rotary tuning with detents, automatic polarity switching, fine tuning, scanning, a 27-MHz IF bandwidth, remote downconverter, tunable audio, and a tuning meter. There is an optional remote control. National Microtech's other unit, the *Apollo Elite*, offers an infrared remote control, microprocessor-based direct/sequential tuning, LED channel display, automatic polarity-switching, fine tuning, scanning, tunable audio, tuning meter, volume control, television set on/off control, mute, channel lockout, remote-antenna control (for use with the company's *Navigator* antenna positioner with memory), and a 22-MHz IF bandwidth.

Radio Semiconductor

For those who need to feed signals to more than one set, Radio Semiconductor's *Locom* system, which consists, in part, of the *BR 220* block receiver (\$260)/*BC 124* block converter (\$95), offers an interesting alternative. In block conversion, rather than tuning the downconverter for a single transponder frequency, the entire C-band is downconverted at once and the receiver uses a broadband UHF tuner to select the frequency of interest. That could be a less expensive approach for multi-set set-ups. Among the *BR 220*'s more noteworthy features are tunable audio and a 23-MHz bandwidth.

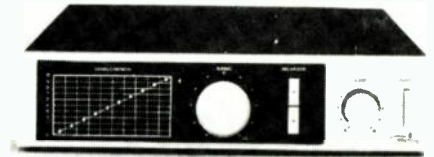

REGENCY SR-1000

Regency

Regency offers two models, the *SR 1000*, priced at \$499, and the *SR 3000*, priced at \$550. The *SR 1000* features polarity control, "X/Y graph" LED signal-strength meter for tuning, variable audio, built-in RF modulator, video/audio output, subcarrier output, inversion control, a weatherproofed remote downconverter, and continuous rotary tuning. The *SR 3000* features detent tuning with defeatable AFC, preset and variable audio-control, signal-strength and center-tuning controls and meters, polarization skew adjustment, dynamic-noise-reduction circuitry, format switch control, external-meter jack, video inversion control, video/audio outputs, a 25-MHz IF bandwidth, and a remote downconverter.

Sat-Tec

Three models are available from Sat-Tec—the *SR-3240*, priced at \$539; the *R-5000SP*, priced at \$279, and the *R-7000*, priced at \$379. The *SR-3240* features rotary detent tuning, LED readout, automatic polarity switching; automatic antenna-selector, built-in scanner, and matrix stereo. The *R-5000SP* offers a polarity switch, AFC, 5.5- to 7.5-MHz audio tuning, signal-strength meter (tuning), rotary tuning, remote downconverter, and a video output. The *R-7000* features a signal-strength meter scanning, polarity control, polarity-skew compensation and stereo.

Wilson Microwave Systems

Two models, the *YM 400*, priced at \$495, and the *YM 1000*, priced at \$750, are offered. The *YM 400* features continuous rotary tuning, scanning, automatic switching between satellite- and terrestrial-TV, signal-strength meter, polarity control switch, 5.5- to 7.5-MHz audio tuning, and a SAW filter. The *YM 1000* features pushbutton tuning, remote control, 5.5- to 7.5-MHz audio tuning, LED channel-readout, signal-strength meter, and automatic switching between satellite- and terrestrial-TV.

Winegard

Winegard offers the model *SC-7035*, priced at \$950, and the model *SC-7035S*, priced at \$1,025. Both units feature continuous rotary tuning with LED display, fine tuning, remote antenna control, scanning, polarity switch, 5.5- to 8-MHz audio tuning, signal-strength meter, and a 27-MHz IF bandwidth. **R-E**

BUYER'S GUIDE

The Dish

MARC STERN

A guide to what to look for when shopping for a dish, and a guide to what's available.

THERE IS NO PART OF A TELEVISION receive-only (TVRO) system that is more obvious than the antenna dish. The dish, of course, is not actually an antenna. Instead it serves a double function, gathering the very weak signals from a geostationary satellite, and focusing them on the antenna itself. In reality, the dish is little more than a signal-reflecting device.

The importance of such a device is quite obvious when you consider the low strength of a downlinked signal. The output power of a typical satellite-TV transponder is on the order of 5 watts. In addition, that signal must contend with traversing 22,000 miles and the losses that

entails. That loss, known as space or spreading loss, can be on the order of 196 dB, so the signal strength on earth can be as low as $.05 \times 10^{-21}$ watts. The result is that the signal can literally be buried in a hash of thermal noise when it reaches the antenna's reflector.

For those reasons, the gain of the TVRO antenna needs to be 35 to 45 dB or more just to pull the signal out of the thermal noise level. That's why relatively large reflectors are needed.

In general, most TVRO dishes are parabolic, although there are some on the market that are spherical. Regardless of the shape, most dishes are made from

either aluminum, stainless steel, or fiberglass (or similar material) with a metallized surface. To reduce the effects of weathering, a metal dish is usually further treated with some heat-absorptive (not reflective) material; the thermal properties of the material are important because we want to keep heat away from the feedhorn. That treatment involves either applying rustproofing or coating the dish with fiberglass. It is important that that step be taken so that the antenna doesn't oxidize or pit, which can change the signal characteristics of the antenna. Pitting caused by oxidation can cause reflections and signal loss at the feedhorn.

Two considerations that you should keep in mind when shopping for a dish for your home TVRO system are the type of construction and wind-loading. In general, dishes can be one-piece or petalized, and either solid or wire mesh. You will find that a dish that is petalized—made up of many sections—is easier to ship than a one-piece unit, but more difficult to assemble. It is also easier to move a petalized dish, should the need arise.

In general, you will also find that a solid dish is more prone to problems in high winds than one that is made up of wire mesh. Solid dishes are also much heavier than mesh ones and can accumulate water or, in freezing weather, ice.

Spherical versus parabolic

Although the majority of dishes on the market are parabolic, spherical dishes do offer some advantages. For starters, the signal reflection characteristics of the dish can be excellent, with a sharper area of focus than that of a parabolic dish. A spherical dish doesn't have to be precisely pointed at a satellite, unlike a parabolic antenna. In fact, it can be as much as 20-degrees off a direct line and the picture will still be usable. That means you can use a spherical dish to focus on several satellites simultaneously. Of course, the focal point for each satellite will be different.

You will primarily find a spherical dish used in a fixed installation with a fixed support that is usually very substantial. That substantial support is of benefit in an area where wind-loading is a significant factor.

The primary disadvantage of the spherical dish, and the main reason it is not popular for use in home TVRO's, is its long focal length, which can reach 12 to 20 feet. (The focal length of a dish is the distance from its center to the focal point—the area where all of the signals are gathered at the feedhorn.)

Special considerations

When you are choosing a dish for your TVRO system, there are some special considerations of which you should be aware.

Dish gain, usually from 35 to 50 dB in a home TVRO system, is related to dish aperture. Unfortunately, dish manufacturers usually quote that specification at the high end of the C-band range, where gain is usually higher, rather than at the middle or low-end of the band. Still, that specification is useful as a guide. In general, you will find a six-foot dish has a gain of about 35 dB, with gain increasing about 1 dB for each extra foot in dish aperture until you reach 11 feet. Beyond 11 feet, you will find about 1/2-dB gain-per-foot. Gain also depends on the curvature, shape (spherical vs. parabolic), and condition of the dish.

Beamwidth tells you how well a particular antenna will accept the signals of one satellite, while rejecting those of others. Therefore, the narrower the beamwidth the more selective is the dish.

For a TVRO system to function properly, it must be properly matched throughout. That is why the VSWR, or Voltage Standing Wave Ratio, must be low, as close to 1 to 1 as possible. If the VSWR of a particular dish is poor, it means too much of the signal is not being focused on the feedhorn, which results in a poor transfer of signal from the antenna to the receiver. That, of course, means that there's a deterioration in the quality of the picture that you eventually see.

Mounting Considerations

There are several types of mounts that are suitable for a TVRO dish. Those are fixed mounts, Az/El mounts, and polar mounts. The fixed mount, as its name implies, is fixed in one direction at one satellite. That type of mount, if suitably reinforced, can withstand high winds the best. Of course, it also has the advantage of not requiring adjustments once it's installed. That advantage is also its chief disadvantage, as it restricts you to viewing only one satellite.

The most versatile mount is the Az/El (AZimuth/ELevation) type of mount. That type of mount allows you to move the dish across the satellite arc, as well as up and down. The chief disadvantage of that type of mount is that a change in one parameter (either azimuth or elevation), will require a change in the other. Hence, that type of mount is very difficult to adjust.

The most popular mount for home TVRO's is the polar mount. It features the adjustability of the Az/El mount, but takes many of the headaches out of adjustment because you only adjust the angle of azimuth; the elevation is taken care of automatically. That type of mount can also be controlled from indoors.

With all of that out of the way, let's take a look at what the dish manufacturers are offering.

Blonder-Tongue

Our first manufacturer, Blonder-Tongue, offers 5 dishes suitable for home TVRO's. Those are the \$2050 model 6034 (9-foot), which is expandable to the \$2440 model 6035 (10-foot); the \$2318 model 6053 (12-foot); the \$5107 model 6048 and the \$5186 model 6050 (15-foot), and the \$6500 model 6026 (16-foot).

Looking a little more closely at the dishes, the 6034/6035 is a solid dish of petalized construction. An interesting feature is that the 9-foot 6034 can be retrofitted with extender panels to turn it into the 10-foot 6035. Gain is 39.5 dBi (9-foot)/40.1 dBi (10-foot), beamwidth is 1.9 (9-foot)/1.7 (10-foot) degrees, VSWR is 1.3:1, and winds to 100 mph can be with-

stood. The dish weighs 350 pounds (9-foot)/440 pounds (10-foot) and is available with either Az/El or polar mounts.

The model 6053 12-foot dish offers a gain of 41.7 dBi and a beamwidth of 1.5 degrees. It is a solid dish of petalized construction, weighs 1100 pounds, and can withstand winds to 125 mph. The dish



BLONDER-TONGUE 6034

comes with a "T-bar" Az/El mount.

Blonder-Tongue's 15-foot models are available with either prime focus (6048) or Cassegrain (6050) feeds. Both models are solid (fiberglass) dishes of petalized construction, weigh 1200 pounds, feature Az/El mounts, and can withstand winds to 100 mph. The model 6048 offers a gain of 43 dBi, a beamwidth of 1.1 degrees, and a VSWR of 1.3:1. The model 6050 features a gain of 43.5 dBi, a beamwidth of 1.12 degrees, and a 1.3:1 VSWR.

Finally, the 16-foot 6026 features a gain of 44.1 dBi, a beamwidth of 0.86 degrees, and a 1.3:1 VSWR.

Boman Industries

Boman Industries offers two dishes, the model SA-3000 and the model SA-2400. Looking at the top-of-the-line SA-3000, that 10-foot one-piece construction, fiberglass dish is rated to withstand winds of up to 120 mph. It boasts a VSWR rating of 1.2:1 and a gain of 40.1 dB. It sells for \$840.50. The smaller (8-foot) SA-2400 is also of one-piece construction, but the material used is spun aluminum. It sells for \$365.50.

Comtech Antenna Corporation

Comtech offers a wide variety of dishes. Their 10-foot model boasts a gain of 40 dBi, a beamwidth of 1.7 degrees, and weighs 650 pounds. It is made of fiberglass, features a manual Az/El mount, and sells for \$1790. The 12.5-foot model has a gain of 42.9 dBi, a beamwidth of 1.4°, and a weight of 800 pounds. It is made of fiberglass, features either an Az/El or polar mount, and sells for \$2060.

Conifer

Conifer offers a 12-foot, petalized wire-mesh dish. The model AN-1200 features a

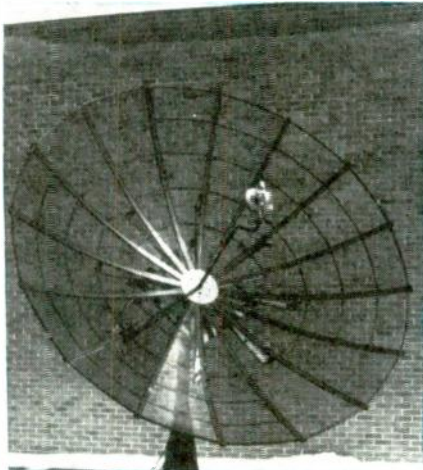

CONIFER AN-1200

gain of 42.3 dBi, a beamwidth of 1.5 degrees, and weighs 300 pounds. It uses a polar mount, is rated to withstand winds up to 100 mph, and sells for \$1300.

Delta Satellite

Delta's *Starduster* is an 8-foot spun aluminum solid dish that boasts a gain of 38.5 dB, uses a polar mount, weighs 69

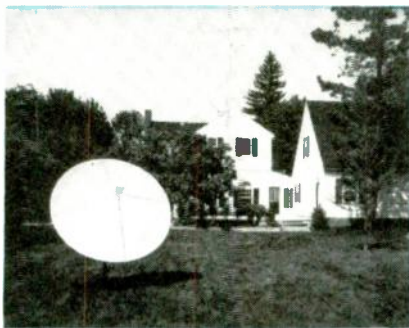

DELTA *Starduster*

pounds, and sells for \$799. Other dishes in the line include the 10-foot fiberglass *Delta I* (\$1149) and the 13-foot *Delta II* (\$1895)

General Instrument

Among the offerings from General Instrument are the *SA081S*, *SA102*, and the *SA122*. The 8-foot *SA081S* features a gain of 38.1 dB and a beamwidth of 2.2 degrees. It is made of aluminum, uses a polar mount, and sells for \$1025. The 10-foot *SA102* features a gain of 40.3 dB and a beamwidth of 1.8–3.8 degrees. It is made from spun aluminum, uses a polar mount, and sells for \$2235. The 12-foot *SA122* features a gain of 42.2 dB and a beamwidth of 1.5–3.2 degrees. It is made of spun aluminum, uses a polar mount, and sells for \$2540.

Industries PPD

The *Sphinx* is a 12-foot petalized, polyurethane dish. It boasts a gain of 42 dBi and a beamwidth of 1.35 degrees. The dish weighs 380 pounds, uses a polar



INDUSTRIES PPD *Sphinx*

mount, and sells for \$1235. A 10-foot version and Cassegrain feed are also available.

Janeil

The Janeil 9-foot dish is a petalized, aluminum mesh unit. It boasts a gain of 39.5 dB and a beamwidth of 1.89 degrees. Its polar mount features a full declination-tracking adjustment. The dish itself weighs 110 pounds; the mount weighs 130 pounds. The suggested retail price is \$929.

Also from Janeil is their *Dark Star* dish. That 12-foot mesh dish sells for \$1149.

KLM

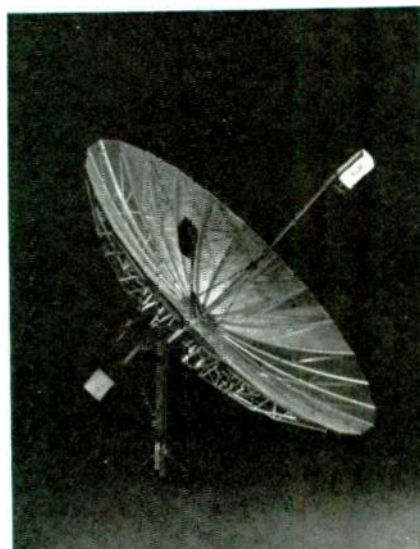

KLM *X-11*

KLM offers 8-, 11-, and 16-foot models. The 8-foot *Mini-X* has a 37.3-dB gain. It is of petalized wire-mesh construction, weighs 85 pounds, uses a polar mount, and can withstand winds to 100 mph. It sells for \$850.

The 11-foot *X-11* has a gain of 40.5 dB. It is of petalized wire-mesh construction, weighs 125 pounds, uses a polar mount, and can withstand winds to 100 mph. The dish sells for \$1420.

The 16-foot *X-16* has a gain of 43.5 dB. It is of petalized wire-mesh construction,



KLM *Mini-X*

weighs 290 pounds, uses a polar mount, and can withstand winds to 100 mph. It sells for \$2995.

Luly Telecommunications

Luly offers a variety of popular-sized wire-mesh dishes. Their 6-foot model has a gain of 35 dB, a beamwidth of 2.8 degrees, and sells for \$950. Their 8-foot model has a gain of 37.5 dB, a beamwidth of 2.2 degrees, and sells for \$1050. Their 10-foot model has a gain of 39.5 dB, a beamwidth of 1.7 degrees, and sells for \$1150. Their 12-foot model has a gain of 41.5 dB, a beamwidth of 1.4 degrees, and sells for \$1250.

McCullough Satellite



MCCULLOUGH SATELLITE *Wagon Wheel*

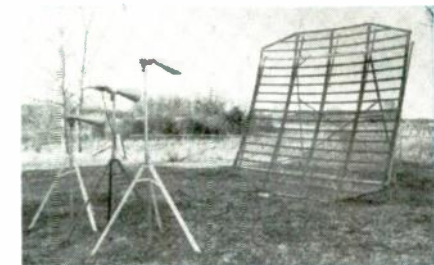

MCCULLOUGH SATELLITE *8-Ball*

McCullough offers both spherical and parabolic dishes in kit form. Their aluminum-mesh *8-ball* spherical dish (featured in the August and September 1981 issues of *Radio-Electronics*) is available in 8- (\$395), 10- (\$445), 12- (\$475) and 16-foot (\$1200) versions. Their aluminum-mesh *Wagon-Wheel* parabolic dishes are avail-

able in 8- (\$300) and 10-foot (\$350) sizes. Also available from the company are 8- (\$300) and 10-foot (\$350) parabolic fiberglass dishes.

Miralite Corp.

The Miralite Corporation offers two dishes that are suitable for home TVRO applications. Their 12-foot model offers 42-dB gain, weighs 300 pounds, and can withstand winds to 125 mph. It sells for \$2484. An 8-foot model, which sells for \$1085, is also available.

Paradigm Manufacturing

Paradigm offers their *Paraclipse* dishes in three sizes. All models are of mesh construction and come with polar mounts. The 9-foot model has 39.3-dB gain and a beamwidth of 1.8 degrees. It sells for \$995. The 12-foot model has a gain of 42.3 dB and a beamwidth of 1.28 degrees. It sells for \$1295. Finally, the 16-foot model has a gain of 44.8 dB and a beamwidth of .9 degrees. That dish sells for \$4995.

Pico Satellite

Pico offers single and dual-feed models. The *SAR-14SF* is a 14-foot dish with a 43.6-dB gain and a 1.27 degree beamwidth. It weighs 356 pounds, is of cast aluminum construction, can withstand winds to 120 mph, and costs \$3350.

The *SAR-10SF* is a 10-foot dish with a gain of 40.8 dB and a beamwidth of 1.51 degrees. It is made of cast aluminum, weighs 205 pounds, and is rated to withstand winds to 125 mph. The dish sells for \$2,050.

In dual-feed models, there is the *SAR-10DF*. That 10-foot dish has a 40.5-dB gain and a 1.55-degree beamwidth. It weighs 205 pounds, is made of cast aluminum, and can withstand winds to 125 mph. It sells for \$2,250.

The 14-foot *SAR-14DF* dual-feed dish has a gain of 43.1 dB and a beamwidth of 1.3 degrees. It weighs 356 pounds, is made of cast aluminum, and can withstand winds to 125 mph. It sells for \$3,350.

Quadralite

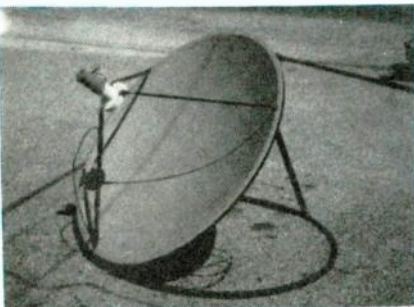

QUADRALITE 4-foot dish

Quadralite offers a rather interesting entry—a 4-foot dish intended for recrea-

tional-vehicle (RV) use. That relatively small dish has a gain of 34 dB and a beamwidth of 3.75 degrees. It is of plastic/fiberglass/metal construction and weighs 85 pounds, including polar mount. The dish sells for \$335.

Regency Satellite Systems

From Regency comes the *SA 9000*. That 7½-foot dish is made from marine



REGENCY SA9000

aluminum, is of one-piece construction, weighs 156 pounds, and offers 38.5-dB gain. It sells for \$595.

Symtel

The *Vision 2000* from Symtel is available in two sizes. The 8-foot model has a gain of 38.5 dB, a beamwidth of 1.9 degrees, uses a polar mount, and weighs 94 pounds; the one-piece, solid-construction dish sells for \$579.

The 10-foot *Vision 2000* has a gain of 40.5 dB, a beamwidth of 1.65 degrees, uses a polar mount, and weighs 167 pounds. That one-piece, solid-construction dish sells for \$899.

USS/Maspro

USS/Maspro markets three antennas. At the low end of its line is the model *300-1*, which has a gain of 42.2 dB, a VSWR of 1.25:1, and a beamwidth of 1.35 degrees. That 12.6-foot dish is made of fiberglass, features two-piece solid construction, weighs 520 pounds, can withstand winds to 125 mph, and uses a polar mount. It sells for \$1095.

The model *380-1* has a gain of 44.4 dB, a VSWR of 1.25:1, and a beamwidth of 1.05 degrees. That 16-foot dish is made of fiberglass, features three-piece solid construction, weighs 1270 pounds, can withstand winds to 120 mph, and uses a polar mount. It sells for \$1895.

At the top-of-the-line is USS/Maspro's commercial-grade model *500-1*. The model *500-1* has a gain of 44.4 dB, a

VSWR of 1.25:1 and a beamwidth of 1.05 degrees. That 16-foot dish is made of fiberglass, features three-piece solid construction, weighs 1270 pounds, can withstand winds to 120 mph, and uses a polar mount. That dish sells for \$4995.

Wilson Microwave

The *MD-9* has a gain of 38.5 dB and a beamwidth of 1.8 degrees. The gal-



WILSON MD-9

vanized-steel, petalized construction, 8-foot, 8-inch dish weighs 250 pounds and can withstand winds to 100 mph. It sells for \$499.

Winegard

The model *SC-1018/SC-1019* (chrome/black satin finish) is a 10-foot perforated aluminum dish. It boasts a gain of 39.5 dB and a beamwidth of 1.6-degrees. It weighs 92 pounds, can withstand winds to



WINEGARD SC1019

125 mph, and uses a polar mount. It sells for \$1077.

Winegard also offers an 8-foot aluminum dish with a gain of 37.5 dB. It uses a polar mount and sells for \$484. **RE**

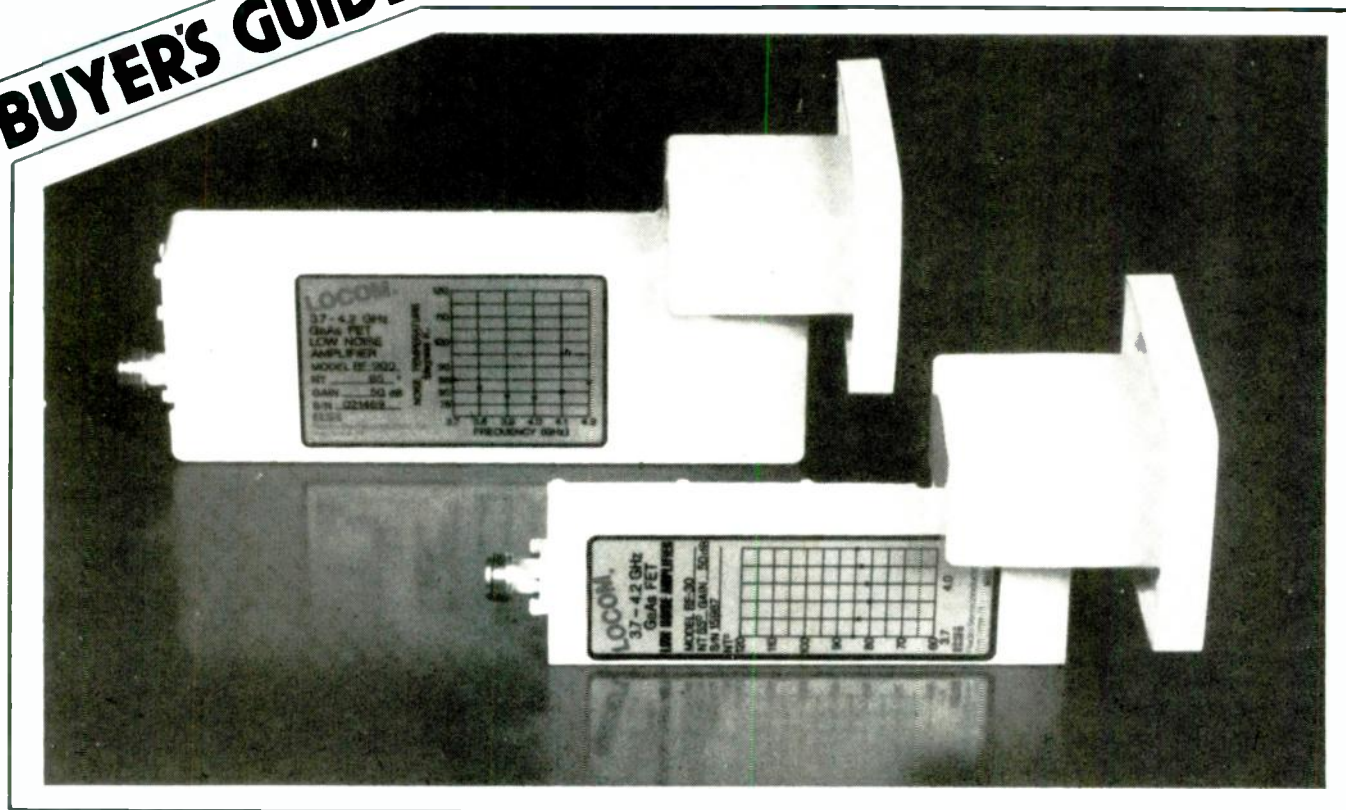
BUYER'S GUIDE

Feedhorns, Waveguides, and LNA's

MARC STERN

A TVRO system has many stages, each doing a specific job and having its own set of specifications. In this article, we'll look at those stages that get the signal from the dish and feed it to your receiver.

THE POPULARITY OF SATELLITE-RECEIVER systems has brought with it a great deal of confusion as to which one to purchase. That's because several manufacturers offer a number of microwave products with hard-to-understand specifications.

To the average consumer, specification sheets contain nothing more than a lot of electronic mumbo-jumbo that only serves to further add to the problem. So to help make the task of deciding which system to purchase a little easier, we've simplified the specifications of some of the devices and listed only the most important.

Feedhorn

One of the most important parts of any home TVRO system—after the dish, of

course—is the feedhorn. That device collects the weak signals that are reflected from the dish and focuses them on the antenna itself.

The most widely used feedhorn arrangement is known as a *prime-focus* arrangement, so named because of the placement of the feedhorn. Located at the spot (known as the focal point) where the reflected signals from the dish are concentrated, its function is to collect as much of the focused signal energy as possible. It is the type most likely to be found in a home TVRO system.

Another type of feed—called a Cassegrain system—uses a second reflector shaped as a hyperbola; hence, it is known as a hyperboloidal subreflector. The first reflector is the dish itself, with the second-

ary reflector located at the prime focal point. The sub-reflector refocuses the reflected satellite signal (from the dish) through an opening (aperture) in the center of the dish to a low-noise amplifier or LNA.

The primary advantage of the Cassegrain arrangement over the feedhorn type is the additional gain that it provides. The disadvantage of that system is that it's harder to adjust than the prime-focus arrangement and the second reflector is in the path of the incident signals. That means that some of the signal will be blocked out (aperture blockage).

There are ways, however, to overcome the drawbacks associated the Cassegrain system. One remedy is to use a larger dish to allow for aperture blockage losses.

However, that's not always convenient.

Waveguide

Unlike the conventional TV receiver where the incoming signal is picked up by an antenna and transferred to the signal-processing circuits in a TV set, microwave signals are reflected from the dish onto a waveguide, which then directs the signal to the antenna. A waveguide is used at microwave frequencies because of its lower loss when compared to coaxial cable. While it is possible to use other cable types, those cables are very expensive.

In many cases, when you look at the feedhorn you will see several metallic circles surrounding the central waveguide. Those rings are part of what is known as a *scalar feed*. The purpose of those rings is to help concentrate any satellite signals in the waveguide.

The antenna

The antenna (also sometimes called the antenna probe or simply the probe) is located in the feedhorn at the end farthest away from the prime focal point. (Note that you cannot buy the probe separately—it comes with the feedhorn.) From the antenna, the signal is fed to the LNA.

Because TVRO systems operate in the gigahertz region, the antenna is tiny—about one-inch overall. That broadband antenna is tuned to be resonant over the C-band frequency range.

Low-noise amplifiers

The signal from the antenna probe is, as stated before, directed to an LNA. That wideband, non-tunable amplifier has an amplification factor of about 100,000 (roughly 50 dB). It is usually encased in a weather-proof container—since it is located outdoors—and mounted just to the rear of the feedhorn (usually as a part of the feed system). It has an input-frequency range of 3.7–4.2 GHz.

Not only does the LNA amplify the satellite signal, but it also amplifies any noise that may be presented to its input. That includes any noise generated by the amplifier itself.

Also, even the noise generated by the radiated heat-energy from the earth can interfere with the satellite signals (which are inherently very weak). That's why an LNA's most important specification is given in Kelvins (or degrees Kelvins). The lower that *noise-temperature* rating, the lower the noise that is generated by the device. Popular LNA's generally have noise temperatures in the range of 80°K–120°K.

In putting together a TVRO system, another important rating to keep in mind is the signal-to-noise ratio (G/T) or figure of merit (expressed in Kelvins or decibels). That figure is a measure of how much electrical noise will be added to

signals presented to the LNA input, however the figure of merit is independent of the gain of the amplifier. In other words, the noise level does not effect the gain of the LNA.

The gain is far more dependent on frequency range than the noise figure. For instance, an LNA with a noise figure of 1.5 dB can have gain variation of as much as 6 dB, as the frequency range changes over the C band. As noted in other articles in this section, manufacturers usually specify the maximum gain figure in their literature, rather than on the average. Therefore, you may find the actual gain at a particular frequency to be considerably lower.

LNA components

Most LNA's use gallium-arsenide (GaAs) FET's, although some use bipolar transistors. The features we need are excellent gain and the ability to take low-level signals and amplify them into usable levels.

The LNA is little more than a signal amplification device. It raises the amplitude of the signal by many orders of magnitude, but that's all it does. That means that the signal exiting the LNA is at the same frequency as that presented to its input.

While, it is possible to feed those signals directly to the satellite receiver through coaxial cable (as was once the case), to do so requires using fairly long runs of very expensive, hard-to-work-with cable—called helix. (The losses associated with "regular" coax at are too high for the cable to be used at microwave frequencies.)

A more practical arrangement is the one found in the most systems today: The downconverter is placed at the output of the LNA (mounted on the dish structure), and its output is fed to the receiver through common coaxial cable. The downconverter acts like the front end of a superheterodyne receiver: It takes the LNA's output and mixes it to produce an intermediate frequency of about 70 MHz.

Low-noise converter

Sometimes the LNA and downconverter are combined into one device, called a low-noise converter (LNC). That eliminates the need to run a line between the LNA and downconverter. The two components may then be mounted in a single waterproof enclosure, which results in reduced installation time and lower manufacturing cost.

Low-noise block downconverter

There is another type TVRO system in which the antenna and LNA handle all transponder frequencies as a block; here the LNA acts as a low-noise block converter or LNB, combining the amplification and mixing functions.

Amplica

Amplica has several LNA models to choose from, ranging in price from about \$300 to \$800. Each of the models, the *ACD30530*, *ACD305329*, *ACD305331* and *ACD305332* has a gain of 50 dB. But each model's noise figure is different: The \$329 *ACD30530* has a noise temperature

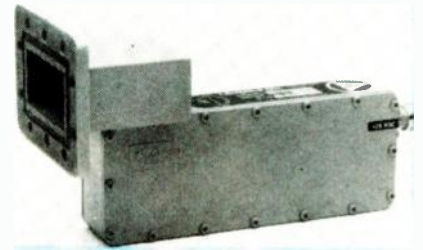

AMPLICA model ADC 305-305 LNA.

of 120°K, the \$399 *ACD305329* has a noise temperature of 100°K, the \$599 *ACD305331* has a noise temperature of 90°K, while the \$799 *ACD305332* has one of only 85°K.

Avantek

A similar situation exists with Avantek's LNA's. While each model has a gain of 48 dB, the noise temperature vary from 120°K for the \$375 *AWC-42120* to 100°K for the \$525 *AWC42100*, to 90°K for the \$689 *AWC-42085*, to 80°K for the \$895 *AWC-42080*.

Boman Industries

The *LNA-912* series of low-noise amplifiers from Bowman features a gain of 50 dB, while their *LNA-910* series features a gain of 53 dB. Six different models are available, ranging in price from \$139 to \$219. Their noise temperatures range from 120°K to 80°K.

Boman also offers a variety of feedhorns including the \$99.50 *RFH-75-I* (\$114.50 with remote) and their *EFH-75-II* (\$79.50). Both are scalar-feed types and use DC motors for antenna probe rotation. The *EFH-90* is priced at \$99.50 and is another scalar feed with 180-degree rotation. (A solid-state version is available.)

The *EFH-90-PH* polarizer mounts in standard feedhorns and costs \$129. It uses a ferrite design to keep moving parts to a minimum. It features 180-degree rotation.

Gillaspie Communications, Inc.

Two LNA's from Gillaspie are avail-

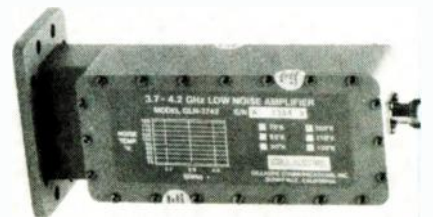

GILLASPIE model GLN-3742 LNA.

able, each with a gain of 50 dB. The *GLN-3742-100N/A* sells for \$175 and has a noise temperature of 100°K. The *GLN-3742-120* sells for \$150, and has a noise temperature of 120°K.

International Satellite Video

International Satellite Video offers their *Polatron III* polarizer, for \$59.95. It's a solid-state polarizer: Polarity changes are accomplished magnetically (no moving parts are used).

M/A-COM Electronics Canada

This line of LNA's features a minimum gain of 50 dB. Priced from \$160 to \$300, the models in the *2016* LNA line are rated at 120°K, 100°K, and 85°K.

Microwave Applications Group

The ferrite polarization rotator, model *FPR-1 C/D*, available for \$132 features



MICROWAVE APPLICATIONS GROUP FPR-1 ferrite polarization rotator.

automatic polarization selection, using Faraday rotation. It has an insertion loss of 0.15 dB and a rotation of 120°.

Radio Semiconductor/Locom

The *RF-900-120*, which sells for \$180 has a noise temperature of 120°K. The *RF-900-100*, which sells for \$160 has a

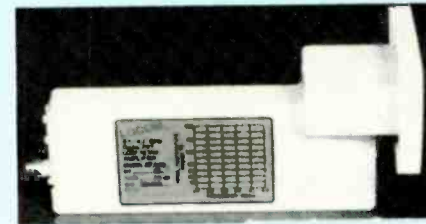

LOCOM models RF-900 (top) and RF-30.

noise temperature of 100°K. The *RF-900-85*, which sells for \$280, is rated at 85°K. Each model has a gain of 52 dB.

R.L. Drake

Drake has three LNA models, the *2575*, *2574*, and the *2573*. They sell for \$329, \$429, and \$599 respectively. The Drake LNA's use GaAs FET amplifiers and each has a gain of 53 dB. Their respective maximum noise temperatures are 120°K, 100°K, and 85°K.

The LNA's, as you might expect use

weatherproof construction and are covered by a 9 month warranty.

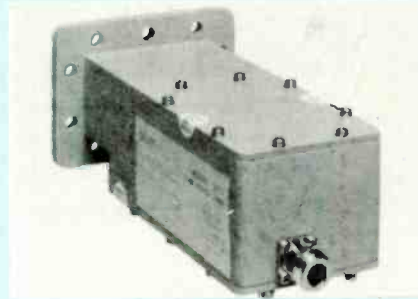

R.L. DRAKE model 2575 LNA.

Syntronic

An integrated LNA and feedhorn is available from Syntronic for \$495. It has no insertion loss between the LNA and feed, and electronic polarity selection (with no moving parts or adjustments). An adjustable choke is included to optimize the focal point. The noise temperature of the integrated LNA/feedhorn is 100°K. Its gain is 50 dB.

Winegard

Winegard's *SC-8101* sells for \$384. It has a gain specified at 50 dB and a noise temperature of 100°K. R-E

Electronics Paperback Books NEW Paperbacks You'll Want To Read CHECK OFF THE ONES YOU WANT

AN INTRODUCTION TO PROGRAMMING THE ATARI 800/800XL...\$5.00. This book is designed to complement the information supplied by the manufacturer. Essential reading for all Atari owners.

20 PROGRAMS FOR THE ZX SPECTRUM & 16K ZX81...\$5.00. Included with each program is a detailed flow chart for debugging and practical applications in logic, statistics, and engineering.

20 SOLDERLESS BREADBOARD PROJECTS...\$5.75. 30 more new projects based on CMOS IC's that you can try in minutes on an electronic breadboard.

BASIC PASCAL IN PARALLEL...\$3.75. Detailed programs in both languages simultaneously. Sample programs illustrate structure.

ELECTRONIC SCIENCE PROJECTS...\$5.75. Fascinating projects for any science fair. Includes: unique clocks, earthquake detectors and more.

30 SOLDERLESS BREADBOARD PROJECTS...\$5.75. 30 more new projects based on CMOS IC's that you can try in minutes on an electronic breadboard.

MICRO INTERFACING CIRCUITS—Book 1...\$5.75. In-depth coverage of how the interconnection can interface a home computer to trans form it into a sophisticated piece of control equipment.

HOW TO GET YOUR ELECTRONIC PROJECTS WORKING...\$5.00. When you can't get that home-built equipment to work, this book may have the answers you need.

INTERNATIONAL DIODE EQUIVALENTS GUIDE...\$5.75. Find substitutes when you need them for diodes, transistors, OC's, photodiodes and display diodes.

DESIGN & MAKE YOUR OWN PRINTED-CIRCUIT BOARDS...\$5.75. Everything you ever needed to know about how to make printed circuit boards at home.

ART OF PROGRAMMING THE ZX81...\$6.25. What has happened when you add the RAM pack, Scrolling, PEEK, POKE, Page graphics and more.

MULTI-CIRCUIT BOARD PROJECTS...\$5.00. 21 sample projects that can all be built on one circuit card. Use the same components in several projects.

HOW TO DESIGN AND MAKE YOUR OWN PCB'S

THE ART OF PROGRAMMING THE ZX81

INTERNATIONAL TRANSISTOR EQUIVALENTS GUIDE...\$7.50. Lists possible substitutes for a popular user-oriented selection of modern transistors. The products of more than 100 manufacturers are included.

A PRACTICAL INTRODUCTION TO MICRO-PROCESSORS...\$5.00. The reader will construct his own simple microprocessor circuit and experiment with it to learn more about how microprocessor's work.

25 SIMPLE AMATEUR BAND ANTENNAS...\$5.00. Includes designs for dipoles, beams, triangles and even a mini-rhombic. Includes a complete set of dimension tables.

INTERNATIONAL TRANSISTOR EQUIVALENTS GUIDE

PRACTICAL ELECTRONIC BUILDING BLOCKS...\$5.75. Electronic circuits are all made up of individual building blocks. Make the blocks, then combine them to build the circuits you need.

EASY ADD-ON PROJECTS FOR SPECTRUM ZX81...\$7.00. Pulse detector, picture digitizer, 5-key pad, model controller, light pen and more.

INTERNATIONAL TRANSISTOR EQUIVALENTS GUIDE

PRACTICAL ELECTRONIC BUILDING BLOCKS...\$5.75. Follow up to Volume 1 presents more building blocks for the experimenter.

MODEL RAILWAY PROJECTS...\$5.00. Electronic projects that will make your model rail road more realistic in both appearance and sound.

ELECTRONICS SIMPLIFIED—CRYSTAL SET CONSTRUCTION...\$4.50. All of these receivers are designed around modern inexpensive components and hand-wound coils.

ELECTRONIC TECHNOLOGY TODAY INC. 1084
P.O. Box 240, Massapequa Park, NY 11762

Number of books ordered

Total Price of Books _____

Sales Tax (NY State Residents only) _____

Shipping and Handling (75¢ 1 or 2 books 30¢ each add. book) _____

TOTAL ENCLOSED _____

Name _____

Address _____

City _____ State _____ Zip _____

PRICES GOOD UNTIL DECEMBER 31, 1984

MANUFACTURER LIST

Anderson Scientific, Inc.
2121 Rand Road
Rapid City, SD 57702

Antenna Technology Corp.
895 Central Florida Parkway
Orlando, FL 32809

Arunta Satellite Telecommunications
Box 15082
Phoenix, AZ 85060

Automation Techniques, Inc.
1550 North 105th East Ave.
Tulsa, OK 74116

Avantek, Inc.
481 Cottonwood Drive
Milpitas, CA 95035-7492

Avcom
500 Research Rd.
Richmond, VA 23236

Birdview Satellite Communications, Inc.
Box 963
Chanute, KS 66720

Blonder-Tongue
Brown Road
Old Bridge, NJ 08857

Boman Industries
9300 Hall Rd.
Downey, CA 90241

Burr Engineering
730 East Michigan Ave.
Battle Creek, MI 49017

Channel Master
Ellenville, NY 12428

Comtech Antenna Corp.
3100 Communications Rd.
Box 428
St. Cloud, FL 32769

Conifer Corp.
1400 North Roosevelt
Burlington, IA 52601

Delta Satellite Corp.
One Echo Plaza
Cedarburg, WI 53012

Earth Terminals
One Microwave Plaza
Cincinnati, Ohio 45242-9502

General Instrument RF Systems
4229 South Fremont Ave.
Tucson, AZ 85714

Gensat/Microdesign Ltd.
1300 Bay St.
Toronto, Ont. M5R 3K8

Gillaspie
365 San Aleso Ave.
Sunnyvale, CA 94086

Gould/Dexcel Division
2580 Junction Ave.
San Jose, CA 95134

Industries PPD, Inc.
1649 sud, rue Belvedere
Sherbrooke, Que., Canada J1H 4E4

International Satellite Video Corp.
Box 5685
Orange, CA 92667

Intersat
1000 Lake Saint Louis Blvd.
Lake Saint Louis, MO 63367

Janeil Corp.
6860 Camby Ave. #113
Reseda, CA 91335

KLM Electronics Inc.
P.O. Box 816
Morgan Hill, CA 95037

Lindsay America
477 East Willow St.
Williamsport, PA 17701

Locator, Inc.
Box 3422
Kimberling City, MO 65686

Lowrance Electronics, Inc.
12000 East Skelly Dr.
Tulsa, OK 74128

LSI Technologies
340A West Trinity Lane
Nashville, TN 37207

Luly Telecommunications Corp.
Box 2311
San Bernardino, CA 92406

Luxor (North America) Corp.
600-108th Ave. N.E.
Suite 539
Bellevue, WA 98009-0032

M/A-COM ProdeIn, Inc.
Box 468
Newton, NC 28658

McCullough Satellite Equipment
Route 5, Box 97
Salem, AR 72576

Microdesign Ltd.
(Gensat) 951 Ainess St.
Downsview, Ont. M3J 2J1

Micro-Link Systems, Inc.
6101 Webster St.
Dayton, OH 45414

Microwave Applications Group
3030 Industrial Parkway
Santa Maria, CA 93455

Miralite
4050 Chandler
Santa Ana, CA 92704

National Microtech, Inc.
Drawer E
Grenada, MS 38901

National Micro-Dynamics, Inc.
6153 Airways Blvd.
Chattanooga, TN 37421

Newton Electronics Inc.
340 East Middlefield Rd.
Mountain View, CA 94043

Odom Antennas, Inc.
1st State Bank Bldg. 202
PO Box 1017
Beebe, AR 72012

Paradigm Manufacturing, Inc.
3711 Meadowview Drive
Redding, CA 96002

Pico Satellite, Inc.
415 Gator Drive
Lantana, FL 33462

Quadralite, Inc.
114 West Corsicana
Athens, TX 75751

Quantum Associates
Box 18
Alpine, WY 83128

Radio Semiconductor, Inc. (Locom)
315 Brenner Pike
State College, PA 16801

Regency Satellite Systems
7707 Records St.
Indianapolis, IN 46226

R.L. Drake Co.
540 Richard St.
Miamisburg, Ohio 45342

Sat-Tec Sales, Inc.
2575 Baird Rd.
Penfield, NY 14526

Symtei, The Barnhart Corp.
6135 2nd St., NW
Albuquerque, NM 87107

Syntronic Instruments, Inc.
100 Industrial Road
Addison, IL 60101

United Satellite Systems(USS/Maspro)
Highway One West
Thief River Falls, MN 56701

Vista Electronics
1101 West Elm St.
Cabot, AR 72023

Wilson Microwave Systems, Inc.
4286 South Polaris Ave.
Las Vegas, NV 89103

Winegard Satellite Systems
3000 Kirkwood St.
Burlington, IA 52601

The Heathkit Catalog & American Technology... Inseparable!

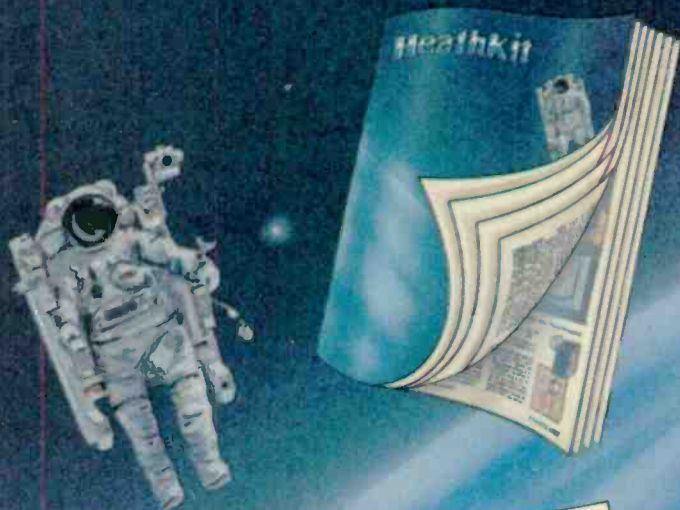

Ever since radio grew into electronics, the illustrated Heathkit Catalog has been a guide to new and exciting electronic kit products for people like you to build. Enjoy. Learn from. And save money.

The Heathkit Catalog is now even better. The ALL NEW full-color catalog features more than 450 different products in electronics, computers and other state-of-art technology. Page after page is devoted to new and exciting products for your home, hobby and business.

If you don't have the latest Heathkit Catalog, you're missing something great! Now's your chance to get involved in American Technology first hand. Your free ALL NEW Heathkit Catalog is waiting for you.

Fill out and return the attached Catalog request card today! Or use reader service number below.

CIRCLE 15 ON FREE INFORMATION CARD

Discover the Challenge



Great innovations in electronics are at your fingertips in each quarterly issue of the Heathkit Catalog. From computers to test instruments to the latest in personal robotics. Act now and send this card for the ALL NEW Heathkit Catalog.

CATALOG OFFER
Heath Company
Dept. 020-229
Benton Harbor, MI 49022

Yes I want to see the latest in electronics from Heathkit. Please send my free copy of the ALL NEW Heathkit Catalog to:

Name _____

Address _____

City _____

State _____ Zip _____
PC-148

Discover the Pride



With Heathkit, you'll discover the pride of accomplishment only a hand-built quality product can provide. From Stereos and TVs to Ham Gear and the latest in education. Act now and send this card for the ALL NEW Heathkit Catalog.

CATALOG OFFER
Heath Company
Dept. 020-229
Benton Harbor, MI 49022

Yes I want to see the latest in electronics from Heathkit. Please send my free copy of the ALL NEW Heathkit Catalog to:

Name _____

Address _____

City _____

State _____ Zip _____
PC-148

Post Office
will not
deliver mail
without stamp.

CATALOG OFFER

Heath Company
Dept. 020-229
Benton Harbor, MI 49022

Post Office
will not
deliver mail
without stamp.

CATALOG OFFER

Heath Company
Dept. 020-229
Benton Harbor, MI 49022

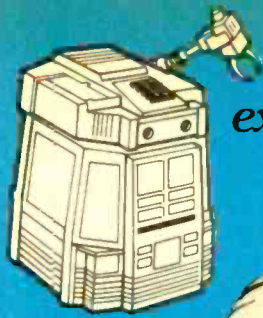

Kitbuilding is an exciting hobby and unique learning experience for the whole family.

Be a part of today's exciting world of high technology.



The best in electronics is hand-built by you.

Building advanced computers and electronic products from kits is a great hands-on way to develop skills and ability in many technologies. Easy step-by-step directions take you through the building process. And we back our products and you with the simple promise: "We won't let you fail." Heathkit builders create more than fine products. They build pride.

OVER 450 KITS TO BUILD

- Computer hardware and software
- Robots
- Self-study courses in electronics
- Precision test instruments
- Computerized weather instruments
- Solar hot water systems
- Automotive and home energy products
- Security devices
- Color TVs and video accessories
- Quality Stereo components
- Amateur radio gear

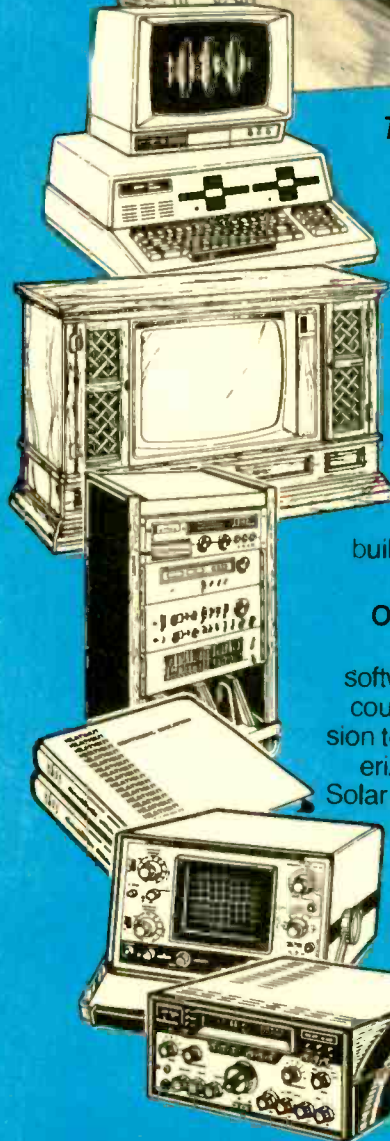

PC-148

Start by ordering your **FREE** Heathkit Catalog today. Or use Reader Service Number
CIRCLE 15 ON FREE INFORMATION CARD.



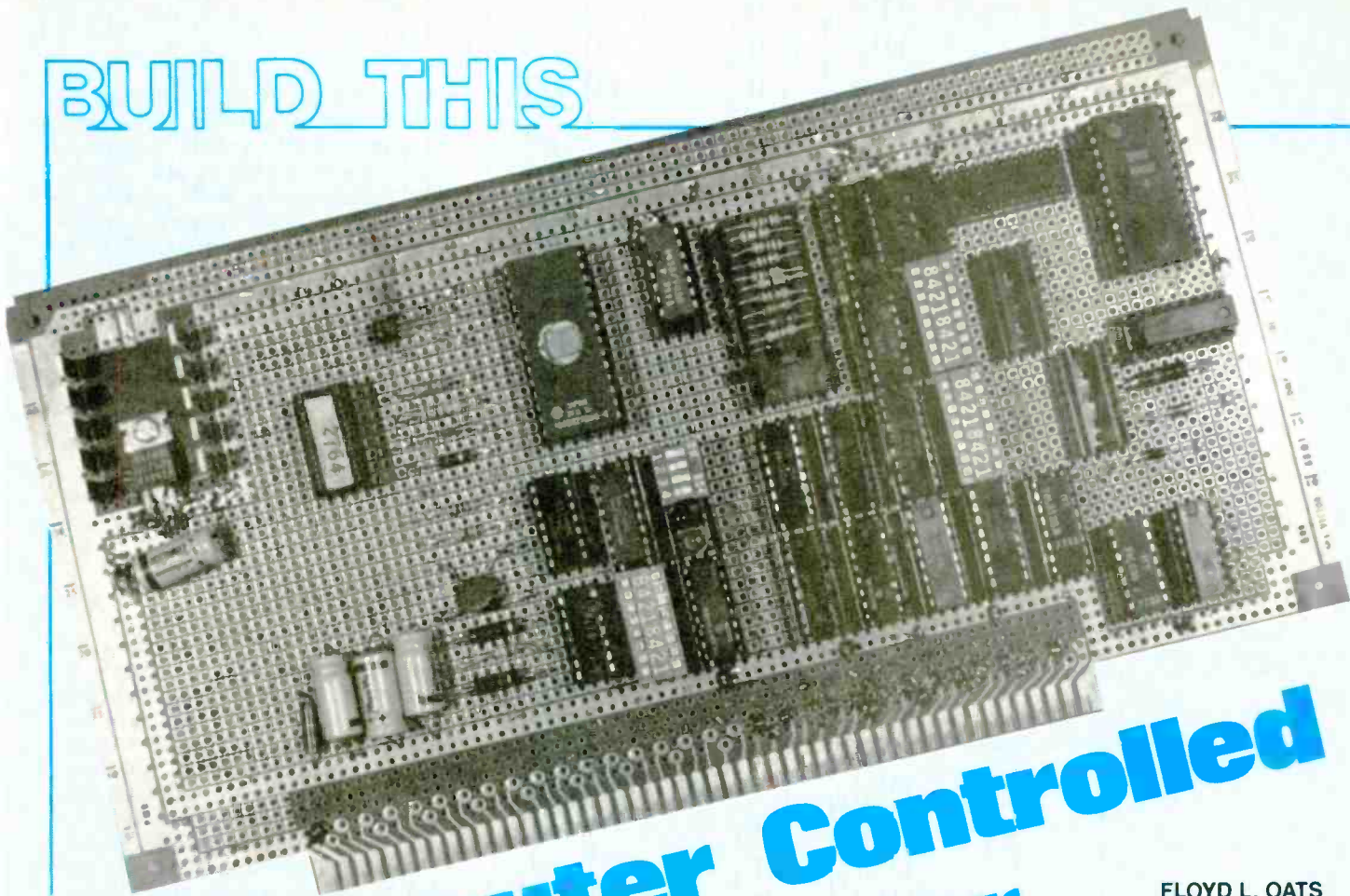

Computer Controlled IC Tester

FLOYD L. OATS

This month we'll test the IC tester and then we'll look at some options that you can add.

Part 2 LAST MONTH, WE DESCRIBED the IC-tester circuit and the theory behind how it works. Now it's time to make sure that it *does* work. After we do that, we'll look at some options that you can add to your tester. For example, we'll build a low-budget logic analyzer—it works by expanding your oscilloscope display to 16 traces.

Testing the tester

Most of the components and wiring are located in the data paths so the inherent self-diagnostic feature of the tester can be utilized as a debugging aid for the finished project. After the device is built and connected to the host computer, preliminary testing can begin.

For the purpose of discussion, we will assume that the device has been mapped into memory addresses CF00H through CFFFH (as it is shown in the schematic). **Note:** An "H" indicates that a number is written in hexadecimal form.

Open all the isolation switches (S1-S16) and make sure that the test socket is empty and that there are no power-supply jumpers between SO3 and SO2. Read the sixteen response bits by performing memory reads on addresses CF00H and CF01H. Both of those addresses should return FFH, indicating that the response is equal to sixteen "1" bits. Next, close all the isolation switches and write sixteen zeros in the stimulus latches by writing 00 into address CF00H. Read the response as before and look for sixteen zero bits. Now write all ones in the stimulus latches by writing FFH into memory address CFFFH and check for a response of all ones, as before. At this point, the tester is in a configuration where all stimulus information should be exactly duplicated on the response lines.

The next test will require a short program to send counting stimuli to the tester. After each stimulus is sent to the latches, the response is accepted and compared with the stimulus for equality. If

single-bit failures are observed during the test, the components and wiring associated with that particular bit should be checked carefully. If the bit patterns don't change or if they don't even resemble the correct patterns, the control circuitry might be at fault. Any discrepancies noted up to this point must be repaired before proceeding with further tests.

The final series of tests will verify the wiring of the isolation switches. Starting with all switches closed, open one switch and send a stimulus of all zeros. The response should be all zeros except for a single "1" bit, which should correspond to the open switch. Now close the switch just tested and open the next switch, then perform a similar stimulus/response test on this switch. Continue in this fashion until all sixteen switches have been tested. The final test is started with all switches open and is similar to the previous test in that one switch at a time is tested. This time the switches will be closed one at a time. Send test patterns of all zeros and

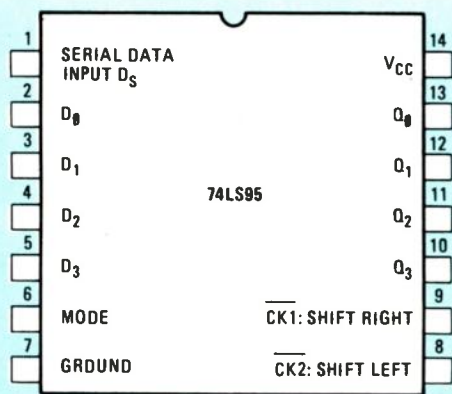

OPERATION	INPUTS					OUTPUTS			
	MODE	CK1	CK2	D _s	D _n	Q ₀	Q ₁	Q ₂	Q ₃
PARALLEL LOAD	H	X	↓	X	I	L	L	L	L
	H	X	↓	X	H	H	H	H	H
SHIFT RIGHT	L	↓	X	I	X	L	q0	q1	q2
	L	↓	X	H	X	H	q0	q1	q2
MODE CHANGE	↑	L	X	X	X	NO CHANGE			
	↑	H	X	X	X	UNDETERMINED			
	↓	X	L	X	X	NO CHANGE			
	↓	X	H	X	X	UNDETERMINED			

I: LOW VOLTAGE ONE SETUP TIME PRIOR TO HIGH-TO-LOW CLOCK TRANSITION
 LOWER CASE LETTERS REPRESENT STATE OF REFERENCED OUTPUT ONE SETUP TIME PRIOR TO HIGH-TO-LOW CLOCK TRANSITION
 †: LOW-TO-HIGH TRANSITION
 ‡: HIGH-TO-LOW TRANSITION

FIG. 5—THE 74LS95. Before you test any IC, you have to prepare a function table. That's not only because you have to determine a valid and complete set of stimuli, but you also have to determine what kind of response you should expect.

look for a response of all ones except for the single closed switch.

Using the tester

In order to test an IC, the isolation switches and the power-supply jumpers must be configured for the specific circuit to be tested. The switches assigned to input pins of the test circuit must be closed and those assigned to output pins and power supply pins must be open. The actual test is done by comparing the set of test responses with a set of known good responses.

The best way to obtain a set of good responses is to issue stimuli to an IC (of the type you want to test) that you know to be good. You can save the responses for future comparison. Actually you should save both stimuli and responses since the patterns issued during the test must exactly match those used to create the initial patterns. A less attractive way of obtaining good response data is to issue patterns to a circuit thought to be good and then manually examine the response data to see if it is correct.

Let's consider the steps involved in testing the SN74LS95, a four-bit shift register with parallel-load capability. Figure 5 shows the pinout for that 14-pin IC along with a table that describes the circuit's functions. The MODE input (pin 6) deter-

mines the mode in which the circuit is operating (parallel load or shift), and also determines which of the two clocks is permitted to change the register contents. The function table reveals that there are edge transitions in the mode-change area that will cause indeterminate results. Those transitions should be avoided during the testing process because they represent invalid stimuli.

Fourteen-pin IC's should be mounted in the 16-pin socket such that pins 8 and 9 of the 16-pin socket are empty. (Consequently, pin 14 of the IC is connected to pin 16 of the test socket and to S16.) Figure 6 shows that and also indicates the required position of each isolation switch for that particular IC. The +5-volt power-supply jumper must be connected from SO3 pin 14 to SO2 pin 16. The ground jumper goes from SO3 pin 7 to SO2 pin 7. Set up the switches and power-supply jumpers, insert the IC into the test socket, and testing can begin.

The 74LS95 has multiple edge-sensitive inputs. As we mentioned previously, counting through the inputs does not generate suitable (complete and valid) stimuli for that IC. We shall use what amounts to a smaller and somewhat simpler set of test patterns as shown in Table 1.

Table 1 indicates that several patterns

are issued to the 74LS95 before each response is read. For example, consider line 12 of the table. A stimulus of 0228H is sent, bringing $\overline{CK2}$, MODE, and D_s high. That is followed by 0068H on line 13, which brings $\overline{CK2}$ low. A response is then accepted; it and should equal 9028H on line 14.

How does the host know when to accept a response? The software driver can take advantage of the fact that the isolation switches for the two power-supply pins are known to be open and that, consequently, those two pins are not sensitive to stimuli. Bits 7 and 16 can be used to imbed control-flag bits into the test data. Those can be used to tell the host whether to generate a stimulus, expect a response, call a subroutine, etc.

For example, when the ground line (bit 7) is made high, as on line 16, it indicates (to the author's test software) that a response is to be taken after the pattern is sent. When the +5-volt line is made high as on line 18, the software driver will call a subroutine to clear the 74LS95 before sending the test pattern on line 18. Notice that line 15 brings bits 16 and 7 of the test circuit low. The software driver writes that pattern and then proceeds to the next pattern on line 16. The pattern on line 16 has bit seven high (ground pin), causing the driver to accept a response (line 17) after sending the 0070H pattern. When both supply lines are high as on line thirty, it signifies "end of test." That use of power supply pins is one way, but not the only way, of simplify the passage of control parameters to the software.

Because the SN74LS95 does not have a separate CLEAR pin, the clear subroutine (Table 1, lines 1-4) must use the parallel-load capability of the circuit to load all zeros into the internal register. The response should be tested after the clear subroutine since a failure here will cause subsequent failures in the main body of the test. It is good general practice to flag the earliest possible failure in a series of tests, especially if the software is going to perform a complete and exhaustive failure analysis.

Options

If you build the tester on a prototyping board designed for your host system, you will almost certainly find that there is plenty of space left on the board for possible expansion. For example, an 18-pin socket may be added for the purpose of testing specific 18-pin circuits such as the popular 2114 RAM series. (The power supply pins would be permanently wired to the power-supply lines, while the other sixteen pins would be wired parallel to the sixteen test socket pins.) Pin correspondence between the test socket and the 18-pin socket can be assigned in any convenient order.

The addition of a PROM or EPROM



FIG. 6—SWITCH SETUP for testing the 7495 4-bit shift register.

programmer is practical because there are already sixteen latches on the board. If you add another SN74LS75, you'll have enough latches for the data and address lines of a 4K PROM. A square- or rectangular-wave generator may be added by selecting a bit and placing it under software control. Parameters describing the desired wave could be passed to software which would then compute the loop variables required to create the wave on the chosen bit line. Squarewave monitoring could be done by bringing the external wave into a bit line and letting the software sample the line. Those are just a few of the many ways to expand the IC tester.

Oscilloscope adapter

The logic analyzer is a very useful tool. But because it's also rather expensive, most hobbyists do not have access to one. However, we'll offer an alternative to the logic analyzer: an adapter for your oscilloscope that allows it to display 16 sig-

nals. Of course, its linearity and general quality of presentation won't match that of the logic analyzer. And it won't imitate the varied and complex functions of a logic analyzer. But it *can* be built from inexpensive, common logic-components. So for a very small expense, you can add a valuable tool for testing digital IC's to your testbench. Perhaps more important, the oscilloscope-adapter logic analyzer can be an excellent tutorial aid.

The author's display-adapter prototype was developed as an expansion of the digital IC tester that was presented last month, and it uses TTL IC's. However, the oscilloscope adapter can be built as a stand-alone unit, and the ideas can be applied to other logic families as well as TTL.

A look at the circuit

The oscilloscope adapter's circuit (its schematic is shown in Fig. 7) uses a counter/multiplexer/converter scheme to time-share sixteen digital signals onto a single

oscilloscope channel.

The display counter, IC12 (a 74LS191 synchronous up/down counter), selects one of the sixteen channels for display. As it counts, each channel is selected in proper sequence—channel 1 is displayed on top, and channel 16 on the bottom.

A 74150 1-of-16 data selector/multiplexer, IC11 accepts the sixteen digital inputs from the tester. It selects one of them to pass to its output (pin 10). The selected input depends on the contents of the display counter.

The inverting buffer/drivers, IC13, along with its associated resistors, form a 5-bit 32-state digital-to-analog (D/A) converter. It combines the four display-counter bits and the single, selected channel bit into one of thirty-two discrete voltage steps—two voltage levels for each displayed channel. The output signal to the oscilloscope swings through more than four volts of the available 5-volt power-supply range.

TABLE 1

BIT VALUES

	SIGNAL TYPE	HEX VALUE	BIT VALUES				ACTION
			16..13	12..9	8..5	4..1	
CLEAR	01 Stimulus	0220	0000	0010	0010	0000	- Bring CK2 and MODE high
	02 Stimulus	0020	0000	0000	0010	0000	- Drop CK2 (load zeros)
	03 Stimulus	0040	0000	0000	0100	0000	- Drop MODE, then test
	04 Response	8000	1000	0000	0000	0000	- All pins low except V _{cc}
PARALLEL LOAD TEST	05 Stimulus	8020	1000	0000	0010	0000	- Clear, then bring MODE high
	06 Stimulus	0222	0000	0010	0010	0010	- Bring CK2, MODE, D ₀ high
	07 Stimulus	0062	0000	0000	0110	0010	- Drop CK2, then test
	08 Response	C022	1100	0000	0010	0010	- V _{cc} , Q ₀ , MODE, D ₀ high
	09 Stimulus	0224	0000	0010	0010	0100	- Bring CK2, MODE, D ₁ high
	10 Stimulus	0064	0000	0000	0110	0100	- Drop CK2, then test
	11 Response	A024	1010	0000	0010	0100	- V _{cc} , Q ₁ , MODE, D ₁ high
	12 Stimulus	0228	0000	0010	0010	1000	- Bring CK2, MODE, D ₂ high
	13 Stimulus	0068	0000	0000	0110	1000	- Drop CK2, then test
	14 Response	9028	1001	0000	0010	1000	- V _{cc} , Q ₂ , MODE, D ₂ high
	15 Stimulus	0230	0000	0010	0011	0000	- Bring CK2, MODE, D ₃ high
	16 Stimulus	0070	0000	0000	0111	0000	- Drop CK2, then test
	17 Response	8830	1000	1000	0011	0000	- V _{cc} , Q ₃ , MODE, D ₃ high
SHIFT TEST	18 Stimulus	8401	1000	0100	0000	0001	- Clear, then bring CK1, D _S high
	19 Stimulus	0041	0000	0000	0100	0001	- Drop CK1, then test
	20 Response	C001	1100	0000	0000	0001	- V _{cc} , Q ₀ , D _S high
	21 Stimulus	0400	0000	0100	0000	0000	- Bring CK1 high D _S low
	22 Stimulus	0040	0000	0000	0100	0000	- Drop CK1, then test
	23 Response	A000	1010	0000	0000	0000	- V _{cc} , Q ₁ high
	24 Stimulus	0401	0000	0100	0000	0001	- Bring CK1, D _S high
	25 Stimulus	0041	0000	0000	0100	0001	- Drop CK1, then test
	26 Response	D001	1101	0000	0000	0001	- V _{cc} , Q ₀ , Q ₂ , D _S high
	27 Stimulus	0400	0000	0100	0000	0000	- CK1 high and D _S low
	28 Stimulus	0040	0000	0000	0100	0000	- Drop CK1, then test
	29 Response	A800	1010	1000	0000	0000	- V _{cc} , Q ₁ , Q ₃ high
	30 Stimulus	8040	1000	0000	0100	0000	- END OF TEST

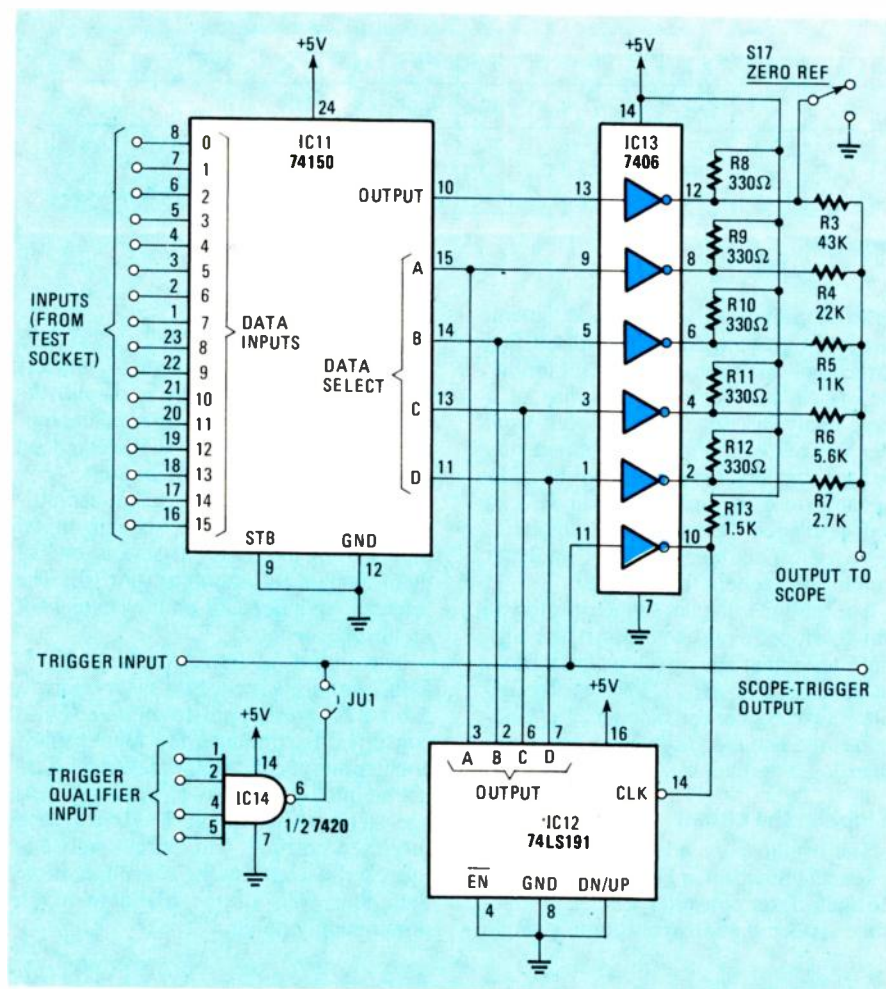

FIG. 7—OSCILLOSCOPE ADAPTER SCHEMATIC. IC12 selects which of IC11's inputs gets sent to the output buffer. The resistor network at the output of the buffer establishes 32 discrete voltage steps—two for each channel. IC14 is a trigger qualifier; it's optional, but suggested. Jumper JU1 is used to take the qualifier in and out of the circuit.

A trigger must be supplied by the logic system or device being observed. The trigger is needed both to act as a clock for the display counter and to initiate a horizontal oscilloscope sweep. The trigger signal is applied to pin 11 of IC13; sixteen of those trigger pulses are required to generate a complete 16-trace image on the scope. In complex digital systems, a single signal that can act as a suitable trigger is not always available—you may need an optional trigger qualifier so that you can create an acceptable trigger. A qualifier gate, such as what is shown for IC14, can be used. We recommend that you add such a qualifier gate along with a provision to enable it simply by the insertion of a jumper.

Switch S17 is an optional zero-reference switch. It is used to place a low logic-level on the least-significant input leg of the converter. When the switch is closed, the scope will display the 16 base lines. By momentarily closing the switch, you can quickly identify a steady-state channel as steady high or steady low. The switch is also useful in linearity tests.

Construction

You probably have enough room left on

your original IC tester board to build the display adapter. Since the wiring or component layout is not critical, practically any construction technique may be used with good results.

There are many possible component substitutions that can be made in the TTL design. For example, the counter does not have to be a 74LS191: It can be another kind of synchronous counter like the 74LS163 or the 74LS193. Or it may be a standard (as opposed to low-power Schottky) TTL counter like the 74191. If substitutions are made, be sure to check the pinout of the new IC and document the changes where necessary. The use of ripple counters such as the 7493 is not recommended in this circuit—they tend to introduce excessive channel-switching transients. The 7406 may be substituted by other open-collector hex inverters including the 7416, and the 7405.

One final construction note: Assuming that you are building the circuit as an expansion of the IC tester, each display channel should be connected to its corresponding pin on the test socket. In other words, channel 1 should display the signal on pin 1 of test socket SO1 and so on. That makes using the analyzer easier.

Using the display adapter

For illustration purposes, let's set up the IC tester so that we can examine the waveshapes associated with the 74LS138 one-of-eight decoder. Table 2 lists the proper stimulus patterns. The trigger should be jumpered from the stimulus latch side of the isolation switch for pin 8 to pin 11 of IC13 in Fig. 7, and the scope should be set to trigger from the positive edge of an external signal. Isolation switches S1–S6 should be closed, and switches S7–S16 should be open.

Notice that the first two stimulus patterns will send a clock pulse to the display counter and trigger the oscilloscope, respectively. As shown in Fig. 8, the counter counts on the leading edge of the trigger pulse and the display begins on the trailing edge. That eliminates the channel-switching lines and lets us see a clean display.

Program your host computer to generate the looping stimulus patterns in Table 2 and run the test on a 74LS138. Connect the oscilloscope test leads to the adapter and, with the test running, we are ready to observe digital waveforms.

Set the vertical-sensitivity control to 1

TABLE 2

STIMULUS (HEX)	COMMENT
0020	Trigger low, count counter
00A0	Trigger high, trigger scope
00A1	
00A2	
00A3	Test patterns
00A4	
00A5	
00A6	
00A7	

Loop back to first stimulus

volt/division and set the timebase to the fastest sweep. The exact sweep speed required for observation will depend on the speed at which the host system emits stimuli. Decrease the sweep speed and carefully observe the counting stimuli on channels one, two, and three, to determine when the proper speed is found. (It will probably be necessary to decalibrate the timebase to display the entire interval between triggers.) If the display shows four or eight traces with connecting steps, then the sweep is too slow but is close to the correct speed. If the display resembles multiple downward staircase waveforms, then the sweep is far too slow. Once the timebase is adjusted, the vertical sensitivity can be adjusted (and decalibrated) so that the sixteen channels cover the entire face of the scope, giving maximum channel separation. The display should resemble that shown in Fig. 9.

(continued on page 111)

AN INNOVATIVE 20 MHz OSCILLOSCOPE THAT EMPHASIZES OPERABILITY

\$535*

The SS-5702 has flexibility and power which make it ideal for the maintenance and troubleshooting of TVs, VTRs, audio equipment and a wide range of other electronic systems by hobbyist as well as professionals. At the top of its class, the SS-5702 uses a 6-inch rectangular, parallax-free CRT.

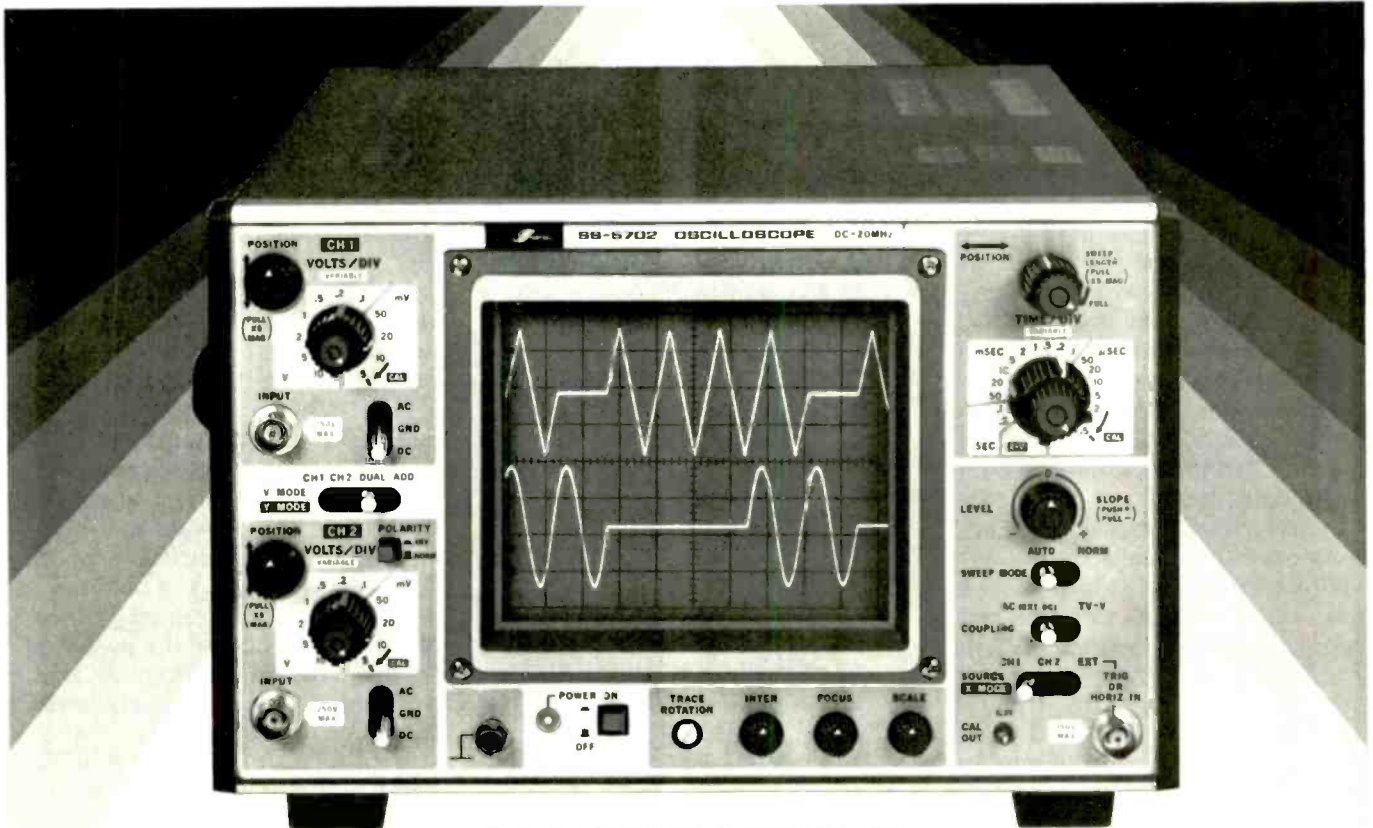

IWATSU SS-5702 DC~20 MHz OSCILLOSCOPE

IWATSU makes more than 20 oscilloscopes as well as an impressive lineup of other instruments including logic analyzers and digital memory scopes. The fastest oscilloscope has a maximum frequency of 350 MHz. And the same technological expertise and product quality that make this super high-frequency oscilloscope possible are incorporated in the SS-5702.

- 6-inch rectangular, parallax-free CRT
- TV-V trigger
- Variable sweep length
- Double Lissajous figure
- 1 mV/div to 10 V/div sensitivity
- 100 ns/div to 0.2 s/div sweep
- Differential input with ADD mode
- DC operation (optional)

* User price, including probes.



IWATSU INSTRUMENTS INC.
420 COMMERCE BOULEVARD, CARLSTADT, NJ 07072 PHONE: (201) 935-5220, TWX: 710-989-0255

■ In Canada: ATELCO, 3400 Pharmacy Avenue, Unit 1, Scarborough, Ontario, M1W 3J8, Phone (416) 497-2208, TWX 610-492-0122

CIRCLE 51 ON FREE INFORMATION CARD

HOBBY CORNER



EARL "DOC" SAVAGE, K4SDS,
HOBBY EDITOR

Why discuss computers?

WE RECEIVE MANY LETTERS FROM OUR readers and every one is appreciated. However, I find it particularly interesting that one sentiment appears about every twentieth letter. After the subject of concern has been covered, there is an added paragraph that states in one manner or another, "forget about computers." In fact, no other topic has been so enthusiastically rejected by so many of you.

I am at a loss to explain the phenomenon. I can't help but wonder where we would be today if we had said, "let's stick to tubes and forget transistors" or later, "stick to transistors and forget integrated circuits."

I must confess that I find computers extremely interesting. In fact, I have seven various makes and models, and each one has proved its worth in appropriate applications. Not only do their innards consist of fascinating electronics, but they are really terrific tools for doing wide variety of tasks. No one, however, intends "Hobby Corner" to become exclusively computer oriented.

What we are trying to say is that the subjects covered here should be balanced. The readers who ask how to get started in computers deserve the same consideration as those who ask how to get started in learning about transistors, or IC's, or electronics in general. So, even if you hate computers, read on—you might pick up an idea. Those of you who have asked how to get started in computer electronics may find the following reply helpful.

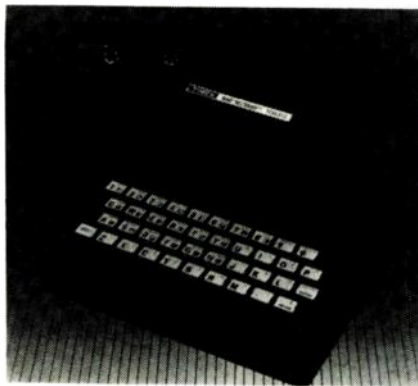

FIG. 1

Mike Stanridge (GA) needs help in designing and building a computer—specifically the video and CPU sections. Well, Mike, that is a tall order.

First, you need a good understanding of digital electronics principles and technology. Reading between the lines of your letter, I gather that your background in that area could stand a little beefing up. I can suggest nothing better than studying some of the books that have been mentioned in past issues of "Hobby Corner," and building and experimenting with the IC circuits that have appeared over the last several years.

I do know, however, that when a fellow wants to work in computer circuits, he doesn't want to wait six months or a year to do so. Therefore, here is a second suggestion for you (and the others reading along).

Get yourself a cheap computer. Perhaps a Radio Shack MC-10 or a Commodore VIC-20. The Timex/

Sinclair 1000 (shown in Fig. 1) has to be the cheapest one around—if you can find it. It uses the popular Z80 microprocessor.

I noticed a new Timex/Sinclair 1000 in a store the other day that was selling for less than \$30. And recently, a friend shelled out \$10 at a yard sale for a 1000 with a 16K expansion memory and a stack of program tapes. It had a small glitch in one section of the keyboard, but at that price, what the heck!

The Timex/Sinclair 1000 is not "a production" machine, but it is a computer of considerable power and, as such, can do amazing things. However, to do more than a minimal amount of useful work (word processing, for example), you would have to spend plenty on additional memory and other peripherals. Therefore, in that case you would be better off getting a larger machine.

I refer to computers such as those above as "learning machines." Electronics hobbyists can get in there to study and dig with no worry of blowing up an expensive machine. With a small investment, budding operators can learn to program and use a computer without losing their shirts if they decide not to continue.

Mike, I suggest that you get a learning machine, an appropriate data book or data sheets on the IC's inside, a schematic or technical manual (if one is available) and a logic probe. You will be surprised at how much you can learn. When you understand how the Timex/Sinclair (or other) machine works, you will be well on your

way in preparation for designing your own.

Where can you find one of those little computers? My guess is that there are a great many of them gathering dust on closet shelves because their owners have graduated to larger machines. So ask around, visit local computer groups, advertise in the local paper and you're sure to find one. They're out there—all you have to do is some detective work.

Good luck to you, Mike, and to others who want to get started in the computer field.

April Fool!

No, it is not April and this is not an April Fool's joke. Instead, it is an early warning about next April. I had intended to wait until March to discuss this topic, but a letter from one reader (who shall remain nameless for obvious reasons) has prompted this discussion now.

Apparently, our friend obtained an old April issue of a magazine—not *Radio-Electronics*—that featured some ridiculous device. The

gist of his letter was that he did not see how such-and-such device could possibly work, but he was interested and did want to build it. His request was for a detailed parts list, schematic, and so on.

Each year many periodicals celebrate the first of April by printing rather farcical articles. Even *Radio-Electronics* tries to provide its readers with a "laugh" in the April issue. Some years ago there was one that regularly went to great lengths, even to the point of presenting a seemingly realistic, detailed construction article. Needless to say, several readers were caught each year.

Of course, discoveries are made daily. And there are now devices that will do things believed impossible a short time ago. However, if you read about something that seems incredible—such as a 100-watt amplifier that's powered by the juice of a lemon, or a dead 6L6 tube mounted on the hood of a car to kill all radar in a five mile radius—check the date on the magazine. It just may be April! R-E

LEARN COMPUTER REPAIR



Train at home in spare time... No previous experience needed

Sales of small computers are running over a billion dollars a year. That's why a whole new business is starting up—devoted entirely to small computer repair. And right now is the time to get in on the ground floor—either working for someone else or in your own computer repair business.

Start making money in electronics

No need to quit your job, change your daily routine or take time from family responsibilities. And you don't waste time going to and from class because you train at home in spare time. The ICS Microcomputer Repair Course is designed for beginners—people with no previous experience who want to get started fast. And you should be ready for an entry-level job repairing small computers even before you finish this course.



You receive microprocessor trainer, digital V.O.M. and much more included with course.

Experts show you what to do... how to do it!

We start you fast with the basics, and everything is explained in easy-to-understand language complete with plenty of diagrams and drawings.

GET INTO SMALL COMPUTER REPAIR

SEND FOR FREE FACTS!

ICS School of Computer Repair, Dept. DE094
(SINCE 1971) Scranton, Pennsylvania 18515

Send free facts and color brochure telling how I can get into computer repair at home in my spare time. No obligation. No salesman will call.

Name _____ Age _____
 Address _____
 City/State/Zip _____

NEW!

From **W.S. JENKS & SON**

Weller® WTCPR \$77.50

Safe for IC soldering. Closed loop, low-voltage circuit automatically controls output. 700 F 1/16" screwdriver tip provided. 600 F and 800 F tips available. Power unit has non-heat sinking iron holder, storage tray for extra tips and tip cleaning sponge with receptacle. Send for free W.S. Jenks & Son electronics tool catalog for complete accessories.

SEND NOW!

FREE CATALOG!
 Over 100 pages. Wide selection of tool sets, test equipment, soldering and desoldering equipment, telecommunications and specialized electronics assembly tools.

W.S. JENKS & SON

2024 West Virginia Ave. NE
 Washington, D.C. 20002
 TOLL-FREE ORDER LINE: 1-800-638-6405

Please send the indicated material:
 Weller WTCPR Soldering Station @ \$77.50
 FREE W.S. Jenks & Son B4 Catalog
 Check/Money Order
 MasterCard Visa Am. Exp.

Card No. _____ Exp. _____
 Signature _____
 Name _____
 Address _____
 City _____ State _____ Zip _____
 VA residents add 4% tax; DC residents add 6% tax.

Announcing DMM confidence

Our figures are in. **The HP 3468A DMM reliability numbers indicate over 50,000 hours MTBF (Mean-Time-Between-Failure).** Order now (\$750*) and have one in your hands in just two weeks—that's fast delivery for this 5½ digit DMM that measures dc and ac voltage and current, and two- or four-wire resistance with basic 0.007% accuracy. And, when needed, electronic calibration (no pots to adjust) is easy. You can even order a battery pack (\$125*) for full portability.

Order this outstanding bench DMM today and we'll also send you information on how to integrate it into your own low-cost measurement system. Call your local HP sales office listed in the telephone directory white pages. Ask for the electronic instruments department.

*U.S.A. price only.

HEWLETT PACKARD

Professional Books That Help You Get Ahead—And Stay Ahead!

Join the **Electronics and Control Engineers' Book Club**® and...

- Keep up with current technology
- Sharpen your professional skills
- Be ready for new career opportunities
- Boost your earning power

THE MCGRAW-HILL COMPUTER HANDBOOK: Applications, Concepts, Hardware, Software. Edited by H. Helms. 992 pp., 475 illus. Everything you need to know about today's computer science and engineering is here in this massive treasure trove of information. Covers everything from Boolean algebra to hardware selection techniques to artificial intelligence. A handy reference work that brings you right up to the minute!
279/721 Pub. Pr., \$79.50 Club Pr., \$49.95

INTUITIVE IC ELECTRONICS: A Sophisticated Primer for Engineers and Technicians. By T. M. Frederiksen. 208 pp., illus. Covering both the simplest and the most complicated IC designs, this lively, easy-to-read volume provides a sophisticated, nonmathematical explanation of the basic internal mechanisms common to all semiconductor devices.
219/230 Pub. Pr., \$24.95 Club Pr., \$18.95

ANTENNA ENGINEERING HANDBOOK, 2/e. Edited by R. C. Johnson and H. Jasik, with contributions by 57 recognized authorities. 1,408 pp., 946 illus. This widely acclaimed Handbook gives you the guidance you need to solve problems in antenna design and application. It provides detailed information on physical fundamentals, patterns, structures, and design techniques for practical modern antennas.
322/910 Pub. Pr., \$95.00 Club Pr., \$62.50

RADIO HANDBOOK, 22/e. By W. Orr. 1,136 pp., more than 1,300 illus. Here's the latest edition of what is universally regarded as the most useful reference in the industry. It's a "course" in communications, a fact-packed reference, and a how-to guide—all in a single book!
582442-6 Pub. Pr., \$39.95 Club Pr., \$33.95

MICROPROCESSOR APPLICATIONS HANDBOOK. Editor-in-Chief, D. F. Stout. 472 pp., 284 illus. At last—a reference guide to microprocessor applications to help you make your systems timely, versatile, and cost-effective.
617/988 Pub. Pr., \$39.95 Club Pr., \$31.45

MICROPROCESSOR AND MICRO-COMPUTER DATA DIGEST. By W. H. Buchsbaum and G. Weissenberg. 336 pp., 93 block diagrams, 106 pin configurations. If you work with electronic devices that use microprocessor or microcomputer integrated circuits, this much-needed book contains all the detailed technical data for every microprocessor IC that is currently listed as a "standard," off-the-shelf item.
582835-9 Pub. Pr., \$29.95 Club Pr., \$22.50

VLSI SYSTEM DESIGN: When and How to Design Very-Large-Scale Integrated Circuits. By S. Muroga. 496 pp., illus., includes self-test problems. This book provides a straight-forward explanation of how to design the integrated circuit chips that are causing this electronics revolution. It focuses on every significant aspect of LSI/VLSI system design.
582823-5 Pub. Pr., \$34.95 Club Pr., \$26.50



New members!
Any one of these great professional books for only **\$289** as a premium with your 1st selection!

INTEGRATED CIRCUITS APPLICATIONS HANDBOOK. By A. H. Seidman. 673 pp., illus. This Handbook presents information on everything from TTL, ECL, MOS, and CMOS logic families to semiconductor and bubble memories. The emphasis is on applications, with a minimum of theory. The math used is essentially limited to simple arithmetic and elementary algebra.
582860-X Pub. Pr., \$39.95 Club Pr., \$29.95

INTRODUCTION TO RADAR SYSTEMS, 2/e. By M. I. Skolnik. 698 pp., 244 illus. This new edition of a widely used text on radar from the systems engineer's point of view brings you full discussions of the many major changes that have occurred in the field recently.
579/091 Pub. Pr., \$40.95 Club Pr., \$31.00

CIRCUITS AND SOFTWARE FOR ELECTRONICS ENGINEERS. By H. Bierman. 352 pp., 200 illus., outsized 8½ x 11 format. This collection of over 340 proven—reliable circuits, computer programs, test methods, and design tools have been selected because of the ingenious ways they adapt devices to other uses.
052/433 Pub. Pr., \$35.00 Club Pr., \$27.95

HANDBOOK OF ELECTRIC POWER CALCULATIONS. Edited by A. Seidman, H. Mahrous and T. G. Hicks. 448 pp., 300 illus. Here are 285 tested and proven procedures for handling the electric power problems most frequently encountered in actual practice. You'll find ingenious, time-saving ways to calculate fuel costs, motor efficiency, and power output.
560/617 Pub. Pr., \$39.50 Club Pr., \$29.95

STANDARD HANDBOOK FOR ELECTRICAL ENGINEERS, 11/e. By D. G. Fink and H. Beaty. 2,448 pp., 1,414 illus. Today's most widely used source of electrical engineering information and data serves you as no other single work when you need detailed, timely, and reliable facts.
209/74X Pub. Pr., \$74.95 Club Pr., \$53.95

Spectacular values up to **\$95.00**

HANDBOOK OF PRACTICAL ELECTRICAL DESIGN. By J. F. McPartland. 416 pp., 300 illus. This volume provides a step-by-step explanation of designing electrical systems for industrial, commercial, and residential applications. Packed with helpful tips for saving time and complying with code requirements from branch circuits to wiring size.
456/95X Pub. Pr., \$39.50 Club Pr., \$27.50

DIGITAL LOGIC DESIGN. By B. Holdsworth. 338 pp., 192 illus. All of the recent advances in digital design techniques are presented here in depth. It's both a text covering basic concepts and a practical guide to design techniques for combinational, clock-driven, and event-driven circuits.
582852-9 Pub. Pr., \$39.95 Club Pr., \$27.50

ELECTRONIC COMMUNICATIONS SYSTEMS. By W. D. Stanley. 566 pp., illus. Emphasizing the signal-processing functions of modulation and demodulation operation, this book presents the essentials of electronic communications in a logical, step-by-step sequence.
582834-0 Pub. Pr., \$25.95 Club Pr., \$20.95

MODERN ELECTRONIC CIRCUITS REFERENCE MANUAL. By J. Markus. 1,264 pp., 3,666 circuit diagrams. Complete with values of components and suggestions for revisions—plus the original source of each circuit in case you want additional performance or construction details.
404/461 Pub. Pr., \$74.95 Club Pr., \$57.95

ELECTRONICS ENGINEERS' HANDBOOK, 2/e. Edited by D. G. Fink & D. Christiansen. 2,272 pp., 2,189 illus. This updated and enlarged edition covers all the latest knowledge in the field, including new advances in integrated circuits, pulsed and logic circuits, laser technology, telecommunications, and much more.
209/812 Pub. Pr., \$79.90 Club Pr., \$57.50

DIGITAL CIRCUITS AND MICRO-PROCESSORS. By H. Taub. 608 pp., heavily illus. This fast-paced, carefully written guide gives you thorough explanations of all the basic principles of digital systems and logic design—plus a solid introduction to microprocessors and microprocessor-based designs.
629/455 Pub. Pr., \$34.95 Club Pr., \$26.50

ELECTRONICS ENGINEERING FOR PROFESSIONAL ENGINEERS' EXAMINATIONS. By C. R. Hafer. 336 pp., more than 200 illus. Actually two books in one—a quick preparation manual to help you pass your P.E. exams on the first try and a rich source of practical electronics engineering information and know-how.

254/303 Pub. Pr., \$29.95 Club Pr., \$21.50

PRACTICAL DIGITAL DESIGN USING ICs, 2/e. By J. D. Greenfield. 717 pp., illus. This revised and expanded Second Edition of a popular guide shows how to get the most out of a wide range of popular integrated circuits. What's more, it contains the specialized know-how today's designer needs to interface ICs with microprocessors.

582853-7 Pub. Pr., \$25.95 Club Pr., \$19.95

OPTICAL FIBER SYSTEMS: Technology, Design, and Applications. By C. K. Kao. 197 pp., illus. From a basic explanation of optical fiber systems to the economic ramifications of their use, this volume provides full coverage of a rapidly changing field.

332/770 Pub. Pr., \$29.50 Club Pr., \$23.95

MCGRAW-HILL ENCYCLOPEDIA OF ELECTRONICS AND COMPUTERS. By S. P. Parker, Editor-in-Chief. 960 pp., 1,266 illus., outsized 8 1/2 x 11 format.

It's a single-volume library that covers the entire world of electronics from Edison's pioneering work in electricity right up to optical fiber communications, control systems, lasers, radar, TV receivers, artificial intelligence and computer storage technology.

454/876 Pub. Pr., \$59.50 Club Pr., \$41.50

DIGITAL CONTROL SYSTEM ANALYSIS AND DESIGN. By C. L. Phillips and H. T. Nagle, Jr., both Auburn University. 556 pp., 316 illus, 7 ready-to-run computer programs. It analyzes and designs closed-loop systems to which digital computers have been added to modify system dynamics. The book develops a wide range of control-system techniques applicable to linear, time-invariant, discrete-time system models.

582944-4 Pub. Pr., \$39.95 Club Pr., \$31.95

HANDBOOK OF MICROCOMPUTER-BASED INSTRUMENTATION AND CONTROLS. By J. D. Lenk. 307 pp., 227 illus. Digital or microcomputer-based instrumentation and control systems can be very complicated—or relatively simple—depending on the application. In this book both systems are described and illustrated—and many examples of actual systems now in use in industry are included throughout.

582866-9 Pub. Pr., \$22.95 Club Pr., \$18.95

COMPUTER METHODS FOR CIRCUIT ANALYSIS AND DESIGN. By J. Vlach and K. Singhal. 656 pp., 148 illus. Computational methods have become an integral part of circuit analysis and design. And a solid understanding of the basics of computer-aided design is a must for engineers who want to achieve their career objectives. This self-teaching book provides that know-how in a logical, easy-to-follow presentation.

582855-3 Pub. Pr., \$42.50 Club Pr., \$33.95

Be sure to consider these important titles as well!

LARGE SCALE INTEGRATION: Devices, Circuits, and Systems. By M. J. Howes & D. V. Morgan
582851-0 Pub. Pr., \$35.95 Club Pr., \$29.95

MICROWAVE SEMICONDUCTOR ENGINEERING. By J. F. White
582553-8 Pub. Pr., \$32.50 Club Pr., \$25.95

MICROPROCESSOR SUPPORT CHIPS: Theory, Design, and Applications. By T. J. Byers
095/183 Pub. Pr., \$39.50 Club Pr., \$31.00

ENGINEERING FORMULAS, 4/e. By K. Geck
232/199 Pub. Pr., \$16.95 Club Pr., \$13.50

ELECTRONICS CIRCUITS NOTEBOOK. Edited by S. Weber
192/448 Pub. Pr., \$35.50 Club Pr., \$27.50

ANALYSIS AND DESIGN OF DIGITAL INTEGRATED CIRCUITS. By D. A. Hodges and H. G. Jackson
291/535 Pub. Pr., \$31.00 Club Pr., \$23.95

HANDBOOK OF OPERATIONAL AMPLIFIER CIRCUIT DESIGN. By D. F. Stout & M. Kaufman
617/97X Pub. Pr., \$39.50 Club Pr., \$29.00

ENGINEERING MATHEMATICS HANDBOOK, 2/e. By J. J. Tuma
654/298 Pub. Pr., \$34.50 Club Pr., \$26.95

PCM & DIGITAL TRANSMISSION SYSTEMS. By F. F. Owen
479/542 Pub. Pr., \$34.95 Club Pr., \$25.95

SIGNALS AND SYSTEMS. By A. Oppenheim, A. Willsky, and I. Young
582674-7 Pub. Pr., \$32.50 Club Pr., \$25.95

DIGITAL COMMUNICATIONS. By J. Proakis
508/271 Pub. Pr., \$37.50 Club Pr., \$29.50

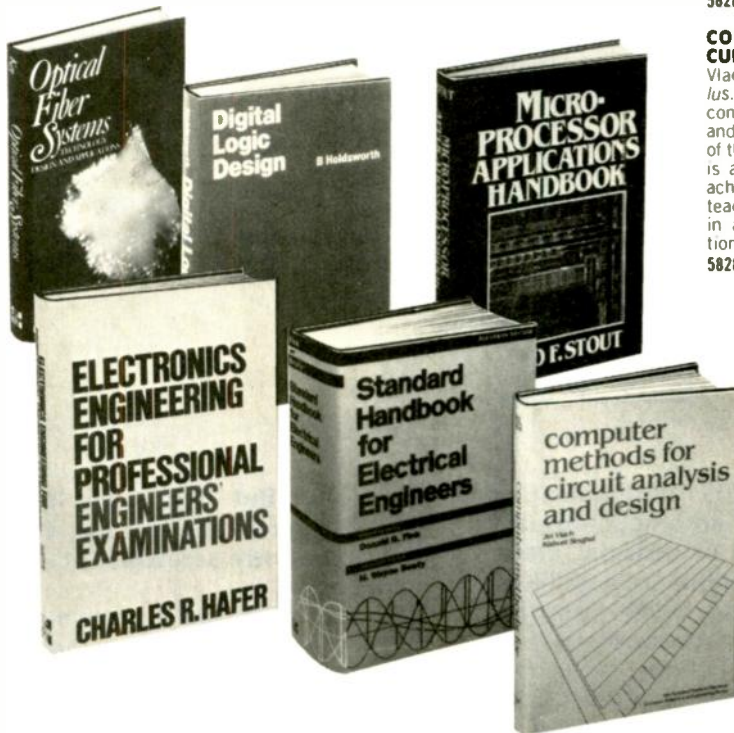

Why YOU should join now!

- **BEST AND NEWEST BOOKS IN YOUR FIELD** — Books are selected from a wide range of publishers by expert editors and consultants to give you continuing access to the best and latest books in your field.
- **BIG SAVINGS** — Build your library and save money too! Savings ranging up to 30% or more off publishers' list prices — usually 20% to 25%.

BONUS BOOKS—You will immediately begin to participate in our Bonus Book Plan that allows you savings up to 70% off the publishers' prices of many professional and general interest books!

■ **CONVENIENCE** — 12-14 times a year (about once every 3-4 weeks) you receive the Club Bulletin FREE. It fully describes the Main Selection and Alternate Selections. A dated Reply Card is included. If you want the Main Selection, you simply do nothing — it will be shipped automatically. If you want an Alternate Selection — or no book at all — you simply indicate it on the Reply Card and return it by the date specified. You will have at least 10 days to decide. If, because of late delivery of the Bulletin you receive a Main Selection you do not want, you may return it for credit at the Club's expense.

As a Club member you agree only to the purchase of three books (including your first selection) during your first year of membership. Membership may be discontinued by either you or the Club at any time after you have purchased the first selection plus two additional books.

Other McGraw-Hill Book Clubs:
Architects' Book Club • Byte Book Club • Chemical Engineers' Book Club
• Civil Engineers' Book Club • Mechanical Engineers' Book Club
For more information, write to:
McGraw-Hill Book Clubs, P.O. Box 582, Hightstown, New Jersey 08520



MAIL THIS COUPON TODAY

McGraw-Hill Book Clubs
Electronics and Control Engineers'
Book Club®
P.O. Box 582, Hightstown, New Jersey 08520

Please enroll me as a member and send me the two books indicated, billing me for the \$2.89 premium and my first selection at the discounted member's price, plus local tax, shipping, and handling charges. I agree to purchase a minimum of two additional books during my first year of membership as outlined under the Club plan described in this ad. A shipping and handling charge is added to all shipments.

Write Code No. of
\$2.89 selection here

Write Code No. of
first selection here

Signature _____

Name _____

Address/Apt. # _____

City _____

State _____ Zip _____

This order subject to acceptance by McGraw-Hill. All prices subject to change without notice. Offer good only to new members.

E33654

DRAWING BOARD



ROBERT GROSSBLATT

Counting with the 4089

ANYBODY WHO HAS BEEN FOLLOWING this column on a regular basis knows that I'm a real freak when it comes to paperwork, data sheets, and generally anything that makes life on the bench a little easier. That's because it's always a good idea to collect as much information as possible before you start "getting your hands dirty."

However, there are limits to how much information you can absorb. Sooner or later you'll find it impossible to learn any more from paperwork alone. That means that you must actually work with a device in order to truly understand its operation. So, in line with that sage advice, let's get our hands dirty, and see what we must do with rate multipliers to make them perform some useful task.

Using rate multipliers

Once again, we'll be using the 4089 for our discussion because, in the first place, it's a CMOS IC—I believe in using CMOS whenever possible. Second, I just happen to have some of them lying around the house—always an important consideration when trying to cut costs!

The chart in last month's column should've given you a good idea of what the 4089 can do. Although the numbers may seem confusing at first, you'll find that actually powering up one of those IC's will make its use a lot clearer. As with most other special-purpose IC's, the majority of the control pins are held either high or low during normal operation. That greatly simplifies understanding how the IC works.

The majority of uses for the rate

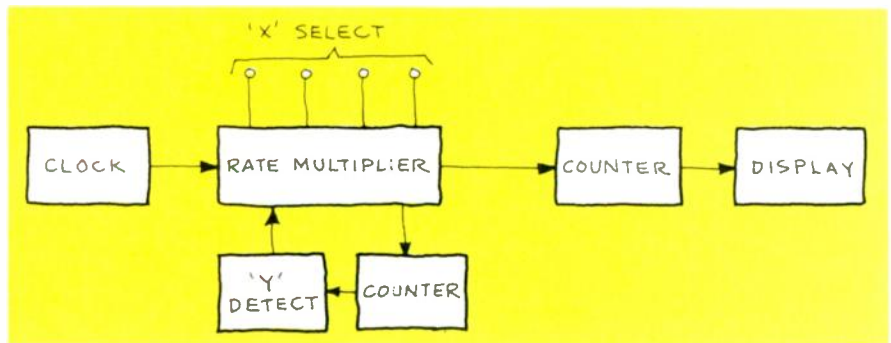

FIG. 1

multiplier will revolve around some sort of arithmetic—usually multiplication or division. Other kinds of operations are possible as well (because more-complex arithmetic, such as square roots or exponential functions, can usually be reduced to repetitive basic arithmetic). But, let's start off by seeing what we have to do to multiply two numbers together.

Multiplication circuit

Figure 1 is a block diagram of the circuit we want to put together to multiply "X" times "Y." Although there are a number of boxes there, things aren't as complicated as they may seem to be. The basic operation of the circuit is simple and the clock can be any type of arrangement that you want to use, as long as it's noise-free and the waveforms look something like a squarewave.

A basic 555 oscillator or some other type of clocking arrangement works fine. You may be wondering about the frequency needed from the clock. Well, the answer to that question will surprise you: It doesn't matter what the frequency is! How's that for

simplicity? But right now, let's clean off our hands and see why that apparently screwball statement is true.

First consider how the rate multiplier works: It takes the input-clock frequency, does some internal division and gives us two kinds of outputs.

Now recall that the "base-rate" is equal to one sixteenth the input clock, and that the "multiplied-rate" is the base rate multiplied by whatever number is presented at the binary inputs. If we were to write that statement as a formula, it would look something like what appears below:

$$\begin{aligned} \text{Base rate} &= \text{Input Clock}/16 \\ \text{Multiplied Rate} &= (X)(\text{Input Clock}/16) \end{aligned}$$

Where "X" is one of the numbers we're multiplying.

That means that every time a pulse appears at the base-rate output, we'll get "X" number of pulses at the multiplied-rate output. To multiply "X" and "Y" all we need to do is count the base-rate pulses and stop after "Y" number of (multiplied-rate) pulses. Getting the right answer is really as simple as

counting the total number of pulses at the multiplied-rate output, or expressed as a formula:

$$\begin{aligned} \text{Base Rate} &= \text{Input Clock} / 16 \\ \text{Multiplied Rate} &= (X)(\text{Base Rate}) \\ &= (X)(\text{Input Clock}/16) \\ X &= (\text{Multiplied Rate}) / (\text{Base Rate}) \\ X &= \frac{[(X)(\text{Input Clock} / 16)]}{(\text{Input Clock} / 16)} \\ X &= X \end{aligned}$$

As you can see, when we're doing multiplication with a rate multiplier, both the input clock and the internal base-number of the IC are completely unimportant—they cancel out. Getting the answer is only a matter of, as we said before, keeping track of the base-rate output pulses and counting up the multiplied-rate pulses.

The only part of Fig. 1 that could be at all tricky is the counter and other associated circuitry needed to detect when "Y" number of pulses have been generated at the base-rate output. There are two ways to do that. The method that you choose depends mostly on the type of counter you decide to use.

Since we want to count something "Y" times, we can either use an up counter starting at zero to detect "Y," or preload a down counter with "Y" to detect a zero. The choice again depends on the IC you want to use. Because up counters are a lot easier to come by, that's the way we'll go. Just remember that it's only a matter of personal choice.

One of the nicest things about CMOS counters is that there's a whole range of ripple counters that provide a one-IC solution to problems just like ours. They come in really handy when you want to count to some large number.

The 4020, 4040, and 4060 are all members of the ripple-counter family, but of those only the 4040 has outputs covering a continuous 12-stage count. That means that you can use it to detect any number from 0 to 4096.

Figure 2 shows the pinout of the 4040. It's used just the way you'd expect it to be; a clock is routed to pin 10, the reset pin is held low, and the IC will advance one count

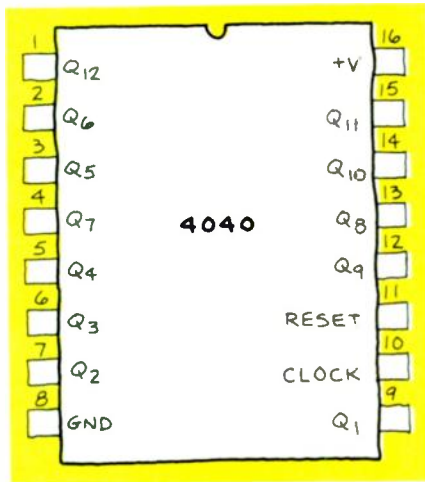

FIG. 2

on the negative-going edge of each incoming clock pulse.

Detecting "Y" involves a bit of gating. How you set things up, naturally, depends on the number that you're trying to detect. For instance, let's say that we want to multiply 14 by 67.

The only special thing about picking the numbers to be multiplied is to make sure that one of them is less than 16. That's because the 4089 has only four weighted inputs and the highest number that those inputs can represent is

15 (or 1111 in binary). However, the 4089 is easily cascaded for larger numbers. We'll examine that in more detail once we get through our example.

Figure 3 is a schematic of the circuit that we're designing; it shows everything except the counter and the display. We'll deal with them later.

The weighted inputs of the 4089 are set to load in a binary 14 (1110). We'll be using $\frac{1}{3}$ of a 4073, 3-input AND gate to decode the Q1, Q2, and Q7 outputs of the 4040. Switch S1 is used to start the whole business going.

When S1 is pressed, IC3 resets and causes the output of the IC4-a to go low. That enables the rate multiplier, IC2, by bringing pin 11 low, causing it to start sending base-rate pulses to the clock input of IC3. For each base-rate pulse, 14 pulses are output at pin 6, the MULTIPLIED-RATE OUTPUT. You can see that the way we're doing our multiplication is to make IC2 count to 14 over and over until it's done it 67 times.

When that happens, 67 is decoded and the output of IC4-a goes high. That resets IC3 to zero

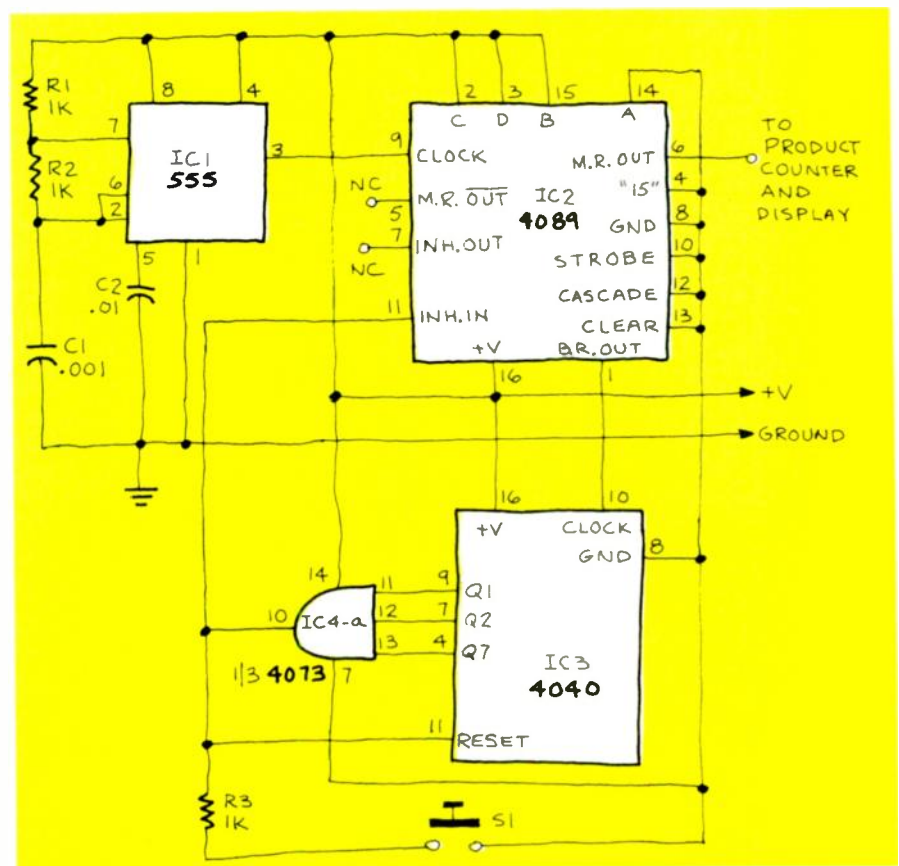

FIG. 3

\$ 100,000.00 CABLE TV CONVERTER LIQUIDATION

- 60 Channel Capacity
- P.L.L. Tuning
- 6 Channel Memory
- TV On-Off Feature
- Infra-Red Wireless Remote Control

ONLY **\$59.95**



- 10% Off On All Quantities Over 50
- Available Only While Quantities Last
- Warranty Restricted to 15 Days After Receipt of Goods
- Allow 2 Weeks for Personal Checks to Clear
- Factory Re-Furbs Available at \$49.95 Each With Full Guarantee

— SPECIAL —

SUNSET CABLE
1 Madison Street • East Rutherford NJ
(201) 777-6733
Master Charge • C.O.D. • Visa

DON'T FORGET



USE
YOUR
READER
SERVICE
CARD

and brings the INHIBIT INPUT (pin 11) of IC2 high, preventing it from putting out any more pulses.

You could easily modify the circuit and use a gated oscillator so that the 4073 (IC4-a) would also stop the clock—there are many ways to accomplish that.

Since IC3 is reset to zero each time the circuit is used, any number that comes after 67 will never appear at the output. If you use a number other than 67, (which you probably will), you'll more than likely have to use a gate with more input legs. Not to worry though, because that can be taken care of by the two remaining gates in the 4073.

To add more inputs, just use a second gate as an input device and the third one to AND the first two together. It's not too difficult to figure out what gating you have to use and since that's not really what we're talking about, we won't go into it.

Next month we'll add a display to the circuit and see what kind of things must be done to cascade two or more rate multipliers together and allow us to multiply by virtually any number we want. We'll also see how to configure the circuit to do division. Believe it or not, that task is much easier than you think! And better yet, it gives us yet another opportunity to use—and become more familiar with—the 4089. R-E



Be an
**ELECTRONICS
TECHNICIAN!**
Get your 2-Year
Associate Degree

Train at home
in spare time!

Now you can train for a money-making career in Electronics. No previous experience necessary. No need to quit your job. Your

Associate Degree gives you all the technical subjects you need—electronic measurement, circuitry, instrumentation—all the training you need to get your Electronics Technician rating. No time wasted on subjects you don't need or traveling to and from class. Instructors are as close as your telephone. Use our 24-hour home-study hot line—we pay the bill.

Thousands of Electronic Specialists
Have Exciting Jobs Like These

Choose from exciting opportunities in the fast-growing space-age industries...Automation, Aerospace, Cable-TV, Missile Design, Electronic Circuitry, Computers, Telemetry and much, much more. Get the same home study training system used by many giant corporations for their own employees. Everything explained in easy-to-understand lessons with plenty of pictures and drawings.

SEND FOR FREE FACTS

- No obligation • No salesman will call
- Mail Coupon Today!

ICS
SINCE 1981

Center for Degree Studies, Dept. DE094
ICS Electronics Center, Scranton, PA 18515

Yes! Rush me free facts telling how I can get my 2-Year Associate Degree in Electronics Technology at home in spare time.

Name _____ Age _____
Address _____
City/State/Zip _____

CABLE TV

CONVERTERS DESCRAMBLERS

Largest Selection
of Equipment Available

\$ Buy Warehouse Direct & Save \$



36 channel
converter
\$4595

36 channel
wired remote
converter
only
\$8895



Send \$2 for complete catalog
of converters and unscramblers

Quantity Discounts • Visa • Master Charge
Add 5% shipping—Mich. residents add 4% sales tax

C&D Electronics, Inc.
P.O. Box 21, Jenison, MI 49428
(616) 669-2440

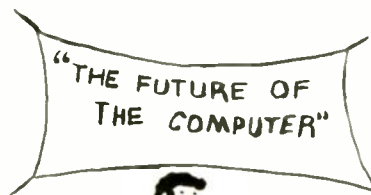

"My computer tells me that there is no future in artificial intelligence."

DESIGNER'S NOTEBOOK

Inverting logic oscillators

ONE OF THE NICEST THINGS ABOUT digital circuits is that you can make an oscillator out of just about anything. Just look around your design and find a few spare parts (unused gates on the board), connect them together and you've got an oscillator. While working with analog components requires some thought, digital stuff is just lying there, begging for the chance to squirt out squarewaves. But that kind of convenience tends to make you sloppy.

Because most gate-type oscillators are essentially trouble free, you can easily get into the habit of thinking that they all are—but they're not! Everybody is familiar with (and has used) the oscillator arrangement shown in Fig. 1. (We've shown it with inverters, but any type of simple inverting logic will fill the bill.)

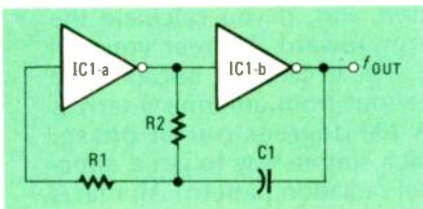

FIG. 1

Oscillator circuits

The circuit in Fig. 1 is simple to put together, forgiving of part values, and relatively stable for a given supply voltage. However, there is one problem associated with it—it won't always oscillate!

Like a good many of you, I've relied on that circuit whenever I needed a simple clock generator. More convenient ones, with fewer parts can be built with Schmitt triggers; however, not every circuit

uses Schmitt triggers.

Imagine my surprise, after having figured out the component values for an oscillator I was building to get the clock frequency I wanted, and found that when I plugged the parts into the board, nothing happened. There I was, the victim of my own sloppiness.

The reason that the oscillator in Fig. 1 won't always work can be understood by taking the part values to the extremes—decreasing component values—and seeing what happens to the circuit. That kind of experimentation can come in handy when it comes to simplifying any circuit.

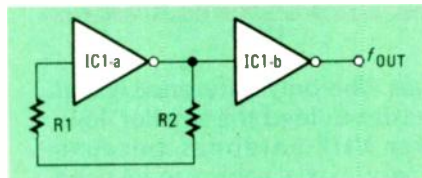

FIG. 2

If we keep on reducing the value of capacitor C1 and let it go to zero, we're going to wind up with the circuit shown in Fig. 2. There we see that IC1-b is no longer a part of the circuit, and it doesn't take much analysis to see that the circuit won't oscillate. What that tells us is that there are limits to the allowable value of the capacitor.

What those limits are will depend on several things; the supply voltage, load, component values, and a whole bunch of other stuff. In other words, what had been a really handy, no-thought type of circuit has turned into one that requires some consideration before we can use it.



ROBERT GROSSBLATT

The problem here is that the schematic in Fig. 1 is not an inherently astable circuit. That can be seen by looking at Fig. 2 and comparing it to Fig. 1. Remember, the capacitor forces the circuit to oscillate and if its value is not large enough (or there is none at all), the circuit will just sit there and do absolutely nothing.

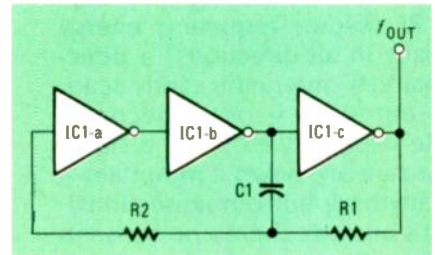

FIG. 3

What we need is a trouble-free oscillator that is inherently astable. Figure 3 is the type of circuit that we're looking for. As stated before, you can do a lot better and greatly simplify things by using Schmitt triggers. For all those other times, however, the circuit shown in Fig. 3 is just what the doctor ordered.

The circuit is sure-starting and trouble-free—it will oscillate over a much wider range than an oscillator made with just two inverters (like the one in Fig. 1). The formula for determining the output frequency is admittedly a bit complex, but several assumptions can greatly simplify things. Since it's not the kind of circuit that you would use if you need good stability or heavy-duty precision, the following approximations are more than adequate:

continued on page 134

COMMUNICATIONS CORNER



HERB FRIEDMAN,
COMMUNICATIONS EDITOR

Antenna systems

SOMEONE ONCE SAID SOMETHING TO the effect that the more things change, the more they remain the same. That thought came to mind recently while traveling through the "outback" of our country—the "Wild West."

Back in the East, most VHF communications antennas are omnidirectional, meaning they radiate RF (Radio Frequency) energy equally in all directions; a directional VHF antenna is rarely seen. But out West it often becomes quite necessary to beam a signal up a canyon, down a mountain—or, anything but omnidirectional. That's because there's no sense in wasting RF energy by beaming it where it's not needed. It is, therefore, not uncommon to run across directional VHF antennas—usually two verticals sticking up from an arm that protrudes from a mast or tower.

Seeing those vertical beams reminded me that one of the standard questions on the FCC Radiotelephone License exam concerns two quarter-wavelength vertical broadcast-band antennas that are spaced one half-wavelength (180 degrees) apart, and are fed out-of-phase by 180 degrees. "What is the radiation pattern," the exam asks. You are supposed to know the answer: "Bi-directional, in-line with the two antennas."

For more than 35 years, the FCC has asked essentially the same question as it concerns antennas for the standard broadcast-band. However, the same technique is used for VHF communications an-

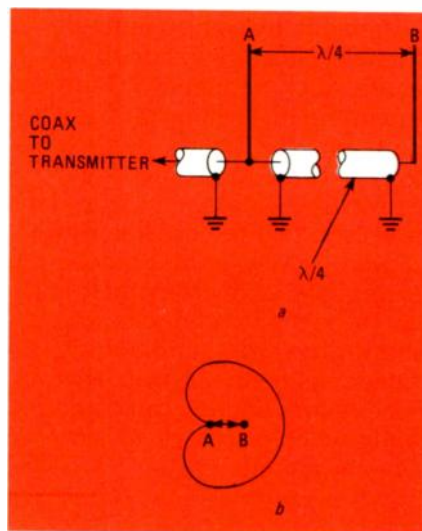

FIG. 1

tennas. The only difference is that it's easier to feed the smaller, low-power VHF antennas because ordinary coaxial cable can be used for the phasing networks. So that you can better understand the characteristics of phasing networks, let's look at a couple of examples.

Antenna Phasing Networks

Figure 1-a shows how two vertical antennas can be installed to provide a unidirectional radiating pattern or, more precisely, a cardioid pattern. A cardioid is a heart-shaped closed curve formed by the overlapping of two equal fixed circles. That pattern is shown in Fig. 1-b. A unidirectional antenna would have greater forward energy and even less energy at the sides; but with an inexpensive antenna system, the cardioid pattern is as unidirectional as we're going

to get. For a highly unidirectional radiation pattern, we would use a multi-element yagi or stacked yagi's—a subject for detailed future discussion.

The two antennas in Fig. 1-a are physically spaced a quarter-wavelength apart, and the RF signal is fed to them 90-degrees out of phase with each other. To accomplish the phase difference, antenna A is fed directly from the transmission line, and a quarter-wavelength section of coax is placed between antennas A and B. The coax cable between the two antennas is an electrical quarter-wavelength, so it delays the energy to antenna B by 90 degrees. By the time the signal reaches antenna B, the wavefront from A has already arrived; the energy from A and B combine in the forward direction. But, if you calculate the energy toward the rear you will find that it cancels, because the wavefront from antenna B arrives at A 180-degrees out of phase. What a simple way to get a directional radiation pattern! All that is needed is just a couple of pieces of wire and some coaxial cable.

However, there is one major problem with that arrangement: The coaxial phasing section won't reach from antenna A to B. And because the coax effectively slows down RF flow within the cable, a half-wavelength of coax is less than a half-wavelength in free space. The reduced speed of the RF flow is called the "velocity factor" which, for coaxial cable, is nominally 66% of the calculated wavelength in free space. For ex-

ample, if a wavelength in free space is 10 feet, an electrical wavelength of coax is 6.6 feet. Let's consider a second example: If a quarter wavelength in free space is three feet, a quarter-wavelength of coax is just short of two feet. Therefore, if the antennas are spaced a quarter-wavelength apart and fed a quarter-wavelength out of phase, the coax from antenna A to B is obviously not going to reach—it will reach only 66% of the required distance.

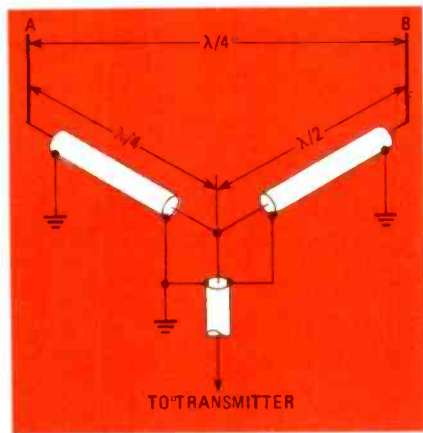

FIG. 2

The way we "stretch" the coax is by changing the method by which the two antennas are fed. One such solution is shown in Fig. 2. There, instead of the coax from the transmitter going directly to point A as in Fig. 1, it is connected through a quarter-wavelength section of coax. From the junction of the main transmission line and the quarter-wavelength coax, a half-wavelength section is connected to point B.

At first glance it might appear as if everything is out of joint, but take a moment to study the phase relationships more closely. Though we have delayed the signal to point A by 90 degrees, we have delayed the signal to point B by 180 degrees. The phase difference between the two is still the desired 90 degrees—the only problem now is that we have more coax than we need going to point B. And since the half-wavelength section is about 30% oversize, we can coil the excess and tape it to the mast or tower if necessary.

You can play with the antenna spacing and coax phasing-sections to handle almost any problem that comes up. For example, let's go

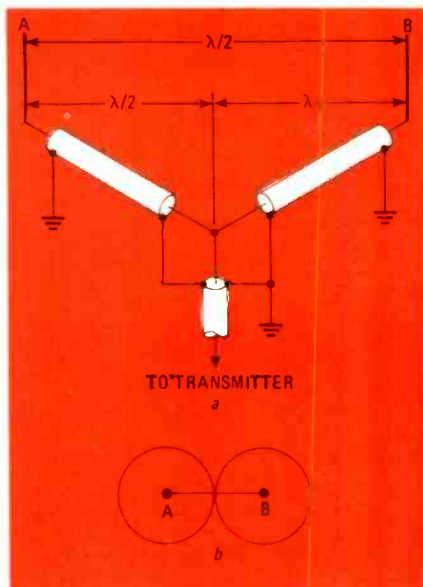

FIG. 3

back to that question of which the FCC is so fond. Imagine that a VHF station for a tow-truck service is to be located in the center of a long, thin island. An omnidirectional antenna is obviously going to radiate RF energy over the water, where it won't do anyone any good. What's needed is a bi-directional or a figure-8 radiation pattern—the same one that is on the FCC tests.

Figure 3 shows the desired pattern and how it's attained. Here the antennas (in Fig. 3-a) are spaced a half-wavelength apart; the signal is fed to them 180 degrees out of phase with each other by using a half-wavelength coax section to antenna A and a full-wavelength coax section to antenna B. The difference between a half-wavelength and a full-wavelength is 180 degrees—the value needed for the bi-directional pattern, and exactly the answer needed for the FCC's question.

Determining how transmission-line phasing-sections work is not only fun, but also gives a good understanding of how to use ordinary coaxial cable to overcome unusual antenna-installation problems. Try working the examples shown using unusual feedline arrangements, such as bringing the feed into point B instead of point A, or experimenting to see how much length must be added to a coax cable to reach from one antenna to the next to achieve the desired phase difference. R-E

EKI

ELECTRONIC KITS INTERNATIONAL, INC.
(Formerly PPG Electronics)

NEW!

**AM RADIO
6 TRANSISTOR
#854/754**

A "Fun to Build" super sensitive 6-transistor AM radio. Exciting hands-on experience. Learn the how and why of a radio by building it yourself. All parts necessary are included, so tune in and discover the fun of building your own! Features: Low power consumption, low cost, easy step-by-step instructions with each kit, alignment procedure and troubleshooting instructions included. Circuit operations explained, wrist strap and cabinet included.



NEW!

FROG PHONE W/CB & CASE

This kit has over 76 electronic parts including speaker, microphone, microswitch, 12 button keypad, two circuit boards, transformer, two LED's, eight transistors, one integrated circuit, twelve diodes, five electrolytic capacitors and sixteen resistors. Comes with step-by-step instruction and learning manual.

**#815/715
NEW!**



Learn about:

- Large scale integration pulse generator IC's
- Matrix keyboards and decoders
- Dual tone generation
- Busy tone generation
- How to repair electronic telephones

OVER 50 KITS AVAILABLE

KIT #

- | | |
|-------------------------------------|---|
| 401 Packet One | 842 12-volt Color Organ |
| 402 Super Inverter | 844 1 W Zapper |
| 403 Space War Gun | 846 12-volt Strobo Stick |
| 404 Missile Detector | 850 Whopper Alarm |
| 800 Logic Probe | 851 Computation Lead Alarm Control |
| 806 Burglar Alarm | 854 Electronic Tennis |
| 808 Decision Maker | 858 Digital Roulette |
| 809 LED Pendulum Metronome | 860 5-74 Volt Regulated Power Supply |
| 811 Double Decision Maker | 862 Musical Wave |
| 813 Simon Decoder | 863 Full-wave Motor Speed Control |
| 814 Rabbit Bumper | 866 Digital Slot Machine |
| 816 Mini-robot | 868 Digital Dice |
| 818 Fish Counter | 870 Wave Tester |
| 820 Summer Lights | 876 6-digit Digital Clock |
| 821 Christmas Tree | 878 Digital Bird |
| 822 One Channel Color Organ | 880 12-volt 2-amp Regulated Power Supply |
| 824 Automatic Siren | 882 Musical Wave |
| 826 Fast Box | 884 Sound Activated Color Organ 1-channel |
| 828 9-Volt Power Supply | 886 Audio Amp/intercom |
| 830 Multi-purpose Power Supply | 888 Librarian Terminator |
| 834 Color Organ 3-channel 1-control | 890 Step action Timing Tester |
| 836 Schenker 4-control Color Organ | 892 Telephone Head Buzzer |
| 840 Variable Strobo Light | 894 Phase Gen/Sound Generator |
| | 898 Binary Clock |

FREE
CATALOG OF ALL KITS
Available nationwide at your local electronics store.

(Or send \$1.00 shipping & handling to address below.)

EKI ELECTRONIC KITS INTERNATIONAL, INC.

791 RED ROCK ROAD
ST. GEORGE, UTAH 84770

**Call TOLL FREE
1-800-453-1708**
For store nearest you.

Special Prices for Educators

CIRCLE 58 ON FREE INFORMATION CARD

STATE OF SOLID STATE



ROBERT F. SCOTT,
CONTRIBUTING EDITOR

Low-power amplifier IC's

IF YOU'VE BEEN FRUSTRATED IN YOUR efforts to complete an electronics project or experiment by the lack of a small, low-power audio amplifier, I urge you to consider building one around either of two power-amplifier IC's recently introduced by the Sprague Electronic Company.

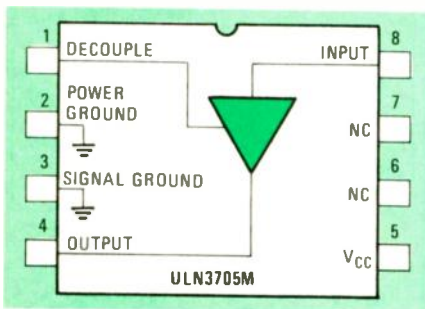

FIG. 1

First we'll look at the ULN-3705M—its pinout is shown in Fig. 1. That class-AB amplifier is housed in an 8-pin mini-DIP and has a voltage gain of 42 dB. Its operating temperature can vary between -20 and $+85^{\circ}\text{C}$.

The typical power-output of the unit can range from 60 to 600 milliwatts, depending on supply voltage and speaker impedance. For example, operating from a 9-volt supply and driving a 16-ohm load, the unit's output power is 600 milliwatts. Audio power output levels for three different speaker impedances (8, 16, and 32 ohms) and supply voltages appear in Table 1.

The recommended supply voltage for the ULN-3705M can range from 4.5 to 9 volts with a 6- to 10-mA quiescent current-drain. However, the amplifier operates (at reduced volume) with supplies

TABLE 1—ULN-3705

Characteristic	Symbol	Test Conditions	Limits			Units
			Min.	Typ.	Max.	
Supply Voltage Range	V_{CC}		1.8	6.0	9.0	V
Quiescent Supply Current	I_{CC}	$V_{CC} = 4.5\text{ V}$	—	6.0	—	mA
		$V_{CC} = 6.0\text{ V}$	—	7.0	15	mA
		$V_{CC} = 9.0\text{ V}$	—	10	20	mA
Voltage Gain	A_v		—	42	—	dB
Audio Power Output	P_{OUT}	$R_L = 8\Omega, V_{CC} = 4.5\text{ V}, \text{THD} = 10\%$	—	220	—	mW
		$R_L = 8\Omega, V_{CC} = 6.0\text{ V}, \text{THD} = 10\%$	250	430	—	mW
		$R_L = 16\Omega, V_{CC} = 4.5\text{ V}, \text{THD} = 10\%$	—	125	—	mW
		$R_L = 16\Omega, V_{CC} = 6.0\text{ V}, \text{THD} = 10\%$	150	240	—	mW
		$R_L = 16\Omega, V_{CC} = 9.0\text{ V}, \text{THD} = 10\%$	—	600	—	mW
		$R_L = 32\Omega, V_{CC} = 4.5\text{ V}, \text{THD} = 10\%$	—	60	—	mW
		$R_L = 32\Omega, V_{CC} = 6.0\text{ V}, \text{THD} = 10\%$	85	110	—	mW
		$R_L = 32\Omega, V_{CC} = 9.0\text{ V}, \text{THD} = 10\%$	—	310	—	mW
Distortion	THD	$P_{OUT} = 50\text{ mW}, R_L = 32\Omega$	—	0.4	1.0	%
		$P_{OUT} = 50\text{ mW}, R_L = 16\Omega$	—	0.5	—	%
Output Noise	V_{OUT}	Input Shorted, $BW = 80\text{ kHz}$	—	225	—	μV
Input Resistance	R_{IN}	Pin 8	—	250 K	—	Ω
Power Supply Rejection	PSRR	C_D (Pin 1) = 500 μF , $f = 120\text{ Hz}$	—	34	—	dB

as low as 1.8 volts without a notable increase in harmonic distortion. Total harmonic distortion is specified at from 0.4–1.0% and 0.5–1.0% for 32- and 16-ohm loads, respectively.

The ULN-3705M is recommended for use as a headphone driver in battery-powered portable radios and tape recorders. It is, therefore, ideally suited for use in audio signal-tracers and bench amplifiers, and is intended as a low-cost alternative to designs using discrete transistors.

Figure 2 shows a typical application for the ULN3705. The circuit's performance is influenced by the

values of two external electrolytic capacitors (C_3 and C_4). One is used for output coupling and the other for feedback and ripple decoupling.

The output-coupling capacitor, C_4 , works with the speaker impedance to control the low-frequency cutoff. The -10-dB points are about 20, 30, and 60 Hz when driving an 8-ohm speaker through coupling capacitors of 500 μF , 250 μF , and 100 μF , respectively.

Capacitor C_3 is used for feedback decoupling and power-supply ripple rejection. The 500- μF capacitor specified provides 34 dB of rejection at 120 Hz. The ampli-

TABLE 2—ULN-3784B

Characteristic	Symbol	Test Conditions	Limits			Units
			Min.	Typ.	Max.	
Supply Voltage Range	V_{CC}		9.0	24	28	V
Quiescent Supply Current	I_{CC}	$V_{IN} = 0\text{ V}$	—	20	—	mA
Quiescent Output Voltage	V_{OQ}	$V_{IN} = 0\text{ V}$, See Note 1	—	12	—	V
Voltage Gain	A_V	$P_{OUT} = 0\text{ W}$	31	34	37	dB
Total Harmonic Distortion	THD	$P_{OUT} = 50\text{ mW}$, $R_L = 8\Omega$, $V_{CC} = 24\text{V}$	—	0.2	—	%
		$P_{OUT} = 50\text{ mW}$, $R_L = 16\Omega$, $V_{CC} = 28\text{V}$	—	<0.2	—	%
		$P_{OUT} = 4\text{ W}$, $R_L = 8\Omega$, $V_{CC} = 24\text{V}$	—	<0.3	5.0	%
Audio Output Power	P_{OUT}	$R_L = 8\Omega$, $V_{CC} = 24\text{ V}$, THD = 5%	4.0	5.0	—	W
		$R_L = 16\Omega$, $V_{CC} = 28\text{ V}$, THD = 5%	4.0	4.8	—	W
Input Impedance	Z_{IN}	Each Input	140 K	170 K	—	Ω
Power Supply Rejection	PSRR	$P_{OUT} = 0\text{ W}$, $f = 120\text{ Hz}$	—	30	—	dB
Equiv. Input Noise Voltage		$f = 20\text{ Hz to } 20\text{kHz}$	—	60	—	μVRMS
Bandwidth (-3 dB)	BW	$P_{OUT} = 1\text{ W}$, See Note 2	—	100	—	kHz

NOTES: 1. The quiescent output voltage typically equals 1/2 the supply voltage.
 2. Unity gain typically occurs between 10 MHz and 100 MHz.

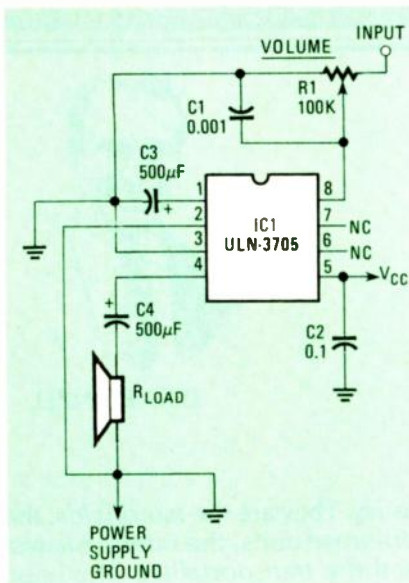

FIG. 2

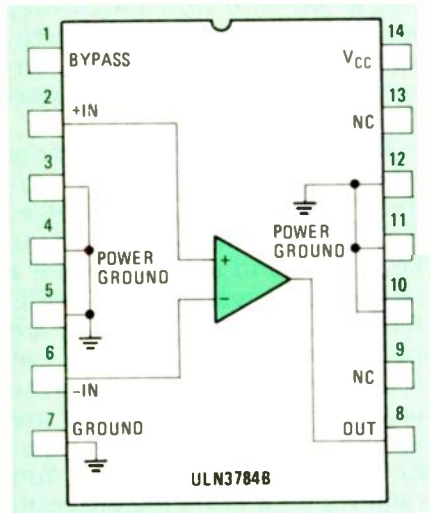

FIG. 3

fier input (pin 8) must be provided with a DC return path to ground for a current of approximately 1 μA . That current produces a voltage (IR) drop that, when multiplied by the circuit's closed-loop DC gain, appears as an error in the output offset-centering. The value of resistance between the input and ground is ideally 100 kilohms or less, although up to 200 kilohms may be used.

The other amplifier, the ULN-3784B, is housed in a 14-pin DIP and is designed for such applications as automotive, communications, and consumer electronics that require a high-quality audio output. The device's pinout is shown in Fig. 3.

The ULN-3784B is a pin-compatible improvement on several earlier designs and is a direct

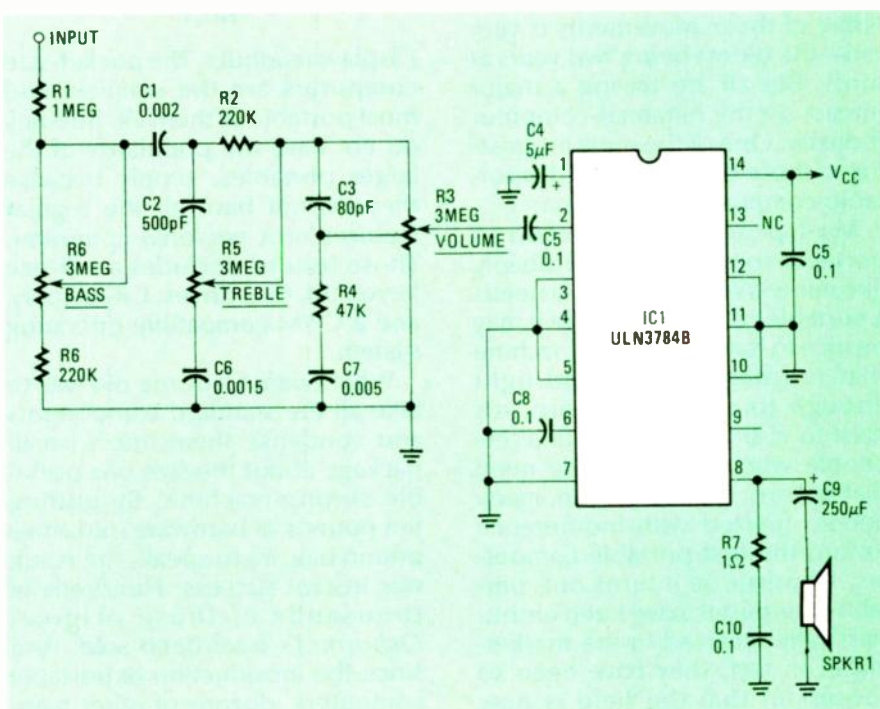

FIG. 4

replacement for National Semiconductor's LM380N and LM384N, and Sprague's ULN-2280B and ULN-2281B IC's. However, it provides a wider margin of protection against supply-voltage transients. Table 2 shows the electrical characteristics of the IC.

The ULN-3784B operates from a single supply that can range from 9 volts up to about 28 volts. The unit

has a 34-dB internally fixed gain. Operating from a 24-volt supply, its typical output power is 4-watts minimum when working into an 8-ohm load. With a 28-volt supply, its power output is 4.8 watts working into 16 ohms.

The ULN-3784B's typical quiescent current is 20 mA, and it has a bandwidth of 100 kHz and its

continued on page 112

COMPUTER CORNER



LOU FRENZEL

Portable computers

THERE IS ALWAYS A LOT GOING ON IN the hyperactive personal-computer field. However, four major trends seem to be dominating the market at the present. Those include the low-end home-computer price war and shake-out; the movement toward IBM PC-compatible systems; the integrated-software movement, and the portable-computer phenomena. None of those movements is very old—the oldest being two years at most. But all are having a major impact on the personal-computer industry. One of the most interesting of those movements is the portable-computer phenomena.

Most people's first reaction to portable computers was probably like mine: Who in the world needs a portable computer? While it may be nice to have a compact machine that is small enough and light enough to carry anywhere, it's hard to visualize more than a few people who might actually need that feature. For that reason, many people reacted with indifference toward the first portable computers. However, as it turns out, portable computers have been enthusiastically received in the marketplace. In fact, they have been so successful that the field is now crowded with competitors.

Industry guru Adam Osborne started the portable-computer business when he introduced his famous *Osborne 1* early in 1981. During that same year, Radio Shack and some of the Japanese manufacturers originally introduced their pocket-size handheld calculator-like personal computers, which contained BASIC in ROM and had LCD (Liquid Crystal



FIG. 1

Display) readouts. The pocket-size computers are the smallest and most portable of them all. But they do not have the popularity of the larger portables, simply because they do not have all the regular features of a personal computer. Those features include a full-size keyboard, disk drives, CRT display, and a CP/M-compatible operating system.

What Adam Osborne did was to take all the standard components and condense them into a small package about the size of a portable sewing-machine. By putting ten pounds of hardware into a five pound bag, so to speak, the result was instant success. Hundreds of thousands of those original *Osborne 1*'s have been sold. And since the introduction of portable computers, dozens of other manufacturers including Kaypro, Compaq, Columbia, Seequa, Dynalogue, and others have come along to take advantage of this totally new market niche. With such fierce competition, prices have dropped while features and functionality have been increased.

Classifying portables

There are four basic categories of portable computers available

today. They are the *handhelds*, the *briefcase* units, the *intermediates*, and the *transportables*. The basic method of categorizing portables has to do with how much they weigh, how large they are, whether they are battery operated, type of display, and the mass-storage method used.

The *handhelds* are really more like large calculators in appearance than anything else. Those units have alphanumeric keyboards and usually feature a one-line LCD readout. The BASIC language is built-in, and they are battery-operated so that you can take them anywhere. Some of the units typical of this category are Radio Shack's *PC-4* and the popular Hewlett-Packard *HP-75C*. You can write your own programs with the built-in BASIC interpreter, and store them on standard audio-cassettes by using a cassette player/recorder and a cassette interface (usually optional). Many handhelds also feature plug-in ROM cartridges that allow you to perform special business, engineering, and statistical or scientific calculations. The handhelds are also the cheapest of the portables. You can get one for less than \$100, although the more advanced units sell for prices ranging up to \$500, depending on the accessories you choose.

The *briefcase* computers are the newest portables on the market. And like the handhelds, they are usually battery-operated so that they can be taken along and used anywhere. These units are larger however, since they contain more circuitry, and larger displays and keyboards. The keyboard is usu-

ally the same full-size you would find on a typewriter. The LCD readouts are used because of their low power consumption. However, the display on a briefcase portable, unlike the handhelds, can present multiple lines of data. For example, Radio Shack's Model 100 briefcase computer (see Fig. 1) can display eight 40-character lines. The Epson HX-20 briefcase computer displays four 20-character lines. Both of those machines have a BASIC interpreter built-in. The Epson HX-20 also contains a micro-cassette player/recorder built-in so that programs may be written, stored, and retrieved. And it also features a tiny built-in printer: Its output format is 24-character lines.

In addition to a BASIC interpreter, the Radio Shack Model 100 also contains built-in applications software. That software includes a text editor for elementary word-processing applications; a simple data-storage program for maintaining telephone numbers and address files; an appointment calendar, and a communications program that allows the unit to be used as a terminal. A built-in 300-baud direct-connect modem allows you to connect the Model 100 to the telephone lines and communicate with remote computers.

In addition to Radio Shack and Epson, other manufacturers include Casio, Nippon Electric, Sunrise Systems, MicroOffice, and Convergent Technologies. All of the machines from those manufacturers weigh about 4 to 5 pounds, are fully battery-operated, and will fit inside a standard-size briefcase.

Next we come to the *intermediate portables* that are somewhat larger and heavier but, of course, they contain more features. The typical intermediate weighs in the 8-to-16-pound range and many of them are still small enough to be put into a briefcase.

One of the most popular intermediate portables is the new *Gavilan*. That machine features an 8088 microprocessor and uses the popular Microsoft MS-DOS operating system. It has an eight-line 80-column LCD readout and contains 64K of RAM, and a single built-in 3.5-inch micro-floppy with a storage capacity of 360K bytes.

There are all sorts of accessories for the unit, including a printer. Again, the unit is battery-powered for complete portability. This 9-pound unit does almost everything that you might expect from a larger machine.

The final category is the *transportables*. They were the first portable computers to go on the market, and are really nothing more than tightly repackaged versions of standard desk-top person-

al computers. The units feature CRT displays, full-size keyboards, and built-in floppy-disk storage. Some of the newer units, like the Kaypro 10, even contain a hard-disk drive.

The reason for the term "transportable" is that the size and weight of the typical unit is such that it can barely be considered portable. Most of these machines weigh in the 20-to-30-pound range and are not all that easy to lug

Because they are built to last...

Global breadboarding sockets are guaranteed for a lifetime.

For more than a decade, Global Specialties' solderless breadboarding has set the standard for quality, durability and dependable performance. Now, we offer a lifetime guarantee. If a Global breadboarding socket fails to perform according to your needs, you merely return it to Global Specialties. We will send you a replacement free of charge. *No questions asked.*

This unconditional guarantee is offered because our breadboarding sockets provide outstanding performance, indefinitely. All of our sockets are made in the United States in our own factory, employing the latest equipment, manufacturing methods and quality control procedures. Each socket and bus strip is molded of high quality plastic material to provide superior strength and durability. Precision-formed contacts and tie-points made from nickel-silver assure excellent contact every time.

Seven sockets and three bus strips are included in our QT Series. Our new UBS-100 and UBS-500 models and our Experimentor line include socket and bus strip contact arrangements in single modular breadboards.

The industry's largest selection, unmatched quality and economy have earned Global solderless breadboarding sockets the reputation for being number one with professionals, hobbyists and students. Now, the unconditional lifetime guarantee is your assurance that when you buy from Global you receive maximum durability and trouble-free performance. Unlike some manufacturers who require that you purchase by mail, our nationwide network of distributors permits you to see and inspect our products before you buy.

See your electronics distributor or for the name of your local distributor, call our toll-free **Product Availability Phone. 1-800-243-6077.**

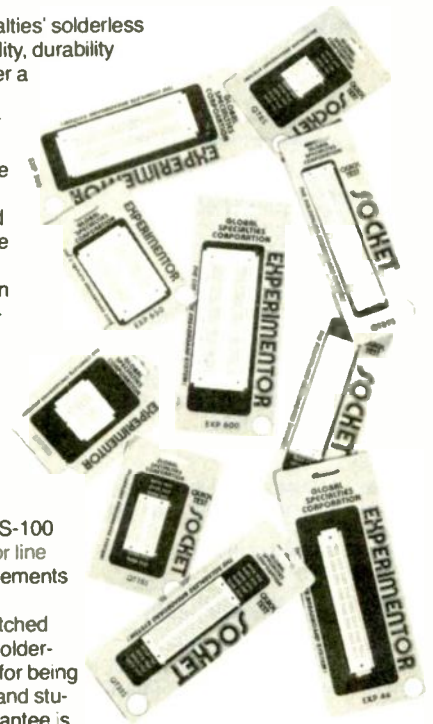

Introducing the UBS Series



Two new solderless breadboarding sockets have been added to the Global line. The new UBS-100 is now the largest socket in the line, with 840 tie-points and the smaller UBS-500 has 430 tie-points. Each includes two rows of bus strips on each side for power and ground connections and the UBS sockets are made of the highest grade plastic material to insure maximum resistance to warping and breaking.



GLOBAL SPECIALTIES
An Interplex Electronics Company

70 Fulton Terrace
New Haven, CT 06512 1819
(203) 624 3103 TWX 710-465 1227

OTHER OFFICES: San Francisco (415) 648-0611,
TWX 910-372 7992, Europe phone Saffron-Walden
0799 21682, TLX 817477

ACCURATE FREQUENCY MEASUREMENT

10HZ TO 1.3GHZ

WITH EXCLUSIVE LED
SIGNAL STRENGTH BAR GRAPH

\$499

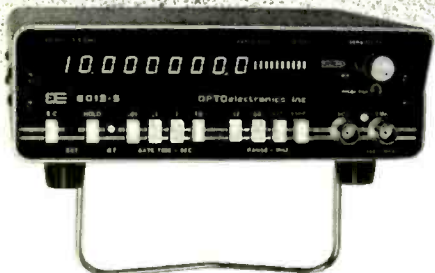

MODEL 8013-S

STANDARD FEATURES:

- VINYL CLAD ALUMINUM CASE
- 9 DIGITS • 4 GATE TIMES
- ± 1 PPM 10 MHZ TCXO TIME BASE
- EXTERNAL CLOCK INPUT/OUTPUT
- DISPLAY HOLD • SENSITIVITY CONTROL
- ACCESSORY POWER JACK ON FRONT PANEL
- CERTIFIED NBS TRACEABLE CALIBRATION
- FULL YEAR GUARANTEE—ALL PRODUCTS
- INPUT POWER 110/220 VAC 50/60 HZ OR 12-15 VDC
- MADE IN U. S. A.—SINCE 1974

OPTIONS:

- #TCXO-80 ± 0.1 PPM EXTRA PRECISION TCXO \$75
- #OCXO-80 ± 0.05 PPM PROPORTIONAL OVEN TIME BASE \$125
- #NI-CAD-86 INTERNALLY INSTALLED NI-CAD BATTERY PACK \$60

SPECIAL BONUS OFFER

BUY OUR LOW FREQUENCY MULTIPLIER MODEL LFM: 1110 FOR ONLY \$75—HALF PRICE IF ORDERED WITH MODEL 8013-S WHILE THIS AD IS CURRENT.

THE LFM: 1110 IS A DELUXE TONE FREQUENCY MULTIPLIER IN A COMPACT VINYL/ALUMINUM CASE FEATURING 10X, 100X & 1000X SIGNAL MULTIPLICATION WITH SELECTABLE LOW PASS FILTERING, AMPLIFICATION AND PHASE LOCK INDICATION. USED FOR RAPID, HIGH RESOLUTION MEASUREMENT OF TONE FREQUENCY SIGNALS.

DELIVERY FROM STOCK
ORDER TOLL FREE FACTORY DIRECT

800-327-5912

From Florida (305) 771-2050

VISA—MC—C.O.D.—RATED FIRMS BY P.O.



OPTOelectronics inc

5821 N.E. 14th Avenue
Ft. Lauderdale, Florida 33334
TELEX 514849

CIRCLE 14 ON FREE INFORMATION CARD

around. Also, most of them are not capable of operating from a battery supply—you have to use a standard AC power-line.

The portables fall into one of two categories. First, there are the 8-bit machines, usually featuring a Z80 microprocessor and running the popular CP/M operating system. The original Osborne and the Kaypro models fall into this category. The other popular group of portables are those that use the 8088 or 8086 16-bit microprocessors. Those latter machines are typically compatible with the popular IBM PC, and can run the MS-DOS operating system. Some of the machines typical of that category are the popular Osborne *Executive*, the *Hyperion*, the Compaq, Seequa *Chameleon*, and the Columbia Data Products *1600-VP*.

The portability issue

In looking at the whole portable-computer affair, it really seems that portability is not the major reason for the popularity of those machines. While most portables weigh less than 30 pounds, and can be carried, they are not exactly what you would call convenient. And though the ability to put a personal computer under an airline seat is a nice idea, few users really need it. There are some true portables like the battery-operated calculator look-alikes and the briefcase computers, but their computing power is far less than that of desk-tops or portables, thereby making them less useful.

The two things that have really made the portable computer popular are its small size and the software it can handle. The small size comes strictly by deliberately engineering a complete machine that is portable. Everything that you need, including a keyboard, disk-drives, display, and all of the other goodies, is packaged in a single container. That makes the unit unusually compact. The fact is, it is considerably smaller than more conventional desk-top computers. When you stop and consider the more traditional personal computers, you'll discover they are not only large, but also usually consist of several separate interconnected items. The resulting

package takes up a lot of space on the desk—in fact, many of them occupy an entire desk. However, the portable compresses all of the same features down into an area that occupies no more space than a typewriter. About the only penalty that you pay is in the display's size. Most portables have 5-, 7-, or 9-inch screens, where the average desk-top computer uses a larger and certainly more readable 12-inch screen.

Overall, people like portables because they have a small "footprint." You can pick them up and move them from one desk to another without the hassel of disconnecting the cables, moving the individual pieces, and then having to reassemble the system at the new site. To move a portable computer, all you do is snap the keyboard back on the front, unplug it, and away you go.

Another feature introduced by Adam Osborne with the original *Osborne 1* computer is bundled software. By bundled we mean that key software packages are included with the computer when it is purchased. Everybody knows that a computer is worthless without software, yet few computers actually include the software. Instead, you are forced to buy the operating system, languages, and application programs separately. However, most portables (the only exception being Compaq) offer several useful software packages with the machine. They include the operating system (either CP/M or MS-DOS), BASIC, and a selection of popular applications programs. Most portable computers include a word processor, a spreadsheet, a data-base management package, and sometimes, a communications program. Those are the packages that most people want and need anyway: Besides, it is always nice to have the software (ready to run) at the time the computer is purchased.

When you add up the total retail price, if you purchased the software individually, you would find that in most cases you are getting well over a thousand dollars worth of software with the purchase of the machine. That's an outstanding bargain, and one that most people have not overlooked. R-E

SERVICE CLINIC

Chip components

THE RAPID ADVANCEMENT OF ELECTRONIC technology has provided us with many interesting and useful consumer products, such as portable VCR's, personal computers, and so on. It was mainly the development of transistors and later, the integrated circuit, that rocketed us into this new era of miniaturization and made possible the development of those and other products.

As a result of the miniaturization process, a new family of components was born. That new family, known as *chip components* (or surface-mounted devices), are small units encapsulated in IC-type packages. Because of their small size, chip components demand that you be especially careful when soldering—you need just the right solder, soldering iron, etc. We'll get to that in a moment. For now, let's see how to identify the component values.

Identifying chip components

Because of their small size, some practical means of identifying chip components had to be developed. But don't worry—it's not hard to learn: The system used for both resistors and capacitors is similar to the method you're already using to identify small capacitors.

Instead of using colored dots or bands, chip resistors are identified by numbers printed on the top of the device, as shown in Fig. 1-a. For example, a 1000-ohm resistor would be marked "102." The first two numbers (10) are the first two digits of the value. The third number is the power-of-ten multiplier. (It tells you how many zeros to add, as seen in Fig. 1-a.)

Ceramic capacitors are marked with a similar system, except that two rows of numbers are used, as shown in Fig. 1-b. For instance, a .047- μ F capacitor would be marked "47" in the top row and "3u" in the bottom one. The top two numbers represent the first and second digit in the part value. The number in the second row is the power-of-ten multiplier. All values are marked in picofarads. (To convert that value to microfarads, the decimal point is then moved six places to the left.) That is practically the same as the system used now for small mica and ceramic types. The letter following the number represents the class or tolerance of the capacitor.

Identifying chip transistors is

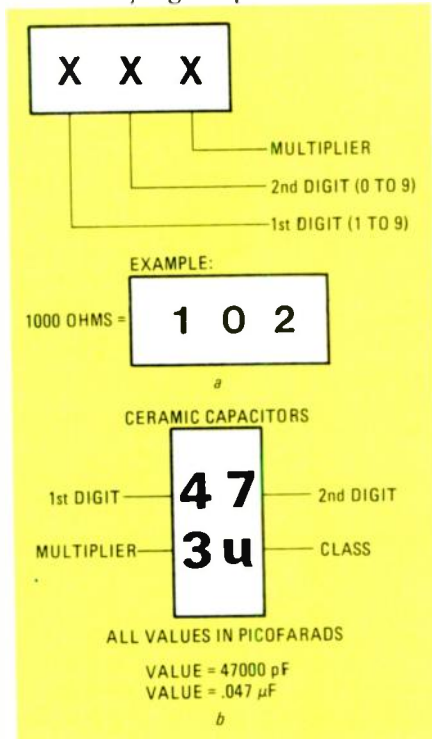

FIG. 1



JACK DARR

TABLE 1

1st LETTER	2S NUMBER	2nd LETTER h _{FE} RANK (GAIN)
E	2SA1022	A to C
F	2SA1034	R to U
H	2SA1035	R to U
(A)	2SB709	O to T
(B)	2SB709A	O to T
(C)	2SB710	P to S
D	2SB710A	P to S
A	2SB766	P to S
B	2SB766A	P to S
C	2SB767	P to S
V	2SC2295	A to C
U	2SC2404	B to E
S	2SC2405	R to U
T	2SC2406	R to U
R	2SC2480	T to S
Y	2SD601	O to T
Z	2SD601A	O to T
W	2SD602	P to S
X	2SD602A	P to S
Q	2SD813	P to R
P	2SD814	P to T
(Z)	2SD874	P to S
(Y)	2SD874A	P to S
(X)	2SD875	P to S

quite different from identifying capacitors and resistors. Chip transistors have two letters printed lengthwise across the top. The first letter shows the "2S" (EIA) number and the second gives the transistor's gain rating. A transistor with a gain rating of "C" will have higher gain than one rated "A" or "B," and so on. While you can replace a transistor with one with higher gain, the opposite is not true. Table 1 is a partial identification chart for chip transistors.

Now let's see what precautions must be taken when using them.

Soldering chip components

Some manufacturers of chip components recommend a solder *continued on page 108*

Radio-Electronics mini-ADS

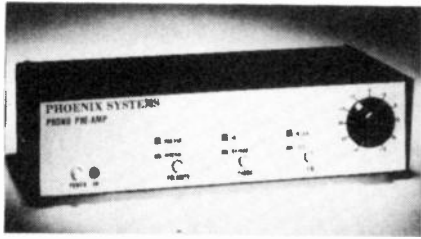

HEAR WHAT YOUR RECORDS ARE SUPPOSED TO SOUND LIKE! Accurate EQ and fast op-amps deliver crystal clear sound. A low noise (discrete) front end properly terminates your cartridge. Polarity and I.E.C. (-3 dB @ 20 Hz) EQ are switchable. P-10-MM Moving Magnet \$150 (kit) \$200 (assembled) P-10-MC Moving Coil \$150 (kit) \$200 (assembled) M/C and VISA ok. **PHOENIX SYSTEMS INC., P.O. Box 628, Manchester, Ct. 06040 (203) 643-4484.**

CIRCLE 84 ON FREE INFORMATION CARD

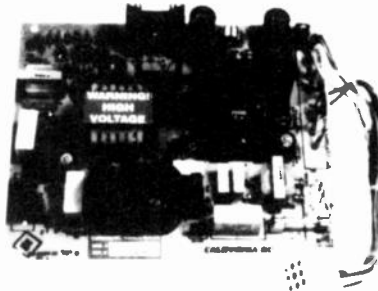

California-DC Regulated Switching Power supply +5v dc @ 5 amp +12v dc @ 2 amp +12v dc @ 1.8 amp -12v dc @ .5 amp 115-230v ac input, fused. EMI filtered. Removable DC Power Harness and Schematics included. 7.4" x 6.2" x 1.7" ht. New units, identical to the Kepco/TDK Supplies as seen at \$59.95.

\$37.50 ea. freight pre-paid in U.S.
1-800-327-7182 Power Plus.
(Call for Quantity Price)

CIRCLE 8 ON FREE INFORMATION CARD

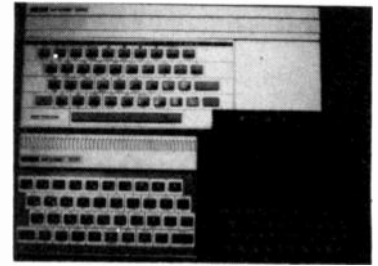

TIMEX/SINCLAIR 1000, 1500, 2068, ZX81, SPECTRUM PRTR I/F—A Centronics parallel printer interface. Order PRTIF: \$50. **EPROMMER**—Programs 2716, 2732, 2764's Order EPRMR: \$75. *Software for TS2068, Spectrum: ASM/DSM*—A full featured assembler/disassembler. Order ASMDSM: \$40. **TEXTEDIT**—A very complete editor, including 64-column mode. Order EDIT: \$40. When ordering, specify type of computer. Money orders or C.O.D. only. Send to **RESEARCH SERVICE LABORATORIES P.O. Box 19124, OKC, OK 73144.**

CIRCLE 10 ON FREE INFORMATION CARD



SUBSCRIPTION TV MANUAL. This information packed book details the methods used by subscription TV companies to scramble and descramble video signals. Covers the Sinewave, Gated Pulse, SSAVI system, and the methods used by most cable companies. Includes circuit schematics, theory, and trouble shooting hints. **Only \$12.95 plus \$2.00 first class P&H. ELEPHANT ELECTRONICS INC., (formally Random Access) Box 41770-R, Phoenix, AZ 85080.**

CIRCLE 31 ON FREE INFORMATION CARD

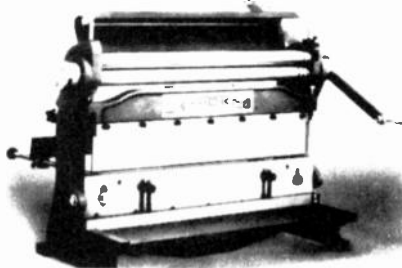

SHEET METAL WORKER—The 24" TRIOK is a Press Brake, Shear and Slip-roll machine—perfect for research and development or maintenance shops. Over a thousand machines world wide in little to the largest companies. For free literature on this and our other sheet metal working machines contact: **PACIFIC ONE CORPORATION, 513 Superior Ave. Suite K-415 Newport Beach, CA 92663, (714) 645-5962.**

CIRCLE 25 ON FREE INFORMATION CARD

CALL NOW AND RESERVE YOUR SPACE

- 6 x rate \$605 per each insertion.
- Reaches 215,460 readers.
- Fast reader service cycle.
- Short lead time for the placement of ads.
- We typeset and layout the ad at no additional charge.

Call 212-777-6400 to reserve space. Ask for Arline Fishman. Limited number of pages available. Mail materials to: mini-ADS, RADIO-ELECTRONICS, 200 Park Ave. South, New York, NY 10003.



DIGITAL BOARD TESTING COURSE—This 18 lesson course, including lesson books, cassette tapes, and workbooks, will give you the information you need to enter the field of test engineering and to learn the latest techniques used in automatic test equipment. Earn your certificate from the Test Engineering Institute. Check/M.O./Mastercard/Visa. \$450 plus shipping. **10 DAY NO RISK TRIAL. Logical Solutions, Inc., 1799 S. Winchester, Suite 201, Campbell, CA 95008. (408) 374-3650.**

CIRCLE 46 ON FREE INFORMATION CARD



APPLIANCE REPAIR HANDBOOKS—13 volumes by service experts; easy-to-understand diagrams, illustrations. For major appliances (air conditioners, refrigerators, washers, dryers, microwaves, etc.), elec. housewares, personal-care appliances. Basics of solid state, setting up shop, test instruments. \$2.65 to \$5.90 each. Free brochure. **APPLIANCE SERVICE, PO Box 789, Lombard, IL 60148. 1-(312) 932-9550.**

CIRCLE 92 ON FREE INFORMATION CARD

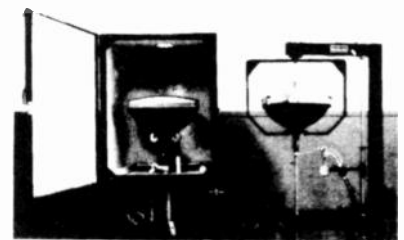

ONE MAN CRT FACTORY, easy operation. Process new or rebuild old CRT's for tv's, bus. machines, monitors, scopes, etc. Color, b&w, 20mm, foreign or domestic. 3x6 ft. space required. Profits???. Average CRT rebuilding cost — \$5. Sell for \$100 = \$95 profit; x 5 CRT's = \$475 daily; x 5 days = \$2375 weekly profit. Higher profits outside U.S.A. Investigate this opportunity today. We service the entire world. Write or call: **CRT Factory, 1909 Louise St., Crystal Lake, Il. 60014, (815) 459-0666.**

CIRCLE 89 ON FREE INFORMATION CARD



CABLE-TV PRICE SLASH!

ITEM	OUTPUT CHANNEL <i>(Circle the one used on your system)</i>		REG.	NOW	QTY.	PRICE
	CH. 2	CH. 3				
JERROLD 400 CONVERTER (58 CH.)	CH. 2	CH. 3	109.00	90.00
(10 or more)	CH. 2	CH. 3	82.00	75.00
JERROLD 450 CONVERTER (66 CH.)	CH. 2	CH. 3	134.00	105.00
(10 or more)	CH. 2	CH. 3	110.00	90.00
EAGLE COMTRONICS 400 MHz CONVERTER ...	CH. 2	CH. 3	109.00	90.00
(10 or more)	CH. 2	CH. 3	82.00	75.00
SB ADD-ON UNIT	CH. 2	CH. 3	129.00	99.00
(10 or more)	CH. 2	CH. 3	79.00	58.00
BRAND NEW SB TRIMODE COMPLETE UNIT	CH. 2	CH. 3	Please call for price quotes and details.	
SB TRIMODE CONVERSION KIT	CH. 2	CH. 3	Please call for price quotes and details.	
MINICODE (N-12)	CH. 2	CH. 3	109.00	89.00
(10 or more)	CH. 2	CH. 3	79.00	56.00
MINICODE (N-12) VARISYNC	CH. 2	CH. 3	119.00	99.00
(10 or more)	CH. 2	CH. 3	86.00	62.00
C-1000 ADD-ON (COMPATIBLE—ALL ZENITH SYSTEMS)	CH. 2	CH. 3	260.00	225.00
(5 or more)	CH. 2	CH. 3	220.00	185.00
MLD-1200-3	CH. 3 ONLY		129.00	99.00
(10 or more)	CH. 3 ONLY		85.00	58.00

IMPORTANT: WHEN CALLING FOR INFORMATION —

Please have ready the make and model # of the equipment used in your area.

Thank You

Name _____

Sub-Total

Street _____

Shipping

City/State/Zip _____

TOTAL

Phone Number Area Code _____ Number _____

Sale of De-scramblers may be prohibited in some states.

If in doubt, check with local authorities. No Ohio orders accepted.

MUST BE SIGNED AND RETURNED WITH YOUR ORDER

I understand that the purchase of these cable T.V. products does not authorize their use on any cable T.V. system. I agree to obtain the proper authorization from local officials or cable company officials in my area.

Signed _____

Add \$2.00 per unit shipping or call for specifics. Payment is accepted by money order or Cashier's check only. COD's & credit cards are not accepted as our low prices prohibit their use.

Transamerican Cable Distributors

449 BROADWAY AVE. • BEDFORD, OHIO 44146 • (818) 956-5839

Please—No Collect Calls

at another location for only \$99.95. UHF Preamp Kit—unit will drastically improve the picture quality of all UHF-TV stations and even find stations you never thought existed! Price \$25.95. Free shipping. MD residents add 5%. **HOWARD RESEARCH AND DESIGN**, PO Box 204, Ellicott City, MD 21043. (301) 465-8116.

HOME ROBOT

MOVIT kits/mini robots, \$25.00-\$75.00. Excellent introduction to personal robotics. **CAL - ROBOT**, 16200 Ventura Blvd. #223, Encino CA 91436. (818) 905-0721.

UHF CONVERTERS/SATELLITE EQUIPMENT BY L.S.R. ENG.

CONVERTER kits with AGC and sound from TV (VCR recordable): Deluxe 111 sinewave, \$79.95 (wooden cabinet \$12.50 extra). Digital Z/FV-5 video inversion (Includes cabinet) \$175.00. Sinewave adaptor for Z/FV-5 (video inversion) \$49.95. Adaptors for Deluxe 111; Z/FV \$49.95. Gated pulse \$39.95. (New!) Sinewave unjammer switch! \$19.95. Stops interference. (New!) Antenna blocking filter! \$19.95, stops broadcasting. Sinewave IN-TV kits (T.F.), economy \$39.95, DLX \$49.95. 90%-assembled kits available, add 30% to cost for assembly. Apartment-sized satellite TVRO system \$795.00, up to 156 ch., completely assembled, tested and guaranteed, 2 full years! Quantity discounts. Minimum order: \$25.00. Free shipping! Payment: cashiers check, money order, Visa or MasterCard. **L.S.R. ENGINEERING**, Dept. RE., Box 6075, Chicago IL 60680. Orders toll free: 1-(800) 432-1422. Information: 1-(312) 764-4330.

ELECTRO-VOICE DEALER

SPEAKER components plus interface, CD35. Sentry, stage, PA speakers, microphones. Low prices. **RICK MARDER**, (201) 561-8123.

EDUCATION & INSTRUCTION

F.C.C. General Radiotelephone license. Home study. Fast, inexpensive! "Free" details. **COM-MAND**, D-91, Box 2223, San Francisco, CA 94126.

UNIVERSITY offers state authorized degree programs in Business or Computer Management. Low tuition. No class attendance. Write, including phone, for brochure: **UNIVERSITY OF SANTA MONICA**, 5161 Venice Blvd., Los Angeles, CA 90019. Call: (213) 933-4200.

FCC commercial licence correspondence course. 60 individual lessons, \$89.50. Payment plan available. Results guaranteed! Information free. **AMERICAN TECHNICAL INSTITUTE**, Box 201, Cedar Mountain, NC 28718.

Your Ticket to a Great Career!

LEARN BASIC ELECTRONICS

TRAIN AT HOME IN SPARE TIME... Because the Electronics Field is growing so fast, it offers excellent career opportunities... even at the entry level. A knowledge of **BASIC ELECTRONICS** can help you get your foot in the door, qualify for good jobs like Technical Rep., Sales Rep., Junior Technician/Tester and more. Easy-to-follow home-study course starts you at the very beginning... explains everything step by step with plenty of photos, charts, diagrams. Multimeter, parts kits, calculator, digital VOM included. Hands-on training lets you learn by doing. Get **FREE FACTS**. No salesman will call. **MAIL COUPON TODAY!**



ICS SINCE 1981 **BASIC ELECTRONICS COURSE**
Dept. OE994 Scranton, PA 18515

Name _____ Age _____

Address _____

City/State/Zip _____

SATELLITE TELEVISION

UNSCRAMBLE secret satellite channels watch all the good stuff. Plans \$19.95—kits \$169.95—complete units \$395.00—Details and order forms \$3.00. **SCRAMCO**, 8688 Royal Drive, Nobleville, IN 46060.

Satellite Descramblers

For West Star 5
AND COMSTAR D-4
Movies Movies Movies

Send \$5.00 for information
Modern Technology
P.O. Box 419 D1
Boston, Ma. 02186
1 (617) 871-5838



SATELLITE antennas, build 8-10-12 foot wood or metal, send \$2.00. **PROTOTYPE ENGINEERS**, Box 1812, Deming, NM 88031.

GEARMOTORS for motorized satellite antenna projects, 110VAC, 101RPM: \$32.50 plus \$4.00 shipping. Actuators 36VDC, 18": \$139.00 plus \$10.00 shipping. **TEM**, 22518 97th, Corcoran, MN 55374. (612) 498-8014.

SATELLITE systems. Quick assembly high quality antenna, LNA's, receivers, low prices. Catalog \$3.00. **STATE SATELLITE**, 5 Broadway, Troy, NY 12180. (518) 272-1130.

REPLACEMENT FOR

ECG®/TRIPLERS/MULTIPLIERS

(MIN. 50 PC. PER TYPE)

TYPE NO	YOUR COST	TYPE NO	YOUR COST	TYPE NO	YOUR COST
500A	7.65	530	10.65	537	11.73
521	10.98	531	10.45	538	9.84
522	9.50	532	12.40	539	9.84
523	7.75	533	9.90	549	14.55
526A	7.75	534	10.48	550	10.05
528	9.40	535	11.48	556	11.90
529	8.90	536A	13.85	557	11.75
				564	11.55

REPLACEMENT FOR ECG® TYPES

TYPE NO	YOUR COST	TYPE NO	YOUR COST
85	FOUR for .99	125	SEVEN for .99
102A	THREE for .99	159AP	FOUR for .99
123A	FIVE for .99	177	EIGHT for .99
123AP	SIX for .99	199	FIVE for .99

SUPER SPECIAL (MIN. 5 PC. EACH)

TYPE NO	YOUR COST	TYPE NO	YOUR COST	TYPE NO	YOUR COST
124	.85	165	2.25	375	.90
128	.45	171	.65	506	.55
129	.45	184	.45	500A	8.95
130	.80	185	.45	523	9.95
152	.40	238	2.25	526A	10.20
153	.40	276	6.95	529	13.75
154	.60	291	.95	712	1.25

JAPANESE TYPES (MIN. 5 PC. EACH)

2SC867A	2.75	HA1366W	1.85	STK0029	3.80
2SC1114	3.25	HA1377A	2.90	STK0080	9.99
2SC1308K	1.95	LA4102	1.25	TA7205AP	1.50
AN214Q	1.45	M51515BL	2.95	TA7208P	1.85
AN239A	4.60	STK433	3.95	TA7222AP	1.95
BA532	1.80	STK435	3.95	UPC1181H	1.25
GH3F	.89	STK437	6.25	UPC1182H	1.25
HA1342A	2.30	STK439	6.50	UPC1185H	2.99

COD ORDERS WELCOME (\$25 MIN. ORDER)

For Complete Component Catalog Call or Write

DIGITRON ELECTRONIC

110 HILLSIDE AVENUE, SPRINGFIELD, N.J. 07081

TOLL FREE: 800-526-4928

In N.J.: 201-379-9016

*ECG IS A TRADE MARK OF PHILIPS ECG
DIGITRON ELECTRONIC IS NOT ASSOCIATED IN ANY WAY WITH PHILIPS ECG

Network Sales, Inc.

GRAND OPENING RETAIL STORE

THOUSANDS OF ITEMS IN STOCK

DELUXE PARTS ASSORTMENTS

#1 Resistors & Trimpots
68 1/2 watt, 5% resistors &
5 PT-15 10K trimpots: 1
each - 51, 75, 100, 470
15K, 3.6K, 51K, 470K
13-1 2K, 2-220 3-100K,
6-330, 6-12K, 7-910
9-3 3K, & 14-4 7K
\$4.50, ea. 10/40.00

#2 Capacitor "A"
Monolithics - 1-560p1
7-1 mfd, & 1- 22 mfd
Silver Micas - 2-10pf & 1
each of 43pf 110pf
560pf, 1200pf, 3000 or
3300pf
\$4.95 ea. 10/45.00

#3 Capacitor "B"
Myrlars 4- 001, 2- 047,
29- 01 Radial lytics 3-10
mfd 16V, 1-1000 mfd 50V
1-2200 mfd 35V Disc
Caps 1 each of 5, 12, 27
36, 110 330pf, 2-120pf
3-39pf, 3-220pf, and 1
Varr Cap 5-35pf
\$7.50 ea. 10/70.00

#4 Coil & Chokes
1 each of 15, 33, and 100
(uh) micro henries
chokes 1-variable RF
coil (same as
#49A537MPC)
\$3.25 ea. 10/30.00

#5 IC's, Sockets, & Semi's
1 each of NE564, LM565,
MC1330, MC1350,
MC1496, LM1889, 7812,
7818, 2N2222A, MV2109,
heat sink 2-MC1458,
4-1N4002, 4-8 pin, 2-14
pin 1-16, & 1-18 pin
socket
\$13.50 ea. 10/125.00

#6 Misc. Hardware
LED & holder, fuse &
holder line cord,
grommet, SPST switch,
DPDT switch, 2-F61
conn & lugs, knob,
4-spacers, 6-screws &
nuts 2-RG-174, match-
ing transformer w/nut
\$5.95 ea. 10/57.50

Network Sales, Inc.

90 TURNER AVE.
ELK GROVE VILLAGE, IL. 60007

312/952-1115
PHONE ORDERS WELCOME

OPEN MON-SAT. 9 to 5

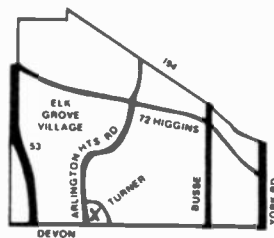

CIRCLE 11 ON FREE INFORMATION CARD

CIRCLE 95 ON FREE INFORMATION CARD

DIGI-KIT CORPORATION

AK, HI, 218-861-0674

NATIONAL SEMICONDUCTOR • PANASONIC • AVIAD • CHEMVAR • ATLANTIC DIODES • ARIES • PLESSEY • MOLEX • AVIAD • E. F. J. OR MACHINE • UNGAR • GC CHEMICALS • SCALED • SEMICONDUCTOR • PANASONIC • QUALITY - Name brand products from nationally recognized manufacturers. SERVICE - Computerized order processing and inventory control. SAVINGS - Volume Discounts • OEM Quantity Pricing • Toll Free 800 Number

INTEGRATED CIRCUITS

Linear	IC	Part No.	Stock
OPAMP	LM201	25	1000
OPAMP	LM202	25	1000
OPAMP	LM203	25	1000
OPAMP	LM204	25	1000
OPAMP	LM205	25	1000
OPAMP	LM206	25	1000
OPAMP	LM207	25	1000
OPAMP	LM208	25	1000
OPAMP	LM209	25	1000
OPAMP	LM210	25	1000
OPAMP	LM211	25	1000
OPAMP	LM212	25	1000
OPAMP	LM213	25	1000
OPAMP	LM214	25	1000
OPAMP	LM215	25	1000
OPAMP	LM216	25	1000
OPAMP	LM217	25	1000
OPAMP	LM218	25	1000
OPAMP	LM219	25	1000
OPAMP	LM220	25	1000
OPAMP	LM221	25	1000
OPAMP	LM222	25	1000
OPAMP	LM223	25	1000
OPAMP	LM224	25	1000
OPAMP	LM225	25	1000
OPAMP	LM226	25	1000
OPAMP	LM227	25	1000
OPAMP	LM228	25	1000
OPAMP	LM229	25	1000
OPAMP	LM230	25	1000
OPAMP	LM231	25	1000
OPAMP	LM232	25	1000
OPAMP	LM233	25	1000
OPAMP	LM234	25	1000
OPAMP	LM235	25	1000
OPAMP	LM236	25	1000
OPAMP	LM237	25	1000
OPAMP	LM238	25	1000
OPAMP	LM239	25	1000
OPAMP	LM240	25	1000
OPAMP	LM241	25	1000
OPAMP	LM242	25	1000
OPAMP	LM243	25	1000
OPAMP	LM244	25	1000
OPAMP	LM245	25	1000
OPAMP	LM246	25	1000
OPAMP	LM247	25	1000
OPAMP	LM248	25	1000
OPAMP	LM249	25	1000
OPAMP	LM250	25	1000

1% Metal Film Resistors

Watt: 1/4, 1/2, 1, 2, 5, 10, 20, 50, 100, 250, 500, 1000 p.c.

Standard Resistor Value

Resistance	Part No.	Stock
100	100-01	1000
1000	100-02	1000
10000	100-03	1000
100000	100-04	1000
1000000	100-05	1000
10000000	100-06	1000
100000000	100-07	1000
1000000000	100-08	1000
10000000000	100-09	1000
100000000000	100-10	1000
1000000000000	100-11	1000
10000000000000	100-12	1000
100000000000000	100-13	1000
1000000000000000	100-14	1000
10000000000000000	100-15	1000
100000000000000000	100-16	1000
1000000000000000000	100-17	1000
10000000000000000000	100-18	1000
100000000000000000000	100-19	1000
1000000000000000000000	100-20	1000

TEXTA INSTRUMENTS I.C. SOCKETS

Body: 3/4" V.D. precision with Copper Alloy Contacts

Accommodates standard IC leads up to 0.018" max and 0.025" wide. Contact is designed and optimized to fit the solder to prevent the contact. Face of the lead, allowing for the maximum range of high temperature forces. Socket is designed to achieve maximum density on boards.

SOLDER TAIL DIP SOCKETS

- Lead length
- Lead pitch
- Lead width
- Lead height
- Lead thickness
- Lead diameter
- Lead length to body
- Lead length to tail
- Lead length to tail (with solder)
- Lead length to tail (with solder and flux)
- Lead length to tail (with solder and flux and lead wire)

THE PLATED SOLDER TAIL

Part No. Description Price

CS108	8 pin solder tail, tin	1.15
CS114	14 pin solder tail, tin	1.95
CS118	18 pin solder tail, tin	2.15
CS122	22 pin solder tail, tin	2.25
CS126	26 pin solder tail, tin	2.35
CS130	30 pin solder tail, tin	2.45
CS134	34 pin solder tail, tin	2.55
CS138	38 pin solder tail, tin	2.65
CS142	42 pin solder tail, tin	2.75
CS146	46 pin solder tail, tin	2.85
CS150	50 pin solder tail, tin	2.95
CS154	54 pin solder tail, tin	3.05
CS158	58 pin solder tail, tin	3.15
CS162	62 pin solder tail, tin	3.25
CS166	66 pin solder tail, tin	3.35
CS170	70 pin solder tail, tin	3.45
CS174	74 pin solder tail, tin	3.55
CS178	78 pin solder tail, tin	3.65
CS182	82 pin solder tail, tin	3.75
CS186	86 pin solder tail, tin	3.85
CS190	90 pin solder tail, tin	3.95
CS194	94 pin solder tail, tin	4.05
CS198	98 pin solder tail, tin	4.15
CS202	102 pin solder tail, tin	4.25
CS206	106 pin solder tail, tin	4.35
CS210	110 pin solder tail, tin	4.45
CS214	114 pin solder tail, tin	4.55
CS218	118 pin solder tail, tin	4.65
CS222	122 pin solder tail, tin	4.75
CS226	126 pin solder tail, tin	4.85
CS230	130 pin solder tail, tin	4.95
CS234	134 pin solder tail, tin	5.05
CS238	138 pin solder tail, tin	5.15
CS242	142 pin solder tail, tin	5.25
CS246	146 pin solder tail, tin	5.35
CS250	150 pin solder tail, tin	5.45
CS254	154 pin solder tail, tin	5.55
CS258	158 pin solder tail, tin	5.65
CS262	162 pin solder tail, tin	5.75
CS266	166 pin solder tail, tin	5.85
CS270	170 pin solder tail, tin	5.95
CS274	174 pin solder tail, tin	6.05
CS278	178 pin solder tail, tin	6.15
CS282	182 pin solder tail, tin	6.25
CS286	186 pin solder tail, tin	6.35
CS290	190 pin solder tail, tin	6.45
CS294	194 pin solder tail, tin	6.55
CS298	198 pin solder tail, tin	6.65
CS302	202 pin solder tail, tin	6.75
CS306	206 pin solder tail, tin	6.85
CS310	210 pin solder tail, tin	6.95
CS314	214 pin solder tail, tin	7.05
CS318	218 pin solder tail, tin	7.15
CS322	222 pin solder tail, tin	7.25
CS326	226 pin solder tail, tin	7.35
CS330	230 pin solder tail, tin	7.45
CS334	234 pin solder tail, tin	7.55
CS338	238 pin solder tail, tin	7.65
CS342	242 pin solder tail, tin	7.75
CS346	246 pin solder tail, tin	7.85
CS350	250 pin solder tail, tin	7.95
CS354	254 pin solder tail, tin	8.05
CS358	258 pin solder tail, tin	8.15
CS362	262 pin solder tail, tin	8.25
CS366	266 pin solder tail, tin	8.35
CS370	270 pin solder tail, tin	8.45
CS374	274 pin solder tail, tin	8.55
CS378	278 pin solder tail, tin	8.65
CS382	282 pin solder tail, tin	8.75
CS386	286 pin solder tail, tin	8.85
CS390	290 pin solder tail, tin	8.95
CS394	294 pin solder tail, tin	9.05
CS398	298 pin solder tail, tin	9.15
CS402	302 pin solder tail, tin	9.25
CS406	306 pin solder tail, tin	9.35
CS410	310 pin solder tail, tin	9.45
CS414	314 pin solder tail, tin	9.55
CS418	318 pin solder tail, tin	9.65
CS422	322 pin solder tail, tin	9.75
CS426	326 pin solder tail, tin	9.85
CS430	330 pin solder tail, tin	9.95
CS434	334 pin solder tail, tin	10.05
CS438	338 pin solder tail, tin	10.15
CS442	342 pin solder tail, tin	10.25
CS446	346 pin solder tail, tin	10.35
CS450	350 pin solder tail, tin	10.45
CS454	354 pin solder tail, tin	10.55
CS458	358 pin solder tail, tin	10.65
CS462	362 pin solder tail, tin	10.75
CS466	366 pin solder tail, tin	10.85
CS470	370 pin solder tail, tin	10.95
CS474	374 pin solder tail, tin	11.05
CS478	378 pin solder tail, tin	11.15
CS482	382 pin solder tail, tin	11.25
CS486	386 pin solder tail, tin	11.35
CS490	390 pin solder tail, tin	11.45
CS494	394 pin solder tail, tin	11.55
CS498	398 pin solder tail, tin	11.65
CS502	402 pin solder tail, tin	11.75
CS506	406 pin solder tail, tin	11.85
CS510	410 pin solder tail, tin	11.95
CS514	414 pin solder tail, tin	12.05
CS518	418 pin solder tail, tin	12.15
CS522	422 pin solder tail, tin	12.25
CS526	426 pin solder tail, tin	12.35
CS530	430 pin solder tail, tin	12.45
CS534	434 pin solder tail, tin	12.55
CS538	438 pin solder tail, tin	12.65
CS542	442 pin solder tail, tin	12.75
CS546	446 pin solder tail, tin	12.85
CS550	450 pin solder tail, tin	12.95
CS554	454 pin solder tail, tin	13.05
CS558	458 pin solder tail, tin	13.15
CS562	462 pin solder tail, tin	13.25
CS566	466 pin solder tail, tin	13.35
CS570	470 pin solder tail, tin	13.45
CS574	474 pin solder tail, tin	13.55
CS578	478 pin solder tail, tin	13.65
CS582	482 pin solder tail, tin	13.75
CS586	486 pin solder tail, tin	13.85
CS590	490 pin solder tail, tin	13.95
CS594	494 pin solder tail, tin	14.05
CS598	498 pin solder tail, tin	14.15
CS602	502 pin solder tail, tin	14.25
CS606	506 pin solder tail, tin	14.35
CS610	510 pin solder tail, tin	14.45
CS614	514 pin solder tail, tin	14.55
CS618	518 pin solder tail, tin	14.65
CS622	522 pin solder tail, tin	14.75
CS626	526 pin solder tail, tin	14.85
CS630	530 pin solder tail, tin	14.95
CS634	534 pin solder tail, tin	15.05
CS638	538 pin solder tail, tin	15.15
CS642	542 pin solder tail, tin	15.25
CS646	546 pin solder tail, tin	15.35
CS650	550 pin solder tail, tin	15.45
CS654	554 pin solder tail, tin	15.55
CS658	558 pin solder tail, tin	15.65
CS662	562 pin solder tail, tin	15.75
CS666	566 pin solder tail, tin	15.85
CS670	570 pin solder tail, tin	15.95
CS674	574 pin solder tail, tin	16.05
CS678	578 pin solder tail, tin	16.15
CS682	582 pin solder tail, tin	16.25
CS686	586 pin solder tail, tin	16.35
CS690	590 pin solder tail, tin	16.45
CS694	594 pin solder tail, tin	16.55
CS698	598 pin solder tail, tin	16.65
CS702	602 pin solder tail, tin	16.75
CS706	606 pin solder tail, tin	16.85
CS710	610 pin solder tail, tin	16.95
CS714	614 pin solder tail, tin	17.05
CS718	618 pin solder tail, tin	17.15
CS722	622 pin solder tail, tin	17.25
CS726	626 pin solder tail, tin	17.35
CS730	630 pin solder tail, tin	17.45
CS734	634 pin solder tail, tin	17.55
CS738	638 pin solder tail, tin	17.65
CS742	642 pin solder tail, tin	17.75
CS746	646 pin solder tail, tin	17.85
CS750	650 pin solder tail, tin	17.95
CS754	654 pin solder tail, tin	18.05
CS758	658 pin solder tail, tin	18.15
CS762	662 pin solder tail, tin	18.25
CS766	666 pin solder tail, tin	18.35
CS770	670 pin solder tail, tin	18.45
CS774	674 pin solder tail, tin	18.55
CS778	678 pin solder tail, tin	18.65
CS782	682 pin solder tail, tin	18.75
CS786	686 pin solder tail, tin	18.85
CS790	690 pin solder tail, tin	18.95
CS794	694 pin solder tail, tin	19.05
CS798	698 pin solder tail, tin	19.15
CS802	702 pin solder tail, tin	19.25
CS806	706 pin solder tail, tin	19.35
CS810	710 pin solder tail, tin	19.45
CS814	714 pin solder tail, tin	19.55
CS818	718 pin solder tail, tin	19.65
CS822	722 pin solder tail, tin	19.75
CS826	726 pin solder tail, tin	19.85
CS830	730 pin solder tail, tin	19.95
CS834	734 pin solder tail, tin	20.05
CS838	738 pin solder tail, tin	20.15
CS842	742 pin solder tail, tin	20.25
CS846	746 pin solder tail, tin	20.35
CS850	750 pin solder tail, tin	20.45
CS854	754 pin solder tail, tin	20.55
CS858	758 pin solder tail, tin	20.65
CS862	762 pin solder tail, tin	20.75
CS866	766 pin solder tail, tin	20.85
CS870	770 pin solder tail, tin	20.95
CS874	774 pin solder tail, tin	21.05
CS878	778 pin solder tail, tin	21.15
CS882	782 pin solder tail, tin	21.25
CS886	786 pin solder tail, tin	21.35
CS890	790 pin solder tail, tin	21.45
CS894	794 pin solder tail, tin	21.55
CS898	798 pin solder tail, tin	21.65
CS902	802 pin solder tail, tin	21.75
CS906	806 pin solder tail, tin	21.85
CS910	810 pin solder tail, tin	21.95
CS914	814 pin solder tail, tin	22.05
CS918	818 pin solder tail, tin	22.15
CS922	822 pin solder tail, tin	22.25
CS926	826 pin	

CPU's & SUPPORT CHIPS			INTER FACE & DRIVERS		
82C43	10.00	8237 16.00			
AMD2901	8.95	8238 3.95			
6502	4.75	8250 10.95			
6800	2.50	8251 8.00			
6803L	12.95	8253 8.00	AYS-1033A	3.75	
6809	8.95	8255A 5.75	AV3-1015D	5.75	
6810	4.00	8257 8.00	1488	9.00	
6821	4.50	8259 8.00	1489	9.00	
6845	13.95	8275 24.50	TR1602B	3.95	
6850	3.50	8279 S 6.95	BR1041L	8.95	
6875	4.50	8288 17.00	3241A	2.95	
8035	8.95	8355 12.95	AYS-3600RP	9.95	
8080A	2.75	TMS9927N1L 9.95	CR7501	7.95	
8085A	10.00	68000L8 39.50	MM5307	18.95	
8086	22.50	Z80A CPU 4.75	MM5369	2.50	
8202	19.95	Z80B CPU 9.00	8130	2.50	
8205	6.50	Z80A CTC 4.50	8830	2.50	
8212	3.00	Z80A DART 9.00	8833	2.50	
8214	4.50	Z80A P10 4.50	8834	2.00	
8216	3.00	Z80A S10 10.95	8837	2.00	
8226	3.50				

SHIFT REGISTERS			DISC CONTROLLERS		
MM1402	1.75	1771 16.50	1795 35.00		
MM1403	1.75	1791 25.00	1797 35.00		
MM1404	1.75	1793 35.00	D765C 35.00		
MM5053	2.50				
MM5056	2.50				
MM5057	2.50				
MM5058	2.50				
MM5060	2.50				

RAM'S			NO. 30 WIRE WRAP WIRE SINGLE STRAND		
21L02.3	90				
2101A.4	90				
2112.1	195				
2114.2	140				
2118.4	2.50				
2147.3	2.50				
2147.5	2.50				
2148.2	6.00				
2151.1	1.95				
2151.2	1.95				
2151.3	1.95				
2151.4	1.95				
2151.5	1.95				
2151.6	1.95				
2151.7	1.95				
2151.8	1.95				
2151.9	1.95				
2152.0	1.95				
2152.1	1.95				
2152.2	1.95				
2152.3	1.95				
2152.4	1.95				
2152.5	1.95				
2152.6	1.95				
2152.7	1.95				
2152.8	1.95				
2152.9	1.95				
2153.0	1.95				
2153.1	1.95				
2153.2	1.95				
2153.3	1.95				
2153.4	1.95				
2153.5	1.95				
2153.6	1.95				
2153.7	1.95				
2153.8	1.95				
2153.9	1.95				
2154.0	1.95				
2154.1	1.95				
2154.2	1.95				
2154.3	1.95				
2154.4	1.95				
2154.5	1.95				
2154.6	1.95				
2154.7	1.95				
2154.8	1.95				
2154.9	1.95				
2155.0	1.95				
2155.1	1.95				
2155.2	1.95				
2155.3	1.95				
2155.4	1.95				
2155.5	1.95				
2155.6	1.95				
2155.7	1.95				
2155.8	1.95				
2155.9	1.95				
2156.0	1.95				
2156.1	1.95				
2156.2	1.95				
2156.3	1.95				
2156.4	1.95				
2156.5	1.95				
2156.6	1.95				
2156.7	1.95				
2156.8	1.95				
2156.9	1.95				
2157.0	1.95				
2157.1	1.95				
2157.2	1.95				
2157.3	1.95				
2157.4	1.95				
2157.5	1.95				
2157.6	1.95				
2157.7	1.95				
2157.8	1.95				
2157.9	1.95				
2158.0	1.95				
2158.1	1.95				
2158.2	1.95				
2158.3	1.95				
2158.4	1.95				
2158.5	1.95				
2158.6	1.95				
2158.7	1.95				
2158.8	1.95				
2158.9	1.95				
2159.0	1.95				
2159.1	1.95				
2159.2	1.95				
2159.3	1.95				
2159.4	1.95				
2159.5	1.95				
2159.6	1.95				
2159.7	1.95				
2159.8	1.95				
2159.9	1.95				
2160.0	1.95				
2160.1	1.95				
2160.2	1.95				
2160.3	1.95				
2160.4	1.95				
2160.5	1.95				
2160.6	1.95				
2160.7	1.95				
2160.8	1.95				
2160.9	1.95				
2161.0	1.95				
2161.1	1.95				
2161.2	1.95				
2161.3	1.95				
2161.4	1.95				
2161.5	1.95				
2161.6	1.95				
2161.7	1.95				
2161.8	1.95				
2161.9	1.95				
2162.0	1.95				
2162.1	1.95				
2162.2	1.95				
2162.3	1.95				
2162.4	1.95				
2162.5	1.95				
2162.6	1.95				
2162.7	1.95				
2162.8	1.95				
2162.9	1.95				
2163.0	1.95				
2163.1	1.95				
2163.2	1.95				
2163.3	1.95				
2163.4	1.95				
2163.5	1.95				
2163.6	1.95				
2163.7	1.95				
2163.8	1.95				
2163.9	1.95				
2164.0	1.95				
2164.1	1.95				
2164.2	1.95				
2164.3	1.95				
2164.4	1.95				
2164.5	1.95				
2164.6	1.95				
2164.7	1.95				
2164.8	1.95				
2164.9	1.95				
2165.0	1.95				
2165.1	1.95				
2165.2	1.95				
2165.3	1.95				
2165.4	1.95				
2165.5	1.95				
2165.6	1.95				
2165.7	1.95				
2165.8	1.95				
2165.9	1.95				
2166.0	1.95				
2166.1	1.95				
2166.2	1.95				
2166.3	1.95				
2166.4	1.95				
2166.5	1.95				
2166.6	1.95				
2166.7	1.95				
2166.8	1.95				
2166.9	1.95				
2167.0	1.95				
2167.1	1.95				
2167.2	1.95				
2167.3	1.95				
2167.4	1.95				
2167.5	1.95				
2167.6	1.95				
2167.7	1.95				
2167.8	1.95				
2167.9	1.95				
2168.0	1.95				
2168.1	1.95				
2168.2	1.95				
2168.3	1.95				
2168.4	1.95				
2168.5	1.95				
2168.6	1.95				
2168.7	1.95				
2168.8	1.95				
2168.9	1.95				
2169.0	1.95				
2169.1	1.95				
2169.2	1.95				
2169.3	1.95				
2169.4	1.95				
2169.5	1.95				
2169.6	1.95				
2169.7	1.95				
2169.8	1.95				
2169.9	1.95				
2170.0	1.95				
2170.1	1.95				
2170.2	1.95				
2170.3	1.95				
2170.4	1.95				
2170.5	1.95				
2170.6	1.95				
2170.7	1.95				
2170.8	1.95				
2170.9	1.95				
2171.0	1.95				
2171.1	1.95				
2171.2	1.95				
2171.3	1.95				
2171.4	1.95				
2171.5	1.95				
2171.6	1.95				
2171.7	1.95				
2171.8	1.95				
2171.9	1.95				
2172.0	1.95				
2172.1	1.95				
2172.2	1.95				
2172.3	1.95				
2172.4	1.95				
2172.5	1.95				
2172.6	1.95				
2172.7	1.95				
2172.8	1.95				
2172.9	1.95				
2173.0	1.95				
2173.1	1.95				
2173.2	1.95				
2173.3	1.95				
2173.4	1.95				
2173.5	1.95				
2173.6	1.95				
2173.7	1.95				
2173.8	1.95				
2173.9	1.95				
2174.0	1.95				
2174.1	1.95				
2174.2	1.95				
2174.3	1.95				
2174.4	1.95				
2174.5	1.95				
2174.6	1.95				
2174.7	1.95				
2174.8	1.95				
2174.9	1.95				
2175.0	1.95				
2175.1	1.95				
2175.2	1.95				
2175.3	1.95				
2175.4	1.95				
2175.5	1.95				
2175.6	1.95				
2175.7	1.95				
2175.8	1.95				
2175.9	1.95				
2176.0	1.				

MCM ELECTRONICS

**WE HAVE WHAT YOU NEED AT
THE PRICES YOU WANT!**

**CALL TOLL FREE
1-800-543-4330
(IN OHIO, 1-800-762-4315)**

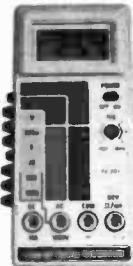

**TENMA®
3 1/2 DIGIT LCD
MULTIMETER**
■ DC Input Impedance 10M ohm
■ Diode and HFE Transistor tests
■ Overload protection ■ Auto
polarity ■ 2 year limited Warranty

\$39⁸⁰
#72-050

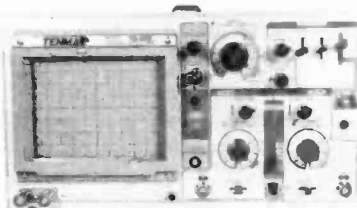

**TENMA®
20MHz DUAL TRACE
OSCILLOSCOPE**

Two High Quality 10:1 probes included.
Backed by our 2 year limited warranty.
For specifications see MCM Catalog #8
page 108.

#72-320 \$389⁹⁵



**TENMA® COMBINATION DMM/
CAPACITANCE METER
(With Transistor Gain Tester)**

■ User can easily read Voltage, AC and DC
current, resistance up to 20M ohms,
capacitance up to 20 microfarad, and HFE on a
clear 1/2 inch, 3 1/2 digit LCD display
■ 2 year limited Warranty

#72-045 \$69⁹⁵
\$74.95 each (2 or more)



**LOGIC
PROBE WITH
MEMORY**

■ Multi-family compatibil-
ity—DTL/TTL/HTL/CMOSIC
■ Detects pulses as short
as 50 nanoseconds

#72-190 \$19⁹⁵

2-WAY SPLITTER



■ Zinc diecast construction
■ Power passive
■ 5-900MHZ
#33-070 89^c (min 10)

**OSCILLOSCOPE
PROBE KIT**



■ Bandwidth: 10:1 position:
100MHz at—3dB into 20pF
■ Rise Time: 10:1 position
less than 3.5ns nominal
■ Kit contains: 10' earth
lead, retractable hook,
Ic test tip, Insulator,
BNC adaptor and
trimming tool.

#72-010 \$24⁹⁵
\$26.95 (1-4) (5-up)

MATCHING TRANSFORMER



■ 75-300 ohm matching
transformer
■ UHF/VHF/FM

#33-050 29^c (min 100)



**CHANNEL
COMBINER**

■ The 33-255 enables the
user to combine a
channel 3 output signal
from an STV, MDS, VCR
or video game device
with an existing MATV
system containing ad-
jacent channels 2 and 4.

#33-255 \$9⁸⁵
\$11.25 (1-9) (10-UP)

3-WAY SPLITTER



#33-200 \$11⁵
■ 75 ohm ■ UHF/VHF/FM
■ Comes with F-59 connector (min 10)



PUSH ON BALUN

■ Quick connect
matching
transformer
#33-010 60^c (min 50)

F-59 CONNECTOR



■ Attached 1/2"
ferrule
#33-410 15^c each

**DELUXE CORDLESS
CABLE CONVERTER
BY JERROLD®**

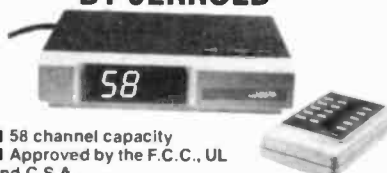

■ 58 channel capacity
■ Approved by the F.C.C., UL
and C.S.A.
■ Wireless hand controller switches channels,
turns TV set on and off and even fine tunes the
picture
■ Compatible with all cable systems
■ Jerrold® model #LCC-58-3

#32-380 \$89⁹⁵ each

**PANASONIC® TYPE VIDEO
HEAD**



■ Replaces VEHS0011
head used in 2-4-6
hour record/play-
back machines
#32-180 \$44⁹⁵ each

**BE SURE TO
CALL FOR
YOUR FREE
120 PAGE
CATALOG!
OVER 4,500
ITEMS!!**



We Also Have... a full line of: test equipment,
computer accessories, telephone accessories, speakers,
television parts, flybacks, yokes, switches, fuses, lamps,
capacitors, resistors, cartridges, styli, wire, CATV equipment,
and many more. **Over 4,500 items AT THE LOWEST PRICES
AROUND!**

Terms:



• \$10 minimum order \$1.00 charge for
orders under \$10.
• \$20 minimum charge card order
• Orders shipped UPS C O D
• Most orders shipped within 24 hours.
• Sales office open 8:30am to 6:00pm
Saturdays 10:00am to 3pm, EST

**MCM
ELECTRONICS**

858 East Congress Park Drive
Centerville, Ohio 45459
513-434-0031

*We have the Largest
Selection of Original
Japanese Semiconductors
in the Country!*

SOURCE NO. RE-2

CB EQUIPMENT

PALOMAR/Pride electronics—exclusive repair facility. Service—update—improvements on these and similar equipment. **PALOMAR-PRIDE REPAIR**, 1320-4 Grand, San Marcos, CA 92069 (619) 744-0720.

CB MODIFICATIONS

Increase channels, range, privacy! We specialize in frequency expanders, speech processors, FM converters, PLL & slider tricks, how-to books, plans, kits. Expert mall-in repairs & conversions 16-page catalog \$2.

CBC INTERNATIONAL, P.O. BOX 31500RE, PHOENIX, AZ 85046 (602) 996-8700

WANTED

INVENTIONS, Ideas, new products wanted for presentation to industry and exhibition at national technology exposition. Call **1-800-528-6050**. Arizona 1-800-352-0458. X831.

OLD tubes: 2A3, 10's, 45's, 50's, 80's, 81's, 211, 242, 845, VT-52, VT-62. **WESTERN ELECTRIC EQUIPMENTS**: (818) 576-2642, David, POB 832, M-Park, CA 91754

NEWSLETTERS

ELECTRONIC SYSTEMS NEWSLETTER is a monthly publication written especially for the electronics hobbyist/experimenter. Fascinating projects, new ideas, sources. Free details. **AF PUBLISHING**, Dept. R2, PO Box 524, So. Hadley, MA 01075.

REEL-TO-REEL TAPES

AMPEX professional series open reel tape, 1800- or 2400-foot on 7-inch reels, used once. Case of 40, \$45.00. 10½ x 3600 feet and cassettes available. MasterCard/Visa. **VALTECH ELECTRONICS**, Box 6-RE, Richboro, PA 18954 (215) 322-4866.

CABLE TV

DEALERS wanted: Channel 2, 3, and 4 notch filters. **Money back guarantee**. Send \$15.00 for sample and quantity price list. Specify channel(s). **LEE KURTZ**, PO Box 291394, Davie, FL 33329.

SINE WAVE PROBLEMS?

THE Strike Back Mode, \$6.00, includes counter-measures. **Problem Manual** includes trouble shooting, alignment, antenna connections, theory, improvements, \$8.00. Both, \$12.00. **SIGNAL**, Box 2512-R, Culver City, CA 90231.

SCANNERS

SCANNERS—discount prices Bearcat BC-100 \$279.99; Bearcat 210XL \$214.99; Bearcat 300 \$335.99; Regency MX3000 \$186.99; JIL SX100 \$138.99; JIL SX200 \$269.99; Bearcat 20/20 \$275.99; Spectrum radar detector \$214.99; plus \$3.00 shipping. Free discount catalog. Lowest prices anywhere on scanners, radar detectors, marine radios, two-way accessories. **SCANNER WORLD**, 10-RE New Scotland, Albany, NY 12208 (518) 436-9606.

INVENTORS!

IDEAS have value! Ever think of an idea, forget it, and see it later on the market? Many people don't forget, act quickly, and are rewarded by American industry. Write down your idea! We offer free disclosure registration and initial consultation regarding your idea's potential value. Call or write without delay for your free information package. **AMERICAN INVENTORS CORPORATION**, 82 Broad Street, Dept. RE, Westfield, MA 01086, (413) 568-3753. A fee based marketing company. Offices coast to coast.

HOME ROBOTS

BUILD your own personal robot. World's largest supplier of kits, parts, publications. Catalog/photos \$5.00 refundable. Design Handbook \$10.00 ppd. **ROBOT SHOP**, Dept. 10, PO Box 582, El Toro, CA 92630.

DESCRAMBLERS-CABLE-UHF-TVRO

"**SINEWAVE**" TV descrambler, video and sound in TV or VCR. Complete kit and instruction manual ready to go \$114.95 plus \$6.10 S & H. "Free flyer information." **CABLE SEARCHER**, P.O. Box 182, Carle Place Station, NY 11514.

DESCRAMBLERS

AMERICAN—CANADIAN

New Satellite Descramblers

C-1000 / ZENITH TYPE

Descrambles "over the air" and "cable" sync suppressed active video inversion signals

Ready to go C-1000 379.95
Complete Kit C-1000K 274.95
Printed Circuit & Manual 24.95

C-100 / JERROLD TYPE

Cable Descrambler for in-band gated suppressed systems

Ready to go C-100 119.95
Complete Kit C-100K 54.95

SEND \$2 FOR COMPLETE INFORMATIVE CATALOG TO DETERMINE WHAT TYPE YOU NEED.

J & D ENGINEERING
P.O. Box 6099

Falmouth, Maine 04105

Buy 1 kit
Get 2nd kit
at ½ price

Dealers Wanted
Special Quantity Pricing
COD's—OK

All J & D products are engineered, not copied, all are guaranteed 90 days & we stand behind our products where others fail to



Active



1984 Mail Order Catalog

The One Stop Electronic Shop!

Call Toll FREE 1-800-343-0874

In the United States:

Mail Orders

P.O. Box 8000
Westborough, Mass.
01581
(Mass) (617) 366-0500

Boston

133 Flanders Road
Westborough, Mass.
01581
(617) 366-9684

Seattle

13107 Northup Way
Bellevue, Wash.
98004
(206) 881-8191

In Canada:

Montreal

5651 Rue Ferrier
Montréal, Québec
H4P 1N1
(514) 731-7441

Toronto

14 Carlton Street
Toronto, Ontario
M5B 1K5
(416) 977-7692

Downsview

86 St. Regis Cr. N.
Downsview, Ontario
M3J 1Y8
(416) 630-0400

Ottawa

1023 Merivale Road
Ottawa, Ontario
K1Z 6A6
(613) 728-7900

Calgary

3220-5th Ave. N.E.
Bay 2
Calgary, Alberta
T2A 5N1
(403) 235-5300

Vancouver

3070 Kingsway
Vancouver, B.C.
V5R 5J7
(604) 438-3321

Visit your nearest Active store, call, write or circle the Reader Service Card for your copy of Active's new catalog.

RAMSEY

THE FIRST NAME IN ELECTRONIC TEST GEAR

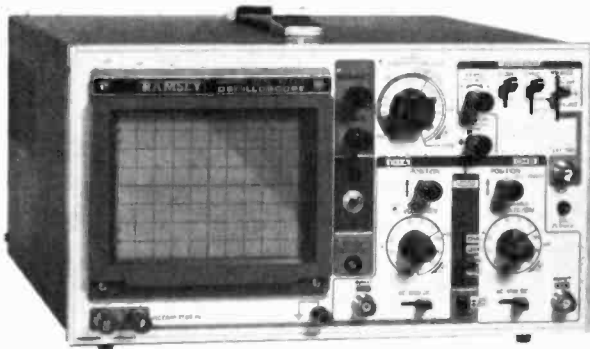

NEW FROM RAMSEY-20 MHz DUAL TRACE OSCILLOSCOPE

Unsurpassed quality at an unbeatable price, the Ramsey oscilloscope compares to others costing hundreds more. Features include a component testing circuit that will allow you to easily test resistors, capacitors, digital circuits and diodes • TV video sync filter • wide bandwidth & high sensitivity • internal graticule • high quality rectangular CRT • front panel trace rotator • Z axis • high sensitivity x-y mode • very low power consumption • regulated power supply • built-in calibrator • rock solid triggering • high quality hook-on probes

\$399.95 high quality hook-on probes included



RAMSEY D-1100 VOM-MULTITESTER

Compact and reliable, designed to service a wide variety of equipment. Features include • mirror back scale • double-jeweled precision moving coil • double overload protection • an ideal low cost unit for the beginner or as a spare back-up unit.

\$19.95

test leads and battery included



RAMSEY D-2100 DIGITAL MULTITESTER

A compact easy to use unit designed to operate like a pro. Featuring • 3 1/2 digit LCD • low BAT. indicator • all range overload protection • overrange indication • auto-polarity • Transistor tester • dual-slope integration • vinyl carrying case

\$54.95

hFE test leads, battery & vinyl carrying case included

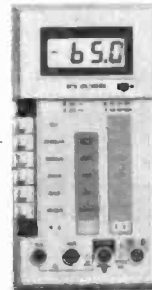

RAMSEY D-3100 DIGITAL MULTIMETER

Reliable, accurate digital measurements at an amazingly low cost • In-line color coded push buttons, speeds range selection • abs plastic tilt stand • recessed input jacks • overload protection on all ranges • 3 1/2 digit LCD display with auto zero, auto polarity & low BAT. indicator

\$59.95

test leads and battery included



CT-70 7 DIGIT 525 MHz COUNTER

Lab quality at a breakthrough price. Features • 3 frequency ranges each with pre amp • dual selectable gate times • gate activity indicator • 50mV @ 150 MHz typical sensitivity • wide frequency range • 1 ppm accuracy

\$119.95

wired includes AC adapter

CT-70 kit \$99.95
BP-4 nicad pack 8.95



CT-90 9 DIGIT 600 MHz COUNTER

The most versatile for less than \$300. Features 3 selectable gate times • 9 digits • gate indicator • display hold • 25mV @ 150 MHz typical sensitivity • 10 MHz timebase for WWV calibration • 1 ppm accuracy

\$149.95

wired includes AC adapter

CT-90 kit \$129.95
OV-1 0.1 PPM oven timebase 59.95
BP-4 nicad pack 8.95



CT-125 9 DIGIT 1.2 GHz COUNTER

A 9 digit counter that will outperform units costing hundreds more. • gate indicator • 24mV @ 150 MHz typical sensitivity • 9 digit display • 1 ppm accuracy • display hold • dual inputs with preamps

\$169.95

wired includes AC adapter

BP-4 nicad pack 8.95



CT-50 8 DIGIT 600 MHz COUNTER

A versatile lab bench counter with optional receive frequency adapter, which turns the CT-50 into a digital readout for most any receiver • 25 mV @ 150 MHz typical sensitivity • 8 digit display • 1 ppm accuracy

\$169.95

wired

CT-50 kit \$139.95
RA-1 receiver adapter kit 14.95



DM-700 DIGITAL MULTIMETER

Professional quality at a hobbyist price. Features include 26 different ranges and 5 functions • 3 1/2 digit, 1/2 inch LED display • automatic decimal placement • automatic polarity

\$119.95

wired includes AC adapter

DM-700 kit \$99.95
MP-1 probe set 4.95



PS-2 AUDIO MULTIPLIER

The PS-2 is handy for high resolution audio resolution measurements, multiplies UP in frequency • great for PL tone measurements • multiplies by 10 or 100 • 0.01Hz resolution & built-in signal preamp/conditioner

\$49.95

wired

PS-2 kit \$39.95



PR-2 COUNTER PREAMP

The PR-2 is ideal for measuring weak signals from 10 to 1,000 MHz • flat 25 db gain • BNC connectors • great for sniffing RF • ideal receiver/TV preamp

\$44.95

wired includes AC adapter

PR-2 kit \$34.95



PS-1B 600 MHz PRESCALER

Extends the range of your present counter to 600 MHz • 2 stage preamp • divide by 10 circuitry • sensitivity 25mV @ 150 MHz • BNC connectors • drives any counter

\$59.95

wired includes AC adapter

PS-1B kit \$49.95

ACCESSORIES FOR RAMSEY COUNTERS

Telescopic whip antenna—BNC plug \$ 8.95
High Impedance probe, light loading 16.95
Low pass probe, audio use 16.95
Direct probe, general purpose use 13.95
Tilt ball, for CT-70, 90, 125 3.95



PHONE ORDERS CALL
716-586-3950

TELEX 466735 RAMSEY CI

TERMS: • satisfaction guaranteed • examine for 10 days; if not pleased, return in original form for refund • add 6% for shipping and insurance to a maximum of \$10.00 • overseas add 15% for surface mail • COD add \$2.50 (COD in USA only) • orders under \$15.00 add \$1.50 • NY residents add 7% sales tax • 90 day parts warranty on all kits • 1 year parts & labor warranty on all wired units.



RAMSEY ELECTRONICS, INC.
2575 Balrd Rd.
Penfield, N.Y. 14626

THE FUN STARTS WITH SHACK® PARTS

Giant Selection!

Personal Service!

See Before You Buy!

Voltage Regulator ICs



Type	Adjustable	Cat. No.	Each
LM723	0 to 40 VDC	276-1740	.99
LM317T	1.2 to 37 VDC	276-1778	2.79

Type	Fixed Output	Cat. No.	Each
7805	+ 5 VDC	276-1770	1.59
7812	+ 12 VDC	276-1771	1.59
7815	+ 15 VDC	276-1772	1.59
7905	- 5 VDC	276-1773	1.59
7912	- 12 VDC	276-1774	1.59

Operational Amplifiers



Type		Cat. No.	Each
741	(Single)	276-007	.89
1458	(Dual)	276-038	.99
LM324	(Quad)	276-1711	1.29
TL082	(Dual)	276-1715	1.89
TL084	(Quad)	276-1714	2.99
TLC271	(Single)	276-1748	1.59
TLC272	(Dual)	276-1749	2.19
TLC274	(Quad)	276-1750	2.99
LM3900	(Quad)	276-1713	1.39
LM339	(Quad)	276-1712	1.49

4000-Series CMOS ICs

Description	Type	Cat. No.	Each
Quad 2-input NOR Gate	4001	276-2401	.99
Quad 2-input NAND Gate	4011	276-2411	.99
Dual Type-D Flip Flop	4013	276-2413	1.19
Decade Counter/Divider	4017	276-2417	1.49
Inverting Hex Buffer	4049	276-2449	1.19
Quad Bilateral Switch	4066	276-2466	1.19

TTL Digital ICs

With Pin-Out and Specs

Type	Cat. No.	Each
7400	276-1801	.89
7404	276-1802	.99
7408	276-1822	1.29
7447	276-1805	1.59
7490	276-1808	1.09

Monolithic Ceramic Capacitors



50 WVDC
NPO, ± 10% ■ Z5U, ± 20%

Value	Temperature Coefficient	Cat. No.	Each
10 pF	NPO	272-151	.69
100 pF	NPO	272-152	.69
470 pF	NPO	272-153	.69
1000 pF	Z5U	272-154	.69
4700 pF	Z5U	272-155	.69
.01 μF	Z5U	272-156	.69
.047 μF	Z5U	272-157	.69
.1 μF	Z5U	272-158	.79

Ceramic Disc Capacitors



pF	Cat. No.	Pkg. of 2	μF	Cat. No.	Pkg. of 2
4.7	272-120	.39	.001	272-126	.39
47	272-121	.39	.005	272-130	.39
100	272-123	.39	.01	272-131	.39
220	272-124	.39	.05	272-134	.49
470	272-125	.39	.1	272-135	.49

Tantalum Capacitors

- 20% Tolerance
- Standard IC Pin Spacing

μF	WVDC	Cat. No.	Each
0.1	35	272-1432	.49
0.47	35	272-1433	.49
1.0	35	272-1434	.49
2.2	35	272-1435	.59
10	16	272-1436	.69
22	16	272-1437	.79

Mini Buzzers



- Little But Loud
- 1 1/16" Mtg. Centers

DC Voltage	Cat. No.	Each
1.5-3	273-053	1.69
6	273-054	1.69
12	273-055	1.69

Quality Transformers

For Audio



Isolation. NEW! 1:1 ratio. For telephone projects, interstage coupling and more. 600 to 900 ohms impedance. 100-megohm isolation at 250 VDC. 273-1375 2.49

Audio Output. 1000-ohm center-tapped primary. 8-ohm secondary. 3/4 x 5/16 x 5/16". 273-1380 . . . 1.29

Toggle Switches



Micro-mini, rated 3 amps at 125 VAC. Body: 1/4 x 5/16 x 3/16". Mounting hole: 3/16". Solder lugs.

Type	Cat. No.	Each
SPST	275-624	1.49
SPDT	275-625	1.59
DPDT	275-626	1.89

Communication ICs

33% Off

Reg. 5.95 **3.99** Each



For RTTY and Modems

XR-2206. FSK generator. 276-2336 . . . Sale 3.99
XR-2211. FSK Decoder. 276-2337 . . . Sale 3.99

CMOS and Bipolar Timers

Low As **1.19**



TLC555. NEW! Silicon CMOS sinks 100 mA, sources 10 mA. Very accurate, yet requires smaller, less costly capacitors. 2 to 18 VDC, single supply. To 2 MHz. 276-1718 1.59
Bipolar. Resettable, 1 μS to 1 hr. Source or sink 200mA. 4.5 to 16 VDC.

Type	Dip	Cat. No.	Each
555 (Single)	8-pin	276-1723	1.19
556 (Dual)	14-pin	276-1728	1.49

Technological Breakthrough! Autoranging LCD Multimeter

79.95 ■ Auto Polarity Reverse
■ Auto Power-Off

Radio Shack's advanced technology DVM "thinks". Just select the function and it automatically selects the range! Non-glare 1 1/16" display, adjustable viewing angle, "beeper" for fast continuity tests, range-hold switch, diode/semiconductor junction check. Measures DCV to 1000, ACV to 500, to 10 amps AC/DC, resistance to 2 megs. Requires two "AA" cells. 22-193 . . 79.95



Engineered for Excellence

We've been bringing the latest in electronic technology to the marketplace for over 60 years. Our Advanced Technology emblem is your assurance that this DVM represents the state of the art in technology, outstanding quality and price breakthrough.

Engineer's IC Mini-Notebook

NEW FOR '85

Only **99¢**



Reference and hobby book covering versatile 555 and 556 integrated circuits. 32 pages. 276-5010 . . . 99¢

Installing Telephones

5.95

Illustrated



Installing Your Own Telephone. A complete do-it-yourself manual with numerous figures, schematics and pictures. 150 pages. 62-1390 5.95

OVER 8800 LOCATIONS WORLDWIDE

CIRCLE 61 ON FREE INFORMATION CARD



Folding Case

A DIVISION OF TANDY CORPORATION

Radio Shack®

Prices apply at participating Radio Shack stores and dealers



NEW!

The complete MICROCOMPUTER BREADBOARDING SOURCE at the lowest prices ANYWHERE!

Just look at all these EXTRAS built into every HANDY test socket and buss strip...

- Total contact labeling... simplifies circuit design/layout
- Self-adhesive backing... for one-step simplified alignment and mounting
- Full 9 14-Pin I.C. Capacity
- Expands both horizontally and vertically... interlocks can't break or twist off
- High temperature plastic housing... to 80°C... no warping or melting ever!
- Prices always up to 25% less than other leading brands

HB-0100 HB-1000 HB-1110
 HB-1210

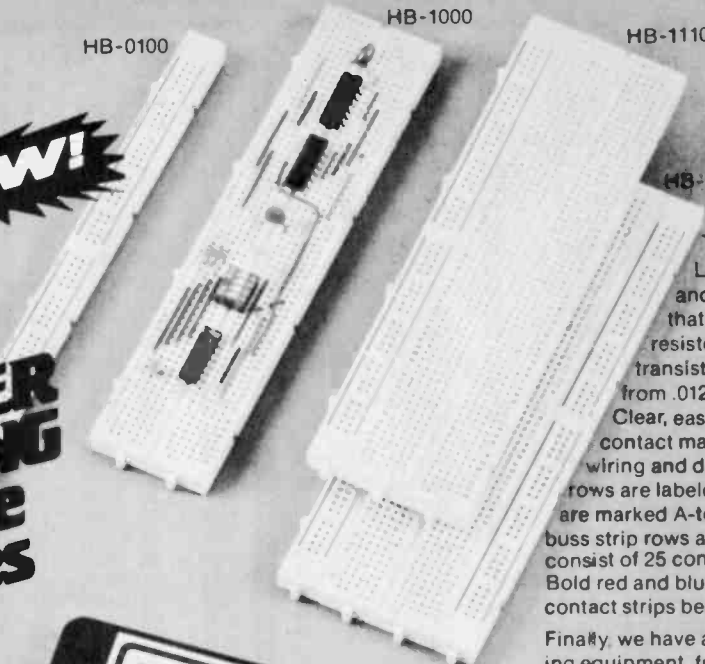

To all these add:
 Long Life, low resistance and wide range contacts that accept combinations of resistors, capacitors, diodes, transistors, I.C.s, etc. with leads from .012 - .032" or 20 - 29 AWG. Clear, easy-to-read-and-identify contact markings simplify layout, wiring and documentation. Socket rows are labeled 1-to-64, and columns are marked A-to-E and F-to-J. Mating buss strip rows are labeled A-to-D and consist of 25 contacts each. Bold red and blue lines show where contact strips begin and end.

Finally, we have a full line of breadboarding equipment, from discrete sockets and buss strips to multi-board assemblies, available at comparable lower-than-low prices.

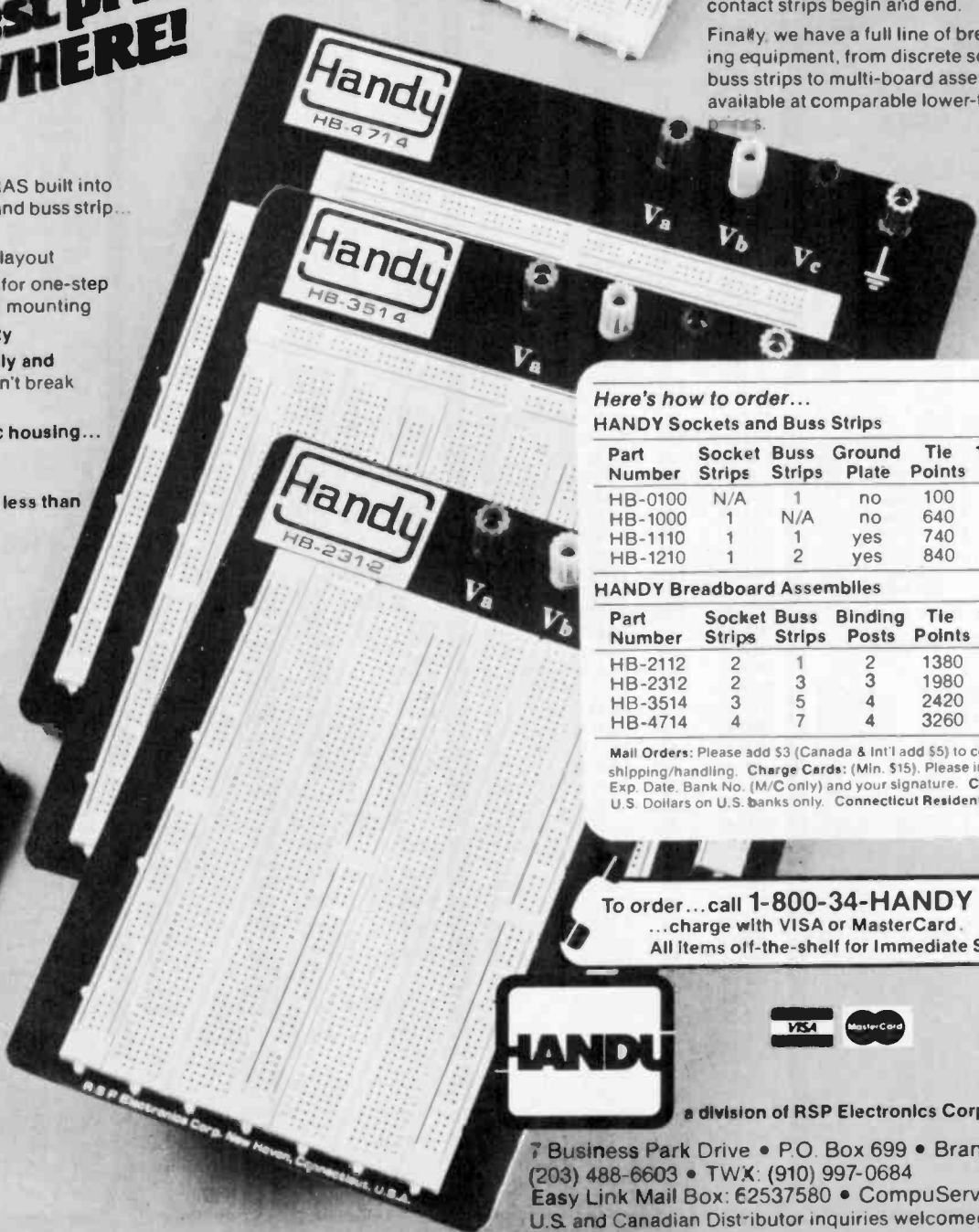

Here's how to order...

HANDY Sockets and Buss Strips

Part Number	Socket Strips	Buss Strips	Ground Plate	Tie Points	14 pin IC's	Price
HB-0100	N/A	1	no	100	N/A	2.25
HB-1000	1	N/A	no	640	9	9.95
HB-1110	1	1	yes	740	9	11.95
HB-1210	1	2	yes	840	9	13.95

HANDY Breadboard Assemblies

Part Number	Socket Strips	Buss Strips	Binding Posts	Tie Points	14 pin IC's	Price
HB-2112	2	1	2	1380	18	24.95
HB-2312	2	3	3	1980	18	31.00
HB-3514	3	5	4	2420	27	47.95
HB-4714	4	7	4	3260	36	63.95

Mail Orders: Please add \$3 (Canada & Int'l add \$5) to cover cost of shipping/handling. Charge Cards: (Min. \$15). Please include Acct No., Exp. Date, Bank No. (M/C only) and your signature. Checks: Drawn in U.S. Dollars on U.S. banks only. Connecticut Residents: Add 7% SalesTax.

To order... call 1-800-34-HANDY
 ... charge with VISA or MasterCard.
 All items off-the-shelf for immediate shipment!



a division of RSP Electronics Corp.

7 Business Park Drive • P.O. Box 699 • Branford, CT 06405
 (203) 488-6603 • TWX: (910) 997-0684
 Easy Link Mail Box: E2537580 • CompuServe: 71346, 1070
 U.S. and Canadian Distributor inquiries welcomed.

Do Kay

COMPUTER
PRODUCTS,
Inc.

ORDER TOLL FREE

(800)
538-8800

(CALIFORNIA RESIDENTS)

(800)
848-8008



STATIC RAMS

2101	256 x 4 (450ns)	1.90
5101	256 x 4 (450ns) (cmos)	3.90
2102-1	1024 x 1 (450ns)	.88
2102L-4	1024 x 1 (450ns) (LP)	.98
2102L-2	1024 x 1 (250ns) (LP)	1.45
2111	256 x 4 (450ns)	2.45
2112	256 x 4 (450ns)	2.45
2114	1024 x 4 (450ns)	.99
2114-25	1024 x 4 (250ns)	1.10
2114L-4	1024 x 4 (450ns) (LP)	1.20
2114L-3	1024 x 4 (300ns) (LP)	1.30
2114L-2	1024 x 4 (200ns) (LP)	1.40
2125	1024 x 1	2.49
2147	4096 x 1 (55ns)	4.90
YMS4044-4	4096 x 1 (450ns)	3.45
YMS4044-3	4096 x 1 (300ns)	3.95
YMS4044-2	4096 x 1 (200ns)	4.45
MK4118	1024 x 8 (250ns)	9.90
YMS2016-200	2048 x 8 (200ns)	4.10
YMS2016-150	2048 x 8 (150ns)	4.90
YMS2016-100	2048 x 8 (100ns)	6.10
HM6116-4	2048 x 8 (200ns) (cmos)	4.70
HM6116-3	2048 x 8 (150ns) (cmos)	4.90
HM6116-2	2048 x 8 (120ns) (cmos)	8.90
HM6116LP-4	2048 x 8 (200ns) (cmos)	5.90
HM6116LP-3	2048 x 8 (150ns) (cmos) (LP)	6.90
HM6116LP-2	2048 x 8 (120ns) (cmos) (LP)	9.95
Z-6132	4096 x 8 (300ns) (Qstat)	33.95
HM6254P-15	8192 x 8 (150ns) (cmos)	38.95
HM6254LP-15	8192 x 8 (150ns) (cmos)	48.95

LP = Low Power Qstat = Quasi-Static

DYNAMIC RAMS

YMS4027	4096 x 1 (250ns)	1.95
UP0411	4096 x 1 (300ns)	2.95
MS5280	4096 x 1 (300ns)	2.95
MK4108	8192 x 1 (200ns)	1.90
MS5298	8192 x 1 (250ns)	1.80
4116-200	16384 x 1 (200ns)	.79
4116-150	16384 x 1 (150ns)	1.20
2118	16384 x 1 (150ns) (5v)	4.90
4184-250	85536 x 1 (250ns)	4.45
4184-200	85536 x 1 (200ns) (5v)	5.45
4164-150	85536 x 1 (150ns) (5v)	6.45

5V = Single 5 Volt Supply

EPROMS

1702	256 x 8 (1us)	4.45
2708	1024 x 8 (450ns)	2.49
2758	1024 x 8 (450ns)	2.49
2758	1024 x 8 (450ns) (5v)	5.80
2718	2048 x 8 (450ns) (5v)	2.95
2716-1	2048 x 8 (350ns) (5v)	5.90
YMS2516	2048 x 8 (450ns) (5v)	5.45
YMS2718	2048 x 8 (450ns)	7.90
YMS2532	4096 x 8 (450ns) (5v)	5.90
2732	4096 x 8 (450ns)	4.45
2732-250	4096 x 8 (250ns) (5v)	8.45
2732-200	4096 x 8 (200ns) (5v)	11.45
2764	8192 x 8 (450ns) (5v)	6.45
2784-250	8192 x 8 (250ns) (5v)	7.45
2784-200	8192 x 8 (200ns) (5v)	16.45
YMS2564	8192 x 1 (450ns) (5v)	14.45
MC68764	8192 x 8 (450ns) (5v) [24 pin]	38.95
27128	16384 x 8 Cell	24.45

5v = Single 5 Volt Supply

74LS00

74LS00	.23	74LS173	.88
74LS01	.24	74LS174	.54
74LS02	.24	74LS175	.54
74LS03	.24	74LS181	2.10
74LS04	.23	74LS189	8.90
74LS05	.24	74LS190	.88
74LS08	.27	74LS191	.88
74LS09	.28	74LS192	.78
74LS10	.24	74LS193	.78
74LS11	.34	74LS194	.68
74LS12	.34	74LS195	.68
74LS13	.44	74LS196	.78
74LS14	.58	74LS197	.78
74LS15	.34	74LS221	.88
74LS20	.24	74LS240	.94
74LS21	.28	74LS241	.98
74LS22	.24	74LS242	.98
74LS26	.28	74LS243	.98
74LS27	.28	74LS244	1.25
74LS28	.34	74LS245	1.45
74LS30	.24	74LS247	.74
74LS32	.28	74LS248	.98
74LS33	.54	74LS249	.98
74LS37	.34	74LS251	.58
74LS38	.34	74LS253	.58
74LS40	.24	74LS257	.58
74LS42	.48	74LS258	.58
74LS47	.74	74LS259	2.70
74LS48	.74	74LS260	.58
74LS49	.74	74LS266	.54
74LS51	.24	74LS273	1.46
74LS54	.28	74LS275	3.30
74LS55	.28	74LS279	.48
74LS63	1.20	74LS280	1.95
74LS73	.38	74LS283	.68
74LS74	.34	74LS290	.88
74LS75	.38	74LS293	.88
74LS76	.38	74LS295	.98
74LS78	.48	74LS298	.88
74LS83	.59	74LS299	1.70
74LS85	.68	74LS323	3.45
74LS86	.38	74LS324	1.70
74LS90	.54	74LS352	1.25
74LS91	.88	74LS353	1.25
74LS92	.54	74LS363	1.30
74LS93	.54	74LS364	1.90
74LS95	.74	74LS365	.48
74LS96	.88	74LS366	.48
74LS107	.38	74LS367	.44
74LS109	.38	74LS368	.44
74LS112	.38	74LS373	1.35
74LS113	.38	74LS374	1.35
74LS114	.38	74LS377	1.35
74LS122	.44	74LS378	1.13
74LS123	.78	74LS379	1.30
74LS124	2.85	74LS385	1.85
74LS125	.48	74LS386	.44
74LS126	.48	74LS390	1.15
74LS132	.58	74LS393	1.15
74LS133	.58	74LS395	1.15
74LS136	.38	74LS399	1.45
74LS137	.98	74LS424	2.90
74LS138	.54	74LS447	.36
74LS139	.54	74LS490	1.90
74LS145	1.15	74LS624	3.95
74LS147	2.45	74LS640	2.15
74LS148	1.30	74LS645	2.15
74LS151	.54	74LS668	1.65
74LS153	.54	74LS669	1.85
74LS154	1.85	74LS670	1.45
74LS155	.68	74LS674	9.60
74LS156	.68	74LS682	3.15
74LS157	.64	74LS683	3.15
74LS158	.58	74LS684	3.15
74LS160	.68	74LS685	3.15
74LS161	.64	74LS688	2.35
74LS162	.68	74LS689	3.15
74LS163	.64	74LS783	23.95
74LS164	.68	81LS95	1.45
74LS165	.94	81LS96	1.45
74LS166	1.90	81LS97	1.45
74LS168	1.70	81LS98	1.45
74LS169	1.70	25LS2521	2.75
74LS170	1.45	25LS2569	4.20

7400

7400	.18	7482	.94	74172	5.90
7401	.18	7483	.49	74173	.74
7402	.18	7485	.58	74174	.88
7403	.18	7486	.34	74175	1.75
7404	.18	7489	2.10	74176	.88
7405	.24	7490	.34	74177	.74
7406	28	7491	.39	74178	1.10
7407	28	7492	.49	74179	1.70
7408	23	7493	.34	74180	.74
7409	.18	7494	.64	74181	2.20
7410	.18	7495	.54	74182	.74
7411	24	7496	.69	74184	1.95
7412	.29	7497	2.70	74185	1.95
7413	.34	74100	1.70	74190	1.10
7414	.48	74107	.29	74191	1.10
7416	24	74109	.44	74192	.78
7417	24	74110	.44	74193	.78
7420	.18	74111	.54	74194	.84
7421	.34	74116	1.50	74195	.84
7422	.34	74120	1.15	74196	.78
7423	.28	74121	.26	74197	.74
7425	28	74122	.44	74198	1.34
7426	.28	74123	.48	74199	1.34
7427	.28	74125	.44	74221	1.34
7428	.44	74125	1.44	74246	1.34
7430	.18	74129	.54	74247	1.24
7432	.28	74132	.44	74248	1.80
7433	.44	74133	.49	74249	1.90
7437	.28	74141	.64	74251	.74
7438	.28	74142	2.90	74259	2.20
7440	.18	74143	2.90	74265	1.30
7442	.48	74145	.59	74273	1.90
7443	.64	74147	1.75	74276	1.20
7444	.88	74148	1.75	74279	.74
7445	.88	74150	1.30	74283	1.95
7446	.68	74151	.54	74284	3.70
7447	.68	74152	.64	74285	3.70
7448	.68	74153	.54	74290	.94
7450	.18	74154	1.20	74293	.74
7451	.22	74155	.74	74298	.84
7453	.22	74156	.64	74351	2.20
7454	.22	74157	.54	74365	.64
7460	.22	74159	1.60	74366	.64
7470	.34	74160	.84	74367	.64
7472	.28	74161	.68	74368	.64
7473	.33	74162	.84	74376	2.15
7474	.32	74163	.68	74390	1.70
7475	.44	74164	.84	74393	1.30
7476	.34	74165	.84	74425	3.10
7480	.58	74166	.95	74426	.84
7481	1.05	74167	2.90	74490	2.50
		74170	1.60		

6500

6502	4.90	6800	58.95
6504	6.90	6801	3.90
6505	8.90	6802	7.90
6507	9.90	6808	12.90
6520	4.30	6809E	18.95
6522	6.90	6809	10.95
6523	9.90	6810	2.90
6545	21.50	6820	4.30
6551	10.85	6821	3.20
		6828	13.95
		6840	11.95
		6843	33.95
		6844	24.95
		6845	13.95
		6847	10.95
6502A	6.90	6850	3.20
6522A	9.90	6852	15.70
6532A	10.95	6860	9.90
6545A	26.95	6862	10.95
6551A	10.95	6875	6.90
		6880	2.20
		6883	21.95
		68047	23.95
		68488	18.95

3 Mhz

6502B	9.90
68000	9.95
68002	21.25
68009E	25.95
68009	28.95
68010	6.90
68021	6.90
68045	18.95
68050	5.90

6800

74S00

74S00	.31	74S163	1.90
74S02	.34	74S168	3.90
74S03	.34	74S169	3.90
74S04	.34	74S174	.94
74S05	.34	74S175	.94
74S08	.34	74S181	3.90
74S09	.39	74S182	2.90
74S10	.34	74S188	1.90
74S11	.34	74S189	6.90
74S15	.34	74S194	1.44
74S20	.34	74S195	1.44
74S22	.34	74S196	1.44
74S30	.34	74S197	1.44
74S32	.39	74S201	6.90
74S37	.87	74S225	7.90
74S38	.84	74S240	2.15
74S40	.34	74S241	2.15
74S51	.34	74S244	2.15
74S64	.39	74S251	.94
74S65	.39	74S253	.94
74S74	.49	74S257	.94
74S85	1.94	74S258	.94
74S86	.49	74S260	.78
74S212	.49	74S274	19.90
74S113			

DISC CONTROLLERS

1771	14.95	2797	84.95
1791	23.95	6843	33.95
1793	25.95	8272	38.95
1795	48.95	UP0765	38.95
1797	48.95	M88076	28.95
2791	79.95	M88077	33.95
2793	79.95	1691	18.95
2795	84.95	2143	17.95

CRYSTALS

1.0000 MHz	3.69	8.0000 MHz	2.69
1.8432 MHz	3.69	10.0000 MHz	2.69
2.0000 MHz	2.89	10.7386 MHz	2.69
2.0972 MHz	2.69	12.0000 MHz	2.69
2.4576 MHz	2.69	14.3182 MHz	2.69
3.2768 MHz	2.69	15.0000 MHz	2.69
3.5795 MHz	2.69	16.0000 MHz	2.69
4.0000 MHz	2.69	17.4300 MHz	2.69
4.1943 MHz	2.69	18.0000 MHz	2.69
4.9160 MHz	2.69	18.4320 MHz	2.69
5.0000 MHz	2.69	19.6608 MHz	2.69
5.0688 MHz	2.69	20.0000 MHz	2.69
5.1850 MHz	2.69	22.1184 MHz	2.69
5.2429 MHz	2.69	32.0000 MHz	2.69
5.7143 MHz	2.69	36.0000 MHz	2.69
6.0000 MHz	2.69	48.0000 MHz	2.69
6.1440 MHz	2.69	49.4350 MHz	2.69
6.4000 MHz	2.69	49.8900 MHz	2.69
6.5536 MHz	2.69		

32.768 KHz 1.69

CRYSTAL CLOCK OSCILLATORS

PART NO.	FREQUENCY	PRICE
1.000	1.0000 MHz	9.95
1.843	1.8432 MHz	9.95
2.000	2.0000 MHz	9.95
4.000	4.0000 MHz	9.95
8.000	8.0000 MHz	9.95
10.000	10.0000 MHz	9.95
16.000	16.0000 MHz	9.95
18.432	18.4320 MHz	9.95
19.660	19.6608 MHz	9.95
20.000	20.0000 MHz	9.95
32.000	32.0000 MHz	9.95

VOLTAGE REGULATORS

7805T	.74	7905T	.84
7805C	.34	7908T	.84
7808T	.74	7912T	.84
7812T	.74	7915T	.84
7815T	.74	7924T	.84
7824T	.74	7905K	1.44
7805K	1.34	7912K	1.44
7812K	1.34	7915K	1.44
7815K	1.34	7924K	1.44
7824K	1.34	7905L	.78
78L05	.68	79L12	.78
78L12	.68	79L15	.78
78L15	.68	LM323K	4.90
78H05K	9.90	UA78S40	1.90
78H12K	9.90		

C,T = TO-220 K = TO-3
L = TO-92

DIP SWITCHES

4 POSITION	.84
5 POSITION	.89
6 POSITION	.89
7 POSITION	.94
8 POSITION	.94

IC SOCKETS

(1 to 99)

8 pin ST	.12	8 pin WW	.58
14 pin ST	.14	14 pin WW	.68
16 pin ST	.16	16 pin WW	.68
18 pin ST	.19	18 pin WW	.98
20 pin ST	.28	20 pin WW	1.04
22 pin ST	.29	22 pin WW	1.34
24 pin ST	.29	24 pin WW	1.44
28 pin ST	.39	28 pin WW	1.64
40 pin ST	.48	40 pin WW	1.94

ST = Soldertail WW = Wirewrap

ZIF SOCKETS

16 pin ZIF	5.90
24 pin ZIF	7.90
28 pin ZIF	8.90

ZIF = TEXTTOOL (Zero Insertion Force)

1984

— THE IC MASTER —
Your ticket to fast and
easy IC selections
\$ 89.⁹⁵



IBM Expansion KIT
Upgrade Chips
4164 200ns 9 @ 5.45 ea.

micromax

VIEWMAX-80 149.⁹⁵

- 80 Column card for Apple II+
- Video Soft Switch
- Inverse Video
- 2 Year Warranty



VIEWMAX-80e 129.⁹⁵

- 80 Column card for Apple IIE
 - 64K RAM expandable to 128K
- 64K RAM Upgrade 43.⁶⁰**

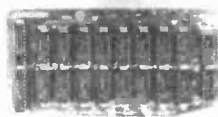

QUV-T8/1
EPROM Eraser

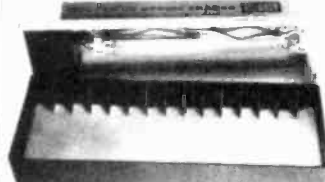

QUV-T8/1 Economy Model:

Low cost EPROM eraser in plastic enclosure. The UV element is in the lid and you place the EPROMS in the bottom half. No timer or switch option.

- Erases up to 8 EPROMS in 15 - 20 minutes.
- 12,000 uWatts at 1" distance.
- 90-Day Warranty **49.⁹⁵**

The FLIP SORT™

The new Flip Sort™ has all the fine qualities of the original with some added benefits: a new design and 50% greater capacity. Holds 75 diskettes and the price is now lower than ever — **\$16.95**



ATHANA

BULK 5 1/4"

DISKETTES
(NO LABEL)

SS/SO	15.90
SS/DD	16.90
DS/DD	22.90

10/14.90
100 up — CALL

APPLE ACCESSORIES

80 Column Apple II+	149.95
80 Column Apple IIE	129.95
Z80 Apple II+	89.00
Z80 Apple IIE	89.00
16K Card	39.95
Cooling Fan	38.95
Power Supply	74.95
Joystick	29.95
RF Modulator	13.95
Disk Drive	199.00
Controller Card	59.95

APPLE COMPATIBLE DISK DRIVE

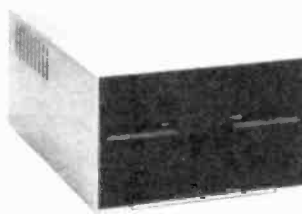

199.⁰⁰

- Shugart mechanism, made in U.S.A.
- Directly replaces Apple Disk II
- Fully compatible with Apple Controller or other Apple compatible controllers.
- One Year Warranty

CONTROLLER CARD... 59.95

COOLING FAN

38.⁹⁵

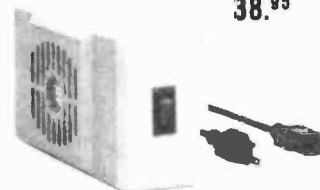

APPLE COMPATIBLE POWER SUPPLY

74.⁹⁵

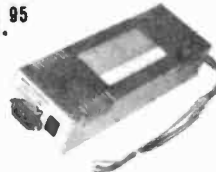

- Powers Apple type systems
- +5V @ 5A +12V @ 3A
-5V @ .5A -12V @ .5A
- Includes Instructions

The Flip Sort PLUS™

The new Flip Sort PLUS™ adds new dimensions to storage. Its smoked acrylic elegance holds over 100 diskettes with all the features you expect from the Flip Sort Family — **\$24.95**



APPLE COMPATIBLE JOYSTICK



29.⁹⁵

16K RAM Card - Apple II+
• 2-Year Warranty



Assembled & Tested **39.95**
For the APPLE HOBBIEST
DoKay KITS:

16K RAM card..... 24.95
80 Column Card II+... 89.95
Z80 Card..... 69.95
Printer Card..... 24.95
80 Column Card IIE ... 89.95
KEYBOARD (99/4)
48 keys 4" x 10" **6.95**



Reg. Power Supply
Model 4A/PS (99/4)
3 DC Outputs:

12V @ .4A, +5V @ 1.1A
-5V @ .2A Highly Filtered

6.95



TERMS: Minimum order \$10.00.
For shipping and handling, include \$2.50 for UPS ground or \$3.50 for UPS Blue (air). For each additional air pound, add \$1 for UPS Blue shipping and handling. California residents must include 6% sales tax; Bay area and LA residents include 6 1/2% sales tax. Prices are subject to change without notice. We are not responsible for typographical errors. We reserve the right to limit quantities and to substitute manufacturers. All merchandise subject to prior sale.

CALL for VOLUME Quotes

HOURS: Mon. - Fri. 7:30 to 5:00
Saturdays 10:00 to 3:00

VISIT OUR RETAIL STORE

2100 De La Cruz Blvd.
Santa Clara, CA 95050
(408) 988-0697

**ALL MERCHANDISE IS
100% GUARANTEED**

Telex: 756440

DoKay



64K APPLE II COMPATIBLE
ASSEMBLED AND TESTED
NOW ONLY **\$399⁰⁰**

MICRO-II COMPUTER
100% APPLE COMPATIBLE



48K **\$340⁰⁰**
64K **\$399⁰⁰**

COOLING FAN



WITH SURGE SUPPRESSOR AND 2 OUTLETS
SALE PRICE **\$39⁰⁰** EACH

AC POWER CENTER



WITH SURGE-SUPPRESSOR
6 OUTLETS
4 CONTROLLED
2 UNCONTROLLED
\$14⁹⁵ EACH

TILTABLE MONITOR STAND

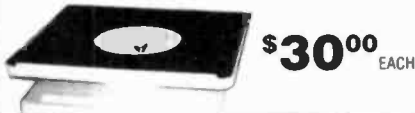

\$30⁰⁰ EACH

DISK BOX



HOLDS 100 PCS.
5 1/4" DISKETTES
WITH REMOVABLE
TOP AND LOCKS
\$14⁹⁵

DISK HOLEPUNCH

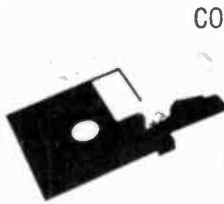

CONVERTS YOUR
DISKETTES
TO DOUBLE
SIDED.
\$8⁹⁹ EACH



HEAD
DISK DRIVE
HEAD CLEANING KIT
for 5 1/4" DISK DRIVES
SALE **\$13⁰⁰** EACH

**DISK DRIVES FOR
YOUR APPLE**



SUPER 5
T-40 SLIM DRIVE
OUR PRICE **\$175⁰⁰**



ALPS-A40
SINGLE SIDED DRIVER
HALF-HEIGHT
OUR PRICE **\$150⁰⁰**



MSCI
FULL HEIGHT
MODEL A2
SALE **\$190⁰⁰** EACH



ASUKA
HALF-HEIGHT
THE MOST QUIET DRIVE
IN THE MARKET
SALE **\$198⁰⁰**



**HEAVY DUTY
JOY STICK**
METAL CASE with
2 MICRO SWITCHES
for APPLE II+ or IIE
SPECIAL **\$19⁹⁵** EACH

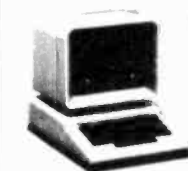

**SPECIAL
MINIATURE
COMPUTER CLOCK**
*LCD CLOCK WITH
TIME AND DATE
AN IDEAL GIFT!
BUY 2 FOR
ONLY **\$9⁰⁰**

PRINTER by Super-5



Parallel Interface (Centronics Compatible)
Standard Microprocessor
Electronics
80cps Bidirectional with
Logic Seeking
96 Character ASCII
Adjustable Sprocket and
Friction Feed

Model CP-80. **\$265⁰⁰**

12" Green



HIGH RES
MONITOR
with
NON GLARE SCREEN
by
GORILLA
\$99⁰⁰

Monitor Cable **\$3.00**

**THE BEST PRINTER CARD
GRAPHIC CARD by:
PRACTICAL PERIPHERALS**



- SUPPORTS ALL KINDS OF SOFTWARE
- SUPPORTS MOST MAKES OF PRINTERS
- DUMP GRAPHICS

OUR PRICE **\$76⁵⁰**

**COMPARE OUR PRICES ON
APPLE COMPATIBLE PERIPHERALS**

AUTOTERM 80 COLUMN CARD w/Soft Switch	\$89.00
80 COLUMN CARD (Videx Compatible)	69.00
SOFT SWITCH for Videx 80 Column Card	35.00
Z80 CP/M CARD	69.00
16K RAM CARD (Language) Cables	39.00
GRAPHIC PRINTER CARD (Support most Printers)	89.00
PARALLEL PRINTER CARD	59.00
SERIAL INTERFACE CARD (RS 232)	59.00
SUPER SERIAL CARD (Communication Card)	120.00
DISK CONTROLLER CARD (Standard)	45.00
DISK CONTROLLER CARD (3-2, 3-3 Auto Select)	55.00
EPRDM PROGRAMMER CARD (for 2716/2732/2764)	75.00
128K RAM CARD (Saturn Compatible)	199.00
TTL IC TESTER CARD (for most TTL IC)	160.00
RGB COLOR INTERFACE CARD	89.00
P.A.L. TV INTERFACE CARD (for European TV)	45.00
CDPY CARD (Wildcard Compatible)	55.00
SPEACH SYNTHESIZER (SAM Card)	35.00
6809 INTERFACE CARD	170.00
CHINESE CRG GENERATOR CARD	CALL
8088 MS/DOS CARD	CALL

RF MODULATOR



Allows you to connect your
computer to your Television.
CH 3/4 Selectable

\$12⁹⁵ EACH



FORMULA INTERNATIONAL INC.

12603 Crenshaw Blvd., Dept. B, Hawthorne, CA 90250
For information (213) 973-1921 • Orders Only (outside Calif.) (800) 672-8758

IBM is a registered trade mark of IBM.
CPM is a registered trade mark of Digital Research.

MINIMUM ORDER \$10.00. CA Residents add 6.5% Sales Tax.
Phone orders accepted on VISA or Mastercard only. No COD's.
Prices subject to change without notice.

SHIPPING AND HANDLING CHARGES

Purchase	Over \$50.00
Under \$50.00	Purchase
10%	5%
15%	10%
25%	20%

Inside CA
Outside CA
Outside USA

STORE HOURS

Mon.-Fri 10am-7pm

Sat. 10am-6pm

PLEASE NOTE: A 15% re-stocking charge will be made to customer for all returned merchandise.

QUALITY SPECIALS

SOPHISTICATED I.C.'S

DATA SHEETS ARE PROVIDED FREE WITH ALL INTEGRATED CIRCUITS LISTED BELOW

PART #	DESCRIPTION	PRICE (EACH)
LS7232	TOUCH SENSITIVE LIGHT DIMMER SWITCH MOMENTARY TOUCH TO SENSOR PLATE TURNS LIGHTS ON OR OFF. PROLONGED TOUCH GRADUALLY DIMS OR BRIGHTENS. A SLOW CLOCK INPUT ALLOWS AUTOMATIC SLOW DIMMING TO OFF IDEAL FOR SOLVING CHILD'S FEAR OF DARK BEDROOM.	\$4.90
R00104	CMOS DIVIDER I.C. HAS TRUTH-TABLE SELECTABLE INPUT TO YIELD DIVIDE BY 100, 1000 OR 10000 OUTPUTS.	\$3.90
LS7033	D.C. TO 5MHz SIX DECADE MOS. UP COUNTER WITH 8 DECADE LATCH AND MULTIPLIED BCD OUTPUTS AND DIGIT STROBES ACCESS TO 150 LATCHES ALLOWS ATTACHMENT OF PRECALCULATED FOR COUNTING TO 500MHz.	\$13.75
LS7270	14 PIN DIP AUTOMOTIVE MARINE ANTI-THEFT DIGITAL LOCK CIRCUIT HAS 5000 4-DIGIT COMBINATIONS WITH 25 MICROAMP STANDBY SAVE MODE FOR VALET PARKING.	\$3.90
R22228C	MULTIPLIER DETECTOR I.C. FOR ANALOG SIGNAL PROCESSING CONTAINS 4 QUADRANT ANALOG MULTIPLIER MODULATORS AND INDEPENDENT HIGH GAIN ONAMP DIFFERENTIAL 4-8 BIT APPLICATIONS FOR PHASE DETECTION UP TO 100 MHz. PLL DESIGN IN SYNC AM DETECTION OF GENERATION TRIANGLE TO SINEWAVE CONVERSION OR FREQUENCY TRANSLATION.	\$3.70
ICL8038	PRECISION WAVEFORM GENERATOR I.C. PRODUCES SINE, SQUARE TRIANGLE, SAWTOOTH OR PULSE WAVEFORMS WITH MINIMUM EXTERNAL COMPONENTS FROM 0.1Hz TO 1 MHz. FOR PRECISION TEST INSTRUMENTS.	\$3.75
R2135C	HIGH FREQUENCY PHASE LOCKED LOOP PLL I.C. FOR BOTH ANALOG AND DIGITAL COMMUNICATIONS 0.5Hz TO 30MHz. USES INCLUDE FM DEMODULATION, FREQUENCY SYNTHESIS FOR CODING/DECODING, MIDBAND DTL, TTL, ECL LOGIC COMPATIBLE.	\$4.70
CS28A	INTRUSION ALARM OPTICAL TRANSDUCER I.C. NEEDS IR LED PHOTO DIODE & PASSIVE PARTS TO BE COMPLETE OPTICAL TRANSDUCER SYSTEM. CAN BE FAIRLY OPEN TO AMBIENT LIGHT WITHOUT FALSE ALARMS.	\$5.95
HALF TITEL DEVICES		
U0N3501T	HALL EFFECT SENSOR FOR MAGNETIC FIELD CHANGES TOO SMALL TO SWITCH THE HALL SWITCH OUTPUT. IT'S A LINEAR FUNCTION OF MAGNETIC FIELD INTENSITY MONOSTRUC. I.C. INCLUDES HALL CELL, AMPLIFIER AND VOLTAGE REGULATOR FOR 4.5 TO 24VDC. FOR HIGH SENSITIVITY AND FLAT RESPONSE 8 PIN DIP.	\$2.80
U0N301M	SAME AS U0N3501 BUT WITH PROVISION FOR NULLING THE OUTPUT OFFSET VOLTAGE 8 PIN DIP.	\$2.80
U0N3804M	HALL EFFECT SENSOR WITH DIFFERENTIAL OUTPUT A LINEAR FUNCTION OF MAGNETIC FLUX SUPPLIED WITH IN DIVIDUAL CALIBRATION CHART AT 25 DEGREES CELSIUS & 5 VOLTS FOR CALIBRATING TESTING AND ALIGNING MAGNETIC SENSING DEVICES 8 PIN DIP.	\$4.90

GOLDSMITH SCIENTIFIC CORPORATION

720 E. Industrial Park Dr., Manchester, NH 03103
PHONE ORDERS WELCOME (603) 424-8030
FREE CATALOG OF NEW DEVICES
POSTAGE—ADD \$4 PLUS \$1.50 INSURANCE. C.O.D. \$2.00 EXTRA
SATISFACTION FULLY GUARANTEED

CIRCLE 86 ON FREE INFORMATION CARD

DON'T BLAME THE SOFTWARE!

Our Isolators eliminate equipment interaction, clean up interference, curb damaging power line spikes and lightning bursts.

ISO-1 ISOLATOR

3 isolated sockets; quality spike suppression; basic protection. . . \$81.95

ISO-3 SUPER-ISOLATOR

3 dual isolated sockets; suppressor; commercial protection. . . . \$122.95

ISO-17 MAGNUM ISOLATOR

4 quad isolated sockets; suppressor; laboratory grade protection. . . \$213.95

ESP® Electronic Specialists, Inc.

171 S. Main, Natick, MA 01760 (617) 655-1532
Toll Free Order Desk 1-800-225-4876
MasterCard, VISA, American Express

CIRCLE 6 ON FREE INFORMATION CARD

AMAZING DEVICES

PERSONAL DEFENSE AND PROPERTY PROTECTION UTILIZE SPACE AGE TECHNOLOGY. CAUTION THESE DEVICES CAN BE HAZARDOUS AND MAY SOON BE ILLEGAL.

PHASORS

POCKET PAIN FIELD GENERATOR — IPG50
Assembled \$59.50
IPG50 Plans \$7.00 IPG5K Kit/Plans \$39.50

PHASOR PAIN FIELD CROWD CONTROLLER — PPF10
Assembled \$250.00
PPF10 Plans \$15.00 PPF1K Kit/Plans \$175.00

BLASTER— Provides a plasma discharge capable of puncturing a can.
BLS10 Assembled \$79.50
BLS10 Plans \$10.00 BLS1K Kit/Plans \$59.50

SHOCKER/PARALYZING DEVICE— Very intimidating and effective.
SHG60 Assembled \$99.50
SHG60 Plans \$10.00 SHG6 Kit/Plans \$79.50

LASERS

RUBY LASER RAY GUN— Intense visible red beam burns and welds hardest of metals. **MAY BE HAZARDOUS.**
RUB3 All Parts Available for Completing Device \$15.00
CARBON DIOXIDE BURNING, CUTTING LASER— Produces a continuous beam of high energy. **MAY BE HAZARDOUS.**
LC5 All Parts Available for Completing Device \$15.00

VISIBLE LASER LIGHT GUN— produces intense red beam for sighting, spotting, etc. Hand held complete.
LGU3 Plans \$10.00 (Kit & Assembled Units Available)

IR PULSED LASER RIFLE— Produces 15-30 watt infra-red pulses at 200-2000 per sec.
LRG3 All Parts & Diodes Available \$10.00

BEGINNERS LOW POWER VISIBLE LASER— Choice of red, yellow, green— provides an excellent source of monochromatic light.
LHC2 Plans \$5.00 LHC2K Kit \$29.50

SECURITY

SNOOPERPHONE— Allows user to call his premises and listen in without phone ever ringing.
SNP20 Assembled \$89.50
SNP20 Plans \$9.00 SNP2K Kit/Plans \$59.50

LONG RANGE WIRELESS MIKE— Miniature device clearly transmits well over one mile. Super sensitive, powerful.
MFT1 Plans \$7.00 MFT1K Kit/Plans \$39.50

WIRELESS TELEPHONE TRANSMITTER— Transmits both sides of phone conversation over one mile, shuts off automatically.
VWPM5 Plans \$8.00 VWPM5K Kit/Plans \$34.50

TALK & TELL AUTOMATIC TELEPHONE RECORDING DEVICE— Great for monitoring telephone use.
TAT20 Assembled \$24.50
TAT20 Plans \$5.00 TAT2K Kit/Plans \$14.50

Our phone is open for orders anytime. Technicians are available 9-11 a.m., Mon-Thurs for those needing assistance or information. Send for free catalog of hundreds more similar devices. Send check, cash, MO, Visa, MC, COD to: **INFORMATION UNLIMITED**
DEPT RB, P.O. Box 716, Amherst, N. H. 03031 Tel. 603.673-4730

CIRCLE 88 ON FREE INFORMATION CARD

TUSA — A WHOLE NEW WORLD OF TV VIEWING WITH TUSA'S NEW MODEL CVU-40, 40 CHANNEL CABLE TV CONVERTER. Receive all the EXTRA CABLE TV "MIDBAND" & "SUPERBAND" CHANNELS on your TV. Dial.

Estimates the need for ranting or leasing. This system takes the "midband" and "superband" channels via TV, VCR or projector can't receive and converts them to standard UHF channels that any TV can tune by.

A MUST FOR VIDEO TAPING FROM CABLE TV! This system allows you to program both pay per view TV decoder required and standard cable channels for taping on any VCR — while you are watching a different channel on your TV.

Simple to install and operates on any make of TV with UHF. **Now \$24.95.** Plus postage.

NOW AVAILABLE
NEW TUNEABLE DELUXE MODEL CVU-1000 **\$29.95 ea.**

WINDWARD 7-ELEMENT SANYO UHF VARIATOR TUNERS
75 OHM UHF YAGI ANTENNAS 75 Ohm Input - 45 MHz Output Channels 14 - 83

OPTIONAL Windward UHF Antenna Phasing 180° Gain NF 1.8dB **\$38.95 ea.**

12 db GAIN Specify Channel **\$8.95 EA.**
4 DR MORE **\$7.95 EA.**

MODEL 115-B-033A **Now! \$16.95 EACH**

All units are brand new from Sanyo. Call for Quantity Prices.

COMPUCARD THE SOLUTION TO Constant POWER PROTECTION

For computers, word processors, modems, etc. using instruments, audio machines, audio video and photographic equipment.

CompuCard's continuous power protection features protect your electronic equipment from voltage fluctuations, providing you with an electronically controlled, clean sine wave voltage with 4 fully protected outlets.

CompuCard CPP-120 **\$59.95**
3-way surge protection against all power line surges. Bi-directional noise interference filter (EMI/RFI). Over-voltage/under-voltage detection & warning system. Built-in diagnostic: 4 outlets, 10 amp overload protection circuit built-in.

CompuCard CPP-12 **\$39.95**
Same as CPP-120 but w/o warning system.

QUALITY POWER TRANSFORMERS
24V CT, 500 MA
\$3.19 ea. 10 - 45 **\$2.75 ea.**
50 or more **\$2.25 ea.**
For Larger Quantities Call

COLORMAX 36 CHANNEL REMOTE CATV CONVERTER

Now you can change channels or fine-tune your TV set by remote control up to 20 ft. away. This unit receives channels 2-13 plus mid & super-band cable channels then outputs them on Channel 3.

MODEL CM35-2P 2 pc. **REMOTE CONTROL**

View of this unit may be subject to change by your local cable TV Co.

1 **\$69.95 ea.**
3 or more **\$64.95 ea.**

TELEPHONE LINE ANALYZER Model 1042

Fast and easy-to-use for quick line checks. No external power required. Isolates problem to telephone line or telephone. Tests wiring, polarity, yourself installation and line functions that affect telephone operation. Complete instructions included. **\$16.95 ea.**

Model 1045 TELEPHONE PRODUCT TESTER

Tests corded/cordless phone operation and automatic phone dialers for all basic functions, defects in line & hand set cords, tone or pulse dial operation, ringing circuit operation, sound volume and voice quality. **\$329.95 ea.**

ISO-TIP

Wahl Soldering Irons

MODEL 7470 Temperature-Adjustable Micro Soldering Station
Contact: 500° to 700°
Perfected for micro circuits and fine wire. Grounded tip. Comes with 3/32" B type tip, 10 wing sponge & stand. 3 wire grounded power supply cord. **\$39.95 ea.**

MODEL 7700 "Quick Change" Iso-Tip Cordless Soldering Iron
Rechargeable completely in 3-4 1/2 hours or in 1-2 hours for partial day. Filtered battery. Cannot overcharge, up to 125 electronic parts can be changed. Kit contains cordless soldering iron, stand, 7545 tip, 7546 tip & instructions. **\$29.95 ea.**

MODEL 7800 Iso-Tip "Hot" Cordless Soldering Iron
Fastest recharging cordless soldering iron on the market. Same as 7800 but recharges in one hour. **\$39.95 ea.**

GEN. INSTRUMENT LC58 58 CHAN. CATV CONVERTER

Receives all the standard VHF, UHF and Superband cable TV channels. Provides excellent reception on any channels that are not being accepted by your local cable company. Converts all cable channels to channel 3 for viewing on your regular TV set. Hand held remote control allows remote channel change and TV set. Hand held antenna remote control allows remote channel change and TV set. To receive the cable frequencies you must subscribe to your local cable company.

\$89.95 **\$94.00**
each

144001 DIODES
15 for \$1.00... 100 for \$5.00

SURPLUS SYLVANIA VHF VARIATOR TUNERS
45 MHz output. Channels 2 through 13 as well as the mid-band channels. Hookup data included. **WHILE THEY LAST \$13.95 ea.**

Car Stereo SIGNAL BOOSTER
Model BF-8808 Amplifies FM radio signals an average of 10db (8 times), improves reception and extends range to allow a greater selection of stations and reduces fading. Install in minutes, under dash on radio antenna cable. Separate switch and indicator light. 12 VDC. **ON SALE \$24.95**

DESIGNER'S NOTEBOOK

continued from page 97

- If R1 is close to R2, then $f = .56/RC$, where R is the average of R1 and R2.
- If R1 is much larger than R2, then $f = .46/R1C$.
- If R1 is much smaller than R2, then $f = .722/R1C$.

The output will be a squarewave with a duty-cycle that's pretty close to 50/50. That only happens with CMOS inverters because the switching point is the threshold of the inverters and (for CMOS) that's halfway up the supply rail. That switching characteristic also makes the circuit almost immune to power-supply spikes and other nasties.

The output frequency of the circuit is a function of the propagation delay through the gates. That means that the output stability will degrade as the frequency increases. The propagation delay is a constant and the lower the frequency, the smaller it (the delay) will be relative to each output pulse.

R-E

ORDER NOW TOLL FREE 800-854-4655
OUTSIDE CALIFORNIA 714-635-5090
INSIDE CALIFORNIA 714-635-5090

R.F. ELECTRONICS

1086-C N. STATE COLLEGE BLVD., DEPT. R ANAHEIM, CALIFORNIA 92806

OPEN TUES - FRI 10 - 6
SAT 10 - 5
CLOSED SUN & MON

MOST ORDERS SHIPPED WITHIN 24 HOURS — NO MINIMUM ORDER
ALL PREPAID ORDERS 2 LBS OR LESS MUST INCLUDE \$2.50 SHIPPING & HANDLING — SHIPPED SAME DAY RECEIVED

CIRCLE 27 ON FREE INFORMATION CARD

WE HAVE QUALITY PARTS, DISCOUNT PRICES AND FAST SHIPPING!

TRANSFORMERS



120 volt primaries

5.6 VOLTS @ 750 MA \$3.00
 6 VOLTS @ 150 MA \$1.25
 12 VCT @ 200 MA \$2.00
 18 V. @ 650 MA \$3.50
 18 VOLTS @ 1 AMP \$4.50
 24 VOLTS @ 250 MA \$2.50
 24 VCT @ 1 AMP \$4.50
 42 VCT @ 1.2 AMP \$4.50

RS-232 EXTENTION



9 LINE CONNECTED. LINES 1 THROUGH 8 & 20. DB25 MALE TO FEMALE. 10 FEET SHIELDED. \$11.00 EACH

MIKE CONNECTOR

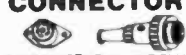

5 CONDUCTOR IN-LINE PLUG AND CHASSIS MOUNT JACK TWIST LOCK STYLE. SAME AS SWITCHCRAFT 12CL5M. \$2.50 PER SET

7 CONDUCTOR RIBBON CABLE



SPECTRA-STRIP RED MARKER STRIP 28 GA STRANDED WIRE \$5.00 PER ROLL (100 FT.)

8 TRACK RECORD/PLAY TAPE DECK



MORSE MODEL 94-A

8 TRACK RECORD WITH AUTO STOP NOT FULLY FUNCTIONAL. REMOVED FROM ASSEMBLY LINE FOR MINOR PROBLEMS. IDEAL FOR PARTS. EACH UNIT CONTAINS SWITCHES, LIGHTS, TAPE MOTOR, BELT, WHEELS, PULLEYS, PRE AMPS, TAPE HEADS, ETC

SPECIAL PRICE \$4.00 EACH
 10 for \$35.00

WALL TRANSFORMER

ALL ARE 115 VAC PLUG IN



4 VDC @ 70 MA \$2.00
 6 VDC @ 100 MA \$2.50
 6 VDC @ 500 MA \$5.00
 15 VAC @ 300 MA \$3.00
 16.5 VAC @ 10 VA \$3.50
 17 VAC @ 500 MA \$4.00

MULTI-SWITCHES

3 STATION NON-INTERLOCKING

3 - 2PDT SWITCHES. EACH OPERATES INDEPENDENTLY.

1 3/4" BETWEEN MOUNTING CENTERS. \$1.75 EACH

5 STATION INTERLOCKING

MADE BY ALPS. 3 - 2PDT AND 2 - 6PDT SWITCHES ON FULLY INTERLOCKING ASSEMBLY.

3 3/4" BETWEEN MOUNTING CENTERS. \$2.50 EACH

5 STATION NON-INTERLOCKING

SAME AS ABOVE. EXCEPT EACH SWITCH OPERATES INDEPENDENTLY.

\$2.50 EACH

METER

0 - 15 V.D.C.

THIS 2-1/4" SQUARE METER MEASURES 0-15 VDC. \$4.50 EACH

SUB-MINIATURE D TYPE CONNECTOR

SOLDER TYPE SUB-MINIATURE CONNECTORS USED FOR COMPUTER HOOK UPS.

DB-15 PLUG \$2.75
 DB-15 SOCKET \$4.00
 DB-15 HOOD \$1.50
 DB-25 PLUG \$2.75
 DB-25 SOCKET \$3.50
 DB-25 HOOD \$1.25

"PARALLEL" PRINTER CONNECTOR

SOLDER STYLE 36 PIN MALE USED ON "PARALLEL" DATA CABLES. \$5.50 EACH

I.D.C. MALE

WILL PRESS FIT ON STANDARD RIBBON CABLE. \$8.00 EACH

COMMUNICATION MICROPHONE



NEW C B STYLE MIKE WITH PUSH S P D T SWITCH. \$5.00 EACH

PUSHBUTTON POWER SWITCH



DOUBLE POLE POWER SWITCH PUSH-ON, PUSH OFF. \$1.00 EACH

NEON W/ RESISTOR

DIRECT OPERATION 7 for \$1.00 FROM 120 VOLT

120V INDICATOR

NEON INDICATOR RATED 120 V 1/3 W MOUNTS IN 5/16" HOLE RED LENS. 75¢ EACH
 10 FOR \$7.00
 100 FOR \$65.00

2K 10 TURN MULTI-TURN POT

SPECTROL #MOD 534-7161 \$5.00 EACH

EDGE CONNECTORS

ALL ARE 156" SPACING

10 PIN EDGE CONNECTOR

TRW #50-10-A-20 \$2.00 EACH

18/36 GOLD SOLDER EYELET

\$2.00 EACH

22/44 TIN P.C. STYLE, NO MOUNTING EARS

\$1.50 EACH 10 FOR \$14.00

22/44 GOLD P.C. STYLE

\$2.00 EACH 10 FOR \$18.00

28/56 GOLD

28/56 GOLD PLATED CONTACTS 156 CONTACT SPACING \$2.50 EACH 10 FOR \$22.00

SWITCHES

MINI-PUSH BUTTON

S.P.S.T MOMENTARY NORMALLY OPEN 1/4" BUSHING

35¢ EACH
 10 FOR \$3.25
 100 FOR \$30.00

SOLID STATE BUZZER

STAR #SMB-06L 6 VDC TTL COMPATIBLE \$1.00 EACH
 10 FOR \$9.00

SOLID STATE RELAY

HEINEMANN ELECTRIC #101 5A-140-5 AMP CONTROL 3-32VDC LOAD 140WAC 5 AMPS SIZE 2" X 1" X 4" HIGH \$5.00 10 FOR \$45.00

SPRING LEVER TERMINALS

TWO COLOR CODED TERMINALS ON A STURDY 2 3/4" x 3 3/4" BAKELITE PLATE. GREAT FOR SPEAKER ENCLOSURES OR POWER SUPPLIES



\$1.00 EACH 10 FOR \$9.00

2 CHANNEL LIGHT ORGAN

EASILY HOOKS INTO STEREO SPEAKERS AND ALLOWS 110 VAC LIGHTS TO DANCE WITH MUSIC. TWO SEPARATE 110 VAC OUTPUTS FOR HIGH AND LOW FREQUENCY AUDIO SIGNALS. USE TWO ORGANS FOR STEREO. \$6.50 PER UNIT
 COLOR LIGHT STRING AVAILABLE \$1.75 EA



FREE! FREE! FREE! SEND FOR NEW LARGER! 48 PAGE CATALOG FREE! FREE! FREE!

LINE CORDS

TWO WIRE 6' 18ga TWO WIRE 3 FOR \$1.00

THREE WIRE 18 INCH 18ga THREE WIRE 2 for \$1.00

8 FOOT 18ga THREE WIRE \$2.00 EACH

KEY ASSEMBLY

5 KEY \$1.00 EACH

CONTAINS 5 SINGLE-POLE NORMALLY OPEN SWITCHES. MEASURES 3 3/4" LONG

6 KEY \$1.25 EACH

CONTAINS 6 SINGLE-POLE NORMALLY OPEN SWITCHES. MEASURES 4 1/4" LONG

BATTERY OPERATED SMOKE DETECTOR



BRK MODEL #79R UL APPROVED 9 VOLT BATTERY OPERATION FOR CEILING OR WALL MOUNT \$8.00 EACH 2 FOR \$15.00

ROTARY SWITCH

1 POLE 6 POSITION 1 1/4" DIA x 1 1/2" HIGH 75¢ EACH 10 for \$6.00

RELAYS

MINIATURE 6 VDC RELAY

SUPER SMALL SPDT RELAY. GOLD COBALT CONTACTS.

RATED 1 AMP AT 30 VDC. HIGHLY SENSITIVE. TTL DIRECT DRIVE POSSIBLE. OPERATES FROM 4.3 TO 6 V. COIL RES 220 OHM.

13-16" - 13/32" - 7/16" AROMAT # RSD-6V \$1.50 EACH 10 FOR \$13.50

13 VDC RELAY

CONTACT S.P.N.C. 10 AMP @ 120 VAC ENERGIZE COIL TO OPEN CONTACTS. COIL 13 VDC 650 OHMS SPECIAL PRICE \$1.00 EACH

4 PDT RELAY

14 pin style 3 amp contacts 24 volt d.c. or 120 volt a.c. coil Used but fully tested \$1.70 EACH specify coil voltage LARGE QUANTITIES AVAILABLE SOCKETS FOR RELAY 50¢ each

COMPUTER GRADE CAPACITORS

2,000 mfd. 200 VDC 13/4" DIA - 5" HIGH \$2.00

3,600 mfd. 40 VDC 13/8" DIA - 3 3/4" HIGH \$1.00

6,400 mfd. 60 VDC 13/8" DIA - 4 1/4" HIGH \$2.50

22,000 mfd. 40 VDC 2" DIA - 6" HIGH \$3.00

31,000 mfd. 15 VDC 13/4" DIA - 4" HIGH \$2.50

72,000 mfd. 15 VDC 2" DIA - 4 3/8" HIGH \$3.50

185,000 mfd. 6 VDC 2 1/2" DIA - 4 1/2" HIGH \$1.50

CLAMPS TO FIT CAPACITORS 50¢ ea

SLIDE POTS

100K linear tape 2" LONG 1 5/8" TRAVEL 75¢ EACH

500K linear taper 2 7/8" LONG 1 3/4" TRAVEL 75¢ EACH

DUAL 100K audio taper 3 1/2" LONG 2 1/2" TRAVEL \$1.50 EACH

CRYSTALS

CASE STYLE HC33/U 2 MHZ \$3.50 EACH

COLORBURST 3579.545 KC \$1.00 EACH

METAL OXIDE VARISTOR

G.E. #V82ZA12 50 VOLTS, NOMINAL D.C. VOLTAGE 5/8" DIAMETER 2 FOR \$1.50

L.E.D.'S STANDARD JUMBO DIFFUSED

RED 10 FOR \$1.50
 GREEN 10 FOR \$2.00
 YELLOW 10 FOR \$2.00

FLASHER LED 5 VOLT OPERATION

RED JUMBO SIZE \$1.00 EACH

BI POLAR LED 2 FOR \$1.70

SUB MINI LED

079 - 098 RED 10 FOR \$1.00
 200 FOR \$18.00
 GREEN 10 FOR \$1.50

LED HOLDERS

TWO PIECE HOLDER FOR JUMBO LED 10 FOR 65¢ 200 FOR \$10.00

CLEAR CLIPLITE HOLDER

MAKE LED A FANCY INDICATOR. CLEAR 4 FOR \$1.00

PHOTO-FLASH CAPACITORS

170 MFD 330 VOLT 1 1/8" - 7/8" 2 FOR \$1.50 10 FOR \$7.00

750 MFD 330 VOLT 2" HIGH - 1 1/4" DIA \$1.25 EACH 10 FOR \$11.00

TRANSISTORS

2N705 5 for \$1.00
 2N2222A 4 for \$1.00
 PN2222 8 for \$1.00
 2N2904 4 for \$1.00
 2N2905 4 for \$1.00
 2N2907 4 for \$1.00

POWER SUPPLY W/ PRE-AMP

THIS SUPPLY WAS USED TO POWER AN 8 TRACK/CASSETTE UNIT. IT WILL SUPPLY APPROX 18 VDC AND INCLUDES A SMALL PRE-AMP TO BOOST SIGNAL LEVEL. RCA PLUGS FOR LINE IN/OUT. \$4.50 EACH

MINIATURE TOGGLE SWITCHES

ALL ARE RATED 5 AMPS @ 125 VAC

S.P.D.T. (on-on) SOLDER LUG TERMINALS \$1.00 EACH 10 FOR \$9.00 100 FOR \$80.00

S.P.D.T. (on-off-on) SOLDER LUG TERMINALS \$1.00 EACH 10 FOR \$9.00 100 FOR \$80.00

S.P.D.T. (on-on) P.C. LUGS THREADED BUSHING \$1.00 EACH 10 FOR \$9.00 100 FOR \$80.00

D.P.D.T. (on-on) SOLDER LUG TERMINALS \$2.00 EACH 10 FOR \$19.00 100 FOR \$180.00

TOLL FREE ORDERS ONLY 1-800-826-5432 (ORDER ONLY) (IN CALIFORNIA: 1-800-258-6666) ALASKA, HAWAII, OR INFORMATION (213) 380-8000

ALL ELECTRONICS CORP.

905 S. Vermont Ave. P.O. BOX 20406 Los Angeles, Calif. 90006

QUANTITIES LIMITED MINIMUM ORDER \$10.00 USA: \$2.50 SHIPPING FOREIGN ORDERS: INCLUDE SUFFICIENT SHIPPING CALIF. RES. ADD 6 1/2% NO C.O.D!

PARTIAL LISTING ONLY - PLEASE CALL OR WRITE FOR FREE CATALOG.

STATIC RAMS

2114	1024 x 4 (450ns)	8/9.95
2114-25	1024 x 4 (250ns)	8/10.95
2114L-2	1024 x 4 (200ns) (LP)	8/13.95
TMM2016-200	2048 x 8 (200ns)	4.15
TMM2016-150	2048 x 8 (150ns)	4.95
TMM2016-100	2048 x 8 (100ns)	6.15
HM6116-4	2048 x 8 (200ns) (cmos)	4.75
HM6116-3	2048 x 8 (150ns) (cmos)	4.95
HM6116LP-4	2048 x 8 (200ns) (cmos) (LP)	5.95
HM6116LP-3	2048 x 8 (150ns) (cmos) (LP)	6.95
HM6264	8192 x 8 (150ns) (cmos)	39.95

DYNAMIC RAMS

4116-250	16384 x 1 (250ns)	8/7.95
4116-200	16384 x 1 (200ns)	8/12.95
4116-150	16384 x 1 (150ns)	8/14.95
4164-200	65536 x 1 (200ns) (5v)	9/49.00
4164-150	65536 x 1 (150ns) (5v)	9/49.00
TMS 4164-15	65536 x 1 (150ns) (5v)	8.95

EPROMS

2708	1024 x 8 (450ns)	3.95
2716	2048 x 8 (450ns) (5v)	3.95
2716-1	2048 x 8 (350ns) (5v)	5.95
TMS2532	4096 x 8 (450ns) (5v)	5.95
2732	4096 x 8 (450ns) (5v)	4.95
2732-250	4096 x 8 (250ns) (5v)	8.95
2732-200	4096 x 8 (200ns) (5v)	11.95
2732A	4096 x 8 (250ns) (5v) (21vPGM)	9.95
2732A-2	4096 x 8 (200ns) (5v) (21vPGM)	13.95
27128	16384 x 8 (300ns) (5v)	29.95

5v = Single 5 volt supply 21vPGM = Program at 21 Volts
SPECTRONICS CORPORATION
 EPROMERASER PE-14, 9chipc capacity 83.00

8000

8039	5.95
8080	3.95
8085	4.95
8087	175.00
8088	29.95
8155	6.95
8748	24.95

8200

8203	39.95
8205	3.50
8212	1.80
8216	1.75
8228	3.49
8237-5	21.95
8243	4.45
8250	10.95
8251	4.49
8253	6.95
8253-5	7.95
8255	4.49
8255-5	5.25
8259	6.90
8259-5	7.50
8275	29.95
8279	8.95
8282	6.50
8284	5.50
8286	6.50

Z-80

Z80-CPU	3.95
Z80-PIO	3.95
Z80A-CPU	4.49
Z80A-CTC	4.95
Z80A-PIO	4.49
Z80A-SIO/IO	12.95
Z80B-CPU	9.95

6500

6502	4.95
6522	6.95
6502A	6.95

6800

6802	7.95
6809E	14.95
6821	2.95
6845	14.95
6850	3.25
6883	22.95

DISK CONTR

1771	24.95
1791	24.95
1793	26.95
2791	54.95
2793	54.95

INTERFACE

8T28	1.89
8T97	.89
DM8131	2.95
DP8304	2.29
9334	2.50
9368	3.95

CLOCK CHIPS

MM5369	3.95
MM58167	12.95
MSM5832	3.95

DATA ACQ

ADC0804	3.49
ADC0809	4.49
ADC0817	9.95

SOUND CHIPS

76488	5.95
AY3-8910	12.95

CRYSTALS

32.768 khz	1.95
1.0 mhz	3.95
1.8432	3.95
2.0	2.95
2.4576	2.95
3.276	2.95
3.579545	2.95
4.0	2.95
5.0	2.95
5.0688	2.95
6.0	2.95
6.144	2.95
8.0	2.95
10.0	2.95
10.738635	2.95
14.31818	2.95
15.0	2.95
16.0	2.95
17.430	2.95
20.0	2.95

DISCRETE

KBPO2 Bridge	.45
1N751 5.1v zener	.25
1N759 12v zener	.25
2N2222	.25
PN2222	.10
2N2905	.50
2N2907	.25
2N3055	.75
2N3904	.10
2N3906	.10
1N4004	10/1.00
1N4148	25/1.00

74LS00

74LS00	.24	74LS157	.65
74LS02	.25	74LS158	.59
74LS03	.25	74LS161	.65
74LS04	.24	74LS163	.65
74LS05	.25	74LS164	.69
74LS08	.28	74LS165	.95
74LS09	.29	74LS169	1.75
74LS11	.35	74LS173	.69
74LS14	.59	74LS174	.55
74LS20	.25	74LS191	.89
74LS21	.29	74LS193	.79
74LS27	.29	74LS194	.69
74LS30	.25	74LS195	.69
74LS32	.29	74LS221	.69
74LS33	.55	74LS240	.95
74LS36	.35	74LS241	.99
74LS42	.49	74LS242	.99
74LS47	.75	74LS243	.99
74LS51	.25	74LS244	1.29
74LS73	.39	74LS251	.59
74LS74	.35	74LS257	.59
74LS75	.39	74LS258	.59
74LS76	.39	74LS259	2.75
74LS85	.69	74LS260	.59
74LS86	.39	74LS266	.55
74LS90	.55	74LS273	1.49
74LS92	.55	74LS279	.49
74LS93	.55	74LS280	1.98
74LS107	.39	74LS283	.69
74LS109	.39	74LS290	.89
74LS112	.39	74LS293	.89
74LS122	.45	74LS299	1.75
74LS123	.79	74LS323	3.50
74LS125	.49	74LS365	.49
74LS126	.49	74LS387	.45
74LS132	.59	74LS368	.45
74LS133	.59	74LS373	1.39
74LS136	.39	74LS374	1.39
74LS138	.55	74LS377	1.39
74LS139	.55	74LS390	1.19
74LS148	1.35	74LS393	1.19
74LS151	.55	74LS640	2.20
74LS153	.55	74LS670	1.49
74LS154	1.90	74LS682	3.20
74LS156	.69	74LS688	2.40

74S00

74S00	.32	74S86	.50
74S02	.35	74S112	.50
74S04	.35	74S124	2.75
74S05	.35	74S138	.85
74S08	.35	74S157	.95
74S10	.35	74S175	.95
74S11	.35	74S240	2.20
74S20	.35	74S280	1.95
74S32	.40	74S287	1.90
74S74	.50	74S288	1.90

7400

7400	.19	7447	.69
7402	.19	7473	.34
7404	.19	7474	.33
7405	.25	7475	.45
7406	.29	7476	.35
7407	.29	7486	.35
7408	.24	7490	.35
7410	.19	7492	.50
7411	.25	7493	.35
7414	.49	74121	.49
7416	.25	74123	.49
7417	.25	74132	.45
7420	.19	74151	.55
7425	.29	74154	1.25
7430	.19	74157	.55
7432	.29	74164	.85
7438	.29	74168	1.00
7442	.49	74192	.79
7445	.69	74193	.79

CMOS

4001	.25	4069	.29
4011	.25	4070	.35
4013	.38	4071	.29
4015	.39	4081	.29
4016	.39	4093	.49
4017	.69	14411	11.95
4020	.75	4511	.85
4024	.65	4518	.89
4027	.45	4520	.79
4040	.75	4553	5.79
4042	.69	4584	.75
4046	.85	74C00	.35
4049	.35	74C04	.35
4050	.35	74C74	.35
4051	.79	74C925	5.95
4066	.39	74C926	7.95

T = TO-220 K = TO-3
 L = TO-92
HEAT SINKS
 TO-3 style .95
 TO-220 style .35

ORDER TOLL FREE

800-538-5000
800-662-6279
 (CALIFORNIA RESIDENTS)

D-SUBMINIATURE CONNECTORS

DB09P	Male 9 Pin D-Sub	\$2.08
DB25P	Male 25 Pin D-Sub	2.50
DB25S	Female 25 Pin D-Sub	3.25
DB25SR	Female 25 Pin Right Angle PC	4.42
GREY HOOD	for DB25 Connectors	1.25

IDC CONNECTORS

IDS26	26 Pin Ribbon Socket	2.43
IDS34	34 Pin Ribbon Socket	3.15
IDS50	50 Pin Ribbon Socket	4.65
IDE34	34 Pin Ribbon Edge Card	3.25
IDP16	16 Male Pin Dip Plug	1.85
RC50	50 Conductor Ribbon Cable	1.38/ft.

JUMBO LEDS

1-99	100-up
RED	.10 .09
GREEN	.18 .15
YELLOW	.18 .15

MOUNTING HARDWARE
 .10 EA. 100/.09 EA.

DISPLAYS

MAN 72	CA. 3"	.99
MAN 74	CC. 3"	.99
FND-357	CC. 375"	1.25
FND-500	CC. 5"	1.49
FND-507	CA. 5"	1.49

ELCOMP

Hardware Handbook
 Mfr's Specs: LOGIC,
 MEMORY, MPU's & more
800 pgs \$14.95

CAPACITORS

10pf	56pf
22pf	82pf
27pf	100pf
33pf	220pf
47pf	.001uf

50V, .05E EACH
MONOLITHIC
 .01uf-mono 50V .14
 .047uf-mono 50V .15
 .1uf-mono 50V .18
 .47uf-mono 50V .25

ELECTROLYTIC

1uf	25V	.14
47uf	35V	.18
470uf	25V	.30
2200uf	16V	.60

AXIAL

1uf	50V	.14
22uf	16V	.14
47uf	50V	.20
220uf	25V	.30

COMPUTER GRADE

44,000uf	30V	3.95
----------	-----	------

BARGAIN HUNTERS CORNER

LM338K VOLTAGE REGULATOR
 * ADJUSTABLE OUTPUT, +1.2V TO +33V
 * 5 AMP CONTINUOUS, 7 AMP PEAK
 * TO-3 PACKAGE **\$3.95**

TR1602 UART **\$2.50**

DISK CONTROLLERS

1771	FM-IBM240	\$6.95
1791	FM/MFM INVERTED BUS	\$14.95
1793	FM/MFM TRUE BUS	\$14.95
2791	w/ DATA SEPARATOR & CLOCK	\$24.95
2793	w/ DATA SEPARATOR & CLOCK	\$24.95
2797	w/ DATA SEPARATOR & SIDE SELECT	\$24.95

SPECIALS END 10-31-84

JDR Microdevices

1224 S. Bascom Avenue, San Jose, CA 95128
 800-538-5000 • 800-662-6279 (CA)
 (408) 995-5430 • Telex 171-110

VISIT OUR RETAIL STORE

HOURS: M-W-F, 9-5 T-Th., 9-9 Sat. 10-3

PLEASE USE YOUR CUSTOMER NUMBER WHEN ORDERING

TERMS: Minimum order \$10. For shipping and handling include \$2.50 for UPS Ground and \$3.50 for UPS Air. Orders over 1 lb. and foreign orders may require additional shipping charges - please contact our sales department for the amount. CA residents must include 6% sales tax. Bay Area and LA residents include 6.75%. Prices subject to change without notice. We are not responsible for typographical errors. We reserve the right to limit quantities and to substitute manufacturer. All merchandise subject to prior sale.

Copyright 1984 JDR Microdevices APPLE IS A TRADEMARK OF APPLE COMPUTER CO.

NEW FOR IBM

PC PEACOCK

COLOR GRAPHICS ADAPTER
BY MA SYSTEMS

- ★ MED. RES. 320x200
- ★ HIGH RES. 640x200
- ★ COMPOSITE AND RGB OUTPUT FOR ALL STANDARD MONITORS
- ★ LIGHT PEN INTERFACE
- ★ CHOICE OF 16 COLORS IN HIGH RES. MODE!
- ★ PARALLEL PORT STANDARD!
- ★ 2 YEAR WARRANTY!
- ★ PLUS FULL IBM COMPATIBILITY

\$239⁹⁵



TANDON

TM 100-2

- ★ SAME DRIVE AS SUPPLIED BY IBM

★ DS/DD · 320K
\$199⁰⁰

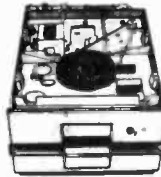

TEAC

FD-55B HALF HEIGHT

- ★ 6ms STEP RATE
- ★ DS/DD
- ★ INCLUDES INSTRUCTIONS

\$159⁰⁰



BUY 2 FOR \$299⁰⁰
AND GET FREE MOUNTING BRACKETS!

MAXIMIZER

BY SIGMA DESIGN

- ★ 1 YEAR WARRANTY
- ★ MULTI-FUNCTION CARD.
- ★ 64K TO 384K RAM
- ★ PARALLEL PORT
- ★ SERIAL PORT
- ★ CLOCK CALENDAR
- ★ SOFTWARE INCLUDED: CLOCK UTILITY, RAM DISK AND SPOOLER.

\$259⁰⁰

OPTIONS:

- ★ SECOND SERIAL PORT
- ★ GAME ADAPTER



SUMMER APPLE SPECIALS

JDR 16K RAM CARD

- ★ 2 YEAR WARRANTY
- ★ EXPAND YOUR 48K APPLE TO 64K
- ★ USE IN PLACE OF APPLE LANGUAGE CARD

\$39⁹⁵

BARE PC CARD 9.95



JDR HALF-HEIGHT DISK DRIVE

- ★ TEAC MECHANICS—DIRECT DRIVE
- ★ 100% APPLE COMPATIBLE—35 TRACK
- ★ 40 TRACK WHEN USED WITH OPTIONAL CONTROLLER
- ★ 1 YEAR WARRANTY

\$169⁹⁵

MA SYSTEMS FD-35

- ★ DIRECT REPLACEMENT FOR APPLE DISK II
- ★ SHUGART MECHANISM—MADE IN U.S.

\$179⁹⁵

40 TRACK CONTROLLER CARD \$49⁹⁵

OMNIGRAPH

BY MA SYSTEMS
PARALLEL GRAPHICS INTERFACE
FOR APPLE II & IIe

- ★ HIGH RES. MULTICOLOR GRAPHICS
- ★ CENTRONICS STANDARD FOR EPSON, OKIDATA...
- ★ SCREEN DUMP, ROTATION, INVERSION, ZOOM, AND MORE!
- ★ 1 YEAR WARRANTY!

\$79⁹⁵



ALL WITH A 2 YEAR WARRANTY

VIEWMAX-80 \$159⁹⁵

★ 60 COLUMN CARD FOR APPLE II +

VIEWMAX-80e \$129⁹⁵

★ 80 COLUMN CARD FOR APPLE IIe

★ 64K RAM EXPANDABLE TO 128K

GRAPHMAX \$129⁹⁵

★ HIGH RESOLUTION GRAPHICS

★ PRINTER CARD

OTHER ACCESSORIES FOR APPLE II

THUNDERCLOCK \$129⁹⁵

- ★ OFFICIAL PRO DOS CLOCK CALENDAR
- ★ 100% MOUNTAIN SOFTWARE COMPATIBLE
- ★ BSR CONTROL OPTIONS AVAILABLE

KRAFT JOYSTICK \$39⁹⁵

- ★ SELF CENTERING
- ★ AXIS ISOLATION

APPLE COMPATIBLE POWER SUPPLY \$49⁹⁵

- ★ USE TO POWER APPLE TYPE SYSTEMS
- ★ +5V @ 4A +12V @ 2.5A -5V @ .5A -12V @ .5A
- ★ APPLE POWER CONNECTOR
- ★ INSTRUCTIONS INCLUDED



ACCESSORIES AND PERIPHERALS

MONITORS



BMC MONITOR STAND
MODEL PA-900
Your Display Will
Tilt & Swivel **\$29⁹⁵**

MONOCHROME

BMC BM JJ1201G GREEN 12" \$89⁹⁵

BMC BM 12EUY 18 MHZ AMBER \$139⁹⁵

BMC BM 12EUN 18 MHZ HIGH RES GREEN \$115⁰⁰

NEC JB1201M -20 MHZ GREEN \$169⁰⁰

ZENITH ZVM-123 -15 MHZ GREEN NEW \$105⁰⁰

COLOR

BMC BM-AU9191U COMPOSITE 13" \$279⁰⁰

NO C.O.D. ORDERS PLEASE

BMC BMX-80 PRINTER

- ★ 80 CPS DOT MATRIX PRINTER
- ★ PRINTS BI-DIRECTIONAL IN 40, 80, 71 OR 142 COLUMNS IN NORMAL, DOUBLE WIDTH OR COMPRESSED TEST.
- ★ PRINT SUPERSCRIPPT AS WELL AS SUPERB GRAPHICS IN CHARACTER OR BIT IMAGE

\$249



5-1/4 DISK FILE

- ★ ATTRACTIVE, FUNCTIONAL DISK STORAGE SYSTEM
- ★ 75 DISK STORAGE CAPACITY

\$16⁹⁹



NASHUA DISKETTES

- 5 1/4" WITH HUB RING
- MD1 SOFT, SS/SD 19⁹⁵
- MD1D SOFT, SS/DD 28⁹⁵
- MD2D SOFT, DS/DD 30⁹⁵
- MD2F SOFT, DS/4D 45⁹⁵
- MD110 10 SECTOR, SS/SD 19⁹⁵
- MD2100 10 SECTOR, DS/DD 30⁹⁵
- 8" WITHOUT HUB RING
- FD1 SOFT, SS/SD 24⁹⁵
- FD1D SOFT, SS/DD 30⁹⁵
- FD2D SOFT, DS/DD 36⁹⁵

VERBATIM

- DATALIFE DISKETTES
- SS/DD SOFT SECTOR 29⁹⁵
- SS/DD 10 SECTOR HARD 29⁹⁵

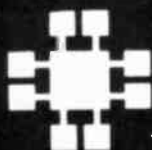

JDR Microdevices

1224 S. Bascom Avenue, San Jose, CA 95128
800-538-5000 • 800-662-6279 (CA)
(408) 995-5430 • Telex 171-110

Apple is a trademark of Apple Computer Corporation

VISIT OUR RETAIL STORE

HOURS: M-W-F, 9-5 T-Th., 9-9 Sat. 10-3

PLEASE USE YOUR CUSTOMER NUMBER WHEN ORDERING

TERMS: Minimum order \$10. For shipping and handling include \$2.50 for UPS Ground and \$3.50 for UPS Air. Orders over 1 lb. and foreign orders may require additional shipping charges — please contact our sales department for the amount. CA residents must include 6% sales tax, Bay Area and LA residents include 6 1/2%. Prices subject to change without notice. We are not responsible for typographical errors. We reserve the right to limit quantities and to substitute manufacturer. All merchandise subject to prior sale.

© Copyright 1984 JDR Microdevices

STATE OF THE ART KITS

TOUCH-TONE DECODER AND ENCODER KITS

HAL-807-12 \$29.95
TOUCH-TONE DECODER, SINGLE LINE IN 12 LINES OUT, COMES COMPLETE WITH P.C. BOARD AND ALL PARTS. NO SOCKETS, CASE OR POWER SUPPLY.

HAL-807-16 \$46.95
TOUCH-TONE DECODER, SINGLE LINE IN 16 LINES OUT, COMES COMPLETE WITH P.C. BOARD AND ALL PARTS PLUS SOCKETS NO CASE OR POWER SUPPLY.

HAL-808-12 \$29.95
TOUCH-TONE ENCODER, 3 x 4 12 CHARACTER, USE FOR DIALING. COMPLETE WITH ALL ELECTRONIC PARTS, INCLUDES SPEAKER FOR AUDIO COUPLING AND L.E.D. FOR VISUAL INDICATION, CRYSTAL CONTROLLED SINGLE IC CHIP & ALUM CASE.

HAL-808-16 \$30.95
TOUCH-TONE ENCODER, 4 x 4 16 CHARACTER, USE FOR DIALING. COMPLETE WITH ALL ELECTRONIC PARTS, INCLUDES SPEAKER FOR AUDIO COUPLING AND L.E.D. FOR VISUAL INDICATION, CRYSTAL CONTROLLED, SINGLE IC CHIP & ALUM CASE.

VARIOUS CLOCK KITS

HAL-5314 (Most Famous Clock Kit) \$12.95
6 DIGIT ELECTRONIC CLOCK KIT, 12 OR 24 HOUR FORMAT, COMPLETE KIT LESS POWER SUPPLY ADAPTOR AND CASE. RUNS OFF ANY 12 VOLT A.C. SOURCE REQUIRES 250 MA.

HAL-5375 (Alarm Clock Kit) \$16.95
8 DIGIT ELECTRONIC CLOCK KIT, 12 HOUR FORMAT ONLY, OPERATE ON 12 VOLTS A.C. OR D.C. HAS TIME BASE ONBOARD, COMES COMPLETE LESS POWER ADAPTOR AND CASE.

HAL-79 SPECIAL (Student Class Kit) \$7.95
4 DIGIT BASIC ELECTRONIC KIT, WITH OPTIONS AND PROVISIONS TO MAKE IT AN ALARM CLOCK AND A D.C. OPERATED CLOCK, COMPLETE LESS OPTIONS, POWER SUPPLY ADAPTOR AND CASE.

OPTION #1 \$2.95

TO MAKE IT AN ALARM CLOCK

OPTION #2 \$4.95

TO MAKE IT A D.C. 12V CLOCK

CLOCK CASE Reg \$6.50 - ONLY \$4.50

ONLY WHEN BOUGHT WITH CLOCK KIT

12 VOLT A.C. ADAPTOR Reg \$4.95 - ONLY \$2.95

ONLY WHEN BOUGHT WITH CLOCK KIT

60 HZ TIME BASE \$4.95

CRYSTAL TIME BASE KIT USING MM5369 - COMPLETE

HAL-FG 100 \$69.95

FUNCTION GENERATOR KIT, 1 HZ TO 100 KHZ IN FIVE BANDS, AMPLITUDE NAD OFFSET ADJUSTABLE, OUTPUT IMP. 500 OHMS, WAVE FORMS - SINE, SQUARE AND TRIANGULAR AND TTL

CLOCK 0 TO 5V LEVEL, 200 NS RISE AND FALL TIME COMPLETE KIT WITH CASE AND POWER SUPPLY AND ALL ELECTRONIC PARTS INCLUDING MANUAL.

SHIPPING INFORMATION: ORDERS OVER \$25 WILL BE SHIPPED POST-PAYD EXCEPT ON ITEMS WHERE ADDITIONAL CHARGES ARE REQUESTED, ON ORDERS LESS THAN \$25, PLEASE INCLUDE ADDITIONAL \$2.50 FOR HANDLING AND MAILING CHARGES. MICHIGAN RESIDENTS ADD 4% SALES TAX SEND 20¢ STAMP OR CASE FOR FREE FLYER

COMPLETE SETS OF P.C. BOARDS AVAILABLE FOR UNICORN ROBOT PROJECT, HEARSAY MATEC PROJECT, PIANO MATEC PROJECT, AND MANY, MANY OTHER KITS AVAILABLE

HAL-TRONIX, INC.
P.O. BOX 1101 - DEPT. R
SOUTHGATE, MICH. 48195
PHONE (313) 295-1782



"HAL" HAROLD C. NOWLAND
W62ZH

P.C. BOARDS AND ART SERVICES

FACE PLATES



ENCLOSURES

WRITE OR CALL
For Literature or Quotes

Let us quote you on any stage of your product from proto types to production.

FABTRON DIV.
P.O. Box 925
Columbia, TN 38401
(615) 381-1143

CABLE TV

SEND \$5.00 FOR COMPLETE CATALOG
R & M DISTRIBUTORS INC
P.O. BOX 266 R15 BOSTON, MA 02190

WERSI electronics ORGAN & PIANO KITS

ALPHA DX 300



fully
DIGITAL
RS232
Interface

For Free Sound Info
Call 1-800-233-3865
or write WERSI USA
Dept. M 8 P.O. Box 5318
Lancaster, PA 17601

THE WORLD LEADER

OPPORTUNITY WITHOUT RISK.

The biggest improvement in 40 years has made U.S. Savings Bonds an ideal investment.

A variable interest rate lets you share in rates offered by today's securities market. No limit on how much you might earn.

What makes this improved Bond ideal is that you're protected by a guaranteed minimum. And if the Bond is held to maturity, you'll double your money.

Take another look at this opportunity without risk.

Take
stock
in America.



Ad Council

A public service of this publication and The Advertising Council.

CIRCLE 75 ON FREE INFORMATION CARD

NEW ORLEANS AND WM. B. ALLEN

UP TO
25% OFF
ON

LARGEST FULL LINE INVENTORY OF
HAND HELD METERS

FOR EXAMPLE

FLUKE 73	\$ 75
FLUKE 75	\$ 88
FLUKE 77	\$115
FLUKE 8020B	\$170
FLUKE 8021B	\$139
FLUKE 8022B	\$126
FLUKE 8024B	\$174
SOAR SX220	\$ 22
SOAR ME540	\$ 44

AS CLOSE AS YOUR
TELEPHONE

CALL TOLL FREE FOR
SAME DAY SHIPMENT ON

**DISCOUNT PRICED
TEST EQUIPMENT**

18 LEADING MANUFACTURERS IN
INSTRUMENTATION INCLUDING
HUNTRON

UP TO
28.5% OFF

ON
HITACHI SCOPES

SAVE UP TO \$480

V212 .. 20MHz (SAVE \$164) ..	\$ 451
V222 .. 20MHz (SAVE \$191) ..	\$ 524
V422 .. 40MHz (SAVE \$246) ..	\$ 679
V650F .. 60MHz (SAVE \$257) ..	\$ 938
V209 .. 20MHz (SAVE \$250) ..	\$ 692
V1050F 100 MHz (SAVE \$343) ..	\$1252
V089 Vectorscope (SAVE \$480) ..	\$1204
V099 .. Waveform (SAVE \$468) ..	\$ 882

All Prices Include FREE \$50 Probe



WM. B. ALLEN SUPPLY CO.

ALLEN SQUARE

300 BLOCK NORTH RAMPART, NEW ORLEANS, LA 70112

CALL TOLL FREE

800 535-9593

LOUISIANA 800 462-9520

CIRCLE 56 ON FREE INFORMATION CARD

ADVANCED COMPUTER PRODUCTS

SEND \$2.00 for 1984 CATALOG

RAM UP-GRADES

64K D RAM (4164-200nS)

9 pcs for \$50.00

16K D RAM (4116-200nS)

8 pcs for \$12.95

REPEAT OF SELL-OUT

58 Key Unencoded Keyboard



\$19.95 ea.

This is a new 58 key terminal keyboard manufactured by a major manufacturer. It's unencoded with SFS keys unattached to any PC board. Solid molded plastic base measures 11" x 4"

Unencoded Key Pad

15 key keypad with 1-10 keys and tab, re-lum., (-), (+) and (.)

Only \$9.95 ea.



STEPPER MOTOR

Operates by applying 12VDC in one direction and then reversing polarity (or square wave). Uses 12VDC. Clock Wise Rotation. Rated 3 RPM at 4 P.P.S. with a 5 degree stepping angle.

ACP Price \$3.95
10 for \$34.95

RS232 SIGNAL TESTER

COEX RS232 LINE TESTER (7) LED INDICATORS

Other Styles Also Available

CONNECTORS

DB25P (RS232) \$2.95
DB25S Female 3.25
Hood 1.48
Set with Hood, Sale 6.95
25.50 S.T. Apple 3.95
25.50 W.W. Apple 4.95
31.62 S.T. IBM 4.95
31.62 W.W. IBM 4.95
50.100 W.W. S-100 Connector 5.95
50.100 S.T. S-100 Connector 3.95

CRT CONTROLLERS

6845 \$14.75 8275 \$34.95
68845 17.50 7220 89.50
6847 17.50 CM45027 17.95
PC466055P 15.75 AC085037 22.00
MC1372 6.75 8350 39.95
TMS9918 39.95 6545 21.50

DATA ACQUISITION

DAC01 \$5.95 ADC0800 \$15.25
DAC08 7.50 ADC0804 3.95
DAC100 7.50 ADC0809 4.95
DAC0800 4.95 ADC0817 9.95
DAC0808 9.95 MC3470 4.95
DAC1020 8.95 140618 1.50
DAC1022 5.95 140618 2.95
F9708 4.95 DAC86EC 8.95

DISK SUPPORT

1691 \$16.95 2791 \$49.50
1771 16.00 2793 49.50
1791 22.95 2793 55.50
1793 25.95 2797 55.50
1795 27.95 6843 31.50
1797 44.50 8272 36.50
2143 18.95 UPD765A 36.00

PALS

PAL10H6 \$3.75 PAL14L4 \$3.95
PAL12H6 3.95 PAL16L8 9.95
PAL14H4 3.95 PAL16R8 7.75
PAL10L8 3.95 PAL16R6 7.75
PAL12L6 3.95 PAL16R4 7.75

FUNCTION GEN.

MC4024 \$3.75 LM566 \$1.95
8038 3.75 XR2206 3.75

UARTS/USRTS

AYS-1013A \$3.95 2350 \$9.75
AYS-1014 6.75 8250 12.50
AYS-1015 6.75 IM6402 7.75
TRI1602A 3.75 IM6403 8.75

BAUD RATE GEN.

MC14411 \$11.50 COM5016 \$15.95
BR1941 10.50 COM1116 11.95
34702 12.75 MMS307 11.95

SOUND CHIPS

76477 \$3.50 MC3340 \$1.95
76488 5.90 SC-01/Verax 39.95
76489 8.50 DT1050/ 34.95
AY38910 8.95 Digitalizer 34.95
AY38912 12.50 MMS4104 14.95

ZERO INSERT SOCKETS

14P12N1F \$5.75 24P12N1F \$7.50
16P12N1F 5.95 28P12N1F 9.95
18P12N1F 7.75 40P12N1F 10.75
20P12N1F 7.95 64P12N1F 18.95

MICROPROCESSORS

68000	\$47.95	6504	\$6.75	8749	\$49.95
6800	3.95	6505	8.95	8755	39.95
68010	10.50	6507	6.95	2.80	3.75
6802	7.50	6535	8.95	Z.800A	4.30
68020	20.95	8039	11.95	Z.800B	9.50
6803	16.50	8080	3.50	28001	44.95
6808	13.50	8085	4.75	78002	48.95
6809E	12.95	8084-2	11.00	83060	19.95
68B09E	27.95	8086	29.95	2650	16.95
6809	11.50	8087	19.90	2601	5.95
68B09	27.95	8088	29.95	8208-1	6.95
6802	4.75	8089	84.95	9.50	
6502A	6.80	8749	34.95	2901A	8.50
6502B	8.75	8746	39.95	29671	37.95

WE STOCK IN DEPTH CALL FOR VOLUME PRICING

EPROMS

1702	\$4.25	2732	\$4.75	2764-250	\$7.75
2708	3.85	2732-250	8.25	2764-200	16.50
2758	4.95	2732-200	8.95	2768-264	39.95
2716	3.55	2732A-2	6.75	68166	41.95
2716-1	5.75	2732A-2	5.75	27128	27.95
TMS2716	7.50	2732A2	10.00	5203AQ	14.50
TMS2516	5.25	2764	6.75	5204Q	13.50
TMS2532	5.75				

STATIC RAMS

2101	\$2.75	2147	\$4.75	5516	\$11.95
2102-1	.98	2016	2.00	6118-4	8.75
2102L-4	1.29	2016	4.95	6118-2	8.75
2102L-2	1.49	2016	6.00	6116P-4	5.90
2111	2.75	4044-4	3.95	6116P2	10.95
2112	2.89	4044-2	6.50	26132	32.50
2114	1.49	4118	9.50	486264	47.50
2114L-2	1.89	5512	15.25	6116	9.95

DYNAMIC RAMS

MK4027	\$1.85	4116-200	\$1.49
UPD411	8.95	4164-200	5.95
UPD411	4.95	4164-150	6.75
MMS280	2.95	MC6805	8.50
MMS290	1.45	1M64-15	8.50
	1.45	41256	79.95

WE STOCK MOST OBSOLETE RAMS. CALL FOR YOUR HARD TO FIND PARTS.

8000 SUPPORT

8155	\$9.95	8238	\$4.75	8271	\$74.95
8156	9.95	8243	5.50	8272	37.50
8202	23.50	8250	10.50	8273	81.50
8203	36.50	8251	5.25	8279	8.95
8205	3.25	8251A	9.95	8279-5	9.95
8212	1.95	8253	6.50	8282	7.95
8214	4.50	8253-5	9.95	8283	7.95
8216	1.95	8255	5.95	8284	7.95
8224	2.20	8255A	9.95	8285	7.95
8226	2.75	8257	7.25	8287	7.95
8228	3.35	8257-5	9.95	8288	24.95
8237	16.50	8259	7.25	8289	48.50
8237-5	21.50	8259-5	37.50		

6500 SUPPORT

6520	\$4.25	6532	\$9.75	6535A	\$26.50
6522	6.75	6534	10.75	6551	11.50
6522A	8.50	6545	21.50	6551A	12.95

6800 SUPPORT

6810	\$2.75	68A0	\$17.95	68B50	\$5.75
6812	6.75	6843	31.50	6852	5.50
6820	4.25	6844	25.00	6860	7.75
6821	11.75	6845	9.95	6875	2.50
6821-2	8.75	6845-5	17.50	6880	2.50
6828	12.50	6847	11.75	68047	22.95
6840	12.50	6850	3.50	68488	19.50

Z-80 SUPPORT

Z80C1C	\$3.95	Z80DART	\$10.75	Z80SIO1	\$12.50
Z80C1C	4.75	Z80DART	10.95	Z80SIO2	11.50
Z80C1C	7.75	Z80DART	18.95	Z80SIO2	12.50
Z80P10	3.95	Z80SIO1	11.50	Z80SIO2	36.00
Z80AP10	4.75	Z80SIO1	12.50	Z80SIO9	11.50
Z80B10	12.50	Z80SIO1	11.50	Z80SIO9	12.50

SOCKETS

LOW PROFILE SOCKETS (TIN)

8 pin LP	16	15	14
14 pin LP	20	19	18
16 pin LP	22	21	20
18 pin LP	24	23	22
20 pin LP	34	32	30
22 pin LP	29	27	24
24 pin LP	38	37	36
28 pin LP	45	44	43
40 pin LP	60	59	58

3L WIREWRAP SOCKETS (GOLD)

8 pin WW	55	54	49
10 pin WW (Tin)	65	63	58
14 pin WW	75	73	67
18 pin WW	80	77	70
18 pin WW	95	90	81
20 pin WW	1.15	1.08	.99
22 pin WW	1.45	1.35	1.23
24 pin WW	1.45	2.26	1.14
28 pin WW	1.60	1.53	1.38
40 pin WW	2.20	2.09	1.89

MUFFIN FAN

The dependable, low cost, largest selling fan for commercial cooling applications.

- 105cm free air delivery
- 4 68" sq. x 1.50" deep.
- Weight - 17 oz.

SPECIAL PURCHASE \$9.50 ea.

* CRYSTALS *

32.768KHz	\$1.95	2.4576	\$2.95	5.7143	\$2.95	14.318MHz	\$2.95
1.000MHz	3.75	3.2768MHz	2.95	6.000MHz	2.95	15.000MHz	2.95
1.642MHz	3.75	3.5795MHz	1.95	6.144MHz	2.95	16.000MHz	2.95
2.000MHz	2.95	4.000MHz	2.95	6.5538MHz	2.95	18.000MHz	2.95
2.010MHz	2.95	5.000MHz	2.95	8.000MHz	2.95	18.432MHz	2.95
2.097152MHz	2.95	5.0688MHz	2.95	10.000MHz	2.95	32.000MHz	2.95

LINEAR

78H05K	\$5.95	LM1414N	\$1.90
78H05	1.49	LM1458CN	4.9
LM1084L	1.49	MC1488N	99
LM1084L	2.95	MC1489N	99
LM3000	99	LM1496M	89
LM301CN	35	LM1566N	1.50
LM304H	1.99	LM1320N	95
LM304H	1.99	LM1850N	95
LM309A	3.25	LM1389N	3.10
LM309CN	29	LM2111N	1.75
LM309CN	98	LM2900N	99
LM309E	1.49	LM2501N	2.50
LM310CN	1.25	LM2117N	2.95
LM3110 CN	.89	CA3013T	2.19
LM312H	1.75	CA3018T	1.99
LM317	1.70	CA3021T	1.99
LM318CN	1.49	CA3023T	2.99
LM319PH	1.25	CA3035T	2.75
LM320K-XX	1.39	CA3039T	1.29
LM320CN-XX	1.25	CA3046M	1.29
LM323K	4.95	CA3059N	3.19
LM324N	9.95	CA3060N	3.19
LM337K	6.95	CA3062N	4.95
LM338K	5.95	LM3065N	1.49
LM339N	1.75	CA3080T	1.29
LM346T-XX	1.25	CA3081N	1.69
LM346H-XX	1.25	CA3082N	1.69
LM348N	1.25	CA3083N	1.55
LM348N	1.95	CA3086N	1.95
LM348N	1.20	CA3089N	2.99
LM3500	5.50	CA3096N	3.49
LM3500N	3.98	CA3097N	1.98
LM360N	1.49	CA130T	1.30
LM372N	1.95	CA140AT	1.19
LM375N	3.75	CA146N	2.49
LM378N	2.75	CA160T	1.19
LM3800CN	1.25	CA190N	1.95
LM381N	1.39	CA3410N	3.49
LM383T	1.95	MC3423N	1.49
LM386N	1.25	MC3460N	3.95
LM387N	1.40	S3324N	3.95
LM387N	1.95	CA3600N	3.39
LM390N	3.75	LM3900N	59
NE531VT	3.95	LM3909N	1.19
NE535V	98	LM3909N	98
NE551T	19.95	LM3914N	3.75
NE555N	1.25	LM3915N	3.95
NE568H-V	1.75	LM3916N	3.75
NE568H-V	1.25	LM3917N	2.95
NE592N	2.75	CA1305N	3.95
LM709NH	1.99	RC4151N	3.70
LM709NH	29	RC4194TK	4.95
LM710NH	.75	RC4195TK	5.40
LM711NH	.29	ULN2001	1.25
LM715N	1.39	ULN2003	1.50
LM723NH	.65	SN75459N	3.95
LM733NH	.98	SN75459N	3.95
LM739N	1.15	SN75452N	49
LM741CNH	.33	SN75453N	49
LM741CN-14	19	SN75454N	49
LM747N	7.75	SN75491N	89
LM747N	1.39	SN75492N	89
LM760CN	2.95	SN75493N	89
LM1310N	1.90	SN75494N	89
MC1330	1.95	TL494CN	1.65



CALL MAIL
(516) 499-9500

6094 Jericho Tpke.
Commack, N.Y. 11725

CTC9R

Philips Remote Cable Converter



• Micro computer technology • Quartz controlled IC's lock in picture & prevent drift • 60 channel selections • Programmable time on & off • 24 hour LED digital clock • Favorite channel memory & recall plus scan • Wireless hand held infra-red transmitter system • Automatic line tune • Adaptable to any brand television • One year warranty service

\$139.95

SPEAKER PHONE

Model #30-9558
Hands Free Conversation
Modular Connectors
Push Button Dial
Volume Control
Mute/Hold Button
Pulse/Tone Switchable
Last Number Redial



\$44.95

GREEN AND AMBER MONITORS

12" Sakata Green **\$119.00**
12" Sakata Amber **\$129.00**

REFURBISHED MONITORS

9" and 12" Bell & Howells
or GBC Commercial Grade
as low as
\$10.00 off with a purchase
of 2 refurbished monitors



\$39.95

BECKMAN CIRCUITMATE DM73

• 5% basic Vdc Accuracy probe-sized dmm **\$63.95**
• 4 ac dc voltage ranges (autoranging)
• 4 resistance ranges (autoranging)
• continuity beeper
• "touch hold" button
• Other Circuitmate Meters Available



Jerrold 58 Channel Wireless Remote Converter \$109.95



Jerrold 36 Channel Remote CATV Converter w/on/off Fine Tuning \$94.95

40 Channel VHF to UHF Block Converter

28.95 Ea.
24.95 4 & up
Deluxe Version - Features fine tuning knob, matching X former & 2 cables \$38.95

BEFORE YOU PAY \$\$ FOR A TELEPHONE SERVICE CALL, TEST IT YOURSELF



Telephone Line Analyze Model #1042

- Tests telephone line functions that affect telephone operation
- Verifies line and ring voltage levels
- Checks condition of telephone line from central office to user's telephone jacks
- Verifies telephone line polarity that can affect polarity sensitive telephones



\$19.95

PROFESSIONAL TELEPHONE PRODUCT TESTER



Features: **MODEL 1045**

- Provides basic operation tests for corded and cordless telephones, answering machines and automatic dialers
- Checks telephone line cords and hardware cords for continuity shorts and interferences
- Verifies number dialed and redialed for pulse or touch-tone telephones
- Provides low and normal level ring test sequence
- Verifies that voice and DTMF (Dual Tone Multiple Frequency) levels are above minimum required level
- Can be used by the consumer without the aid of a salesperson—an easy-to-follow instruction card is provided with the tester.
- Can be used by the salesperson to demonstrate operation and features of telephone products and to screen returns before making an exchange



\$335.95

Dealers Welcome

Visa MC BAC Amex. All above prices include 4% cash discount. C.O.D. money order, check Add for Shipping

Min. Order \$25.00	to 75.00	\$2.50
International shipping Add'l	76.00 to 250.00	\$4.50
Prices subject to change without notice.	251.00 to 500.00	\$6.00
COD 2.00 Extra	501.00 to 750.00	\$8.50
*Add'l shipping for monitors	751.00 to 1000.00	\$12.00
	Over 1000.00	\$12.50

(516) **Mon Th Tu W F Sa**
499-9500 9-8 9-6 9:30-5

ADVERTISING INDEX

RADIO-ELECTRONICS does not assume any responsibility for errors that may appear in the index below.

Free Information Number	Page	
77	Active Electronics	124
80	Advanced Computer Products	139
—	Advance Electronics	26,27
12	All Electronics	135
88	Amazing Devices	134
67	AMC Sales	115
92	Appliance Service	106
87	AP Products	24
72	AW Sperry	34
—	BEC Electronics	118
7	Beckman Instruments	15
16	B&K	29
—	Brad Cable Electronics	96
—	C&D	96
18	CEI	44
—	CIE	18-21
—	Command Productions	110
26,35,97	Communications Electronics	2,25,30-31
91	Computed Ventures	107
50	Contact East	107
68	CPU	CD section 6
89	CRT	106
70	DECO	107
60	Diamondback	130
65	Digikey	121
11	Digitron	120
5	Dokay	128,129
58	EKI	99
59	Electronic Rainbow	68
6	Electronic Specialists	134
81,82	Electronic Warehouse	42,112
—	Enterprise Development	111
39	Etronix	115
40	Firestik II	116
—	Fluke Manufacturing	Cover 4
—	Fordham Radio	5
76	Formula	131
33	Global Specialties	103
86	Goldsmith Scientific	134
—	Grantham College of Engineering	35
64	GTE	46
75	Haltronix	138
15,38,98	Heath	13,23,81-82
100	Hewlett Packard	89
49	HMR Sales 107	107
—	ICS	89,96,111
28	Instrument Mart	45
51	Iwatsu	87
41	Jameco	132,133
30	Jan Crystal	109
74	JDR	136,137
37	Jensen	107
44	J. Walter Satellite Receiver	107
83	KCS	130
63	KLM	67
45,78	Leader Instruments	41
46	Logical Solutions	106
—	Litic Systems	130
—	McGraw Hill Co.	47-49,90-93
93	McIntosh Labs	114
19	MCM	123
66	MEJ	113
96	Mouser	113
69	Multitech	43
—	Newtone Electronics	28
95	Network Sales	120
—	NRI	8-11,33
—	NTS	36-39
90	Omnitron	22
14	Optoelectronics	104
25	Pacific One	106
53	Paia	109
47	Philips ECG	1
29	Philips Tech Electronics	130
84	Phoenix Systems Inc.	106
32	Pocket Tech	17
8	Power Plus	106
52	PTS	108
61	Radio Shack	126
79	Ramsey	125
31	Random Access	106
23	Ross Custom Electronics	107
10	Research Service Lab.	106
27	RF Electronics	134
24	R&M Distributors	107
43	RSP Handy	127
9	Satellite TV Week	64
71	Sintec	110
57	Solid State Sales	122
36	Spartan Electronics	140
55	TAB	114
73	Teltone	107
—	Tektronix	Cover 2
62	Test Probes	113
—	Texas Instruments	40
94	Trio Kenwood	50
—	Transamerican Cable	119
99	Uniden Bearcat	7
13	Vaco	79
56	WM B Allen	138
48	WS Jenks	89
—	Zenith	Cover 3

Gernsback Publications, Inc.
200 Park Ave. South
New York, NY 10003
(212) 777-6400
Chairman of the Board: M. Harvey Gernsback
President: Larry Steckler

ADVERTISING SALES 212-777-6400

- Larry Steckler
publisher
- Arlene Fishman
advertising coordinator
- Lisa Strassman
credit manager
- Donna Goldstein
credit associate
- Dianne Sciremammano
advertising associate
- Naomi Matten
advertising assistant

Sales Offices

EAST/SOUTHEAST
Stanley Levitan
Radio-Electronics
200 Park Ave. South
New York, NY 10003
212-428-6037, 212-777-6400

MIDWEST/Texas/Arkansas/Okla.
Ralph Bergen
Radio-Electronics
540 Frontage Road—Suite 325
Northfield, IL 60093
312-446-1444

PACIFIC COAST/ Mountain States
Marvin Green
Radio-Electronics
15335 Morrison St.—Suite 227
Sherman Oaks, CA 91403
818-986-2001

Radio-Electronics mini-ADS



TELSTONE'S TRK-957 KIT makes boardboarding a low-power, central office quality DTMF detection system easy and inexpensive. The included M-957 receiver decodes 12 or 16 digits and operates from 5 to 12V dc. Its sensitivity, wide dynamic range, noise immunity, and low power consumption are ideal for telephone switching, computer and remote control applications. Only \$24.75. To order, call: TELSTONE, 1-800-227-3800, ext. 1130.

CIRCLE 73 ON FREE INFORMATION CARD

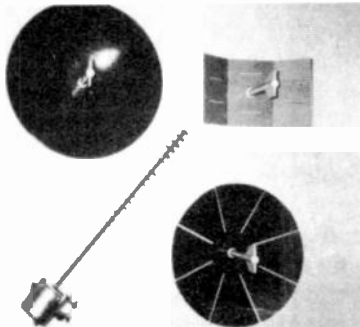

Bring in those hard to get channels with these low priced amateur microwave T.V. receivers. HMR Mini—\$64.95; HMR Daisy Dish—\$69.95; Spectra Dish—\$89.95; MDS 52 ROD—\$89.95. All systems complete and fully guaranteed. Free Shipping. Cable converters call or write for quantity pricing. Add \$4.00 for COD orders. Call today. H.M.R. Sales, 221 East Camelback, Suite 1, Phoenix, Arizona 85012, Phone 602-993-0398.

CIRCLE 49 ON FREE INFORMATION CARD

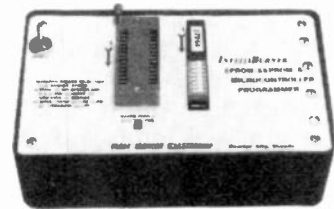

IntelliBurner EPROM-EEPROM & MICRO-CONTROLLER PROGRAMMER \$299

Communicates through the serial port of any personal computer. Use your PC's modem software to read, verify, or program all popular EPROMs, EEPROMs and 87xx series micro controllers. Custom software included for IBM, CP/M or Radio Shack PCs. Other programmers from \$149. Bare PC boards with software from \$39. **ROSS CUSTOM ELECTRONICS**, 1307 Darlene Way #A12, Boulder City, NV 89005. 702-293-7426.

CIRCLE 23 ON FREE INFORMATION CARD



ZENITH Z-TAC CABLE T.V. DESCRAMBLER. Brand new tag-along. Positive and negative video \$225.00 plus 5% shipping and handling. Visa, MasterCard, C.O.D. accepted. For Complete information and our Catalog send \$5.00 to **R&M DISTRIBUTORS**, P.O. Box 266-R15, Boston, Ma. 02190. (617) 871-5838.

CIRCLE 24 ON FREE INFORMATION CARD

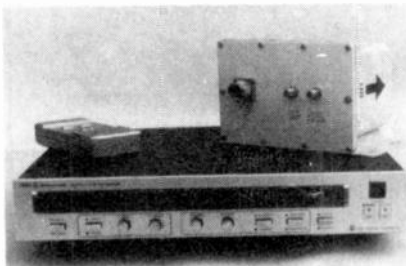

SATELLITE TELEVISION RECEIVER SEMIKIT with dual conversion downconverter. Features infrared remote control tuning, AFC, SAW filter, RF or video output, stereo output, Pcolorator controls, LED channel & tuning indicators. Install six factory assembled circuit boards to complete. Semikit \$400.00. Completed downconverter add \$100. Completed receiver and downconverter add \$150. **JAMES WALTER SATELLITE RECEIVER**, 2697 Nickel, San Pablo, CA 94806. Tel 415-724-0587.

CIRCLE 44 ON FREE INFORMATION CARD



FREE 1984 ELECTRONIC TOOL & INSTRUMENT CATALOG is packed with over 5,000 quality technical products for assembling, testing and repairing electronic equipment. All products fully illustrated with photographs, detailed descriptions and pricing to allow for easy ordering by phone or mail. Most orders are shipped within 24 hours. 100% satisfaction guarantee. **CONTACT EAST**, 7 Cypress Drive, Burlington, MA 01803. (617)272-5051.

CIRCLE 50 ON FREE INFORMATION CARD

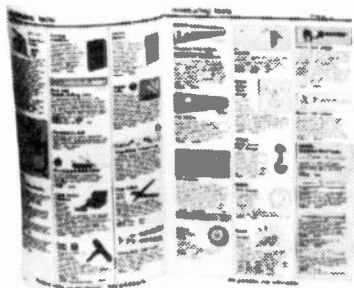

FREE CATALOG OF HARD-TO-FIND TOOLS is packed with more than 2000 quality items. Your single source for precision tools used by electronic technicians, engineers, instrument mechanics, schools, laboratories and government agencies. Also contains Jensen's line of more than 40 tool kits. Send for your free copy today! **JENSEN TOOLS INC.**, 7815 46th St., Phoenix, AZ 85040. (602) 968-6231.

CIRCLE 37 ON FREE INFORMATION CARD

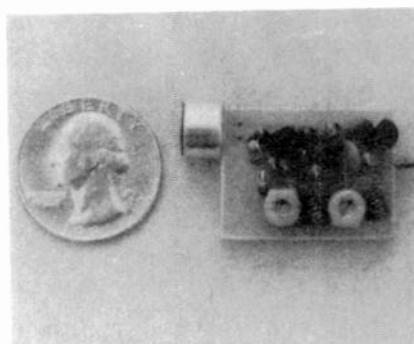

THE MOST EXCITING KIT YOU WILL EVER BUILD The model WAT-50 miniatur FM transmitter uses a 4-stage circuit NOT to be confused with a simple wireless microphone. Up to 1 mile range. So sensitive, it will pick-up a whisper 50 feet away! Use with any FM radio. Complete kit only \$29.95 tax inc. **FREE SHIPPING.** **DECO INDUSTRIES**, BOX 607, BEDFORD HILLS, NY 10507.

CIRCLE 70 ON FREE INFORMATION CARD



DESOLDERING TOOL. Compact, easy to use and clean. A Soldering iron with a built in vacuum pump operates with one hand, eliminating the need for two separate tools. **2-WIRE DESOLDERING TOOL** only \$18.95. **3-WIRE SOLDERING TOOL** only \$21.95. Replacement tips 1.2mm or 1.5mm at \$1.50. To order call 800-492-2373 or in Md 301-428-0995. **COMPUTER VENTURES**, P.O. Box 271, Germantown, MD 20874.

CIRCLE 91 ON FREE INFORMATION CARD

containing 63% tin to 37% lead, with a pure rosin-flux core. Others recommend a solder with 2-3% silver added to reduce "silver migration" in components having fired-on silver-platinum conductors (like some small ceramic capacitors, for example).

Silver migration during soldering results in weak joints and poor adhesion. The addition of silver to the solder raises its cost a bit, and also raises the melting temperature. (No, silver solder isn't

something new, it has been around for some time now.)

As far as soldering irons are concerned, there are many that are compatible with high-tech soldering, and are available in a variety of styles and prices.

The power rating for the irons should range from 10 to 50 watts. Remember that as components decrease in size, they also increase in heat sensitivity. Therefore it is recommended that you do not use an over-rated iron. Note: Because

of the electrostatic sensitivity of chip components, isolated or grounded-tip soldering irons should be used. Needless to say, surface-mounted parts will have to be replaced by exact duplicates because nothing else will fit in their places.

When it comes to desoldering, any one of three desoldering methods may be used; wicking, heat plus a suction device, or a desoldering iron (which are made by several of the major manufacturers). Each one will give good results if properly used—so, it's just a matter of personal preference. I happen to like the desoldering iron.

When desoldering always use the smallest size iron you can; a 30-watt iron will do a good job on the average small part. Just be sure that the solder is completely melted when either soldering or desoldering. That is especially necessary when replacing parts. Make sure that the joint is bright and shiny, not "frosty or fuzzy-looking." If you do see something like that, you know that you have a cold solder joint.

One of the longest jobs we had turned out to be a bad solder joint at the bottom of the base winding of a driver transformer for a horizontal output stage. (I did tell you that it was an intermittent, didn't I?) As if that wasn't enough, we had three of the same model set with the same problem! Fix one and you've fixed all three.

I wrote to the service manager of the firm that manufactured the set about it and he wrote back saying: "Yes, we've run into that problem, but only in about 20% of the sets!" That one nearly went by me, until I finally realized that 20% of the sets meant one in every five sets had a problem!

After that, when ever one of those sets came in, we went right to that joint and resoldered it. In fact, we caught some that didn't even have that problem, but definitely did have a bad solder joint.

In any repair, it's also a good idea to clean the board after any resoldering. That gets off any remaining flux; that stuff is sticky and can catch dust, which will almost certainly result in trouble in the future.

R-E

The
Professionals'
Choice

PTS

"PTS rebuilt modules are better than brand new . . .

I use PTS modules and tuners because of their automatic updates. Compared to original manufacturers' new and rebuilt parts, PTS is better. Quality and turnaround makes the difference. PTS does a better job of rebuilding cause that's all they do."

Try PTS rebuilt modules and tuners for:

- Fast 8 hour rebuilding service
- Full year limited warranty
- One stop shopping for all makes/all models
- Availability at over 1500 authorized stocking distributors
- Quality rebuilds that meet or exceed original manufacturers' specs.



For your free copy of the PTS Price and Technical Information Guide write:

PTS CORPORATION
P.O. Box 272
Bloomington, IN 47402
(812) 824-9331

CIRCLE 52 ON FREE INFORMATION CARD

COMPUTER DIGEST

NEW KIND OF MAGAZINE FOR ELECTRONICS PROFESSIONALS

OP-AMP DESIGN... You can use your computer to save yourself a lot of time and work in designing Operational Amplifiers.

COMMODORE CASSETTE INTERFACE...

How to build a simple circuit that lets you use ANY small audio tape recorder with your Commodore computer.

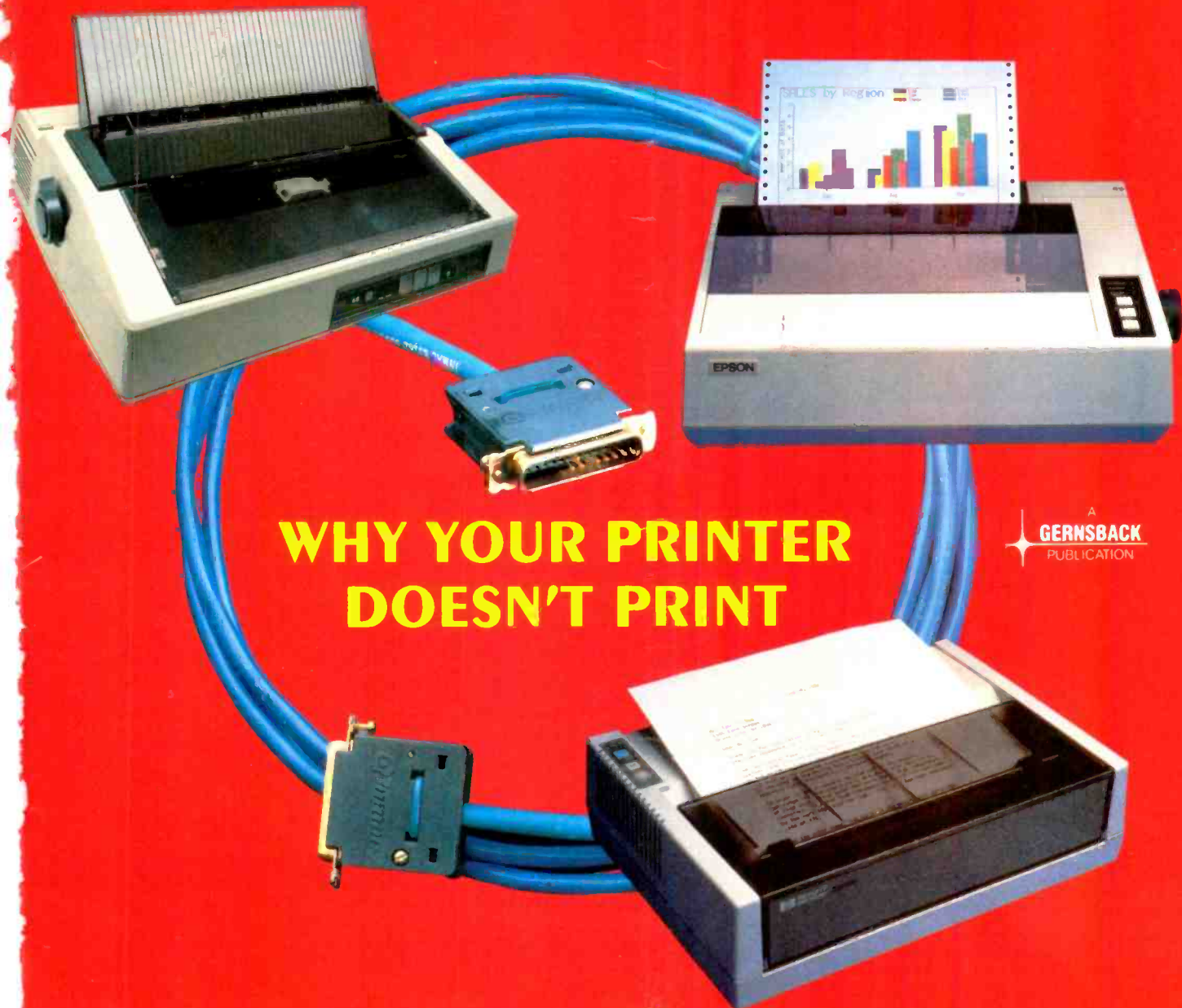

**WHY YOUR PRINTER
DOESN'T PRINT**

A
GERNSBACK
PUBLICATION

Electronics Paperback Books

Quality Paperbacks at Affordable Prices

30 SOLDERLESS BREADBOARD PROJECTS-BOOK 1. \$5.75. Whenever possible the same parts are used in several projects. Even a first-time builder can complete these circuits.

MODERN OP-AMP PROJECTS. \$5.00. Wide range of specialized op-amp circuits including lo-noise, lo-distortion, ultra-hi input impedance, etc.

HOW TO GET YOUR ELECTRONIC WORKING. \$5.00. Helps you troubleshoot and repair home-built projects of every description.

IC PROJECTS FOR BEGINNERS. \$5.00. Inexpensive digital and linear IC's are used to assemble this selection of circuits intended for the beginner.

MINI-MATRIX BOARD PROJECTS. \$5.00. A variety of projects that can all be built upon a mini-matrix board that has 10 strips and is 24 holes long.

MULTI-CIRCUIT BOARD PROJECTS. \$5.00. 21 fairly simple projects that can all be built on a single printed-circuit board. All are powered by a 9V battery.

ART OF PROGRAMMING THE 1K ZX81. \$6.25. Topics include full screen, scrolling, PEEK & POKE, plus actual working programs.

THE 6809 COMPANION. \$5.00. Written for the average assembly language programmer. A discussion of 6809 features & reference work for the 6809 programmer.

ART OF PROGRAMMING THE 1K ZX81. \$5.00. How to use the features of the ZX81 in programs that fit the 1K machine and are still fun to use.

INTRODUCTION TO BASIC PROGRAMMING TECHNIQUES. \$5.00. Based on author's own experience in learning BASIC and helping others to learn to program.

A MICROPROCESSOR PRIMER. \$4.50. Plainness approach to computing for the beginner. Step-by-step explains computer operations and assembly.

PRACTICAL COMPUTER EXPERIMENTS. \$4.50. Fills in background to microprocessor by constructing typical computer circuits using discrete logic components.

THE PRE-COMPUTER BOOK. \$5.00. Aimed at the absolute beginner with no knowledge of computers. A non-technical discussion that helps you enter the computer world painlessly.

AN INTRODUCTION TO VIDEO. \$5.00. Perfect for the person just about to buy a VCR. Discusses pros & cons of the various formats; video discs, videotext, tape copying and more.

BASIC & PASCAL. \$4.00. Takes BASIC & Pascal and develops programs in both languages simultaneously.

FIRST BOOK OF TRANSISTOR EQUIVALENTS & SUBSTITUTES. \$3.75.

PRACTICAL COMPUTER EXPERIMENTS. \$4.50.

ELECTRONICS SIMPLIFIED CRYSTAL SET CONSTRUCTION. \$4.50.

ELECTRONIC HOUSEHOLD PROJECTS. \$4.50.

REMOTE CONTROL PROJECTS. \$4.50. Radio-control infra-red, visible light, & ultrasonic systems are all included along with methods of applying them.

ELECTRONIC TEST EQUIPMENT CONSTRUCTION. \$4.50. Construction details of a wide range of test equipment the experimenter can build at home.

POWER SUPPLY PROJECTS. \$4.50. Contains designs and construction details for almost any power supply the experimenter is likely to need.

ELECTRONIC TIMER PROJECTS. \$5.00. Timing circuits for almost any application the experimenter might need. A most valuable reference.

ELECTRONIC COUNTER DRIVER & NUMERICAL DISPLAY PROJECTS. \$4.50. Features applications & projects using various types of numerical-display devices.

PRACTICAL ELECTRONIC BUILDING BLOCKS-BOOK 1. \$5.00. All electronics circuits consist of simple building blocks. When you know how to make the blocks you can easily create your own projects.

HOW TO MAKE WALKIE TALKIES. \$5.00. Describes equipment for low-power handheld operation. 112 pages of must reading for the dedicated experimenter.

INTERNATIONAL DIODE EQUIVALENTS GUIDE. \$5.75. Helps you find substitutes for the many different types of semiconductor diodes in use today.

INTERNATIONAL TRANSISTOR EQUIVALENTS GUIDE. \$7.50. Products of more than 100 manufacturers are listed & cross-referenced with possible replacements.

ELECTRONIC CALCULATOR USERS HANDBOOK. \$3.95. Presents formulae data; methods of calculation, conversion factors & more from the view of the calculator user.

LINEAR IC EQUIVALENTS AND PIN CONNECTIONS. \$8.25. Shows equivalents & pin connections of a popular user-oriented selection of linear IC's.

RADIO CONTROL FOR BEGINNERS. \$4.50.

ELECTRONIC GAMES. \$4.50.

SPECIAL OFFER Book 1 & Book 2 PRACTICAL ELECTRONIC BUILDING BLOCKS. \$9.00. Shipping Included. Save \$1.75.

ELECTRONIC MUSIC PROJECTS. \$4.50.

POPULAR ELECTRONIC PROJECTS. \$3.75.

PROJECTS IN OPTO-ELECTRONICS. \$5.00.

RADIO CIRCUITS USING IC'S. \$4.50.

ANTENNA PROJECTS. \$5.00. Covers practical antenna designs including active-loop & ferrite types that are easy & inexpensive to build.

RADIO STATIONS GUIDE. \$4.75. Comprehensive listing of transmitters around the world. Presents location, frequency power.

LONG DISTANCE TV RECEPTION (TVDX) FOR THE ENTHUSIAST. \$5.00. Practical & authoritative introduction to this unusual aspect of electronics.

ELECTRONIC AMPLIFIER CRYSTAL SET CONSTRUCTION. \$4.50. Packed full of easy to duplicate designs for crystal radio receivers.

AN INTRODUCTION TO RADIO DXING. \$5.00. Listen in your home, to broadcast originating thousands of miles away. Tells how you can do it.

PRACTICAL ELECTRONIC BUILDING BLOCKS-BOOK 2. \$5.00. Circuits that process signals. Combines with those in Book 1.

THE SIMPLE ELECTRONIC CIRCUIT & COMPONENTS. \$5.75. All the fundamental theory needed to lead to a full understanding of the simple electronic circuit and its components.

ALTERNATING CURRENT THEORY. \$5.75. Alternating current theory without which there can be no comprehension of speech, music, radio, or Television.

FIRST BOOK OF HI-FI SPEAKER ENCLOSURES. \$4.50.

SOLID STATE NOVELTY CIRCUITS. \$3.50.

28 TESTED TRANSISTOR PROJECTS. \$4.25.

SEMICONDUCTOR TECHNOLOGY. \$5.75. Everything you always needed to know about solid-state devices in one volume.

COMMUNICATIONS. \$7.50. Covers most modern communication systems. Line, microwave, submarine, satellite, digital multiplex, radio & telegraphy.

MICROPROCESSING SYSTEM & CIRCUITS. \$7.50. A truly comprehensive guide to all of the elements of a microprocessing system.

ELECTRONIC TECHNOLOGY TODAY INC.
P.O. Box 240, Massapequa Park, NY 11762

RE 10/84

Number of books ordered

Total Price of Books\$

Sales Tax (NY State Residents)

Shipping (75¢ 1st two books, 30¢ ea additional)

TOTAL ENCLOSED\$

Name _____

Address _____

City _____ State _____ ZIP _____

CONTENTS

Vol. 1 No. 6

October 1984

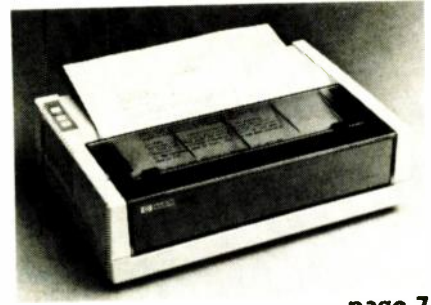

page 7

7 Why Your Printer Doesn't Print

In the first of a two-part series, we learn all about parallel printers and what makes them tick. **Herb Friedman**

11 Computerized Op-Amp Calculator

Here's how you can take all the dog work out of designing operational amplifiers: Use VisiCalc and let your computer do it for you. **Kirk Vistain**

15 Commodore Cassette Interface

Built this simple unit and your Commodore computer will work with almost any standard audio cassette recorder. **Walter G. Piotrowski**

4 Editorial

5 Letters

5 New Products

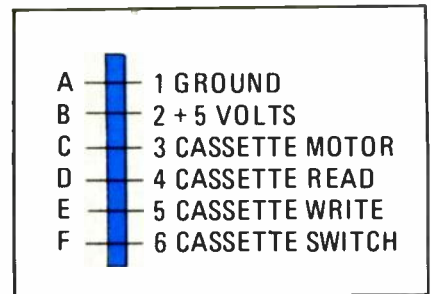

page 15

ON THE COVER

Looking up at you from the middle of our cover, is an RS232 connector. And clockwise, starting at the other end of the cable, is the NEC printer, followed by the Epson and at the lower right, Hewlett Packard's entry. See page 7.



EDITORIAL

The future is here today!

This century has been a highly innovative one. If you stop to think that at the beginning of the 20th Century, man was still bound to Earth and hadn't learned to fly, that medical science was almost barbaric as compared to today, and that electronics was but a fantastic-fiction dream, you pause and wonder at our accomplishments.

If you look at our progress in this past 100 years and try to look ahead to the next 100, it's sufficient to boggle the mind. The very computer on which this editorial is now being written could not have existed those scant few years ago.

Let's try a small exercise—an experiment, if you will. We're going to "brainstorm" or "blue-sky" the coming of the future.

Our readers are, for the most part, intelligent, scientific types. Let's concentrate on the future of computer technology. Where will we be in another century, as far as computers are concerned? What will computers be doing, how will they be doing it, and what will we be doing with them? And please, nothing off-the-wall.

Give us those things with sound, scientific basis, following normal developmental processes. Send your ideas to **ComputerDigest**, 200 Park Avenue South, New York, NY 10003. Got any artistic skills? Send along sketches too.

This will make an interesting project for our readers; and, of course, when all the results are tabulated, we'll put an article together that should make some fantastic reading. All entries will become the property of Gernsback Publications, Inc., and no submissions can be returned.

So put your thinking caps on, and get to work. We'll be anxious to see what you come up with!

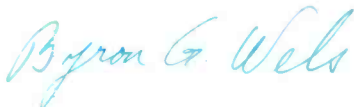

Byron G. Wels
Editor

ComputerDigest is published monthly as an insert in Radio-Electronics magazine by Gernsback Publications, Inc., 200 Park Avenue South, New York, NY 10003. Second-Class Postage Paid at New York, N.Y. and additional mailing offices. All rights reserved. Printed in U.S.A.

A stamped self-addressed envelope must accompany all submitted manuscripts and/or artwork or photographs if their return is desired should they be rejected. We disclaim any responsibility for the loss or damage of manuscripts and/or artwork or photographs while in our possession or otherwise.

COMPUTER DIGEST

Hugo Gernsback (1884-1967)
founder

M. Harvey Gernsback, editor-in-chief

Larry Steckler, CET, publisher

Art Kleiman, editorial director

Byron G. Wels, editor

Brian C. Fenton, technical editor

Carl Laron, associate editor

Robert A. Young, assistant editor

Ruby M. Yee, production manager

Robert A. W. Lowndes, production associate

Dianne Osias, production assistant

Karen Tucker, production assistant

Jacqueline Weaver, circulation director

Arline R. Fishman, advertising coordinator

Gernsback Publications, Inc.
200 Park Ave. South
New York, NY 10003

Chairman of the Board:

M. Harvey Gernsback

President: Larry Steckler

ADVERTISING SALES 212-777-6400

Larry Steckler
Publisher

EAST/SOUTHEAST

Stanley Levitan
Radio-Electronics
200 Park Ave. South
New York, NY 10003
212-777-6400

MIDWEST/Texas/Arkansas/OKla.

Ralph Bergen
Radio-Electronics
540 Frontage Road—Suite 325
Northfield, Illinois 60093
312-446-1444

PACIFIC COAST

Mountain States

Marvin Green
Radio-Electronics
15335 Morrison St., Suite 227,
Sherman Oaks, CA 91403
818-986-2001

LETTERS

Wants portables

I'd like to see an applications-oriented article on portable computers. I'm sure that a lot of other readers would be just as interested.—Sam Bennett, Fresno, CA.

Sounds like a great idea Sam. We'll get one of our experts busy on that one right away!

No games?

How come you don't report on new computer games the way some computer magazines do? —Fred Morrison, Madison, WI.

Fred, take a look at our front cover. It says 'A New Kind of Magazine For Electronics Professionals.' We want all the readers we can get, but no magazine can be all things to all people.

Settle an argument

A friend says that a good computer "hacker" can break into almost any computersystem, regardless of the security. I am wondering if that statement is really true? —Gene Lyons, Atlanta, GA.

Gene, while nothing is ever 100%, the odds are against it, despite what the movies show! Cracking the most basic system would take more patience than most people have, and a system, where codes are periodically changed, would be all but foolproof.

More kudos!

I would like to see *ComputerDigest* continue to present concise summaries of current events in the computer field, and am relieved to have

discovered a computer magazine which is not just a sales pitch! —P. D. Broadhurst, Channel Islands.

Thank you too, Mr Broadhurst. More and more, our readers are beginning to learn what we're all about! It's very gratifying indeed.

More hardware

I'm so tired of software-only articles that I could write some myself, just from the ones I read! Yours is the last magazine that contains useable information on projects and hardware. And printing my comments is not expected. —Irving E. Shivar, Jr., Camden, SC.

Surprise, Mr. Shivar! Thanks for understanding (and appreciating) what we're trying to do. Keeping a wide variety of readers happy is our goal. ◀▶

COMPUTER PRODUCTS

For more details use the free information card inside the back cover

PORT EXPANDERS/SWITCHERS, *Data Director* models Q23, Q24, Q25, Q13, Q14, and model Q15 are a series of "port traffic cops"—port expanders with A/B/C switch routing—that can switch one port to any of three devices, or one device to any of three ports.



CIRCLE 111 ON FREE INFORMATION CARD

Model Q23, model Q24, and model Q25 are in stand-alone cabinets, while model Q13, model Q14, and model Q15 are designed to fit inside

Computer Accessories' model P12 Power Director (line-conditioning power-control accessory) cabinet.

The three models in each series meet specific connector needs for a given port or system. For standard RS-232 serial ports, *Data Director* offers model D825 female (models Q13, Q23) or male (models Q14, Q24) connectors. For standard parallel (printer) ports, *Data Director* (models Q15, Q25) offers 36-pin Centronics-style connectors.

Model's Q23, Q24, and Q25 are priced at \$199.00 each; models Q13, Q14, and Q15 are priced at \$189.00 each.—**CA Computer Accessories**, 7696 Formula Place, San Diego, CA 92121.

POWER OUTLET EXPANDER/FILTER, the *Power Director* model P22, model P2, and model P12 are designed to filter radio-frequency noise, spikes, glitches, and surges that imperil sen-

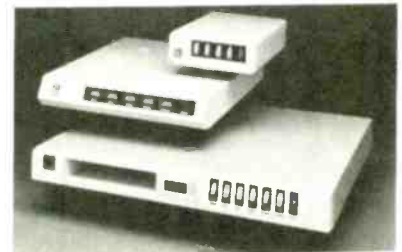

CIRCLE 112 ON FREE INFORMATION CARD

sitive electronics equipment.

These are desktop-design devices and individual and collective (master) outlet control are part of the design. Each outlet is monitored with a power pilot light (amber for the individual outlets, red for the master) a circuit breaker adds overload protection. While the pilot lights are located on the front panel, the actual outlets are out of sight on the back panel.

The stand-alone model P22 (sized to stack with such items as disk drives

and modems) offers four outlets and is available for \$99.00. The monitor-base model P2 (sized to fit under a CRT or video monitor) offers five outlets and is available for \$129.00. The model P12 (sized to fit atop the IBM PC system unit, for example) offers six outlets, plus a digital clock and stowaway storage areas for diskettes, quick-reference cards, or small manuals, is priced at \$199.00.—**Computer Accessories Corporation**, 7696 Formula Place, San Diego, CA 92121

VIDEO TAPE/DISC CONTROLLER, model VPC, is a plug-in board that lets an IBM PC (or similar computer) control industrial-type videotape

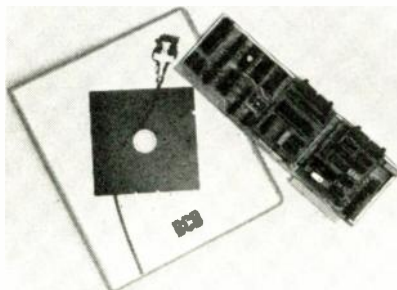

CIRCLE 113 ON FREE INFORMATION CARD

recorders with frame-accurate precision. It can also control videodisc players. The internal microprocessor, and up to 32K of RAM/ROM, translates simple user commands into complex videotape-recorder and/or videodisc player operators. The model VPC's motherboard plugs into the computer and may host one or two "video modules" to control tape, disc, or one of each.

The model VPC with tape or disc video module is priced at \$1195.00; with tape and disc video modules, it costs \$1695.00.—**BCD Associates, Inc.**, 5809 S.W. 5th Street, Oklahoma City, OK 73128

UNINTERRUPTIBLE POWER SUPPLY,

model 1350, provides 10 minutes of backup electric power for computers during a power failure. It weighs 32 pounds and fits in a compact, 1/2 cubic-foot space.

The model 1350 provides 120 volts at 350 volt-amps—sufficient power for a computer, disk-drive, printer, and monitor. The unit has a transfer time of 12 milliseconds, typical, and a single-phase 60-Hz supply ($\pm 0.5\%$). It also contains a patented clipper circuit to

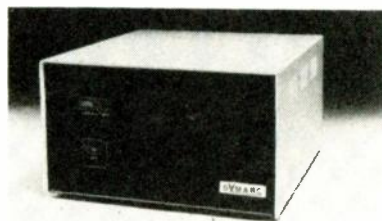

CIRCLE 114 ON FREE INFORMATION CARD

provide on-line surge protection from both normal and common-mode transients. RFI suppression is handled by Sprague filters.

The model 1350 has a suggested retail price of \$750.00 and comes complete with a maintenance-free battery.—**Dymarc Industries**, 21 Governor's Ct., Baltimore, MD 21207

HIGH-DENSITY DISKETTE, model 2HD, features a new coating technology that allows the 5.25-inch diskette to store up to 1.6 megabytes, or 60% more than the conventional 5.25-inch 96 TPI floppy. The improved storage value helps to close the gap between the 5.25-inch rigid and the

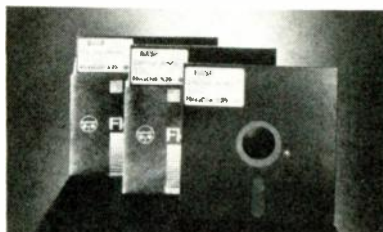

CIRCLE 115 ON FREE INFORMATION CARD

5.25-inch floppy. It is priced at \$9.25 per disk.—**BASF Systems Corporation**, Crosby Drive, Bedford, MA 01730.

AMBER MONITOR, model SA-1000, has a 12-inch CRT and a non-glare, high contrast faceplate. Among its features are composite video-input signal, a resolution of 900 dots center and 800



CIRCLE 116 ON FREE INFORMATION CARD

dots corner. It also includes an RCA-type input connector, and 2000 character display format (5 x 7 dots, 80 characters x 25 lines).

The amber monitor model SA-1000 is priced at \$159.00.—**Sakata USA Corporation**, 651 Bonnie Lane, Elk Grove Village, IL 60007.

Check These FANTASTIC BUYS Join our over **50,000** Satisfied Customers

DEX 4100 FACSIMILE (FAX) MACHINES
Ideal for Experimental Page Scanner or Low Cost Copier

Found in offices everywhere, these units can transmit & receive to and from other Standard Telecopier Machines over standard phone lines. Transmits documents and photos. Features auto feed of originals, built-in roll feed, page cutter for automatic sizing & photo mode for the grey scale & halftones.

OPERATIONAL! **\$169.00** ca.

PARALLEL, TTL INPUT I/O "SELECTRIC" TYPEWRITER/PRINTER These machines have built-in driver and decoder circuitry and take TTL level 6-bit character, plus a 4-bit function input signals. Easily driven by most any micro. Use as a typewriter (with add'l "repeat" circuitry) or as a KSR I/O printer or both. Table Top" style case.

TESTED AND OPERATIONAL! **Only!! \$299.00** ca.

SHUGART SA-400 "MINI-FLOPPY" DRIVES
Model SA-400, used, whole, untested, less power supply & case. Data and schematics included. Removed from Equipment.

UNUSED **Only!! \$99.00** ca.

SSDD, DUAL MINIDISKETTE DRIVE
w/supply & 2 TEAC (w SA-400 interface) Mini-Floppy Drives in DEC case. Made for Digital Equipment Corp. Incl Pwr Supply, Case.

Only!! \$299.00 ca.

G.E. "TERMINET 1200" FEATURING:
110, 300, & 1200 Baud (11, 30 & 120 cps). Full KSR & RS-232-C I/O, compact table-top configuration upper & lower case continuous band, made in USA by General Electric, tested and operational.

Only!! \$349.00 ca.

120 CPS*
RS-232

Prices do not include packaging and shipping.
Write or Call for Our Latest Flyer NOW!!! *Selectric" is a registered trademark of IBM Corporation

Computer Products & Peripherals Unlimited

WAREHOUSE: 18 Granite St. Haverhill, Mass. 01830
MAIL ORDERS: Box 204, Newton, New Hampshire 03858

617/372-8637
Sorry No Collect Calls
MasterCard & VISA Accepted

CIRCLE 68 ON FREE INFORMATION CARD

WHY YOUR PRINTER DOESN'T PRINT...

It's standards that make parallel printers work. It's the lack of standards that gives us trouble.

HERB FRIEDMAN

■ *Standards* are what keeps the world working. They insure that an 8-32 screw from Outer Mongolia will fit an 8-32 nut manufactured in Lower Sandusky, Ohio: that your telephone will access any other telephone in North America, possibly the world: that the portable TV you purchased in New York—which was manufactured in Osaka—will not blow up when you plug it in to a power outlet in Yellowknife.

Unfortunately, manufacturers of many kinds of consumer equipment are prone to utilizing only part of a standard, preferring—for whatever the reason—to make their own proprietary modifications to the standard for what often appears to be no rational reason. In actual fact, many times an actual standard or a *de facto* standard is modified to intentionally prevent a device from being used with any other equipment supposedly using the *standard*. Printers intended for use with personal computers are an excellent example of modified standards, which is often the reason you can't get your old and faithful printer to work with the new computer, or why your new computer won't work with someone else's printer. For example, we all know the IBM graphics printer is an Epson. Right? Only partially right. Use your old Epson and you'll print the standard ASCII characters, but not the IBM graphics.

And while we're talking about IBM, we all know the Epson printer, or a Smith Corona L-1000 daisy wheel, or any of a hundred printers have *standard* Centronics-type connections. So does the IBM. So how come you can't plug a Centronics type printer into an IBM-compatible personal computer? Because while the connections are standard, the connector isn't. IBM-compatible computers employ a DB-25 connector for their parallel printer output, but the DB-25 is the standard for RS-232/O, it in no shape, form or manner is the equivalent of the truly standard Centronics-type Delta connector. To use a Centronics-type printer with an IBM-compatible computer the user must purchase a special, and somewhat expensive, adapter cable having a DB-25 on one end and a Centronics connector

on the other end. But don't blame only IBM for not using a *standard*. How about Diablo and Xerox (same printer, different brand name)? Their daisy printers—considered the very finest by most users—have what is supposedly a standard RS-232 serial I/O. True enough, it's standard, only the connections aren't the ones used by most of the computer manufacturers. Take your printer home, plug it in, and it's an odds-on bet it won't work properly, if at all.

Get it working.

The best way to start interfacing a printer is to just get it working. If it can at least print the full ASCII alphanumeric character set and feed paper you're on your way. We'll start with parallel printer connections because they are the least troublesome. Parallel printer connections are called Centronics-type because they are the connections for the earliest printers—manufactured by Centronics—that were used with personal computers. To their credit, the Centronics connections were well thought out and have never required upgrading or a retrofit. The only time they give trouble is when a manufacturer goes out of their way to muck things up, as did Apple with non-sequential wiring of their parallel printer card; IBM and IBM-compatible computers with their use of a DB-25 connector for the parallel output; and Radio Shack with their card edge-connectors having non-sequential numbering and a forced automatic line feed after carriage return. Fortunately, the Centronics interfacing was so well thought out that most users can easily get around any problems created by the computer manufacturer. The Centronics printer connections are shown in Table 1. While there are many individual circuit connections because Centronics provided for every possible kind of parallel handshaking and fault indication, every connection isn't necessarily used by every printer. For example, a printer that uses the BUSY for handshaking (stopping and starting the computer's output) won't use the ACK, and vice versa.



THE NEW HP 2225 INKJET PRINTER from Hewlett Packard is fully portable, may be used with portable or desktop computers. operates below 50 dB.

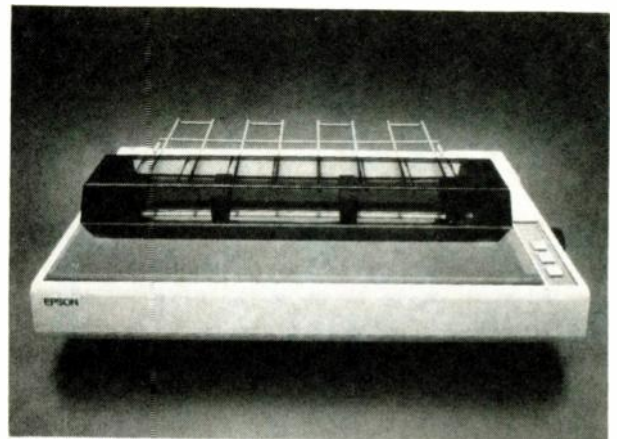

EPSON'S RX-100 DOT MATRIX PRINTER operates at a speed of 100 characters per second on a 136-column carriage.

But be careful! Sometimes you can make a false assumption and get yourself into really-big trouble. The safest bet is that anything that can go wrong, will go wrong.

Unfortunately, some manufacturers modify the wiring of the signal pair returns—which are grounded—or put +5 volts on one of the normally-unused pins. If in doubt, the safest thing to do is wire only those connections which are absolutely required for parallel operation, the ones indicated with an asterisk (*), for no manufacturer will meddle with them (so far); they are safe to use because a computer or printer will automatically reject their use if not needed. The connections marked with a "pound" (#) symbol are normally unused and they are the ones manufacturers often employ to provide external voltages for external accessories—or they tie them together and connect them to +5 volts—which can prove a disaster. Do not use these wires unless you are absolutely certain you need them. Try running the printer without them. Be especially careful of terminal #18, which is often, but not always used to provide +5 volts from the printer or the computer for powering ancillary devices, such as a serial-to-parallel converter. Some manufacturers put the full rail voltage on the connection, others provide the 5 volts through a resistor. If in doubt, leave this connection open because 5 volts on #18 is not part of the standard wiring. Depending on the equipment, the wrong hook-up can cause a lot of damage. Same thing for terminals 33-36. They aren't used for standard connections. Some manufacturers use them for providing power to ancillary hardware or tie them to +5 volts. If in doubt, leave the connections open. Terminals 16 (GND) and 17 (CHASSIS) are "ground." Terminals 19 thru 30 are return lines for the signal and handshaking circuits, "return" being a fancy word for "common" or "ground" connection.

Depending on the particular printer and the computer being used, your equipment might work if all terminals 19 thru 30 aren't connected; then again, the equipment might not work. Your equipment will always work if the wires are individually brought through from one connector to the other, but if you're making up a multi-wire cable and are short on connecting wires,

you can connect terminals 19 thru 30 to terminal 16; and if in doubt, also connect 17 to 16. Be extremely careful of terminal 35; do not use it unless you know what you're doing. While not used in the Centronics standard, one very popular computer uses it for a redundant ground while an equally popular printer uses it for +5 volts.

In your anxiety to get things going, you tend to look for shortcuts. This can result in dire consequences. While it may seem expedient to take advantage of "unused" terminals, they aren't always as available as they might seem.

The potential for a catastrophic failure is obvious, so don't use terminals 33 through 36 unless you have schematics for everything. Do not eliminate any standard connections thinking they aren't needed.

Some connections accommodate several different fault indicators which your computer might require for operation. For example, while the BUSY signal normally tells the computer the printer isn't ready for data because it's printing, some printers use the BUSY to also stop the computer when the ribbon runs out, the cover is open, the power is off, the paper has run out, etc. Other printers put the out of paper indicator, cover open, ribbon out, etc. on the FAULT line. The safest bet is to always use all the standard connections. Normally, Centronics-type connectors can be wired straight across, that is, the wire connected to terminal #1 on one side connects to terminal #1 on the opposite side.

To their credit, even when using different connectors (ie., card edge-connectors) Radio Shack has always arranged the circuits in the Centronics order so the wiring is always correct when connectors are squeezed on ribbon cable. Unfortunately, this isn't the case with other computers. The IBM-compatibles use a DB-25 for the parallel output, and the terminal numbers simply don't match. Also, you can mistake the IBM parallel printer output for an RS-232 connection, and it is possible to blow out something in the computer, so be extremely careful when making parallel printer connections to a DB-25 connector. Also, a commonly used computer (the Osborne 1) and at least one printer buffer (the Angel) don't have standard parallel Centronics connectors, so again take extreme care if you make up your own cables because the connections aren't in the Centronics order.

TABLE 1
Standard Centronics-Type configurations
for Scotch "Delta" 36-pin connectors.

KEY	PIN	FUNCTION
.	1	DATA STROBE
.	2	DATA 1
.	3	DATA 2
.	4	DATA 3
.	5	DATA 4
.	6	DATA 5
.	7	DATA 6
.	8	DATA 7
.	9	DATA 8
.	10	ACK
.	11	BUSY
#	12	PAPER EMPTY (PE)
#	13	SELECT PRINTER
!.	14	SIGNAL GROUND
.	15	NC
.	16	GND
!.	17	CHASSIS GND
#	18	(CAUTION - + 5VDC)
!.	19	PAIR GROUND
!.	20	PAIR GROUND
!.	21	PAIR GROUND
!.	22	PAIR GROUND
!.	23	PAIR GROUND
!.	24	PAIR GROUND
!.	25	PAIR GROUND
!.	26	PAIR GROUND
!.	27	PAIR GROUND
!.	28	PAIR GROUND
!.	29	PAIR GROUND
!.	30	GROUND (GND)
#	31	INPUT PRIME
.	32	FAULT
#	33	NC
#	34	NC
#	35	NC
#	36	NC

There is not necessarily any correlation between printers as far as codes are concerned. Again, the lack of actual standards is plainly evident. Ask any manufacturer of printers about this, and you'll probably be told that they do indeed cleave to rigorous standards—their own! The confusion is borne out when you get down to the hard wiring. To see precisely what can happen, take a look at Table 2.

The printer codes.

Regardless of whether the printer is serial or parallel input and the actual order of the connections, the most frustrating difficulties you're likely to face when installing your printer are the *printer codes*, for which there is essentially no standard other than for the ASCII characters. With virtually no exception, every modern printer can do something more than just print the 96 ASCII characters. Depending on the particular model and type of printer, it's possible to underline characters; boldface through multi-striking and carriage shift; print letters larger, smaller or in italics (matrix printers); print trade marks, smiling or happy faces; or foreign characters or Greek or electrical symbols. You name it and there's a printer out there that can do it. Your only problem is to tell the printer what you want to do, and that's where printer codes come in. All printers uses

standard ASCII codes for the character set and control codes. The ASCII code is numbered from 0 through 127 in decimal, which corresponds to hex 0 through hex 7F. (Printer codes can be either decimal or hex, depending on the particular printer and/or software. The codes from 0 to 31 are non-printing *Control Codes*, meaning they can be used to "trigger" specific computer or printer functions. Decimal code 32 (hex 20) is the *space*. The ASCII codes from 33 (hex 21) to 126 (hex 7E) produce the *ASCII character set*: the alphanumerics which can be printed by a printer capable of printing the full 96 character set.

Code 127 (hex 7F) is the old teletype *delete*: The modern printer either doesn't respond to code 127 or prints a "block." Normally, every printer responds to ASCII codes 32 to 126. For example, if the computer sends a 32 (hex 20) to the printer every printer made will space. If the computer sends a 65 (hex 41) to the printer every English-language printer made for use with personal computers will print the letter A. The first problem with printer standards you're likely to run across are the ASCII codes below 32. (See Table 2.) Some are truly standard, for example, 13 (hex 0D) is always used for CR (carriage return) while 10 (hex 0A) is always used for LF (line feed), and 27 (hex 1B) is always ESC (escape). And that's about where the standards really end. For example, while an 8 (hex 08) will cause most printers to backspace, your printer might not recognize 8 as the backspace control code, hence, any software you have that backspaces with an ASCII 8 for strikeover or underline won't budge your printer; it might require some other code, or use a special code for underscoring. For example, send a 25 (hex 19) to a Smith-Corona TP-1 daisywheel printer and every character will underline. Send a second 25 and the underline will stop. But if you have a Smith-Corona TP-2 printer the second Hex 19 won't do a thing because it requires a 31 (hex 1F) to stop the underline. Tricky? You bet! Unless your software can be modified, or can send user-programmed control codes from within the program, there's no way you're going to get the underline straightened out. And if you think Smith-Corona underline is tricky, try the Epson with Graftrax.

Underscore *on* is ESC-1 (hex 1B 5F 31); underline *off* is ESC-0 (hex 1B 5F 30). (Someone must have been asleep at the design board because one of the most popular personal computers cannot output a control code zero (0) from its word processor.)

Everyone for themselves.

From ASCII 128 and higher it's every manufacturer for themselves. For example, the famed budget-priced Smith-Corona daisy printers do not respond to codes above 127. On the other hand, the Radio Shack model DWP-210 daisy wheel printer has a few additional characters accessed by printer codes higher than 127.

For example, a 169 (hex A9) will produce the single character imprint TM (for Trade Mark), while a 171 will produce the circled-C (©) used to indicate copyright. Similarly, a 222 will produce the ¢, which is not on the standard ASCII keyboard (it is a typewriter character).

While daisy printers might respond to a few specific printer codes above 127, it's the matrix-type printers

TABLE 2

ASCII	CODE	PRINTER #1	PRINTER #2
0	NUl	NULL	NO RESPONSE
1	SOl	SET LINE SPACING	NO RESPONSE
2	ST>	DEFAULT LINE SPACING	NO RESPONSE
3	ET>	NO RESPONSE	NO RESPONSE
4	EO	NO RESPONSE	END OF TEXT
5	EN·	NO RESPONSE	NO RESPONSE
6	AC·	NO RESPONSE	ACKNOWLEDGE
7	BE	SOUNDS BELL	NO RESPONSE
8	BS	NO RESPONSE	BACKSPACE
9	HT	NO RESPONSE	TAB
10	LF	LINE FEED	LINE FEED
11	VT	VERTICAL TAB	NO RESPONSE
12	FF	FORM FEED	FORM FEED
13	CR	CARRIAGE RETURN	CARRIAGE RETURN
14	SO	EXPANDED CHARACTERS	NO RESPONSE
15	SI	COMPRESSED CHARACTERS	NO RESPONSE
16	DLE	NO RESPONSE	NO RESPONSE
17	DC1	ACCEPT DATA (X-ON)	ACCEPT DATA (X-ON)
18	DC2	COMPRESSED OFF	TAB SET
19	DC3	DESELECT (X-OFF)	DESELECT (X-OFF)
20	DC4	EXPANDED OFF	TAB CLEAR
21	NAK	NO RESPONSE	NO RESPONSE
22	SYN	NO RESPONSE	NO RESPONSE
23	ETB	NO RESPONSE	NO RESPONSE
24	CAN	NORMAL CHARACTERS	MARGIN RELEASE
25	EM	NO RESPONSE	UNDERSCORE ALL
26	SUB	NO RESPONSE	NO RESPONSE
27	ESC	NO RESPONSE	NO RESPONSE
28	FS	NO RESPONSE	LEFT MARGIN SET
29	GS	NO RESPONSE	NO RESPONSE
30	RS	NO RESPONSE	UNDERSCORE WORD
31	US	NO RESPONSE	END UNDERSCORE

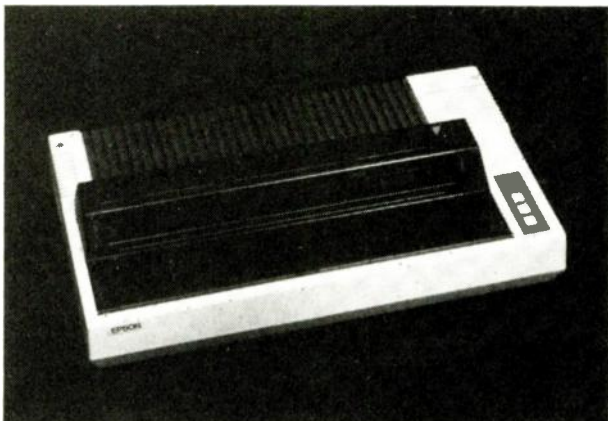

THE NEW FX-100 PRINTER FROM EPSON operates at 160 characters per second, carries a suggested retail price of \$895.00.

that really get mileage from 127 and higher—and they cause the most standardization problems. For example, connect your old reliable printer to your new IBM-compatible computer and program for a few of the IBM graphic characters. Depending on the particular model printer you might wind up with unusual graphic symbols, or even italic characters, but you won't get the graphic characters that match those in the computer's documentation. The reason, of course, is because only codes 32 to 127 are standard. The Epson printers sold under the IBM label have internal ROMS with a completely different set of graphics than any other model for the codes above 127. To obtain the IBM graphics, whatever matrix printer you use must be

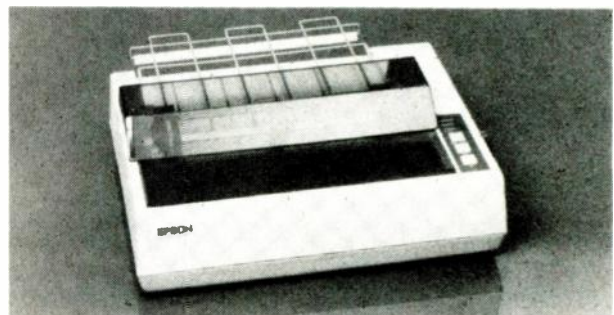

THE RX-80 DOT MATRIX PRINTER FROM EPSON has tractor and friction feed, prints 100 characters per second, offers two full 96-character ASCII sets plus nine international sets including 128 type styles.

specifically programmed from ASCII 128 up to produce the IBM graphics. (That's why IBM can charge so much for a printer you could otherwise purchase for several hundred dollars less.) Similarly, if you try to use an older Radio Shack printer with a new Radio Shack computer something's not going to work when your software attempts to produce graphics, because the late model computers are intended for printers with a different "graphic set" than the earlier printers.

Essentially, if you're into using computer hardware and software from several manufacturers you've got to triplecheck that the graphic ASCII codes are all compatible, else you will wind up with "garbage" or just empty blank spaces on the paper. In Part 2 we'll untangle the serial printers and the parallel-to-serial and serial-to-parallel converters. ◀▶

COMPUTERIZED OP-AMP CALCULATOR

KIRK VISTAIN

Find all the circuit values for three important op-amp configurations in an instant with this spreadsheet template.

■ What electronics hobbyist wouldn't love to be able to calculate all the resistor and capacitor values for a differential op-amp circuit in less than a minute? Better yet, imagine being able to do it for inverting, non-inverting, and differential configurations simultaneously. You can eliminate arithmetic errors, change designs in mid-stream, or perform "what-if" analyses to your heart's content.

Well, the op-amp "calculator" we'll describe in this article helps you do it. It's an op-amp design template written for use with the popular and powerful *Supercalc*, an electronic spreadsheet from Sorcim Corporation. It was developed on a Xerox 820, with an 80 column display, operating under CP/M, but it should work on any computer running *Supercalc*. Note that you'll need to use horizontal scrolling on a 40-column display.

To use the template, simply load in an installed *Supercalc* program, then load the template, which we've named OPAMPC. Figure 1 shows the screen after loading. At the upper left is the *user choice* selection. The number (no alphabetical prefixes or suffixes, please) of the desired op-amp is typed in, and the gain-bandwidth product (GBP) is automatically returned to the right. (That selection is customized by the user).

Next, the desired input resistance (INPUT R), voltage gain (A_v), low-frequency cutoff (LOW F), and high-frequency cutoff (HIGH F) are entered. The rest of the operation is automatic.

Resistor and capacitor values are simultaneously calculated for three basic configurations, and automatically rounded to the nearest EIA standard values. Circuit parameters are then recalculated using those values, and displayed in the ACTUAL column. Percent deviation from desired performance is returned in the next column to the right. In most cases, those errors are kept to less than 10%.

Why use *Supercalc*? There are a number of reasons. First, *Supercalc* is a versatile piece of software that can be adapted to many different purposes. For that reason, it is among the first programs a new computer owner buys. Secondly, because of its many logical and arithmetic commands, much of a programmer's work is already done, so designing and entering a template is quicker than writing a program in say, Pascal or BASIC. We could have used *Visicalc*, another electronic spreadsheet, but doing so would have forced us to sacrifice the automatic rounding-to-EIA-standards that makes OPAMPC so convenient. No doubt, some enterprising programmers will come up with ways to adapt this template to their particular spreadsheet program.

Three types of error messages are included, summarized at the upper right of the worksheet. Each amplifier configuration is represented separately, listed under INDEX. If the actual or desired Gain-Bandwidth Product (GBP) is greater than the rated GBP of the selected op-amp, a 1 appears. If not, 0 is returned. A similar function is provided to test whether R2

USER CHOICE				
OPAMP:	1458	RATED GBP:	1e5	INDEX
INPUT R:	1e5	INDEX	GBP:	1e5
GAIN (Av):	5	0.1, Invert.	0	0
LOW Fc:	2e4	1.4, Non	0	0
HIGH Fc:	2e4	2.5e4, Diff	0	0

0 Indicates Selected R or C Out of Range

DIFFERENTIAL	AMP MODE	ACTUAL	% ERROR
R1	1e5	1e5	0.00
R2	5.1e5	5.1e5	0.00
R3	1e5	1e5	0.00
R4	5.1e5	5.1e5	0.00
C1	4.7e-08	4.7e-08	0.00
C2	1e-08	1e-08	0.00

FIG. 1—VIDEO DISPLAY (80 column) as it looks during a sample differential amp calculation using OPAMPC.

(negative feedback resistor) is less than 1 megohm, a necessity for proper DC stability in common bipolar op-amps. If you're using BiFET's, you can change the flag point to account for their lower current requirements. Refer to the device manufacturer's data.

An R2 error will also occur if calculations result in a value out of the lookup table's range. That will be corroborated in the individual amplifier sections.

Structure of OPAMPC

OPAMPC is functionally divided into three sections. In USER CHOICES, device number and desired circuit parameters are entered. GBP and R2 error flags are included, along with an index of the calculation section.

The CALCULATION area of the spreadsheet contains the formulas necessary to determine component values from the user's choices. Inverting, non-inverting, and differential configurations are treated separately. Spacing between the subsections aids readability and quick access when using the window mode.

The LOOKUP TABLES are the key to the rounding function. That section is automatically searched by the CALCULATION area to find the standard resistor or capacitor value closest to the calculated one. Don't be intimidated by its 151-line length! It's quickly built, using *Supercalc's* automatic functions.

Theory of operation

Figure 2 shows three common amplifier designs, and the formulas used to determine component values. The OPAMPC template is based on an AC model, and was specifically written for audio applications. Power supply connections are not shown, nor are compensation or offset circuits. Many devices use internal compensation, and offset is usually not a big problem. If in doubt, consult one of the many op-amp design books available.

Most of the formulas shown in Fig. 2 were simply converted into *Supercalc* format and entered onto the worksheet (more on that later).

Inverting amp

OPAMPC ignores the negative component of the inverter's output, a common convention. Remember, though, that the output signal will actually be 180° out of phase with the input.

The 1E6 factor in the calculation for C1 produces an answer in microfarads, instead of farads. That applies to the other configurations as well. 1E6 is *Supercalc's* shorthand for 1×10^6 . Using the optional resistor R3 will minimize input offset, although, commonly, the non-inverting input is simply tied to ground.

Non-inverting amp

In the non-inverting amp, for minimum offset, $R3 = R1 \parallel R2$ (the symbol \parallel means "in parallel with"). The value of R3 is equal to the input resistance, so whatever value you select in the USER section appears opposite R3. We know that the gain of a non-inverting op-amp is $1 + (R2/R1)$, but how do we use that formula without selecting a fixed value for R2 and R1? Remember that

whatever combination of resistors we pick must have a parallel value equal to R3.

The trick is trying to get R1 and R2 solved for two different equations simultaneously in a way *Supercalc* could handle. After trying many of the normal methods for that, unsuccessfully, we hit upon the idea of simply defining $R1 + R2 = 1$ megohm. That automatically kept the feedback resistor below our design limit of 1 megohm, eliminating an annoying and clumsy term in the calculations to boot.

You may have noticed that an undefined condition will exist if the user selects a gain less than or equal to 1, because $(A_v - 1)$ will then equal 0, by which you can't divide, or a negative number, whose square root is not a real number.

The low-frequency rolloff points of the inverting and non-inverting inputs respectively are $-f_c$ and $+f_c$. The value of $+f_c$ is user-selected and equal to low f_c . The value of $-f_c$ is arbitrarily set for five times $+f_c$ in order to minimize low-frequency noise gain.

Differential amp

The calculations for the differential configuration are virtually identical to those for the inverting mode, except that they apply to both inputs. Best CMRR (Common Mode Rejection Ratio) requires $+f_c = -f_c$, where $+f_c$ is the cutoff frequency of the non-inverting input, and $-f_c$ is the cutoff frequency of the inverting input. For simplicity, we let $R1 = R3$ and $R2 = R4$. That results in differing input resistances for the inverting and non-inverting inputs.

User-selected INPUT R becomes the resistance of the inverting input, with the non-inverting input R being calculated and returned opposite r_{in+} . It will always be higher than the user-selected figure, but that is not generally a problem in signal circuits. The differential input resistance, R_{DIFF} , appears in cell F42, and is the sum of R_{IN+} and R_{IN-} .

Lookup table

Seldom do calculations yield precise, convenient, standard values for resistors and capacitors. If we intend to translate our design to the real world, however, that is necessary.

Consequently, OPAMPC contains lookup tables, which effectively round calculated values to EIA standards. We use *Supercalc's* built-in LOOKUP function and some long lists to do this.

Building the worksheet

To ease entry, we've divided OPAMPC into two files, called OPCALC.CAL, which contains amplifier formulas and the user choice section, and LOOKVAL.CAL, the resistor, capacitor, and op-amp lookup tables. Once we've built and saved those two files, we'll combine them into a single template called OPAMPC.CAL. (.CAL signifies a file of *Supercalc* type. The file type is understood and need not be stated when working within the *Supercalc* program.)

Good practice calls for frequent saves and backing up all files on a separate disk.

To build the lookup tables, first enter the headings as shown in Fig. 3. The column widths were selected only so

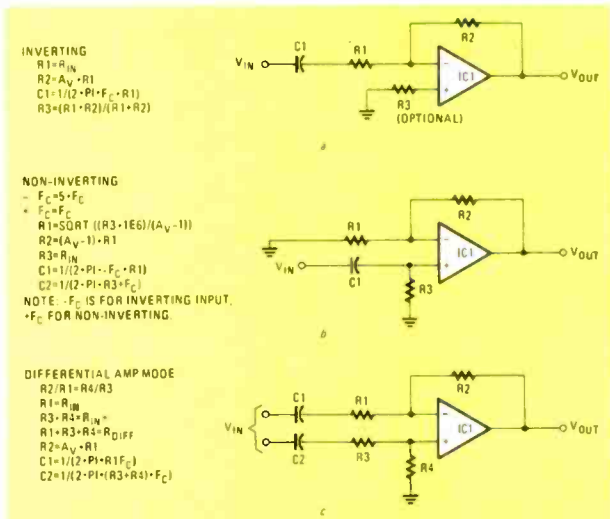

FIG. 2—THREE OP-AMP CONFIGURATIONS. An inverting amp is shown in a, a non-inverting amp in b, and a differential amp in c.

the headings would fit. Once the tables are integrated on the OPAMPC worksheet, column width will be irrelevant.

Next, starting at cell D3, enter the following series of numbers in column D:

1E-5	2.2E-5	4.7E-5
1.1E-5	2.7E-5	5.6E-5
1.5E-5	3.3E-5	6.8E-5
1.8E-5	3.9E-5	8.2E-5

Put a 0 in C2 and D2 and enter the formula D3 + C*.9 in cell C3. Replicate it in the range C4:C100. Now, enter the formula D3 + C*10 at cell D15 and replicate it from D16:D100. Enter 0's at the bottom of the capacitor list in cells C101 and D101.

The resistor table is built similarly. Zeros go into cells F2 and G2. The following list is entered into column G, starting at G3:

1	1.8	3.3	5.6
1.1	2	3.6	6.2
1.2	2.2	3.9	6.8
1.3	2.4	4.3	7.5
1.5	2.7	4.7	8.2
1.6	3	5.1	9.1

The formula G3 + C*.95 goes into cell F3 and is replicated from F4 to F150. Similarly, cell G27 gets G3 + C*10, which is replicated in the range G25:G150. Zeros are then entered at F151 and G151.

The op-amp list should be customized for whatever devices you favor. We've shown a few popular ones as an example in Fig. 3. The list can be as short or long as you want, but remember to put a 0 at the beginning and end to avoid ERROR or N/A messages. You will also need to modify the expression in E5 to match the list's range.

You'll notice the resistor list is longer than that used for capacitors. For accuracy's sake, the complete USA Standard C83.2 (formerly EIA GEN 102), Series 10, sequence is used for resistors. That way, no matter what the result of a calculation (assuming it is not out of range) a standard value within $\pm 5\%$ of it can be found. We selected Series 20 values ($\pm 10\%$) for the capacitor list, because "in-between" capacitors are scarce.

WIDTH:	12	8	12	4	10	5		
	A	B	C	D	E	F		
1:	OF AMP	LIST	MAX	GBP	CAPACITOR	LOOKUP	RESISTOR	LOOKUP
2:								
3:		324	.2E6	D3*.9	1.E-5	mF	G3*.95	1.1
4:		741	.2E6	D4*.9	1.2E-5	mF	G4*.95	1.2
5:		1458	.5E6	D5*.9	1.5E-5	mF	G5*.95	1.3
6:		1458	.5E5	D6*.9	1.8E-5	mF	G6*.95	1.5
7:				D7*.9	2.2E-5	mF	G7*.95	1.6
8:				D8*.9	2.7E-5	mF	G8*.95	1.8
9:				D9*.9	3.3E-5	mF	G9*.95	2
10:				D10*.9	3.9E-5	mF	G10*.95	2.2
11:				D11*.9	4.7E-5	mF	G11*.95	2.4
12:				D12*.9	5.6E-5	mF	G12*.95	2.7
13:				D13*.9	6.8E-5	mF	G13*.95	3
14:				D14*.9	8.2E-5	mF	G14*.95	3.3
15:				D15*.9	0.3*10	mF	G15*.95	3.6
16:				D16*.9	0.4*10	mF	G16*.95	3.9
17:				D17*.9	0.5*10	mF	G17*.95	4.3
18:				D18*.9	0.6*10	mF	G18*.95	4.7
19:				D19*.9	0.7*10	mF	G19*.95	5.1
20:				D20*.9	0.8*10	mF	G20*.95	5.6
21:				D21*.9	0.9*10	mF	G21*.95	6.2
22:				D22*.9	1.0*10	mF	G22*.95	6.8
23:				D23*.9	1.1*10	mF	G23*.95	7.5
24:				D24*.9	1.2*10	mF	G24*.95	8.2
25:				D25*.9	1.3*10	mF	G25*.95	9.1
26:				D26*.9	1.4*10	mF	G26*.95	9.1
27:				D27*.9	1.5*10	mF	G27*.95	9.3*10
...			
...			

FIG. 3—LOOKUP TABLE HEADINGS and general layout, in formula display. The column widths shown were selected only so the column headings would fit. Once the tables are integrated with the OPAMPC worksheet, column width will be irrelevant.

After we've built the lookup table on the worksheet, we'll save it on disk as LOOKUPCAL. Making another backup copy is an excellent idea. The tired hand or mind, not to mention a faltering powerline, could trash a screen or disk, obliterating many hours of work. If you don't have a backup copy of a file on another disk, you don't have the file.

In order to reduce calculation time when using the worksheet, it is advisable to use only the lookup-table values, not the formulas. Otherwise, every time we hit <!>, the "force calculation" command, the lookup table will recalculate, greatly reducing the speed of the worksheet. So, do another save of the lookup table, but this time with values only. Name the file LOOKVAL.CAL.

	A	C	D	E	F	G	H
1:							
2:							
3:							
4:							
5:							
6:							
7:							
8:							
9:							
10:							
11:							
12:							
13:							
14:							
15:							
16:							
17:							
18:							
19:							
20:							
21:							
22:							
23:							
24:							
25:							
26:							
27:							
28:							
29:							
30:							
31:							
32:							
33:							
34:							
35:							
36:							
37:							
38:							
39:							
40:							
41:							
42:							
43:							
44:							

FIG. 4—OPCALC.CAL HEADINGS. The headings should be typed in exactly as shown here.

Op-amp calculation area

Now we'll build a worksheet called OPCALC.CAL. It will contain all the amplifier calculations and error messages. Set the worksheet for manual calculation before starting.

Refer to Fig. 4 and format the columns to these widths:

Column A: 12	Column E: 8
Column B: 0	Column F: 6
Column C: 8	Column G: 5
Column D: 12	Column H: 8

Type in the headings exactly as they appear in Fig. 4, using *Supercalc's* text formatting options as needed.

You'll notice that column B has a width of 0. That effectively hides the unrounded results of the amplifier calculations, so as to avoid confusion. You can still enter formulas, which will then show up on the status line. If ever the need should arise, Column B can be expanded to the standard 9 characters to show the precise results.

After checking your work for accuracy, refer to Fig. 5 for the

LOOKVAL.CAL. You should ask for options and answer P (for part) when queried by *Supercalc*. Then load range A1:G15 into A48.

Protecting the template

To prevent inadvertent erasure of the contents of a cell, which might result in erroneous calculations, it is important to use *Supercalc's* PROTECT command. Once the entire worksheet is protected, the user choices section, cells C5:C9 are UNPROTECTED to allow entry at those points only. The OPAMPC template is now complete. Save to disk as OPAMPC.CAL.

Display formatting

Unless instructed otherwise, *Supercalc* will present the results of any calculations in the "general" format. It will display them as ordinary real numbers if the column is wide enough. Otherwise, it will use exponential notation. We have found that intelligibility is improved if the resistors and capacitors are expressed exponentially. The same is true of the GBP.

Integer notation is preferred for the device number, gain, low f_c , and error flags. Percent of error (%error) requires the <\$> (two-point decimal or "dollar sign") format.

Using op-amp

Invoke the GLOBAL command to set the worksheet for manual calculation by columns. Position row 2 at the top of the screen. Next, use WINDOW to put a horizontal split at row 12. Make sure that both sections scroll independently. Later, when you become more familiar with OPAMPC, you can eliminate clutter on the screen by using the GLOBAL command to suppress the border.

Let's say we wish to design a differential amplifier, using a 1458 IC. Place the cursor into the upper left cell of the bottom window. Looking at the index in the upper window, you can see that the differential configuration starts at cell A36. Use <=> to jump there, then put the cursor back into the upper window and start entering your performance choices in column C. Remember to use only the device number in cell C5. No alphabetical suffixes or prefixes are allowed.

To calculate, invoke the <!> command twice. A quick glance to the right will tell you if any errors have occurred. The error flags section gives information even on configurations not currently displayed. Column C, in the lower window, displays rounded values. To the right, in column F, actual performance, recalculated using the rounded values, is shown. The percentage of deviation from the entries in the user choice section appears in column H.

Input resistance for all except the non-inverting (+) input of the differential amp will be within $\pm 5\%$ of that selected. The high frequency cutoff selection is included only to calculate required GBP, so no error checking is done for it.

OPAMPC is a valuable tool for the electronics hobbyist. It allows a designer to quickly calculate the three most common op-amp configurations at once. Its speed makes rapid design changes and "what if" analyses routine. Of course, it can't eliminate the "fine-tuning" necessary to produce the optimum design, but it does get you well into the ball-park.

If you have any questions about this template, feel free to contact the author on CompuServe. Address your message to Kirk Vistain, user number 72356,1355. OPAMPC is easy to enter and easy to use. Have fun with it! ◀▶

FIG. 5—OPAMPC FORMULAS. Columns have been expanded and formula display has been selected in this example. During normal use, the worksheet is formatted as in Fig. 1.

formulas. You'll note the columns are expanded beyond their normal width for clarity. You don't have to do that on your worksheet, since any formula entered in a cell will show up in the status line, regardless of column width.

Use the replicate function to simplify entering the lookup statements in column C. Be sure to select the ask for adjust option to prevent REPLICATE from changing the address of the lookup table. Notice that capacitor and resistor lookup tables have different addresses. When done, save the completed worksheet as OPCALC.CAL.

The union

To complete the OPAMPC template, start with a blank worksheet and load OPCALC.CAL (All) onto the screen. Ignore any error indications. Move the cursor to A48 and load

COMMODORE CASSETTE INTERFACE

Use an ordinary audio cassette recorder with your Commodore 64 or VIC-20!

WALTER G. PIOTROWSKI

■When I saw the advertisement, I couldn't believe it: a computer with a real keyboard for only \$84.97. Even if the VIC-20 was not much of a computer, it had to be worth at least that much, so I bought one.

One afternoon, my son went to work on the computer and, by bedtime, had written a long program. Unfortunately, he wasn't aware at the time that we had no mass-storage device on which to save the program. The next day, we went back to the store where we bought the computer and learned that the least-expensive mass storage device for the VIC was a cassette recorder that was priced almost as high as the computer itself. We already had two cassette recorders that were gathering dust, so I hoped that there was some way we could use one of them instead of the relatively expensive *Datasette*.

The VIC cassette port

The VIC-20's cassette port is a card-edge connector on the machine's rear. The signals available on the card-edge fingers are shown in Fig. 1. The CASSETTE WRITE

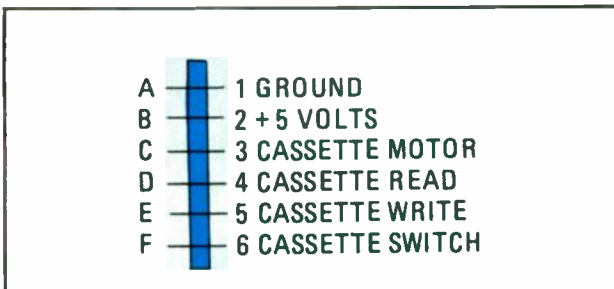

FIG.1—CASSETTE PORT SIGNALS. Note that the CASSETTE SWITCH output is called CASSETTE SENSE on the Commodore 64.

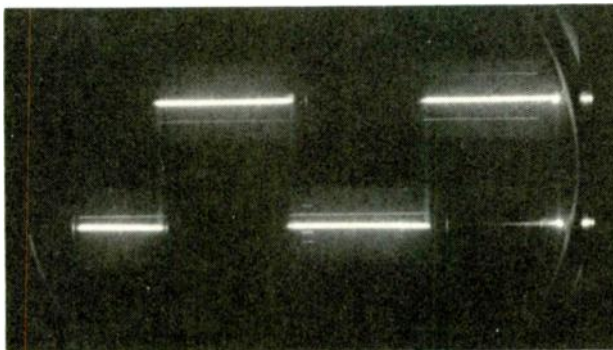

FIG.2—CASSETTE-WRITE OUTPUT WAVEFORM is part of the sync data that precedes the actual data. When data is being transferred, the duty cycle of the waveform is varied.

output (E-5), and the CASSETTE READ input (D-4), are both logic-level signals. A look at the VIC's schematic showed that both signals go to 6522 PIA's (Peripheral Interface Adapters). I connected my scope to the CASSETTE WRITE output, typed SAVE, and found a five-volt, audio-rate squarewave. Unfortunately, that squarewave can't be recorded directly on audio tape. There are two reasons for that: First, the signal level must be reduced—trying to input this signal directly into the recorder's microphone jack overloads the record amplifier. The second problem is because the waveform is a squarewave. When you try to record a squarewave, the recording process attenuates the high-frequency components. The result is that you don't get a squarewave back when you play the tape. Figure 2 shows the squarewave output of the cassette port. Figure 3 shows the recorded signal—which has little resemblance to the squarewave.

Because the computer expects to see a 5-volt squarewave when it reads the tape, it will not be able to read the tape recorded on a standard cassette

PARTS LIST

Resistors

R1—10K, 1/4-watt trimmer potentiometer
R2—10K, 1/4-watt, 10%

Semiconductors

IC1—74LS14 hex Schmitt trigger

Miscellaneous

Project Box (Radio Shack 270-220); 6/12 Card-Edge Connector (.156-inch centers); 14-pin IC socket; SPST toggle switch; 2 miniature phone plugs, Coaxial DC power plug (5.0mm O.D., 2.1mm I. D.), etc.

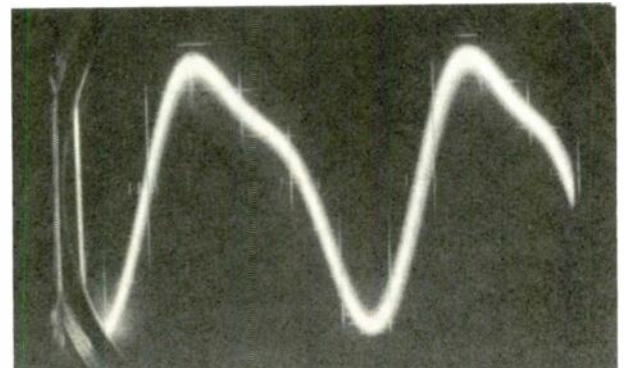

FIG.3—SQUAREWAVE AFTER RECORDING and being played back on a cassette recorder.

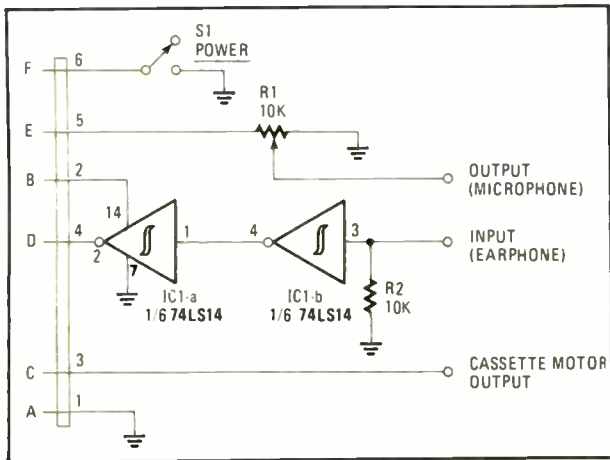

FIG.4—SCHEMATIC DIAGRAM of Commodore cassette interface.

recorder—unless you find a way to turn the recorder output back into a squarewave before the computer sees it.

Before we discuss how to get the squarewave back, let's take a look at the other cassette-port signals, the CASSETTE MOTOR output and the CASSETTE SWITCH (OR CASSETTE SENSE) input.

Commodore's *Datasette* recorder doesn't have a power cord. As you might guess, it receives its operating voltage from the computer—specifically from the CASSETTE MOTOR output on card-edge pin C-3. That output is driven by a 2SD880 power transistor. The output voltage is 6.4 volts.

My cassette recorders, which are fairly old, have 7.5-volt input jacks, alongside the mike and headphone jacks. The recorders run perfectly on this 6.4 volt output. Most newer recorders operate on 6 volts, so you should be able to use any of them with the VIC.

The cassette switch input has to be pulled to ground before the VIC will turn on the cassette motor voltage. If it isn't grounded when you type a command (SAVE, LOAD or VERIFY), you will get a message on the screen that tells you to push a button on the recorder. Apparently, the *Datasette* grounds the CASSETTE SWITCH line whenever one of its buttons is depressed. (The software checks to see that a button has been pressed before trying to move the tape.)

How the adapter works.

The schematic of the circuit that allows you to use an ordinary tape recorder with your Commodore computer is shown in Figure 4. The playback line contains two Schmitt trigger inverters. The first conditions the tape's output signal back into a squarewave. Since it also inverts the signal, we need the second inverter to fix the signal's polarity.

The switch in the CASSETTE SWITCH line is not essential; things will work right if the cassette switch is always grounded. The switch does, however, provide some extra flexibility in using the recorder.

Any construction method can be used. The only caution is that when you connect the wires to the coax power connector, don't forget that the center is ground!

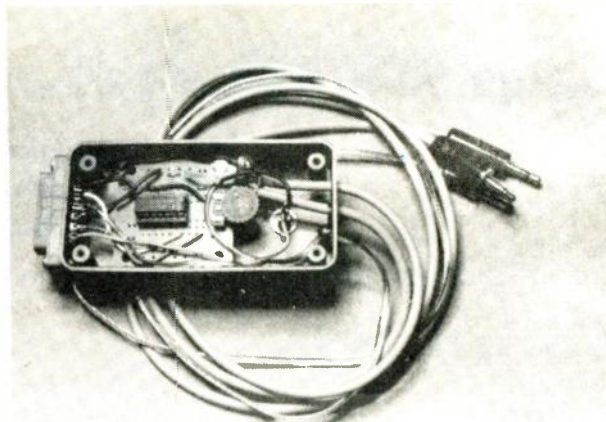

FIG.5—THE INTERFACE mounts nicely on half a standard dual-IC board and fits inside the smallest Radio Shack project case.

You'll find that without even trying very hard, you'll be able to fit everything into the smallest Radio Shack project case. The prototype's construction is shown in Fig. 5.

Checkout and use

Setting up the adapter couldn't be easier. Simply set potentiometer R1 so that the output (when you're SAVE-ing a program) is about 0.1 volt peak-to-peak or less. (If you don't have an oscilloscope you can measure for about 50 millivolts with a DC voltmeter.) The exact voltage isn't critical, since most tape recorder inputs have automatic record-level circuits. You might have to experiment a bit with the volume and tone controls on playback. With my recorder, I get the best results with the volume control at about $\frac{7}{8}$ full and the tone control at maximum treble. Start with those



FIG.6—HOOKED UP AND READY TO GO, the interface needs only to be checked out and then never needs to be touched again.

settings and play back a tape that you have recorded. The volume control setting is the most important, and setting it too high is better than too low. Once it is correctly set, you should not have to adjust it again. Figure 6 shows the completed unit hooked up and ready to go.

You should find that the interface works correctly with pre-recorded tapes as well as those you SAVE yourself. ◀▶

SERVICE QUESTIONS

COLOR CONVERGENCE

I can't get a Sony KV9000 to converge no matter what I do. I've checked everything and it looks OK. Any help that you can give me will be greatly appreciated.—B.P., Bronx, NY

I wonder if you checked the potential difference between the inner and outer conductors of the (two-conductor) anode lead; one carries the high voltage and the other carries several hundred volts less (adjustable with the horizontal-static control). Make sure that the anode is correctly seated and that the voltage difference exists.

SHORTED FILTER CAPACITORS

I have a GEKE-II chassis that keeps destroying the power-supply filters. When I first got the set, I found C1 and C2 had been replaced. I changed them both a second time, and one week later I found one section of C2 shorted again. What's happening?—A.S., Bedford, OH

The answer I have is so simplistic that I almost hesitate to give it, yet it's the only one that makes sense. Are you observing voltage ratings? Some filter sections are rated at 450 volts and others 350 volts. If the previous service technician crossed them, and you are duplicating his errors, the same breakdowns will keep occurring. Check the actual wiring against the diagram.

BLOWN HORIZONTAL OUTPUT TRANSISTORS

I have a GE19YA chassis that keeps blowing horizontal output-transistors every few days. I feel like hanging it up and going back to painting barns.—F.S., Newton, IL

Sometimes it looks like a pretty good idea, doesn't it? Painting barns, that is. Until then, try replacing C702, which is connected across the transistor. It is recommended that whenever the transistor is found shorted, the capacitor should be changed too. It's a critical component, so get a GE original if you can.

RETRACE LINES

I have two RCA CTC97 chassis in the shop, both with retrace lines in the picture. Parts substitution doesn't seem to help. Any ideas?—G.S. Waco, TX

Try checking R3116. It's the 220-kilohm resistor connected across the low-impedance circuitry, so you will have to lift it before it can be measured. You may find it open. Also check R3043, C2119, Q3019, and Q3020.

DISAPPEARING SOUND

I have a Zenith 19EC45 chassis in which the sound comes on for a few seconds, and then the circuit breaker trips. Please help.—E.J., Alvada, CO

You probably have a short in the horizontal output-circuit. Start by checking the transistor with an ohmmeter. If it's OK, lift the input lead to the high-voltage tripler. If the breaker holds, replace the tripler. Another common breakdown in that set is the feed-thru capacitor, marked C232 on the schematic. That is a post-type component mounted through the chassis pan, and it arcs internally. You can bypass it by using a 100-picofarad, 1000-volt capacitor in its place.

BAD HORIZONTAL AND VERTICAL HOLD

I'm calling for help once more. I have a Zenith 20YC48 chassis that's giving me poor horizontal and vertical hold. I've checked everything and have gotten nowhere. Can you help?—L.P., Potomac, MD

I've seen the vertical integrator (A1) give a lot of trouble in that chassis. Check it by clipping it out and temporarily using a 100,000-ohm resistor in its place. I've seen the dual-diode (X8) and the 68,000-ohm resistor connected to pin 5 of the 6U10 cause horizontal-hold problems. If you're having trouble with both vertical and horizontal lock-in, you must re-examine all components in the sync section. Don't overlook X4, the sound and sync detector.

NEED INFORMATION

I have been trying in my area libraries and book stores to locate

Call or Write Us
for Your Crystals
- just one or hundreds -
for Communications
for Industrial Use
for Your Technology



- You will get
- Cost Savings
- Prompt Service
- High Stability

Serving Crystal Users Since 1958

JAN CRYSTALS
P.O. Box 16017, Fort Myers,
Florida 33906 All Phones
(813) 936-2397



CIRCLE 30 ON FREE INFORMATION CARD

FREE MAIL ORDER CATALOG

Tuners,
amplifiers,
effects,
keyboards,
studio equipment,
drum computers,
easy to assemble kits,
books & more



name _____

address _____

city _____ state _____ zip _____

RAA Electronics, Inc.

Dept. 5R, 1020 W. Wilshire Blvd.
Oklahoma City, OK 73116
800-654-8657 9AM-5PM CST M-F

CIRCLE 53 ON FREE INFORMATION CARD

Be an FCC LICENSED ELECTRONIC TECHNICIAN!



Earn up to \$600 a week and more!

Learn at home in spare time. No previous experience needed.

No costly School. No commuting to class. The Original Home-Study course that prepares you for the FCC Radiotelephone license exam in your spare time! An FCC Government license is your "ticket" to thousands of exciting jobs in Communications, Radio & TV, Mobile two-way, Microwave, Computers, Radar, Aerospace and more. You don't need a college degree to qualify, but you do need an FCC License. **No need to quit your job or go to school!** You learn how to pass the FCC License exam at home at your own pace with this easy-to-understand, proven course. It's easy, fast and low cost! **GUARANTEED PASS.** You get your FCC License or money refunded. Write for free details. Soon you could be on your way to being one of the highest workers in the electronics field. **Send for FREE facts now. MAIL COUPON TODAY!**

COMMAND PRODUCTIONS

FCC LICENSE TRAINING, Dept. 90
P.O. Box 2223, San Francisco, CA 94126

Rush FREE facts on how I can get my FCC License in spare time. No obligation. No salesman will call.

NAME _____

ADDRESS _____

CITY _____

STATE _____

ZIP _____

some current books that deal with **countdown, start, fail-safe, shut-down, and protector circuits. But so far, I've had no luck. Can you help me locate books on those topics?—L.M., Wisconsin Rapids, WI**

All of the circuits in question are relatively new and as such each manufacturer designs his own particular version (often redesigning them from one model to another). I doubt if we will ever be treated to one book that can cover it all because it would become obsolete with the next model year. Perhaps the best advice that I can offer you is to subscribe to as many of the manufacturer's technical-literature services as you can handle: In that way you can pick up a little information here and there. R-E

EQUIPMENT REPORTS

continued from page 45

various CP/M commands and utility programs. For more detailed information, or for users unfamiliar

with the CP/M operating system, there's the Osborne book. The version of the book that is supplied with the package is written specifically for the Apple, and will guide you step-by-step through the different CP/M commands and utilities.

The Microsoft BASIC reference manual assumes that the user already has some familiarity with BASIC. Its purpose, as its name implies, is as a reference for all the commands, statements, and functions of Microsoft BASIC.

For those who want to use non-standard I/O devices, or use software that requires some modifications to CP/M, the information needed to perform those tasks is found in the system programmer's manual. That manual is not included in the package. Apparently to encourage the mailing in of registration cards, which often are simply discarded instead, that manual is sent to you by Microsoft upon their receipt of that card.

The *Premium Softcard IIe* carries a suggested retail price of \$395. R-E

QUALITY COMPONENTS - NOT MAIL ORDER "SECONDS"

Send \$1.00 postage and handling for FREE COMPLETE CATALOG which includes coupon for \$1.00 OFF purchase

ARIES ZERO INSERTION FORCE SOCKETS -

can actuated, true zero insertion - tin plated solder tail pins - capable of being plugged into dip sockets, including wire wrap.

Stock No.	No. of Pins	1-9	10-49	50
11055	24	4.98	\$4.35	\$3.90
11056	28	5.15	4.50	4.05
11057	40	6.81	5.95	5.35
11058	64	12.02	10.50	9.45

IC COOLERS* from UNITRACK* dissipate over 2 watts of heat from IC's producing longer life and better performance. Just push IC cooler on - heat is collected from top and bottom of IC and dissipated. Won't shake loose!

Stock No.	No. Pins	Price
22225	14	\$2.29
22226	18	.29
22228	18	20 .29

WILD ROVER

Touch switch capsule. Operating motion is 005" without the use of a levered arm. Extremely fast on and off with low noise. Normally operated 115 VAC, 1.5 amp, 30 milliohm resistance - .615 radius by 160 thick.

Stock No.	1-9	10 & Up
12098	\$1.42	\$1.28

SCREW MACHINED SOCKET PINS, loose, packaged in bags of 100

Stock No. 11310 is solder tail with gold collar on shell. Stock No. 11311 is wire wrap with gold coated gold shell.

Stock No.	Description	1 Bag	5 Bags	10 Bags
11310	Bag of 100 solder tail pins	4.95	8.45	\$3.95
11311	Bag of 100 wire wrap pins	11.95	10.75	9.50

3 X 4 Elastomeric Keyboards

Each keyboard has a board, elastomeric pad with contacts, ABS bodies and double shot molded keys. Rating: 12 VDC @ 20mA. Contact Res. less than 500 ohms. Bounce: less than 10 m sec.

Stock No.	Stock Operating	Key Travel	Price
11291	120540	2.09	\$4.95 \$4.50
11292	80540	1.85	3mm .95 2.50

TI WIRE WRAP SOCKETS

Tin plated phosphor bronze contact - 3 wrap

Stock No.	No. Pins	1-99	100	499	500
11301	8	\$4.00	\$3.60	\$3.30	
11302	14	.59	.54	.45	
11303	18	.64	.58	.48	
11304	18	.73	.66	.55	
11305	20	.99	.90	.75	
11306	22	1.12	1.02	.85	
11307	24	1.25	1.14	.95	
11308	28	1.52	1.38	1.15	
11309	40	2.05	1.86	1.55	

TI LOW PROFILE SOCKETS

Tin plated copper alloy 588 contact pins with gas tight seal

Stock No.	No. Pins	1-24	25-99	100
11201	8	\$10.09	\$9.08	
11202	14	14 .13	.12	
11203	16	16 .15	.14	
11204	18	18 .17	.15	
11205	20	20 .18	.16	
11206	22	22 .20	.18	
11207	24	24 .22	.20	
11208	28	28 .26	.25	
11209	40	40 .37	.33	

SUB CUB I and SUB CUB II are high quality, complete LSI Counter Modules with LCD readout. Modules plug in p.c. board (Stock No. 51071). Complete function evaluation kit (Stock No. 51070) contains: p.c. board, 4.5V battery and variable frequency oscillator to supply train of count pulses. Stock No. 51070 has LATCH, RESET and TEST functions (3 buttons). P.C. board unplugs for bread-board work.

Stock No.	Description	Price
51071	Complete Function Evaluation Kit (includes batteries but does not include display counter)	7.50
51072	SUB-CUB I display counter module only	18.00
51073	SUB-CUB II display counter module only	24.00
51074	Panel Bezel Evaluation Kit for SUB-CUB II (does not include SUB-CUB II counter module)	12.00
51075	DATA SHEET	.25

SINGLE ROW SOCKETS

Strip of 25 collet sockets/pins-mount odd center components easily. Gold plated contacts.

Stock No.	1-24	25	50
10240	\$1.70	\$1.50	\$1.30

Strip of 40 pins with single beam sockets. Tin plated contacts.

Stock No.	1-99	100	500	1000
10850	\$1.09	\$0.90	\$0.82	\$0.72

The Battery Just Wrap Tool

New battery powered tool wires insulated wire around .025 square posts without need for pre-cutting and pre-stripping. Complete with bit and 100 ft. 30 AWG wire.

Stock No.	Description	Price
13340	Battery just-wrap tool with bit	850.95
13341	Replacement bit	10.99
13342	100 ft. blue replacement wire	7.54
13343	100 ft. white replacement wire	7.54
13344	100 ft. yellow replacement wire	7.54
13345	100 ft. red replacement wire	7.54

MICRO Charts - colorful 8 1/2" x 11" charts eliminate the need to stumble through manuals and summaries. Fully decoded - instant access - totally comprehensive - gives pin outs, cycle times, buy notes, etc. etc.

Stock No.	Reference	Price
23010	Z80 CPU	\$5.95
23011	8088/8085 a	9.95
23012	8082/8083	9.95
23013	8086 and relatives	9.95
23014	547400 TTL Pinouts	9.95
23015	Basic Algorithms	9.95
23016	8088/8085 a	9.95
23017	How to generate test from a sample	9.95
23017	Warranty	9.95

PIN FORMING TOOL

puts IC's on their true row to row spacing. One side is for 300 centers. Flip tool over for devices .600 centers. Put device in tool and squeeze.

Stock No.	Price
11059	\$12.95
10200	\$14.95

NEW! ANTI-STATIC MODEL

OK MACHINE AND TOOL

IC INSERTION/EXTRACTION KIT Includes DIP IC extractor and inserters to accommodate all IC's from 14 to 40 pin. Tools that engage conductive surfaces are CMOS safe and include grounding lugs. Stock No. 13309 \$41.34

SOCKET WRAP IT

Dip socket sized plastic panels with numbered holes in pin locations. Ship onto socket before wire wrapping to identify pins. Also write on them for location, IC part number, function, etc. Simplifies initial wire wrapping troubleshooting and repair. \$1.95 per pack

THERMOPROBE: Identifies Dead Components - Replaces Volt Meters

Identify dead components which do not emit heat. Just point thermistor probe, within 1/16" of board - move over components and see which are dead. Stock No. Price 22300 \$21.95

SCOTCHFLAX Breadboard Systems Basic kit

Stock No.	Description	Price
03500	Basic Kit	\$79.95
03511	Basic board, 4.5 x 5.5	19.50
03506	Intel 5BC-8010 Board, 12 x 6.75	64.95
03507	Motorola M-6800 Board, 9.75 x 6	42.95
03508	5-100 Board, 10 x 5.5	36.95
03509	2-80 Board, 7.7 x 7.5	39.95
03510	Eurocard Board, 8.3 x 3.9	21.95

Stock No. Description Price
03500 Basic Kit \$79.95
03511 Basic board, 4.5 x 5.5 19.50
03506 Intel 5BC-8010 Board, 12 x 6.75 64.95
03507 Motorola M-6800 Board, 9.75 x 6 42.95
03508 5-100 Board, 10 x 5.5 36.95
03509 2-80 Board, 7.7 x 7.5 39.95
03510 Eurocard Board, 8.3 x 3.9 21.95

We accept VISA MC C.O.D. CHECK or M.O. INCLUDE SHIPPING CHARGES \$10 to \$150 \$3.00 \$100 to \$250 \$4.00 over \$250 \$5.00

Stock No. Description Price
03500 Basic Kit \$79.95
03511 Basic board, 4.5 x 5.5 19.50
03506 Intel 5BC-8010 Board, 12 x 6.75 64.95
03507 Motorola M-6800 Board, 9.75 x 6 42.95
03508 5-100 Board, 10 x 5.5 36.95
03509 2-80 Board, 7.7 x 7.5 39.95
03510 Eurocard Board, 8.3 x 3.9 21.95

Stock No. Description Price
03500 Basic Kit \$79.95
03511 Basic board, 4.5 x 5.5 19.50
03506 Intel 5BC-8010 Board, 12 x 6.75 64.95
03507 Motorola M-6800 Board, 9.75 x 6 42.95
03508 5-100 Board, 10 x 5.5 36.95
03509 2-80 Board, 7.7 x 7.5 39.95
03510 Eurocard Board, 8.3 x 3.9 21.95

Stock No. Description Price
03500 Basic Kit \$79.95
03511 Basic board, 4.5 x 5.5 19.50
03506 Intel 5BC-8010 Board, 12 x 6.75 64.95
03507 Motorola M-6800 Board, 9.75 x 6 42.95
03508 5-100 Board, 10 x 5.5 36.95
03509 2-80 Board, 7.7 x 7.5 39.95
03510 Eurocard Board, 8.3 x 3.9 21.95

Stock No. Description Price
03500 Basic Kit \$79.95
03511 Basic board, 4.5 x 5.5 19.50
03506 Intel 5BC-8010 Board, 12 x 6.75 64.95
03507 Motorola M-6800 Board, 9.75 x 6 42.95
03508 5-100 Board, 10 x 5.5 36.95
03509 2-80 Board, 7.7 x 7.5 39.95
03510 Eurocard Board, 8.3 x 3.9 21.95

Stock No. Description Price
03500 Basic Kit \$79.95
03511 Basic board, 4.5 x 5.5 19.50
03506 Intel 5BC-8010 Board, 12 x 6.75 64.95
03507 Motorola M-6800 Board, 9.75 x 6 42.95
03508 5-100 Board, 10 x 5.5 36.95
03509 2-80 Board, 7.7 x 7.5 39.95
03510 Eurocard Board, 8.3 x 3.9 21.95

Stock No. Description Price
03500 Basic Kit \$79.95
03511 Basic board, 4.5 x 5.5 19.50
03506 Intel 5BC-8010 Board, 12 x 6.75 64.95
03507 Motorola M-6800 Board, 9.75 x 6 42.95
03508 5-100 Board, 10 x 5.5 36.95
03509 2-80 Board, 7.7 x 7.5 39.95
03510 Eurocard Board, 8.3 x 3.9 21.95

Stock No. Description Price
03500 Basic Kit \$79.95
03511 Basic board, 4.5 x 5.5 19.50
03506 Intel 5BC-8010 Board, 12 x 6.75 64.95
03507 Motorola M-6800 Board, 9.75 x 6 42.95
03508 5-100 Board, 10 x 5.5 36.95
03509 2-80 Board, 7.7 x 7.5 39.95
03510 Eurocard Board, 8.3 x 3.9 21.95

Stock No. Description Price
03500 Basic Kit \$79.95
03511 Basic board, 4.5 x 5.5 19.50
03506 Intel 5BC-8010 Board, 12 x 6.75 64.95
03507 Motorola M-6800 Board, 9.75 x 6 42.95
03508 5-100 Board, 10 x 5.5 36.95
03509 2-80 Board, 7.7 x 7.5 39.95
03510 Eurocard Board, 8.3 x 3.9 21.95

Stock No. Description Price
03500 Basic Kit \$79.95
03511 Basic board, 4.5 x 5.5 19.50
03506 Intel 5BC-8010 Board, 12 x 6.75 64.95
03507 Motorola M-6800 Board, 9.75 x 6 42.95
03508 5-100 Board, 10 x 5.5 36.95
03509 2-80 Board, 7.7 x 7.5 39.95
03510 Eurocard Board, 8.3 x 3.9 21.95

Stock No. Description Price
03500 Basic Kit \$79.95
03511 Basic board, 4.5 x 5.5 19.50
03506 Intel 5BC-8010 Board, 12 x 6.75 64.95
03507 Motorola M-6800 Board, 9.75 x 6 42.95
03508 5-100 Board, 10 x 5.5 36.95
03509 2-80 Board, 7.7 x 7.5 39.95
03510 Eurocard Board, 8.3 x 3.9 21.95

Stock No. Description Price
03500 Basic Kit \$79.95
03511 Basic board, 4.5 x 5.5 19.50
03506 Intel 5BC-8010 Board, 12 x 6.75 64.95
03507 Motorola M-6800 Board, 9.75 x 6 42.95
03508 5-100 Board, 10 x 5.5 36.95
03509 2-80 Board, 7.7 x 7.5 39.95
03510 Eurocard Board, 8.3 x 3.9 21.95

Stock No. Description Price
03500 Basic Kit \$79.95
03511 Basic board, 4.5 x 5.5 19.50
03506 Intel 5BC-8010 Board, 12 x 6.75 64.95
03507 Motorola M-6800 Board, 9.75 x 6 42.95
03508 5-100 Board, 10 x 5.5 36.95
03509 2-80 Board, 7.7 x 7.5 39.95
03510 Eurocard Board, 8.3 x 3.9 21.95

Stock No. Description Price
03500 Basic Kit \$79.95
03511 Basic board, 4.5 x 5.5 19.50
03506 Intel 5BC-8010 Board, 12 x 6.75 64.95
03507 Motorola M-6800 Board, 9.75 x 6 42.95
03508 5-100 Board, 10 x 5.5 36.95
03509 2-80 Board, 7.7 x 7.5 39.95
03510 Eurocard Board, 8.3 x 3.9 21.95

Stock No. Description Price
03500 Basic Kit \$79.95
03511 Basic board, 4.5 x 5.5 19.50
03506 Intel 5BC-8010 Board, 12 x 6.75 64.95
03507 Motorola M-6800 Board, 9.75 x 6 42.95
03508 5-100 Board, 10 x 5.5 36.95
03509 2-80 Board, 7.7 x 7.5 39.95
03510 Eurocard Board, 8.3 x 3.9 21.95

Stock No. Description Price
03500 Basic Kit \$79.95
03511 Basic board, 4.5 x 5.5 19.50
03506 Intel 5BC-8010 Board, 12 x 6.75 64.95
03507 Motorola M-6800 Board, 9.75 x 6 42.95
03508 5-100 Board, 10 x 5.5 36.95
03509 2-80 Board, 7.7 x 7.5 39.95
03510 Eurocard Board, 8.3 x 3.9 21.95

Stock No. Description Price
03500 Basic Kit \$79.95
03511 Basic board, 4.5 x 5.5 19.50
03506 Intel 5BC-8010 Board, 12 x 6.75 64.95
03507 Motorola M-6800 Board, 9.75 x 6 42.95
03508 5-100 Board, 10 x 5.5 36.95
03509 2-80 Board, 7.7 x 7.5 39.95
03510 Eurocard Board, 8.3 x 3.9 21.95

Stock No. Description Price
03500 Basic Kit \$79.95
03511 Basic board, 4.5 x 5.5 19.50
03506 Intel 5BC-8010 Board, 12 x 6.75 64.95
03507 Motorola M-6800 Board, 9.75 x 6 42.95
03508 5-100 Board, 10 x 5.5 36.95
03509 2-80 Board, 7.7 x 7.5 39.95
03510 Eurocard Board, 8.3 x 3.9 21.95

Stock No. Description Price
03500 Basic Kit \$79.95
03511 Basic board, 4.5 x 5.5 19.50
03506 Intel 5BC-8010 Board, 12 x 6.75 64.95
03507 Motorola M-6800 Board, 9.75 x 6 42.95
03508 5-100 Board, 10 x 5.5 36.95
03509 2-80 Board, 7.7 x 7.5 39.95
03510 Eurocard Board, 8.3 x 3.9 21.95

Stock No. Description Price
03500 Basic Kit \$79.95
03511 Basic board, 4.5 x 5.5 19.50
03506 Intel 5BC-8010 Board, 12 x 6.75 64.95
03507 Motorola M-6800 Board, 9.75 x 6 42.95
03508 5-100 Board,

DIGITAL IC TESTER

continued from page 86

You can use the display adapter to view signals that originate outside of the tester. With the test socket empty and the power supply jumpers removed, open the isolation switches and jumper the system sig-

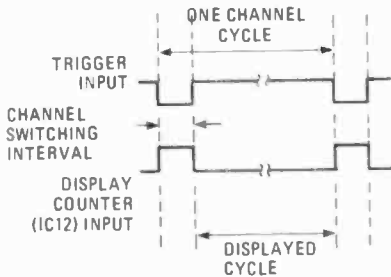

FIG. 8—THE COUNTER COUNTS on the leading edge of a logic trigger, but the scope triggers on the trailing edge. That eliminates the channel-switching lines from the display.

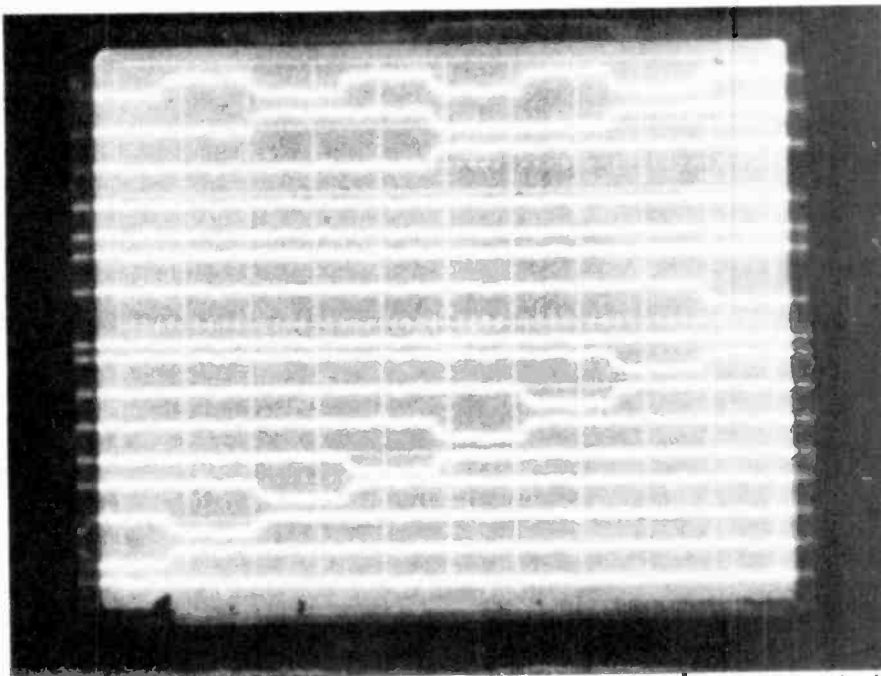

FIG. 9—THE OSCILLOSCOPE DISPLAY showing the waveforms generated by the 74LS138 test circuit. While it may not be the most eloquent logic analyzer, it can be an excellent teaching or learning tool.

nal(s) to the test socket pin(s). Bring in a suitable trigger, crank up the system, and you are ready to observe the chosen signals and their relationship to each other. Be aware that the displayed signals are now driving the additional load presented by the circuitry connected to the test socket—that includes the output drivers, the multi-channel adapter, and, perhaps, additional expansion hardware. System signals that are heavily loaded might not be able to drive that additional load.

The selection or generation of a trigger is most crucial in creating a stable and meaningful display. The trigger pulses

should be evenly spaced, and all displayed signals should repeat themselves exactly between triggers. The qualifier can be useful in dealing with complex systems, but proper qualification hinges on your

familiarity with the logic system. In general, under-qualified triggers tend to create brilliant but jittery displays. On the other hand, over-qualified triggers yield diminished or even non-existent displays. In situations where trigger selection is relatively simple, the multi-channel adapter can become a tutorial aid. You can learn a lot by observing signals in a properly operating digital device. As you continue to use the adapter and really get a good "feel" for it, you will probably find many additional uses for the adapter. We'll find even more uses for the IC tester when we continue.

R-E

PARTS LIST

All resistors are ¼-watt, 5%

R3—43,000 ohms

R4—22,000 ohms

R5—11,000 ohms

R6—5600 ohms

R7—2700 ohms

R8—R12—330 ohms

R13—1500 ohms

Semiconductors

IC11—74150 1-of-16 selector/multiplexer

IC12—74LS191 binary synchronous up/down counter

IC13—7406 hex inverting buffer

IC14—7420 dual 4-input NAND gate

Other components

S17—SPST switch

9 reasons why the real pros prefer Endeco desoldering irons



- Operates at 120v, 40w. Idles at 20w for longer tip life
- Flexible, burn resistant Neoprene cord set
- Cool, unbreakable polycarbonate handle
- Exclusive bracket insures alignment, prevents damage
- Safety light in handle tells when it's on
- Stainless steel construction
- Temperature control. Low, high or off.
- Eight tip sizes. Comes with .063 I.D.
- Converts to soldering iron with ¼" shank type tip

See your distributor or write . . .

Enterprise Development Corp.

5127 E. 65th St. • Indianapolis IN 46220
PHONE (317) 251-1231

For Home or Business: WHAT...WHEN...HOW...



LEARN HOW TO USE A COMPUTER

Now at Home in Spare Time, you can learn everything you always wanted to know about personal computers. How to program in BASIC. How to understand and use more than 80 BASIC commands and functions. How to write and run your own programs...for both personal and business applications. How to use pre-packaged software and change it to meet your special needs. How to make sense of the overwhelming maze of books. Information and advice available at your local computer store.

More Than Just A Computer Manual

This is more than just another programming manual...it's an entire comprehensive course written by experts. Yet, because it was especially developed for home study, you learn everything right in your own home, without changing your job or lifestyle, without attending a single class.

Plus You Get Your Own Computer

To give you practical hands-on experience, this course includes your own personal computer—plus a cassette recorder that lets you save your programs on tape. Get all the facts. MAIL COUPON TODAY!

ICS COMPUTER TRAINING Dept. DE094
SINCE 1981 Scranton, PA 18515

Rush free facts how I can learn computer applications, programming and operation at home in spare time.

Name _____ Age _____

Address _____

City/State/Zip _____

Phone-including area code (_____) _____

STATE OF SOLID STATE

continued from page 101

power-supply rejection ratio (PSRR) is 30 dB.

Figure 4 shows how the ULN-3784B is used as an amplifier with bass and treble controls.

Additional information on both devices is available on request from Sprague Electric Company, Semiconductor Division, 115 Northeast Cutoff, Worcester, MA 01606. Refer to Engineering Bulletin 21717.12 for the ULN-3784B and to Engineering Bulletin 21717.23 for the ULN-3705M low-voltage amplifier. R-E

NEW IDEAS

continued from page 32

their "contacts" will remain open and no signal will appear at the output. We use the output from pin 3 of IC3 (a 7555 timer) to gate IC2-b and IC2-c. Note that the signal from IC3 is inverted before it is fed to IC2-b but not before it is sent to IC2-c. Thus, the pulsing output from IC3 will alternately switch the display between probes

Two voltage-divider networks determine the position that the trace is to be shown on the screen. Because we want to display both signals at the same time, the high and low levels for one probe must be different from the high and low levels for the other probe. For INPUT 1, the divider is made up of resistors R2, R3, and R4, and for the other, R10 and R11.

The addition of R3 in the first voltage-divider circuit increases the voltage level of both the high-level and low-level inputs from probe 1. Thus, the probe-1 signals will be displayed at the top of the signals from probe 2. The probe-1 trace is displayed between the 3- and 4-volt mark, while the probe-2 trace is shown between zero and one-volt. That can be shown by the following formulas, which assume a high level of +5-volts.

Probe 1:

$$\text{High} \cong \frac{R_4}{R_2 + R_4} (V) \\ = \frac{220K}{56K + 220K} (5V) \cong 4V$$

$$\text{Low} \cong \frac{R_4}{R_2 + R_3 + R_4} (V) \\ = \frac{220K}{56K + 100K + 220K} (5V) \cong 3V$$

Probe 2:

$$\text{High} \cong \frac{R_{11}}{R_{10} + R_{11}} (V) \\ = \frac{56K}{220K + 56K} (5V) \cong 1V$$

Low $\cong 0V$

With the scope set to trigger on one input, signals up to 50 kHz can be monitored. That makes the circuit ideal for low to medium speed logic-level inputs. Certain frequencies can cause garbage (harmonics of the sampling frequency) to be displayed; however, adjusting potentiometer R6 will correct that.—Jeff Verive

A QUALITY TRIPLE-REGULATED POWER SUPPLY AT A LOW, LOW PRICE!!

NOT A KIT!



MODEL PS101
FULLY ASSEMBLED & TESTED!

\$ **119** ⁸⁸

FULL 1 YEAR REPLACEMENT WARRANTY

— Made In The United States —

This DC triple regulated variable power supply has all the features you could ask for plus a full 1 year guarantee. Fully adjustable from 1½ VDC to 35 VDC! Three completely independent supplies that offer many advantages! They can be either a pos. supply or a neg. supply...they can also be stacked in series so that a 5V and two 15V supplies can total a 35 VDC supply or any combination of the three...(after one of the terminals is grounded to give it a reference)...for the first time you can now purchase this American made fully adjustable power supply at a price that is one-half of what you'd expect to pay!

SPECIFICATIONS

3 outputs:

Fixed 5 VDC $\pm 0.2V$

2 variable $\leq 1\frac{1}{2} V$ to $\geq 15 VDC$

Polarity—floating; can be used as pos. or neg.

Ripple less than 10mV at full load.

Regulation $\leq 1\%$ no load to full load.

Line Regulation $<0.2\%$ 108 VAC to 135 VAC.

Current:

Fixed supply 1.0 amp max.

Variable supplies 0.5 amp max.

Protection built in, current limiting, with thermal shutdown.

Power: 108-135 VAC.

Dimensions: 8¼" x 3¼" x 7¼" (WxHxD)

Wood grain finished metal case.

Weight: 4 lbs., 9 ozs.

Lighted on/off power switch, easy-to-read

Voltmeter and large binding posts.

Warranty: one year full replacement warranty from date of purchase.

DISTRIBUTOR AND REPRESENTATIVE INQUIRIES INVITED



VISA, MASTERCARD, AMEX TELEPHONE ORDERS ACCEPTED!
6 Herman Drive, E. Granby, CT 06026 □ 203/651-0285

CIRCLE 81 ON FREE INFORMATION CARD

BATTERIES

continued from page 58

TABLE 7—
BATTERY MANUFACTURERS

Lithium batteries

Altus Corporation
1610 Crane Court
San Jose, Ca. 95112

Tadiran
6312 Variel Avenue
Woodland Hills, Ca. 91367

Varta Batteries, Inc.
150 Clearbrook Road
Elmsford, N.Y. 10523

Lead-acid batteries

Technacell
2117 South Anne St.
Santa Anna, Ca. 92704

Eagle Plicher Ind., Inc.
PO Box 130
Seneca, Mo. 64865

Gould Inc.
931 N. Vandalia St.
St. Paul, Minn. 55114

Nickel-cadmium batteries

Gould Inc.
931 N. Vandalia St.
St. Paul, Minn. 55114

Varta Batteries, Inc.
150 Clearbrook Rd.
Elmsford, N.Y. 10523

General Electric
Battery Business Dept.
PO Box 861
Gainesville, Fl. 32602

By now you should know enough about all the different battery chemistries to make an intelligent decision as to which battery system (or combination of systems) is best for your application. And if you're not exactly sure, you should have enough information to know what the right questions are. Battery manufacturers will be more than happy to send you data sheets, catalogs, and application notes so you can find out whatever you want to know. Table 7 is a good beginning list of companies you can contact for information. Don't hesitate to write to them—they know more than you do and can save you lots of time and trouble. And a twenty-cent stamp is a pretty cheap insurance policy when it comes to saving twenty dollars worth of batteries. R-E

PROBES FOR SALE

FROM THE BEST SOURCE FOR OSCILLOSCOPE
PROBES AND DMM/VOM TEST LEAD SETS,

- Low Cost
- High Quality
- Excellent Performance
- Slender, Flexible Cable
- Wide Range of Choice
- Switchable X1 and X10 Attenuation Factor
- 100 MHz Bandwidth

MODEL SP100

\$41⁰⁰



**TEST
PROBES, INC.**

TPI

Your Probe
Specialists

COLINE U.S. SALES & STOCKING SOURCE

P.O. BOX 2113, LA JOLLA, CALIFORNIA 92038 (619) 459-4197

CIRCLE 62 ON FREE INFORMATION CARD

ELECTRONIC COMPONENTS

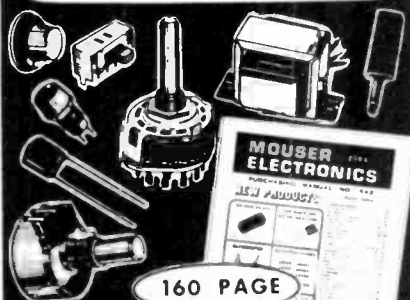

160 PAGE

FREE CATALOG

MANUFACTURERS OF QUALITY ELECTRONIC COMPONENTS

- BATTERY CLIPS & HOLDERS
- CABLE SETS • CONNECTORS • CAPACITORS
- DISPLAYS • LEDs • FUSES • JACKS & PLUGS
- KNOBS • LAMPS • POTENTIOMETERS
- RF COILS • RELAYS • RESISTORS
- SWITCHES • SEMICONDUCTORS • SPEAKERS
- TEST EQUIPMENT • TRANSFORMERS • TOOLS
- WIRE & CABLE

OVER 15,000 DIFFERENT ITEMS IN STOCK!

- Sales and Order Desk Open from 8:00a.m. (PST)
- TERMS C.O.D. Visa, MasterCard (Open Accounts Available)
- Phone and Mail Orders Welcome
- Catalogs Mailed Outside USA Send \$2.00

MOUSER ELECTRONICS

11433 WOODSIDE AVE. SANTEE, CA 92071
PHONE (619) 449-2222 TWX 910-331-1175

CIRCLE 96 ON FREE INFORMATION CARD

ACTIVE RECEIVING ANTENNA

Gives excellent reception,
50 KHz to 30 MHz.

New MFJ-1024 Active Receiving Antenna mounts outdoors away from electrical noise for maximum signal.

Gives excellent reception of 50 KHz to 30 MHz signals. Equivalent to wire hundreds of feet long. Use any SWL, MW, BCB, VLF or Ham receiver.

High dynamic range RF amplifier. 54 in. whip. 50 foot coax. 20 dB attenuator prevents receiver overload. Switch between two receivers. Select auxiliary or active antenna. Gain control. "ON" LED. Remote unit, 3x2x4 in. Control, 6x2x5 in. 12 VDC or 110 VAC with optional adapter, MFJ-1312, \$9.95.

\$129.95
(\$4.00 shipping)

Order from MFJ and try it. If not delighted, return within 30 days for refund (less shipping). One year unconditional guarantee.

Order today. Call TOLL FREE 800-647-1800. Charge VISA, MC. Or mail check, money order. Write for free catalog. Over 100 products.

CALL TOLL FREE 800-647-1800

Call 601-323-5869 in Miss., outside continental USA, tech/order/repair info. TELEX 53-4590.

MFJ ENTERPRISES, INCORPORATED

Box 494, Mississippi State, MS 39762

CIRCLE 66 ON FREE INFORMATION CARD

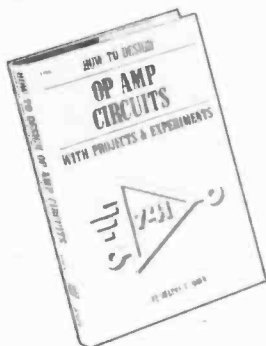

Let Delton Horn Show You How To Design Your Own Op Amp Circuits for Pennies Per Project



Using these 37 hands-on, step-by-step projects and experiments, Delton T. Horn shows you how to design and build practical, working op amp circuits. Horn focuses on the 741 op amp chip—the most versatile, inexpensive, and commonly used op amp—and provides you with experiments ranging from active filters, signal generators, and pulse circuits to power supply, detector, metering, and digital circuit applications. Horn leads you easily through all the fundamentals of op amp characteristics and applications, reinforcing each principle with hands-on experiments, and makes even the most complex mathematical information easy to follow!

Instant Order, Call toll free: (800) 233-1128
(in PA, HI, or AK call direct: 717-794-2191)

How to Design Op Amp Circuits, with Projects and Experiments

432 pp./420 illus.
\$21.95 Hardbound.
Order No. 1765H

No-Risk, 15-Day FREE Trial

TAB BOOKS Inc.
P.O. Box 40
Blue Ridge Summit, Pa. 17214

Please send me *How to Design Op Amp Circuits, with Projects and Experiments* (No. 1765H) at \$21.95 (plus postage/handling).

Check enclosed for \$ _____ (Publisher pays postage and handling via Bookpost).

Full Money-Back Guarantee

Name _____
Address _____
City/State/Zip _____

VISA and MasterCard orders can be relayed by phone.

Foreign customers must pay in advance in U.S. dollars and add \$2 per book for shipping and handling. PA add 6% sales tax. All orders subject to credit approval. Prices subject to change. RET 104

CIRCLE 55 ON FREE INFORMATION CARD

FREE

McIntosh STEREO CATALOG and FM DIRECTORY

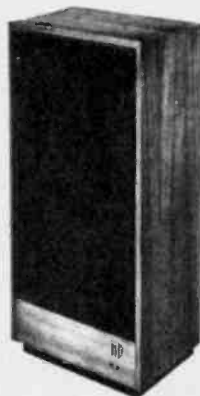

Get all the newest and latest information on the new McIntosh stereo equipment in the McIntosh catalog. In addition you will receive an FM station directory that covers all of North America.

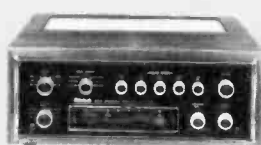
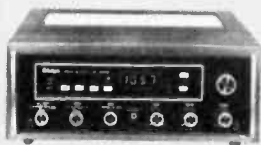

SEND TODAY!

McIntosh Laboratory Inc.
East Side Station P.O. Box 96
Binghamton, N.Y. 13904-0096

RE

NAME _____

ADDRESS _____

CITY _____ STATE _____ ZIP _____

If you are in a hurry for your catalog please send the coupon to McIntosh. For non rush service send the Reader Service Card to the magazine.

CIRCLE 93 ON FREE INFORMATION CARD

SATELLITE STEREO

continued from page 54

PARTS LIST

All resistors are 1/4-watt, 5% unless otherwise noted.

- R1, R18—6800 ohms
- R2, R19—100 ohms
- R3, R17—1 megohm
- R4, R6, R7, R10—R13, R20, R22, R23, R26—R29, R44—10,000 ohms
- R5, R21—5000 ohms, linear-taper potentiometer
- R8, R24—100,000 ohms
- R9, R25—1500 ohms
- R14, R30—R33—1000 ohms
- R15, R16, R34, R35, R39, R42—470 ohms
- R36, R38—75 ohms
- R37—330 ohms
- R40—750 ohms
- R41—3300 ohms
- R43—4700 ohms

Capacitors

- C1—5—55 pF trimmer capacitor
- C2, C5—C10, C19—23, C26—0.001 μ F ceramic disc
- C3, C14, C27—0.01 μ F, ceramic disc
- C4, C18, C35—22 pF, ceramic disc
- C11, C24—39 pF, ceramic disc
- C12, C25, C34—0.05 μ F, ceramic disc
- C13—150 pF, ceramic disc
- C15, C28—0.1 μ F, Mylar
- C16, C29—100 μ F, 16 volts, electrolytic
- C17, C30—C32—2.2 μ F, 50 volts, electrolytic
- C33—470 μ F, 10 volts, electrolytic

Semiconductors

- IC1—MC7808 8-volt regulator
 - IC2—MC10116 triple line receiver
 - IC3, IC4—NE564 phase-locked loop (Signetics)
 - IC5— μ A4136 quad op-amp
 - D1, D2—MV2209 varactor diode
 - LED1—miniature red LED
- Other components**
- L1—12 μ H, high-Q
 - L2—3.9 μ H, high-Q
 - J1—J3—RCA-type phono jacks
 - J4—miniature phone jack
 - S1—DPDT push-on/push-off

The following are available from Video Control, 3314 H. Street, Vancouver, WA 98663, (503) 693-3834: Complete kit including all parts, printed circuit board, chassis, AC power adapter, and manual \$79.00; PC board and manual only, \$19.50; AC power adapter, \$10.00. Include \$3.50 for shipping and handling for all orders.

minus the L-R subcarrier (the right-channel information).

Building the circuit

Because of the high frequencies involved, using a printed-circuit board is

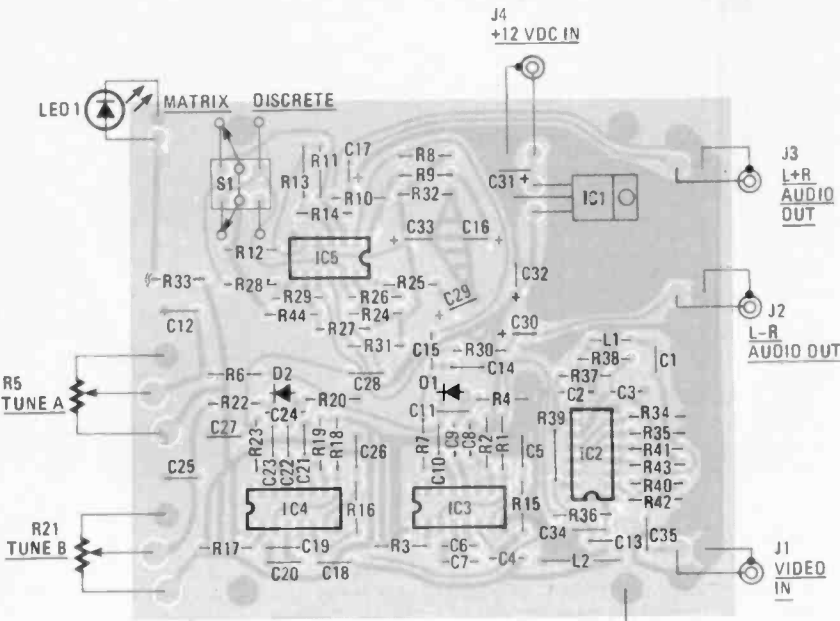

FIG. 7—PARTS-PLACEMENT DIAGRAM. Note that some parts are soldered on the component side as well as the "solder" side. While those places aren't specially marked, you will notice that the groundplane is not etched away in those places.

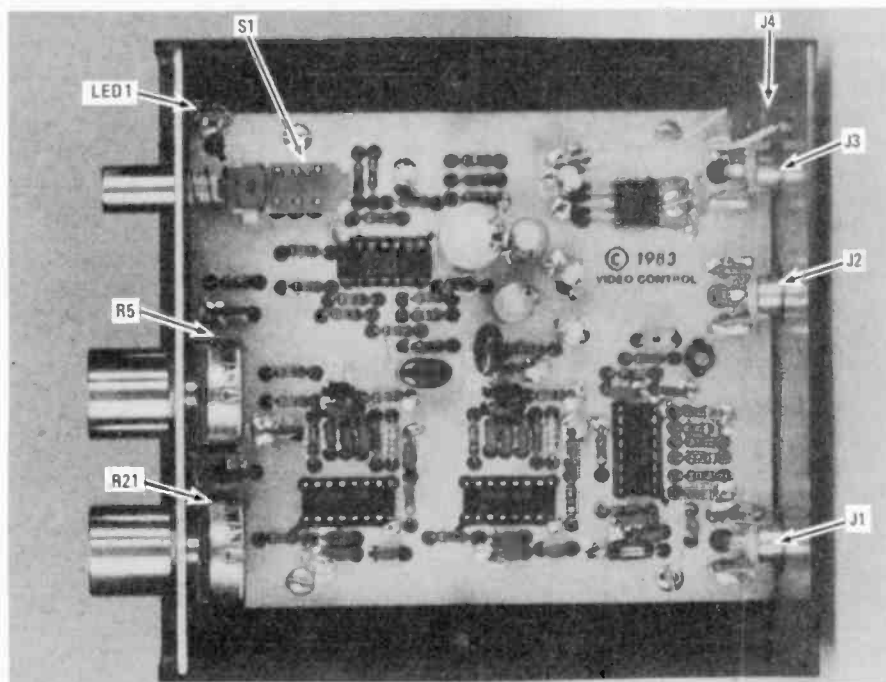

FIG. 8—TO KEEP LEAD LENGTHS SHORT, all the components (except for power-input jack J4) are mounted directly to the board.

essential. The component side of the PC board is shown in Fig. 5 while the solder side is shown in Fig. 6.

Since the circuit is composed of three active sections, with each section operating around the 6.5 MHz range, construction and circuit-board layout is very important. When soldering components to the board, lead lengths should be kept as short as possible to keep the very sensitive front-end (the amplifier in the input stage) from oscillating.

Notice that the component side of the board serves as a ground plane for shielding and reduction of crosstalk. Some of

the components must be soldered to the ground plane as well as to the solder side. If you look at Fig. 7, the parts-placement diagram, that is evident wherever the component placement holes are touching the groundplane.

Since you want to keep lead lengths to a minimum, you should start soldering the low-profile parts (resistors, for example) onto the board first. If all of the parts are the same height, simply laying the board on a flat surface will press all the parts flush against the board and your lead lengths can be kept as short as possible. Next solder the higher profile parts such as

Learn micro-processing with the new MICRO-PROFESSOR 1P

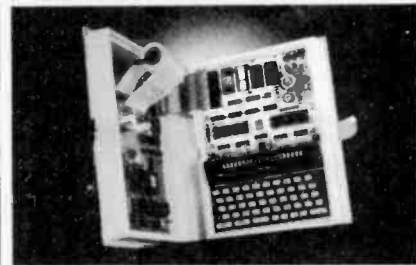

Students, engineers or technicians—upgrade your micro-processing skills with the new Micro-Professor 1P.

The MPF-1P features:

- extensive software support
- more built-in memory
- improved keyboard
- larger display

Three tutorial guides help cover all capabilities. The ideal training tool! MPF-1P will deliver you into the growing world of micro-processing. Invest now!

Plus—FREE GIFT Only \$179.95

Check this box for FREE Z-80 Microprocessor Programming and Interfacing textbook when you order within 7 days. \$12.95 value.

ETRONIX
Dept. RE194
14803 N.E. 40th
Redmond, WA 98052

For immediate action call TOLL FREE:

1-800-426-1044

Full money back guarantee.



CIRCLE 39 ON FREE INFORMATION CARD

SUPER LONG PLAY TAPE RECORDERS

10 Hour Model — \$95.00*
14 Hour Model — \$159.00*

Modified Panasonic Sirmine. high quality. AC-DC Recorders provide 5 or 7 continuous hours of quality recording & playback on each side of cassette for a total of 10 or 14 hours depending on model. Built-in features include • Voice level control. • Digital counter. etc. TDK DC 180 Cassette Furnished



PHONE RECORDING ADAPTER
Records calls automatically. All Solid state connects to your telephone jack and tape recorder. Starts recording when phone is lifted. Stops when you hang up. \$24.50*
FCC APPROVED

VOX VOICE ACTIVATED CONTROL SWITCH
Solid state. Self contained. Adjustable sensitivity. Voices or other sounds automatically activate and control recorder. Uses either re-corder or remote mike. \$24.95*

*Add for ship & hdg. Phone Adapter & Vox \$1.50 ea. Recorders \$4.00 ea. Cal. Res. add tax. Mail order, VISA avail., Dealer Inquiries invited. Free data.
AMC SALES INC., Dept. A 9335Lubec St., Box 928, Downey, CA 90421 (213) 889-8519

CIRCLE 67 ON FREE INFORMATION CARD

TECHNICIANS,

Get serious about your profession;



Now you can order the "Study Guide for the Associate—Level CET Test" from the International Society of Certified Electronics Technicians. It includes material covering the most often missed questions on the Associate CET Exam. 8½" x 11", paperback, 80 pages.

GET CERTIFIED!

Send check to IS CET, 2708 W. Berry St., Ft. Worth, TX 76109.

Name _____
 Address _____
 City _____
 State _____ Zip _____
 _____ copies @ \$5.00 ea.

Send material about IS CET and becoming certified.

SEE YOUR DEALER TODAY

FROM



HERE'S A TIP THAT'S PERFECT!

AM/FM AUTO RADIO AND CB

'Frestik' II

GOLDEN SERIES

BARE-HANDS TUNABLE "NO TOOLS NEEDED" HIGH PERFORMANCE ANTENNAS

ALSO ANTENNAS FOR CORDLESS TELEPHONES MONITOR SCANNERS

Dealer & Distributor Inquiries Invited SEND FOR FREE CATALOG

'Frestik' Antenna Company
 2614 East Adams, Phoenix, AZ 85034

Name _____
 Street _____
 City _____
 State _____ Zip _____

Serving the CB and Communications Market Since 1962.

5-YEAR REPLACEMENT WARRANTY

CIRCLE 40 ON FREE INFORMATION CARD



FIG. 9—FRONT-PANEL CONTROLS. To make the unit easier to use, you might want to mark the settings for your favorite transponders around the tuning controls.

IC's. Do not use IC sockets when you install the IC's. Follow by installing the other components except LED1. (LED1 must poke through a hole in the front panel.)

Calibration

When your construction work is finished, apply power via a wall-mounted AC adapter, and connect the left and right audio-channel outputs to the appropriate stereo receiver/preamplifier audio inputs (AUX IN, for example). The next step is to test the unit by tuning in a satellite TV stereo transponder that has a strong video signal. A good one to start with is MTV (Music Television)—you can be virtually certain of finding a stereo signal there. (MTV is on Satcom F3, transponder 11.)

To begin, turn up the stereo's volume to a moderate level to where the hiss is not too obnoxious. Push the DISCRETE/MATRIX switch, S1, in the DISCRETE position. Turn R5 (TUNE A) completely clockwise and R21 (TUNE B) completely counterclockwise. Now begin adjusting R21

clockwise until the L-R subcarrier is found. The phase-locked loop will lock onto the subcarrier when R21 is correctly positioned. You should hear a hollow or echo sound when properly locked onto the L-R subcarrier. Now C1 must be adjusted—using a non-inductive tool—until there is the least amount of noise present on the L-R subcarrier. Next begin turning R5 counterclockwise until the L+R subcarrier is located. The proper settings of the front panel controls will be evident when the L-R channel has a lot of "ambience" signals. In other words, it will sound hollow and echo. Now engage switch S1 to the MATRIX position (extended) and listen to the music blend in full stereo. Both TUNE controls (R5 and R21) can now be fine-tuned by ear.

When tuning in a discrete transponder, the procedure is identical, except leave the switch S1 in the DISCRETE (extended) position. Because the audio subcarriers on different transponders are often at different frequencies, you may need to fine-tune front-panel controls R5 and R21. R-E

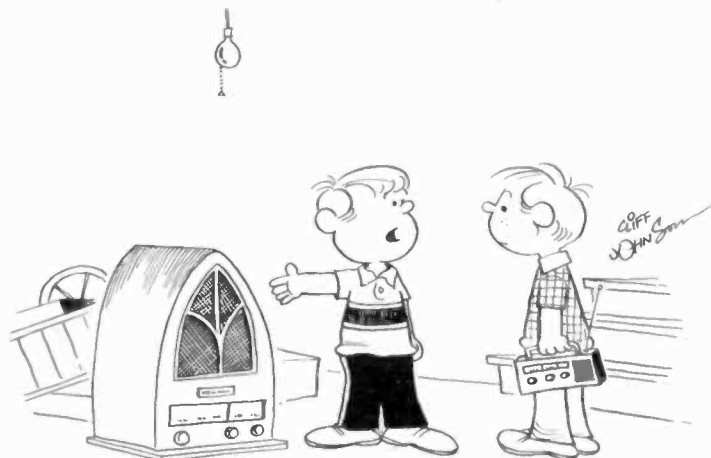

"MY MOM SAYS IT'S A RADIO BOY, IT MUST TAKE A LOT OF BATTERIES TO RUN ONE THAT SIZE!"

MARKET CENTER

FOR SALE

CABLE-TV SECRETS—the outlaw publication the cable companies tried to ban. HBO, Movie Channel, Showtime, descramblers, converters, etc. Suppliers list included. \$8.95. **CABLE FACTS**, Box 711-R, Pataskala, OH 43062.

RESISTORS ¼W&½W5% 3 cents. 1%metalfilms, precision custom wirewounds, \$1.00 refundable to: **JR INDUSTRIES**, 5834-B Swancreek, Toledo, OH 43614.

FREE catalog featuring scanner accessories, carrier/subcarrier detectors, voice scramblers, unusual kits. **CAPRI ELECTRONICS**, Route 1R, Canon, GA 30520.

THE Intelligence Library—Restricted technical information & books on **electronic surveillance, surveillance-device schematics, lock-picking, investigation, weapons, identification documents, covert sciences, etc.** The best selection available. **Free brochures.** **MENTOR**, (Dept. Z), 135-53 No. Blvd., Flushing, NY 11354.

CABLE-TV equipment, notch filters for "beeping" channels. Information \$1.00. **GOLDCOAST**, PO Box 63/6025 RE, Margate, FL 33063.

RF parts/Motorola transistors. MRF454 \$16.00, MRF455 \$12.00. Catalog available. **RF PARTS CO.**, 1320-4 Grand, San Marcos, CA 92069. (619) 744-0720.

UP to \$500.00 per month. Sell computer software in your home. Write to: **COMPUTER SERVICES**, PO Box 7748, Tucson, AZ 85725.

RECONDITIONED test equipment. \$1.00 for catalog. **JAMES WALTER TEST EQUIPMENT**, 2697 Nickel, San Pablo, CA 94806.

TOKO Coil Set (four) \$8.00. **BFQ85** substitute transistor \$2.00. **High quality PCB** with plated holes and reflow solder \$12.00. Or all for only \$20.00. **JIM RHODES**, 1025 Ransome Lane, Kingsport, TN 37660.

CONNECTORS—audio, co-axial, aviation, computer, industrial, and many other types. Send \$2.00 for complete price list and ordering information. Largest inventory in country. **CONNECTOR TECHNOLOGY INC.**, 5A Veronica Ave., Somerset, NJ 08873.

WHOLESALE F-59 cable connector \$80.00/1000. Free **MATV** catalog **SASE**. (212) 897-0509. **D&WR**, 68-12 110 St., Flushing, NY 11375.

CHANNEL 3—60dB notch filter. 63.5MHz. \$32.00. **CROSLEY**, Dept. 763, Box 840, Champlain, NY 12919.

THE BEST PLACE to BUY, SELL or TRADE NEW and USED EQUIPMENT
NUTS & VOLTS MAGAZINE
BOX 1111-E • PLACENTIA, CA 92670
(714) 632-7721

Join Thousands of Readers Nationwide
Every Month

ONE YEAR U.S. SUBSCRIPTIONS
\$7.00 - 3rd Class • \$12.50 - 1st Class

\$25.00 - Lifetime - 3rd Class



NUTS & VOLTS
HAM GEAR
COMPUTERS
SOFTWARE
SCANNERS • OPTICS
TEST EQUIPMENT
MICROWAVE
SATELLITE
AUDIO VISUAL
NEW PRODUCTS
COMPONENTS • KITS
ANTIQUE SELECT
PUBLICATIONS
PLANS • SERVICES

CABLE-television facts and secrets. Now you can get the informative publication that CATV companies have been unsuccessfully trying to get banned for 15 years. Movie Channel, HBO, and Showtime converters, etc. Send \$8.75 to: **CABFAX**, P.O. Box 091196, Bexley, OH 43209.

TUBES, new, unused. Send self-addressed, stamped envelope for list. **FALA ELECTRONICS**, Box 1376-2, Milwaukee, WI 53201.

FREE Pay-TV reception. "How-To" book. HBO, Showtime, Cinemax. \$4.95. **DIPTRONICS**, Box 80 (R2), Lake Hiawatha, NJ 07034.

CABLE-TV converters and descramblers. Low prices, dealers wanted. Send \$5.00 for catalog. **R & M DISTRIBUTORS**, Box 266-1, Boston, MA 02190, (617) 871-5838

RADAR JAMMER!



- Causes speed radar guns to read out either: —a percentage of your true speed, or whatever speed you dial in
 - Activated by your Escort and most other detectors
 - Especially effective against instant-on radar
 - Operates on both X and K bands (not FCC approved)
 - **MONEY-BACK GUARANTEE**, if not satisfied.
- WARNING:** The device described in this literature is not legal for use against police radar.

Complete literature & plans package. send \$14.95 to:

Philips Instrument Design Co. Inc.

9513 S.W. Barbur Blvd. #109S, Portland, OR 97219
VISA and M/C order line: (503) 626-6764

LATEST bug-detection equipment for home or office. Literature, \$1.00. **CLIFTON**, Box 220-X, Miami, FL 33168.

BRADFORD parts 50% off—"JOE", **TROY TV PARTS**, 76 Second Ave., Troy, NY 12180

TI-99/4A owners. Get your free catalog of new, exciting, low cost software. **DYNA**, Box 690, Hicksville, NY 11801.

WANTED: Old RCA, Cunningham, Western Electric tubes, amplifier, speakers. McIntosh, Marantz, Tannoy, Altec, JBL. (713) 728-4343. **MAURY CORB**, 11122 Atwell, Houston, TX 77096.

TOP-quality imported, domestic kits, surplus, discount electronics, computer components. Free catalog. **TEKTRASONIX**, 175 Fifth Ave., Suite 3194, N.Y., NY 10010.

CONVERTERS all types for all systems. Lowest prices anywhere, quantity discounts, dealer inquiries accepted. Send \$1.00 for catalog, **PG VIDEO CORP.**, PO Box 296, Latham, NY 12110. (518) 274-6593.

AUTOMOTIVE Security Catalog. 1984. 24-page color catalog, \$2.00. **ASE**, Dept. 1, PO Box 382, Plainview, NY 11803.

BUY direct from Far East! Send \$3.95 for list of 250 electronics manufacturers. **ASHTON ENTERPRISES**, Box 19081, Minneapolis, MN 55419.

COMPUTER hacking: How it's done and how to stop it. Details: **A.T.I.S.**, 61 Gatchell, Buffalo, NY 14212.

To run your own classified ad, put one word on each of the lines below and send this form along with your check for \$2.50 per word (minimum 15 words) to:
Radio-Electronics, 200 Park Avenue South, N.Y., N.Y. 10003

ORDER FORM

PLEASE INDICATE in which category of classified advertising you wish your ad to appear. For special headings, there is a surcharge of \$20.00.

- () Plans/Kits () Business Opportunities () For Sale
() Education/Instruction () Wanted () Satellite Television
() _____

Special Category: \$20.00

PLEASE PRINT EACH WORD SEPARATELY, IN BLOCK LETTERS.

1	2	3	4	5
6	7	8	9	10
11	12	13	14	15
16	17	18	19	20
21	22	23	24	25
26	27	28	29	30
31	32	33	34	35

PLEASE INCLUDE FOR OUR FILES YOUR PERMANENT ADDRESS AND PHONE NUMBER.

CLASSIFIED COMMERCIAL RATE for firms or individuals offering commercial products or services). \$2.50 per word prepaid (no charge for zip code)...**MINIMUM 15 WORDS**. 5% discount for 6 issues, 10% for 12 issues within one year, if prepaid.

NON-COMMERCIAL RATE (for individuals who want to buy or sell a personal item) \$2.00 per word prepaid...no minimum.

ONLY FIRST WORD AND NAME set in bold caps. Additional bold face (not available as all caps) at 25¢ per word. All copy subject to publisher's approval. **ADVERTISEMENTS USING P.O. BOX ADDRESS WILL NOT BE ACCEPTED UNTIL ADVERTISER SUPPLIES PUBLISHER WITH PERMANENT ADDRESS AND PHONE NUMBER.** Copy to be in our hands on the 20th of the third month preceding the date of the issue (i.e., August issue closes May 20th). When normal closing date falls on Saturday, Sunday, or a holiday, issue closes on preceding working day.

CATALOG: telephones, alarms, intercoms, P.A., video, and data link equipment kits. Send \$3.00 to cover postage to **EPPA ELECTRONICS**, Box 166, Brooklyn, NY 11204

GATED-Sync Pulse instruction booklet. Don't be left out due to the advancing technology in video scrambling techniques. Learn by doing. Complete descrambling circuits included. For additional information, send SASE to **SOKOLOWSKI**, 97-20 221 Street, Queens Village, NY 11429.

TUBES: "Oldies", latest. Supplies, components, schematics. Catalog free (stamp appreciated). **STEINMETZ**, 7519-RE Maplewood Ave., Hammond, IN 46324.

VOICE synthesizer. Timex TS2068/1000 ML-Program has large expandable vocab, excellent sound. \$16.95pp. **TAD PAINTER**, Box 166055, Irving, TX 75016.

"**SATELLITE** descramblers"—Lowest prices anywhere. Dealer inquiries welcome. Send \$3.00 for catalog. We ship C.O.D.'s. **STARVIEW INC.**, PO Box 103, Rexford, NY 12148. (518) 785-1288.

DELUXE cable/UHF converters. Zenith, SSAVI-1—\$199.95. Zenith Cable—\$299.95. Jerrold, Oak and others available. Dealers wanted. \$2.00 catalog—**UNITED ELECTRONIC SUPPLY**, Box 1323, Elgin, IL 60121-0119. (312) 697-0600.

REVERBERATION FOR ORGANS

Solid state with controls for reverberation and room size. **EVERY ORGAN SHOULD OWN ONE.** Send for free flyer—**DEVTRONIX ORGANS, INC.** 6101 WAREHOUSE WAY SACRAMENTO, CALIFORNIA 95826 Dept. B

BUY BONDS

WRITE FOR McGEE'S SPEAKER & ELECTRONICS CATALOG

1001 BARGAINS IN SPEAKERS
Tel: 1 (816) 842 5092
1901 MCGEE STREET KANSAS CITY, MO. 64138

NEW, unique semi-custom, multi-instrument CMOS multimelody IC's. Special—\$15.00 each and data postpaid. S.A.S.E. brings flyer. **K. BOUFAL, ELECTRONICS CONSULTANT**, 244 Fitzwater Street, Philadelphia, PA 19147.

NEWEST cable-TV facts. Manual includes: theory, schematics of popular descramblers and converters, secret techniques and more. \$11.00 cash. Free CATV equipment catalog. **ELECTRON**, Box 169, 17 No. State Street, Room 1222, Chicago, IL 60602.

UNUSUAL surplus items—low prices—guaranteed quality! Free flyer. **ELECTRONIX LTD.**, 3214 South Norton, Sioux Falls, SD 57105.

HIGH voltage shocker plans—Build from scrap box parts, 9 volts. Only \$3.95. **ENTIUM**, Box 1650 (0), Carolina, P.R. 00628.

25,000 tubes \$2.00 and \$3.00 each. Send stamped envelope stating needs. **FOX**, 22661 Glenwood, Mt. Clemens, MI 48043.

TV shop closed out. Inventory for sale. Best offer takes. **Box 425, San Ysidro, CA 92073.**

CORDLESS phone owners. Increase distance, reduce static on 1.749MHz phones. Details \$1.00 refundable. **HP PHONES**, Box 273, Mesa, AZ 85201.

VCR and TV troubleshooting. Hundreds of moneymaking timesaving tips \$11.95 **JA Electronics**, 1708 Chestnut Muskogee, OK 74403.

CABLE-TV products. Jerrold, Hamlin, and Oak converters. Send \$3.00 for information. **ADDITIONAL OUTLET CORP.**, 111 E. Commercial Blvd., Ft. Lauderdale, FL 33334.

FREE catalog—electronics accessories: Tools, multimeters, components. **ARCEE INDUSTRIES**, PO Box 193, Ronkonkoma, NY 11779.

FREE catalog—video/cable accessories: Battery packs, cable, converters. **ARCEE INDUSTRIES**, PO Box 193, Ronkonkoma, NY 11779.

CABLE converters, all types, send \$2.00 for prices, also kits \$39.95. **AMERICAN VIDEO**, PO Box 132, Troy, NY 12181. (518)-273-2699

PLANS & KITS

PRINTED-circuit boards. Quick prototypes, production, design, reflow solder. Send print or description for quote to **KIT CIRCUITS**, Box 235, Clawson, MI 48017.

HI-FI speaker kits, auto speaker systems and speaker components from the world's finest manufacturers. For beginners and experts. Free literature. **A & S SPEAKERS**, Box 7462R, Denver, CO 80207 (303) 399-8609.

FREE KIT Catalog

FUNCTION GENERATOR KIT \$59.95
Auto-Ranging Cap-meter kit \$79.95

Phone 209-772-2076

Write or Phone for FREE CATALOG

DAGE SCIENTIFIC INSTRUMENTS
BOX 144 VALLEY SPRINGS CA 95252

contains TEST & EXPERIMENTER'S EQUIP.

CABLE-TV converters: Jerrold, Hamlin, SB-3, AN-3, Mini-Code, Zenith & more. UHF converters: Deluxe II sinewave kits \$95.00, gated pulse add/on \$70.00. Complete units 195.00 with gated pulse \$255.00. (Quantity discounts.) Repairs of all converters & cable boxes. Send SASE (54 cents postage) or call for info. 1(312) 637-4408. **HIGGINS ELECTRONICS**, 6014 W. Nelson, Chicago, IL 60634.

SERIAL and parallel printer interfaces. Centronics, Selectric, Teletype. **CULLINS**, 917 Prestwick, Bedford, TX 76022.

PROJECTION TV...Convert your TV to project 7 foot picture...Results comparable to \$2,500.00 projectors...Total cost less than \$30.00...Plans and 8" lens \$19.95...Illustrated information free. **MACROCOMA-GB**, Washington Crossing, PA 18977. Creditcard orders 24 hours, (215) 736-3979.

CRYSTAL radios! Plans! Kits! Plans and catalog \$3.00. **COUNTRY CRAFTS INC.**, Box 310, Edgewood, NM 87015.

IC radio transmitter! Over 300 foot range. Easy to build. Plans only \$4.00. **SWAN**, Box 81201, Corpus Christi, TX 78412.

CATALOG: Hobby, CB broadcasting! Linears, transmitters, bugs, scramblers, downconverters, antennas, modifications, more! **PANAXIS**, Box 130-F10, Paradise, CA 95969.

SECURITY schematics, transistor, ultrasonic and IC designs, \$8.00. For large list of plans send \$2.00 (refundable) to **SELECTRONICS**, PO Box 9606, Detroit, MI 48209.

NEW! Three-function kit with impressive sound quality. Converts mono to stereo or enhances stereo with two distinct modes. From 30-20 KHz, \$39.95 plus \$3.50. California add 6.5%. **SINETRON**, PO Box 661571, Sacramento, CA 95866.

AMAZING NEW PRODUCTS

TONE talking memory dialer—This credit card size tone dialer can memorize and recall one hundred-32 digit phone numbers and is ideal for MCI and Sprint customers. A few features include special access entry code, alarm, stopwatch and calculator functions for only \$79.95. The **Listener**—represents the latest technology in the area of monitoring devices. Plugs into any modular phone jack. Its remote activation feature and ultra-sensitive microphone allows the user to telephone from anywhere in the world and listen into what is happening

BEC Electronics

P.O. BOX 461244R
GARLAND, TX. 75046
(214) 487-9031

OVER 45,000 SOLD SINCE 1977! SOUND EFFECTS KIT

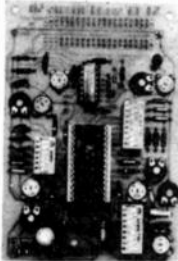

This unit uses the TI 76477 IC and after the easy assembly is completed you will be able to reproduce almost any sound you want! Quality PC board and all necessary components are provided. All you need to add is a speaker. The circuitry of the kit provides you with a Pulse Generator, MUX Oscillator & Comparator to make more complex sounds a snap. Programming examples provided to help you get used to using the unit.

18.50 ea.
2/34.50

Special

SUPER MUSIC MAKER KIT 27.95

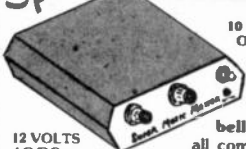

INCLUDES CASE & ROM CHIP ORDER KSM-03

12 VOLTS AC/DC SPEAKER NOT INCLUDED

This popular kit is great for car horns or doorbell applications. We include all components and quality PC board. You'll love our easy to follow assembly instructions. The package price includes the kit, case w/front panel tune selection switches, and a preprogrammed 2708 memory chip (ROM) with 35 additional tunes; (60 total). Additional ROM's are available for 9.95 to 14.95 ea. (Listing sent with order). Order Now! Offer expires March 30, 1984! 12VAC transformer is available. **Order TN-20 2.60 ea.**

OUR PRODUCT CATALOG IS CRAMMED WITH NEAT GOODIES! SEND 50¢ REFUNDABLE ON 1ST ORDER. FREE W/ORDER.

- COD MINIMUM \$20.00 * ADD \$2.50 FOR COD'S
- UPS DELIVERY ADDRESS MUST ACCOMPANY ALL COD ORDERS
- \$1.00 HANDLING ON ORDERS UNDER \$10.00
- ADD 6% FOR SHIPPING
- TEXAS RESIDENTS ADD 5% STATE SALES TAX
- ALL FOREIGN ORDERS ADD 25% FOR SHIPPING (CANADA 15%) NO FOREIGN COD'S
- CALL (214) 487-9031 TO PLACE CREDIT CARD OR COD ORDER

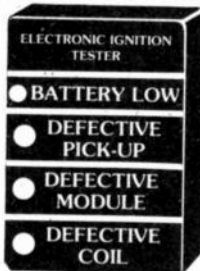

TESTS: Battery Condition, Pick-up Coil, Ignition Module, and HV Coil

11.88 each → order 2 **ORDER: AS-25** BEFORE MARCH 30 PAY 18.50 FOR BOTH!

THE BEST DEAL!

This hand held Automotive Tester checks and tests the functions listed below easily and quickly. The original manufacturer sold over a million units in 1983 at 19.95 each. Instructions and charts are printed on the back of each unit. This tester will save hours of frustration and pay for itself the first time used! Units are all new, 100% guaranteed for 90 days from date of purchase.

WINDSHIELD WIPER DELAY

Complete assembled PC card with IC, relay, and control with schematic. Complete with custom molded plastic case with bracket and hardware. Special introductory price! 5.95 **Order: AS-01**

LM1800 Audio IF & Separate 2W Audio output ICL-1808 .99
TDA1802 2W Audio output
Order: ICL-1002 1.25
LM301 Linear 8 pin Op Amp
Order: ICL-01A .39
CD 4433 Counter & 7 seg. decoder/driver IC House #
Order: ICL-4433 .69

TELEPHONE RINGER SEMI KIT

Contains special ML8284 tone ringer IC and components to build a pleasant tone ringer for your phone. 5 pgs. of specs and circuits. **Order: KTR-01S 2.50** PC Board for above **Order: PCB-01 2.00**

TRANSFORMER

24 VAC @ 3A
12 VAC @ 1A
6 VAC @ 2A
Completely Shilded! 115 VAC Primary
7.55 ea 10/68.50
ORDER: TN-30

Now! This season!

SWITCH YOUR TV TO SIX DIFFERENT PROGRAM SOURCES ELECTRONICALLY!



Model S10W 10.8" wide, 2.7" high, 7.28" deep

Now, with the Zenith Video Organizer at your command, you switch your TV *electronically*...from one function or program source to another...free of the nuisance of changing cable connections by hand.

You select any one of six different program sources for viewing, including up to three different sources for recording. You can even watch one program source while recording another.

Fact is, you can watch your favorite football team in action while simultaneously recording another game...the news...or some other program for playback at another time. All this without having to change cable connections by hand!

Thanks to the Zenith Video Organizer, you do all your TV switching electronically – from one program source or function to another with push-button ease.

It's this crisp, electronic push-button versatility of the Video Organizer – achieved by typically Zenith advanced engineering – that brings the television receiver closer to its promised service as a combination home entertainment and information center all-in-one.

If you're not yet in tune with the variety of functions and program sources addressable with Zenith's Video Organizer, check with your Zenith dealer soon.

There you will see that today there's more to Zenith than meets the eye! The broadest-ever line of Zenith video accessories, for example!

ZENITH

The Quality Goes In Before The Name Goes On®

Zenith Sales Company
Service, Parts & Accessories Division
Franklin Park, Illinois 60131

You touch.

It holds.

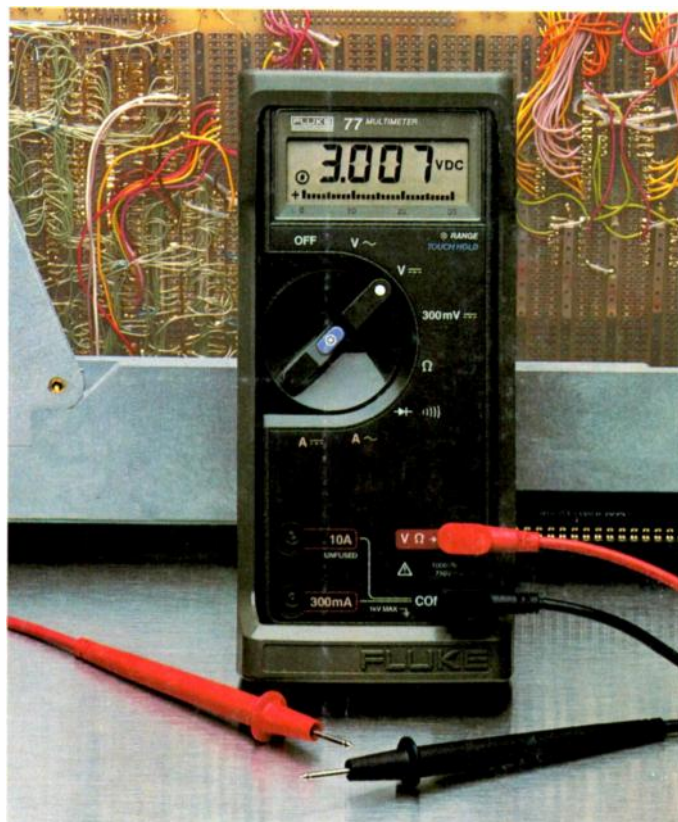
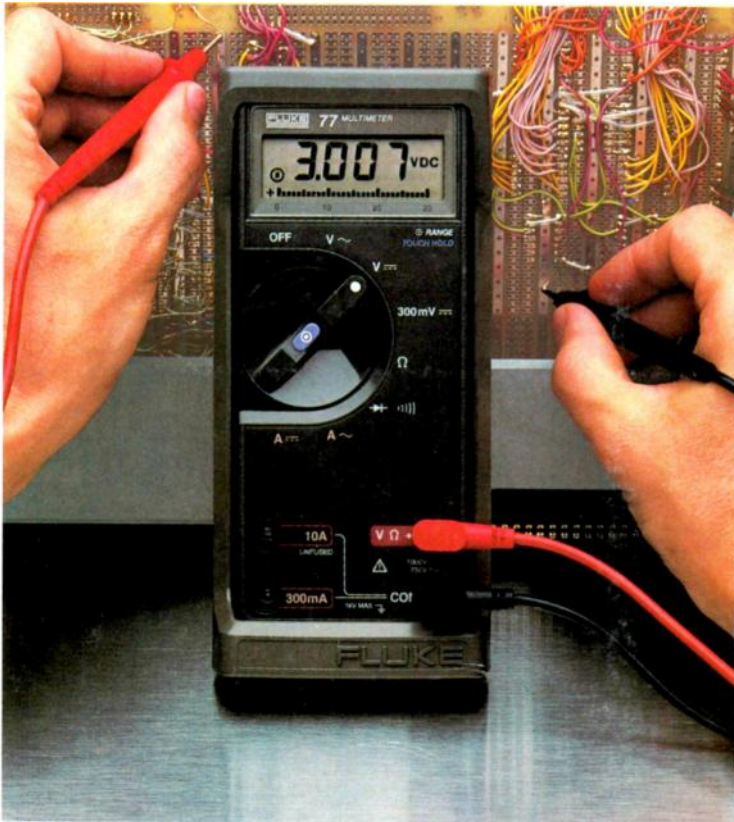

\$129* gets you the world's first handheld digital/analog multimeter with "Touch Hold."

The Fluke 77

Its unique "Touch Hold" ** function automatically senses and holds readings, leaving you free to concentrate on positioning test leads without having to watch the display.

Then, when you have a valid reading, it signals you with an audible beep.

The Fluke 77 is perfect for those test situations where accessibility is a problem, or when extra care is needed for critical measurements.

It's the top model in the world champion Fluke 70 Series line — the first industrial quality autoranging multimeters to combine digital and analog displays. These tough, American-made meters feature a three-year warranty and 2000+ hour battery life.

So call now for the complete story on the Fluke 77 with "Touch Hold." Because if you don't deserve the world's first, who in the world does?

For the name of your distributor or a free brochure, call our toll-free hotline anytime **1-800-227-3800, Ext. 229.**

From outside the U.S., call 1-402-496-1350, Ext. 229.

FROM THE WORLD LEADER IN DIGITAL MULTIMETERS.



FLUKE 73

\$85*
Analog/digital display
Volts, ohms, 10A, diode test
Autorange
Audible continuity
0.7% basic dc accuracy
2000+ hour battery life
3-year warranty

FLUKE 75

\$99*
Analog/digital display
Volts, ohms, 10A, mA, diode test
Audible continuity
Autorange/range hold
0.5% basic dc accuracy
2000+ hour battery life
3-year warranty

FLUKE 77

\$129*
Analog/digital display
Volts, ohms, 10A, mA, diode test
Audible continuity
"Touch Hold" function
Autorange/range hold
0.3% basic dc accuracy
2000+ hour battery life
3-year warranty
Multipurpose holster

* Suggested U.S. list price, effective July 1, 1984
** Patent pending

