

# Radio- Electronics

**BUILD YOUR OWN ROBOT:  
ASSEMBLING THE BODY**

\$1.25 DEC. 1980

Build a hi-fi mini-speaker system  
Finding faults in coaxial cables  
A look at H-P's personal computer

Troubleshooting hints and tips  
How to connect hi-fi accessories  
Build the universal logic tester

## ELECTRONICS IN YOUR NEXT CAR

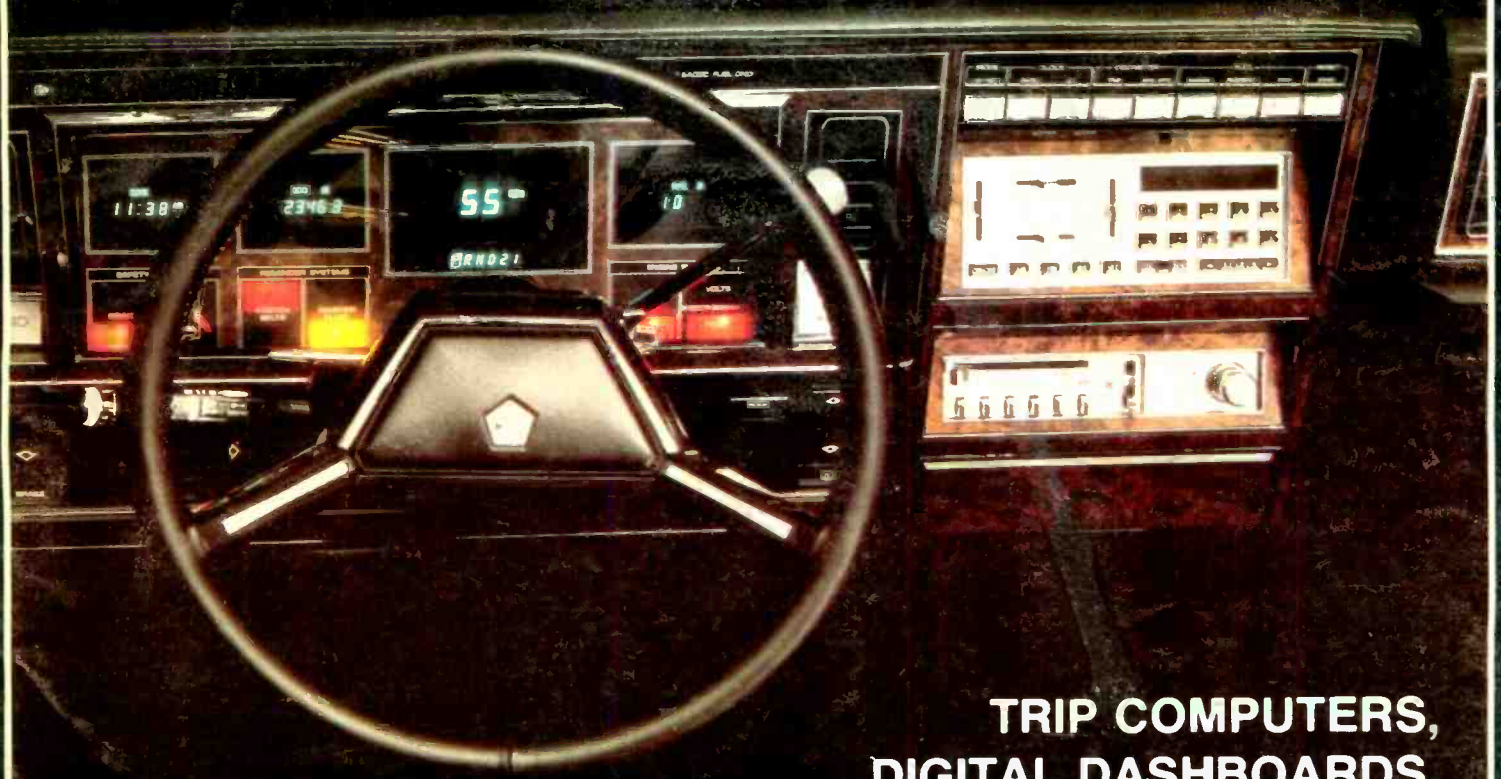

**TRIP COMPUTERS,  
DIGITAL DASHBOARDS,  
AND MICROPROCESSOR IC'S  
GIVE U.S. CARS A BRIGHT FUTURE**

303092 DRX 645CM091 14 A DEC86  
LLOYD DANKNELL  
6450 MYRTLEWOOD DR  
CUPERTINO CA 95014  
12  
71896 48783

# A LIFETIME GUARANTEE AND 11 OTHER REASONS TO BUY AN "OPTOELECTRONICS" FREQUENCY COUNTER

- 1. SENSITIVITY:** Superb amplifier circuitry with performance that can't be matched at twice the price. Average sensitivity of better than 15 mV from 10 Hz to 500 MHz on every model and better than 30 mV from 500 MHz to 1.1 GHz on the Series 8010A and 8013.
- 2. RESOLUTION:** 0.1 Hz to 12 MHz, 1 Hz to 50 MHz, 10 Hz over 50 MHz.
- 3. ALL METAL CASES:** Not only are the heavy gauge aluminum cases rugged and attractive, they provide the RF shielding and minimize RFI so necessary in many user environments.
- 4. EXTERNAL CLOCK INPUT/OUTPUT:** Standard on the 8010/8013 series and optional on the 7010 series is a buffered 10 MHz clock time base input/output port on the rear panel. Numerous uses include phase comparison of counter time base with WWVB (U.S. National Bureau of Standards). Standardize calibration of all counters at a facility with a common 10 MHz external clock signal, calibrate scopes and other test equipment with the output from precision time base in counter, etc., etc.
- 5. ACCURACY:** A choice of precision to ultra precision time base oscillators. Our  $\pm 1$  PPM TCXO (temperature compensated xtal oscillator) and  $\pm 0.1$  PPM TCXO are sealed units tested over 20-40°C. They contain voltage regulation circuitry for immunity to power variations in main instrument power supply, a 10 turn (.05 PPM) calibration adjustment for easy, accurate setability and a heavily buffered output prevents circuit loads from affecting oscillator. Available in the 8010 and 8013 series is our new ultra precision micro power proportional oven oscillator. With  $\pm .05$  PPM typical stability over 10-45°C, this new time base incorporates all of the advantages of our TCXO's and virtually none of the disadvantages of the traditional ovenized oscillator: Requires less than 4 minutes warm-up time, small physical size and has a peak current drain of less than 100 ma.
- 6. RAPID DISPLAY UPDATE:** Internal housekeeping functions require only .2 seconds between any gate or sample time

- period. At a 1 second gate time the counter will display a new count every 1.2 seconds, on a 10 second gate time a new count is displayed every 10.2 seconds. (10.2 seconds is the maximum time required between display updates for any resolution on any model listed).
- 7. PORTABILITY:** All models are delivered with a 115 VAC adapter, a 12 VDC cord with plug and may be equipped with an optional ni-cad rechargeable battery pack installed within its case. The optional Ni-Cad pack may be recharged with 12 VDC or the AC adapter provided.
- 8. COMPACT SIZES:** State-of-the-Art circuitry and external AC adapters allowed design of compact easy to use and transport instruments.  
Series 8010/8013: 3" H x 7-1/2" W x 6-1/2" D  
Series 7010: 1-3/4" H x 4-1/4" W x 5-1/4" D
- 9. MADE IN U.S.A.:** All models are designed and manufactured at our modern 13,000 square foot facility at Ft. Lauderdale, Florida.
- 10. CERTIFIED CALIBRATION:** All models meet FCC specs for frequency measurement and provided with each model is a certificate of NBS traceable calibration.
- 11. LIFE TIME GUARANTEE:** Using the latest State-of-the-Art LSI circuitry, parts count is kept to a minimum and internal case temperature is only a few degrees above ambient resulting in long component life and reliable operation. (No custom IC's are used.) To demonstrate our confidence in these designs, all parts (excluding batteries) and service labor are 100% guaranteed for life to the original purchaser. (Transportation expense not covered).
- 12. PRICE:** Whether you choose a series 7010 600 MHz counter or a series 8013 1.3 GHz instrument it will compete at twice its price for comparable quality and performance.

MODEL 8010A/8013 1.1 GHz/1.3 GHz

MODEL 7010A 600 MHz



| MODEL    | RANGE<br>(From 10 Hz) | 10 MHz TIME BASE |           |        | AVG. SENSITIVITY |                    | GATE<br>TIMES            | RESOLUTION |        |                    | EXT. CLOCK<br>INPUT/OUTPUT | SENSITIVITY<br>CONTROL | NI-CAD<br>BATTERY PACK |        |
|----------|-----------------------|------------------|-----------|--------|------------------|--------------------|--------------------------|------------|--------|--------------------|----------------------------|------------------------|------------------------|--------|
|          |                       | STABILITY        | AGING     | DESIGN | 10 Hz to 500 MHz | 500 MHz to 1.1 GHz |                          | 12 MHz     | 60 MHz | Max. Freq.         |                            |                        |                        |        |
| 7010A    | 600 MHz               | $\pm 1$ PPM      | <1 PPM/YR | TCXO*  | 15 mV            | N/A                | (3)<br>1, 1, 10 sec.     | 1 Hz       | 1 Hz   | 10 Hz<br>(600 MHz) | YES<br>OPTIONAL            | NO                     | YES<br>OPTIONAL        |        |
| 7010.1A  |                       | $\pm 0.1$ PPM    |           |        |                  |                    |                          |            |        |                    |                            |                        |                        |        |
| 8010A    | 1.1 GHz               | $\pm 1$ PPM      | <1 PPM/YR | TCXO*  | 15 mV            | 30 mV              | (4)<br>01, 1, 1, 10 sec. | 1 Hz       | 1 Hz   | 10 Hz<br>(1.1 GHz) | YES<br>STANDARD            | YES                    | YES<br>OPTIONAL        |        |
| 8010.1A  |                       | $\pm 0.1$ PPM    |           |        |                  |                    |                          |            |        |                    |                            |                        |                        |        |
| 8010.05A |                       | $\pm .05$ PPM    |           |        |                  |                    |                          |            |        |                    |                            |                        |                        | OCXO** |
| 8013.1   |                       | $\pm 0.1$ PPM    |           |        |                  |                    |                          |            |        |                    |                            |                        |                        | TCXO*  |
| 8013.05  | 1.3 GHz               | $\pm .05$ PPM    | <1 PPM/YR | OCXO** | 15 mV            | 30 mV              | (4)<br>01, 1, 1, 10 sec. | 1 Hz       | 1 Hz   | 10 Hz<br>(1.3 GHz) | YES<br>STANDARD            | YES                    | YES<br>OPTIONAL        |        |

TCXO = Temperature Compensated Xtal Oscillator

\*\*OCXO = Proportional Oven Controlled Xtal Oscillator

## SERIES 7010A

|                |  |          |
|----------------|--|----------|
| #7010A         | 600 MHz Counter - 1 PPM TCXO                                   | \$199.95 |
| #7010.1A       | 600 MHz Counter - 0.1 PPM TCXO                                 | \$249.95 |
| <b>OPTIONS</b> |  |          |
| #70-H          | Handle/Tilt Bail (not shown)                                   | \$2.95   |
| #Ni-Cad-701    | Ni-Cad Battery Pack & Charging Circuitry Installed Inside Unit | \$19.95  |
| #EC-70         | External Clock Input/Output                                    | \$35.00  |
| #CC-70         | Carry Case - Padded Black Vinyl                                | \$9.95   |

## SERIES 8010A/8013

|           |                                |          |
|-----------|--------------------------------|----------|
| #8010A    | 1.1 GHz Counter - 1 PPM TCXO   | \$399.00 |
| #8010.1A  | 1.1 GHz Counter - 0.1 PPM TCXO | \$450.00 |
| #8010.05A | 1.3 GHz Counter - .05 PPM Oven | \$499.00 |
| #8013.1   | 1.3 GHz Counter - 0.1 PPM TCXO | \$550.00 |
| #8013.05  | 1.3 GHz Counter - .05 PPM Oven | \$599.00 |

## OPTIONS

|             |  |         |
|-------------|--|---------|
| #Ni-Cad-801 | Ni-Cad Battery Pack & Charging Circuitry Installed Inside Unit | \$49.95 |
| #CC-80      | Carry Case - Padded Black Vinyl                                | \$ 9.95 |

## ACCESSORIES

|           |  |          |
|-----------|--|----------|
| #TA-100   | Telescope antenna with right angle BNC   | \$ 9.95  |
| #P-100    | Probe, 50 Ohm, 1X  | \$13.95  |
| #P-101    | Probe, Lo-Pass Audio Usage   | \$16.95  |
| #P-102    | Probe, Hi-Z General Purpose  | \$15.95  |
| #LFM-1110 | Low Frequency Multiplier X 10, X 100, X1000 For High Resolution of Audio Freq. | \$119.95 |



# Optoelectronics inc

5821 N.E. 14th Avenue, Fort Lauderdale, Florida 33334

1-800-327-5912

TERMS: Orders to U.S. and Canada, add 5% for shipping, handling and insurance to a maximum of \$10.00. All other orders add 15%. C.O.D. collection fee \$2.00. Florida orders add 4% state tax. Personal checks must clear before goods are shipped.

FROM FLORIDA (305) 771-2051/2  
CIRCLE 17 ON FREE INFORMATION CARD



# Beep Free

*Doctors use them and so do many businessmen. The pocket beeper now takes a giant step forward with the introduction of the own-your-own system.*

You're away from your desk in a meeting. Suddenly your pocket beeper starts beeping. You pull it out of your pocket, press a button and you hear your secretary's voice with a message.

"Big deal," you say. "What's so special about that. There are thousands of pagers like it in use." Yes, but this one is different.

## TOTAL CONTROL

In the first place, you own the entire system. You own the transmitter and the beepers. Secondly, the system is inexpensive. It costs less than leasing one traditional beeper for a year. And finally, it solves the problems that other pagers can't solve—but more on that later.

The new Auto Page paging system consists of a transmitter that sits on your secretary's desk. When a call comes in, she presses a button which sends out a signal to your paging device. The antenna rests on your secretary's file cabinet and plugs easily into the transmitter so there's no installation.

## MAKES NO SENSE

But like many breakthrough products the Auto Page System has limitations. The system was designed for office, factory, farm or home use. So its range is limited to one mile with voice and two miles with tone.

For doctors who are constantly on the road, the Auto Page does not make sense. For the business person, however, who moves frequently through an office or factory, the system is ideal.

Instead of using expensive paging or loud speaker systems, you can locate and communicate with your staff in privacy no matter where they are within your premises.

## SERIOUS THOUGHTS

You can use up to six different pagers, each on different channels, and the entire system with two beepers costs only \$395.00.

Once you own the system there are no further costs. Conventional pagers rent for up to \$25.00 per month so in eight months the Auto Page System with two pagers would pay for itself and from then on your secretary can literally 'beep free.'

Each additional beeper costs \$75.00 or the equivalent of a three month lease on the typical beeper. But you can't compare a typical beeper with the Auto Page. The Auto Page has voice transmission. The typical beeper does not. The Auto Page is a totally personal system that can be used anywhere. The typical beeper must be used near a big city. And finally, the typical system is expensive—many times the cost of the Auto Page System.

## HERE AND THERE

We suggest that before you decide to purchase, you experience the freedom and convenience of personal paging. Order a system from JS&A on our 30-day trial. Give a beeper to each member of your staff. See how easy it is to set up a system (just plug it in). And then actively use it for a month. If personal paging is not the most convenient and efficient way to communicate, return it anytime within 30 days for a prompt and courteous refund.

We've tested our system at construction sites, in large buildings, on farms, in the country, with motel operators and several small businesses. Based on our personal observations and sales success, we are convinced that the Auto Page System of personal paging is the future of paging.

JS&A is America's largest single source of space-age products—further assurance that your modest investment is well protected. Service should not be required for many years as the Auto Page is totally solid state, but if service is ever required, just pop your receiver or transmitter in its mailing carton and mail to the Auto Page service-by-mail center which will promptly repair and return your unit.

To order your system, send your check or money order for **\$395.00** for a system with two beepers and **\$75.00** for each additional beeper up to six (Illinois residents add 6% sales tax) to the address below. Please add \$4 for postage and handling. Credit card buyers may use our toll-free number below.

We'll send you a transmitter, antenna, beepers, one-year limited warranty and complete instructions.

Personal paging and low-cost personal communications are nicely packaged in a system that will make your company more efficient from the very first day you test our system. Order one for your test at no obligation, today.



Dept. RA One JS&A Plaza  
Northbrook, Ill. 60062 (312) 564-7000  
Call TOLL-FREE ..... 800 323-6400  
In Illinois Call ..... (312) 564-7000

© JS&A Group, Inc., 1980

# You can't buy a better frequency counter than our new 6001.

## Even if you spend \$300 more.

Count the extra range. The extra precision. The dollars you save. And you understand why, at \$425,\* our new Model 6001 650 MHz Precision Frequency Counter offers you more value than those of other leading manufacturers.

A look at the competitive models\*\* from B&K, Ballantine, Data Precision, Fluke and Hewlett-Packard will tell you why.

You can spend as much as \$695 and get a range of only 10 Hz to 600 MHz (as compared with our guaranteed 5 Hz - 650 MHz).

You can spend

\$620 and get only 1/10 the precision ( $\pm 5$ ppm as compared to our 0.5ppm).

You can settle for a six- or seven-digit display instead of our eight. Half the range and one-fifth the accuracy at about the same price. Or spend considerably more, for equal precision and extra features you'll probably never need.

It's this simple: if you're looking for a high-precision, wide-range counter, nothing compares to our Model 6001. With its

switchable audio-band low-pass filter. Selectable 0.1/1.0/10-sec. gate. Internal/external timebase selection. Unit-count mode. High-brightness display. True TTL inputs. Built-in temperature-controlled oven. And NBS-traceable standard. To name just a few of its many advantages.

Make your own comparison. Ask us for full specs and a demonstration.

The rest is a matter of dollars and sense.



CIRCLE 21 ON FREE INFORMATION CARD

**GLOBAL  
SPECIALTIES  
CORPORATION**

Call toll-free for details  
**1-800-243-6077**  
During business hours

70 Fulton Terr. New Haven, CT 06509 (203) 624-3103. TWX 710-465-1227  
OTHER OFFICES: San Francisco (415) 421-8872. TWX 910-372-7992  
Europe: Phone Saffron-Walden 0799-21682. TLX 817477  
Canada: Len Finkler Ltd. Downsview, Ontario

\*Suggested U.S. resale. Prices, specifications subject to change without notice. \*\*Comparison based on manufacturers' literature and suggested resale. © Copyright 1980 Global Specialties Corporation.

**SPECIAL FEATURE**

- 45 ELECTRONICS IN YOUR NEXT CAR**  
Part 1. Digital dashboards, trip computers, and microprocessors—a look at how electronics is changing the American car. **Martin Bradley Weinstein**

**BUILD**

- 49 LOW FREQUENCY CONVERTER**  
Add-on accessory extends the low-frequency range of the Synthesized Function Generator. **Gary McClellan**
- 52 MINI-SPEAKER SYSTEM**  
A high-performance speaker system for your hi-fi in a mini-sized package. **Gary Stock**
- 55 BUILD YOUR OWN ROBOT**  
Part 5: Construction details for completing the body and adding a voice. **James A. Gupton**
- 63 UNIVERSAL LOGIC TESTER**  
A one-IC device that checks out not only components, but entire circuits. **Fred Blechman, K6UGT**

**CIRCUIT APPLICATIONS**

- 84 HOBBY CORNER**  
A call for do-nothing circuits plus a light-panel project. **Earl "Doc" Savage, K4SDS**
- 100 NEW IDEAS**  
A winning circuit application from our readers

**AUDIO**

- 71 CONNECTING SIGNAL PROCESSORS TO YOUR SYSTEM**  
How to connect multiple-signal processing devices to your system and insure optimum performance. **Len Feldman**
- 78 R.E.A.L. SOUND LAB TESTS DUAL 606 TURNTABLE AND ORTOFON ULM55E CARTRIDGE**  
Ultra low-mass turntable/cartridge combination rates excellent.

**VIDEO**

- 77 CCD COMB FILTERS FOR TELEVISION**  
How CCD devices are being used to improve picture quality. **Karl Savon**
- 102 SERVICE CLINIC**  
An unusual regulator circuit from Hitachi. **Jack Darr**
- 104 SERVICE QUESTIONS**  
R-E's Service Editor solves technician's problems.

**RADIO**

- 92 COMMUNICATIONS CORNER**  
A look at "quartz-locked" receivers and what they're all about. **Herb Friedman**

**COMPUTERS**

- 75 HEWLETT-PACKARD'S HP-85**  
A rundown on H-P's entry into the personal computer arena. **Jules H. Gilder**

**EQUIPMENT REPORTS**

- 32 Flute 8050 Digital Multimeter**
- 36 Cincinnati Electrosystems Model 113 Continuity Tester**
- 38 Antenna Incorporated Persuader CB Antenna**
- 40 Taco/Jerrold Maximizer TV/FM Preamp**

**DEPARTMENTS**

- |                                     |                                  |
|-------------------------------------|----------------------------------|
| <b>126 Advertising Index</b>        | <b>127 Free Information Card</b> |
| <b>16 Advertising Sales Offices</b> | <b>26 Letters</b>                |
| <b>106 Books</b>                    | <b>107 Market Center</b>         |
| <b>98 Computer Products</b>         | <b>88 New Products</b>           |
| <b>16 Editorial</b>                 | <b>96 Radio Products</b>         |

**ON THE COVER**

Digital dashboards, trip computers and microprocessors—electronics is finding its way into automobiles. This first part of a four-part series will explore how electronics is being applied to the automobile and its impact on the driver. For an in-depth look at digital dashboards, turn to page 45.

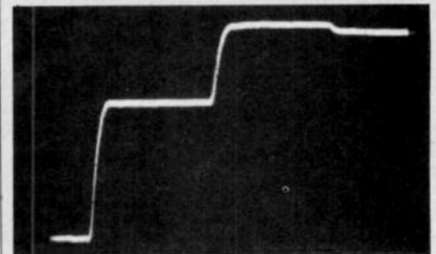

**USING EQUIPMENT** you already have, you can pinpoint the location of faults along coaxial transmission cables. This technique is especially useful for buried cables. For the complete story, turn to page 67.

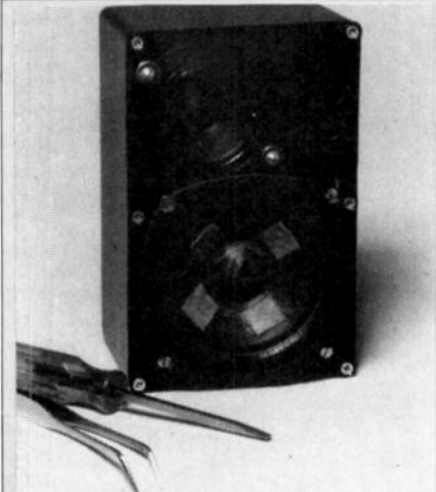

**HIGH-PERFORMANCE MINI SPEAKERS** you can build for your hi-fi system. Complete construction details start on page 52.

Radio-Electronics, (ISSN 0033-7862) Published monthly by Gernsback Publications, Inc., 200 Park Avenue South, New York, NY 10003. Controlled Circulation Postage Paid at Concord, NH. One-year subscription rate: U.S.A. and U.S. possessions, \$13.00. Canada, \$16.00. Other countries, \$18.00. Single copies \$1.25. © 1980 by Gernsback Publications, Inc. All rights reserved. Printed in U.S.A.

**Subscription Service:** Mail all subscription orders, changes, correspondence and Postmaster Notices of undelivered copies (Form 3579) to Radio-Electronics Subscription Service, Box 2520, Boulder, CO 80322.

A stamped self-addressed envelope must accompany all submitted manuscripts and/or artwork or photographs if their return is desired should they be rejected. We disclaim any responsibility for the loss or damage of manuscripts and/or artwork or photographs while in our possession or otherwise.

# looking ahead

## MINI-COMBO



The second portable combination camera-VCR has made its bid for the home movie market. Following by two months Sony's demonstration of its "Video Movie" system (**Radio-Electronics**, October, 1980), Hitachi showed a working model of its experimental *Mag Camera*, combining an MOS solid-state camera with a quarter-inch VCR. Unlike Sony's unit, which can record only 20 minutes on a microcassette, the *Mag Camera* uses a cassette just slightly larger than an audio cassette for two hours' recording time. While Sony said that its Video Movie was four to five years off, Hitachi has a goal of two years for marketing its *Mag Camera*.

The long-playing mini-cassette will use metal tape, which moves at a slow 0.63 ips. Nevertheless, it is capable of high-fidelity stereo sound because the FM audio track is combined with the video signal on the helical path. A conventional longitudinal sound track is also included for dubbing. The entire camera-VCR combination weighs about 5.7 pounds. Hitachi also said it would have a MOS camera on the Japanese and American markets next year at around \$1,625; it weighs about 3.5 pounds, including electronic viewfinder and power zoom lens, or 2.4 pounds without the viewfinder. It's the first solid-state camera to have a firm date for the consumer market. The MOS image sensor is  $\frac{2}{3}$  inch in diameter, has 260 lines horizontal resolution, and avoids the sticking and lag common to vidicon cameras.

## ELECTRONIC PHONE BOOK

The French government telephone system plans to eliminate the telephone directory and substitute electronic terminals in the homes of all subscribers over the next 10 years, distributing more than 30,000,000 free terminals. The first test operation is now in effect in several areas of France, with the first 250,000 terminals to be installed by some time in 1981. Each terminal has an alphanumeric keyboard to enable the subscriber to type out the category of information sought—"restaurants," for example. Restaurants are then displayed by category, with open hours, prices, etc. The system also provides the traditional alphabetical listings. France says that the new system, including the free terminals, is cheaper than printing and distributing phone books, and has the additional advantage of continuous updating.

## FILM'S DEFENSE

The near-certainty of electronic camera-recorders sized to compete with super-8 provoked a defensive reaction at the Fotokina exposition in Cologne, Germany, with traditional film camera makers showing devices to play home movies through a television set or dub them onto tape. Those were shown by Grundig (already in production) and Elmo of Germany and Sankyo, Yamawa and Goko of Japan. Goko's unit uses a 24-sided prism in place of a mechanical shutter and is capable of producing many special effects, including fades, dissolves, and titling on videotape. It also permits video monitoring of film while editing or inserting special effects.

## PROJECTION TV PRICES

They may be on the way down, judging from recent developments. Most three-tube TV projectors have been priced in the high three-thousands or lower four-thousands of dollars—except for Henry Kloss's Novabeam, which is pegged at \$2,995. Pushing for more popular acceptance of projection, Sony has introduced two new two-piece systems, at \$2,495 for a 50-inch picture and \$2,995 for a 72-inch picture. Advent responded with a 72-inch two-piecer with remote control (which Sony lacks) at a suggested list price of \$3,295, but with sufficient promotional allowances to be priced competitively with Sony's same-sized unit. Other models from different manufacturers are expected to compete at similar prices. The lowest-priced three-tube unit is probably still the Heath at \$2,195 plus shipping—and plus assembly labor, of course.

## 3-D CASSETTES

If you want a new thrill from your home videocassette recorder, how about objects popping out of the screen? MCA Videocassette is planning to revive some of the old 3-D movies on cassette, and at presstime had hoped to have the first two ready before Christmas. They're the old classics, "Creature from the Black Lagoon" and "It Came from Outer Space." Although the movies originally required polarized glasses for viewing, they have been modified for the use of red and green glasses on the home screen (you can't polarize the light on picture tubes). Each movie cassette will come equipped with four pairs of glasses and will sell for \$65.

## VIDEODISCS NATIONWIDE

In time for Christmas, optical videodisc players and discs are generally available in all major market areas of the United States. The big expansion from a few markets began this fall, when Pioneer added some 20 new areas, including all of the top 20, with Magnavox's compatible players not far behind. Pioneer accompanied its national rollout with an advertising campaign, designed to increase consumer awareness of the videodisc. About 160 different titles—principally feature movies—are available now on disc, and player owners are clamoring for more. The players carry suggested list prices from \$749 to \$799.

DAVID LACHENBRUCH  
CONTRIBUTING EDITOR

# We've got it all together.



Xcelite



Lufkin



Boker



Nicholson



Xcelite



Xcelite

**Boker  
Crescent  
Lufkin  
Nicholson  
Weller, Wiss  
Xcelite**

When you think about tools for a customized tool kit remember these leading brand names from Cooper. They ensure uncompromising quality and years of dependable service.

They are designed to meet your unique service, repair and maintenance needs. So, be sure you specify Cooper Tools when ordering.

And don't forget, customized tool kits containing Cooper Tools are available from a selected group of Cooper distributors. Don't take chances on tools. Ask for Cooper tools or write for the name of the nearest custom kit supplier.



Wiss



Crescent



Weller

# from Cooper The Toolmaker. T.M.



**The Cooper Group**

BOKER\* CRESCENT\* LUFKIN\*  
NICHOLSON\* PLUMB\* WELLER\* WISS\* XCELITE\*  
P.O. Box 728, Apex, North Carolina 27502

CIRCLE 7 ON FREE INFORMATION CARD

**"Here's the best news yet about Fluke Digital Multimeters.**

**Now you can carry one home."**

Right now, in selected electronics supply stores across the country, Fluke is introducing a new line of low-cost DMM's: the Fluke Series D. With their distinctive dark cases and full range of accessories, these five DMM's are designed to meet the test and measurement needs of the uncompromising service technician, home hobbyist, student or working engineer.

Fluke perfected the handheld DMM and set tough standards for accuracy and reliability that have made analog meters obsolete, and other digitals seem clumsy by comparison.

You've probably heard about their superior electrical performance, mechanical

ruggedness and environmental endurance. And now you can see for yourself at your favorite electronics dealer why Fluke DMM's have become the professional's choice the world over.

#### Series D Handheld Models.

**D 800:** Fluke's lowest-priced DMM, easy to operate, with six functions, 24 ranges and 0.5% dc voltage accuracy. Guaranteed a full year by Fluke. A sure-fire solution to basic measurement needs. \$125.\*

**D 802:** Basic dc accuracy of 0.1% and conductance for high resistance measurements to 10,000 M $\Omega$  make this multimeter a solid price/performance value. \$179.\*



If your dealer doesn't carry Series D Multimeters yet, call this number. We'll be happy to tell you who does. 1-800-426-9182



**D 804:** A powerful, versatile handheld DMM with nine functions, 26 ranges, 0.1% basic dc accuracy and more. Direct temperature readings in °C with K-type thermocouples; peak hold on voltage and current functions; even an audible indicator for instant continuity and logic level detection. Available January 1981. \$229.\*

#### Series D Bench/Portables.

**D 810:** By means of a Fluke-built hybrid converter, this multi-purpose DMM delivers True RMS measurements of ac voltage and current with speed and precision. Also features conductance, 0.1% basic dc accuracy, an extra 10A range and diode test. \$259.\*

**D 811:** Same performance features as the D 810 with the added convenience of battery power. Rechargeable "C" size Ni-Cad batteries deliver up to 40 hours continuous operation. \$299.\*

#### Series D Accessories.

A wide range of accessories to extend the measurement capabilities of your Series D Multimeter is available, including temperature and current probes, carrying cases, deluxe test leads and thermocouples.

With Series D Multimeters so easy to find and economical to own, Fluke has made selecting the right DMM much simpler. This is your opportunity to own a Fluke.



**From the world leader in DMM's. Now we've designed one for you.**



# NRI will train you at home to be an electronics professional in the growing world of communications.

Learn to service, repair, and install everything from microwave antennas  
to two-way radios...from radar sets to TV transmitters.

TV Tape Recorders



TV Broadcasting

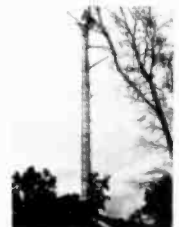

Antenna Systems



Marine Communications



Aviation Communications & Navigation Systems



Direction Finders, Loran

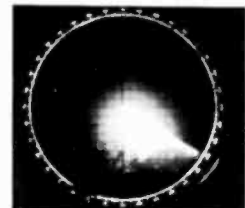

Radar



No other home-study course gives you such complete, professional training in so many fields of communication. No other gives you the actual bench training with kits and demonstration units specially designed for learning. Only NRI gives you the thorough preparation and training you need to achieve professional competence in the wide world of communications.

### Learn at Home in Your Spare Time

Learn at your own pace, right in your own home. There's no need to quit your job or tie up your evenings

with night classes. No time or gas wasted traveling to school...NRI brings it all to you. You learn with NRI-pioneered "bite-size" lessons and proven, practical "power-on" training.

### Build Your Own 2-Meter, Digitally Synthesized VHF Transceiver

NRI training is "hands-on" training. You get honest bench experience as you build and test this industrial-quality two-way radio and power supply. You reinforce theory lessons as you induce and correct faults, study individual circuits and learn how they interface with others. Or, at your option, you can train with a fully-assembled forty-channel mobile CB and base-station power supply converter.

You also build and keep for use in your work a transistorized volt-ohm

meter and digital CMOS frequency counter. NRI even gives you special lessons to get your Amateur License so



you can go on the air with your VHF transceiver.

### FCC License or Full Refund

In all, you get 48 lessons, 9 special reference texts, and 10 training kits...the training you need to become a professional. And NRI includes training for the required FCC radiotelephone license examination. You pass or *your tuition will be refunded in full*. This money-back agreement is valid for six months after the completion of your course.

### Free Catalog, No Salesman Will Call

NRI's free, 100-page full-color catalog shows all the equipment you get, describes each lesson and kit in detail, tells more about the many specialized fields we train you for. It includes all facts on other interesting areas like TV and audio servicing or digital computer electronics. Mail the postage-paid card and see how we can make you a pro.

If the card has been removed, write to:



**NRI Schools**  
McGraw-Hill Continuing  
Education Center  
3939 Wisconsin Ave.  
Washington, D.C. 20016



Mobile Radio



CB Radio



Aircraft Guidance & Landing Systems



AM & FM Broadcasting

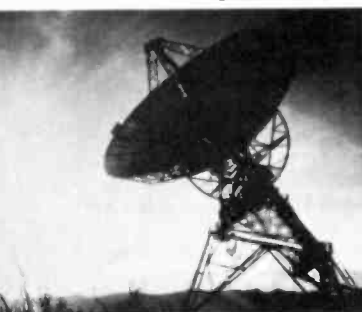

Microwave Relay

## Improving boiler safety

Low water levels lead all other causes of accidents in both industrial boilers and those used for commercial heating. Sediment build-up and contamination in mechanical and electrical low-water sensors can cause a false indication of high water, allowing the true water level to become dangerously low.

A new electronic probe introduced by Honeywell solves the contamination problem. Like the standard probe, it consists of a metal rod inserted in the boiler through an insulator. Current flows in a series circuit through the coil of a relay, through the probe, then through the water to the boiler body, which forms the ground and return circuit. Thus, while the probe touches water, the relay remains closed.

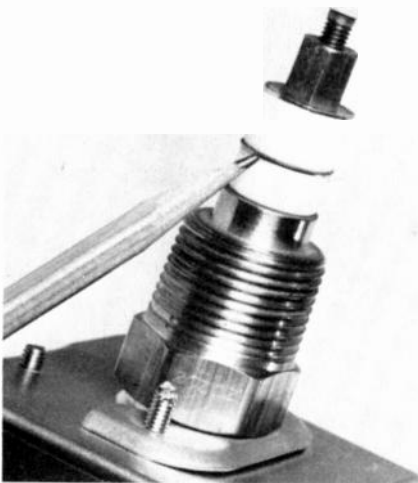

THE GUARD-RING midway down the insulator is connected to the electric line and to the input of the relay coil that holds the circuit closed. When the insulator is clean, it has no effect. If conductive contamination builds up on the insulator, it shunts current around the relay to cause it to drop out, stopping the burner.

But conductive contamination can build up on the insulator, between the probe and the grounded boiler. Current through this contamination layer can keep the relay closed and give a false indication of high water.

In the Honeywell *Guard-Ring* probe, the input, instead of going first through the relay coil, is connected to the ring (see photo) and another lead from the ring goes to the coil. If contamination builds up between the ring and probe, and between the ring and the grounded boiler, shunt circuits are formed across the relay coil, reducing the current through it. When the resistance of these two shunts drops enough, the relay contacts open and the boiler burner goes

out. Thus—unlike the standard probe—the *Guard-Ring* type of boiler low-water probe is a fail-safe device.

## Parental Supervision by Cable

A special feature of a new two-way interactive cable-TV system—the TOCOM 55—is that it includes a "parental access" control with which parents can pre-select the programs to be received, thus offering them a safeguard against inappropriate programming for their children. The Irving (Texas) company is in the news because its system is featured in five of the six bids for the cable-TV franchise for nearby Dallas—a system planned to be one of the most advanced—if not the most advanced—in the country.

The TOCOM 55 can receive not only 55 TV channels, but 55 channels of "text," graphic displays, movies, etc. (The text is transmitted in the vertical intervals between fields and frames.) It is on those special non-broadcast channels that the parental access control is expected to be most useful.

Among the other advanced features of the system are a 24-hour emergency alert that allows the system center to activate the TV sets on its circuit and alert all subscribers should any danger—such as tornadoes or floods—pose a threat to the community.

Computer security can be provided, with smoke and intrusion detectors installed in the home and the central computer sending out a "polling" pulse every few seconds. An alarm is turned in and the subscriber alerted if danger is detected.

Among the "text" displays from which the subscriber can select are a wide variety of wire service, financial, weather service, and community service news, airline schedules, shopping guides, and other features of general and specialized interest.

With the two-way feature, the viewer can participate in opinion surveys, call up information from data banks and specialized services, and gain access to pay-per-view programming, which may include live events as well as movies. A test of cable marketing services is expected in the near future.

## Better space satellite forecast

GOES-D, the latest Geostationary Operational Environmental Satellite, carries new instrumentation that may help meteorologists to improve greatly the accuracy of their weather forecasts.

The primary payload of GOES-D is a visible and infrared spin-scan radiometer atmospheric sounder (VISSR). Built by the Hughes Santa Barbara Research Center to provide new data on the vertical structures of temperature and moisture in the atmosphere, it will increase the information

available to the forecaster.

"Our monitoring of severe storms is limited to observing the development of tops of clouds as they build altitude," says a leading weather expert. "If there is what we call an 'undercast' we can't make soundings beneath the top cloud layer." Making measurements literally in depth will greatly enhance the ability of meteorologists to determine the intensity of building storms and to track them as they build.

## GOES SATELLITE

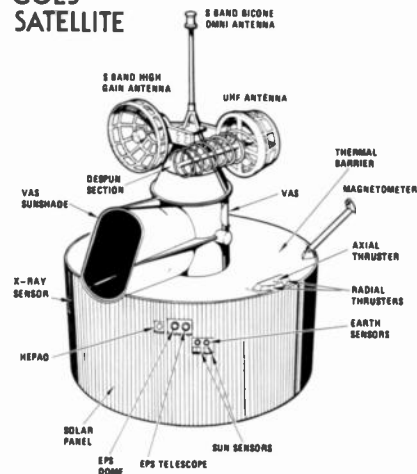

THE HUGHES GOES-D SATELLITE, about 12 feet high and 7 feet in diameter, operates in synchronous orbit 22,300 miles above a spot on the equator, where it can "see" practically the whole Western Hemisphere. The spacecraft spins at 100 rpm, scanning a strip of the planet for its "cloud pictures" each spin. The antennas are "de-spun" so that they point constantly at the earth. The satellite transmits visible imagery with a resolution of 0.6 miles (9 km) and infrared imagery with a resolution of 4.3 miles (6.9 km). The vertical atmospheric sounder (VAS) picks up and transmits data formerly not collectable.

GOES-E and GOES-F are now under construction. One of them will replace earlier satellites; the other will remain on the ground as a spare.

The new satellite will not only transmit data to earth—delivering every 30 minutes the type of cloud picture familiar to TV weathercast viewers—it will pick up information from earth surface platforms—which transmit data gathered by such instruments as river, rain, and tide gauges, seismometers, and automatic weather stations—and forward it to various users in the U.S.

The platforms transmit at regular intervals, or when interrogated by the satellite. If instruments sense changes beyond normal parameters, an emergency alarm mode is entered, transmitting the data as it is picked up.

*continued on page 14*

# A sweeping statement about our new Function Generator: It provides a clean signal at a carefree price.

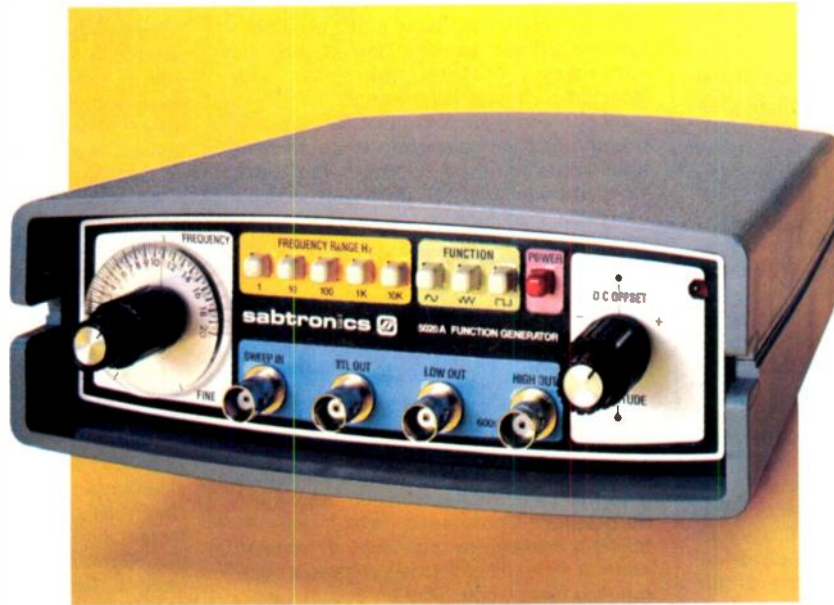

Sabtronics can offer low prices because we sell what we manufacture, directly to you. And the 5020A Function Generator you get from us is second to none in price/performance. We give you the waveform you want — 1 Hz all the way up to 200 kHz in five overlapping ranges: stable, low-distortion sine waves, high linearity triangle waves, fast rise/fall-time square waves — plus a separate TTL square wave output and high and low level main outputs. For precise frequency settings we have a fine control in addition to the usual primary control found in competitive units.

The sweep input allows external frequency control and frequency sweeping over 100:1 range, and control over both the output amplitude and DC offset is provided for all wave forms.

Get a clean signal at a price that won't clean you out. Send in the coupon and order your new 5020A Function Generator now. Credit card holders may call (813) 623-2631.

## BRIEF SPECIFICATIONS

**Frequency Range:** 1 Hz-200 kHz in 5 overlapping ranges (1 Hz-20Hz, 10Hz-200 Hz, 100Hz-2kHz, 1kHz-20kHz, 10kHz-200kHz).



**Waveforms:** Sine wave, square wave, triangle wave. **Outputs (BNC connector):** High: 10V p-p max (600Ω), Low: - 40dB

of high output (600Ω), TTL: Standard TTL level capable of driving 10 TTL loads. **Input:** Impedance 27 kΩ, DC coupled sweeps the output frequency <100:1. **Power requirement:** 105-120V 50/60 Hz, 4 VA max. **Dimensions:** 8" wide X 6.5" deep X 3" high (203 X 165 X 76mm). **Weight:** 1.5 lbs. (680 g).

Making Performance Affordable

**sabtronics**  
INTERNATIONAL INC.

5709 N. 50th Street, Tampa, FL 33610  
(813) 623-2631

|   |   |
|---|---|
| Sabtronics International, Inc., 5709 N. 50th Street, Tampa, FL 33610  |   |
| _____ Model 5020A Function Generator kit(s) @ \$85.00   | \$ _____  |
| _____ Model 5020A Function Generator(s) assembled @ \$99.00   | \$ _____  |
| For delivery in Florida, add 4% Sales Tax   | \$ _____  |
| Shipping and handling @ \$6.00 per instrument*  | \$ _____  |
| 10% deposit for C.O.D. orders   | \$ _____  |
| I enclose <input type="checkbox"/> money order <input type="checkbox"/> check.<br>(Allow 2-3 weeks for personal checks to clear.) |   |
| Charge: <input type="checkbox"/> Visa <input type="checkbox"/> Mastercard   |   |
| Account No. _____   | Exp. Date _____   |
| Name _____  |   |
| Street _____  |   |
| City _____  | State _____ Zip _____   |
| *USA only. Canada \$7.50; Overseas airmail \$25.00.   |   |
|   | RE  |

# what's news

continued from page 12

## "Deregulation" benefits

The 17 million cable-TV viewers now have access to a considerably greater range of services than was possible in the past, as a result of FCC's deletion of the rule forbidding cable-TV systems to pick up most programs from outside their own areas, and a rule preventing cable stations from televising programs that are also shown by local broadcasters.

Cable systems can now carry as many stations from outside their own areas as they desire. And by paying a royalty into an industry fund they can also transmit syndicated programs that up to the present were available only to the network or independent stations that subscribed to them.

The action reverses an FCC trend that dates back before 1972, when the two rules were passed. It was felt at the time that the very existence of broadcasting might be threatened by the rising cable systems, and efforts were directed toward protecting the broadcasters from a danger which—it is now seen—did not exist. Broadcasting profits have grown rapidly, in spite of the rapid expansion of cable.

The broadcasters—understandably—are unhappy, and "moments after the Commission made its decision," according to *The New York Times*, the National Association of Broadcasters (NAB) issued a strong denunciation of the "irresponsible" action. It is probable that they will appeal the decision to the courts.

## Programmable car radio

The Clarion PE-959A car-radio receiver/tape player can be programmed to bring in up to five AM and five FM stations automatically at predetermined times. "A typical use of the microprocessor-equipped PE959," says the manufacturer, "would be to set it for a traffic report at 8:00 am, then let it switch to an FM station for music until 8:30 am, when it would transfer automatically to another station for a news report."

Other features of the new radio are an improved signal-actuated stereo control circuit (SASC), Dolby noise reduction, tape

equalization switch for CrO<sub>2</sub> and metal tapes, local/distance switch, separate electronically controlled bass and treble controls, electronic balance control, and an auto-reverse cassette mechanism with locking fast forward and rewind.

All controls except the fast forward and rewind/eject are solid-state electrical controls, contained on a slender ¼-inch thick faceplate. The PE-959A mounts in virtually every car. It includes a low-distortion pre-amplifier and is equipped for quick, easy connection to any Clarion power amp.

The new radio is not cheap—the manufacturer lists it at \$899.95.

## Digital disc standard urged

Philips of the Netherlands and Sony of Japan have announced that they will seek global acceptance for their Optical Digital Compact Disc system. They are submitting it to the coming Digital Audio Disc Standardization Conference, which has 45 member companies registered at present, and will make all efforts to promote a common worldwide specification acceptance.

The recording and reproduction of sound as coded pulse signals permits wider frequency response and a much greater dynamic range than the older analog approach. Thus, sound quality is improved and distortion minimized. The non-contact (optical) pickup system assures a long life for the disc. Due to the digital technology, additional information—such as text or program data—may be incorporated in the record. The system is compact—though the disc diameter is only 12 cm (less than 5 inches), 60 minutes of high-density recording may be placed on one side of it. In short, say the two sponsors, the Optical Digital Compact Disc system is a breakthrough in sound quality.

## NATESA's 30th convention

The 30th annual convention of the National Association of Television and Electronic Service Associations was held at the Ramada O'Hare (Chicago) August 7 to 10,

1980. Total attendance was 320.

Among the several resolutions voted, possibly the most important one urged abolition of the so-called list price schedules on components, and release of those to the public, because of the wide differences in legitimate costs of services involved in providing components. Another urged limiting warranties to 90 days.

An addition to the Code of Ethics requires members to accept judgement of NATESA's customer-complaint policing committees, after proper study of all facets of complaints. That reinforces customer protection that is already assured by the Code of Ethics.

Many subjects discussed officially reflected general unhappiness with the direction of industry practices.

Elected to serve as 1980-81 Officers, were: Leo Emond Cloutier, Electronic Service Center in Los Angeles, President; Ellis Hall, Hall's Radio & TV Service, Middletown, Ohio, Vice President, and Tom Lesney, Community Radio & TV of Highland, Indiana, Secretary. Richard Ebare, Essex Junction, Vermont, was retained as Treasurer for the fifth term, and Paul F. Kelley of Warwick, Rhode Island assumes the post of Immediate Past President. Frank J. Moch & Associates was retained as Executive Director.

Philip Horn was named NATESA's 1980 Friend of Service (FOS). George Weiss, retiring Immediate Past President, was awarded NATESA's Shurnavon Award. Richard Ebare was presented a special plaque in recognition of exceptional service as Treasurer for five years. Lelia Aunspaw was presented with a "conversation piece" desk pen set as a memento of her two years service as Secretary. Meal and social functions were sponsored by PTS Electronics, GTE Sylvania, Magnavox, RCA, Sony, Zenith, GE, and Sams; Golf was sponsored by ET/D. Attendance awards were generously donated by Magnavox, Panasonic, and Quasar.

The Indian Lakes Resort in Bloomingdale, IL was confirmed as site of the next NATESA Convention, on August 19-23rd, 1981.

## CBS Supports Antiope

The Columbia Broadcasting System has recommended to the FCC that it adopt the French-developed Antiope as a national standard for a broadcast teletext system. In so doing, CBS has broken with the rest of the industry, which has been cooperating with a committee set up under the aegis of the Electronic Industries Association to develop a U.S. teletext standard. The committee, however, appeared to be making no progress in agreeing on a standard, which may have been the main reason for the CBS action.

R-E



WORLD'S FIRST PROGRAMMABLE CAR RADIO—the Clarion Corporation of America's PE-959A

# Sabtronics Hand-held Digital Multimeters

## Having such excellent instruments makes it tough to explain our low price.

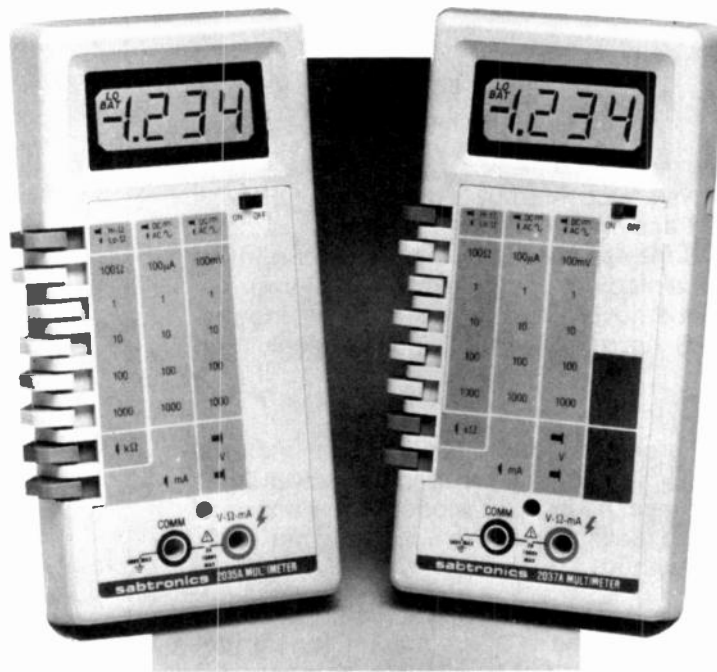

Accurate performance you can rely on, time after time. That's what you expect from a quality DMM. But don't expect to pay as much for it any more. Because now Sabtronics brings you top quality DMMs with more features and better accuracy than other comparable units on the market today. And ours cost surprisingly less!

### We cut the price. Not the quality.

What you get is a precision crafted instrument that features single-chip LSI logic, as well as a laser trimmed resistor network. And a stable band-gap reference element ensures better long-term accuracy. Basic DCV accuracy is 0.1%. The Model 2035A gives you 32 measurement ranges and 6 functions. The Model 2037A has an additional temperature measurement function and comes complete with a sensor probe.

### First in features. First in price.

Both models feature touch-and-hold capability with the optional probe — it's so convenient, you'll wonder why the expensive models don't have it yet! And two-terminal input for all measurement functions — this eliminates lead switching and makes your job easier.

Of course, auto zero, auto polarity and overload protection are standard. And you get 200 hour operation from a single 9V transistor battery. A low battery indicator warns you of the last 20% of battery life. And the big, sharp LCD readouts allow easy viewing in bright sunshine or low ambient light. Built-in calibration references let you calibrate the unit any time, any place.

You can buy Sabtronics multimeters assembled or in kit form with simple step-by-step instructions.

### Why the low price?

We sell what we manufacture, directly to you.

Send in the coupon and order your new digital multimeters now. Credit card holders may call.

**BRIEF SPECIFICATIONS**  
 DC Volts: 100 $\mu$ V to 1000V, 5 ranges;  
 AC Volts: 100 $\mu$ V to 1000V, 5 ranges;  
 DC Current: 0.1 $\mu$ A to 2A, 5 ranges;  
 AC Current: 0.1 $\mu$ A to 2A, 5 ranges;  
 Hi-Ohms: 0.1 $\Omega$  to 20M $\Omega$ , 6 ranges;  
 Lo-Ohms: 0.1 $\Omega$  to 20M $\Omega$ , 6 ranges;  
 Temperature: -50 $^{\circ}$ C to +150 $^{\circ}$ C (-58 $^{\circ}$ F to +302 $^{\circ}$ F), 2 ranges (Model 2037A only);  
 Dimensions: 3 $\frac{1}{2}$ " wide X 6 $\frac{3}{4}$ " long X 1 $\frac{1}{8}$ " deep (89 X 171 X 36mm);  
 Weight: 11 oz. (excl. battery);  
 Overload Protection: 1000V DC or AC peak all voltage ranges, 250V DC or AC peak all Ohms ranges, 2A/250V fuse all current ranges.

Making Performance Affordable

**sabtronics** INTERNATIONAL INC.

Sabtronics International, Inc., 5709 N. 50th Street, Tampa, FL 33610, (813) 623-2631

Please send me the following.

|  |          |
|--|----------|
| _____ Model 2035A Hand-held Multimeter kit(s) @ \$74 95 each         | \$ _____ |
| _____ Model 2035A Hand-held Multimeter(s), assembled @ \$99 95 each  | \$ _____ |
| _____ Model 2037A Hand-held Multimeter kit(s) @ \$99 95 each         | \$ _____ |
| _____ Model 2037A Hand-held Multimeter(s), assembled @ \$119 95 each | \$ _____ |
| _____ THP-20 Touch-and-Hold Probe(s) @ \$19 95 each                  | \$ _____ |
| Shipping and handling @ \$5 00 per instrument*                       | \$ _____ |
| For delivery in Florida, add 4% Sales Tax                            | \$ _____ |
| 10% deposit for C.O.D. orders  | \$ _____ |

I enclose  check  money order (Allow 2 to 3 weeks for personal checks to clear)

Charge:  Visa  Master Charge

Account No \_\_\_\_\_ Exp Date \_\_\_\_\_

Name \_\_\_\_\_

Address \_\_\_\_\_

City \_\_\_\_\_ State \_\_\_\_\_ ZIP \_\_\_\_\_

\*Continental U.S. only. AK, HI, & PR \$6 00 Canada \$7 50, overseas air mail \$21 00



## Keep the Public Airwaves Public

The so called public airways are covered by a complex set of rules and regulations governing transmissions. Albeit perhaps too complex, those rules and regulations are needed to insure the continued usefulness of the airways as a medium for the exchange of information. The rules and regulations governing the **reception** of information-bearing signals in the U.S. have been virtually non-existent. Then came subscription TV.

Here, a television station broadcasts **encoded** program material that is viewed on a standard TV set. When a prospective viewer signs up for the subscription TV service, he gets a decoder that is attached to his TV set. The subscription fee is usually on a monthly basis; it's like single-channel cable TV without the "cable."

Subscription TV has already created a black market for the decoders. The decoders are being sold out of basements, garages, and the like. That has prompted the subscription-TV companies to prosecute the sellers of the decoders in the courts.

Many electronics people feel that it should be legal to sell the decoders. After all, the subscription-TV companies are using the public airways to broadcast their signals and the public has the right to receive and decode those broadcasts. We agree with that point of view. The broadcast license granted by the FCC does not give the subscription-TV companies a monopoly over the reception of its signals. Fortunately, recent court decisions uphold that point of view. To grant such control and make **reception** illegal would set a precedent that would have far-reaching effects, especially in a democracy.

There is, however, another point to consider—theft of service. The subscription-TV companies are providing a service and using that service without paying for it *is* theft. The decoders should be sold freely on the open market and anyone wishing to buy or build such a decoder should have the freedom to do so. However, arrangements should be made between the viewers and the subscription-TV companies to pay for the use of the service.

Let's keep the public airwaves public.



**ART KLEIMAN**  
Managing Editor

## Radio-Electronics®

Hugo Gernsback (1884-1967) founder  
M. Harvey Gernsback, editor-in-chief  
Larry Steckler, CET, publisher  
Arthur Kleiman, managing editor  
Josef Bernard, K2HUF, technical editor  
Jack Darr, CET service editor  
Leonard Feldman  
    contributing high-fidelity editor  
Karl Savon, semiconductor editor  
Herb Freidman, communications editor  
Gary H. Arlen, contributing editor  
David Lachenbruch, contributing editor  
Earl "Doc" Savage, K4SDS, hobby editor  
Ruby Yee, production manager  
Robert A. W. Lowndes, production  
    associate  
Joan Burwick, production assistant  
Gabriele Margules, circulation director  
Arline R. Fishman,  
    advertising coordinator

Cover photo courtesy Chrysler Corporation

Radio-Electronics is indexed in *Applied Science & Technology Index* and *Readers Guide to Periodical Literature*.

Gernsback Publications, Inc.  
200 Park Ave. S., New York, NY 10003  
President: M. Harvey Gernsback  
Vice President: Larry Steckler  
Secretary/Treasurer: Carol A. Gernsback

### ADVERTISING SALES 212-777-6400

Larry Steckler  
Publisher

### EAST

Stanley Levitan  
Radio-Electronics  
200 Park Ave. South  
New York, NY 10003  
212-777-6400

### MIDWEST/Texas/Arkansas/Okla.

Ralph Bergen  
The Ralph Bergen Co.  
540 Frontage Road—Suite 361-A  
Northfield, Illinois 60093  
312-446-1444

### PACIFIC COAST Mountain States

Jay Eisenberg  
J.E. Publishers Representative Co.,  
8732 Sunset Blvd.,  
4th Floor,  
Los Angeles, CA 90069  
213-659-3810  
San Francisco, CA 94124  
415-864-3252

### SOUTHEAST

Paul McGinnis  
Paul McGinnis Company  
60 East 42nd Street  
New York, N.Y. 10017  
212-490-1021





# DISCWASHER D4 SYSTEM



# A NEW STANDARD OF RECORD CARE

## **NEW D4 FLUID**

Inherently more active against record contamination. Inherently safe for record vinyl. Preferentially absorptive formula carries all contamination off the record.

## **NEW D4 FABRIC**

Unique directional fibers preferentially remove fluid and contamination. D4 fabric results in clearly better cleaning, better drying and ultimately residue-free surfaces.

## **UNMATCHED VALUE**

The Discwasher D4 System is enhanced by the durability and aesthetics of the hand-finished walnut handle. Included in the D4 System are the DC-1 Pad Cleaner and new instructions.

**discwasher**<sup>®</sup>  
PRODUCTS TO CARE FOR YOUR MUSIC

Discwasher, Inc., 1407 N. Providence Rd., Columbia, MO 65201

CIRCLE 49 ON FREE INFORMATION CARD

# You gotta shop around.

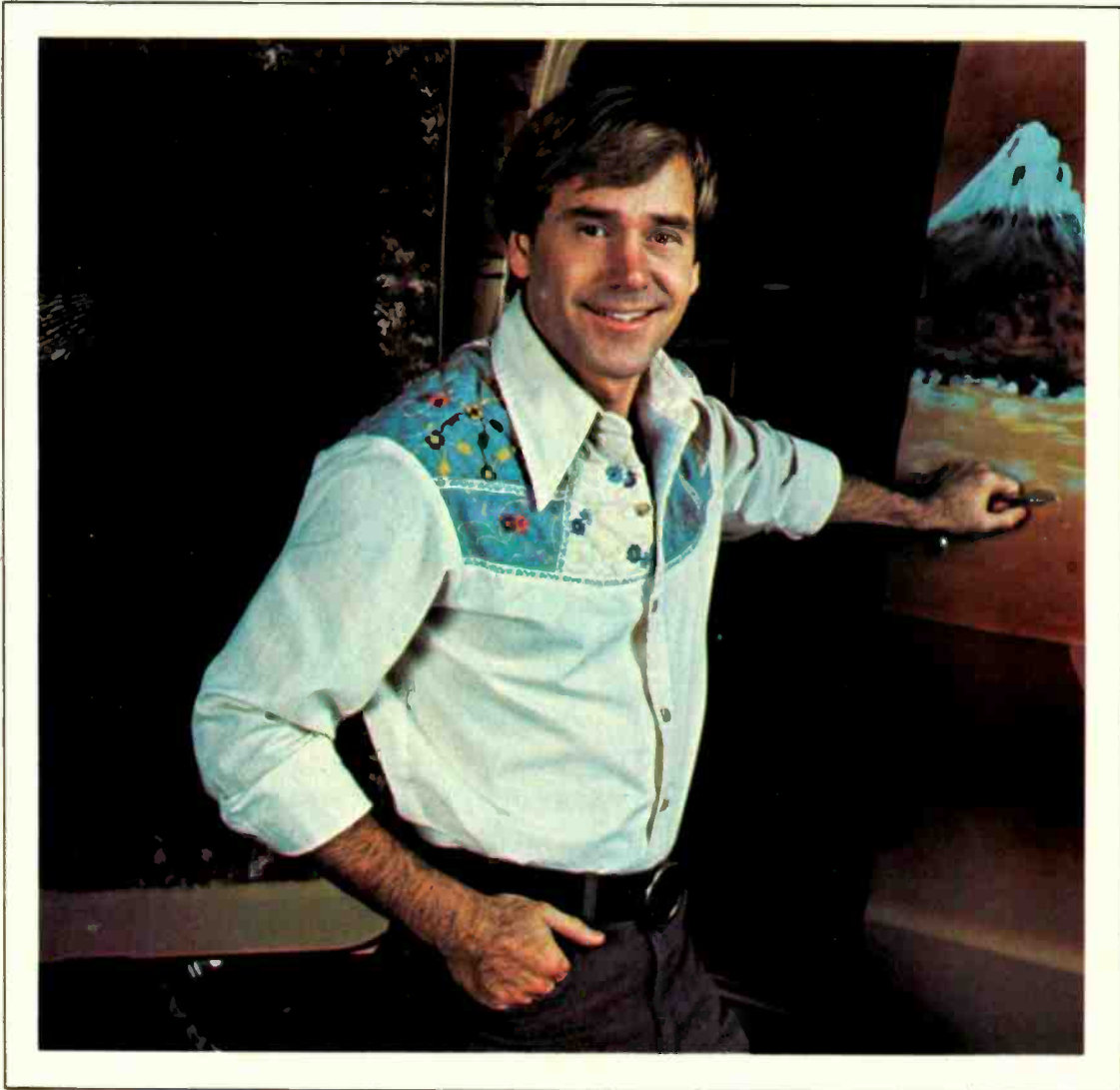

**When you do, you'll probably pick CIE.  
You can't afford to settle for  
less when it comes to something like  
electronics training that could  
affect your whole life.**

**W**hen you shop around for tires, you look for a bargain. After all, if it's the same brand, better price—why not save money?

Education's different. There's no such thing as "same brand!" No two schools are alike. And, once you've made your choice, the training you get stays with you for the rest of your life.

So, shop around for your training. Not for the bargain. For the best. Thorough, professional training to help give you pride and confidence.

\* \* \*

If you talked to some of our graduates, chances are you'd find a lot of them shopped around for their training. They pretty much knew what was available. And they picked CIE as number one.

### Why you should shop around yourself.

We hope you'll shop around. Because, frankly, CIE isn't for everyone.

There are other options for the hobbyist. If you're the ambitious type—with serious career goals in electronics—take a close look at what we've planned for you at CIE.

### What you should look for first.

Part of what makes electronics so interesting is it's based on scientific discoveries—on ideas! So the first thing to look for is a program that starts with ideas and builds on them!

That's what happens with CIE's Auto-Programmed® Lessons. Each lesson takes one or two principles and helps you master them—before you start using them!

### How practical is the training?

This is the next big important question. After all, your career will be built on what you can do—and on how well you do it.

Here are ways some of CIE's troubleshooting programs help you get your "hands-on" training...

**With CIE's Personal Training Laboratory...**

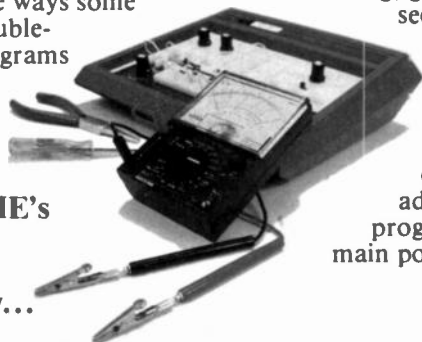

you learn and review the basics—perform dozens of experiments. Plus, you use a 3-in-1 precision Multimeter to learn testing, checking, analyzing!



**When you build your own 5 MHz Triggered-Sweep, Solid-State Oscilloscope** you take your first real professional step. You use it as a doctor uses an X-ray machine—to "read" waveform patterns... lock them in...study, understand and interpret them!

**When you get your Digital Learning Laboratory** you'll be into digital theory—essential training today for anyone

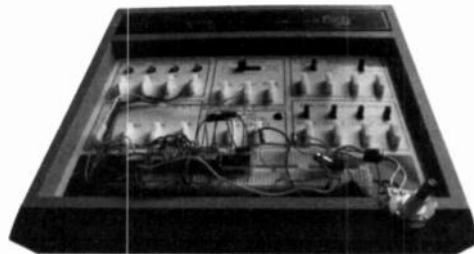

who wants to keep pace with the state of the art of electronics in the eighties. With CIE's Digital Lab, you'll be applying in dozens of fascinating ways the theory you've learned. For example, you'll compare analog and digital devices. You'll learn to make binary to decimal conversions and to work with semiconductor devices and circuits. You'll see how digital equipment is vital in today's exciting, growing fields such as security where digital theory provides the brains for space-age alarm and protective devices.

Of course, CIE offers even more advanced training programs, too. But the main point is simply this:

All this training takes effort. But you'll enjoy it. And it's a real plus for a troubleshooting career!

### Do you prepare for your FCC License?

Avoid regrets later. Check this out before you enroll in any program.

More than half of CIE's courses prepare you for the government-administered FCC License exam. In continuing surveys, nearly 4 out of 5 CIE graduates who take the exam get their Licenses!

### Associate Degree

Now, CIE offers an Associate in Applied Science Degree in Electronics Engineering Technology. In fact, all or most of every CIE Career Course is directly creditable towards the Associate Degree.

### Shop around...but send for CIE's free school catalog first!

Mail the card. If it's gone, cut out and mail the coupon. If you prefer to write, mention the name and date of this magazine. We'll send you a copy of CIE's FREE school catalog—plus a complete package of independent home study information! For your convenience, we'll try to have a representative contact you to answer your questions. Mail the card or coupon—or write:  
CIE, 1776 East 17th St.,  
Cleveland, OH 44114.



**YES...** I'm shopping around for the right kind of career training in electronics troubleshooting — and CIE sounds well worth looking into. Please send me my FREE CIE school catalog — including details about the Associate Degree program — plus my FREE package of home study information!

Print Name \_\_\_\_\_

Address \_\_\_\_\_ Apt. \_\_\_\_\_

City \_\_\_\_\_

State \_\_\_\_\_ Zip \_\_\_\_\_

Age \_\_\_\_\_ Phone \_\_\_\_\_  
(area code)

Check box for G.I. Bill information:  
 Veteran  Active Duty

**Mail today!** RE-02

## INTERCITY PAGING



Personal paging via satellite—envisioned by science-fiction writers and “Dick Tracy” comic strips—has begun between New York and Chicago, with messages beamed via a Westar circuit. The venture is called “Sat Alert,” and it was created by Rogers Aircall, a Chicago paging company which handles the connection in that city. Travelers in New York and Chicago can be “beeped” even during out-of-town trips as the satellite constantly links the paging systems in the two cities.

The New York-Chicago link is envisioned as the first phase of a national radio-paging communications system which will be in place within several years.

## SATELLITE PIRACY

An amendment which would have prohibited private reception of satellite signals has been dropped from pending Communications Act legislation. Intense lobbying by equipment manufacturers and private earth-station users is credited for making Congressmen change their minds about the proposed amendment—although there is still the possibility that it may be reintroduced in the future.

Led by the new SPACE association, which looks after the interests of private-terminal users, opponents of the law said it could hamper development of satellite technology and might even impede development of direct-to-home broadcast plans. The actual Capitol Hill maneuvering for the legislation was complicated, and the anti-piracy amendment was shuttled between various bills in the waning days of this year’s Congressional session.

## STILL MORE PROGRAMMING

Despite a constant threat that satellite space for TV programming will soon dry up, more shows are constantly taking to the skies—and still others are being planned. One indicator of how busy the skies will be this year is the recent announcement from Western Union that almost all Westar time is booked for fall and winter. That means little or no time will be available for individual events; independent TV stations will be especially hard hit by such a situation since much of their seasonal sports coverage (especially basketball and hockey) would have to return to terrestrial transmission.

Meanwhile, on cable-TV services, there’s a new load of programming—and, coincidentally, much of it is sports-oriented. ESPN is now in 24-hour service every day of the week. USA Network has introduced two new sports series: SportsProbe and Sports Scene. And Modern Satellite Network has begun carrying a weekly football show on Saturday mornings, with highlights of week’s games.

Video Sports Network is using time on Satcom I Transponder 16 to carry a 22-game series of Auburn and Mississippi University football games (on a delayed basis) this fall.

All-movie channel Premiere is still slated to begin service in January 1981, although the transponder and satellite assignments still hadn’t been made as we went to press. And Premiere still faces a challenge in the form of a legal antitrust suit, which could postpone or cancel its plans for first-run movie presentations.

In addition, Satori begins its seventh season of “Celebrity” magazine, carried on Satellite Program Network aboard Satcom I. The “Home Shopping Show” a marketing-via-catalog type program, is also being offered by Modern Satellite Network, and GalaVision Spanish-language pay TV is presenting an award-winning Brazilian-made dramatic series, “Malu Mujer.”

## AROUND THE SATELLITE CIRCUIT

- Five more international satellites will be going up during the coming years thanks to a recent decision by Intelsat; each bird will have a capacity of about 15,000 circuits—and much of the service will be used for hopping signals around within member nations. That means, countries which don’t have their own domestic satellites will use the Intelsat birds to beam signals (mostly voice, but also likely to include some TV programming) to distant cities. The new Intelsat satellites will be Ford Aerospace high-powered vehicles, with more details about placement and use expected in coming months.

- Even Congress agrees that satellites pose the most promising segment of the communications revolution. In a proposal for future Federal policies, Capitol Hill’s Office of Technology Assessment envisions a “trend” toward more satellite activity and a new industry structure. Among the interesting ripple effects of that shifting communications technology will be “the creation of a new . . . vocabulary” for dealing with all the changes.

- Comstar D4 is now slated for launch in December, two months earlier than originally planned. Comsat General, which will launch and operate the satellite, wants to have the bird in orbit for checkout prior to the Spring eclipse season, which will put a strain on batteries aboard existing Comtar satellites.

GARY H. ARLEN  
CONTRIBUTING EDITOR

# YOU'VE SEEN THE REST... NOW LOOK AT THE BEST!



EZ 6200  
\$100



EZ 6100  
\$135

**EZ 6100**  
DCV 0-1000 5-Autoranges  
ACV 0-600 4-Autoranges  
DCMA 0-200 2-Ranges  
ACMA 0-200 2-Ranges  
Ω 0-2000K Ω 5-Autoranges  
Low Power Ω 0-2000K Ω  
4-Autoranges  
Plus Continuity Buzzer

**EZ 6200**  
DCV 0-1000 5-Autoranges  
ACV 0-600 4-Autoranges  
DCMA 0-200 1-Range  
ACMA 0-200 1-Range  
Ω 0-2000K Ω 5-Autoranges  
Low Power Ω 0-2000K Ω  
4-Autoranges

Free \$20 case.  
Offer good through  
December 31, 1980.

## PRESENTING EASY-METER™ UNPRECEDENTED FIVE-YEAR WARRANTY PLUS FREE \$20 CASE OFFER.

- Autoranging on Volts and Ohms
- Easy reading 3½ digit display
- CMOS—LSI advanced circuitry
- Autopolarity
- Automatic indication, unit and signs
- Easy to operate
- Economically powered with two "AA" 1.5V batteries
- Low battery drain, 200 hours continuous operation
- Low battery warning sign
- Lo Power and Normal Ohm ranges
- Range hold

- Buzzer continuity check
- Zero adjust feather-touch button
- AC/DC -Lo Ω/Ω function selection by feather-touch button
- Safety fused
- Pocket-size, compact, lightweight, nicely balanced
- Shock resistant ABS housing
- Reliable, accurate, and rugged

See your A.W. Sperry distributor today,  
or call A.W. Sperry Instruments Inc.  
516-231-7050.

**A.W. SPERRY INSTRUMENTS INC.**  
**The Measurable Advantage.**

CIRCLE 61 ON FREE INFORMATION CARD



### New Portable Digital Capacitance Meter



Call For Our Price

#### MODEL 820

- Measures capacitance from 0.1 pF to 1 Farad
- Resolves to 0.1 pF
- 10 ranges for accuracy and resolution
- 4 digit easy-to-read LED display
- 0.5% accuracy
- Special lead insertion jacks or banana jacks
- Fuse protected
- Uses either rechargeable or disposable batteries
- Overrange indication

### FLUKE DIGITAL MULTIMETERS

#### Model 8022A: The Troubleshooter

\$139

- Six functions
- 3 1/2-digit resolution
- 0.25% basic dc accuracy
- LCD display
- Overload protection

#### Model 8020A: The Analyst

\$179

#### Model 8024A: The Investigator

\$219



NEW

#### • Seven functions

- dc voltage
- ac voltage
- dc current
- ac current
- resistance
- diode test
- conductance (1/R)
- 3 1/2-digit resolution
- 0.1% basic dc accuracy
- LCD display
- Overload protection
- Free case
- Two year parts and labor warranty

#### • Nine functions

- dc voltage
- ac voltage
- dc current
- ac current
- resistance
- diode test
- conductance (1/R)
- logic level and continuity detect
- temperature (K-type thermocouple)
- Peak hold on voltage and current functions
- Selectable audible indicator for continuity or level detection
- 3 1/2-digit resolution
- 0.1% basic dc accuracy
- LCD display
- Overload protection

### DATA PRECISION Model 938 0.1%, 3 1/2-Digit, LCD DIGITAL CAPACITANCE METER



X-Mas Special \$149 reg. \$179

- WIDE RANGING — from 199.9 pF full scale (0.1 pF resolution) up to 1999  $\mu$ F full scale, in eight ranges, virtually every capacitance you'll ever need to measure
- FAST AND EASY TO USE — Direct reading, pushbutton ranges. Just plug in and read.
- EXCEPTIONALLY ACCURATE — provides  $\pm$ 0.1% basic accuracy
- TOUGH AND COMPACT — Built to take rough usage without loss of calibration accuracy. Fits and goes anywhere; takes very little bench space; always handy for quick capacitance checkout, matching, calibration, and tracking
- PORTABLE — Palm-sized, light-weight, operates up to approximately 200 hours on a single 9V alkaline battery
- EASY READING — big, clear, high-contrast 3 1/2-digit LCD display, a full 0.5" high, readable anywhere.
- VALUE PACKED — Outstanding measurement capability and dependability. Outperforms DC time-constant meters, and even bridges costing 2 to 5 times as much
- RELIABLE — warranted for 2 full years



### LX304 DIGITAL MULTIMETER

FAST, EASY, ONE HAND OPERATION



AVAILABLE NOW \$89<sup>95</sup>

### New Low Distortion Function Generator



Call For Our Price

#### MODEL 3010

- Generates sine, square and triangle waveforms
- Variable amplitude and fixed TTL square-wave outputs
- 0.1 Hz to 1MHz in six ranges
- Push button range and function selection
- Typical sine wave distortion under 0.5% from 0.1Hz to 100kHz
- Variable DC offset for engineering applications
- VCO external input for sweep-frequency tests

### New Sweep/Function Generator



Call For Our Price

#### MODEL 3020

- Four instruments in one package—sweep generator, function generator, pulse generator, tone-burst generator
- Covers 0.02Hz-2MHz
- 1000:1 tuning range
- Low-distortion high-accuracy outputs
- Three-step attenuator plus vernier control
- Internal linear and log sweeps
- Tone-burst output is front-panel or externally programmable

Simpson

**BK PRECISION**

**LEADER**

**DORIC**



Non-Linear Systems

**WESTON**



**DATA PRECISION**

**PORTABLE OSCILLOSCOPES**  
BATTERY OPERATED

MS-15



Single Trace 15MHz



Non-Linear Systems

Call For Our Prices

MS-215



Dual Trace 15 MHz

MS-230



Dual Trace 30MHz

THESE 1980 B&K OSCILLOSCOPES  
ARE IN STOCK AND AVAILABLE  
FOR IMMEDIATE DELIVERY



**BK PRECISION**

- 1479A Dual-Trace 30 MHz
- 1477 Dual-Trace 15 MHz
- 1432 Dual-Trace 15 MHz Portable
- 1476 Dual-Trace 10 MHz
- 1466 Single-Trace 10 MHz
- 1405 Single-Trace 5 MHz

CALL FOR OUR  
EARLY BIRD SPECIAL LOW PRICE



**KEITHLEY MODEL 130  
DIGITAL MULTIMETER**

|            | RANGE                         | ACCURACY |
|------------|-------------------------------|----------|
| DC VOLTAGE | 200mV, 2V, 20V, 200V, 1000V   | .5%      |
| AC VOLTAGE | 200mV, 2V, 20V, 200V, 750V    | 1%       |
| DC CURRENT | 2mA, 20mA, 200mA, 2000mA, 10A | 2%       |
| AC CURRENT | 2mA, 20mA, 200mA, 2000mA, 10A | 3%       |
| RESISTANCE | 200Ω, 2kΩ, 20kΩ, 200kΩ, 20MΩ  | .5%      |

**NEW**  
**\$109**



**HITACHI**

- V-151B 15 MHz Single Trace
- V-152B 15 MHz Dual Trace
- V-301B 30 MHz Single Trace
- V-302B 30 MHz Dual Trace
- V-550B 50 MHz Dual Trace,  
Dual Time Base

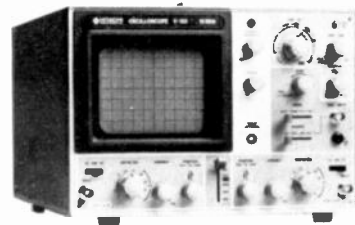

Call For  
Special Intro  
Price Offer

**80MHz Counter with Period Function**

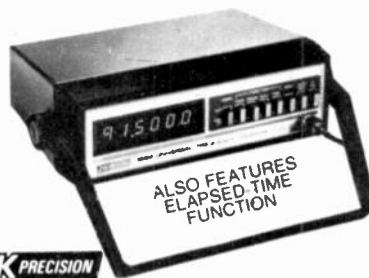

MODEL 1820

- 5Hz to 80MHz reading guaranteed—100MHz typical
- Period measurements from 5Hz to 1MHz
- Period average, auto and manual positions
- One PPM resolution
- Totalizes to 999999 plus overflow
- Elapsed time measurements from 01 to 9999 99 seconds plus overflow
- One-megohm input resistance
- Bright 43 high LED readouts

Call For Our Price



THE TEST EQUIPMENT SPECIALISTS  
TOLL FREE HOT LINE  
**800-223-0474**

54 WEST 45th STREET, NEW YORK, N.Y. 10036 212-687-2224

**ADVANCE ELECTRONICS**



# letters

## COMMUNICATIONS RECEIVERS

In regard to Mr. Friedman's comments on communications receivers ("Communications Corner," R-E, June 1980), he must be a lot younger than I thought. While it is true that the Collins S-line receivers were the first SSB receivers of merit, the 51-J series Collins receivers were the pioneer units in the HF receiver field.

The 51-J-1, 2, 3, and 4 series had a tunable PTO (Permeability Tuned Oscillator), a crystal-controlled conversion oscillator, as well as a tunable crystal filter having several degrees of selectivity.

The mechanical filter did not replace the crystal filter or the tunable IF. It was an advance in the state of the art for the enhancement of IF selectivity. It provided (for the first time) extremely steep IF skirt selectivity. The mechanical filter minimized adjacent channel interference but did nothing for heterodynes or other QRM in the passband. The Collins 51-J-4 was the first HF receiver to use mechanical filters, although the J-3 series could be retrofitted with the three filters in use at that time: 1, 3, and 6 kHz.

I was privileged to use Collins serial number 1 of the 51-J-1 series, as well as many of its successors. Even though they were all tube-type, as was the early S-line series, they were exceptionally stable in regard to frequency drifts, and a fantastic improvement over any other receiver of that or subsequent periods, up to the introduction of quality, solid-state receivers.

DONALD R. GREENWOOD,  
Grants Pass, OR

*Ah, yes. The 51-J series—a magnificent receiver, but also a boat anchor. Actually, the last of the boat anchors. The fact is, I used a tunable crystal filter on my first "good" receiver, a pre-WWII Hammarlund HQ-120. (I think it was the 120; things get a little hazy through the years.)*

*The advantage of the S-line over the 51-J series was simply that the S-line was virtually all new technology, or modern applications of older technologies. The 51-J series was essentially the best to that date, done as well as was possible; but with the exception of the PTO, it wasn't really modern. Probably we could debate that point fore-*

*er, and since we both used the same receivers, we'd probably enjoy reminiscing about "gold-plated receivers."*

HERB FRIEDMAN  
Communications Editor

*Herb Friedman and Don Greenwood are either younger than I thought or have reached the age where the passing of time has blurred their memories. The 51-J-4 was not the first receiver in the Collins line that incorporated a mechanical filter. In 1951/52, Collins supplied a kit so the owner could retrofit the 75-A-2 with a mechanical filter. The 75-A-3 was the first to come off the production line with a mechanical filter as a standard feature.*

*The 75-A-4 is considered, by many who have used it, to be one of the best amateur-band receivers ever made. Given a few minutes to warm up, the 75-A-4's stability is as good as many solid-state sets used by amateurs today. When the going gets rough, and you have a CB'er next door—or a couple of strong locals on the band—it takes the superior overload-immunity of a tube set such as the 75-A-4 (or Drake 2-B)*

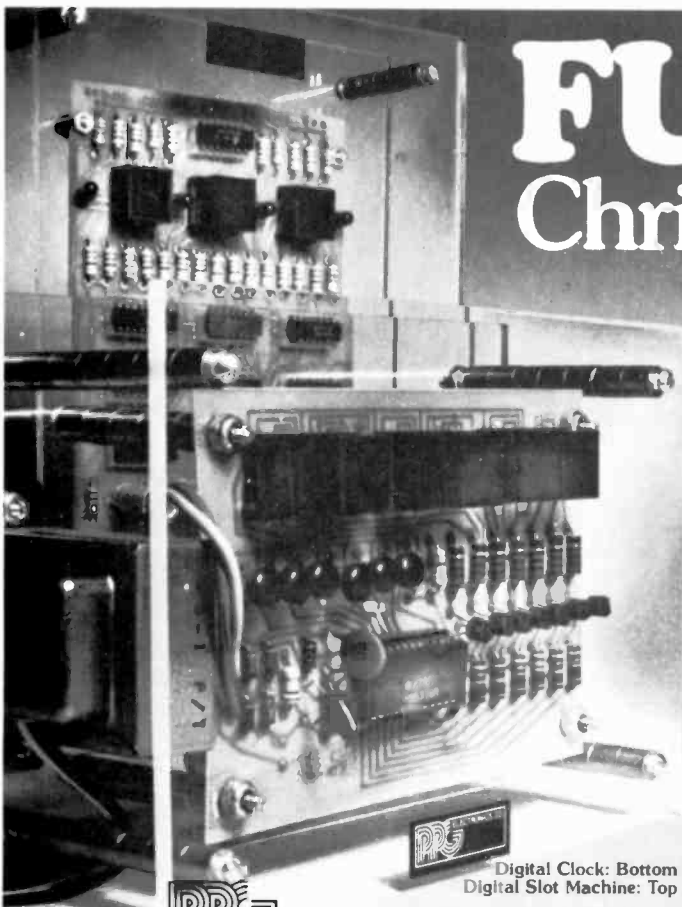

# FUN KITS! Christmas Specials!

Discover a whole new world of electronic fun and excitement! Here are just three of the 49 useful and low-cost electronic kits you'll find in PPG Electronic's latest kit catalog.

### LOGIC PROBE \$15.95 (Model No. 805)

Find out what's happening in your digital logic circuitry! This new digital logic probe kit takes only a few minutes to build, yet gives readings of professional quality. Long, slim body makes the probe ideal for crowded circuits. Works with TTL and CMOS circuitry. Powered by circuit under test. A bargain at the price! Time to build: ½ hour.

### DIGITAL CLOCK \$39.95 (Model No. 876)

Here's a clock you'll be proud to build. 6 large ½" numbers show hours, minutes and seconds. Great for office, den or shop. Features separate switches for setting minutes and seconds, plus hold switch for perfect synchronization. 110V AC. An ideal Christmas gift! Time to build: 2 hours.

### DIGITAL SLOT MACHINE \$39.95 (Model No. 866)

Works like a Las Vegas slot machine. 3 LED readouts rotate, stop one at a time, then four LED flashers blink, if you're a winner! A beautiful kit! A unique conversation piece! Time to build: 2 hours.

### SATISFACTION GUARANTEED

All parts sold by us in kit form are fully guaranteed and are replaced FREE, if they are ruined during construction, for whatever reason.

### SPECIAL 3-KIT OFFER! Only \$89.95

As a special Christmas bonus (good through December 31, 1980), you may purchase all three kits for the low price of only \$89.95. Order now to avoid the Christmas rush!

Logic Probe

Digital Clock: Bottom  
Digital Slot Machine: Top



PPG ELECTRONICS CO., INC.  
14663 Lanark St., Van Nuys, CA 91402 • (213) 988-3525

California residents add 6% sales tax. FREE catalog shipped with order. For catalog only send \$1.00.

Americard accepted. Add \$1.50 shipping charge to order.

TO ORDER: Call (213)

988-3525 or write directly

to PPG, Mastercharge, VISA, Bank

Americard accepted. Add \$1.50 shipping charge to order.

CIRCLE 20 ON FREE INFORMATION CARD



to give you 100 percent copy.

If you think that your solid-state receiver is the best yet, borrow a 75-A-4 or a Drake 2-B, and test it alongside your rig on the operating desk. You'll soon find out that "later isn't always better."

BOB SCOTT, W2PWG  
Technical Editor (retired)

### MUSIC ON HOLD

I read the article that Bruce L. Mackey had in your June 1980 issue about "Music on Hold," by Jules Gilder.

Mr. Mackey is right: the device will not work if the voltage polarity reverses. When I built the device, I had the same problem, but eliminated it by adding a bridge rectifier.

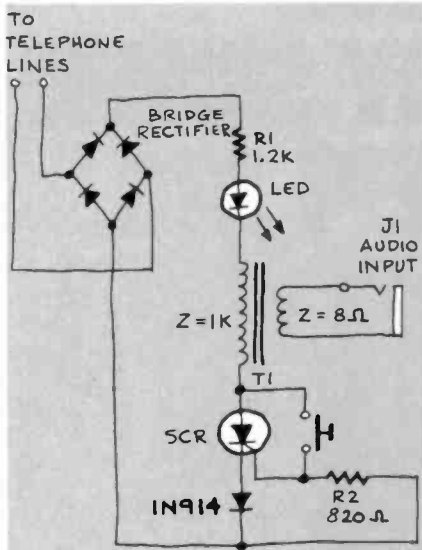

You need not change the device otherwise, to have music on hold. Just install the bridge rectifier as shown in the diagram, and everything will work fine.

J. R. GILMOOR  
Netherlands Antilles

### WIDE-RANGE AUDIO GENERATOR

Regarding your "Wide-Range Audio Generator" feature (May, 1980): my compliments on an excellent project. I built the generator for about \$25, plus my junk-box parts, and I feel that it would be hard to equal its performance with any commercial equipment costing less than \$100-\$150.

However, I noticed a few minor mistakes in the article:

1. Polarity of C9 is backwards on schematic (Figure 2).
2. HF and LF limit-trimmer pot labels are reversed on parts-placement diagram (Figure 4).
3. In the parts list: R34, 22 ohms is missing; D1, D2 read 0.1 volts—that should be 5.1 volts, and with the knobs, the "or" should be changed to "and."

I made a few changes from the published plans. Mounting the board horizontally instead of vertically allowed me to use the next size smaller Radio Shack case (No. 270-252). I recommend using a linear taper pot for R5 (fine-frequency control) as the audio taper pot specified put all the charge at one end of rotation. I was unable to find an MPF-102 FET, so substituted a 2N3819 (Radio Shack No. 276-2035); the results were good. I also changed R2 from a 2.2

megohms to 1.0 megohms to give the fine-frequency control a bit more range (about 300 Hz).

Please ask Richard Schroeder to send you some more construction articles.

PAUL E. PENNINGTON  
Martinez, GA.

### CABLE TV

I agree with you in regard to "Ma Bell and Cable TV" (your editorial in the August issue), but in some respects, I disagree.

In principle, you're quite correct in suggesting that cable TV be bound by the same precepts as "Ma Bell." In practice—well, that's something else.

"Ma Bell" is gigantic. It's well established. It has grown stepwise over a 100-year period. It is highly diversified and has

little or no competition in most markets.

On the other hand, cable TV is composed of hundreds of small firms. Little guys. Companies often locally owned. In larger cities, the cable TV competition is stiff, several firms competing for the same business. In addition, cable TV had to spring up "full-grown"—no time to start small. It had to plunge deeply and quickly into the market as fast as possible. No time gradually to plow back revenues to obtain further growth. Hence, cable TV is more highly capitalized relative to its young life.

Cable TV needs to be allowed to re-coup its investment; it needs incentive to encourage entry into the market and to grow. "Ma Bell" does not.

A. C. ACTON  
Midland, MI

R-E

**HOBBY-BLOX™**  
The modular, circuit building system for electronic hobbyists.

**Be careful. Your hobby is about to become an obsession.**

The 14 modular units in the solderless, Hobby-Blox™ system are color-coded and cross-indexed. Projects go faster, easier.

For the beginner, there are two starter packs. One for integrated circuits, one for discrete components. Each has its own 10 project booklet.

Once you get into Hobby-Blox, look out. You're going to get hooked.

For a free catalog and the name of your nearest Hobby-Blox dealer, call Toll Free 800 321-9668. In Ohio call collect (216) 354-2101.

Patents Pending.  
©A.P. PRODUCTS INCORPORATED 1980

**AP** A.P. PRODUCTS INCORPORATED  
9450 Pineneedle Drive  
P.O. Box 603  
Mentor, Ohio 44060  
(216) 354-2101  
TWX: 810-425-2250  
In Europe, contact A.P. PRODUCTS GmbH  
Bäumlesweg 21 • D-7031 Weil 1 • W. Germany

Free Project-of-the-Month to Hobby-Blox purchasers!  
CIRCLE 9 ON FREE INFORMATION CARD

**THESE ARE NOT  
HOME-MADE TRAINING DEVICES.  
THESE ARE PRODUCTION MODEL  
MICRO-SYSTEMS.  
NO OTHER HOME STUDY SCHOOL  
OFFERS THEM EXCEPT NTS.**



1.



2.



3.

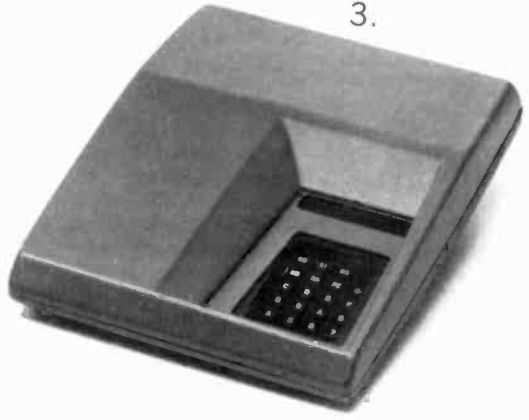



2-Meter FM Transceiver

# IN FACT, NTS ELECTRONICS PROGRAMS INCLUDE THE WIDEST ARRAY OF SOLID-STATE AND DIGITAL EQUIPMENT EVER OFFERED BY ANY HOME STUDY SCHOOL.

Now, for the first time, you can learn all about microcomputers by working with your own production model at home. We'll explain the principles of troubleshooting and testing this remarkable instrument and, best of all, we'll show you how to program it to do what you want.

It's the perfect opportunity for you to learn BASIC high level language programming and assembly language programming.

Then, to learn how to localize microcomputer problems and solve them, you'll experiment and test with a digital multimeter and other testing gear.

But most important, you get to assemble and work with today's most sophisticated microcomputers, not home-made training devices. We believe this makes learning a lot more relevant and exciting.

In fact, production-model equipment is featured in all NTS electronics programs.

Our Color TV servicing program boasts the NTS/HEATH digital color TV (25" diagonal) you actually build and keep.

In Communications Electronics you'll build and keep an NTS/HEATH 2-meter FM transceiver, along with digital multimeter and service trainer.

Whichever NTS electronics program you choose, you can count on working with much the same kind of equipment you'll encounter in the field.

Find out more in our full color catalog on the program of your choice.

NTS also offers course in Auto Mechanics, Air Conditioning and Home Appliances. Check card for more information.

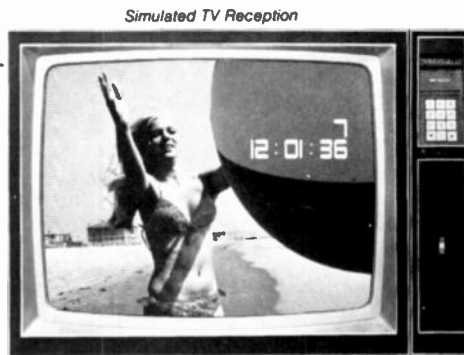

Simulated TV Reception



Digital Multimeter

1. The NTS/HEATH H-89 Microcomputer features floppy disk storage, "smart" video terminal, two Z80 microprocessors, 16K RAM memory, expandable to 48K. Available in NTS's Master Course in Microcomputers.
2. The NTS/Rockwell AIM 65 Microcomputer A single board unit featuring an on-board 20 column alphanumeric printer with 20 character display. A 6502-based unit 4K RAM, expandable. Available in NTS's Microprocessor Technology Course.
3. The NTS/KIM-1 Microcomputer A single board unit featuring a 6 digit LED display with an on-board 24 key hexadecimal calculator-type keyboard. A 6502 based microcomputer with 1K of RAM memory, expandable. Available in NTS's Master Course in Electronic and Industrial Technology.

NO OBLIGATION. NO SALESMAN WILL CALL.  
APPROVED FOR VETERAN TRAINING.

**NTS NATIONAL TECHNICAL SCHOOLS**  
TECHNICAL TRADE TRAINING SINCE 1905  
Resident and Home-Study Schools  
4000 SO. FIGUEROA ST., LOS ANGELES, CA. 90037



**NATIONAL TECHNICAL SCHOOLS**

4000 South Figueroa Street, Dept. 206-111  
Los Angeles, California 90037

Please rush FREE color catalog on course checked below

- |   |   |
|---|---|
| <input type="checkbox"/> MicroComputers/MicroProcessors | <input type="checkbox"/> Auto Mechanics     |
| <input type="checkbox"/> Communications Electronics     | <input type="checkbox"/> Air Conditioning   |
| <input type="checkbox"/> Digital Electronics            | <input type="checkbox"/> Home Appliances    |
| <input type="checkbox"/> Industrial Technology          | <input type="checkbox"/> Color TV Servicing |

Name \_\_\_\_\_ Age \_\_\_\_\_

Address \_\_\_\_\_

Apt. \_\_\_\_\_ City \_\_\_\_\_

State \_\_\_\_\_ Zip \_\_\_\_\_

- Check if interested in G.I. information.  
 Check if interested ONLY in classroom training in Los Angeles.

# equipment reports

## Fluke Model 8050A DMM



CIRCLE 101 ON FREE INFORMATION CARD

IN THIS DAY OF EXOTIC TEST INSTRUMENTS there never seems to be an end to what can be accomplished in smaller and smaller packages. That fact is demonstrated by one of the slickest pieces of equipment to be placed on the market in a long time.

The Fluke 8050A Digital Multimeter (DMM) (John Fluke Mfg. Co., Inc., P.O. Box 43210, Mountlake Terrace, WA 98043) will

perform measurements that in the past may have required several different (and expensive) instruments. At first glance the unit looks like any other new digital voltmeter in a compact case. However, as one begins to look closer he suddenly finds that the 8050A will do things that may surprise him. As with all new technical equipment, it is urged that the prospective operator read and thoroughly understand the instruction manual before making use of the unit.

The 8050A uses a 4½-digit LCD to display the value of the function chosen by the eleven pushbuttons on the front panel. In addition to the usual numerals, the large LCD also is used to tell the operator that the unit is being used on a high-voltage circuit by displaying the letters "HV" following the numbers. Of course, the polarity is indicated by a plus or minus sign. There are other indicators provided. Those include "dB", "Rel", and a battery-test indication ("BT") in cases where the battery option has been added. There are nine functions and 39 ranges that cover just about every measurement you would require in normal servicing, experimentation, or in the laboratory.

Aside from the usual features found on any

good DMM, the Fluke 8050A includes some that may be unique in units of this size and price range. For instance, have you ever tried to measure decibels in a particular circuit only to discover that the source impedance was different from that for which your meter was calibrated? The problem can be solved by a series of calculations that will convert your readings into values which represent those in the actual circuit. The 8050A, however, solves the problem by offering sixteen standard impedances stored in its memory. The LCD displays the impedance you have selected. Those loads range from 8 ohms to 1200 ohms.

Have you ever needed to compare several resistors for matching purposes? The procedure can be quite time-consuming, to say the least. In the 8050A there is a feature that allows you to store in the instrument's memory the value you want to match, and the amount by which each resistor you check from that time on deviates from that value will be indicated on the LCD. For instance, you may want to match a 1,000 ohm resistor. After its value has been stored in the DMM's memory, another resistor may now give a reading of -1, and

*continued on page 36*

INTERNATIONAL FM-2400CH

## FREQUENCY METER FOR TESTING MOBILE TRANSMITTERS AND RECEIVERS

Portable • Solid State • Rechargeable Batteries

The FM-2400CH provides an accurate frequency standard for testing and adjustment of mobile transmitters and receivers at predetermined frequencies.

The FM-2400CH with its extended range covers 25 to 1000 MHz.

The frequencies can be those of the radio frequency channels of operation and/or the intermediate frequen-

cies of the receiver between 5 MHz and 40 MHz.

Frequency stability:  $\pm .0005\%$  from  $+50^\circ$  to  $+104^\circ\text{F}$ .

Frequency stability with built-in thermometer and temperature corrected charts:  $\pm .00025\%$  from  $+25^\circ$  to  $+125^\circ$  (.000125% special 450 MHz crystals available).

- Tests Predetermined Frequencies 25 to 1000 MHz
- Extended Range Covers 950 MHz Band
- Pin Diode Attenuator for Full Range Coverage as Signal Generator
- Measures FM Deviation.

FM-2400CH (meter only) ..... \$690.49

RF crystals (with temperature correction) ..... \$28.89 ea.

RF crystals (less temperature correction) ..... \$21.92 ea.

IF crystals ..... catalog price

Write for catalog



INTERNATIONAL CRYSTAL MFG. CO., INC.  
10 North Lee Oklahoma City, Okla. 73102

CIRCLE 69 ON FREE INFORMATION CARD

Unless you operate a tracking station for deep-space probes

YOUR BEST BET AMONG ALL-WAVE RECEIVING ANTENNAS IS THE NEW IMPROVED COMPACT OUTDOOR **McKAY DYMEK DA100D**

Rooftop, balcony, anywhere outdoors . . . this tough little four-footer gives very high performance in limited space. Makes most receivers come in better. Equals, and very often outperforms, longwire antennas. For convenience, price, quality, performance . . . **McKAY DYMEK DA100** is the name to remember.

For \$139.00 you get:

- lifetime, nonmetallic outdoor case
- neat, newly-designed indoor control
- wide range 50 to 30,000 kHz
- shielded, potted amplifier
- 110-240VAC or 12VDC
- attenuator switch to prevent RF overload
- satisfaction of joining thousands of enthusiastic owners worldwide
  - 30-day trial option
  - plus a dozen or more other features

add \$5.00 for shipping  
call residents—add 6%  
sales tax



BUY FACTORY DIRECT • ORDER NOW

**MK** McKAY DYMEK CO  
111 So College Ave.  
P O Box 5000  
Claremont, CA 91711



Tel 714/621-6711  
TWX 910-581-4990

"...an outstanding product on any absolute scale of measurement without regard to price." -STEREO REVIEW



Read more of what Stereo Review magazine had to say about the Yamaha CR-840 receiver:

"The harmonic distortion of the CR-840 was so low that without the most advanced test instruments it would have been impossible to measure it."

When speaking of the OTS (Optimum Tuning System), an easy-to-use Yamaha feature that automatically locks in the exact center of the tuned channel—for the lowest possible distortion, Stereo Review said, "The muting and OTS systems operated flawlessly."

Among Yamaha's most significant features is the continuously variable loudness control. By using this control, the frequency balance and volume are adjusted simultaneously to compensate for the ear's insensitivity to high and low frequency sound at low volume settings. Thus, you can retain a natural-sounding balance regardless of listening level. As Stereo Review states, "...another uncommon Yamaha feature."

And there's more. Like the REC OUT/INPUT SELECT feature. These separate controls allow you to record from one program source while listening to another program source. All without disturbing the recording process. Stereo Review's comment was, "...the tape-recording functions of the CR-840 are virtually independent of its receiving functions." One could not ask for greater flexibility.

In summing up their reaction to the CR-840, Stereo Review said, "Suffice it to say that they (Yamaha) make it possible for a

moderate-price receiver to provide performance that would have been unimaginable only a short time ago."

And the CR-840 is only one example in Yamaha's fine line of receivers. For instance, High Fidelity magazine's comment about the Yamaha CR-640 receiver: "From what we've seen, the Yamaha CR-640 is unique in its price range."

And Audio magazine has remarks on the Yamaha CR-2040 receiver: "Without a doubt, the Yamaha CR-2040 is the most intelligently engineered receiver that the company has yet produced, and that's no small feat, since Yamaha products have, over the last few years, shown a degree of sophistication, human engineering, and audio engineering expertise which has set them apart from run-of-the-mill receivers."

Now that you've listened to what the three leading audio magazines had to say about Yamaha receivers, why not listen for yourself? Your Yamaha Audio Specialty Dealer is listed in the Yellow Pages.



To obtain the complete test report on each of these receivers, write: Yamaha International Corp., Audio Division, P.O. Box 6600, Buena Park, CA 90622.

Quotes excerpted from June 1979 Issues of Stereo Review, High Fidelity and Audio magazines. All rights reserved.



CIRCLE 68 ON FREE INFORMATION CARD

# Heath/Zenith Instruments:



Heath/Zenith instruments are professional units that give you good value for your money. A wide selection to let you choose the unit with the features you need – without paying for a lot of bells and whistles you don't. Manufactured to strict Heath/Zenith standards. Inspected at every step of assembly to assure performance to specifications. They're built to last; built to give

you reliable service. 61 U.S. and Canadian locations offer service, should it ever be necessary. Whether you need a test instrument for electronics service work, manufacturing and design, or serious hobby applications, Heath/Zenith instruments are a good choice. The selection offered here is just part of our total instrument line. Order TOLL FREE 800-253-0570.



## New 10 Hz-225 MHz Frequency Counter



**\$159<sup>95</sup>**

- 10 mV typical sensitivity
- Single input gives entire range
- Crystal-controlled time base
- 0.1, 1.0 second dual time gates
- Full voltage protection
- Easy-to-read 8-Digit display
- 3.38" H x 7.25" W x 9.0" D

SM-2410 ..... 159.95  
(\$2.30 shipping & handling)  
SMA-2400-1, Antenna ..... 9.95  
(\$1.60 shipping & handling)



## New 5 Hz-512 MHz Frequency Counter



**\$299<sup>95</sup>**

- Ideal for 2-way UHF work
- Ovenized, high-stability, crystal timebase
- 8-Digit resolution
- 10 mV typical sensitivity
- .01, .1, 1, 10 second gate times to fit your needs
- Trigger level control
- Frequency ratio function
- Period function
- 4.25" H x 10.0" W x 13.0" D

SM-2420 ..... 299.95  
(\$2.75 shipping & handling)  
SMA-2400-1, Antenna ..... 9.95  
(\$1.60 shipping & handling)



## New Hand-held 512 MHz Counter



**\$179<sup>95</sup>**

- Easy-to-read 7-digit display
- 10 mV typical sensitivity
- Includes nickel-cadmium batteries
- AC or battery operation
- .1 second and 1 second time gates with automatic decimal point placement
- Leading zero blanking
- Crystal-controlled time base
- Full voltage protection
- 2.0" H x 3.38" W x 8.25" D

SM-2400 ..... 179.95  
(\$1.90 shipping & handling)  
PS-2404 120V Battery Eliminator/Charger (required) ..... 4.95  
(\$1.60 shipping & handling)  
PS-2405 240V Battery Eliminator/Charger (required) ..... 12.95  
(\$1.60 shipping & handling)  
SMA-2400-1 Telescopic Antenna ..... 9.95  
(\$1.60 shipping & handling)

## Hand-held Multimeter gives 0.1% accuracy

**\$129<sup>95</sup>**

- Measure voltage, current, resistance
- Easy-to-read Liquid Crystal Display
- Five DC voltage ranges – 200mV-1000V
- Five AC voltage ranges – 200mV-750Vrms
- Four DC current ranges – 2mA-2000mA
- Four AC current ranges – 2mA-2000mA
- Six resistance ranges – 200 Ω-20MΩ
- Uses one 9V battery or 120/240 VAC
- 2.0" H x 3.5" W x 7.5" D

SM-2215 ..... 129.95  
(\$1.75 shipping & handling)  
IMA-2215-1 Leather Carrying Case .. 14.95  
(\$1.60 shipping & handling)  
PS-2350 120VAC Battery Eliminator .. 4.95  
(\$1.60 shipping & handling)  
PS-2450 240VAC Battery Eliminator .. 14.95  
(\$1.60 shipping & handling)



# professional quality, excellent value

## General-purpose Power Supply



\$210<sup>00</sup>

- Supplies B+, C- and filament voltages
- 0-400 VDC output at 0-100 mA continuous (125 mA intermittent)
- Output variation less than 1% from no load to full load for 100-400VDC
- Ripple less than 10 mVrms
- Output impedance 10 Ω from DC-1 MHz
- C- Voltage 0 to -100 VDC at 1mA
- Filament voltage 6.3 VAC at 4 amp.
- 5.5" H x 13.38" W x 11.25" D

SP-2717 ..... 210.00  
(\$4.40 shipping & handling)

## Tri-Power Supply



\$185<sup>00</sup>

- Fixed 5 VDC at 1.5A and two continuously-adjustable 0-20 VDC at 500mA
- Interconnect outputs in any combination
- Clutch-coupled 20 VDC supplies for dual-tracking operation
- All outputs short-circuit proof
- Ripple and noise less than 5 mVrms
- Load or live regulation provides less than 0.1% (20 mV) variation on 20V supplies and less than 2% variation on 5V supply
- 4.5" H x 10.75" W x 9.0" D

SP-2718 ..... 185.00  
(\$3.15 shipping & handling)

## Sine-square wave Audio Generator



\$185<sup>00</sup>

- 1 Hz-100 kHz frequency range
- 0.003-10 Vrms sine wave output (10k Ω load)
- 0.003-1 V sine wave output (600 Ω load)
- Meter calibrated in volts and dB
- -62 to +22 dB ranges
- 0.1-10 V square wave output (2000 Ω load)
- 50 nanosecond risetime
- 5.13" H x 13.25" W x 7.0" D

SG-5218 ..... 185.00  
(\$2.85 shipping & handling)

## Dual-trace DC-10 MHz Oscilloscope

\$650<sup>00</sup>

- Two vertical input channels with 10 mV/cm sensitivity
- 11-step attenuator for 10mV/cm to 20V/cm deflection factors
- 19-step horizontal time base from 0.2 sec/cm to 0.2 usec/cm
- Vertical accuracy within 3%
- X5 horizontal expansion
- Calibrated 1V peak-to-peak square wave signal
- 35 ns vertical rise time
- Automatic triggering
- 120/240 VAC, switch-selectable
- 6.9" H x 12.9" W x 19.3" D

SO-4550 ..... 650.00  
(\$5.50 shipping & handling)



## Combination x1, x10 Scope Probe

\$29<sup>95</sup>

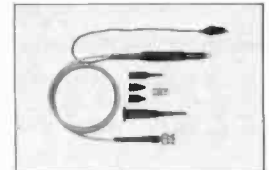

- Switch-selectable x1 and x10 attenuation at probe tip
- Center (ground) switch position allows quick zero level check
- DC to 15 MHz (x1) and DC to 80 MHz (x10) bandwidths
- 4.0 nS (x10) rise time
- Insulating tip, BNC tip adapter, IC tip, insulated compensation capacitor adjustment tool, vinyl case

PKW-105 ..... 29.95  
(\$1.60 shipping & handling)

**Order TOLL-FREE:**

**800-253-0570**

8:00 AM to 8:00 PM Eastern Time M-F. Sorry, toll-free service not available in Alaska, Hawaii or Michigan. Call 616-982-3411. 24 hours a day, seven days a week. TLX: 72-9421

**HEATH**  
**ZENITH**

**Instruments**

For information on other Heath/Zenith Instruments write:  
Dept. 020-720, Benton Harbor, MI 49022  
GX-383

To receive your order faster, charge it!  
Use your Visa, MasterCard or Heath Revolving Charge.  
Please have your card or account number handy when you call.



61 Service locations throughout the United States and Canada

Heathkit Electronic Centers in the U.S. and Canada are listed in phone directory white pages.

\*Units of Veritechnology Electronics Corporation.



**EQUIPMENT REPORTS**  
continued from page 32

you will know that its value is 999 ohms. If the reading had been +4, the value would be 1,004 ohms, etc. That function, called RELATIVE by Fluke is also available on other ranges such as volts, amps and dB.

Resistances can be measured to values as low as 10 milliohms, voltages can be checked to a resolution of 10  $\mu$ V and a resolution of 0.01  $\mu$ A (10 nanoamps) can be anticipated on the 200  $\mu$ A range. The unit offers two conductance ranges, using the international term "siemens." It can measure conductance to as high as 100,000 megohms. Another unique feature not often found on DMM's is the ability of the 8050A to be used to make beta measurements on transistors with the use of a simple circuit whose construction is outlined in the excellent manual provided with the equipment.

How many manufacturers have invited you to evaluate their instruction manuals? Very few, probably. John Fluke not only invites your comments, but, even provides a special page in the manual to assist you in rating the instructions and giving you the means to return your suggestions. The manual is to be commended and is one of the best this reviewer has seen in a long time.

The 8050A watches over those absent-minded technicians, engineers, and hobbyists who are always forgetting to switch ranges on the multimeter. This DMM is protected to at least 500 volts on all resistance ranges, to a minimum of 750 volts on AC ranges, and to one kV on the DC ranges. A more complete list of the voltages will be found in the manual.

The AC voltage ranges are of the true-RMS

variety for frequencies up to 50 kHz. Ranges from 10 mV to 750 volts are provided. The DC capability runs from 10  $\mu$ V to one kV, and measurements up to two amps are possible on both AC and DC. Auto-polarity, overload, dual-slope-integration measuring techniques, and overrange indication are all features of the 8050A.

The eight-position handle also serves as a stand to elevate the front of the unit for easier viewing. Four rubber-like inserts in the bottom of the gray plastic cabinet hold the unit firmly in position when sitting flat on a shelf. As is the case with most other test equipment today, the test leads are terminated in safety connectors at the instrument end. There is no danger of accidental contact with the ends of those leads as they fit into recessed jacks on the front panel. There are also safety rings on the probes which preclude the possibility that the fingers will get too near the probe tips. The line cord is of the three-wire grounded type, which further adds to the safety built into the 8050A. The unit can be adjusted to operate on AC from 90 to 270 volts (47 to 440 Hz). It comes complete with a "Certificate Of Calibration" and with a list of accessories that can be used with the meter to obtain more useful and varied measurements than you could ever dream would be possible for such a small piece of equipment.

The Fluke 8050A DMM measures 8 1/2 X 2 1/2 X 10 inches (22 X 6 X 25 cm) and weighs 2 lbs, 6 oz (1.08 kg). The list price is \$329.00.

The best way to appreciate the Fluke 8050A is to get your hands on one for a short time. You'll not want to do without it once you've become accustomed to using it! If you know someone who has one, ask him to let you try it

for a short time. Better be prepared, though, because you may end up ordering one. **R-E**

**Cincinnati ElectroSystems  
Model 113 Continuity  
Tester**



**CIRCLE 102 ON FREE INFORMATION CARD**

CINCINNATI ELECTROSYSTEMS INC., 469 Wards Corner Road, Loveland, OH 45140, has an interesting little instrument, their model 113 Continuity Checker. They also have a sense of humor. This is what they call a part of *continued on page 38*

**BK PRECISION**

# Microcomputer-Controlled Autoranging DMM Model 2845



- Computer stabilized accuracy to 0.1%
- Auto-perfection  
Selects range for maximum resolution
- Audible continuity indicator  
Built-in audible tone generator
- G-MOV overload protection  
Provides AC and DC voltage range protection to 1000 VDC or AC peak
- Shielded in RF fields  
Accuracy maintained in RF fields

- Long life, high reliability  
Four hermetically sealed reed relays perform range switching with virtually no contact wear.
- Microcomputer intelligence  
Designed around 4-bit microcomputer. Analyzes stored data and range that provides greatest display resolution. Program memory capacity 1024 x 8 bits of ROM supported by 48 x 4 bits of data memory RAM

**... in stock and available for immediate delivery.**

Dual Trace 5" 30 MHz Triggered Scope Model 1479A



Sweep/Function Generator Model 3020

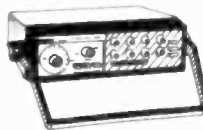

Semiconductor Transistor Tester Model 520B



Portable Digital Capacitance Meter Model 820



**Order with Confidence and get the Fordham Advantage!**

Call for our prices **TOLL FREE**  
**(800) 645-9518**  
in N.Y. State call (516) 752-0050

**FORDHAM**

855 Conklin St. Farmingdale, N.Y. 11735



- Master Charge
- BankAmericard
- VISA = COD
- Money Order
- Check
- COD's extra



# Do more than ever before— spend less than you planned



## Heath makes the All-In-One Computer more versatile

Many satisfied customers know Heath takes the risk out of buying a balanced computer system. With the Heathkit All-In-One Computer, you get 16K Random Access Memory (expandable to 48K), keyboard, video terminal and floppy disk system — together in one self-contained, compact unit — for up to hundreds of dollars less than comparable systems.

Heath now makes the All-In-One Computer more versatile than ever! The new Heathkit H77 Floppy Disk System gives the All-In-One even more data storage and recall capacity. Combined, the All-In-One and H77 Floppy Disk give you up to 300K

bytes of on-line data storage — enough to hold entire files. You can mount operating system and program disks at the same time, to make computing even faster.

You can run programs written in MICROSOFT™ BASIC™ and Assembly Languages, and all current software written for the popular Heathkit H8 Computer.

Heath User's Group (HUG) will share with you a library of over 500 programs to make your computer serve you in ways you never imagined.

There's no better way to learn about computer systems — and save money — than by building one yourself.

Concise, easy-to-follow Heathkit assembly manuals show you the way, from start to finish. And a nationwide network of service centers protects your computer investment.

Join the Heathkit computer family today — and pocket the savings!

For complete details on Heathkit computer systems, as well as nearly 400 other electronic kits for your home, work or pleasure, send today for your free, value-packed Heathkit catalog. Or pick up your copy at the nearest Heathkit Electronic Center.

**CIRCLE 82 ON FREE INFORMATION CARD**

# Heathkit®

SEND FOR FREE CATALOG

VISIT YOUR HEATHKIT STORE

Write to: HEATH COMPANY,  
DEPARTMENT 020-724,  
BENTON HARBOR, MI 49022



In the U.S. and Canada, visit your nearby Heathkit Electronic Center where Heathkit products are also displayed, sold and serviced. See the white pages of your phone book. In the U.S., Heathkit Electronic Centers are units of Veritechnology Electronics Corporation.

## EQUIPMENT REPORTS

continued from page 36

their Black Box series—and it is. In engineering a black box is a small box, with only two terminals, that “does something.” The model 113 is just that; it’s a black box that will fit in the palm of your hand. (It has three terminals, but that is immaterial.)

It’s a level-detector for making fast go/no-go continuity tests. All solid-state, it has two indicators—a LED on the panel, and an audible tone from a 1.5-inch speaker. Either one may be used, or both, to indicate continuity. There are two inputs. The LOW input will give an indication of continuity in any circuit with resistance of less than 500 ohms. The HIGH input is similar, but works from 0 to 100K ohms.

Each input has an adjustment for the trigger point, accessible from the front panel. You can set the LOW input, for example, so it will indicate continuity for any value below 470 ohms, but not above. The HIGH adjustment works the same way for that range.

The level of the tone signal can be set to MAX (+75 dBA) or NORM(al) (65 dBA) with a switch; the center position turns the tone off. The LED is always activated. You can select CONT(inuous) output—tone heard as long as there is continuity—or PULSE—a beep that sounds for one second, then stops. This is used to save batteries.

Power comes from three 1.5-volt “AA” alkaline batteries in the case. Battery life is estimated at from 50,000 to 100,000 operations, in PULSE mode. There is no switch; the Model 113 is ready to go at any time, and uses

no current unless it is in operation and reading continuity.

This device can be used for quite a few go/no-go tests such as continuity in multiconductor cables, PC-board conductors, diode testing, and other kinds of routine continuity tests. Price of the model 113 is \$39.95. **R-E**

## Only VIZ bench DMM's tell so much for so little

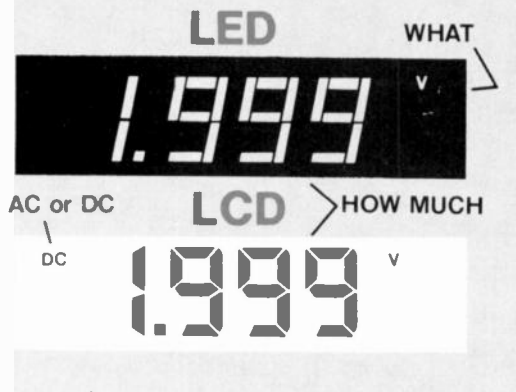

### Manual ranging

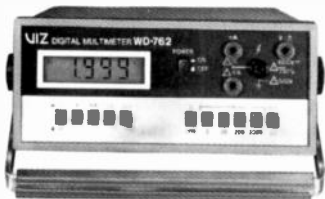

WD-762 LCD display \$210



WD-760 LED display \$199.95

### Autoranging

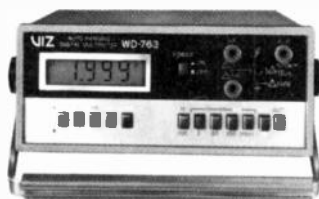

WD-763 LCD display \$265



WD-761 LED display \$255

These are all laboratory quality instruments for bench or battery use. Supplied with AC adapter, spare fuse and deluxe probes. Features include:

- Accuracy 0.1% DCV
- Full range hi or lo power ohms, pushbutton selectable
- 10 amp AC or DC
- Fully shielded against RFI
- Voltage ranges from 0.1mV to 1000V AC & DC.

See your local VIZ distributor.

# VIZ

VIZ Mfg. Co., 335 E. Price St., Philadelphia, PA 19144  
Over 70 test instruments in the line

## Antenna Incorporated Model 13505 Persuader CB Antenna

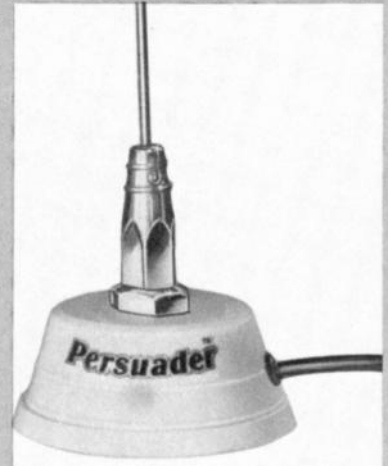

CIRCLE 103 ON FREE INFORMATION CARD

IT'S ALWAYS NICE TO HAVE THE FEELING that you've got the edge over the other guy. The model 13505 Persuader magnet-mount mobile CB antenna (Antenna Incorporated, 26301 Richmond Road, Cleveland, OH 44146) can give you that feeling.

In test made during a band opening, the Persuader was compared with another popular antenna and was able to pull signals out of the mud when the other couldn't hear them at all. Signals received by the Persuader were always several S-units stronger than the same signals picked up by the reference antenna.

Transmitting, the SWR was found to be nearly flat across the entire band. That may be due partially to the fact that the antenna is base-loaded and partially to its longer-than-normal (approximately 60 inches) length. The additional length also would account for the antenna's greater sensitivity.

The magnetic mount is completely covered in heavy rubber to avoid marring the surface of the auto. There seems to be no danger of the antenna becoming dislodged from the surface on which it is placed and, indeed, it takes a rather strong pull to remove it.

The antenna comes with twelve feet of RG-58U coax, complete with a PL-259 connector ready to plug into your rig. No tuning of the antenna was required and it was not found necessary to “prune” the whip for optimum results. In fact, it is doubtful whether the SWR could have been any lower than it was with the antenna right out of the carton.

If you travel in an area where the overpasses offer little clearance, you may find yourself with a bit of a problem if you mount the Persuader on the roof of a standard-size car. Because of its extra length, it may, from time to time, brush against some of those “low bridges.” No harm will be done, but it could become an annoyance if it happens too often.

continued on page 40

CIRCLE 16 ON FREE INFORMATION CARD



# BUILD A MASTERPIECE OF SOUND

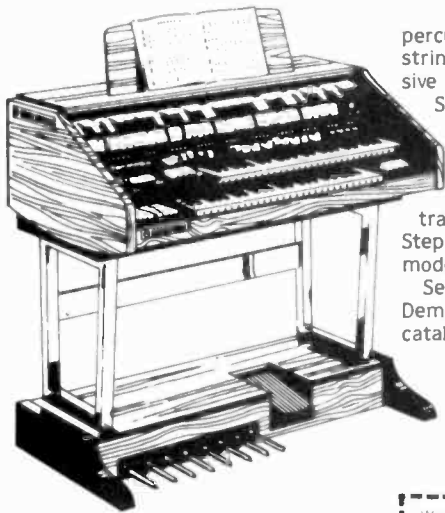

percussion and sustain. Wersi's famous string orchestra and bass guitar. Exclusive Sound Computer for 32-128 "One Stop Sounds" (total organ presets).

Transposer. And lots more.

Build your own masterpiece of sound. No technical knowledge required. Just follow the clearly illustrated, easy to understand instructions. Step by step. Choose from at least 10 models. (Also factory assembled.)

Send \$6.00 with coupon for your Wersi Demo-Package (LP with 104-page color catalog).

**WERSI**

Wersi has combined select features of the electronic music field, added its own creations and years of research by top engineers and musicians, to produce an incomparable line of organs.

Space-age technology. True-to-life voicing with full drawbar system. Polyphonic

Wersi Electronics, Inc. Dept. 21  
1720 Hempstead Road  
Lancaster, PA 17601

Wersi Organs & Kits  
Dept. 21  
14104 E. Firestone Blvd.  
Santa Fe Springs, CA 90670

Enclosed is \$6.00 for my Demo-Package (LP with 104-page color catalog.)

Name \_\_\_\_\_  
Address \_\_\_\_\_  
City \_\_\_\_\_ State \_\_\_\_\_ Zip \_\_\_\_\_

CIRCLE 22 ON FREE INFORMATION CARD

# THE LEADER DOES IT AGAIN!

Always first, PANAVISE proudly presents the two newest additions to their top quality product line.

## Model 333 Rapid Assembly Circuit Board Holder

This circuit board holder features eight position rotating adjustment and six positive lock positions in the vertical plane. Cross bars are available up to 30 inches in length to hold circuit boards up to 28 inches in width. Extra arms can be added for dual or multiple board holding. Spring loaded, the 333 features tilt angle adjustment, height adjustment and quick board rotations for easy component insertion and soldering.

Suggested retail price is \$35.95.

## Model 376 Self Centering Extra Wide Opening Head (BASE NOT INCLUDED)

Double action jaws provide fast opening and closing and support of heavy loads. Opens to a full 9 inches. Ribbed on one side and "V" grooved on the other, the 376's reversible jaw pads firmly hold cylindrical or odd shaped items. Fits all of the Series 300 Bases.

Suggested retail price is \$19.95.

For more information contact your local dealer or PANAVISE.

Prices are suggested retail and subject to change without notice.

**PANAVISE**

PANAVISE PRODUCTS INC.  
2850 E 29th St. Long Beach, CA 90806  
(213) 595-7621

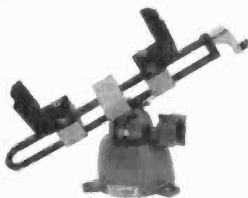

CIRCLE 59 ON FREE INFORMATION CARD

## EQUIPMENT REPORTS

continued from page 38

Also, the whip tends to sway and bend in the wind when you are traveling at a fair rate of speed. That presents no practical difficulties, but can be alarming the first time you notice it happening.

The Persuader carries a suggested retail price of \$38.48 and could turn your CB rig into a better performer. You may find that your rig will have to be readjusted to match the new antenna, but that is always the case if you want to obtain the best performance from a new piece of equipment. And, in this case, judging from our tests, it's worth it. **R-E**

## Taco/Jerrold Maximizer TV/FM Preamp

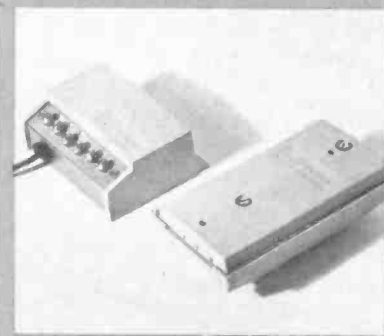

CIRCLE 104 ON FREE INFORMATION CARD

IF YOU LIVE IN A TELEVISION RECEPTION fringe area or if you would like both TV and FM-radio signal improvement, the new *Powermate 5000 "Maximizer"* from Taco/Jerrold is certainly worth investigating.

We decided to test two different models: the 5214 (channels 2-13 and FM), and the 5283-2 (VHF-TV, UHF-TV, and FM). Both modules were selected for 300-ohm transmission-line impedance because we felt that this would be the most typical installation choice for our readers.

Many other options are available from Taco/Jerrold (1 Taco St., Sherburne, NY 13460). Their TV accessory line is extremely broad, allowing for considerable flexibility and customizing for individual requirements. For example, UHF-only preamps are available, as are preamps with impedances of 75 ohms for coaxial cable runs. Even mixed impedances (300-ohm antenna input, 75-ohm coax transmission line) are offered.

Antenna preamplifiers should always be mounted at the antenna, never at the TV receiver. The reason is simple. The purpose of such an amplifying device is to provide gain for incoming signals. Transmission lines have a tendency to pick up noise, and even to absorb weak signals. If the preamplifier is placed at the receiver, it will amplify not only the desired signal, but any noise on the line as well. By mounting the preamplifier at the antenna (or "masthead"), signals are boosted immediately upon capture, and "ranrodged" down the transmission line, overriding noise; they are strong enough to afford the loss of a little strength.

In order to avoid having to run 120 volts AC up to the antenna preamplifier, a separate power supply is mounted next to the TV receiver.

continued on page 42

# Why the smallest digital scanner is also one of the smartest.

We started with very fast, sophisticated microprocessors. Then we made some highly complex circuitry very simple to operate. Just one touch tells the new M400 to monitor any active police, fire, weather and emergency frequency in your area. That's a lot of return for practically no effort. And it makes the M400 perfect for your home or car.

scan modes — whichever is best for you. We've also set aside a priority channel so you can monitor your favorite frequency every second. There's even a digital quartz clock and elapsed timer. And the control panel is backlit for the best possible visibility — day or night.



## 575 Channels, No crystals.

We've preprogrammed 545 channels with commonly used public service frequencies. Then we coded the touch sensitive keyboard with symbols for police, fire, marine, mobile telephone and weather. So all you have to do is touch the symbol for the type of activity and band you want to monitor. The M400 does the rest. If you want to search for unknown frequencies, the M400 lets you do that, too. And for those channels you want to store and hear again, you have 30 programmable channels to use. Plus you can use either manual or

**Take all the action with you.**

With the new Regency Touch M400, you can have all the action, no matter where you are. It's the most complete scanner made primarily for mobile\* use. And it works just great at home. So get the small scanner that's very smart. At your Authorized Regency Scanner Dealer.

  
Regency

Regency Electronics, Inc.  
7707 Records Street  
Indianapolis, Indiana 46226

\*Use of mobile scanners prohibited in certain locales.

**CIRCLE 31 ON FREE INFORMATION CARD**

# Radio-Electronics®

is available in

## MICROFICHE

from

**MICROCARD EDITIONS**

A Division of

Information Handling Services

P.O. Box 1154

Englewood, Colorado 80110

**BELL & HOWELL CO.**

Micro Photo Division

Old Mansfield Road

Wooster, Ohio 44691

Attn.: Mr. Spiers

and in

## MICROFORM

from

**UNIVERSITY MICROFILMS**

300 N. Zeeb Road

Ann Arbor, Michigan 48106

Xerox copies of individual articles can also be purchased from University Microfilms.

Please write companies for complete information

### EQUIPMENT REPORTS

continued from page 40

Low-voltage AC (approximately 12 volts for the 5000 series) is fed up the transmission line to power the preamplifier, which has a built-in rectifier circuit. RF-choke coils are used to isolate the high frequency signals from the power supply.

The preamplifier circuit contains three bipolar transistors, one for VHF and FM, and two for UHF. A user-adjustable wavetrap is provided for notching out interfering signals from local broadcasters, whether the offending powerhouses are TV or FM stations. (No adjustment is needed if there is no local problem.) A pair of shunt wires *must* be clipped to activate the FM amplification section—otherwise the factory-tuned trap will null out FM broadcast-band signals.

Average gain for the *Maximizer* series is typically 17-19 dB on VHF, and 15-17 dB on UHF. Noise figure is 4.5 dB on VHF, and 3.5-6.5 dB on UHF. The bipolar transistors are capable of withstanding up to 50,000-microvolt RF signals before -46 dB crossmodulation occurs.

The masthead (preamplifier) portion of the *Maximizers* are designed conveniently to accept either tubular mast mounting or square-boom mounting. A universal hardware kit is provided to allow the installer to use either option as necessary.

The preamp is hinged for quick access to the binding posts used to attach the transmission lines. The terminals have toothed washers which bite securely into the 300-ohm line, assuring adequate electrical contact with the conductors without the need of stripping the

insulation from the ends of the lines.

Lightning protection and static discharge are both provided on the *Maximizer*. Naturally, no lightning arrestor can protect equipment from a direct hit, but induced surges from nearby strokes are thwarted.

Protection against moisture intrusion is provided by foam ridges along the edges of the hinged lid. When the lid is screwed shut, the weatherstripping squeezes down against the lead-in wires, keeping the weather out of the innards.

A deep-fringe area was selected to test the Taco-Jerrold *Maximizer*. A modest log-periodic VHF-TV antenna was provided for reception of channels 2-13, and a Jerrold "Sharpshooter" corner Yagi was used to test system performance on UHF. A competitive preamplifier was used as a standard of performance to judge the effectiveness of the *Maximizer* in doing its job.

There was virtually no difference in performance between the *Maximizer* and the competitive preamp. Unquestionably, both units performed admirably, boosting signals from the noise level up to acceptable reception quality. In some cases, we received signals that in effect were non-existent before the preamplifiers were brought into play.

But performance alone is not the only criterion for judging the acceptability of a product. Quality of construction is important... especially important where outside exposure is intended. The Taco-Jerrold 5000 series is ruggedly built, functionally designed, and reasonably priced—in the \$40 range. The Sharpshooter UHF corner Yagi is also typical of the high-quality heavy-duty construction of Taco/Jerrold TV equipment.

R-E

**LEADER**  
Instruments Corp.

# Oscilloscopes

**2 YEAR WARRANTY**

Probes included on all scopes



Model LBO-507

### 20 MHz, TRIGGERED

- Single trace, automatic trigger for highly stable, bright display.
- 17.5nSec rise time • 10mV/cm to 20V/cm Vertical Sensitivity, 11 steps



Model LBO-508A

### 20 MHz, DUAL TRACE

- Add, subtract modes on CH-1 & CH-2 facilitate easy checkout for simultaneous pulses, signal levels, distortion & noise cancelling.

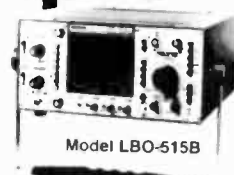

Model LBO-515B

### 30 MHz, VARIABLE DELAYED SWEEP, DUAL TRACE

- Built in variable delay circuitry — 1µSec to 5 Sec. • 5mV/Div. Vertical Sensitivity.



Model LBO-520A

### 35 MHz, FIXED DELAY, DUAL TRACE

- Dual trace, 35 MHz bandwidth.
- 5mV/cm Vertical Sensitivity • 10.0 ns

## COLOR BAR GENERATORS, BRIDGES, TESTERS.

NTSC Color Bar Pattern Generator

Model LCG-396



- NTSC color bars
- Provides full field or I/Q insertion plus on-off control of chroma and luminance
- Better checking and adjusting of purity and white balance via red, blue, green, white factors
- Dots and single crossbars for convergence, raster and all other alignment requirements
- 75Ω Video I/Q ports fixed and RF output for TV and VTR equipment
- Equalizing pulse phase locked to color sub-carrier

Completely Portable, Battery Operated TV Color Analyzer

Model LCG-397



- RF or composite video outputs
- 0-100% variable color burst or easy chroma service
- 16 convergence patterns — 10 bar-gated, 3 bar-gated and rainbow patterns
- 3 dot patterns, 2 crosshatch patterns
- 3 vertical lines and 3 horizontal lines plus gray scale
- Oscilloscope trigger outputs
- Battery operated • standard "C" cells • 1.5V each

Transistorized LCR Bridge

Model LCR-740



- Highly accurate 3 digit readout
- Measures Inductance (L), Capacitance (C) and Resistance (R) within 0.1% accuracy
- Readouts variable with built-in 10% over-range
- Loss Factor scale (D)
- Operates on 1.9V battery or through built-in AC adapter

FM Multiplex Stereo Generator

Model LSG-231



- RF Composite and Audio Outputs
- Checks separation, balance and alignment in the field or on the bench
- 18MHz pilot signal - 2% accuracy
- 19MHz audio signal - 1% accuracy
- Composite stereo output 87MHz SCA switch sensitive
- Internal modulation capability
- Selectable pre-emphasis

Order with Confidence and get the Fordham Advantage!

Call for our prices **TOLL FREE**  
**(800) 645-9518**  
in N.Y. State call (516) 752-0050

# FORDHAM

855 Conklin St. Farmingdale, N.Y. 11735



- Master Charge
- BankAmericard
- VISA • COD
- Money Order
- Check
- COD's extra

CIRCLE 73 ON FREE INFORMATION CARD

NOW AVAILABLE!

# WATT WIZARD™

**POWER FACTOR CONTROLLER CUTS THE COST OF RUNNING ELECTRIC APPLIANCES BY AS MUCH AS 50% -- AND YOU CAN EVEN SEE THE SAVINGS!**

For over a year now, in magazines and newspapers the world over, there have been enthusiastic write-ups on a remarkable new device that can cut your electric bill while helping the U.S. save huge quantities of fuel.

"The NASA/Nola power saver," wrote a *Popular Science* senior editor, "was developed by Frank Nola at NASA's Flight Center in a program to reduce power consumption in spacecraft motors. Nola calls it a PFC — power-factor controller. I prefer to call it a power saver, however, because that's what it does."

## NASA TESTED IT

According to NASA documents, "The device has been tested at Marshall Center on over 40 types of motors, with power savings ranging up to 60%, depending on the loading. The motors tested were both single-phase and three-phase, ranging from ½ H.P. to 5 H.P. Most motors will show up to 40 — 50% savings when running lightly loaded or unloaded, and some will show 5-to-7% savings at rated load."

NASA's Technical Support Package showed that "The Power Factor Controller applies to induction type electric motors — the most commonly used type in all major home appliances and the most commonly used by industry."

## HOW IT SAVES POWER

*Popular Electronics* explained it this way: "AC induction motors characteristically run at a nearly constant speed that's fixed by power-line frequency and independent of load and supply voltage. When heavily loaded, the motor draws line current that is nearly in phase with the applied voltage...Under light load conditions, the motor develops less torque by allowing more lag between the voltage and the current. This reduces the power factor while leaving the current essentially the same in magnitude.

"To minimize this waste, Nola's device monitors the motor's power factor and when it detects light load conditions, it reduces the supply voltage..... The current, now more nearly in phase with the voltage, therefore does as much useful work as before, but it and the voltage are smaller, resulting in a net savings of electric power."

## THE SAVINGS CAN ADD UP

The cost of electric power keeps going up. In 1980-81 and beyond you'll pay more and more for the privilege of running your electric appliances.

Right now, the typical consumer pays about \$8 per month to operate a 16.5 cu. ft. frost-free freezer...\$10 to run a 17.5 cu. ft. frost-free refrigerator...and

*National Aeronautics and Space Administration  
Patent No. 4,052,648*

about \$60 for an air conditioner used during summer months. That's what you're paying to run just one of these appliances per year.

Nola's power saver can soon pay for itself, then start reducing your electric bills. Until now, the device has not been available — except for industrial models priced at \$80 or more.

## INTRODUCING THE WATT WIZARD

Cynex, an American manufacturer of electrical and electronic products and a prime contractor for the U.S. Army, has been licensed by NASA to manufacture Frank Nola's power saver. Cynex calls it the Watt Wizard.

The "Watt Wizard" says Ray Beauchea, the firm's Marketing Director, regulates the voltage fed into an induction motor making the motors run more efficiently and quieter, while lengthening motor life.

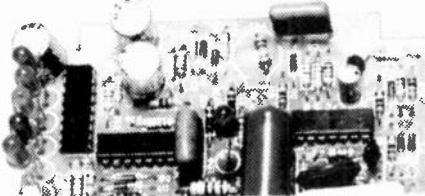

*The Watt Wizard features a unique, constant power saving readout. So you can constantly monitor you're energy savings.*

## SIMPLE TO USE

Cynex makes several models of the Watt Wizard (all with solid state design), including the 110 v. AC plug-in model we're offering. It's for single phase fractional H.P. motors (less than 1 H.P.) used in most freezers, refrigerators, fans, swimming pool pumps, vacuum cleaners, sewing machines, etc.

Simply plug the Watt Wizard into any electrical outlet, then plug the appliance into the Watt Wizard. There's no wiring required. Unlike some competitor's models (if and when available), the appliance does not have to be turned on before being plugged into the power saver. You can leave the appliance — whether on or off — plugged into the Watt Wizard all the time. Or you can move the Watt Wizard to various locations.

## OTHER MODELS AVAILABLE

Air conditioners, washers and dryers require wire-in model. If you lack mechanical skill, you probably need an electrician to install it. We also offer it in 220 VAC single or three-phase.

**CIRCLE 10 ON FREE INFORMATION CARD**



MERCURY 1980©

## EXCLUSIVE ADVANCE FEATURES

The Watt Wizard also includes two more unique features which no competitor has. It's fused so if you accidentally overload the device, it won't burn out. Just change the fuse, which is available at any auto supply store.

And Watt Wizard features a unique LED readout, so you can actually tell, at any moment, exactly how much power you're saving — 10%, 20%, 30%, 40% or 50%. This feature is available only on the Watt Wizard.

There's a "power-on" light, too. And the Watt Wizard comes with the manufacturers 1 year limited warranty.

## LOW COST — AND A TAX CREDIT

We're offering the Watt Wizard for only \$39.95, with immediate delivery. Want two? Then its just \$37.95 each. Or splurge and get three at \$34.95 each. Wire-in models for heavy duty motors are \$6 more for each unit. Add just \$2.50 postage/handling for each order (not each unit).

And next year, when you fill out your tax return, you can deduct a full 15% energy tax credit - for additional savings.

## 30-DAY MONEY-BACK GUARANTEE

Try the Watt Wizard for up to 30 days. If not completely satisfied, return it (insured) for a full refund.

The sooner you send for the Watt Wizard, the more you can save on your electric bills. To order, send your check or money order to the address below. Or charge it to your Visa, MasterCard, American Express, or Carte Blanche credit card. If using your charge card, you can also order via our toll-free phone number:

**800-257-7850**

(In New Jersey, Call: 800-322-8650)  
N.J. residents, add 5% sales tax.

Or mail your order to:

INTERNATIONAL SALES GROUP  
**MERCURY**  
THE IMAGINATION PEOPLE®

Dept. RE-12, Lakewood Plaza  
Lakewood, New Jersey 08701

# HITACHI OSCILLOSCOPES

Single and dual trace, 15 and 30 MHz. All four high sensitivity Hitachi oscilloscopes are built to demanding Hitachi quality standards and are backed by a 2-year warranty. They're able to measure signals as low as 1mV/division (with X5 vertical magnifier). It's a specification you won't find on any other 15 or 30 MHz scopes. Plus: Z-axis modulation, trace rotation, front panel X-Y operation for all four scope models, and X10 sweep magnification. And, both 30 MHz oscilloscopes offer internal signal delay lines. For ease of operation, functionally-related controls are grouped into three blocks on the color coded front panel. Now here's the clincher: For what you'd expect to pay more, you actually pay less. Suggeste list price of our top line V-302B dual trace 30 MHz is only \$995.00. The other models comparably less. Check our scopes before you decide.

## Hitachi...The measure of quality.

- V-302B 30 MHz Dual Trace \$995.00
- V-301 30 MHz Single Trace \$745.00
- V-152B 15 MHz Dual Trace \$735.00
- V-151B 15 MHz Single Trace \$570.00



**HITACHI**  
Hitachi Denshi America, Ltd.

For more information, contact  
Hitachi Denshi America, Ltd.,  
175 Crossways Park West, Woodbury, N.Y. 11797  
(516) 921-7200.



# More sensitive to your input.



## ELECTRONICS IN YOUR NEXT CAR

*Microprocessors have arrived on the automotive scene and are rapidly replacing and augmenting the old "idiot lights" and gauges. Here's a look at what your next car will be able to tell you.*

MARTIN BRADLEY WEINSTEIN

MICROPROCESSOR I/O LINES RUN THROUGH the top-of-the-line dashboards in today's cars. Cadillac, for example, included this description in a recent press release:

"A digital instrument-panel cluster, featuring digital display of vehicle speed, fuel level, and fuel range is standard on Elegante and Biarritz models...optional on other Seville and Eldorado models."

There are a number of reasons for going electronic, including cost, reliability, and "sex appeal". We're going to take a look at the new trends in dashboard electronics as part of a **Radio Electronics** series on automotive electronics.

### The goals

Remember, in most cases electronics in the dashboard is replacing mechanical and electromechanical instrumentation. In some cases, electronics represents a higher initial cost—but not in all. In every case, design changes of every sort are expensive for a carmaker to implement, and a decision to do so is not made frivolously.

Chrysler Executive Engineer R. D. Rossio outlines the four key reasons for going more electronic:

"One, to be truly innovative. This is not engineering gimmickry. We wanted to do what electronics does best—eliminate or reduce noise, wear, and the chance of malfunction, and to provide reliable performance.

Two, to offer quicker and easier serviceability. One electronic module contains the brains and the readouts—and incorporates an ability to diagnose and pinpoint its own problems.

Three, to make it a reliable system, one which provides a maximum of accurate information with an absolute minimum number of vulnerable internal components.

And four, make the system easy to use. We call that "humanistics"—a system that requires little driver participation."

Walter Doelt of Ford adds a few very practical points. One is that with electronics—and especially single-chip microprocessor approaches—you not only reduce the number of components that can go bad, you also greatly reduce the number of connections. In the experience of the automotive industry, as in that of others, connections have proven by far the weakest link in terms of system reliability.

Also, with a microprocessor, (according to Doelt) you can freeze a basic design very early in the design cycle, then use software updates to fudge in changes in calibration later, as they become necessary.

### The Chrysler Five

The 1981 Chrysler *Imperial* features five digital displays (clock, odometer, speedometer, gear selector, and fuel display), separate system indicators

for the *safety, reminder, and engine* systems, plus a brightness detector, metric conversion button, and a diagnostic unit.

The clock gives time, date, and elapsed time since the ignition was turned on.

The odometer features a permanent semiconductor memory, capable of extended data retention even with power removed. That not only eliminates the noise and wear problems of mechanical mile-minders, it also makes the odometer virtually tamper-proof. Input to the odometer is a transmission-mounted reed-switch. The odometer "only" accumulates to 200,000 miles; replacement odometers include a module flag identifying them as such, and the vehicle's previously accumulated mileage is registered with them.

In addition to vehicle mileage, a trip odometer records up to 2,500 miles. Also, the driver can call up his trip average speed.

The speedometer display is front and center, and updates the selected format (US-mph or metric-km/h) speed display every half second. U.S. and Canadian models read up to 85 mph (137 km/h); international models of 119 mph (199 km/h).

The "P-R-N-D-2-1" gear-select indicator looks like today's mechanical gizmos, except that the letters are larger and flagged with backlighted squares.

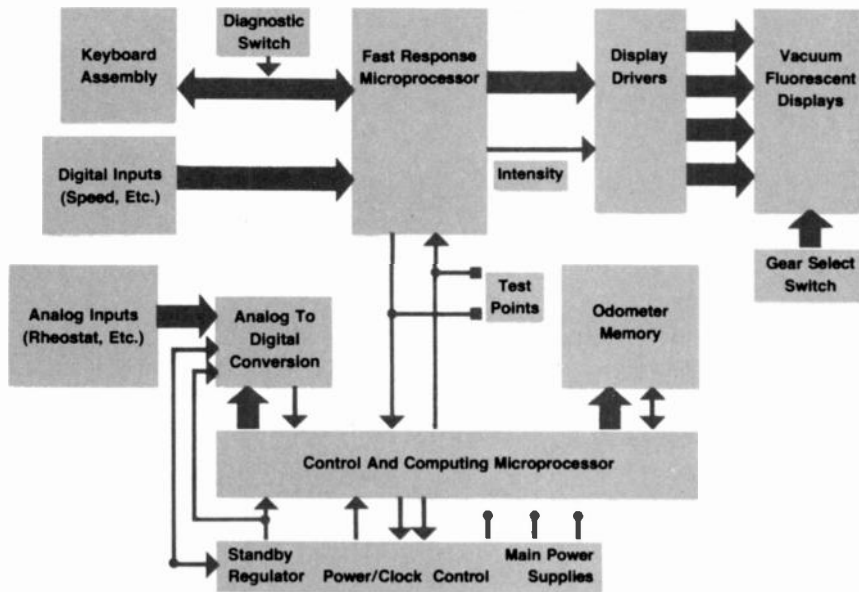

**INSTRUMENT CLUSTER** of 1981 Chrysler Imperial uses two microprocessors. The first interfaces primarily with the automobile; the second with the driver.

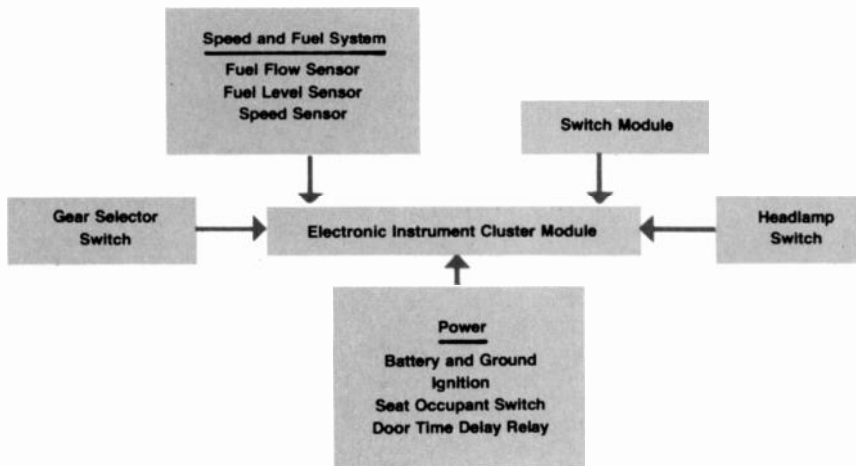

**ELECTRONIC INSTRUMENT CLUSTER SYSTEM** in Chrysler Imperial consists of five digital displays plus indicators for Safety, Reminder and Engine systems. Some of its sources of data are shown above.

The electronic fuel gauge displays FULL as long as 14 or more gallons remain in the tank. The numerical value of the remaining fuel capacity is displayed when anything less than 14 gallons (or 53 liters, in case the metric display format has been selected) remains. With less than 2 gallons (about 8 liters) remaining, the display flashes LOW at 2-second intervals.

RANGE, PRESENT, and TRIP push-buttons indicate how much farther the gas in your tank can take you, your current miles-per-gallon fuel efficiency and your trip average fuel efficiency. If metric units have been selected, the fuel efficiency is displayed in liters-per-100-kilometers. Readings are updated every two seconds for *present* fuel economy; trip readings are updated every 16 seconds.

The digital displays are vacuum fluorescent, blue-green, and daylight-readable. Photoelectric ambient light

sensors and a microprocessor input from the headlight switch adjust the display brightness appropriately to keep it easily visible while not obtrusively glaring.

The three system indicators are panel-lighted with incandescent lamps. A graphic panel indicates any door ajar; a BRAKE telltale (the "nice" word for *idiot light*) indicates any problem with one of the brake systems. Together, those are the *safety* system indicators.

The *reminder* system includes a low windshield-washer fluid telltale and a 4-to-8-second FASTEN SEAT BELT light. It's accompanied by a pleasant electronic chime—not so much because of customer disgust with buzzers, but because buzzers make for too many electrical noise problems at virtually no cost advantage.

The *engine* systems indicators include oil pressure, coolant temper-

ature, and system-voltage telltales.

The Chrysler digital dash includes an on-board self-test pushbutton that performs a diagnostic routine to aid the service man—who usually wouldn't know a logic probe from a motorized swizzle stick.

### Ford's ideas

From an electronicist's point of view, the advanced Ford *Electronic Message Center* is an especially attractive use of display technology. That blue-green vacuum fluorescent display offers two lines of 16-segment alphanumeric, ¼-inch high. It can display a total of 36 messages using a vocabulary of 77 words.

Electronically, it incorporates a microprocessor (6800-series), two RAM's, a ROM, two PIA's, a custom-gate package, a display assembly with two latched drivers, a sequencer, display logic, two regulators, and two dual op-amps.

Still, like idiot lights, most alerts are based on threshold measurements. The idea is to give a driver warning in plenty of time to avoid system damage, though not necessarily at the first sign of trouble—that can turn into an "annoyance" for the driver, the car companies have found.

According to Ford Electrical and Electronics Division chief engineer Jerome G. Rivard, "The *Electronic Message Center* component of the panel communicates with drivers for the first time in words, numbers, and audible tones, providing them with information never before available in mass-production vehicles."

The normal display is a digital clock with time in numbers plus AM or PM, the month as an abbreviated word, the date in numbers and the day-of-the-week as an abbreviated word.

A problem with brake-system pressure, alternator output, oil pressure, or the engine temperature is treated by the message center as "critical", prompting warnings at four-second intervals accompanied by a one-second audio tone.

Low fuel (which is acknowledged with a display of the remaining distance the car can be expected to go on the remaining fuel at current efficiency), door-ajar, and trunk-ajar conditions are "secondary", prompting four-second warnings at 16-second intervals, accompanied by an initial audible tone.

"Auxiliary" warnings for low washer fluid, headlamp failure, taillamp failure, or brakelight failure appear once for four seconds when the condition first occurs, and again each time the engine is started.

In addition, the electronic message center performs what Ford calls "trip log" functions. Those include distance traveled, elapsed time, average speed,

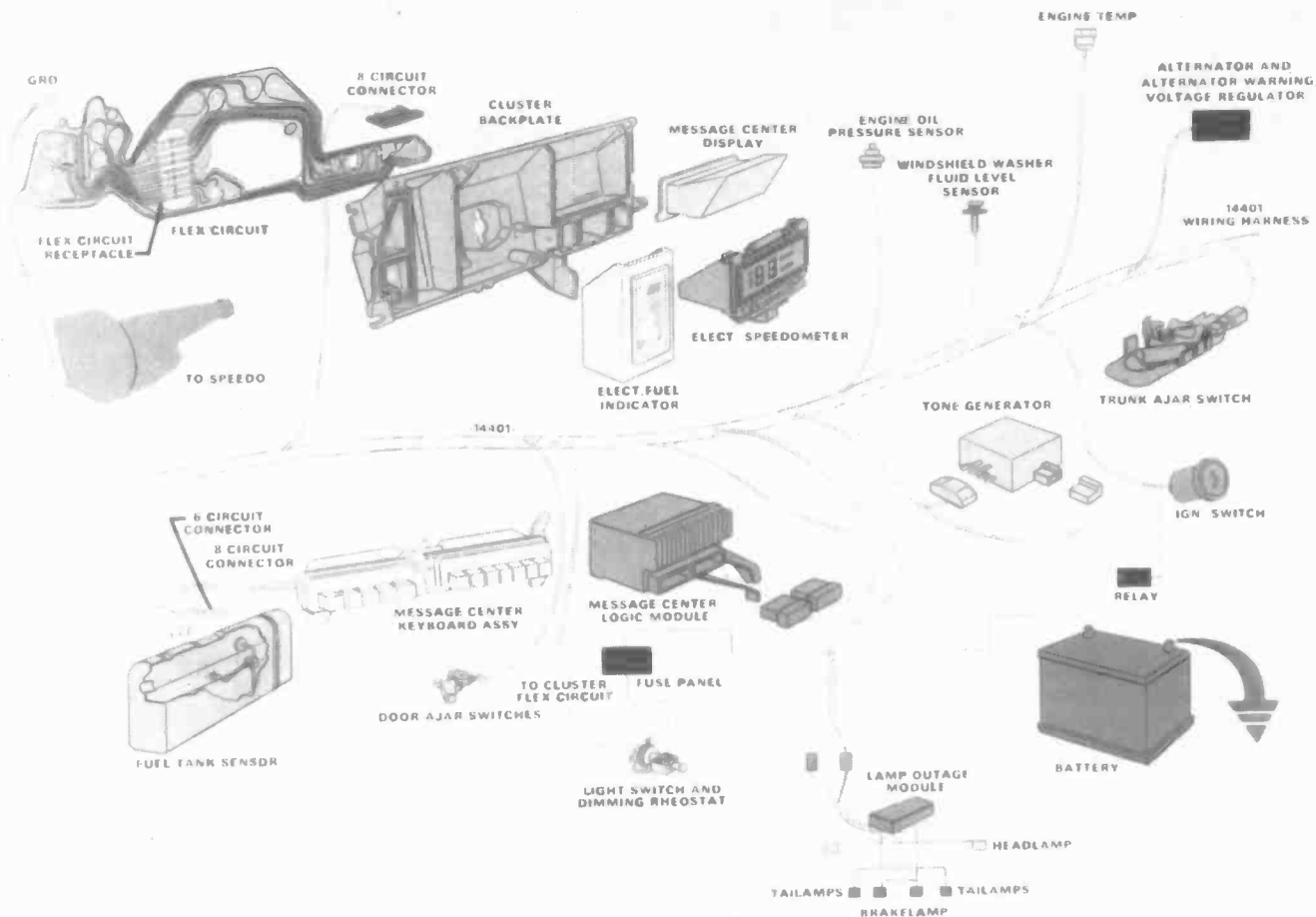

A NETWORK OF CABLES like the human nervous system connects each of the devices and areas monitored in the Lincoln Continental with the microprocessor-based logic module.

### TYPICAL DIAGNOSTIC CHART for troubleshooting the digital dashboard inside Chrysler's Imperial.

| PROBLEM  | CAUSE   | SOLUTION   |
|--|---|--|
| NO DISPLAYS WHEN ENTERING VEHICLE  | <ol style="list-style-type: none"> <li>1. DEFECTIVE DOOR SWITCH</li> <li>2. DEFECTIVE IGN LIGHT TIME DELAY RELAY</li> <li>3. DEAD BATTERY</li> <li>4. DEFECTIVE WIRING CONNECTION TO CLUSTER MODULE</li> <li>5. BLOWN FUSE, CAVITY 6</li> <li>6. DEFECTIVE ELECTRONIC MODULE</li> </ol> | <ol style="list-style-type: none"> <li>1. REPLACE SWITCH</li> <li>2. REPLACE RELAY</li> <li>3. CHARGE OR REPLACE</li> <li>4. CHECK AND REPAIR</li> <li>5. REPLACE FUSE</li> <li>6. REPLACE MODULE</li> </ol> |
| NO DISPLAYS AFTER VEHICLE IS STARTED   | <ol style="list-style-type: none"> <li>1. DEFECTIVE IGNITION SWITCH</li> <li>2. DEFECTIVE WIRING TO THE ELECTRONIC MODULE</li> <li>3. BLOWN FUSE, CAVITY 11</li> <li>4. DEFECTIVE ELECTRONIC MODULE</li> </ol>  | <ol style="list-style-type: none"> <li>1. REPLACE SWITCH</li> <li>2. CHECK AND REPAIR</li> <li>3. REPLACE FUSE</li> <li>4. REPLACE MODULE</li> </ol>   |
| DISPLAYS FLICKER WHEN STARTING VEHICLE   | <ol style="list-style-type: none"> <li>1. LOW VOLTAGE CONDITION DUE TO A DISCHARGED BATTERY</li> <li>2. LOW VOLTAGE CONDITION DUE TO EXCESSIVE CRANKING OF ENGINE</li> </ol>  | <ol style="list-style-type: none"> <li>1. CHARGE OR REPLACE THE BATTERY</li> <li>2. CORRECT DEFECTIVE STARTING CONDITION</li> </ol>  |
| LOSS OF DISPLAYS WHEN VEHICLE IS STARTED AND PANEL DIMMER SWITCH IS PULLED OUT | <ol style="list-style-type: none"> <li>1. DIMMER SWITCH CONTROL KNOB COMPLETELY CLOCKWISE</li> <li>2. DEFECTIVE DIMMER SWITCH</li> <li>3. BLOWN FUSE, CAVITY 13 OR CAVITY 5</li> </ol>  | <ol style="list-style-type: none"> <li>1. ADJUST DIMMER SWITCH COUNTER-CLOCKWISE</li> <li>2. REPLACE SWITCH</li> <li>3. REPLACE FUSE</li> </ol>  |
| CLOCK INACCURATE   | <ol style="list-style-type: none"> <li>1. LOSS OF BATTERY POWER</li> <li>2. DEFECTIVE ELECTRONIC MODULE</li> </ol>  | <ol style="list-style-type: none"> <li>1. RESTORE POWER AND RESET TIME</li> <li>2. REPLACE MODULE</li> </ol>   |

distance to destination, estimated time of arrival, and fuel economy. *Trip average* fuel economy is computed from miles traveled and fuel consumed

since the last reset of the function; *instantaneous* fuel economy is calculated from fuel flow and speedometer inputs. When the F/ECON button is

pressed, the message center displays first the trip average fuel economy for four seconds, then automatically changes to instantaneous fuel economy.

A pushbutton selects English or metric units for all displays. The message center also features extended self-test capabilities.

### Speed, fuel and telltales

If Ford's dashboard digital speedometer catches on, traffic cops may be throwing their radar guns away in favor of just reading your dashboard from a car or two away! The beast features 3½-inch-tall digits (up to 85 mph or 137 km/h), plus some smaller letters to indicate the units of display. The circuitry includes a custom logic-package, decoder/driver, regulator, and quad op-amp. Remember, the speedometer is receiving pulses that relate to drive shaft position, so the pulse rate is proportional to speed of the car and an electronic speedometer is essentially a small frequency counter.

The electronic fuel gauge, on the other hand, requires a microprocessor, a display driver, and a dual op-amp—but it is more than your standard swaying needle. Four bar-graphs are stacked atop each other. The top represents the top quarter tank of fuel—three-fourths as wide as the top one, represents the 1/2 to 3/4 tank level. The next, half as wide as the top bar graph, represents the ¼ to ½ tank level. The bottom bar graph, one-fourth as wide as the top one, represents the last ¼ tank. Each bar-graph segment indicates about 3% of total tank capacity. Segments are lighted either brightly (fuel remaining—the bottom segments) or dimly (fuel depleted—the top segments). In the case of the last segment (when just 3% or less of tank capacity remains) being the only one lighted, an ISO (International Standards Organization) low-fuel warning symbol flashes once per second. In addition, the display includes ISO symbols for fuel (a gas pump and hose), plus the labels F, ½ and E.

Ford is also making extensive use of the car-silhouette graphic display, with LED's positioned at labeled points on the display to warn of low fuel, low washer-fluid level, low-beam headlight failure, tail-lamp failure or brakelamp failure. Legends are rear-lighted, and a pushbutton test switch verifies LED and driver operation (LED driver, not the guy behind the wheel) by lighting them all.

Lamp failures are detected by monitoring current to the lamps. Washer-fluid level is monitored by a sensor in the reservoir cap. That graphic display, of course, is available on models that don't already monitor those same functions through an electronic message center.

### Aftermarket computer dash

Okay, you've gone drool-happy about the convenience of microprocessor dashboard doo-dahs and you want one for your old tub at any price. You

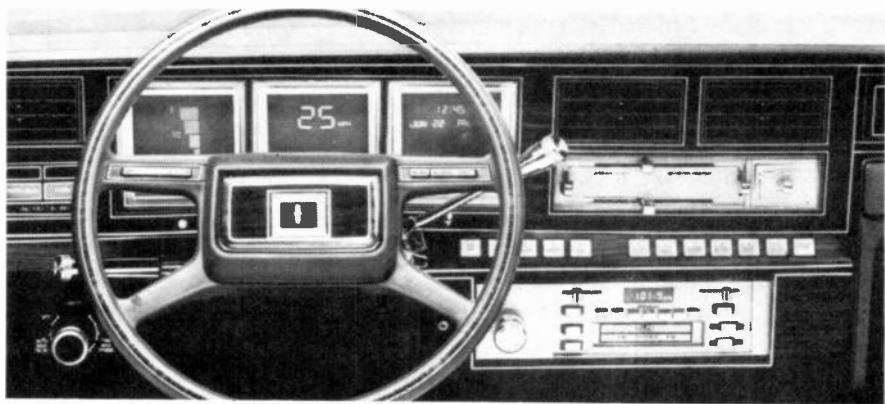

**ELECTRONIC INSTRUMENT PANEL** with Message Center is typical of what we'll be seeing from Ford. Row of buttons to right of shift lever is used to select various computer displays.

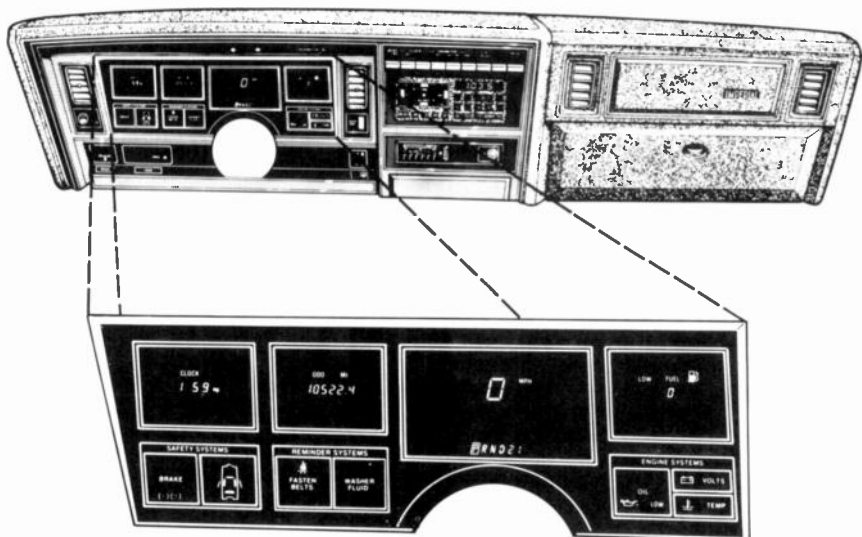

**INSTRUMENT CLUSTER—CHRYSLER IMPERIAL**

**DISPLAY GRAPHICS** tell time, date, trip elapsed time, accumulated mileage, trip mileage, average speed, fuel level, etc. Note systems warnings at bottom of instrument cluster.

remember the *Compu-Cruise* introduced by Zemco years ago—a calculator-size pod with lots of keys to press, a vacuum fluorescent display, and a custom version of the National Semiconductor COP (Control-Oriented Processor) doing the work inside.

Now Zemco (12907 Alcosta Blvd., San Ramon, CA 94583) offers that kind of utility in its newest incarnation, the ZT-1 and ZT-2.

They offer time of day, elapsed time, a stopwatch with a lap timer, trip time, time to arrival, time to empty, and an alarm. Distance traveled since fillup, distance to destination, and distance to empty. Fuel used since fillup, fuel used on trip, fuel needed to reach destination, and fuel remaining to empty. Current speed and trip average speed. Engage-at-speed cruise control and digital key-in-speed cruise control, both with resume. Current fuel consumption rate, trip average fuel consumption rate, current fuel efficiency, and trip average fuel efficiency. Inside and outside temperature. Battery voltage. And nighttime display dimming. Oh, yes—you have your choice of English or metric units.

The *Price On-board Computer* from Crown Products Group (Division of Prince Corp.), 35 Madison Avenue, Holland, MI 49423, is another trip computer offering fifty functions.

### The future

The single most significant change that technology is likely to bring to an automotive dashboard in the next few years is synthetic speech. A talking dashboard can alert you to problems, as appropriate, without ever pulling your eyes away from the road. Trip-status information can be recited on command.

The heads-up displays used in military jet aircraft make use of special angled semi-reflective panels. If those become less expensive in the near future, digital status displays can be presented in the driver's field of view—the numbers would appear to float in space in front of the car.

In months to come we'll tell you how state-of-the-art electronics is helping your engine run better, and how it's making car servicing better and easier, together with other interesting facts.

R-E

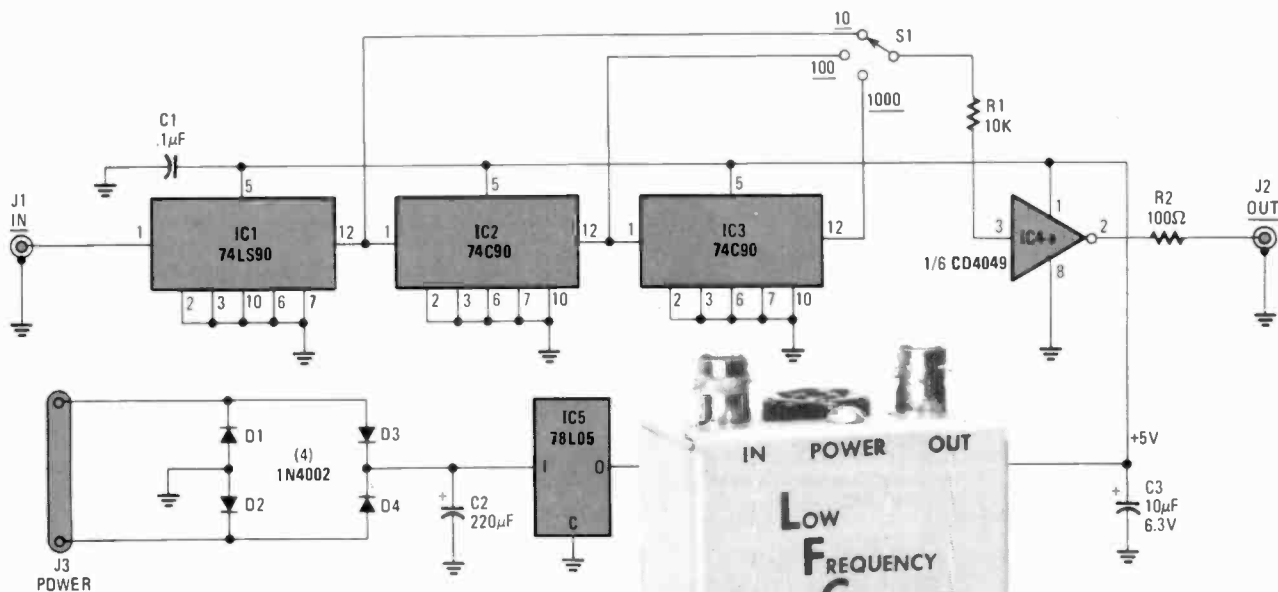

## Low Frequency Converter

*Extend the range of June's Synthesized Function Generator down to 1/10 Hz. This accessory is easy to build and will give high resolution without degrading performance.*

THE CONSTRUCTION ARTICLE ON THE SFG (SYNTHESIZED FUNCTION Generator) in the June 1980 issue has caused quite a bit of interest in high-performance function generators. But one of the shortcomings of the SFG project is that it won't go below 100 Hz. That is because of the basic design of that instrument. Any changes in circuitry would increase the time it takes to lock on frequency and its performance would be seriously degraded.

But there is a simple and effective way to extend the SFG's frequency range down to lower frequencies, and it can be done in a manner that *won't* degrade the performance. That is the purpose of the low-frequency converter. Now you can effectively extend the output of your SFG down to 0.1 Hz. And as a bonus, the original output signals and waveforms are still available to use. Plus, this project is adaptable to other function generators or signal generators with a range of up to 10 MHz! The low-frequency converter provides a symmetrical squarewave output signal, the frequency of which is equal to the input signal divided by 10, 100, or 1000.

The low-frequency converter is inexpensive and easy to build. When it comes to the construction, the parts are contained on a single PC board. And since there are only 5 IC's (none special), the work will go fast and easy. The parts cost isn't too unreasonable either, as a result of using common parts. Besides the advantage of being able to convert high

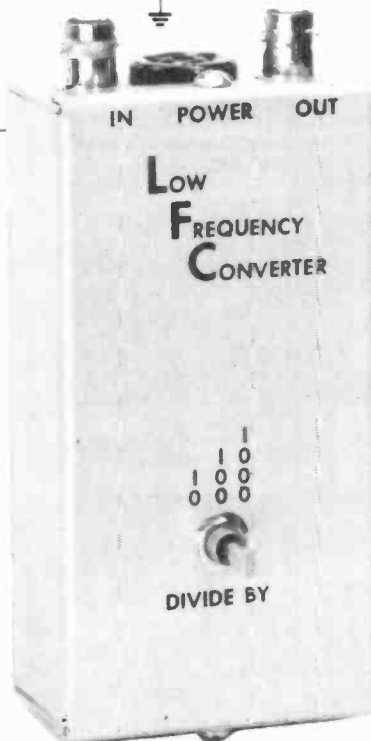

GARY McCLELLAN

frequencies to low, you'll like the easy construction and low cost.

Not to be left out, is the feature of switch-selectable divisors. Thus, you can select whether you want to divide the input signal by 10, 100, or 1000. And regardless of what position you choose, the output will be exactly 1, 2, or 3 decades less than what you started with! With that, let's get started with the project!

### How it works

Basically, the low-frequency converter consists of three decade counters, an output buffer, and a simple regulated power supply. (See block diagram in Fig. 1 and schematic in Fig. 2.) Each counter divides the preceding signal by 10, and is tapped off to drive switch S1. Also, the counters have been wired so that the output signal is symmetrical, in order to produce a type of waveform useful in more applications.

Switch S1 taps off the divided signals and drives inverter IC4. That device insures that there will be enough output to drive coax at high frequencies, or TTL devices.

Finally, the converter is completed by a simple regulated power supply based on a 5-volt, 100-mA regulator (IC5). The AC voltage to run the project comes from a surplus calculator-battery charging plug. That takes care of the theory. Now on to the construction!

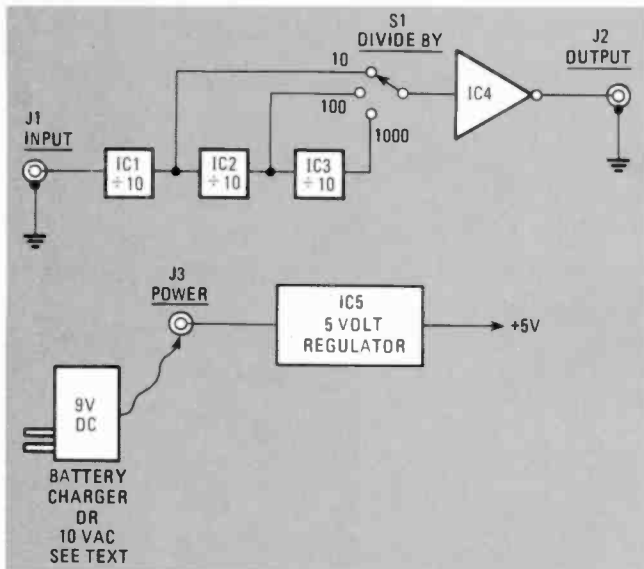

FIG. 1—BLOCK DIAGRAM of the low-frequency converter. It is used to divide the input signal by factors of 10, 100, and 1000.

### Putting it together

As you can see from the photo, this is a simple project to build. In fact, you don't even have to use a PC board unless you want to! However, a board *does* give the project a professional appearance. So you might want to make yourself a board from the pattern in Fig. 3 and parts placement guide in Fig. 4. After exposing, developing, and etching the board, drill all holes using a number 64 drill for the components and a 1/8-inch drill for the three mounting holes at the edges.

Now you are all set to begin construction. That will be easy, as you know that the bulk of the components are on the single PC board. Start by installing 14-pin sockets for IC1, IC2 and IC3. (It is a good idea here *not* to shave a few dollars by eliminating sockets; invariably a soldered IC will be bad!) Then continue by installing the 16-pin socket for IC4. Install capacitor C1 (0.1  $\mu$ F) above IC3, then move down to IC1 and install C3 (10  $\mu$ F). Note that the positive end faces away from IC1. Then move to the bottom edge of the board and install C2 (220  $\mu$ F), with the positive terminal facing C3. That takes care of the capacitors.

Now for the resistors. Install R2 (100 ohms) above IC4 in the center of the board, and R1 off-board as shown. Leave the lead full length, put a piece of insulating spaghetti over it,

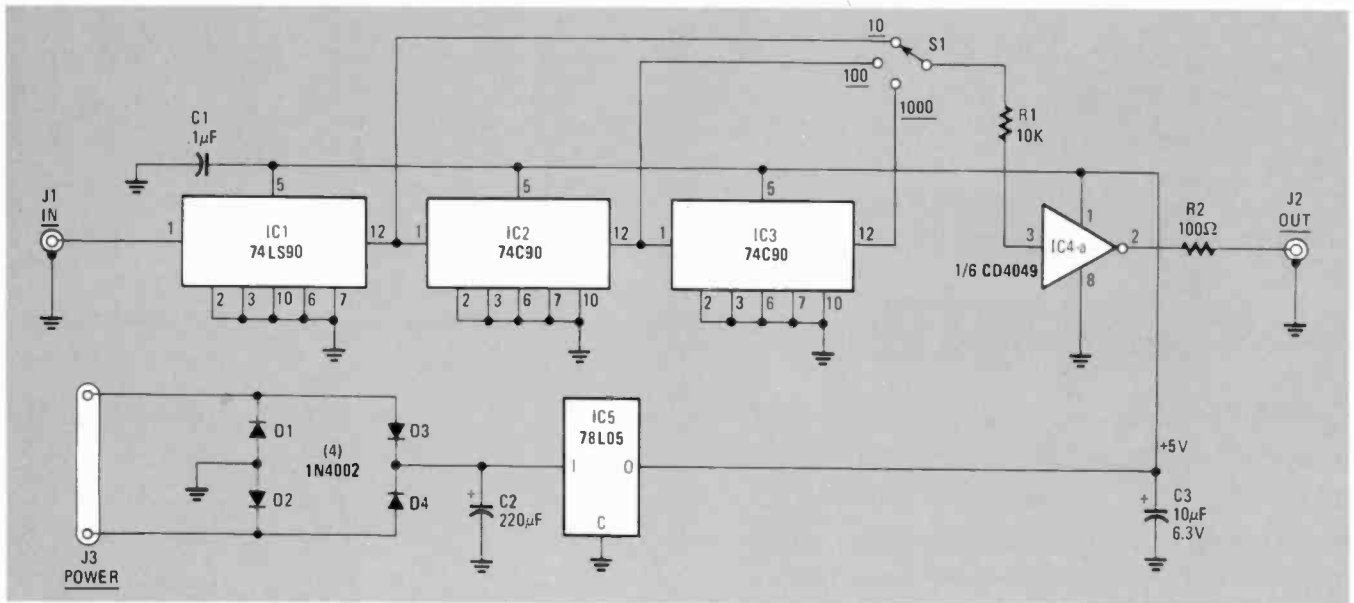
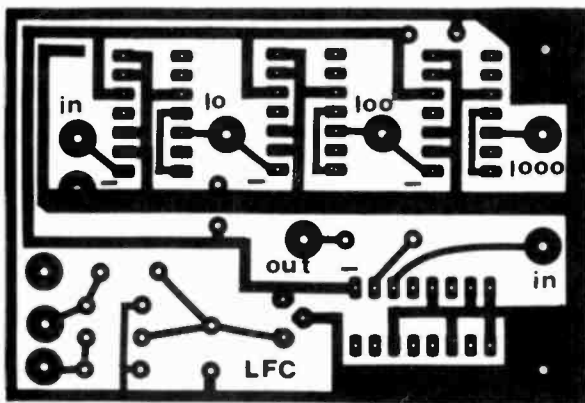

FIG. 2—THE CIRCUIT of the converter is relatively simple. Basically, it's three cascaded decade dividers followed by an Inverter.

### PARTS LIST

- C1—0.1  $\mu$ F disc capacitor
- C2—220  $\mu$ F, 16 volts, electrolytic
- C3—10  $\mu$ F, 6.3 volts, tantalum
- D1-D4—1N4002 silicon diodes
- IC1—74LS90N low-power Schottky decade counter
- IC2-IC3—National MM74C90N CMOS decade counter
- IC4—CD4049 CMOS hex inverter
- IC5—MC78L05, 5-volt, 100-mA voltage regulator
- J1-J2—BNC connectors
- J3—2-terminal connector (see text)
- R1—10,000 ohms, 1/4 watt, 5% resistor
- R2—100 ohms, 1/4 watt, 5% resistor
- S1—Single pole, three-position miniature rotary or toggle switch
- Miscellaneous—9-10 volt, 100-300 mA battery charger (see text), PC board, cabinet, knob for switch, spacers, hardware, wire, etc.

The PC board is available from Technico Services, 2610 Johnson Ave., La Habra, CA 90631 for \$5.50 postpaid. Foreign orders are \$2 additional. California residents add state and local taxes as applicable.



3 INCHES

FIG. 3—FOIL PATTERN for the printed-circuit board. Circuit is so simple that using stripboard or perforated board and point-to-point wiring will be a cinch.

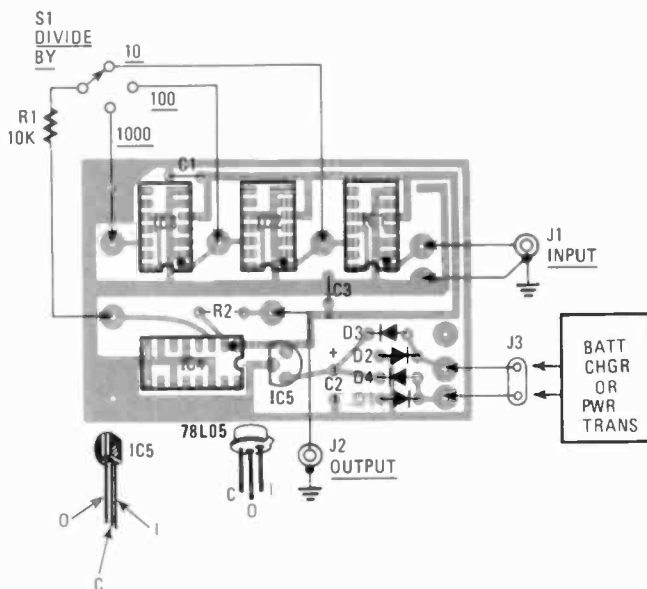

FIG. 4—PARTS PLACEMENT DIAGRAM also shows connections to off-board components. Diodes D1-D4 are not needed if DC supply is used.

and then solder the end to the IN pad next to IC4. The free end will be connected later.

Now you can install the diodes. Note that most battery chargers have a rectifier built in, so check your charger with a DC voltmeter first. If that is the case, and you get a DC output, leave off the diodes and skip this part. However, if your charger has an AC output (8–12 volts AC), install the diodes. Install D3 and D4 first, with the cathodes (banded ends) pointing to the left as shown, then install D1 and D2 with the cathodes pointing in the opposite direction.

Finish up the board by installing IC5 (78L05). Note how the flat spot in the case faces IC4. Then install the rest of the IC's beginning with IC4. Note that pin 1 has been identified on the foil side of the board. As you insert the 7490's, be sure that IC1 is the 74LS90 and that the rest of the 74C90's go in the IC2 and IC3 positions. Otherwise, the CMOS version may be damaged by static electricity if plugged into the IC1 socket. That finishes up the PC-board assembly. Check it over carefully for errors, and promptly correct any that you find. Then set the board aside until after the box is prepared.

The case may be nothing more than installing the board in your SFG and powering it from the existing power supply. Or perhaps you would like to use a separate box, as we did. The latter has a big advantage in that you are free to use the converter with other equipment when not needed with the SFG. At any rate, the choice of cabinet is up to you.

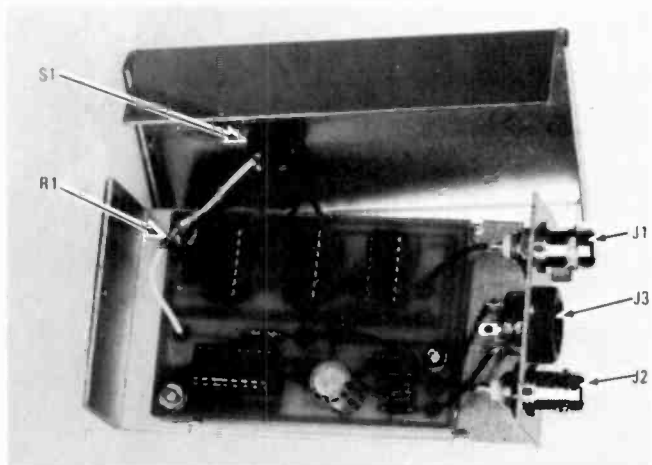

INSIDE VIEW of the low-frequency converter for use with the synthesized function generator and other similar generators. You may want to place the power connector on the end away from the coax connectors.

Start by drilling mounting holes in the box for S1 and J1 to J3. Note that J3 can be any 2-pin connector that doesn't ground a pin to the cabinet, so use whatever is available. After the holes are drilled and deburred, place the board inside the box behind the S1 hole and mark the mounting holes. Then drill with a 1/8-inch drill, deburr, and clean up the box. If desired at this point, you can apply decal labels to improve the appearance of the box and make the project easier to use. Use press-on letters and titles from your local electronics store to do the job.

Now you can assemble the parts in the box and finish the project. Install S1 first and then the jacks. Then install the spacers inside the box for the PC board. Since the board wires to the switch, attach the connecting wires to it first, and then to the board. After that, install the board on the spacers and connect the remaining wires to the jacks. Finish up by installing the board on the spacers with hardware. That takes care of the construction.

### Operating the converter

Using the LFC is a snap! Simply connect the input to any TTL-compatible signal source, and set the DIVIDE BY switch for the desired divisor. The output signal will then be exactly a tenth, hundredth, or a thousandth of the input signal. A good example of that feature is when the SFG is programmed for 100 Hz. By connecting this project to the rear-panel connector of the SFG and switching its range-switch to GEN, you can get outputs of 10 Hz, 1 Hz, and 0.1 Hz. Yet, if desired, the original 100-Hz sine, triangular and squarewave output is available. That feature is especially handy for general testing of several types of circuitry at once. **R-E**

## SOLID STATE NEWS

### Microprocessors

Fairchild's PEP is a low cost development and evaluation board for the F3870 microprocessor. At \$450 it is attractive for industrial, educational, and hobbyist computer applications. The system is useful in debugging hardware and software for F3870, F3872, F3876 and F3878 single-chip microprocessor systems.

The PEP system has a keypad and a six-digit LED display. It interfaces with RS-232C or current loop terminals at 110, 300 or 1200 baud rates. System firmware supports a high speed paper tape reader for program loading.

The PEP consists of 2K bytes of static RAM expandable to 4K on board. The board has a 2K ROM-based monitor, memory map strapping options, crystal-controlled system clocks, four general-purpose programmable timers, and four general-purpose interrupt controls. The 2K memory simulates the F3870 ROM and the 4K expansion simulates the larger F3872, F3878 or F3876 ROM's. An additional 128-byte workspace is provided for storing processor registers. Fairchild Camera and Instrument Corporation, 464 Ellis St., Mountain View, CA 94042.

Texas Instruments continues to expand their 16-bit 9900 line with a new 4 MHz

processor increasing throughput by one-third. The TMS9900-40 CPU uses separate address and data buses to reduce the delays associated with sharing these two functions on the same leads. This new CPU supports DMA, memory mapped and CRU I/O techniques. (CRU is a command page switching technique allowing memories larger than 65K to be addressed.) The other devices presently available in the 4 MHz 9900 family are the TIM9904-40 clock generator/driver, the TMS9901-40 peripheral systems interface and the TMS9902-40 asynchronous communications controller. The 9900J-40 JL CPU is priced at \$41.25 each in 100 quantities. **R-E**

## HIGH PERFORMANCE MINISPEAKER SYSTEM

*Get big sound from little speakers at a modest cost. Here's how to build your own minispeaker that will rival the performance of commercial ones.*

GARY STOCK

SOME SAY IT WAS THE ORIGINAL 1973-74 energy crisis and the 55 mile-per-hour speed limit that first started the automotive hi-fi boom and gave us the so-called "minispeaker." Others believe that the smaller sizes of urban apartments generated a need for small, high-performance speakers. And a few think that the minispeaker is just an old European concept revived and cleverly merchandised by a handful of importers.

Whatever the original source of the trend, these breadloaf-sized small speakers have become extremely popular in the past few years, and with good reason. They are physically unobtrusive and easily shoehorned into any available space. They perform admirably in applications ranging from extension speakers in the home, to automotive and RV speakers, to rear-channel speakers in elaborate time-delay music systems. Most important, the best of the breed sound simply astonishing—as open and lifelike as conventional speakers many times their size.

For less than thirty dollars, you can build your own high-performance minispeaker, and achieve essentially the same level of performance as found in the \$70 to \$150 audio-salon models. It uses the same basic format as assembled versions: a sturdy cast-aluminum enclosure having an internal volume of about two liters, with a 4½-inch bass/midrange speaker and a separate tweeter. And, it has the same high-style modernistic appearance as the hi-fi-store version, with rounded corners and (if you so choose) a smooth matte finish.

Before we get into the construction of the minispeaker, let's discuss each of the system's components, to get an idea of how it works.

### **Bass/midrange driver**

Like most other speakers of its type, our minispeaker uses a single small bass/midrange driver to reproduce frequencies up to about the 5,000-Hz crossover point. The driver is relatively small, to fit into the modestly sized enclosure, and it is thus limited in the amount of bass energy it can put out. That is because at bass frequencies either a large cone area or

the ability of the cone to move a considerable distance back and forth (called the speaker's *excursion*) is required. The driver's designers have alleviated that problem somewhat by using a so-called "long throw" design, in which a roll-surround and extra-long voice coil permit the speaker cone to travel farther than cones of conventional 4½-inch speakers, but lack of high-level bass output remains the speaker's major shortcoming. For reproduction of music in a normal size bedroom or den, the speaker will be limited to output levels of 90 dB SPL (Sound Pressure Level) or so at low frequencies. The system's response rolls off at 12 dB-per-octave below approximately 100 Hz.

At high frequencies, the bass/midrange driver's small diameter becomes an advantage. The degree of directionality or beaminess of any speaker is inversely related to its diameter, so a 4½-inch driver will disperse high frequencies over a wider area than would the 10- or 12-inch driver of a conventional bookshelf speaker. It is that lack of directionality that gives the best of the current minispeakers, and this unit, their sense of openness and depth.

### **Treble driver**

The minispeaker's treble driver is a 2-inch, paper cone unit. It operates over a narrower range than do many treble units in two-way systems, covering only the two octaves from 5,000 to 20,000 Hz. Since the power requirements at those high frequencies are fairly low, the driver's construction has been oriented toward smooth, extended response, achieved in this case through a lightweight aluminum center-dome and a very lightweight voice coil, with a thin but well-damped





paper material for the cone. It is interesting to note that, although there is nothing in loudspeaker-design theory that dictates that a given driver *must* have low moving-mass in order to achieve extended high frequency response, in practice it usually works out that way: Heavy cones and moving assemblies usually decouple from the voice coil at high frequencies and simply stop moving.

### Crossover network

The speaker's crossover network, shown in Fig. 1, is a first-order high-pass filter connected to the tweeter, with a series resistor to the tweeter, tweeter's output level (it is several dB more efficient than the bass unit, as is commonly the case in two-way designs). Acoustically, however, the network is somewhat more complex, in that the bass driver has a rolloff in its response at about 5,000 Hz as a result of its mechanical characteristics. Briefly, the voice coil of the bass/midrange driver decouples from the cone neck gradually in that range of frequencies, with a resultant 6 dB-per-octave attenuation at high frequencies. Both of the drivers have total power responses (theoretically, the integrated sum of their outputs as measured at an infinite number of points in a complete sphere around the speaker—practically achieved by measuring a driver's output at several discrete points) that roll off below their fundamental resonances at 12 dB-per-octave. They also roll off at 6 dB-per-octave, above the frequency at which the wavelength is equal to the diameter of the cone. Both of those curves also figure into the final characteristics of the crossover. In the final analysis, both drivers roll off at about 12-dB-per-octave outside their respective passbands, although individual frequency- and phase-response curves may not reflect that.

### Enclosure

Like most small speakers, our minispeaker uses an acoustic suspension design; that is to say, its bass driver's

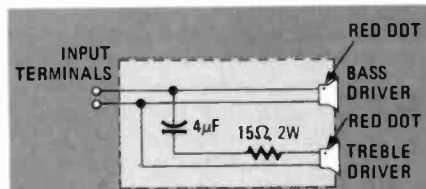

FIG. 1—CROSSOVER NETWORK uses a 4 µF capacitor to limit drive to treble driver.

stiffness is determined not by the stiffness of the cone edge, but rather by the stiffness of the small volume of air trapped in its enclosure. Below the system's resonant frequency of about 100 Hz, output falls at 12 dB-per-octave, as it does for all other sealed speakers. The enclosure itself is exceptionally rigid because of its aluminum construction, and therefore fairly resistant to the excessive vibration of panel walls sometimes found in larger wooden enclosures.

### Acoustical treatment of the bass/midrange driver

During assembly of the minispeaker, the cone and domed dust-cap of the bass/midrange driver must be treated with a damping compound in order to achieve best response. That compound has three functions:

1. It adds additional mass to the cone to balance the factors of cone stiffness, cone mass, and cabinet volume for optimal bass response.
2. It eliminates the tendency of the cone paper to absorb moisture under humid conditions and protects it from response variations caused by changes in the weather.
3. It damps out independent motion of different parts of the cone. That cone break-up, as it is called, is a major cause of peaks and dips in frequency response and results in unnatural sound. Four small felt pads are also cemented to the cone to reduce break-up.

### Assembling the speaker

The first step in constructing the minispeaker is to prepare the enclosure. Since the enclosure is cast metal, first remove the rough edges from both parts of the cabinet using a fine, flat file. Then, with Fig. 2 as a guide, mark out the front-panel mounting-holes as well as the boundaries of the driver mounting-holes. All of the front-panel mounting-holes should then be center-punched and drilled. Use a 3/16-inch bit and deburr the holes if necessary. Two additional 21/64-inch holes for the banana-jack connectors should be drilled on the rear face of the aluminum cabinet at this point (locating them at one corner of the back panel generally minimizes the wire run down to the rear deck or shelf, but the position of the connector holes is not critical). The same 21/64-inch bit should also be used

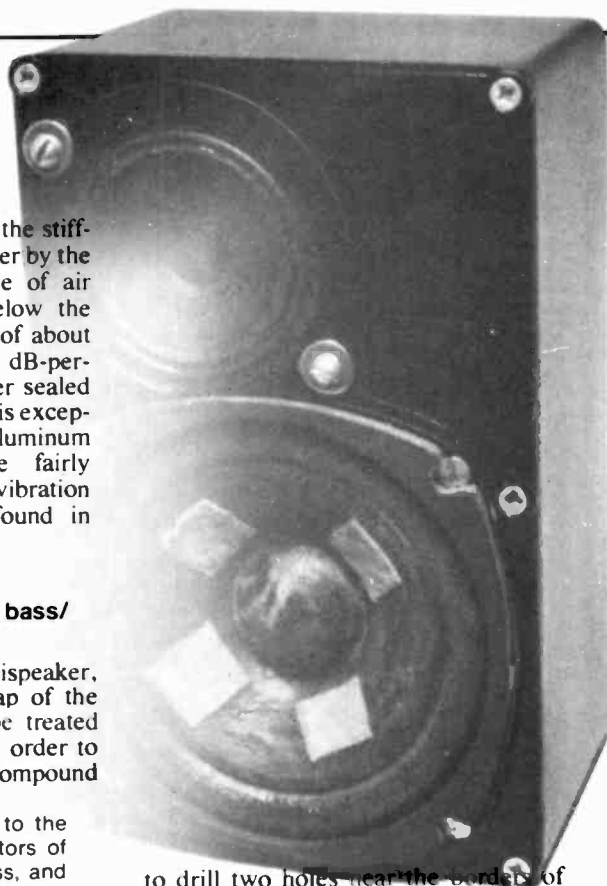

to drill two holes near the borders of the driver-hole markings; those will serve as the entry holes through which the head of the nibbling tool is inserted. Nibbling the driver mounting-holes takes a good 30 minutes per enclosure, and requires careful attention to the edge markings.

When the holes are complete, smooth the cut edges with a half-round file and with coarse sandpaper. Then give the entire enclosure—both the front panel and the cabinet section—a finish sanding, preparatory to painting. Any good spray enamel can be used to paint the enclosure, but for best adhesion, an initial coat of metal primer is usually necessary.

Part of the treble driver's frame will have to be cut away with metal-cutting shears, as shown in Fig. 3, to permit the unit to fit in the compact case. The template in Fig. 2 will indicate where to cut. Be very careful not to cut too close to the cone of the speaker, or to bend the frame.

With the enclosure painted and fully dry, install the drivers, sealing them into the enclosure using a bead of caulking compound, as shown in Fig. 4. Use 8/32 round-headed hardware, with washers for the treble unit (Fig. 5), and lock all of the nuts and bolts with a thread-locking compound to prevent them from loosening and causing buzzes and rattles. When the drivers have been fully tightened down, there will be some excess caulking compound that has been squeezed out by the

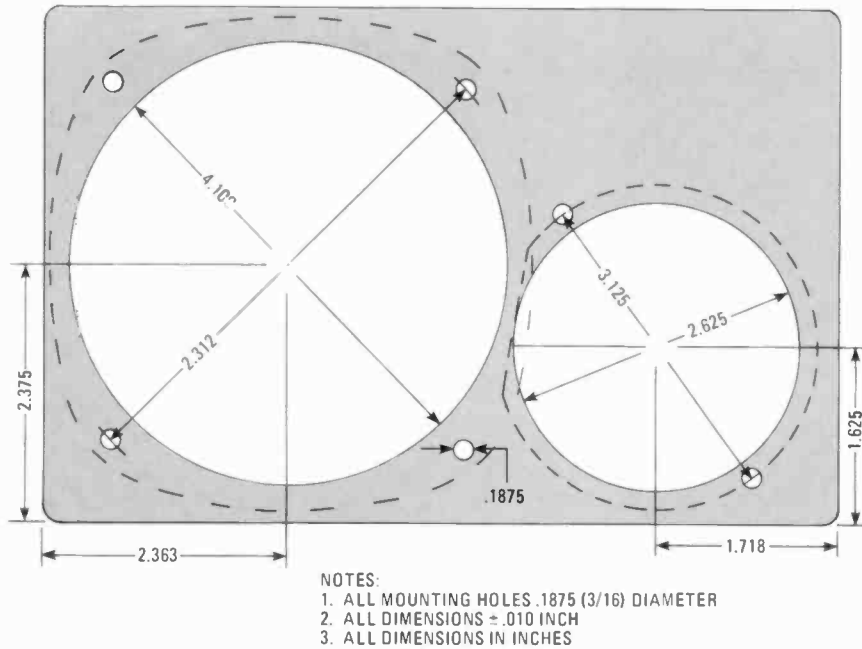

FIG. 2—CUTTING AND DRILLING template for front panel also indicates section of treble-driver frame that must be cut away to meet space restrictions.



FIG. 3—TREBLE DRIVER'S FRAME is trimmed using metal-cutting shears.



FIG. 4—CAULKING COMPOUND is used to give air-tight seal when speakers are mounted.

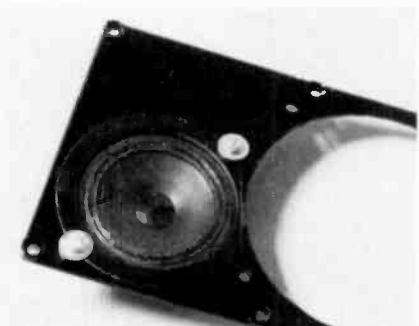

FIG. 5—METAL WASHERS secure treble driver frame to front panel.

### PARTS LIST

- Cast aluminum enclosure with cover, approximately  $7.4 \times 4.75 \times 3$  inches (Bud CU-347 or equivalent)
- 4.5-inch bass/midrange speaker (A11EC80-02F)\*
- 2.25-inch treble speaker (MTR225HFC or K225)\*
- 15-ohm, 5-watt composition or wirewound resistor
- 4  $\mu$ F, 35-volt mylar, or nonpolarized electrolytic, capacitor
- Banana jacks (2), one ea. red and black, with matching plugs
- 8-32  $\times$  3/4 round-head bolts with nuts and lockwashers (6 sets)
- Felt feet (4)
- Miscellaneous:** 18-gauge insulated wire in two different colors, clay-type rope caulking compound (Mortite brand or equivalent), acrylic matte medium (available at art supply stores), grille material, solder, etc.

\*NOTE: One source for these speakers is McGee Radio & Electronics Corp., 1901 McGee St., Kansas City, MO 64108. Catalog available upon request.

tightening process. It should be cleaned away using a cotton-swab stick or other pointed object that will not scratch the painted surfaces.

Install the rear-panel banana connectors and solder two 8-inch leads from them to the terminals of the bass/midrange driver, taking care to maintain polarity. Then solder the series-connected capacitor and resistor of the crossover network to the bass driver's additional positive lug, and to the tweeter's positive terminal. The capacitor and resistor should be cemented to the front panel surface using an RTV silicone-type adhesive, as shown in

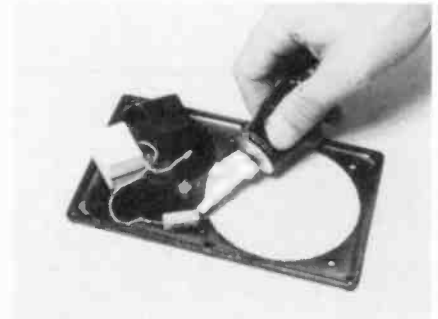

FIG. 6—SILICONE SEALANT holds crossover network components to front panel.

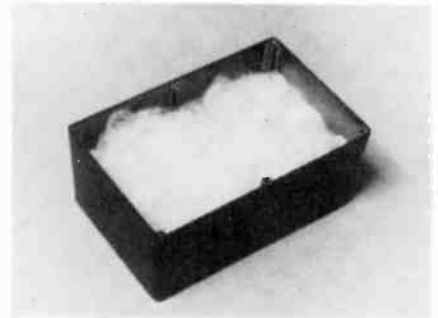

FIG. 7—POLYESTER PILLOW BATTING makes a good and inexpensive acoustic absorbent.

Fig. 6. Another short wire runs from the bass/midrange driver's negative terminal to the tweeter's negative terminal, to complete the ground side of the crossover network.

The speaker is now fully wired and electrically complete, but a number of additional steps are required to assure good acoustic performance. As shown in Fig. 7, the enclosure should be loosely filled with polyester pillow-stuffing material, which acts as an acoustic absorbent to suppress resonances inside the cabinet. When that has been done, the enclosure should be closed up, after a bead of caulking compound has been placed in the ridge near the rim of the front panel to seal the cabinet. Any excess compound squeezed out as the six fastening screws are tightened should be cleaned away as described above.

The most unusual step in the mini-speaker's assembly is the treatment of its bass/midrange driver cone with a damping/waterproofing compound. As discussed earlier, the compound and the felted material added to the cone have several purposes.

To treat the cone, apply a liberal coating of matte medium (see parts list) to the cone surface, covering the domed center portion and the surface of the cone out to the roll surround, but *not* the surround itself. When first applied, the material is white, though ultimately it dries clear. While the first coat is still wet, position four 1  $\times$  1-inch squares of common fabric-store felt on the flat conical portion of the cone surface, as shown in Fig. 8. Let it dry for several hours, and then apply a second coat

*continued on page 105*

# BUILD THIS

# UNICORN-1 ROBOT

*Part 5—It's time to get the show on the road! In this part we'll finish the body, give the robot a voice, and provide the means to command it.*

JAMES A. GUPTON, JR.

LAST MONTH, THE FOURTH PART OF THIS SERIES DESCRIBED THE CONSTRUCTION of the body frame and covered the areas of adding body rotation and arm-movement capabilities. In this part we'll complete the body wiring, add some simple electronics, cover the frame with a decorative skin, and build a remote-control box.

Before getting started, a point about the shoulder motors, discussed in Part 4, must be made. The gear motors recommended usually have their drive-shafts offset slightly from the center. That means that if both the left and the right motors were to be installed right-side-up, one arm would be farther forward than the other.

To avoid that embarrassment, mount one of the motors upside down.

Figure 35 illustrates the use of terminal strips for motor connections and limit-switch wiring. Those "local" terminal strips simplify connections between the components and the 32-position "master" terminal strip located in the mobility base. Circuit tracing is further simplified by the use of separate cables for the right and left sides of the robot's body. Color coding is used extensively to make things even easier to follow. But even if you use the wiring diagrams provided with this series it would be a good idea for you to make your own diagrams, showing the color codes and terminal identification system you use. That will fix in your mind exactly how *your* robot is set up.

A "left" terminal strip and a "right" one should be attached to the same support columns used to mount the shoulder motors. If shoulder motors are still in the future for your robot, the strips can be mounted on the columns nearest the points where the arms are attached to the body.

## Voice of the robot

Two inexpensive options you can add to your robot are an amplifier and speaker, and a horn. The speaker is located at the front of the robot, between two support columns (that is shown in Fig. 27 of Part 4). Two crosspieces should be added to give the speaker further support. Figure 36 shows a 6 × 9-inch speaker, together with a 12-volt horn, in place. Take care to "contour" the

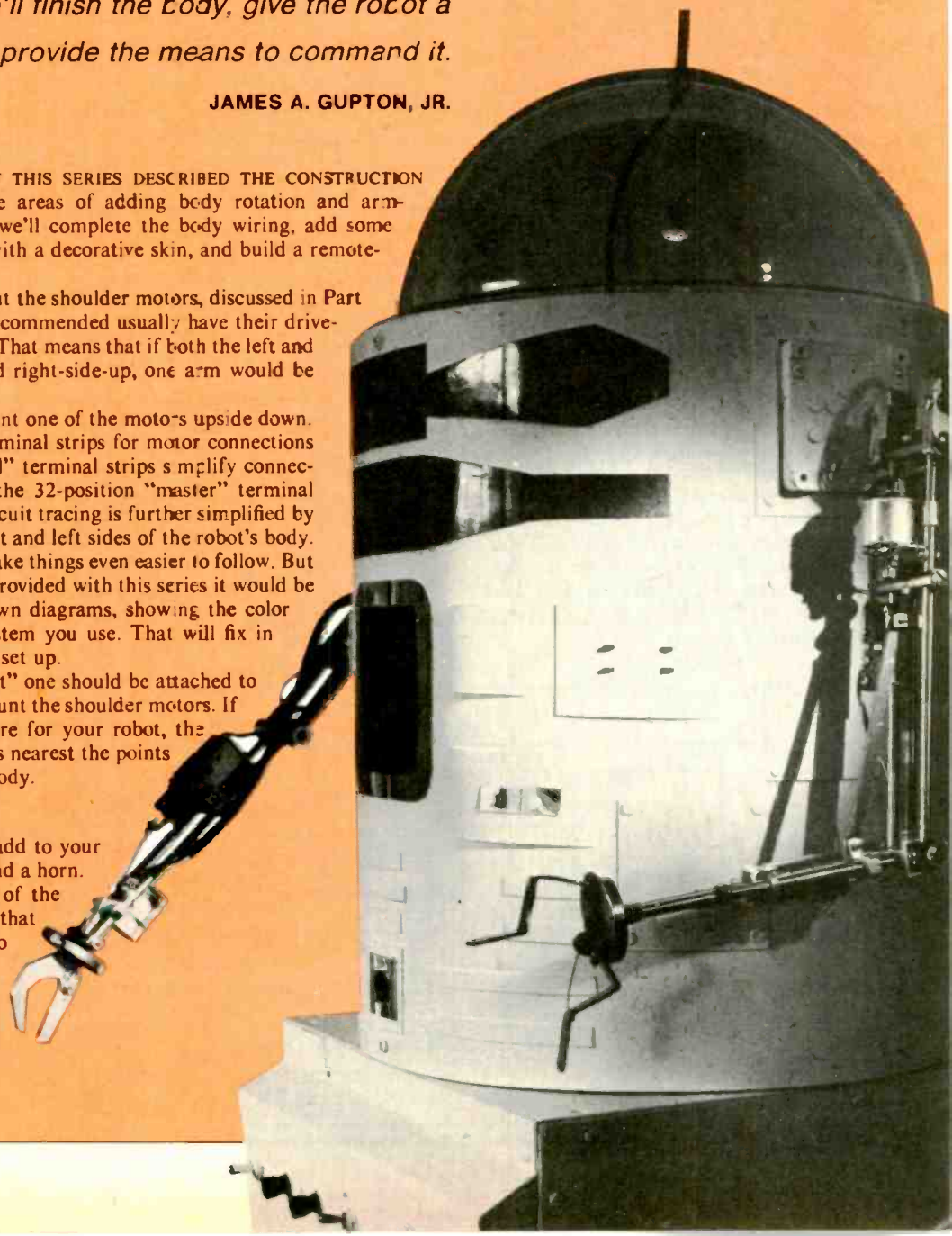

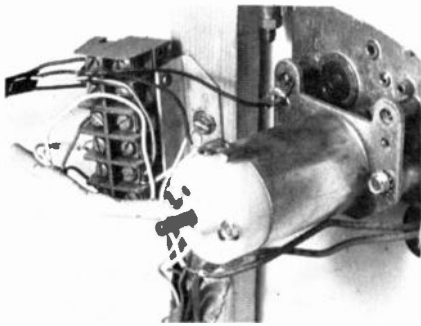

FIG. 35—LOCAL TERMINAL STRIPS make connections to motors and switches simpler.

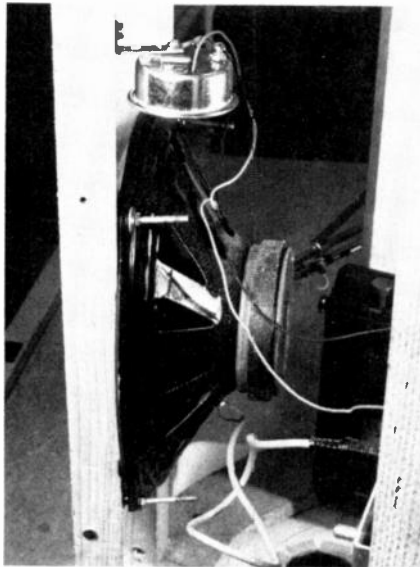

FIG. 36—SPEAKER AND HORN will later be covered by grille mounted over hole in skin.

crosspieces to conform to the bulkhead shapes, in order to prevent the skin from bulging at this location.

The amplifier for the speaker can be new, or scrounged (from a discarded 8-track tape player, for example), or built from scratch using one or two IC's. If you decide to build your own, refer to back issues of *Radio-Electronics* for ideas. For example, see "μA783 Audio Amplifier," November 1980 issue.

The voice of the robot may be pre-recorded on cassette and played back through an inexpensive recorder, using the amplifier and speaker connected to the recorder's earphone jack. The cassette recorder's motor can be controlled from the command console through a connection to the recorder's MOTOR jack by means of a subminiature phone plug.

It would be a good idea to use miniature phone jacks at the amplifier so that the speaker and audio connections can be easily disconnected if repairs are needed, and to simplify the changeover from cassette recorder to wireless microphone later on.

### The skin

So far, the robot has taken shape pretty well, but has still looked somewhat . . . naked. Now that the terminal strips and audio options have been installed, we can remedy that.

The fabrication of the skin is a bit tricky, so take your time, have patience, and double-check each step before going on to the next. Your efforts will be rewarded in the end.

The skin will be made out of *Formica*, which is available in 30-inch widths at most lumber or construction-supply houses. For the size robot we've been describing, you'll need 65 inches of .030-inch thick material. Figure 37 shows the final skin dimensions.

The first, and most difficult, part of this operation involves cutting the holes for the shoulder motors so that everything will line up perfectly. You'd better get someone to help you.

To start, use a *metal* tape measure (the fabric ones used in making clothes are not accurate enough) to determine the distance along the circumference of the top bulkhead from the front edge of one shoulder-motor housing to the front edge of the other. Mark the top bulkhead at the midway point.

The tape measure has to be held firmly against the bulkhead all the way, and must not sag. Also, to avoid any error that

might be induced by the presence of the end-clip (it will prevent you from keeping the end of the tape measure in contact with the bulkhead), start measuring three or four inches from the end of the tape.

**Remember, later, that you did this! If you started three inches from the end of the tape, and your reading was 22 inches, the actual distance was 19 inches!**

Now, unroll the sheet of skin material with its slick side (that will become the outside of the skin) up. Using one-inch-wide masking tape, secure it to a flat surface and measure it from end to end, the long way, to determine its center. Do that near both the "top" and the "bottom" of the sheet and then draw a center line through both points, using a china-marking pencil.

On either side of the center line, mark the positions of the shoulder-motor front edges. Do that by first dividing the distance measured earlier along the top bulkhead by two, and then making a mark, on either side of the center line, at this distance from it.

Then measure the horizontal and vertical dimensions of the shoulder-motor faceplates, and note their distance from the top of the top bulkhead. Mark those points on the skin material, using the front-edge markings as a starting point. You should wind up with a rectangle *approximately* the size of the motor-mounting plates and starting about 1/4-inch from the top of the material, if you are building a robot the same size as the prototype.

Before you start on the shoulder motor openings, double-check all your measurements! Remember, you're a surgeon, now. With an old magazine or pile of newspapers under the work area, you can begin. You can use either a single-edged razor blade (dangerous), a sharp pocket knife (also dangerous), or an *X-acto* knife (less dangerous). Work gloves wouldn't be a bad idea.

Very carefully, cut along the *inside* of the inscribed area, using several light strokes rather than one heavy one. The

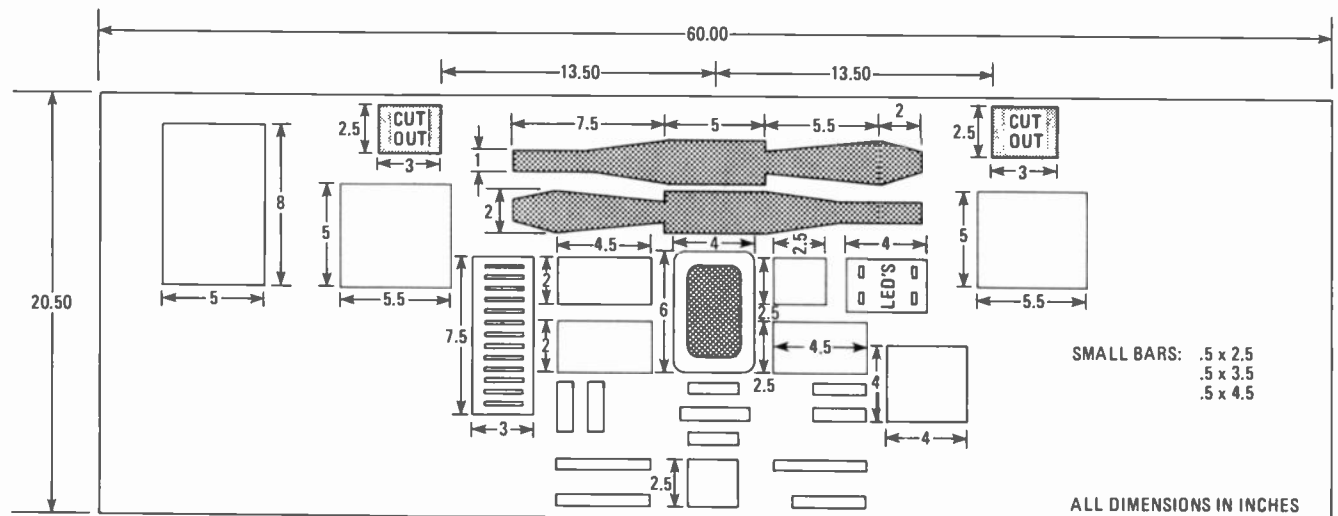

FIG. 37—FORMICA SKIN measures 20.5 x 60 inches. Text gives information on skin embellishments.

## PARTS LIST

| Item                | Size                        | Quantity     | Supplier's part no. | Supplier | Item   | Size             | Quantity   | Supplier's part no. | Supplier |
|---------------------|-----------------------------|--------------|---------------------|----------|--|------------------|--|---------------------|----------|
| Formica             | 30 X 60 in., .030-in. thick | 1            |                     | Local    | Terminal strip   | 8-position       | 3  | 264-670             | Ⓘ        |
| Plastic dome        | 18-in. diameter             | 1            | 85,216              | Ⓒ        | Switches:<br>S1, S7<br>S2, S5, S9  | SPST<br>N.O.     | 2  | 275-324             | Ⓘ        |
|                     | or<br>12-in. diameter       | 1            | 85,108              | Ⓒ        |  |                  | 3  | 275-1547            | Ⓘ        |
| Grommets            | to fit 1/2-in. hole         | 4            |                     | Local    | S3, S4, S6, S8,<br>S10-S12   | DPDT, center-off | 7  | 275-1545            | Ⓘ        |
| Self-tapping screws | 1/2-inch                    | 5 (see text) |                     | Local    |  |                  | <b>Miscellaneous:</b> amplifier and cassette recorder, decorative trim, adhesive, hardware for speaker and horn mounting, etc. |                     |          |
| Spray paint         | 13-oz. can                  | 3            |                     | Local    | <b>SUPPLIERS:</b>  |                  |  |                     |          |
| Speaker             | 6 X 9 inches                | 1            | 40-1268             | Ⓘ        | Ⓒ <b>Edmund Scientific Co.</b><br>101 East Gloucester Pike<br>Barrington, NJ 08007 |                  |  |                     |          |
| Buzzer              | 12 VDC                      | 1            | 273-051             | Ⓘ        | Ⓘ <b>Radio Shack</b><br>(consult local phone book)                                 |                  |  |                     |          |
| Cable               | 8-conductor color coded or  | 100 ft.      |                     | Ⓙ        | Ⓙ <b>Electronics supply house</b><br>(consult local phone book)                    |                  |  |                     |          |
|                     | 15-conductor color-coded    | 50 ft.       |                     |          |  |                  |  |                     |          |
| Control box         | 7 X 11 X 2 inches (approx.) |              |                     | Ⓙ        |  |                  |  |                     |          |

first cut should do no more than leave a slight mark on the surface; if you apply too great a pressure on the material, you can fracture it. That is critical along the top edge of the motor opening, since it can weaken the skin in this area, and could cause it to split later on.

If you do make an error, though—either in location or in “surgery”—you get one more chance. The material is wide enough for you to rotate it 180 degrees and start again. That, however, is your last chance! (Actually, you get one more—you can bury your mistakes under a “gasket” made of 1/2-inch strips of skin material cemented around the openings like a picture frame.)

After both openings have been cut, press the skin against the body to verify their positioning—but don't expect an exact fit at this point. You will almost certainly have to file the openings to size. Gently use a fine warding file to enlarge

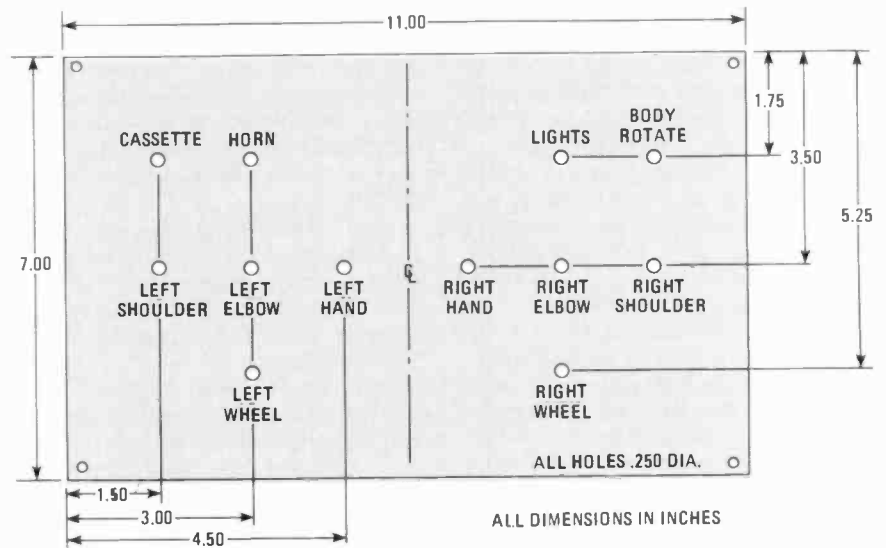

FIG. 39—DRILLING TEMPLATE shows suggested switch placement. Dimensions and layout may be revised to meet specific requirements.

the holes. Always file from the outside in, using single strokes. Never apply pressure on the return stroke, since that will cause the surface of the skin material to chip.

When the motor-mount openings have been trued and fitted, the next step is to measure the distance from the top of the top bulkhead to the bottom of the bottom one. Transfer that dimension to the skin material (in at least two places) and draw a line along the entire length of the skin to indicate its bottom. Cut along the outside of that line using a pair of heavy scissors. You should now have a piece of material that will completely enclose the

robot's body—and then some. Save the part you cut off—it can be turned into surface embossments later.

Place the skin into position over the robot's body, using the shoulder-motor openings as locating points. Wrap the skin around the body so it overlaps. Locate the nearest support-column position and mark the skin on both sides of it to give at least 1/2-inch of overlap at that point. Be sure to mark both the top and bottom of the skin. You can use the scissors to cut the skin to size.

One more opening has to be cut—the one for the speaker. Remove the skin



FIG. 38—COMMAND CONSOLE provides the means for controlling remotely via cable.

from the robot and again tape it down in your work area. Determine where the speaker opening will be (use the same techniques described above) and mark a rectangle over the center line that is 1/2-inch smaller on each side than the size of the speaker cone. The surgical technique for cutting this hole is the same as before.

### Embellishments

There are several simple things that can be done to give the robot a more sophisticated appearance. The easiest is to cover the speaker opening with a piece of porous foamed-plastic or metal speaker-grille material. That, of course, should be mounted from the inside of the skin.

Self-adhesive, metallized sheet plastic can be used to give the effect of chrome.

The skin may be embossed using remnants of the skin material, cut to size and attached with contact cement, plastic glue or epoxy. The smooth surface of the skin material is reluctant to accept certain cements and should be roughened with coarse sandpaper prior to receiving the add-on's. Use weights on the embossments until the glue sets. You can get some ideas for embossments from those shown in Fig. 37, but let your imagination rein free!

In cutting out the embossments, you should observe the natural curve of the material. The shapes you cut for *horizontal* embossments should be cut so their grain runs the same way as that of the skin. Those for *vertical* shapes should be cut against the natural curl.

An ordinary hole-punch can be used to simulate rivets or—better yet—screw heads can be severed from their stems and glued to the skin. Try using silicone sealing compound, which will give adhesion along with a bit of flexibility.

Once the cement has set, the skin can be permanently affixed to the body. After seating the motor facings in their openings, wrap the skin around the body to the "lap" position you determined earlier. Start at the center line and drill a small hole to, and through, the top bulkhead to act as the lead hole for a sheet-metal self-tapping screw.

That type of screw is preferred because it holds better in particle board (the bulkhead material) than regular wood screws.

If your alignment is good, you'll need only five screws to secure the skin—one each at the top and bottom of the front center-line, and one each at the top, middle and bottom of the rear overlap area. Use more if it makes you feel better.

### Finishing

Before you paint the body, clean it up. Excess cement that may have seeped from under the embossments can be removed using a sharp blade. If there is so much seepage that it resists cutting, remove it with a file and, toward the end,

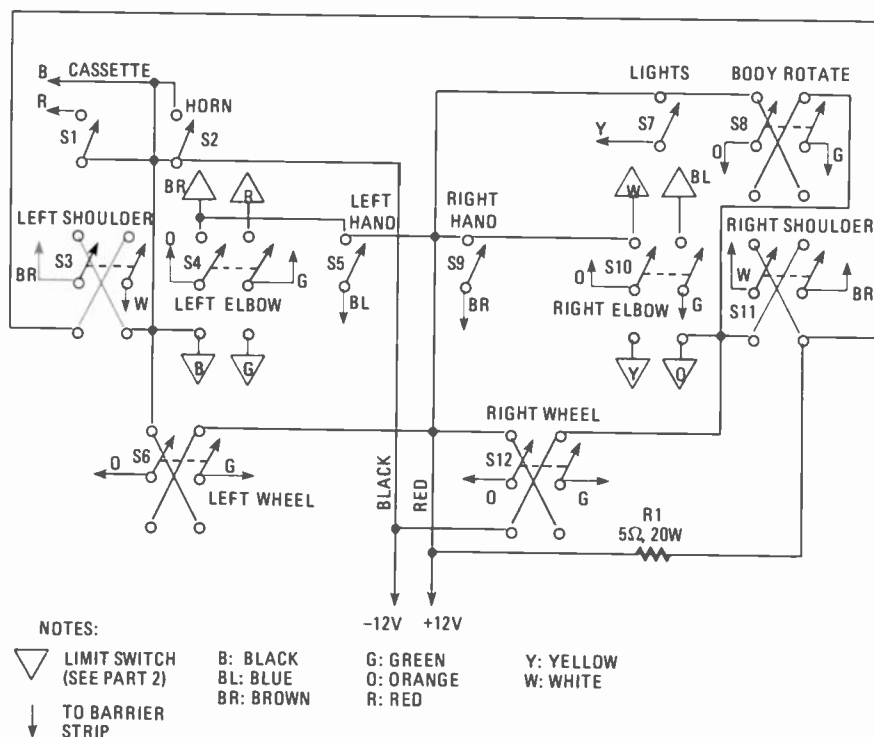

FIG. 40—CONTROL CONSOLE wiring diagram, as viewed from top of switch panel. Switches are shown in black; wiring and connections to terminals in color.

with No. 000 emery cloth.

Before applying the paint, cover any metallized areas with masking tape, trimmed to size. Also, be sure to cover the speaker opening. You don't have to cover the motor-mounting plate or the motor shaft unless the shaft already fits very tightly into the *manipulator's* opening. If that is the case, tape only the shaft.

Also, cover any areas—such as the mobility base—that you may not want to paint, or may want to paint a different color. (If necessary, a little paint remover, *gingerly applied*, will completely erase your mistakes.)

Flat white (although the choice is up to you) spray enamel produces a good finish, and three light coats will do a better job than one heavy one. Hold the spray can about a foot from the surface, using strokes that begin at the top of the body and go to the bottom. Work your way around the body, and then rest and let the paint dry. Do that three times.

If, for some reason, the paint drips, let it dry completely and then file and sand it down. Repaint that area very lightly. (Such repainting *doesn't* count as one of the three coats.)

Any embossments you want to be of a color different from that of the skin should be painted before the skin is done. After the skin has been painted, the appropriate areas should be roughened and the embossments cemented to them. Take care—touching up can be very touchy!

Finally, before attaching the robot's manipulators to the shoulder motors, drill or punch (using a chassis punch) two 1/2-

inch diameter holes, about one inch apart, in the skin on either side of the gear-motor axle, and about two inches below it. Place rubber grommets into those holes to protect the motor and limit-switch wires that you will now pass through them—to be connected to the "local" terminal strips—from abrasion. Allow enough slack in those wires to permit the manipulators to move from a straight-up position to one about 45 degrees beyond the straight-down one (so they extend slightly behind the robot).

### Control console

This is the moment we've been waiting for—the means to give the robot its first instructions. The control console, shown



FIG. 41—ROBOT'S DOME can be made from salad-spinner or from terrarium cover.

in Figs. 38 and 39, is connected by an umbilical cable to the mobility base. The box may be any convenient size—the author used one measuring  $7 \times 11 \times 2$  inches. The switch holes are  $\frac{1}{4}$ -inch in diameter and should be drilled before the control console is finished. Refer to Fig. 40 for a top view of the console, showing the wiring connections. Note the use of color-coding. A total of 12 switches is required (see parts list). Press-on lettering can be used to designate the switch functions, and a coat of clear acrylic spray applied to protect the labels from wear and tear.

The umbilical cable may be made up of four 8-wire cables, or two 15-wire ones. It

will run to the 32-position mobility base terminal strip (Part 3, Fig. 26), from which signals will be routed to the appropriate switches and motors. While DC power *can* be supplied to the robot via the umbilical cable, heavy cable would be needed; it is better to rely on the battery in the mobility base (see Part 3).

It should be noted that the 12-volt negative (–) line is common to all switches, including those wired to operate at reduced voltage (with 5-ohm dropping resistors).

The reader should also refer to Part 2 of this series, which discusses the wiring of the limit switches—and give particular attention to Fig. 18.

Finally, the robot's crowning glory, shown being added in Fig. 41, is a clear plastic dome—that can be made from part of a "salad-spinner" or is available from the source indicated in the parts lists.

This completes the basic design details of Unicorn-1 . . . but there's more to come. The next installment will cover such topics as:

1. LED's for motor-direction indication.
2. A rotatable end effector for the robot's arm and a new extendible arm.

And those two items are only the beginning . . . R-E

# Solid State News

## HMOS 2114 RAM

Intel has announced the 2114A HMOS version of the  $1K \times 4$ -bit static random-access-memory. While it draws 40% less current than the standard 2114 part, the new version has a speed range of 120 to 250 nanoseconds. Pin-for-pin compatibility between the old and new parts make them useful in upgrading existing systems as well as in new designs of microprocessor systems, buffer memories, and main memory systems.

Intel has now had three years experience with the HMOS process and says that it has proven to be very reliable and widely accepted.

The RAM's range from the 120 nanosecond, 40 milliamp, 2114-AL-2 to the 250 nanosecond, 70 milliamp, 2114A-5. Prices for the respective RAM's are \$20 each for the high-speed, low-current IC, and \$10.80 each for the higher-current, lower-speed part, in 100 quantities.

Intel is also offering a math processor IC to add high-speed mathematical capability to microprocessor systems. Most microcomputers rely on software routines to carry out time-consuming math functions. The Intel 8232 and 8231 arithmetic-processing units are aimed at industrial control, numerical control, scientific calculation, and graphics and pattern generation. Speed improvements are in the range of 10 to 100 times compared to software-supported floating-point math systems. The IC's referred to are shown in Fig. 1.

The 8232 does 64-bit, double-precision floating-point addition, subtraction, multiplication, and division. It can also do 32-bit math at higher speed. Single-precision multiplication takes about 100 microseconds.

The 8231 does fixed point, 16-bit and



FIG. 1

32-bit addition, subtraction, multiplication, and division, and can also calculate sine, cosine, tangent, inverse sine, inverse cosine, inverse tangent, square root, logarithm, natural logarithm, exponentials, and powers.

The IC's use a 16-bit arithmetic logic unit, a microprogrammed algorithm controller, an 8 by 16 operand stack, a 10-level working register stack, command and control registers, and a control ROM.

Both devices come in 24-pin packages and require +12- and +5-volt power supplies. They interface to the 8080, 8085, and 8088 microprocessors as well as to other processors with 8-bit data buses. Intel Corporation, 3065 Bowers Avenue, Santa Clara, CA 95051.

## Microprocessors

Fairchild's PEP is a low-cost development and evaluation board for the F3870

microprocessor. At \$450 it is attractive instrument for industrial, educational, and hobbyist computer applications. The system is useful in debugging hardware and software for F3870, F3872, F3876 and F3878 single-chip microprocessor systems. The PEP's program memory can be downloaded from a cross-assembler running on another microprocessor development system.

The PEP system has a keypad and a six-digit LED display. It interfaces with RS-232C or current-loop terminals at 110, 300 or 1200 baud rates. System firmware supports a high speed paper tape reader for program loading from that medium.

The PEP consists of 2K bytes of static RAM expandable to 4K on board. The board has a 2K ROM-based monitor, memory map strapping options, crystal-controlled system clocks, four general-purpose programmable timers, and four general-purpose interrupt controls. The 2K memory simulates the F3870 ROM and the 4K expansion simulates the larger F3872, F3878 or F3876 ROM's. An additional 128-byte workspace is provided for storing processor registers. Fairchild Camera and Instrument Corporation, 464 Ellis St., Mountain View, CA 94042.

Texas Instruments continues to expand their 16-bit 9900 line with a new 4 MHz processor increasing throughput by one-third. The TMS9900-40 CPU uses separate address and data buses to reduce the delays associated with sharing these two functions on the same leads. This new CPU supports DMA, memory mapped and CRU I/O techniques. (CRU is a command page switching technique allowing memories larger than 65K to be addressed.)

The other devices presently available in the 4 MHz 9900 family are the TIM9904-40 clock generator/driver, the TMS9901-40 peripheral systems interface and the TMS9902-40 asynchronous communications controller. The 9900J-40 JL CPU is priced at \$41.25 each in 100 quantities. R-E

## USEFUL TROUBLESHOOTING HINTS & TIPS

*Expensive equipment isn't the answer to every service problem. Here are some alternate approaches.*

ELLIOTT S. KANTER

IT SEEMS A SHAME THAT IN OUR NEW technology, the older and more comfortable methods of troubleshooting are lost forever. If any of you are old enough to remember or to have worked with vacuum tubes, you will no doubt recall the use of the "circuit-disturbance" technique for troubleshooting a vacuum-tube circuit. In the older and less complicated days, all one had to do was, in effect, to short the grid to ground and listen (assuming the circuit was an amplifier) for a corresponding click at the output. The louder the click, the more stages of operational amplification. But, alas, all of that has changed. Today's test equipment is more likely to consist of such tools as multi-digit voltmeters with accuracies in the area of 0.1%. The purpose of this article is to explore some new techniques which actually have their basis in older technology and to take a fresh look at some of the problems we all face in repairing sophisticated equipment. Case histories of actual problems will be used wherever possible.

### The "lost" power supply output

It started out as a routine service call to an area hospital. A newly-installed patient-monitoring system was malfunctioning at one bedside. As long as the medical technician plugged in an analog-display device or module, there wasn't any problem, but the moment a digital-display module was connected, the lights dimmed and the system failed. Each monitor unit contained its own regulated DC power supplies with + and - 12-volts and 5-volts DC available and, according to the manual, the supplies were capable of providing at least one full ampere in all modes. There was a conventional "crowbar"

circuit to shut down in the event of problems, but a cursory check with a meter showed that the crowbar had not shut the supply down; nor did it appear that any of the supply voltages were off.

According to the manufacturer, the supply voltages were to be 12 and 5-volts respectively, with a tolerance of  $\pm 5$  mV, and that indicated the use of a digital voltmeter for verification and adjustment, if necessary. No adjustment was required; a check of the boards revealed no shorted components, and the cables connecting the supply with the "motherboard" in the cabinet also appeared to be essentially normal. Yet, when power was applied to a digital module, everything came to a shutdown. Normal troubleshooting techniques were used, and the digital meter verified that the correct voltages were present at each and every "land" on the motherboard for each position.

A different module was tried and the same result: shutdown. Having tried virtually everything possible, I substituted another power supply and still found the same condition. It was obvious that the problem was no doubt simple, yet had escaped my multi-digit, three-decimal-point-accuracy meter. Looking through my tool box, I found a device that I felt just might be the answer to my problems, or at least could start me in the right direction. A piezo-electric sounder, capable of operating over a range of 6 to 28 volts DC was left over from another service call. I also had a small full-wave bridge; and the circuit shown in Fig. 1 was born.

In essence, the basic device is a voltage sniffer, which in my case enabled me to locate the source of my problem. How, you ask, did a few components with value of perhaps ten dollars solve

a problem that the digital meter could not? The answer is simple: The little tester could do something that the high-priced meter could not—it could *load the circuit down*, by about 20 mA. That corresponded to the load presented by the digital-display devices, and within a few minutes I was able to locate the problems with *both* power supplies.

Although they measured and indicated correct voltages on *high-input impedance* meters, neither of them could deliver the rated circuit due to cold-solder joints between the wiring terminals and the PC-board lands. Those cold-solder joints were drawing the supplies down to the point where they could not furnish the 60 mA or so required to operate the modules. The liberal application of a 100-watt soldering iron to the terminals solved the problem. The circuitry shown by the

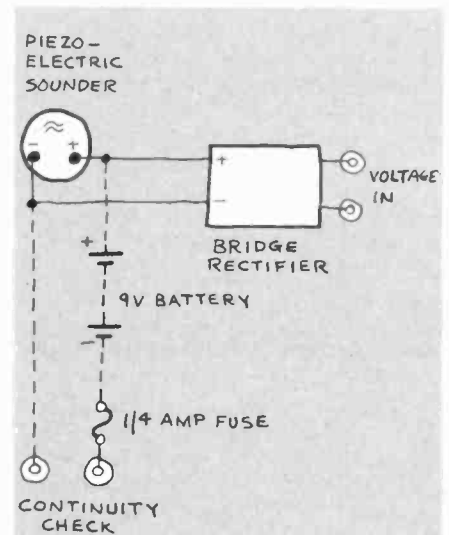

VOLTAGE SNIFFER loaded down circuit mentioned in text, pinpointing the trouble.





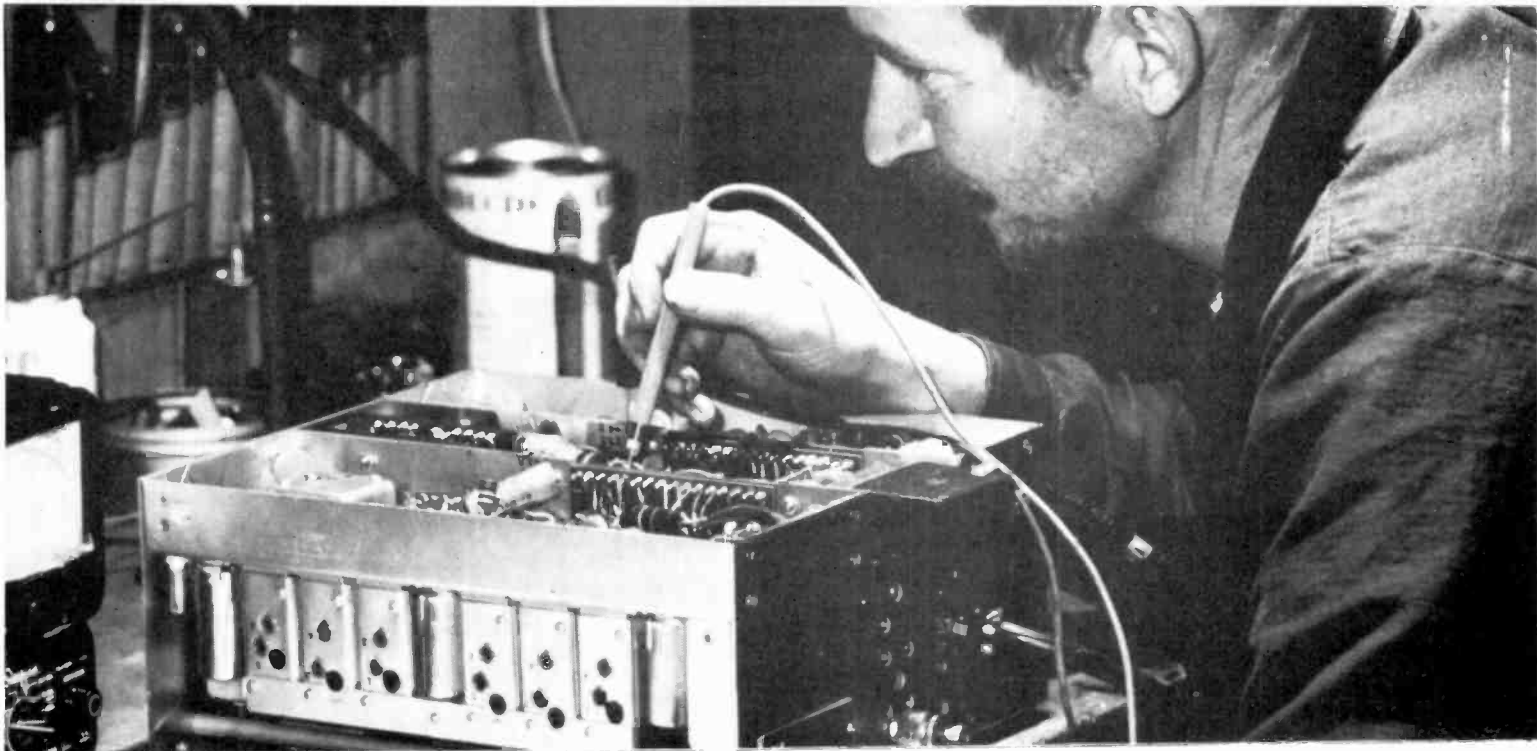

dotted lines was added later so that this same device could function as an audible continuity tester, another valuable addition to the service toolkit.

What that case reminded me of was the fact that *simpler* might just be *better*. Having watched electricians test circuits using lamps attached to test leads probably gave me the basic idea for this tester, but there is a fuse added in the "continuity" side just in case you try to sniff DC using the wrong test leads. The tester has literally paid for itself a hundred times over by allowing me to check for the presence of voltage without having to worry about polarity (that's why a bridge rectifier is used).

#### From my wife's sewing basket

Have you ever come across a tape deck where a belt had slipped off a pulley and there were two ways to get it back on? The first was to disassemble the entire works and run the risk of losing small parts, or watching those brass-headed Phillips screws disintegrate before your eyes. The second was to find some way of getting into the works gingerly, and re-positioning the belts back on the pulleys without wasting time in disassembly and reassembly or running the risk of losing parts.

The answer or solution came to me one night as I rummaged my way through my wife's sewing basket. I came upon some lovely thin plastic probes which just happened to have a tiny hook at one end. I couldn't believe my eyes! Here's exactly what I'd been looking for. I'd never found anything like it in an electronics tool catalog, but not only did my wife have *one*—she had a whole assortment of different sizes and shapes. On questioning, she identified that belt positioner as a

crochet hook, and further informed me that they were available in a variety of sizes—and to keep my hands off her stuff! A trip to the local department store provided a literal treasure chest of tools, and all of them found in the "Notions-Sewing" department. The size "G" hook seems to fill the bill for me although I gently bent it a bit after softening the plastic in hot water to make it even more useful. What's even better, those hooks come in conductive (metal) and non-conductive (plastic) versions, and cost less than a dollar. The plastic versions are also a best bet for probing for loose wires and components while the chassis is "hot." Because they are plastic, there is no danger of short circuits.

After finding the ideal tool once in her sewing bag, I remembered what I used to use to clean out solder from circuit board holes when I worked at the hospital. Back then, I'd use a 28-gauge syringe/needle assembly, but it seems that the federal government frowns on "civilians" having needles and syringes, and I had to give that trick up when I left the hospital. You see, the needle was made of stainless steel and solder would not adhere to it. After heating the pad, you could pass the needle into the hole, and remove the heat. The remaining solder would cool and you could then remove the needle (the plastic syringe made a great handle), leaving a perfectly clean hole. What was even better was the fact that those needles were available in a variety of sizes, which were the same as wire gauges. I really missed them—until I spied my wife's collection of sewing needles and *glory be*—they were stainless steel, came in a variety of sizes, and I couldn't get into trouble for using

them (unless I tried to take them from my wife).

Again, at the department store, I purchased an assortment of sewing needles and made a tool using small sections of dowel rod, about four inches long, and about the diameter of a pencil. I drilled a tiny pilot hole in one end, inserted the needle, sharp-end out, and a drop of glue secured the tool. When I finished, a collection of the best hole cleaners was mine for a few pennies worth of materials and a drop or two of glue. They work just as well as the hospital supplies and can be easily carried in my tool kit. Please note—put a small cork or piece of plastic foam around the tips, since they are sharp and can cause painful punctures. The handle prevents you from getting burned, for although stainless steel does not permit solder to adhere, it does conduct heat well.

#### Testing for safety

Most cities now require certain key electrical outlets in damp areas such as basements and workshops to have specially protected GFI (Ground-Fault Interrupter) circuits installed. What those devices do is to monitor the state of the lines and, if a fault current of 5 mA or greater is detected between the "hot" line and ground, trip the circuit and cut the power. Those devices have probably saved a lot of lives, and new tool extension-cord sets have them built-in. But, if you don't test a GFI device, how do you know it is working? More important: Will it work and save you from a potentially dangerous electric shock when the time comes?

Testing a GFI is simple, and the circuit in Fig. 2 shows you how to make a simple set to test the 5-mA GFI's normally found around your home. A

plastic-shelled three-prong plug is used together with a variable resistor and a switch. A small neon indicator completes the circuit. The indicator will be on before you press the test switch and *must* extinguish after the GFI trips.

If the lamp remains on there are two possible problems: 1) The GFI is defective, or 2) the resistance doesn't simulate a 5-mA-fault from ground to the "hot" side of the line. You should measure the current as you adjust the resistor; the calculated resistor value for a nominal 120-volt line is 24K ohms. To use the device, simply plug it into an outlet protected by a GFI. The lamp should be on; depress the switch and the lamp should now be off. Reset the GFI after having established that it is in working order.

### Static electricity and CMOS don't mix

One drawback to CMOS circuitry is that while it can operate better at lower voltages and current drains than TTL, and produces less heat, it just can't tolerate static electricity. Static electricity, or the control of it, is a familiar subject to people who work in hospital operating rooms. They don't deal with CMOS all that much, but in the medical profession, static-electric discharges have proven in some cases to be fatal. Those cases had to do with leaks of flammable gas, such as an anaesthetic, in the operating room. A minute spark caused by a static-electric discharge has been sufficient at time to cause an explosion.

Techniques to control static electricity were developed, and those interested in the many ways it can, or should, be controlled can get a copy of NFPA (National Fire Protection Association) Booklet 56A, which should be available in your library. Static electricity is produced by friction when two dissimilar materials come into contact. That's more or less a simple explanation, and equally simple is a method to static-proof your work area. All you have to do is to eliminate differing materials or potentials. In the operating room, we used conductive furnishings and rubber. But, those are not conductive in the insulator/conductor sense we're all familiar with.

Conductivity, from a static-electric standpoint refers to a material that measures from about 25K ohms to 1 megohm. If all surfaces can be held to around that value, there isn't much chance for a static-electricity problem to develop, providing you keep the humidity at a minimum value of 50%. That's easy; simply fill a wastebasket with water, roll up the Sunday newspaper and tie it securely, and let it sit in the water and act as a wick.

That takes care of the humidity, but what about the work area? The top of Fig. 3 shows a conductive surface that

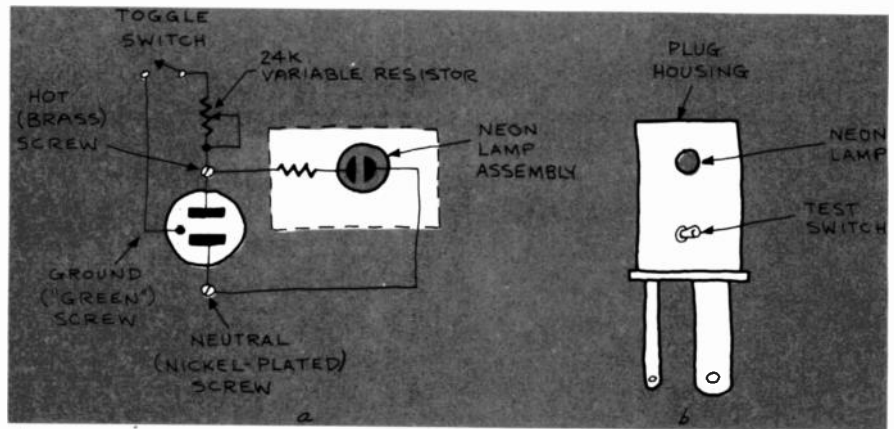

FIG. 2—GROUND FAULT INTERRUPTER circuit tester (at left) is easily housed inside plastic-shelled three-prong plug.

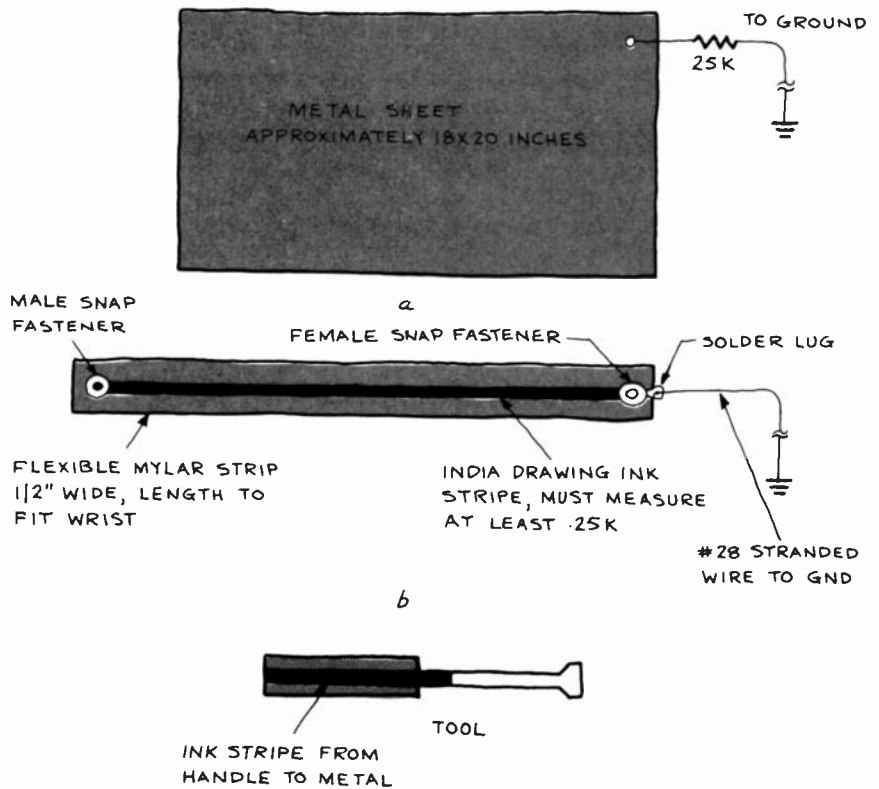

FIG. 3—INDIA INK is conductive and can be used for grounding purposes. Several coats will give you a resistance of about 25K ohms.

is connected through at least a 25K ohm resistor to ground. The conductive surface becomes the top of your workbench. Next, we go back a few years and make a Mylar bracelet for you to wear that will have a resistance of at least 25K ohms. Oldtimers will remember the use of India drawing ink to make resistors. All you do is paint a stripe on the Mylar bracelet, allow it to dry, measure with an ohmmeter and repeat until you have at least 25K, but less than 1 megohm, of resistance. (See bottom of Fig. 3.) Then connect to ground through a flexible wire. That part is tricky and you may need assistance in securing the snap fasteners (again the "Notions" department) to the ends of a flexible plastic strip.

With the work surface conductive, and you likewise, plus the added humidity, you still might want to make the hand tools you use conductive, as well, by painting a stripe of ink from the metal to the handle where it will be in contact with you and thence to ground. **Note: That makes the tools somewhat conductive so don't rely on them when working around live circuits.**

Now that you have put everything at a safe potential, electrically or static-electrically speaking, you shouldn't have any problems with static discharge ruining your IC's. Just remember to refill the wastebasket with water every so often.

I hope that you will be able to put these tips and circuits to good use. R-E

# BUILD THIS

## Universal Logic Tester

Here's a one-IC testing device that not only checks out components, but also entire circuits!

FRED BLECHMAN, K6UGT

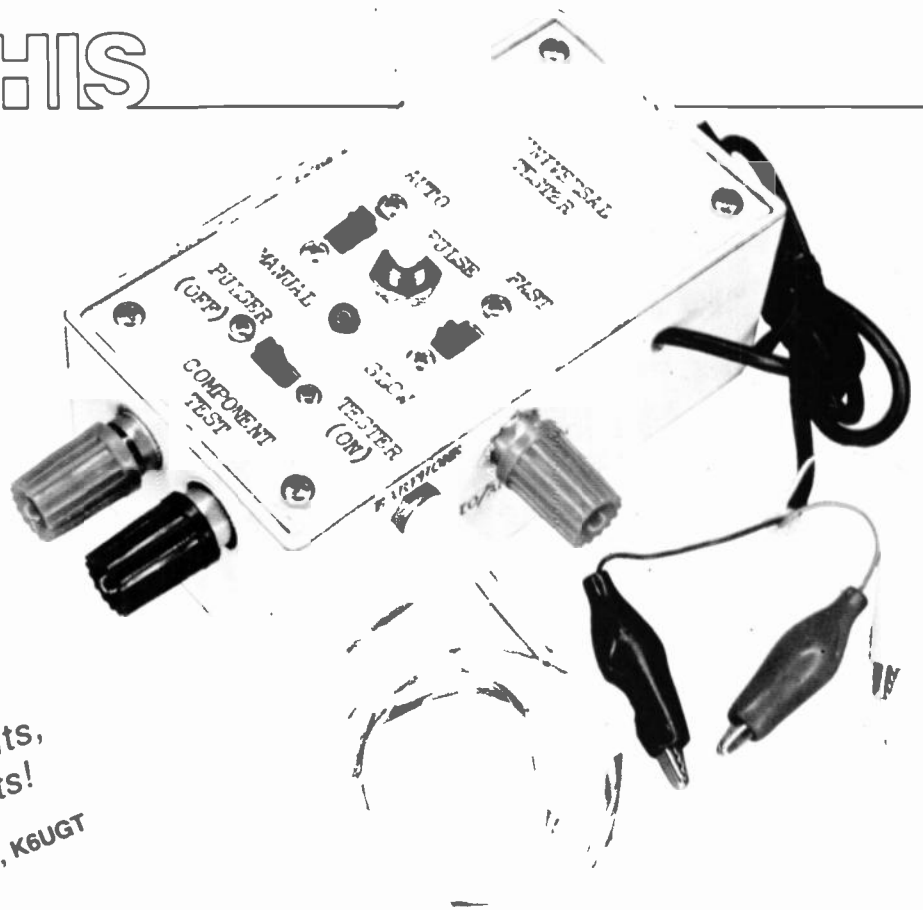

THE UNIVERSAL TESTER IS USED TO troubleshoot digital logic and counting circuits. It performs useful checks of resistors, capacitors, transistors, and most other electronic components. It can also be used to test audio and AM radio circuits.

When used as a digital pulser, the trigger lead of the Universal Tester can be made to change state from high to low or low to high on command, by pressing a pushbutton. Using two slide switches you can program the trigger lead to change state either three times every two seconds or about 550 times a second, with a LED displaying the status. That is extremely useful in clocking digital counting circuits manually, fast, slow, or as you desire. In that mode, the Universal Tester is powered by the circuit itself (from 3- to 15-volts DC), so it can be used with TTL, DTL, or CMOS circuits.

When used as a troubleshooting instrument, the Universal Tester generates a 550-Hz string of squarewave pulses with a 50% duty cycle. When those pulses are fed through an earphone or speaker in series with a component under test, the pulses are heard as a tone. The LED acts as a visual indicator. If the resistance is low, the sound is loud and the LED is off; if it is high (around 100,000 ohms) the sound is barely audible and the LED is bright. That means you can test a circuit for

continuity, with a rough idea of the resistance in between the test points.

### How it works

The schematic (Fig. 1) shows the simple Universal Tester circuit. A single 4069 hex-inverter IC is used. If switch S4 is in the PULSER (OFF) position, power is obtained externally by connecting the black clip to ground and the red clip to the positive circuit voltage. Inverters IC1-a and IC1-b, together with R1, R2, and C1, provide an alternate-action output at pin 4 of IC1-b. Each time S1 is depressed the logic level (high or low) at pin 4 changes, and stays at that state until switch S1 is depressed again.

Inverters IC1-e and IC1-f, together with R3, R4, and C2, produce a square-wave at a frequency of about 550 Hz, with the output signal at pin 10. When switch S3 is put in the SLOW position, capacitor C3 is placed in parallel with C2 and the output is now slowed down to about 1½ pulses per second.

Switch S2 selects either the manual pushbutton output or the AUTO (automatic 2-speed) output, which is fed through a buffer made up of inverters IC1-c and IC1-d connected in parallel. This provides more driving power than using either section by itself. That is done because the outputs of each section are limited in their ability to source or sink current.

The LED monitors the status of pins 6 and 8 of IC1, glowing whenever they are high. Resistor R5 raises the impedance at the output so the Universal Tester doesn't look like a virtual short to an external circuit, and also provides current-limiting for LED1. In the MANUAL mode, the LED goes on or off each time you push S1. In the AUTO mode, the LED blinks on and off about three times every two seconds with switch S3 set in the SLOW position and will appear to be on constantly with S3 set in the FAST position; actually it's on only half the time.

The white clip-lead is the output and triggers or clocks the circuit under test.

When switch S4 is placed in the TESTER (ON) position, an internal 9-volt battery supplies the power to drive IC1 and the Universal Tester becomes a squarewave generator if S2 is set on AUTO. With S3 set in the FAST position, the squarewave is running at about 550 Hz. If an eight-ohm earphone or speaker is plugged into jack J1, then binding posts BP2 and BP3 are terminals in an open circuit between the squarewave signal and the earphone. By putting any component across those binding posts you complete the circuit. The sound—or absence of sound—and LED response will tell you a lot about the component, as will be discussed in detail later.

Binding post BP1 is isolated from the output of the IC by a relatively-high-

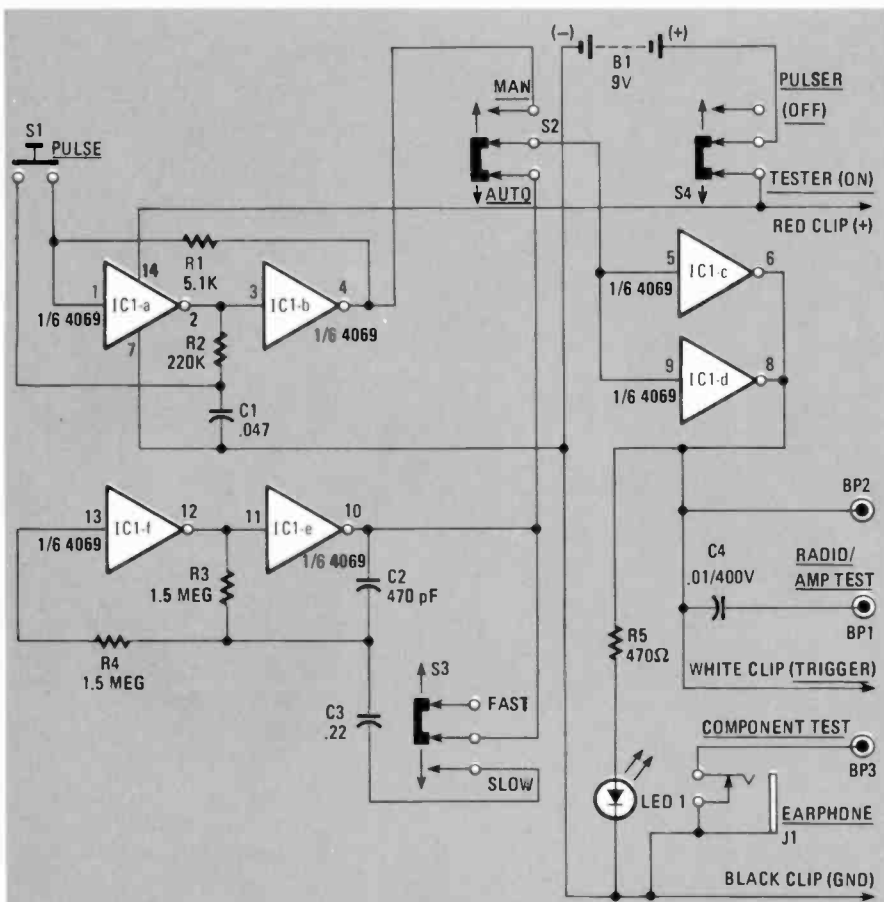

FIG. 1—UNIVERSAL LOGIC TESTER uses all six sections of a 4069 IC. Circuit is simple enough to be built on a piece of perforated construction board using point-to-point wiring.

voltage capacitor to protect the IC when testing tube-type audio amplifiers and radios, or when dealing with voltages above 15 volts. The capacitor passes the squarewave pulses, but blocks DC.

### Construction

The Universal Tester can be assembled in any small plastic box, using a perforated board to hold the components. However, for the convenience of readers, a PC-board layout (Fig. 2) and parts-placement diagram (Fig. 3) are provided. A complete kit of parts is available (see parts list).

Assembly is straightforward. Mount the resistors, capacitors, and IC socket on the component side of the board and solder them to the foil side. Clip off ex-

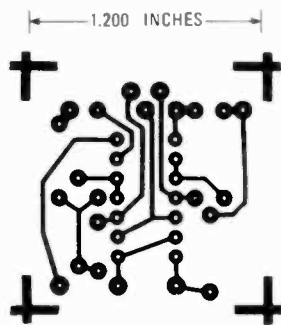

FIG. 2—PC BOARD is so small that it can be etched on a scrap left over from another project.

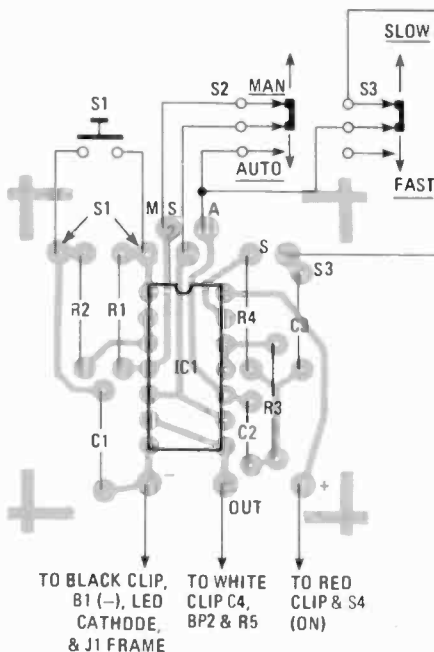

FIG. 3—PARTS PLACEMENT DIAGRAM also indicates connections to components mounted on- and off-board.

cess leads. Install IC1 last and use care when handling it, since it is a CMOS device and can be damaged by static charges. (That's why you use a socket—if the IC is damaged, all you have to do is pull it out and replace it with a good one. Trying to remove an IC

that's been soldered directly to the PC board is a lot more difficult and may even cause further harm.) Make sure the notch on the IC, designating the pin-1 end, is facing the S2 holes in the board.

Figure 4 shows the wiring from the PC board to the other components. In the author's unit, shown in the photos, the battery is held in the bottom of the box by double-sided tape. The binding posts and earphone jack mount on the cabinet sides. All the switches and the LED are mounted on the top panel, and the circuit board is held to the underside of the panel by double-sided tape. The clip leads are at the end of a three-conductor unshielded cable that comes through a hole in the side of the cabinet. Nothing is critical about the parts layout, so you may package the circuit any way you like.

### Checkout

Leave S4 in the PULSER (OFF) position. Connect the red clip lead to the positive terminal of a 6- or 9-volt battery, with the black clip lead connected to the minus (-) side of the battery. Switches S2 and S3 should be in the MANUAL and SLOW positions. The LED may, or may not, be on. Press S1 and watch the LED; if it was off it should go on, and if it was on it should go off. Each time you press the switch (S1),

### PARTS LIST

#### Resistors ¼ watt, 5%

- R1—5100 ohms
- R2—220,000 ohms
- R3, R4—1.5 megohms
- R5—470 ohms

#### Capacitors

- C1—.047  $\mu$ F, ceramic disc
- C2—470 pF, ceramic disc
- C3—.22  $\mu$ F, ceramic disc
- C4—.01  $\mu$ F, tubular, 400 VDC minimum

#### Semiconductors

- IC1—4069 or 4069B CMOS hex inverter
- LED1—jumbo red LED
- J1—miniature earphone jack, N.C. (normally-closed)
- B1—nine-volt "transistor" battery
- S1—momentary push-button switch, N.O.
- S2-S4—SPDT subminiature slide switch (S3 may be SPST)
- BP1-BP3—binding post (Radio Shack 274-661 or equivalent)

**Miscellaneous:** PC or perforated circuit board, 14-pin IC socket, battery clip, 8-ohm earphone, 3 mini-alligator clips with colored insulators, 3-conductor cable, enclosure, wire, solder, etc.

A complete kit of parts (excluding enclosure, battery, earphone and solder) is available for \$9.95 postpaid in US and Canada (foreign orders please add \$1 in US funds; CA residents please add 6% sales tax) from: PPG Electronics Co., 14663 Lanarc St., Van Nuys, CA 91402.

TABLE 1

| COMPONENT DESCRIPTION        | GENERAL SYMBOL(S) | POLARITY        |         | RESISTANCE OR IMPEDANCE                         |   | REMARKS                            |
|------------------------------|-------------------|-----------------|---------|---|---|------------------------------------|
|                              |                   | BP2 (+)         | BP3 (-) | SOUND   | LED                                     |                                    |
| RESISTIVE LOAD OR CONTINUITY |                   | NOT SIGNIFICANT |         | 0Ω = LOUD<br>15K = LOW<br>100K = BARELY AUDIBLE | 0Ω = OFF<br>50Ω = DIM<br>500Ω = FULL ON | UNDEFINED OVER 100K OHMS.          |
| REACTIVE OR INDUCTIVE LOAD   |                   |                 |         | LOW Ω = LOUD<br>HIGH Ω = LOW                    | LOW Ω = OFF OR DIM<br>100 Ω = ON        | UNDEFINED OVER 100K OHMS           |
| PNP TRANSISTOR               |                   | E               | B       | LOUD  | OFF                                     | REVERSE LEADS: LOW OR NO SOUND     |
|                              |                   | C               | B       | LOUD  | OFF                                     | REVERSE LEADS: NO SOUND            |
| NPN TRANSISTOR               |                   | B               | C       | LOUD  | OFF                                     | REVERSE LEADS: NO SOUND            |
|                              |                   | B               | E       | LOUD  | OFF                                     | REVERSE LEADS: LOW OR NO SOUND     |
| CAPACITOR (NON-POLARIZED)    |                   | NOT SIGNIFICANT |         | 500pF = VERY LOW<br>.002μF = LOW<br>22μF = LOUD | FULL ON                                 | UNDEFINED BELOW 500 pF             |
| CAPACITOR (POLARIZED)        |                   | +               | -       | LOUD  | DIMS SLIGHTLY                           | LED WILL DIM MORE WITH HIGH VALUES |
| DIODE / RECTIFIER            |                   | +               | -       | LOUD  | OFF                                     | REVERSE LEADS: NO SOUND            |
| LED (LIGHT-EMITTING DIODE)   |                   | +               | -       | LOUD  | OFF                                     | REVERSE LEADS: LOW OR NO SOUND     |

the LED should change state.

Now place S2 in the AUTO position. The LED should turn on and off at a rate of about three times every two seconds. When S3 is moved to the FAST position, the LED should stay lighted at a slightly lower brightness.

Now disconnect the battery and move switch S4 to the TESTER (ON) position. That connects the internal nine-volt battery to the circuit. Perform the same tests—the results should be the same.

If any of the tests fail, check to see that the IC is installed with pin 1 in the right position, that all resistors and capacitors are located properly, and that all solder connections are good. Also check *between* solder connections on the PC board, especially around the IC, to make sure that you don't have any solder bridging across traces. Refer to the PC-board layout to see which pads are connected together.

Be sure the switches are wired correctly according to Fig. 5. If everything is the way it should be and the Universal Tester still doesn't work properly, check the switches themselves for proper operation with an ohmmeter; sub-miniature slide switches are sometimes the unsuspected culprits. Also be

sure the LED is not wired in "backwards": the cathode, usually marked by a flat or notch at the base, should be connected to ground ("—" terminal of the battery). If all else fails, remove the IC from the socket and replace it. Make sure that none of its pins were bent under when it was inserted.

Assuming that the Universal Tester has passed the tests to this point, let's go on to final testing. With S4 set to the TESTER (ON) position, and S2 and S3 in AUTO and FAST, respectively, temporarily connect a wire between binding posts BP2 and BP3. The LED (which should have been on) should now go out. Remove the wire. The LED should come back on. Touch the white clip lead to the black clip lead; the LED should go out. Now touch the white clip lead to the red clip lead and the LED should get brighter. **Do not** touch the red clip lead to the black clip lead, since that shorts out the battery!

Next you'll need an eight-ohm earphone or a small speaker with a miniature phone plug attached. Plug that into J1. When a wire is placed across BP2 and BP3 you should hear a steady tone, and the LED will go out. To check the RADIO/AMP TEST output, unplug the earphone or speaker and use jumper clip

leads to connect one terminal of the earphone or speaker to BP3 (which is circuit ground when nothing is plugged into J1) and the other terminal to BP1. You'll hear the same tone, but at a lower volume, and the LED will be unaffected. The same thing should happen using the black clip lead in place of BP3. That completes the checkout. Now let's go on to using it.

## Use

If you do any digital design, kit building, or construction projects, then counting or logic circuits are usually involved. Use the Universal Tester in the PULSER mode and connect the red and black clip leads to the circuit's positive voltage line and ground, respectively. Connect the white clip lead to the point in the circuit where you want to apply pulses. Set the switches to MANUAL and SLOW. If the LED is on, you have a logic "1" at the white clip lead. If the LED is dark, you have a logic "0". Pushbutton switch S1 changes the logic state each time it is pressed, and the LED indicates that state. To make the state change automatically, set S2 to AUTO and S3 to FAST or SLOW. At last you'll be able to check out those counting circuits at a slow enough speed for

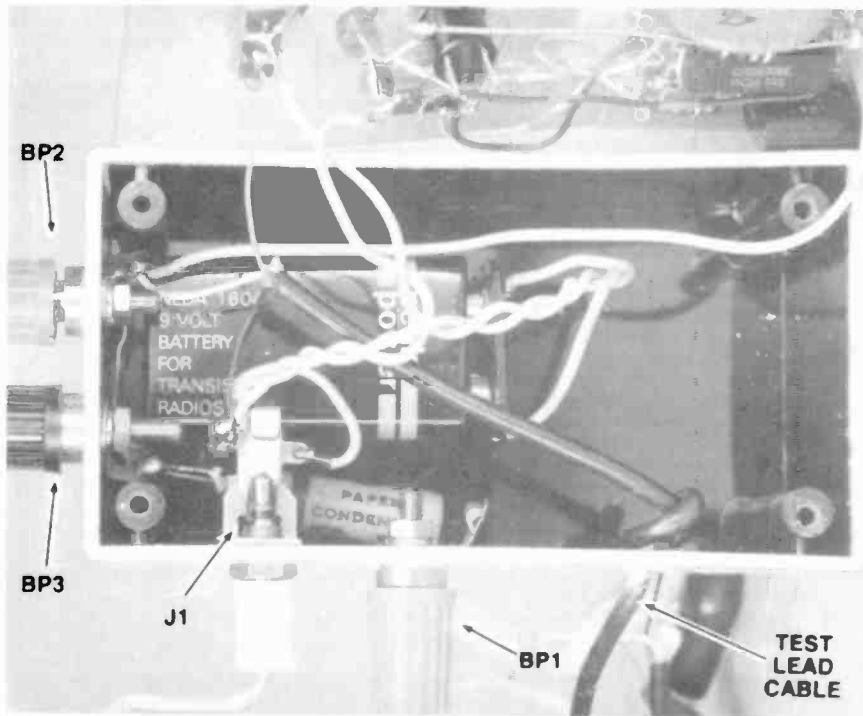

FIG. 4—BINDING POSTS and earphone jack are mounted on case. Refer to Fig. 3 for details of connections to PC board.

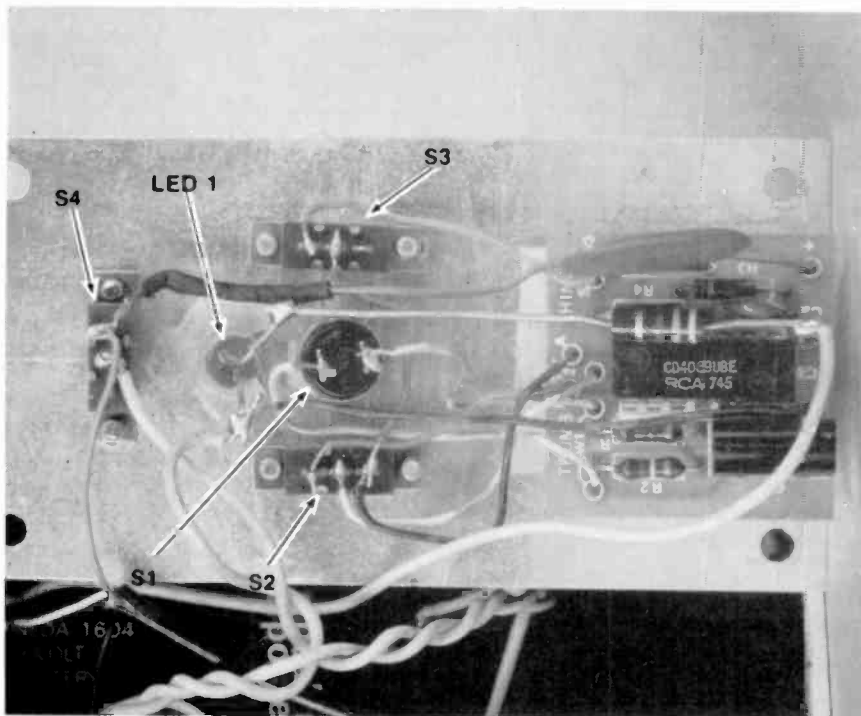

FIG. 5—SWITCHES AND LED are mounted from component-side of PC board. Switch mounting-nuts secure assembly to top of case.

you to see what's happening!

Using the Universal Tester in the MANUAL mode, you can put a known state at the input to logic circuits, and change the state at will to see the effect at the other end of the logic circuits. With the Universal Tester and a simple logic probe (see the August 1980 issue of *Radio-Electronics* for a "\$10 Logic Probe") you can analyze or debug most circuits.

To test components, plug in the earphone or speaker and put switch S4 in the TESTER position. With S2 in AUTO and S3 in FAST, the LED should glow. You should hear nothing. However, when a component is placed across BP2 and BP3, the sound heard and the LED's status will indicate its condition. Testing results for various components are shown in Table 1. Polarized components, such as electrolytic or tantalum

capacitors, diodes, LED's, and transistors, should be connected so that the positive component lead is connected to the positive binding post, BP2.

A particular advantage in testing transistors is that you can identify each lead, as well as determine whether they are NPN or PNP types. The base lead is the one that is common when a loud sound is produced by connecting to either of the other two leads. If the base is connected to BP2 the transistor is an NPN type; if the base is connected to BP3 it is a PNP. However, if you now reverse the leads, the base-emitter junction may cause a low sound to be produced (if there is sufficient leakage in the reverse-bias direction), but that won't happen with the base-collector reverse-biased! So, if you get any sound at all in the reverse-bias condition, one of the two leads is probably the emitter. That can be a handy way to identify those junk-box or bargain-basement transistors with unknown leads.

When testing Zener diodes with ratings below 9 volts, you'll hear some sound when they are connected in either the forward or reverse direction. However, when the anode is connected to BP2 (positive) the tone will be louder and the LED will go out; when reversed, the Zener flow will allow some sound and the LED will dim.

You can devise your own tests for SCR's, triacs, optocouplers, and other electronic devices.

To test amplifiers (audio or low-frequency RF) and AM radios put S4 in the TESTER position, with S2 in AUTO and S3 in FAST—the same as for component testing, except that the earphone is not used. Connect the black clip lead to the ground side of the circuit under test. Connect a separate wire to the RADIO/AMP TEST binding post (BP1), and use the free end of that wire as a signal injector "hot" lead. Starting at the speaker of the circuit under test, move the signal wire back toward the front-end, stage by stage. When you note a sharp reduction in the volume of the sound from the circuit speaker, you will have found the dead or defective stage.

Since the 550 Hz squarewave output is rich in harmonics you'll be able to probe circuits through the AM broadcast band and beyond. (A squarewave is the sum of the basic sinewave frequency and many odd harmonics). Since the Universal Tester is radiating an RF signal, you may find it unnecessary to connect the ground lead in testing radio circuits.

While the Universal Tester won't replace an oscilloscope or multimeter, in many cases it will do the job for you. It is small, portable, and inexpensive—and will do *some* things that scopes and multimeters can't!

R-E

# HOW TO

## Locate Faults in Coaxial Cables

JOSEPH J. CARR

*Troubleshooting and determining the characteristics of coaxial cable can easily be done with the help of a time domain reflectometer. You can make your own using equipment you already have.*

TRANSMISSION LINES ARE NOTORIOUSLY difficult to troubleshoot. Faults become even more gruesome to troubleshoot when they are located in coaxial cable that is buried either underground or inside a wall. Both TV master-antenna people and communications people occasionally have to troubleshoot coaxial cable transmission lines. How would you like to be the chief engineer of a broadcast station, and find that you have a bad transmission line 150 feet long buried underground? Would you like to dig a 150-foot trench between the transmitter building and the antenna tuning box? Not I!

But how do you go about locating the fault? You could use an ohmmeter, but that only (sometimes) tells you whether or not a fault exists. For the MATV or broadcast technician trying to locate the fault to within a foot or so, along a 100 - 150-foot hidden path, that is not much help. You could also try using an antenna impedance bridge—but that doesn't always help, either.

There is a system, though, that does work. How would you like an instrument that will tell you *whether* a fault exists, *where* it exists along the cable and allows you to measure a cable's approximate SWR (Standing Wave Ratio), its length—and lets you determine its velocity factor? Does that sound impossible? It isn't; that can all be done by a standard instrument called a *time domain reflectometer* (TDR).

Commercially available TDR's are very expensive; but you can make a simple TDR using only a pulse generator and a good oscilloscope. You will need a fast-risetime pulse generator, and an oscilloscope with a wide bandwidth. The wider the oscilloscope's bandwidth, the better, but usable results can be obtained on models with just a 10-15-MHz bandwidth. That TDR will not produce results as accurate as the commercial instrument, and it will only work properly with resistive loads, but it will suffice for most applications.

The equipment connections for the TDR are shown in Fig. 1. The output of the pulse generator is connected to both the vertical input of the oscilloscope and to the input end of the coaxial cable, using a "T"-connector. It is important to keep the length of cable between the T-connector and the oscilloscope as short as possible. In the pulse-generator circuit to be shown later, a T-connector is mounted to the cabinet housing the generator, so the pulse output is connected directly to the oscilloscope input.

The value of the load resistor ( $Z_L$ ) should match the characteristic impedance of the coaxial cable ( $Z_0$ ). Since we cannot easily understand the patterns of reactive loads, it is important that only resistive loads be used. If the coaxial cable is connected to an antenna, or MATV preamplifier, or to any other form of reactive load, then disconnect it and substitute a dummy load at the output end of the coaxial cable.

The TDR works by passing a step-function (i.e., the leading edge of the pulse from the generator) down the line. The horizontal sweep of the oscilloscope is triggered by that pulse. The horizontal sweep controls are then adjusted to display only the top half of the output pulse. In most cases, a 1-MHz square-wave is used as the pulse. That pulse has a 500-nanosecond duration along the top edge (1000-nanosecond total duration). That frequency is chosen because it permits the testing of foam-filled cables up to 200 feet in length, and regular coaxial cable up to 160 feet in length (the difference is due to the difference in velocity factors between the two cables).

The pulse from the generator does not travel as rapidly down a coaxial cable as it does through space. Thus, a pulse of a given frequency will take longer to travel the same distance on an insulated line than it will through air. The amount by which the pulse signal is slowed is determined by the dielectric constant of the insulator and is called the *velocity of propagation* or *velocity factor*. Both are related to the velocity of light. Velocity factor  $V_F$  is expressed as a decimal value and velocity of propagation  $V_P$  is expressed as a percentage of the velocity of light. The speed at which the pulse travels down the coax line is the product of  $V_F$  and the speed of light (300,000,000 meters per second). Foam-filled coaxial line has a velocity factor of 0.8 so the velocity of a pulse down the cable is  $(0.8) \times (30 \times 10^8)$  meters per second or  $2.4 \times 10^8$  meters per second. Similarly, regular polyethylene-filled cable has a velocity factor of 0.66 so a wave travels at  $(0.66 \times 3 \times 10^8)$  or  $1.98 \times 10^8$  meters per second.

When the incident, or forward, pulse reaches the load, it will either be totally

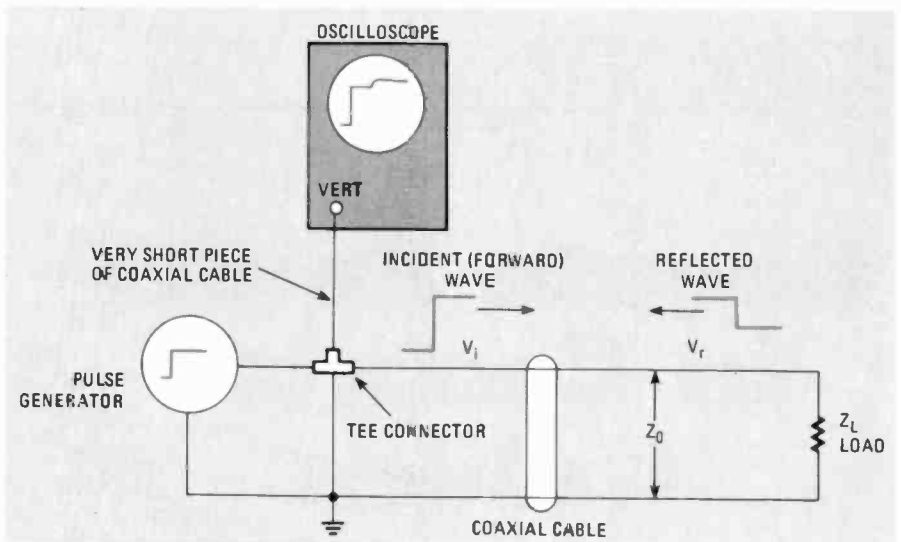

FIG. 1—TDR INTERCONNECTIONS. Pulse generator must be as close to scope as possible.

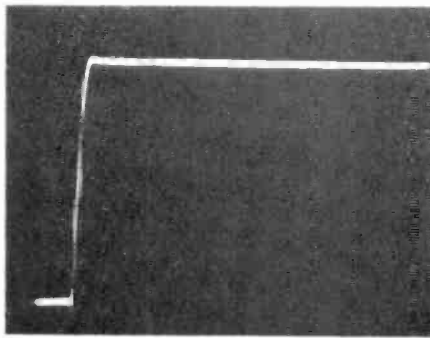

FIG. 2—IDEAL SCOPE DISPLAY indicating that input and output impedances are equal.

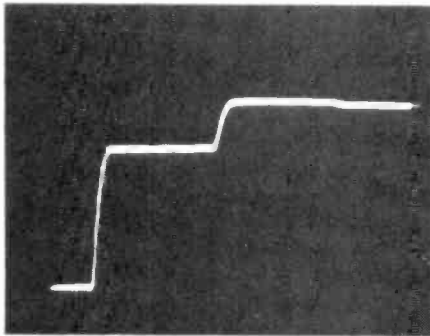

FIG. 3—LOAD IMPEDANCE GREATER than input impedance. Reflected pulse is added to incident pulse.

absorbed (if  $Z_L = Z_0$ ), or will be partially absorbed, and partially reflected ( $Z_L \neq Z_0$ ). In the case of a complete short circuit or complete open circuit in place of  $Z_L$ , all of the pulse will be reflected.

With a TDR, the reflected pulse combined with the incident pulse is displayed. That comparison allows us to make certain measurements. Figures 2—5 show four possible situations. The condition in Fig. 2 shows what happens when the load is matched to the characteristic, or surge, impedance of the coax. There is no reflection taking place, so the top edge of the waveform is flat. But look what happens in the case where  $Z_L$  is greater than  $Z_0$  (Fig. 3). In that case, the reflected pulse is

added to the incident pulse, and produces the oscilloscope display shown. By determining the delay time between the two pulses and their relative amplitudes, the measurements described earlier can be determined.

A similar curve, shown in Fig. 4, is obtained for cases in which  $Z_L$  is less than  $Z_0$ . In that case, however, the reflected pulse is subtracted from the incident pulse, and produces a dip in the line.

The curve resulting from an open line will resemble Fig. 5. Note that the second hump is almost as large as the first. In an ideal transmission line, the two humps would have equal amplitudes. The difference noted here is due to the loss in the coaxial cable. A similar curve is obtained when the cable is

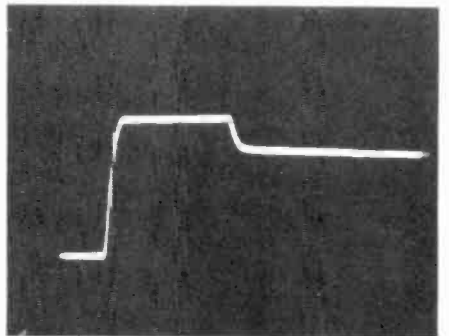

FIG. 4—LOAD IMPEDANCE LESS than input impedance. Reflected pulse subtracts from incident pulse in this case.

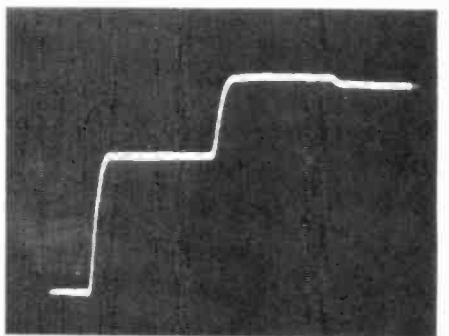

FIG. 5—OPEN-LOAD curve. In theory, incident and reflected pulses are equal.



shorted. In both cases, the entire incident pulse is reflected. The standing-wave curves for those two cases differ only in *phase* (i.e., the location of the nodes and antinodes).

### Equipment

The only expensive piece of equipment required for this TDR is a wide-band oscilloscope. Most laboratories, service shops, and even many hobbyists, now own such scopes. The scope must have a vertical bandwidth of at least 10 MHz, but a greater bandwidth would be better.

If you own a fast-risetime pulse generator, then you are ready to make some of those tests. Many squarewave generators or function generators will have a fast enough risetime, but beware: some will not. In the laboratory where I ran my experiments, the pulse-and-function generators were moderately expensive and from a well-known manufacturer. They did not, though, have a risetime that was sufficiently fast for TDR work. Interestingly enough, a simple TTL squarewave generator that can be built for a few dollars will produce a pulse having the required risetime. The circuit is shown in Fig. 6.

The generator is constructed using a Motorola MC4024 VCO IC, according to instructions given in the MC4024 spec sheet and Don Lancaster's *TTL Cookbook*. Note that the MC4024 is TTL—not CMOS, as it might seem. The value of C1 is hand-picked to yield a precise 1-MHz output. In my case, the value was 560 pF, but the exact value will vary from circuit to circuit.

The generator was built inside a small cabinet that was fitted with a BNC connector at one end and a grommet through which the two leads from the +5 volt DC power supply could pass. Capacitor C2 can be anything in the 1-to-10  $\mu$ F range, and should be tantalum. It should be mounted where the +5 volt lead comes into the cabinet. Capacitor C3 is mounted as close to the V+ and ground pins of IC1 as possible. When the pulse generator is constructed in that manner,

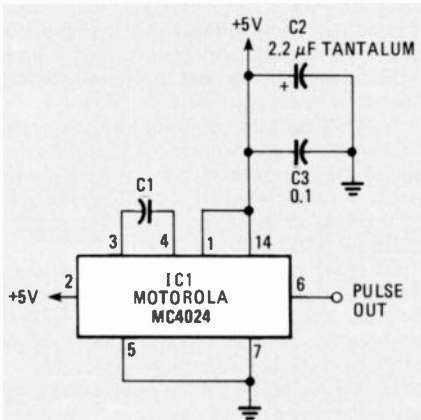

FIG. 6—SCHEMATIC of pulse generator using Motorola MC4024. Despite nomenclature, this IC is TTL, not CMOS.

it can be connected directly to the BNC vertical-input connector of the oscilloscope.

The circuit shown in Fig. 6 should produce pulses with an adequate risetime. It was used without problem by this author. But if you want to improve that risetime, then try connecting a high-speed TTL gate as an output buffer (see Fig. 7), or drive the input of a high-speed TTL flip-flop. Of course, in the latter case the frequency of the oscilloscope must be twice the required frequency; i.e., 2 MHz instead of 1 MHz.

Another possible variation on that circuit, also derived from the MC4024 applications notes, is shown in Fig. 8. The MC4024 is a VCO (Voltage Controlled Oscillator). In the original circuit of Fig. 6 we tied the voltage input to V+, and allowed the device to oscillate at a fixed frequency. But in Fig. 8 we use a voltage divider to produce a variable voltage. Potentiometer R1 can be adjusted to bring the oscillator frequency exactly to 1 MHz.

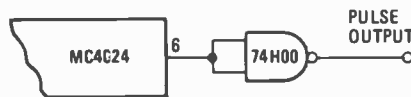

FIG. 7—RISETIME can be improved by using high-speed 74H00 IC after pulse generator.

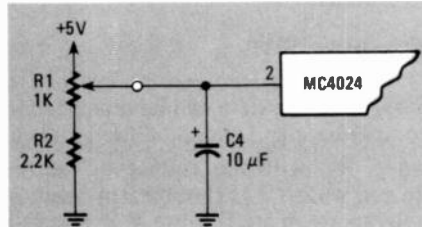

FIG. 8—FREQUENCY of pulse generator can be altered using voltage-divider circuit.

### Making measurements

We can measure the time between the start of the incident pulse and the return of the reflected pulse along the horizontal axis of the oscilloscope. We can also measure the relative amplitudes of the reflected and incident pulses on the vertical axis. Keep in mind, however, that the value of the reflected pulse is only approximate since there is some loss during propagation along the line.

Figures 9-a and 9-b show the values needed to make most measurements with our simple TDR. Time T is the difference between the start of the incident pulse and the return of the reflected pulse. It therefore represents *twice* the time needed for a wave to propagate down the line (i.e., down and back). We could measure T between any two similar points on the incident and reflected pulses, but we find that there is some loss of sharpness at the bottom and top of the pulses (as might be expected). We can be more precise if we measure the time interval, T, using the

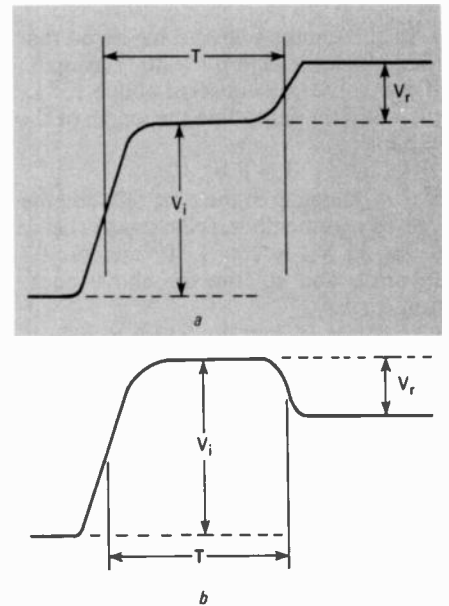

FIG. 9—VALUES USED in making TDR computations. Refer to text for full explanation.

*midpoints* of the two pulse edges.

The incident voltage  $V_i$  is measured from the baseline to the first horizontal section of the curve. The reflected voltage  $V_R$  is measured from the first horizontal section of the curve to the second.

In an actual laboratory experiment, 65 feet of 75-ohm, foam-filled, coaxial cable (the type normally used in MATV work) was used. Measuring T on the oscilloscope showed 3.4 divisions between the pulse-edge midpoints, when the horizontal control was set to 0.05  $\mu$ s/div. The value of T, then, is:

$$3.4 \times 0.05 \mu\text{s} = 0.17 \mu\text{s}$$

This time, 0.17  $\mu$ s, is the same as  $1.7 \times 10^{-7}$  seconds, and we will use *seconds* in the following calculations. The formula we'll use for many of our measurements is:

$$T = 2L/V_p$$

Where:

T is the time, measured as in Figure 9, expressed in *seconds* (s).

L is the length of the coaxial cable being tested.

$V_p$  is the velocity of propagation of the pulse along the cable ( $V_p$  is  $2.4 \times 10^8$  meters-per-second for foam cables with a velocity factor of 0.8, and  $1.98 \times 10^8$  meters-per-second for regular coax with a velocity factor of 0.66).

### Finding cable length, or length to fault

We may use the above equation to find the length of the coaxial cable or the distance to a fault on the cable. Since it is rare for a cable to reflect all of the energy fed into it, even when the fault is a short, there will be two humps in most defective cables. One, the larger, will indicate the point where the fault is located, while the smaller will be at the load end. Multiple faults show up as multiple humps.

In the example above we noted that the value of T was  $1.7 \times 10^{-7}$  seconds. If we solve the equation above for L, then we can determine the length of the cable:

$$L = T V_p / 2$$

So, by plugging in the time (T), and the velocity (remember, foam coax is being used, so  $V_p$  is  $2.4 \times 10^8$  meters-per-second), and solving the above equation for L:

$$L = \frac{1}{2} (1.7 \times 10^{-7}) (2.4 \times 10^8)$$

or 20.4 meters

Let's see. The cable is supposed to be 65 feet long. Let's find out how long it actually is. One meter equals 3.27 feet, so:

$$L = \frac{3.27 \text{ ft}}{\text{meter}} \times 20.4 \text{ meters}$$

or 66.7 feet

### Finding the velocity factor

Suppose that we go to a hamfest, auction, or surplus store and buy some coaxial cable of unknown type. How can we determine the velocity factor? Easy ... we cut off a known length, and solve the first equation for  $V_p$ . Since  $V_p$  is a fraction of the speed of light, we can then calculate the velocity factor of the cable. Let us say that we have a 50-foot (15.3 meter) length. Measuring T, i.e., the time to the first hump on the CRT screen, we find that it is  $0.15 \mu\text{s}$ , or  $1.5 \times 10^{-7}$  seconds.

$$V_p = \frac{2 \times L}{T}$$

or  $\frac{(2) (15.3 \text{ m})}{(1.5 \times 10^{-7} \text{ s})}$

or  $2.04 \times 10^8$  meters-per-second

To find the actual velocity factor ( $V_F$ ), use the following equation:

$$V_F = \frac{V_p}{C}$$

### Holographic radar

A microwave radar-like system that could give actual images of the object on which the waves are focused—instead of mere blips of light—has been proposed by Dr. Nabil Farhat of the University of Pennsylvania. Dr. Farhat, who has worked extensively in microwave holography and electron optics, is now working with his students on just such a system, which he believes can be ready for practical use in a few years.

In the proposed technology, microwaves bounced off an object are received by a widely dispersed array of special receivers that form a microwave lens. Since a lens must be larger than the longest wave it receives, a microwave lens must cover a large area, possibly as great as 40 miles in diameter.

The information received by the lens is stored in a computer and sorted out into a series of rapidly changing "projection holograms." These are used to form a

$$\text{or } \frac{2.04 \times 10^8 \text{ meters-per-second}}{3.00 \times 10^8 \text{ meters-per-second}}$$

or 0.68

### Measuring surge impedance ( $Z_0$ )

The surge impedance, also called characteristic impedance, ( $Z_0$ ), is a very important factor in planning systems that include transmission lines. That value must be known, or an impedance mismatch, with its attendant SWR, will result. The measurement is made by taking a length of the cable—say 30 to 80 feet—and connecting a 100-ohm potentiometer across the load end (be careful not to use a wirewound pot; only carbon will do the trick). Carefully adjust the potentiometer, while applying a pulse to the source end of the line, until you obtain the trace of Fig. 2, or something similar to it, which indicates that the surge impedance equals the load impedance for resistance. The trace in Fig. 10 was the best that I could do using a single-turn potentiometer. The potentiometer is then disconnected from the cable, and an ohmmeter is used to measure its resistance. That is the surge impedance of the cable being tested. In the case shown, the value of the pot, as read on a quality DPM, was 73.5 ohms.

### Measuring SWR

An approximate measurement of the SWR of the system can be obtained by comparing the voltage of the incident wave ( $V_i$ ) with the voltage of the reflected wave ( $V_r$ ). That measurement is only approximate because  $V_r$  is reduced by cable losses, and those losses are difficult to predict, especially on a pulse waveform. They can be computed by comparing pulse amplitudes at both ends of the cable, and adding a correction factor to the amplitude obtained in the measurement of  $V_r$  on the TDR.

dynamic three-dimensional image.

This "imaging radar" might make it possible to identify satellites or aircraft by their shape, and to take much clearer photographs in space than can be taken by visible light. (Photos taken through telescopes are blurred by the atmosphere, which hardly affects microwaves.) Since the images are holographic, a viewer could see different aspects of the object "photographed" by moving his head from side to side, giving the sensation of seeing a fully stereoscopic image.

Bats and dolphins, which use sonic ranging, gave Dr. Farhat the clue to "frequency diversity," the new imaging principle in the system. He had noted that sounds made by those creatures change frequency regularly, presumably making the received echoes richer in information. He also noted that bats and dolphins appear to be able to use this principle to discern the fine detail in their environment.

By following their example, and sweeping

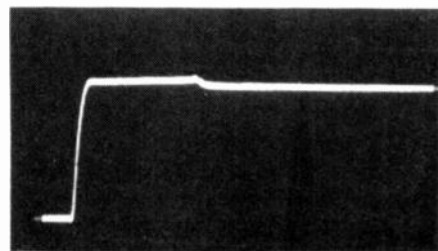

FIG. 10—SCOPE TRACE obtained in determining characteristic impedance of cable.

One possible means for determining the correction factor is to compare the  $V_r$  and  $V_i$  values with the line open-circuited. They *should* be equal; i.e.,  $V_r = V_i$ . In our case (Fig. 5), the incident wave had an amplitude of 3.6, while the reflected wave had an amplitude of 3.2—only 89% of the correct amplitude. We can, then, multiply measured values of  $V_r$  by  $3.6/3.2$ , or 1.125, to obtain the correct value. The actual VSWR is found from the formula:

$$\text{VSWR} = \frac{V_i + V_r}{V_i - V_r}$$

In the laboratory, we found that using a 150-ohm load on 75-ohm cable, produced the following values:  $V_i = 3.6$  divisions, and  $V_r = 1$  division (both vertical). Applying the correction factor,  $V_r = 1.125$  divisions. We may substitute these values in the VSWR equation as follows:

$$\text{VSWR} = \frac{3.6 + 1.125}{3.6 - 1.125}$$

or  $\frac{4.725}{2.475}$

or 1.91:1

TDR's have proven themselves to be very valuable in transmission-line measurements. The technique we've described allows small-budget users to gain some of the benefits of time-domain reflectometry. R-E

the microwaves rapidly across a number of frequencies, under computer control, the detail picked up can be increased dramatically. An even more important result—from a practical point of view—is that the frequency-diversity principle makes it possible to reduce the cost of the microwave lens to a practical figure.

A small number of frequency-diversity receivers can do the work of thousands of single-frequency receivers distributed over the same area. That would reduce the cost of the lens from an estimated \$50 million to about \$100,000.

Dr. Farhat suggests that the system might also be used for "passive" imaging (without a transmitter), for viewing celestial objects. Many of those emit a large range of frequencies—including microwaves—naturally. By sorting them out properly, he says, scientists might use giant telescopes to form images of the heavenly bodies with definition and clarity of detail formerly impossible.

## Signal Processors— How to connect them to your system

*The tape monitor circuit of your system is much more useful than its name would seem to indicate. Some of its applications are discussed here.*

LEN FELDMAN  
CONTRIBUTING HI-FI EDITOR

IN THE NOVEMBER 1980 ISSUE, AN ARTICLE entitled "The Ins and Outs of Interfacing System Components" discussed the various ways in which the components of a high-fidelity stereo system are connected to each other, and the different system options that are available to the first-time purchaser. It was pointed out, too, that a simple circuit-interruption point—that's commonly known as a tape-monitor circuit—has been responsible for the development of a wide variety of add-on or accessory audio products that could not have been used by consumers were it not for that simple circuit.

Let's start by reviewing the way in which a tape-monitor circuit is incorporated into a preamplifier, or an integrated amplifier, or even into an all-in-one stereo receiver. Figure 1 is repeated here from the previous article. So long as switch S1 remains in the SOURCE position, ordinary program sources are connected by the selector switch to the following stages of the amplifier and are fed out to the loudspeaker system. (Only one channel of the hi-fi system is shown for the sake of simplicity.) When switch S1 is in the TAPE position, however, some type of audio device must be connected between the TAPE OUT and the TAPE IN jacks if any sound at all is to be heard from the system. (Figure 1 and all subsequent hookup diagrams show one channel only.)

Originally, the tape-monitor circuit was intended primarily for connection of a tape deck—more often than not, an open-reel or reel-to-reel deck. Such

decks invariably had separate record and play heads, as well as separate electronics associated with each of those magnetic heads. Thus, the signal fed to the line inputs was ultimately recorded onto the tape, while the signal picked up by the playback head was amplified by the recorder's electronics and fed to the TAPE IN jack of the tape-monitor circuit for reproduction via the

loudspeakers. Since separate record and play heads were the rule, rather than the exception, for open-reel decks, the user of the deck could monitor recorded results a fraction of a second after the recording was made (the time differential was determined by the distance between the record and play heads and by the tape speed); hence the name "tape-monitor circuit."

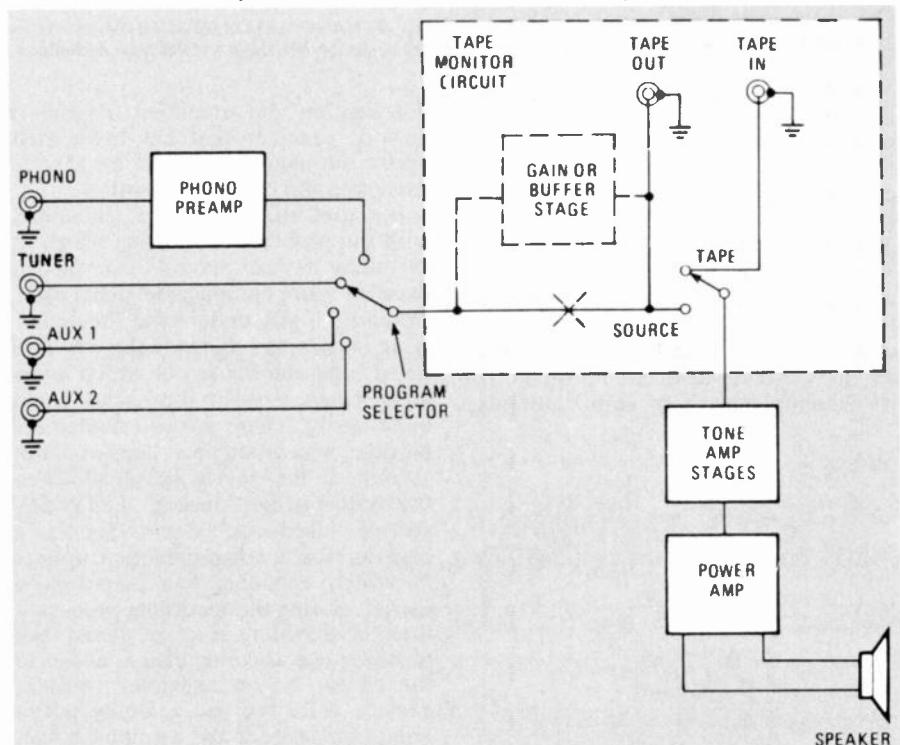

FIG. 1—TAPE MONITOR CIRCUIT is actually a point of access to the signal path within the preamplifier. Although originally used for connection to a tape deck, many signal processors and add-on accessories can be connected to the system at this point.

Owners of cassette decks that have only two heads (erase and a combination record/play head) are often confused by the tape-monitor circuitry. Even though such cassette decks are connected in exactly the same manner as three-headed open-reel units used to be, what the listener or user hears when the tape-monitor switch is turned on during a recording session is not the resultant recording at all, but rather the signal that has been amplified by the deck's own electronics for application to the record/play head in the record mode. In effect, what you then are monitoring is only the input signal about to be recorded, and not the recording itself. Under such circumstances, you might just as well leave the tape-monitor switch in the SOURCE or OFF position.

### The many accessories

Given a convenient circuit-interruption point (or two, or sometimes even three), innovative manufacturers of audio equipment began coming up with devices *other* than open-reel or cassette decks that would fit very nicely into the signal path via the tape-monitor loop, as it is sometimes called. The following is a list of just some of the many products that connect to a high-fidelity component system via those versatile little input and output jack pairs:

- Graphic equalizers
- Reverberation units
- Noise-reduction units
- Expanders
- Quadraphonic decoders
- Parametric equalizers
- Audio time-delay units
- Dynamic filters
- Transient eliminators

While it is unlikely that any single listener would own, or even want to own, all of the devices named above, it is not unusual for many high-fidelity component systems to contain two, three, or even four of the devices named. Since most receivers, amplifiers, and preamplifiers contain only two tape-monitor circuits (some contain only one), how, then, is the audio experimenter expected to connect so many add-on devices? Fortunately, the manufacturers of those devices

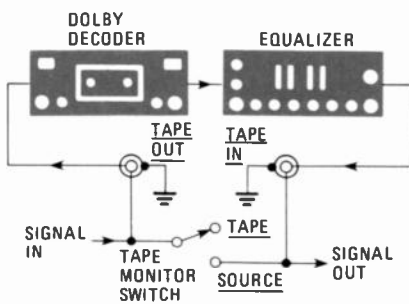

FIG. 2—A DECODER of any sort should always be placed ahead of the equalizer.

were well aware of the problem; to circumvent it, and still allow the user to incorporate a tape deck or two as well as the accessory products mentioned above, most of the latter products are equipped with their *own* tape-monitor loops to *replace* effectively

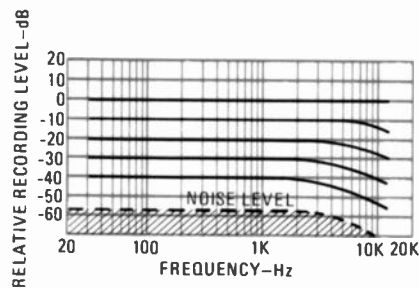

FIG. 3—RESPONSE OF DOLBY SYSTEM is dependent on both frequency and loudness.

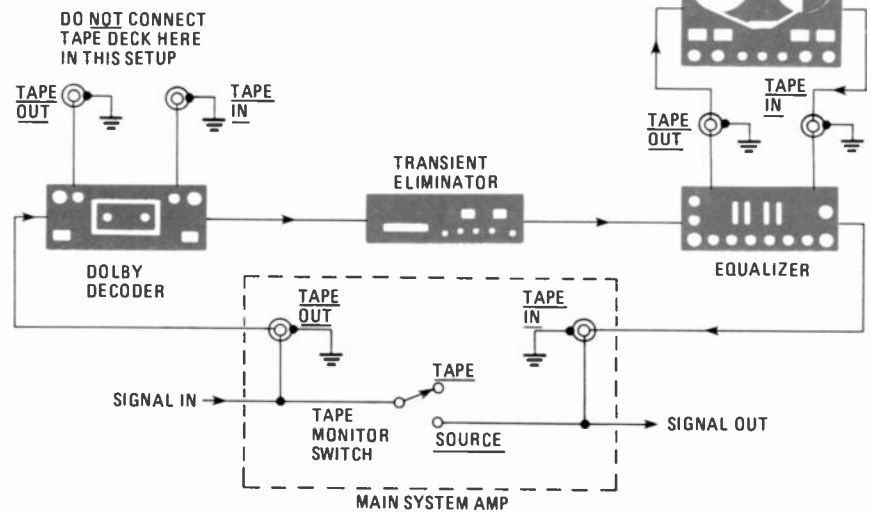

FIG. 4—MANY ADD-ON DEVICES include their own TAPE-IN and TAPE-OUT jacks. Recorder should use jacks on equalizer to take best advantage of its capabilities.

the one on the amplifier, preamplifier, or receiver that has been used up by the incorporation of the device itself into the overall system.

But that still leaves the audiophile with the problem of deciding which of the many devices should come first in the ever more complicated signal path. Actually, if you understand the underlying principles behind the devices listed, you can figure out which items must come first in the signal chain quite easily. There are two fundamental rules which you must keep in mind:

First, if the device being added to the system is the "decode" half of any sort of closed-loop system—such as a decoder for a noise-reduction system in which encoding has taken place earlier, during the recording process—then the decoding function should take place before anything else is added to the chain. As an example, consider Fig. 2. Here we see a Dolby noise-reduction decoder and a graphic equalizer, installed via the tape-monitor loop of an amplifier. The Dolby add-on box comes *ahead* of the equalizer.

Consider the action of the Dolby decoder. It must sense the precise relationships between loudness levels and frequencies contained in the program material being reproduced. Response curves of the Dolby decoder are shown in Fig. 3. That device may well be thought of as a form of expander that is frequency selective. If you were to have connected the two devices in the reverse order, and would have used the graphic equalizer to adjust response to your own taste (or to compensate for other components or room acoustics), the relative relationships between levels and frequencies would be totally upset before the signal reached the Dolby device (or any other expander that may be frequency selective). The

noise-reduction device could not possibly track the signal correctly.

Conversely, any device designed to alter system overall amplitude-vs-frequency response (commonly called frequency response) should be inserted into the signal path at the last possible point in the chain, or just before the signal returns to the existing amplifier chain in the component system.

### The tape deck

As mentioned earlier, most of the add-on devices we have been discussing duplicate the TAPE-OUT and TAPE-IN jacks that are used up by the device itself being connected to the main system components. If more than one add-on device is used, how do you determine where to plug in your tape deck? If one of the devices in question is a graphic or parametric equalizer, you will probably want to use the newly available tape-monitor loop on that equalizer for connection of the tape deck, as illustrated in the diagram of Fig. 4. That is because most graphic and parametric equalizers offer the user

the opportunity to apply equalization before or after taping.

In other words, your equalizer might well have a switch on its front panel that will give you a choice of pre-equalizing (the signal then going to the recorder is already equalized before it magnetizes the tape) or post-equalization (only the signal playing back from the tape is equalized, for listening purposes, but response on the tape itself is flat or unequalized). Were you to hook in your recorder at any other point (e.g. via the extra tape-monitor loop available on the noise-reduction unit also shown in Fig. 4) that flexibility would be lost and you would be confined to using your equalizer only for playback of tapes or other program sources, and not for the recording of tapes with pre-equalization.

### Audio time-delay devices

The new audio time-delay units that have become quite popular in the United States are designed to simulate the ambience of large listening space (concert halls, auditoriums, even cathedrals) by delaying the main stereo signals for a number of milliseconds (the longer the delay, the larger the apparent listening space) and feeding those delayed signals to a second stereo amplifier and a pair of speakers that are usually positioned behind the listener at the rear of the listening room.

From the above description, you might well conclude that connection to the inputs of such audio time-delay units need be made only from the TAPE OUT jacks of your existing component system and that the tape-monitor switch might well be left in its SOURCE position, as shown in Fig. 5. Indeed, the system will work that way; but there are disadvantages to operating the front speakers "straight through" with a parallel takeoff for the secondary amplifier and speaker pair. One of the disadvantages has to do with the fact that in many of the newer audio time-delay units, there is circuitry which alters the signal intended for the front speakers as well as circuits for delaying and altering the rear-channel signals. Unless you hook up the system via a tape-monitor loop (i.e., place the monitor switch in the TAPE position and connect the "front" outputs of the audio-delay device to the TAPE IN jacks, while the "rear" outputs of the audio-delay unit go to the newly added stereo amplifier as shown in Fig. 6), you simply will not be able to avail yourself of that additional front-channel signal processing.

Another disadvantage of the hook-up arrangement shown in Fig. 5 is that every time you change the overall level or loudness of your front channels (using the main volume control on your existing amplifier or receiver) you will have to adjust the volume control for

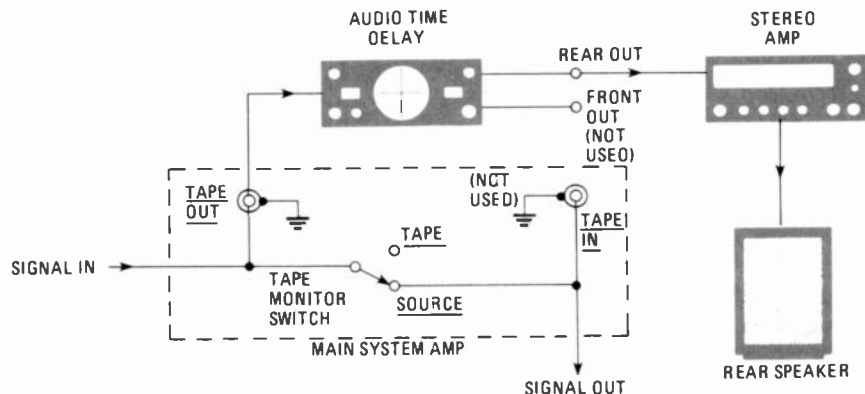

FIG. 5—ONE WAY OF CONNECTING audio time delay into a sound system. Although this may work, the method shown below is better.

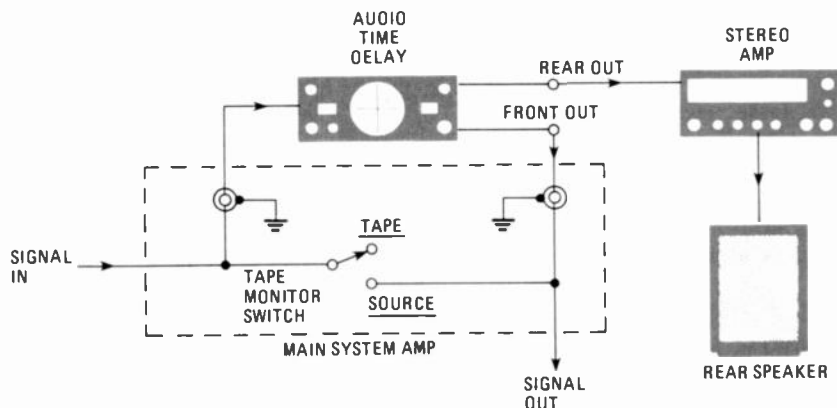

FIG. 6—RECOMMENDED SETUP for adding audio time delay. This takes advantage of any special processing that may be added to the front channel.

the rear channels (on the audio time-delay unit) separately. If, on the other hand, you connect up the audio-delay system and related amp and speakers as shown in Fig. 6, there is usually a master volume control on the new audio-delay unit that will now control the overall level of all four loudspeakers. The master volume control on your older amplifier or receiver need then only be used to establish initial loudness relationships between front and rear channels.

As for the position of audio time-delay units in the signal chain, many of those devices are also frequency-selective (they act differently upon different portions of the frequency spectrum) and therefore, as with the case of decoders, companders, expanders, and the like, that device should come *ahead* of any graphic or parametric equalizers, or dynamic filters, both of which are specifically designed deliberately to upset the precise frequency-amplitude relationships of the program signals being processed.

For those few readers who still own quadrasonic matrix decoders, the same rules apply. That is, the quad decoder should be the first item in a line of accessory products, since many matrix 4-channel systems depend upon precise phase relationships between

left-encoded and right-encoded signals being picked up from matrix 4-channel records. Any tone-control system is likely to alter those phase relationships drastically; and if the 4-channel decoder comes after such tone-tailoring devices, a proper job of 4-channel decoding cannot be done by the quad decoders.

### Tape-to-tape dubbing

Many of today's hi-fi receivers, integrated amplifiers, and separate pre-amplifiers provide tape-to-tape dubbing facilities whereby, if two tape decks are connected to the system, it becomes possible to copy tapes from one machine to the other. That, of course, requires at least two tape-monitor loops. If you own two decks, as well as some of the accessory devices discussed here, the question arises as to how to incorporate both decks in such a manner that tape dubbing can be done most effectively. There are several alternatives that will work, but my own experience has taught me that the simplest way to derive maximum flexibility with ease of installation is to use *one* of the existing tape decks (preferably the one *from* which you wish to copy tapes) connected to an original tape-monitor loop on your basic equipment (your amp or receiver) while the second

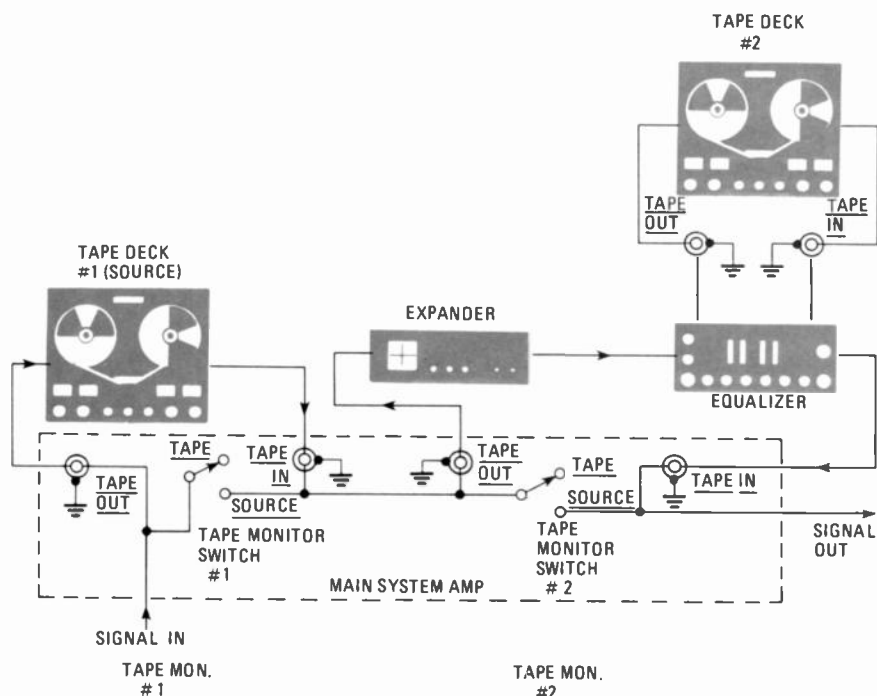

FIG. 7—TAPE-TO-TAPE dubbing is best accomplished with one deck connected to amplifier's tape monitor circuit and other to monitor circuitry of an add-on device.

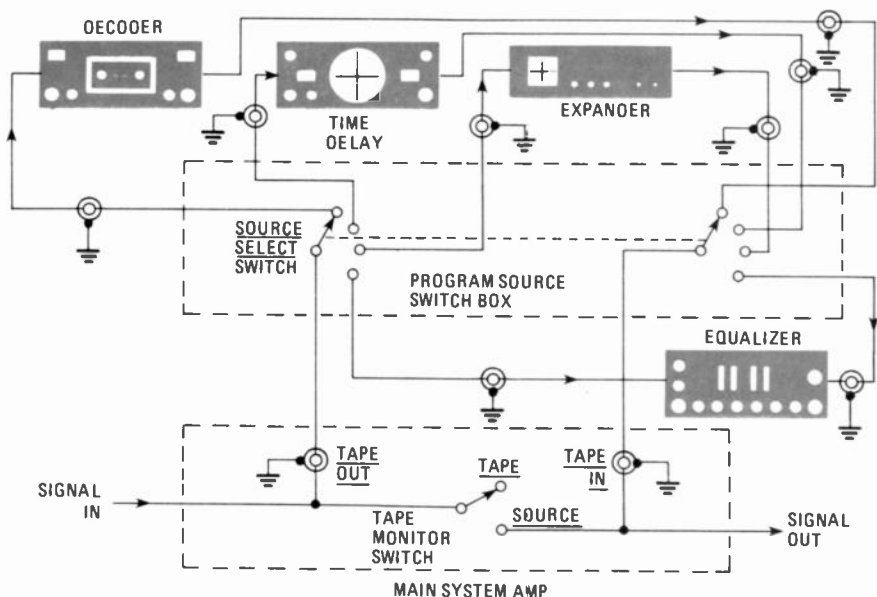

FIG. 8—SWITCH BOX allows you to select which of several devices will be placed in tape monitor loop. Setup shown allows only one device at a time to be used.

deck is best connected via one of the tape loops now provided by one of the add-on devices (the equalizer, if one is used). The arrangement would be as shown in Fig. 7.

#### In parallel or in series?

The examples we have discussed up to this point all involve series chains of devices. The signal passes from the TAPE OUT jacks of a tape-monitor loop, through one add-on device, on to another, and so forth, until the output of the last add-on device plugs back into the TAPE IN jacks of the tape-monitor loop involved. While we have not been

able to cover all possible combinations of add-on devices in this discussion, we have shown examples of the major ones and given some guidelines for determining the priority of others. In some instances, you may run into a combination of add-on components that leave some doubt in your mind as to which should come first and which next in the signal path. In that event, you can, of course, experiment with all of the combinations and permutations, making certain that the final arrangement provides the kind of sound quality and control flexibility that you set out to achieve.

If that is too much of a chore, however, there is one other alternative. You can obtain still another outboard device known as a program-source switch box. Such a switch box, available from several manufacturers, performs the same function as a program-source switch, except that it is connected to your system at the tape-monitor loop; and all of the other outboard devices are connected to the jacks available on the switch box, as shown in Fig. 8. Should you choose that sort of simple way out, be aware that you will only be able to use *one* of the add-on devices shown at any given time, since even if the switch is of a pushbutton configuration that permits depressing more than one button at a time, one device is likely to load down its companion, causing improper operation of both or all devices selected for simultaneous use. For really complex systems, you may want to use some of your add-on accessory items in parallel, with the type of switching box described, plus other devices in series with the switch box.

The lowly tape-monitor circuit found on most hi-fi equipment has led to the development of a variety of useful audio accessories that might never have been thought of if there had been no place to plug them in. Many of those devices will be accepted by audio enthusiasts; then, no doubt, they will be incorporated into major components. Some receivers and amplifiers, for example, already offer graphic equalizers instead of simple tone controls. As such incorporation takes place, no doubt there will be other devices that can be added externally to an audio system to make it sound better. We hope that the makers of those future devices will specify how they are to be hooked into the basic system, so that their addition to a system provides benefits instead of degraded sound quality. **R-E**

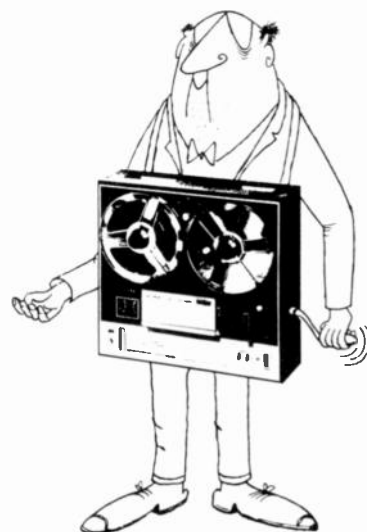

# HEWLETT- PACKARD'S HP-85



*If you're a professional in search of a small computer, Hewlett-Packard's HP-85 may be for you.*

JULES H. GILDER

HEWLETT-PACKARD'S *HP-85* IS NO ORDINARY PERSONAL COMPUTER. In fact, it is being marketed as "a personal computer for the professional." And with its \$3250 price tag for a basic 16K unit, a relatively small percentage of sales can be expected from home hobbyists.

Although the *HP-85* is expensive, it is a well thought out and nicely designed product. Open the high-impact typewriter-size carrying case and you'll be pleasantly surprised. Inside is a fully integrated computer system which includes a 92-key keyboard, a 5-inch black-and-white video monitor, a digital tape memory system capable of storing 200K of programs and a 4-inch thermal printer that is capable of handling the standard text and the high resolution graphics of the *HP-85*. The best thing about this computer system is that everything is built into a single unit. There's no interconnecting cables, no fuss; just plug the 20-pound unit into a 110-volt outlet and it's ready to go.

### High-resolution graphics offered

Graphics is a powerful tool offered by the *HP-85* that makes the computer quite attractive. In the alphanumeric mode, the display will present the program, data, system commands, and results. Tap a key to enter the graphics mode, and the raw data is converted into a meaningful graph. Press another key, and a hard-copy version of the graph is reproduced on the built-in thermal printer. When switching from the alphanumeric mode to the graphics mode, the information that is on the screen is not lost, but stored in a buffer. There are two separate buffers, one for the alphanumeric mode and one for the graphics mode.

In the high-resolution graphics mode it is possible to display up to 50,000 dots arranged as a 256-wide  $\times$  192-high matrix. To help you draw your graphics, 16 special commands are available. They make it possible to draw, erase, and redraw lines, position labels or axes anywhere on the screen, scale the axes, locate their origin, etc. Because the resolution in the graphics mode is so good, and individual dots on the screen can be accessed, it is possible to design special symbols, logos, or character fonts to display on the screen. Thus it should be possible to produce text in Greek, Russian, Hebrew, Arabic, and a host of other languages using special alphabets.

In the normal text-display mode, data are displayed in 16 lines of 32 characters each. Another feature of the display is that up to 64 lines of text can be held in memory. That means that it is possible to have text scroll up and down the screen.

Data and programs can be entered using the computer's 92-key keyboard which is divided into two major sections: a numeric keypad and a standard typewriter keyboard.

### Output goes to paper and magnetic tape

As mentioned earlier, for hardcopy output, the *HP-85* has a built-in thermal printer. That is a bidirectional printer, which means that it's pretty fast; in fact, it can print two 32-character lines per second. The printer output is designed to permit convenient strip-charting and continuous graphs. That is done by rotating the printout on the paper 90 degrees from the normal text mode; it means that on the standard X-Y axis, graphs in the X-direction can be as long as necessary. And, of course, the printer handles the full ASCII character set.

In addition to the built-in printer, the *HP-85* also has a built-in tape system to which programs can be saved and data can be written. That system differs from those used in most other personal computer systems in that it is a carefully designed system that includes a special built-in tape transport with built-in software to manage it. Unlike other tape systems available in personal computers, this one includes a comprehensive file-management system that maintains a catalog of all programs on the tape and does a fast-forward search at up to 60 inches-per-second until it finds the file requested. Data transfer speed is 10 inches-per-second. Also, the direction of the tape movement is controllable by software. The total rewind time is 29 seconds for the standard 140-foot tape in the data cartridge.

Each magnetic tape cartridge can hold up to 42 separate files for a total of 210K of data storage or 192K of program storage.

### Extended BASIC isn't really

The programming language that is supplied with the *HP-85* is called Extended BASIC. It is a superset of the standard ANSI BASIC, as are many other home computer BASIC's. That widely publicized claim can be misleading, however, because it fosters the idea that HP's BASIC is similar to all the other BASIC's, when it really isn't. In fact, ANSI's standard does not cover a lot of things, so two BASIC's can claim to be ANSI compatible and still be incompatible with each other.

One area where that shows up is in the handling of strings. Unlike Microsoft BASIC, which is the real *de facto* standard in personal microcomputers, HP BASIC does not allow for



EXPANSION AND I/O modules plug into rear of HP-85.

string arrays. For example, when the following statement is encountered in HP BASIC:

```
A$(1,1)
```

it merely refers to a single character, while in Microsoft BASIC it refers to an entire string of characters.

Another drawback of HP BASIC is that it doesn't have the BASIC commands PEEK and POKE in it. Those are in virtually all other personal-computer BASIC's with exception of the BASIC used in Texas Instruments' 9914 computer.

A nice element that *is* included in HP BASIC is a protection feature that should have been included in other BASIC's as well. There are four levels of security built in, which can protect the program from being listed, edited, duplicated, appearing in the catalog, or being written over. At level 0, the program cannot be listed or edited; at level 1, it also cannot be duplicated; at level 2, the program cannot be overwritten; and at level 3, you get all of the others plus the fact that the program's name is not shown in the catalog listing of all the programs on the tape.

#### Non-standard processor used

The heart of the *HP-85* is not the Z80, 8080, or even the 6502, but a special NMOS microprocessor that was custom-built for Hewlett-Packard. Unlike other 8-bit microprocessors, which can only access a maximum of 64K bytes of memory, this one accesses up to 112K bytes of memory. The basic *HP-85* comes with 16K of random-access memory (RAM) and 32K of read-only memory (ROM). The RAM capabilities can be expanded to a total of 32K of RAM. The amount of ROM available to the system can be expanded to 80K in increments of 8K to give it programming and operating-system capabilities. That is done by adding up to 6 modules to plug-in slots. Each of those modules contain 8K of ROM.

The basic computer also comes with an internal clock and programmable timers that make it possible to time events and control processes. It also has a built-in programmable beeper that has a fixed frequency but a variable duration. One of the best things about the *HP-85* is its well-written, detailed, 350-page owner's manual.

#### Beware of these drawbacks

While on the surface the *HP-85* seems to be a good buy for the money, there are things that you ought to be aware of before you consider purchasing one. First of all, at \$3250, the *HP-85* is about \$1000 more expensive than an equivalent Apple or PET system; and if you are considering adding on two floppy-disk drives and an external impact printer, then the balance really falls in favor of other home computers. The reason is that a dual floppy system with an external

printer will cost about \$6000, at least twice the price of other personal-computer systems. Another serious drawback is that there is no interface to machine language available. There are no PEEK or POKE statements in HP BASIC so it is not possible to access machine-language routines through BASIC. In addition, there is no way that a user can write his own programs in machine language. When the computer was introduced, HP was asked if there was an assembler/editor available for the computer. The answer was, "No." But even if one did become available at some future date, because the microprocessor is a custom-designed chip, the instruction set would probably also be unique, requiring a special effort to learn and understand it.

Another minus for the *HP-85* is that it has no way of storing graphic images permanently in machine-readable form. If you compose a picture on the screen manually, there is no way for you to store that picture on tape for future use, other than to figure out a way to write a program that will do what you just did by hand. The reason for that is that the screen display is not memory-mapped. That means that unlike all other personal computers, where the screen is simply an extension of the ordinary RAM and addressable on a byte-by-byte basis, the display RAM in this computer is not addressable by the microprocessor.

#### Can you afford \$18 for a blank tape cartridge?

If you do not mind paying \$18 for a blank tape cartridge, then the *HP-85* is for you, because that is exactly how much it will cost to buy one that is compatible with the *HP-85* tape drive. And you only get that price if you buy five at a time. If you buy fewer, the price goes up even higher. Even worse than that is the fact that any "canned" (ready-to-run) software that you purchase for the *HP-85* will cost considerably more than the same software that is available for other machines. The reason is again the expensive data cartridge and the lack of any commercial duplicators that can handle that particular cartridge. For example, HP offers a circuit-analysis program for \$95. A similar, if not better, program is offered by Hayden Book Company for the Apple, PET, and TRS-80 microcomputers for only \$24.95. The same is true of many of the other packages that Hewlett-Packard offers. If they were being made available on other home computers the price would probably be 60-70% cheaper.

All-in-all, the *HP-85* is not a big bargain. But there will always be people around who will buy anything that has an HP label on it.

R-E



# TECHNOLOGY TODAY

## CCD COMB FILTERS FOR TELEVISION

KARL SAVON  
SEMICONDUCTOR EDITOR

*Charge-coupled devices are now being used to produce dramatic improvements in TV-picture resolution.*

ONE OF THE MOST SIGNIFICANT PAPERS presented at the last fall's IEEE Chicago consumer-electronics conference was the description of a practical baseband comb filter for television receivers built around a charge-coupled device (CCD). It is the first high-volume application of a CCD, and as one of the paper's authors stated, to the surprise of some skeptics, that it is in the showroom today.

Figure 1 shows the system block diagram that includes a one-horizontal-line CCD delay element. The rationale behind comb filters in television receivers is the improvement it brings to the separation between luminance and chrominance signals. Color television theory is based on the fact that luminance signals occur in bands peaked at harmonics of the horizontal scan rate, so that the chroma information can be sandwiched between the luminance spectral components. However, due to practical limitations, primarily the inability of conventional circuitry to filter the intermingled signals properly, luminance bandwidth must be reduced and effects known as "dot crawl" and "cross color" persist. You have, no doubt, observed those imperfections in certain types of video signals such as a striped suit and 45-degree edges.

The comb filter is a transverse filter that has a comb-like frequency response,

ideal for separating the chroma and luminance signals. RCA carries the idea further by using a metal-oxide-semiconductor (MOS) charge-coupled device that can operate from DC to over four megahertz—a reasonably priced L-C delay line cannot match CCD performance.

An interesting aspect of the problem that the RCA system has specifically addressed is vertical resolution. Since the comb-filter technique adds signals together after a one-horizontal-line delay, the signals contained on adjacent horizontal lines tend to merge, reducing the distinction between lines. This results in a reduction in vertical resolution. If nothing were done about that loss of vertical information, the increase in horizontal resolution produced by a comb-filter system would be accompanied by a self-defeating vertical "smear."

The block diagram shown in Fig. 1 includes several components for improving vertical resolution. These components include: a vertical detail low-pass filter, a nonlinear amplifier, a vertical-peaking low-pass filter, and a restoration low-pass filter. The system design introduces a concept of vertical peaking not much different in concept than the traditional idea of horizontal peaking. The vertical-peaking circuit must restore vertical resolution without overpeaking that would ex-

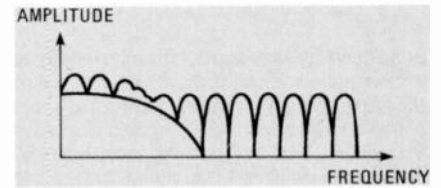

FIG. 2—FREQUENCY RESPONSE of vertically-peaked luminance signal.

aggerate the effects of noise, co-channel interference and alternate line set-up variations. The nonlinear amplifier produces a dead spot in the peaking output during a 5-IRE unit portion of the chroma signal. The luminance signal is combined with the band-limited chroma signal or vertical-detail signal, producing the response shown in Fig. 2. Addition of the vertical-detail signal and the band-limited chrominance signal enhances the vertical transitions. Chrominance null depths are approximately 40 dB over a frequency range of 3.08 to 4.08 MHz, and luminance nulls are on the order of 30 dB over the same frequency range.

Shielding reduces radiation from the switched 10.74 MHz clock signal. The clock is generated by limiting the 3.58 MHz chroma subcarrier oscillator output to produce harmonics and then extracting the third harmonic component with an L-C filter. The NMOS CCD is mounted in a 24-pin plastic DIP that contains the comb filter and the necessary clock logic and driver circuitry. It also has an AC-coupled high impedance video input, buffered combed luminance, combed chrominance, and vertical detail outputs.

This new approach results in a picture that has horizontal resolution greater than 330 lines compared to the 260-line resolution of previous receivers.

Without comb filtering, the luminance is typically rolled off at 3 MHz with a rejection trap at the 3.58 MHz subcarrier frequency in order to minimize dot-crawl patterns. The chroma signal is also band-limited to about 500 kHz on each side of the subcarrier.

The CCD system is used in RCA's 1980 19- and 25-inch Limited Edition Color Trak models.

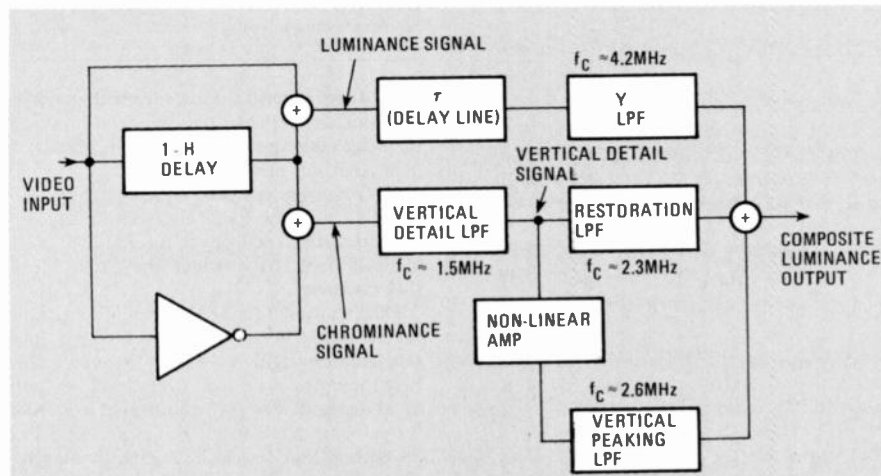

FIG. 1—CCD COMB FILTER includes vertical-peaking circuits to improve vertical resolution.

# R.E.A.L. SOUND

## Dual Model 606 Turntable and Ortofon ULM 55E Cartridge



1

CIRCLE 106 ON FREE INFORMATION CARD

LEN FELDMAN

CONTRIBUTING HI-FI EDITOR

IN RECENT YEARS, MANY AUDIO EXPERTS AS well as audio enthusiasts have begun to realize the importance of a proper interface between a phono cartridge and the pickup arm in which it is installed. Yet, traditionally, most turntable systems are supplied without a cartridge, leaving it pretty much up to the purchaser or the audio salesperson to recommend suitable cartridges for use with a given system. Often, the turntable/pickup arm combination ends up unable to provide its optimum performance because of an improper selection of the phono cartridge.

While Dual's *model 606* turntable (as well as their other models) can, of course, be purchased without a cartridge, the company makes this model available with an installed Ortofon *model ULM 55E* phono cartridge. ULM stands for *Ultra-Low-Mass*, and is the abbreviation that is used to describe this ultralightweight cartridge as well as Dual's completely redesigned pickup arm.

The *model 606* shown in Fig. 1, is a single-play turntable system with semi-automatic features. Movement of the arm away from its rest post and towards the outer diameter of the turntable platter turns on the direct-drive motor and illuminates the strobe light that shines upon a series of metal dots located on the vertical rim of the platter. Alongside the front of the pickup arm is a cueing lever that, when activated, gently lowers the arm into playing position. Although movement of the arm to the correct position must be done manually, a set-down location aid in the form of an easily felt

detent is provided for correct positioning of the arm for 12-inch and 7-inch records. If that feature is not desired (as, for example, when seeking other points in a record), the detent feature can be turned off by means of a knurled knob located immediately behind the cueing lever. Farther towards the rear of the unit, near the pickup-arm pivot assembly but mounted on the baseplate of the system, is an anti-skate adjustment control, calibrated separately for use with either conical- or elliptical-shaped styli.

At the front left corner of the turntable are a speed selector knob and a pitch control knob. Since the direct-drive motor of the *model 606* is electronically driven, speed change and adjustment are also purely electronic and involve no mechanical linkages. The direct-drive motor used in this turntable is a high-torque DC servo type. The speed-monitoring system uses a CMOS regulator circuit and an integral frequency generator that, in effect, checks speed consistency 120 times during each revolution of the platter.

As for the ULM pickup-arm of the *model 606*, it is a refined and redesigned version of Dual's highly respected straight-line tubular arm with four-point gyroscopic gimbal suspension. Its vernier-adjustable counterweight establishes zero-balance first, and then a tempered flat-wound spring applies tracking force directly at the pivot point without altering effective mass of the arm/cartridge combination. A cross-sectional view of the pivot system is shown in Fig. 2.

RADIO-ELECTRONICS AUDIO LAB  
**R.E.A.L. SOUND**  
RATES

DUAL 606 TURNTABLE  
AND ULM 55E CARTRIDGE

**EXCELLENT**

Copyright © Gernsback Publications Inc., 1979

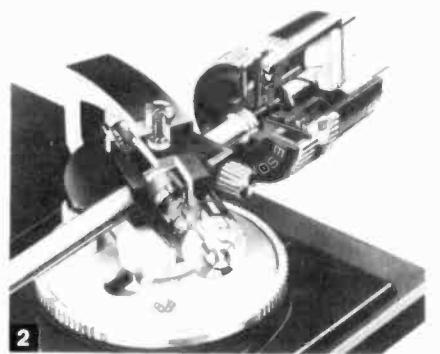

### MANUFACTURER'S PUBLISHED SPECIFICATIONS:

#### Turntable System:

**Platter diameter:** 12". **Platter Weight:** 3.08 lbs. **Available Speeds:** 33 $\frac{1}{3}$  and 45 rpm. **Time To Reach Rated Speed (33 $\frac{1}{3}$  rpm):** 2 to 2.5 seconds. **Pitch Control Range:** 10%. **Strobe Sensitivity for 0.1% Speed Deviation (at 60 Hz):** 7.2 divisions per minute. **Wow-and-Flutter:** 0.05% unweighted; 0.03% WRMS. **Rumble:** (Dln-A unweighted): 50 dB; (Dln-B weighted): 75 dB. **Pickup Arm Length:** 8.7". **Offset Angle:** 24.07 degrees. **Tangential Tracking Error:** 0.16 degrees/centimeter. **Pickup Arm Bearing Friction:** (vertical): 7 mg.; (horizontal): 15 gm. **Tracking Force Range:** 0 to 3 grams. **Overall Dimensions:** (base): 16 $\frac{1}{2}$  wide  $\times$  3.5 high  $\times$  14 $\frac{1}{2}$  inches deep; (with dust cover): 5.18 inches high.

#### ULM 55-E Cartridge (optionally supplied):

**Weight:** 2.5 grams (including bracket & hardware). **Stylus Shape:** biradial, 6  $\times$  18  $\mu$ m. **Tip Mass:** 0.35 mg. **Frequency Response:** 10 Hz to 25 kHz. **Output Voltage at 1 kHz per cm/sec:** 0.7 mV or greater. **Channel Separation at 1 kHz:** greater than 25 dB. **Channel Balance at 1 kHz:** less than 1.5 dB. **Static Vertical Compliance:** 30  $\mu$ m/mN. **Dynamic Lateral Compliance:** 25  $\mu$ m/mN. **Recommended Tracking Force:** 1.0 to 1.75 grams. **Vertical Tracking Angle:** 20 degrees. **Recommended Load Resistance:** 47,000 ohms. **Recommended Load Capacitance:** 400 pF

As we mentioned earlier, the combination of a low-mass pickup arm and an ultra-low weight cartridge adds up to a higher natural resonance point that lies above the region of maximum warp-frequency typically found on records—above 8 Hz and below 12 Hz. However, merely moving up the frequency of resonance does not in itself necessarily reduce the amplitude of that resonance.

Dual's solution to the problem is a mechanical anti-resonance filter housed in the pickup-arm counterweight. That filter is tuned broadly to the range of resonant frequencies that are to be damped. The owner's manual supplies a list of some popular cartridges and indicates the setting that should be selected on a movable calibrated knurled ring located at the front of the counterweight, based upon car-

tridge mass and compliance. In the case of the supplied Ortofon ULM 55E cartridge, that setting was 12.5. In use, the mechanical filter vibrates out-of-phase with the resonance, partially cancelling it out. According to Dual, addition of the filtering system typically reduces the amplitude of arm resonance by around 20%, while in the case of an arm equipped with a mating Ortofon ULM cartridge, amplitude of resonance ends up about 50% lower than it would be with a conventional cartridge and without the filter. A detailed partial cross-section view of the counterweight to illustrate the built-in mechanical anti-resonance filter, is shown in Fig. 3.

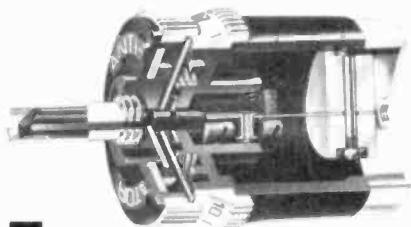

3

Since the unit we tested was supplied with the Ortofon ULM cartridge, a word is in order concerning this unusual pickup. Originally introduced by Ortofon as the models LM-30 and LM-20, the new low-mass cartridge quickly became known as the *Concorde 30* and *Concorde 20* because of its distinctive appearance that resembles the tilted-down nose of that supersonic aircraft. In addition to its ultra-low mass of just 2.5 grams (which accounts for its improved low-frequency reproduction), the stylus tip mass has also been reduced, and the lower the mass of the stylus tip, the more accurately it can track transient signals in the treble range. The cantilever of the cartridge is constructed of a hardened aluminum alloy with an external diameter of 0.45 mm and a wall thickness of only 0.035 mm.

The cartridge itself is a moving-iron type, based upon the variable-magnetic-shunt principle (VMS) upon which Ortofon holds world patents. Ortofon claims to have improved the magnetic circuit of the design to provide sufficient output voltage to drive all modern amplifiers or preamplifiers despite the miniaturization of its coils and cantilever.

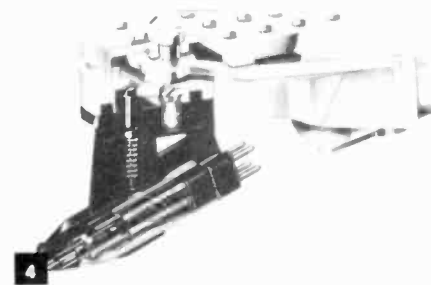

4

A closeup view of the Ortofon ULM cartridge mounted in the lightweight headshell of the Dual model 606 is shown in Fig. 4. While the headshell of the arm is permanently affixed to the arm itself, the cartridge can be easily removed and, if desired, other cartridges having standard 1/2-inch mounting centers can be

| TABLE I<br>RADIO-ELECTRONICS PRODUCT TEST REPORT |                         |                       |
|--|-------------------------|-----------------------|
| Manufacturer: Dual (United Audio)                |                         | Model: 606            |
| TURNTABLE SYSTEM MEASUREMENTS                    |                         |                       |
| <b>PERFORMANCE CHARACTERISTICS</b>               | <b>R-E Measurements</b> | <b>R-E Evaluation</b> |
| Wow-and-flutter (% WRMS)                         | 0.025                   | Superb                |
| Rumble, unweighted (dB)                          | 52                      | Excellent             |
| Rumble, (Din weighted B) (dB)                    | 75                      | Superb                |
| Speed accuracy (%)                               | Strobe, adjustable      | N/A                   |
| Speed adjustment range ( $\pm$ ___%)             | 4.5                     | Excellent             |
| Speed build-up time (rotations)                  | 0.6                     | Excellent             |
| <b>COMPONENT MATCHING CHARACTERISTICS</b>        |                         |                       |
| Tracking force range (___ to ___ grams)          | 0 to 3.0                |                       |
| Anti-skating force range (___ to ___ grams)      | 0 to 3.0                |                       |
| Available speeds (RPM)                           | 33 $\frac{1}{3}$ , 45   |                       |
| Drive system                                     | Direct drive            |                       |
| Motor type                                       | DC Servo                |                       |
| Power requirements                               | 120V, 50/60Hz, 2 W      |                       |
| <b>MISCELLANEOUS EVALUATIONS</b>                 |                         |                       |
| Adequacy of controls                             |                         | Excellent             |
| Automatic Features, performance                  |                         | Superb                |
| Speed stability                                  |                         | Excellent             |
| Vertical tone arm friction                       |                         | Superb                |
| Lateral tone arm friction                        |                         | Excellent             |
| Quality of construction                          |                         | Superb                |
| <b>OVERALL TURNTABLE SYSTEM RATING</b>           |                         | Excellent             |

| TABLE 2<br>RADIO-ELECTRONICS PRODUCT TEST REPORT           |                         |                       |
|--|-------------------------|-----------------------|
| Manufacturer: Ortofon                                      |                         | Model: ULM-55E        |
| PHONOGRAPH CARTRIDGE MEASUREMENTS                          |                         |                       |
| <b>FREQUENCY RESPONSE (H-kHz, <math>\pm</math> ___ dB)</b> | <b>R-E Measurements</b> | <b>R-E Evaluation</b> |
|  | 10-20, 2.0 See Fig. 5   | Excellent             |
| <b>STEREO SEPARATION</b>                                   |                         |                       |
| Separation, 1 kHz (dB)                                     | 28.0                    | Very good             |
| Separation, 10 kHz (dB)                                    | 24.0                    | Very good             |
| Separation, 30 kHz (dB)                                    | N/A                     | N/A                   |
| <b>CHANNEL BALANCE, 1 kHz (dB)</b>                         | 0.5                     | Excellent             |
| <b>TRACKABILITY MEASUREMENTS</b>                           |                         |                       |
| Stylus velocity at 1 kHz (cm/sec)                          | Better than 40          | Superb                |
| Stylus velocity at 10 kHz (cm/sec)                         | Better than 30          | Superb                |
| <b>COMPONENT MATCHING CHARACTERISTICS</b>                  |                         |                       |
| Output level, 1 kHz, 3.54 cm/sec (mV)                      | 4.0                     |                       |
| Optimum load impedance (ohms)                              | 47K (400 pF)            |                       |
| Tracking force range (___ to ___ grams)                    | 1.0 to 1.75             |                       |
| Cartridge weight (grams)                                   | 2.5                     |                       |
| <b>OVERALL PHONO CARTRIDGE RATING</b>                      |                         | Excellent             |

used and mounted with the aid of the hardware supplied. In addition, a stylus-orientation gauge is supplied separately to precisely align the stylus tip of an alternate cartridge. If heavier cartridges than the Ortofon are used (and that means just about any other cartridge), it is necessary to add weights (which are supplied in the included bag of accessories) to the counterweight so that static zero-balancing of the pickup arm can still be accomplished.

### Lab Measurements

Table 1 lists the results of our lab measurements of the turntable, while in Table 2 we have summarized our findings with respect to the optional Ortofon cartridge. Wow-and-flutter was extremely low, measuring even a bit less than the 0.03% WRMS specified by the manufacturer. As for rumble content, the 75 dB reading obtained for weighted (Din B) rumble was surpassed in the past only by turntables costing nearly three times as much as the Dual 606. Once set by means of the pitch control, the strobe markings remained "stationary" for the better part of two hours; the

time required to complete all of our measurements. Correct speed, from a non-rotating condition, was reached by the platter in just over 1.0 seconds, as opposed to the 2.0 to 2.5 seconds claimed by Dual while pitch-adjustment range measured 9.0%, just a bit less than the 10% claimed.

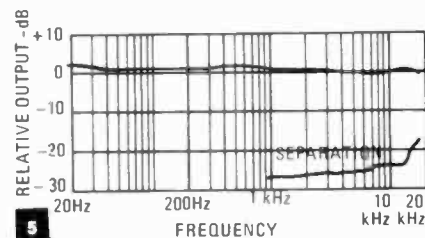

5

Frequency response of the ULM cartridge is plotted from 20 Hz to 20 kHz (the available frequencies on our test record) in Fig. 5. To obtain that response, we had to add about 200

pF of external capacitance at the input jacks of our reference phono preamp, since the total cable capacitance of the *model 606* was only 150 pF per channel. Failure to add that additional capacitance would have resulted in a somewhat higher positive peak in the response curve at around 15 to 16 kHz. We can, of course, understand why Dual elected *not* to incorporate the extra capacitance (or to use higher capacitance audio cables) since, after all, the *model 606* can be used with many other cartridges, some of which would have a severe high-frequency attenuation if they were "loaded" with 400 pF of capacitance at their output terminals.

In examining Table 2 you will note that results for trackability both use the phrase "better than" (40 cm-per-sec for mid-frequencies; 30 cm-per-sec for high frequencies). That is because those figures represent the greatest velocities supplied in the trackability test record (Shure *TTR-103*) that we used for our tests. At those high velocities, the cartridge was still tracking perfectly, so the presumption is that we might have been able to achieve proper tracking at even higher velocities. In that respect, however, it should be noted that we had to adjust the anti-skating control so that it was set to a reading of 1.0 gram, even though our tests were conducted at a downward-tracking force of 1.5 grams. It is not unusual to find that anti-skating calibration is not precisely accurate on turntable systems and this critical adjustment should really be made under actual listening conditions, preferably with a test record such as the one we used. Even if such a test record is unavailable, it is often possible to achieve a correct anti-skate setting by listening critically to very heavily recorded passages of a musical record and noting any breakup. Sometimes, an adjustment of as little as 0.5 grams (of the anti-skate calibration indicator) can make the difference between adequate tracking of such passages and inability to track them properly.

### Summary

Our overall product analysis together with our summary comments about this excellent turntable/cartridge combination will be found

TABLE 3

## RADIO-ELECTRONICS PRODUCT TEST REPORT

Manufacturer: Dual/Ortofon

Model: 606/ULM-55E

### OVERALL PRODUCT ANALYSIS

|                         |  |
|-------------------------|--|
| Retail price            | <b>\$280.00 (\$390.00 with optional cartridge)</b> |
| Price category          | <b>Medium</b>                                      |
| Price/performance ratio | <b>Superb</b>                                      |
| Styling and appearance  | <b>Excellent</b>                                   |
| Sound quality           | <b>Excellent</b>                                   |
| Mechanical performance  | <b>Superb</b>                                      |

**Comments:** The engineers at Dual seem to have met every remaining problem that has plagued the science of record playing in this moderately priced turntable/cartridge combination. Frankly, while most audiophiles prefer to choose their own phono cartridges when purchasing a record-playing system, it would be counterproductive in our view to purchase the *606* with anything but the ultra-low-mass Ortofon cartridge for which it was so obviously intended. With a total effective mass (including the 2.5 gram cartridge) of only 8 grams, overall pickup-arm/cartridge low-frequency response is pushed up to around 10 Hz, well above the region of maximum warp-frequencies and nicely below the lowest frequency of recorded sound. Furthermore, the unique anti-resonance filters incorporated in Dual's pick-up arm counterweight reduce the amplitude of this resonance to levels which permit positive tracking of the grooves of even badly warped records. In our listening tests it was clear that harmonic and intermodulation distortion levels had been suppressed to virtually inaudible levels, even when listening to pure-tone signals from test records which had previously yielded clearly perceptible distortion levels.

The suspension system used for the baseplate of the *606* is also excellent, as evidenced by our ability to bring the system into close proximity with the loudspeakers while playing music at very loud levels. Properly positioned (away from the speakers) the *606* was virtually impervious to any form of acoustic feedback, either airborne or mechanically induced.

In terms of performance, the Dual *model 606* has all the refinements of that company's higher-priced *models 622* or *650RC*, the chief difference being that the *622* offers automatic start and repeat-play while the *650RC* offers wireless remote control of start and cue functions. Thus, if you are seeking pure performance and are willing to set down the pickup arm (by means of the cueing lever) at the right position in the record, the *606* represents the best value of these three turntable offerings from Dual. Everything about this fine turntable system smacks of precision mechanical craftsmanship and, judging from its construction, this system should perform in a trouble-free manner for many years to come. In our opinion, the Dual *606* with its Ortofon cartridge rates an Excellent R.E.A.L. rating, bordering on Superb.

in Table 3. Both in terms of lab measurement and extensive listening tests, the Dual *model 606* performed in a most exemplary manner. If you own, or plan to own, some of the new direct-to-disc or digitally-mastered records, turntables such as this new *Dual 606* come not a moment too soon, for such records are more demanding of a turntable/cartridge system

than anything you have previously played. We were unable to find any records of either type which posed problems for this combination of turntable and cartridge. Considering its price, performance and sound quality, we would therefore assign a R.E.A.L. rating of Excellent bordering on superb, to this moderately priced combination. **R-E**

# Solid-State News

### Op-amps

Harris Semiconductor has new HA-5100 and HA-5110 BIFET operational amplifiers produced using laser trimming methods to keep input offsets under 1.5 millivolts. In many applications external offset reduction components are unnecessary. Gain-bandwidth product is 80 MHz and settling time is under 2 microseconds to 0.1% for a 10-volt output step.

Harris claims the HA-5190 to be the industry's first *true* op-amp with performance previously available only in hybrid and modular devices. Slew rate is 200 volts-per-microsecond and settling time 70 nanoseconds within 0.1% for a 5-volt output step. Gain-bandwidth product is 150 MHz, full power bandwidth 6.5 MHz and input offset 5 millivolts. Those devices use the proprietary Dielectric Isolation process in which an insulating layer of silicon dioxide surrounds the bottom

and sides of each active area to eliminate parasitic and performance-robbing leakage paths. Harris Semiconductor Group, P.O. Box 883, Melbourne, FL 32901.

### GPIB transceiver

Motorola has released the first octal GPIB bi-directional transceiver conforming to the IEEE 488-1975 instrument bus standard. Only two devices are necessary to implement the 16-line bus, in comparison to the four circuits necessary using previously available quad transceivers.

The MC3447P octal transceiver uses no external logic parts in most applications. The device has eight driver/receiver pairs. The bi-directional paths are activated in one direction at a time with the unused device put into a high-impedance open state. The plastic version of the MC3447P is priced at \$3 each in hundred quantities. Motorola Semiconductor

Products Inc., P.O. Box 20912, Phoenix, AZ 85036.

### Bucket brigade devices

The BBD3009 is a low-noise 256-stage *Bucket Brigade Device* (BBD) that has delay times between 0.54 and 12.8 milliseconds. Typical insertion loss is 0 dB and S/N about 88 dB. The BBD3009's clock frequency range is from 10 kHz to 200 kHz. The device is useful in reverberation, vibrator chorus, phaser/flanger effects, and audio signal delay applications in telephone and voice communication systems. Volume price is \$2.75 each.

Panasonic has also announced the BBD3008, a 2048 stage BBD with delays up to 104.8 milliseconds and 78 dB S/N. Quantity prices are \$14.95 each. Panasonic Electronic Components Division, One Panasonic Way, Secaucus, NJ 07094. **R-E**

# Hand-held computer power is here!

## An autoranging DMM breakthrough from B&K-PRECISION.

B&K-PRECISION's new microcomputer controlled Model 2845 is a major advance in digital multimeter technology. At a price comparable to ordinary manually operated units the 2845 brings microcomputer intelligence to a handheld portable DMM. When applied to a circuit, its computer selects the range providing maximum resolution without the slow "hunting" action characteristic of many bench-type autoranging DMM's.

The 2845 is certainly the most user oriented hand-held DMM available. No other DMM can match its speed and simplicity of operation. With tilt stand, large display and optional AC power adapter, it becomes a remarkable inexpensive bench DMM.

- Microcomputer autoranging speeds operation and stabilizes readings
- Auto-skip program for best resolution in least time
- Easiest, fastest-to-use DMM available
- 0.1% basic DC accuracy
- 3½ digit, 0.5" LCD display
- Continuity test "beeper"
- Range-lock, holds selected range
- Measures AC/DC voltage; AC/DC current; resistance
- Meets tough U.L. 1244 safety standards

Available for immediate delivery from your local distributor. Call toll-free 800-621-4627 for additional information and the name of your local distributor.

**BK PRECISION**

**DYNASCAN CORPORATION**

6460 West Cortland Street  
Chicago, Illinois 60635 • 312/889-9087

Int'l. Sls., 6460 W. Cortland St., Chicago, IL 60635  
Canadian Sales: Atlas Electronics, Ontario

Model 2845 \$175



CIRCLE 41 ON FREE INFORMATION CARD





# hobby corner

A call for do-nothing circuits plus a light-panel project and a new 3rd hand.  
EARL "DOC" SAVAGE, K4SDS, HOBBY EDITOR

A TOY THAT ENCOURAGES AND DEMANDS the exercise of imagination—such a toy would help a child grow; yet it is scarce in the marketplace. Fortunately, you can make a top-notch entertainer and imagination stimulator from the parts resting in your junk box (with perhaps a few additions).

Some years ago when my children were young, I built an airplane cockpit, and a control room of a submarine, and a spaceship control room, and a hundred other things. It was just a typewriter-size wooden box but when opened, there was a panel full of dials, switches, lamps, meters and counters. When operated in the correct combinations, those controls gave plenty of action with flashing lights, rising and falling meters and even sound.

For countless hours that box and its operators cruised the deepest oceans, traveled the roads of the world, flew through the fiercest storms, and rocketed to the planets and stars. Yet, it did nothing—so we dubbed it "The Idiot Box."

My first grandchild appeared on the scene last fall and I am planning to haul the old idiot box out of the attic and refurbish it. As slow as I am, he'll be ready to operate the controls by the time I get the work completed. Moreover, I don't want to simply clean it up—I want to bring it up to the current "state of the art." That means IC's and LED's and digital readouts and oscillators and so on. Let's face it: An idiot box should be a *real* idiot box! So I am trying to dream up all kinds of realistic, exciting, do-nothing circuits.

Perhaps you, too, would like to build an idiot box for your boy or girl, little sister or brother. Let's have a contest for the best circuits. The more action and the least cost, the better. Send in your circuits and we'll print the best ones. Then, we can build the best idiot boxes that money can *not* buy!

## Light-panel project

Our project for this month is a light-panel to impress and mystify your friends. I am sure you have seen the panels of flashing lights on Star Trek's Enterprise. They appear in every such control room to hit the movie or TV screen. Did you know, by the way, that in the old days the monster computers had similar light

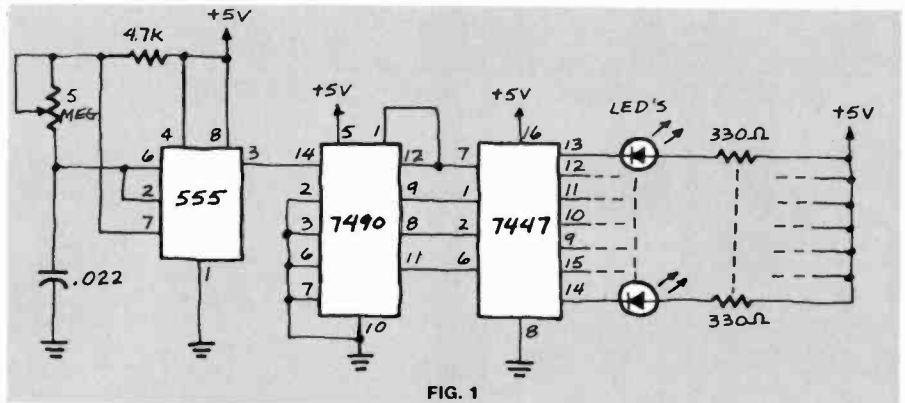

FIG. 1

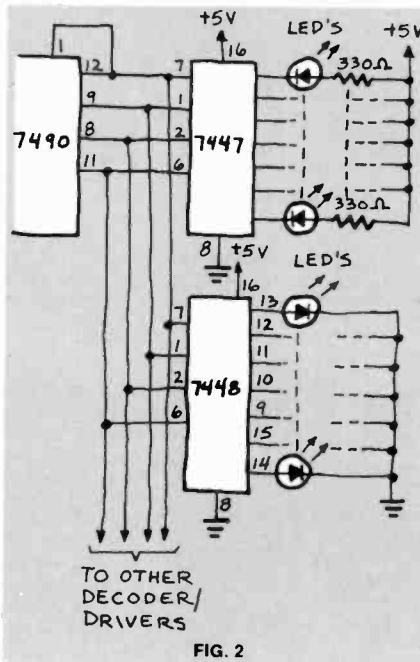

FIG. 2

panels (they provided a means of reading the contents of the memory registers).

Well, now you can have your own to stand alone or you can provide it with an obvious but dummy connection to your computer, TV, radio, audio amp, et cetera. Then, you will be able to say that its function is just about anything! And in the building process, you'll learn more about IC's.

The basic circuit for the light panel is given in Fig. 1. The circuit is driven by a 555 oscillator. We have used and discussed this clock circuit several times in the past. The clock pulses are converted

to BCD counts by the 7490 that, in turn, feeds the 7447.

That 7447 decoder/driver switches the LED's connected to its outputs in place of the usual digital readout segments. This design gives an *apparent* random pattern on the LED's. So far, so good—but still fairly boring.

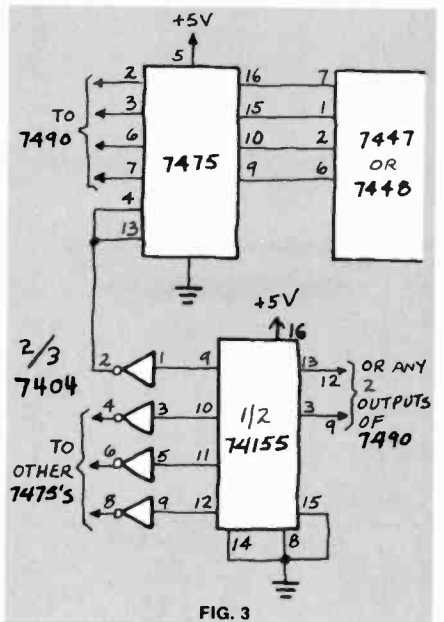

FIG. 3

We liven things up by adding a second row of LED's as shown in Fig. 2. As you see, even more rows can be added. Mount the LED's in two separate rows, one under the other. In addition, mix up the order of the LED's so identical patterns of light don't show up on the rows.

*continued on page 86*



# Beckman brings a new dimension to hand held Digital Multimeters

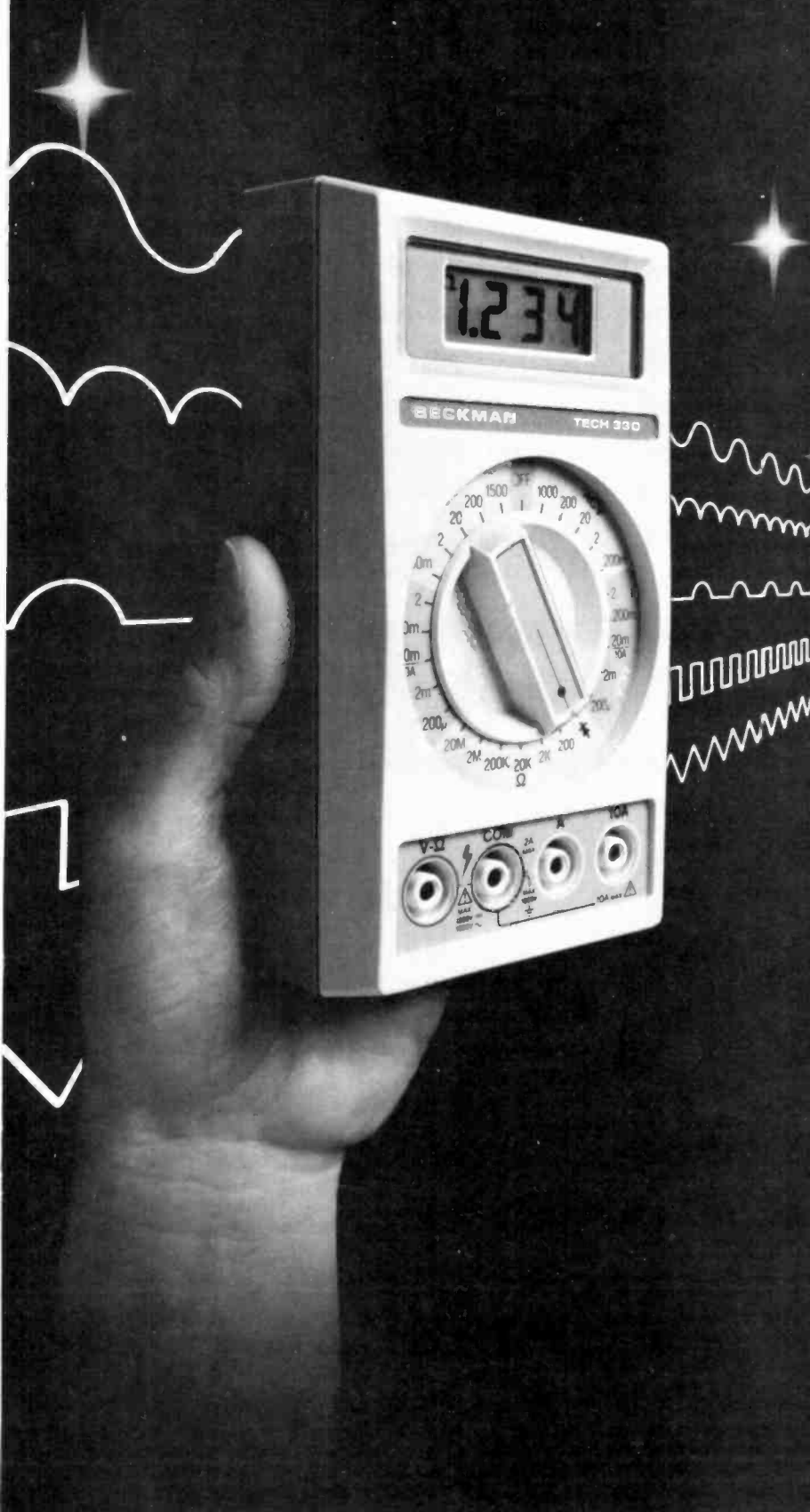

## True RMS capability at an affordable price





Now you can measure the exact power content of *any signal* — regardless of waveform. Beckman delivers the new TECH™ 330 multimeter with true RMS capability and many more fine performance features for just \$210.

Unlike most multimeters calibrated to read only the true power content of sine waves, the TECH 330 extends its true RMS capability to give you accurate readings of both sine and non-sine waveforms.

True RMS makes a significant difference in accuracy when measuring switching power supplies, flyback power circuits, SCR or TRIAC controlled power supplies or any other circuit generating a non-sine signal.

The TECH 330 also accurately measures the entire audio band up to 20 kHz. But that's not all you can expect from Beckman's top-of-the-line multimeter.

Measurement Comparison Chart

| Waveforms (Peak = 1 Volt)   | Average Responding Meter | Beckman TECH 330 | Correct Reading |
|---|--------------------------|------------------|-----------------|
| Sine Wave<br>                       | 0.707V                   | 0.707V           | 0.707V          |
| Full Wave Rectified Sine Wave<br>  | 0.298V                   | 0.707V           | 0.707V          |
| Half Wave Rectified Sine Wave<br> | 0.382V                   | 0.500V           | 0.500V          |
| Square Wave<br>                   | 1.110V                   | 1.000V           | 1.000V          |
| Triangular Sawtooth Wave<br>      | 0.545V                   | 0.577V           | 0.577V          |

You also get 0.1% basic dc accuracy, instant continuity checks, 10 amp current ranges, a separate diode test function, 22 megohm dc input impedance, and an easy-to-use rotary switch.

With so much capability in hand, you'll be able to depend on the TECH 330 for a long time. That's why Beckman designed it tough enough to go the distance.

Enclosed in a rugged water-resistant case, the TECH 330 can take a 6-foot fall onto concrete and still perform up to spec. And to further ensure reliable, trouble-free operation, the TECH 330 gives you 1500 Vdc overload protection, RF shielding, 2000-hour battery life, gold switch contacts, and fewer electronic components to worry about.

Add another dimension to your world of electronics. Visit your Beckman distributor today for more information on the TECH 330 and Beckman's complete line of digital multimeters, starting at \$120.

For your nearest distributor, or a free brochure:

**CALL TOLL FREE  
24 HOURS A DAY, 7 DAYS A WEEK**

**1-(300)-821-7700 (ext. 517)**

in Missouri 1-(800)-892-7655 (ext. 517)

**BECKMAN**

CIRCLE 18 ON FREE INFORMATION CARD

Take a  
giant step  
forward...

# Learn professional audio recording technology.



Complete the  
**Multi-track Recording Technology**  
curriculum in one year, or earn the  
**B.S. Degree in Music Technology**  
via the Institute of Audio Research—  
New York University joint program.

Winter '81 Quarter starts  
Monday January 5th.

Write or call for brochure



**Institute  
of Audio  
Research**

64 University Place  
Greenwich Village  
New York, N.Y. 10003  
(212) 677-7580

Established  
1969

Licensed by N.Y. State Dept. of Education

## HOBBY CORNER

continued from page 84

Don't be thrown by the 7447 and the 7448 in Fig. 2. You can use either one or both types just so long as you wire the LED's properly. Both types are shown so you can go easy on your junk box.

Now if you really want to get fancy, check out Fig. 3. Here, a 7475 four-bit latch is inserted in the address lines of each decoder/driver. When pins 4 and 13 are high, the LED's blink away; when they are brought low, the LED's freeze (latch) in the pattern they happened to have at the moment of change.

The latches can be addressed sequentially by the inverted (7404) outputs of the 74155 data distributor as shown in Fig. 3. If you are building a *big* panel, the other sections of the 7404 and 74155 can be used, too. As noted, you can get a non-regular selection sequence by using other combinations of the 7490 outputs to address the 74155. In any case, the rows of LED's blink and then freeze one at a time.

Your panel can be further improved by using a mixture of LED colors. Each row could be a different color but I prefer to mix colors within the rows to give the display more variety.

With several rows of LED's, you really have *something*—only you can say *what*. Shades of Captain Kirk! R-E

**IF YOU'RE AN  
ADVERTISER  
WHO NEEDS  
JUST A LITTLE  
SPACE LIKE  
THIS 1/6 PAGE,  
CALL YOUR  
NEAREST  
RADIO-ELECTRONICS  
SALES OFFICE  
RIGHT NOW.  
YOU'LL DISCOVER  
YOU DON'T  
HAVE TO SPEND  
A LOT OF \$\$\$  
TO REACH THE  
PEOPLE WHO  
DO SPEND A LOT.**

**NEW YORK**  
Stan Levitan  
212-777-6400

**CHICAGO**  
Ralph Bergen  
312-446-1444

**LOS ANGELES**  
J.E. Publishing  
213-659-3810

**Radio-  
Electronics**



## Introducing... **arkon's exclusive line!**

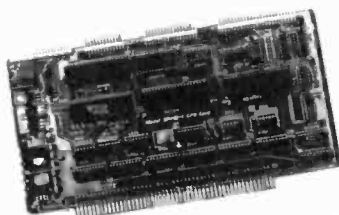

## arkon kits

All ARKON kits are complete with PCB.  
Logic Probe Kit, with case... \$24.95  
RS232 to TTL Converter Kit... \$ 9.95  
VD-1 Video Modulator Kit... \$ 8.95  
ET1 Sound Generator Kit... \$44.95

### CP/IO-1

An S-100 system card, wired and tested that will outperform the mass market systems in versatility, price and speed. It has all the CPU (8080) disc control (1771) and IO (8255) needed for a disc based CPM system. Interfaces, to all common 8" and 5 1/4" drives. (Shugart, Memorex, BASF, Siemens, Wang). Also features EIA RS232 port (110 to 9600 baud), fully vectored interrupts (TMS5501), on board digital data separator, 2K bytes EPROM, 24 fully handshaked IO lines, dual mapped IO, cassette interface on board, fully buffered... \$495.00

### ASC II KEYBOARD KIT

60 key complete ASCII character set. Highest commercial quality key switches. Uses a KR 2376 ST encoder IC. Output compatible with TTL. Caps lock for upper case alpha characters. Repeat key. Parity and/or data invertable. Positive and negative keypressed and strobe signals. Requires +5V to +30V at 100mA. Complete kit all parts... \$99.95

### COLOR VIDEO MODULATOR

The ultimate APPLE II color modulator. Provides proper level shifting to clean up the familiar smearing effects of simpler modulators. Available at the same price.

Assembled and tested with die cast case... \$49.95  
Kit... \$24.95

### S-100 MOTHER BOARD

Exclusively ARKON's, the A6S100 6 slot mother board, designed for the system builder using modern boards where few slots are required. Provision for semi-active termination.  
A6S100... \$24.95  
S-100 edge connector... \$5. ea/6 for \$25.00.

### SUPER S-100 XFORMER

Designed by ARKON, built by HAMMOND. A transformer that fits almost all requirements in building a computer power supply. Transformer no. 120165 uses standard line voltage and provides 3 outputs:  
8V at 18A for +5V supply.  
28Vct at 4.5A for ±15V supply.  
22V at 4.5A for disc drives.  
A unique value... \$49.95

Send certified cheque, money order, ChargeX, Master Charge... Include expiry date, card number and signature. We process only prepaid orders. Minimum order \$10.00 Add 5% (minimum \$2.00) for shipping and handling. Ontario residents add 7% sales tax. All prices subject to change. Dealer inquiries welcome.

409 Queen Street West, Toronto, Ontario Canada,  
M5V 2A5. Tel. (416) 868-1315.

**arkon  
electronics Ltd**

**Good news for you and your customers. NESDA/ISCET rates RCA serviceability:**

# 'Excellent'

***"The RCA CTC 108 and CTC 109 chassis have earned the highest possible serviceability rating category...***

***Excellent... by incorporating serviceability features required in the ISCET Serviceability Rating Form.***

***"RCA's many years of cooperation with ISCET's Serviceability Committee has helped produce excellent results."***

***—Dean R. Mock, Chairman, NESDA/ISCET Serviceability Committee***

ISCET's 92% (CTC 108) and 93% (CTC 109) ratings were good news to us. Because they mean that some of the most demanding critics in the industry agree that we've succeeded in de-

signing chassis that not only give your customers a first rate picture, but are easy to repair too. Here are some reasons why they think so:

**All subassemblies plug into chassis.** No tools are needed to remove chassis (main circuit board). Just remove the cabinet back, unplug subassemblies and the chassis is ready for removal.

**Roadmapping on both sides of the board.**

Although the XL-100 chassis use single-sided circuit boards, double road-mapping means you can easily trace circuits from either side.

**Circuits and voltages directly identified.** Major circuit areas as well as power supply source and key pulse voltages are labeled by name on the board. So you can find them fast.

That all means that when you do have to repair our new XL-100 chassis, in most cases you can fix them quickly and easily.

And you won't have to waste your valuable time trying to find out where to go to fix what you already know is wrong.

Because to us that's what really counts. Making your job easier and your customers happier.



# RCA

**RCA IS MAKING  
TELEVISION  
BETTER AND BETTER.**

For your free subscription to RCA COMMUNICATOR, our magazine of news and advice for service technicians, write: RCA, Dept. 1-455, 140 North Sherman Drive, Indianapolis, IN 46201.

## ILP AUDIO MODULES



- Built-in heatsinks
- Protected circuitry
- No external parts required
- 5 connections
- 5 year warranty!

### HY50 Amplifier 30 WATTS RMS \$28.95

High performance amp with rugged aluminum heat-sinks. Measure only 4" x 2" x 1" thick! Mounts with 2 screws. Gives 30 watts RMS at 0.02% distortion. Response 10 — 45 KHz. 4 to 16 ohms.  $\pm 25$  V/2A.

HY30. 15 watts RMS. Size/specs as HY50. 20 V/2A. 25.95

### HY200 Amplifier 120 WATTS RMS \$79.95

High performance amplifier with large heatsink area for cool operation. Fully protected circuitry. Distortion only 0.01% at 120 watts RMS (1 KHz). Response 10 Hz — 45 KHz. S/N ratio 100 db. Only five connections. Amazingly compact — only 4 1/2" x 4" x 2" D. Mounts with 2 screws. Requires  $\pm 45$  V/3A. 4 to 16 ohms.

HY120. 60 W RMS. Specs/size as HY200.  $\pm 35$  V/2A 59.95

HY400. 240 Watts RMS (4 ohm). Double the power, double heatsink area! Same specs as HY120/200. May be used into 8 ohms at reduced output.  $\pm 45$  V/4A \$99.95



### HY6 Mono Preamp \$25.95

### HY66 Stereo Preamp 48.95

Inputs for RIAA phono, tape with monitor, tuner, auxiliary and microphone; full tone control circuitry. Incredible performance: Response DC to 100 KHz, distortion 0.05%, S/N 90 db. Output to 4.5 V RMS. Supplied with edge connectors. Compact. Reliable. Internal voltage regulation — use from 15 to 50 V safely!

Name \_\_\_\_\_

Address \_\_\_\_\_

City \_\_\_\_\_ Zip \_\_\_\_\_

Please send \_\_\_\_\_ Amt. \_\_\_\_\_

Check ( ) M/O ( ) Visa ( ) M/C ( )

Number \_\_\_\_\_ Exp. \_\_\_\_\_

**GLADSTONE** Electronics (716) 849-0735

901 Fuhrmann Blvd., Buffalo, N.Y. 14203

CIRCLE 63 ON FREE INFORMATION CARD

## Want to cut out a career as a two-way radio technician?

MTI offers the only training for professional FM two-way radio available. Qualified technicians are employed in government, industry, and public service. But training is your key.

You could cut out a career as a two-way radio technician by cutting out this coupon. We'll send you information on how you can learn more about this specialized field, at home.

Name \_\_\_\_\_

Address \_\_\_\_\_

City \_\_\_\_\_

State/Zip \_\_\_\_\_

B3M



## Mobile Training Institute

Box 735, Camp Hill, PA 17011-U.S.A.

CIRCLE 55 ON FREE INFORMATION CARD

# new products

More information on new products is available. Use the Free Information Card inside the back cover.

**OSCILLATOR, Model 4400**, is an ultra-low distortion, stable-amplitude sine-wave oscillator covering the frequency range from 1 Hz to 110 kHz. It produces less than .001% distortion for measuring audio-preamplifier and power-amplifier harmonic distortion. It features a flat response of .05 dB across the frequency range, which eliminates the need to constantly monitor input voR-



CIRCLE 151 ON FREE INFORMATION CARD

age level during frequency-response tests and has a 3-digit tuning selector for precise frequency selection. The 4400 provides a 7-volt RMS sine-wave output and has a 3-position pushbutton attenuator calibrated in 20-dB steps, which, along with the 30-dB vernier, provide a total dynamic range of 90 dB. Simultaneous inverted (180°) and quadrature (90°) outputs are also provided. Price is \$550.—Krohn-Hite Corp., Avon Industrial Park, Bodwell St., Avon, MA 02322.

**RADAR DETECTOR**, the *Fuzzbuster III*, is designed to pick up signals from all types of radar; it automatically rejects signals from non-radar sources. It features dielectrically-coupled wave guide technology that gives optimum sensitivity



CIRCLE 152 ON FREE INFORMATION CARD

against all types of radars and has a sensitivity control to allow adjustment for the operating environment. This compact unit, measuring 4 x 5 x 1 1/4 inches, can be installed on virtually any dashboard. Retail price is \$139.95.—Electrolert, Inc., 4949 S. 25-A, Troy, OH 45373.

**CAPACITORS, feed-thru**, are a combination of a feed-through insulator and bypass capacitor in a single component, and are designed for communications, automotive, and consumer electronic-equipment systems. The capacitors provide a convenient and economical means of feeding power to electronic systems and of bypassing those power circuits to prevent RF radiating from the system via power-input lines. They also bypass interference picked up by the power-supply lines and prevent its introduction into the system. Minimal inductance to ground also makes

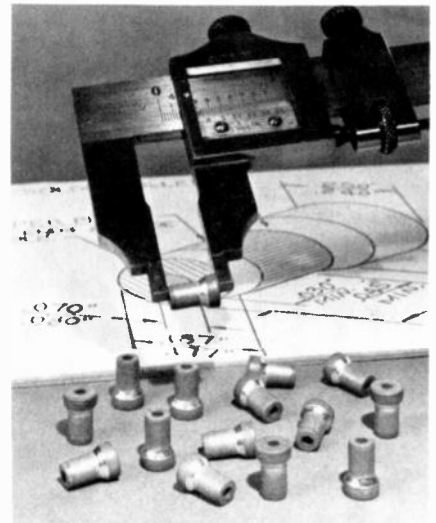

CIRCLE 153 ON FREE INFORMATION CARD

the components effective bypass devices up into the VHF region. Capacitance is 1000 pF; voltage rating is 500 WVDC. Price range of the *feed-thru* capacitor is 5 to 7 cents each in production quantities.—RMC-Radio Materials Corp., Marketing Dept., 4242 W. Bryn Mawr Ave., Chicago, IL 60646.

**DIGITAL MULTIMETER, model 2845**, is a 3 1/2-digit, handheld unit featuring microcomputer-controlled autoranging. After the user selects the function and connects the *model 2845* to the cir-



CIRCLE 154 ON FREE INFORMATION CARD

cuit under test, the microcomputer analyzes the applied signal and then selects the range that will give the greatest resolution. When input to the

*continued on page 90*

# PHONE WIZARD

**DICTOGRAPH®** the producer of communication systems for the White House and Pentagon, introduces a space age computer phone. An amazing futuristic instrument capable of 25 functions and memory bank storage of 30 numbers — convenient compact size — all at a price that will make you smile!



This incredible phone dialer lets you regulate outgoing phone calls using a secret lock command.

No one's got it. And if they do, it's twice the size and triple the price. The Phone Wizard is lightweight (only 15 oz.) and compact, measuring only 8 1/4" x 6" x 1 1/2". The Phone Wizard was selected as the "Most Innovative Electronic Product of the Year" at the recent 1980 International Consumer Electronic Show. All American made, it is approved by the FCC (U.S. Government).

The Phone Wizard is based on a unique 'Logical Language Sequence', which gives each key multiple use. This feature is activated by pressing a predetermined code onto a multiple use key (like a multi-function digital watch).

## It's an Automatic Dialer

Think of the number of people you frequently call. The Phone Wizard stores up to 30 often used phone numbers (up to sixteen digits each) in its Memory Bank.

When dialing don't pick up the phone, just push the right button and listen. The built in loud speaker lets you hear the other person answer or the busy signal.

Glance at the big bright LED display. You'll immediately know the right number is being dialed—

## More Outstanding Features

- Pressure sensitive keys, solid face (no buttons).
- Beep tones tell you that each digit is being dialed or stored correctly.
- Back-Space Erase lets you 'erase' a wrong number. Easy as pie.
- Want to confirm a stored number? Just press the storage button twice. Instantly you'll see a big read-out so you can verify.
- Automatically rings your number up to six times, then stops when your party isn't home.

## Connects to Any Phone System In Minutes

**MODULAR PLUG SYSTEMS.** Installing the Phone Wizard to any modular plug takes only minutes. Simply unplug line from phone and plug into connection labeled 'line'. Then plug one end of Phone Wizard cord (included) into connection marked 'phone' and the other end back into telephone. Even older platforms require only an inexpensive adapter. This adapter is available at any stereo/radio store and connects in seconds. In addition, Phone Wizard automatically transforms dialer phones to

push button.

**INTERNAL PHONE SYSTEMS** sometimes require the dialing of 1 or 2 digit excess number to connect with the main system, for recording reasons. With Phone Wizard, you can still store frequently used numbers, and still press only one key for dialing. For example, the excess number is 91. Just press 91. Then press Pause, which allows enough time for internal recording. Then continue pressing the number desired, say 265-829-2112. The LED will display 91P2658292112. Now press Store/Reset and the desired storage position. Instantly, the number is stored for "one-touch" dialing.

**PRIVATE PHONE COMPANIES** such as SPRINT or MCI are easily used with Phone Wizard. The only difference is that you'll use two memory keys. The first stores the computer access number, for instance, 492-5000. The second stores your authorization number, plus the full number you want memorized. To place the call, press the first key (storing access number), wait for the computer's signal. Then rapidly press the second key TWO times. Now your call is automatically placed.

**MULTI-LINE** phone systems require an adapter, which is quickly installed. Up to 5 lines can be hooked into the adapter. Or you can connect other phone accessories. Ordering instructions follow.

## Busy Number Buster and Emergency Dialer

Suppose the number you're calling is busy, just touch the Re-Dial Key, to recall. Still busy? Just program the Phone Wizard to redial later on (up to 15 times, one per minute). A special sign on the display will indicate that the number is being redialed.

**Emergency!** Here's the quickest and easiest mechanism for dialing the Police or Fire Dept.

## Conference Speaker For Group Conversations

Activate the One-Way Conference Speaker by depressing a button. Conduct group meetings over the phone. Everyone on your end will hear the phone conversation through Phone Wizard's loudspeaker. You relay ideas and suggestions from the group by speaking through the telephone receiver, and everyone hears the answer. Meet by phone, you'll save time, effort, and not

to mention those high gas bills.

## Digital Clock, Stop Watch and Timer

Time of day displayed in hours, minutes and seconds.

**Stop Watch Feature** times all calls automatically—great for gauging long-distance calls, keeping records, cutting down on expenses by limiting calls, etc.

You can even time a particular PART of a call. That's how exact this special feature is.

## Prevents Unauthorized Use

An ingenious combination electronic lock allows you to prevent unauthorized long distance outgoing calls. Simply press in the secret code. This locks the dialer unit and the phone itself.

Use it for 30 days if you're not completely satisfied return it at our expense. Every cent will be refunded promptly.

The price? Not those inflated prices you may have seen around town—but only \$119.95 plus \$2.75 for insured shipping. For two \$109.95 each plus \$2.75 each for insured shipping. For use with multi-line system, please include \$30 for optional adaptor. You'll receive complete, easy-to-follow instructions plus a 90-day Parts and Labour Warranty, and service (if ever needed) is readily available. Phone now so we can get your tryout unit right out to you. You're not risking a cent.

**Call TOLL FREE:  
800-526-2801  
800-257-7850**

In New Jersey, Call: 800-322-8650  
N.J. residents please add 5% sales tax.

Call any time, 7 days a week. Be sure to have your credit card handy—either Visa, Master Charge, American Express, Carte Blanche or Diners Card.

Save while this offer lasts. You'll not find a better bargain on a top-quality handsome, easy-to-use Phone Dialer anywhere.

If ordering by mail, send your check, money order, or credit card information to:

**INTERNATIONAL SALES GROUP  
MERCURY  
THE IMAGINATION PEOPLE®**

**Dept. RE-12, Lakewood Plaza  
Lakewood, New Jersey 08701**

CIRCLE 77 ON FREE INFORMATION CARD

# FREE... Catalog of great gift ideas



You'll find the right gift for all the electronics buffs on your Christmas list— from clocks and radios to gas-saving car accessories to computers— all in easy-to-build, money-saving kits. Prices start at under \$20. This year, shop the fast, easy way in the Heathkit Catalog.



## Heathkit®

If coupon is missing, write  
Heath Co., Dept. 020-722,  
Benton Harbor, MI 49022.

Send to: Heath Co., Dept. 020-712,  
Benton Harbor, MI 49022.

Send my free Heathkit Catalog now.  
I am not currently receiving your catalog.

Name \_\_\_\_\_

Address \_\_\_\_\_

City \_\_\_\_\_ State \_\_\_\_\_

CL-745 Zip \_\_\_\_\_

CIRCLE 23 ON FREE INFORMATION CARD

## NEW PRODUCTS

continued from page 88

meter reaches a level greater than the range in use, an "auto-skip" feature skips to the next highest range. Basic DC accuracy is 0.1%, with values indicated on a 0.5-inch high LCD display. The 2845 measures DC and AC volts, DC and AC current and resistance. Other features are a built-in audible tone generator that eliminates the need to look up at the meter, "range-lock" control, and protection against overloads. In the ohms range, it resists overloads of up to +1000 and -450 volts DC or 300 volts AC. Comes with test leads, built-in tilt stand, detailed operating manual, and spare fuse. Suggested retail price is \$175.—B&K-Precision, Sales Dept., 6460 W. Cortland St., Chicago, IL 60635.

**AC VOLTMETER/AMMETER, model 30-K**, is an all-in-one pocket-sized tester. AC voltages are measured in three ranges: 150, 300 and 600 volts. AC current is measured in 6 ranges: 6, 12, 30, 60, 120 and 300 amperes. The *model 30-K*



CIRCLE 155 ON FREE INFORMATION CARD

includes the drop-resistant clamp-on *model 30* Volt/Ammeter, the *model 101* line separator for in-circuit ammeter readings, the *model 32* Ohms (0-1000 ohms) probe for measuring resistance and a heavy-duty padded vinyl carrying case. Suggested retail price is \$95.00.—Triplet Corp., One Triplet Dr., Bluffton, OH 45817.

**TECHNICIAN'S REPAIR KIT, model TRK-4**, is a kit of precision miniature tools designed for everyone from the occasional handyman to the serious hobbyist. The *TRK-4* combines four kits into one; it includes a screwdriver and awl kit with screwdriver blades sizes .055, .070, .080, and .100 inches, and an offset open-end wrench kit



CIRCLE 156 ON FREE INFORMATION CARD

with wrench sizes  $\frac{1}{8}$ ,  $\frac{3}{32}$ ,  $\frac{1}{16}$ ,  $\frac{1}{4}$ , and  $\frac{3}{16}$ -inches. It also includes a Phillips and Allen kit with numbers 0 and 1 Phillips blades and .050, .062, and .078-inch Allen wrenches, and lastly, a socket wrench kit with sizes  $\frac{3}{64}$ ,  $\frac{1}{32}$ ,  $\frac{1}{16}$ ,  $\frac{1}{8}$ , and  $\frac{3}{32}$ -inch socket wrenches. Suggested retail price is \$20.—Moody Tools, Inc., 42-60 Crompton Ave., East Greenwich, RI 02818.

R-E

## ESR METER checks electrolytics IN-CIRCUIT and is TV shop FIELD-TESTED:

The most fantastic instrument I've ever bought—Billings, Mt. Used it 3 months; it only missed once—Marinette, Wis. (Typical). Squeal & no sync: 3 bad caps in B+ & AGC; Many Thanks—Taos, N.M. Please ship another; very satisfied—Glen Rock, Pa. It's fantastic—St. Joseph, Mo. Please rush; heard good reports—Hicksville, N.Y. One tremendous meter—Alexandria, Minn. Send your Super meter; heard about it—N. Olmstead, Ohio. Love that ESR Meter—Acton, Mass. Used it intensively for 30 days; it's been 100% effective—Pittsburgh, Pa. I understand that if I'm not completely flabbergasted, you will refund my money—Sanford, Fla. (Refund not requested).

60-day Satisfaction Guarantee.

Send check or M.O. or call

(313) 435-8916 for COD

Or write for free brochure to:

*Creative Electronics*

ESR Brochure \$99.00  
1417 N. Selfridge postpaid  
Clawson, Mich. 48017 in USA

CIRCLE 42 ON FREE INFORMATION CARD

Discone™ Model DCX

### MAKE YOUR SCANNER REALLY PERFORM!

... with Hustler multi-band monitor antennas.

Whether it's mobile or base, Hustler has the antenna that provides exceptional scanner performance, resulting from advanced engineering and use of quality materials.

If you want real performance... get Hustler!

Clearly the choice of those who know quality

See your dealer or write:

**HUSTLER** INC.

3275 North B Ave. Kissimmee, Florida 32741

MOM Magnetic Mount

CIRCLE 29 ON FREE INFORMATION CARD

# All new! All construction projects!

Here's the new quarterly magazine you've been waiting for—*Radio-Electronics Special Projects*—page after page of all new, never-before published construction articles on Test Equipment, Computers, Electronic Music, Communications, Automotive and Hobby Projects.

They're the kind of projects you want to build, the kind only *Radio-Electronics* has the expertise to design, and the first issue is filled with brand-new construction articles like these:

**Test Equipment**  
**Digital Scope Multi-plexer**—to convert almost any scope into a 4-trace unit.  
**Frequency Multiplier**—to extend the range of your frequency counter.  
**Safety Cooker**—that protects unattended equipment against electrical problems.  
**Battery Box/Switching Box**—a great accessory for any bench.  
**Car Test Probe**—use it to test auto-

motive electrical systems.  
**Digital IC Tester**—to make quick work of testing digital IC's.

**Electronic Music**  
**The Chord Egg**—to generate an endless series of chords automatically.  
**Words And Music**—a programmable music generator that's ideal for doorbells.  
**Big Sound For Chord Organs**—to enhance the sound

from electromechanical chord organs.

**Computers**  
**Digital Logic Trainer**—that teaches how micro-processors work.  
**Save Your Files**—cassette tape recorder controller makes using tape as computer memory storage easy.  
**Programmable Sound Generator**—adds sound capability to almost any computer system.

**Hobby**  
**Adventures of the IC's**—applications for LM3914 and VMOS power FET's.  
**Digital Do-Nothing Box**—lights, counts, teaches binary and digital number systems.

**Communications**  
**Digital Readout Add-on For Communications Receivers**—to update older receivers easily.  
**Microphone Acoustic Coupler**—a sim-

ple add-on for any communications system.  
And lots more—all new, and all on your newsstands October 2

Or ...

Use the handy coupon and get your *advance copy* of *Radio-Electronics Special Projects* (mailed after August 25) delivered right to your door. Make sure you get your copy by ordering... today!



VOL. 1, No. 1

\$1.95  
WINTER  
1980

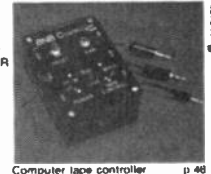

Computer tape controller p 46

## All New Construction Projects Computers. . . Test Equipment. . . Communications Electronic Music. . . Hobby Circuits. . . and more

RADIO-ELECTRONICS SPECIAL PROJECTS

WINTER 1980

RETAILER: SEE PAGE 26 FOR SPECIAL DISPLAY ALLOWANCE PLAN

Digital display for communications p 55

Programmable sound generator p 92

Digital IC tester p 40

TRS-80 control box p 14

Digital logic trainer p 32

4-channel adapter p 5

Bargraph voltmeter p 59

Digital do-nothing box p 10

**W**e will ship your magazine, postpaid in U.S. and Canada, within 6 weeks of receipt of your order. All other countries add \$3 for postage.

I want \_\_\_\_\_ magazines @ \$3.00 each. First-Class postpaid. Includes handling (U.S.A. & Canada)

I have enclosed \$ \_\_\_\_\_ (Foreign, add \$3.00 for Air Mail postage per copy.)

**Radio-Electronics  
Special  
Projects**

45 East 17th Street  
New York, N.Y. 10003

|                |       |     |
|----------------|-------|-----|
| Name           |       |     |
| Street Address |       |     |
| City           | State | Zip |

# communications corner

**"Quartz-locked" receivers. Here's a look at what they're all about.**

HERB FRIEDMAN, COMMUNICATIONS EDITOR

"THE XTAL IS DEAD. LONG LIVE QUARTZ." It's only been a few short years since crystal manufacturers were crying. To hear them tell it, with the advent of the CB frequency synthesizer that needed but two or three crystals (*Xtals* to those of us who actually worked with vacuum tubes) to generate 40 CB frequencies, the crystal industry was going the way of buggy-whip manufacturing.

Yet here it is some five years later and we are literally drowning in a sea of consumer and professional equipment that relies heavily on crystals. The crystal business has never been better, only now we refer to those same little vibrating devices as *quartz* (*quartzes*???)

Somehow the term *quartz* connotes a level of excellence never attained by the crystal: There are high-fidelity enthusiasts who would never consider a turntable that wasn't "quartz-locked."

And then there are consumers that actually equate *quartz* with *quality*.

(A local jeweler sells digital watches for as low as \$9.95. He sells *quartz* watches for \$100 and up. In actual fact, the \$9.95 digital watch and the "quartz" model both have a crystal—quartz—controlled timebase; but it's hard to sell "quartz accuracy" at \$100 when you can buy the same thing for \$9.95.)

The truth is that quartz is often used because the associated *low-cost* circuitry requires a precision frequency reference that is *similarly low in cost*; and more often than not, that's the reason why quartz is used to begin with. Three "circuits" used in communications equipment easily come to mind.

The first is anything with a microprocessor and/or synthesized frequency control. Any computer requires a stable, reliable, and accurate timebase.

The least expensive hardware with those characteristics is the crystal-controlled—or quartz—oscillator. (A microprocessor generally is used to control or provide the frequencies needed for tuning or transmitting, but frequency synthesis can be independent of other computer functions.)

As a general rule of thumb, receiving and/or transmitting frequency tolerance is easily achieved at the lowest possible cost by using a crystal timebase with the required tolerance. If a transmitter's output frequency must have a tolerance of 0.005%, the easiest possible way to do that is to use a crystal with 0.005% tolerance (after temperature stabilization) and to "lock" a frequency synthesizer to it.

## The quartz-locked circuit

A common form of a quartz-locked frequency synthesizer used in consumer equipment is shown in Fig. 1. The fundamental frequency is generated by a VCO (Voltage Controlled Oscillator). Frequency-multiplier amplifiers raise the VCO's output frequency to the desired carrier frequency,  $f_c$ . If the VCO operates at a relative high frequency, an output sample is fed to a frequency divider whose output is fed to a phase-lock detector. The divider output can either be equal to the frequency of a reference quartz oscillator that is also fed to the detector, or the divider output can be a low multiple of the quartz reference-frequency.

Often, where extreme tolerance is necessary, the quartz oscillator frequency might be very low, say 50 kHz, and it might be multiplied to a higher frequency before input to the phase-lock detector. That is done because low-frequency crystals have greater temperature and aging stability than high-frequency crystals. Also, depending on the required frequency tolerance and stability, the transmit carrier sample might be taken directly from the transmitter's output, as indicated by the dashed line.

The phase-lock detector compares the sample from the transmitter with the quartz-generated reference frequency and generates an output voltage when there is a difference in frequency between the two. The output voltage, which is actually a control voltage for the VCO, causes a change in VCO frequency until the detector no longer de-

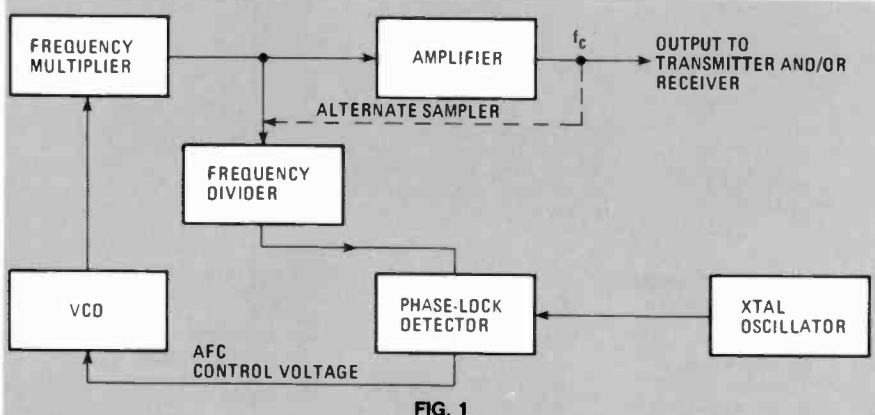

FIG. 1

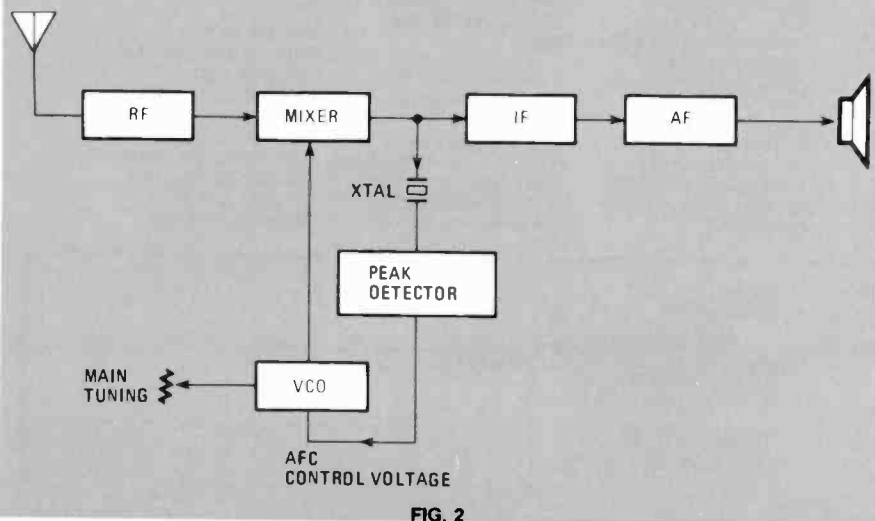

FIG. 2

continued on page 94



ITEM NO.  
WK-7

CMOS SAFE

# IC INSERTION/EXTRACTION KIT

**KIT INCLUDES**

- MOS-1416 14-16 CMOS SAFE INSERTER
- MOS-2428 24-28 CMOS SAFE INSERTER
- MOS-40 36-40 CMOS SAFE INSERTER
- EX-1 14-16 EXTRACTOR
- EX-2 24-40 CMOS SAFE EXTRACTOR



**OK MACHINE & TOOL CORPORATION**  
3455 CONNER ST., BRONX, N.Y. 10475 U.S.A.  
PHONE (212) 394-6600 TELEX NO. 125091



PRINTED IN U.S.A.

PATENT PENDING

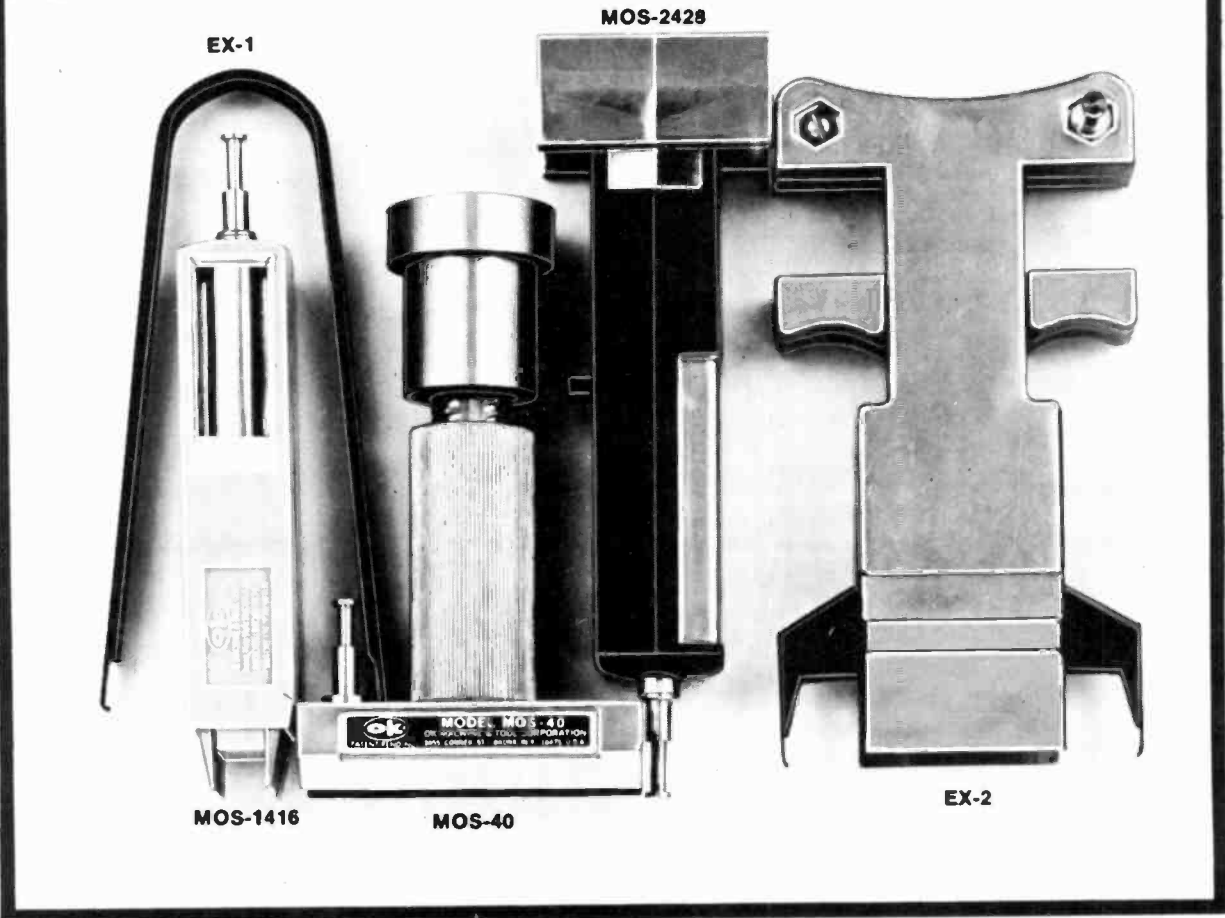

|      |                                    |         |
|------|------------------------------------|---------|
| WK-7 | COMPLETE IC INSERTER/EXTRACTOR KIT | \$29.95 |
|------|------------------------------------|---------|

**INDIVIDUAL COMPONENTS**

|          |                                    |         |
|----------|------------------------------------|---------|
| MOS-1416 | 14-16 PIN MOS CMOS SAFE INSERTER   | \$ 7.95 |
| MOS-2428 | 24-28 PIN MOS CMOS SAFE INSERTER   | \$ 7.95 |
| MOS-40   | 36-40 PIN MOS CMOS SAFE INSERTER   | \$ 7.95 |
| EX-1     | 14-16 PIN EXTRACTOR TOOL           | \$ 1.49 |
| EX-2     | 24-40 PIN CMOS SAFE EXTRACTOR TOOL | \$ 7.95 |

MINIMUM BILLING \$25.00. ADD SHIPPING CHARGE \$2.00. NEW YORK RESIDENTS ADD APPLICABLE TAX.

**OK MACHINE & TOOL CORPORATION 3455 CONNER ST., BRONX, N.Y. 10475 (212) 994-6600/TELEX 125091**

CIRCLE 64 ON FREE INFORMATION CARD

# LEARN MICROPROCESSING on your own computer!

## You Learn How To:

- Design & code microprocessor software
- Use logic & Bit Manipulation Techniques
- Enter & execute programs on your own computer
- Understand Microprocessor Architecture & Support Chips
- Control Programmable Input/Output Ports
- Implement Real-Time Interrupt Handling & Data Transfer
- Design your own microcomputer



8085 MICROPROCESSOR TRAINING UNIT \$299.95

## You Will Receive:

- A fully tested and assembled 8085A Microcomputer with 1K RAM, 1K EPROM and 1K PROM Memory, Programmable I/O, Keyboard Unit, CPU Card, Display and Operating System. 44 pin edge connector can be configured to any bus structure; area on CPU Card for Custom wire-wrap design or user defined interface circuitry, completely expandable
- Complete Step-by-Step Instruction Manual
- Complete User's Manual with programs included
- 252 page 8085A Cookbook takes you from basic microprocessor concepts to actual design of an 8085A Microcomputer
- 344 page 8080/8085 Software Design Book 1 with over 190 executable program examples plus detailed examination of all 244 instructions and typical assembly language program for the 8080/8085 Microprocessor

Satisfaction Guaranteed: If not completely satisfied you may return the product within 30 days for a full refund.

**RATED BEST VALUE BY INSTRUMENTORS**



CREDIT CARD ORDERS CALL TOLL-FREE



14905 NE 40th, Dept RE 121

REDMOND, WA 98052

1-800-426-6254 EXT 1121

YES! I want to start learning Microprocessors. Please rush me

8085AAT Microprocessor Training Unit at \$299.95 plus \$3.00 P & H

8085 Cookbook 21697 \$12.95 ... 8080/8085 Software Book 21541 \$9.50

NAME \_\_\_\_\_ DIVISA DMSTCD

ADDRESS \_\_\_\_\_

CITY \_\_\_\_\_ ST. \_\_\_\_\_ ZIP \_\_\_\_\_

CARD NO \_\_\_\_\_ EXP. DATE \_\_\_\_\_

SIGNATURE \_\_\_\_\_

**CIRCLE 25 ON FREE INFORMATION CARD**

## COMMUNICATIONS CORNER

continued from page 92

tests a difference in frequency. In that way the transmit frequency is locked—*quartz-locked* if you will—to a crystal-controlled oscillator.

Obviously, for receiving, carrier frequency  $f_c$  is simply the signal required by one of the local-conversion mixers.

It's important not to confuse *quartz-lock* with *digital tuning*; it's *not* the same thing. Nowhere in our illustration is there any digital synthesis. The multipliers could be ordinary harmonic amplifiers, or harmonic mixers. Alternately, all frequencies other than that of the VCO could be digitally generated. Or, all frequencies could be digitally generated, locked to the quartz reference without need for a VCO. No matter how it's done, the output frequency is locked to the output of a quartz reference oscillator.

Another use for quartz coming into more common use is the automatic frequency control shown in Fig. 2. So far, the main application of quartz-locked AFC is in FM tuners, but it is certain to be used in many different receivers requiring more precise tuning than can be obtained through the medium of human hand.

Figure 2 is a more or less conventional receiver (single conversion

shown for clarity) with a VCO local oscillator. A sample of the mixer output, which is the IF frequency, is passed through a crystal cut for the IF frequency. The crystal works in its series-resonant mode, appearing as a low-impedance path to the IF signal; hence, the signal passed to the peak detector is maximum when the mixer output is precisely at the same point the IF frequency.

If the local oscillator attempts to drift, or even if the received-signal drifts in frequency, the mixer's output frequency similarly attempts to drift off the IF frequency. The crystal is now fed an off-resonance signal and it appears as a higher-than-usual impedance, thereby reducing the signal passed to the peak detector. The peak detector senses that change in applied signal voltage and outputs an AFC correction-voltage to the VCO that results in the restoration of the IF frequency from the mixer.

Note that the AFC does not attempt to bring the oscillator on some predefined carrier frequency; that would only correct local oscillator drift. By tracking the mixer output the VCO can also correct for received signal frequency drift. (That is the rudimentary basis of "tracking" SSB receivers and transceivers which are rumored to be "in the pipeline.")

R-E

**HICKOK**  
the value innovator



Model 333

Model 331

# DMM + Vari-Pitch + Logi-Trax = MX-333 World's Fastest Troubleshooter

- 0.1% Basic Accuracy
- LCD Display In Unique Wide View Case
- Uses Single 9V Battery
- Compact Size, Rugged Construction
- Overload Protection
- Exclusive VARI-PITCH Audible Output (MX333)
- Fast LOGI-TRAK Logic Function (MX333)
- 20Ω Range (MX333)

... plus these popular sellers in stock and available for immediate delivery.



### Compact Video Generator

- Video output for VTR, CCTV and monitor applications
- Adjustable RF, channel 2-4
- 11 rock stable patterns • 10 step gray scale staircase • 3 bar and 10 bar gated rainbows
- Adjustable chroma levels (0-150%) • Crystal controlled chroma and timing oscillators for stability from 20 to 125
- Rugged high impact thermoplastic case and protective cover

Model 240



### Pocket Semiconductor Analyzer

- Automatic "hands-off" operation — frees both hands for troubleshooting
- Instant GOOD-BAD analysis — including LEAKAGE — of NPN's, PNP's, FET's, diodes & SCR's, in or out-of-circuit
- Rugged, all solid state — no moving parts
- Compact polypropylene case
- Will not damage transistors, diodes, or circuits under test
- Powered by 2 std. 9 V batteries (not inc.)

Model 216

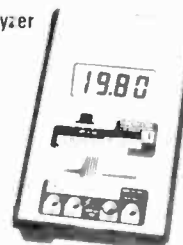

### LCD Digital Multimeter

- Automatic polarity, zero and over-range indication
- Easy-to-read 1 1/2" high LCD display
- 1 1/2 year battery life in typical use
- 12 oz. including 9V battery
- Withstands 4 ft. drop without loss of accuracy
- Automatic decimal point, built in low battery indicator, diode and transistor testing capability (LX304 only)

LX 304 LX 303

Order with Confidence and get the Fordham Advantage!

Call for our prices **TOLL FREE (800) 645-9518**

in N.Y. State call (516) 752-0050

**FORDHAM**

855 Conklin St. Farmingdale, N.Y. 11735



- Master Charge
- BankAmericard
- VISA • COD
- Money Order
- Check
- COD's extra

CIRCLE 74 ON FREE INFORMATION CARD



# Personal Computers & Microprocessing

Here are three inexpensive programmed learning courses designed to keep you up to date in digital electronics and computer programming.

## PROGRAMMING COURSE COMPUTER PROGRAMMING IN BASIC

### CONTENTS

BASIC is the language of the small computer, and the most easy-to-learn computer language in common use. With "Computer Programming in BASIC" you can teach yourself this language quickly and in detail. In 60 straightforward lessons you will learn the five essentials of programming: problem definition; flowcharting; coding the program; debugging; clear documentation. Contents include:

**Book 1:** Computers and what they do well; READ, DATA, PRINT, powers, brackets, variable names; LET; errors; coding simple programs.

**Book 2:** High and Low level languages; flowcharting; functions; REM and documentation; INPUT, IF...THEN, GOTO; limitations of computers; problem definition.

**Book 3:** Compilers and Interpreters; loops, FOR...NEXT, RESTORE; debugging; arrays; bubble sorting, TAB

**Book 4:** Advanced BASIC; subroutines; string variables; files; complex programming; example, glossary.

## THE ALGORITHM WRITERS GUIDE

This book explains how to master two of the more difficult aspects of good programming: problem definition and flowcharting. It shows how to define questions, organize them into the best sequence and then how to draw the flowchart. This flowchart is then used as the basis of the program.

## OUR CUSTOMERS

Design of Digital Systems has been bought by more than half the 50 largest corporations in America, and by Motorola, Intel, DEC, National Semiconductor, Fairchild, General Instrument, Hewlett-Packard, Heath Co., M.I.T., NASA, Smithsonian Institute, Bell Telephone Labs. And many, many more, as well as corporations and individuals in over 50 countries.

- Order free by phone
- Mastercharge/VISA
- No shipping charges
- Save \$5

## NO RISK GUARANTEE

There's absolutely no risk to you. If you're not completely satisfied with your courses, simply return them to Cambridge Learning Inc. within 30 days. We'll send you a full refund, plus return postage.

## TAX DEDUCTIBLE

In most cases, the full cost of Cambridge Learning courses can be a tax deductible expense.

## PHONE ORDERS — FREE

To order by phone, call (617) 664-3657 with your credit card information. It won't cost you a dime, because we'll deduct the cost of the call from the price of the course you order.

## TO ORDER BY MAIL

You may use the order form below if you wish, but you don't need to. Just send your check or money order (payable to Cambridge Learning Inc.) to the address below. If you don't use the order form, make sure your address is on the check or the envelope, and write exactly what you are ordering on your check. We also accept Company purchase orders.

## AIR MAIL

The prices shown include surface mail postage anywhere in the World. Air mail postage costs an extra \$10.

## DISCOUNTS

Call or write for details of educational and quantity discounts, and for dealer costs.

## SAVE \$5

If your total order exceeds \$30 you receive a \$5 discount. Order at no obligation today.

## ADVANCED COURSE DESIGN OF DIGITAL SYSTEMS

### CONTENTS

Design of Digital Systems is written for the engineer and serious hobbyist who wants to learn more about Digital Electronics. Its six large format volumes—each 11¼"x8¼"—are written to lead you step by step through number systems and Boolean Algebra, to memories counters and simple arithmetic circuits and finally to a complete understanding of the design and operation of electronic calculators, microprocessors and computers.

**Book 1:** Computer Arithmetic

**Book 2:** Boolean Logic

**Book 3:** Arithmetic Circuits

**Book 4:** Memories and Counters

**Book 5:** Calculator Design

**Book 6:** Computer Architecture

## INTRODUCTORY COURSE DIGITAL COMPUTER LOGIC AND ELECTRONICS

### CONTENTS

Digital Computer Logic & Electronics is designed for the beginner. No mathematical knowledge other than simple arithmetic is assumed, though you should have an aptitude for logical thought. It consists of four volumes—each 11¼"x8¼"—and serves as an introduction to the subject of Digital Electronics.

Contents include: Binary, octal and decimal number systems; conversion between number systems; AND, OR, NOR and NAND gates and inverters; Boolean Algebra and truth tables; DeMorgans Laws; design of logical circuits using NOR gates; R-S and J-K flip-flops; binary counters, shift registers and half-adders.

This course serves as an excellent introduction to our advanced "Design of Digital Systems".

TO: CAMBRIDGE LEARNING INC. 1 Judith Drive, North Reading, MA 01864

Please send me

\_\_\_\_\_ sets of Computer Programming in BASIC ... \$22.95 \$ \_\_\_\_\_

\_\_\_\_\_ sets of Design of Digital Systems ..... \$19.95 \$ \_\_\_\_\_

\_\_\_\_\_ sets of Digital Computer Logic and Electronics, \$14.95 \$ \_\_\_\_\_

\_\_\_\_\_ Algorithm Writers Guide ..... \$5.95 \$ \_\_\_\_\_

Massachusetts Residents add 5% Sales Tax ..... \$ \_\_\_\_\_

**If your order is over \$30 deduct \$5 discount**

Enclosed is money order/check payable to

Cambridge Learning Inc. for total ..... \$ \_\_\_\_\_

NAME \_\_\_\_\_

ADDRESS \_\_\_\_\_

CITY/STATE/ZIP \_\_\_\_\_

# radio products

More information on radio products is available. Use the Free Information Card inside the back cover.

**BASE STATION ANTENNAS, ASP-711 Series** and **ASP-712 Series**, are two series of lightweight all-weather high-band antennas. The **ASP-712 Series** antenna is shown below the **ASP-711 Series** antenna in the above photograph. Note that the photo is turned sideways showing both



CIRCLE 111 ON FREE INFORMATION CARD

antennas lying down rather than the correct vertical orientation. The two-dipole, 6-dB gain **ASP-711 Series** antennas weigh 13 pounds and have a rated wind velocity of 93 mph with a 1.65 safety factor. The four-dipole, 9-dB gain **ASP-712 Series** antennas weigh 25 lbs. and have a rated wind velocity of 82 mph with a 1.65 safety factor.

Both series are available in models covering the frequency ranges 150 to 160 MHz, 155 to 165 MHz and 164 to 174 MHz. All are rated at 500 watts maximum RF power and have a VSWR of less than 1.5:1 across a 10-MHz bandwidth. Dipoles are field-adjustable to allow offset gain or omni-directional patterns. Suggested retail price for **ASP-711 Series** is \$127.50; for **ASP-712 Series** is \$254.50.—**Professional Products Div.**, The Antenna Specialists Co., 12435 Euclid Ave., Cleveland, OH 44106.

**CB RADIO, model 3-5900**, is called "Help!", and is designed for the non-CB'er as a two-way emergency-communications or travel-information system. It is designed to be used when needed and stored away when not in use. The **model 3-5900** is a 40-channel transceiver that is equipped with a 12-volt auto adapter plug-in attachment. To operate, the user inserts the adapter into the car's cigarette-lighter socket, attaches the magnetic antenna to the roof, selects the channel, and begins transmitting. Other features include a two-function LED bar-graph meter, digital LED channel readout, built-in condenser microphone and a magnetic antenna with a 10-foot cord. The trans-



CIRCLE 112 ON FREE INFORMATION CARD

ceiver, cords, and antenna all fit into a rugged case that can be stored in the trunk or under some car seats when not in use. Suggested retail price is \$115.95.—**General Electric, Audio Electronics Products**, Syracuse, NY 13201. **R-E**



## Portable Oscilloscopes

15 MHz Triggered Miniscope Model MS-15

15 MHz Dual Trace Triggered Miniscope  
Model MS-215

30 MHz Dual Trace Triggered Miniscope  
Model MS-230

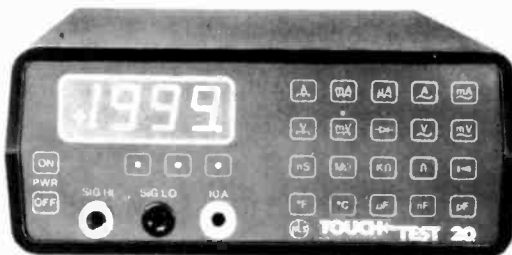
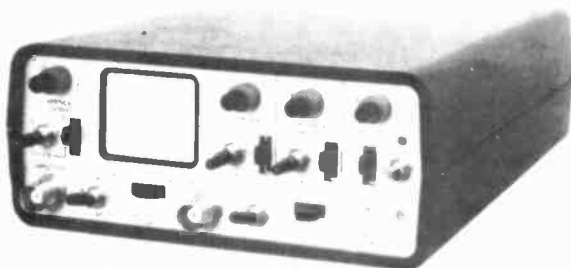

### New Touch/Test 20 Multimeter

A portable/bench-type meter than tests and measures 10 electrical parameters, 20 functions & 45 ranges.

#### MEASURES:

■ AC and DC Voltage ■ AC and DC Current ■ Resistance ■ Temperature, °C & °F ■ Conductance ■ Capacitance ■ Performs diode/transistor and continuity tests

#### FEATURES

■ Touch selection and control of functions, ranges and power. ■ Large (0.55" high) LED readout. ■ In-circuit test capabilities. ■ Size: 2.9" H x 6.4" W x 7.5" D. ■ Weighs less than 3 lbs.

Order with Confidence and get the Fordham Advantage!

Call for our prices **TOLL FREE**  
**(800) 645-9518**

in N.Y. State call (516) 752-0050

# FORDHAM

855 Conklin St. Farmingdale, N.Y. 11735



■ Master Charge  
■ BankAmericard  
■ VISA ■ COD  
■ Money Order  
■ Check  
■ COD's extra

# POCKET TYPEWRITER

*The World's Smallest Typewriter is also a full function calculator. It prints out messages, labels, issues invoices and acts as your personal information center.*

How many times have you said, "I can't even read my own handwriting?" Often the information you're frantically trying to decipher is very important! It would help if you could pull out a typewriter every time you had to jot down messages, thoughts or calculations, but that wasn't very practical — until now — With Memowriter, you can do exactly that! Now you can carry a typewriter and calculator everywhere and use it when needed!

## COMPLETELY PORTABLE

Memowriter is small enough to carry in your pocket. It measures only 7-13/32" x 1-5/16" x 3-3/4" and weighs only 0.79 lbs. Actually, it's not much larger than your billfold! But Memowriter is actually a miniature typewriter made possible by advanced electronic technology and large scale integrated circuitry. A full alphabet keyboard and a full function calculator Plus "Word Memories", which lets you store computation constants and word comments for recall use in complex calculations. More about "word memories" later.

## EASY-TO-USE TYPEWRITER

Switch the mode selector to TYPE. In the TYPE mode you can enter work, character and number information. For example press the Memo key. Now type letters. To enter a number, simply press Data and then the desired numbers. To advance to the next line, press Shift and Return. Now continue entering words or numbers. It's easy! As you're typing, the information appears on the Liquid Crystal Matrix Dot display.

## CORRECT AND PRINT

You made an error? The Buffer Memory stores up to 48 characters. If you make a mistake, use the left or right arrow keys to align the cursor with the character. Now just type in the correction. When you've reached 48 characters in the Buffer Memory, press Print, and all the data you entered is printed, error-free, on plain white paper. If you have more data to input, continue as explained, again up to 48 characters — then Print. When finished, you'll have a beautifully lined up word and/or number message — permanently recorded.

## IT'S A CALCULATOR!

Typing capabilities and calculator — All In One! Memowriter is a full function calculator. Simply flip the mode selector to COMP and your calculator is ready! Addi-

|                 |              |
|-----------------|--------------|
| FOB             | 567.89+      |
| INSUR.          | 3.%          |
|                 | 584.9267*    |
|                 | 584.9267+    |
| FREIGHTAGE      | 45.67=       |
|                 | 630.5967*    |
| CIF             | 630.5967+    |
| I-DUTY          | 15.%         |
|                 | 725.186205*  |
|                 | 725.186205+  |
| HANDLING CHARGE | 23.45=       |
|                 | 748.636205*  |
|                 | 748.636205+  |
| H-M/U           | 30.%         |
|                 | 973.2270665* |
|                 | 973.2270665+ |
| F-M/U           | 40.%         |
|                 | 1362.517893* |

## INVOICE

tion, multiplication, division and subtraction. Plus you can compute constants, power, reciprocal, add-on/discount, percent and chain calculations! Floating or fixed decimal and a 4-key memory.

## WORD MEMORIES

Memowriter has amazing memory. You can store almost 30 words and numbers (120 characters) in his memory bank for future use. Here's how you do it: Say you're selling pens for \$2.95 each. You want to store this constant for future sales calculations. You'll select P for the word memory. Now here's the simple sequence you would press in the TYPE mode: Memo P "Pen Data 2.95" It's memorized! To recall this line of data, you'll just press P. Now when computing in the COMP mode, you'll see how convenient "word memories" becomes. For example, to calculate the cost of 4 pens, press the following key sequence in the COMP mode: Memo P x 4 That's all! The answer appears on the display. Press Print and the entire operation is permanently recorded on paper!

## INFINITE USES

Memowriter's amazing "word memories" will help you quickly compute and print sales reports, itemized discount sales calculations — while you're riding on the train! You can even type yourself a fully detailed itinerary, with plane schedules, arrival and departure times, appointment times, addresses and telephone numbers — and you can prepare this while riding in a taxi or waiting in line! You can even make copies for your secretary, spouse or partner. Just press Print repeatedly, until you have the needed number of copies!

## TRY AT NO-RISK FOR 30 DAYS

We've tried to give you an idea of the Memowriter's capabilities. But there are more — and too many to describe in one page! That's why we are inviting you to try

TO MR. NORTH  
TEL. CALL FROM  
MR. BAKER

PLEASE CALL BACK  
NO. 212-123-4567

11-11-81  
BY JACKSON

## TELEPHONE MESSAGES

SHARP  
22-22 NAGAIKECHO  
ABENO-KU, OSAKA  
JAPAN

## LABEL PRINTING



SHARP NEWEST INVENTION, THE "MEMOWRITER" HAS ALPHABET KEYS IN TYPEWRITER-LIKE ARRANGEMENT

Memowriter on a 30-day, no risk trial. Memowriter is only \$139.95 plus \$2.50 insured shipping. Send for Memowriter today. Try it for 30 days. If you're not completely satisfied, send it back and we'll refund your money promptly!

Memowriter comes complete with AC adapter, roll paper, ribbon cartridge, soft case, template and instruction manual. Order extra paper, 10 rolls only \$16.95.

## DON'T MISS OUT ORDER NOW

Inventories may be tight before the holidays. So don't wait — order now. Simply send a check or money order to us at the address below. Credit card holders can call one of our toll-free numbers anytime:

**800-526-2801**

If Busy or No Answer Call

**800-257-7850**

In New Jersey call 800-322-8650  
N.J. residents please add 5% sales tax.

INTERNATIONAL SALES GROUP  
**MERCURY**  
THE IMAGINATION PEOPLE<sup>®</sup>

Dept. RE-12, Lakewood Plaza  
Lakewood, New Jersey 08701

CIRCLE 78 ON FREE INFORMATION CARD

# computer products

More information on computer products is available.  
Use the Free Information Card inside the back cover.

**FREQUENCY SYNTHESIZER**, the *Proteon PRO80*, is a single-card, phase-continuous, *MULTIBUS*-compatible unit designed for such applications as measurement and control, communi-

cations and tracking, system simulation, and automatic test. The *Proteon PRO80* can make frequency/phase changes in less than 300 nanoseconds after the execution command is given.

## ADVANCE is Proud to Introduce the WESTON ROADRUNNER A Breakthrough in Price/Performance Level of the New Generation of Multimeters

The WESTON ROADRUNNER ADMM with its "beeping" Audio Response allows you to take your eyes off the meter and still take a measurement.

Now, in a custom-designed field service unit, important measurement functions can be HEARD as well as seen. In addition, functions not previously available from digital multimeters are standard benefits on this compact, easily handled instrument...a truly new dimension in the art of checking and testing. An audio signal response guides the operator in testing. An audio signal response guides the operator in testing and permits full concentration on the task without having to refer to a visual reading. The clearly audible "beeping" signal provides instant answers to quick, sure and accurate testing.



BEEP  
BEEP

### SPECIFICATIONS

| DC VOLTAGE                           | RANGE | ACCURACY |
|--------------------------------------|-------|----------|
| 200mV, 2V, 20V, 200V, 1000V          |       | .5%      |
| AC VOLTAGE                           |       |          |
| 200mV, 2V, 20V, 200V, 750V           |       | .75%     |
| DC CURRENT                           |       |          |
| 2mA, 20mA, 200mA, 2000mA             |       | 1%       |
| AC CURRENT                           |       |          |
| 2mA, 20mA, 200mA, 2000mA             |       | 1.5%     |
| RESISTANCE                           |       |          |
| 200Ω, 2kΩ, 20kΩ, 200kΩ, 2000kΩ, 20MΩ |       | .5%      |

Weight: 1 lb. Dimensions: 7.5 in. x 3.4 in. x 1.9 in.  
Power: Single 9V battery  
Battery Life: Up to 200 hrs. with alkaline battery

ONLY \$139

**X-Mas Special  
FREE CASE**  
(offer expires Dec. 31, 1980)

Case \$10.00  
Shipping \$3.00

### The Roadrunner ADMM Features

- Six Functions
- 29 Ranges
- 0.5% Accuracy on DCV
- 5 Range Audio Response Function
- Color coded easy-to-read front panel and pushbuttons
- 0.5" LCD Display
- Rugged Case for "Field Use"
- RFI Shielded

Operating over a 10-Hz to 2-MHz range, it offers 0.0023-Hz resolution and can provide 1-μHz resolution under microprocessor control. Output waveform is sine or square. The unit is programmed using a straight-forward binary number base and binary frequency commands can be

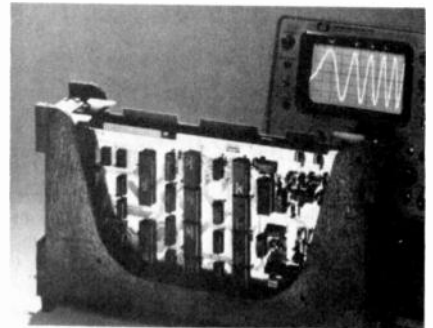

CIRCLE 121 ON FREE INFORMATION CARD

updated in 25 microseconds. Frequency stability is 100 ppm on internal reference, or the built-in crystal oscillator can be locked to an external frequency standard. Price is \$1300 each (1-9) with OEM quantity discounts.—*Proteon Assoc., Inc.*, 24 Crescent St., Waltham, MA 02154.

**ACCOUNTS RECEIVABLE SYSTEM** for the *TRS-80* is a "balance forward" type system that provides complete end-of-month billing, ready-to-mail statements, automatic customer-record updating, totals for general ledger posting, optional message lines on billing statements, and full accounts-receivable analysis including activity status.

This Radio Shack program requires a minimum configuration of a Model I *TRS-80* Level II system with 16K of RAM, expansion interface, two disc drives and an 80-column (or wider) printer. If a third disc drive is added, the package can handle up to 500 accounts and 2500 transactions per month.

The *Accounts-Receiveable Package* is priced at \$149.95 and is available at Radio Shack stores and dealers and Radio Shack Computer Centers.—*Radio Shack*, 1 Tandy Center, Fort Worth, TX 76102.

CIRCLE 122 ON FREE INFORMATION CARD

**GPIB-488 ADAPTOR**, model 488-80B, permits the connection of the *TRS-80* Model I computer to the GPIB-488 bus. That allows the computer to communicate with any number of scientific instruments that use this bus as a standard. A min-



CIRCLE 123 ON FREE INFORMATION CARD

imum of 16K of RAM and Level II BASIC are required. The software, supplied on cassette or disc, will work with Level II BASIC, Level III BASIC and Disc BASIC. Price is \$225.—*Scientific Engineering Laboratories*, 11 Neil Drive, Old Bethpage, NY 11804.

R-E

THE TEST EQUIPMENT SPECIALISTS  
TOLL FREE HOT LINE  
800-223-0474

34 WEST 45TH STREET NEW YORK, N.Y. 10036 212 687 2224

**ADVANCE  
ELECTRONICS**



# new ideas

## VHF TONE TRANSMITTER

I'D LIKE TO SHARE WITH YOU A SIMPLE, inexpensive and very useful circuit. Originally designed to generate horizontal bars on a TV screen to aid in vertical-linearity adjustments (test patterns are hard to find these days), the circuit is actually more useful as a RF signal generator that can be used for simple checks of TV and FM-radio RF, IF and AF stages. Its range is about 50 feet with a short whip antenna, but for most applications no antenna is required.

The first section, a tone generator, is made up of a unijunction transistor, Q1, and R1, R2, R3, and C2. Transistor Q1 pulses on and off at a rate determined by the time constant of R1 and R2, together with the capacitance of C2 and the B1-emitter junction of Q1. Trimmer potentiometer R2 determines the frequency of the tone generated and allows a range of approximately 100 Hz to over 5 kHz.

Transistor Q2 is the RF oscillator. Its frequency is set by tuned circuits consisting of L1, C5, C6, and the interelectrode capacitance of Q2. The values shown will give a tuning range of about 55 to 108 MHz. Capacitor C6 provides positive feedback from the emitter to the collector of Q2, for oscillation.

The audio tone generated by Q1 is applied to the base of Q2, causing the collector current to vary at the frequency of the tone, yielding an amplitude-modulated (AM) signal. This, in turn, varies Q2's collector-to-emitter capacitance (which makes up part of the tuned circuit) and causes the output frequency to vary similarly, producing a frequency-

modulated (FM) signal, as well. The RF signal is coupled to the antenna through capacitor C7.

Most of the component values are non-critical. Q2 can be almost any silicon RF transistor, such as a 2N3904. (Note: depending on the transistor, the bias-resistor values may have to be changed to obtain stable oscillation.) Capacitor C6 should be a silver mica type; all the others can be ceramic discs or paper. I used 1/2-watt resistors as a compromise between size and physical strength.

Tuning-capacitor C5 is a small trimmer. I used a mica trimmer in my prototype and soldered a short shaft (a machine screw with the head cut off) to its adjustment screw; doing that permitted me to attach a small knob for adjustment purposes.

Coil L1 consists of five turns of number-18 bare wire, close-wound on a piece of 1/4-inch wooden dowel. The length of the winding is about 3/4-inch. One end of capacitor C7 is soldered to the coil one turn away from the nine-volt supply end (refer to Fig. 1) and the other end of the capacitor goes to the antenna. The circuit is easily built on a piece of perforated construction board that can be placed, along with the nine-volt transistor battery, in a small plastic box.

To adjust the vertical height and linearity of a TV set, place the tone transmitter near the set and use R2 to select the number of horizontal bars to be displayed. Once the picture is steady and the bars are sharp, adjust the set's vertical controls so that all the bars are of the same height and are evenly spaced.

Be certain to tune the tone transmitter

to an unused TV channel to avoid (illegal) interference with the reception of broadcast stations!

The fundamental tuning range of 55 to 108 MHz covers the lower TV channels and the FM broadcast band, but harmonics can still be detected—although more weakly—on the upper-VHF and UHF channels. The fact that both AM and FM signals are generated makes it possible to use this transmitter to check almost any receiver within its frequency range. A TV set's sound section (discriminator) will reject the AM portion of the signal, while its video section will respond to it. Similarly, the TV sound section, and FM receivers, will respond to the FM signal produced.—Robert M. Laskie

## NEW IDEAS

This column is devoted to new ideas, circuits, device applications, construction techniques, helpful hints, etc.

All published entries, upon publication, will earn \$25. In addition, Panavise will donate their model 324 Electronic Work Center, having a value of \$49.95. It combines their circuit-board holder, tray base mount, and solder station. Selections will be made at the sole discretion of the editorial staff of **Radio-Electronics**.

I agree to the above terms, and grant **Radio-Electronics Magazine** the right to publish my idea and to subsequently republish my idea in collections or compilations of reprints of similar articles. I declare that the attached idea is my own original material and that its publication does not violate any other copyright. I also declare that this material had not been previously published.

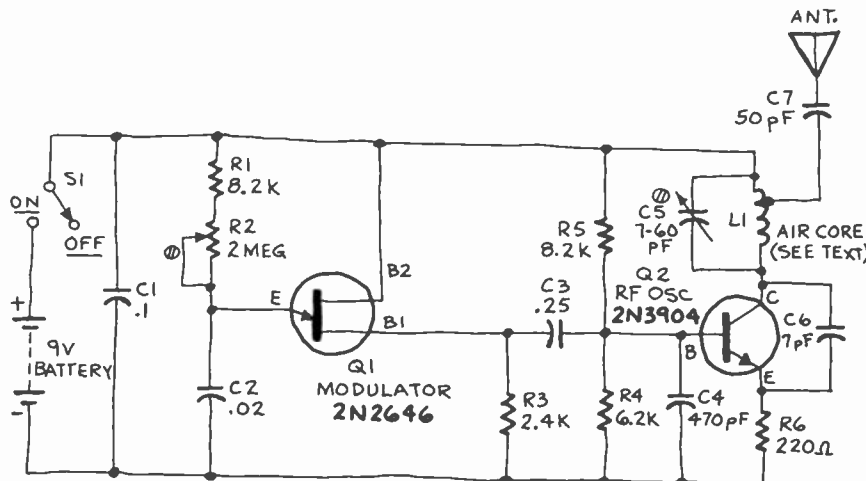

Fig. 1

Title of Idea

Signature

Print Name

Date

Street

City

State

ZIP

Mail your idea along with this coupon to: **New Ideas Radio-Electronics**, 200 Park Ave. South, New York, NY 10003



# An in-depth look at the only "plug-in" remote control system you'll ever need for your home.

NOW AVAILABLE  
DELUXE WALL  
SWITCH MODULE  
(Not shown) **\$18.95**



## You're in control by remote control.

Simply plug in The Controller™ and the BSR System X-10™ modules, and control lights and appliances anywhere in the house by pressing a few buttons. So it's easy to take control.

## There's no end to all of the control you've got.

You can turn on the TV, radio or stereo in the morning to help you wake up without getting up from bed. Or at night, turn on the lights before going downstairs so you don't have to fumble in the dark. Turn off unnecessary lights and help get your electric bill under control. Or, dim the lights and save energy, too.

And when it's time to turn in, just push a button and turn everything off. And sleep soundly. But, if you hear a strange noise in the middle of the night, you can press a button to turn on all the lights and scare the daylights out of an intruder.

## The Controller is designed to control every room in the house.

By pressing the buttons on the Command Console keyboard, command signals are transmitted over

existing household wiring to the module of your choice. The Lamp Module turns on, off or dims any incandescent lamp up to 300 watts. The Appliance Module turns appliances like TVs, window fans or stereos on and off. And the Wall Switch Module is designed to turn on, off or dim any light or lamp up to 500 watts normally operated by a wall switch.

There's even a Cordless Controller that transmits signals to an Ultrasonic Command Console from up to 30 feet away. So there's plenty of control for everyone.

## Simplicity is built into the system.



No special wiring is needed. Simply plug The Controller Command Console into any wall outlet in any room of the house.

Then plug your lamps and appliances into the appropriate modules. Plug in

the modules. And you're ready to take control.

## BSR X-10 SUPER SPECIAL DELUXE ULTRASONIC CONSOLE

REGULARLY \$49.95  
NOW \$29.95

With the purchase of three or more modules

Modules normally \$17.00 ea.

Modules of your choice

3 for \$47.95 6 for \$83.95

Ultrasonic Hand Unit

Normally \$24.95 Now \$18.95

Please add \$3.00 for shipping

TOLL FREE HOT LINE

800-223-0474

**THE TIMER™** Automatically Programs Lights, Appliances. Just plug in The Timer and the BSR X-10 modules and you can program up to 8 lights and appliances to go On and Off up to twice a day. UL listed. \$74.95 if purchased separately. If purchased with 3 or more modules \$59.95

**NEW**



# ADVANCE ELECTRONICS

54 West 45 Street, New York, N.Y. 10036 212-687-2224

# service clinic

## An unusual regulator circuit from Hitachi.

JACK DARR, SERVICE EDITOR

WE TRY OUR BEST TO KEEP UP WITH THE newer circuits used in TV today, especially in the regulated DC power-supply area. That is where a great many of the troubles show up. Here's one that started showing up in the Clinic mailbag and also at the same time on my bench. That kind of coincidence has followed me around for years. There are several very unusual features.

This is a regulated DC power supply, as used in Hitachi chassis NP4SX-H2. (Sams No. 1619-1.) The circuit-action is the same as in other sets; a control transistor varies the DC output voltage, and it is controlled by an error-amplifier stage, etc. However, the principle used here is novel. What it does is control output voltage by varying the value of the input filter capacitor! That capacitor acts as a reservoir for charge developed by the rectified AC line voltage. The bigger the reservoir, the greater the charge it holds. Its capacitance is varied by putting a transistor in

series with its return (negative) lead. The transistor is controlled by an SCR, which is controlled by a differential-amplifier circuit called a phase detector.

If the DC output voltage goes up, the SCR is left off, as is the transistor. That raises the impedance in the return of the capacitor making it smaller and thus able to hold less charge. The output voltage decreases. If the DC output voltage goes down, the SCR is gated on, the transistor conducts and the impedance in the return leg of the capacitor is reduced, thus letting the capacitor hold more charge.

Figure 1 shows the schematic of the circuit, as provided by Hitachi. Transistors TR903 and TR904 are the difference-amplifiers. The transistor with the higher base voltage is off, while the other transistor is on. Collectors of both transistors go to the gate of SCR TR901, through different resistor networks. The base of TR904 is normally 0 volts. The base of TR903 samples the DC output

across the input filter capacitor C908, through a resistor network. If the voltage across the capacitor goes up, the base of TR904 goes up, and it cuts off. That leaves the SCR turned off, as well as transistor TR905. This reduces the voltage across the capacitor. If the voltage across the capacitor goes down, TR904 is turned on, which gates SCR TR901 on. When SCR TR901 conducts, so does the "control" transistor TR905. The charge on the capacitor rises and the voltage comes back up.

Besides that, the output voltage is sampled by a voltage-divider/reference-voltage network on the output. That controls the base voltage of TR907, which is an error amplifier that aids in the same process. For conduction of TR905, apparently the SCR must be conducting, and the error amplifier must also be conducting to bias TR905 on.

The action of the difference-amplifier circuit is quite complex. It seems to be controlled both by the DC voltage levels of the output, and an AC signal from the ripple-output of the rectifier.

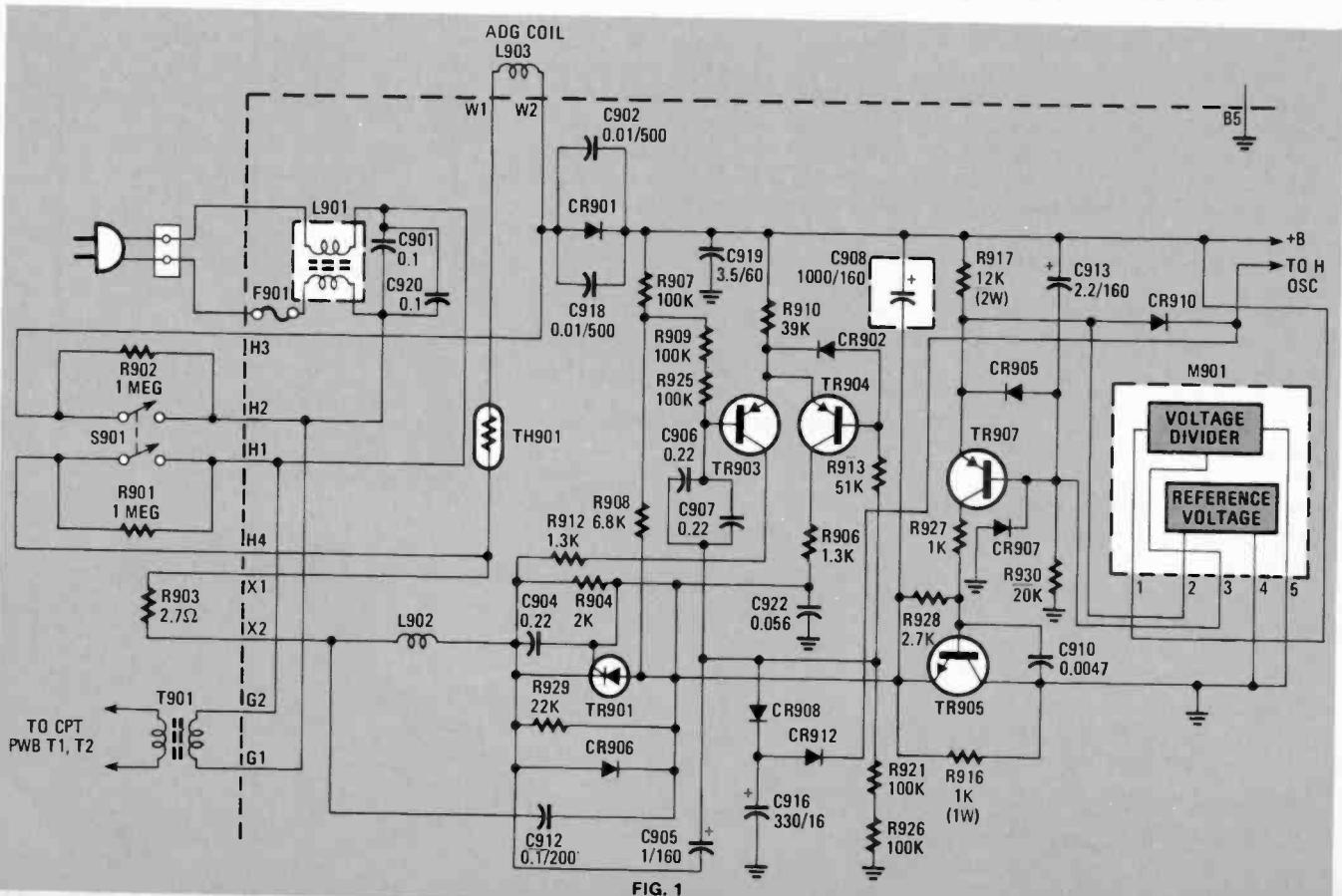

FIG. 1

The base voltage of TR907 comes from a voltage-divider/reference-voltage module, which is M901. A tap on the voltage divider develops the base voltage. No resistance values are given for that in the parts lists. It's a ceramic, flat 5-pin device, Hitachi 2370141.

Not shown on that schematic is the high-voltage hold-down circuit. That also has an SCR, TR708, and a reference module, M701 (Hitachi 2370151). The SCR anode is connected through a 680-ohm resistor to the base of the horizontal oscillator transistor. The voltage divider/detector network is connected to a winding on the flyback, pin 4, which develops a pulse. That develops a DC voltage in the module.

If the flyback output goes up the high-voltage also increases and the increased voltage from the module triggers the SCR. The SCR turns on and shorts the horizontal oscillator, killing the whole stage. When the SCR turns on, it stays on. The power must be turned off to allow it to reset.

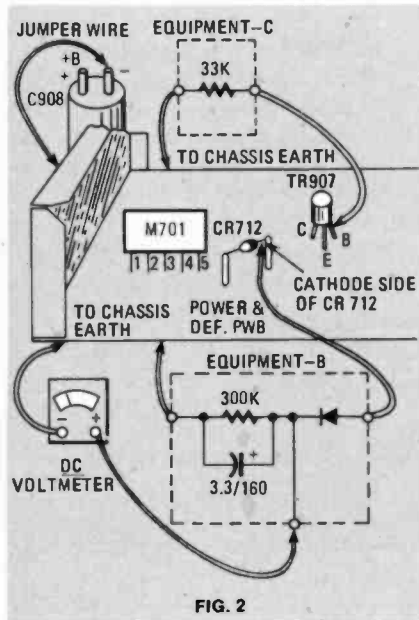

FIG. 2

The Hitachi instructions include a test setup for checking the action of the high-voltage shutdown circuit as well as the low-voltage regulator. Figure 2 shows the test setup. The negative return of C908 is jumpered to ground, shunting the SCR-etc. A 33K resistor (Equipment-C) is hooked from TR907 base to ground. A precision DC voltmeter is connected to the cathode of CR712, which is the diode used to rectify the flyback pulse for the operation of the sensing circuit. That is done through a network, shown as "Equipment-B," consisting of a diode (its anode to CR712 cathode) and a 300K resistor shunted by a 3.3  $\mu$ F capacitor, to ground. The DC voltmeter connects to the junction of the diode and R-C network.

Plug the set into a variable-voltage line transformer. Set the line voltage to about

# CREATE ANY RHYTHM

new improved memory



Our popular Programmable Drum Set's simple programming system allows even first time users to structure bass, tom, snare, wood-block and clave sounds into any rhythm in any time signature. Versatile memory organization provides simultaneous storage of two separate rhythm patterns each with its own bridge rhythm. Bridges are activated from either the control panel touch plate or optional foot switch and are automatically synchronized to the main rhythm.

Improved memory circuitry lets the "save" mode hold rhythm patterns for over one year while battery life for normal operation has been extended to several hundred hours.

In easy to assemble kit or fully assembled.

- ( ) Send #3750 'Drum Set Kit, \$89.95 plus \$3 shipping enclosed.
- ( ) Send #3750 'Drum Set Assembled, \$154.95 plus \$3 shipping enclosed.
- ( ) Send Free Catalog.

Name: \_\_\_\_\_  
 Address: \_\_\_\_\_  
 City: \_\_\_\_\_ State: \_\_\_\_\_ Zip: \_\_\_\_\_  
 VISA: \_\_\_\_\_ MC: \_\_\_\_\_ Card No. \_\_\_\_\_

**PRCCOM** ELECTRONICS, DEPT. 12 R. 1020 W. WILSHIRE, OKLA CITY, OK 73116

CIRCLE 66 ON FREE INFORMATION CARD

## The world of electronics gee-wizardry

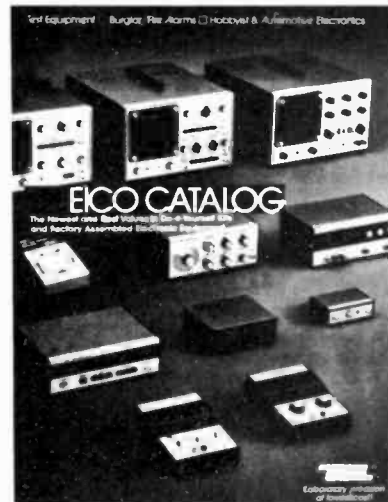

## -YOURS FREE.

32-pages of test instruments—from the latest digital multimeters to the famous EICO scopes. Security systems. Automotive and hobbyist products. Kits and assembled, EICO quality. EICO value. For FREE catalog, check reader service card or send 50¢ for first class mail.

**EICO** 108 New South Road  
 Hicksville, N.Y. 11801

CIRCLE 48 ON FREE INFORMATION CARD

## SAVE TIME AND MONEY!

### 6100 UNIVERSAL DESIGNER

- Save on digital bread boarding
- Easy transition from prototype to wiring diagrams
- Aids digital circuit design

Kit \$49.95  
 Assembled \$59.95

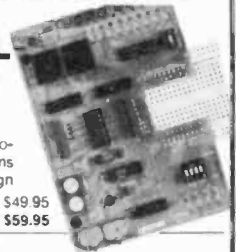

### SELF-TEACHING AID:

6101 DIGITAL LOGIC COURSE \$29.95

- Learn digital logic with 26 self teaching experiments.

### 0101 SOLID STATE CLOCK/CALENDAR UNIT

BIG 2 1/2" DISPLAY!

- 12/24 hour selectable
  - Alarm output
- Kit \$49.95  
 Assembled \$79.95  
 Oak Case \$29.95



Satisfaction Guaranteed on All Assembled Units

FOR FAST DELIVERY CALL TOLL-FREE  
**1-800-426-6254** EXT. 112

**PRCCOM** 14905 N.E. 40TH. DEPT RE12  
 REDMOND, WA 98052 (206) 883-9200

- Please rush me the following:
- 6100 UNIVERSAL DESIGNER KIT \$49.95
  - 6100 UNIVERSAL DESIGNER ASSEMBLED \$59.95
  - 6101 DIGITAL LOGIC COURSE \$29.95
  - 0101 CLOCK/CALENDAR KIT \$49.95
  - 0101 CLOCK/CALENDAR ASSEMBLED \$79.95
  - OAK CASE \$29.95

ADD \$3.00 PER ORDER POSTAGE & HANDLING

NAME: \_\_\_\_\_  
 ADDRESS: \_\_\_\_\_  
 CITY: \_\_\_\_\_ ST: \_\_\_\_\_ ZIP: \_\_\_\_\_  
 CREDIT CARD NO. \_\_\_\_\_ EXP: \_\_\_\_\_  
 SIGNATURE: \_\_\_\_\_  VISA  MASTERCARD

CIRCLE 28 ON FREE INFORMATION CARD

## 9 reasons why the real pros prefer Endeco desoldering irons

1. Operates at 120v, 40w. Idles at 20w for longer tip life
2. Flexible, burn resistant Neoprene cord set
3. Cool, unbreakable polycarbonate handle
4. Exclusive bracket insures alignment, prevents damage
5. Safety light in handle tells when it's on
6. Stainless steel construction
7. Temperature control. Low, high or off.
8. Eight tip sizes. Comes with .063 I.D.
9. Converts to soldering iron with 1/4" shank type tip

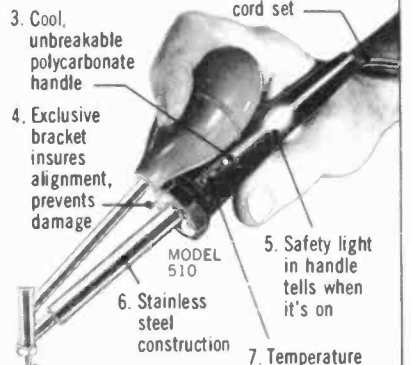

See your distributor or write . . .

### Enterprise Development Corp.

5127 E. 65th St. • Indianapolis IN 46220  
 PHONE (317) 251-1231

CIRCLE 70 ON FREE INFORMATION CARD

**SERVICE CLINIC**

*continued from page 103*

95 VAC. Set the brightness and contrast controls fully counterclockwise. Turn the set on. The picture should disappear at an indicated voltage of about +148 volts, as the AC line voltage is gradually raised. If it does, that is OK. Turn set off and unhook the jumpers and networks. Turn it on again, normal AC line voltage, and check to make sure the picture is stable and will not go out at any setting of the brightness control.

So far, various problems have shown up in those chassis. In the one on our bench, we found that there was no regulation at all. The regulator transistor TR905 was leaky. When it was replaced, it worked. (Caution: Do not rely on ohmmeter checks to find leakage like that. Either replace the transistor, using one with a high breakdown voltage, or use a good leakage tester.) In the first case that we heard of, the M901 module was defective. In another one, the M701 module was bad.

When you run into troubles in those sets, check all DC voltages first, and be sure to check for the regulator action. If need be, set the DC voltage at normal level, which is shown in the Sams as +121 VDC, then check the rest of the set for operation. No waveforms are given on any of the service data, but we found a

12-volt P-P sawtooth, at vertical frequency, on the gate of TR901, the control SCR, after repairs had been completed.

That is quite a complex and unusual circuit, but if you use standard tests, and reasoning, to find out what your results mean, it shouldn't be too hard to fix. Good luck, fellows! Thanks very much to a Canadian technician, Don Hughes of London, Ont., who sent me copies of the Hitachi factory circuit "explanation" of how it works. One important precaution; be on the lookout for *modifications* of that circuit! I noted in the factory data, and two Sams folders, that apparently there had been quite a few—so keep an eye peeled. The main action seems to be the same, though. **R-E**

**service questions**

**NO +120 VOLT SUPPLY**

*In this Admiral 2M10, I get nothing at all out of the +120-volt supply. The +155-volt output of the rectifier is OK. There's voltage on the collector of Q900, the pass driver, but nothing at all on the base or emitter. If I short base-emitter on this transistor, I get raster and sound! Any clues?—T.D., Bellevue, OH.*

OK, let's warm up the crystal ball and see if anything shows up. You say you can

short the base to emitter of the pass-driver transistor Q900 and get something. So, your pass transistors, Q101/Q102, are apparently working. The DC voltage on the base of Q900 is fed from the +155-volt line. The voltage here comes through the start diode, D902; the lower end of this circuit senses the +212-volt boost voltage from the flyback. (Needless to say—no +120-volts equals no boost or anything else.) Just for the heck of it, check that Zener diode which is a 125-volt unit. For a crystal-ball guess, it looks to me as if the start diode could be open! That also feeds a short pulse of DC through to start the horizontal oscillator.

**OUTPUT-TRANSFORMER REPLACEMENT**

*I need an output transformer for a Sentinel 241-T battery radio that I'm trying to fix for an old customer. Can you help me find a substitute?—J.J., Farmington, IA.*

Of course! A Thordarson 24S99 is exactly what you want. This is a 25,000-ohm plate, to 4-ohm voice-coil, unit—if you can't find the Thordarson one.

**NEW POWER TRANSFORMER NEEDED**

*The power transformer burned up on this Sears stereo amplifier. Part number 80-527-0. Sears doesn't have a replacement. It's in Sams Photofact 1358-5.—J.H., Lenoir City, TN*

**ORDER FORM**

**Electronics Paperback Book Club**  
Quality Paperbacks at Affordable Prices

**\$15 for a 15% discount**

I've checked off the book I want **FREE** and have included my \$15 membership fee. I understand that this fee makes me a member of your book club for one year and that during that time I can order as many books as I want and deduct 15% from the list price.

**\$25 for a 20% discount**

I've checked off the free book and have enclosed my \$25 membership fee. I understand that this fee makes me a member of your book club for one year and that during that time I can order as many books as I want and deduct 20% from the list price. I further understand that I can use my \$25 membership fee as a credit toward future purchases.

**CASH NOW**

I've checked off the books that I want to buy.

To order from this ad: Check off the books you want. Total the prices. Add in 25¢ per book for shipping. NY State residents add Sales Tax. Total it up, enclose your check and mail.

- Handbook Of IC Equivalents and Substitutes **\$1.95**
- First Book Of Diode Characteristics, Equivalents & Substitutes **\$2.95**
- 28 Tested Transistor Projects **\$2.96**
- 50 CMOS IC Projects **\$2.95**
- A Practical Introduction to Digital IC's **\$2.95**
- Beginners Guide To Building Electronic Projects **\$3.50**
- Essential Theory For the Electronics Hobbyist **\$3.50**
- 1st Book Of Transistor Equivalents and Substitutes **\$1.50**
- 2nd Book Of Transistor Equivalents and Substitutes **\$2.95**
- How To Build Your Own Metal & Treasure Locators **\$2.95**

- Electronic Calculator Users Handbook **\$2.95**
- Handbook Of IC Audio Preamp and Power Amp Construction **\$2.95**
- 50 Circuits Using Germanium Silicon and Zener Diodes **\$1.95**
- 50 Projects using Relays SCR's and Triacs **\$2.95**
- 50 FET (Field Effect Transistor) Projects **\$3.50**
- Digital IC Equivalents and Pin Connections **\$6.95**
- Linear IC Equivalents and Pin Connections **\$6.95**
- 50 Simple LED Circuits **\$1.95**
- How To Make Walkie-Talkies **\$3.50**
- Radio Circuits Using ICs **\$3.50**
- Popular Electronic Projects **\$3.50**
- Electronic Music and Creative Tape Recording **\$3.50**
- Projects In Opto Electronics **\$3.50**

**ORDERING INFORMATION**

How many books have you ordered .....

Total Price .....

Shipping (25¢ per book) .....

Subtotal .....

Tax (NY State Residents) .....

Total Enclosed .....

**MAIL TO:**

**ELECTRONIC TECHNOLOGY TODAY INC.**

17 Slate Lane, Central Islip, NY 11722

No Canadian Orders

Signature .....

Name .....

Address .....

City ..... State ..... Zip .....

You don't need an exact duplicate! All you need is one that'll give you the correct voltage and current rating. In this case, that is any 12-volt transformer with a center tap.

Sams shows the maximum output current as only 70 mA, so it needn't be a big one. Any "filament transformer" rated 12.6 volts at one amp will do. Watch out for the size so that it'll go in the cabinet.

If you need new rectifiers, use any stock silicon diodes; there are a lot of those. Anything with a 50-volt rating or better, and capable of handling one amp, is fine.

### TRANSISTOR REPLACEMENT

*I need a replacement transistor for a Fisher 500-TX receiver. This is Q971 (TR1000). The replacement transistor guides don't show this correctly; the original is PNP, and the one shown is NPN. Fisher says they don't have it. Can you help?—W.L., Ozone Park, NY.*

I'm afraid you've tripped over a typo in the guide! A TR1000 is shown, also a TR1001, which ought to make up a comp-symm pair (PNP/NPN). In another guide, Sylvania shows TR-1000 as ECG-129 (PNP). Complementary type is ECG-128, which is NPN. Both come in TO-39 cases, which is very close to the TO-5's. R-E

### HIGH PERFORMANCE continued from page 54

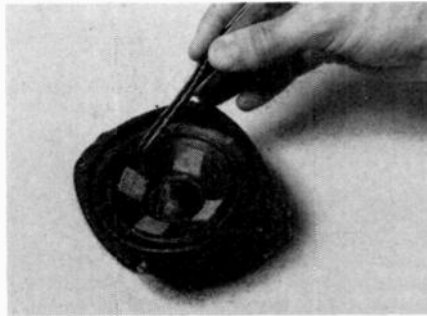

FIG. 8—FELT PADS cemented to bass/mid-range driver reduce "break-up."

covering both the cone with its center dome and the felt squares. Top that off with a third coat several hours later.

When the cone treatment has dried to a clear finish, the speaker is electrically and acoustically complete and is ready to be connected and used. For home applications, you may want to put felt feet on the bottom of the enclosure to prevent scratching the surface it will rest on. A fabric grille may be stretched over the front of the speaker and glued in place, or perforated metal or plastic screens the

shape and size of the drivers may be silicone-cemented to the driver frame-rims for a professional "high-tech" look.

For automotive applications, the speaker will require a mounting bracket such as the C-shaped brackets sold by Radio Shack for mounting of its minispeaker. Alternatively, a bracket can be made up from sheet metal or heat-formed acrylic sheet.

When setting up your minispeaker for listening, remember that positions near corners, or where walls and floor (or ceiling) meet, tend to augment bass performance, while positions far from room surfaces usually minimize bass output, so your speaker will more than likely sound best near a wall or multiple walls.

You may also wish to experiment with the inward angle of the speakers in terms of their effect on the stereo image, and with vertical—as opposed to horizontal—positioning of the cabinet (vertical orientation often provides a more clearly localized center image of the music). Whatever your choice of positioning and set-up details, though, we're sure you will find the sound of the speaker astonishing, especially coming from a box just about the size of a cobblestone! R-E

## YOU DESERVE IT! GET IT EVERY MONTH!



**Radio Electronics**  
Build or alter your home stereo system  
 1000—5 is the real standard!  
 Largest part of only \$1.95 (cover)

Come on, treat yourself—and save money too. Subscribe to RADIO-ELECTRONICS today, and make sure that you get all the interesting, exciting and authoritative electronics reporting in any magazine month after month. Don't miss a single one of the upcoming issues jam-packed with test reports on new equipment, projects to build, servicing ideas, and news of solid state, computers, hi-fi, hobbies and everything electronics. Save money too—as much as \$10 off the newsstand price. **Subscribe to RADIO-ELECTRONICS, come on, you deserve it—check off the money saving offer you prefer on the handy coupon, and start enjoying RADIO-ELECTRONICS every month.**

### Get the Best—Every Month! Mail Today!

YES! please send me

Payment enclosed, 14 issues for \$13.00 (You save \$4.50 off newsstand price.)

Payment enclosed, 28 issues for \$25.00 (Save More! \$10.00 off newsstand price.)

Bill me, 1 year—12 issues only \$13.00 (You save \$2.00 off newsstand price.)

Bill me, 2 years—24 issues only \$25.00 (Save more! \$5.00 off newsstand price.)

Extra shipping: Canada \$3.00 per year, all other countries \$5.00 per year.

Check here if this is a new subscription.

Check here if you are extending or renewing your subscription (please print)

Name \_\_\_\_\_

Address \_\_\_\_\_

City \_\_\_\_\_ State \_\_\_\_\_ Zip Code \_\_\_\_\_

Mail to: **Radio Electronics**  
 P.O. Box 2520,  
 Boulder, Colorado 80322

Allow 6-8 weeks for delivery of first issue.

## NOW, ADJUST YOUR D104 WITH ONE FINGER!



The Fingertip Volume Control makes it simple — without screwdrivers, nail files or special tools.

**NO DRILLING! NO SOLDERING! NO CUTTING!**  
 Remove the stock bottom plate, screw on the Fingertip Volume Control, adjust with one finger, and talk. It's that simple!

**THE QUALITY UNIT!**  
 Rugged black Cyclocac with aluminum look dial is both durable and attractive. No-scratch rubber feet protect fine furniture.

**FITS THEM ALL!**  
 The Fingertip Volume Control fits all TUG8, TUG9, and TUP9 D104 microphones, including the Golden Eagle, Silver Eagle, and Blackfoot models. Complete instructions and hardware included.

**SATISFACTION GUARANTEED!**

**URBAN ENGINEERING, INC.**  
 P.O. Box 571052  
 Miami, Florida 33157

Yes, please send me \_\_\_\_\_ Fingertip Volume Control(s) at \$7.95 plus 80 cents postage and handling each (Florida residents add 4% tax). I understand that if I am not completely satisfied, I can return the unit(s) within ten days for a full refund.

Name (please print) \_\_\_\_\_

Address \_\_\_\_\_

City/State/Zip \_\_\_\_\_

My check is enclosed, please ship within 14 days

I have enclosed a money order for immediate shipping

Charge my credit card:  Visa  Master Charge

Card No. \_\_\_\_\_ Exp. Date \_\_\_\_\_ Sig. \_\_\_\_\_

CIRCLE 40 ON FREE INFORMATION CARD

Put Professional Knowledge and a  
**COLLEGE DEGREE**  
in your Electronics Career through  
**HOME  
STUDY**

**Earn Your  
DEGREE**

by correspondence, while continuing your present job. No commuting to class. Study at your own pace. Learn from complete and explicit lesson materials, with additional assistance from our home-study instructors. Advance as fast as you wish, but take all the time you need to master each topic.

The Grantham electronics degree program begins with basics, leads first to the A.S.E.T. degree, and then to the B.S.E.T. degree. Our free bulletin gives complete details of the program itself, the degrees awarded, the requirements for each degree, and how to enroll. (We are located at 2500 S. LaCienega Bl., Los Angeles, Calif.) Write to our mailing address shown below for *Bulletin RE81*.

**Grantham College of Engineering**  
P. O. Box 35499  
Los Angeles, California 90035  
*Worldwide Career Training thru Home Study*



"IN JUST 10 DAYS, I'LL SHOW YOU HOW TO DO  
**REAL MATH**  
ON YOUR SCIENTIFIC CALCULATOR!"

$$\int_a^b f \quad \frac{df}{dx} \quad \sum_{n=1}^{\infty} a_n \quad \lim_{n \rightarrow x}$$

- Quick.
- Easy.
- Guaranteed.
- Fun, too!

STEP UP your math skills fast — thousands already have — by using my new method in guidebook form. It's called *CALCULATOR CALCULUS* and comes with this guarantee: If after 10 days you're not astounded at the problems you're solving on your own calculator, return the guidebook for an immediate refund.

But the point is - you won't want to send it back. For this is the *easiest, fastest shortcut* ever! The day you receive your copy in the mail you'll want to put it to work. It's that exciting and helpful.

My name is Dr. George McCarty. I teach math at the University of California. I wrote this guidebook to cut through the confusion. It does just that — with worked-out examples, simple exercises and practical problems — all designed to work on your calculator!

**POWER METHODS.** Need to evaluate functions, areas, volumes — solve equations — use curves, trig, polar coordinates — find limits for sequences and series? It's all here!

If you're in the biological, social or physical sciences, you'll be doing Bessel functions, carbon dating, Gompertz' growth curves, half-life, future value, marginal costs, motion, cooling, probability, present value — and plenty more (even differential equations).

Important numerical techniques? Those algorithms are here, too — rational and Padé approximation, bracketing, continued fractions, Euler's method, Heun's method, iteration functions, Newton's method, predictor-corrector, successive substitutions, Simpson's method and synthetic division.

**LOOK AT WHAT USERS SAY:** Professor John A. Ball of Harvard College (author of the book *Algorithms*

for *RPN Calculators*) writes:

"I wish I had had as good a calculus course."  
Professor H. I. Freedman of the U. of Alberta, writing in *Soc. Ind. Appl. Math Review*, states: "There can be no question as to the usefulness of this book...lots of exercises...very clearly written and makes for easy reading."  
C. B. of Santa Barbara says:

"Your book has given me much instruction and pleasure. I do not hesitate to recommend it. *CALCULATOR CALCULUS* is a book that inspires the reader to understand everything down to the last detail. You seem to have put your heart into the teaching part of good writing."

**MONEY-SAVING OFFER.** For a limited time, you can invest in *CALCULATOR CALCULUS* for only \$14.95 plus \$1 for postage and handling (or \$3 by AIR), US or foreign. Calif. residents add 90¢ sales tax. If you need a suitable calculator, add \$22 (US only, UPS paid; in Calif. add \$1.32 tax) and I'll send you a TI-30 right along with your guidebook! As pennywise Ben Franklin said, "An investment in knowledge pays the best dividends." (Tax deductible for professionals.)

**NO RISK WHATEVER!** Send for it today. Be sure to give me your complete mailing address with your check or money order. If you want to charge it (Visa or MC), include your card no. and exp. date. Prompt shipment guaranteed. Thank you!

©1980 EduCALC Publications, Dept D-1  
Box 974, Laguna Beach, California 92652  
In California, call 714-497-3600; elsewhere  
TOLL FREE 24-hour Credit Card orders:  
800-854-0561, Extension 845; Dept. D-1

**CIRCLE 47 ON FREE INFORMATION CARD**

**books**

More information on new books is available. Use the Free Information Card inside the back cover

**PIMS—PERSONAL INFORMATION MANAGEMENT SYSTEM**, by Madan Gupta. SCNELBI Publications, P.O. Box 133 PP STN, Milford, CT 06460. 88 pp. 8 1/2" X 10 1/2" in. Softcover \$9.95, plus 75¢ postage/handling.

This book describes a data-base management program designed for both novices and experienced users who desire a program for a small computer system such as the TRS-80 or other computers using *Microsoft BASIC*. Fifteen program applications are described along with complete source listings and operating instructions.

**CIRCLE 91 ON FREE INFORMATION CARD**

**HOW TO BUILD ELECTRONIC PROJECTS**, by Douglas R. Malcolm, Jr. Gregg Division, McGraw-Hill Book Company, 1221 Avenue of the Americas, New York, NY 10020. 137 pp including index. 5 1/2" X 8 inch. Softcover. \$7.95.

This book is designed for the beginning electronics student and hobbyist, but can also serve as a review for advanced students. It starts with an introduction to basic electronics, showing the student how to read the schematic symbols of common components such as resistors, capacitors, and transformers, along with an explanation of their operations. An entire chapter is devoted

to soldering, since the mastery of that operation will be crucial to success in any electronics construction project.

The second part goes directly to projects that the student can take on from what he or she has learned from part one. Those include such basic transistor or special semiconductor projects as a simple 110-volt AC tester, an audio amplifier, an oscillator, and a DC power supply.

In the third part, the student is introduced to digital projects, such as a flasher for bicycles, a water-level indicator, and a code oscillator. Parts lists, schematics, and component layouts are given for all the projects; test procedures are also included.

**CIRCLE 92 ON FREE INFORMATION CARD**

**THE ILLUSTRATED COMPUTER DICTIONARY**, by Donald D. Spencer. Charles E. Merrill Publishing Company, Columbus, OH 43216. 187 pp. 5 1/2" X 9 inch. Softcover. \$9.95.

This book is intended to present clear, precise definitions covering the broad language of the many aspects of computers; it contains nearly 3000 words, phrases, and acronyms, and is generously illustrated with diagrams, charts, and photos. There are thumbnail sketches of the most important precursors and developers of computer techniques (even including L Frank Baum and his wind-up mechanical creation, Tik-Tok of Oz); definitions of the important programming languages; terms used by business people relating to computer-based management activities; terms relating to the effects of computers upon society; metric terms, which are becoming more and more prevalent, and terms relating to the use of computers in education—as well as the full gamut of words that everyone working or playing with computers needs to know.

**CIRCLE 93 ON FREE INFORMATION CARD**

**THE PRACTICAL HANDBOOK OF AMATEUR RADIO FM & REPEATERS**, by Bill Pasternak, W6BTF, with Mike Morris, W6ILQ, Technical Advisor. Tab Books, Blue Ridge Summit, PA 17214. 538 pp. including glossary, appendix, and index. 5 1/2" X 8 1/2" in. Softcover \$9.95.

This is a "first" comprehensive, single-volume work on ham radio repeaters. It covers all kinds of amateur radio FM and repeaters, and contains enough advanced concepts to interest even the veteran repeater-user.

Profusely illustrated with diagrams, photos, and charts, there are 46 chapters, putting all kinds of FM/repeater topics within easy reach. The circuits that are shown are the favorites of the contributors and authors—who are the first to acknowledge that others may be better. Everyone into this game has his or her own way of doing things—and if your way works for you, then it's right!

The reader is shown just what jobs a repeater should perform, and how it can be made to perform more efficiently, stretching the distance over which the user can transmit. There are many tips on how to boost performance by using mobile equipment, tube-type amplifiers, portable repeaters, decoders, etc., as well as how to handle RF interference and deliberate interference. Just about any question that may occur to a person interested in FM operations is answered in this book.

R-E

**CIRCLE 94 ON FREE INFORMATION CARD**















# A Microcomputer for everyone at a Micro Price

The **MicroAce** - a new generation of miniature computers  
**A COMPLETE COMPUTER for \$149.00 for 1K Kit**

Post and Packing FREE

(Add 6% Tax for Shipments inside California)

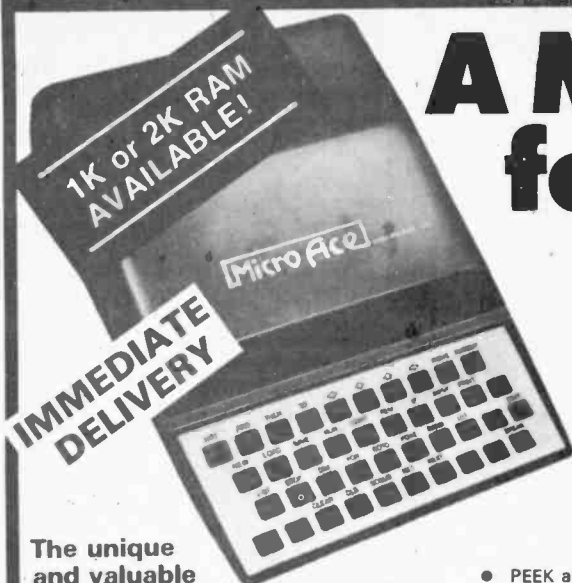

## The unique and valuable components of the MicroAce

The MicroAce is not just another personal computer. Quite apart from its exceptionally low price, the MicroAce has two uniquely advanced components: the powerful BASIC interpreter, and the simple teach yourself BASIC manual.

The unique versatile BASIC interpreter offers remarkable programming advantages:

- Unique 'one-touch' key word entry: the MicroAce eliminates a great deal of tiresome typing. Key words (RUN, PRINT, LIST, etc.) have their own single-key entry.
- Unique syntax check. Only lines with correct syntax are accepted into programs. A cursor identifies errors immediately. This prevents entry of long and complicated programs with faults only discovered when you try to run them.
- Excellent string-handling capability - takes up to 26 string variables of any length. All strings can undergo all relational tests (e.g. comparison). The MicroAce also has string input - to request a line of text when necessary. Strings do not need to be dimensioned.
- Up to 26 single dimension arrays.
- FOR/NEXT loops nested up to 26.
- Variable names of any length.
- BASIC language also handles full Boolean arithmetic, conditional expressions, etc.
- Exceptionally powerful edit facilities, allows modification of existing program lines.
- Randomise function, useful for games and secret codes, as well as more serious applications
- Timer under program control.

- PEEK and POKE enable entry of machine code instructions, USR causes jump to a user's machine language sub-routine.
- High-resolution graphics with 22 standard graphic symbols.
- All characters printable in reverse under program control.
- Lines of unlimited length.

## 'Excellent value' indeed!

For just \$149.00 (excluding handling charge) you get everything you need to build a personal computer at home... PCB, with IC sockets for all ICs; case; leads for direct connection to a cassette recorder and television (black and white or color); everything!

Yet the MicroAce really is a complete, powerful, full-facility computer, matching or surpassing other personal computers at several times the price.

The MicroAce is programmed in BASIC, and you can use it to do quite literally anything, from playing chess to managing a business.

The MicroAce is pleasantly straightforward to assemble, using a fine-tipped soldering iron. It immediately proves what a good job you've done: connect it to your TV... link it to the mains adaptor... and you're ready to go.

## Fewer chips, compact design, volume production-more power per Dollar!

The MicroAce owes its remarkable low price to its remarkable design: the whole system is packed on to fewer, newer, more powerful and advanced LSI chips. A single SUPER ROM, for instance, contains the BASIC interpreter, the character set, operating system, and monitor. And the MicroAce 1K byte

RAM (expandable to 2K on board) is roughly equivalent to 4K bytes in a conventional computer - typically storing 100 lines of BASIC. (Key words occupy only a single byte.)

The display shows 32 characters by 24 lines.

And Benchmark tests show that the MicroAce is faster than all other personal computers.

No other personal computer offers this unique combination of high capability and low price.

## The MicroAce teach-yourself BASIC manual.

If the features of the BASIC interpreter mean little to you - don't worry. They're all explained in the specially-written book free with every kit! The book makes learning easy, exciting and enjoyable, and represents a complete course in BASIC programming - from first principles to complex programs. (Available separately - purchase price refunded if you buy a MicroAce later.) A hardware manual is also included with every kit.

**The MicroAce Kit:**  
**\$149.00 with 1K COMPLETE**  
**\$169.00 with 2K**

Demand for the MicroAce is very high: use the coupon to order today for the earliest possible delivery. All orders will be despatched in strict rotation. If you are unsuccessful in constructing your kit, we will repair it for a fee of \$20.00, post and packing FREE. Of course, you may return your MicroAce as received within 14 days for a full refund. We want you to be satisfied beyond all doubt - and we have no doubt that you will be.

Z80 A microprocessor chip, widely recognised as the best ever made.

Sockets for TV, cassette recorder, power supply.

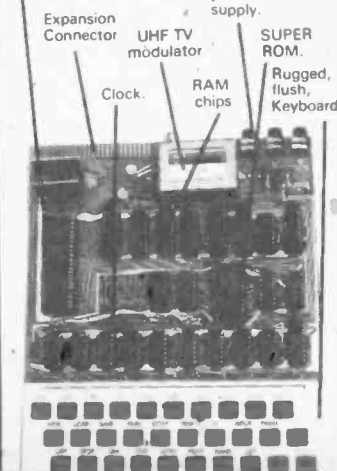

## Your MicroAce kit contains...

- Printed circuit board, with IC sockets for all ICs.
- Complete components set, including all ICs - all manufactured by selected world-leading suppliers.
- New rugged keyboard, touch-sensitive, wipe-clean.
- Ready-moulded case.
- Leads and plugs for connection to domestic TV and cassette recorder. (Programs can be SAVED and LOADED on to a portable cassette recorder.)
- Mains adaptor of 600 mA at 9VDC nominal unregulated.
- FREE course in BASIC programming and user manual.

## JOIN THE REVOLUTION - DON'T GET LEFT BEHIND - ORDER YOUR MICRO ACE NOW!!

Send Check, Money Order or quote your Credit Card No. to:  
**MicroAce 1348 East Edinger, Santa Ana, California, Zip Code 92705.**  
 or phone (714) 547 2526 quoting your Credit Card Number.

| Quantity                               | Description     | Unit Price   | TOTAL |
|--|-----------------|--------------|-------|
|  | MicroAce Kit 1K | \$149.00     |       |
|  | MicroAce Kit 2K | \$169.00     |       |
|  | Manual          | \$10.00      |       |
|  | 1K Upgrade Kit  | \$29.00      |       |
| Shipments inside California add 6% TAX |                 | <b>TOTAL</b> |       |

- Amex.
- Diners
- Check
- Money Order
- Master Charge
- Visa

Card No. \_\_\_\_\_

Exp. Date \_\_\_\_\_

Name \_\_\_\_\_

Address \_\_\_\_\_

City \_\_\_\_\_ State \_\_\_\_\_ Zip \_\_\_\_\_

**XENON STROBE TUBE & TRIGGER COIL**  
STROBE LIGHT SCHEMATICS INCLUDED  
C24061 \$1.75

**LED Flasher Kit**  
Simple to build kit using the popular LM 555 timer IC. It produces high speed green LED. Comes complete with all parts, including the PCB board. The battery is not included.  
C2381 \$2.49

**SOUND EFFECTS GENERATOR BASIC KIT**  
Now it's possible to build your own sound effects generator without spending a fortune. We supply you with the 1176477 sound chip plus an etched and drilled glass epoxy PC board with schematic and layout instructions. This board makes it simple to build a generator capable of phaser sounds, locomotive, sirens, airplanes, clocks, etc. Does not require DIP switches or other expensive/unusual components. You supply a few standard resistors, capacitors, switches, pots, speaker, 2N2222 transistor and 9V battery.  
C23883 BASIC KIT CONTAINING 1176477, PC BOARD AND INSTRUCTIONS.  
ONLY \$5.95

2N2222 TRANSISTOR FOR ABOVE C2388A .39 EACH

**ELECTRONIC WARNING FLASHER KITS**  
3VDC MODEL C23207 \$6.95  
6VDC MODEL C23808 \$8  
12VDC MODEL C23976 \$10.95

**ELECTRONIC STROBOSCOPE KIT**  
IMPENETRABLE AID FOR TROUBLESHOOTING OR DEMONSTRATING OPTICAL PHENOMENA. OPTICALLY STOPS MOTION OF FANS, WHEELS, PULLEYS, FLYWHEELS, ETC. THE STROBOSCOPE OPERATES FROM STANDARD 115VAC AND FEATURES BRIGHT XENON FLASH TUBE AND IC DESIGN. CONTINUOUSLY VARIABLE FLASH RATE FROM 100-5000RPM. THE KIT COMES WITH ALL COMPONENTS INCLUDING PC BOARD, 1/2" X 6" X 10" BOARD. DOES NOT INCLUDE CASE. SIZE OF BOARD: 3 1/2" X 4 3/4".  
C24070 \$29.95

**120 VAC Xenon Strobe Kit**  
Complete xenon tube xenon light kit. Contains all parts, PC board, and instructions.  
C23871 \$7.50

**Wheel of Fortune**  
Popular game device with LED's, transistors & IC's. Great for gifts and a great way to learn about electronics. Includes all parts, PC board & instructions.  
C23888 \$8.99

**CHANEY electronics inc.**  
P.O. BOX 27038, DENVER, CO. 80227 (303) 781-5750  
Send for our free giant catalog of unique items!!!  
CIRCLE 24 ON FREE INFORMATION CARD

# FREE ELECTRONICS CATALOG!

Over 1,500,000 Parts in Stock!

- No minimum order
- Volume discounts
- Orders shipped same day
- 100% money-back guarantee
- Phone orders accepted

We carry semiconductors, capacitors, resistors, switches, potentiometers, transformers, hardware, and much, much more

WRITE OR CALL TODAY for your FREE CAL WEST catalog! Collect Calls Accepted!

(213) 889-2209

- Mastercharge
- Visa
- BankAmericard



31320 Via Colinas, Suite 105  
Westlake Village, CA 91361

CIRCLE 2 ON FREE INFORMATION CARD

# MUSICIANS

## WE HAVE THE CRAIG ANDERTON BOOKS!

These books have helped thousands of musicians to learn more about musical electronics - while having fun and saving money at the same time.

"Electronic Projects for Musicians" \$7.95 Includes 19 do-it-yourself projects for musicians, plus 4 chapters of introductory material.

"Home Recording for Musicians" \$9.95 Tells how to get professional sounds out of consumer-oriented multitrack equipment.

ALSO... check our catalogue for Craig's full line of MusiKits

### 16K DYNAMIC RAM SPECIAL: 8/\$39!

Expand memory in TRS-80™ I and II, as well as machines made by Apple, Exidy, Heath H89, newer PETS, etc. Low power, high speed (4 MHz). Add \$3 for 2 dip shunts plus TRS-80 conversion instructions. TRS-80 is a trademark of the Tandy Corporation

### DC ROBOT MOTOR SPECIAL

DC fractional horsepower motor runs on about 1 to 5V. Not a servo motor by any means, but good for experimenting with robots, toys, games, etc. 10/\$2.95

### SOLDERTAIL

#### SOCKETS

- 8 pin 100/\$5.95
- 14, 16 & 18 pin 50/\$4.95
- 20 pin 40/\$4.95
- 24, 28 pin 30/\$4.95
- 40 pin 20/\$4.95

### SEMICONDUCTORS

- Gen purpose signal diodes 50/\$2
- GT5306 NPN darlington 100/\$8.95
- NPN sim 2N3904 100/\$7.95
- PNP sim 2N3906 100/\$8.95
- 4N28 opto-isol 5/\$2
- SN76477 sound IC 1/\$2.50
- MA1003 12V DC clock module \$14.95

TERMS: All orders payable in advance. Shipping charges included. Billing \$15 per \$25 orders. VISA and MasterCard orders \$25 per \$25 orders. Payment through bank transfer address for UPS orders. See terms through our website for more information. Subject to change without notice.

FREE CATALOGUE: Find out more about our exceptional product line. For our 1988 catalogue, call or write for status. For our 1989 catalogue, call or write for status.

# GODBOUT

GODBOUT ELECTRONICS  
Bldg. 725, Oakland Airport, CA 94614  
CIRCLE 51 ON FREE INFORMATION CARD

# Announcing

# KITS • KITS •

NEW... PRE-DRILLED PCB'S FOR ALL KITS

### CRYSTAL RADIO KIT

A self powered radio which uses a resonant circuit and detector for AM radio reception. An ideal project for the beginner

Model # EK80CR001

PRICE \$8.95

### STROBE LITE KIT

Fantastic for special effects. Variable speed Xenon flash gives you a "STILL MOTION" effect. A real attention getter

Model # EK80SL001

PRICE \$21.95

### 16 CHANNEL LED CHASER KIT

A very familiar sight seen at discos, department stores, and on neon signs. 16 LED's flash in sequence up down or alternate. Adaptable to 120 vac. (Extra)

Model # EK80LC016

PRICE \$22.95

### 16 CHANNEL MULTI-MODE LED CHASER KIT

We're proud to add this to our line. It's similar to our 16 channel led chaser but with many extra features. There are over 60 selectable modes. A few are: Up, Down, Skip, Pulse, Scramble, Single Pulse, Multi Pulse and many more. An optional 120 vac board is available. (Extra)

Model # EK80LCM16

PRICE \$32.95

Edu-Kit Ltd.  
P.O. Box 147  
Niagara Square Station  
Buffalo, N.Y., 14201

*EduKit* LTD.  
CIRCLE 76 ON FREE INFORMATION CARD

### 1.5 to 24v POWER SUPPLY KIT

A variable Power Supply suitable for many digital and linear applications. Delivers an output current of 100ma. from 1.5v to 15v and 500ma. from 16v to 24v

MODEL # EK80PS024

PRICE \$24.95

### POWER SUPPORT 120

A 120 volt power board which allows you to connect regular lamps to our LED Chaser Kits. 8 channels are supplied per board with 150 watts per channel. They can be easily interfaced for 16 channels.

Model # EK80PLC120

PRICE \$24.95

### 0-28 VOLT POWER SUPPLY KIT

A true 0 to 28 volts capable of delivering 1 amp continuous. Full wave rectification, filtering and capacitance multiplication provides a clean dc source for sensitive audio and digital work. An ideal supply for the experimenter

Model # EK80PS028

PRICE \$39.95

### 5 WATT IC AUDIO AMPLIFIER KIT

A general purpose 5 watt amplifier with Thermal Overload and Short Circuit Protection. Because of its low operating voltage and high power output, it allows the user to use it as an add-on amplifier for car stereo.

#### Specifications:

- Frequency Response: 40Hz to 15KHz B<sub>1</sub>-3dB
- Power Output: 5 watts at 4 ohms  
7 watts at 2 ohms
- Distortion: 5% at 7 watts at 2ohms
- Load Impedence: 2 to 16 ohms
- V Supply: 12 to 15vdc

Model # EK80A005

PRICE \$19.95

# ramsey the first name in Counters!



## 9 DIGITS 600 MHz \$129<sup>95</sup> WIRED

**PRICES:**

|   |          |
|---|----------|
| CT-90 wired, 1 year warranty            | \$129.95 |
| CT-90 Kit, 90 day parts war-<br>ranty   | 109.95   |
| AC-1 AC adapter                         | 3.95     |
| BP-1 Nicad pack + AC<br>Adapter/Charger | 12.95    |
| OV-1, Micro-power Oven<br>time base     | 49.95    |
| External time base input                | 14.95    |

The CT-90 is the most versatile, feature packed counter available for less than \$300.00! Advanced design features include; three selectable gate times, nine digits, gate Indicator and a unique display hold function which holds the displayed count after the input signal is removed. Also, a 10mHz TCXO time base is used which enables easy zero beat calibration checks against WWV. Optionally, an internal nicad battery pack, external time base input and Micro-power high stability crystal oven time base are available. The CT-90, performance you can count on!

**SPECIFICATIONS:**

|              |  |
|--------------|--|
| Range:       | 20 Hz to 600 MHz   |
| Sensitivity: | Less than 10 MV to 150 MHz<br>Less than 50 MV to 500 MHz                           |
| Resolution:  | 0.1 Hz (10 MHz range)<br>1.0 Hz (60 MHz range)<br>10.0 Hz (600 MHz range)          |
| Display:     | 9 digits 0.4" LED  |
| Time base:   | Standard-10,000 mHz, 1.0 ppm 20-40°C.<br>Optional Micro-power oven-0.1 ppm 20-40°C |
| Power:       | 8-15 VAC @ 250 ma  |

## 7 DIGITS 525 MHz \$99<sup>95</sup> WIRED



**SPECIFICATIONS:**

|              |  |
|--------------|--|
| Range:       | 20 Hz to 525 MHz   |
| Sensitivity: | Less than 50 MV to 150 MHz<br>Less than 150 MV to 500 MHz                  |
| Resolution:  | 1.0 Hz (5 MHz range)<br>10.0 Hz (50 MHz range)<br>100.0 Hz (500 MHz range) |
| Display:     | 7 digits 0.4" LED  |
| Time base:   | 1.0 ppm TCXO 20-40°C   |
| Power:       | 12 VAC @ 250 ma  |

The CT-70 breaks the price barrier on lab quality frequency counters. Deluxe features such as, three frequency ranges - each with pre-amplification, dual selectable gate times, and gate activity indication make measurements a snap. The wide frequency range enables you to accurately measure signals from audio thru UHF with 1.0 ppm accuracy - that's .0001%! The CT-70 is the answer to all your measurement needs, in the field, lab or ham shack.

**PRICES:**

|   |         |
|---|---------|
| CT-70 wired, 1 year warranty            | \$99.95 |
| CT-70 Kit, 90 day parts war-<br>ranty   | 84.95   |
| AC-1 AC adapter                         | 3.95    |
| BP-1 Nicad pack + AC<br>adapter/charger | 12.95   |

## 7 DIGITS 500 MHz \$79<sup>95</sup> WIRED



**PRICES:**

|   |         |
|---|---------|
| MINI-100 wired, 1 year<br>warranty        | \$79.95 |
| MINI-100 Kit, 90 day part<br>warranty     | 59.95   |
| AC-Z Ac adapter for MINI-<br>100          | 3.95    |
| BP-Z Nicad pack and AC<br>adapter/charger | 12.95   |

Here's a handy, general purpose counter that provides most counter functions at an unbelievable price. The MINI-100 doesn't have the full frequency range or input impedance qualities found in higher price units, but for basic RF signal measurements, it can't be beat! Accurate measurements can be made from 1 MHz all the way up to 500 MHz with excellent sensitivity throughout the range, and the two gate times let you select the resolution desired. Add the nicad pack option and the MINI-100 makes an ideal addition to your tool box for "in-the-field" frequency checks and repairs.

**SPECIFICATIONS:**

|              |   |
|--------------|---|
| Range:       | 1 MHz to 500 MHz                          |
| Sensitivity: | Less than 25 MV                           |
| Resolution:  | 100 Hz (slow gate)<br>1.0 KHz (fast gate) |
| Display:     | 7 digits, 0.4" LED                        |
| Time base:   | 2.0 ppm 20-40°C                           |
| Power:       | 5 VDC @ 200 ma                            |

## 8 DIGITS 600 MHz \$159<sup>95</sup> WIRED



**SPECIFICATIONS:**

|              |   |
|--------------|---|
| Range:       | 20 Hz to 600 MHz  |
| Sensitivity: | Less than 25 mv to 150 MHz<br>Less than 150 mv to 600 MHz |
| Resolution:  | 1.0 Hz (60 MHz range)<br>10.0 Hz (600 MHz range)          |
| Display:     | 8 digits 0.4" LED   |
| Time base:   | 2.0 ppm 20-40°C   |
| Power:       | 110 VAC or 12 VDC   |

The CT-50 is a versatile lab bench counter that will measure up to 600 MHz with 8 digit precision. And, one of its best features is the Receive Frequency Adapter, which turns the CT-50 into a digital readout for any receiver. The adapter is easily programmed for any receiver and a simple connection to the receiver's VFO is all that is required for use. Adding the receiver adapter in no way limits the operation of the CT-50, the adapter can be conveniently switched on or off. The CT-50, a counter that can work double-duty!

**PRICES:**

|   |          |
|---|----------|
| CT-50 wired, 1 year warranty  | \$159.95 |
| CT-50 Kit, 90 day parts<br>warranty                                     | 119.95   |
| RA-1, receiver adapter kit  | 14.95    |
| RA-1 wired and pre-program-<br>med (send copy of receiver<br>schematic) | 29.95    |

## DIGITAL MULTIMETER \$99<sup>95</sup> WIRED



**PRICES:**

|  |         |
|--|---------|
| DM-700 wired, 1 year warranty            | \$99.95 |
| DM-700 Kit, 90 day parts<br>warranty     | 79.95   |
| AC-1, AC adaptor                         | 3.95    |
| BP-3, Nicad pack + AC<br>adapter/charger | 19.95   |
| MP-1, Probe kit                          | 2.95    |

The DM-700 offers professional quality performance at a hobbyist price. Features include: 26 different ranges and 5 functions, all arranged in a convenient, easy to use format. Measurements are displayed on a large 3 1/2 digit, 1/2 inch LED readout with automatic decimal placement, automatic polarity, overrange indication and overload protection up to 1250 volts on all ranges, making it virtually goof-proof! The DM-700 looks great, a handsome, jet black, rugged ABS case with convenient retractable tilt bail makes it an ideal addition to any shop.

**SPECIFICATIONS:**

|                     |                                  |
|---------------------|----------------------------------|
| DC/AC volts:        | 100uV to 1 KV, 5 ranges          |
| DC/AC<br>current    | 0.1 uA to 2.0 Amps, 5 ranges     |
| Resistance:         | 0.1 ohms to 20 Megohms, 6 ranges |
| Input<br>impedance: | 10 Megohms, DC/AC volts          |
| Accuracy:           | 10.1% basic DC volts             |
| Power:              | 4 °C cells                       |

**AUDIO SCALER**

For high resolution audio measurements, multiplies UP in frequency.

- Great for PL tones
- Multiplies by 10 or 100
- 0.01 Hz resolution!

\$29.95 Kit \$39.95 Wired

**ACCESSORIES**

|   |         |
|---|---------|
| Telescopic whip antenna - BNC plug  | \$ 7.95 |
| High impedance probe, light loading   | 15.95   |
| Low pass probe, for audio measurements                                      | 15.95   |
| Direct probe, general purpose usage   | 12.95   |
| Tilt bail, for CT 70, 90, MINI-100  | 3.95    |
| Color burst calibration unit, calibrates counter<br>against color TV signal | 14.95   |

**COUNTER PREAMP**

For measuring extremely weak signals from 10 to 1,000 MHz. Small size, powered by plug transformer-included.

- Flat 25 db gain
- BNC Connectors
- Great for sniffing RF with pick-up loop

\$34.95 Kit \$44.95 Wired

ramsey electronics, inc.  
2575 BAIRD RD. • PENFIELD, NY 14526

PHONE ORDERS  
CALL 716-586-3950

**TERMS** Satisfaction guaranteed - examine for 10 days, if not pleased, return in original form for refund. Add 5% for shipping + insu. once to a maximum of \$10. Overseas add 15%. COD add \$2. Orders under \$10, add \$1.50. NY residents, add 7% tax.

CIRCLE 15 ON FREE INFORMATION CARD









# Shop Radio Shack America's Number 1 "Parts Place"™ No Minimum Order! No Waiting! New Items! All Prime Devices!

## Tone-Generating Keypad Module

**NEW! 16<sup>95</sup>**

Auto-patch! Remote control circuits!  
Produces 12 standard Touch-Tone™ frequencies. 1.5x2" face. Requires 3-5VDC @ 16 mA. Includes data.  
277-1010 ..... 16.95  
TV Colorburst Crystal. 3.58 MHz.  
272-1310 ..... 1.99

Touch-Tone is a registered trademark of AT&T.



## Unique LEDs

Low As **1<sup>29</sup>**

Perfect for Electronics Or Model Building!

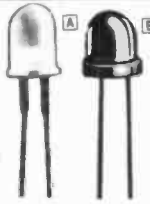

**A** TriColor. Red on DC, green on reverse DC, and yellow on AC. T-1 1/4 size. 2.2V at 25 mA.  
276-035 ..... 1.39

**B** Red Flasher. CMOS IC and LED in one package! 3-5VDC. Rate: 5 Hz. 20 mA at 5VDC.  
276-036 ..... 1.29

## Deluxe Dual-FET 26-Range Multimeter

**49<sup>95</sup>**



- 10-Megohm Input
- Dual Linear Scales for Easy Reading
- Carrying Handle/Stand
- Ohms Range-Doubler

Dual-FET input for maximum accuracy and minimum circuit loading. 4 1/2" mirrored-meter prevents parallax errors. Measures AC/DC volts, DC current, resistance. Includes leads. Battery extra 22-209 ..... 49.95  
Carrying Case. 22-153 ..... 6.95

## Ribbon Cable & Connectors

**New! Low As 4<sup>99</sup>**

- A** 40-Pin Card Edge Connector. Compatible with many microcomputers. 276-1558 ..... 5.95
- B** 40-Conductor Ribbon Cable. 5 ft. 278-771 ..... 6.95
- C** DBM 25 Connector. Insulation—displacement type. For easy hookup to standard RS-232 bus. 276-1559 ..... 4.99

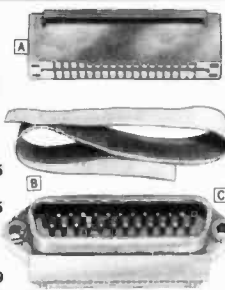

## Quad IC Timer

**NEW! 2<sup>99</sup>**



**NE 558.** Like having four 555s in one 16-pin DIP! Resettable time from 1 μs to 1 hour. Output can source or sink up to 200 mA. Operates from 4.5 to 16VDC. Full specs included. 276-1742 ..... 2.99

## Submini SPDT DIP Relay

**2<sup>99</sup>**

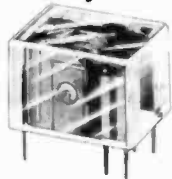

5VDC Coil

Only 3/8x5/16" Contacts rated 1 amp at 125VAC. Coil resistance: 56 ohms.  
275-216 ..... 2.99

## Color-Coded Guide

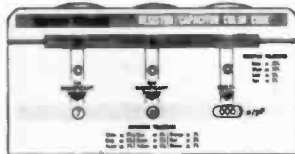

**39¢** Really handy! Quick numerical readout of resistor, capacitor, and inductor values and tolerances.  
271-1210 ..... 39¢

## IC Audio Amplifier

Make Your Car Tape Player Sound Like New!

**3<sup>19</sup>**



**LM383/TDA2002.** Build in big power to your next audio circuit! Provides up to 8 watts RMS with 13.8VDC power supply. Overload protected. TO-220 case.  
276-703 ..... 3.19

## Accessories to "Wrap Up" Wiring

Low As **1<sup>59</sup>**



- A** Spiral Wrap. Neatly bundles long lengths of wire. 5" clear and 5" black. 3/8" 276-1638 ..... 1.99
- B** Heat-Shrinkable Tubing. Fits over wire and shrinks when heated. 1/8 to 1/2" dia. Sizes: 4" long. 278-1627 ..... Set of 14, 1.59

## 12V Lamp Assemblies

Pkg. of 2 **1<sup>89</sup>**



Perfect panel lights. 1 red and 1 green with snap-in mounting tabs for 1/2" diameter hole. Long 4" leads. Bulbs included.  
272-332 ..... Pkg. 2/1.89

## 16 Axial-Lead Electrolytics

**5<sup>95</sup>**

**New!**



\$10.94 individual parts value! Contains 3 each of 4.7, 10, 47μF; 2 of 22, 100μF; 1 of 220, 470, 1000μF. 35WVDC. Includes reusable storage box. 272-604 ..... 5.95

## Sound Generator "Music Synthesizer" IC

**4<sup>49</sup>**

Linear/1<sup>2</sup>L Device



**SN76477.** Create almost any type of sound—music, explosions, phasers, gunshots. Built-in pre-amplifier provides line-level output. 6-15VDC. 28-pin DIP. Includes applications and data. 276-1765 ..... 4.49

## 4-Position DIP Switch

**1<sup>49</sup>**

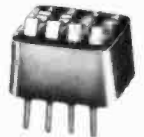

4-position miniature SPST switch for digital or low-current switching. Ideal for socket or PC board mounting. Standard .100x.300" DIP centers. Fits 8-pin socket.  
275-1304 ..... 1.49

## Heavy-Duty Cabinet

**10<sup>95</sup>**

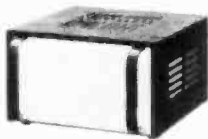

Ideal for housing your next project. Includes louvered top for ventilation, handles for easy carrying, and non-slip rubber feet. 5 1/4x9 1/2x6 1/4" 270-270 ..... 10.95

## 16K Dynamic RAM

**13<sup>95</sup>**

**New!**



**MM5290-055/4116.** 16,384x1 bits in a 16-pin DIP. Access time: 250 ns. Refresh: 1ms. Requires +5, +12, -5VDC. TTL compatible.  
276-2505 ..... 13.95

# BONUS COUPON

## Save 10%

Save 10% on your purchase of items totalling \$5 or more on this page. Offer good at participating stores and dealers. Quantities are limited, so hurry!

With this coupon

# Radio Shack®

A DIVISION OF TANDY CORPORATION - FORT WORTH, TEXAS 76102  
OVER 7000 LOCATIONS IN 40 COUNTRIES

WHY WAIT FOR MAIL ORDER DELIVERY?  
IN STOCK NOW AT OUR STORE NEAR YOU!

CIRCLE 71 ON FREE INFORMATION CARD



7400

Table listing various computer models under the 7400 series, including SN7400N, SN7401N, SN7402N, etc., with their respective prices.

74LS00

Table listing various computer models under the 74LS00 series, including 74LS00N, 74LS01N, 74LS02N, etc., with their respective prices.

Advertisement for a 16K upgrade, featuring a circular logo with '16K UPGRADE ONLY \$49.95 SPECIFY COMPUTER' and an image of a computer component.

Advertisement for an Apple Silentype keyboard, stating 'We Now Have The Apple Silentype IN STOCK' and 'With Apple Intelligent Interface Card. Reg. \$95.00'.

Advertisement for an Interface Card, stating 'Interface Card Has All Software For Hi-Res. Graphics & Pascal Use.' and 'NOW ONLY \$549.00'.

Advertisement for Beckman Digital Multimeters, featuring the slogan 'AS LOW AS \$100' and listing various models and their prices.

Advertisement for the MUSIC MACHINE 9 with 9 voices, including a 'NEW!' banner and details about its features and price of \$129.95.

Advertisement for Floppy Disk Drives, listing models like MPI B51-5W and prices ranging from \$279.00 to \$1.70.

Advertisement for Logic CONTINENTAL SPECIALTIES, listing various logic components like Model L61 and Model L62 with their prices.

Advertisement for Proto Clips, listing various clip models like 14-Pin Clip and 40-Pin Clip with their prices.

Advertisement for Proto Boards, listing various board models like PCB-100 and PCB-103 with their prices.

ACP'S INTELLIGENT COMPUTER PRODUCTS & GADGETS

Order now in time for Christmas

Large advertisement for 'THE BONE FONE' featuring a cartoon dog wearing headphones and a telephone handset, with a price of \$65.95.

ADVANCED COMPUTER PRODUCTS

Advertisement for Apple II 16K or Apple II Plus \$990 Disk System Special, including a list of compatible hardware and software options.

NEW! California Computer Systems APPLE Clock Only \$124.95

NEW! Z80 Software for APPLE CPM 2.2 & M BASIC 5.0 \$325.00

Advertisement for ATARI 800 & 400 Personal Computer System, including ATARI 800 \$825.00 and ATARI 400 \$449.00.

Table listing various software titles available for the ATARI computer systems, such as 'Basic Electricity' for \$35.00 and 'Word History' for \$35.00.

Advertisement for Texas Instruments 99/4 Personal Computer, featuring 'Superior Color, Music, Sound and Graphics' and a price of \$1099.00.

Advertisement for Commodore PET AS LOW AS \$775.00, including a list of discount prices for various models and components.

Advertisement for Single Board Computer Selection Guide, listing various board models like BOARD 1 and BOARD 2 with their prices.

Advertisement for Quartz LCD Watch with Snooze Alarm, featuring a watch image and a price of \$21.95.

Advertisement for Fire Fox Radio Controlled Off-Road Vehicle, featuring a radio-controlled truck image and a price of \$49.95.

Advertisement for Introducing the Calculator Lighter, featuring a calculator image and a price of \$69.95.

RETAIL STORES OPEN MON-SAT STORE #1 1310 'B' E. Edinger Santa Ana, CA 92705

STORE #2 674 El Camino Real Tustin, CA 92680

P.O. Box 17329 Irvine, Calif. 92713 Direct Order Lines: (714) 558-8813

CIRCLE 37 ON FREE INFORMATION CARD

**POTTER BRUMFIELD 4 PDT RELAYS**

- 14 pin style
- 3 amp contacts
- 24 volt d.c. or
- 120 volt a.c. (D)
- Used but fully tested

\$1.50 each  
specify coil voltage  
LARGE QUANTITIES AVAILABLE

**FLASHER L E D**  
Litronix FRL-4403  
diffused red led with built in flashing unit T 1 1/2 package pulse rate 3hr @ 5v 20 ma.

2 for \$1.70

**COMPUTER GRADE CAPACITORS**  
ALL ARE BRAND NEW

1,700 MFD. 150 VDC \$2.00  
2 1/2 in. dia. x 4 1/4 in.

3,000 MFD. 150 VDC. \$2.00  
3 in. dia. x 4 1/4 in.

6,400 MFD. 60 VDC. \$2.50  
1-3/8 in. dia. x 4 1/4 in.

22,000 MFD. 15 VDC. \$2.50  
2 in. dia. x 2 1/2 in.

22,000 MFD. 50 VDC \$3.50  
3 in. dia. x 4 1/4 in.

CLAMPS TO FIT CAPACITORS 50¢ ea.

22/44 EDGEBOARD CONNECTOR TIN SOLDER TAIL 156" x .200"

LARGE QUANTITIES AVAILABLE \$1.35 each, 10 for \$12.50

**TRANSFORMERS**

115 volt primaries

3 VOLTS @ 200MA \$1.25  
6 VOLTS @ 250MA \$1.25  
12.6 VOLTS C.T. @ 250MA \$1.50  
12.6 VOLTS C.T. @ 1 AMP. \$2.75  
16.5 VOLTS @ 3 AMP \$6.50

50K SLIDE POT 75¢ each  
Knobs for Slide Pots 70¢ each audio taper

**PHOTO - FLASH CAPACITOR**  
1100 MFD 330 VOLTS  
3 1/2" x 1 1/2" \$1.50 Each

**3 X 5 SPEAKER**  
3 oz. Magnet  
8 OHM Impedance \$2.50 each  
LARGE QUANTITIES AVAILABLE

**ALL ELECTRONICS CORP.**  
905 S. Vermont Ave. SEND FOR OUR FREE CATALOG  
Los Angeles, CA 90006  
(213) 380-8000

Store & Warehouse Hours  
9 AM - 5 PM  
Monday thru Friday  
Saturday  
10 AM - 3 PM

TERMS  
• Quantities Limited  
• Min. Order \$10.00  
• Add \$2.00 Shipping USA  
• Calif. Res. Add 6%  
• Prompt Shipping

## ELECTRONIC DESIGN LAB CA-16

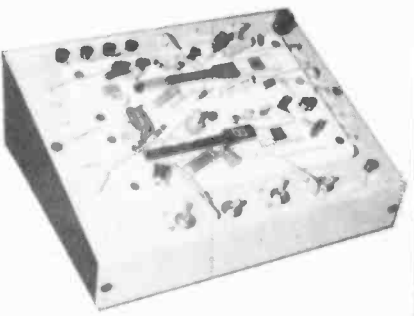

*Components not included*

- Variable function generator 1 HZ to 100 KHZ TTL, CMOS logic levels
- Six regulated supply voltages, all short circuit proof, including 5 volt 1 amp
- Four logic indicators and debounce switches
- Two CMOS to TTL convertors
- Two large breadboards, all point to point connections - no soldering

Everything is at the users finger tips. Our Design Lab will soon pay for itself in time and component savings. An excellent aid for engineers, technicians, students, and hobbyists. \$99.95.

*Free brochure*

**CASCADE LABS**  
4156 South Alder Avenue  
Freeland, Washington 98249 (206) 221-7483

## LONG PLAY 10 HOUR TAPE RECORDER



Top quality AC-DC cassette recorder, modified to provide 5 continuous hours of recording and playback of true fidelity, distortion-free sound on each side of cassette for a total of 10 hours. Unit has many special built-in features. TDK D-C180 cassette supplied.

**ONLY \$125.00\***

### PHONE RECORDING ADAPTER

Record incoming and outgoing calls automatically with this all solid state unit connected to your telephone jack and tape recorder. Starts recording when phone is lifted. Stops when you hang up, making a permanent record. Easily installed. No monthly charges. FCC APPROVED **\$24.50\***

### VOX VOICE ACTIVATED CONTROL SWITCH

Solid state. Self contained. Excellent adjustable sensitivity. Voices or other sounds activate and control recorder. Uses recorder mike or remote mike.

2 1/4 x 1 3/4 x 3/4" **\$24.95\***

Phone call Adapter \$24.50\*, VOX \$24.95\* (\* plus \$1.00 ea. shipping & handling), 10 hr. Recorder \$125.00\* (\* plus \$4.00 shipping & handling). California residents add tax. Mail Order, VISA, M/C, cod's okay, quantity discounts available. Money back guar. Free data.

AMC SALES, Dept. 19 9335 Lubec St., Box 928  
Downey, CA 90241, Phone (213) 869-8519

CIRCLE 36 ON FREE INFORMATION CARD

CIRCLE 27 ON FREE INFORMATION CARD

CIRCLE 26 ON FREE INFORMATION CARD

## CONCORD COMPUTER COMPONENTS

1971 SOUTH STATE COLLEGE / NAHEIM, CA. 92806  
(714) 937-0637

VISA MASTERCHARGE CHECK OR M/D NO COD

MINIMUM ORDER \$10.00  
ADD \$1.50 FOR FRIT  
CAL RES ADD 6%

We stock and sell over 12,000 types of computer components

### \$100 MEMORY BOARD

## 16K STATIC RAM



**\$249.00**  
ASSEMBLED & TESTED

FULLY STATIC OPERATION  
4K BANK ADDRESSABLE  
EXTENDED MEMORY MGMT  
MEETS IEEE PROPOSED  
5-100 SIGNAL STANDARDS  
4 MHZ OPERATION

California Computer Systems

### CPU CRYSTALS

| Freq     | Application | price  |
|----------|-------------|--------|
| 1.00 Mhz | 6800        | \$7.50 |
| 1.8432   | MC14411     | 4.50   |
| 2.00     | G-8/TVgrms  | 4.50   |
| 2.01     | TV grms     | 2.90   |
| 2.4576   | 34702baud   | 5.60   |
| 4.00     | 4004/4040   | 4.50   |
| 4.194304 | 8038        | 3.60   |
| 5.00     | misc. CPU's | 4.50   |
| 5.0688   | Com SO16    | 4.50   |
| 10.0     | misc. MPU's | 4.50   |
| 13.0     | "           | 4.50   |
| 14.31878 | "           | 4.50   |
| 18.0     | 8080/8008   | 5.60   |
| 22.1184  | 8080A       | 5.60   |
| 27.0     | "           | 5.60   |
| 32.0     | "           | 5.60   |
| 32.768   | MSM5832     | \$2.85 |

## video 100



**\$129**

12" BLACK & WHITE LOW COST VIDEO MONITOR

Leadex Corp.

### E PROMS

No "Glitches", Surges Or Interference

The MPD 117 is the low-cost solution to your power distribution problems. The MPD 117 has a high performance EMI filter, built-in circuit breaker, fuse, surge and line voltage stabilizer, illuminated "on/off" switch for matched outlets, and is built with rugged I.E.C. approved components and housing in an all steel chassis with convenient mounting lugs.

**\$87.50**

2708 1Kx8 \$6.75  
2716 2Kx8 14.95  
2732 4Kx8 54.95

SINGLE 5VOLT FOR 2 for \$100 2716 & 2732

### MODEL 8008



**IMPACT PRINTER**

- Dot resolution graphics in six densities
- 180 character buffer
- Fully adjustable tractor to 9-1/2"

**\$649.00**

base inc.

|         |     |          |      |
|---------|-----|----------|------|
| SN7400N | .20 | SN7482N  | 1.05 |
| SN7402N | .22 | SN7492N  | .50  |
| SN7404N | .22 | SN7493N  | .48  |
| SN7408N | .24 | SN7495N  | .60  |
| SN7410N | .22 | SN7496N  | .70  |
| SN7412N | .28 | SN74122N | .39  |
| SN7413N | .35 | SN74136N | .95  |
| SN7414N | .49 | SN74141N | .69  |
| SN7416N | .29 | SN74151N | .65  |
| SN7417N | .29 | SN74153N | .65  |
| SN7423N | .28 | SN74154N | 1.25 |
| SN7425N | .25 | SN74155N | .80  |
| SN7430N | .23 | SN74157N | .69  |
| SN7437N | .24 | SN74160N | .95  |
| SN7438N | .24 | SN74181N | .65  |
| SN7440N | .22 | SN74183N | .85  |
| SN7442N | .57 | SN74183N | .87  |
| SN7443N | .78 | SN74165N | .87  |
| SN7445N | .78 | SN74174N | .95  |
| SN7451N | .20 | SN74175N | .69  |
| SN7454N | .20 | SN74180N | .75  |
| SN7474N | .32 | SN74181N | 1.15 |
| SN7475N | .32 | SN74393N | 1.69 |

### MSM5832 MICROPROCESSOR REAL-TIME CLOCK/CALENDAR

### GENERAL DESCRIPTION

The MSM5832 is a monolithic, metal-gate CMOS integrated circuit that functions as a real-time clock/calendar for use in low-oriented microprocessor applications. The on-chip 32,768 Hz crystal controlled oscillator time base is counted down to provide addressable 4-bit BCD data of SECONDS, MINUTES, HOURS, DAY-OF-WEEK, DATE, MONTH, and YEAR. Data accuracy is controlled by 4-bit address, chip select, read/write and hold inputs. Other functions include 12H/24H format selection, leap year identification and manual 30 second correction.



**\$124.95**

### apple clock/calendar

- Seconds, minutes, hours, day-of-week, month, date, & year.
- On board batteries with one year life.
- Uses MSM5832-crystal controlled.

California Computer Systems

## apple II plus

### With 48K of memory!

# \$1089.00

With the purchase of the APPLE II 48K select from the below SPECIAL PRICING!

- Base printer... \$599
- Disk II w/cont... \$35
- Disk II... \$75
- Firmware Card... \$49
- UHF/PCA Cable... \$5
- PASCAL Card... \$399
- Star Printer Cd... \$179
- SuperDisk... \$29
- 3-way I/O Select... \$39
- Video 100 12"... \$199

Plexiglass cover as shown **\$24.95**



# The Most Professionally Designed and Economically Priced Component Kits

## Capacitors

| Deluxe     |  | Economy   |
|------------|--|-----------|
| 19.95 each | Radial Electrolytics<br>1 mfd through 2200 mfd                           | 6.95 each |
| 80 pieces  | 16wv through 50wv  | 30 pieces |
| 19.95 each | Axial Electrolytics<br>1 mfd through 4700 mfd                            | 6.95 each |
| 80 pieces  | 16 wv through 50 wv  | 30 pieces |
| 19.95 each | Axial Non-Polar Lytics<br>1 mfd through 100 mfd                          | 6.95 each |
| 50 pieces  | 16 wv through 50 wv  | 20 pieces |
| 19.95 each | Low Leakage Electrolytics<br>"Tantalum Replacement"                      | 6.95 each |
| 60 pieces  | Max leakage .4 microamps<br>.1mfd through 100 mfd<br>10 wv through 50 wv | 20 pieces |
| 19.95 each | Dipped Tantalums<br>.1 mfd through 47 mfd                                | 6.95 each |
| 50 pieces  | 6.3 wv through 35 wv   | 20 pieces |
| 19.95 each | Polyester Films<br>Non-inductive types<br>.001 mfd through .47 mfd       | 6.95 each |
| 100 pieces | 100 wv 10 % Tolerance  | 35 pieces |
| 19.95 each | Metallized Polyester Films<br>.01 mfd through 1.0 mfd                    | 6.95 each |
| 60 pieces  | 250 wv through 630 wv  | 20 pieces |
| 19.95 each | Ceramic Discs<br>10 pfd through 1 mfd                                    | 6.95 each |
| 100 pieces | 50 wv through 500 wv<br>All popular temperature characteristics          | 30 pieces |
| 19.95 each | Monolithic Ceramclcs<br>"New Most Popular Ceramic Capacitor"             | 6.95 each |
| 50 pieces  | Radial Dipped, 100pfd through<br>1mfd - 100 wv                           | 15 pieces |

## Resistors

|             |   |            |
|-------------|---|------------|
| 19.95 each  | 1/4 Watt Carbon Film  | 6.95 each  |
| 1000 pieces | 5% Tolerance 1.0 ohm through 10 meg   | 300 pieces |
| 19.95 each  | 1/2 Watt Carbon Film  | 6.95 each  |
| 1000 pieces | 5% Tolerance 1.0 ohm through 10 meg   | 300 pieces |
| 19.95 each  | 1/4 Watt Metal Film (RN55D)   | 6.95 each  |
| 400 pieces  | 1% Tolerance 49 ohm through 499K  | 100 pieces |
| 19.95 each  | Resistor Networks   | 6.95 each  |
| 40 pieces   | 5% Tolerance 4 pin styles<br>8 pin 7 resistor 8 pin 4 resistor<br>6 pin 5 resistor 6 pin 3 resistor | 15 pieces  |

## Diodes

|            |   |           |
|------------|---|-----------|
| 19.95 each | Switching Diodes                              | 6.95 each |
| 60 pieces  | 25 PIV to 75 PIV<br>2NSEC to 6NSEC            | 15 pieces |
| 19.95 each | Zener Diodes                                  | 6.95 each |
| 50 pieces  | 5.1V to 30.0V                                 | 15 pieces |
| 19.95 each | Diode Rectifiers                              | 6.95 each |
| 100 pieces | 50 PIV to 1000 PIV<br>1 amp (1N4001 - 1N4007) | 25 pieces |

Kits guaranteed for quality and popular assortment all parts sold separately—send for catalogue and price sheets (Send self-addressed envelope)

Other items available: IC's, Crystals, connectors, fuses, LED's, tubes, switches, lamps, speakers, etc..... Will make special kits upon request. Five million dollar electronic inventory.

Please send orders or inquiries to: **Quad Marketing Corp.**, P.O. Box 126, Woodbury, NY 11797.

CIRCLE 62 ON FREE INFORMATION CARD

4Kx16 MEMORY BOARD with 64 IC chips (2102) in sockets. Super deal at \$50 the complete board.

**\$29 AUTO SECURITY SYSTEM** alarm system \$7.00

SPACE MAN toy module PC board w/musical IC synthesizer chip. ROM has 5 programs, wierd noises blinking LEDs \$3.00 each

DATA STATION CONSOLE w/keyboard 9 inch monitor, power supply. Logic boards broken. \$80 Send for details on this one.

Computer video monitor chassis 9 inch, 12 volt used \$40  
Computer video monitor chassis 12 inch, new \$50  
Hy Gain CB chassis, trunk mount \$9.00



SEE IN THE DARKNESS

IR viewer, portable, new with choice of one lens...close up, telephoto or gen. purpose. Requires 6 volt DC btry. \$250

Parallel ASCII-II Keyboard

Unused ..... \$50.00

Red LED's large ..... 10/\$1.00

Shipping extra on all merchandise

Govt surplus walky talky, used cond. 47-55.4 mc range. Ant. \$5 each extra. With data.

\$25 ea 2 for \$45

AN/PRC-6



Meshna Inc., PO Box 62, E. Lynn, Mass. 01904

CIRCLE 30 ON FREE INFORMATION CARD

## CFR Associates EXCLUSIVE! SURPLUS COMPUTER BARGAINS

### 8 INCH FLOPPY DRIVES

Used, removed from systems. Mfd. by MPI Division of Control Data. These are the CDC floppy! Includes schematics & I/O data. Sold "As-Is" but complete and whole! An incredible BARGAIN, easy to interface with most commercial controllers. Features "hard" sectoring.

Special Price ..... **Only \$229.00**..  
Buy 3 and SAVE BIG!! ..... **3/\$599.00**  
Plus Shipping

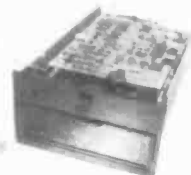

### DAISY TERMINALS

featuring the DIABLO HyType Daisy Printer. This exciting terminal features: RS232C ASCII, 110-1200 BAUD, KSR operation plus fantastic PLOTTER mode with bi-directional horiz. & vert'l movement, 1/60" H & 1/48" V increments. 15" platen, prints at 10, 15 & 30 cps! Uses plastic printwheel and has many more exciting features. Includes operator's manual & schematics. Used & returned.

Now Only ..... **\$1499.00**  
Add \$30.00 for Shipping Crate. Pay Shipping On Delivery

### \* SELECTRIC Typewriter Terminals

USED, off-lease. Features IBM Selectric Printer RS232 I/O. Takes BCD code type elements. Whole and complete. "AS-IS" (may need some adjustments). SEE OUR OCT. 1980 ADVERTISEMENT in this magazine. 15" carriage, type ball included. 110 VAC includes power supply, I/O and printer circuits and more.

Only ..... **\$469.00**  
Add \$18.00 for Shipping Crate. Pay Shipping On Delivery  
Maintenance Manuals Available. \$25.00

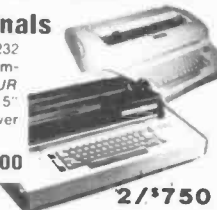

2/\$750

GET YOUR COPY OF OUR LATEST FLYER!

Circle the Bingo Card Number or Send a 1st Class Stamp for a Free Copy.

**CFR ASSOCIATES, INC.**  
18 Granite Street  
Haverhill, Mass. 01830

617-372-8536  
Phone Orders  
Welcome



CIRCLE 44 ON FREE INFORMATION CARD







# OR FREE NFORMATION ISE THESE OST-PAID ARDS

**1**

Print your name, address and Zip code on one of the attached postage-paid cards.

**2**

Circle the number (or numbers) on the card that corresponds to the number at the bottom of each advertisement or editorial item that you want information on. Advertisers' free-information numbers also appear in the ad index at the left on the facing page.

**3**

Mail the card. It's Postage-Paid.

**NOTE:**

Use the postcard address for Free Product Information only. Address all editorial inquiries to Editor, RADIO-ELECTRONICS, 200 Park Avenue South, New York, N.Y. 10003.

POSTAGE-PAID FREE INFORMATION CARD

REA 1280

|    |    |    |    |    |    |    |    |    |     |     |     |     |     |     |     |
|----|----|----|----|----|----|----|----|----|-----|-----|-----|-----|-----|-----|-----|
| 1  | 11 | 21 | 31 | 41 | 51 | 61 | 71 | 81 | 91  | 101 | 111 | 121 | 131 | 141 | 151 |
| 2  | 12 | 22 | 32 | 42 | 52 | 62 | 72 | 82 | 92  | 102 | 112 | 122 | 132 | 142 | 152 |
| 3  | 13 | 23 | 33 | 43 | 53 | 63 | 73 | 83 | 93  | 103 | 113 | 123 | 133 | 143 | 153 |
| 4  | 14 | 24 | 34 | 44 | 54 | 64 | 74 | 84 | 94  | 104 | 114 | 124 | 134 | 144 | 154 |
| 5  | 15 | 25 | 35 | 45 | 55 | 65 | 75 | 85 | 95  | 105 | 115 | 125 | 135 | 145 | 155 |
| 6  | 16 | 26 | 36 | 46 | 56 | 66 | 76 | 86 | 96  | 106 | 116 | 126 | 136 | 146 | 156 |
| 7  | 17 | 27 | 37 | 47 | 57 | 67 | 77 | 87 | 97  | 107 | 117 | 127 | 137 | 147 | 157 |
| 8  | 18 | 28 | 38 | 48 | 58 | 68 | 78 | 88 | 98  | 108 | 118 | 128 | 138 | 148 | 158 |
| 9  | 19 | 29 | 39 | 49 | 59 | 69 | 79 | 89 | 99  | 109 | 119 | 129 | 139 | 149 | 159 |
| 10 | 20 | 30 | 40 | 50 | 60 | 70 | 80 | 90 | 100 | 110 | 120 | 130 | 140 | 150 | 160 |

Please send me 12 issues of R-E for \$13.00 and bill me. (Canada \$16.00)  
Please print. Only one card per person.

NAME \_\_\_\_\_

COMPANY NAME (If applicable) \_\_\_\_\_

ADDRESS \_\_\_\_\_

CITY \_\_\_\_\_ STATE \_\_\_\_\_ ZIP \_\_\_\_\_

Void after February 28, 1981

Include Zip Code to insure delivery



NO POSTAGE  
NECESSARY  
IF MAILED  
IN THE  
UNITED STATES

**BUSINESS REPLY MAIL**  
FIRST CLASS PERMIT NO. 597 BOULDER, COLORADO

POSTAGE WILL BE PAID BY ADDRESSEE

**Radio-Electronics®**

SUBSCRIPTION SERVICE

P.O. Box 2520

BOULDER, COLORADO 80321



POSTAGE-PAID FREE INFORMATION CARD

REA 1280

|    |    |    |    |    |    |    |    |    |     |     |     |     |     |     |     |
|----|----|----|----|----|----|----|----|----|-----|-----|-----|-----|-----|-----|-----|
| 1  | 11 | 21 | 31 | 41 | 51 | 61 | 71 | 81 | 91  | 101 | 111 | 121 | 131 | 141 | 151 |
| 2  | 12 | 22 | 32 | 42 | 52 | 62 | 72 | 82 | 92  | 102 | 112 | 122 | 132 | 142 | 152 |
| 3  | 13 | 23 | 33 | 43 | 53 | 63 | 73 | 83 | 93  | 103 | 113 | 123 | 133 | 143 | 153 |
| 4  | 14 | 24 | 34 | 44 | 54 | 64 | 74 | 84 | 94  | 104 | 114 | 124 | 134 | 144 | 154 |
| 5  | 15 | 25 | 35 | 45 | 55 | 65 | 75 | 85 | 95  | 105 | 115 | 125 | 135 | 145 | 155 |
| 6  | 16 | 26 | 36 | 46 | 56 | 66 | 76 | 86 | 96  | 106 | 116 | 126 | 136 | 146 | 156 |
| 7  | 17 | 27 | 37 | 47 | 57 | 67 | 77 | 87 | 97  | 107 | 117 | 127 | 137 | 147 | 157 |
| 8  | 18 | 28 | 38 | 48 | 58 | 68 | 78 | 88 | 98  | 108 | 118 | 128 | 138 | 148 | 158 |
| 9  | 19 | 29 | 39 | 49 | 59 | 69 | 79 | 89 | 99  | 109 | 119 | 129 | 139 | 149 | 159 |
| 10 | 20 | 30 | 40 | 50 | 60 | 70 | 80 | 90 | 100 | 110 | 120 | 130 | 140 | 150 | 160 |

Please send me 12 issues of R-E for \$13.00 and bill me. (Canada \$16.00)  
Please print. Only one card per person.

NAME \_\_\_\_\_

COMPANY NAME (If applicable) \_\_\_\_\_

ADDRESS \_\_\_\_\_

CITY \_\_\_\_\_ STATE \_\_\_\_\_ ZIP \_\_\_\_\_

Void after February 28, 1981

Include Zip Code to insure delivery



NO POSTAGE  
NECESSARY  
IF MAILED  
IN THE  
UNITED STATES



**BUSINESS REPLY MAIL**  
FIRST CLASS PERMIT NO. 217 CLINTON, IOWA

POSTAGE WILL BE PAID BY ADDRESSEE

# Radio-Electronics®

FREE PRODUCT INFORMATION

P.O. Box 2707

CLINTON, IOWA 52735

## RADIO ELECTRONICS

Subscribe today to the magazine that keeps you up-to-date with the newest ideas and innovations in electronics. (If you already are a subscriber, do a friend a favor and pass this subscription card along to him.)

### check offer preferred

1 Year—12 issues **ONLY \$13.00**  
(You save **\$2.00** over newsstand)

2 Years (**SAVE MORE**)—24 issues **\$25.00**  
(You save **\$5.00** over newsstand)

Payment enclosed

Bill Me

Check here if you are extending or renewing your subscription

Name \_\_\_\_\_

Company Name (if applicable) \_\_\_\_\_

Address \_\_\_\_\_

City \_\_\_\_\_ State \_\_\_\_\_ Zip \_\_\_\_\_

**IMPORTANT**

Extra Postage: Canada \$3.00 per year.

All other countries \$5.00 per year.

**4SMO**



NO POSTAGE  
NECESSARY  
IF MAILED  
IN THE  
UNITED STATES



**BUSINESS REPLY MAIL**  
FIRST CLASS PERMIT NO. 217 CLINTON, IOWA

POSTAGE WILL BE PAID BY ADDRESSEE

# Radio-Electronics®

FREE PRODUCT INFORMATION

P.O. Box 2707

CLINTON, IOWA 52735

# For new ideas in electronic read Radio-Electronics

## During the next 12 months

Radio-Electronics will carry up-to-the-minute articles on

- hobby computers
- solid-state technology
- TV games • CB
- color TV • stereo
- test equipment
- radio
- radar detectors
- industrial electronics
- servicing
- TV-radio-stereo
- experimenter circuits
- exceptional construction projects

Don't take a chance on missing even one issue. Subscribe now and save!



NEW IDEAS AND INNOVATIONS IN ELECTRONICS

The newest ideas and innovations in electronics appear in Radio-Electronics. Keep up-to-date!

Subscribe Today!

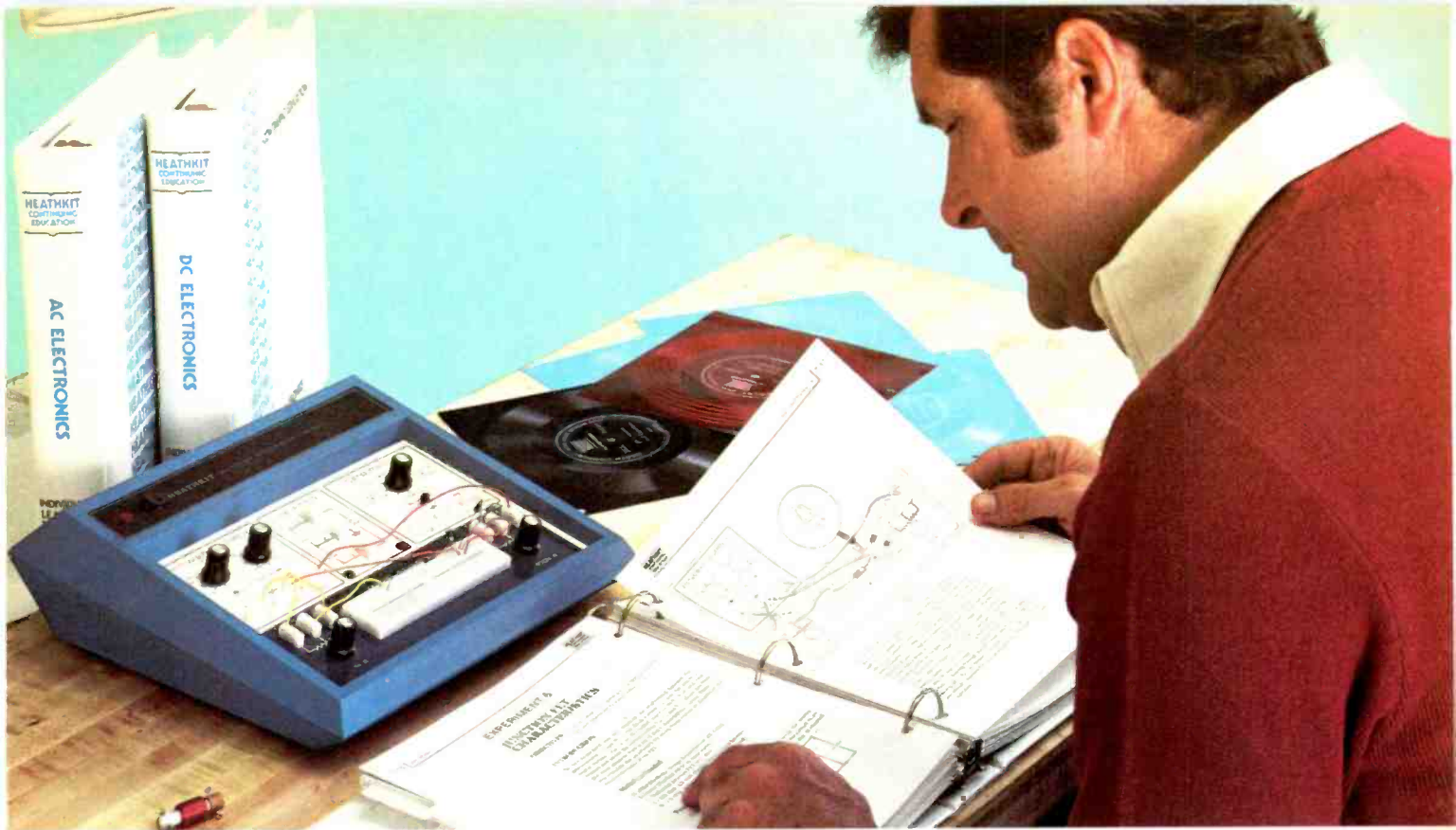

## Teach yourself the latest in electronics: from the fundamentals to microprocessors

Waiting for you in the new Heathkit Catalog is an exciting world of educational self-study programs, that can take you from fundamental electronics through microprocessor interfacing and computer programming.

Heathkit/Zenith Educational Systems offers 11 pages of information on 25 educational courses you can take in your home. All are clear, concise college-level courses designed to advance your level of knowledge.

Whether you're an old hand at electronics, just beginning or perhaps interested in learning about computer operation and programming, Heathkit/Zenith Educational Systems has the course for you.

Educational courses featured in the new Heathkit Catalog include: Fundamental Electronics — from DC and AC to Semiconductor Devices, Electronic Circuits and Test Equipment; and Advanced Electronics courses on Phase-Locked Loops, IC Timers and Active Filters.

Heathkit/Zenith Educational Systems' full line of computer-related educational programs — including Computer Programming, BASIC, Assembly and COBOL Language courses and self-instruction courses on Digital Techniques and Microprocessors — is also available.

Self-Instruction Courses from Heathkit/Zenith Educational Systems are the effective, low-cost way to learn tomorrow's technology today:

Effective because each Heathkit/Zenith course is uncompromisingly developed for applied, useful learning. First, you read clear, concise text material. Then, you see each concept in large, easy-to-understand visuals. Finally, you get hands-on experience by performing experiments.

Low-cost because everything you need is included with each course. For example, electronic parts are included with each Electronic Fundamentals course, to make experimenting easier. And trainers, cassettes, slides and filmstrips are available for many courses, to enhance your learning experience.

Turn to pages 71-82 of the latest Heathkit Catalog for the full story on Heathkit/Zenith Educational courses.

If you don't already have a Heathkit Catalog, send for your copy today — at one of the addresses listed below. Or pick up your copy at the nearest Heathkit Electronic Center\* in the U.S. and Canada, where Heathkit/Zenith Educational Courses are displayed and sold.

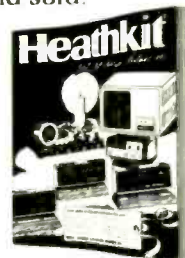
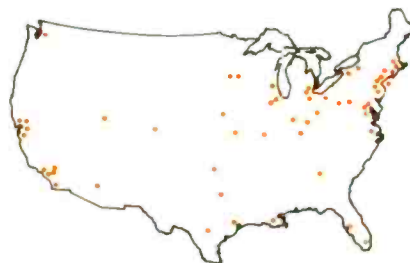

*Don't wait until tomorrow for knowledge you can learn today.*

### HEATHKIT/ZENITH EDUCATIONAL SYSTEMS

Dept. 020-723, Benton Harbor, MI 49022

In Canada, write Heathkit/Zenith Educational Systems,  
1480 Dundas St. E., Mississauga, Ontario L4X 2R7

(\*See the white pages of your phone book for the location nearest you in the U.S. Heathkit Electronic Centers are units of Veritechnology Electronics Corporation.)

ED-151

# IF YOU OWN A RADIO, THIS MICROPHONE WILL LET YOU TRANSMIT FURTHER AND CLEARER OR WE'LL GIVE YOU YOUR MONEY BACK!



**Guaranteed to out perform any mic on any radio!**

A speech processor microcircuit, designed by us, that eliminates splatter, boosts power and recharges its own battery. A patented American invention made in an American town.



## CHECK OUT THE EXCLUSIVE FEATURES!



- CLIPS ANYWHERE
- PROCESSES SPEECH WITH COMPUTER CIRCUIT
- SOUND SENSITIVE 2 INCHES OR 2 FEET
- NOISE CANCELLING
- TWO MICS WITH ONE SWITCH
- FRESH CHARGE WITH NO BATTERIES

## YOUR DOUBLE GUARANTEE

### GUARANTEE I:

The K40 Speech Processor is guaranteed to outperform any microphone it replaces or return it for a complete and full refund within 7 days from the K40 Dealer that installed and tuned it.

### GUARANTEE II:

Unconditionally guaranteed for 12 months. Guaranteed against cracking, chipping, or rusting. Guaranteed against mechanical failure. Guaranteed against electrical failure. No exclusions. No gimmicks. For a full 12 months.

**\$44.50** Suggested Retail

AMERICAN ANTENNA  
ELGIN, ILLINOIS 60120  
© COPYRIGHT AMERICAN ANTENNA

... Sold exclusively by **3500** American **K40** Dealers throughout the U.S. & Canada.

CIRCLE 5 ON FREE INFORMATION CARD