

TROUBLESHOOTING COMMUNICATION RECEIVER

\$1.25 ■ FEB. 1979

Radio-^{IND}Electronics

THE MAGAZINE FOR NEW IDEAS IN ELECTRONICS

SOLAR TRACKING SYSTEM

A guide to building a system that controls solar energy panels so they track the sun.

WIRE WRAP JUNGLE

New construction technique combines PC and wire-wrap assembly to get the best of both worlds.

AUDIO TEST STATION

Construction details for a high-quality audio test instrument that combines several important test instruments into a single cabinet.

CASES AND CABINETS

A roundup of commercially available off-the-shelf enclosures that add a professional look to your projects.

PLUS:

- ★ Two Hi-Fi Test Reports From R-E's Audio Lab
- ★ New IHF Amplifier Standards
- ★ Jack Darr's Service Clinic
- ★ State-Of-Solid-State
- ★ Computer Corner
- ★ Hobby Corner
- ★ CET Test

Build A Pro Quality
STRING SYNTHESIZER
It's A Bargain



GERNSBACK
CORPORATION



RETAILER: SEE PAGE 97 FOR
SPECIAL DISPLAY ALLOWANCE PLAN



The President base station. In the manner to which you've become accustomed.

People have come to associate superb quality with President CB.

And rightly so. When we build a base station, we go all out.

Every President base station is a masterpiece of performance, with a full complement of controls and indicators for your enjoyment of CB at its absolute best.

The Madison is a good example: the finest 40 channel base yet achieved by the President engineering art.

It's a single sideband CB, with a full 4 watts output on AM, 12 watts peak envelope power on single sideband for extraordinary performance, range and total talkpower.

Despite unsurpassed receiver sensitivity, bleedover just isn't a problem. Our adjacent channel rejection sets a standard for the industry. And you can set your own standard of sensitivity with a variable RF gain control.

A digital clock turns on the radio at a pre-selected time. An alarm reminds you of scheduled calls.

Two big meters read signal strength received, relative RF output, modulation and standing wave ratio.

There's a digital LED channel indicator. Three more LEDs to indicate when you're on upper sideband, lower sideband or AM. Still another LED glows when you're transmitting.

A built-in variable mike gain control eliminates the need for a separate power mike.

We've even given the Madison's big speaker its own separate cabinet, so you can put it where it sounds best.

Your local CB specialist is the place to find President equipment. Plus the best in accessories and service, including installation, warranty back-up and the

most expert advice in town. Ask him about the new Madison base station.

It's unequivocally President.

In the grand manner.



PRESIDENT

Engineered to be the very best.

President Electronics, Inc.

16691 Hale Avenue · Irvine, CA 92714 · (714) 556-7355

In Canada: Lectron Radio Sales Ltd., Ontario

CIRCLE 38 ON FREE INFORMATION CARD

The Age of Affordable Personal Computing Has Finally Arrived.

Ohio Scientific has made a major breakthrough in small computer technology which dramatically reduces the cost of personal computers. By use of custom LSI micro circuits, we have managed to put a complete ultra high performance computer and all necessary interfaces, including the keyboard and power supply, on a single printed circuit board. This new computer actually has more features and higher performance than some home or personal computers that are selling today for up to \$2000. It is more powerful than computer systems which cost over \$20,000 in the early 1970's.

This new machine can entertain your whole family with spectacular video games and cartoons, made possible by its ultra high resolution graphics and super fast BASIC. It can help you with your personal finances and budget planning, made possible by its decimal arithmetic ability and cassette data storage capabilities. It can assist you in school or industry as an ultra powerful scientific calculator, made possible by its advanced scientific

math functions and built-in "immediate" mode which allows complex problem solving without programming! This computer can actually entertain your children while it educates them in topics ranging from naming the Presidents of the United States to tutoring trigonometry all possible by its fast extended BASIC, graphics and data storage ability.

The machine can be economically expanded to assist in your business, remotely control your home, communicate with other computers and perform many other tasks via the broadest line of expansion accessories in the microcomputer industry.

This machine is super easy to use because it communicates naturally in BASIC, an English-like programming language. So you can easily instruct it or program it to do whatever you want, *but you don't have to*. You don't because it comes with a complete software library on cassette including programs for each application stated above. Ohio Scientific also offers you hundreds of inexpensive programs on ready-to-run cassettes. Program it yourself or just enjoy it; the choice is yours.

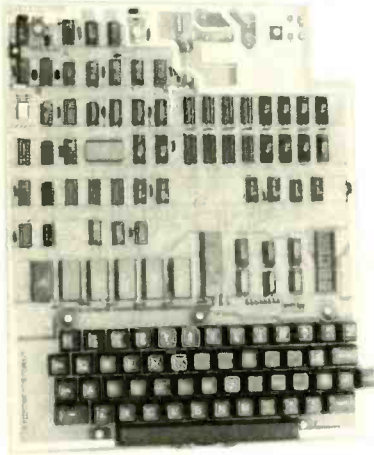

Ohio Scientific offers you this remarkable new computer two ways.

Challenger 1P \$349

Fully packaged with power supply. Just plug in a video monitor or TV through an RF converter to be up and running.



Superboard II \$279

For electronic buffs. Fully assembled and tested. Requires +5V. at 3 Amps and a video monitor or TV with RF converter to be up and running.

Standard Features

- Uses the ultra powerful 6502 microprocessor
- 8K Microsoft BASIC-in-ROM
Full feature BASIC runs faster than currently available personal computers and all 8080-based business computers.
- 4K static RAM on board expandable to 8K
- Full 53-key keyboard with upper/lower case and user programmability
- Kansas City standard audio cassette interface for high reliability
- Full machine code monitor and I/O utilities in ROM
- Direct access video display has 1K of dedicated memory (besides 4K user memory), features upper case, lower case, graphics and gaming characters for an effective screen resolution of up to 256 by 256 points. Normal TV's with overscan display about 24 rows of 24 characters; without overscan up to 30 X 30 characters.

Extras

- Available expander board features 24K static RAM (additional), dual mini-floppy interface, port adapter for printer and modem and an OSI 48 line expansion interface.
- Assembler/editor and extended machine code monitor available.

ORDER FORM

Order direct or from your local Ohio Scientific dealer.

- I'm interested. Send me information on your:
- Personal Computers Business Systems
- Send me a Superboard II \$279 enclosed
- Send me a Challenger 1P \$349 enclosed
- Include 4 more K of RAM (8K Total) \$69 more enclosed

Name _____

Address _____

City _____ State _____ Zip _____

Payment by: BAC (VISA) _____ Master Charge _____ Money Order _____

Credit Card Account # _____

Expires _____ Interbank # (Master Charge) _____
Ohio Residents add 4% Sales Tax

TOTAL CHARGED OR ENCLOSED _____

All orders shipped insured UPS unless otherwise requested. FOB Aurora, OH

Interested in a bigger system? Ohio Scientific offers 15 other models of microcomputer systems ranging from single board units to 74 million byte hard disk systems.

OHIO SCIENTIFIC
America's Largest Full Line Microcomputer Company
1333 S. Chillicothe Road • Aurora, Ohio 44202 (216) 562-3101

GOULD PROFESSIONAL OSCILLOSCOPES AT PRICES YOU CAN AFFORD.

Whatever your interest in electronics, you know that a quality oscilloscope with a broad range of features and functions can make your work a lot easier. Gould oscilloscopes are built to solve your problems and priced so you can afford the professional equipment you need right now. All are complete, ready for use, including passive probes, input leads and a comprehensive maintenance and operation manual.



OS245A

The OS245A is a compact, dual trace instrument with a 10MHz bandwidth and 5mV/div sensitivity. It has exceptional trigger performance and a full compliment of facilities for industrial, educational, and field service applications.

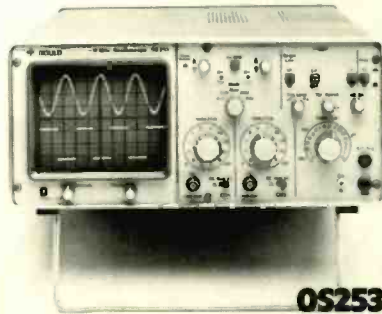

OS253

The OS253 is a 12MHz dual-channel scope with all the features of the OS245A plus a larger display area, more sensitivity and channel sum and difference.

The dual trace OS255 weighs only 15 lbs. yet offers features normally found in more expensive instruments such as flexible triggering facilities and 2mV/cm sensitivity across its full 15MHz bandwidth.



OS255

The dual beam OS260 gives true representation of two separate signals on the same time frame without beam chopping or alternating. Features include a high brightness CRT operating at 10kV

allowing a clear display of all waveforms.



OS260

For additional information on this exciting new line of sensibly priced, professional oscilloscopes or for sales locations in your area: call toll free (800) 325-6400 Ext. 77. In Missouri call (800) 342-6600.

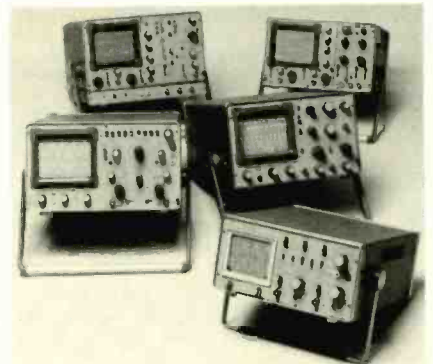

Gould also manufactures an additional line of general purpose oscilloscopes for industrial, scientific and laboratory applications.

 **GOULD**

Radio-Electronics®

THE MAGAZINE FOR NEW IDEAS IN ELECTRONICS
 Electronics publishers since 1908

FEBRUARY 1979 Vol. 50 No. 2

BUILD ONE OF THESE

- 37 **Pro Quality String Synthesizer**
 Latest Innovation in electronic music synthesizers is easy to build yet gives the soloist and small groups the background needed to enhance the performance.
- 42 **Solar Tracking System**
 Electronic servo system swivels the solar collector panel so it follows the sun.
- 45 **Audio Test Station**
 Part 2: Not an easy project. This all-in-one unit combines several important test instruments. Build it a section at a time.

GENERAL ELECTRONICS

- 4 **Looking Ahead**
 Tomorrow's news today.
- 49 **Cases & Cabinets for Everyone**
 Another installment of a roundup showing cases for projects and where you can get them.
- 53 **PC/Wire Wrap—New Construction Technique**
 Combining wire-wrap with a printed circuit is the answer to many layout and construction problems. See how an expert does it.
- 68 **You Can Be A CET**
 Another quiz to help you get ready to take the NESDA/ISCET CET test.

COMMUNICATIONS

- 63 **Troubleshooting Communications Receivers**
 The right signal generator plus good diagnostic ability and precise bench techniques lead to rapid 2-way radio repairs.
- 65 **FM Detector and Filter Tests**
 Proper operation of FM detectors is vital to reliable operation of 2-way radio gear. Here's how they work and how to keep them working.

STEREO HI-FI PRO SOUND

- 56 **New IHF Amplifier Specifications**
 New testing standard makes amplifier comparisons more realistic for the layman. Provides a closer correlation between what he hears and what the lab technician measures.
- 59 **R.E.A.L. Audio Tests Yamaha CR-420 AM/FM Receiver**
 Earns a "Very Good" for overall sound quality.
- 62 **R.E.A.L. Audio Tests SAE 4100 Time Delay System**
 Rates an "Excellent" for overall sound quality.

MONTHLY FEATURES

- 74 **Hobby Corner**
 Learn solid-state circuitry as you complete your monophonic music maker.
- 76 **Computer Corner**
 8085—A look at two memory IC's that are among the 8085 family of devices.
- 80 **Jack Darr's Service Clinic**
 Troubleshooting starter circuits in pulse-width modulated power supplies.
- 81 **Service Questions**
 R-E's Service Editor solves technician problems.

EQUIPMENT REPORTS

- 24 **A.P. Products Powerace 103 Breadboard & Power Supply**
- 26 **Simpson 462 Digital Multimeter**
- 32 **C.W. Moser 6502 Editor Assembler**
- 34 **Hustler MOT Monitor Antenna**

DEPARTMENTS

- | | |
|------------------------------|--------------------|
| 122 Advertising Index | 97 Market Center |
| 14 Advertising Sales Offices | 6 New & Timely |
| 92 Computer Products | 96 New Literature |
| 78 Communications Products | 86 New Products |
| 123 Free Information Card | 95 Next Month |
| 16 Letters | 94 Stereo Products |

ON THE COVER

It looks like an electronic organ, but it isn't. It is a string synthesizer. Plunk the keys and play a banjo, or guitar, or piano, or . . . Build one for yourself. Construction details start on page 37.

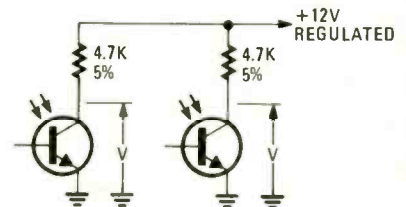

PHOTOTRANSISTOR SENSORS for the heart of this solar tracking device that follows the sun. Use it with your solar energy collection system. Complete details start on page 42.

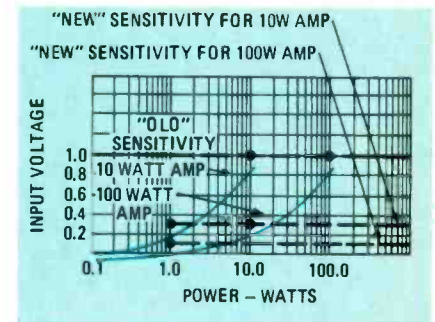

NEW IHF SENSITIVITY RATING specifies the input voltage required to produce a 1-watt output. Story starts on page 56.

Radio-Electronics, Published monthly by Gernsback Publications, Inc., 200 Park Avenue South, New York, NY 10003. Phone: 212-777-6400. Second-class postage paid at New York, NY and additional mailing offices. One-year subscription rate: U.S.A. and U.S. possessions, \$9.98, Canada, \$12.98. Other countries, \$14.98. Single copies \$1.25. © 1979 by Gernsback Publications, Inc. All rights reserved. Printed in U.S.A.

Subscription Service: Mail all subscription orders, changes, correspondence and Postmaster Notices of undelivered copies (Form 3579) to Radio-Electronics Subscription Service, Box 2520, Boulder, CO 80322.

A stamped self-addressed envelope must accompany all submitted manuscripts and/or artwork or photographs if their return is desired should they be rejected. We disclaim any responsibility for the loss or damage of manuscripts and/or artwork or photographs while in our possession or otherwise.

As a service to readers, Radio-Electronics publishes available plans or information relating to newsworthy products, techniques and scientific and technological developments. Because of possible variances in the quality and condition of materials and workmanship used by readers, Radio-Electronics disclaims any responsibility for the safe and proper functioning of reader-built projects based upon or from plans or information published in this magazine.

Looking ahead

Videodisc mergers? Although many different noncompatible videodiscs have been demonstrated, as outlined previously ("Looking Ahead," **Videodisc boxscore**, November, 1978), the multiplicity of these systems may evaporate or dwindle as manufacturers face reality. The optical system, which basically was a compromise between similar Philips and MCA systems, is already being produced by Magnavox (videodisc players) and MCA Disco-Vision (videodisc records) in the United States. In Japan, the joint Japanese-American company, Universal Pioneer, plans to start player production this year.

So the optical system is the one manufacturers wish to stop, if they want to field simpler nonlaser players. Nonlaser systems have been demonstrated by RCA, Matsushita, JVC, Toshiba and Telefunken—the latter now being on limited sale in both Europe and Japan in a 10-minute-per-disc version. The RCA and JVC versions are capacitance systems. Matsushita and Telefunken are classified as mechanical systems. Except for RCA and Toshiba, which are compatible, the systems have little in common except that they're nonoptical. They all use grooved discs (except for JVC) and spin at 450, 900, or 1800 rpm. Even the center-hole diameters are different.

Although it's not official yet, there's strong evidence to suggest an effort will be made to bring all these systems into compatibility before commercializing them. The resulting system—if there *is* one—is expected to have some features of the optical version, such as being able to provide slow and fast motion but to be potentially less expensive in terms of players and perhaps discs. The result could be a sort of "stop-Philips" effort; in effect, optical vs. nonoptical systems. Although this situation isn't ideal, two "standards" are preferable to five or six.

New watch display: Electrochromic displays are claimed to be price-competitive with LCD's, but have some major advantages. The first company to announce the commercialization of this technique is Sharp, which says it will have a line of ECD's this spring.

Several companies have been working on ECD's for four or five years. These displays use metallic chemicals that change to a dark color when a voltage is applied. Once changed, they retain their color until the voltage is reversed—a power-saving feature. They have considerably higher visibility than LCD's, primarily because their image is nondirectional. They can be manufactured in any color, and the numerals stand out clearly against a contrasting background. The color of Sharp's initial displays will be blue. Electrochromic displays are relatively slow and, in their initial development, at least, it was felt they were not fast enough for calculators. Sharp hasn't stated whether its product will have a calculator display.

TV developments: A new single-gun color tube, scheduled to be sold this year in small-screen battery-powered sets manufactured by Matsushita, is claimed to have an extremely low power drain, making it

possible for a set to operate for three hours on nine flashlight batteries. Its color phosphors are separated by black control stripes that emit ultra-violet rays for beam indexing. If this sounds familiar to some color TV oldtimers, it bears a striking similarity to Philco's widely demonstrated (but never produced) "Apple" tube of the 1950's.

Photochromic glass has been used in windows and sunglasses, and now it may be adapted to black-and-white TV. The Corning Glass product darkens under strong light and lightens when ambient light is less intense. For outdoor viewing of a portable TV, the glass darkens enough to eliminate the need for a separate plastic sunshield. For indoor viewing, the glass lightens—providing proper contrast under all viewing conditions. Corning is now working on the development of a glass that darkens enough to provide these contrast-enhancing features.

"Picture-in-picture" TV is offered in Europe as a special feature that lets the viewer watch two channels simultaneously, the supplementary channel being superimposed in a corner or at the bottom of the large-screen color picture. The only trouble is, the secondary picture is in black-and-white. Now, Hitachi says it has changed all that and will be selling a two-picture color set in which *both* the main and the superimposed pictures are in color. A digital semiconductor memory makes it possible to provide the second-channel insert in color.

In-flight video: Video tape is about to take over for film in the airborne movie business. Bell & Howell has sold American, Continental and Laker Airlines on a new technique that uses a modified VHS 1/2-inch videocassette recorder and a projection TV system. Among the advantages of a VHS system is the size of the cassette, as contrasted with the large 16-mm movie reel used in film systems. And with film systems, the reels generally are changed by engineers on the ground. Flight attendants can easily flip a cassette in the VCR, which is mounted in a luggage rack. The projector uses three side-by-side 5-inch monochrome projection tubes, weighs 65 lbs. and is installed in the cabin ceiling. The picture is projected onto a standard 30- by 40-inch pull-down screen. Bell & Howell says it plans to introduce a home version of the projector this year for built-in and conventional installations. Its advantages over other home systems, as claimed by the manufacturer, are: it's bright enough to be able to use any flat movie screen, or even a light-colored wall, instead of a parabolic directional screen.

Another new Bell & Howell "why-didn't-they-think-of-it-before" system for the airlines is a wireless headphone for stereo music or movie sound. For the high-ceilinged new planes, Bell & Howell will also supply wireless attendant-call and light-switch systems.

DAVID LACHENBRUCH
CONTRIBUTING EDITOR

Automotive "brain" astounds the experts, puts both computer and cruise control at your fingertips!

For the first time ever, you can put a true computer in your car, truck or RV which gives you the most effective and functional cruise control ever designed, plus complete trip computing, fuel management system, and a remarkably accurate quartz crystal time system. It is called CompuCruise™.

So simple a child can operate, the new CompuCruise combines latest computer technology with state-of-the-art reliability in a package which will not likely be available on new cars for years to come.

CRUISE CONTROL WITH A MEMORY, UNIQUE SEEK-AND-HOLD CAPABILITY.

CompuCruise remarkable cruise control performs in a totally different manner than any other unit because it is more than a simple speed maintaining device. With CompuCruise, you establish your desired cruising speed even before you reach the highway and activate the system any time by simply pressing a button. CompuCruise then seeks and maintains the desired speed until you override or shut off the system. You resume cruise control again at any time by pressing the same button. CompuCruise, unlike most vacuum-mechanical systems, is fully electronic, more accurate and more reliable than any other unit you can buy.

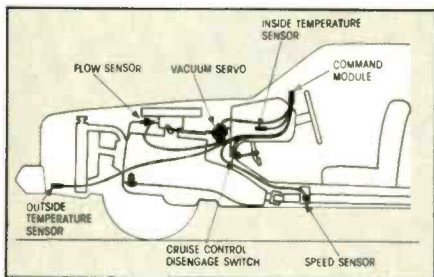

AIRLINE PILOTS COMPARE COMPUCRUISE™ TO SOPHISTICATED AVIONICS EQUIPMENT.

Similar to types of computers used on modern airliners, the CompuCruise slim panel-mounted control module contains a digital readout and back-lighted control buttons, both readily visible in the dark. By quickly learned systems of inquiry, the driver can elicit virtually any informa-

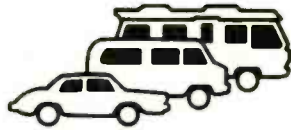

tion relating to time, distance, fuel and performance of his vehicle.

There are a number of digital-type instruments on the market which can be purchased for your car, purporting to provide functional data on performance, but all are basically calculators, operating on fixed information provided by the driver.

CompuCruise is a true computer, operating from automatic data sensors which constantly react to changing conditions, automatically recomputing vital data every second. Each function operates independently, with data displayed and updated constantly until you change your request of the computer.

Fuel management takes on new significance because CompuCruise tells you the most effective driving speeds, the type and brand of gasoline most suitable for your vehicle. It will tell you the effects of different types of tires and different tire pressures, road conditions, and engine tune-up condition. You can get instantaneous computations on current gas mileage, fuel required to arrival, and actual fuel remaining.

Battery condition can be checked regularly, saving you from the potential embarrassment of being stranded without warning.

TYPICAL DATA:

- ✓ Cruise Control
- ✓ Time, E.T., Lap Timer, Alarm
- ✓ Time, Distance, Fuel to Arrival
- ✓ Time, Distance, Fuel to Empty
- ✓ Time, Distance and Fuel on Trip
- ✓ Current or Average MPG, GPH
- ✓ Fuel Used, Distance since Fillup
- ✓ Current and Average Vehicle Speed
- ✓ Inside, Outside or Coolant Temperature
- ✓ Battery Voltage
- ✓ English or Metric Display

COMPUCRUISE™ DIGITAL QUARTZ CRYSTAL TIME SYSTEM IS INCREDIBLE.

CompuCruise digital time system performs four independent time functions encompassing (a) stop watch and lap timer functions, (b) hours, minutes and seconds, (c) alarm or warning function, and (d) trip time indicator. The time system operates full time, whether your vehicle is operating or not. It will even wake you up after a short roadside nap.



YOUR COMPUCRUISE IS SMART! IF YOU PUSH THE WRONG BUTTON IT WILL LET YOU KNOW BY DISPLAYING "ERROR".

COMPUCRUISE™ WORKS ON FOREIGN OR AMERICAN CARS; IS PRICED FOR THE AVERAGE MAN'S BUDGET

You do-it-yourselfers can readily install the unit, but complete and detailed instructions are also included for the automotive service facility. CompuCruise units are fully operable on most foreign or American cars, trucks or RV's. At \$199.95 the unit is only a few dollars more than the cost of cruise control alone on most vehicles, yet offers a whole new world of computerized management functions.

This is an exclusive system, fully warranted for 90 days from installation, delivered to you complete with all required hardware. You need only basic tools for the total job.

When you receive your unit, inspect it completely. If you are not 100% satisfied, return the complete unit before installation and your money will be refunded without question.

TO ORDER YOUR UNIT, complete the coupon below, enclosing \$199.95 (ADD \$5.50 if front-wheel drive). This covers all shipping, insurance and handling costs. Your unit will be shipped within three weeks.

NOTE: Mountable on foreign or domestic vehicles including standard trans. **EXCEPT FOR DIESEL OR FUEL INJECTED ENGINES.**



(415) 935-4960

Technically competent personnel available to answer your questions.



COMPUCRUISE

TO: ZEMCO, Inc. (415) 935-4960
1136 Saranap Avenue
Walnut Creek, CA 94595

Ship _____ CompuCruise™ units @ \$199.95
Model 44 (WITH CRUISE CONTROL)
 Add \$5.50 for front-drive

Ship _____ CompuCruise™ Units @ \$159.95
Model 41 (WITHOUT CRUISE CONTROL)
 Add \$5.50 for front-drive

Total enclosed: \$ _____
(CA residents add Sales Tax)

Charge to my Master Charge Visa

Card Number _____

Date Expires _____

Signature _____

Make vehicle: _____

Name: _____

Address: _____

City: _____ State & Zip _____

Electronic music newsletter now available

A monthly newsletter, *Device*, is now available to those in the electronic music field. The publication covers such topics as new product reviews of musical equipment, construction articles, circuit-design features, etc.; it carries no advertising and is entirely subscription-supported. Yearly rates: \$15 (U.S.); \$16 (Canada/Mexico); \$18 (international). For information, write *Device*, P.O. Box C, Carmichael, CA 95608.

ANIK-B COMMUNICATIONS SATELLITE

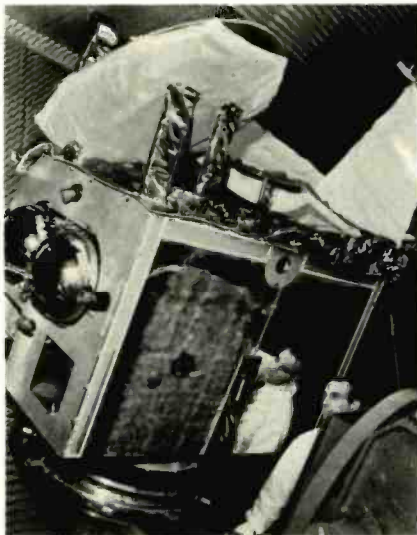

ANIK-B, a domestic communications satellite, has been constructed by RCA Astro-Electronics for Telesat Canada. It is the first such satellite to operate in the dual frequency bands of 6- and 4-GHz and 14- and 12-GHz. A Telesat engineer is shown here performing antenna pattern measurements. The mirrors are part of the thermal system that keeps the spacecraft at cool operating temperatures.

Bell Labs scientists win 1978 Nobel Physics Prize

Bell Labs scientists Dr. Arno A. Penzias and Dr. Robert W. Wilson received the 1978 Nobel Prize in Physics jointly with Professor Piotr Kapitsa of the Moscow Academy of Sciences (Prof. Kapitsa received his award for his work in low-temperature physics).

Drs. Penzias and Wilson won their shared prize for their work in cosmic microwave background radiation. As early as 1964, when they were using a Bell Labs antenna to search for radio noise sources that were interfering with satellite communications, they discovered a faint pervasive radio signal that remained steady round the clock, season to season—an unusual

and unique phenomenon. After eliminating possible sources of the signal (such as the Milky Way, the sun, poorly fitted antenna joints, even nesting pigeons!), the conclusion became inescapable—the signal was the result of the radiation still remaining after the big bang that had created the universe approximately 2 billion years ago. Their conclusions were verified by Professor Robert H. Dicke of Princeton who had been conducting similar studies.

Although the "Big Bang" theory had been known to astro-physicists for a long time, up until Penzias and Wilson's discovery of the background radiation, the theory had never been satisfactorily verified. When the two physicists (along with Prof. Dicke and his co-workers independently) published their results, their discovery was finally understood to be a major breakthrough in understanding the origins of the universe.

Videocassette exchange service available

Owners of Beta and VHS 1/2-inch format VCR's can avail themselves of the services provided by the Video Cassette Exchange Division of Discotronics Inc., New Jersey, in which customers can either buy or exchange videocassettes at greatly reduced rates.

The 1979 catalog lists approximately 600 prerecorded film titles, some of which have never been seen on TV. The company also offers trade-in privileges that are similar to those of a rental library. And, for convenience, they also provide a nationwide home pickup service for a small charge. For more information, contact Robert Edwards, Discotronics Inc., 50 North Main Street, Cranbury, NJ 08512.

New communication service proposed by radio amateur group

In 1977 amateur radio operators of WA2RPC (Center for Advanced Study in Education, Graduate School of CUNY, New York City) filed a petition with W2KPKQ, requesting the implementation of a community service that would use the communicating concept to broadcast messages on UHF channels.

Communicating uses a low-power community-based repeater station that can transmit audio and video signals up to a 30-mile radius, using a high antenna. The repeater station receives signals from different areas of the community and then transmits them via any unused UHF TV channel. The petitioning group additionally requested that low-power facilities be exempt from the usual rigid broadcast standards in an effort to keep costs down.

Praising the communicating concept, the FCC has stated that: "The petition and comments by others suggest an imagina-

tive and potentially beneficial public service television concept . . . an activity that deserves considerable attention in the overall inquiry."

Swiss watch firm designs microminiature DMM

Heuer Time & Electronics, Inc., watch and timepiece manufacturer, has taken the plunge into the world of microelectronic instrumentation by designing what it calls "the world's smallest digital multimeter," using the company's experience in microminiaturizing watches.

The *model DM 2000* meter (displayed for the first time at Newcom '78, Las Vegas) weighs less than 3 oz., including probe and

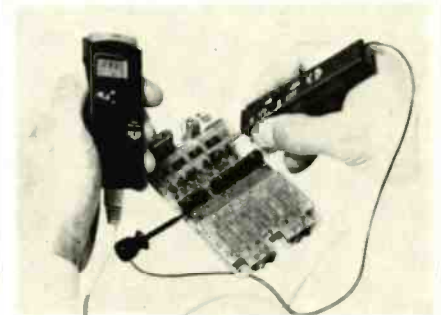

MICROMINIATURE DIGITAL MULTIMETER provides multiple ranges, modern microminiaturization techniques, remote-control probe, LCD readout and high reliability. The instrument weighs less than 3 oz., including probes and batteries.

batteries, and (minus probe) measures only 4 × 0.78 × 0.47 inches. In addition to its four measurement range capability—to 1000 DC, 700 VAC, AC/DC current to 2 amperes, and resistance to 20 megohms—two major technical features lie in its true AC RMS measurement and complete RF shielding. It also provides up to 100-hour battery life, an error-free LCD display (due to its remote-control probe), plus great reliability for field-service applications where accuracy and portability can be vital.

The *model DM 2000* is expected to sell for \$450. For further information, write Hans J. Kueffer, Heuer Time & Electronics, 960 South Springfield Avenue, Springfield, NJ 07081.

Newsflash!

As we're about to go to press, we've received word that Texas Instruments has received type-approval from the FCC on a computer that connects to the antenna terminals of a TV receiver. Could it be that Texas Instruments will be entering the home computer market? Formal introduction of this new device is scheduled to take place at the Consumer Electronics Show,

continued on page 12

new design... new features...unique, time-tested principle!

Weller® controlled output soldering station

Model WTCPN. New convenience-features. Striking contemporary appearance. Completely new design. Now more than ever in a class by itself. Only Weller's advanced engineering could have improved on its own predecessor WTCPL Station, popular standard of the electronics industry.

- new heat shield for cool operator comfort
- new plug-in iron design for zero down-time
- new integral tip-storage tray
- new larger sponge for easier tip cleaning
- improved, unitized rocker switch and neon indicator light
- new impact-resistant case

And add to these new features Weller's unique, proven, closed-loop, low-voltage circuit, with its "interchangeable brains" in the tip . . . a ferromagnetic sensor that controls the temperature at 600, 700, or 800°F., protecting sensitive workpieces. To change temperatures, simply change tips with knurled thumb-screw. More than 50 options in configuration, tip size, reach, and temperature! Exclusive-process triple-plating prevents tip oxidation and "freezing".

With all these new features and exclusive principles, Model WTCPN is still all function . . . no frills! It's UL-listed and OSHA-compliant, of course. And now it's available at leading electronic distributors . . . coast-to-coast. See it there. For technical information, write on your letterhead.



The Cooper Group
Electronics Division

WELLER® • WISS® • XCELITE®

P.O. BOX 728, APEX, NORTH CAROLINA 27502. 919/362-7511

CIRCLE 41 ON FREE INFORMATION CARD

Everybody's making money selling microcomputers. Somebody's going to make money servicing them.

New NRI Home Study Course Shows You How to Make Money Servicing, Repairing,
and Programming Personal and Small Business Computers



Seems like every time you turn around, somebody comes along with a new computer for home or business use. And what's made it all possible is the amazing microprocessor, the tiny little chip that's a computer in itself.

Using this new technology, the industry is offering compact, affordable computers that will handle things like payrolls, billing, inventory, and other jobs for businesses of every size...perform household functions including budgeting, environmental systems control, indexing recipes, and more. And thousands of hobbyists are already owners, experimenting and developing their own programs.

Growing Demand for Computer Technicians

This is only one of the growth factors influencing the increasing opportunities for qualified computer technicians. The U.S. Department of Labor projects over a 100% increase in job openings for the decade through 1985. Most of them *new* jobs created by the expanding world of the computer.

Learn at Home in Your Spare Time

NRI can train you for this exciting, rewarding field. Train you at home to service not only microcomputers, but their larger brothers, too. Train you at your convenience, with clearly written "bite-size" lessons that you do evenings or weekends, without going to classes or quitting your present job.

Assemble Your Own Microcomputer

NRI training goes far beyond theory. It includes practical experience, too. As you progress, you perform meaningful experiments building and studying electronic circuits on the NRI Discovery Lab.[®] You assemble test instruments that include a transistorized volt-ohm meter and a CMOS digital frequency counter...instruments you learn on, use later in your work.



And you build your own microcomputer. Each step of construction advances your knowledge, gives you deeper insights into this amazing world that's upon us.

This is the only microcomputer designed for learning. It looks, operates, and performs just like the finest of its kind...actually does more than many commercial units. But NRI engineers have designed components and planned the assembly procedure so it demonstrates important principles, gives you working experience in detecting and correcting problems.

And that's what NRI training is all about.

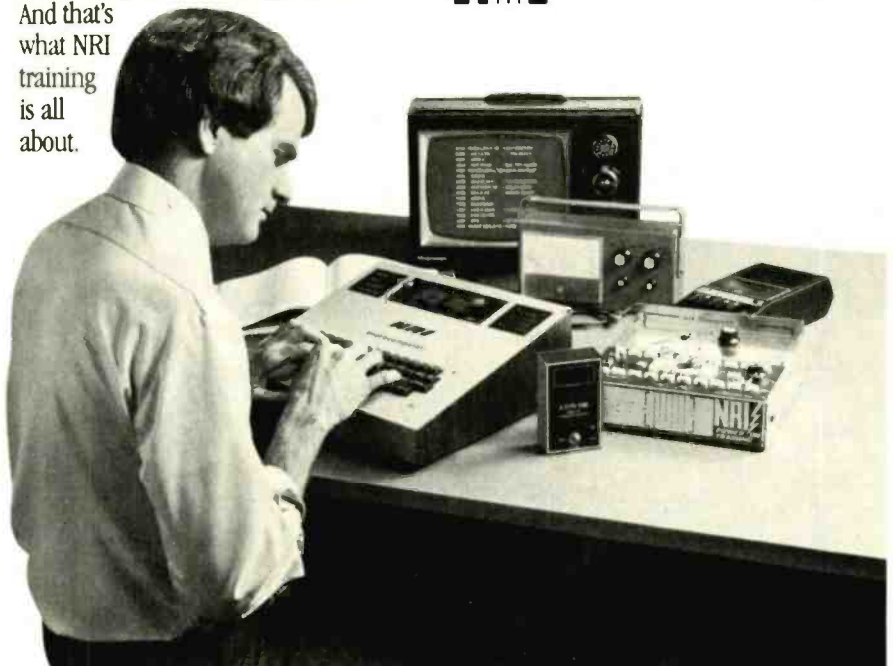

Other Opportunities in Electronics

Since 1914, before commercial radio was even on the air, NRI has been the way to learn new electronics skills. Today's modern offerings include, in addition to three different computer courses, TV/Audio/Video Systems Servicing, with training on the only designed-for-learning 25" diagonal color TV, with state-of-the-art computer programming. Or, check out our Complete Communications Course, preparing you to enter this booming field servicing, installing, and repairing equipment like microwave, broadcast, CB, shortwave radio, paging, radar, and more.

Mail Postage-Paid Card for Free Catalog No Salesman Will Call

Send today for your free copy of our 100-page, full-color catalog. It describes all of our electronics courses in detail, showing kits, equipment, and lesson plans. Look it over at your convenience, then decide how NRI can help you make the most of your talents. There's no obligation and no salesman will ever call or bother you. With more than a million students and unmatched experience in home training, NRI gives you the most in training for new opportunity! If card has been removed, write to:



NRI Schools
McGraw-Hill Continuing
Education Center
3939 Wisconsin Avenue
Washington, D.C. 20016

continued from page 6

which will be held in Las Vegas on January 6-9.

We have also learned that Atari is preparing to introduce a BASIC interpreter for their programmable video game. This will also be introduced at CES.

Admiral TV production is discontinued

Rockwell International Corporation recently announced that it would discontinue all its Admiral TV products. Admiral marketing activities are currently being phased out, and, once current commitments are fulfilled, all production will cease at the Harvard, IL, and Taiwan plants.

Charles Fazio, president of Rockwell's consumer operations, has emphasized that the company would continue to provide warranties, service and spare parts support; and added that the phasing out of its TV production would enable Rockwell to concentrate its efforts on its ongoing appliance business and other operations.

The reason given for discontinuing the Admiral TV line was "intense price competition, particularly from Japanese sources," which the company felt did not justify any additional outlay of its resources.

Two-layer solar cell provides 28% conversion to electricity

Varian Associates, Inc., of Palo Alto (under contract to the Department of Energy's Scandia Labs) has developed a prototype solar cell system that converts 28.5% of the sun's rays to electricity.

The Varian system uses two different cells—an aluminum gallium arsenide (AlGaAs) cell and a silicon cell—to perform the conversion. A special filter between the cells separates solar radiation into long and short wavelengths; it permits the longer rays to penetrate the silicon cell, while allowing the shorter rays to pass through into the AlGaAs cell. This effect is achieved by using a concave mirror to focus the solar energy onto the filter. The AlGaAs cell converts 17.4% of the rays to electricity, while the silicon cell converts 11.1% of the rays.

Sandia Labs supervisor Dr. Donald G. Schueler predicts that by 1986, photovoltaic systems "will produce electricity for \$1 per-peak-watt of installed capacity, or from 6¢ to 8¢ per kilowatt-hour."

Sprague and Johnson receive EIA awards

During its fall 1978 conference, the Electronic Industries Association voted to award the EIA Medal of Honor to Robert C. Sprague, Sr., for his devotion and long years of service to the Association and the electronic industry. Among Mr. Sprague's most recent accomplishments are his efforts to revise the Custom Penalty Laws to

remove unfair penalty provisions for the industry. Active for many years in EIA, he was a member of the Board of Governors since 1943 and board chairman from 1950-1954. This is the second time Mr. Sprague has won the EIA Medal of Honor, the first having been 25 years ago. The presentation will be made at EIA's spring 1979 meeting.

At the same conference, Raymond E. Johnson, EIA general counsel, received the EIA Distinguished Service Award, the first staff member to be so honored. Mr. Johnson has served as EIA general counsel since 1970 and was elected corporate secretary in 1972. He received his award for his years of distinguished service to EIA and his involvement in the Association on all levels.

RCA electron gun sharpens color TV pictures

RCA Laboratories and the technical staff of the RCA Picture Tube Division have developed a device that is used to create sharper color television pictures. This latest

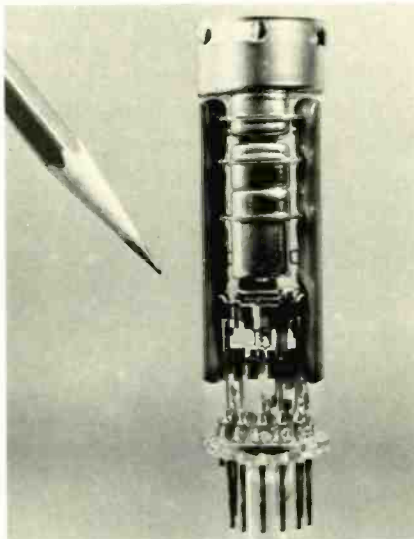

IMPROVED ELECTRON GUN developed by RCA Picture Tube Division can be used in all sizes of color TV tubes to create sharper pictures.

development is a new kind of electron gun that "shoots" invisible beams at color phosphors on the picture tube face. The result is improved focus and, thus, sharper pictures. The gun, which is now in commercial production, can be used on any size picture tube.

The results of this joint effort were presented in a paper delivered at the annual Chicago Fall Conference on Consumer Electronics by Picture Tube Division engineers Richard H. Hughes and Jim Y. Chen.

Metal-tape standards surveyed at ITA meeting

Representatives of companies manufacturing record and playback equipment, audio tape, duplicating equipment and ferric oxide attended a late 1978 meeting of the Audio Technical Executive Committee of the International Tape Association (ITA), to discuss industry-wide standardization of metal audio cassette tape.

However, because record/playback and erase heads are still not standardized, the committee could not come to any firm decision about standards for metal tape. Several companies, however, stated their readiness to enter the metal-tape market.

Among these were 3M Company, which already introduced their metal-particle *Metafine* tape, and Sharp Electronics with its prototype metal-tape recorder. Panasonic is presently developing metal-tape cassette decks and a duplicator for 1/2-inch VHS videocassettes. Fuji and 3M together are working on high-energy contact duplication of metal-particle videotape. BASF plans to introduce its metal-tape product at the 1979 Berlin Fair. Other companies continuing their R & D activities are Ampex, Maxell, Sony and TDK. Oxide supplier Hercules, Inc., said it would be producing metal-tape particles in quantity by 1979.

FCC asks, should TV sets be graded?

The Federal Communications Commission has started an inquiry to determine whether it should set up a system for grading TV receivers, since it feels that customers do not presently have enough information to help them select the best TV's and antennas for their needs. Here are some of the questions the FCC is asking:

1. If the consumer wants more information on TV systems, what kinds of data should be made available, how should it be presented and would it really improve one's ability to select a set? Should the equipment have a permanent label affixed? Should there be a brochure enclosed with each set? A letter-grading system, or a descriptive grade system (i.e., "excellent," "good," etc.)?

2. Some TV sets experience "snow" on the picture screen that is the result of noise. Should TV receivers show the maximum noise value for that set? How should this be presented to the public?

3. Should each purchased set contain more installation and operating instructions than are presently provided?

Deadline for filing comments with the FCC is February 1, 1979. The docket number is Gen. Doc. 78-307, and for a copy of the notice, write Consumer Assistance Office, Federal Communications Commission, Washington, DC 20554. **R-E**

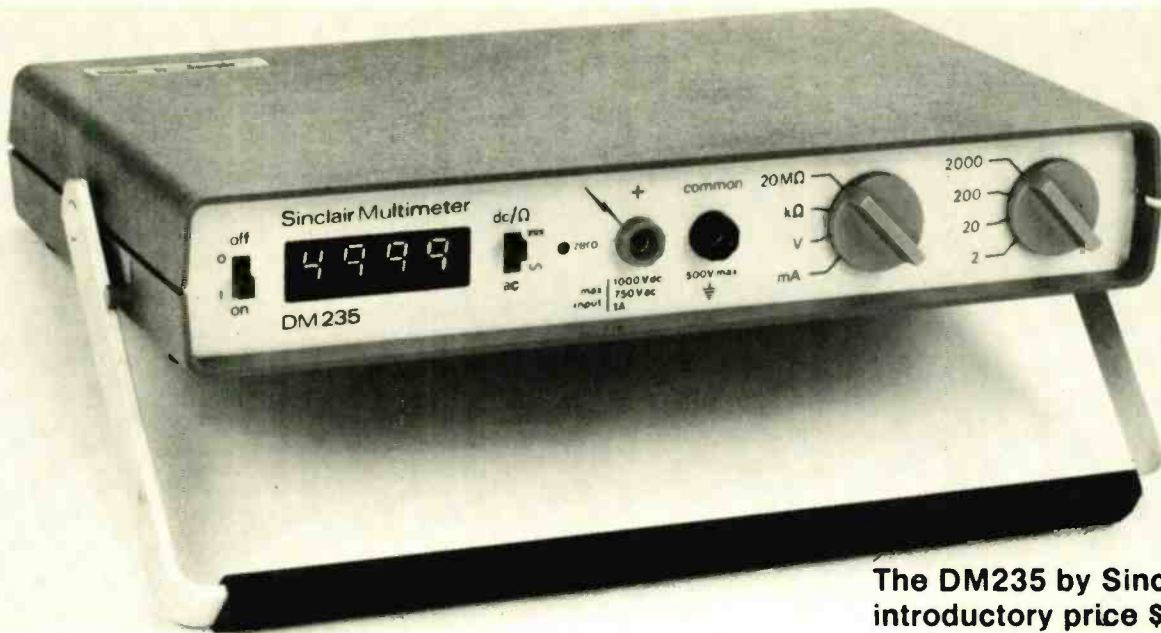

The DM235 by Sinclair
introductory price \$89.95.

Full Performance, "Portable/Benchtop" Digital Multimeter!

Sinclair's new DM235. The best digital meter value in the world at \$89.95!

The Sinclair DM235 provides full facilities for every application, including field servicing, testing and laboratory work, at a price no other digital multimeter can approach.

High accuracy, resolution and input impedance are combined with a large, wide-angle LED display to provide quick, clear, unambiguous readings wherever you use it.

Automatic polarity selection, simple clear controls and the use of a single input terminal pair for all functions, provide for maximum convenience in operation.

The DM235 measures DC \equiv and AC \sim volts, DC \equiv and AC \sim current, and resistance in a total of 21 ranges (with an additional 5 diode test ranges), giving it the versatility to tackle any job.

The display is a full $3\frac{1}{2}$ digits reading to ± 1999 . Large, high brightness 8mm LEDs give clear, unambiguous readings with an ultra wide angle of view. And an LED display means proven life-time reliability.

The Sinclair DM235 is fully portable and has complete independence of AC line via operation from four C size (R14) cells. Alternatively, where continuous operation on the bench is required, an optional AC adaptor/charger is available. To increase flexibility still further, a rechargeable battery pack and an ever-ready carrying case with neck strap are also available as options, as is a 30kV probe.

A sensible new concept in meter design for use on the bench or in the field!

Up till now, choosing a meter suitable for use on the bench and in the field hasn't been easy. Either you bought a bulky, bench instrument that was awkward to carry around, or a hand-held portable that was difficult to use on the bench. The Sinclair concept is different — by keeping the thickness down to only a fraction over $1\frac{1}{2}$ " (40mm) and the weight down to under $1\frac{1}{2}$ lbs (650gms), we've produced an instrument that has all the advantages of conventional bench meters, but packs neatly into any tool kit or brief case.

• Fully protected • Accuracy is quoted as a percentage of reading • Resistance ranges provide a diode test facility at 5 decade steps of current • Automatic overrange indication by horizontal bars • Automatic decimal point placement • Facility for battery condition test

• Reading rate $2\frac{1}{2}$ per second • Temperature coefficient $<0.05/\text{°C}$ of applicable accuracy specification • Dimensions $10" \times 5.8" \times 1.6"$ ($255 \times 148 \times 40\text{mm}$) • Weight less than $1\frac{1}{2}$ lbs (640gms)

Features you'd expect to pay \$200 or more for:

• Lightweight, but extremely rugged cyclac case (stackable) • Large, bright, wide angle LED display reading to ± 1999 • Automatic polarity selection • Industry standard $10\text{M}\Omega$ input impedance 0.5% of reading basic accuracy • Full multimeter facilities including AC \sim current • Resistance measurement up to $20\text{M}\Omega$ • Direct reading of semi-conductor forward voltages at 5 different currents • Simple, unambiguous controls with readings always in volts, mA or $\text{K}\Omega$ • Selection of all functions from a single input terminal pair • Automatic decimal point placement • Automatic overrange indication • Operation from disposable or rechargeable cells, or from AC adaptor/charger • 1 year over-the-counter service policy • $3\frac{1}{2}$ digit resolution

The Sinclair DM235 at \$89.95 has all the features you'll most likely ever need. There is no reason to pay more, whether your application is to outfit a team of engineers, or for the hobbyist. It is fully protected, amazingly rugged (drop it without damage), lightweight, stackable...the advantages go on and on. And with Sinclair's innovative "Portable Benchtop" design, the DM235 is truly the only meter you'll ever need whether you are in the shop, on the road, or at work in the field.

A background of experience

It is part of a new range of instrumentation based on 'state-of-the-art' circuit design and complements an impressive record of electronic world firsts — from programmable pocket calculators to miniature T.V.s — where Sinclair has held a world lead through innovative electronics.

Supplied Complete with test leads and prods, and operator's instruction manual

Try the Sinclair DM235 for 2 weeks — No obligation.

Call toll free: 1-800-235-6945.
Calif. res. call: 805-966-7187.

Or send coupon:

Starshine Group.

924 Anacapa St., Dept. 636, Santa Barbara, CA 93101

Please promptly ship _____ Sinclair DM235 Digital Multimeter(s) @ \$89.95 ea. (plus \$3.95 shipping and insurance). If not completely satisfied I can return it within 2 weeks of receipt for a courteous, quick refund.

Also send the following optional accessories:

AC adaptor/charger @ \$8.95 ea.

Rechargeable battery pack @ \$19.95 ea. (Must be used with AC adaptor/charger).

Heavy duty carrying case @ \$29.95 ea.

30kV High voltage probe @ \$29.95 ea.

Check or money order enclosed (CA res. add 6% sales tax).

Charge my credit card number below.

BankAmericard/Visa Master Charge (interbank no. _____)

Diners Club Carte Blanche American Express

Credit Card No. _____ Exp. Date _____

Name _____

Address _____

City/State/Zip _____

Signature _____



COMMUNICATIONS RECEIVER BREAKTHROUGH

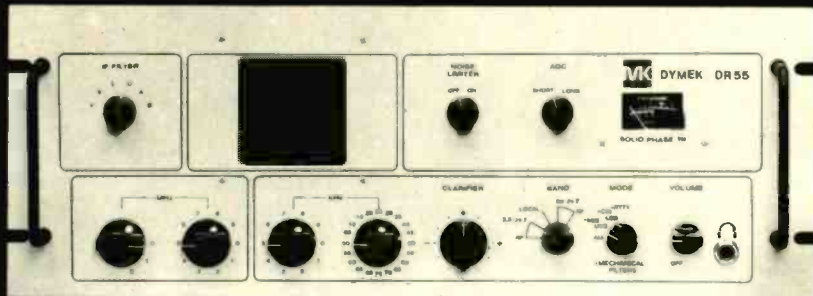

A FULLY SYNTHESIZED GENERAL COVERAGE RECEIVER AT AN ECONOMICAL PRICE

McKay Dymek brings you a fully synthesized general coverage receiver for less than you'd expect to pay for a single channel, single mode unit. The DR 55 is an economical solution to the need for WWV monitors for time and frequency calibration, back up capability for main receivers, and point to point communications receivers for industrial, governmental and marine uses.

Fully synthesized general coverage (50kHz to 29.7 MHz continuous)

Digital Phase Locked Loop synthesis is used providing quick, accurate and quartz crystal stable tuning at all frequencies.

A High Level RF front end design using CATV RF power transistors and a double balanced diode mixer followed by a crystal filter provides immunity from intermodulation and crossmodulation interference without the need for antenna preselector adjustments under normal conditions. (Matching DP 4044 passive RF Preselector available for use near transmitters).

Class D AM envelope detection is used providing less than 1.5% T.H.D. at 90% modulation.

Automatically adjusting threshold peak noise limiters enhance reception on both AM and SSB-CW-RTTY modes during conditions of impulse noise interference.

Any channel can be selected in seconds using the rotary synthesizer programming switches. This extreme simplicity of operation allows frequency changes in a fraction of the time required with conventional mechanically tuned receivers.

Ceramic filters are provided as the standard final selectivity element with optional Collins mechanical filters for Upper and Lower SSB, CW and RTTY.



McKay Dymek Co.
111 South College Ave.
PO Box 5000
Claremont CA 91711

**30 DAY
FREE TRIAL**
(Applies in U.S. only)

For more information
Call or Write today.
800/854-7769
Calif. 800/472-1783

CIRCLE 52 ON FREE INFORMATION CARD

HELP US FIGHT FOR YOUR LIFE

Have Your Blood Pressure Checked

American Heart Association 
We're Fighting For Your Life

Radio-Electronics®

Hugo Gernsback (1884-1967) founder

M. Harvey Gernsback, editor-in-chief and publisher

Larry Steckler, KTX-3644, CET, editor

Arthur Kleiman, KTZ-3288,
managing editor

Robert F. Scott, CET, W2PWG,
KXX-8533, technical editor

Sonia Greenbaum, copy editor

Jack Darr, CET service editor

Leonard Feldman
contributing high-fidelity editor

Karl Savon, semiconductor editor

David Lachenbruch, contributing editor

Earl "Doc" Savage, K4SDS, hobby editor

Vincent P. Cicenja, production manager

Barbara Fenimore, production assistant

Harriet I. Matysko, circulation director

Arline R. Bailey, advertising coordinator

Cover design by Louis G. Rubsamem

Cover photo by Mel Small

Radio Electronics is a member of the *Institute of High Fidelity* and is indexed in *Applied Science & Technology Index* and *Readers Guide to Periodical Literature*.

Gernsback Publications, Inc.
200 Park Ave. S., New York, NY 10003
(212) 777-6400

President: M. Harvey Gernsback
Vice President: Larry Steckler
Treasurer: Carol A. Gernsback
Secretary: Bertina Baer

ADVERTISING SALES

Paul McGinnis
Director of Marketing

EAST

Stanley Levitan
Radio-Electronics
200 Park Ave. South
New York, NY 10003
(212) 777-6400

MIDWEST/Texas/Arkansas/Okla.

Ralph Bergen
The Ralph Bergen Co.
540 Frontage Road—Suite 361-A
Northfield, Illinois 60093
(312) 446-1444

PACIFIC COAST

Mountain States
Jay Eisenberg
J.E. Publishers Representative Co.,
8732 Sunset Blvd.,
4th Floor,
Los Angeles, CA 90069
(213) 659-3810
Sales Mart Building
1485 Bayshore Blvd., Box 140
San Francisco, CA 94124
(415) 467-0125



SAVE \$25.00

Model 8100 Frequency Counter Kit

- Range: 20Hz to 100MHz
- High Sensitivity
- Resolution to 0.1Hz

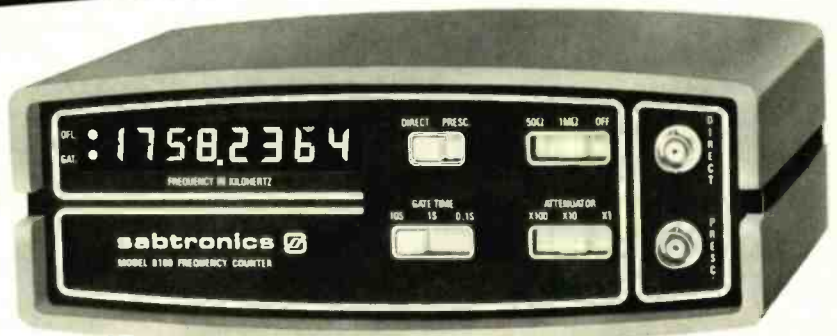

Now you can forget about price/performance trade-offs when you select a frequency counter. In Sabtronics' Model 8100 kit you get all the characteristics of superior performance at a low, affordable price.

This frequency counter, employing LSI technology, has the performance and input characteristics you demand: guaranteed frequency range of 20Hz to 100MHz (10 Hz to 120MHz typical); selectable hi/lo impedance; superior sensitivity; selectable resolution and selectable attenuation. Plus an accurate time base with excellent stability.

An 8-digit LED display features gate activity indicator, leading zero suppression and overflow indicator. You would expect to find all these features only on high-priced instruments — or from Sabtronics' advanced digital technology.

BRIEF SPECIFICATIONS:

- Frequency Range: 20Hz to 100MHz guaranteed. (10Hz to 120MHz typical)
- Sensitivity: 15mV RMS, 20Hz to 50MHz (10mV typical); 25mV RMS, 50MHz to 100MHz (20mV typical)
- Selectable Impedance: 1MΩ / 25pF or 50Ω
- Attenuation: X1, X10 or X100
- Accuracy: ± 1Hz plus time base accuracy
- Aging Rate: ± 5ppm/yr.
- Temperature Stability: ± 10ppm, 0°C to 40°C
- Resolution: 0.1Hz, 1Hz, 10Hz selectable
- Display: 8-digit LED, overflow indicator, gate activity indicator
- Overload Protection
- Power Requirement: 9-15 VDC @ 330mA



Model 2000, 3½ Digit DMM Kit

- 5 Functions, 28 Ranges
- Basic DCV Accuracy: 0.1% ± 1 Digit

The amazing Sabtronics 2000 is the choice of both professionals and hobbyists. It's the only portable/bench DMM that offers so much performance for such an astonishing low price.

You get basic DCV accuracy of 0.1% ± 1 digit; 5 functions giving 28 ranges; readings to ± 1999 with 100% overrange; overrange indication; input overload protection; automatic polarity; and automatic zeroing.

The all-solid-state Model 2000 incorporates a single LSI circuit and high-quality components. Our clear, step-by-step manual simplifies assembly. Complete kit includes a rugged high-impact case ideal for both test-bench and field use.

BRIEF SPECIFICATIONS:

- DC volts in 5 ranges: 100 µV to 1kV
- AC volts in 5 ranges: 100 µV to 1kV
- DC current in 6 ranges: 100 nA to 2A
- AC current in 6 ranges: 100 nA to 2A
- Resistance: 0.1Ω to 20MΩ in 6 ranges
- AC frequency response: 40 Hz to 50kHz
- Display: 0.36" (9.1mm) 7-segment LED
- Input Impedance: 10MΩ
- Size: 8"W x 6.5"D x 3"H (203 x 165 x 76 mm)
- Power requirement: 4.5-6.5 VDC · 4 "C" cells (not included).

Special Offer! Save \$25.00*

If you order both the frequency counter and DMM kits now, you pay only \$144.90 including shipping and handling. You save \$25.00 off the combined regular low price of \$169.90. Order both kits now. This special offer good for a limited time only.

*Special offer good in USA only.

Making performance affordable.

sabtronics

13426 Floyd Circle · Dallas, Texas 75243
Telephone 214/783-0994

Special offer expires January 31, 1979

Sabtronics International Inc. 13426 Floyd Circle Dallas Tx 75243		RE-2
<input type="checkbox"/> Yes, I want to take advantage of your special \$25.00-off offer.*		
Please send _____ Model 8100 and Model 2000 kit(s) for only \$144.90 total including shipping and handling		
Please send _____ Model 8100 Frequency Counter kit(s)	@ \$89.95 ea.	\$ _____
Shipping and handling	\$ 5.00/unit*	\$ _____
Please send _____ Model 2000 DMM kit(s)	@ \$69.95 ea.	\$ _____
Shipping and handling	\$ 5.00/unit*	\$ _____
Texas residents add sales tax		\$ _____
Total enclosed		\$ _____
<input type="checkbox"/> Check <input type="checkbox"/> Money Order <input type="checkbox"/> Charge my Master Charge <input type="checkbox"/> Visa		
Acc. No. _____		Exp. Dt. _____
Name _____		
Address _____		
City _____	State _____	Zip _____
*USA only. CANADA: \$6.50. FOREIGN: \$19.00 AIRMAIL.		

letters

THE TERM "BAUD" EXPLAINED

The article entitled "Digital Data Transmission—How A Computer Communicates" (May 1978 issue) provides a highly readable introduction to the subject that many novice computer enthusiasts will find

00 01 10 11 10 10 01 00

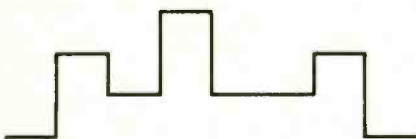

enlightening. However, the author commits a "technical foul" in making the unqualified statement that the term "baud" is used interchangeably with the term "bits-per-second."

The term baud means the number of times-per-second the line condition changes. If the line condition represents

the presence or absence of a *single* bit (as in two-state signaling), then the signaling speed in bauds is the same as bits-per-second. If, however, the signaling is not two-state, then bauds are *not* equal to bits-per-second. The latter condition exists, for instance, in "di-bit" or four-state signaling (see diagram), in which the baud rate is equivalent to the number of bits-per-second times two.

This explanation is an adaptation from *Introduction to Teleprocessing* by James Martin, a reference I recommend for those interested in further exploring the subject of digital data transmission.

MARVINO A. HILL
Los Angeles, CA

THE FUTURE OF ELECTRONICS

This is in answer to your September 1978 editorial in which you invited readers to send in their look at the future of electronics. Your No. 4 idea is not at all far out. At the very least, should gravity prove to be

meta- or parapsychical, control of the successful anti-gravity device will almost certainly be electronic in nature.

Electronics touches all fields of activity, even if remotely. Thus, all one has to do is just settle back and enter the light-trance state to foresee some very likely developments in coming decades. Whatever they may be, electronics will play a major part in their initiation, development, production, use and, yes, even in their eventual obsolescence. Here are my "predictions":

Transportation: In but half a century we have seen a transition from the horse to 500-passenger aircraft; the motor car has changed our life so drastically that should we run out of fuel our society as we know it would die like the dinosaurs; and the locomotive has been relegated to hauling freight. And still the insatiable appetite for travel expands.

One mode of transportation will revolutionize public, private and personal trans-
continued on page 23

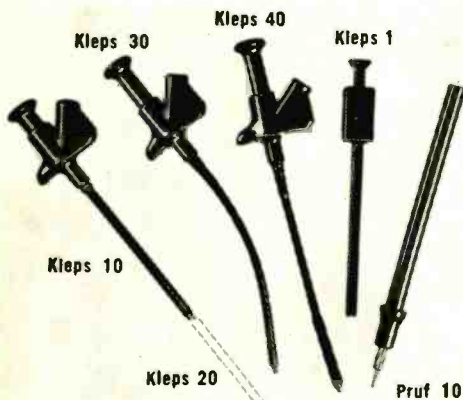

Clever Kleps

Test probes designed by your needs—Push to seize, push to release (all Kleps spring loaded).

- Kleps 10.** Boathook clamp grips wires, lugs, terminals. Accepts banana plug or bare wire lead. 4 3/4" long. **\$1.59**
- Kleps 20.** Same, but 7" long. **\$1.69**
- Kleps 30.** Completely flexible. Forked-tongue gripper. Accepts banana plug or bare lead. 6" long. **\$1.99**
- Kleps 40.** Completely flexible. 3-segment automatic collet firmly grips wire ends, PC-board terminals, connector pins. Accepts banana plug or plain wire. 6 1/4" long. **\$2.89**
- Kleps 1.** Economy Kleps for light line work (not lab quality). Meshing claws. 4 1/2" long. **\$1.09**
- Pruf 10.** Versatile test prod. Solder connection. Molded phenolic. Doubles as scribing tool. "Bunch" pin fits banana jack. Phone tip. 5 1/2" long. **\$.99**

All in red or black - specify. (Add 50¢ postage and handling). Write for complete catalog of - test probes, plugs, sockets, connectors, earphones, headsets, miniature components.

Available through your local distributor, or write to:

RYE INDUSTRIES INC.
127 Spencer Place, Mamaroneck, N.Y. 10543
In Canada: Rye Industries (Canada) Ltd.

CIRCLE 22 ON FREE INFORMATION CARD

Where's the screwdriver?



In a tool box, tools and parts are everywhere. They're hard to find. They get lost. (And they get dirty.)

With a Platt tool case, that wouldn't happen. It's designed so you'll know where everything is. Smaller tools are in individual pockets in our patented one-piece pallet. Larger tools and parts are in compartments. And papers and order book are in lid pockets. (Everything is neat and clean.)

And Platt's tool case helps you look more professional. It comes in handsome, lightweight, durable ABS Thermoplastic. Or rich looking vinyl reinforced by ABS Thermoplastic. What's more, it also has a 5 year guarantee.

Contact us for complete information on Platt's full line of tool cases and your nearest distributor.

Pat. No. 3,880,285

Cases for business and industry.

2301 S. Prairie Ave., Chicago, Ill. 60616 (312) 225-6670

platt



CIRCLE 61 ON FREE INFORMATION CARD

LX303

ALL THE MOST WANTED FEATURES AT A MOST WANTED PRICE...

BIG 1/2" HIGH LCD DISPLAY
USE INDOORS OR OUT
200 HOUR 9V BATTERY LIFE
AUTO ZERO, POLARITY,
OVERRANGE INDICATION
100 mV DC F.S. SENSITIVITY
19 RANGES AND FUNCTIONS



Removable cover stores test lead set furnished as part of the unit.



Available accessories include AC adapter, padded vinyl carrying case, 40KV DC probe, 10 Amp DC shunt.



X10 DCV probe adapter available for protecting input up to 10KV.



\$74.95

HICKOK

Here is the handful of accuracy you've been waiting for. Handsomely encased. Compact. Efficient. Only 8 ounces. Hickok's exciting, new LX 303, 3 1/2 digit Mini-Multimeter with high quality components, one year guarantee and rugged Cyclocac® case offers features previously found only in expensive units... at a price under \$75.00!

So why wait any longer? The amazing LX 303 is here, NOW! Another American made test equipment breakthrough from Hickok, The Value Innovator. Order today!

See your local Hickok distributor or order below

SPECIFICATIONS:

DC VOLTS (5 RANGES): 0.1mV to 1000V; Accuracy $\pm 0.5\%$ rdg $\pm 0.5\%$ f.s.; Input impec: 10M Ω ; Max. input 1kV except 500V on 200mV range.

AC VOLTS (40Hz to 5kHz): 0.1V to 600V; Accuracy: $\pm 1.0\%$ rdg $\pm 0.5\%$ f.s. (-2dB max. at 5kHz); Max. input: 60CV.

RESISTANCE (6 LOW POWER RANGES): 0.1 Ω to 20M Ω ; Accuracy: $\pm 0.5\%$ rdg $\pm 0.5\%$ f.s. ($\pm 1.5\%$ rdg on 20M Ω range); input protected to 120VAC all ranges.

DC CURRENT (6 RANGES): .01mA to 100mA; Accuracy: $\pm 1.0\%$ rdg $\pm 0.5\%$ f.s.

DIMENSIONS AND WEIGHT: 5-7/8" x 3-3/8" x 1-3/4", 8 oz.; **POWER:** 9V battery (not included) or Hickok AC adapter; **READ RATE:** 3/sec.

ADVANCE ELECTRONICS

TO ORDER CALL TOLL FREE
800-223-0474

34 West 45th Street, New York, N.Y. 10035 212-687-2224



PLEASE SEND ME

_____ Hickok LX303 Digital Multimeters @ 74.95 ea.
 _____ RC-3 AC Adapter, 115VAC (220VAC avail.) @ 7.50 ea.
 _____ CC-3 Deluxe Carrying Case @ 7.50 ea.
 _____ VP-10 X10 DCV Probe Adapter @ 14.95 ea.
 _____ CS-1 10A DC Current Shunt @ 14.95 ea.
 _____ VP-40 40 KV DC Probe @ 35.00 ea.

Payment encl. Bill my: Master Charge VISA

Account # _____ Exp. Date _____

Name _____

Address _____

City _____ State _____ Zip _____

Add \$3.00 Postage and Handling, N.Y. residents add sales tax.

You gotta shop around.

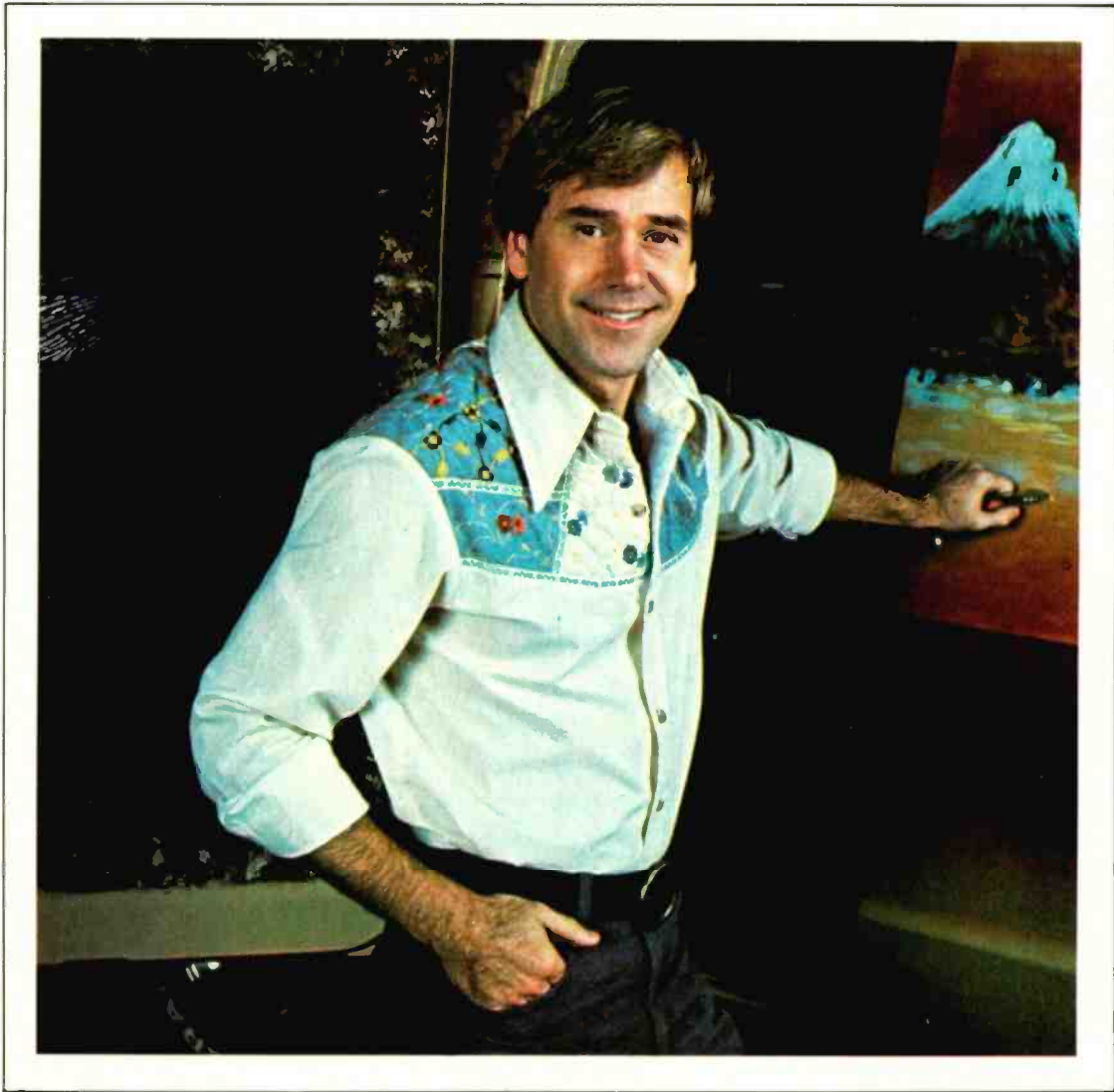

**When you do, you'll probably pick CIE.
You can't afford to settle for
less when it comes to something like
electronics training that could
affect your whole life.**

When you shop around for tires, you look for a bargain. After all, if it's the same brand, better price — why not save money?

Education's different. There's no such thing as "same brand." No two schools are alike. And, once you've made your choice, the training you get stays with you for the rest of your life.

So, shop around for your training. Not for the bargain. For the best. Thorough, professional training to help give you pride and confidence.

* * *

If you talked to some of our graduates, chances are you'd find a lot of them shopped around for their training. They pretty much knew what was available. And they picked CIE as number one.

Why you should shop around yourself.

We hope you'll shop around. Because, frankly, CIE isn't for everyone.

There are other options for the hobbyist. If you're the ambitious type — with serious career goals in electronics — take a close look at what we've planned for you at CIE.

What you should look for first.

Part of what makes electronics so interesting is it's based on scientific discoveries — on ideas! So the first thing to look for is a program that starts with ideas and builds on them!

That's what happens with CIE's Auto-Programmed® Lessons. Each lesson takes one or two principles and helps you master them — before you start using them!

How practical is the training?

This is the next big important question. After all, your career will be built on what you can do — and on how well you do it.

Here are ways some of CIE's troubleshooting programs help you get your "hands-on" training...

With CIE's Experimental Electronics Laboratory...



you learn and review the basics — perform dozens of experiments. Plus, you use a 3-in-1 precision Multimeter to learn testing, checking, analyzing!



When you build your own 5 MHz Triggered-Sweep, Solid-State Oscilloscope you take your first real professional step. You use it as a doctor uses an X-ray machine — to "read" waveform patterns... lock them in... study, understand and interpret them!

When you get your Zenith 19-inch Diagonal Solid-State Color TV you



Pattern simulated.

apply your new skills to some real on-the-job-type troubleshooting! You learn to trace signal flow... locate malfunctions... restore perfect operating standards — just as with any sophisticated electronics equipment!



When you work with a completely Solid-State Color Bar Generator —

actually a TV signal transmitter — you study up to ten different patterns on your TV screen... explore digital logic circuits... observe the action of a crystal-controlled oscillator!

Of course, CIE offers a more advanced training program, too. But the main point is

simply this:

All this training takes effort. But you'll enjoy it. And it's a real plus for a troubleshooting career!

Do you prepare for your FCC License?

Avoid regrets later. Check this out before you enroll in any program.

For some troubleshooting jobs, you must have your FCC License. For others, employers often consider it a mark in your favor. Either way, it's government-certified proof of specific knowledge and skills!

More than half of CIE's courses prepare you for the government-administered FCC License exam. In continuing surveys, nearly 4 out of 5 CIE graduates who take the exam get their Licenses!

Shop around... but send for CIE's free school catalog first!

Mail the card. If it's gone, cut out and mail the coupon. If you prefer to write, mention the name and date of this magazine. We'll send you a copy of CIE's FREE school catalog — plus a complete package of independent home study information! For your convenience, we'll try to have a representative contact you to answer your questions. Mail the card or coupon — or write: CIE, 1776 East 17th St., Cleveland, OH 44114.

CIE Cleveland Institute of Electronics, Inc.

1776 East 17th Street, Cleveland, Ohio 44114
Accredited Member National Home Study Council

YES... I'm shopping around for the **right** kind of career training in electronics troubleshooting — and CIE sounds well worth looking into. Please send me my FREE CIE school catalog — including details about troubleshooting courses — plus my FREE package of home study information! **RE-57**

Print Name _____

Address _____ Apt. _____

City _____

State _____ Zip _____

Age _____ Phone _____ (area code)

Check box for G. I. Bill information:
 Veteran Active Duty

Mail today!

These new **Persuader™ Antennas** low profile, extra long whip deliver performance equal to, or better than anything else on the road!

There's a hand-wound, hand-tuned
coil in the cup...



a major advance in
antenna technology
from the Antenna Pros
field tested and
field proven by
thousands of CBers

Only \$34.98 suggested retail. Compare
with K-40 at \$38.50 or any other antenna. You'll see
there's no comparison.

5 year guarantee

Materials and workmanship of PERSUADER ANTENNAS
(Models 13505 & 17605) are guaranteed for a full five years
if this antenna is installed by the dealer and a full three years
if this antenna is installed by the consumer.

Any part that falls within the guarantee period will be replaced absolutely free
provided the registration card has been completely filled out and returned to
Antenna Incorporated.



A word from the Old Pro:

When you buy this antenna,
my reputation... built over 38 years in
the antenna business... will be riding on
your roof. I'm confident that the
Persuader Antennas will persuade you...
you've chosen the Best.

M.R. Friedberg, President
Antenna Incorporated

In stock at your dealer now...

or call the Antenna Hotline... 1-800-447-4700.
(Illinois: 800-332-4400; Sorry, no Hotline service in Alaska or Hawaii).



Charge to Visa or Master Charge... and we'll
have your nearest dealer ship your Persuader
Antenna promptly, in the mount and color of your choice. Hotline
orders add \$1.50 for shipping and handling. Applicable local
taxes extra. Allow 2 to 4 weeks for delivery.

The family of fine antennas from the fine antenna family.

Antenna Incorporated

26301 Richmond Road, Cleveland, Ohio 44146 (216) 464-7075

In Canada: Cardon Import Canada Ltd., P.O. Box 937 Hamilton, Ontario L8N 3P9
Antenna Incorporated, International Division, P.O. Box 1002 Rockville Centre, New York 11571

CIRCLE 83 ON FREE INFORMATION CARD

Completely
pre-assembled
and pre-tuned

Just take it out of
the package, and
install it on the
car. No tuning
necessary...
check it out with
a watt meter and
see for yourself!

Super-good looking
low silhouette
design.
Your choice of
cup colors
design-coordinated
to late-model cars.

SIERRA
BRONZE



DIAMOND FIRE
BLACK



ATLANTIS
BLUE



FIRETHORN
RED



SNOWCAP
WHITE

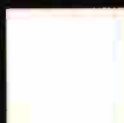

CLASSIC
SILVER
AS
SHOWN

AND
CRYSTAL
CLEAR

60" Stainless steel
tapered whip...
and NO spring

There's a
Coil-in-the-cup

Magnet
Mount

These features will persuade you... The Persuader™ Antenna is Your Best Antenna Choice

60" Stainless Steel Tapered Whip...and No Spring

The super-long whip increases the aperture of the antenna. This increases

- the signal capture area on reception
- the transmit signal and radiation intensity at the horizon
- bandwidth to well over a 40-channel capability

The 125" diameter whip is tapered, so shock is distributed evenly. There's no spring to stretch, break, or bend the whip away from the straightest possible upright position.

Exclusive coil-in-cup design

Loading of most low-profile antennas is by a simple printed circuit board that can't be tuned and will eventually burn out. These new Persuader antennas are completely pre-assembled and pre-tuned and feature an actual hand-wound, hand-tuned copper wire loading coil tested with 500 watts, rated at 100 watts continuous. It's even more efficient than our base-loaded coils because it's wound to a larger diameter, with fewer turns.

This unique design also involves fewer mechanical and electrical connectors—fewer resistive contacts between loading coil and cable terminations—less chance for dust, moisture or road gunk to contaminate the contacts.

This concept has been field tested by thousands of CBers in our Model 13503 (shorter whip, plain white cup). Your good buddies will tell you everything we say about it is true.

Available with Trunk-Lip or Magnet Mount

for performance:

- SWR of 1.5:1 or less across all 40 AM and SSB channels.
- Shunt-fed loading coil is DC grounded for quiet performance; bleeds off static from rain, snow, air particles. Performance is virtually identical to body mount antennas.
- Center-roof placement of magnet mount provides your most uniformly omni-directional signal. (Can also mount on trunk lid).
- Unique Antenna Incorporated design provides capacitive coupling. Aluminum plate puts the ground potential right at the mounting surface.

for convenience: Magnet and trunk lip, the two easiest installations! Place the antenna where you want it, plug the cable into the transceiver. No holes to drill. Readily removed for anti-theft protection. Magnet mount supplied with 12' RG-58/U coaxial cable with PL-259 type connector; trunk lip mount with 17' of cable.

for magnet mount adherence: Heavy-duty 2½" magnet in plastic cup with soft rubber gasket. Holds at top highway speeds of 55 mph. (Trunk lip mount recommended for vinyl roof cars.) Since it won't walk, it won't detune! "Oil-can" effect of cup; resting on gasket, provides a larger magnet plane than if the magnet itself were touching the surface—yet there's less weight on the car, less scratch potential.

All magnet mount benefits
are standard...
not an extra-cost accessory!

LETTERS

continued from page 16

portation: The Transmitter! It is inconceivable that electronics will not play a major role in bringing the matter transceiver out of the sixth dimension and into the fifth, perhaps by the year 2000.

The workhorse locomotive will continue to be the major transport for heavy goods. Two excellent substitutes besides anti-grav for the rails: freight transmitters and automated factories that will manufacture any product (including foodstuffs) locally upon demand. An automated factory that might use hydrogen from water as its raw material would certainly use electronics in 100 interconnected ways.

Entertainment: Stage plays have given way to movies, and movies in turn have been taken over by TV. The same play that was artfully done for 1978 airwaves, can carry its message via satellite simultaneously to easily a hundred million, or even a couple of billion viewers.

The future patron of the arts must be so enraptured by sight, sound, smell, etc., that he *becomes* the protagonist. While we might anticipate that we'll tap into nerve endings surgically to heighten the total effect, it is more likely that a helmet fitted over your head will have the desired effect. Electronic? Of course.

Students of metaphysics declare that everyone who ever lived is recorded in the "Akashic" records "out there" in the sixth dimension. Assume that there *is* such a record, most certainly one day a workshop experimenter will discover the way to tap that great recording at will and select out one at a time of the billions of recordings that exist in that "other dimension," like tuning across AM, FM, SSB, CB, etc. frequency bands. Through the simple application of tuned resonance or PLL, we'll separate each (recording) to be received serially, and the roar of "pure noise" will change to recognizable intelligence.

To any who say that everything's been invented, I can only reply, "There are more things in heaven and earth, Horatio, than are dreamed of in your philosophy!"

A READER
Geyserville, CA

HEAT ENGINE EFFICIENCY

Mr. Smiles' letter in the August 1978 issue merits congratulations for compactness, but I have never seen so much misinformation packed in so little space!

The limiting efficiency of heat engines (of which the internal combustion engine is one type and not the most efficient, at that) is determined by the second law of thermodynamics. According to this law, the limiting efficiency is determined by the equation:

$$E = \frac{T_h - T_c}{T_h}$$

where T_h represents the high-temperature side of the engine and T_c , the low-temperature side of the engine.

For an internal combustion engine, the high temperature can be taken as the combustion temperature, which is approximately 1700°C or 2000°K (Kelvin or absolute temperature); my conversion is not exact, but the value is only approximate.

The low temperature is the temperature at which the gas is exhausted from the cylinder, which can be taken as 500°K. Then, the theoretical limiting efficiency of such an engine is easily calculated as 75%, which is far greater than Mr. Smiles' value of 30%.

It is true, of course, that present-day internal combustion engines are far less efficient than the value calculated above. This is due to *practical* limitations on what type of engines can be constructed economically, a far cry from the theoretical limitation Mr. Smiles complains about.

However, there is an even greater flaw in his argument. This lies in assuming that the efficiency of converting light into electricity by a photovoltaic cell is limited by the same considerations that limit heat engines, when in fact such a cell is not a heat engine. The best analogy in this case is that of a storage battery that is charged and discharged at the same temperature. If heat-engine considerations were applied to this case, the above equation would indicate that $E=0$, so that no matter how much energy you could transmit to the battery, none would be extracted. However, real storage batteries are 80% to 90% efficient, as is the photocell. There is no *theoretical* reason why the efficiency could not be created as high as desired, although there may be *practical* reasons for not doing so.
DR. HOWARD MARK
Suffern, NY

CABLE TV CONVERTERS

With reference to the Looking Ahead article regarding the problem of cable TV converters used with VTR's, perhaps you'd be interested in a few of the tricks we've come up with to get around the converter hassle.

The first is quite simple: A few of the converter-only channels have harmonics that fall into the standard VHF TV broadcast frequencies, although not, of course, right on top of the existing channels. If you off-tune the fine-tuning adjustment far enough, these harmonics can be received as clearly as on Channels 2-13, without a converter box. Just what can be received this way will vary from cable company to cable company; obviously not all stations can be picked up without the little black box (actually ours is brown). For a start, Channel "1" comes in just off Channel 7. Most color sets and some black-and-white sets have enough range to pull in these extra channels. Presumably, the tuners on VCR's can also receive them (all our VTR's are studio models without integral tuners, so I don't know for sure).

The second trick is a bit more complex: We "borrowed" it from Philips. Here in Canada converters cost around \$100 a shot, except for Philips' little black box, which goes for \$45. Rather than having a mass of buttons and a varactor tuner, their "converter" is just an oscillator that shifts everything up into the TV's UHF frequency band, where the UHF tuner can sort out the extra channels, much like the front end of a superheterodyne radio. We've built up several circuits to do this, and, of course, they are very simple.

Thank you for the prolific video material you put into **Radio-Electronics**.
STEVE RIMMER
The Underground Tube
Markham, Canada

equipment reports

AP Products Powerace Model 103 Breadboard Systems

THE POWERACE SERIES OF SOLDERLESS BREADBOARDING SYSTEMS manufactured by AP Products adds the convenience of combining various built-in power supplies, meters, LED indicators, switches, debouncing circuits, and pulse and clock generators on the basic plug-in matrix boards. If you do a fair amount of IC breadboarding, the usefulness of built-in sources and monitors is well worth their additional cost.

The *model 103 Powerace* includes three fixed-voltage power supplies. The alternative is to use three separate, or even combined, supplies, which, with their bulk and interconnecting leads, add greatly to the cost of a basic breadboarding system and severely restrict its portability.

In the *Powerace model 103*, a slanted control panel contains the data and logic



CIRCLE 132 ON FREE INFORMATION CARD

switches, power-supply distribution buses, a voltmeter and an ON-OFF switch. The nearly horizontal breadboarding section is a 1680 terminal—a solderless panel composed of two AP Products *Super Strips*.

The *Powerace model 103* has self-contained +5-volt power supplies, plus tracking +15-

volt and -15-volt power supplies. Ripple and noise measurements are less than or equal to 10 mV under full load, and load and line regulation is better than 1% for all three power supplies. The 5-volt supply is current-rated to 650 mA, and the 15-volt supplies are rated to 250 mA each. The power supplies are protected with a 1-amp fuse in the transformer primary, and their outputs are brought out to four-terminal distribution buses.

The zero-center, 5% accuracy voltmeter is calibrated from -15 to +15 volts and is wired to a solderless bus strip on the panel. One side of the meter and its corresponding four terminals are wired to the power-supply ground.

Two LED driver/displays (L1 and L2) are mounted on the control panel; each consists of an LED and a single solderless terminal that is used to jumper to the logic points that will be monitored on the breadboard section. Each LED indicator is driven by a Darlington-transistor-connected circuit with an LED current-limiting resistor and a 100K base input resistor. The maximum input drive current is 1 μ A.

NOTHING BEATS WRAP-WIRING for changeable, fast and reliable connections if you use **NEW VECTOR WRAP POSTS** and unique **"SLIT-N-WRAP"** T.M. *daisy chain wiring tools*.

Rectangular shanks press into .041" diameter holes tightly. Posts are .025" sq. Sharp corners on wrap posts bite into wire for best contact. Pyramidal ends slide easily into wrapping bits. Install into cards with low cost manual gang insertion tools.

1. T46-4-9 NAIL HEAD, .032" high, pin length .30" \$16.91 per thousand.
2. T68 SLOT HEAD, .090" deep, pin length .54" (.36 pin length also available). \$16.40 per thousand.
3. T49 TRIFURCATED Kilo wrap post, Pin length .54" (Pin length .039" also available.) \$18.12 per thousand.
4. R32 SOCKET PINS fit DIP tabs and have .50" pin length below. \$112.42 per thousand.
5. T46-3-9 WRAP POST, double end, .42" pin length above and .48" below. \$20.90 per thousand. (Three other lengths also are offered.)
6. P184 SLIT-N-WRAP tool with wire. No pre-strip o-cut. \$30.00.

Write for free samples of all five wrap post designs.

Vector
ELECTRONIC COMPANY, 12466 Gladstone Av.,
Sylmar, California 91342
(213) 365-9661, TWX (910) 496-1539
Prices subject to change without notice.

CIRCLE 55 ON FREE INFORMATION CARD

THIS SIGN



ON YOUR DOOR

(wall, truck, or caddy)

TELLS YOUR CUSTOMERS
THAT YOU ARE THE P.R.I.D.E.
OF ELECTRONICS SERVICE

Your NESDA membership says you are:

Professional, Reliable, Industrious,
Dependable and Ethical

Don't YOU want to
say nice things about
YOUR business?

JOIN NESDA

write for information to:
NESDA, 1715 Expo Lane
Indianapolis, IN 46224

An Extraordinary Offer to introduce you to the benefits of Membership in
ELECTRONICS BOOK CLUB

invites you to take
 this 1,302-page
 robotics library
 for only

\$1.99

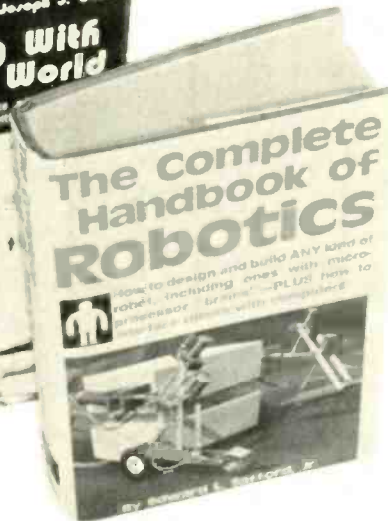
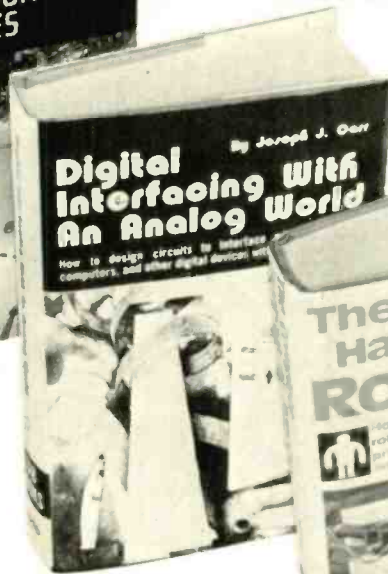
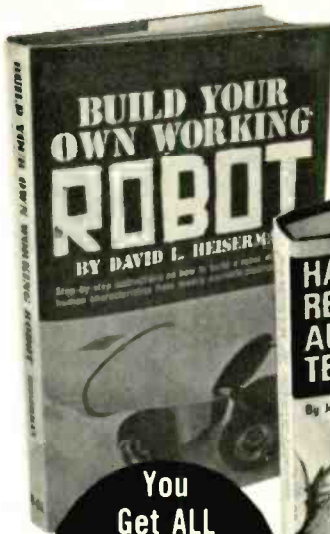

You
 Get ALL
 FOUR of These
 Huge Books
 For Only
\$1.99

- ✓ Only \$1.99 for ALL FOUR!
- ✓ Regular List Price \$47.80
- ✓ Top-Quality Hardbinding
- ✓ Contains the very latest info on Robotics!
- ✓ Almost 800 illustrations
- ✓ Contains over 500,000 words
- ✓ 1,302 data-packed pages

Build Your Own Working Robot

Complete instructions—plans, schematics, logic circuits, and wiring diagrams—for building Buster, the most unique pet in the world! Not for novices, Buster is a sophisticated experiment in cybernetics. You build him in 3 phases, and watch his personality develop as you add progressively more advanced circuitry to his mainframe. The first-phase robot, Buster I, is "leash-led," and dependent on his master for decision-making; Buster II has a basic brain; equipped with a wireless mike, he can enter a room and talk with the occupants. Buster III responds when called, and when "hungry" finds his charger, and plugs himself in. Watch his personality evolve as you build him from the ground up in a learning experience unparalleled in electronic construction. 238 pps., 117 illus. List \$8.95.

Handbook Of Remote Control & Automation Techniques

A practical, step-by-step guide to designing, building, and installing hundreds of remote control systems, and scores of automated devices...from garage door openers to light sensors, from intercom controls to electromechanical timers—to interfacing a microprocessor with household devices. You'll learn how to apply electronic and mechanical techniques to remote-control with computers, with audible tones, with ultrasonics, with radio waves, with light beams, with dozens of special systems. You can build light and power failure sensors, position indicators, tone-operated systems, tone generators, RC hydraulic devices, and you'll see how to interface mechanical devices, hydraulic systems, and electric motors with electronic systems. 294 pps., 250 illus. List \$12.95.

Digital Interfacing With An Analog World

A GIANT 406-page handbook that shows you how to design circuits to interface microprocessors, computers, telephones, and other digital devices with the analog world...that shows you how to really put your microcomputer to work to measure certain conditions, or to control external devices. Tells you all about how to go about it—how to convert energy produced by pressure, force, position, temperature, etc. into an electrical voltage or current your microcomputer can deal with. It shows you, tells you, describes and discusses things you can do with those I/O ports other than connect them up to a prefabricated peripheral! It's a "meaty" volume chock-full of practical info on a wide range of topics for engineers, computer hobbyists, engineering technicians, and robotics builders. 406 pps., 277 illus. List \$12.95.

The Complete Handbook Of Robotics

How to design and build ANY kind of robot...including ones with microprocessor "brains"—PLUS how to interface robots with computers! It's a single sourcebook that contains all the techniques you'll need for creating, designing, building, and operating your own robot from beginning to end...with enough options to create a whole family of robotic wonders—controls can be electrical or electronic; power can be electrical, hydraulic, or pneumatic; your robot can operate by radio control or with a full range of sensors to move about on its own. This practical volume gives ALL the info needed to build a walking, talking friend and companion, or even a helpful servant. Includes 7 Chapters on advanced robot circuits, controls, and sensors. 364 pps., 137 illus. List \$12.95.

Let us send you this 4-volume, 1,302-page Robotics Library as part of an unusual offer of a Trial Membership in Electronics Book Club.

Here are quality hardbound volumes, each especially designed to help you increase your know-how, earning power, and enjoyment of electronics. Whatever your interest in electronics, you'll find Electronics Book Club offers practical, quality books that you can put to immediate use and benefit.

This extraordinary offer is intended to prove to you through your own experience, that these very real advantages can be yours...that it is possible to keep up with the literature published in your areas of interest, and to save substantially while so doing. As part of your Trial Membership, you need purchase as few as four books during the

coming 12 months. You would probably buy at least this many anyway, without the substantial savings offered through Club Membership.

To start your Membership on these attractive terms, simply fill out and mail the coupon today. You will receive the 4-volume Robotics Library for 10-day inspection. YOU NEED SEND NO MONEY. If you're not delighted, return the books within 10 days and your Trial Membership will be cancelled without cost or obligation.

ELECTRONICS BOOK CLUB, Blue Ridge Summit, Pa. 17214

Facts About Club Membership

- The 4 introductory books carry a publisher's retail price of \$47.80. They are yours for only \$1.99 for all 4 (plus postage/handling) with your Trial Membership.
- You will receive the Club News, describing the current Selection, Alternates, and other books, every 4 weeks (13x a year).
- If you want the Selection, do nothing; it will be sent to you automatically. If you do not wish to receive the Selection, or if you want to order one of the many Alternates offered, you simply give instructions on the reply form (and in the envelope) provided, and return it to us by the date specified. This date allows you at least 10 days in which to return the form. If, because of late mail delivery, you do not have 10 days to make a decision and so receive an unwanted Selection, you may return it at Club expense.
- To complete your Trial Membership, you need buy only four additional monthly Selections or Alternates during the next 12 months. You may cancel your Membership any time after you purchase these four books.
- All books—including the Introductory Offer—are fully returnable after 10 days if you're not completely satisfied.
- All books are offered at low Member prices, plus a small postage and handling charge.
- Continuing Bonus: If you continue after this Trial Membership, you will earn a Dividend Certificate for every book you purchase. Three Certificates plus payment of the nominal sum of \$1.99 will entitle you to a valuable Book Dividend of your choice which you may choose from a list provided Members.

ELECTRONICS BOOK CLUB

Blue Ridge Summit, Pa. 17214

Please open my Trial Membership in ELECTRONICS BOOK CLUB and send my 4-volume Robotics Library, invoicing me for only \$1.99 plus shipping. If not delighted, I may return the books within 10 days and owe nothing, and have my Trial Membership cancelled. I agree to purchase at least four additional books during the next 12 months after which I may cancel my membership at any time.

Name _____ Phone _____
 Address _____
 City _____
 State _____ Zip _____
 (Valid for new Members only. Foreign and Canada add 15%.) RE-29

Two single-pole, double-throw (SPDT) data switches toggle between ground and the 5-volt power supply via an isolation resistor. Each SPDT switch can supply 10 mA, and four-terminal buses are provided for each. Two additional momentary contact \overline{Q} - \overline{Q} logic switches complete the controls. These SPDT switches toggle ground between the inputs of two 7403 flip-flops. The noninverted and inverted outputs of the two switch-controlled debouncing flip-flops are brought out to four-terminal buses. The flip-flops have a sink capability of 15 mA in the low state, and supply up to 5 mA in the high state.

The breadboard matrix itself uses tie-point blocks with 0.1- X 0.1-inch spacing. Two *Super Strips* are mounted side by side on a metallic ground plane, each strip with 25 five-terminal buses that can be chained to form supply ground feeders. Groups of five interconnected terminals form insertion points for IC's, with a total of 1280 tie points for plugging in circuit components. Nine 14-pin DIP's can fit on the *Super Strips*, which are composed of acetal copolymer. Transistors, resistors, capacitors and diodes can be inserted in the board by bending their leads to the proper spacing. The solderless pins accept solid wire between sizes AWG No. 20 and No. 30.

The *model 103's* instruction sheet comes complete with schematic and parts list so you know just where you stand in case you try some unconventional hookup. An optional breadboard jumper wire kit (No. 923351 JK1) contains a set of 350 No. 22 wires in 14 lengths—0.1 to 5 inches; the kit sells for \$10. The *Powerace model 103* is priced at \$124.95. AP Products Incorporated, Box 110-Q, 72 Corwin Drive, Painesville, OH 44077. **R-E**

Simpson Model 462 Digital Multimeter



CIRCLE 133 ON FREE INFORMATION CARD

SIMPSON ELECTRIC COMPANY (853 DUNDEE Ave., Elgin, IL 60120) has developed a very compact digital multimeter, the *model 462*. This DMM makes all the standard readings: AC/DC volts, ohms, and either AC or DC current, with an accuracy of 0.25% of reading. The display uses 3 1/2-inch-high LED's that are large enough to be read 15 feet away.

Both AC and DC voltages start at a very low 0-200-mV range. The DMM reads DC up to 1000 volts, and AC to 600 volts RMS. The resistance range can be read from 1.0 ohm to 20 megohms, with the lowest resistance range from 0-2000 ohms.

Here comes the handy part: Both voltage ranges and the resistance ranges are *autoranging*. You can read any voltage from 0.01 to 1000 VDC without any adjustment; all you have to do is move the test leads! Just "stick 'em on" there and read the meter. Other features include fully automatic decimal-point placement and zeroing. Only the two lowest

voltage ranges, 0-200 mV, are not autoranging. The lowest resistance range, however, is autoranging, and is selected by pressing the white AUTO pushbutton. All other ranges are manually selected by pressing one of five grey pushbuttons in the bottom row.

You select the desired reading by pressing one of four black pushbuttons in the top row, marked K-Ohms, mA, 200 mV or V. The AC/DC and ON-OFF switches are push-push controls. All other controls are of the standard latching type; when one is pushed, the other is released. The pushbuttons are spaced far enough apart to allow a normal human fingertip to hit only the one desired. (I've seen earlier-model DMM's where you had to use a darned needle to hit 'em!)

The *model 462* is housed in a neat, compact and insulating plastic case. The test leads are recessed, no bare metal is exposed at all; test prods are also included with the *model 462*. The handles are corrugated with a guard ring, and the points are sharp. The test clips are well insulated; they screw on and won't fall off, which can save you a lot of time fishing them out of tight places in the chassis that you happen to be servicing.

The *model 462* is powered by four heavy-duty type AF NiCad batteries. A special charging unit with a recessed plug comes with the instrument. Fully charged batteries provide eight hours of use. The charger can be left permanently plugged in for bench work. For portable use, just pull the charger plug and take off. For emergencies when the heavy-duty batteries are not available, four AA NiCad batteries can be used, but they will provide only six hours of use.

continued on page 32

NEW LBO-508 DUAL TRACE OSCILLOSCOPE

A 20MHz OSCILLOSCOPE AT A 10MHz PRICE



SPECIFICATIONS

VERTICAL AMPLIFIER	
IDENTICAL FOR BOTH CHANNELS	
SENSITIVITY:	10mV/cm - 20V/cm CALIBRATED IN 15 STEPS (1:28 SEQUENCE UP TO 60V/cm WITH VARIANCE CONTROL)
ACCURACY:	± 3%
BANDWIDTH:	(DC) DC - 20MHz (1.3dB, 4 cm) (AC) 2Hz - 20MHz (1.3dB, 4 cm)
RISE TIME:	37.5nSec
INPUT IMPEDANCE:	1M OHM SHUNTED BY 35pF
INPUT COUPLING:	AC, DC, GND
MAX. INPUT VOLTAGE:	600V (DC & AC p-p)
CHANNEL 2 POL:	INVERTS CH 2 POLARITY
INPUT CONNECTOR:	BNC
TIME BASE	
SWEEP SPEED:	0.8 MICRO SECONDS/cm - 200mSec/cm
ACCURACY:	± 5%
MAGNIFICATION:	± 2.5% MAX SPEED 100mSec/cm
DUAL TRACE DISPLAY	
MODE:	CH1, CH 2, X-Y, DUAL, ADD.
CHOP (AUTOMATIC SEL IN DUAL MODE):	200mSec/cm - 0.5mSec/cm
ALT (AUTOMATIC SEL IN DUAL MODE):	200 MICRO SECONDS/cm - 0.8 MICRO SECONDS/cm
ADD:	SUM OR DIFFERENCE (WITH CHANNEL 2 INVERT)
X-Y DISPLAY	
(X = CH 1 Y = CH 2)	
SENSITIVITY:	Y AXIS: 10mV/cm - 20V/cm X AXIS: 10mV/cm - 20V/cm X AXIS DC OR 2Hz - 8000Hz (1.3dB, 10cm) LESS THAN 3MAT 100KHZ
BANDWIDTH:	
X-Y PHASE:	
SYNCHRONIZATION	
MODE:	TRIGGER, AUTOMATIC
SIGNAL SOURCE:	INTERNAL (CH1 OR CH2) OR EXTERNAL, + OR - SLOPE
TRIGGER SENSITIVITY:	TRIGGERED (INT) 2Hz - 15MHz AT 1 cm (EXT) 2Hz - 15MHz AT 100mV p-p

ANOTHER QUALITY TEST INSTRUMENT BY **LEADER Instruments Corp.**

MIDWINTER SPECIAL
Regularly \$769.95 now \$639.95
Including 2 probes
Shipping not included
Sale ends April 30, 1979

FOR MORE INFORMATION OR TO ORDER CALL

TOLL FREE HOT LINE
800-223-0474

VISA

ADVANCE ELECTRONICS

54 West 45 Street, New York, N.Y. 10036 212-687-2224

THE TEST EQUIPMENT SPECIALISTS

**“General Electric
is your most complete source
for general line and industrial
electronic components.”**

Your reputation is our reputation
Tube Products Department • Owensboro, Kentucky 42301

GENERAL  ELECTRIC

Train with NTS for the MicroComputers, digital the first name

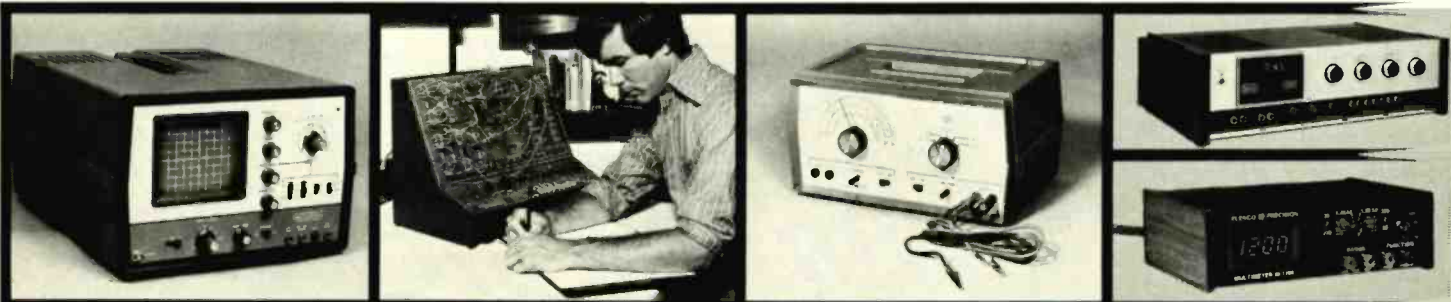

MicroComputers



The world of electronics is daily becoming more challenging. Technology is growing more specialized, and the importance of digital systems increases every day. Test instruments, home entertainment units and industrial control systems are all going digital. And now, NTS training programs include a wider choice of solid-state and digital equipment than ever before offered in any home study course: Advanced NTS/Heath digital color TV (25" diagonal with optional programming capability), NTS/Heath microcomputer, digital test equipment, digital stereo receiver (70 watts per channel), NTS compu-trainer, plus much more state-of-the-art equipment to make your training exciting and relevant.

The equipment you receive with NTS training programs is selected to provide you with a solid

background in electronic systems. Kits and lessons are designed to work together to demonstrate electronic principles and applications. The kit-building not only shows you how electronic hardware functions, but how various circuit designs accomplish different purposes. Your lessons guide you through any number of experiments associated with many projects. This is the Project-Method, and it works. Step-by-step, you learn how and why digital electronics has become a part of our world, and the even bigger role it is sure to play in the future.

Whether you are looking for training in Consumer, Commercial, or Industrial electronics, NTS offers fourteen courses, some basic, many advanced, in several areas of electronics. An all-new full-color NTS catalog shows you what each course covers,

electronics of the future.

systems and more...from
in home study.



and every piece of equipment included.
Send for it today, and see for yourself what's really
happening in electronics training technology at NTS.
Find out how much has changed, and what new
directions the field is taking. You'll probably want to
be a part of it.
It's free. Just mail the card or coupon. Today.

**NO OBLIGATION. NO SALESMAN WILL CALL.
APPROVED FOR VETERAN TRAINING.**

NATIONAL TECHNICAL SCHOOLS

TECHNICAL-TRADE TRAINING SINCE 1905
Resident and Home-Study Schools
4000 South Figueroa St., Los Angeles, Calif. 90037

NATIONAL TECHNICAL SCHOOLS Dept. 206-029
4000 South Figueroa Street, Los Angeles, California 90037

Please send FREE Color Catalog and Sample Lesson.

- Color TV Servicing
- B & W TV and Radio Servicing
- FCC License Course
- Electronic Communications
- Electronics Technology
- Audio Electronics Servicing
- Digital Electronics
- MicroComputers/MicroProcessors

Name _____

Address _____

Apartment Number _____ Age _____

City _____

State _____ Zip _____

- Check if interested in G.I. Bill information.
- Check if interested ONLY in classroom training in Los Angeles.



professional microphones...by

SHURE®

Shure Brothers Inc., 222 Hartrey Ave., Evanston, IL 60204, In Canada: A. C. Simmonds & Son Limited
Manufacturers of high fidelity components, microphones, sound systems and related circuitry.

CIRCLE 2 ON FREE INFORMATION CARD

You have your own calculator. Why not a DMM?

EQUIPMENT REPORTS continued from page 32

4400 words, this means sacrificing some functions, including one of the best—the EDIT command.

For maximum system flexibility and use, two external pieces of hardware are required: an audio cassette recorder, and a separate playback cassette machine. The system also supports a CRT, keyboard and printer.

The text editor, which occupies half of the program space, executes 20 commands. The AUTO command sets up automatic line numbering with user-specified increment size. Text files can be loaded, renumbered, recorded and printed. The RUN command executes an assembled program; the ASSEMBLE command calls the assembler; and the MANUSCRIPT command suppresses line numbers when listing. The EDIT command performs text file searches to change or delete selected alphanumeric characters within specified line-number ranges.

The assembler recognizes labels up to 10 characters long and has five conventional fields: line number, label, mnemonic, operand and comment. Assembly can be performed from the text file that was previously created with the text editor or from tape. Programs longer than available memory storage space are assembled from tape.

The first assembler pass generates the symbolic table (label file) and outputs whatever errors are detectable at that stage. A second pass creates the object file and output listings. An optional third assembler pass creates an

object file in relocatable format. A series of 16 pseudo-ops allow you to control assembler features such as continuing assembly in spite of low severity errors, as well as storing data bytes.

There are six listings: First, a hexadecimal dump program that produces a formatted object-code output listing. The next four listings are commented source listings, including break detection, motor control, relocating loading and tape loader software. The system is recorded on a cassette tape for easy initialization. The cassette loading program must be performed manually since it prepares the computer to load the editor-assembler tape itself.

The cassette tape, a 24-page manual and the program listings are available for \$30 from C. W. Moser, 3239 Linda Drive, Winston-Salem, NC 27106. **R-E**

Hustler Model MOT Monitor Antenna

WITH THE WIDESPREAD USE OF THREE-BAND (low-VHF, high-VHF and UHF) programmable scanners, more and more antenna manufacturers are meeting the demand for compatible three-band monitor antennas. New-tronics Corporation (15800 Commerce Park Drive, Brookpark, OH 44142) has recently introduced the *Hustler model MOT* mobile antenna. The *model MOT* is available only as a trunk-mount unit. It performs well on the three frequency ranges for which it was designed—37–50 MHz, 150–174 MHz and 450–512 MHz.

The *model MOT* comes equipped with 16

EQUIPMENT REPORTS continued from page 26

The *model 462* is well protected against accidental overload. Over-voltage protection is provided to 1000 volts on all autoranging modes and to 650 volts on even the manually selected 0–200-mV ranges. The AC ranges are protected up to 600 volts on the autorange, to 240 volts RMS on the two low ranges, and to 650 volts on the higher ranges. Even the ohmmeter ranges are protected against over-voltage up to 250 VRMS on all ranges. I made the stock AC rejection test, and it came out

fect of RG-58 coaxial cable, and is terminated with a Motorola antenna plug.

The *model MOT* is a center-trap antenna designed to act as a 16-inch one-quarter-wave whip when operating in the high-VHF band, and it automatically couples an additional 18 inches of active length (including resonant trap) when operating in the low-VHF band. The lower 16 inches is used as a three-quarter-wave whip in the UHF band.

The mounting assembly is firmly secured, both mechanically and electrically, to the trunk lid of a car by tightening two Allen-head set screws (a wrench is provided).

Because the entire antenna when mounted measures less than 3 feet, the *model MOT* poses no particular problem when used under normal mobile operating conditions. No tuning or pruning of the antenna is required; it is factory-pretuned.

In our tests, the *model MOT* proved most satisfactory for a low-cost, three-band monitor antenna. Remember that a mobile antenna uses the vehicle body as part of a complete system, and unless the manufacturer's recommended application techniques are not followed closely, the antenna cannot be expected to perform at maximum efficiency.

The antenna comes in a blister package for rack display, with the element separated from the mount. The element is easily installed through a hole in a tightening nut and locked securely in place on the mount by a small wrench (also provided).

The *model MOT* monitoring antenna appears to be well designed and rugged enough to withstand most mobile monitoring applications. It is available for \$24.95. **R-E**

Pulse and function generators for today's digital world



Pulse generator
WR-549A \$119.00



Function generator
WR-550A \$139.00

Here are two new digital wave-form generators for today's logic designers and digital troubleshooters.

They're ideal for teaching, experimenting, or servicing digital-address TV tuners, binary digital instruments, digital clocks, small computers, calculators, TV games...practically anything digital.

- Pulse width adjustable from 100 nsec to 0.1 sec within 5Hz-5MHz range
- Output voltage adjustable from 0-15V at 600Ω, 0-6V at 50Ω
- On and off time independently adjustable
- Sine, sawtooth, and square-wave output 1Hz to 1MHz
- 4Vpp fixed-output for TTL and CMOS
- 10-V adjustable dc offset plus sweep
- Peak-to-peak output 0-20V at 600Ω

See them at your VIZ distributor.

**VIZ Test
Instruments Group**
of VIZ Mfg. Co.

335 E. Price St., Phila., PA 19144

Formerly
ICR
Instruments

Jim-pak[®]

electronic components

One-Stop Component Center

EXCITING NEW KITS!!

Regulated Power Supply

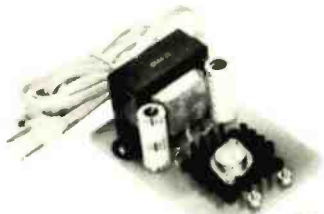

- ★ Uses LM 309K
- ★ Heat sink provided
- ★ P.C. board construction
- ★ Provides a solid 1 amp @ 5V
- ★ Includes components, hardware and instructions
- ★ Size: 3-1/2" x 5" x 2" high

JE200 5v 1amp

4-Digit Clock Kit



JE730

- ★ Bright .357" lit. red display
- ★ Sequential flashing colon
- ★ 12 or 24 hour operation
- ★ Extruded aluminum case (black)
- ★ Pressure switches for hours, minutes and hold functions
- ★ Includes all components case and wall transformer
- ★ Size: 3-1/4" x 1-3/4" x 1-1/4"

Function Generator Kit



- ★ Provides 3 basic waveforms: sine, triangle & square wave
- ★ Frequency range from 1 Hz to 100K Hz
- ★ Output amplitude from 0-volts to over 6 volts (peak to peak)
- ★ Uses a 12V supply or a ± 6V split supply
- ★ Includes chip, P.C. board, components and instructions.

JE2206B

NOW!!! OVER 300 AUTHORIZED DISTRIBUTORS... HERE'S JUST A SAMPLING:

ALABAMA Mobile ALASKA Anchorage ARIZONA Yuma CALIFORNIA Bellflower Berkeley Mission Viejo Monterey Oceanside Paio Alto Pasadena Sacramento Sacramento San Carlos San Diego San Fernando San Francisco San Jose San Luis Obispo Santa Ana Santa Cruz Santa Maria Santa Monica Suisun City Sunnyvale Vallejo Walnut Creek COLORADO Aurora CONNECTICUT Bridgeport FLORIDA Ft. Lauderdale GEORGIA Atlanta HAWAII Honolulu IDAHO Idaho Falls ILLINOIS Evanston Evanston Grove/land Mount Prospect	Lafayette Radio Electronics TV Mart Yuma Electronics Earl's Hobby Shop Al Lasher Electronics Tower Electronics Corp. Zackit Electronic Center Zack Electronics Dow Radio Inc. Heathkit Electronic Center Zackit J & H Outlet Store Radio Shack A.S.C. Mira Mesa San Fernando Electronics Zack Electronics United Radio & TV Supply Mid-State Electronic Supply Quality Electronics Santa Cruz Electronics Caps Electronics Mission Control Byte Shop Sunnyvale Electronics Zackit Byte Shop of Walnut Creek Cam Co Electronics Bridgeport Computer Computers For You Atlanta Computer Mart Integrated Circuit Supply Audiotronics Itty Bitty Machine Co. Tri-State Electronic Corp. Moyer Electronics Tri-State Electronic Corp.	ILLINOIS (Continued) Oak Park Rockford Schaumburg INDIANA East Chicago IOWA Indianola KANSAS Wichita KENTUCKY Lexington LOUISIANA Baton Rouge Houma Mer Rouge MARYLAND Churchville Damascus La Vaie Rockville Rockville Towson Towson MASSACHUSETTS Pittsfield Waltham Worcester MICHIGAN Crawston Detroit Flint Lansing Midland Mt. Clemens Niles MINNESOTA Duluth Hopkins St. Paul MISSOURI El Dorado Springs MONTANA Billings Bozeman NEBRASKA Lincoln Lincoln	Speptronics Inc. Imperial Computer Systems Data Domain Acro Electronics Corp. Electronix Limited Amateur Radio Equipment Company Radio-Electronic Equipment Co. Pelican Electronics Pelican Electronics Pelican Electronics Churchville Electronics Damascus CB J & M Electronics Computer Workshop Heathkit Electronic Center Baynesville Electronics Inc. Heathkit Electronic Center Pittsfield Radio Co. Inc. Computer Mart Inc. RM Electronics Inc. Radio Supply & Engineering Heathkit Electronic Center Hobby Electronic Center Fulton Radio Supply Co Computronix Corp. The Computer Store Niles Radio Supply Northwest Radio of Duluth Heathkit Electronic Center Heathkit Electronic Center Beckman Electronics Conley Radio Supply Electronic Service & Dist. Altair Computer Center Scott Electronic Supply Inc.	NEBRASKA (Continued) Omaha Omaha NEVADA Las Vegas NEW JERSEY Briktown Cherry Hill Pompton Lake Ramsey NEW MEXICO Las Cruces NEW YORK Endwell Kingston New York Troy Utica NORTH CAROLINA Boone Durham Greensboro Raleigh NORTH DAKOTA Fargo OHIO Bucyrus Cincinnati Columbus Dayton Seymour OKLAHOMA Oklahoma City OREGON Albany Coos Bay Portland Salem PENNSYLVANIA Hershey Pittsburgh York RHODE ISLAND Cranston Pawtucket TENNESSEE Chattanooga Clarksville Cookeville	Heathkit Electronic Center Omaha Computer Store Century 23 Radio Shack Associate Store The Computer Emporium Computer Corner of New Jersey Typetronic Computer Store Mannie's Electronic Supply Computer Tree Inc. Greylock Electronics Computer Mart of New York Trojan Electronics Am-Com Electronics Alpha Digital Systems Futureworld Byte Shop Byte Shop of Raleigh The Computer Company Mead Electronics Heathkit Electronic Center Altair Computer Center Universal Amateur Radio Bits, Bytes & Micros Oregon Ham Sales Herrick Electronics Portland Radio Supply Computer Pathways Microcomputer Systems Inc. Heathkit Electronic Center G. Y. C. Company Jabbour Electronics City Jabbour Electronics City William's Data Comp Div. Masstronics Wagon's Stereo Center	TENNESSEE (Continued) Knoxville Nashville TEXAS Amarillo Dallas Houston Houston Houston San Antonio UTAH Midvale Provo VIRGINIA Alexandria Alexandria Charlottesville Hampton Norfolk Richmond Roanoke Virginia Beach WASHINGTON Longview Moses Lake Pasco Seattle Seattle Seattle Spokane Tacoma WEST VIRGINIA Morgantown Wheeling WISCONSIN West Allis CANADA Alberta (Calgary) Ontario (Willowdale) Quebec (Montreal) Berkshire GUAM Panama City PANAMA Panama City SINGAPORE	Byte Shop Electra Distributing Co. Computer Encounters Inc. Altair Computer Center CompuShop Interactive Computers Sherman Electronics Supply Inc. Heathkit Electronic Center Alpine Electronic Supply Co. Computer Hardware Store Heathkit Electronic Center Lafayette Radio Lafayette Radio Avec Electronics Corp. Avec Electronics Corp. The Computer Place Heathkit Electronic Center Progress Electronics Ron's Electronics Riverview Electronics Amateur Radio Supply C-Com Empire Electronics Personal Computers C & G Electronics Electro Distributing Co. Lafayette Radio Olson Electronics The Computer Shop Home Computer Centre Wang's Microcenter NewBear Computing Store Marianas Electronics Sanitrol, S.A. Inter-trade (PTE) Ltd.
---	--	---	---	---	---	--	---

ASK YOUR ELECTRONICS STORE TO STOCK JIM-PAK[®] TODAY!!

JIM-PAK[®] • 1021 HOWARD AVENUE, SAN CARLOS, CALIFORNIA 94070 • (415) 592-8097

SWITCHES CRYSTALS CONNECTORS HEAT SINKS FUSEHOLDERS TEST CLIPS DIP JUMPERS CABLE ASSEMBLIES SWITCHES CRYSTALS CONNECTORS HEAT SINKS

SWITCHES CRYSTALS CONNECTORS HEAT SINKS FUSEHOLDERS TEST CLIPS DIP JUMPERS CABLE ASSEMBLIES SWITCHES CRYSTALS CONNECTORS HEAT SINKS



TRUST US TO TAME YOUR ARC ENEMY.

High voltage used to be the enemy of field technicians.

In order to measure it accurately, they'd either have to tote bulky test equipment to the installation site, or tote the unit to the test bench.

Then, in 1967, ITT Pomona Electronics introduced the first high voltage test probe with a built-in meter.

This compact, lightweight instrument made high voltage trouble-shooting practical and convenient anywhere. And it became an instant success everywhere.

Now we make six different ITT Pomona Electronics high voltage test probes. There are models for color and black and white television, microwave ovens, neon signs, electronic air cleaner systems, etc.

Best of all, they're priced so low that every serviceman can have one along.

See our new catalog for details on the full high voltage test probe line. Plus more than 640 other products you know and trust.

ITT Pomona Electronics, 1500 East Ninth Street, Pomona, CA 91766 • Phone: (714) 623-3463 • TWX: 910-581-3822

AVAILABLE THROUGH YOUR FAVORITE ELECTRONIC PARTS DISTRIBUTOR

FREE 1979 YEARBOOK CATALOG

Contains 100 pages of adapters, cable assemblies, jacks, plugs, boxes, sockets, connectors, jumpers, clips, probes, patch cords, wire, and much more. Yours free upon request. See our pages in EEM.



Pomona Electronics **ITT**

CIRCLE 37 ON FREE INFORMATION CARD



String Synthesizer

An introduction to the latest innovation in electronic music synthesizers. The string synthesizer gives the soloist and small groups the background needed to enhance the performance.

MARVIN JONES

STRING SYNTHESIZERS, AND THEIR RECENT popularity, represent the culmination of over a decade's worth of work in developing and improving electronic music synthesizers. String synthesizers are the first of what we expect will be a long line of special-purpose instruments designed to avoid the clutter of patch cords and a strong technical background required to run the early breeds of synthesizers. Recent surges of interest in guitar and drum synthesizers indicate that these instruments will follow in the string synthesizers' path.

It is very natural that the string synthesizer was the first special-purpose synthesizer to come along. Since the inception of popular music, one of the staples of the "hit record" sound has been the lush, flowing orchestrated backgrounds. Unfortunately, few vocalists and solo musicians do well enough to allow hiring orchestras to perform live. Thus, the lush background was always missing in concerts. Organs helped, but weren't quite the same. Then there's always the problem of being able to afford an orchestra for the recording session in the first place! String synthesizers have changed all that. Now musicians are using these units to perform anything from country music to avant garde, in locations ranging from your neighborhood bar to Madison Square Garden!

Strangely enough, the basic circuitry in a string synthesizer is more a result of

combo organ technology than of synthesizer technology. The rich moving sounds they produce are so powerful that most anyone (musician or not) gets a kick out of playing with them. And all the commercially available units use the same basic circuitry to achieve the effect of violins and cellos 'en masse.'

This article will describe how to build a professional-quality string synthesizer, but first let's take a look at how these magical machines are used, and then

discuss how the circuitry works. The model 1550 synthesizer is of particular interest since it is available in kit form as well as assembled, and there are a number of options available such as stereo outputs and a microprocessor interface card. The instrument also produces a percussive electric-piano voicing.

How it is used

The majority of the features on string synthesizers can be found on the front

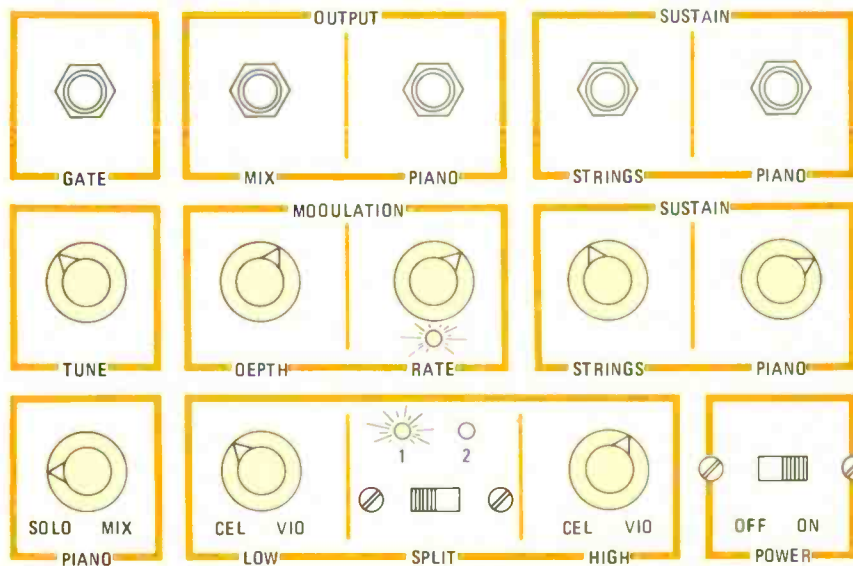

FIG. 1—LAYOUT OF THE CONTROL PANEL. It is operated with the left hand. Five jacks are provided for output and interfacing connections.

panel of the instrument. The front panel of the model 1550 is shown in Fig. 1. All connection points for outputs and interfacing are in the top row of the panel, and are provided via five 1/4-inch phone jacks. The bottom two rows of the panel provide the multiple user controls which alter and mix the various voices of this instrument.

The GATE jack provides a voltage which steps from 0 to about +9 volts whenever a key is pressed on the keyboard. This allows the instrument to trigger external effects or processing equipment such as synthesizer modules. Many of the standard synthesizers manufactured today have an array of "systems interfacing" jacks to allow external signals to be processed and become the basis for more complex sounds with polyphonic synthesizer textures. When string synthesizers are used in this way, it is easy to synthesize "brass" sounds, and other special effects using the circuitry inside the syn-

thesizer in conjunction with the string synthesizer.

There are two signal outputs on the stock synthesizer. The first is the MIX output, or the master output. At this jack will appear the sustained string voices plus a variable mix of the electric piano sound. The second output provides only the PIANO signal. This output is useful if you wish to use separate mixing, equalization, or special effects for the two different voicings. When using a standard 1/4-inch 2-conductor phone plug in the PIANO jack, the piano signal is automatically removed from the composite signal at the MIX jack. This allows complete separation of the two types of signals if desired. Alternatively, you could use a 1/4-inch 3-conductor phone plug which has no connection made to the ring section of the plug. The piano signal will appear now at both output jacks, with the user selecting either or both outputs with the PIANO mix control (explained later).

The SUSTAIN jacks allow provisions for remote control of the amount of time it takes for a signal to fade out once the key is released. For those of you familiar with synthesizer terminology, this would actually relate to the "release" control on an ADSR (Attack, Delay, Sustain, Release) envelope generator. Note that there are separate, fully variable sustain controls for each of the two types of signals—string and piano. Some commercial units have only a long/short sustain switch, or no control at all. The most common use of the sustain jacks will be for sustain foot switches, which will operate much like the sustain pedal on an acoustic piano. When the two conductors of the jack are shorted together, the front panel sustain control will operate normally to set the minimum sustain time. When the foot switch contacts are opened, the sustain time increases to maximum as though the front panel control were turned to maximum. For the foot switch itself, a normally

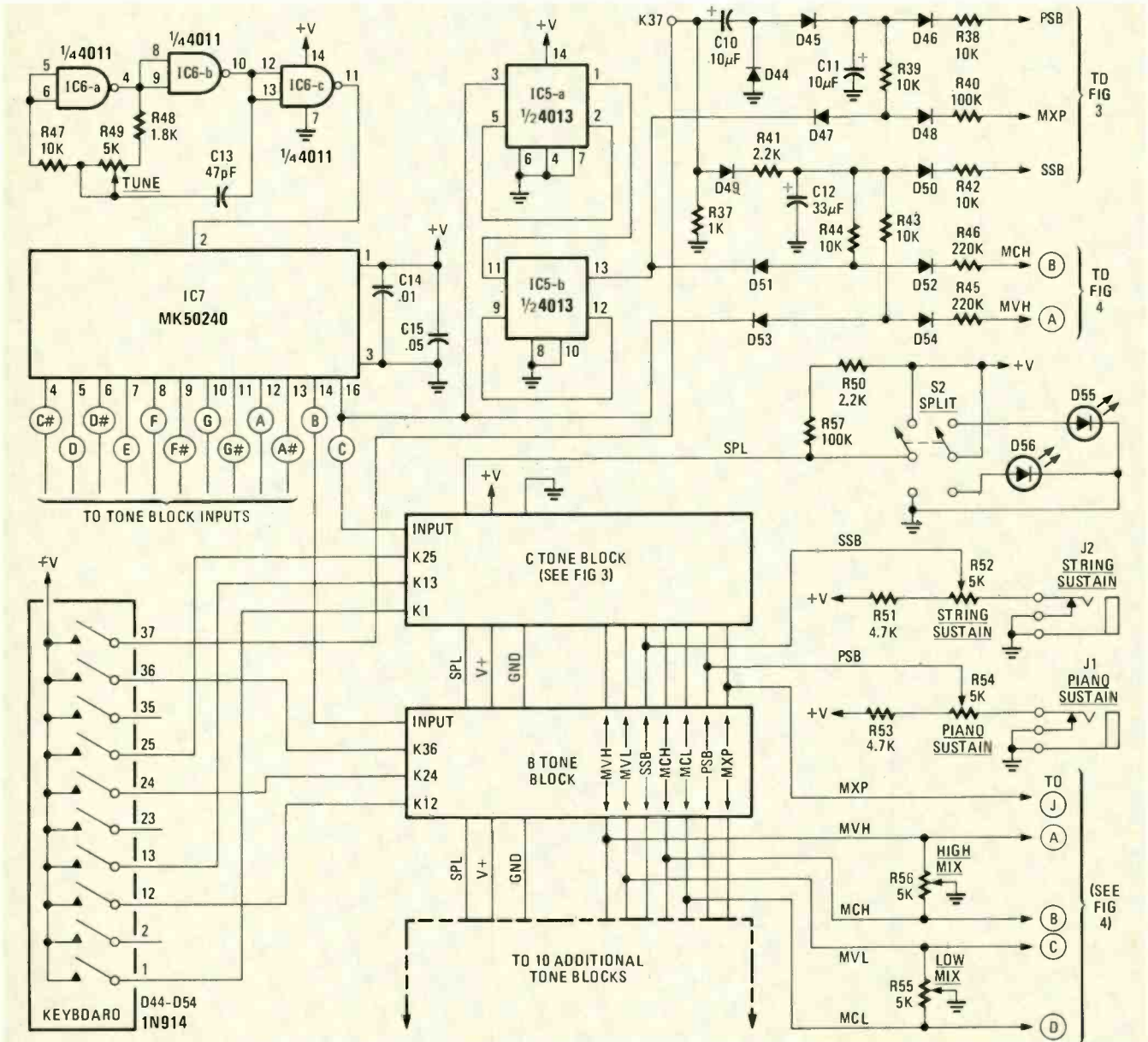

FIG. 2—BASIC SCHEMATIC for the main section. This circuit contains the twelve identical tone blocks that develop the shaping, keying and mixing for the three octaves of each note.

closed momentary-contact switch can be used to provide action similar to acoustic piano sustain pedals, or a positive contact switch can be used to provide push-on, push-off sustain control action.

Internal design of the model 1550 synthesizer allows for use of variable foot pedals (such as pedal volume control voltage (0 to +5 volts) to remotely program the sustain times for either of the voices. This allows all the versatility of the front panel controls without requiring the musician to remove his hands from the keyboard.

The TUNE control is fairly standard. It allows the instrument to be tuned to other instruments, yet provides a full octave of transposition so you can extend the range of the instrument for special compositions. With a little practice, the TUNE control can even be used as a performance device, allowing orchestral glides or pitch blends for special effects.

Perhaps the most important and powerful controls on the model 1550 (or any string synthesizer) are those controls that allow the user to modify the operation of the chorusing and vibrato circuits. These controls are important in allowing each musician to alter the basic string sound to suit musical requirements or individual tastes. Unfortunately, this is where many commercial units fall short in the eyes of musicians. The chorusing circuitry is responsible for taking the single "reedy" voice of the organ circuitry and making it sound as if there are a great number of simultaneous voices occurring. This effect is obtained by using analog delay lines to generate two "echoes" of the original signal. The time delay is so short (constantly varying between 0.5 ms and 20 ms) that it is not heard as a distinct echo. Rather, it appears as if there is another instrument playing in unison with the original voice. With two delay lines, we can generate three-voice chorusing which is sufficient to confuse the human ear into believing it is hearing a large number of voices. By now you should see why this circuitry is so important to the effective generation of orchestral effects.

This synthesizer provides two controls for user alteration of chorusing effects. DEPTH determines the amount of chorusing in the effect. At minimum setting, there is no frequency modulation occurring at all, yielding a bland reed-organ voice. This would be useful for basic combo organ effects, or for external processing as mentioned earlier. As the DEPTH control is advanced, the two delayed voices are frequency modulated by an increasing amount. At approximate mid-rotation, the typical string chorus with vibrato is achieved. Further rotation of the control creates very heavy vibrato and pitch deviations of about a semi-tone for special effects.

The RATE control varies the speed of pitch fluctuations (vibrato) in the

chorusing circuitry. At minimum, the vibrato is so slow that it is not heard as actual pitch variations but as a rich, ethereal rolling effect similar to several phase shifters or flangers sweeping simultaneously. This control setting provides a thick pipe-organ effect that is actually spine-tingling! As it is advanced, the vibrato rate increases through normal settings to fast quivering vibrato for special effects. The adjacent LED indicates the speed of one of the low-frequency vibrato oscillators for use as a visual guide of control settings when you are on stage or in the studio.

The PIANO SOLO/MIX control is used to send the piano voice to either the master MIX output, or to the solo PIANO output. The control acts as a panning control, so the signal can be applied to the two outputs in any blend. When using only the MIX output, the PIANO control will act as a volume control for the amount of piano signal available in the master mix. When a standard 2-conductor 1/4-inch plug is used to carry the piano signal from the PIANO jack, the piano signal is disabled from the MIX jack and the PIANO MIX control will act as a volume control for the amount of signal appearing at the PIANO jack. When a 3-conductor plug is used (with no connection to the ring) for the piano output, the PIANO MIX control acts as a panning control to send variable amounts of piano signal to the two outputs. Interesting stereo imaging effects can be obtained with this configuration.

The large box of controls centered in the bottom of the panel is used to design the string voicing you desire. The SPLIT switch is used to select the point at which the keyboard can be divided. At position 1, the keyboard voicing will be split at the first octave. In position 2, the keyboard will split at the second octave. LED's show the selected split location at a glance. Once the split function is selected, the LOW mix control will set the desired blend of violins and cellos for all keys *below* the selected split position. The performer can select violins only, cellos only, or any combination of the two. It should be mentioned here that the cellos are 2 octaves lower than the violins.

The HIGH mix control serves a similar function for all keys *above* the selected keyboard split point. With these controls, you can easily configure the keyboard for the type of music you will be playing. For example, if the composition uses simple droning cello parts, but a violin part that moves and jumps over a wide range, then you would set the split switch for the first octave, and set the LOW mix for cellos and HIGH mix for violins. An infinite variety of voicings are available with these controls. The string mix and split controls take on added power when the stereo output is added to the unit. With the option installed, the selected split location can also become the point at which the stereo effect is split. Or, in an alternate

stereo operation mode, the violins can be routed to one side and cellos to the other side. In this mode, the LOW and HIGH mix controls are instrumental in determining the "width" of the stereo effect by determining the violin/cello content of each half of the keyboard.

How it works

The schematic for the main circuit is shown in Fig. 2. Three of the four gates in IC6 generate a high-frequency clock signal (around 1 MHz.) This clock signal is applied to the Top-Octave Generator, IC7, where it is divided by the twelve integers required to produce the twelve equally tempered frequencies of a scale. These frequencies will be divided into the lower octaves inside each of their respective tone blocks. Since the keyboard used in this synthesizer is actually 3 octaves plus one note (the highest "C"), additional circuitry must be provided for the tone generation of that extra note.

IC5 and associated resistors, capacitors, and diodes provide this function. This circuitry works exactly like the circuitry in the Tone Blocks, and will be discussed later. The additional circuitry in Fig. 2 shows the operation of the various front panel controls. The SPLIT switch, S2, generates a high (+V) or low (ground) logic signal which represents a high or low keyboard split location, respectively. The second section of S2 controls the LED SPLIT function indicators. Sustain controls, R52 and R54, generate control voltages that are variable from 0 to about +5 volts.

The selected control voltage is applied to the buses that run along the edge of the tone block circuit boards. Thus, this voltage is a master control that effects the sustain time of all thirty-seven notes of the keyboard. The sustain jacks, J1 and J2, provide an interrupt function for the sustain control voltage. When a plug is inserted into a jack, the voltage on that sustain bus can be remotely varied or switched (shunted) for variable sustain function. The MVH, MVL, MCH and MLH string voice signal buses (*Mix Violins High, Mix Violins Low, Mix Cellos High, and Mix Cellos Low*) are applied to mix controls, R55 and R56.

With these controls, the signals can be shunted to ground in the desired proportions. The resulting mixtures of string voices, as well as the raw piano-bus signal, is fed to additional circuitry for final processing.

In Fig. 2, also note that +V is applied to the common bus of the keyboard, and depression of any key provides, in effect, a logic signal to the tone block circuitry. A positive voltage designates a key being played. The open circuit of a released key is pulled back to ground by an input pull down resistor at each keying input of each tone block. Master buses running throughout the tone blocks also distribute +V, ground, and the split logic signal.

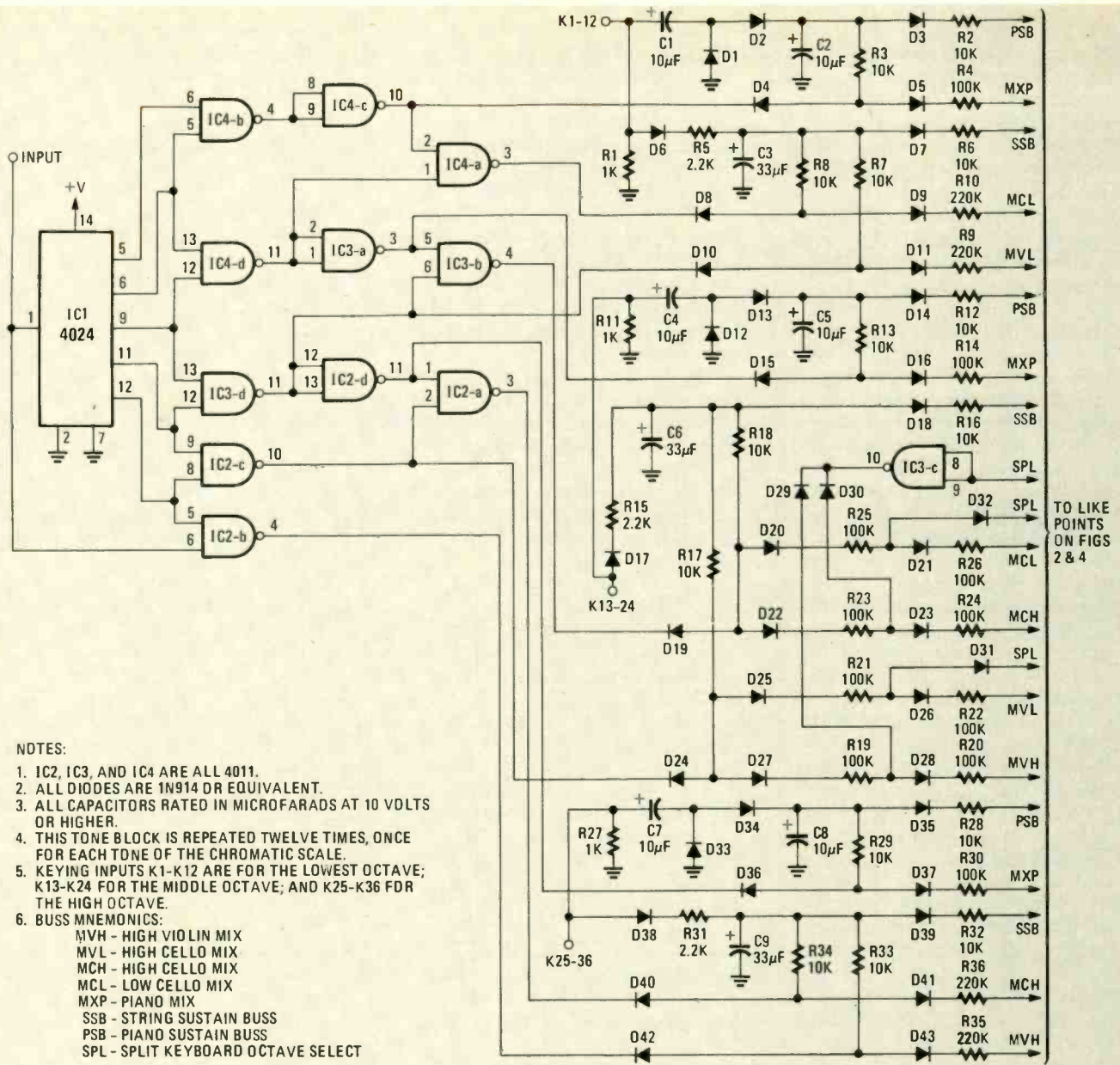

NOTES:

1. IC2, IC3, AND IC4 ARE ALL 4011.
2. ALL DIODES ARE 1N914 OR EQUIVALENT.
3. ALL CAPACITORS RATED IN MICROFARADS AT 10 VOLTS OR HIGHER.
4. THIS TONE BLOCK IS REPEATED TWELVE TIMES, ONCE FOR EACH TONE OF THE CHROMATIC SCALE.
5. KEYING INPUTS K1-K12 ARE FOR THE LOWEST OCTAVE; K13-K24 FOR THE MIDDLE OCTAVE; AND K25-K36 FOR THE HIGH OCTAVE.
6. BUSS MNEMONICS:
 MVH - HIGH VIOLIN MIX
 MVL - HIGH CELLO MIX
 MCH - HIGH CELLO MIX
 MCL - LOW CELLO MIX
 MXP - PIANO MIX
 SSB - STRING SUSTAIN BUSS
 PSB - PIANO SUSTAIN BUSS
 SPL - SPLIT KEYBOARD OCTAVE SELECT

FIG. 3—CIRCUIT OF ONE OF THE TWELVE TONE BLOCKS. These identical circuits provide the necessary waveshaping, keying and mixing for all notes. The mixing and chorusing circuit (Fig. 4) will be presented next month.

The circuitry for one of the twelve tone blocks is shown in Fig. 3. This circuitry generates the waveshaping, keying, and mixing for three octaves of any chromatic note. The twelve tone blocks are identical and all are contained on two large PC boards in addition to the top octave and highest "C" circuitry discussed in the main schematic.

The whole process begins with the input of a high-pitched squarewave from the top-octave generator. This waveform switches between +V and ground, and directly drives the input of the tone block circuitry. IC1 is a 4024 7-stage counter which divides the input frequency into lower octaves. Only the first five divisions, plus the original input, will be used. The first bank of NAND gates (IC4-b and -d, IC3-d and IC2-b and -c) are driven by the counter and used to convert the squarewave signals to pulse waves with a 25% duty cycle.

The harmonic content of this type waveform more closely approximates the sound of a violin. The high-octave violin signal is obtained at pin 4 of IC2-b, while the middle-octave violin appears at pin 10 of IC2-c, and the low violin at pin 11 of IC3-d. The three lowest octaves of NAND gate outputs are additionally fed through inverters consisting of IC4-c, IC3-a, and IC2-a. This inversion maintains proper phase relationships so the remaining waveshaping circuit will operate correctly.

Immediately after inversion, these waveforms are selected for use as the piano signal. At this point, these waveforms still have a 25% duty cycle. Finally, NAND gates IC4-a, IC3-b, and IC2-a are used to mix the inverted waveform with the non-inverted waveform which originated one octave higher. The result is a pulse wave with a 12.5% duty cycle. The extremely wide harmonic spacing

occurring in this waveform very closely approximates a cello waveform, and is consequently used as the signal source for this voicing.

The remaining keying and mixing circuitry is roughly divided into three sections, one for each octave that will be keyed by the keyboard. Additionally, each of these three sections is further divided into a section for strings and another for the piano effect. The input terminal labelled K1-K12 is the lowest octave keying input. NOTE that there is actually only one input at this point to each tone block. However, this one point will be labelled differently for each chromatic tone block. For example: K1 will be in the "C" tone block, K2 in the "C#" tone block, and so on through K12 in the "B" tone block.

When a key is depressed, the keying input jumps to a positive voltage. The first thing to happen is the piano keying.

PARTS LIST

The following lists the components according to type and quantity and is included as an aid to help you acquire the parts necessary to build the model 1550.

Resistors— $\frac{1}{4}$ -watt, 10% unless

otherwise noted

- 5—10 ohms
- 1—100 ohms
- 5—470 ohms
- 46—1000 ohms
- 1—1800 ohms
- 37—2200 ohms
- 6—2700 ohms
- 6—4700 ohms
- 1—8200 ohms
- 205—10,000 ohms
- 1—15,000 ohms
- 3—22,000 ohms
- 147—100,000 ohms
- 50—220,000 ohms
- 1—170,000 ohms

Potentiometers

- 2—100 ohms, trimmer
- 5—1000 ohms, trimmer
- 1—50,000 ohms, trimmer
- 7—5000 ohms, linear taper
- 1—100,000 ohms, dual-section, linear taper

Capacitors

- 1—47 pF disc ceramic
- 2—100 pF disc ceramic

- 1—500 pF disc ceramic
- 10—.001 μ F disc ceramic
- 3—.01 μ F disc ceramic
- 7—.05 μ F disc ceramic
- 1—0.1 μ F Mylar
- 12—1 μ F, 10 volts, electrolytic
- 2—2.2 μ F, 10 volts, electrolytic
- 4—5 μ F, 10 volts, electrolytic
- 82—10 μ F, 10 volts, electrolytic
- 37—33 μ F, 10 volts, electrolytic
- 1—250 μ F, 20 volts, electrolytic
- 1—1000 μ F, 20 volts, electrolytic

Semiconductors

- 12—CD4024 7-stage divider (RCA, National, Motorola)
- 37—CD4011 quad NAND gate (RCA, Motorola, National)
- 1—MK50240 top-octave generator (Mostek, AMI)
- 2—CD4013 Dual D-type flip-flop (Motorola, National, RCA)
- 1—7805 positive 5-volts regulator (Motorola, National, Signetics)
- 1—7905 negative 5-volts regulator (Motorola, National, Signetics)
- 1—CA3080 transconductance amplifier (RCA)
- 2—SAD-1-24 analog delay line (Reticon)
- 4—566 voltage-controlled oscillator (Signetics, National)
- 4—2N5139 or similar NPN transistor

- 1—2N5129, 2N3904 or similar PNP transistor

- 4—1N4003 rectifier diodes
- 527—1N914 silicon switching diode
- 3—TIL209 red light-emitting diode

Miscellaneous

- 1—power transformer, 24 VCT, 1A
- 40—flea clips
- 2—socket, 16-pin DIP (for SAD-1024's)
- control knobs, mounting hardware, case, line cord, etc.

Note: The following are available from Paia Electronics, 1020 W. Wilshire, Oklahoma City, OK 73116:

1550A PC board \$30.00 postpaid

1550B PC board \$30.00 postpaid

1550C PC board \$10.00 postpaid

1550LED PC board \$2.00 postpaid

(All boards are etched, drilled and screened with parts placement layout.)

Set of four PC boards \$70.00 postpaid

A 37-note (3-octave) organ keyboard (Order No. AGO-37) \$60.00 plus \$5.00 postage and handling

Complete kit of parts including case, keyboard and step-by-step instructions (Order No. 1550) \$295.00 shipped freight collect

Fully assembled unit (order No. 1550AS) \$600.00 freight collect.

The positive step-voltage that is dropped across R1 is differentiated by C1. The positive spike generated is sufficient to forward bias D2 and dump a charge on C2. Simultaneously, C1 is charging to absorb that +V which has been applied to it. By the time the positive charging spike for C2 falls and C1 has a full charge, D2 has become reverse biased, eliminating the front end of this circuit as a possible discharge path for the charge on C2. The only possible discharge is through R3 and R4 to the virtual ground of the piano mix bus (MXP). This R—C combination (R3, R4, C2) sets the maximum sustain time for the piano signal.

To get a variable amount of shorter sustain time, the voltage on the piano sustain bus (PSB) can be lowered from about +5 volts to ground with the front panel control. If this bus is anywhere lower than the peak charge of C2 (about +5 volts), D3 becomes forward biased, offering C2 a lower impedance discharge path through R2. This causes the charge on C2 to fall more rapidly than normal thus making the sustain time shorter. When the key is released, the drop in keying voltage across R1 causes a negative spike to be generated by C1. Diode D1 becomes forward-biased by the spike and shorts it to ground. Resistor R1 will then serve to quickly discharge C1, preparing the piano keying circuit for the next key depression.

The only remaining section of the piano circuit is the signal-gating (envelope or amplitude contour) circuitry built around D4 and D5. This circuit is the

standard diode-keying configuration that has been used in electronic organs for quite some time. The pulse wave being used as the piano-signal source is being continuously applied to the cathode of D4. While the piano circuit is at rest, C2 is discharged leaving the anode of D4 at ground. This leaves D4 continuously reverse-biased and stops any signal transmission through it. When a key is pressed, a pattern of rising and falling DC voltage is generated across C2 as described earlier. This voltage will now forward bias D4 and allow the piano signal to pass. When the piano signal happens to be at a high level (the top of the pulse wave), the voltage at the junction of D4 and D5 will be pulled up to a DC voltage equivalent to the charge remaining on C2. When the piano pulse wave switches to a low level (near ground), D4 conducts and the junction of D4 and D5 will be pulled nearly to ground.

This high-speed (audio frequency) switching continues until the C2 charge has been depleted via the discharge path through R3 and R4. From the previous discussion, we see that the charge on C2 has a sharp increase followed by a long decay. The audio signal passed through D4 and D5 takes on the same attack and decay characteristics, thus duplicating the effect of a plucked or hammered piano string.

Diode D5 is used primarily to avoid interaction with other notes which may be simultaneously applied to the audio mix buses. In addition to being one of the

major determinants of the timing for the piano effect, R4 is also used as a mixing resistor and gain-setting component for this one piano note.

The same low-octave keying input we have been discussing for the piano circuits will also be used to gate a violin and cello sound at the same time. The keying voltage applied to R1 will forward bias D6 and cause C3 to charge via R5. The larger value of C3 and the current limiting of R5 cause C3 to charge more slowly, generating a "softer" attack, to more closely imitate the build-up that occurs when a section of strings bows a new note. This DC voltage is concurrently applied to two diode keying sections. Resistor R8, D8, and D9 are used to gate the low-octave cello signal being applied to D8. Resistor R7, D10, and D11 impose envelope control on the violin signal.

The entire keying section for the top octave of the tone block is identical to the circuitry we have just covered. The high-octave keying inputs are K25 through K36, and the high-octave signal sources are tapped from higher frequency outputs of the NAND gate waveshaping circuit. Also, the violin and cello outputs from the high-octave keying are permanently connected to the high-violin and cello-mix buses. Otherwise, the circuits are the same.

Next month we will discuss the power supply and the middle-octave mixing and chorusing circuits and then go on to construction details. This will include foil patterns for the PC boards and diagrams showing parts placement.

R-E

Solar Tracking System

Solar-energy collectors work best when constantly oriented to trap the most energy from the sun. This electronic servo system swivels the collector panel so it follows the sun across the sky.

RODNEY A. KREUTER

THE MOST COMMON USES FOR SOLAR energy systems today are space heating and hot-water preheating. These systems generally use nonmovable flat-plate collectors; and for a low-temperature system, flat plate is probably the best choice. If, however, your system needs high-temperature water or steam, or uses solar cells to generate electricity, a tracking system is the only way to go.

A solar tracking system consists of a motor-sensor combination that locates the sun and points a collector toward it. A non-sensing system can even be built using a constant speed motor, but such a system has more disadvantages than advantages.

The solar collector tracking system discussed in this article is intended as a guide, not as an absolute system. (For example, why track the sun if there is little or no energy to be gained?) We'll examine how to construct a simple circuit using a com-

parator that will not let the motor operate until a certain level of sunlight is present.

The basic system

Figure 1 shows a block diagram of the solar tracking system, which consists of four basic modules: 1) a pair of phototransistor sensors; 2) a difference amplifier; 3) a deadband amplifier; and 4) a servomotor and motor drive transistors.

Figure 2 shows how the phototransistor sensor is constructed. Note that the phototransistors are mounted on perpendicular surfaces so that a shadow effect occurs when the sun is not directly overhead.

The difference amplifier (see Fig. 1) subtracts the output of sensor B from the output of sensor A and multiplies the result by about 4.7.

The deadband amplifier is a fairly unique device. It amplifies the output of the difference amplifier by about

2.5 only if the output of the difference amplifier is greater than 0.6 volt

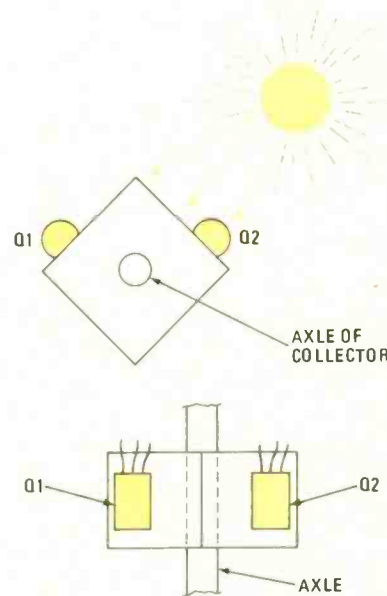

FIG. 2—PHOTOTRANSISTOR SENSORS are mounted at right angles to each other. The output of the sensors are equal when the sun is directly over the apex.

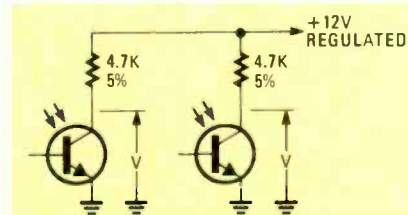

FIG. 3—PHOTOTRANSISTOR SENSORS must have matched outputs for correct circuit operation. Circuit above provides easy method for obtaining matched outputs.

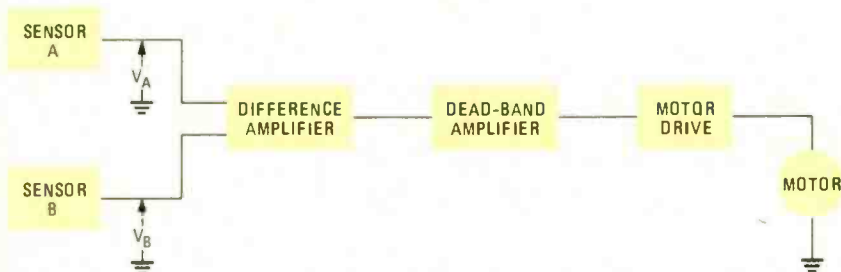
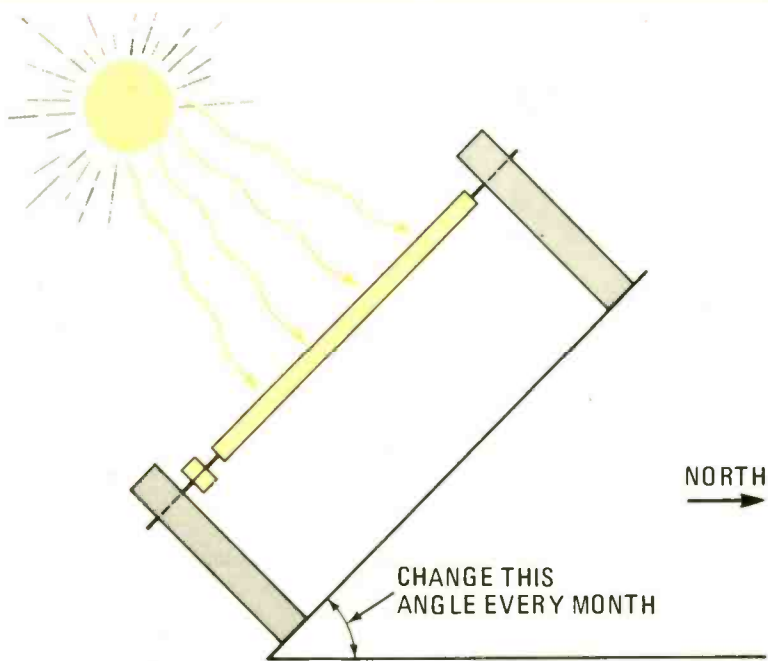

FIG. 1—SOLAR TRACKING SYSTEM uses phototransistor sensors to detect the position of the sun. Circuitry drives motor to position solar energy panels and minimize the difference in output from the two sensors.



or less than -0.6 volt. If the output of the difference amplifier is between -0.6 volt and 0.6 volt, the deadband amplifier provides a stable zero volt output.

The servomotor drive circuit consists of four push-pull Darlington connected transistors, which produce enough current to drive a fair-sized 12-volt motor.

Circuit operation

Two phototransistors are used as brightness sensors. When operated from a constant-voltage power supply, the collector current of each transistor is proportional to the amount of illumination they receive.

Due to variations in manufacturing processes, the phototransistors may not be well matched, so it is a good idea to buy a few extra phototransistors and match them yourself. The procedure is very simple.

First, breadboard the circuit shown in Fig. 3. Place two phototransistors side by side with the flat side down. Shine a *diffused* light source (a handkerchief placed over a bare high-intensity bulb will do) on the transistors. Note that the base connection is not used.

Apply power to the circuit and measure the voltage from one of the collectors to ground; this will be your reference transistor. Adjust the dis-

tance of the light source so that the reference voltage reads about 3. Measure the collector voltage of the second transistor and write it down. Repeat this procedure with a reference voltage of 6 and 9, measuring all the transistors against the same reference transistor. Select the two transistors that give the closest results for your sensors.

PARTS LIST

- All resistors $\frac{1}{2}$ watt, 10%.
- R1—1000 ohms (to start—see text)
 - R2—680 ohms (to start—see text)
 - R3—500-ohm trimmer (to start—see text)
 - R4, R6, R12, R13—100,000 ohms
 - R5, R7—470,000 ohms
 - R8—5000-ohm trimmer
 - R9, R10—3300 ohms
 - R11—10,000 ohms
 - R14, R15—1000 ohms
 - C1—C4—0.0001 μ F
 - C5, C6—0.1 μ F
 - D1—D4—1N914
 - D5, D6—50-volt rectifiers (current rating depends on motor current)
 - Q1, Q2—2N5777 photodarlington or equal
 - Q3—2N2222
 - Q4—MJE3055
 - Q5—2N2907
 - Q6—MJE2955
 - A1, A2—Op-amps, dual 741, 1558, 747, two 741's, two 301's, etc. Pin numbers depend on type and case style; 3900 or 324 types not recommended.
 - S1, S2—Normally closed switches
 - M1—12-volt reversible motor
 - Misc.—Power supply, case, shielded cable for sensors, etc.

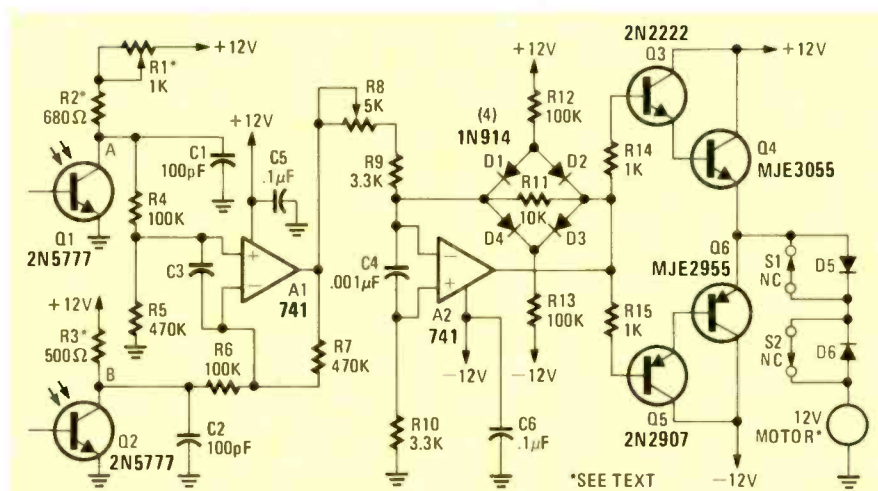

FIG. 4—CIRCUITRY detects difference in output from phototransistor sensors and switches the Darlington motor-drive transistors to minimize the difference.

This matching may sound confusing but remember, you need two transistors that will give equal output voltages when illuminated equally. Small variations can be compensated for by the circuit, so it's not critical if the transistors are not matched exactly.

Figure 4 shows the schematic diagram of the tracking system. Difference amplifier A1 is fairly straightforward. Its output can vary from about -11 to 11 volts. The output polarity determines the direction the collector must move and the magnitude determines how far it must move. The whole idea is to move the collector and sensors so that the two phototransistors are equally illuminated by the sun. This condition occurs when the outputs from the two phototransistors are equal.

In electronics, two voltages are almost never equal for any period of time. I learned this the hard way by trying to get a simple comparator to output zero volts when the two input voltages were "equal." I didn't take drift into account.

The deadband circuit is an "almost equal" circuit. If the output of the difference amplifier is almost zero (meaning the two sensor outputs are almost equal), the output of the deadband amplifier will be zero. If the output of the difference amplifier exceeds the "deadband range," the output of the deadband amplifier heads for the rails (positive or negative saturation, in this case -12 or 12 volts). The amount of deadband output is adjustable by R8, and, with the values shown, can vary from about ± 0.37 volt to ± 0.95 volt.

Transistors Q3-Q6 are used as current amplifiers since the output of the op-amp cannot drive a motor directly. Almost any transistor types can be used as long as they can handle the motor current.

Normally closed switches S1 and S2 are placed at the two travel limits of the collector. When the collector reaches one of these limits, a switch opens, and this places a diode in the motor's current path. If the motor and diodes are connected correctly, this will prevent the collector from moving any farther in this direction but will allow the motor to reverse the current. You may have to reverse the polarity of both diodes depending on the type motor used.

Construction

Since only one IC is used for the

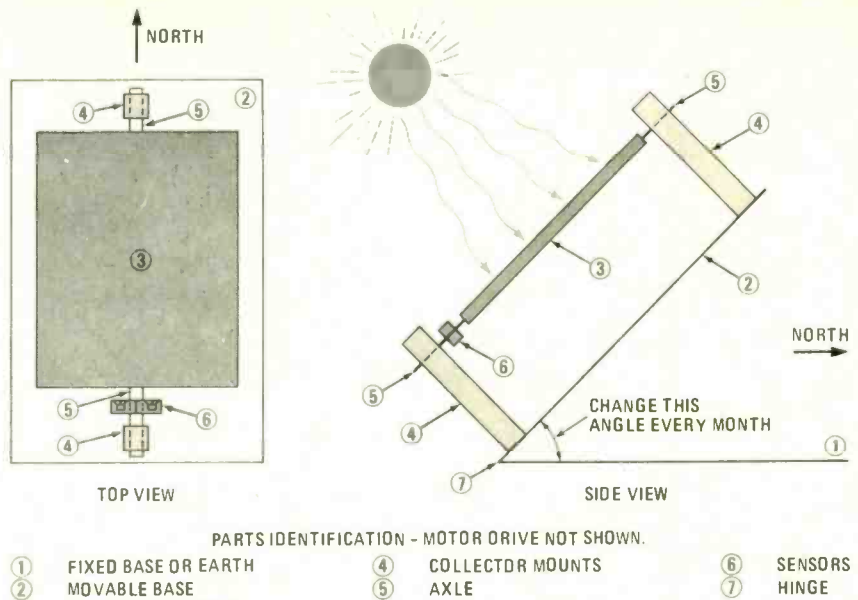

FIG. 5—SENSOR UNIT is correctly mounted on the axis of the solar energy panels.

tracking system, almost any type of construction is possible, including PC or perforated board construction and the component layout is not critical.

Heat-sink output transistors Q4 and Q6 if your motor draws more than 500 mA.

Use trimmers for R1 and R8 since they are only set once.

Mount the sensors on the axle of the collector, not on the collector itself. Mounting them on the collector would cause the collector to overshadow the sensors in the morning (see Fig. 5). Paint the area around the sensors with flat black paint so that they will not respond to reflections.

Use a 12-volt reversible motor that draws less than approximately 6 amps with the transistors shown. The power supply must be able to handle the total motor load so make sure it is sized accordingly. It's a good idea to provide the final transistors with their own unregulated power supply, and the rest of the circuit should have a regulated 12-volt supply. The total current drawn by the op-amps is negligible, so a pair of Zener diodes should be adequate.

The motor should be geared down so that running flat out, the collector takes about 10 minutes to travel from one limit to the other. A small motor geared down as much as this will move a fair-sized collector.

Adjustments

Since the angle of the sun changes very slowly throughout the year, changing the angle of the collector

once a month should be sufficient.

For the following electrical adjustments you will need: a bright sunny day; the circuit described in this article and a geared-down motor connected to a collector-sensor; a VOM; and a 12-volt bipolar power supply.

With the collector and sensors pointed *directly* at the sun and the motor disconnected, measure the output of the two sensors. Resistors R1, R2 and R3 may have to be changed to compensate for transistor variations. Even though they should be matched, the light current can vary by a factor of 100. For example, with a white light source of 2 mw-per-cm² falling on a 2N5777, the collector current can vary from 0.5 mA to 50 mA. (Remember that while you are testing, the sun is moving, so you must keep the collector pointed directly at the sun.)

Select an R3 resistor that will yield an output of about 3 volts with a bright sun. Raising the resistance will drop the voltage. Resistor R2 should equal about 70% of resistor R3 and resistor R1 about 60%; use the closest standard values.

After selecting R1, R2 and R3, point the sensors directly at the sun again and measure V_a and V_b . Adjust R1 until these values are equal, and connect the motor.

The setting of R8 determines how far the sun must move before the tracking system compensates for the movement. Your system requirements will determine your choice. If the system seems to "hunt," increase the setting of R8.

Audio Test Station

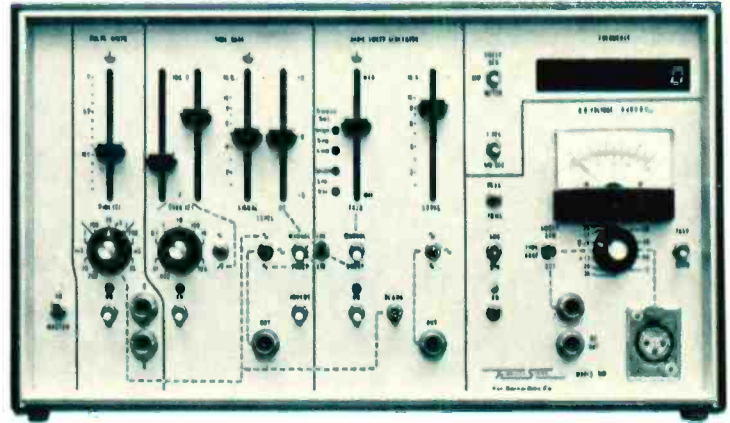

Part 2—A host of precision instruments are required if you want to put high-quality audio equipment through its paces. This month we cover the test station's power supply and timebase circuits.

RAY DAVISON

THIS, THE SECOND ARTICLE DESCRIBING Fidelity Sound's model 101 Audio Test System describes the power supply and timebase circuits and presents the construction details for these sections. Last month, we presented the overall block diagram and described the general operation of the model 101.

The traditional straightforward and largely self-explanatory power-supply circuit is shown in Fig. 3. The timebase and audio-generator output amplifiers are supplied by single-stage regulated supply. The rest of the analog circuitry is double-regulated. The pulse and counter sections have individual regulators. The diode/R-C circuits coming directly from the secondary of the transformer provide the

trigger for the counter timebase.

The timebase circuit is shown in Fig. 4. The basis of this section is oscillator IC201. It is an emitter-coupled multivibrator that can be considered as an integrator and a comparator in a closed loop. The output of the comparator will always be one of two possible voltages. The output of the integrator will be a straight line whose slope is a function of the

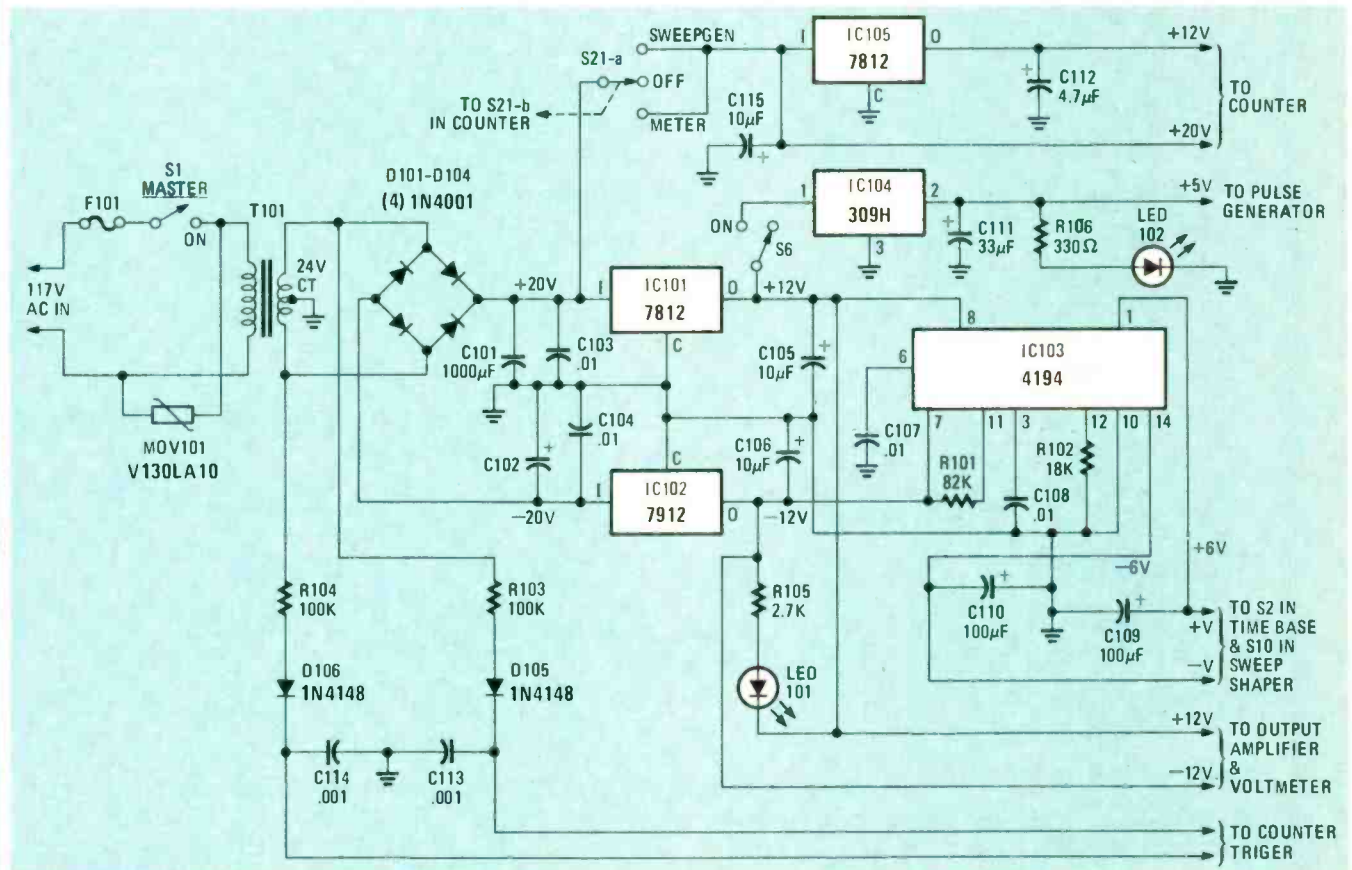

FIG. 3—THE POWER SUPPLY delivers all the operating voltages required by the various internal circuits. Some supply sources are double-regulated.

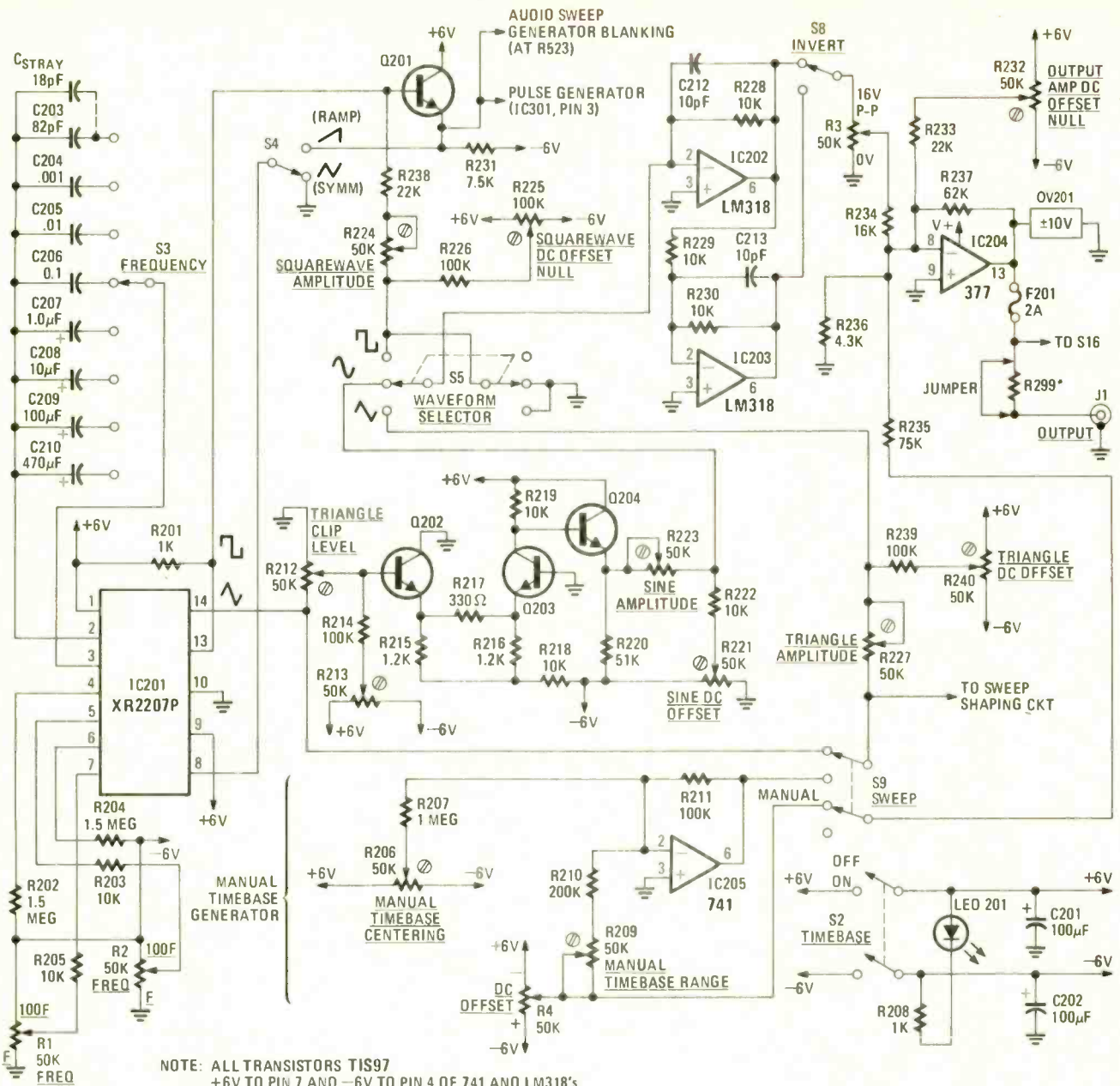

FIG. 4—THE TIMEBASE GENERATOR is designed around the Exar 2207 current-controlled oscillator. Frequency is determined by switchable capacitors and two side pots on the front panel.

TIMEBASE

Resistors, 1/4 watt, 5% unless otherwise specified

R201, R208—1000 ohms
 R202, R204—1.5 megohms
 R203, R205, R218, R219, R222, R228–R230—10,000 ohms
 R206, R209, R212, R213, R221, R223–R225, R227, R232, R240—50,000 ohms, trimmer
 R207—1 megohm
 R210—200,000 ohms
 R211, R214, R226, R233, R239—100,000 ohms
 R215, R216—1200 ohms
 R217—310 ohms
 R220—51,000 ohms
 R231—7500 ohms

R234—16,000 ohms
 R235—75,000 ohms
 R236—4300 ohms
 R237—62,000 ohms
 R238—22,000 ohms
 R299—See text
Capacitors
 C201, C202—100 μ F, 10 volts
 C203—82 pF
 C204—0.001 μ F
 C205—0.01 μ F
 C206—0.1 μ F
 C207—1.0 μ F, aluminum electrolytic, low voltage, low leakage. See text.
 C208—10 μ F, aluminum electrolytic, low voltage, low leakage. See text.
 C209—100 μ F, aluminum electrolytic, low

voltage, low leakage. See text.
 C210—470 μ F, aluminum electrolytic, low voltage, low leakage. See text.
 C212, C213—10 pF
 Q201–Q204—TIS97
 IC201—XR-2207
 IC202, IC203—LM318
 IC204—LM377
 IC205—LM741
 OV201—LA 10 over-voltage limiter
 F201—2-amp fuse
 S2, S9—SPDT toggle switch
 S3—SPDT rotary switch
 S4, S8—SPDT toggle switch
 S5—DPDT toggle switch
 J1—BNC panel jack

POWER SUPPLY

Resistors 1/4 watt, 5% unless otherwise noted

- R101—82,000 ohms
- R102—18,000 ohms
- R103, R104—100,000 ohms
- R105—2700 ohms

R106—330 ohms

Capacitors

- C101—1000- μ F, 16-volt, electrolytic (two 500 μ F in parallel)
- C102—500 μ F, 16-volt electrolytic
- C103, C104, C107, C108—0.01- μ F disc

C105, C106, C115—10- μ F, 16-volt electrolytic

- C109, C110—100- μ F, 16-volt electrolytic
- C111—33- μ F, 16-volt electrolytic
- C112—4.7- μ F, 16-volt electrolytic
- C113, C114—0.001- μ F disc

Miscellaneous

- MOV1-V130LA10 thyristor
- D101—D104—1N4001
- D105—D106—1N4148
- IC101, IC105—7812
- IC102—7912
- IC103—4194
- IC104—309H
- LED1, LED2—
- T101—24-volt, 1-amp transformer
- F101—
- S1—SPST toggle switch
- S21—DP3T toggle switch

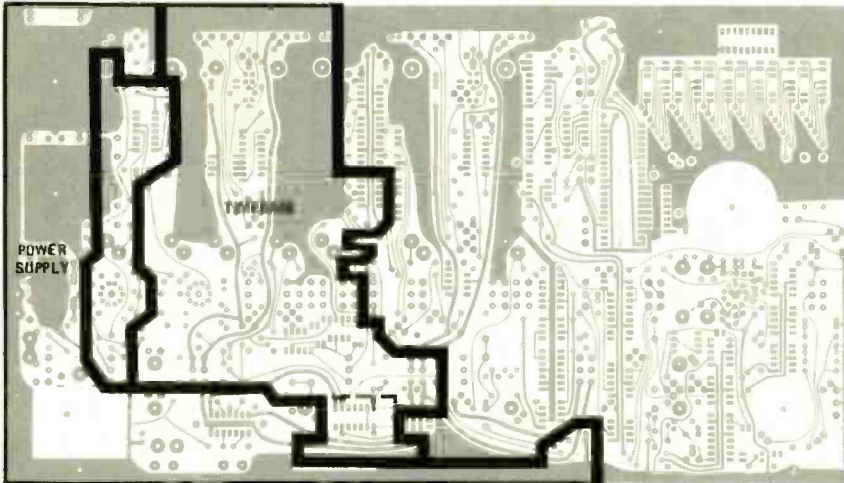

FOIL PATTERN of the component side of the PC board overlaid with the outlines of the power supply and timebase sections that are shown in the parts-placement illustration below.

The following are available from FSI, 1894 Commercenter W., No. 105, San Bernardino, CA 92408: Complete kit, \$495.00; cabinet and circuit board, \$115.00. Set of semiconductors, \$195.00; seven slide pots with knobs, \$17.00, set of trimmers including four multiturn pots, \$17.00.

California residents add state and local taxes as applicable.

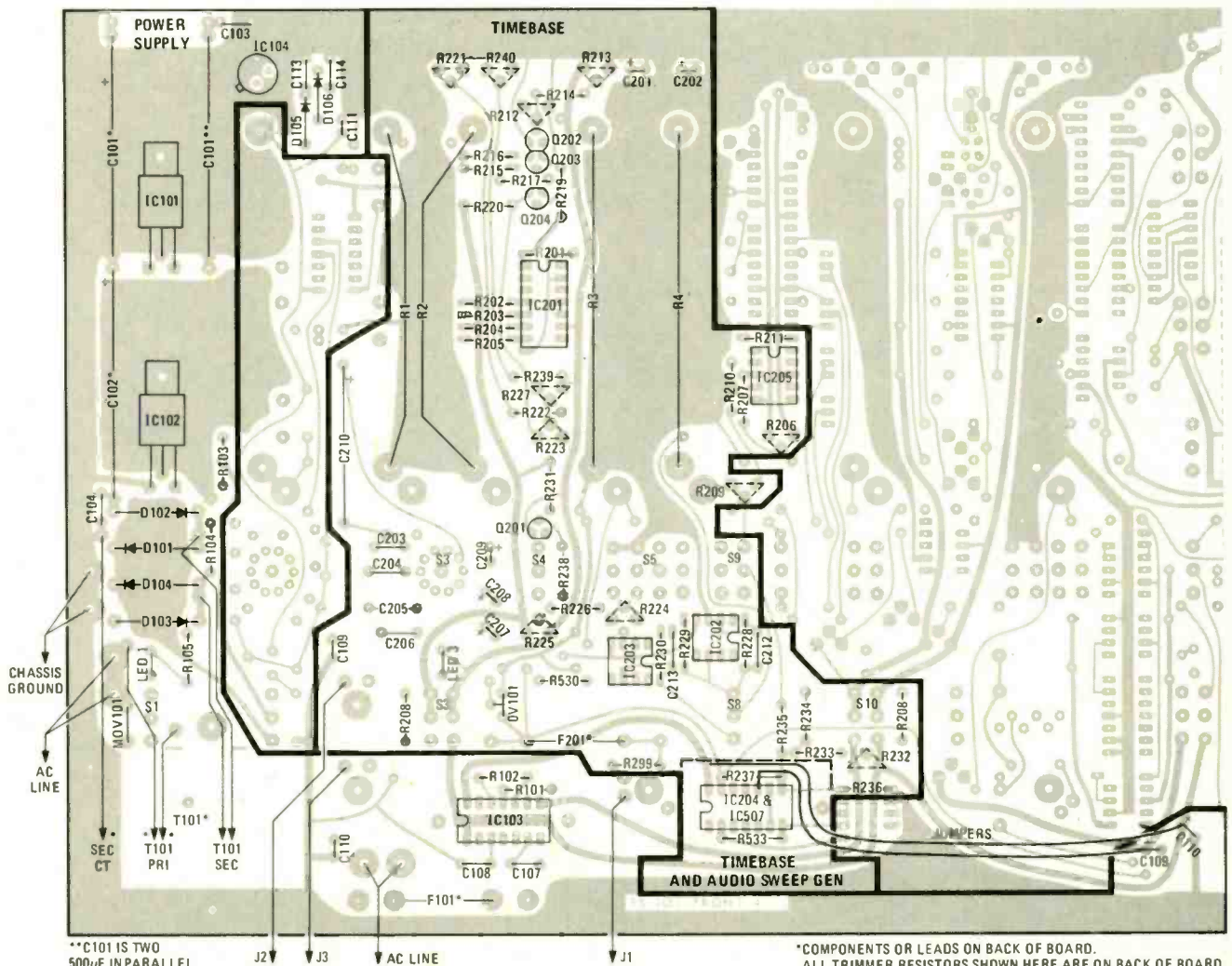

**C101 IS TWO 500 μ F IN PARALLEL

*COMPONENTS OR LEADS ON BACK OF BOARD. ALL TRIMMER RESISTORS SHOWN HERE ARE ON BACK OF BOARD.

COMPONENT LAYOUT for the power supply and timebase generator are shown. Power supply parts are coded in the 100 series and timebase parts in the 200 series. Components on the front panel have codes beginning with 1.

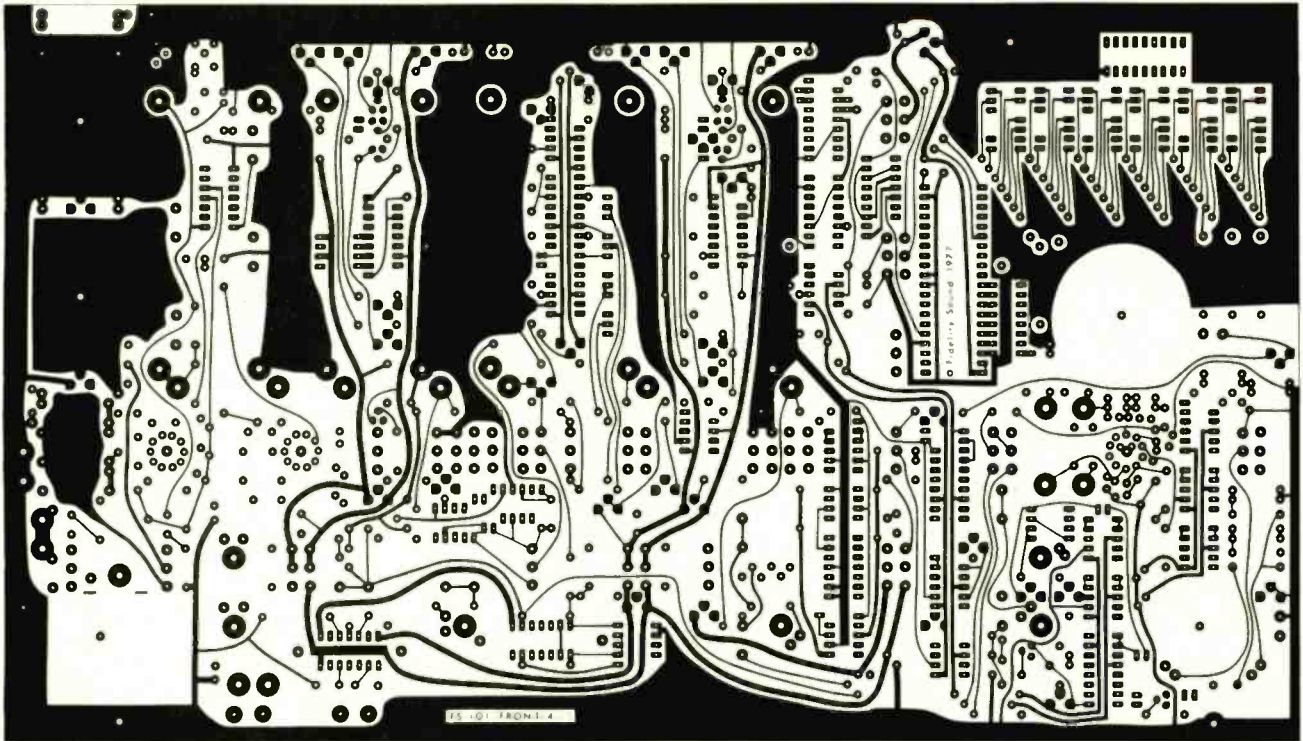

PRINTED CIRCUIT PATTERN for the front side of the PC board shown half size. Most components are on this side.

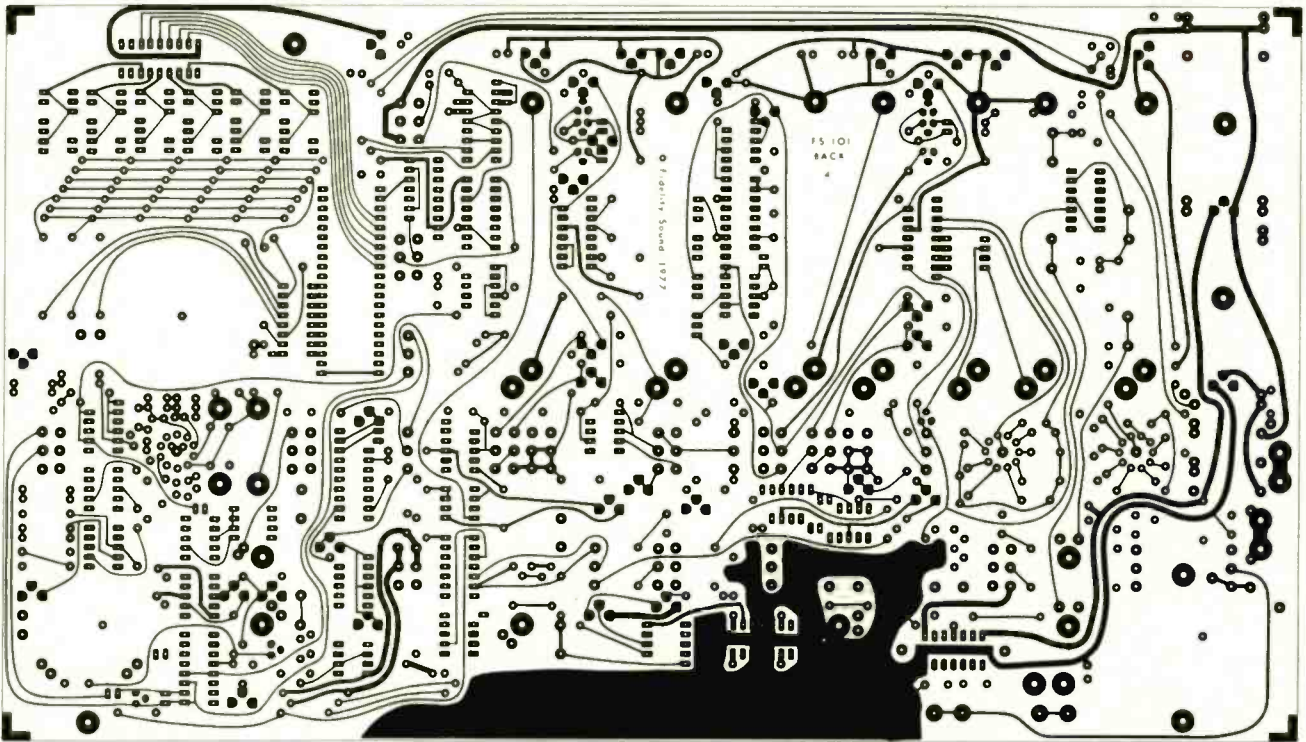

FOIL PATTERN for the back surface of the board shown half size. It carries the fuses and most trimmers.

charging current supplied to the capacitor. The output of the integrator is then fed back to the comparator.

The integrator is essentially a constant-current source applied to a capacitor. If the current applied to the capacitor is constant, the change in voltage across that capacitor will also be constant. When power is applied, the output of the comparator begins to charge the capacitor through the constant-current source. This causes the voltage across the capacitors to rise linearly. When that voltage, which is

applied back to the comparator, reaches a predetermined point, the comparator switches states and begins to charge the capacitor in the reverse direction. This causes the voltage across the integrating capacitor to change linearly in the opposite direction.

The result is that the output of the integrator is a triangle wave and the output of the comparator is a squarewave. The peaks of the triangle wave align with the edges of the squarewave since it is these edges that cause the integrator to

change its output slope. If the charging rates represented by the plus and minus slopes of the integrator are equal, the slopes will be of equal magnitude and opposite sign, and, hence, both the triangle wave and the squarewave will be symmetrical.

The output of the integrator is at IC201 pin 14, and the comparator output is at pin 13. Both these outputs are buffered and do not represent the actual oscillator voltages.

continued on page 78

Cases And Cabinets For Your Projects

ONE OF THE MAJOR CONSIDERATIONS FACING THE amateur electronic experimenter and constructor is the physical layout and appearance of the finished project. In the days of vacuum tube and 12 by 16 in. chassis, most projects could be finished off nicely by adding a front panel and slipping the whole thing into a cabinet that could be handcrafted from wood or readily available sheet metals. Today, most electronic projects are assembled on printed-circuit boards or similar materials and are sometimes only one-tenth the size of its old vacuum-tube equivalent.

To select a case or enclosure that is most suitable for your project, you must have a pretty good idea as to what is available. Too, if your make and model specified in a magazine article is not available through your usual supplier, you should be aware of equivalents and possible substitutes. These charts list off-the-shelf enclosures, cases and chassis boxes in various material combinations, colors and sizes.

These charts list cases and cabinets not covered in the June and October 1978 issues of *Radio-Electronics*. While every effort has been made to ensure that these charts are as complete as possible, it is not always possible to include all the options and ordering information. It is, therefore, a good idea to obtain catalogs from the manufacturers.

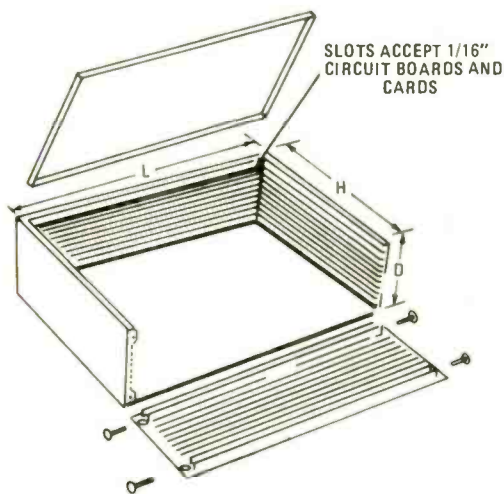

INSTRUMENT CASES

Internal side walls are grooved to position and hold PC boards. Both base and two side panels are removable for easy access to contents.

To find out more about the products or distributors, a list of addresses of each manufacturer follows. To obtain a catalog, simply circle the corresponding No. on the Free Information card.

Apollo — Box 245, Vaughnsville, OH 45893. **Circle No. 135.**
Buckeye — 555G Marion Road, Columbus, OH 43207. **Circle No. 136.**

Bud Electronics — Dept. G., 4605 East 355 Street, Willoughby, OH 44094. **Circle No. 137.**

GC Electronics — Division of Hydrometals, Inc., Rockford, IL 61101. **Circle No. 138.**

Intra Fab, Inc. — 660 Lenfest Rd. San Jose, CA 95133. **Circle No. 139.**

Lafayette Electronics — 111 Jericho Turnpike, Syosset, NY 11791. **Circle No. 140.**

La France — Enterprise and Executive Avenues, Philadelphia PA 19153. **Circle No. 141.**

LMB Products — 725 Ceres Avenue, Los Angeles, CA 90021. **Circle No. 142.**

Premier Metals — 381 Canal Place, Bronx, NY 10451. **Circle No. 144.**

Radio Shack — 2617 West 7th Street, Ft. Worth TX 76107. **Circle No. 144.**

Rose/Stahlin — 500 Maple Street, Belding, MI 48809. **Circle No. 145.**

Scientific-Atlanta — Optima Enclosures-2166 Mountain Industrial Road, Tucker, GA 30084. **Circle No. 146.**

TenTec, Inc. — Dept. G., Industrial Park, Sevierville, TN 37862. **Circle No. 147.**

Vector Electronics Co. — 12460 Gladstone Ave., Sylmar, CA 91342. **Circle No. 148.**

Vero Electronics, Inc. — 171 Bridge Road, Hauppauge, NY 11787. (516) 234-0400. **Circle No. 149.**

Zero Mfg. — 777 Front Street, Burbank, CA 91503. **Circle No. 150.**

Length	Height	Depth	Mfr.	Model No.	Case Material	Comments	Options	Color
1.21	1.21	1.6	Vector	W-16-12-12B	Al	holds 1/16" p.c. cards	inner panels, base	consult mfr for latest colors
1.51	1.51	2.0	Vector	W20-15-15B	Al	holds 1/16" p.c. cards	inner panels, base	consult mfr for latest colors
2.31	3.81	1.0	Vector	W10-23-38B	Al	holds 1/16" p.c. cards	inner panels, base	consult mfr for latest colors

chart continued on following page

INSTRUMENT CASES

Length	Height	Depth	Mfr.	Model No.	Case Material	Comments	Options	Color
2.85	2.11	4.5	Vector	W45-28-21B	Al	holds 1/16" p.c. cards	inner panels, base	consult mfr for latest colors
2.85	4.61	1.6	Vector	W16-28-46B	Al	holds 1/16" p.c. cards	inner panels, base	consult mfr for latest colors
2.85	4.61	2.0	Vector	W20-28-46B	Al	holds 1/16" p.c. cards	inner panels, base	consult mfr for latest colors
3.10	2.11	1.6	Vector	W16-31-21B	Al	holds 1/16" p.c. cards	inner panels, base	consult mfr for latest colors
3.10	3.10	1.6	Vector	W16-31-31B	Al	holds 1/16" p.c. cards	inner panels, base; bezels	consult mfr for latest colors
3.10	3.10	2.0	Vector	W20-31-31B	Al	holds 1/16" p.c. cards	inner panels, base; bezels	consult mfr for latest colors
3.10	4.17	2.0	Vector	W20-42-31B	Al	holds 1/16" p.c. cards	inner panels, base	consult mfr for latest colors
4.61	2.11	4.5	Vector	W45-46-21B	Al	holds 1/16" p.c. cards	inner panels, base	consult mfr for latest colors
4.61	3.10	2.0	Vector	W20-46-31B	Al	holds 1/16" p.c. cards	inner panels, base; bezels	consult mfr for latest colors
4.61	3.61	2.0	Vector	W20-46-36B	Al	holds 1/16" p.c. cards	inner panels, base	consult mfr for latest colors
4.61	4.62	3.0	Vector	W30-46-46B	Al	holds 1/16" p.c. cards	inner panels, base; bezels	consult mfr for latest colors
4.61	6.17	2.0	Vector	W20-46-62B	Al	holds 1/16" p.c. cards	inner panels, base	consult mfr for latest colors
4.61	6.61	2.0	Vector	W20-46-66B	Al	holds 1/16" p.c. cards	inner panels, base; bezels	consult mfr for latest colors
6.61	3.61	2.0	Vector	W20-66-36B	Al	holds 1/16" p.c. cards	inner panels, base	consult mfr for latest colors
6.61	4.61	2.0	Vector	W20-66-46B	Al	holds 1/16" p.c. cards	inner panels, base, slide panels, bezels	consult mfr for latest colors
6.61	4.61	3.0	Vector	W30-66-46B	Al	holds 1/16" p.c. cards	inner panels, base; slide panels, bezels	consult mfr for latest colors
6.61	4.61	4.5	Vector	W45-66-46B	Al	holds 1/16" p.c. cards	inner panels, base; slide panels, bezels	consult mfr for latest colors
8.61	4.61	3.0	Vector	W30-86-46B	Al	holds 1/16" p.c. cards	inner panels, base; slide panels, bezels	consult mfr for latest colors
8.61	4.61	4.5	Vector	W45-86-46B	Al	holds 1/16" p.c. cards	inner panels, base; slide panels, bezels	consult mfr for latest colors
10	4.61	3.0	Vector	W30-100-46B	Al	holds 1/16" p.c. cards	inner panels, base	consult mfr for latest colors
10	4.61	4.5	Vector	W45-100-46B	Al	holds 1/16" p.c. cards	inner panels, base	consult mfr for latest colors
10	6.61	3.0	Vector	W30-100-66B	Al	holds 1/16" p.c. cards	inner panels, base	consult mfr for latest colors
10	6.61	4.5	Vector	W45-100-66B	Al	holds 1/16" p.c. cards	inner panels, base	consult mfr for latest colors
13	7	8	Bud	MD-1960	Steel	removable side & top	1963 for slope front	grey or blue

chart continued on following page

INSTRUMENT CASES

Length	Height	Depth	Mfr.	Model No.	Case Material	Comments	Options	Color
14	8	9	Bud	MD-1961	Steel	removable side & top	1964 for slope front	grey or blue
16	8	9	Bud	MD-1962	Steel	removable side & top	1965 for slope front	grey or blue

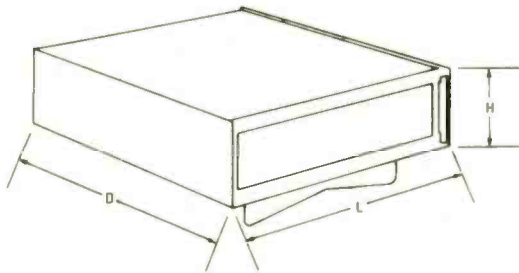

PORTABLE INSTRUMENT CASES

Modern design with handles and tilt stands available. Some are even adaptable to rack mounting.

Length	Height	Depth	Mfr.	Model No.	Case Material	Comments	Options	Color
5-7/10	3-1/2	13	Buckeye	3501	Al	concealed fasteners	tilt stand rack adapter	grey with suede-like finish consult mfr for color
5-7/10	5-1/4	13	Buckeye	5251	Al	concealed fasteners	tilt stand rack adapter	
5-7/10	7	13	Buckeye	7001	Al	concealed fasteners	tilt stand rack adapter	
5-7/10	8	13	Buckeye	8001	Al	concealed fasteners	tilt stand rack adapter	
5-7/10	8-3/4	13	Buckeye	8751	Al	concealed fasteners	tilt stand rack adapter	
5-7/10	10-1/2	13	Buckeye	1051	Al	concealed fasteners	tilt stand rack adapter	
8-1/2	3-1/2	13	Buckeye	3502	Al	concealed fasteners	tilt stand rack adapter	Stock and custom colors. Consult manufacturer
8-1/2	5-1/4	13	Buckeye	5252	Al	concealed fasteners	tilt stand rack adapter	
8-1/2	7	13	Buckeye	7002	Al	concealed fasteners	tilt stand rack adapter	
8-1/2	8	13	Buckeye	8002	Al	concealed fasteners	tilt stand rack adapter	
8-1/2	8-3/4	13	Buckeye	8752	Al	concealed fasteners	tilt stand rack adapter	
8-1/2	10-1/2	13	Buckeye	1052	Al	concealed fasteners	tilt stand rack adapter	
8-1/2	2-7/16	9-1/4	La France	CH 200	ABS	detented tilt/carry handle	without handle	Stock and custom colors. Consult manufacturer
8-1/2	2-11/16	9-1/4	La France	CH 225	ABS		without handle	
8-1/2	2-15/16	9-1/4	La France	CH 250	ABS		without handle	
8-1/2	3-3/16	9-1/4	La France	CH 275	ABS		without handle	
8-1/2	3-7/16	9-1/4	La France	CH 300	ABS		without handle	
8-1/2	3-11/16	9-1/4	La France	CH 325	ABS		without handle	
8-1/2	4-7/16	9-1/4	La France	CHS 400	ABS		without handle	
8-1/2	5-7/16	9-1/4	La France	CHS 500	ABS		without handle	
8-1/2	6-7/16	9-1/4	La France	CHS 600	ABS		without handle	

chart continued on following page

PORTABLE INSTRUMENT CASES

Length	Height	Depth	Mfr.	Model No.	Case Material	Comments	Options	Color
9-1/2	3-1/2	13	Premier	TIC-030913	Al/vinyl	top carrying handle	↑ tilt stand rack adapters PC card cages ↓	↑ 13 stock colors avail- able. Consult manufacturer ↓
9-1/2	5-1/4	13	Premier	TIC-050913	Al/vinyl	top carrying handle		
9-1/2	7	13	Premier	TIC-070913	Al/vinyl	top carrying handle		
9-1/2	8-3/4	13	Premier	TIC-080913	Al/vinyl	top carrying handle		
9-1/2	10-1/2	13	Premier	TIC-100913	Al/vinyl	top carrying handle		
9-1/2	12-1/4	13	Premier	TIC-120913	Al/vinyl	top carrying handle		
9-1/2	14	13	Premier	TIC-140913	Al/vinyl	top carrying handle		
9-1/2	3-1/2	17	Premier	TIC-030917	Al/vinyl	side carry handgrips		
9-1/2	5-1/4	17	Premier	TIC-050917	Al/vinyl	side carry handgrips		
9-1/2	7	17	Premier	TIC-070917	Al/vinyl	side carry handgrips		
9-1/2	8-3/4	17	Premier	TIC-080917	Al/vinyl	side carry handgrips		
9-1/2	10-1/2	17	Premier	TIC-10017	Al/vinyl	side carry handgrips		
9-1/2	12-1/14	17	Premier	TIC-120917	Al/vinyl	side carry handgrips		
9-1/2	14	17	Premier	TIC-14017	Al/vinyl	side carry handgrips		
11-1/3	3-1/2	13	Buckeye	3503	Al	concealed fasteners	↑ tilt stand; rack adapter tilt stand; rack adapter tilt stand; rack adapter tilt stand; rack adapter tilt stand; rack adapter ↓	↑ grey with suede-like finish. Consult mfr. for stock colors ↓
11-1/3	5-1/4	13	Buckeye	5253	Al	concealed fasteners		
11-1/3	7	13	Buckeye	7003	Al	concealed fasteners		
11-1/3	8	13	Buckeye	8003	Al	concealed fasteners		
11-1/3	8-3/4	13	Buckeye	8753	Al	concealed fasteners		
11-1/3	10-1/2	13	Buckeye	10503	Al	concealed fasteners		
12-1/2	6-3/4	11-5/8	La France	CLS 625	ABS		↑ tilt stand tilt stand tilt stand ↓	↑ Stock and custom color Consult manufacturer ↓
12-1/2	7-3/4	11-5/8	La France	CLS 725	ABS			
12-1/2	8-3/4	11-5/8	La France	CLS 825	ABS			
15-5/8	3-1/2	13	Premier	TIC-031513	Al/vinyl	side carry handgrips	↑ tilt stand; PC card cages tilt stand; PC card cages tilt stand; PC card cages tilt stand; PC card cages tilt stand; PC card cages ↓	↑ ↓
15-5/8	5-1/4	13	Premier	TIC-051513	Al/vinyl	side carry handgrips		
15-5/8	7	13	Premier	TIC-071513	Al/vinyl	side carry handgrips		
15-5/8	8-3/4	13	Premier	TIC-081513	Al/vinyl	side carry handgrips		
15-5/8	10-1/2	13	Premier	TIC-101513	Al/vinyl	side carry handgrips		

WITH SO MANY FINE DIGITAL CIRCUITS BEING presented in electronic hobbyist magazines, one is tempted to construct them at the earliest possible opportunity. These articles generally present the projects using one of two construction techniques—either using a printed-circuit type of construction, or wire-wrap techniques. Little needs to be said about the PC board type of project construction, since usually a complete PC layout is provided with the article that can be copied using many different techniques to reproduce the circuit (or sometimes a PC layout may even be offered by a manufacturer at a bargain price).

This article discusses the wire-wrap technique and presents several ways to cut down on the time-consuming job of wire-wrapping each and every individual terminal point. The technique is useful for digital and computer-circuit applications, and hams and CB enthusiasts will also find it useful.

Wire-wrap tools

First, let's discuss the various tools and wire-wrap terminals that are currently available to the hobbyist. An example is the wire-wrap tool manufactured by the OK Machine & Tool Corp. The cost of this tool is nominal for what it will do; i.e., wire-wrap a measured and stripped length of wire between two terminals. It does the job quickly (after the wire is prepared) and is an excellent addition to your electronic tool kit. Not only does it wrap the wire, it is also designed to unwrap it, which adds up to a good design in a single tool.

Now, here's what I consider to be a versatile wire-wrap tool—the Vector *Slit-N-Wrap*. Here, an ingenious design makes wire-wrapping a simple job. No need to measure the wire length between terminals that will be wire-wrapped together to form the circuit path. This single tool allows you to slip the tool (the wire is contained on a spool in the tool's

Combining wire-wrap with a printed circuit can be the answer to many layout and construction problems connected with many projects. Here are some hints in using this technique.

PC/Wire-Wrap-

New Construction Technique

JAMES E. TEMPLE

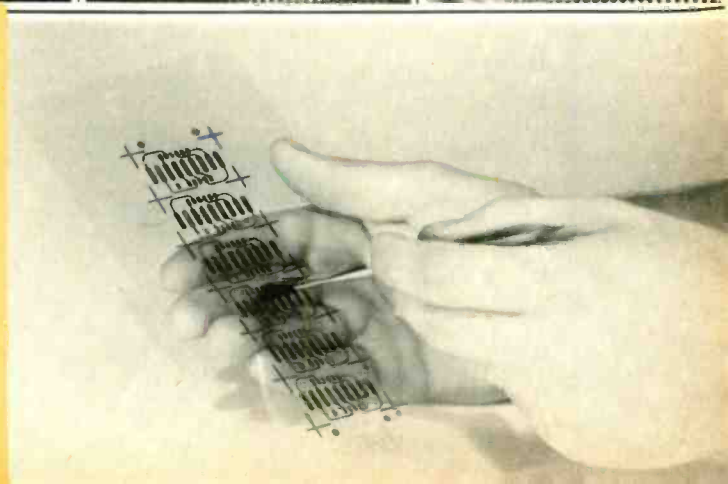
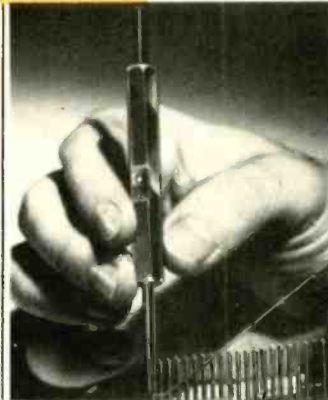

handle) over the terminal, wrap the wire seven turns or more and then directly run the wire to the next terminal to be wrapped, again slipping the tool over the end of that terminal and wrapping seven times around the post. If the particular circuit path must be wired to more than two terminal posts, then this tool allows you to continue wrapping to the next post without having to measure a new wire length. Just continue to wrap all the terminals that must be connected to this particular circuit path. When the last terminal in the series to be wire-wrapped is finished, just cut the wire and proceed to the next circuit path. It is just that simple with the Vector *Slit-N-Wrap* tool, and a great time-saver.

One of the nicest things that Vector has done is to support the needs of those who must use wire-wrap for their circuits. Vector has a complete line of wire-wrap posts and the tools to insert them in the epoxy boards.

Sockets

There are also IC wire-wrap sockets that are usually available with three levels of wrapping space. Many companies offer these sockets; and, of course, the choice of terminal pins or sockets is up to you. However, Robinson-Nugent, Inc., has an extensive line of different types of sockets, terminals and pins. One of the most handy types of sockets is the wire-wrap strip socket (model *WB-25-55-G*), which comes in a 25-pin-length IC connector. These sockets are easily cut to the pin length you need, are easily cemented to

the board for mounting and are flexible if changes are required. If you have an oddball type of IC (let's say, 22-pins, 30-pins, etc.) and you just cannot find the right wire-wrap socket for it, then these strip sockets can come to the rescue. Simply cut the strip to size and form the IC socket from it.

Another excellent product manufactured by Robinson Nugent is their low-profile, wire-wrappable J-pin designed for IC DIP packages. These pins offer an extreme low profile to the circuit board; sockets can be made from them directly; they are space-savers; and are wire-wrapped to the underside of the J-pin.

Avoiding the jungle

Up to now we have discussed the tools, terminals and many other products offered by manufacturers that support the wire-wrap construction technique. Now let's get to the heart of the article—how to avoid the jungle and mass of wires when you wire-wrap. If you are like many hobbyists who have used the technique and have completed several wire-wrap projects, you will know what I mean by a jungle. The back of a finished wire-wrap board contains hundreds of inches of wire, and many wires cross each other, along with various colors you may have used to color-code the wires. If a change is made, you must be very careful to cut or unwrap the correct wires, and if several levels of wire-wrap exist on any single terminal, extra care is needed to make these changes.

There are ways to cut down on the

number of wire-wrap connections you have to make. You can combine a printed-circuit board with wire-wrap terminals. The number of connections can be reduced by using a combination of similar lines, wire-wrap sockets, and just plain common sense and planning. For example, when a construction project calls for similar pinouts to be connected, as in the case of a computer memory board, print the redundant connections to the IC sockets right on a PC board. Then just solder in the similar terminals to be connected, either to the upper side or the lower side of the PC board.

As for other electronic circuits, review your project and look for similar pinouts of the IC; for instance, the power connections, the clock inputs, or a group of IC's that are of the same type. All that you need do is plan a PC card (double-sided copper), layout the IC on the board, use an etchant pen or lacquer etchant to draw the connecting lines that are redundant in nature (after drilling the holes into the PC board, of course), and eliminate as many wire-wrap connections as possible in the design. Be sure to provide for the terminal pins that act as connectors between the foils on the top of the board to the foils on the bottom of the board. Once the design has eliminated as many wire-wrap lines as possible, etch the board, clean it, insert the sockets or J-pins, and finish wrapping the circuit paths you could not combine onto the PC card. With the right design and careful preparation, the PC lines will eliminate as much as one-half or more of the wire-

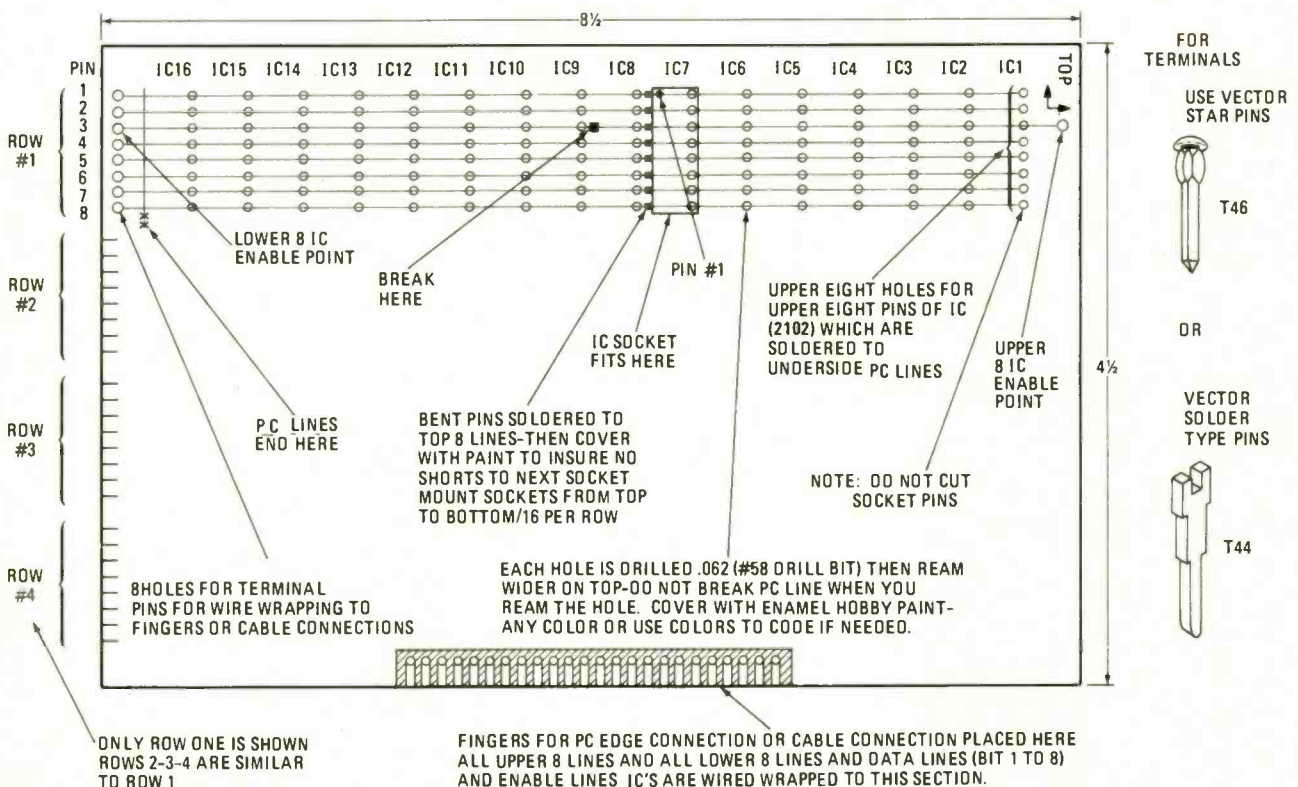

FIG. 1—A PRINTED-CIRCUIT card for a memory board. Bottom tracks are directly under the top ones. The trick here is to solder pins on one side of each socket directly to the upper tracks.

wrap lines. Rather than having a jungle of wires, you will have an orderly system that is easy to change or add to. It works!

How to design a PC board

Let's take a particular type of IC package and design a PC card and plan the wire-wrap terminals. (See Fig. 1.) I can best show how to eliminate redundant lines by using the popular 2102 memory IC. I have constructed a memory card, 3½ inches wide by 7 inches long, containing over 64 IC's. Consider this: Eight 2102's provide a memory word that is 8 bits wide. This means eight 2102's will provide 1024 8-bit memory locations. Each 2102 has 16 pins, eight on each side. Of the 16 pins, 10 are used for the memory address, one for read-write control, and one for chip-enable. Of the four remaining pins, one is used for the positive power-supply connection and one for the ground or return connection. All these pins are paralleled together between the eight 2102's. Only the data-in pin and the data-out pins will be considered as separate line- or wire-wrap connections. Of course, if several 8-bit-wide memory banks are being considered, these same pins will be paralleled to the same pins within the other memory banks.

Let's take a look at how we can eliminate some wire-wrap connections so that there are only a few. This will enable you to get a large number of IC packages in a very tight space.

Figure 1 shows the layout of the double-sided PC board. Two memory banks are shown. Each bank contains 1024 8-bit words. One bank consists of IC1—IC8, the upper lines of the PC layout and the terminal pins for wire-wrapping. The other consists of IC9—IC16. The eight foil traces on the foil side of the board parallel eight traces on the component side and are, therefore, not visible in Fig. 1.

Note from the layout for the 64 IC's (8K of memory, 2102 type) that only 32 holes are drilled for each 1K of memory. These holes are for the upper eight pins (one side) of the DIP wire-wrap socket.

Bend eight socket terminals (only one side of the DIP) at a right angle to the socket (see Fig. 2), cut the leads short and insert the other eight socket pins through the holes to be soldered to the lower PC traces. The right-angle pins are soldered to the upper PC traces. Thus, there are eight parallel foil traces on the upper and lower side of the PC card that are isolated by the thickness of the epoxy board itself.

To make sure the eight socket pins that are pushed through the board do not make contact with the upper eight parallel foil traces, it is best to take an Xacto knife with a No. 17 blade and ream the holes from the top of the PC board (see Fig. 3). To further insure isolation, use enamel paint to cover the holes on the top side. Now, when the sockets are pushed

into place, the top right-angle pins and the lower terminal pins are soldered, and the lower eight pins and the upper eight pins are electrically isolated from each other. This type of setup requires that when you insert the sockets, you start

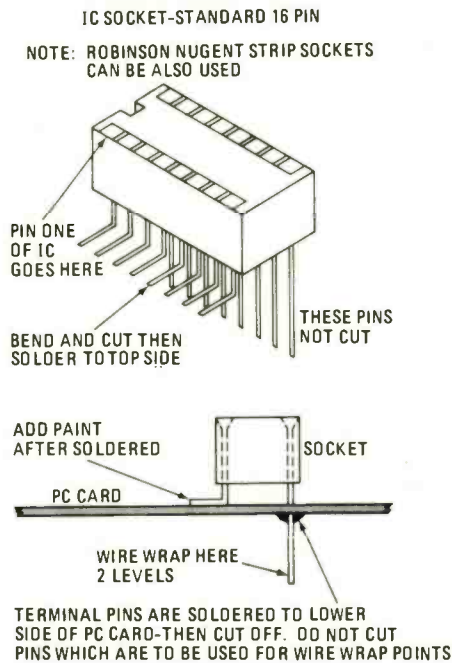

FIG. 2—HOW SOCKETS ARE MODIFIED when you are using the combined printed-circuit and wire-wrap techniques.

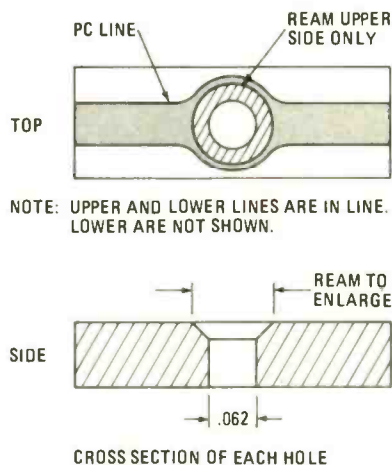

FIG. 3—ISOLATING THE PINS that go through the board to the bottom traces is simple. You can use an Xacto knife as a reamer.

from the uppermost top socket (IC1) and solder the connections. Then, to protect against possible shorts, paint over the top soldered pins with the enamel. Now, the next row of IC sockets can be soldered in place until all sockets are mounted to the PC board.

When you design the PC layout, bring the eight foil traces on the component side to a stopping point beyond the foil traces on the bottom of the board. On the component side, also extend the IC enable trace at the opposite end of the board and break the trace between IC8 and IC9 (this isolates the two memory banks).

Now (for the traces on the component side only) drill eight holes into the extended portion of the traces, insert eight terminal pins and solder the pins. For the eight foil traces on the bottom side of the board, cut the socket terminals short right up to the solder connection, all except for the top row of terminals. This row of terminals is now used for wire-wrap connections to the traces on the bottom side of the board. Make sure not to cut the data-in or data-out pins on the sockets since these pins will be paralleled to the other data-in and data-out pins and finally wire-wrapped to the input for the cable connections to the card.

On the component side of the card, you can use PC lines to make edge-connector fingers, the type of fingers or number of lines will depend upon the type of bus to which the card will be connected. Or, you can make a provision for wiring in a cable to connect to the bus lines. (Wires should be soldered in, and you can use the wire-wrap pins that allow wire-wrapping to the lower side of the wire cable.) Finally, for the fingers or the wire cable, insert the wire-wrap terminal pins, solder them firmly to the card, and finish the PC board by wire-wrapping the connections to the appropriate pinouts for the particular bus structure.

What you have just constructed is a compact tri-level PC board. Redundant or similar lines have been connected by foil traces, soldered to the sockets (modified for solder connections to the PC board), and all that remains is to wire-wrap the end terminal pins of each row of IC's. The few wire-wrap wires you have used can be taped to the card to secure them; changes made to the circuit are easier as each line is accessible, both top and bottom. With an 8½- by 4½-inch card, there is no reason why 64 DIP IC's cannot be located on it. It is possible that on a 9- by 16-inch-wide card you can cram in four times the number of IC's, and in terms of memory for computers, provide a 32K board. What we have not provided for on this type of memory board is bank-select in 1K increments, nor did we buffer the memory address lines or buffer the data lines. However, this problem is easily overcome by a second memory control and select card of appropriate design.

What we have demonstrated are the principles of combining the best of two worlds in project construction; that is, using PC layouts (to eliminate many redundant lines to the various IC's) and using wire-wrap sockets modified to the card for solder and wire-wrap connections. Using this technique you can fit a great many IC's in a highly crowded space, and wire-wrapping the final connections is made simple. Less than one-half of the wire-wrap connections will be required by this type of construction, yet all lines are accessible if changes or additions to the circuit are required. R-E

New IHF Amplifier Specifications

Amplifier comparisons made more realistic for the layman by a new IHF testing standard that provides a closer correlation between what he hears and what the lab technician measures.

LEN FELDMAN
CONTRIBUTING HI-FI EDITOR

AFTER NEARLY THREE YEARS OF DELIBERATIONS, the Institute of High Fidelity (IHF) has published and approved a new standard entitled "Methods of Measurement for Audio Amplifiers." This standard (IHF-A-202, 1978) supersedes an earlier IHF standard that had been used since 1966 but rendered obsolete in 1974 when the Federal Trade Commission ruled that the continuous power rating of an audio amplifier intended for home entertainment had to be specified in a somewhat different manner than had been done using the old standard.

One of the major new measurements incorporated in the new standard is dynamic headroom. This measurement was designed to help consumers select one of two amplifiers having the same *continuous* power-output ratings but achieving significantly different loudness levels when fed with the same short-term dynamic musical signals.

An amplifier having a very "stiff" power supply may produce very little more output power than its rated continuous power level under such conditions, whereas an amplifier with a "soft" or less-regulated supply may, under the same conditions, deliver power greater than its continuous rated level. The dynamic headroom dB specification may therefore vary from 0 (for the stiffly regulated power-supply amplifier) to +3.0, or even more.

Now that the new standard has become officially recognized by the IHF, let's look at some of the other new measurement methods it describes. The new standard attempts to correlate more accurately what the consumer *hears* when listening to an amplifier and what the technician *measures* for that amplifier during

lab tests. Equally important, the new standard insures that *all* manufacturers that publish amplifier or preamplifier specs make all measurements in identical fashion and report their findings uniformly so that prospective purchasers are not comparing "apples and oranges" when looking at competing products.

Since **Radio-Electronics** publishes complete high-fidelity test reports on audio amplifiers and preamplifiers, in future reports, we will adopt the new measurement techniques described in the standard. While to detail every one of the new measurements is beyond the scope of this article, we'll try to explain those major changes in measurement techniques that will affect the test reports. Those interested in obtaining the complete standard may do so by sending a check or money order to The Institute of High Fidelity, 489 Fifth Avenue, New York, NY 10017, in the amount of \$7.50. Ask for Standard IHF-A-202, 1978.

New reference levels

One of the most confusing factors

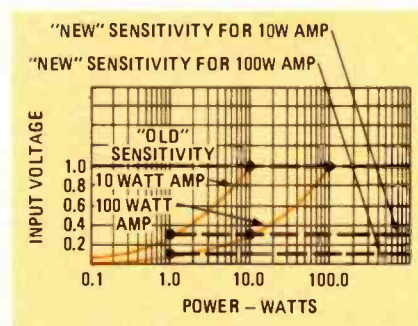

FIG. 1—NEW IHF SENSITIVITY rating specifies the input voltage required to produce a 1-watt output.

found in published amplifier specifications has been the lack of uniformity in the reference levels used to make sensitivity and signal-to-noise ratio measurements. For instance, let's consider two

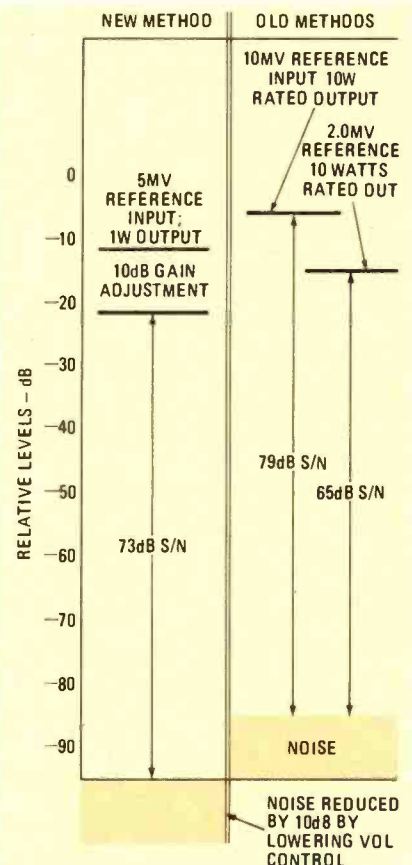

FIG. 2—NEW IHF S/N RATIO STANDARD specifies reference input level and output level. The volume control is adjusted to obtain the specified 1-watt output level. The old standard required S/N to be measured at full-rated output.

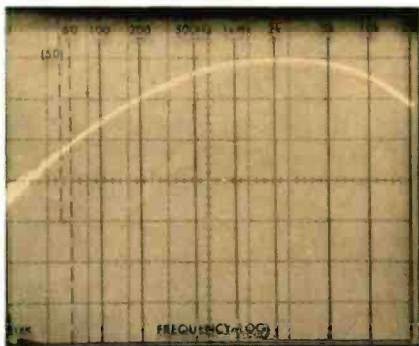

FIG. 3—RESPONSE of A-weighting network used in hum measurements.

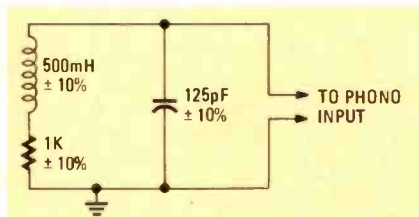

FIG. 4—NETWORK approximates the impedance of a magnetic phono cartridge. To comply with new IHF standard, network must be connected to phono preamp for S/N measurements.

audio amplifiers, one with a 10-watt power-output rating and the other with a 100-watt-per-channel rating. An amplifier's input sensitivity has traditionally been measured so as to describe how much input-signal amplitude is required for the given amplifier to deliver its *rated* output (with the volume control turned all the way up to maximum). Suppose each of the two amplifiers in our example requires an input signal of 1.0 volt to deliver its rated output. This implies that both amplifiers have "equal sensitivity." Yet, if 1 volt is fed into the 100-watt-per-channel amplifier, it will *sound* 10-dB louder than if it were fed to the 10-watt-per-channel amplifier! It is therefore clear that the *gain* of the two amplifiers is not identical.

In the new standard, amplifier sensitivity is still measured with the volume control turned up fully, but now it is specified as the voltage required to produce 1.0 watt at the speaker-output terminals (or 0.5 volts in the case of a separate preamplifier), regardless of the full power (or voltage output) rating. Using that reference output level in the two examples, the input sensitivity of the 10-watt amplifier is now 0.316 volt (for a 1-watt output), while the input sensitivity of the 100-watt-per-channel amplifier is 0.1 volt (for a 1-watt output). These concepts are shown in Fig. 1, in which power output for the two amplifiers is plotted against input voltage.

S/N reference levels

Even more confusing were previous

methods of measuring signal-to-noise (S/N) ratios.

Again, let's look at two hypothetical amplifiers. One integrated amplifier has a phono-input sensitivity of 2.0 mV (i.e., 2.0 mV applied to the phono-input terminals at 1 kHz drives the amplifier to its full rated output if the volume control is turned up all the way). Let's assume that the S/N measurement (when the signal is removed and the input jacks are shorted) is 65 dB.

Another amplifier manufacturer, whose phono preamplifier is just as noisy as the first, decides that a 65-dB value does not look "good enough" in print. So, he chooses an input reference level of 10 mV. But, of course, when 10 mV are applied to this amplifier, the amplifier will overload (since it, too, would produce full rated output from a 2.0-mV signal with the volume control turned up fully).

Therefore, the manufacturer *lowers* the volume-control setting until rated power output is obtained once more. And he would have to lower it by approximately 14 dB! Assuming that the residual noise is a function only of the phono preamplifier, the manufacturer now reads a S/N ratio of 79 dB, even though the preamp section in his unit is no less noisy than that of his competitor!

In order to establish uniform S/N readings, the new standard dictates that the input-signal level be fixed at 5.0 mV for a magnetic phono section, and at 0.5 volt for a high-level input such as the tuner, auxiliary, or tape input on a preamplifier or integrated amplifier. In addition, the *output* reference level must be adjusted (as in the case of sensitivity measurements) to a 1.0-watt level (for a power amplifier) or 0.5 volt (for a preamplifier). This adjustment is made by using

PRIMARY SPECS FOR POWER AMPLIFIERS:

1. Continuous Average Power Output
2. Dynamic Headroom
3. Frequency Response
4. Sensitivity
5. A-Weighted Signal-To-Noise Ratio

PRIMARY SPECS FOR PREAMPLIFIERS:

1. Frequency Response
2. Maximum Voltage Output
3. Total Harmonic Distortion
4. Sensitivity
5. A-Weighted Signal-To-Noise Ratio
6. Maximum Input Signal
7. Input Impedance

PRIMARY SPECS FOR INTEGRATED AMPLIFIERS:

1. Continuous Average Power Output
2. Dynamic Headroom
3. Frequency Response
4. Sensitivity
5. A-Weighted Signal-To-Noise Ratio
6. Maximum Input Signal
7. Input Impedance

TABLE 1—PRIMARY SPECS that must be provided by manufacturer to comply with new IHF standards.

1. Clipping Headroom
2. Output Impedance
3. Wideband Damping Factor
4. Low-Frequency Damping Factor
5. CCIR/ARM Signal-To-Noise Ratio
6. Tone-Control Response
7. Filter Cutoff Frequency
8. Filter Slope
9. Crosstalk
10. A-Weighted Crosstalk
11. CCIR/ARM Crosstalk
12. SMPTE Intermodulation Distortion
13. IHF Intermodulation Distortion
14. Transient-Overload Recovery Time
15. Slew Factor
16. Reactive Load
17. Capacitive Load
18. Separation
19. Difference of Frequency Response
20. Gain-Tracking Error
21. Tone-Control Tracking Error

TABLE 2—SECONDARY SPECS that may be provided at manufacturer's discretion.

TABLE 3
RADIO-ELECTRONICS PRODUCT TEST REPORT

Manufacturer:

Model:

AMPLIFIER PERFORMANCE MEASUREMENTS

	R-E Measurement	R-E Evaluation
POWER OUTPUT CAPABILITY		
RMS power/channel, 8-ohms, 1 kHz (watts)		
RMS power/channel, 8-ohms, 20 Hz (watts)		
RMS power/channel, 8-ohms, 20 kHz (watts)		
RMS power/channel, 4-ohms, 1 kHz (watts)		
RMS power/channel, 4-ohms, 20 Hz (watts)		
RMS power/channel, 4-ohms, 20 kHz (watts)		
Frequency limits for rated output (Hz-kHz)		
<i>Dynamic headroom (dB)</i>		
DISTORTION MEASUREMENTS		
Harmonic distortion at rated output, 1 kHz (%)		
Intermodulation distortion, rated output (%)		
Harmonic distortion at 1-watt output, 1 kHz (%)		
Intermodulation distortion at 1-watt output (%)		
DAMPING FACTOR AT 8 OHMS, 50 Hz		
PHONO PREAMPLIFIER MEASUREMENTS		
Frequency response (RIAA \pm dB)		
Maximum input before overload (mV)		
<i>Hum/noise, "A"-weighted, referenced to 1W or 0.5V output, for 5-mV input (dB)</i>		
HIGH-LEVEL INPUT MEASUREMENTS		
Frequency response (Hz-kHz, \pm dB)		
<i>Hum/noise, "A" wt'd, re 0.5 or 1W out, 0.5V in (dB)</i>		
<i>Residual noise, "A" wt'd, minimum volume, re 1W out (dB)</i>		
TONAL COMPENSATION MEASUREMENTS		
Action of bass and treble controls	See Fig.	
Action of secondary tone controls	See Fig.	
Action of high- and low-frequency filters	See Fig.	
COMPONENT MATCHING MEASUREMENTS		
<i>Input sensitivity, PH-1/PH-2, re 1W or 0.5V out (mV)</i>		
<i>Input sensitivity, high-level, re 1W or 0.5V out (mV)</i>		
Output level, tape outputs, at rated output (mV)		
Output level, headphone jack, at rated output (mV or mW)		
EVALUATION OF CONTROLS, CONSTRUCTION AND DESIGN		
Adequacy of program source and monitor switching		
Adequacy of input facilities		
Front panel layout		
Action of controls and switches		
Design and construction		
Ease of servicing		
OVERALL AMPLIFIER PERFORMANCE RATING		

with those manufacturers who have used an A-weighting network in making S/N measurements, and requires that type of network to be inserted between the output of the amplifier and the meter used to measure the noise voltage or residual noise.

Most manufacturers have traditionally measured phono signal-to-noise ratios by inserting a shorting plug in the phono-input jacks. In the case of many phono-preamplifier circuits, this test method does not reflect what actually happens when you connect a magnetic cartridge to those same phono inputs. A magnetic cartridge has a certain amount of DC resistance, plus a finite amount of inductance. Instead of inserting a shorting plug, the new standard requires using a network that approximates the complex impedance "observed" by the phono inputs when a cartridge is actually connected; a diagram of this network is shown in Fig. 4.

For making S/N measurements of the high-level inputs on an amplifier or pre-amplifier, a 1000-ohm resistor will be used to terminate the input jacks.

Primary amp/preamp ratings

To rate amplifiers according to the new IHF standards, the manufacturer must list certain primary ratings in order of their importance. For a basic power amplifier, five basic ratings must be shown; while for an integrated amplifier or a preamplifier, seven primary ratings must be given. Table 1 lists the primary ratings in each case.

At least 21 other secondary ratings and how to measure them are included in the IHF standards, and can be listed (in part or in whole) by the manufacturer at his own discretion. Table 2 shows these secondary ratings.

Future test reports

It has been Radio-Electronics' practice to publish tabular listings of measured results on amplifiers, receivers and pre-amplifiers in its high-fidelity test reports. Table 3 shows the form that will be used in future test reports. The italicized items in this table represent either new specs not previously reported on, or those that have been reported on using earlier techniques and that will now be measured in accordance with the new standards. Since it will probably take some time before all manufacturers begin to use the standards, it may be somewhat difficult to compare their published specifications with those measured according to the new standard. For example, signal-to-noise ratios may seem poorer or lower than those specified using older methods.

In time, however, it is hoped that most serious high-fidelity manufacturers will adopt the new measurement techniques and ratings; this will make it that much easier for an audio consumer to select good hi-fi amplification equipment. **R-E**

the master volume control. This makes a lot of sense since it places the master volume control at a setting that approximates that which a consumer would normally use in actual music listening. No one ever listens to a hi-fi stereo system with the volume control turned up fully (in most cases, this would overdrive the amplifier or preamplifier into severe clipping, since amplifier gain has nothing to do with maximum amplifier power or voltage output).

Figure 2 shows the old and the new methods of measuring signal-to-noise; it is assumed that other amplifier stages do not affect overall noise. Actually, we have already discovered that very often you cannot compute new S/N values from the old values (even taking into account new reference input and output levels) since, as the new input and output reference levels are set up (by the volume control and by varying signal-input levels), other noise-producing stages affect the measurement. Thus, it is next to impossible to convert from the old measurement meth-

od to the new by simply juggling dB and gain figures.

A-weighting

In the past, some manufacturers used a weighting network in signal-to-noise measurements while others did not. A weighting network recognizes the fact that the human hearing system does not respond equally to all audible frequencies, especially at low listening levels. Our ears are less sensitive to line frequency or hum than to mid-frequencies, and are also less sensitive to ultra-high frequencies. In the past some manufacturers used an A-weighting network to take into account the subjective aspects of residual noise. This network has a frequency-response characteristic that is shown in Fig. 3, in which you will note that much less importance is given to 60-Hz noise (about 20-dB less) than to noise at, say, 1 kHz. Similarly, noise at 10 kHz is given approximately 5-dB less importance than noise at mid-frequencies.

The new standard is in conformance

Radio-Electronics Audio Lab Tests

Yamaha CR-420 AM/FM Receiver



1
CIRCLE 130 ON FREE INFORMATION CARD

LEN FELDMAN
CONTRIBUTING HI-FI EDITOR

THE PUBLISHED SPECIFICATIONS FOR YAMAHA'S relatively low-powered *model CR-420* receiver contain one term you may not have seen before. This is the NDCR specification (*Noise Distortion Clearance Range*). Yamaha (6600 Orangethorpe Avenue, Buena Park, CA 90622) developed this specification in the belief that it tells more exactly what you can expect from the product in terms of combined noise and distortion during actual use. When you read this claim, you'll note that, with the volume control turned down 20-dB below its maximum (typical of normal use), the *model CR-420* receiver produces no more than 0.1%

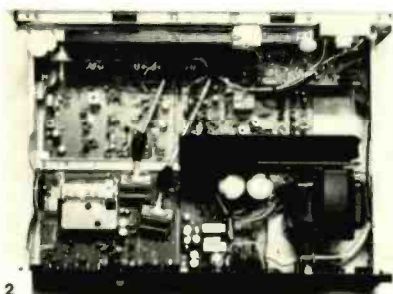

2

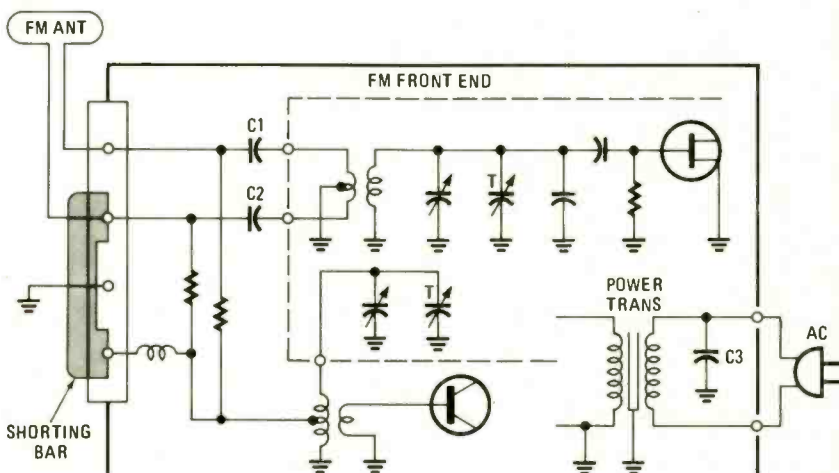

3

combined noise and distortion at any listening level from 100 mW to the full rated output of 22 watts-per-channel. While it can be argued that distortion at a -60 -dB level (compared with output level) is far less annoying than

noise at that same level, this extra specification gives you some idea of what you can expect in the way of dynamic range.

The NDCR specification is only one of several innovative features associated with this low-cost receiver. The front panel of the *model CR-420* is shown in Fig. 1. To the left of the long and narrow dial calibration area is a single tuning meter that serves as a signal strength meter in the AM mode and as a center-of-channel tuning meter for the FM mode, with FM frequencies calibrated at every half-MHz. Three tiny LED indicators to the right of the scales inform you whether you are listening to AM, FM, or stereo FM. Step-type BASS and TREBLE controls are located just below the tuning meter, and next to them is an independent loudness control. This control is used to change listening levels after the main volume control has been adjusted to realistic listening levels, depending upon the program source selected. The control covers a range (downward in level) of around 20 dB, and as it is rotated away from the flat or maximum clockwise position, this introduces just the right amount of loudness compensation. This arrangement works far better than the usual combination volume/loudness-control-plus-switch found on many competitive receivers.

Recording-output and program-source selector switches are also operated independently of each other. This makes it possible to feed one program to an associated tape deck while

MANUFACTURER'S PUBLISHED SPECIFICATIONS:

FM TUNER:

Usable Sensitivity (mono): $1.8 \mu\text{V}$ (10.3 dBf). **50-dB Quieting:** mono; $3.5 \mu\text{V}$ (16.1 dBf); stereo, $43.5 \mu\text{V}$ (38 dBf). **S/N Ratio:** mono, 77 dB; stereo, 71 dB. **Capture Ratio:** 1.0 dB. **Selectivity:** 65 dB. **Image Rejection:** 50 dB. **AM Suppression:** 56 dB. **IF and Spurious Rejection:** 75 dB. **Harmonic Distortion:** mono, 0.15% at 100 Hz and 1 kHz, 0.3% at 6 kHz; stereo, 0.25% at 100 Hz and 1 kHz, 0.8% at 6 kHz. **Stereo Separation:** 40 dB at 1 kHz, 30 dB at 50 Hz and 10 kHz. **Frequency Response:** 30 Hz to 15 kHz, $+1.0$, -3.0 dB. **Muting Threshold:** $5.0 \mu\text{V}$ (19.2 dBf).

AM Tuner:

IHF Sensitivity: $18 \mu\text{V}$ per meter. **Selectivity:** 20 dB. **S/N Ratio:** 50 dB. **IF and Image Rejection:** 40 dB. **Harmonic Distortion:** 0.6%.

Amplifier:

Power Output: 22 watts-per-channel, 8 ohms, 20 Hz to 20 kHz. **Harmonic Distortion:** 0.05%. **IM Distortion:** 0.05%. **Damping Factor:** 40. **Input Sensitivity:** phono, 2.0 mV; high level, 120 mV. **Frequency Response:** phono, RIAA ± 0.5 dB; high level, 20 Hz to 20 kHz, ± 1.5 dB. **S/N Ratio:** phono, 91 dB (referenced to a 10-mV input); high level, 97 dB. **Noise Distortion Clearance Range:** for 0.1% THD, 20 Hz to 20 kHz with volume control at -20 dB; phono to speakers, from 100 mW to 22 watts. **Bass Range:** ± 12 dB at 50 Hz. **Treble Range:** ± 11 dB at 20 kHz. **High Filter Cutoff:** 6 dB-per-octave above 10 kHz. **Low Filter Cutoff (built-in):** 12 dB-per-octave below 10 Hz.

General Specifications:

Power Consumption: 130 watts, 120 volts 60 Hz. **Dimensions:** $17\frac{3}{4}$ "W \times $6\frac{3}{8}$ "H \times $12\frac{3}{4}$ " inches D. **Weight:** 19 lb. **Suggested Retail Price:** \$280.

TABLE 1
RADIO-ELECTRONICS PRODUCT TEST REPORT

Manufacturer: Yamaha

Model: CR-420

FM PERFORMANCE MEASUREMENTS

	R-E Measurement	R-E Evaluation
SENSITIVITY, NOISE AND FREEDOM FROM INTERFERENCE		
IHF sensitivity, mono: (μ V) (dBf)	1.7 (9.8)	Excellent
Sensitivity, stereo (μ V) (dBf)	8.0 (23.3)	Good
50-dB quieting signal, mono (μ V) (dBf)	2.5 (13.2)	Excellent
50-dB quieting signal, stereo (μ V) (dBf)	33.0 (35.6)	Very good
Maximum S/N ratio, mono (dB)	76	Excellent
Maximum S/N ratio, stereo (dB)	70	Excellent
Capture ratio (dB)	1.0	Excellent
AM suppression (dB)	58	Good
Image rejection (dB)	52	Fair
IF rejection (dB)	75	Good
Spurious rejection (dB)	78	Good
Alternate channel selectivity (dB)	65	Good
FIDELITY AND DISTORTION MEASUREMENTS		
Frequency response, 50 Hz to 15 kHz (\pm dB)	0.3	Excellent
Harmonic distortion, 1 kHz, mono (%)	0.06	Superb
Harmonic distortion, 1 kHz, stereo (%)	0.07	Superb
Harmonic distortion, 100 Hz, mono (%)	0.06	Superb
Harmonic distortion, 100 Hz, stereo (%)	0.075	Superb
Harmonic distortion, 6 kHz, mono (%)	0.12	Excellent
Harmonic distortion, 6 kHz, stereo (%)	0.15	Excellent
Distortion at 50-dB quieting, mono (%)	0.4	Very good
Distortion at 50-dB quieting, stereo (%)	0.35	Very good
STEREO PERFORMANCE MEASUREMENTS		
Stereo threshold (μ V) (dBf)	8.0 (23.3)	Good
Separation, 1 kHz (dB)	54	Superb
Separation, 100 Hz (dB)	45	Excellent
Separation, 10 kHz (dB)	43	Superb
MISCELLANEOUS MEASUREMENTS		
Muting threshold (μ V) (dBf)	5.0 (19.2)	Very good
Dial calibration accuracy (\pm kHz at MHz)	50-overall	Excellent
EVALUATION OF CONTROLS		
CONSTRUCTION AND DESIGN		
Control layout		Excellent
Ease of tuning		Very good
Accuracy of meters or other tuning aids		Excellent
Usefulness of other controls		Excellent
Construction and internal layout		Very good
Ease of servicing		Excellent
Evaluation of extra features, if any		Very good
OVERALL FM PERFORMANCE RATING		Excellent

you listen to a completely different program source. Volume and balance controls are concentrically mounted, and next to them is the tuning knob.

The bottom of the panel contains a pushbutton power on-off switch; two phone jacks (for dual stereophonic headphone listening); speaker selector pushbuttons for choosing one or both pairs of speaker systems (which can be connected to the *model CR-420*); a high-cut filter switch; an AM/FM selector pushbutton; a mono/stereo mode selector; and an FM muting switch which, when pressed to OFF, also switches the FM reception into the monophonic mode, regardless of the incoming FM signal.

The rear panel of the *model CR-420* contains terminals for 75-ohm, 300-ohm FM and external AM antennas. Nearby are the phono and auxiliary input jacks as well as the tape-out and tape-in jacks and a chassis ground terminal. Two rows of spring-loaded color-coded speaker terminals are next, followed by a pair of convenience AC receptacles (one switched, the other unswitched). A wide variety of additional components can be connected to the *model CR-420* receiver.

Circuit highlights

An internal view of the chassis is shown in Fig. 2. The power-supply circuitry is well isolated from low-level and RF circuits, and the two major rotary switches are connected to

front-panel knobs via long coupling shafts and swivel joints. This design places the actual switches close to the circuits they must select.

The front-end section of the receiver uses a three-gang tuning capacitor and a junction FET for the RF amplifier stage. The IF section uses a four-element ceramic filter, a two-stage

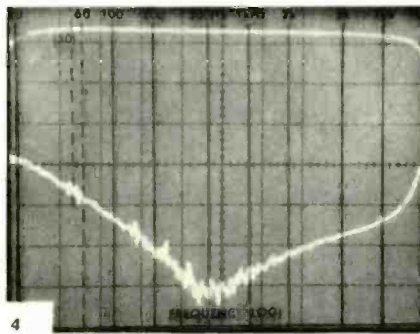

direct-coupled amplifier and a three-stage differential amplifier with a current limiter. The FM demodulator is a wideband balanced-type ratio detector; and a phase-locked-loop IC is used for multiplex stereo decoding.

A special circuit allows the external FM antenna to serve for AM reception thus eliminating the need for a bar antenna. During AM

reception, the FM antenna acts as a whip antenna because of the high impedance provided by capacitors C1 and C2 (see Fig. 3). Using capacitor C3 to bypass the power-transformer primary side, the ground side of the AM antenna coil is grounded via the power-line cord; this provides a whip antenna effect. To increase the antenna's sensitivity, the shorting bar shown in Fig. 3 bridges the terminals as shown. If overloading results, the bar can be removed.

The power-amplifier section of the *model CR-420* is direct-coupled and consists of a differential amplifier stage with constant-current circuitry, a Class-A driver stage with two-stage thermal compensation, a Darlington pair full complementary single-ended push-pull DC-coupled output stage, and a power-consumption limiter-type protection circuit.

A speaker protection relay separates the amplifier and speakers when the power switch is turned on or whenever more than ± 2 volts DC is present at the speaker output terminals.

FM measurements

Table 1 summarizes measurements made for the FM tuner section. The results can be compared with the manufacturer's published specifications shown elsewhere in this report. Almost every performance specification was either equalled or exceeded, except for the monophonic and stereophonic signal-to-noise claims, which were nonetheless excellent. The 1-kHz distortion readings of 0.06% in mono and 0.07% in stereo are about as low as we have ever read, even when lab testing the very highest-priced separate tuners. Stereo FM separation of better than 50 dB at mid-frequencies and above 40 dB at 10 kHz is also unusual in receivers in any price or power category.

Figure 4 is a scope analysis of FM frequency response and separation. Note that FM de-

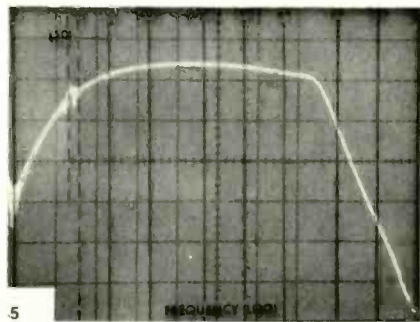

emphasis no longer plays a part in these measurements since in our lab we now use a signal processor ahead of our FM generator, which applies the required pre-emphasis to the swept modulating test signal to achieve a flat "net" response.

Figure 5 is a scope photo of AM response and, as is true of most stereo receivers providing AM reception, response began to fall off at around 3 kHz.

Amplifier measurements

Table 2 contains a summary of all amplifier/preamplifier-control measurements made on the *model CR-420*. The performance of this section was consistent with that of the tuner. Power ratings are conservatively stated since we obtained an output of 34.0 watts-per-channel at mid-frequencies and 31 watts-per-channel at 20 kHz, as opposed to the 22-watt-per-

channel FTC power rating claimed. At an actual rated output of 22 watts-per-channel (at mid-frequencies), harmonic distortion was an extremely low 0.008% while 1M distortion was almost equally low, with readings of only 0.009%. Distortion readings at the 1-watt level were largely distortion plus noise (with the noise component contributing more to the single-meter reading than the distortion), but they were well below Yamaha's 0.1% NDCR index figure and well below the rated 0.95% THD figure, even ignoring that noise was a contributing factor to the total reading.

The range of the BASS and TREBLE controls of the model CR-420 is shown in Fig. 6. Note that turnover frequencies are positioned lower (for the BASS) and higher (for the TREBLE) than is usual with simple feedback-type con-

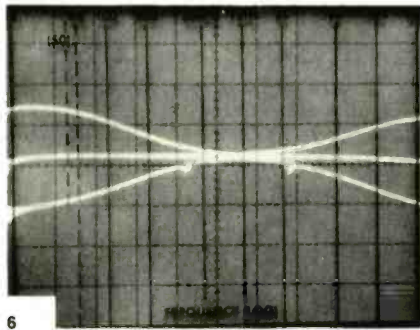

6

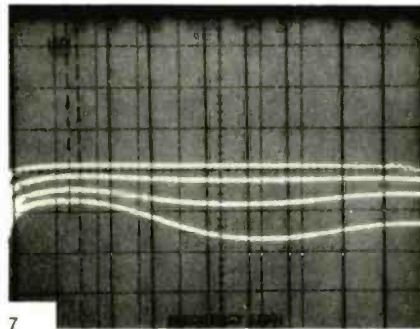

7

trols. This design feature makes it possible to augment extreme bass or extreme treble that might be deficient.

Figure 7 shows the system response at various loudness control settings. When these measurements and sweep-frequency analyses were made, the volume control remained at a fixed setting and only the separate loudness control setting was altered. At mid-frequencies, this control provides up to 20 dB attenuation, but as can be seen from the progressively lower amplitude sweeps, compensation at the bass end of the spectrum increases as the control setting is lowered.

Summary

Table 3 contains an overall product evaluation together with our positive conclusions regarding the model CR-420. Although in the past we have tested more costly Yamaha receivers and other components, this is our first experience with one of their lower-priced products. We have had an opportunity to use the receiver for better than two weeks, and it is easy to see why these receivers are well accepted. Yamaha has brought as much care and thoughtful engineering to "beginner" sets as to its sophisticated separate components. **R-E**

TABLE 2
RADIO-ELECTRONICS PRODUCT TEST REPORT

Manufacturer: Yamaha

Model: CR-420

AMPLIFIER PERFORMANCE MEASUREMENTS

	R-E Measurement	R-E Evaluation
POWER OUTPUT CAPABILITY		
RMS power/channel, 8-ohms, 1 kHz (watts)	34.0	Excellent
RMS power/channel, 8-ohms, 20 Hz (watts)	33.0	Superb
RMS power/channel, 8-ohms, 20 kHz (watts)	31.0	Excellent
RMS power/channel, 4-ohms, 1 kHz (watts)	N/A	N/A
RMS power/channel, 4-ohms, 20 Hz (watts)	N/A	N/A
RMS power/channel, 4-ohms, 20 kHz (watts)	N/A	N/A
Frequency limits for rated output (Hz-kHz)	Below 10-45	Superb
DISTORTION MEASUREMENTS		
Harmonic distortion at rated output, 1 kHz (%)	0.008	Excellent
Intermodulation distortion, rated output (%)	0.009	Excellent
Harmonic distortion at 1-watt output, 1 kHz (%)	0.025	Very good
Intermodulation distortion at 1-watt output (%)	0.02	Very good
DAMPING FACTOR, AT 8 OHMS	51.4	Very good
PHONO PREAMPLIFIER MEASUREMENTS		
Frequency response (RIAA \pm dB)	+0.5 -0	Very good
Maximum input before overload (mV)	140	Very good
Hum/noise referred to full output (dB) (at rated input sensitivity) ("A" weighted)	80	Excellent
HIGH LEVEL INPUT MEASUREMENTS		
Frequency response (Hz-kHz, \pm dB)	13-41, 1.0	Very good
Hum/noise referred to full output (dB) ("A" weighted)	102	Excellent
Residual hum/noise (minimum volume) (dB) ("A" weighted)	103	Excellent
TONAL COMPENSATION MEASUREMENTS		
Action of bass and treble controls	See Fig. 7	Good
Action of secondary tone controls		N/A
Action of low-frequency filter(s)		N/A
Action of high-frequency filter(s)		Good
COMPONENT MATCHING MEASUREMENTS		
Input sensitivity, phono 1/phono 2 (mV)	2.1	
Input sensitivity, auxiliary input(s) (mV)	105	
Input sensitivity, tape input(s) (mV)	105	
Output level, tape output(s) (mV)	105	
Output level, headphone jack(s)	125 mV	
EVALUATION OF CONTROLS, CONSTRUCTION AND DESIGN		
Adequacy of program source and monitor switching		Very good
Adequacy of input facilities		Very good
Arrangement of controls (panel layout)		Excellent
Action of controls and switches		Excellent
Design and construction		Very good
Ease of servicing		Very good
OVERALL AMPLIFIER PERFORMANCE RATING		Excellent

TABLE 3
RADIO-ELECTRONICS PRODUCT TEST REPORT

Manufacturer: Yamaha

Model: CR-420

OVERALL PRODUCT ANALYSIS

Retail price	\$280
Price category	Low
Price/performance ratio	Superb
Styling and appearance	Excellent
Sound quality	Very good
Mechanical performance	Very good

Comments: Yamaha is an audio component manufacturer that does not sacrifice control or quality when "stepping down" to its lowered power receiver designs. The tuner section (at least the FM) of the model CR-420 exhibited performance characteristics as good as those of higher-priced models, and, even though the unit is not equipped with selectable IF bandwidth, a high-enough alternate channel selectivity was balanced with an adequate bandwidth, so that the distortion levels observed during our tests (at full 100% modulation levels) were incredibly low—often limited by the capabilities of our test equipment. Stereo separation in FM was very high.

Perhaps more important than the measured test results was the intelligent control layout. The separate record-out switch and program source switch are a welcome innovation in a receiver at this low price and permit you to record one program source while listening to another. Yamaha retained the center-of-channel tuning mode for the single meter when it is used for FM tuning. We wish that the MUTE switch had been made independent of the stereo/mono FM mode, since the present arrangement prevented us from checking out some weak-signal stations in the stereo mode.

At (or even slightly above) its rated power-output level, the model CR-420 delivers good tight sound that is well balanced and uncolored. With so many new speaker systems requiring no more power than the receiver can supply, it's nice not to have to opt for a super-powered unit just to obtain other high-quality features.

Radio-Electronics Audio Lab Tests

SAE Model 4100 Time Delay System



1 CIRCLE 131 ON FREE INFORMATION CARD

MOST SERIOUS AUDIOPHILES KNOW THAT ANY stereo component system, no matter how superior its music-reproduction capabilities, still falls short of recreating the total musical experience of attending a live concert in an acoustically proper environment. When you attend a live concert in a large auditorium, much of the sound reaches you not from the stage, but as reflections from the walls, ceiling and other areas of the auditorium. This reverberant sound is delayed in time in amounts that depend upon the hall's dimensions. The duration of the sound reflections can also vary greatly, depending upon the hall size and the reflective nature of its surfaces. These effects are called the acoustics or reverberance of the concert hall and it is this reverberant effect with its associated time delay that the Scientific Audio Electronics (701 E. Macy, Los Angeles, CA 90012) *model 4100* attempts to recreate in a home listening room.

The *model 4100* (see Fig. 1) requires another stereo amplifier and another pair of speakers in addition to itself and your present stereo component system. The unit is designed to be used between the preamplifier output and the power amplifier input of an existing stereo system.

Performance measurements

The *model 4100* requires relatively few static bench measurements. The few we did make are summarized in Table 1. Lest you become dismayed at the seemingly poor frequency response obtained from the rear-channel outputs, a few words of explanation are needed.

Long ago it was established that reverberant or reflected sound in a concert hall does not contain very much high-frequency content. This is because the highs are more readily absorbed by the structural surfaces of the concert hall than the low and mid-frequencies that are more easily reflected from surfaces. In addition, our outer ear is so shaped that high frequencies reaching us from behind are not as readily perceived as treble frequencies reaching us from the front. If the rear channels reproduced all the frequencies with uniform intensity, the effect would be unreal and we would perceive the rear speakers as being primary producers of program content, which is not the purpose of a time-delay system.

The effectiveness of a device such as the *model 4100* is more easily determined by listening tests than by static bench measurements, and our comments and overall product analysis in Table 2 confirm that the *model 4100* produces the desired effect in a home music system very successfully. Nevertheless, to give you some idea of what is taking place inside the "black box," we fed a series of burst tones into the inputs of the *model 4100*. In the scope photo of Fig. 2, the upper trace represents the tone-burst input, while the lower trace represents the signal obtained by using

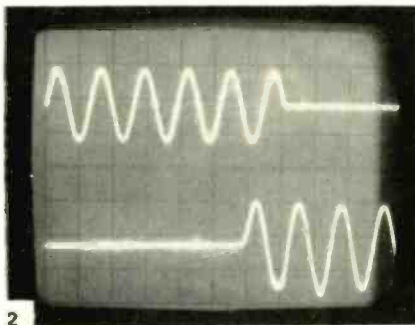

only the "short" time-delay slide control set to its maximum setting. The signal has clearly been delayed by the requisite amount (sweep rate was 2 μ s-per-horizontal division).

Summary

The *model 4100* Time Delay Ambience System will appeal to those audio purists who are willing to add the necessary additional stereo amplifier and extra speakers to their hi-fi systems to achieve total realism in home music-reproduction systems. This system should enable a user to duplicate every kind of listening environment. **R-E**

MANUFACTURER'S PUBLISHED SPECIFICATIONS:

Total Harmonic Distortion: 0.5%. **Intermodulation Distortion:** 0.5%. **Signal-to-Noise Ratio, referred to rated output:** front outputs, 95 dB; rear outputs, 60 dB. **Frequency Response:** rear outputs only, 50 Hz to 5 kHz, ± 1.0 dB. **Weight:** 15 lb. **Dimensions:** 2 $\frac{3}{4}$ H \times 15 W \times 8 inches D. **Suggested Retail Price:** \$500.

TABLE 1

RADIO-ELECTRONICS PRODUCT TEST REPORT

Manufacturer: Scientific Audio Electronics

Model: 4100

AUDIO TIME DELAY PERFORMANCE MEASUREMENTS

	R-E Measurement	R-E Evaluation
Total harmonic distortion, 1 kHz (%)	0.3	Good
IM distortion (%)	0.2	Very good
S/N ratio, front (dB)	90	Excellent
S/N ratio, rear (dB)	77	Excellent
Frequency response, rear (Hz-kHz)	36-5.0, -1.0 dB	See text

TABLE 2

OVERALL PRODUCT ANALYSIS

Retail price	\$500
Price category	Medium
Price/performance ratio	Very good
Styling and appearance	Excellent
Sound quality	Excellent
Mechanical performance	Very good

Comments: The merits of a time-delay unit such as the SAE *model 4100* are directly proportional to the degree of flexibility it affords. The greater the number of variables in time delay and reverberation, the more likely the unit will be able to duplicate the sonic environment that best fits the music reproduced in your listening room. The *model 4100* excels in this respect, thanks to the three time-delay levels and its ability to introduce continuously variable amounts of short, medium and long delay. SAE engineers and listening panel must have done a great deal of listening before choosing these delay times since, in our extended listening tests, we were always able to find some combination of delays and regeneration (reverberation) that resulted in an apparent room-size enlargement just about perfect for the particular program source.

However, as with all such devices, the effect can be overdone, and you are cautioned to adjust it with care. If you can "hear" sound coming from the rear speakers, the rear sound level is probably too high and should be backed off. The BLEND pushbutton, in which a delayed sound signal is fed back to the front speakers as well as to the rear speakers, did not prove to be useful in our setup, although it might prove effective if you simply want to add some reverberation to "dry" program sources recorded with close-microphone techniques.

A device such as the *model 4100* should not be confused with any 4-channel reproduction scheme. But, in its own way, this time-delay unit offers one of the chief advantages of 4-channel sound—the feel of a concert hall—that was almost entirely ignored in the early 1970 attempts at quadraphonic sound reproduction.

Troubleshooting Communications Receivers

The right signal generator, good diagnostic ability and precise bench techniques lead to rapid repair of 2-way radios.



FOREST BELT

MANY OF THE ARTICLES ON TEST EQUIPMENT tend to be of the "what it does" variety. Some of them, like lab reports, provide a list of specifications and comments on the conformance or nonconformance to the specs by the instrument being examined. This special section takes a different approach.

We will take an in-depth look at communications signal generators and how to properly use one to troubleshoot. We will also look at what instrument features make the job easier and which instruments have those features. The following pages of this article will attempt to bring you this knowledge, along with explanations and illustrations.

Using the best available information, all data has been checked and rechecked. Some test equipment manufacturers did not respond to our requests for detailed information. We have either omitted their instruments or told you what we could learn about them by other means. In either case, there is a lot of information here to insure successful two-way-receiver troubleshooting, no matter what kind of land/mobile, marine, or CB outfits you should run across.

Troubleshooting communications receivers

You can approach diagnosing two-way radios from two standpoints: First, and probably most common, you can analyze a symptom or set of symptoms, then track down the specific defect causing those symptoms.

Or—and I consider this the better approach—you can start a procedure that takes you all the way through the trans-

mitter-receiver. Along the way you virtually cannot miss encountering any defect that exists. Moreover, checking the entire set this way anticipates many minor troubles, and helps you correct them before they cause a breakdown. Best of all, you put the transmitter and receiver in tip-top condition, right up to specifications.

An approach like this proves effective whether you're troubleshooting CB radios, FM two-way radios, aircraft transceivers, marine radio-telephones, or ham gear. The result is thorough servicing, mixed with what is commonly called preventive maintenance—grade-A insurance against most callbacks.

This special section deals with signal generators, with the emphasis on receivers and the receive function of transceivers. Obviously, certain transmit functions can also be traced with communications

signal generators: mainly in microphone amplifiers and modulators.

For a start, let's examine in more detail this overall troubleshooting approach. The block diagram of Fig. 1 shows the receive stages in a typical FM two-way radio. Receive stages in CB transceivers differ somewhat, since they receive AM or SSB signals.

The receive stages shown in Fig. 1 represent those of a recent model single-conversion UHF-FM receiver. Not long ago, UHF receivers needed a second conversion, down to 455 kHz. Only filters at that low IF frequency could confine bandwidth or selectivity enough for narrowband FM (5-kHz deviation). But technology never stands still. Now, sharply selective crystal filters at 10.7-MHz (especially in tandem as shown here) can hold IF selectivity tightly to the necessary

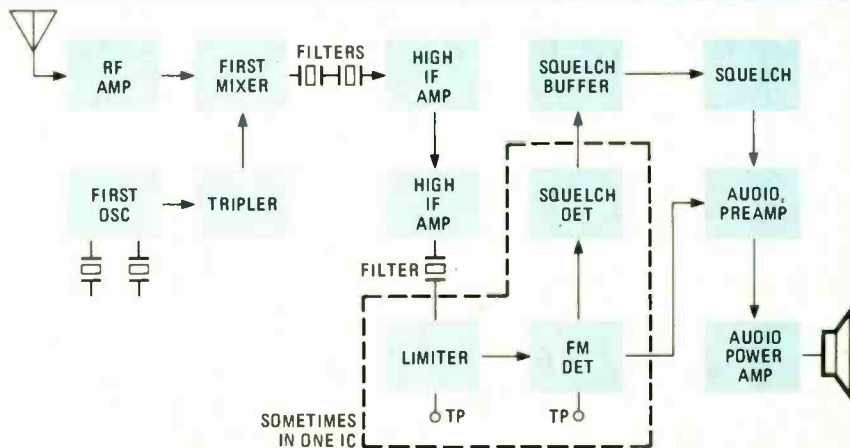

FIG. 1. RECENT MODEL UHF-FM RECEIVER reflects single-conversion design. Older UHF sets used dual conversion, and did not contain IC's.

20-kHz bandwidth. The need for a second oscillator and mixer is eliminated.

This changes very little the way you approach overall troubleshooting. As you will see later, dual-conversion receivers require a generator that reaches accurately down into the submegahertz frequencies.

First things first

An excellent place to begin troubleshooting is around the discriminator. You need an accurate 10.7-MHz signal source, unmodulated. Of course, if the discriminator comes after a series of low-IF amplifiers, let's say, the 455-kHz variator—that's the signal source to use.

The important thing to remember is *accuracy*. Today's more expensive signal generators have plenty of accuracy. However, you should not attempt a discriminator adjustment with just any old signal generator. One of exceptional accuracy and tight stability is a must. Lacking an expensive generator, you may have to make do with one that has less stability; if so, *always* monitor its output with a frequency counter.

Once the discriminator is calibrated, turn your attention to the IF stages immediately preceding it. In the Fig. 1 example, this means you test the IF amplifier and limiter stages at a frequency of 10.7 MHz. In a dual-conversion receiver, this step deals with 455-kHz stages.

Go to the limiter first. You'll discover that a quick meter check of the action in this stage indicates some things about the operation back towards the front end of the receiver, without even injecting a signal. Monitoring the effects, at the limiter, of an input signal tells you even more.

After checking the limiter, assess the operation of the IF amplifiers and the associated selectivity filters. Again, certain tests reveal whether or not these stages and components perform the way they are intended to. If they don't, correct the trouble before you proceed. Some later tests will depend on the proper operation of these IF stages.

Alignment tells a story

Knowing that transmitter troubleshooting responds well to an alignment procedure in diagnosis, smart technicians apply similar techniques for the IF and RF sections of communications receivers.

Therefore, if the receiver is a dual-conversion set, you next switch your signal generator to the high intermediate frequency and test those stages. As you will discover, you can verify the accuracy of your signal generator by two measurements—one using your frequency counter, and another made at the discriminator of the receiver. (Details will follow later in this article.)

The same procedure works when you

TABLE 1—FM SIGNAL GENERATORS¹

Brand	Model	Frequencies	Accuracy (ppm) ²	Output (mV)	Tone-Squelch Frequencies (Hz)
Cushman	CE-4B	0.01-999.9999	3	100	10.0-9999.0
	CE-5	0.05-519.999	9	100	
ifr	FM/AM 1000A	0.03-1000.0	5	5	5.0-9999.9
Lampkin	107C	0.001-1000.0	5	100 50	10.0-9999.0
	109	2.0-512.0	10		
	303				
Singer/Ailtech	FM-10CS	0.05-1300.0	10	1	
Wavetec	3001	1.0-520.0	100	1000	
	3002	0.001-520.0	100	1000	

NOTES:

1—All but Wavetec are part of FM communications service monitors.

2—ppm = parts per million, each part equivalent to 0.00001% of dialed frequency.

3—Dual-tone generator, with variable delays and durations.

check the receiver's RF sections. If the previous tests have been performed correctly, you can quickly zero-beat the receiver to a base transmitter or to a tightly controlled signal generator. (Today's generators (see Table 1) with digital settings have an accuracy that exceeds the FCC requirement for transmitters.)

Next on the agenda

It may come as a surprise that audio-and-squelch diagnosis *follows* the IF and RF troubleshooting procedure. Yet, using a meter to check most two-way radios makes it easy to check out most of these sections—up to and including the FM detector—without having to listen to the receiver.

Furthermore, only if all these tests come out as they should are squelch-system tests meaningful. This is because FM two-way radios depend on noise-operated squelch. Squelch problems in these sets often arise from defects in the RF or IF sections. Anything that reduces the amount of front-end circuit noise at the discriminator can cause "soft or erratic squelch." You could drive yourself crazy trying to track it down in the squelch section.

For this and other reasons, therefore, we suggest getting the discriminator, the low and high IF sections, and the RF and oscillator/mixer stages all in tip-top shape before you worry about squelch or audio.

Also, you can then check out the squelch and audio without having to use an audio generator. Simply feed a frequency-modulated signal (again, most modern generators can be frequency-modulated as well as amplitude-modulated) through the front end of the set (which you have proved OK) and proceed with testing.

This possibility becomes even more important when tone-coded squelch is involved. In these systems, receiver squelch opens up and "hears" only mes-

sages with an accompanying subaudio tone from the transmitter.

First, of course, you must understand how these squelch systems work. Second, you must be able to check the way squelch turns the audio on and off. Finally, you test how the squelch is opened up by the subaudio tone. This last requirement involves using a rather special audio generator, which is beyond the scope of this Special Section.

Final checks

One other important circuit within a receiver is the power supply: Certain DC voltages are regulated.

Before you undertake any other procedures, measure and verify that these regulated DC voltages are where they are supposed to be.

Not many mobile sets use electro-mechanical relays nowadays. Yet you may come across older gear that does use such relays.

Ordinarily, there are only two answers to relay problems: Either burnish the contacts or replace the relay. Only the most experienced relay expert is truly successful in trying to "bend the contacts" so they make and break in proper sequence. Considering the time you might spend on this procedure, and the likelihood of an early failure, your money is better spent on a new part.

Finally, do the customary final touch-ups. If a pilot light looks a little dark, it should be replaced because it will probably burn out soon. Dust out the chassis and clean up the front panel. Use a little alcohol on a *Q-Tip* to clean almost any corner. Remove knobs so you can clean behind them rather than leave a "ring around the collar."

Most important of all, service the set thoroughly. Whether you use the procedures described in this Section or ones of your own, check the set thoroughly. That's the only way to do the job conscientiously.

FM Detector And Filter Tests

Proper operation of FM detectors is vital to reliable operation of 2-way radio communication. Here's how they work and how to fix 'em.

BEFORE EMBARKING ON TESTS, YOU should understand how an FM demodulator works. Three basic types are used—discriminator, ratio detector and quadrature detector. Each is different, yet the principle of operation is roughly the same.

A frequency-modulated IF signal goes to the primary of a demodulator transformer. The signal is coupled inductively to the secondary. However, capacitance coupling also feeds the signal into the same circuits that are driven by the transformer secondary. This mixes inductively coupled and capacitively coupled signals, 90 degrees out-of-phase with each other.

A pair of diodes, connected in series-opposing at each end of the transformer secondary, act as detectors. However, the 90-degree phase difference causes them to conduct equally under one condition only—when the signal entering the transformer primary is precisely at the resonant frequency of the transformer primary and secondary circuits.

However, during frequency modulation, the signal deviates above and below the center frequency at an audio rate. Imbalance caused by the quadrature signals is proportional to the amount of frequency deviation.

Demodulators in double-conversion receivers center on a 455-kHz frequency. In others, the demodulator centers at whatever IF has been chosen; 10.7 MHz is usual.

Figure 1 shows an example of a basic FM discriminator that is used in many G-E two-way receivers. When the frequency swings above resonance, diode D1 conducts the most current. The voltage across the 220-pF capacitor becomes positive at the junction of D1. The farther the frequency deviates from center, the greater the positive voltage. When the frequency swings below resonance, diode D2 conducts the most current, and diode D1 conducts less. Voltage becomes posi-



LAMPKIN LABORATORIES MODEL 107C

tive at the junction of the capacitor and diode D2. Polarity across the capacitor thus alternates back and forth in step with the frequency deviation.

If you remember your frequency-modulation theory, you know that deviations occur at an audio or voice-frequency rate. The resulting alternating voltage across the 220-pF capacitor corresponds exactly with those voice frequencies. The RF is eliminated by the 220-pF capacitor. The demodulator thus recovers audio or voice modulation from the IF signals.

The discriminator shown in Fig. 2 differs only in how the quadrature or phase-shifted signal is fed to the secondary circuits. A "phantom center tap" is set up by a capacitive divider across the secondary.

The overall effect is identical. A signal precisely at resonance (of the transformer) results in the two diodes conducting equally and developing an equalized potential (0 volt) across the load capacitor. You can measure this zero voltage through a metering circuit—in Fig. 2, the 15K resistor and 0.01- μ F decoupling capacitor.

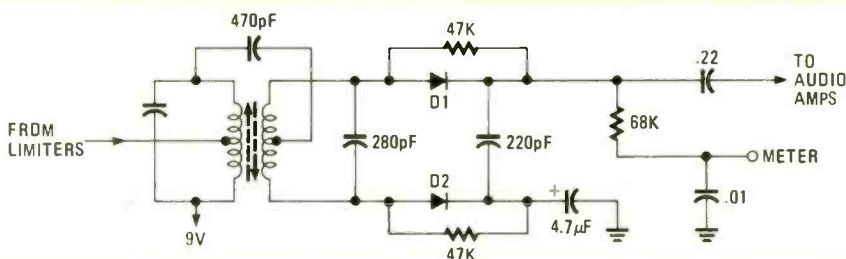

FIG. 1—BASIC FM DISCRIMINATOR is based on old Foster-Seeley design. The capacitor shifts phase by 90 degrees.

Either of two things can move this DC "output" voltage away from zero. First, if the center frequency fed to the transformer is slightly off—that is, not exactly at 455 kHz—the resting meter voltage reads slightly positive (above frequency) or slightly negative (below frequency). Second, with an exact incoming frequency, any misalignment of the transformer resonance, particularly secondary misadjustment, drastically alters the meter reading. In other words, the discriminator meter reads zero only when the incoming frequency is exactly 455 kHz, and when both transformer coils are adjusted to resonate precisely at 455 kHz.

From this, you can determine how to "calibrate" a discriminator; i.e., set it accurately at zero. Feed an accurate 455-kHz signal into the transformer from the limiter stages, and adjust the transformer coils for a zero reading at the discriminator metering point.

Just one precaution: The accuracy of this 455-kHz test signal is crucial. Use a crystal-controlled source, or a highly accurate synthesized generator, or keep a frequency counter on the generator you use. This is the only way you can truly calibrate the discriminator.

Figure 3 shows another type of demodulator. Note how the quadrature signal passes between two capacitive dividers, one across the primary and another across the special three-winding secondary of the discriminator transformer. This particular discriminator is used in Motorola two-way radios. Sometimes it is called a *phase discriminator*; some technicians call it a *capacitance discriminator*. The bottom part (inset) of Fig. 3 restructures the usual diagram to help you understand the operation of the demodulator a little better.

Diode D2 grounds the bottom end of the transformer secondary on the half-cycles in which the top end of the winding is negative (and the bottom end is positive). During that half-cycle, R1 is the load. Diode D1 couples the other end of the secondary to R2 on the other half-cycles. At resonance, D1 and D2 conduct almost identically. The DC voltages they develop show up across capacitor C4. Since these voltages are equal, they cancel each other. Therefore, the voltage at the metering point is exactly 0 (to ground).

Let the frequency being fed to the transformer deviate even slightly from

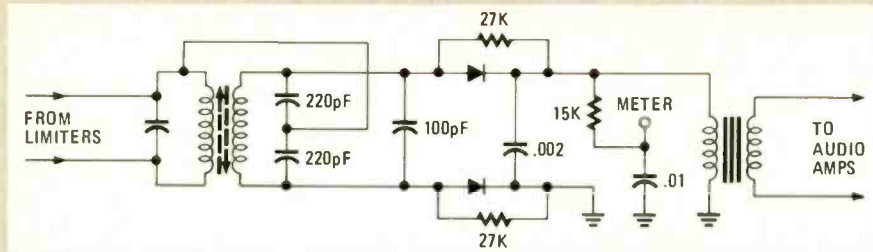

FIG. 2—DIFFERENCE IN SHIFTING PHASE does not alter the operation of this FM detector.

the transformer's resonant frequency and one diode conducts slightly more than the other. The voltage developed across C4 becomes something other than zero. If the frequency goes up, D1 conducts the most and the voltage at the metering point swings positive. Below resonant or center frequency, D2 conducts more and the voltage at the meter point is negative.

Hence, as frequency modulation deviates the signal up and down from the center frequency, the voltage across C4 follows the deviations closely and frequency demodulation occurs.

One thing you will discover when you examine the functional block diagram of almost any two-way radio is that a stage or two of *limiting* precedes the FM discriminator. *Limiters* are saturated stages that level out any amplitude variations that exist in a signal. It is important, for the recovered voice signals to be clear, that a discriminator type of demodulator be fed a pure FM signal. Many factors between the transmitter modulator and the receiver demodulator can vary the signal level, in effect adding some amplitude modulation. Most discriminators are sensitive to amplitude modulation, so limiters are necessary.

Once a limiter is saturated, it develops a base current that is somewhat proportional to the signal fed into the stage. Consequently, connecting a meter across a base resistor will indicate whether the limiter works or not. Virtually all commercial FM two-way radios contain at least one metering point for evaluating the limiter, which is why it's handy as an alignment indicator.

Broadcast FM receivers and some older communications receivers contain a variant called a *ratio detector*. The most notable circuit variation is that the diodes are connected as series-aiding rather than as series-opposing. Capacitors still produce a quadrature phase shift and the same results are obtained as with a discriminator; that is, frequency deviations cause a change in voltage across an output or a load capacitor and voice signals are recovered from a frequency-modulated IF signal.

A ratio detector effectively cancels the amplitude modulations that accompany the IF signal to the detector. Therefore, less limiting is needed. Nevertheless, you almost never find a communications receiver without limiters between the low-IF amplifier and the FM demodulator.

Modern systems

Figure 4 shows a modern-day FM demodulator. Instead of a discriminator transformer, a fixed-frequency ceramic filter couples the IF signal from the limiters to the diodes. Designed especially for this purpose, this unique filter offers an extra advantage: high selectivity. Aging seldom changes the filter's resonant frequency more than a few Hertz, so you never have to adjust it; it either works or it doesn't.

The 90-degree phase difference occurs in the discriminator filter itself. Two output voltages develop across R1 and R2, and are fed to diodes D1 and D2. Because they are connected in series-aiding, diodes D1 and D2 deliver a combined DC output voltage that is precisely zero when the frequency that is fed to the filter exactly matches its center resonance. Deviations up or down from the center frequency produce a net positive or negative voltage across R3. Capacitor C3

provides a time constant with this load fast enough to respond properly to voice frequencies, and yet slow enough to eliminate most of the IF component. Network L1 and C5, together with bypass capacitor C4, filter out any remaining 455-kHz signal. As a result, capacitor C6 couples voice signals onto the audio-amplifier stages.

As always in communications discriminators, there is a test point across the DC output. In this design, since you cannot adjust the quadrature circuit, this test point serves mainly to help you judge whether the filter discriminator is good or bad, or adjust the conversion oscillators.

State-of-the-art two-way radios use an IC for the limiter/discriminator sections. Even with these circuits, a 90-degree phase shift is necessary. So, you will find an adjustable quadrature transformer connected to two pins of the IC. This tunable coil serves the same purpose (insofar as adjustment is concerned) as the secondary of a discriminator transformer.

Figure 5 shows a simplified representation of an integrated-circuit FM demodulator system, with limiters and a quadrature detector contained in one IC.

The quadrature coil is located externally. Tuning it is similar to tuning the secondary of a discriminator or ratio detector, but with one significant difference. You do not align for a zero-centered

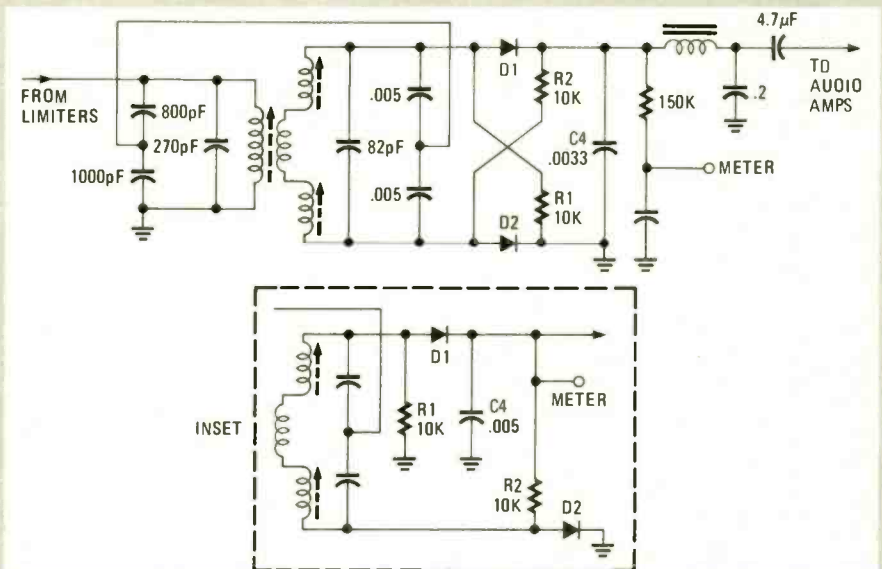

FIG. 3—CAPACITIVE DISCRIMINATOR incorporated in many Motorola two-way receivers; inset shows restructured circuits so you can understand how demodulators work.

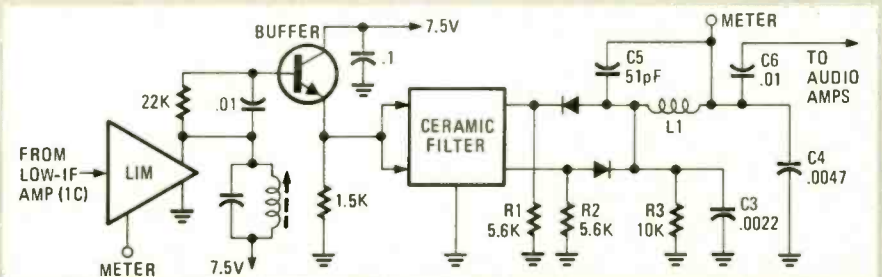

FIG. 4—FM DETECTOR (from marine VHF set) is driven by ceramic filter; it features high selectivity and cannot be adjusted.

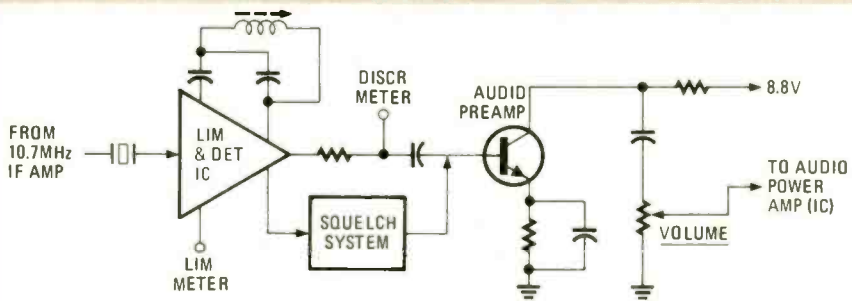

FIG. 5—IC'S IN MODERN DESIGN often combine a limiter and FM detector; the alignment coil is still external.

meter reading. Instead, with a very precise IF signal fed in from the IF amplifiers, you align for an exact 24- μ A meter reading. This happens to be "zero-center" on this quadrature-detector S-curve. Naturally, the circuit includes a detector metering point.

Limiter stages are part of the same IC. As is common practice, there is a metering point for measuring the limiter current. You can use limiter metering to adjust for RF and IF alignment.

The Fig. 5 set has an IF of 10.7 MHz. To calibrate the discriminator, use only a signal source that is synthesized with a digital readout, or is tightly crystal-controlled.

Testing FM detectors

The first test for a discriminator is whether or not it will zero-center properly. This is called "calibrating" the discriminator. (Earlier we stressed the necessity for signal-source accuracy.)

Another important point: DO NOT try calibrating the discriminator from the front end or, in double-conversion sets, with a high-IF signal. Why? If either oscillator happens to be off-frequency, you would zero-center the discriminator incorrectly, or you would unknowingly use an incorrect signal. Perform this part of troubleshooting using only an unmodulated IF signal.

Feed a precisely accurate 455-kHz low-IF signal into the base of the second receiver mixer. If the receiver is single-conversion, use whatever frequency the IF and discriminator take, but feed in the signal at the mixer base. The mixer stage thus isolates any capacitive effect the generator cable has on tuning of subsequent stages.

The signal should be very strong for this test and adjustment procedure. Set the generator-output level high—for at least 500 mV of IF signal.

Connect your DC meter at the discriminator test point. If the meter reads either side of zero, adjust the discriminator coil (the secondary—usually the bottom slug) to center the discriminator as closely to zero as possible. Make sure again that the test signal is precisely at the right IF; otherwise, any later adjustments will be incorrect. Also remember that, in some sets, zero center is at some specified meter reading.

If you can't zero the discriminator, this means trouble, and diodes are the most frequent offenders. Diodes should be fairly well matched; that is, forward resistance should be about the same in both. There should be almost *no* leakage. A faulty coil or capacitor can also prevent zeroing. Get this corrected before proceeding any further.

Next, test the discriminator for balance. This is where a decade-type generator frequency control comes in handy.

With the discriminator accurately zeroed, reset the generator frequency for 1 kHz *above* the center frequency. Note the new discriminator meter reading. Then, reset the generator frequency to 1 kHz *below* the center frequency. The meter reading should move in the opposite direction from zero and exactly the same amount. In other words, equal frequency swings above and below center frequency should result in equal but opposite voltage swings.

Diodes again are your prime suspect when a discriminator fails to show balance. Sometimes, however, a badly mistuned *primary* coil creates this effect, even when the secondary seems to zero normally. However, go easy: all primary tuning requires that you readjust the secondary for zero. Capacitor values that have shifted (as a result of age or heat) can also cause unbalance. In addition, check the decoupling for the primary winding and the discriminator secondary.

Poor discriminator balance can be caused by a faulty ceramic or crystal IF filter. Although this is not the usual symptom of a bad selectivity filter, don't overlook it. (In a moment we'll tell you how to test filters.)

Connect your DC meter at the metering point in the limiter stage nearest the discriminator. Adjust all low-IF transformer and limiter coils for a maximum reading at the limiter.



CUSHMAN MODEL CE-4B

For this check, don't feed in too much IF signal. Set the signal generator attenuator at zero and turn it up until you see the limiter reading rise slightly. If, when you align the IF and limiter coils, the reading goes higher, keep reducing the generator-output signal. If you oversaturate the limiters, these adjustments will be too broad and you won't obtain accurate alignment.

Broad adjustments in any case signify trouble. Look for a leaky transistor, a faulty transformer or an open decoupling capacitor. Eliminate the trouble before proceeding to any other part of the receiver.

Finding filter defects

Check out low-IF filters when you have your instruments connected for IF alignment. Keep the generator set exactly at the discriminator's center frequency. Feed in just enough signal to quiet some of the circuit noise heard in the speaker. Meter the limiter at the same time. You will note that slight quieting occurs after the limiter reading starts rising.

Now, set the generator-output high so the receiver is almost but not completely quieted. This signal level brings the limiter reading up to about halfway between threshold limiting and "flattening out" or oversaturation. It is important to hear a tiny bit of circuit noise, and note the limiter meter reading.

Now, raise the generator frequency exactly 1 kHz *above* the center frequency. Pay close attention to the increased noise level of the receiver and the exact degree of reduction in limiter reading.

Next, shift the generator frequency to 1 kHz *below* center. The meter reading should fall off almost exactly the same amount as for 1 kHz above the center frequency. Speaker noise increases.

You can make and interpret this test in a matter of seconds. If you have any doubts, swing the generator frequency 2 kHz above and below center. Again, the noise levels on either side of center should be the same, with matching reductions in the limiter reading.

If there had been any earlier unbalance in the discriminator or quadrature detector, this test indicates whether you can blame it on defective filters.

Sometimes, when a discriminator zeroes OK but cannot be balanced exactly, some careless folks settle for a compromise balance, with the discriminator resting a little off-center. This results in audio distortion, especially during full signal modulation from another station or transmitter. Always test both the discriminator *and* filter balance to be sure.

Where filters are ganged, you may wonder which one is bad. Try injecting the test signal between the two filters. Isolate the signal generator with a 50-pF capacitor in series with the cable. Injection tracing lets you isolate which filter has changed characteristic.

R-E



You Can

An installment of a continuing series
readiness to qualify as a

TRY YOUR HAND AT THESE SAMPLE TEST questions on electronic components and circuits. The answers to this month's and a new set of questions will appear in a future issue of **Radio-Electronics**. When you feel ready to take the CET Exam write to IS CET: 310 1/2 Main St., Ames, IA 50010. Ask for the name and number of the nearest Certification Administrator, and take the CET exam.

Chapter 5 questions, electronic components & circuits

1. Which of the following statements regarding the circuit shown in Fig. 1 is true:

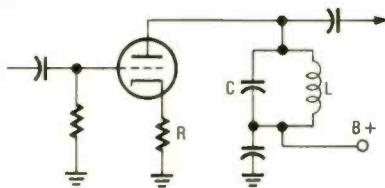

FIG. 1

- () a. will pass all frequencies except one band near the resonant frequency of the L—C circuit.
- () b. will reject all frequencies except one band near the resonant frequency of the L—C circuit.
- () c. the value of R will determine the resonant frequency of the L—C tank circuit.
- () d. resistor R provides regeneration for the circuit.

2. In the circuit shown in Fig. 2:

- () a. R and C act as a tone control.
- () b. R varies the frequency of oscillation.

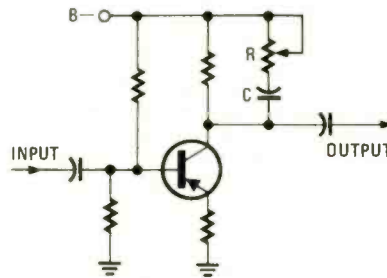

FIG. 2

- () c. R varies the collector voltage.
 - () d. R varies the DC voltage on C.
3. In the Fig. 3 circuit:
- () a. D will conduct when the voltage at E1 is lower than its breakdown potential.
 - () b. D is a protective device which will cause R to open if E2 voltage rises above D breakdown voltage.
 - () c. D will conduct when E1 voltage is

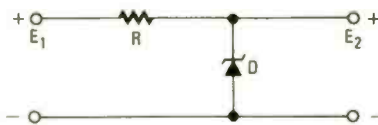

FIG. 3

- higher than its breakdown potential.
- () d. the circuit is that of a simple half-wave power supply.

4. Regarding the circuit shown in Fig. 4:

- () a. the circuit cannot work as D1 and D2 cancel any signal at E.
- () b. the circuit could work as a regulated power supply.

- () c. the position of the pointer at R

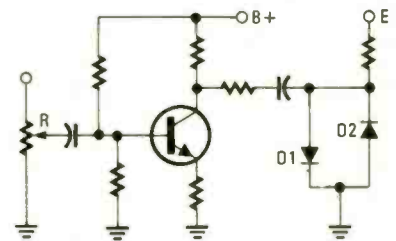

FIG. 4

would determine the DC voltage at E.

- () d. D1 and D2 are noise limiters.

5. Regarding the circuit shown in Fig. 5:

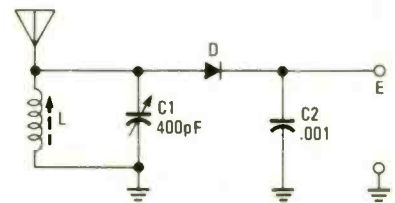

FIG. 5

- () a. it will work best if a high impedance headset is connected at E.
- () b. it cannot work without a power supply connected at E.
- () c. it cannot operate over the entire AM broadcast band unless both the L and C1 are variable.
- () d. the value of C2 will determine the station to be received.

6. The circuit shown in Fig. 6:

- () a. could be used to turn on an alarm.
- () b. is a sound-operated relay circuit.

Be A CET



of questions aimed at checking your Certified Electronic Technician

DICK GLASS

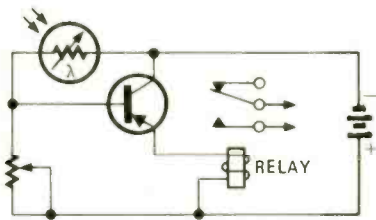

FIG. 6

- () c. can be used to measure fluid flow.
 - () d. is an overload protector.
7. What type of circuit is shown in Fig. 7?

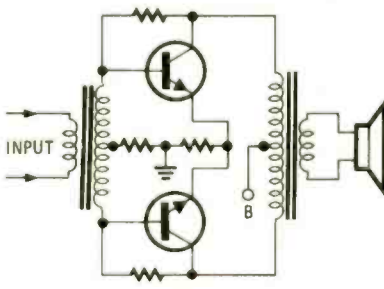

FIG. 7

- () a. a complementary symmetry amplifier circuit.
- () b. a push-push amplifier.
- () c. a push-pull amplifier.
- () d. an emitter-follower amplifier circuit.

8. The circuit in Fig. 8 is a:

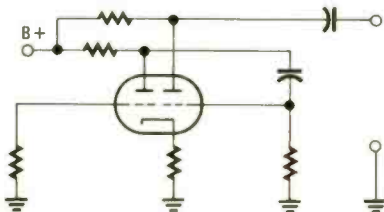

FIG. 8

- () a. multivibrator.
- () b. blocking oscillator.
- () c. Armstrong oscillator.
- () d. Hartley oscillator.

9. Figure 9 is a:

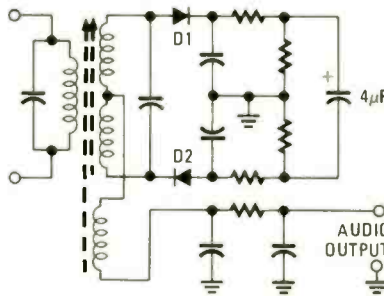

FIG. 9

- () a. ratio detector.
- () b. quadrature detector.
- () c. discriminator.
- () d. full-wave bridge.

10. In Fig. 10, pins 3, 4, 5, 7, 10, 11, & 12 of the IC might be used for:

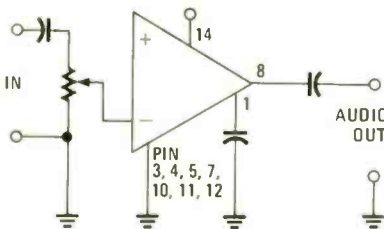

FIG. 10

- () a. heat sinks.
- () b. optional input level connections.
- () c. optional output level connections.

- () d. they have no purpose.

Be sure to keep this month's issue of **Radio-Electronics** so you can check your answers in the next CET test. R-E

Answers To Prior Quiz

Correct answers to Chapter 4 questions on transistors and semiconductors

Here are the answers to the questions on transistors and semiconductors that appeared in the November 1978 issue.

1. Correct answer is "b."
Collector and emitter DC voltages on transistors vary widely. Determining that either of these elements has a DC voltage is useful in troubleshooting but the most useful check is to see if the bias voltage (emitter-to-base) is in the range that will permit the semiconductor to operate.
2. Correct answer is "d." The collector of an NPN transistor is positive in relation to the base and emitter. The emitter would be approximately 0.6 volt more negative than the base.
3. Correct answer is "a."
4. Correct answer is "a."
5. Correct answer is "d."
6. Correct answer is "c": A tunnel diode is unique in that it will oscillate at UHF frequencies.
7. Correct answer is "c."
8. Correct answer is "a."
9. Correct answer is "b" (an N-channel JFET).
10. Correct answer is "c."

ANNOUNCING ... A New CREI Program: Minicomputer & Microprocessor Technology Including A Microprocessor Laboratory

Now you can learn at home
the new technology that is
revolutionizing electronics

The microprocessor has ushered in the age of microtechnology and electronics will never again be the same. The microprocessor has made possible the placing of an entire computer on a silicon chip one quarter inch square. The microprocessor "miracle chip" is in the process of changing the world. Soon all technical personnel in electronics will have to understand and work with the microprocessor. It is invading virtually every area of electronics. And it is profoundly affecting your electronics career.

Brand New Program

CREI has a brand new program to help you learn how to work effectively with this revolutionary electronics development. CREI's new program in Minicomputer and Microprocessor Technology is designed to prepare you for this field by giving you the education and practical experience you need.

The program provides solid preparation in electronics engineering technology with a specialization in minicomputers and microprocessors. In addition, it includes a microprocessor laboratory which features a fully programmable microcomputer which utilizes the Motorola 6802 microprocessor chip. This is an extremely important element of your program.

Programming Essential

As you may well know, you must learn how to *program* the microprocessor in order to design, service or troubleshoot microprocessor electronic systems. There is only one effective way to learn this all-important skill of programming, and that is by actually *doing it*. CREI's new program gives you this opportunity as you work with the exciting microprocessor laboratory.

Programming Is Easy

With CREI's new program, learning the skill of programming is simple. Within a few hours you'll be programming the microprocessor and in a short time you'll learn how to program it in three languages: BASIC, assembly and machine languages. In addition, you will learn how to interface the microprocessor with other systems and to test and debug specialized programs.

Preparation at Home

Wide Choice of Programs

Please note, however, that CREI's new program is only one of 16 state-of-the-art programs in advanced electronic technology offered by CREI. So even if you choose not to specialize in micro-processor technology, CREI has an advanced electronics program to meet your needs.

With CREI, you may choose from any of the following areas of specialization in advanced electronics:

- Microprocessor Technology
- Computer Engineering
- Communications Engineering
- Digital Communications
- Electronic Systems
- Automatic Controls
- Industrial Electronics
- Television Engineering
- Microwave Engineering
- Cable Television
- Radar and Sonar
- Nuclear Instrumentation
- Satellite Communications
- Aeronautical and Navigational
- Solid State Theory
- Nuclear Engineering

Unique Lab Program

An exclusive option available with CREI programs in electronic engineering technology is CREI's unique Electronic Design Laboratory program. It gives you actual experience in designing practical electronic circuits. It also helps you to understand the theories of advanced electronics and gives you extensive experience in such areas as tests and measurements, breadboarding, prototype construction, circuit operation and behavior, characteristics of electronics components and how to apply integrated circuits. Only CREI offers this unique Lab Program.

Practical Engineering

CREI programs give you a practical engineering knowledge of electronics. That is, each part of your training is planned for your "use on the job." By using your training, you reinforce the learning process. And by demonstrating your increased knowledge to your employer, you may qualify for faster career advancement.

Free Book

There isn't room here to give you all of the facts about career opportunities in advanced electronics and how CREI prepares you for them. So we invite you to send for our free catalog. This fully illustrated, 56 page book describes in detail the programs, equipment and services of CREI.

Qualifications

You may be eligible to take a CREI college-level program in electronics if you are a high school graduate (or the true equivalent) and have previous training or experience in electronics. Program arrangements are available depending upon whether you have extensive or minimum experience in electronics.

Send for this FREE Book describing your opportunities and CREI college-level programs in electronics

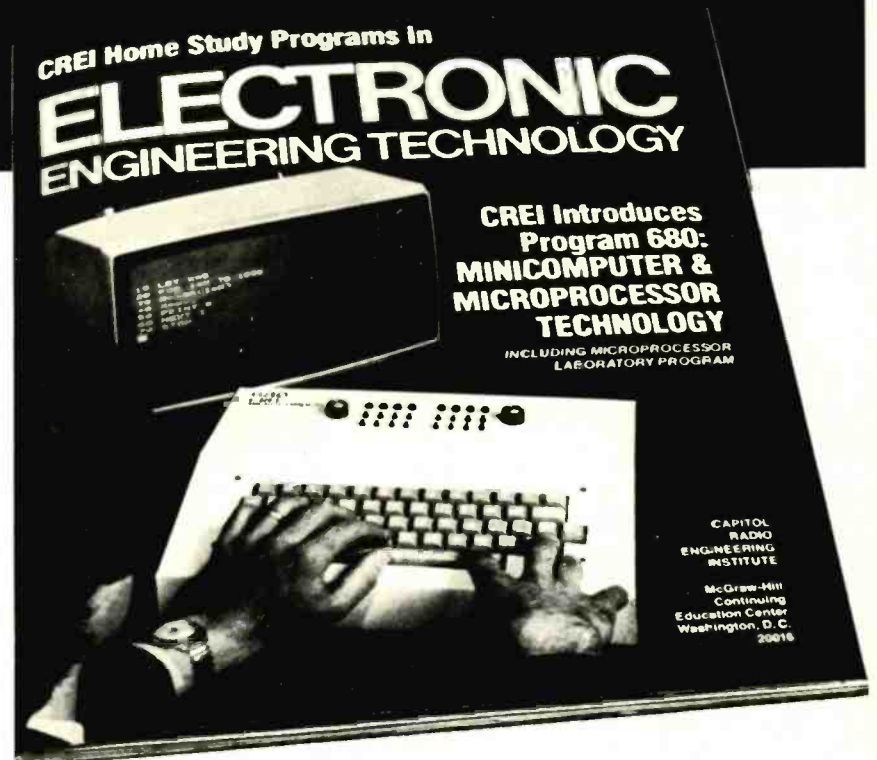

Mail card or write describing qualifications to

CREI CAPITOL RADIO ENGINEERING INSTITUTE

McGraw-Hill Continuing Education Center
3939 Wisconsin Avenue Northwest
Washington, D.C. 20016

Accredited Member National Home Study Council

GI Bill

CREI programs are approved for training of veterans and servicemen under the G.I. Bill.



HOBBY CORNER

Learn solid-state circuitry as you complete your monophonic music maker.

EARL "DOC" SAVAGE, K4SDS, HOBBY EDITOR

DID YOU GET YOUR MULTI-E-TONE GENERATOR and note selector assembled and operating (see "Hobby Corner," *Radio-Electronics*, January 1979)? This month it's time to add an automatic control system. We'll build a push-one-button-to-play circuit and then add triggers.

The push-to-play circuit calls for a pulse generator and a counter. Figure 1 shows a basic 555 astable multivibrator used as a variable-rate pulser. The rate and, therefore, the length of each note in the tune is determined by R1, R2 and C1. You can increase or decrease any of those components to change the available range of lengths.

Pressing switch S1 removes pin 4 from ground; this enables the 555 pulser that puts out (pin 3) a string of pulses for as

The 7404 inverter between pin 4 of the 555 and pin 2 of the 7493 does two jobs. It returns the counter to zero when the 555 is disabled, thus insuring (1) that the tune starts at the beginning regardless of where it stopped, and (2) that zero output pin 1 (74154) is activated. Since no tone was connected to the pin 1 output, the device is silent when S1 is not pressed.

You can use switch S1 to turn on a doorbell, as an alarm clock output or any other device of your choice. As long as the switch is activated, the tune plays. The circuit now plays as much of your tune as there is time for. That's OK, but it seems unfinished!

So let's add another 555 to make the circuit play the tune in whole multiples only—no more part tunes. The 555

Why not use a 556 dual timer in place of the two 555's? Sure, you can do that, but right now we're going to talk about adding even more controller timers.

Control timers

Suppose, for example, that you would like to use your tune player in place of a doorbell, and you have *two* doors. If you use two switches on one controller timer, it won't be possible to know whether your visitor is at the back or the front of the house. To solve this problem, set up another controller 555, as shown in Fig. 2. Adjust the timing so that one controller plays one-half the tune and the other controller plays the whole tune, or the whole tune once and twice. If your home has three doors, just use three controllers.

When you use more than one 555 controller, you cannot simply tie all the outputs together. The most direct method is to use one or more OR gates (see Fig. 3). If one or more inputs goes high, then the output also goes high and activates the pulser.

There is one more potential problem: Perhaps a heavy-handed visitor or some other occurrence triggers and re-triggers a controller when you don't want it to repeat. For example, suppose you want the alarm clock to repeat until you turn it off but you don't want to activate the on-

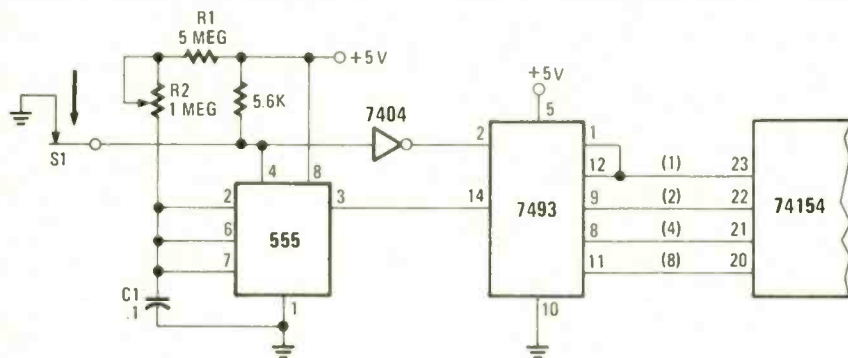

FIG. 1—PUSH-TO-PLAY circuit.

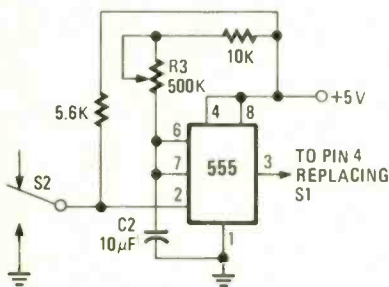

FIG. 2—MONOSTABLE controller circuit.

long as the switch is open. The 7493 binary counter counts the pulses and encodes them to binary 0-15 for the 74154 note selector. This arrangement, of course, replaces the four manual switches that were added temporarily to the 74154 input, as described last month.

monostable shown in Fig. 2 will do just that.

Remove the pin 4 line from the pulser and connect it to the controller output, pin 3. Now just a quick tap on S2 starts the tune, and it plays until the controller times out. Adjust R3 until the time-out occurs right at the end of the tune. (Depending upon how long each note sounds, you may have to change the value of R3 and/or C2 to get into the correct timing range.)

Now you have a doorbell, clock alarm or whatever other device you like that plays *your* tune through to the last note regardless of how long S2 is closed. Of course, it may play it five or 10 times if your visitor has a heavy finger, but this feature is good to have on a clock alarm if you are a heavy sleeper!

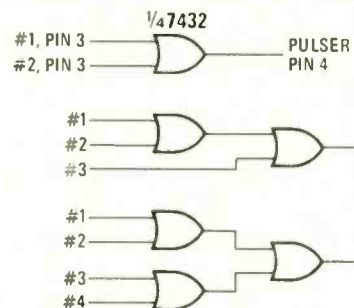

FIG. 3—CONTROLLER COUPLERS.

the-hour chime. The circuit shown in Fig. 4 causes the controller to trigger once and *only once* for each closing of switch S3 no matter how long it is closed.

The single trigger circuit is a little tricky. In fact, you can provide different effects by changing the values of R4 and C4 and even by taking out the diode across the capacitor. These possibilities are available: (1) a single trigger when S3

is closed and another when it is opened; (2) a single trigger on closing and another available as soon as the first time-out is completed; and (3) a single trigger on closing following by a "dead-time" of from several seconds to several minutes during which the switch will not re-trigger. The values given in Fig. 4 put my prototype in case (2) above, but much depends upon the *quality* of C4 and how much leakage it has.

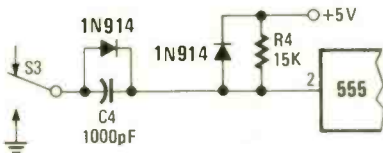
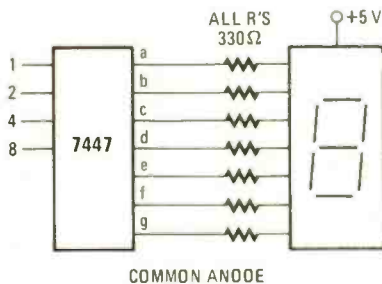
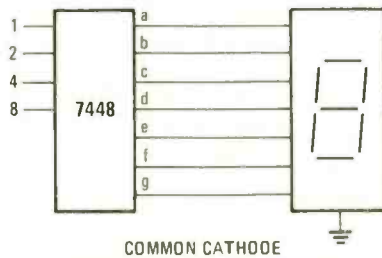

FIG. 4—SINGLE-TRIGGER (time-out) circuit.



COMMON ANODE



COMMON CATHODE

FIG. 5—TWO READOUTS AND DRIVERS.

There are many variations that you can make in these circuits. Build a tune-maker to suit your needs and, then, package it accordingly. Here are just four more ideas:

1. Use gates to detect the 15, 30, 45 and 00 minutes on your digital clock and trigger tune-maker chimes.
2. Put in a second 74154 and 7493 to give you a 30-note capability.
3. Drive the 74154 with an 8573 or an 8574 (256 × 4 PROM) for 256 variations of your 16 notes.
4. Take a fistful of 1N914's and build a diode matrix to select any number of notes.

Let us know what you have done with the tune-maker, and we'll share as many ideas with other readers as possible. Have fun!

R-E



HIGH BLOOD PRESSURE.
Treat it...and live.

The National High Blood Pressure Education Program,
U.S. Department of Health, Education, and Welfare.

Why buy a multi-capability counter for frequency-only measurements?



The 1911A multicounter makes accurate field transmitter frequency checks easy with the optional battery-pack and whip antenna.

For accurate readings in the presence of noise. Our new 1911/12A multi-counters have both trigger-level and attenuator controls.

For high resolution measurement of low frequency control tones in the period or period-average mode.

For economy. They're priced about the same as many frequency-only models, with totalize, autozero, autoranging, manual and automatic range selection, and more. Standard.

- 1911A for 250 MHz applications: \$495.*
- 1912A for measurements to 520 MHz: \$620.*

Call (800)426-0361, toll free, or write: John Fluke Mfg. Co., P.O. Box 43210, Mountlake Terrace, WA 98043.

*(U.S. price)



1912A 520 MHz model

Fluke Multicounters for Communications Service



2110-8001

CIRCLE 46 ON FREE INFORMATION CARD

CIRCLE 72 FOR DEMONSTRATION

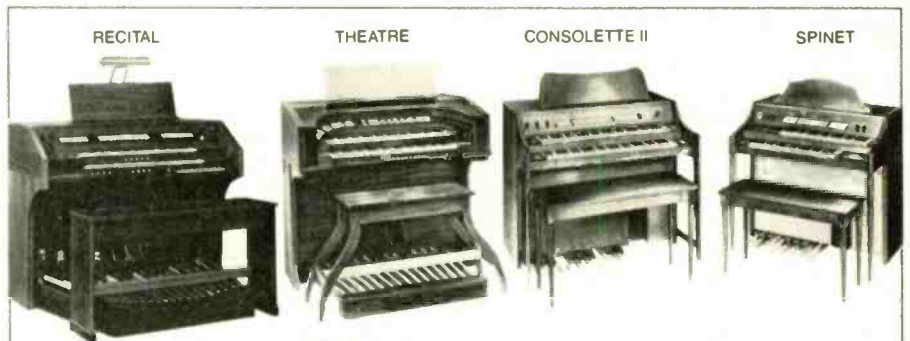

You can assemble any of these Schober Organs

—and save 50% off store prices.

This coupon will bring you the fascinating Schober color catalog which describes the organs and shows you how easy it is to assemble them from Schober's complete kits. Include \$1 if you want a 12-inch demo record.

The Schober Organ Corp., Dept. 183
43 West 61st Street, New York, N.Y. 10023

- Please send me the Schober Organ Kit Catalog.
 Enclosed is my \$1 for the 12-inch demo record.

Name _____

Address _____

City _____ State _____ Zip _____

CIRCLE 31 ON FREE INFORMATION CARD

computer corner

8085 *A look at one memory IC that is among the 8085 family of devices.*

J. TITUS, C. TITUS, D. LARSEN AND P. RONY

IN A PREVIOUS COLUMN (JANUARY 1979), we described the new Intel 8085 microprocessor IC. This is an upgraded type of 8080 microprocessor, since it has features that are not found on the 8080 device. One of the advantages in using the 8085 is the availability of "family" devices that can be used with little or no additional external logic. This makes the 8085 and its family ideal for small controllers, instruments and games, where ex-

*This article is reprinted courtesy American Laboratories. Dr. Rony, Department of Chemical Engineering, and Mr. Larsen, Department of Chemistry, are with the Virginia Polytechnic Institute & State University. Both Mr. J. Titus and Dr. C. Titus are with Tychon, Inc.

pansion and the ability to run large programs such as BASIC may not be required.

This month we will describe one of the 8085-family devices, the 8155 read/write memory.

8155 RAM

The 8155 read/write memory IC contains 256 bytes of memory, which is probably more than enough for a small system. In most cases, the read/write memory will be used for temporary storage of data or results, as well as register and address information. The 8155 is also bus-compatible with the 8085 system through the use of the bidirectional address-data bus and standard control sig-

nals. In this case, only the $\overline{IO}/\overline{M}$, \overline{RD} and \overline{WR} signals are necessary for memory control. The ALE, CLOCK and RESET signals from the 8085 are also provided for internal control of the IC.

The 8155 has some I/O lines—in fact, there are two 8-bit I/O ports and one 6-bit I/O port. The two 8-bit I/O ports can be operated in either the input or output mode; individual bits cannot be selected. These two ports are called ports A and B. The 6-bit I/O port (port C) can be operated in several ways, but these are beyond the scope of this article. Let us just say that these operations allow the I/O ports to perform in a manner similar to that provided by the mode 1 and mode 2 operation of the 8255 programmable peripheral interface.

The 8155 read/write memory also contains a 14-bit programmable counter, re-



costly call- backs...

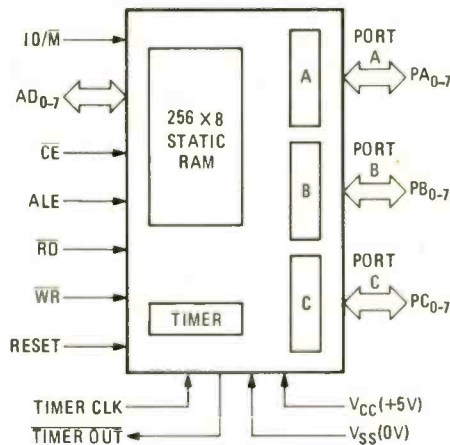
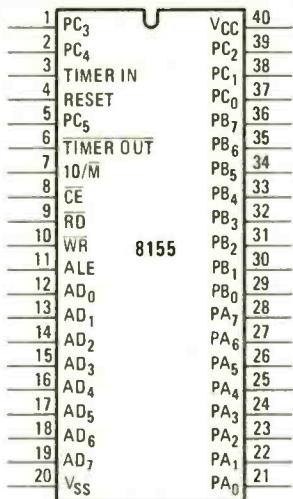

ferred to as a timer. The timer uses either the 8085's clock output or an externally applied clock signal. The timer's output is available as a pin on the 8155 IC, and it can be used several ways, depending on your requirements. It could be connected to the Serial Input Data (SID) pin 5 to be sensed by the RIM instruction, or connected to one of the 8085's interrupt pins (RST 7.5, for example) so that the end of the timer's period could be detected via an interrupt. The timer's output is fairly flexible, being programmed to operate in one of four ways:

Control Bits		Mode Of Operation
M2	M1	
0	0	Output a logic 0 during the second half of the count.
0	1	Output a squarewave, same as 00 above, but reload and restart the count at the end of each count sequence.
1	0	Output a single short pulse at the end of the count sequence.
1	1	Output a single pulse at the end of the count, but reload and restart the count at the end of each count sequence.

Control bits M2 and M1 are the most significant ones in the 16-bit value programmed into the counter. Since the counter is only 14-bits-long, the control bits are not included in the count itself, but are used by the control logic to determine the counter-output state when the count has been finally decremented to zero. Whenever a new 14-bit count value is reprogrammed into the counter, these two control bits must also be included in the new 16-bit word.

The 8155 read/write memory also has an internal control register that is loaded with an 8-bit byte that is used to determine operation of the I/O ports and the 14-bit counter.

R-E

make more money with RCA SKs...

... and your customers will really appreciate your reliable service.

You eliminate costly call backs because: with RCA SKs you know you're using the best. RCA guarantees it. We'll replace any defective SK within one year of purchase by the dealer. We can afford to make this offer because our malfunction rate is one of the lowest in the industry — less than one percent.

With RCA SKs you know your customer is getting the right semiconductor. Our SK line includes over 900 replacement transistors, rectifiers, thyristors, integrated circuits and high voltage triplers that meet or exceed the OEM standards for the 150,000 domestic or foreign semiconductors our SKs can replace.

You save time because you'll identify the exact SK you need quickly in RCA's easy-to-use Replacement Guide with complete installation data. And on every SK package you'll find all the necessary technical specifications, physical characteristics and terminal diagrams.

All hardware, when needed, is also included right in the SK package which saves you extra trips back to the truck or back to the shop.

You make more money because: you can work faster, more efficiently with RCA SKs. And you virtually end costly call-backs which means a lot more satisfied customers as well.

For details on how to order, see your RCA SK Distributor. Or contact RCA Distributor and Special

Products Division, Deptford, N.J. 08096, Attention: Sales Promotion Services.



RCA

SK Solid State Replacement

communications products

AUDIO TEST STATION continued from page 48

More information on new products is available from manufacturers of items identified by a Free Information number. Free Information Card is inside the back cover.

ANTENNA MOUNTS, model TRM-3, model WM-12, model WM-18. The heavy-duty model TRM-3 is a 3-foot-high tripod that accommodates TV, FM, CB and antenna masts to 1 1/4 inches in diameter. It can be roof-mounted or used in the field without bolting the legs. Comes fully assembled, with cap screws and hex nuts for securing the mast.

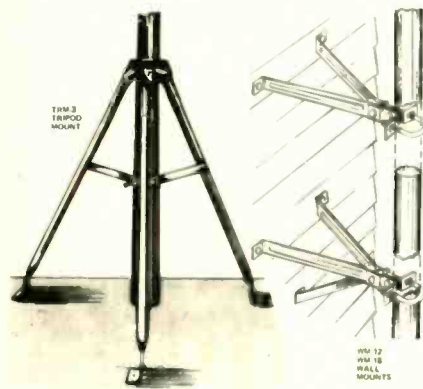

CIRCLE 126 ON FREE INFORMATION CARD

The models WM-12 and WM-18 are 12-inch and 18-inch wall mounts, respectively; both include brackets, U-bolts and hardware for up to 1 1/4-inch diameter masts. List prices: model TRM-3, \$16.90; model WM-12, \$9.50; and model WM-18, \$13.45.—RMS Electronics, Inc., 50 Antin Place, Bronx, NY 10462.

TWO-METER TRANSCEIVER KIT, model HW-2036A, has a 143.5-MHz—148.5-MHz operating range and features a phase-locked synthesizer/VCO loop and choice of simplex, or ± 600 -kHz split operation. Features tone encoding, built-in 5- and 11-VDC regulators, hash filter/regulator and gimbal mount. The model HW-2036A-1 (with



CIRCLE 127 ON FREE INFORMATION CARD

Micoder II mike/auto patch) costs \$289.95; the model HW-2036A-2 (with standard PPT mike) costs \$269.95.—Heath Co., Dept. 350-640, Benton Harbor, MI 49022.

CB MULTIMONITOR, model CB MM6, is designed for 23- or 40- channel mobile/base station equipment and offers six functions in a single unit: An antenna-matching network to adjust

SWR; an SWR bridge and reflected power indicator; a built-in low-pass filter (to eliminate second and third harmonics); a complete antenna monitoring system with warning light; a built-in dummy load with modulation indicator; and a choice of



CIRCLE 128 ON FREE INFORMATION CARD

using a regular mobile CB antenna or AM/FM antenna for CB communications. The unit comes with two antenna inputs. Other specifications include a 26.5-MHz to 27.5-MHz frequency range, handles 5 watts of input power, 50-ohm input impedance, up to 4:1 VSWR mismatch correction, and spurious signal suppression of -25 dB. The model CB-MM6 measures 2 3/4 W X 4 L X 1 1/4 inches H, and lists for \$49.95.—RMS Electronics, Inc., 50 Antin Place, Bronx, NY 10462.

AM/FM POWER ANTENNA, model FA-80, features a 10-pole motor and is fully shielded against noise transmission and reception. The antenna is completely automatic—it is activated and deactivated by the vehicle's ignition system; as an option it can be connected to car radio's on-off

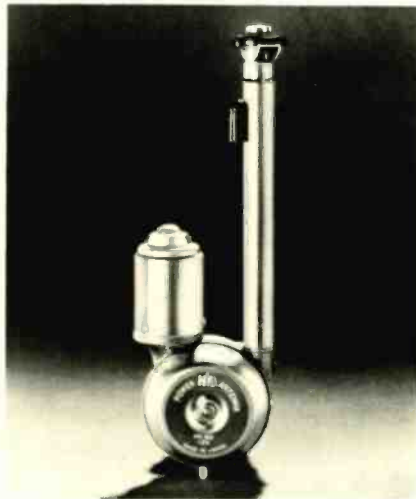

CIRCLE 129 ON FREE INFORMATION CARD

switch. The flush-mounted head protects against theft.—Harada Industry of America, Dept. P, 145 E. Albertoni St., Carson, CA 90746. R-E

Rotary switch S3 selects the integrating capacitor, and the charging current is determined by the networks connected to IC201 pins 4 through 7. Small-value capacitors charge faster than larger capacitors for the same charging current so a smaller capacitor selected by S3 will produce a higher frequency. Also for a given capacitor, increasing the charging current by varying R1 and R2 also increases the frequency.

The comparator or squarewave output from pin 13 is applied to Q201, an external buffer. The buffer is necessary because the internal squarewave buffer is an open collector, and the output impedance on the positive edge of the squarewave is equal to R201. Therefore, any significant change in the external load on pin 13 alters the amplitude of the positive edge of the squarewave.

The two resistor networks connected to pins 4 through 7 each control a separate current source for charging the integrating capacitor. These sources can be used singly or in pairs. When used in pairs, the currents of each are added. The voltages applied to IC201 pins 8 and 9 determine which of these current sources is active.

The outputs of both pins 13 and 14 are approximately symmetrical around 0. The output of Q201 ranges from approximately 0 to +V (+6 volts). With S4 in the SYMM position, IC201 pin 8 is at level 0 and pin 9 at +V. This enables both pins 6 and 7 and, therefore, the charging current from the integrating capacitor for both the positive and negative ramps is the total current drawn from pins 6 and 7. When the wiper of R1 is at ground, only a very small current is drawn from pin 7, and the charging rate, or frequency, is determined by R204. Resistor R204 therefore determines the low frequency point when R1, the front panel frequency-adjust slide pot is at the minimum setting. When the wiper of R1 is at -V (-6V), most of the charging current is provided by R205, since it is much smaller than R204. Resistor R205 then determines the high frequency limit when R1 is at the maximum setting. With these values for R204 and 205, the frequency range of R1 is 100:1. The reason that R204 and R205 are not also 100:1 is because even with R1 at ground, R205 contributes slightly to the charging current and therefore R204's contribution must be reduced to compensate. When R1 is at -V, the R204 contribution is negligible compared with that of R205.

When S4 is in the RAMP position and the output from IC201 pin 13 is high, pin 8 is also high. In this case, pins 4 and 5 are activated and they perform exactly as do pins 6 and 7. Remember that the squarewave output of pin 13 is at a constant voltage during rise of the ramp

voltage of pin 14. Therefore, during the positive-going ramp of pin 14, the current is controlled by pins 6 and 7. During the negative portion of the ramp, current is controlled by pins 4 and 5; or, as viewed from the front panel, R1 controls the time of the positive-going ramp and R2 controls the time of the negative-going ramp. If R1 and R2 are in extreme opposite positions, the result is positive and negative ramps with a 100:1 time ratio. With S4 in the ground (symmetrical) position, R1 controls the time of a symmetrical triangular waveform. The result of all this (looking at the front panel), is that R1 and R2 provide a 100:1 change of frequency, and each step of S3 provides a 100:1 change.

We know that the timebase section derives its name from the fact that its primary function is to sweep the audio generator and the time (actually the inverse of time—frequency) base of an X-Y display. To accomplish this, the timebase only has to provide a variable-symmetry triangle wave at low frequency. However, once the basic oscillator is established, it is relatively easy to let it provide other useful functions.

For instance, an effective way to check the proper action of a mixer is to apply two triangle waves, one, high-amplitude at a low frequency; the second, a lower amplitude at a higher frequency. If the mixer is functioning properly, each input retains its individual characteristics at the output, but one input will be riding on the other. The timebase section was designed to provide the three basic waveforms over at least the full spectrum of needed audio frequencies.

A piece of test equipment that many classify as "nice to have" but difficult to justify as a separate purchase is a pulse generator. Again, however, since there is already a basic oscillator in the timebase section, it is relatively simple to shape it into a pulse output. Therefore, the total frequency range of the timebase oscillator is made as wide as the capabilities of the basic oscillator can provide.

You then have a three-function generator with a useful frequency range of 0.002 Hz to 100 kHz and a pulse repetition rate of 0.002 Hz to about 800 kHz. The pulse-shaping section will be covered next month.

To provide the maximum possible versatility to the timebase oscillator, the range of integrating capacitors has been made as wide as practical. There is no DC bias across the integrating capacitor, and the manufacturer of IC201 has specified that the capacitors be nonpolar. This requirement is easily implemented for small-value capacitors; however, large-value nonpolar capacitors are rare and usually large sized.

The problem with using a polarized-type capacitor in a bipolar circuit is that the polarized capacitor tends to leak when you try to charge it in the reverse direc-

tion. If the leakage represents a significant portion of the charging current, the voltage rise across the capacitor (and hence across the output triangle wave) will be an exponential rather than a linear rise. This is because the leakage current increases with the charging voltage. If the leakage is significant, then at some voltage level, the leakage current and charging current will be equal, the voltage will cease to rise and oscillation will also cease. Additionally, some types of polarized capacitors can be damaged by reverse voltage.

Actually, this circuit works quite well with some aluminum electrolytic capacitors. With a supply voltage of ± 7 , the

charging voltage is only about ± 1.5 . Aluminum electrolytic capacitors can tolerate the 1.5-volt reverse voltage. However, low-leakage capacitors, and only those with the lowest voltage ratings, should be used in this circuit.

Note that the integrating capacitors are all evenly spaced one decade apart except for the largest and smallest capacitors. The 470- μ F value capacitor is simply the largest value that will consistently work in this circuit. Also note that the smallest capacitor (C203) must be reduced from its nominal value by an amount that is equal to the stray capacitance of the board and switch circuit.

continued on page 82

A 20MHz OSCILLOSCOPE UNDER \$500?



YES !!

LBO - 507 by

LEADER
Instruments Corp.

FEATURES:

- 20 MHz bandwidth
- Unique trigger circuit for maximum display stability
- 10 MV sensitivity
- Bright display
- TV trigger
- Built-in calibration signal
- Triggered and automatic sweep
- Built-in TV vertical and horizontal sync separation circuits
- Check most digital logic circuitry, including CMOS
- 18 sweep range selections
- Sweep to 1μ SEC/cm

SPECIFICATIONS

VERTICAL AMPLIFIER	
SENSITIVITY	10mV/cm — 20V/cm CALIBRATED IN 31 STEPS (10:8 SEQUENCE UP TO 50V/cm WITH VARIANCE CONTROL)
ACCURACY	±3%
RANGE WIDTH	DC (DC—20MHz) 1.5dB, 4 cm AC (2Hz—20MHz) 1.5dB, 4 cm
RISE TIME	17.5nSec
INPUT IMPEDANCE	1M OHM BALUNED BY 75 Ω (7.5pF)
INPUT COUPLING	AC, DC, GND
MAX. INPUT VOLTAGE	600V (DC & AC @ 1)
INPUT CONNECTOR	BNC
TIME BASE	
SWEEP SPEED	0.5 MICRO SEC/CM — 2000 SEC/CM, 18 STEP, 1:8 SEQUENCE UP TO 5000 SEC/CM WITH VARIABLE CONTROL
ACCURACY	±5%
MAGNIFICATION	±5.75% (MAX SPEED 100x/cm)
SYNCHRONIZATION	
MODE	TRIGGERED & AUTOMATIC
SIGNAL SOURCE	INTERNAL OR EXTERNAL, + OR - SLOPE
SENSITIVITY	TRIGGERED (INT.) 2mV—150mV AT 1cm (EXT.) 2mV—150mV AT 100mV/cm AUTOMATIC (INT.) 50mV—150mV AT 1cm (EXT.) 50mV—150mV AT 100mV/cm
HORIZONTAL AMPLIFIER	
SENSITIVITY	200mV/cm (MAG. x5) 1V/cm (MAG. x1) UP TO 5V/cm WITH FINE ADJUSTER

**NEWCOM
SHOW
SPECIAL !!**

MIDWINTER SPECIAL

Save \$100 Regularly \$549.95
Now \$449.95 including probe
Shipping not included
Sale ends April 30, 1979



212-687-2224

THE TEST EQUIPMENT SPECIALISTS

**TOLL FREE HOT LINE
800-223-0474**

54 West 45 Street, New York, N.Y. 10036

**ADVANCE
ELECTRONICS**

service clinic

Troubleshooting starter circuits in pulse-width modulated power supplies.

JACK DARR, SERVICE EDITOR

THE AUGUST 1978 SERVICE CLINIC, WE discussed pulse-width modulation (PWM) power supplies, and briefly mentioned the starter circuit. Now let's explain this circuit in more detail. This circuit is absolutely indispensable because it gives the horizontal oscillator circuit a swift kick to get it started. The PWM circuit must receive gate pulses from this circuit to operate. So, all PWM power supplies use some form of starter circuit. Keep in mind that all this activity takes place in a fraction of a second! When power is applied, the B+ voltage comes up very quickly in all solid-state circuits. Oscillator, driver and horizontal-output circuits start just as quickly.

So, all it takes is a short pulse of DC voltage, somewhere near the right value to get the oscillator going. Once the oscillator is running, the horizontal-output stage starts, as well as the PWM supply, and everything takes off. Some of these stages use quite complex circuits, but basically they're all similar. For example, the RCA CTC-85 color chassis circuitry looks complicated but isn't (see Fig. 1).

The B+ line (unregulated) is provided by a nonisolated bridge rectifier, from the AC line through L201—an AC line choke. At turn-on, a current pulse comes from the + terminal of the bridge and flows through the primary of start-up transformer T201. The current flows through this transformer because a large electrolytic 800- μ F capacitor, C304, is connected to it (C304 later becomes a filter capacitor).

When a capacitor of this size is discharged, it resembles a short circuit to a current source. Translation: the current flows into the capacitor until it is fully charged. While this is flowing, we get a pulse of current through the primary of T201. The transformer's secondary develops the two DC voltages needed—+22 and +27 VDC through the rectifier diodes and filter capacitors. These DC voltages now feed the horizontal oscillator, driver and buffer stages. When these stages start operating, they generate drive pulses to feed the horizontal-output stage and the PWM circuitry (this is on the regulator-control module). The PWM circuit feeds a regulated B+ voltage to

the horizontal-output stage.

Now that we've got our starting kick and things are going, we have to disable the starter circuit or it might interfere with the normal DC supplies, which are all developed by the flyback. The following method is used in all the starter circuits I've seen so far.

In Fig. 1, note D301 and D304, which are connected to the starting DC lines feeding the oscillator, driver, etc. During start-up, these two diodes are reverse-biased and do nothing. There is a +DC voltage on their cathodes but no voltage at all on the anodes. This is because the normal supply voltage is not working yet. (Remember this is taking place in a very short time!)

Shortly thereafter, the oscillator circuit and other stages are fed their normal supply voltages, so that they continue operating. Now, the starter circuit has no AC supply to keep it running. The start voltage drops. The starter diodes are now reverse-biased and cut off (there is a + voltage on the cathodes, and no voltage at all on the anodes). This isolates the starter transformer from the DC lines, which

stays inactive until the set is turned off again. This diode reaction is used for all the starter control circuits I've seen so far.

An interesting test, mentioned in the RCA *Technical Manual*, can be performed. If the starter circuit is not working, nothing happens. After checking the starter diodes, the filter capacitors, transformers, etc., for shorts and opens, you can start the horizontal oscillator by momentarily connecting a +22 VDC supply to the +27-volt input. All it takes is a very short current pulse somewhere near the normal voltage. (Although I haven't tried this, it looks as if you could do this with a bias box. The RCA manual suggests using a 22.5-volt battery, but these batteries are not very common.)

Check the starter circuit for a short DC pulse just as the set is turned on. It is best to use an analog meter because even a small kick of the needle is detectable. Set the meter to approximately the 15-volt scale so that the motion of the needle is easier to observe.

Most problems in these circuits can easily be located with the standard tests—checking diodes, filter capacitors, transformers, etc., for shorts or opens. In the RCA CTC-85 chassis, the entire B+ supply is isolated from the AC line by

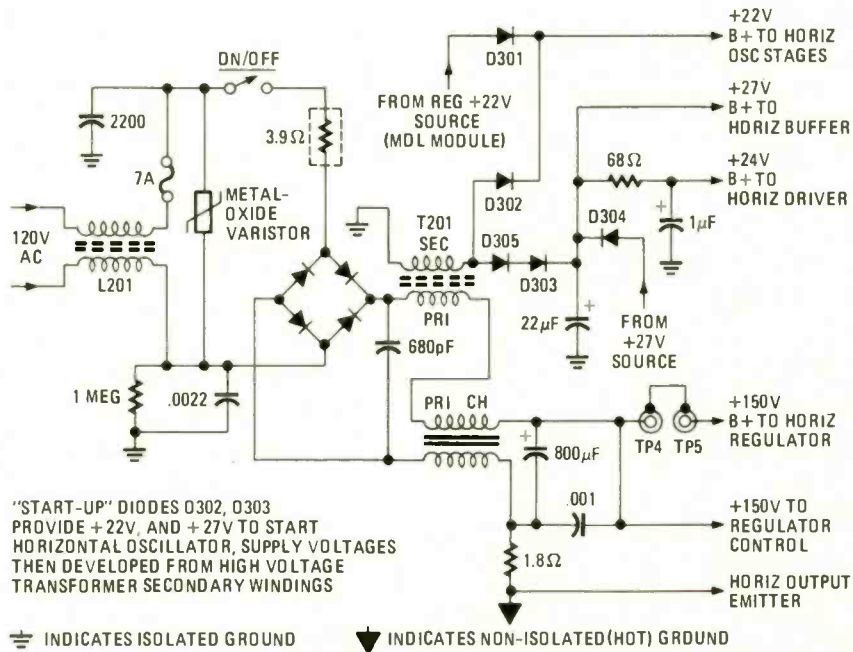

FIG. 1

the horizontal-output transformer; the unregulated B+ supply is not. This leads to the use of two "grounds," one isolated, the other "hot." However, this ground lead isn't really very hot, since it's only a very little way (one diode drop and a 1.8-ohm resistor) away from the isolated ground, or B- line. So little, in fact, that the hot ground can be used as the test equipment ground lead for voltage and waveform checks.

The starter circuit is not difficult to troubleshoot if you know what it does and how it does it. It's just that trying to explain the procedure isn't easy! The PWM won't work till the oscillator starts, the output stage won't work till the oscillator starts, but the output stage must be running to feed the oscillator! Something like the mythological worm with its tail in its mouth!

Thanks to RCA for the CTC-85 *Color Chassis Technical Manual*, which provided Fig. 1 and much data. R-E

service questions

HEATER STRING SHORT

There's a short in a Sears 19-inch color set that I can't find. The 5-amp fuse in the heater string blows quickly. The 40KD6 tube was bad, as well as the 12BY7 tube. Any ideas?—M. R., E. Chicago, IN.

A common cause of this kind of trouble is a heater-to-cathode short in one of the tubes, perhaps one in the middle of the series circuit. (Note: The cathode of the tube must be directly grounded to cause this particular short.) When it happens, the heater circuit is grounded in the middle; this raises the heater voltage on all tubes between the short and the source, and it will usually blow some of the tubes.

(Feedback: "Bulls-eye! I found a 6GH8 tube with the heater-to-cathode short, and another 12BY7 tube was open.")

VERTICAL BLACK LINES

I've had problems in several TS-934 Quasar chassis with one or two small vertical dark lines at the left side of the screen. So far all I've done is try new damper and horizontal-output tubes until I find some that help. Do you have any data on this?—L. J., Eveleth, MN.

Quasar's booklet, *6 Years of Servicing*, says that this problem can be caused by damaged insulation on the red wire between pin 5 of the high-voltage transformer and pin 9 of the damper tube. The cure is to place heavy plastic sleeving over this lead to prevent leakage to the edge of the chassis. (This lead is on the socket side of the chassis under the damper/output tube, and goes to a terminal strip and hash choke L502.) R-E

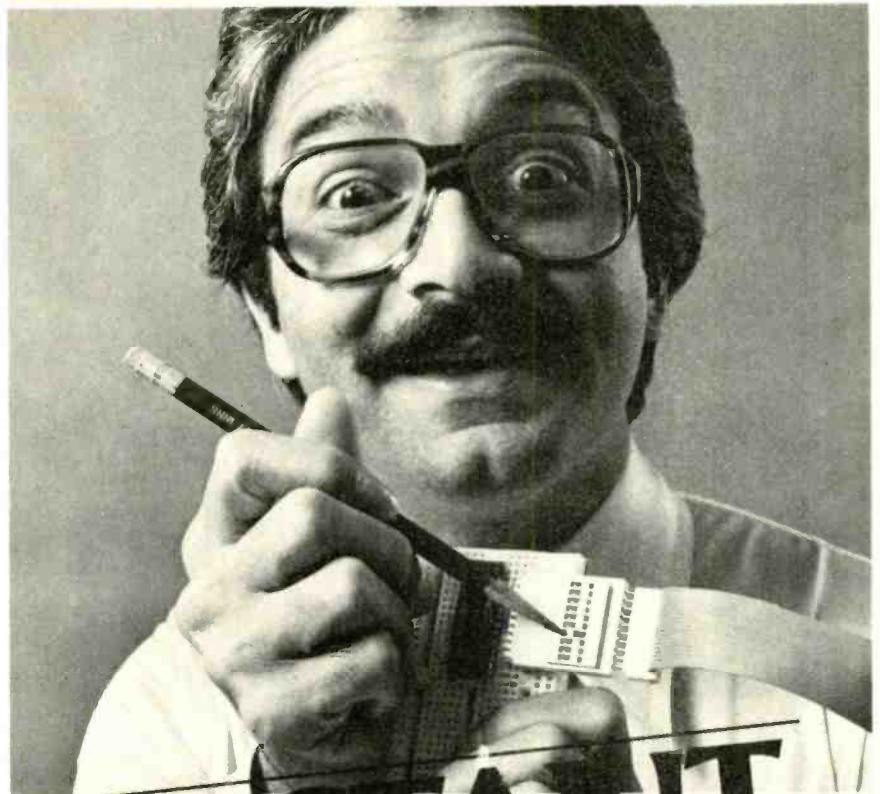

INSTANT.

The way you check line-by-line with an A P Intra-Switch or Intra-Connector.

You plug your Intra-Switch in-line with standard socket connectors, and instantly you've got a separate, independent on-off switch for each and every line in your flat ribbon cable. To switch, you nudge with a pencil point. It's that quick.

Imagine how much time and trouble Intra-Switch will save you in your diagnostic and quality testing, your programming and selective line inhibiting.

Or, plug in your Intra-Connector (see box) the same way, and you have an extra set of male contacts

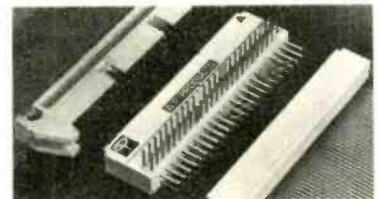

at right angles. Instant line-by-line probeability—and an easy way to tap your system and daisy chain it into new areas.

Both Intra-Connectors and Intra-Switches come in 20, 26, 34, 40 and 50-contact models.

Where? At your nearby A P dealer. Where's that? Phone (toll-free) 800-321-9668. And ask for the complete A P catalog, *The Faster and Easier Book*.



**A P PRODUCTS
INCORPORATED**

Box 110B • 72 Carwin Drive
Painesville, Ohio 44077
Tel. 216/354-2101
TWX: 810-425-2250

Faster and Easier is what we're all about.

CIRCLE 62 ON FREE INFORMATION CARD

The best speaker kit isn't a kit at all!



The best speaker kit is a system designed by Electro-Voice that allows you to choose your own level of performance; from a studio monitor to a modest bookshelf system, from a wide selection of woofers, tweeters, mid-range drivers and crossovers.

Then Electro-Voice provides detailed plans on how to construct the enclosures designed specifically for the drivers you chose.

Only Electro-Voice gives you all the options. But, then, Electro-Voice is known for their superb quality speakers — not for kits.

To get your component speaker catalog and construction plans package, just send \$1.00 to Electro-Voice Component Speaker Systems, 600 Cecil St., Buchanan, MI 49107.



600 Cecil Street, Buchanan, Michigan 49107

Electro-Voice Component Speaker Systems, 600 Cecil St., Buchanan, MI 49107.

Please send me _____ E-V component speaker packages.

I have enclosed \$1.00 for each package ordered.

Name _____

Address _____

City/State/Zip _____

RE-2-79

AUDIO TEST STATION *continued from page 79*

Accuracy and stability are mainly dependent on the components' cost and the amount of care taken during calibration. The oscillator is quite stable, and the timing components can be stable and either precision or trimmable. We decided that the components should be stable but that absolute accuracy was not important. The frequency counter can read down to approximately 1 Hz. By noticing the last digit bobble, it is even possible to interpolate to a sensitivity of less than 1 Hz. Frequencies of less than 1 Hz should perhaps be selected as subjective rather than absolute values. Therefore, the resistors, similar to most of the resistors throughout the rest of the system, are 5% carbon film; the capacitors are as temperature stable as readily available with the tolerance of the smaller values at $\pm 5\%$ and that of the electrolytic capacitors at $\pm 20\%$.

Timebase output circuitry

The output of Q201 serves four functions: One has already been discussed; the other functions will be covered as they apply to other circuits. Transistors Q202 and Q203 form a triangle-to-sinewave converter. Each transistor logarithmically clips one peak of the triangle wave. Resistor R212 determines the degree of rounding of the peak, and R213 makes sure that the peaks are clipped equally. Transistor Q204 buffers the common-collector output of Q203.

Trimmer resistors R224, R223 and R227 as selected form the input resistor to inverter IC202. Each of the three basic waveforms are generated with different signal levels; therefore, these resistors provide that each waveform has the same amplitude at the output of IC202. Trimmers R225, R221 and R240 provide offset nulling for each waveform, with R226, R222 and R239 controlling the sensitivity of those adjustments.

Switch S5 selects one of the three signal lines to be applied to IC202. Note that the squarewave line when it is not selected is grounded through the other half of switch S5. This minimizes square-wave crosstalk into the sinewaves or triangle waves at time of selection. The rise- and falltimes of the squarewave are fast enough to cause a spike waveform to propagate across the contacts of S5 or across the circuit board.

The output of IC202 goes to IC203, which is connected as a unity-gain inverter. Switch S8 then inverts at the output whatever waveform was selected by S5. This is valuable for interfacing with certain other types of equipment and can also help provide a stable scope-trigger for internal calibrations.

Resistor R3 is the front-panel-amplitude slide pot, and IC204 is one-half of an

LM377. This device is generally considered only as a driver for low-power speaker systems, to be used with a single power supply. However, it is far more versatile and actually easier to implement with a split power supply than with a single power supply. Also, from the speaker-driver applications it is not always obvious that this is an operational amplifier suitable for op-amp applications. It is fast enough for the full audio spectrum.

One of the most powerful audio applications for an operational amplifier is as a mixer. The negative inputs of IC204 and IC201-IC203 are connected as a summing junction. This creates a perfect mixer; that is, several independent signals can be added together each with independent gain or loss, without any signal affecting any other signal.

A first encounter with this circuit is often rather mysterious. When you troubleshoot a signal-processing system, you often take an oscilloscope, start at the input and then walk through node-by-node to the output, observing the waveforms and watching for any change from node to node. Normally, the only change from input to output is a change in amplitude. If a node in the chain does not have a signal, you can generally assume that something has either interrupted or grounded the signal since you checked the previous node; also you would not

continued on page 84

Try this exciting new hobby!

Build your own electronic concert organ. It's easy. No technical knowledge required. Just follow the clearly pictured instructions of the famous Wersi do-it-yourself system. Choose from seven different models. Send \$2.00 (refundable) with coupon for colorful 104 page catalog.

WERSI



Wersi Electronics, Inc.
Dept. 42
1720 Hempstead Road
Lancaster, PA 17601

Enclosed is \$2.00 for my copy of your 104 page catalog.

Name _____

Address _____

City _____ State _____ Zip _____

CIRCLE 20 ON FREE INFORMATION CARD



PHILIPS

BK PRECISION

LEADER

FLUKE

TRIPLETT

VIZ formerly NSA

DATA PRECISION



Non-Linear Systems

DORIC

HICKOK

Simpson

FLUKE

DIGITAL MULTIMETERS

8020A

- 26 Ranges—5 Functions plus New Conductance Function for up to 10,000 M Ω Leakage Measurements
- Extensive Overload and Transient Protection
- Rugged Construction—1 Year Warranty
- Hi/Lo Power Ohms for In-circuit Resistance and Diode Testing
- 10 M Ω AC/DC Input Impedance Doesn't Load Circuit
- 200 Hour, 9V Battery Life—Low Battery Indicator
- Large LCD Readout—2000 Counts
- 1 Year Calibration Cycle—Only 3 Adjustments
- One Hand Operation
- Complete with Battery and Test Leads

The 8020A has been designed with the user in mind and features exclusive one-hand operation. For harsh service environments, the 8020A has a ruggedized case and extensive overload/transient protection backed up by a 1-year warranty. Long term stability (1-year calibration cycle) is excellent with only three call adjustments. Up to 200 hours of continuous operation can be expected from a single 9V alkaline battery.

BASIC SPECIFICATIONS

Range	DC Volts	AC Volts	DC Current	AC Current	Capacitance	Resistance
0.2	0.2	0.002	2A	0.032	2000+	200 M Ω
1000V	750V	2A	2A	200+	20 M Ω	2 M Ω
Resolution	100 μ V	100 μ V	1 μ A	1 μ A	0.1 Ω	0.1 M Ω
Accuracy	(0.25 + 1)	(0.75 + 2)	(0.75 + 1)	(1.5 - 2)	(0.2 + 1)	(0.3 + 1)

\$169.

LBO-520
30MHz, Fixed Delay

LEADER
Instruments Corp.



- Dual trace, 30MHz bandwidth
- 5mV/cm Vertical Sensitivity
- Fixed delay facilitates hi-speed readings of the leading edge of a pulse or pulse train.
- Add, subtract, alternate selection, chopped, and front panel X-Y modes broaden areas of application.
- TV-V and TV-H sync, for both C-1 & 2.

\$849.⁹⁵

Regular price \$1,050.



LEADER
Instruments Corp.

LCR-740
Transistorized LCR Bridge

- Highly accurate 3 digit readout
- Measures Inductance (L), Capacitance (C) and Resistance (R), within $\pm 0.5\%$ accuracy.
- Range expandable—built-in 10% over range.
- Loss Factor scale (D).
- Battery, or AC adapter operation.

\$279.⁹⁵ Regular price \$310.

NEW YEAR'S SPECIALS

Prices do not include shipping. Sale ends Feb. 28, 1979

New 15MHz portable 3" dual-trace scope

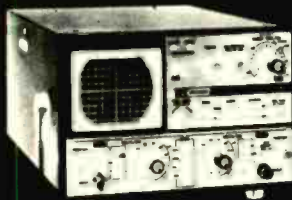

MODEL
1432

- 15MHz bandwidth with smooth, soft-clipped, leading response extends beyond 20MHz
- 2mV/div., vertical sensitivity
- Operates on 117VAC, 234 VAC, 270VAC or optional internal battery pack
- Fully regulated high- and low-voltage supplies
- Multiple addition and subtraction (2) channels and 0 reference
- Minimums selected across ranges cover 0.5 microsecond to 5.0 microsecond
- TTL Compatible T state input
- Constant time, monostable only
- 6.6 x 6.6 x 14.2"
- Includes low-profile 9011 dual in-line and accessory kit
- Built-in sync separator

BK PRECISION

\$639.⁹⁵

Regular price \$840.

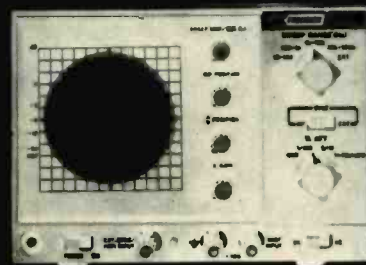

5MHz Solid State 3" Oscilloscope

MODEL
1403A

BK PRECISION

- 5 MHz with high sensitivity
- Four propagation lines, external, fixed internal, push, buttons
- 0.25 modulation monitor
- 0.25 modulation and right-angle, peak-to-peak
- Use the 100A to measure more capacitance covered from measuring
- High brightness CRT and ultraviolet green

\$209.⁹⁵

Regular price \$250.

3-1/2 Digit DMM with .5% Accuracy



BK PRECISION

MODEL
2810

\$109.⁹⁵

Regular price \$130.

- 3 1/2 digit easy to read LED display
- 0.5% .20 accuracy typical
- 150-h, 8111 resolution
- 10 ohm range and control to zero load resistance
- Selectable High-Low power ohms or four ranges
- Auto zeroing
- Completely sealed protected or 10000 counts
- 100% overrange reading to 2000 counts
- Protected against RF interference
- Completely portable

MASTERCARD
VISA

THE TEST EQUIPMENT SPECIALISTS

TOLL FREE HOT LINE
800-223-0474

ADVANCE
ELECTRONICS

54 West 45 Street, New York, N.Y. 10036 212-687-2224

AUDIO TEST STATION

continued from page 82

observe that signal in any subsequent node. However, in this circuit (if R3 is not at ground) there is a signal at the left side of R234, but the right side of R234 shows just 0 volt.

This phenomenon is called a *virtual ground*. The input impedance of IC204 (as seen from the wiper of R3) is simply R234. For any signal from R3 that might attempt to pass back through R235, it's as if the right side of R235 were grounded. Turning up the sensitivity control on the scope may reveal a very severely clipped remnant of the signal. However, the output of IC204 is the original signal with a gain of R237 divided by R234.

In addition, there is a DC level that is the voltage at the left of R233 times R237 divided by R233. In this case, the voltage should be zero since R233 provides the offset null of IC204. Front-panel DC offset is applied through R235.

Resistor R236 is necessary for frequency compensation. OP-amp IC204 is internally compensated to be stable at gains greater than 10 (the gain being determined by the ratio of feedback resistor R237 to input resistors R234, etc.). Resistor R236 can be calculated, but is most easily determined empirically. Substitute

a variable resistor for R236, set S5 to the squarewave position, observe the output of IC204, and adjust R236 for both minimum risetime and minimum overshoot at 1 kHz.

Resistor R4 is the front-panel DC offset. With S9 in the SWEEP position, the R4 output mixes with the signal from R3 to provide a ± 5 -volt DC offset of that signal.

Switch S9 provides the manual timebase mode. With S9 in the SWEEP position, the triangle-wave output of the oscillator is used to sweep the frequency of the audio sweep generator as well as the timebase of an X-Y display. Setting S9 switch to the MANUAL position opens the direct connection between R4 and IC204. The triangle wave is removed from its sweep function, and R4 is substituted for it—both for the sweep circuitry and for the timebase output. Switch S5 must be in the TRIANGLE position. Resistors R209 and R206 adjust the output of IC204 so that the signal from R4 that arrives at the upper half of S9 will exactly replace the triangle wave at switch S9.

The LM377 IC has both overcurrent and thermal shutdown. It can apply at least ± 5 volts to a less than 10-ohm load. If a higher signal or power level is required, an LM378 or an LM379 can be substituted, as these IC's are equivalent.

The LM377 is rated at a total supply voltage of 26. The LM378 and LM379

are both rated at 35 volts. The only way to differentiate between those devices that can tolerate a higher voltage from those that can't is to experiment. (The premium price of the LM378 pays for destroying a lot of good LM377's to locate some of the higher voltage units we need.) The LM379 is an LM378 with a metal heat sink on top. A tab at each end lets you solder it into a circuit board; the device is also drilled and tapped so that you can mount an additional heat sink or mount the unit to a chassis.

Although the LM377 is quite immune from self-destruction, it can be damaged by applying a large external voltage at J1. Overvoltage sensor OV201 protects the output of IC204 from external damage. If ± 10 volts or more is applied to the output terminal, OV201 shorts to ground and prevents the external voltage from reaching IC204. If this voltage is present for any significant time, F201 blows, thereby protecting OV201 from excess dissipation.

The external overvoltage protection is optional. There are several devices on the market designed to limit voltage, and the PC board is set up to accept several different types. The recommended LA10 device costs approximately \$20. Even though this \$20 is there to protect a \$3 output amplifier, **the value lies in eliminating repair costs and downtime.**

Resistor R299 establishes the output impedance. The jumper around R299 is on the circuit board. Normally, R299 is omitted in which case the output impedance is less than 1 ohm. If some other output impedance is desired, it is inserted as R299 and the jumper on the board is cut. The jumper is on the reverse side of the board readily accessible in a finished unit, which makes it easy to attach R299.

Timebase calibration

Connect a reasonably well-calibrated oscillator scope to J1. (The scope is the only calibration standard that will be used and it is assumed that amplitude calibrations are not critical.)

- Set the scope input to DC.
- Set all trimming resistors to their center positions.
- Turn on master power switch S1 and S2.
- Set S5 to TRIANGLE and S8 to NOT INVERT.
- Set R3 to maximum and R4 to 0.
- Set S3 to 1 kHz.
- Set S4 to symmetrical.
- Set R1 to lower position.
- The output should show a clean triangle wave at about 1 kHz.
- Set R3 to zero.
- Make sure that R4 is at 0.
- Adjust R232 for zero offset.
- Set R3 to maximum.
- Adjust R227 for 16 volts peak-to-peak.
- Adjust R240 for zero offset.
- Switch S5 to squarewave.
- Adjust R224 for 16 volts peak-to-

This is easy- anyone can solder- WITH KESTER SOLDER

KESTER
SOLDER

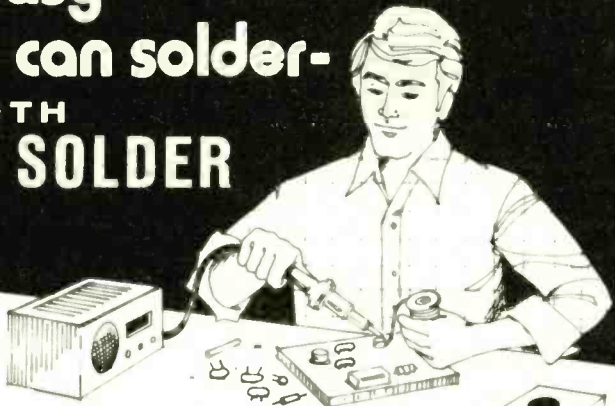

Handymen! Hobbyists! DO-IT-YOURSELFERS!

Let Kester Solder aid you in your home repairs or hobbies. For that household item that needs repairing — a radio, TV, model train, jewelry, appliances, minor electrical repairs, plumbing, etc. — Save money — repair it yourself. Soldering with Kester is a simple, inexpensive way to permanently join two metals.

When you Solder go "First Class" — use Kester Solder.

For valuable soldering information send self-addressed stamped envelope to Kester for a FREE Copy of "Soldering Simplified".



KESTER SOLDER
Litton 4201 WRIGHTWOOD AVENUE/CHICAGO, ILLINOIS 60639

CIRCLE 3 ON FREE INFORMATION CARD

peak.

Adjust R225 for zero offset.

Switch S5 to sinewave.

Adjust R223 for approximately 16 volts peak-to-peak and R222 for approximately zero offset. Both these resistors will be readjusted later.

Switch the scope input to AC.

Adjust R212 for slight clipping.

Adjust R213 for symmetrical waveform.

With the scope set to AC, adjusting R213 will cause the average level of the waveform to shift; therefore, symmetry is achieved when the positive-going and the negative-going peaks are exactly the same distance from the center line on the scope.

Adjust R212 for minimum sinewave distortion. A sinewave plotted on the face of the scope can greatly assist in this. Use an 8 X 8-centimeter overlay, and a harmonic distortion analyzer can be used if one is available.

Adjust R223 for 16 volts peak-to-peak.

Switch the scope input to DC.

Adjust R222 for zero offset.

Set S5 to triangle wave.

Check the waveform quality at each position of S3.

At the 10K position, the waveform will be distorted; however, the 10K position is only intended to trigger the pulse generator. When you initially check the low-frequency ranges, set R1 to 100 F. Any deviation from strict linearity indicates a leaky capacitor. A slight curving of the

waveform is acceptable for most applications. However, if curving is severe, the circuit may not oscillate at all at low currents. For the lowest positions of S3, set the horizontal timebase of the scope to external; this will produce just a vertical trace. Then, follow the oscillator through at least a couple of cycles to insure there is no excessive leakage. At the 0.002 setting of switch S3, a single cycle is approximately 8 minutes. If the scope beam stops while approaching one peak, increase R1 slightly. This increases the charging current. The beam should continue slightly, which indicates excessive leakage. Increasing R1 past some point should cause the oscillator to restart.

Replace the capacitor that is leaky.

Then,

Set R3 to maximum.

Set S9 to manual.

Set R4 to zero.

Set R206 for zero output.

Move R4 to +5 volts.

Set R209 for a +8-volt output.

Move R4 to -5 volts.

The output should be approximately -8 volts. Resistors R206 and R209 will be fine-tuned later on.

The combination of 50K (R3) and 16K (R234) produces a taper similar to the audio taper in most controls.

That's it for now. Next month, we'll cover the pulse generator, sweep shaper and audio sweep generator. R-E

in portable multimeters, compare our features, our quality, our price!

Analogue, LED, and LCD—SOAR has the battery-operated multimeters for your application: the engineering and test lab, the field service technician, the small repair shop, and the radio hobbyist. Just take a look at some of the features of our instruments.

ME-221 ANALOG MULTIMETER

It's drop-proof—the taut band absorbs shocks to 50 G's, and the meter movement is made in the U.S.A. Rugged and versatile, this multimeter has no equal at our price—\$30.00

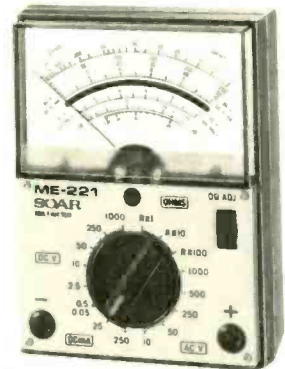

ME-521DX DIGITAL MULTIMETER

This truly portable (12.7 oz.) 3½-digit LED precision instrument has a HI-LO switch for all ranges, five function modes, and an accuracy of 0.5% (typical). Price—\$115.00



ME-523 DIGITAL MULTIMETER

For the price, this is the best multimeter on the market today. It presents the function mode right on the LCD display, has a HI-LO switch for all ranges, an extremely long battery life, and an accuracy of 0.25% (typical). And all this for a price of \$150.00



And let's not forget our workhorse ME-522. It has almost all the features of the 523, but at an even lower price—\$135.00

Contact us TODAY for more details on SOAR's portable multimeters—and why not also inquire about our complete line of bench-type, tilt view DMM's.



SOAR ELECTRONICS (U.S.A.) CORP.
813 2ND STREET
RONKONKOMA, NEW YORK 11779
TEL. (516) 981-6444/TELEX 144638

CIRCLE 57 ON FREE INFORMATION CARD

ELCETRONICS LOGIC PROBE

\$19.95

DOES IT
ALL!

- ALL MODE ADAPTABILITY
- FULL INSTRUCTIONS



- TAKES POWER FROM CIRCUIT
- POLARITY PROTECTED
- NO OTHER TEST EQUIPMENT NEEDED

FEATURES:

- HI/LO PULSE (SONS)
- SHORT OR OPEN MEMORY DETECTION
- 3 FOOT CORD
- NO QUESTIONS GUARANTEE
- IMMEDIATE SHIPMENT

COMPLETE EASY ASSEMBLY KIT \$14.95

ELCETRONICS

P.O. BOX 2522R
PADUCAH, KY. 42001 Ph.502/442-7940

CIRCLE 35 ON FREE INFORMATION CARD

B&K-PRECISION's new digital probe offers more than logic



Model
DP-50

- Reveals pulse presence to 50MHz
- Priced at only \$50
- Multi-family, compatible with TTL, DTL, RTL, CMOS, MOS, and HiNIL
- Clearly displays in-circuit logic activity
- Memory mode to "freeze" pulse display
- Pulse mode to "stretch" short pulses
- 2 megohm input impedance
- Typically detects pulses to 10 nanoseconds
- Overload and reverse polarity protected

The new B&K-PRECISION DP-50 50MHz digital probe simplifies the troubleshooting and analysis of all digital circuits by clearly displaying in-circuit logic activity and pulse presence.

This compact instrument includes every important logic probe feature and more. Three bright LED indicators display pulse presence and high- and low-logic states. Unlike ordinary logic probes, the DP-50 digital probe will continue to indicate pulse presence to 50MHz.

Available for immediate delivery at your local distributor.

BK PRECISION
DYNASCAN
CORPORATION

6460 West Cortland Street
Chicago, Illinois 60635 • 312/889-9087
In Canada: Atlas Electronics, Ontario

CIRCLE 56 ON FREE INFORMATION CARD

new products

More information on new products is available from manufacturers of items identified by a Free Information number. Free Information Card is inside the back cover.

DUAL-TRACE 100-MHz SCOPE, model PM3262, is a dual-channel, 100-MHz instrument that provides both a main timebase and an alternate timebase to display trigger signals simulta-

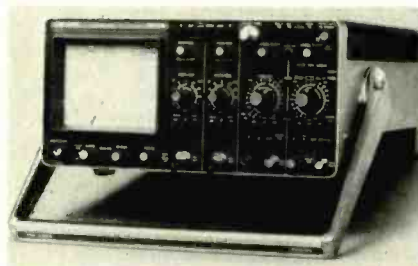

CIRCLE 120 ON FREE INFORMATION CARD

neously. Offers a 5- to 10-mv-per-division sensitivity, rectangular CRT with internal graticule, pushbutton-selectable trigger modes, X 10 magnification, $\pm 3\%$ accuracy, and X-Y operation. Unit operates on 140 VAC; 200-264 VAC, 440 Hz; and 250 VDC. It comes with probes, filters, cover, adapters, and manual, with other optional accessories available. The model PM3262 measures 12.5 X 6.1 X 16.2 in., weighs 21.1 lb., and costs \$2345.—Philips Test & Measuring Instruments, Inc., 85 McKee Drive, Mahwah, NJ 07430.

DUST REMOVER Micro-Duster, uses nonflammable, nontoxic filtered compressed gas to remove lint, dust, oxide particles, etc., from delicate instruments. Suggested applications include audio components, computer tapes and heads, timepieces, camera lenses and other optical de-



CIRCLE 121 ON FREE INFORMATION CARD

vices. **Micro-Duster** produces over 1800 one-second bursts (25-30 minutes continuous dusting) in a single can. It comes with a 6-inch extension tube; for hard-to-reach areas, **Vibra-Jet** attachment provides extended range. Comes in 15-oz. cans with a suggested retail price of \$2.50. Available only through Chemtronics distributors.—Chemtronics, Inc., 45 Hoffman Ave., Hauppauge, NY 11787.

SOLDERLESS BREADBOARD COMPONENTS, Quick Test (QT) sockets and bus strips, are spring-clip arrays behind a series of small holes on a molded plastic surface that can accommodate AWG Nos. 22-30 wire sizes. Sockets comprise 5-tie-point spring-clip terminals on either

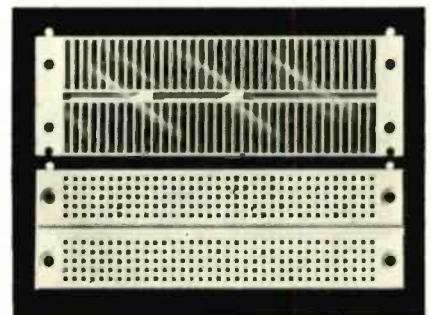

CIRCLE 122 ON FREE INFORMATION CARD

side of a 0.3-inch channel, and can be used either alone or ganged with jumper leads for larger arrays. Bus strips contain twin rows of interconnected tie-points to provide 35, 47 or 59 tie-point terminals. The sockets come in 7 lengths with from 14 to 118 terminals; the bus strips measure from 4.1 to 6.5 inches long, with twin buses of 35, 47, 59 tie points each. Prices: QT sockets, \$3-\$12.50; bus strips, \$2-\$2.50.—Continental Specialties Corp., 70 Fulton Terrace, New Haven, CT 06509.

ADVANCED DRAFTING AID, Paramatic Drafting Set, is designed for technical designers and requires no T-square or parallel bar. The set consists of a vinyl-covered drafting board with

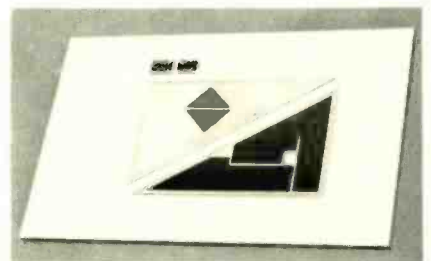

CIRCLE 123 ON FREE INFORMATION CARD

two 11-inch clear nylon triangles, each locking into a precise horizontal or vertical position on

the board. Also contained is a *Paramatic Line Guide* to permit drawing horizontal parallel lines without moving the triangle from position. *Paramatic Drafting Set* with 13-inch by 21-inch board costs \$45; with 20-inch by 26-inch board, \$85.—**Design Instrument Mfg. Co., Inc.**, 9849 Belfast Dr., Garden Grove, CA 92644.

COMPUTER GAME, *Merlin*, offers 6 games of chance for 1 or 2 players from age 7 to adult. Games range from simple "Tic-Tac-Toe" to advanced "Mindbender." The unit uses a TI micro-processor with 2K-byte memory and 1s battery



CIRCLE 124 ON FREE INFORMATION CARD

operated. *Merlin* can counter moves with its own strategy, and uses electronically synthesized sounds to communicate wins and losses. Approximate retail price, \$33.—**Parker Brothers**, 50 Dunham Rd., Beverly, MA 01915.

For
faster
service

USE
ZIP
CODE

on
all
mail

INTERNATIONAL FM-2400CH

FREQUENCY METER FOR TESTING MOBILE TRANSMITTERS AND RECEIVERS

• Portable • Solid State • Rechargeable Batteries

The **FM-2400CH** provides an accurate frequency standard for testing and adjustment of mobile transmitters and receivers at predetermined frequencies.

The FM-2400CH with its extended range covers 25 to 1000 MHz.

The frequencies can be those of the radio frequency channels of operation and/or the intermediate frequencies of the receiver between 5 MHz and 40 MHz.

Frequency stability: $\pm .0005\%$ from $+50^\circ$ to $+104^\circ\text{F}$.

Frequency stability with built-in thermometer and temperature corrected charts: $\pm .00025\%$ from $+25^\circ$ to $+125^\circ$ (.000125% special 450 MHz crystals available).

- Tests Predetermined Frequencies 25 to 1000 MHz
- Extended Range Covers 950 MHz Band
- Pin Diode Attenuator for Full Range Coverage as Signal Generator
- Measures FM Deviation

FM-2400CH (meter only) Cat. No. 035320	\$595.00
RF crystals (with temperature correction)	24.90 ea.
RF crystals (less temperature correction)	18.90 ea.
IF crystals	catalog price

Write for catalog



INTERNATIONAL CRYSTAL MFG. CO., INC.
10 North Lee / Oklahoma City, Okla. 73102

CIRCLE 60 ON FREE INFORMATION CARD



WHERE ELSE
BUT DAVIS ?

600 MHz Mini Counter at \$149⁹⁵!

All Davis Frequency Counters deliver highest quality at low cost. But Series 7200 plug-in or battery-powered Mini Counters are truly minimal cost, general purpose instruments that sacrifice no basic performance characteristics. No other counter offers such superior features at Mini Counters' prices. One year warranty on assembled units, 90-day on kit components.

- 2 MODELS:** Kit \$149.95 Assembled \$199.95
- All Metal Cabinet
 - 8 Digit .4" LED Display
 - Crystal Time Base (1 ppm after cal.)
 - 115 V or 12 V operation
 - Selectable Gate Times, .1 & 1 sec.

OPTIONS: Portable w/Ni-Cad Battery (Built-in Charger) \$39.95
Crystal Oven (1 ppm 10 to 50°C) \$39.95 Handle \$5.00

Order direct from factory. Add \$3.00 for shipping, \$1.00 extra for C.O.D., and 7% sales tax in N.Y. State. Payment by certified check, money order, Master Charge, VISA. Credit-rated company P.O. accepted. Money back guarantee if returned in good condition in 10 days. Kits returnable only unassembled.

For more information, request FREE DESCRIPTIVE LITERATURE, or for in-depth preview, send \$3.00 for 32-page INSTRUCTION MANUAL. Detailed, illustrated. Credited against purchase of either unit.



DISTRIBUTOR INQUIRIES INVITED
Affordable quality is the Davis difference.

DAVIS ELECTRONICS

636 Sheridan Drive, Tonawanda, N.Y. 14150 • 716/874-5848

CIRCLE 64 ON FREE INFORMATION CARD

Read about The Newest, Most Exciting



The GD-1186 Digital Readout Electronic Scale shows you your weight in bright easy-to-read digits to eliminate guessing and interpolating. It uses an advanced strain-gauge transducer for outstanding precision just like expensive laboratory scales.

The GR-2001 Computerized Programmable Color TV lets you select a complete evening's viewing, then just sit back and relax. Changes channels automatically, it can even rotate your TV antenna!



The ID-4001 is the first totally computerized digital personal Weather Station that tells you indoor-outdoor temperature, wind chill, wind speed and direction, barometric pressure and more. Stores and retrieves info, too!



new

The OC-1401 Aircraft Navigation Computer gives you full on-board computer power right in your hand. Helps you compute important flight data for safer and more efficient flight planning. Accepts and computes data for up to nine different flight legs.



Two new FCC-approved linear amplifiers add plenty of power to your Amateur Radio station. Choose from 1 kW or a hefty 2 kW to really get your signal out!



new

Exciting 2-Meter Amateur Radio Gear includes a new hand-held transceiver with minimum 2 watts out and 600 kHz offsets, and our famous HW-2036A, the mobile 2-meter industry standard.



Our low-priced IO-4205 is the ONLY DC-5 MHz oscilloscope we know of that offers DUAL-TRACE versatility for sophisticated measurements!



The finest oscilloscope we've ever offered gives you DC to 35 MHz response with DUAL-TRACE and DELAYED SWEEP — it's the one you can use for virtually all electronic measurement and design work. Compares to scopes costing twice as much.

new

We've got the Personal Computer System you need, with the software support for any application you wish to program. Our "total" design computer systems include both 8-bit and 16-bit units with a full line of peripherals, accessories and floppy disk storage. With full documentation and optional software.



new

The new WH14 Line Printer provides the top value "hard copy" print-out of your computer programs.

Heathkit stereo equipment is famous for fine sound reproduction and outstanding specifications. Our new rack-mount series of stereo components continues this fine tradition. A sophisticated new stereo amplifier, digital readout tuner and graphic output indicator are available now. A super preamp and a handsome new rack are coming soon. And we have a complete line of stereo speakers to complement them.



new

Choose from these and nearly 400 other quality, money-saving electronic kits for your home, your hobby, or your business.

Catalogs are also available at Heathkit Electronic Centers Coast-to-Coast (Units of Schlumberger Products Corporation) where Heathkit products are displayed, sold and serviced. See the white pages of your phone book.

Electronic Products in your ...

FREE

HEATHKIT[®] CATALOG

Some of the most exciting electronic products around are easy-to-build kits from Heath! From the world's first fully computerized digital readout weather station to a computerized color TV you can program for an entire evening's viewing, Heath leads the way in sophisticated electronics. And every Heathkit product comes with a comprehensive step-by-step instruction manual that makes kitbuilding fun and easy. Choose from nearly 400 electronic kits you can build yourself in this new FREE catalog. Send for your copy today!



Building a Heathkit product can be great family fun and an education in electronics at the same time. And you'll have a top-performing piece of electronic equipment at a low price!



The best to you from the Laboratories at Heath! Heathkit engineering and design has established a world-wide reputation for quality, value and innovation in bringing you the newest and best electronic products in easy-to-build kit form. This catalog continues that tradition. Our wide selection of new for '79 products includes: 1. a new DC solid-state dual-trace oscilloscope; 2. an all-new deluxe electronic telephone dialer; 3. sophisticated new digital readout stereo FM-AM tuner. Read about these and nearly 400 other fun-to-build products in this bright, new catalog!

Send for your
FREE Copy Today!

If card or coupon is missing, write:
Heath Company, Dept. 020-500
Benton Harbor, Michigan 49022

HEATH
Schlumberger

Heath Company, Dept. 020-500
Benton Harbor, Michigan 49022

FREE CATALOG!

Please send me my FREE Heathkit Catalog.
I am not currently receiving your catalogs.

Name _____

Address _____

City _____ State _____

CL-684 Zip _____

Put Professional Knowledge and a
COLLEGE DEGREE
in your Electronics Career through
HOME STUDY

Earn Your DEGREE

by correspondence, while continuing your present job. No commuting to class. Study at your own pace. Learn from complete and explicit lesson materials, with additional assistance from our home-study instructors. Advance as fast as you wish, but take all the time you need to master each topic. Profit from, and enjoy, the advantages of directed but self-paced home study.

The Grantham electronics degree program begins with basics, leads first to the A.S.E.T. degree, and then to the B.S.E.T. degree. Our free bulletin gives complete details of the program itself, the degrees awarded, the requirements for each degree, and how to enroll. Write for *Bulletin R-79*.

Grantham College of Engineering
2500 S. Lacienege Blvd.
P.O. Box 33499
Los Angeles, CA 90035

Worldwide Career Training thru Home Study
CIRCLE 17 ON FREE INFORMATION CARD

★ **FREE!** ★



NEW CATALOG OF HARD-TO-FIND PRECISION TOOLS

Jensen's new 152-page catalog is jam-packed with more than 3000 quality items. Your single source for hard-to-find precision tools used by electronic technicians, scientists, engineers, instrument mechanics, schools, laboratories and government agencies. This popular catalog also contains Jensen's world-famous line of more than 40 tool kits. Plus 10 pages of useful "Tool Tips" to aid in tool selection. Send for your free copy today!

JENSEN TOOLS & ALLOYS
1230 SOUTH PRIEST DRIVE - TEMPE, AZ 85281

CIRCLE 4 ON FREE INFORMATION CARD

computer products

More information on new products is available from manufacturers of items identified by a Free Information number. Free Information Card is inside the back cover.

S-100 BUS EXTENDER BOARD KIT, model TB-2, is an S-100 bus-compatible card with several new features: A built-in logic probe with 7-segment display; a pulse catcher with LED; and a "kluge board" (with holes on a 0.1-inch grid) that aids in

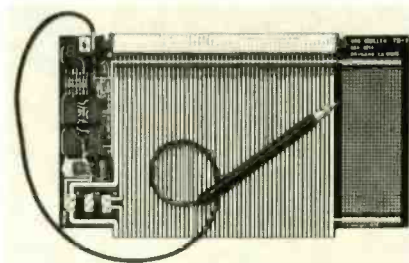

CIRCLE 113 ON FREE INFORMATION CARD

assembling debug or test circuits. Power is provided by an on-board 5-volt regulator. Other features include power-supply links for current measurement and independent supply switching; edge connector label; and gold-plated edge connectors. List price, \$35.—Mullen Computer Products, Box 6214, Hayward, CA 94545.

8-LEVEL READER/PUNCH is equipped with a serial interface that operates with a standard acoustic coupler or an RS-232-compatible interface. The serial interface converts reader contact inputs and punch solenoid outputs to RS-232 levels and ASC11 codes computer hookup. The

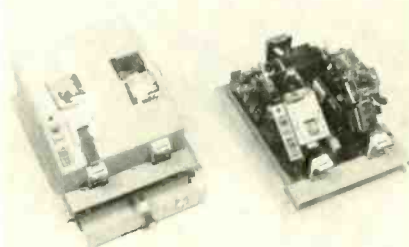

CIRCLE 114 ON FREE INFORMATION CARD

unit can also be used as a remote paper-tape terminal. Applications include typesetting, numeric control, program paper tape loading and paper tape generation/duplication. Parallel interface version is also available. Prices: serial version, \$895; parallel version \$695.—NCE/Computer, Box 8610, Ann Arbor, MI 48107.

COMPUTER SOFTWARE is packaged on mini-diskettes in North Star format, ready for implementation in any S-100 8080/Z80 system. The applications programs include: financial, mathematical analysis, statistical and miscellaneous,

games (including Trap, Taxman, Calendar, Civilwar, Lunar Lander), backorder and mailing list (using disc data files), plus North Star DOS for Centronics printer (retail sales reporting and profile, both using disc files). Price: \$35 each.—MicroAge Mail Order, 1425 W. 12th Place # 101, Tempe, AZ 85281.

CIRCLE 115 ON FREE INFORMATION CARD

MEMORY BOARD, 32K Bytesaver, comes assembled or in kit form, and is compatible with the S-100 bus and with System Two and System Three computers. The board contains a 2716 PROM programmer, compatible with Intel 2716 PROM's or equivalent. Fast data storage is implemented by a single write into an erased PROM. The board also provides a 32K-byte ROM capability. Switches are provided to protect and

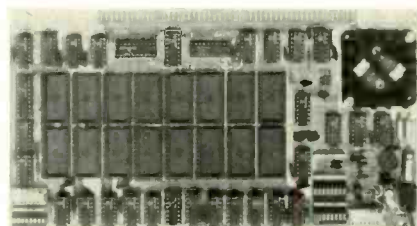

CIRCLE 116 ON FREE INFORMATION CARD

unprotect ROM's, shadow ROM sockets, select card addresses and control Bank-Select or DMA I/O features. Prices: 32K Bytesaver, kit, \$195; assembled, \$295.—Cromemco, Inc., 280 Bernardo Ave., Mountain View, CA 94040.

S-100 BUS PROM BOARD, model 8K Plus 2, is available in kit form (plus sockets) or fully assembled. The board is designed for use with eight 2708 EPROM's, and has two provisions for either 2716's or pin-compatible 8316 ROM's. The board's circuitry can pull Ready-Line low for use with low-speed ROM's, and three extra 16-pin

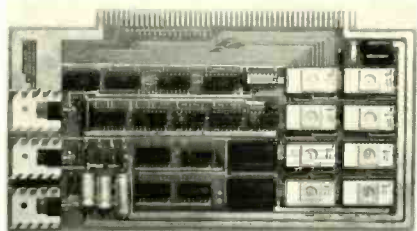

CIRCLE 117 ON FREE INFORMATION CARD

pads are included for TTL PROM's, power-on Jump, etc. The board is made of epoxy glass with solder-tinned pads and buses and gold-plated edge connectors. Prices: kit, \$59.95; assembled, \$109.95.—Mini Micro Mart, 1618 James St., Syracuse, NY 13203.

COMPUTER TAPE CASSETTES, *Microettes*, are designed for microcomputer use (Apple, Heath, IMSAI, MITS). Each cassette tape comes in hard plastic box with two labels. The 50-foot tape length is suitable for from 8K-byte to 40K-byte memory storage of most personal computers. Available in sample size, \$1; 10-pack, \$7.50; 100-pack, \$58.—Microsette Co., 777 Palomar Ave., Sunnyvale, CA 94086.

CIRCLE 118 ON FREE INFORMATION CARD

MICROPROCESSOR ANALYZER, model MPA-80, is designed for use with 8080- or 8085-based systems. The unit provides real-time analysis of processor operations and can single-step the program either by machine or instruction cycle. Its features include hardware breakpoint capability,

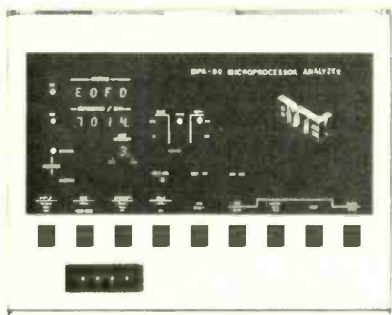

CIRCLE 119 ON FREE INFORMATION CARD

ity, a reverse trace mode, hexadecimal displays that display optimum information for each type of instruction (opcode, 1 or 2 data bytes, memory or branch addresses), and status indicators. Recommended applications are for engineering, production, test and field service. Personality modules provide the interface to your system. Prices: \$845; personality modules (8080 or 8085), \$145.—BYTEK, Box 3026, Burbank, CA 91504.

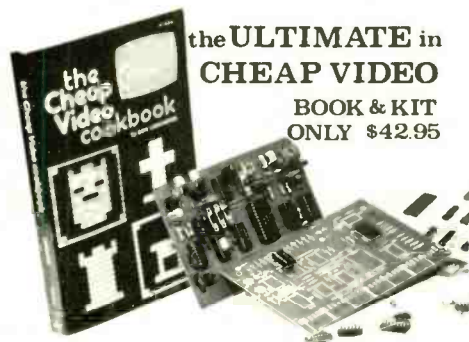

the **ULTIMATE** in
CHEAP VIDEO
BOOK & KIT
ONLY \$42.95

Don Lancaster's "Cheap Video" concept allows almost unlimited options, including:

- * Scrolling - Full performance cursor.
- * Line Character formats of 16/32, 24 80, 32/64 ... or almost anything.
- * Graphics - up to 256 X 256 B&W; 96 X 128 COLOR (requires low-cost option modules)
- * Works with 6502, 6800 and other micros.

SPECIAL OFFER: Buy the Kit (upper case alpha-numeric option included) & get the Book at 1/2 price.

NEA ELECTRONICS, 1020 W. WILSHIRE BLVD., OKLAHOMA CITY, OK 73116

I'm Sold. PLEASE RUSH..... () SEND FREE CATALOG

() TVT 65g Kit & Cheap Video Cookbook \$42.95 enclosed

() TVT 65g Kit only (book required for assembly) \$39.95

name _____
address _____
city _____ state _____ zip _____

NEA ELECTRONICS, DEPT. 2-R, 1020 W. WILSHIRE BLVD., OKLAHOMA CITY, OK 73116

CIRCLE 67 ON FREE INFORMATION CARD

HOBBYISTS! ENGINEERS! TECHNICIANS! STUDENTS!

Write and run machine language programs at home, display video graphics on your TV set and design microprocessor circuits—the very first night—even if you've never used a computer before!

ELF II featuring RCA COSMAC mini-COMPUTER \$99.95



ELF II by NETRONICS

As featured in POPULAR ELECTRONICS

Shown with optional 4k Memory Board, GIANT BOARD™ & Kluge Board.

Stop reading about computers and get your hands on one! With ELF II and our new *Short Course* by Tom Pittman, you can master computers in no time at all! ELF II demonstrates all 91 commands an RCA 1802 can execute and the *Short Course* quickly teaches you how to use each of the 1802's capabilities. ELF II's video output lets you display an alphanumeric readout or graphics on any TV screen or video monitor plus enjoy the latest video games, including an exciting new target/missile gun game that was specifically developed for ELF II.

But that's not all. Once you've mastered computer fundamentals, ELF II can give you POWER with add-ons that are among the most advanced found anywhere. No wonder IEEE chapters plus hundreds of universities and major corporations have chosen the ELF II to introduce their students and personnel to microprocessor computing!

Learn The Skill That May Soon Be Far More Important Than Your College Degree!

The ability to use a computer may soon be more important to your earning power than a college degree. Without a knowledge of computers, you are always at the mercy of others when it comes to solving highly complex business, engineering, industrial and scientific problems. People who understand computers can command MONEY and get in on the action; you must learn computers. Otherwise you'll be left behind.

ELF II Is The F-A-S-T Way To Learn Computer Fundamentals!

Regardless of how minimal your computer background is now, you can learn to program a computer in almost no time at all. That's because Netronics has developed a special *Short Course on Microprocessor And Computer Programming* in non-technical language that leads you through every one of the RCA COSMAC 1802's capabilities so you'll understand everything ELF II can do...and how to get ELF II to do it!

All 91 commands that an 1802 can execute are explained to you, step-by-step. The text, written for Netronics by Tom Pittman, is a tremendous advance over every other programming book in print.

Keyed specifically to the ELF II, it's loaded with "hands on" illustrations. When you're finished, ELF II and the 1802 will no longer hold any mysteries to you.

In fact, not only will you be able to use a personal computer creatively, you'll also be able to read magazines such as **BYTE...INTERFACE AGE...POPULAR ELECTRONICS and PERSONAL COMPUTING** and understand the articles.

If you work with large computers, ELF II and our *short Course* will help you to understand what makes them tick.

A Dynamite Package For Just \$99.95!

With ELF II, you learn to use machine language—the fundamental language of all computers. Higher level languages such

as FORTRAN and BASIC must be translated into machine language before a computer can understand them. With ELF II you build a solid foundation in computers so you'll really know what you're doing, no matter how complicated things get.

Video output also makes ELF II unique among computers selling for such a low price. Attached to your TV set, ELF II becomes a fabulous home entertainment center. It's capable of providing endless hours of fun for both adults and children of all ages! ELF II can create graphics, alphanumeric displays and fantastic video games.

No additional hardware is required to connect ELF II to your TV's video input. If you prefer to connect ELF II to your antenna terminals instead, simply use a low-cost RF modulator (to order only—see coupon below).

ELF II'S 5-card expansion bus (connectors not included) allows you to expand ELF II as your needs for power grows. If you're an engineer or hobbyist, you can also use ELF II as a counter, alarm, lock, thermostat, timer or telephone dialer, or for countless other applications.

ELF II Explodes Into A Giant!

Thanks to ongoing work by RCA and Netronics, ELF II add-ons are among the most advanced anywhere. Plug in the **GIANT BOARD™** and you can record and play back programs, edit and debug programs, communicate with remote devices and make things happen in the outside world. Add **Kluge Board** to get ELF II to solve special problems such as operating a more complex alarm system or controlling a printing press. Add **4k RAM** board and you can write longer programs, store more information and solve more sophisticated problems.

Expanded, ELF II is perfect for engineering, business, industrial, scientific and personal finance applications. No other small computer anywhere near ELF II's low price is backed by such an extensive research and development program.

The **ELF-BUG™** Monitor is an extremely recent breakthrough that lets you debug programs with lightning speed because the key to debugging is to know what's inside the registers of the microprocessor and, instead of single stepping through your program, the **ELF-BUG™** Monitor, utilizing break points, lets you display the entire contents of the registers on your TV screen at any point in your program. You find out immediately what's going on and can make any necessary changes. Programming is further simplified by displaying 24 bytes of RAM with full address, blinking cursor and auto scrolling. A must for serious programmers!

Netronics will soon be introducing the ELF II **Color Graphics & Music System**—more breakthroughs that ELF II owners will be the first to enjoy!

Now BASIC Makes Programming ELF II Even Easier!

Like all computers, ELF II understands only "machine language"—the language computers use to talk to each other. But, to make life easier for you, we've developed an **ELF II Tiny BASIC**. It talks to ELF II in machine language for you so that you can program ELF II with simple words that can be typed out on a keyboard such as PRINT, RUN and LOAD.

"Ask Now What Your Computer Can Do... But What Can It Do For YOU!"

Don't be trapped into buying a dinosaur simply because you can afford it and it's big. ELF II is more useful and more fun than "big name" computers that cost a lot more money.

With ELF II, you learn to write and run your own programs. You're never reduced to being a mere keypunch operator, working blindly with someone else's predeveloped software.

No matter what your specialty is, owning a computer which you really know how to use is sure to make you a leader. ELF II is the fastest way there is to get into computers. Order from the coupon below!

NOW AVAILABLE FOR ELF II—		SEND TODAY!	
<input type="checkbox"/> Tom Pittman's <i>Short Course On Microprocessor & Computer Programming</i> teaches you just about everything there is to know about ELF II or any RCA 1802 computer. Written in non-technical language, it's a learning breakthrough for engineers and laymen alike. \$5.00 postpaid!	<input type="checkbox"/> Deluxe metal cabinet with plexiglas dust cover for ELF II. \$29.95 plus \$2.50 p&h.	<input type="checkbox"/> ELF II connects to the video input of your TV set. If you prefer to use your antenna terminals, order RF Modulator, \$8.95 postpaid.	<input type="checkbox"/> GIANT BOARD™ kit with cassette I/O, RS 232-C/TTY I/O, 8-bit P I/O, decoders for 14 separate I/O instructions, and a system monitor/editor. \$39.95 plus \$2 p&h.
<input type="checkbox"/> Kluge (Prototype) Board accepts up to 36 IC's. \$17.00 plus \$1 p&h.	<input type="checkbox"/> 4k Static RAM kit. Addressable to any 4k page to 64k. \$89.95 plus \$3 p&h.	<input type="checkbox"/> Gold plated 86-pin connectors (one required for each plug-in board). \$5.70 postpaid.	<input type="checkbox"/> Professional ASCH Keyboard kit with 128 ASCII upper/lower case set, 96 printable characters, onboard regulator, parity, logic selection and choice of 4 handshaking signals to mate with almost any computer. \$64.95 plus \$2 p&h.
<input type="checkbox"/> Deluxe metal cabinet for ASCII Keyboard. \$19.95 plus \$2.50 p&h.	<input type="checkbox"/> ELF II Tiny BASIC on cassette tape. Commands include SAVE, LOAD, =, +, *, (), 26 variables A-Z, LET, IF THEN, INPUT, PRINT, GO TO, GO SUB, RETURN, END, REM, CLEAR, LIST, RUN, PLOT, PEEK, POKE. Comes fully documented and includes alphanumeric generator required to display alphanumeric characters directly on your TV screen without additional hardware. Also plays tick-tack-toe plus a drawing game that uses ELF II's hex keyboard as a joystick. 4k memory required. \$14.95 postpaid.	<input type="checkbox"/> Tom Pittman's <i>Short Course on Tiny BASIC</i> for ELF II. \$5 postpaid.	<input type="checkbox"/> Expansion Power Supply (required when adding 4k RAM). \$34.95 plus \$2 p&h.
<input type="checkbox"/> ELF-BUG™ Deluxe System Monitor on cassette tape. Allows displaying the contents of all registers on your TV at any point in your program. Also displays 24 bytes of memory with full addresses, blinking cursor and auto scrolling. A must for the serious programmer! \$14.95 postpaid.	<input type="checkbox"/> Coming Soon: A-D, D-A Converter, Light Pen, Controller Board, Color Graphics & Music System...and more!	<p>Netronics R&D Ltd., Dept. RE-2 333 Litchfield Road. Phone New Milford, CT 06776 (203) 354-9375</p> <p>Yes! I want to run programs at home and have enclosed: <input type="checkbox"/> \$99.95 plus \$3 postage & handling for RCA COSMAC ELF II kit, <input type="checkbox"/> \$4.95 for power supply (required), <input type="checkbox"/> \$5 for RCA 1802 User's Manual, <input type="checkbox"/> \$5 for <i>Short Course on Microprocessor & Computer Programming</i>.</p> <p><input type="checkbox"/> I want mine wired and tested with power supply, RCA 1802 User's Manual and <i>Short Course</i> included for just \$149.95 plus \$3 p&h!</p> <p><input type="checkbox"/> I am also enclosing payment (including postage & handling) for the items checked at the left.</p> <p>Total Enclosed (Conn. res. add tax) \$ _____ <input type="checkbox"/> Check here if you are enclosing Money Order or Cashier's Check to expedite shipment. USE YOUR <input type="checkbox"/> VISA <input type="checkbox"/> Master Charge <input type="checkbox"/> Interbank # _____ Account # _____ Signature _____ Exp. Date _____ PHONE ORDERS ACCEPTED (203) 354-9375 Print Name _____ Address _____ City _____ State _____ Zip _____</p> <p>DEALER INQUIRIES INVITED</p>	

CIRCLE 58 ON FREE INFORMATION CARD

FREE
— GROUP SUPPLIES

NATCAM
catalog
Shopping center for small and precision tools

A fine selection of small tools, measuring instruments, hard-to-find items for shop, home and lab. Convenient one-stop shopping for technicians, engineers, craftsmen, hobbyists. Major credit cards accepted, satisfaction assured. Get your NATCAM catalog today.

National Camera, Inc.
2000 West Union Ave., Dept. GBF
Englewood CO 80110 USA

CIRCLE 5 ON FREE INFORMATION CARD

FREE SWTH

CATALOG

Audio—Computers
Instruments
Kits & Assembled

**COMPUTER
PRODUCTS
CATALOGUE**

Southwest Technical Products Corporation
219 W. RHAPSODY
SAN ANTONIO, TEXAS 78216

CIRCLE 68 ON FREE INFORMATION CARD

stereo products

More information on new products is available from manufacturers of items identified by a Free Information number. Free Information Card is inside the back cover.

MICROPHONE MIXER, model MX3000, is a sound-studio unit designed to handle any high-power amplifier without using external preamp. It has provisions for 6 mike inputs and 2 stereo line inputs. Other controls include individual mike attenuators, and stereo/mono switches, a master control switch and headphone monitor. Speci-

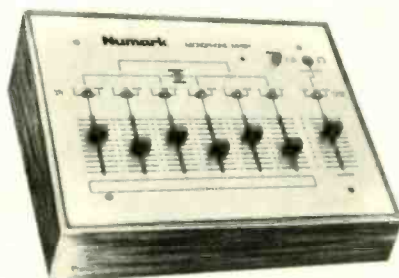

CIRCLE 109 ON FREE INFORMATION CARD

fications are: input sensitivity (mike), 0.5 mV, (line) 65 mV; output impedance, 100 ohms; hum and noise (mike), -52 dB, (line) -65 dB; frequency response (mike) 20 Hz-18 kHz (1 dB); (line) 10 Hz-30 kHz (-1 dB). The unit measures 12 3/4 W X 9 1/4 H X 3 1/2 inches D, and weighs 6 1/2 lb. Suggested retail price: \$149.95.—Numark Electronics Corp., 503 Raritan Center, Edison, NJ 08817.

TAPE RECORDER CARE KIT provides a flexible way to clean tape heads in hard-to-reach spots. The kit contains various plug-together plastic



CIRCLE 110 ON FREE INFORMATION CARD

tools, a mirror, a variety of felt applicator tabs, and a bottle of tape head cleaner. Price: \$8.95.—Maxell Corp. of America, 130 Commercial Way, Moonachie, NJ 07074.

SIGNAL PROCESSOR/PREAMPLIFIER, model SP4002, contains two separate phono preamps with a 0- to 150-pF variable cartridge loading capability and a variable impedance of 100 mV at 47,000 ohms; both accept any cartridge with a 0.28- to 300-mV output capability. Each preamp contains inputs and outputs, and provides a vari-

able ± 20 -dB gain, 97-dB S/N ratio, 300-mV overload capability, plus the newly approved RIAA equalization curve. Front-panel controls include signal processing switches (including



CIRCLE 111 ON FREE INFORMATION CARD

subsonic filter, external loops, equalizer, monophonic mixer for Channels A and B and tape-record switches; volume and balance control switches; power on-off switch; and source selection switch. Built into the preamplifier unit is a graphic equalizer providing from 15-dB to 22-dB boost-per-octave and a better than 114-dB S/N ratio. Also included on the front panel are headphone jacks and an extra tape recorder jack. Price: \$699.—Soundcraftsman, 1721 Newport Circle, Santa Ana, CA 92705.

AM/FM STEREO RECEIVER, model STR-V7, is a top-of-the-line unit that provides 150 watts-per-channel RMS into 8 ohms from 20 Hz to 20 kHz, with no more than 0.07% THD and IM distortion. Its features include tape monitors and dubbing; stepped-attenuator volume control; bass and treble controls; high-cut and low-cut filter switches; and a loudness-compensation switch. The receiver also includes an FM bandwidth switch, linear dial calibration, flywheel coupling, FM muting switch, center tuning and signal-strength meters.

The tuner front end contains a MOSFET RF amplifier, 4-gang tuning capacitor and oscillator;



CIRCLE 112 ON FREE INFORMATION CARD

the IF stage comprises 4-element ceramic filters, a differential amplifier and 5 banks of limiters. A phase-locked-loop multiplex IC provides 48-dB at 1-kHz stereo separation. The amplifier section contains a toroidal-coil transformer and two 15,000- μ F capacitors; and the preamp features RIAA phono equalization and provides 25-mV overload protection. Suggested list price: \$820.—Sony Corp. of America, 9 W. 57th St., New York, NY 10019.

next month

■ Your Own Computer

A special section devoted to personal computing with the accent on peripheral devices, including printers, terminals and floppy discs. You won't want to miss the many hints on selecting and setting up a system and the round-up listings of peripheral devices.

■ Rechargeable Batteries—Past, Present And Future

A look at the improvements that have taken place in the last 10 years and what may take place in the next 10 years, with a special look at lithium cells.

■ Build A String Synthesizer

Part 2—Construction details for a professional-quality music synthesizer that can be built for many times less than commercially available instruments.

Want to Switch to Land Mobile Servicing?

WE CAN HELP YOU SWITCH

... by providing professional HOME STUDY training for you and your technicians. MTI has been providing specialized training in land mobile servicing for 18 years. We would like to help you also. For more information, cut out this coupon.

NO SALESMAN WILL CALL!

Name _____
Address _____
City _____
State/Zip _____

A38



Mobile Training Institute
Box 735, Camp Hill, PA 17011

CIRCLE 27 ON FREE INFORMATION CARD

THE BIG PLUS + Graphic Equalizer

ASSEMBLED
\$189.95

KIT
\$99.95



LOADED with Quality Features!

- Stereo . . . Eleven Bands Per Channel • Extremely Low Noise & Distortion • LED Peak Indicators • Center Detent ("flat") sliders • Built-in "record" Switching • Line and Microphone Level Inputs/Outputs • Regulated Power Supply • Fully Guaranteed • Horizontal or Vertical Cabinets • Kit or Fully Assembled • Plus Much, Much More!

Absolutely equals or exceeds overall performance and features of any graphic equalizer made today!

AARON-GAVIN INSTRUMENTS, INC.

17231 Corla Avenue Tustin, California 92680

Yes! I've enclosed \$_____ RUSH me: cabinet send brochure
_____ assembled equalizers at \$189.95, p.p.d. Horizontal (flat) Vertical (up-right)
_____ unassembled equalizer kits at \$99.95, p.p.d. California residents include 6% sales tax
Name _____ Visa & Master Charge orders accepted
Address _____ Card No. _____
City _____ State _____ Zip _____ Exp. Date _____ Bank No. _____

Dealer inquiries invited

Accuracy like a VTVM... Convenience like a VOM...

NEW BATTERY-OPERATED FET SOLID-STATE VOLT-OHMMETER #116

Easy-to-build KIT

\$44.78 =116K

Factory-Wired & Tested

\$60.05 =116W

Now you can get all the benefits of a VTVM (laboratory accuracy, stability and wide range) but with its drawbacks gone: no plugging into an AC outlet, no waiting for warm-up, no bulkiness. New Field Effect Transistor (FET) design makes possible low loading, instant-on battery-operation and small size. Excellent for both bench and field work.

Compare these valuable features:

- High impedance low loading: 11 meg-ohms input on DC, 1 megohm on AC
- 500-times more sensitive than a standard 20,000 ohms-per-volt VOM
- Wide-range versatility: 4 P-P AC voltage ranges: 0-3.3, 33, 330, 1200V; 4 RMS AC voltage ranges: 0-1.2, 12, 120, 1200V; 4 DC voltage ranges: 0-1.2, 12, 120, 1200V; 4 Resistance ranges: 0-1K, 0-100K, 0-10 meg., 0-1000 meg.; 4dB ranges: -24 to +56dB.

Sensitive easy-to-read 4 1/2" 200 micro-amp meter. Zero center position available. Comprises FET transistor, 4 silicon transistors, 2 diodes. Meter and transistors protected against burnout. Etched panel for durability. High-impact bakelite case with handle useable as instrument stand. Kit has simplified step-by-step assembly instructions. Both kit and factory-wired versions shipped complete with batteries and test leads. 5 1/4" H x 6 3/4" W x 2 7/8" D. 3 lbs.

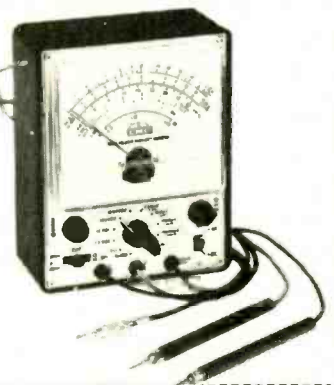

Send FREE catalog of complete EMC line and name of nearest distributor. RE-2

Name _____
Address _____
City _____
State _____ Zip _____

EMC

ELECTRONIC MEASUREMENTS CORP.
625 Broadway, New York, N.Y. 10012

HOLD IT!

Anywhere you want it.

PanaVise tilts, turns, rotates. One quick turn of the control knob and you securely position your work exactly where you want it. Holds firmly but gently the most delicate electronic parts and P. C. boards.

Whether you're into building home electronics, trouble shooting, or professional servicing... you'll wonder how you got along without this modestly priced 'extra hand.'

Model 396 Wide Opening PanaVise shown. An ingenious variety of other interchangeable bases, holders and accessories also available. See your electronics distributor, or write for FREE brochure.

PANAVISE® Dept. CE2
2850 29th St., Long Beach, CA 90806



CIRCLE 54 ON FREE INFORMATION CARD

The world of electronics gee-wizardry

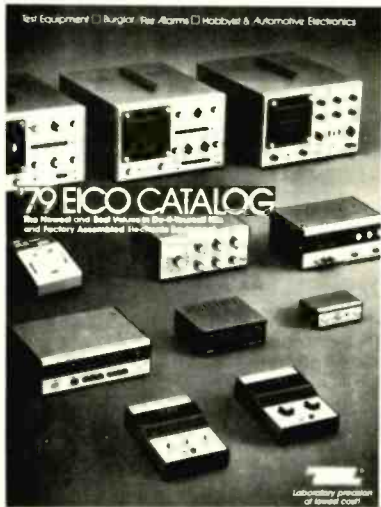

-YOURS FREE.

32-pages of test instruments — from the latest digital multimeters to the famous EICO scopes. Security systems. Automotive and hobbyist products. Kits and assembled. EICO quality. EICO value. For FREE catalog, check reader service card or send 75¢ for first class mail.

EICO® 108 New South Road
Hicksville, N.Y. 11801

CIRCLE 26 ON FREE INFORMATION CARD



endeco soldering & desoldering equipment

SOLDERING IRONS

Pencil style. Safety light. Two heats — 20w and 40w. 6 tips. Unbreakable handle. 2 and 3 wire neoprene cords.

DESOLDERING IRONS

Pencil style. Safety light. Some operate at 40w. Idle at 20w. 8 tip sizes. 2 and 3 wire neoprene cords.

SOLDERING & DESOLDERING KITS



Everything needed to solder or desolder or both. All in a handy lifetime metal box with hasp.

See your distributor or write...

Enterprise Development Corp.
5127 E. 65th St. • Indianapolis IN 46220
PHONE (317) 251-1231

CIRCLE 29 ON FREE INFORMATION CARD

new lit

More information on new lit is available from the manufacturers of items identified by a Free Information number. Use the Free Information Card inside the back cover of this issue.

ELECTRONICS CATALOG, 48 pages of discounted items for electronics hobbyists, educators, dealers. Includes hundreds of items from basic components to TV and hi-fi equipment, a radar warning system, telephone keyboard, clock assembly, etc. Catalog also includes a 16-page wholesale supplement listing items of special interest to dealers and volume users.—ETCO Electronics Corp., North Country Shopping Center, Rte. 9 North, Plattsburgh, NY 12901.

CIRCLE 105 ON FREE INFORMATION CARD

BRADFORD COMPONENTS CATALOG, 8 pages listing components for servicing Bradford TV's and appliances. Included are resistors, VDR's, transistors, diodes, electrolytics, semiconductors; several parts kits are featured, as are Bradford service manuals. Price: \$1.50 (refundable with first purchase).—The Marcel Companies, Parts Division, 57 Enfield St., Enfield, CT 06082.

TROUBLESHOOTING GUIDE, *Common Production Soldering Problems: Causes and Cures*, is a four-page article detailing the most common soldering defects and can be used as a reference for assembly and production personnel. Some of the problems discussed are insufficient or excessive solder on joints, solder joint discoloration and solder bridges, nonwetting and dewetting conditions, measing and cold joints. Possible causes for solder defects plus suggested solutions accompany each section.—Multicore Solders, Westbury, NY 11590.

CIRCLE 106 ON FREE INFORMATION CARD

QUARTZ CRYSTALS catalog contains 7 pages describing high-quality crystals for a wide variety of equipment applications—from replacement units to new, modified or experimental equipment. Crystals are available for Motorola, GE, E.F. Johnson, Comco and other manufacturers. Complete descriptions and specifications are given along with technical information for all crystal sizes and types—from micro-miniature to large and cold-weld varieties.—Savoy Electronics, Inc., 1175 N.E. 24th St., Fort Lauderdale, FL 33310.

CIRCLE 107 ON FREE INFORMATION CARD

ELECTRONIC WIRE/CABLE CATALOG, *Catalog No. 878*, 180 pages of multi-conductor cables, computer cables, hookup wires, coax cables, wire and cable assembly packages, and shielded/unshielded cords and portable cordage. Catalog includes such products as power-limited low-energy cable (UL-approved); bus-cable assemblies for IEEE-488 interconnections; and CEE color-coded wire. Construction details, specifications and electrical characteristics are given in both conventional and metric units. Price: \$2.50.—Belden Corp., 2000 S. Batavia Ave., Geneva, IL 60134.

market center

CLASSIFIED COMMERCIAL RATE (for firms or individuals offering commercial products or services). \$1.50 per word (no charge for zip code) . . . minimum 15 words.

NONCOMMERCIAL RATE (for individuals who want to buy or sell personal items) 85¢ per word . . . no minimum.

ONLY FIRST WORD AND NAME set in bold caps. Additional bold face (not available as all caps) at 10¢ per word. Payment must accompany all ads except those placed by accredited advertising agencies. 5% discount for 6 issues, 10% for 12 issues within one year, if paid in advance. All copy subject to publisher's approval. Advertisements using P.O. Box address will not be accepted until advertiser supplies publisher with permanent address and phone number. Copy to be in our hands on the 26th of the third month preceding the date of the issue (i.e., August issue closes May 26). When normal closing date falls on Saturday, Sunday or a holiday, issue closes on preceding working day.

PLANS & KITS

LINEAR AMPLIFIER: Ham only 2-30 MHz, 100 watt, solid-state. **FREQUENCY COUNTER:** 300 MHz, miniportable/mobile, memory! **VOX—COMPRESSOR:** Splatter-free modulation booster. Construction plans \$3.00 each. All \$7.50! Many others, catalog with order. **PANAXIS PRODUCTIONS**, Box 130-F2, Paradise, CA 95969

SCANNER users—Build many useful accessories. Free kit catalog. **CAPRI ELECTRONICS**, Route 1R, Canon, GA 30520

AMPLIFIER kits: Low TIM. Class A, BI-FET circuitry. Free 60-page manual. **MOONLIGHTER ELECTRONICS**, 117 Inverness, San Francisco, CA 94132

CIA TOOL KIT. Complete schematics for 30 electronic surveillance devices. \$15.00. **MICRON RESEARCH**, PO Box 118, Woodstown, NJ 08098

PRINTED circuit boards from your sketch or artwork. Affordable prices. Also fun kit projects. Free details. **DANOCINTHS INC.**, Box 261, Westland, MI 48185

AMAZING ELECTRONIC PROJECTS and PRODUCTS: Lasers Super Powered, Burning, Cutting, Rifle, Pistol Pocket. See in Dark—Shotgun Directional Mike—Unscramblers—Giant Tesla—Stunwand—TV Disrupter—Energy Producing, Surveillance, Detection, Electrifying, Ultrasonic, CB, Auto and Mech. Devices, Hundreds More—All New Plus **INFO UNLTD PARTS SERVICE**. Catalog \$1. **Information Unlimited, Dept. R8 Box 716 Amherst, N.H. 03031.**

SAVE 50%. Build your own speaker system. Write for catalog: **McGEE RADIO**, 1901 McGee, Kansas City, MO 64108

PROJECTION TV. . . . Convert your TV to project 7 foot picture. Results equal to \$2,500 projector. Total cost less than \$20.00 Plans & lens \$16.00. Illustrated information free. **MACROMG B**, Washington Crossing, PA 18977

FOR SALE

FREE catalog (anglais). IC's, semi's. **CORONET ELECTRONICS**, 649A Notre Dame W., Montreal, Que. Canada, H3C 1H8. US inquiries.

To run your own classified ad, put one word on each of the lines below and send this form along with your check for \$1.50 per word (minimum 15 words) to:

Radio-Electronics, 200 Park Avenue South, N.Y., N.Y. 10003

ORDER FORM

PLEASE INDICATE in which category of classified advertising you wish your ad to appear. For special headings, there is a surcharge of \$10.

() Plans/Kits () Business Opportunities () For Sale
() Education/Instruction () Wanted ()

Special Category: \$10

(PLEASE PRINT EACH WORD SEPARATELY, IN BLOCK LETTERS.)

1	2	3	4	5
6	7	8	9	10
11	12	13	14	15
16	17	18	19	20
21	22	23	24	25
26	27	28	29	30
31	32	33	34	35

PRINTED CIRCUIT

Positive Acting Photo Resist; Carbide bits; Bubble etchers; Artwork; Epoxy Glass Boards.

Send stamp & address label for flyer

TRUMBULL

833 Balra Dr., El Cerrito, CA 94530

RADIO & TV tubes 36¢ each. One year guaranteed. Plus many unusual electronic bargains. Free catalog. **CORNELL**, 4217-E University, San Diego, Calif. 92105

NAME brand test equipment. Up to 50% discount. Free catalog and price list. **SALEN ELECTRONICS**, P.O. Box 82, Skokie, IL 60076

SPEAKER INFORMATION KIT

Get 70 pages of speaker facts, specs, construction tips plus info on our raw speakers, crossovers and a line of 9 quality hi-fi speaker system kits. We'll send you our **full-color catalog**, plus **How to Hook Up Your System**, an exhaustive step-by-step treatise on hi-fi system installation; and our **Speaker Operating Manual**, chock full of facts on how to get the most from any speaker system, for Free. Even if you don't buy from us we want you to have the facts. That's how we got to be the world's largest manufacturer of speaker kits.



Send to:
Speakerlab, Dept. 2-RE
735 N. Northlake
Seattle, WA 98103

STAMP collectors. Fine sets of no-gum unused Canadian postage stamps. More than \$2 face value only \$1 US funds plus SASE. Quantities limited. **G. STECKLER**, 24 Straw La., Hicksville, NY 11801

Big CATALOG Write for Your Free Copy

Connectors

TRI-TEK incorporated

7808 N. 27th Avenue
Phoenix, Arizona 85021
(602) 995-9352

VCR'S, CPU's, etching solution, and much more at discount prices. For more information send 50¢ to: **CHARLES LEWIS**, Moravia, IA 52571

Independent News Company, Inc. is pleased to announce a Retail Display Plan available to all retailers interested in earning a display allowance on Radio-Electronics magazine and who purchase the magazines from suppliers other than Independent News Co., Inc., or the publisher.

To obtain details and a copy of the formal contract please write to **Director, Retail Sales Division, Independent News Co., Inc., 75 Rockefeller Plaza, New York, N.Y. 10019**. Under the display plan in consideration of your acceptance and fulfillment of the terms of formal contract to be sent to you upon your request you will receive a display allowance of 10% of the cover price per copy sold by you. This plan will become effective with all issues of Radio-Electronics delivered to you subsequent to the date your written acceptance of the formal Independent News Co., Inc. Retail Agreement is received and accepted by our Company.

Burglar - Fire - Smoke Alarm Catalog

• Billions of dollars lost annually due to lack of protective warning alarms.

FREE CATALOG Shows you how to protect your home, business and person. Wholesale prices. Do-it-yourself. Free engineering service.



Burdex Security Co.

Box 82802 RE-029 Lincoln, Ne. 68501

SPECIAL offer available. 7" reel to reel tape new \$1.00 per roll plus .50¢ shipping per roll. Order from: **LABTRONICS**, 850-167 Lombard Avenue, Winnipeg, Man., Canada R3B 0V8

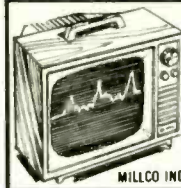

BIG SCREEN OSCILLOSCOPE

Converted from ANY Size TV Set...
Hams, Technicians, Hobbyists, Broadcasters!
Minor, inexpensive changes convert TV set to super sensitive testing device. No electronic experience needed! Follow clear cut plans. Fully illustrated. Use in workshop, lab, school, etc.
Any size screen... Any size TV set...

Complete Set of Plans... \$4 (INCL. 50¢ FOR POST & HANDLING)
MILICO IND., DEPT. OP-02 BOX 91, KOSSE, TX 76653

A CARD player's dream. 25¢ to **LANGEN**, Box 191-CB, Downsview, Ont M3M 3A3

FREE KIT Catalog

STOP! Take a minute & let us send our latest kit catalog. If you like, send us the name & address of a friend who may also be interested and we'll include to you our booklet "How to build electronic thermometer".

contains **TEST & EXPERIMENTER'S EQUIP.**

DAGE SCIENTIFIC INSTRUMENTS
BOX 1054R LIVERMORE CA 94550

SELLING Rider's manuals, early Sams' Photo-facts, individual service diagrams. **SUPREME PUBLICATIONS**, Box 46, Highland Park, IL 60035

YOUR PHONE CALLS ON TAPE

Record incoming and outgoing calls automatically with this all solid state unit connected to your telephone jack and tape recorder. Starts recording when phone is lifted. Stops when you hang up, making a permanent record. Easily installed. No extra monthly phone charges. FCC APPROVED
2-1/4 x 1-3/4 x 3/4 **\$24.50***



VOX

VOICE ACTIVATED CONTROL SWITCH

Self contained solid state. Excellent adjustable sensitivity. Recorder activated by voices or other sounds. Uses recorder mike or remote mike. Great for home, business, etc.
\$24.95*



AMAZING ELECTRONIC MICRO MINI MIKE

Among world's smallest, solid state, self contained WIRELESS MIKE. Mercury Bat. furn. Picks up most sounds and transmits without wires up to 300 ft. thru FM Radio. Tuneable. Use as mike, ampl., alarm & alert system, baby sitter, hot line, etc. (*Plus \$1.00 Pstg. & Hdg.) Money back guarantee. California residents add tax. Free data. Mail order. Visa, M/C, Cod's o.k. Quantity discount available. **AMC Sales**, Dept. 29, 9335 Lubec St. Box 928, Downey, Calif. 90241 Phone (213) 869-8519

MINIATURE electret microphone cartridges. Response 50Hz to 20kHz, ±3dB. Just add resistor, capacitor, and 1.5V to 6V. Model 35: 10mm diameter by 10mm length, \$3.50 ppd. Model 26: 6mm diameter by 4.5mm length, \$6.00 ppd. **GEOFFREY SOUND LABS**, Dept. M, 24 N. Wabash, Room #823, Chicago, IL 60602

TASCO offers reliable TV antenna system components below wholesale prices. Write for our **FREE 32 page catalog** full of great surplus bargains. Such bargains as:

- F-59 - 17¢
- F-56 - 20¢
- 75-300 ohm Transformer ACU-1 - 95¢
- MS-2 2-Way Splitter - \$2.95
- MS-4 4-Way Splitter - \$4.95

TEXAS ANTENNA SUPPLY CO.
P.O. BOX 30143
HOUSTON, TEXAS 77009

TEST equipment catalog listing used Tektronix, HP and GR equipment at bargain prices. Price \$1.00 refundable with first order. **PTI**, Box 8699, White Bear Lake, MN 55110

CAR STOLEN CAR CAN BE LOCATED
PROTECT AUTOMOBILE, BOAT, TRAILER, AIRPLANE, HOME & OFFICE. Make a FOOL PROOF silent radio alarm by using your Battery, Transmitter, Switches & Receiver (not included). Attach to NEW INVENTION! "LOCK IN CONTROL". Easy, simple installation. INTRODUCTORY OFFER \$29.95 with **MONEY BACK GUARANTEE** when returned in 15 days. Print NAME & ADDRESS. Send check or **MONEY ORDER**, 6% tax CA. We will send you a LOCK IN CONTROL with PLANS. **FREE INFORMATION** FOWLER ALARMS, P.O. Box 64466 RE-2, Los Angeles, CA. 90064
© Fowler Alarms 1977

SOLAR equipment bargain catalog for the do it yourselfer. Contains latest in solar cells, differential controls, and all equipment related to solar energy. \$1.00. **EXTERNAL ENERGY**, Box 643, Tempe, AZ 85281

BREATHE REFRESHING "VITAMINS OF THE AIR" with an amazing **NEGATIVE ION GENERATOR**. ROOM-PORTABLE-CAR UNITS, TESTERS AND ACCESSORIES. (Dealers Wanted).
Send \$1.00 for fascinating details to **GOLDEN ENTERPRISES, INC.** P.O. Box 1282-RE, Glendale, Arizona 85111

MICROWAVE leakage detector 245M low cost oven monitor for every owner and serviceman. \$52.00 freight prepaid. **UCE**, 20 N. Main, Norwalk, CT 06854

PUSHBUTTON AM AUTO RADIO 7.99

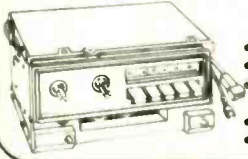

AU-580
• All Are Brand New
• Mts. In-Under Dash
• With Volume and Tone Control
• 12 VDC Neg. Grd.
• Solid-State • 6 lbs.

2400 FT. MYLAR RECORDING TAPE 79¢



Reg. 1.29 TA-974
SALE
• Quality Mylar Tapes
• 7" Reel
• Made By Famous U.S. Mfr.
• Supplied Less Storage Box
• Shpg. wt. 1 lb.

Olson 1000 OHMS PER VOLT TESTER 8.99



TE-184
• Pocket Size Goes Anywhere
• Easy to Read Meter

REPLACEMENT TONE ARM 69¢



HF-035
• For All Manual Portable Phonos
• Sapphire Stylus • 3 Volt Output
• Replacement for Kiddie Phonos
• Mono Flip Over Cartridge • Wt. 1/4 lb.

SALE SWR METER 7.99



FIELD STRENGTH INDICATOR CB-067 Reg. 11.99
• For Accurate Tuning of CB Antenna • Styles Vary
• Range 2 to 30MHz • 52 Ohms Impedance • Wt. 1 lb.

8-TRACK CASSETTE 49¢

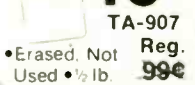

40-MINUTE BLANK 60 MINUTE BLANK
TA-907 Reg. 99¢ TA-879 Reg. 1.49
• Erased, Not Used • 1/2 lb.
• Ideal for Music or Voice • 1/2 lb.

8 OHM EARPHONES 29¢



PH-405
• Package of 4
• Earphones Without Plugs
• Shpg. wt. 1/4 lb.

500-Ft. Hookup Wire Kit \$2



Reg. 4.28 WW-579
• For Printed Circuits or Wiring Project, Hobbyist and Repair
• Less Than 1 Cent A Foot
• Five 100-Ft. Rolls

Olson electronics Dept. LM 260 S. Forge St. Akron, Ohio 44327

NAME _____
ADDRESS _____
CITY _____
STATE _____ ZIP _____

Qty.	Stk. #	Description	Price Ea.	Total

Tax _____
Postage _____
Total _____

For 24 Hour PHONE Service Call (216) 535-1800

Please send me a free subscription to Olson Value Packed Catalog. (Within the Continental USA Only)

AMERICA'S LARGEST SUPPLIER

of ORIGINAL Japanese Semi-Conductors
for CB, TV and Stereo Repair

We carry only genuine replacement parts

TYPE	25-UP	10-24	1-9	TYPE	25-UP	10-24	1-9	TYPE	25-UP	10-24	1-9	TYPE	25-UP	10-24	1-9
2SA 102	.20	.27	.30	2SC 696	1.00	1.20	1.30	2SD 234	.60	.70	.80	TA 7205P	1.60	1.80	2.00
2SA 234	.45	.53	.59	2SC 710	.20	.27	.30	2SD 235	.60	.70	.80	TA 7310P	1.30	1.45	1.60
2SA 473	.45	.53	.59	2SC 711	.20	.27	.30	2SD 261	.35	.40	.45	TBA 810SH	1.90	2.10	2.40
2SA 484	1.50	1.75	1.95	2SC 730	3.00	3.20	3.40	2SD 287	2.50	2.70	2.90	TC 5080P	5.00	5.20	5.80
2SA 495	.30	.35	.40	2SC 732	.20	.27	.30	2SD 313	.60	.70	.80	TC 5081P	3.00	3.20	3.40
2SA 497	1.00	1.20	1.30	2SC 735	.20	.27	.30	2SD 315	.60	.70	.80	TC 5082P	3.40	3.55	3.90
2SA 509	.30	.35	.40	2SC 756	1.50	1.80	2.00	2SD 325	.60	.70	.80	UHC 002	4.20	4.40	4.90
2SA 561	.30	.35	.40	2SC 756A	1.50	1.80	2.00	2SD 427	1.80	2.00	2.25	UHIC 004	4.20	4.40	4.90
2SA 562	.30	.35	.40	2SC 781	1.90	2.10	2.40	2SD 525	.90	1.10	1.20	UHIC 005	4.20	4.40	4.90
2SA 564A	.20	.27	.30	2SC 784	.30	.35	.40	2SD 526	.60	.70	.80	UPC 20C	2.10	2.50	2.80
2SA 634	.40	.45	.50	2SC 799	2.00	2.20	2.50	FET				UPC 563	1.90	2.10	2.40
2SA 643	.30	.40	.45	2SC 828	.20	.27	.30					2SK 19BL	.45	.55	.60
2SA 673	.35	.40	.45	2SC 839	.30	.35	.40	2SK 23	.70	.80	.90	UPC 576	1.90	2.10	2.40
2SA 678	.35	.40	.45	2SC 867	3.20	3.40	3.70	2SK 30	.40	.45	.50	UPC 592HZ	.70	.80	.90
2SA 682	.80	.90	1.00	2SC 867A	3.20	3.40	3.70	2SK 33	.60	.70	.80	UPC 1001	1.90	2.10	2.40
2SA 683	.30	.35	.40	2SC 897	2.00	2.20	2.50	2SK 35	.60	.70	.80	UPC 1008C	4.20	4.40	4.90
2SA 684	.35	.40	.45	2SC 930	.20	.27	.30	2SK 39	.90	1.10	1.20	UPC 1020H	1.90	2.10	2.40
2SA 695	.40	.53	.59	2SC 945	.20	.27	.30	3SK 22Y	1.40	1.60	1.80	UPC 1025H	1.90	2.10	2.40
2SA 699A	.50	.64	.70	2SC 983	.50	.64	.70	3SK 39	.90	1.10	1.20	UPC 1154	2.00	2.20	2.50
2SA 706	.85	1.00	1.10	2SC 959	1.10	1.20	1.30	3SK 40	.90	1.10	1.20	UPC 1155	2.00	2.20	2.50
2SA 719	.30	.35	.40	2SC 1000BL	.35	.40	.45	3SK 41	1.30	1.45	1.60	UPC 1156	1.90	2.10	2.40
2SA 720	.30	.35	.40	2SC 1014	.50	.64	.70	3SK 45	1.30	1.45	1.60	UPC 14305	3.00	3.20	3.40
2SA 733	.20	.27	.30	2SC 1018	.60	.70	.80	3SK 48	3.40	3.55	3.90	UPD 861	8.00	8.40	9.50
2SA 747	4.20	4.40	4.90	2SC 1030C	1.80	2.10	2.40	3SK 49	1.30	1.45	1.60	UPD 857	8.00	8.40	9.50
2SA 818	.70	.80	.90	2SC 1061	.70	.80	.90	IC				UPD 858	6.00	6.30	7.00
2SA 841	.20	.27	.30	2SC 1079	3.40	3.55	3.90					AN 2140	1.30	1.70	1.90
2SB				2SC 1096	.45	.55	.60	AN 239	4.20	4.40	4.90	PLL 02A	5.00	5.30	5.90
2SB 22	.30	.35	.40	2SC 1098	.50	.64	.70	AN 247	2.50	2.70	3.00	PLL 03A	7.60	8.00	8.80
2SB 54	.20	.27	.30	2SC 1111	2.10	2.50	2.80	AN 274	1.50	1.75	1.95	DIODES			
2SB 75	.35	.40	.45	2SC 1124	.80	.90	1.00	AN 313	3.00	3.20	3.40	1S 84	.45	.55	.60
2SB 175	.20	.27	.30	2SC 1172B	3.20	3.60	3.95	AN 315	1.80	2.00	2.25	1S 332	.35	.40	.45
2SB 186	.20	.27	.30	2SC 1173	.50	.55	.60	BA 511A	1.80	2.00	2.25	1S 953	.16	.18	.20
2SB 324	.30	.35	.40	2SC 1226	.50	.55	.60	BA 521	1.90	2.10	2.40	1S 1007	.35	.40	.45
2SB 337	.70	.80	.90	2SC 1226A	.50	.55	.60	HA 1151	1.50	1.75	1.95	1S 1209	.35	.40	.45
2SB 405	.30	.35	.40	2SC 1239	2.20	2.70	2.90	HA 1156	1.60	1.80	2.00	1S 1211	.35	.40	.45
2SB 407	.80	.90	1.00	2SC 1306	1.30	1.45	1.60	HA 1306W	2.00	2.20	2.50	1S 1555	.20	.22	.25
2SB 434	.80	.90	1.00	2SC 1307	1.90	2.10	2.40	HA 1322	2.50	2.70	3.00	1S 1588	.20	.22	.25
2SB 435	.90	1.10	1.20	2SC 1318	.35	.40	.45	HA 1339A	2.50	2.70	3.00	1S 1885	.16	.18	.20
2SB 463	.90	1.10	1.20	2SC 1383	.30	.35	.40	HA 1366	2.50	2.70	2.90	1S 2076	.20	.22	.25
2SB 473	.80	.90	1.00	2SC 1384	.35	.40	.45	HA 1366W	2.50	2.70	2.90	1S 2093	.35	.40	.45
2SB 474	.70	.80	.90	2SC 1419	.60	.70	.80	LA 4031P	1.80	2.00	2.25	1S 2473	.16	.18	.20
2SB 492	.60	.70	.80	2SC 1675	.20	.27	.30	LA 4400	1.90	2.10	2.40	1N 34	.12	.13	.15
2SB 507	.80	.90	1.00	2SC 1678	1.10	1.25	1.40	LA 4400Y	2.00	2.20	2.50	1N 60	.12	.13	.15
2SB 528D	.70	.80	.90	2SC 1728	.70	.80	.90	LA 4420	2.00	2.20	2.50	10D 1	.30	.35	.40
2SB 595	1.10	1.40	1.50	2SC 1730	.45	.53	.59	M51513L	2.00	2.20	2.50	10D 10	.45	.55	.60
2SB 596	1.10	1.40	1.50	2SC 1760	.70	.80	.90	STK 011	3.80	4.00	4.40	V06B	.30	.35	.40
2SC				2SC 1816	1.50	1.75	1.95	STK 013	7.60	8.00	8.80	ZENERS			
2SC 281	.30	.35	.40	2SC 1856	.50	.64	.70	STK 015	4.20	4.40	4.90	WZ 071	.20	.22	.25
2SC 372	.20	.27	.30	2SC 1908	.30	.35	.40	STK 435	4.50	5.00	5.60	WZ 075	.20	.22	.25
2SC 373	.20	.27	.30	2SC 1909	1.80	2.00	2.25	TA 7045M	2.00	2.20	2.50	WZ 090	.20	.22	.25
2SC 380	.20	.27	.30	2SC 1945	4.50	5.00	5.60	TA 7060P	.70	.80	.90	WZ 120	.20	.22	.25
2SC 394	.20	.27	.30	2SC 1957	.60	.70	.80	TA 7061P	.90	1.10	1.20	WZ 152	.20	.22	.25
2SC 458	.20	.27	.30	2SC 1970	2.10	2.50	2.80	TA 7062P	1.10	1.25	1.40	MISC.			
2SC 495	.45	.55	.60	2SC 1978	5.40	6.00	6.60	TA 7089P	2.00	2.20	2.50	SG 613	5.20	5.40	5.95
2SC 509	.35	.40	.45	2SC 2028	.50	.64	.70	TA 7202P	2.50	2.70	2.90	78L05	.90	1.00	1.10
2SC 515A	.80	.90	1.00	2SC 2029	1.50	1.80	2.00	TA 7203P	2.50	2.70	2.90	MPS U31	1.50	1.70	1.90
2SC 517	2.50	2.70	3.00	2SC 2076	.50	.64	.70	TA 7204P	2.00	2.20	2.50				
2SC 535	.30	.35	.40	2SC 2091	.90	1.10	1.20								
2SC 634A	.35	.40	.45	2SC 2092	1.80	2.00	2.25								
				2SC 2166	1.40	1.60	1.80								
				2SD											
				2SD 72	50	64	70								

Minimum order \$5.00. Add \$1.00 postage and handling. Ask for our complete price list when ordering. Overseas buyers. Manufacturers. Distributors or Dealer orders welcome. All parts are guaranteed against factory defects for one year. C.O.D. orders are welcome. 48-hour delivery.

ORDER TOLL FREE

EAST

Nationwide 800-543-1607
Ohio 800-582-1630
Mon-Fri 10:00 to 7:00 Saturday 10:00 to 5:00
P.O. Box 40325 • Cincinnati, Ohio 45240

WEST

Nationwide 800-543-1642
California (Call Collect) 213-533-1221
Mon-Fri 9:00 to 5:00 Sat 9:00 to 3:00
P.O. Box 3375 • Torrance, California 90510

Telex: 21-4732
Fuji-Svea[®]

ELECTRONIC SUPERMARKET

Phone Orders:
(617) 532-2323
BA, MC or AE

P.O. BOX 619 — DEPT. R-2 LYNNFIELD, MASS, 01940

ULTRASONIC MOTION DETECTOR



This alarm sensor fills the protected area with an energy screen that cannot be seen, felt or heard. Triggers your alarm whenever burglar moves through detector field. Mounts on ceiling, wall, desk, shelf etc. Optional delay mode, auto reset. Operates on 12.5 VDC. A close-out that originally sold for \$179.00. Sh. Wt. 3 Lbs. Qty. Ltd. Order No. 8030336 **\$49.95**

EQUIPTO SUPER RACK CABINETS

Size: 24" X 24" X 68" with rails on front & back for mounting equipment on 19" centers. No doors or sides. List price \$185.00 — NEW \$100.00. Your cost only \$50.00 each. Qty. Ltd. Frt. Collect. 8820469 **\$50.00**

SPECIAL PRICE!



\$199.88

Phone orders (617) 532-2323 — Use your Charge Card - Visa - MC - AE
TERMS: Add Postage; No C.O.D.'s; \$10.00 Minimum Order

REMOTE CONTROL SYSTEM \$25.00

Brand New! Originally for TV use... You can use it to control stereo on/off, tape on/off, volume & much much more. All are controlled from across the room with a hand held xmitter. For the serious custom designer. Includes: Transmitter, receiver & Miq's schematics. Sh. Wt. 2 lbs. . . 8C30372. . . \$25.00/sets

16/8 WATT STEREO AMP \$5.78



Neat assembled board contains all solid state components & a DARLINGTON drive, push-pull output, all with complementary power tub transistors & mounted to large heat sinks. Accepts input from tape decks, magnetic or ceramic phono cartridges, mikes, etc. Requires a 48V transformer & 1 meg volume control. (not supplied). Output 8 into 8 ohms. (supplied with data). Sh. Wt. 1 Lb. . . 8Y0513 . . . \$5.78
1 Stereo Xformer . . . 8G0530 . . . \$2.88
1 Stereo Pkg — 16 watts W/xformer and controls. Sh. Wt. 4 Lbs. . . 8E0544 . . . \$13.88

KEY-TO-TAPE RECORDER

Singer/Pertec systems w/display station, keyboard, 7-track magnetic data recorder, controller, etc. Read back circuit allows search on record key, editing, duplicating, etc. Units were working when taken out of service & are complete & ready-to-go, but they may require minor adjustment. Sold on an "AS IS" basis only. Data not supplied with this unit, but available separately. Md. 43017 — 7 track Data Recorder. Order No. 75F70296 **\$199.88**
(Unit shipped by truck, freight collect)

DATA PACKAGE 75F70296-M \$28.50

For faster service
USE ZIP CODE
on all mail

PICTURE TUBE MACHINE
We buy and sell NEW and USED CRT rebuilding machinery. COMPLETE TRAINING. Buy with CONFIDENCE from the ORIGINAL MFR.

For complete details send name, address, zip to:

LAKESIDE INDUSTRIES
4071 N. Elston Avenue
Chicago, Ill. 60618
Phone: 312-583-6565

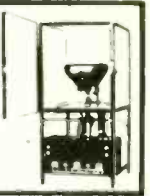

BUSINESS OPPORTUNITIES

MECHANICALLY inclined individuals desiring ownership of Small Electronics Manufacturing Business—without investment. Write: BUSINESSSES, 92-R, Brighton 11th, Brooklyn, NY 11235

CABLE FM station. No experience required, excellent spare-time income, others operate for you. Details free. BROADCASTING, Box 130-F2, Paradise, CA 95969

GET cash commission with each order from friends, neighbors, for America's finest shoes. Easy. Profitable. No experience needed. Selling outfit free! MASON SHOES, K-460, Chippewa Falls, WI 54729

HIGHLY PROFITABLE ONE-MAN ELECTRONIC FACTORY

Investment unnecessary, knowledge not required, sales handled by professionals. Ideal home business. Write today for facts! Postcard will do. Barta-RE- N, Box 248, Walnut Creek, CA 94597.

VINYL's where the money is! Professionally repair, refinish, recolor furniture, luggage, car tops. Quick, easy. Two small \$20 jobs a day earn you \$1000 a month. Homes, cars, offices, restaurants, unlimited customers. Start earning after a few days practice. Sensational details free. VIP, 2013 Montrose, Chicago, IL 60618

CIRCLE 40 ON FREE INFORMATION CARD

BULLET ELECTRONICS

The SE-01 is a kit that contains all the parts needed to build a programmable sound effects generator. Designed around the new Texas Instruments 76447 Sound Chip, the board provides banks of Mini DIP switches and pots to program the various combinations of the SLF Oscillator, VCO, Noise, One Shot and Envelope Controls. Another IC is used to implement an Adjustable Pulse Generator. Level Comparator and Multiplex Oscillator for even more versatility. The 3 1/4" by 5" plated PC Board features a prototype area to allow for user added circuitry. Easily programmed to duplicate Explosions, Phasor Guns, Steam Trains, or an almost infinite number of other sounds, the unit has a multitude of applications. The \$16.95 price includes Assembly Manual, Programming Charts, and 76477 Chip specifications (speaker not included). Available from stock.

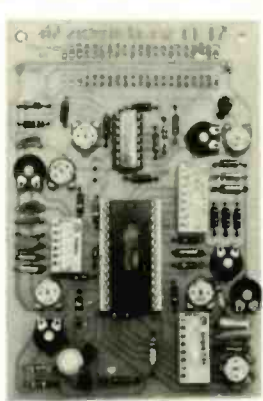

BULLET ELECTRONICS

P.O. BOX 19442 R (214)823-3240
DALLAS, TX. 75219

NO COD'S - ADD 5% FOR SHIPPING ORDERS UNDER \$10.
-SEND CHECK OR MONEY -TEX RESIDENTS ADD 5% TAX ADD .75 FOR HANDLING
ORDER OR CHARGE CARD NO. FOREIGN ORDERS ADD 10%
PHONE ORDERS ACCEPTED ON VISA & MC COPYRIGHT 78

MC1469R POSITIVE VOLTAGE REGULATOR
1/2 AMP COMPLETE SPEED AND APPLICATIONS SHOW HOW TO BUILD FIXED OR VARIABLE POWER SUPPLIES FROM 5 TO 25VDC DRIVE EXTERNAL SERIES PASS FOR CURRENT TO 20 AMPS.
1.25 EA.
18/10 DO
HOUSE #

IL-1 OPTO ISOLATORS
BY LITRONIX & PIN DIP STANDARD PIVOT LED TRANSISTOR COMINATION 50¢
WHILE THEY LAST!

HOUSE # PNP POWER
10-3
100 WATTS @ VDC TO AMPS.
IDENTICAL TO 2ND 1.00

CAPACITORS
SMALL SIZE!
2500 MFD @ 15 VDC RADIAL 3/10
500 MFD @ 35VDC 5/10 ALUM.
350 MFD @ 25VDC 7/10 ALUM.
1 MFD @ 20VDC DISC CERAMIC 15/10
.022 @ 100VDC Mylar 8/1.00
.02 @ 50VDC Mylar 6/1.00
1.5mfd @ 25V Tant Alum 6/1.00
.47mfd @ 35V Tant Alum 6/1.00
2.2mfd @ 25V Tant Alum 5/1.00
22mfd @ 20V Dio Tant 4/1.00
33mfd @ 10V Dio Tant 4/1.00

YOU'VE SEEN IT ON QUALITY STEREO GEAR
SUPER DEAL!
BLACK INSERT BRUSHED CHROME
DPOT Toggle ALCO CB1-022 1A @ 125V
7/8" hole to hole
.49

WIREWRAP Wire
30 Gauge
KYNAR[®] Insulat.
500 FT
4.50

NEW ITEMS:
MVI824 Vancap Diode 10pfd Nom 2:1 Tuning Range 49¢
2N5583 High Freq. Amp 1 Watt @ 1.5 GHz TO-5 Case style, House # 50¢
MFC4000B 1/2 Watt Audio Amp 4 pin plastic pack 50¢
HI10103 100V 3A SCR Ultra sensitive gate drives from TTL TO-220 55¢
HI0355 50V 3A Triac Sensitive Gate TO-5 46¢

MC1351P FM-IF AMP AND DISCRIMINATOR
USED IN FM & TV SOUND CIRCUITS REQUIRES MINI NEW EXTERNAL COMPONENTS 14 PIN DIP DIRECT REPLACEMENT FOR HEPC KING, ECO, 74c and MANY OTHERS' HOUSE # WITH SPECS 50¢

739 FAIRCHILD
EQUAL LOW NOISE AUDIO PRE-AMPLIFIER
89¢ 2/1.69

EMITTER RESISTORS
HARD TO FIND VALUES!
.1 ohm @ 5W
25 ohm @ 5W
YOUR CHOICE... 7/1.00

MPP131 N-CHANNEL DUAL GATE MOSFET
DESIGNED FOR AMPLIFIER AND DRIVER APPLICATIONS TO 200 MHz PLASTIC CASE UNIT, CASE HOUSE NUMBERED WITH SPECS
50¢

FANTASTIC SOUND EFFECTS CHIP
THIS 28 PIN MANTEL CONTAINS A LOW FREQUENCY OSCILLATOR, VCO, NOISE OSCILLATOR, ONE SHOT, MIXER AND ENVELOPE CONTROL, WITH 8 GAGE MANUAL 5 to 3VDC 3.95

25A 100V SCR
1.95
Perfect for battery chargers, switching supplies, crowbars, etc.

FND510 694
COMMON ANODE REDOUT CHARACTER LIMIT 24 PER CUSTOMER!
LED'S: AMBER RED \$1.89 GREEN 4.89
MEDIUM RED .35 MINI GREEN .38 RED .10 YELLOW .16
1.5V @ 10-30 mA

MJ900 - MJ1000
COMPLEMENTARY PNP 800m DARLINGTON POWER TRANSISTORS 8 AMPS WE SUPPLY A SCHEMATIC TO BUILD A HIGH-POWER 350W LOW-DISTORTION AUDIO AMP WITH ONLY ONE ADDITIONAL TRANSISTOR AND A DOZEN INEXPENSIVE COMPONENTS TO-3 CASE STYLE BUY A PAIR FOR **\$3.00!**

ALL COMPONENTS 100% GUARANTEED
C43071 WIDE BAND 4 AMP @ 8000C 50¢
2N2586 SUPP ENCL 1/8 6/1.00
721 OP AMP 8 PIN DIP 5/1.00
723 VOLTAGE REG 14 PIN DIP 50¢
MPS430 NPN HOUSE # 8/1.00
725 OP AMP LOW NOISE HOUSE # 99¢
7815 15V 1A REGULATOR HOUSE # 69¢
2N4343 P CHANNEL J FET 4/1.00
2N4111 PNP MED PWR 40W TO-220 3/1.00
2N829 PROGRAMMABLE UNMARKED TYPN 7800S 50¢
TRIC 200V 5A UNMARKED 3/1.00

Diodes
1N4003 200V 1A 15/1.00
1N4006 800V 1A 12/1.00
1N270 Germanium Diode 8/1.00
1N38A Germanium Diode 10/1.00
1N4148 Cut & Bent for PC Board insertion 100/1.25
UNMARKED POWER DIODES with cathode bands. Guaranteed to be at least 400PIV @ 1A 100% Good parts Epoxy Case 25/1.00

Active Electronic Sales Corp.

Features.....

BRAND NEW!

JUST RELEASED
1979 IC MASTER
2500
pages



Complete Integrated circuit data selector. Master guide to the latest I.C.'s including microprocessors and consumer circuits.

Free Quarterly Updates **\$39.95**

Texas Instruments Low Profile Sockets



Finest Quality Socket available in the world. Nobody can match Texas Instruments quality — a unique combination of I.C. technology and multi-metal expertise.

Over one million pieces in stock.

Contacts	Price	Contacts	Price
8 PIN	.08	22 PIN	.22
14 PIN	.12	24 PIN	.24
16 PIN	.14	28 PIN	.28
18 PIN	.18	40 PIN	.40
20 PIN	.20		



GENERAL INSTRUMENT

1 Amp Rectifiers (Epoxy)

Stock level	Part No.	Price
1 Million	1N4001 50V	.029
6 Million	1N4002 100V	.039
1.4 Million	1N4003 200V	.045
1.9 Million	1N4004 400V	.049
9 Million	1N4005 600V	.055
4 Million	1N4006 800V	.065
1.7 Million	1N4007 1000V	.07

1.5 Amp Single Phase Silicon Bridge Rectifiers

Stock level	Part No.	Price
320000	W06M 600V	.34
110000	W08M 800V	.39

SWITCHING DIODES

Part No.	Price
1N914 (100V 4NS)	.027
1N4148 (100V 4NS)	.027



Zilog

Z80-CTC	\$10.90
Z80A-CTC	\$13.10
Z80-DMA	46.00 \$32.20
Z80-CPU	14.85 \$13.60
Z80A-CPU	23.95 \$16.20
Z80-SIO/0	59.00 \$45.00
Z80A-SIO/0	66.00 \$50.00
Z80-PIO	11.95 \$10.90
Z80A-PIO	11.95 \$13.10
Z80-SIO/1	59.00 \$45.00
Z80A-SIO/1	66.00 \$50.00

CMOS's

GD4000BE 17	CD4042BE 59	CD4515BE \$1.95
CD4001BE 17	CD4043BE 57	CD4516BE 69
CD4002BE 17	CD4044BE 55	CD4518BE 79
CD4003BE 87	CD4045BE 39	CD4519BE 47
CD4007BE 17	CD4049BE 33	CD4520BE 69
CD4008BE 75	CD4050BE 33	CD4522BE 99
CD4009BE 39	CD4051BE 54	CD4526BE 99
CD4010BE 39	CD4052BE 54	CD4527BE \$1.09
CD4011BE 17	CD4053BE 54	CD4528BE 69
CD4012BE 17	CD4060BE 99	CD4531BE 74
CD4013BE 32	CD4066BE 44	CD4532BE \$1.19
CD4014BE 73	CD4068BE 21	CD4539BE 99
CD4015BE 69	CD4069BE 21	CD4543BE \$1.39
CD4016BE 35	CD4070BE 29	CD4555BE 65
CD4017BE 62	CD4071BE 21	CD4556BE 65
CD4018BE 69	CD4072BE 21	CD4581BE \$2.25
CD4019BE 39	CD4073BE 21	CD4582BE 79
CD4020BE 69	CD4075BE 21	CD4584BE 60
CD4021BE 69	CD4076BE 25	CD4585BE 90
CD4022BE 69	CD4077BE 25	40014PC 59
CD4023BE 17	CD4078BE 21	40085PC \$1.09
CD4024BE 49	CD4081BE 21	40097PC 60
CD4025BE 17	CD4082BE 21	40098PC 60
CD4026BE \$1.39	CD4085BE 69	40160PC 89
CD4027BE 39	CD4086BE 69	40161PC 99
CD4028BE 57	CD4093BE 40	40162PC 89
CD4029BE 74	CD4104BE \$2.25	40163PC 99
CD4030BE 35	GD4502BE 85	40174PC 89
CD4033BE \$1.45	GD4508BE \$2.25	40175PC 89
CD4034BE \$2.25	CD4510BE 88	40192PC \$1.19
CD4035BE 64	CD4511BE 99	40193PC \$1.19
CD4040BE 74	CD4512BE 59	40194PC \$1.10
CD4041BE 74	CD4514BE \$1.95	40195PC \$1.10

MICROPROCESSOR

CHIPS CPU's

Stock level	Part No.	Price
4600	8080A	5.95 5.50
16000	6800	8.95 7.95

INTERFACE SUPPORT CIRCUITS

Stock level	Part No.	Price
4000	8212	1.98
1400	8214	4.95 3.95
2800	8216	1.98
1500	8224	2.75
4000	8226	1.98
1700	8228	4.75
700	8238	4.75
5800	8251	5.95 4.95
550	8253	14.95
11000	8255	5.95
400	8257	9.95
800	8259	14.95

3300	6810	3.95 3.50
2200	6820	4.95 3.95
4200	6821	4.95 3.95
3000	6850	5.95 4.95
1200	6852	5.95 4.95

LINEAR I.C.'S

LM324N	.49	Quad Op Amp
LM339N	.49	Quad Comparator
LM555N-8	.29	Timer
LM556N-14	.59	Dual Timer
LM723CN	.34	Voltage Regulator
LM723CH	.39	Voltage Regulator
LM741CH	.37	Op Amp
LM741CN-8	.24	Op Amp
LM1458N-8	.39	Dual Op Amp

VOLTAGE REGULATORS

PART NO.	UNIT PRICE	DESCRIPTION
LM323K	\$5.50	3 Amp 5 Volt Regulator
78H05KC	\$5.75	5 Amp 5 Volt Positive Regulator TO3
7800UC Series TO-220/ILM340T	.79	Positive Voltage Regulators (Plastic) 1 Amp 5, 6, 8, 12, 15, 18, 24 Volts
78MOHC Series TO-5/ILM340H	\$1.50	Positive Voltage Regulator 1/2 Amp 5, 6, 8, 12, 15, 18, 24 Volts
7800KC Series TO-3/ILM340K	\$1.60	Positive Voltage Regulator 1 Amp 5, 6, 8, 12, 15, 18, 24 Volts
78L00AWC Series TO-92	.29	Positive Voltage Regulator 100 MA 2.6, 5, 6.2, 8.2, 12, 15 Volts
7900UC Series TO-220/ILM320T	\$1.10	Negative Voltage Regulator 1 Amp 5, 6, 8, 12, 15, 18, 24 Volts
79M00HC Series TO-5/ILM320H	\$1.50	Negative Voltage Regulator 1/2 Amp 5, 6, 8, 12, 15, 18, 24 Volts
7900KC Series TO-3/ILM320K	\$1.95	Negative Voltage Regulator 1 Amp 5, 6, 8, 12, 15, 18, 24 Volts
78MG72C	\$1.25	Dual In Line Adjustable 4 Terminal Positive Voltage Regulator
78GUI TO-220	\$1.45	1 Amp Adjustable Positive Voltage Regulator
78S40PC	\$2.50	Switching Regulator

All new major manufacturer production material offered. Largest variety of device types available anywhere.

MOS Static RAM's

Stock level	Part No.	Price
11400	2114	\$7.50
	4K (1K x 4) 300NS	
74000	2102LFPC	\$1.19
	1K 350NS (Low Power)	
19700	2114	\$6.95
	4K (1K x 4) 450NS	

MOS Dynamic RAM's

Stock level	Part No.	Price
16000	4K 4027	\$2.95
	4K (4K x 1) 300NS 16 PIN	
21500	416-3	\$9.95
	200NS	
93000	416-5	\$7.95
	300NS	

UART's

Stock level	Part No.	Price
44000	AY5-1013A	\$4.95
3800	AY3-1015	\$5.95

1K CMOS RAM

Stock level	Part No.	Price
21400	5101	\$4.95
	450NS (Low Power)	



Active Electronic Sales Corp.

P.O. BOX 1035 FRAMINGHAM, MASSACHUSETTS 01701

Over-the-counter sales,
12 Mercar Rd., Natick, Mass 01760
Behind Zayres on Rt. 9
Telephone Orders & Enquiries (617) 879-0077

IN CANADA 3 LOCATIONS

5651 FERRIER ST.
MONTREAL, QUEBEC
H4P 2K5
Tel: (514) 735-6425

4800 DUFFERIN ST.
DOWNSVIEW, ONTARIO
M3H 5S9
Tel: (416) 681-1115

MINIMUM ORDER \$10.00 • ADD \$2.00 TO COVER POSTAGE & HANDLING

Foreign customers please remit payment on an international bank draft or international postal money order in American dollars.

BAXTER CENTRE
1050 BAXTER ROAD
OTTAWA, ONTARIO
K2C 3P2
Tel: (613) 820-9471



Radio Shack: No. 1 Parts Place

Low Prices and New Items Everyday!

Top-quality devices, fully functional, carefully inspected. Guaranteed to meet all specifications, both electrically and mechanically. All are made by well-known American manufacturers, and all have to pass manufacturer's quality control procedures. These are not rejects, not fallouts, not seconds. In fact, there are none better on the market! Always count on Radio Shack for the finest quality electronic parts!

TTL and CMOS Logic ICs

Full-Spec Devices
Direct from
Motorola and
National Semiconductor



Type	Cat. No.	ONLY
7400	276-1801	35¢
7402	276-1811	39¢
7404	276-1802	35¢
7406	276-1821	49¢
7410	276-1807	39¢
7413	276-1815	79¢
7420	276-1809	39¢
7427	276-1823	49¢
7432	276-1824	49¢
7441	276-1804	99¢
7447	276-1805	99¢
7448	276-1816	99¢
7451	276-1825	39¢
7473	276-1803	49¢
7474	276-1818	49¢
7475	276-1806	79¢
7476	276-1813	59¢
7485	276-1826	1.19
7486	276-1827	49¢
7490	276-1808	79¢
7492	276-1819	69¢
74123	276-1817	99¢
74145	276-1828	1.19
74150	276-1829	1.39
74154	276-1834	1.29
74192	276-1831	1.19
74193	276-1820	1.19
74194	276-1832	1.19
74196	276-1833	1.29
4001	276-2401	49¢
4011	276-2411	49¢
4012	276-2412	69¢
4013	276-2413	89¢
4017	276-2417	1.49
4020	276-2420	1.49
4021	276-2421	1.49
4023	276-2423	69¢
4027	276-2427	89¢
4028	276-2428	1.29
4046	276-2446	1.69
4049	276-2449	69¢
4050	276-2450	69¢
4051	276-2451	1.49
4066	276-2466	99¢
4070	276-2470	69¢
4511	276-2447	1.69
4518	276-2490	1.49
4543	276-2491	1.89

SN-76477 Sound/Music Synthesizer IC

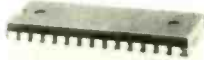

2.99 Featured In Oct. Popular Electronics

Creates almost any type of sound — music to "gunshots"! Built-in audio amp. Includes 2 VCO's. LF osc., noise gen., filter, 2 mixers, envelope modulator, logic circuit. 28-pin DIP. With data/applications circuits. 276-1765 2.99

Analog Audio Delay IC MN 3002



10.95

For Phase-Shifter, Reverb & Delay Circuits

"Bucket Brigade" device uses 512 shift registers to provide a continuously variable electronic delay for complex audio signals. Includes data sheet and applications circuits. 276-1760 10.95

Heat Sinks

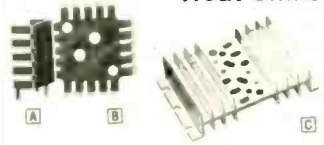

A TO-220. For PC board-mounted power semiconductors in TO-220 cases. Anodized aluminum.

B 276-1363 79¢
C TO-3 Sink. For PC or chassis mtg. 276-1364 1.39
Universal. Mounts 2 devices, accepts 9 case styles. 276-1361 2.69

Top-Quality IC and PCB Accessories

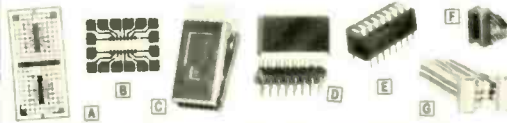

A PC Board. Mounts two 14 or 16-pin ICs or sockets for bread boarding. Copper clad 2 1/2 x 5 x 1 1/8" 276-151 2.99
B PC Board. Mounts single 14 or 16-pin IC or socket. 276-024 Pkg. of 2/99¢
C 16-Pin IC Test Clip. 276-1951 3.99
D 16-Pin DIP Header. With snap-on cover 276-1980 1.29
E 8-Rocker 16-Pin DIP Switch. 276-1301 1.99
F Vertical 16-pin Socket. For LED displays 276-1986 1.49
G 16-Pin DIP Jumper Cable. 18" long. 276-1976 3.99

Project Boxes

Aluminum Cover

The popular, low-cost way to house your electronic experiments.



3 1/4 x 2 1/4 x 1 1/4" 270-230 1.19
4 x 2 1/4 x 2 1/4" 270-231 1.29
5 1/8 x 2 1/4 x 1 1/4" 270-233 1.49
6 x 3 3/4 x 2" 270-627 1.79
7 x 4 x 2 x 2 1/4" 270-232 2.49

Miniature Hobby Motors



High-torque permanent magnet type. 1/16" dia. shaft.
A 12VDC, 350mA. 2x13/16" 273-210 69¢
B 6.9VDC, 500mA. 1 1/8 x 3/4" 273-209 Pkg. of 2/99¢

PC Potentiometers

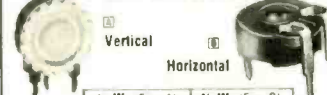

Ohms	1/8" W. (Fig. A)		1/4" W. (Fig. B)	
	Cat. No.	Eq.	Cat. No.	Eq.
500k	271-220	49¢	—	—
1k	271-227	49¢	271-333	39¢
5k	271-217	49¢	—	—
10k	271-216	49¢	271-335	39¢
25k	—	—	271-336	39¢
50k	271-219	49¢	—	—
100k	271-220	49¢	271-338	39¢
500k	271-221	49¢	—	—
1 Meg	271-220	49¢	—	—

Switches



A Miniature Toggle. 6A @ 125VAC SPDT. 275-662 2.49
DPDT. 275-663 2.89
DPDT. Center-Off. 275-664 2.99
B Momentary SPST. 275-609 1.89
C Momentary SPDT. 275-1549 1.99
D SPST Mercury. 275-027 99¢

Molded Connectors

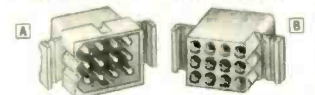

Molded nylon body. Each circuit rated 8A @ 250V. Standard .093" pin diameter.
A 4-Pin Male. 274-224 99¢
6-Pin Male. 274-226 1.19
9-Pin Male. 274-229 1.39
12-Pin Male. 274-232 1.49
B 4-Pin Female. 274-234 99¢
6-Pin Female. 274-236 1.19
9-Pin Female. 274-239 1.39
12-Pin Female. 274-242 1.49
2-Pin Male & Female. (Not Shown.) 274-222 Pair 89¢

8080A Microprocessor and Support Chips

New — 100% Prime
SALE



All With Full Data and Specs

8080A Microprocessor. 2 μs cycle time. 276-2510. Reg. \$12.95 Sale 9.95
8201B Bus Driver. 8-bit bidirectional. 276-2508. Reg. \$3.95 Sale 4.95
8154 128x8-Bit RAM I/O. 40-pin DIP. 276-2511. Reg. \$9.95 Sale 7.95
8212 I/O Port. Data latch and buffer. 276-2512. Reg. \$4.95 Sale 3.95
8224 Clock and Generator Driver. 276-2524. Reg. \$3.95 Sale 2.95
8228 System Controller and Bus Driver. 276-2528. Reg. \$6.95 Sale 5.95
8251 Programmable Communication Interface. 276-2551. Reg. \$9.95 Sale 7.95
8255 Programmable Peripheral Interface. 276-2555. Reg. \$9.95 Sale 7.95

RAM Memory ICs

Under 450 nS Access Time

2102 1024 x 1 Array. Low-cost static memory chip. 16-pin DIP. Buy 8 and Save!
276-2501 2.49 Ea. or 8/14.95
2114L 1024 x 4 Array. NMOS static RAM. 18-pin DIP.
276-2504. Reg. \$12.95 Sale 10.95

IC Breadboard Sockets



Modular boards snap together and feature standard 0.3" center. Accept 22 through 30-gauge solid hookup wire.
A 550 connections in 2 bus strips of 40 tie points each with 47 rows of 5 connected tie points. 2 1/2 x 6" 276-174 9.95
B 270 connections in 2 bus strips of 40 tie points each with 23 rows of 5 connected tie points. 2 1/2 x 3 3/4" 276-175 5.95
C Mini-Socket. 22 rows of 5 tie points each, plus 2 bus strips with 10 connections each. 2 1/2 x 1 1/8" 276-176. Reg. \$3.95 Sale 2.99

Solar Cells



4cm x 2cm Silicon Cell

Silicon-type cell converts light to electrical power, delivering up to 100 mA at 0.5V. Use several in series-parallel for higher voltage or current.
276-120 2.99

Electricity from Light



2 1/4" Dia. Silicon Cell

Highly efficient! Delivers up to 400 mA at 0.5V. Ideal for solar power projects, battery charging and operating electronic equipment.
276-121 5.99

Computer Data Manuals and Semiconductor Handbook



A Intel® 8080/8085 Programming Manual. Handy reference for programming with Intel's assembly language. 62-1377 3.95
B Intel Memory Design Handbook. Explains use of Intel's memory components and support circuits in systems. 62-1378 3.95
C Intel Data Catalog. 928 pages of specifications on most of Intel's standard microcomputer-related products. 62-1379 4.95
D Semiconductor Reference and Application Handbook. Complete specs and applications for popular IC transistors, diodes. 276-4002 1.95

Low-Cost Plug-In PC Boards



For 22-pin connectors. 4 1/2 x 4 1/8" grid. 3 styles available.
Standard. 276-152 3.49
Digital. 276-154 3.49
Op-Amp. 276-153 3.49
22-Pin Dual Connector. 276-1551 2.99

WHY WAIT FOR MAIL ORDER DELIVERY?
IN STOCK NOW AT OUR STORE NEAR YOU!

Prices may vary at individual stores and dealers

Radio Shack®

A DIVISION OF TANDY CORPORATION • FORT WORTH, TEXAS 76102
OVER 7000 LOCATIONS IN NINE COUNTRIES

THE MOST ADVANCED TIMEPIECE OF ITS KIND IN THE WORLD!

LCD Quartz Alarm Chronograph with calendar and dual time zone!! Watch is the same as Selko but you pay a lot more for the name! Features:



- * 24 hour alarm
- * Chronograph counts up to 12 hrs., 59 mins. 59.9 sec.
- * Precision of chrono up to 1/10 sec indicated by 10 moving arrows!!
- * Lap time (with chrono running uninterrupted)
- * Time displays by LCD for hour, min, sec, day, date of the week and AM/PM.
- * Calendar gives out date/day
- * Dual time zone for any two cities of the world at your own choice.
- * With light switch to allow you to see the time in the dark!

\$65.50

ONE YEAR FULL WARRANTY!



It is a multi-plug extension cord for 110V AC Maximum 12 plugs **\$3.50 EA.**

Mount This Side Up. Insert Plug Prongs Here

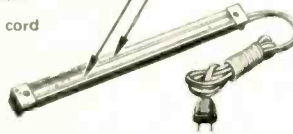

3-579 MHz
Color TV Crystal



ON SALE **\$1.25 EA.**
10 for \$11.00

6V 2AMP Rechargeable Battery



for moped, backup light system, alarm system, CB or other purpose. All brand new, never charged!
SPECIAL PRICE \$4.25 EA

WHAT A SAFE WAY TO SHOOT!

Electronic shooting game for all ages. Target uses photo electric cell and pistol shoots light beams.

Range approx. 10 ft. and target makes sound. Not a kit! Battery not included.
\$13.50 per set



SANYO HYBRID

Audio power amplifiers I.C. Max. hi-fi output power, minimum ext. components needed.



15 Watts	STK-028	\$ 8.50
23 Watts	STK-054	\$13.50
30 Watts	STK-056	\$17.50
50 Watts	STK-050	\$26.50
10W + 10W (stereo)	STK-040	\$14.50
15W + 15W (stereo)	STK-041	\$25.50
20W + 20W (stereo)	STK-043	\$31.50

*data sheet comes with purchase

JUMBO 1" LED ALARM CLOCK MODULE

- Assembled - not a kit!
- Features:
- * 1" 4 digits red LED display
 - * 12 hours real time format
 - * 24 hours alarm audio output (just add speaker)
 - * Power failure indicator
 - * Count down timer 59 mins.
 - * 12-16V AC 50/60 Hz input
 - * 10 min. snooze control



\$8.50 EACH

FCM 701

Transformer **\$1.75**

THE MOST POPULAR MM5314 CLOCK KIT

- Features:
- * 12/24 Hours Display
 - * 50/60 Hz Input
 - * 6 Digits Bright Orange Readouts



Kit includes plastic case, MM 5314 I.C. One set transistor drivers, P.C. Board, gas discharge displays, all other electronic parts and transformer. Catalog no. DC-8SP

SPECIAL PRICE \$17.95 PER KIT

NEW MARK III 9 Steps 4 Colors LED VU



Stereo level indicator kit with arc-shape display panel!! This Mark III LED level indicator is a new design PC board with an arc-shape 4 colors LED display (change color from red, yellow, green and the peak output indicated by rose red). The power range is very large, from -30dB to +5dB. The Mark III indicator is applicable to 1 watt - 200 watts amplifier operating voltage is 3V - 9V DC at max 400 MA. The circuit uses 10 LEDs per channel. It is very easy to connect to the amplifier. Just hook up with the speaker output!

IN KIT FORM \$17.50

9 STEPS LED LEVEL INDICATOR KIT



for most stereo amplifiers
This new project works as a pair of VU meter to indicate the output level of your amplifier from -20dB to +3dB. Kit includes all LED, transistors, electronic components, P.C. Board and instructions.

Easy to build and fun to see.
ONLY \$12.50 EA.

ELECTRONIC DUAL SPEAKER PROTECTOR

Cut off when circuit is shorted or overload to protect your amplifier as well as your speakers. A must for DCL circuits.



KIT FORM **\$8.75 EA.**

It is not a pack of cigarettes. It is a new FM wireless mic kit! New design PC board fits into a plastic cigarette box. (case included) Uses a condenser microphone to allow you to have a better response in sound pick-up. Transmits up to 350 ft! With an LED indicator to signal the unit is on.



KIT FORM **\$7.95**

AN AIR HORN!

Good for anything needing sound. This is not electronic, but we bought them with some other deals. They are all brand new in boxes. **\$2.50 EA.**



60W + 60W STEREO AMPLIFIER



COMPLETED UNIT - NOT A KIT!

OCL pre amp. & power stereo amp. with bass, middle, treble 3-way tone control. Fully assembled and tested, ready to work. Total harmonic distortion less than 0.5% at full power. Output maximum is 60 watts per channel at 8Ω. Power supply is 24 - 36V AC or DC. Complete unit

*Kit form **\$37.50** Assembled **\$49.50 ea.**
Power transformer **\$ 8.50 ea.**

22W + 22W STEREO HYBRID AMPLIFIER KIT

It Works in 12V D.C. As Well! Kit includes 1 PC SANYO STK-024 stereo power amp. IC LM 1458 as pre amp, all other electronic parts, PC Board, all control pots and special heat sink for hybrid. Power transformer not included. It produces ultra hi-fi output up to 44 watts (22 watts per channel) yet gives out less than 0.1% total harmonic distortion between 100Mz and 10KHz.
\$32.50 PER KIT

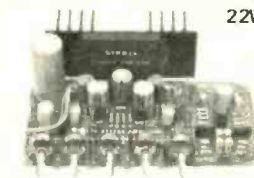

POWER TRANSFORMER **\$6.50 EACH**

COMPUTER GRADE CAPACITORS



All capacitors are Brand New U.S. made in standard size

6000MFD 50V	\$2.60 EA.
9000MFD 50V	\$3.25 EA.
11000MFD 35V	\$3.20 EA.
14500MFD 40V	\$3.40 EA.
23000MFD 20V	\$3.00 EA.
58000MFD 20V	\$3.20 EA.
100,000MFD 6V	\$2.50 EA.

DIP SWITCHES



(On-Off Contacts)	
4 positions	\$1.50
5 positions	\$1.60
6 positions	\$1.70
7 positions	\$1.70
8 positions	\$1.80
10 positions	\$2.00

ELECTRONIC WHEEL OF FORTUNE KIT!

With 10 numbers split into black and white on dial. The LED turns when you hit the play switch, then it slows down and stops on one number. It sounds like a motor inside, but there is none. Lots of fun and easy to build. Kit comes with nice looking case, all electronic parts, P.C. Board and LEDs. Battery not included. **\$12.50**



SUPER 15 WATT AUDIO AMP KIT



ONLY \$23.50 each

Uses STK-015 Hybrid Power Amp
Kit Includes: STK-015 Hybrid IC, power supply with power transformer, front Amp with tone control, all electronic parts as well as PC Board. Less than 0.5% harmonic distortion at full power 1/2dB response from 20-100,000 Hz. This amplifier has QUASI-Complimentary class B output. Output max is watt (10 watt RMS) at 4Ω.

63 KEYS ASC 11 DECODED COMPLETE KEYBOARD

by Honeywell

with dual color key tops, uses TMS 5000 decoder LSI. (Schematic data included)



SPECIAL \$56.50 NOT A KIT!

PROFESSIONAL CASE

for our 0-30V Power Supply. It is a nice looking metal cast case with giant 4" volt/amp meter; output binding post and fuse holder, on/off switch and line cord!
ONLY \$21.50 EA.



CASE 030

MANY SOUND DECISIONS!

Solid state sound Indicator operating voltage 6V DC 30μA. Small size approximately 1/4" X 1 1/4".

Model EB2116 (Continuous)
Model EB2126 (Slow Pulse)
Model EB2136 (Fast Pulse)



\$3.60 EACH



Slow Pulse



Fast Pulse

1Watt AUDIO AMP

All parts are pre assembled on a mini PC Board
Supply Voltage 6-9V D.C.
SPECIAL PRICE \$1.95 ea.



"FISHER" 30 WATT STEREO AMP

MAIN AMP (15W X 2)

Kit includes 2 pcs. Fisher PA 301 Hybrid IC all electronic parts with PC Board. Power supply: 16V DC (not included). Power Band with (KF 1% ± 3dB). Voltage gain 33dB. 20Hz - 20KHz.

Super Buy Only \$18.50



5W AUDIO AMP KIT

2 LM 380 with Volume Control

Power Supply 6-18V D.C.

only \$5.00 ea.



TIMER KIT

Time Controlled from 1-100sec.

Ideal to be used as timer delay unit for burglar alarm, photo service, and other purposes.
Max. loading 110V, 2 AMP.
Supply voltage 12-18V D.C.
\$11.50 each



FT-10 ELECTRONIC IC TIMER

ELECTRONIC ALARM SIREN

COMPLETE UNIT

Ideal for use as an Alarm Unit or hookup to your car back up to make a reverse indicator.
Light Output up to 130dB
Voltage Supply 6-12V **\$7.50**

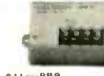

AU-999

SOUND ACTIVATED SWITCH

All parts completed on a PC Board
SCR will turn on relay. Buzzer or trigger other circuit for 2-10 sec. (adjustable)
Ideal for use as door alarm, sound controlled toys and many other projects.
Supply voltage 4.5V-9V D.C.
\$1.75 ea./2 for \$3.00



LINEAR SLIDE POT 500KΩ SINGLE

Metal Case 3" Long

2 FOR \$1.20



DIGITAL ELECTRONIC LOCK KIT

for auto ignition, entry door, burglar alarm, etc.
\$6.50 ea. 4 Digits Programmable to CMOS I.C. Any Combination IN CIRCUIT



400R RELAY AND KEY PAD NOT INCLUDED

BATTERY POWERED FLUORESCENT LANTERN

FEATURES

- Circuitry designed for operation by high efficient, high power silicon transistor which enable illumination maintain in a standard level even the battery supply drops to a certain low voltage.
- 9" 6W cool/daylight miniature fluorescent tube.
- 6 X 1.5V UM-1 (size D) dry cell battery.
- Easy sliding door for changing batteries.
- Stainless reflector with wide angle increasing illumination of the lantern.



\$9.60 EACH MODEL 888-R

FM WIRELESS MIC KIT



\$6.95 EACH KIT

This new model FM wireless MIC kit uses 3 high freq. transistors, works in the FM range (88-108 MHz). It transmits the sound wave fidelity clearly over long distances (up to 250 ft.). Kit comes with all electronic parts, P.C. Board and mini microphone!

WE FOUND THE CASE FOR THE FM MIC!! Small nice looking aluminum case size like a pack of cigarettes. It is an intercom. Audio amp inside with a mic jack, a mini toggle sw on top, can be used for many projects. We give you the circuit data as well.
VERY SPECIAL PRICE 2 for \$4.99



Sub-Mini Size Condenser Microphone

\$2.50 each
FET Transistor Built-In



FLUORESCENT LIGHT DRIVER KIT

12V DC POWERED

Lights up 8-15 Watt Fluorescent Light Tubes
Ideal for camper, outdoor Auto or Boat

Kit includes high voltage coil, power transistor, heat sink, all other electronic parts and PC Board, light tube not included!
ONLY \$5.50 PER KIT



POWER SUPPLY KIT

0-30V D.C. REGULATED

Uses UA723 and 2N3055 Power TR output can be adjusted from 0-30V, 2 AMP. Complete with PC board and all electronic parts.

0-30 POWER SUPPLY **\$10.50 each**

Transformer for Power Supply, 2 AMP 24V X 2 \$6.50
30V DC Panel Meter \$4.20



12V DC MINI RELAY

P.C. Board Solder Type

2AMP Contact SPDT \$1.30 EA
2AMP Contact DPDT \$1.75 EA
5AMP Contact 4PDT \$2.70 EA



12V D.C. AUTO DIGITAL CLOCK

Complete Unit

Not a Kit!



0.4" blue color 4 digits display. Turn off readouts when car is not running. X'ral controlled time base for time accuracy. Special designed case for easy mounting on top of your dashboard. Ideal for car boat and campers.
SALE! ONLY \$7.80 ea. \$24.50

ELECTRONIC SWITCH KIT

CONDENSER TYPE

Touch On Touch Off uses 7473 I.C. and 12V relay
\$5.50 each



AUTO ALARM KIT



The Crimefighter Auto Alarm is an electronic, self-controlled auto protection system, normally mounted within the glove box of an automobile. Two minutes after turning off the ignition, the alarm automatically turns itself "on". When auto is re-entered, the horn will sound after a 10-45 second entry delay. The automobile owner, by inserting the ignition key, will activate the alarm. Once activated, the alarm will sound for two minutes before automatically turning off. The alarm then resets and is ready to again protect the vehicle from unwanted entry.

FEATURES: Simple installation: 5 wires. Automatically turns on when auto is parked. Adjustable entry time. Extended exit time to allow for unobstructed exit from vehicle. Numerous applications include protection of boats, campers, trailers, motorcycles, trucks. Cannot be deactivated by "hot wiring" an auto. Cannot be turned off without ignition key. Negative ground only.

ONLY \$14.00 PER KIT



AA SIZE NiCD BATTERY
6 in a pack 1.2V
X 61 500 MA/HR
\$4.80 PER PACK

BRAND NEW EVEREADY CH15 AA size Ni-CD 500 MA/HR. 4 for \$5.50
Only limited quantity available

Sub Mini Size PANEL METER 500 U.A.
ONLY \$1.20 ea

PANEL METER (D.C. Type)
Size 60MM X 66MM
White Face Type
\$5.50 ea. 0-50 U.A. 0-30V
0-1MA 0-50V
0-5MA 0-100V
0-100MA

TRANSFORMERS

ALL 117 VOLT INPUT

30V	4AMP	\$7.50 EA.
36V CT	3AMP	\$6.50 EA.
48V CT	3AMP	\$6.50 EA.
24V CT	3AMP	\$6.50 EA.
24V CT	0.8AMP	\$1.80 EA.
12V CT	0.8AMP	\$1.80 EA.
12V CT	120MA	\$1.25 EA.

AC POWER SUPPLY

Wall Type Transformer

12V AC	Output	200MA	\$2.75 EA.
16V CT AC	Output	100MA	\$2.10 EA.
16V DC	Output	120MA	\$1.90 EA.
12V DC	Output	100MA	\$1.90 EA.

WIDE ANGLE PANEL METER

1 1/4" x 1 1/4"
IMA Full Scale (scale marks 0-100)
\$1.50 each

HOUR INDICATOR

This unit is 1 5/8" long operating voltage 4V D.C. will tell you how many hours your circuit of machine has been in service up to 100 hours.
Limited Quantity **ONLY \$1.75 ea.**

HEAVY DUTY CLIP LEADS

10 pairs - 5 colors
Alligator clips on a 22" long lead. Ideal for any testing.
\$1.85/pack

MINI-SIZED I.C. AM RADIO

Size smaller than a box of matches!
Receives all AM stations
Batteries and ear phone included
Only \$8.50



MINI-MINI TOGGLE SWITCH

Half size of standard toggle switch rated 3 amp 125V AC contact 1-9 10-99
MS 244 SPDT 1.00 0.90
MS 245 DPDT 1.20 1.10
LARGE QUANTITY AVAILABLE FOR OEM

SUBMINIATURES TOGGLE SWITCHES

SPDT	On/Off	\$1.30 ea
DPDT	On/Off	\$1.50 ea
3PDT	On/Off	\$1.75 ea

Mini size Rocker Type
Also available at the same price

MINI SIZE REED RELAY

Approx. 1" square
SPST Normal Open Contact rated 1 AMP
Coil 6-12V DC
All brand new by AMF
3 for \$2.00

PUSH-BUTTON SWITCH

N/Open Contact
Color: Red, White, Blue, Green, Black. 4/\$1.00
N/Close also
Available \$0.25 ea.
LARGE QTY. AVAILABLE

SOLID STATE ELECTRONIC BUZZER

Mini size 1" x 3/4" x 1/4"
Supply voltage 1.5V
Ideal for Alarm or Tone Indicator
\$1.50 each

MINIMUM ORDER \$10.00. California residents add 6% sales tax and 10% shipping. Out of state add 15% of total purchase for shipping charges, out of USA and Overseas add 25% of total purchase. **12/78**
SEND CHECK OR MONEY ORDER TO:



FORMULA INTERNATIONAL INC.

12603 CRENSHAW BOULEVARD • HAWTHORNE, CALIFORNIA 90250

For more information please call (213) 973-1921, (213) 679-5162

STORE HOURS 10-7 Monday - Saturday

SEND \$1.00 FOR DETAILED CATALOG



PASS FCC EXAMS

The Original FCC Test Answers exam manual that prepares you at home for FCC First and Second class Radiotelephone licenses. Newly revised multiple choice exams cover all areas tested on the actual FCC exam. Plus "Self Study Ability Test." Proven! \$9.95 postpaid. Moneyback Guarantee.



COMMIND PRODUCTIONS
Radio Engineering Division

P.O. Box 20348-C
San Francisco, CA 94128

TELEPHONE bugged? Don't be Watergated! Countermeasures brochure \$1.00. NEGEYE LABORATORIES, Box 547-RE, Pennsboro, WV 26415

UNIVERSITY degrees by mail Bachelors, Masters, Ph'D's... Free revealing details. COUNSELLING, Box 317-RE2, Tustin, CA 92680

ASTONISH your friends with magic, E.S.P., card tricks you can do. Details: LANGEN, Box 191-CA, Downsview, Ont, M3M 3A3

GOVERNMENT SURPLUS

JEEPS — \$59.30! — cars — \$33.50! — 450,000 items! Government surplus—most comprehensive directory available tells how, where to buy—your area—\$2.00—moneyback guarantee—**GOVERNMENT INFORMATION SERVICES**, Department VA—2, Box 99249, San Francisco, CA 94109

MANUALS for Govt. surplus radios, test sets, scopes. List 50¢ (coin). BOOKS, 7218 Roanoke Drive, Washington, DC 20021

WANTED

MAJOR NY publisher has immediate opening for freelance acquiring editor electronic handbooks, troubleshooting manuals, texts. Qualified candidate should have successful publishing record, good leads to other tech writers, heavy publication/copy editing experience. Reply: 118 Concord Ave., Oceanside, NY 11572

FREE SHORTWAVE CATALOG



NEWEST EDITION—ONE-STOP SHOPPING FOR SWLS
• RECEIVERS special DX mods • ANTENNAS
• PRESELECTORS • TUNERS • CALIBRATORS
• CLOCKS • HEADPHONES • BOOKS • LOGS
GILFER SHORTWAVE
Dept. RE-2, Box 239, Park Ridge NJ 07656

DELTA saves you \$\$ in electronics

Capehart RP-1000 Stereo System **\$30 Off**



FM
AM

LESS THAN WHOLESALE!!!

The RP-1000 system consists of an AM/FM stereo radio-phonograph, TWO twin dual cone speakers in molded enclosures (to make a 4-way speaker system), phono dust cover, 45 rpm adapter and a headphone jack. The RP-1000 is rated at 50 watts AM, 535 to 1665 KHz, and FM, 87 to 108 MHz. All our brand new in original factory cartons and are complete with a factory 90-day warranty. The original retail was \$99.95.

Delta #5664R
\$69.95
ORIGINAL RETAIL \$99.95
Phono Stereo

Currently sold at \$85
Bodine Motors



Bodine NC-1282-120V, 54 sq. in. Motor speed 1400-1700rpm. 1/2 MFD capacitor, evnt. duty torque 5.7 lb-in. Shaft speed 1730rpm. For horizontal use. 4 1/2 tapped holes in face of gear motor. Shaft is 3/8 dia & 1" long. Current net price is \$24. We include capacitor #5570R. Each

MINI-DIPPED TANTALUM CAPACITORS

Delta No.	Value	Price
2758R	.001mf @ 50V	4 for \$1.00
2760R	.002mf @ 100V	4 for \$1.00
2761R	.01 mf @ 50V	3 for \$1.00
2764R	0.1 mf @ 35V	3 for \$1.00
2759R	0.1 mf @ 50V	5 for \$1.50
2770R	2.2 mf @ 35V	5 for \$1.50
2765R	3.3 mf @ 16V	3 for \$1.00
2766R	3.9 mf @ 16V	3 for \$1.00
2767R	22 mf @ 16V	5 for \$1.50
2757R	22 mf @ 35V	5 for \$2.00

These capacitors in limited quantities!

DOES YOUR SMALL PROJECT NEED A POWER SUPPLY

We've obtained a limited quantity of SONY SWITCHING POWER SUPPLIES AT a ridiculous price! This power supply is the "State of the Art" for greater efficiency, smaller size & weight. They are rated at 25V or 28V @ 1 amp, and are removed from new TV sets. With a little ingenuity and a "do-it-yourself" kit from Delta you can build 3 very valuable supplies in 50V @ 1A, +12V @ 500 ma, or 5.0V @ 500 ma & +12V @ 250 ma. Note: These supplies are great for small projects using TTL or DTP Amps.

Delta No.	Description	500 ma	2 For
5646R	26V or 28V @ 1.0A	\$15.00	
5647R	5.0V @ 1.0A	8.95	17.00
5648R	+12V @ 500 ma	9.95	19.00
5649R	5.0V @ ma & +12V @ 250 ma	10.95	21.00

DELTA Burglar ALARM

When there is a new development in electronics, it takes some time before that development is available to hobbyists and experimenters, especially at surplus prices. This time we have reversed the trend, and announce a DELTA EXCLUSIVE: the DELTA MOTION DETECTOR. This device detects any motion or movement for a minimum distance of 8-ft. The secret is in the ultra complex custom LSI chip, which combines the latest in linear & digital circuitry. The device is completely self-contained, in a case 6 x 3 x 2 1/2", and operate from four "AA" NiCad batteries. Nothing else is needed, for the device to perform its basic function, motion detection. When motion or movement is detected, a "whoop" alarm is sounded. The MOTION DETECTOR is designed to provide either an audible or silent alarm. The silent alarm is controlled by a timer, which delays the alarm up to 30 seconds. The silent alarm activates a relay, whose contacts are brought out to plug, and will activate ANY device, such as siren, horn, tape recorder, telephone dialer, etc.

The Motion Detector works on a CHANGE OF LIGHT. Any change of 5% or more, triggers the detector. Works within a range of 0.1 candlepower (almost dark) to 100 candlepower, (bright, brittle, a range of 1000 to 1. NO external light source is needed.

When left in a darkened or semi-darkened room, the Motion Detector acts as a fantastic FIRE ALARM. The light from a single match, anywhere in the room, triggers the alarm, so that the device becomes an intrusion alarm and fire alarm, all in one.

Delta No.	Description	Sale
5611R	Complete motion detector kit (less batteries)	\$24.50
1072R	Motion Detector Chip only, with data	8.95
5611R	P.C. boards, set of 2	6.50
5636R	Battery charger for above	5.95
5635R	Completely assembled kit, w/batteries & charger	69.50

FREE 1-YR. SUBSCRIPTION TO DELTA'S 'SURPLUS NEWSPAPER' PLUS FREE 120-PG. CATALOG

DELTA ELECTRONIC HOBBIES
5151 BUFORD HWY. DORAVILLE, ATLANTA, GA.

MONSANTO MAN 6640

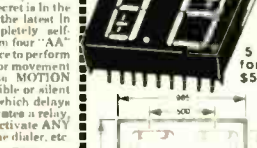

Dual Digit Readout
\$5 for \$5

DELTA ELECTRONICS
P.O. BOX 2, DEPT. 2R
7 OAKLAND ST.,
AMESBURY, MASS.
01913
TEL. (617) 388-4705

Give to the college of your choice.

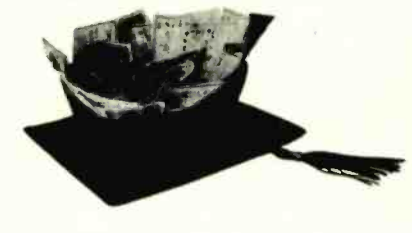

YOU'RE UNDER SURVEILLANCE!!

A HOST OF PEOPLE, AGENCIES, AND COMPUTERS ARE BUSY SPYING ON YOU AND YOUR BUSINESS EVERY DAY, OFTEN ILLEGALLY...

HOW TO STOP IT OR DO IT BACK!

THE BIG BROTHER GAME

A Large Format (8 1/2" x 11") Quality Paperback, 240 Pages

\$9.95

BUGGING
WIRETAPPING
TAILING
OPTICAL AND
ELECTRONIC SURVEILLANCE
SURREPTITIOUS ENTRY
DETECTIVE TECHNIQUES
WEAPONS
COUNTERMEASURES

"A VIRTUAL ENCYCLOPEDIA ON SURVEILLANCE... EVERYTHING YOU'VE ALWAYS WANTED TO KNOW ABOUT SPYING."

PLAYBOY MAGAZINE

With Each Order You Receive Free Other Material And Literature For Investigative Procedure... Depending on luck for success is like fishing without bait

QUIMTRONIX
Postpaid—P.O. Box 548-RE
Seattle, Washington 98111

CIRCLE 8 ON FREE INFORMATION CARD



FREQUENCY COUNTER KIT

Outstanding Performance

Incredible Price

\$89⁹⁵

CT-50

The CT-50 is a versatile and precision frequency counter which will measure frequencies to 60 MHz and up to 600 MHz with the CT-600 option. Large Scale Integration, CMOS circuitry and solid state display technology have enabled this counter to match performance found in units selling for over three times as much. Low power consumption (typically 300-400 ma) makes the CT-50 ideal for portable battery operation. Features of the CT-50 include: large 8 digit LED display, RF shielded all metal case, easy pushbutton operation, automatic decimal point, fully socketed IC chips and input protection to 50 volts to insure against accidental burnout or overload. And, the best feature of all is the easy assembly. Clear, step by step instructions guide you to a finished unit you can rely on. **Order your today!**

CT-50, 60 MHz counter kit
 CT-50WT, 60 MHz counter, wired and tested
 CT-600, 600 MHz scaler option, add

\$89.95

\$159.95

\$29.95

CB-1, Color TV calibrator-stabilizer

DP-1, DC probe, general purpose probe

HP-1, High impedance probe, non-loadin

\$14.95

\$12.95

\$15.95

SPECIFICATIONS:

Frequency range: 6 Hz to 65 MHz, 600 MHz with CT-600
 Resolution: 10 Hz @ 0.1 sec gate, 1 Hz @ 1 sec gate
 Readout: 8 digit, 0.4" high LED, direct readout in mHz
 Accuracy: adjustable to 0.5 ppm
 Stability: 2.0 ppm over 10 to 40° C, temperature compensated
 Input: BNC, 1 megohm, 20 pF direct, 50 ohm with CT-600
 Overload: 50VAC maximum, all modes
 Sensitivity: less than 25 mv to 65 MHz, 50-150 mv to 600 MHz
 Power: 110 VAC 5 Watts or 12 VDC @ 400 ma
 Size: 5" x 4" x 2", high quality aluminum case, 2 lbs
 ICS: 13 units, all socketed.

CAR CLOCK



The UN-KIT, only 5 solder connections

Here's a super looking, rugged and accurate auto clock which is a snap to build and install. Clock movement is completely assembled—you only solder 3 wires and 2 switches, takes about 15 minutes! Display is bright green with automatic brightness control photocell—assures you of a highly readable display, day or night. Comes in a satin finish anodized aluminum case which can be attached 5 different ways using 2 sided tape. Choice of silver, black or gold case (specify)

DC-3 kit, 12 hour format **\$22.95**
 DC-3 wired and tested **\$29.95**
 110V AC adapter **\$5.95**

Under dash car clock



12/24 hour clock in a beautiful plastic case features: 6 jumbo RED LEDs, high accuracy (1min/mo), easy 3 wire hookup, display blanks with ignition, and super instructions. Optional dimmer automatically adjusts display to ambient light level

DC-11 clock with mtg. bracket **\$27.95**
 DM-1 dimmer adapter **2.50**

PRESCALER



Extend the range of your counter to 600 MHz Works with any counter. Includes 2 transistor pre-amp to give super sens., typically 20 mv at 150 MHz. Specify +10 or +100 ratio.

PS-1B, 600 MHz prescaler **\$59.95**
 PS-1BK, 600 MHz prescaler kit **49.95**

OP-AMP SPECIAL

741 mini dip **12/\$2.00**
 B1-FET, mini dip, 741 type **10/\$2.00**

VIDEO TERMINAL

A completely self-contained, stand alone video terminal card. Requires only an ASCII keyboard and TV set to become a complete terminal unit. Two units available, common features are: single 5V supply, XTAL controlled sync and baud rates (to 9600), complete computer and keyboard control of cursor, Parity error control and display. Accepts and generates serial ASCII plus parallel keyboard input. The 3216 is 32 char. by 16 lines, 2 pages with memory dump feature. The 6416 is 64 char. by 16 lines, with scrolling, upper and lower case (optional) and has RS-232 and 20ma loop Interfaces on board. Kits include sockets and complete documentation

RE 3216, terminal card **\$149.95**
 RE 6416, terminal card **189.95**
 Lower Case option, 6416 only **13.95**
 Power Supply Kit **14.95**
 Video/RF Modulator, VD-1 **6.95**
 Assembled, tested units, add **60.00**

CALENDAR ALARM CLOCK

The clock that's got it all! 6-5" LEDs, 12/24 hour, snooze, 24 hour alarm, 4 year calendar, battery backup, and lots more! The super 7001 chip is used. Size: 5x4x2 inches. Complete kit, less case (not available) **\$34.95**

30 Watt 2 mtr PWR AMP

Simple Class C power amp features 8 times power gain. 1 W in for 8 out, 2 in for 15 out, 4 W in for 30 out. Max. output of 35 W, incredible value, complete with all parts, less case and T-R relay

PA-1, 30 W pwr amp kit **\$22.95**
 TR-1, RF sensed T-R relay kit **6.95**

FM MINI MIKE KIT



A super high performance FM wireless mike kit! Transmits a stable signal up to 300 yards with exceptional audio quality by means of its built in electret mike. Kit includes case, mike, on-off switch, antenna, battery and super instructions. This is the finest unit available.

FM-3 kit **\$12.95**
 FM-3 wired and tested **16.95**

CLOCK KITS



our Best Seller
 your Best Deal

Try your hand at building the finest looking clock on the market. Its satin finish anodized aluminum case looks great anywhere, while six 4" LED digits provide a highly readable display. This is a complete kit, no extras needed, and it only takes 1-2 hours to assemble. Your choice of case colors: silver, gold, bronze, black, blue (specify).
 Clock kit, 12/24 hour, DC-5 **\$22.95**
 Clock with 10 min. ID timer, 12/24 hour, DC-10 **27.95**
 Alarm clock, 12 hour only, DC-8 **24.95**
 12V DC car clock, DC-7 **27.95**
 For wired and tested clocks add \$10.00 to kit price.

Hard to find PARTS

LINEAR ICs		REGULATORS	
301	\$.35	78MG	\$1.25
324	1.50	723	.50
380	1.25	309K	.85
380-8	.75	7805	.85
555	.45	78L05	.25
556	.85	7905	1.25
566	1.15	7812	.85
567	1.25	7912	1.25
1458	.50	7815	.85
3900	.50	TTL ICs	
CMOS ICs		74503	.35
4011	.20	7447	.65
4013	.35	7475	.50
4046	1.85	7490	.50
4049	.40	74196TI	1.35
4518	1.25	SPECIAL ICs	
5368	1.75	11C90	33.50
TRANSISTORS		10116	1.25
2N3904 type	10/1.00	4511	2.00
2N3906 type	10/1.00	5314	2.95
NPN 30W Pwr	3/1.00	5375AB	2.95
PNP 30W Pwr	3/2.00	7001	6.50
2N3055	.60	4059+N	9.00
UJT 2N2646 type	3/2.00	7208	17.95
FET MPF102 type	3/2.00	LEDs	
UMF 2N5179 type	3/2.00	Jumbo red	8/1.00
MRF-238 RF	11.95	Jumbo green	6/1.00
SOCKETS		Jumbo yellow	6/1.00
8 pin	10/2.00	Mini red	8/1.00
14 pin	10/2.00	Micro red	8/1.00
24 pin	10/2.00	BIPOlar	.75
24 pin	4/2.00	FERRITE BEADS	
28 pin	4/2.00	With info. specs	15/1.00
40 pin	3/2.00	6 hole balun	5/1.00

Ramsey's famous MINI-KITS

FM WIRELESS MIKE KIT

Transmits up to 300' to any FM broadcast radio, uses any type of mike. Runs on 3 to 9V. Type FM-2 has added sensitive mike preamp stage.

FM-1 kit **\$2.95** FM-2 kit **\$4.95**

VIDEO MODULATOR KIT

Converts any TV to video monitor. Super stable, tunable over ch 4-6. Runs on 5-15V, accepts std. video signal. Best unit on the market!

Complete kit, VD-1 **\$6.95**

SUPER SLEUTH

A super sensitive amplifier which will pick up a pin drop at 15 feet! Great for monitoring baby's room or as general purpose amplifier. Full 2 W rms output, runs on 6 to 15 volts, uses 8-45 ohm speaker.

Complete kit, BN-9 **\$5.95**

COLOR ORGAN/MUSIC LIGHTS

See music come alive! 3 different lights flicker with music. One light for lows, one for the mid-range and one for the highs. Each channel individually adjustable, and drives up to 300W. Great for parties, band music, nite clubs and more.

Complete kit, ML-1 **\$7.95**

tone DECODER

A complete tone decoder on a single PC board. Features 400-5000 Hz adjustable range via 20 turn pot, voltage regulation, 567 IC. Useful for touch-tone decoding, tone burst detection, FSK, etc. Can also be used as a stable tone encoder. Runs on 5 to 12 volts.

Complete kit, TD-1 **\$5.95**

POWER SUPPLY KIT

Complete triple regulated power supply provides variable 6 to 18 volts at 200 ma and +5V at 1 Amp. Excellent load regulation, good filtering and small size. Less transformers, requires 6.3V @ 1 A and 24 VCT.

Complete kit, PS-3LT **\$6.95**

LED Blinky KIT

A great attention getter which alternately flashes 2 jumbo LEDs. Use for name badges, buttons, warning panel lights, anything! Runs on 3 to 15 volts.

Complete kit, BL-1 **\$2.95**

WHISPER LIGHT KIT

An interesting kit, small mike picks up sounds and converts them to light. The louder the sound the brighter the light. Completely self-contained, includes mike, runs on 110VAC, controls up to 300 watts.

Complete kit, WL-1 **\$6.95**

SIREN KIT

Produces upward and downward wail characteristic of a police siren. 5W peak audio output, runs on 3-15 volts, uses 3-45 ohm speaker.

Complete kit, SM-3 **\$2.95**

ramsey electronics

BOX 4072, ROCHESTER, N.Y. 14610

PHONE ORDERS CALL
 (716) 271-6487



TERMS: Satisfaction guaranteed or money refunded. COD, add \$1.50. Minimum order, \$6.00. Orders under \$10.00, add \$75. Add 5% for postage, insurance, handling. Overseas, add 15%. NY residents, add 7% tax.

SURPLUS SPECTACULAR!

2 METER MOBILE ANTENNA

\$12.95

BRAND NEW FACTORY BOXED ANTENNAS MADE BY WELL KNOWN TOP LINE MFR. FOR POLICE AND GOVT. AGENCIES. ORIGINAL COST IN HUGE QUANTITIES WAS TWICE OUR LOW PRICE.

Plus \$1 Shipping

FEATURES: -HIGHEST QUALITY; DESIGNED FOR USE WITH STATE & COUNTY POLICE VEHICLES. MOLDED FIBREGLASS HELICALLY WOUND WHIP (FLOURESCENT ORANGE), HEAVILY PLATED PARTS, SEALED MATCHING TRANSFORMER.
-SINGLE HOLE MOUNT (1/2" DIA) WITH ALL MOUNTING HARDWARE INCLUDING TRIM RINGS AND RUBBER SEALS. ALSO WORKS WITH MOST "CLAMP TYPE" ADAPTERS.
-TUNES FROM 140-176 MHz -- WHIP CUTTING CHART SHOWS WHIP LENGTH VS FREQUENCY. CUT FOR 2M HAM BAND, FIRE & POLICE BANDS (FOR SCANNERS) OR EVEN USE IN THE MARINE BAND!
-COMPLETE WITH ALL PARTS - WHIP, LOADING COIL (TRANSFORMER), HARDWARE, COAX (RG58A/U), PL259 CONNECTOR, AND COMPLETE INSTALLATION AND TUNING INSTRUCTIONS.

DOES IT GET OUT ? YOU BET !! 5/8 WAVE VERTICALS ARE MOST WIDELY USED IN COMMERCIAL AND 2 METER FM WORK BECAUSE OF THE LOW RADIATION ANGLE AND CONSIDERABLE GAIN OVER SHORTER VERTICAL WHIPS. BANDWIDTH IS GOOD, RESULTING IN LOWER SWR OVER A WIDER FREQUENCY RANGE. A LESSER DEPENDENCE ON A GROUND PLANE MEANS EASIER MOUNTING IN MANY CASES. (THESE ANTENNAS WERE USED ON POLICE MOTORCYCLES WITH EXCELLENT RESULTS -- ON GROUND PLANE ?) GIVE THEM A GOOD GROUND PLANE (LIKE A CAR ROOF) AND THEY'RE NEARLY UNBEATABLE !

LIMITED QUANTITIES

WHIP LENGTH (in) VS FREQ (MHz)

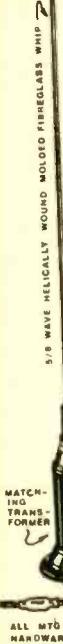
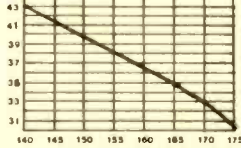

MATCHING TRANSFORMER
ALL STD HARDWARE

LASER POWER SUPPLIES

COMMERCIAL QUALITY SUPPLIES FEATURE 120 VAC INPUT, RECTIFIED AND FILTERED DC OUTPUT! THESE NEW UNITS ORIGINALLY COST THE MFR ABOUT \$30 EACH IN BIG QUANTITIES. USE FOR LASERS, BUG ZAPPERS, HIGH VOLTAGE EXPERIMENTS OF ALL SORTS. SUPPLIES ARE POTTED IN PLASTIC WITH THE RECTIFIERS ACCESSIBLE THROUGH A REMOVABLE PLATE.

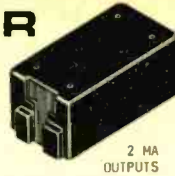

2 MA OUTPUTS
12.500 Vdc
25 Watts L-1250
\$7.95 Plus \$2 Shp.
(They are HEAVY!)

7.500 Vdc
15 Watts L-750
\$6.95 Plus \$1.40 shipping



CRYSTALS

HC-6 case
tune w/18pf
FRESH STOCK I

3.579 MHz \$125
4.000 MHz \$150
4.194 MHz \$150



BEZELS

NEW. EASY MOUNT
RED LENS BLACK FRAME VIEWING AREA D.8" N. A WIDTH GIVEN.

J-1200 2" Wide \$1.79
J-1300 3" Wide \$2.29
J-1400 4" Wide \$2.98

"OUR FIFTH YEAR"
DIAMONDBACK
ELECTRONICS COMPANY
PO BOX 194
SPRING VALLEY, IL 61362

... FREE CATALOG ...
ALL MERCHANDISE 100% GUARANTEED
MINIMUM ORDER \$5
ALL RESIDENTS ADD 5% SALES TAX
PLEASE INCLUDE SUFFICIENT POSTAGE
RATES QUOTED ARE CONTINENTAL US ONLY
PHONE ORDERS 815/664-5151

CIRCLE 70 ON FREE INFORMATION CARD

YOUR SCOPE OR COUNTER/TIMER CAN INSTANTLY MAKE PRECISE CAPACITANCE MEASUREMENTS WITH THE ...



The C-PROBE is a precision test instrument using the latest CMOS IC technology to transform a capacitor's value into something your scope or counter/timer already understands ... DIGITAL PULSES. The C-PROBE replaces the usual probe and causes a direct readout of a capacitor's value from 1 pF to over 10,000 Mfd. on the scope or C/T.

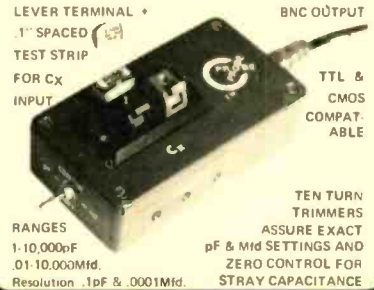

ACTUAL COUNTER/TIMER & SCOPE DISPLAYS W/C PROBE

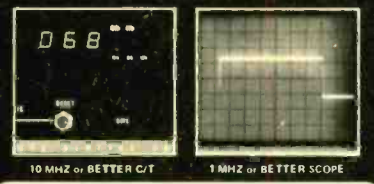

SHIPPED WITHIN 10 DAYS OF ORDER/ FULLY CALIBRATED & WITH 100 HOUR, EASILY REPLACEABLE BATTERY

Box 3751
Thousand Oaks, CA 91359
805/496-7673
INTERNATIONAL INSTRUMENTATION, INC.
(Dealer enquiries welcome)
C-PROBES @ \$49.95 Each
CALIBRATION CAPACITORS
pF RANGE @ \$1.14 Each
Mfd RANGE @ \$1.49 Each
SHIPPING & HANDLING
USA \$2.00 EUROPE \$4.50
CA 6% SALES TAX

CIRCLE 24 ON FREE INFORMATION CARD

Original Japanese Replacement Parts for TV, Stereo and CB

25-UP 10-24 1-9			25-UP 10-24 1-9			25-UP 10-24 1-9			25-UP 10-24 1-9			25-UP 10-24 1-9			25-UP 10-24 1-9								
2SA102	.29	.34	.39	2SC460	.45	.50	.55	2SC1114	3.40	3.60	3.80	2SC2072	3.55	3.75	3.95	AN247P	2.40	2.60	2.90	TA7089P	1.95	2.15	2.45
2SA473	.45	.55	.60	2SC481	1.25	1.35	1.45	2SC1116A	3.20	3.45	3.80	2SC2076	.45	.60	.65	AN247A	1.50	1.70	1.90	TA7092	4.40	4.90	5.40
2SA484	1.85	2.05	2.35	2SC482	1.25	1.35	1.45	2SC1124	.80	.85	.95	2SC2091	.85	1.05	1.15	AN313	4.20	4.40	4.60	TA7120P	1.45	1.65	1.85
2SA495	.25	.30	.35	2SC485	1.25	1.35	1.45	2SC1127	.80	.85	.95	2SC2092	1.75	1.95	2.20	BA511A	1.70	1.90	2.15	TA7139P	1.55	1.75	1.95
2SA497	.90	1.15	1.25	2SC495	.45	.55	.60	2SC1162	.70	.75	.85	2SC2098	3.00	3.20	3.45	BA521	1.85	2.05	2.35	TA7153P	5.70	6.30	6.10
2SA509	.30	.35	.40	2SC509	.30	.40	.45	2SC1166	.25	.35	.40	2SD72	.50	.60	.65	HA1511	1.45	1.70	1.85	TA7203P	2.45	2.60	2.85
2SA562	.25	.30	.35	2SC517	2.90	3.10	3.25	2SC1172B	3.10	3.50	3.85	2SD91	1.30	1.40	1.55	HA1156	1.60	1.75	1.95	TA7204P	1.95	2.10	2.45
2SA564A	.25	.34	.39	2SC535	.30	.35	.40	2SC1173	.50	.65	.70	2SD92	1.40	1.55	1.75	HA1306W	1.90	2.10	2.40	TA7205P	1.55	1.75	1.95
2SA534	.35	.40	.45	2SC620	.45	.50	.55	2SC1177	10.90	12.40	13.80	2SD180	1.55	1.75	1.95	HA1332	2.40	2.60	2.90	TA7310P	1.25	1.40	1.55
2SA636	.80	.85	.90	2SC632A	.35	.40	.45	2SC1209	.25	.35	.40	2SD187	.30	.40	.45	HA1339	2.45	2.65	2.95	TA7607P	5.80	6.00	6.20
2SA643	.30	.35	.40	2SC634A	.40	.45	.50	2SC1226	.50	.60	.70	2SD218	2.95	3.20	3.45	HA1339A	2.45	2.65	2.95	TA7609P	4.40	4.60	4.80
2SA673	.30	.40	.45	2SC697A	3.20	3.50	3.90	2SC1226A	.50	.60	.70	2SD234	.60	.70	.80	LA1222	2.10	2.30	2.50	TC5080P	4.80	5.00	5.60
2SA678	.40	.50	.55	2SC710	.20	.27	.30	2SC1237	1.70	1.90	2.15	2SD235	.60	.70	.80	LA3101	3.45	3.60	3.75	TC5081P	2.90	3.10	3.30
2SA683	.40	.50	.55	2SC711	.20	.27	.30	2SC1239	2.10	2.65	2.85	2SD261	.30	.35	.40	LA4031P	1.75	1.95	2.20	TC5082P	3.30	3.45	3.80
2SA684	.40	.50	.55	2SC712	.20	.27	.30	2SC1306	1.25	1.65	1.95	2SD267	2.50	2.65	2.85	LA4032P	1.75	1.95	2.20	UHC0002	4.90	5.10	5.60
2SA695	.40	.50	.55	2SC717	.35	.40	.45	2SC1307	2.15	2.65	2.85	2SD291	2.05	2.45	2.75	LA4220	2.25	2.40	2.55	UHC0003	4.90	5.10	5.60
2SA699A	.50	.60	.65	2SC730	2.95	3.15	3.35	2SC1318	.30	.40	.45	2SD313	.60	.65	.70	LA4400	1.85	2.05	2.35	UHC0004	4.90	5.10	5.60
2SA706	.85	.95	1.05	2SC732	.20	.25	.30	2SC1364	.30	.40	.45	2SD315	.60	.70	.80	LD3141	1.70	1.80	1.90	UHC0005	4.90	5.10	5.60
2SA720	.30	.35	.40	2SC733	.20	.25	.30	2SC1383	.30	.40	.45	2SD325	.60	.65	.75	MS115P	4.85	4.90	4.95	UHC0006	4.90	5.10	5.60
2SA733	.25	.27	.30	2SC734	.20	.25	.30	2SC1384	.30	.40	.45	2SD330	.60	.70	.80	MS1513L	1.95	2.15	2.45	UHC0007	4.90	5.10	5.60
2SA747	4.15	4.35	4.85	2SC735	.20	.25	.30	2SC1424	2.75	2.85	2.95	2SD358	7.0	7.5	8.0	MN3001	13.20	14.85	16.50	UHC0008	2.00	2.40	2.70
2SB22	.45	.50	.55	2SC756	1.45	1.75	1.95	2SC1448A	1.00	1.10	1.20	2SD359	7.0	8.0	9.0	MN3002	9.25	10.40	11.55	UHC0009	4.90	5.10	5.60
2SB54	.30	.35	.40	2SC756A	2.00	2.10	2.20	2SC1475	.65	.85	.95	2SD367	.75	.85	.95	MN3003	5.64	6.34	7.04	UHC0010	2.00	2.40	2.70
2SB77	.30	.40	.45	2SC778	2.80	3.10	3.30	2SC1509	.55	.60	.65	2SD427	1.75	1.95	2.20	PL101A	4.00	4.15	4.65	UHC0011	4.90	5.10	5.60
2SB175	.35	.40	.45	2SC781	1.95	2.15	2.45	2SC1567A	.60	.65	.75	2SD525	.60	.70	.80	PL102A	4.95	5.20	5.80	UHC0012	4.90	5.10	5.60
2SB186	.20	.27	.30	2SC784	.30	.35	.40	2SC1675	.25	.30	.35	2SD526	.60	.70	.80	PL103A	7.50	7.90	8.70	UHC0013	4.90	5.10	5.60
2SB187	.30	.40	.45	2SC789	.75	.85	.95	2SC1678	1.25	1.40	1.55	2SK19	.45	.50	.55	SG264A	7.00	7.40	7.80	UHC0014	2.52	2.74	2.98
2SB324	.25	.35	.40	2SC793	1.95	2.15	2.45	2SC1687	.40	.45	.50	2SK23	.80	.95	1.05	SG609	4.10	4.30	4.50	UHC0015	1.70	1.85	2.10
2SB367	1.10	1.20	1.35	2SC799	1.95	2.15	2.45	2SC1727	1.20	1.25	1.30	2SK30	.40	.45	.50	SG613	5.05	5.45	5.85	UHC0016	1.70	1.85	2.10
2SB405	.25	.30	.35	2SC829	.20	.27	.30	2SC1728	.90	.95	1.00	2SK33	.60	.65	.75	SM5104	7.90	8.40	8.90	UHC0017	2.00	2.15	2.35
2SB407	.70	.85	.95	2SC829	.20	.27	.30	2SC1775	.30	.35	.40	2SK41	.50	.55	.60	STK011	3.55	3.95	4.35	UHC0018	2.52	2.74	2.98
2SB463	1.00	1.05	1.15	2SC833	.30	.35	.40	2SC1816	1.45	1.70	1.95	2SK45	.60	.65	.75	STK013	8.90	10.00	11.10	UHC0019	1.70	1.85	2.10
2SB474	.70	.80	.90	2SC867A	4.00	4.25	4.50	2SC1817	1.45	1.70	1.95	2SK55	.60	.65	.75	STK015	4.10	4.30	4.80	UHC0020	1.70	1.85	2.10
2SB507	.70	.80	.90	2SC900	.20	.27	.30	2SC1908	.25	.35	.40	3SK22Y	1.60	1.70	1.80	STK050	23.10	25.98	28.86	UHC0021	1.85	2.05	2.35
2SB511	.70	.75	.85	2SC930	.20	.27	.30	2SC1909	2.00	2.55	2.75	3SK31	1.20	1.35	1.50	STK415	7.10	7.60	8.10	UHC0022	1.85	2.05	2.35
2SB557	2.05	2.45	2.75	2SC945	.20	.27	.30	2SC1945	4.40	4.90	5.50	3SK37	1.70	2.00	2.30	STK435	4.45	4.95	5.55	UHC0023	1.80	1.95	2.20
2SC183	.40	.50	.55	2SC1000BL	.35	.40	.45	2SC1957	.60	.70	.80	3SK40	1.25	1.40	1.65	STK439	8.00	9.00	10.00	UHC0024	1.80	1.95	2.20
2SC184	.40	.50	.55	2SC1013	.45	.60	.65	2SC1969	3.50	3.90	4.30	3SK41	1.25	1.40	1.65	TA7045M	1.95	2.15	2.45	UHC0025	1.80	1.95	2.20
2SC372	.20	.27	.30	2SC1014	.50	.60	.65	2SC1973	.60	.65	.70	3SK45	1.25	1.40	1.65	TA7055P	1.95	2.15	2.45	UHC0026	1.80	1.95	2.20
2SC373	.20	.27	.30	2SC1018	.70	.75	.85	2SC1974	1.25	1.65	1.85	3SK48	3.30	3.40	3.70	TA7061P	.85	1.05	1.15	UHC0027	1.80	1.95	2.20
2SC3d0	.20	.27	.30	2SC1030	1.80	2.05	2.35	2SC1975	1.25	1.65	1.85	3SK49	1.25	1.40	1.65	TA7062P	1.05	1.20	1.35	UHC0028	7.90	8.30	9.40
2SC382	.30	.40	.45	2SC1056	4.50	4.70	4.90	2SC2009	.70	.80	.85	AN115	2.00	2.15	2.25	TA7063P	1.25	1.35	1.50	UHC0029	7.90	8.30	9.40
2SC387A	.30	.40	.45	2SC1060	.65	.75	.85	2SC2021	.55	.60	.65	AN228	1.55										

30 MHZ LOW COST FREQUENCY COUNTER KIT

- Features:**
- Frequency Range—100Hz to 30MHz min., resolution 100 Hz
 - All TTL Circuitry—No tears in the eyes when replacing IC's
 - FET Input Stage—Offers high input impedance
 - High Sensitivity—15mV typical
 - Xytal Time Base—0.001% 10MHz for better accuracy
 - On Board Regulator—No external power supply needed
 - All IC's Socketed—Easy to service
 - Easy to Operate—No switches to flip
 - Tin Plated & Screened Board—For easy assembly

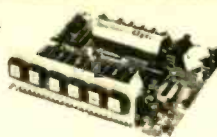

COMPARE and SAVE!

\$54.95

KEY # T-380-30A

KIT INCLUDES: Detailed Instructions (22 pages), All parts including transformer (case not available).

OUR BEST SELLER

5V 10A POWER SUPPLY KIT

Includes: Extra large heat sink, power transistor, ICP regulator, P.C. board with OVP.

Kit No. T-500 \$14.95

With optional rectifiers and filtering cap. \$17.95

2-20V ADJ. POWER SUPPLY KIT INCLUDES: Transformer, P.C. Board, Large heat sink, Large filtering capacitor and all the parts with detailed instructions. KIT # 14M \$12.95

Car Battery Eliminator

KIT INCLUDES: Transformer, PC Board, Large heat sink, Large filtering capacitor

KIT#700 \$16.95

0.8" 4 Digit Jumbo Display Alarm Clock Kit

Features:

- A. Fairchild 0.8" FSC8000 Display Array
- B. Fairchild Super-Chip - F-3817PC
- C. P.C. Board, Transformer, Speaker and all parts included (less case)

D. Detailed Instructions \$19.50

Plastic Molded Instrument Case

H—2 7/16" 3 1/16" W—8 1/2" D—9 1/4"

Adjustable heights to accommodate most needs. Available in tan & gray.

Model #CH-200 \$19.50

Instrument Case for Kit

H—2 1/2" W—6 1/16" D—6 1/4"

Ideal for many smaller projects. Similar to CH-200 less handle.

CM-6-225 \$9.40

6-DIGIT AUTO CLOCK KIT WITH ALARM

Features:

- A. Fairchild 0.5" FND 500 Series Display
- B. Display Board may be removed
- C. X'tal time base
- D. P.C. Boards, speaker, IC's and all parts.
- E. Detailed Instructions

KEY # T-1302

\$19.95

Z-80 CPU BOARD/KIT

On board 2708 EPROM addressable to any 4K boundary above 32K, Power-on-jump to any 4K boundary above 32K, or the on board 2708. On board run-stop flip-flop and optional generation of Memory Write allow front panel-less operation.

BARE BOARD \$34.00

\$130.00 (2M1Z) \$145.00 (4MHZ)

ASSEMBLED & TESTED ADD \$50.00

I.C. SOCKETS

Lo-pro		Wire Wrap	
8-pin	5 pcs 10 pcs 100 pcs	5 pcs 10 pcs 100 pcs	
14-pin	0.80 1.50 12.00	1.90 3.50 32.00	
16-pin	0.95 1.75 15.00	2.10 3.90 36.00	
18-pin	1.05 2.00 17.00	2.50 4.20 39.00	
20-pin	1.40 2.50 23.00	3.20 6.00 55.00	
22-pin	1.60 3.10 28.00	3.50 6.50 60.00	
24-pin	1.80 3.40 32.00	3.75 7.00 65.00	
24-pin	1.85 3.50 33.00	4.25 8.00 75.00	
28-pin	2.20 4.20 39.00	4.75 9.00 85.00	
40-pin	3.50 6.20 59.00	6.50 12.00 100.00	

HAMMOND BREADBOARD KIT

BIMBOARD 1 \$9.95 ea.

Accepts DIP packages without adaptors or damaging component leads.

Contacts are double sided, nickel silver, current carrying capacity of 1 Amp with less than 10 milliohms contact resistance.

Total of 550 sockets identified by a letter and number matrix for recording experiments

Bus strip section runs up each side of board.

Component bracket (included with each board) will fit on any of the four edges or down the center.

BIMBOARD 2 \$23.95

2 Bimboards and 2 component brackets

1 Aluminum base with 4 insulated Terminals

BIMBOARD 3 \$34.95

3 Bimboards and 3 component brackets

1 Aluminum base with 4 insulated terminals.

BIMBOARD 4 \$43.

4 Bimboards and 4 component brackets

1 Aluminum base with 4 insulated terminals.

FULLY ENCODED 74-key keyboard

manufactured by Micro Switch for Honeywell (Limited Qty) \$50.00 ea

PRECUT WIRE WRAP WIRE

30 Kynar in red, orange, blue, yellow, green, black, white.

Pre-stripped both end.

	100	500	1000	5000
2 1/2 in.	.78	2.40	4.30/K	3.89/K
3 in.	.82	2.60	4.71/K	4.22/K
3 1/2 in.	.86	2.80	5.12/K	4.55/K
4 in.	.90	3.00	5.52/K	4.88/K
4 1/2 in.	.94	3.21	5.93/K	5.21/K
5 in.	.98	3.42	6.34/K	5.52/K
5 1/2 in.	1.02	3.65	6.75/K	5.86/K
6 in.	1.06	3.85	7.16/K	6.19/K
6 1/2 in.	1.15	4.05	7.57/K	6.52/K
7 in.	1.20	4.25	7.98/K	6.85/K
7 1/2 in.	1.25	4.45	8.39/K	7.18/K
8 in.	1.29	4.65	8.80/K	7.53/K
8 1/2 in.	1.32	4.85	9.21/K	7.84/K
9 in.	1.36	5.05	9.62/K	8.17/K
9 1/2 in.	1.40	5.25	10.03/K	8.50/K
10 in.	1.45	5.51	10.44/K	8.83/K
Add in	10	.41	82/K	66/K

BARE BOARD \$34.00

\$130.00 (2M1Z) \$145.00 (4MHZ)

ASSEMBLED & TESTED ADD \$50.00

8080 A CPU BOARD/KIT

With 8 level vector interrupt, CPU chip 8080 clock chip 8224, crystal Gen. 18MHz; vector interrupt chip 8214.

BARE BOARD \$28.50 KIT \$95.00

Assembled and Tested \$145.00

REAL TIME CLOCK FOR S-100 BUSS

On board 1MHz Crystal Oscillator; two independent Interrupts 16 bit counter in 10 s steps; and decade steps from 100 s to 10 sec.

Kit #120 Assemble & Tested \$179.95

BARE BOARD \$24.00

8K STATIC RAM

Kit #	6501	7001	2501
	\$129.95	\$139.95	\$169.95

ASSEMBLED/TESTED ADD \$25.00 Bareboard \$25.00

16K STATIC RAM KIT \$375

BOARD \$24.00 ASSEMBLE/TEST \$425.00

32K STATIC RAM

BARE BOARD \$35.00

KIT ASSEMBLE/TESTED

250ns \$795.00 \$875.00

450ns \$625.00 \$775.00

2708/2716 EPROM KIT \$59.95

Special Kit With Beas

2708's \$129.95

Bare Board \$30.00

ULTRAVIOLET EPROM ERASER

Erase up to 48 ICs each erase

\$49.50

MICROCOMPUTER COMPONENTS

MICROPROCESSORS	8080A SUPPORT DEVICES
18 16.95	16-W 16-S 16-K 9.70
180 22.00	16-W 16-S 16-K 9.70
280A 28.00	16-W 16-S 16-K 9.70
CDP1802CD 18.95	16-W 16-S 16-K 9.70
24 24.95	16-W 16-S 16-K 9.70
48 22.44	16-W 16-S 16-K 9.70
AM7901 22.95	16-W 16-S 16-K 9.70
2950 27.95	16-W 16-S 16-K 9.70
4502 11.95	16-W 16-S 16-K 9.70
4800 82.38	16-W 16-S 16-K 9.70
6807 25.00	16-W 16-S 16-K 9.70
8008 11.95	16-W 16-S 16-K 9.70
8008 11.95	16-W 16-S 16-K 9.70
8015 22.00	16-W 16-S 16-K 9.70
8080A 9.95	16-W 16-S 16-K 9.70
8085 87.5	16-W 16-S 16-K 9.70
8085 75.00	16-W 16-S 16-K 9.70
IMS9900TL 27.00	16-W 16-S 16-K 9.70

FREQUENCY COUNTER LSI CHIPS

1CM7207 \$ 8.25

1CM7207 \$18.95

6.5536 MHz X'ytal \$ 4.25

SAVE MORE BUY THEM ALL FOR \$28.00

STOP WATCH CHIP

1CM7205 \$18.50

3.2768 MHz X'ytal \$ 4.75

Trimmer Cap. \$ 0.50

ALL FOR JUST \$21.50

TRIACS

Part	Rating	Price
TIC 206A	3A 100V	.80
TIC 206B	3A 200V	.90
TIC 206D	3A 400V	1.00
TIC 216A	6A 100V	.80
TIC 216B	6A 200V	1.00
TIC 216D	6A 400V	1.25
TIC 236B	12A 200V	1.40
TIC 236D	12A 400V	1.70
TIC 253B	20A 400V	2.50
TIC 253D	20A 600V	2.95
TIC 253E	20A 600V	3.55
TIC 263B	25A 200V	3.10
TIC 263D	25A 400V	3.70
TIC 263E	25A 600V	4.25

MINIATURE CONSOLES

15° SLOPING PANELS

A	B	C	D	E	F	G	H	I	J	K	L	M	N	O	P	Q	R	S	T	U	V	W	X	Y	Z
4.0	5.5	2.0	1.1	3.3	2.2	1-B	1-G	1-L	5.50	1-W	1-S	1-K	5.50												
6.5	5.5	2.0	1.1	3.3	2.2	2-B	2-G	2-L	6.10	2-W	2-S	2-K	6.10												
6.5	8.5	2.0	1.1	3.3	2.2	3-B	3-G	3-L	6.70	3-W	3-S	3-K	6.70												

TRANSISTORS

Part	Rating	Price
NPN Gen Pur 30V	10/51.00	
PNP Gen Pur 30V	10/51.10	
2N5458 Gen Pur FET	10/54.00	
2N5245R F FET	10/55.00	
2N2222 Switching	10/51.75	
2N3055 150W Power	10/56.00	

POWER TRANSISTORS

MATCHED PAIR

MOTOROLA MJE2955 PNP

MJE3055 PNP

10 AMP 60 VOLT 90 WATTS

\$2.25 PER PAIR

MINIATURE SLIDE SWITCH

DPDT 20 ea

10 for \$1.75

100 for \$15.00

30° SLOPING PANELS

A	B	C	D	E	F	G	H	I	J	K	L	M	N	O	P	Q	R	S	T	U	V	W	X	Y	Z
4.0	5.5	3.0	1.1	3.7	2.2	9-B	9-G	9-L	5.50	9-W	9-S	9-K	5.50												
6.5	5.5	3.0	1.1	3.7	2.2	10-B	10-G	10-L	6.10	10-W	10-S	10-K	6.10												
6.5	7.2	4.0	1.1	5.7	2.2	11-B	11-G	11-L	6.70	11-W	11-S	11-K	6.70												

0.2" L.E.D. Lamps

Color	15x	100/10.00
Green	20x	100/15.00
Yellow	20x	100/15.00
Amber	20x	100/15.00

PUSH BUTTON SWITCH

White, green and yellow

30x ea \$1.00

48x ea \$1.00

JUMBO LED READOUT ARRAY

- 1.00 Inch High Characters
- Common Cathode Connections
- 3 1/2 Digits with Colons
- Independent Segments

LT1012 \$7.50

CRYSTALS ±0.002%

Frequency (MHz)	2.4576	4.0000	6.144	10.000	32.000
1.8432	2.667	4.1943	6.400	14.318	36.0000
3.000	4.9152	6.5536	14.391	48.0000	
3.200	5.0000	8.0000	18.000		
3.2768	5.0688		18.4320		
2.000	3.5795	5.1850	20.0000	@3.50	
2.0100	5.7143	6.0000	22.1184		
2.097152	@4.75	6.0000	27.0000		

SOLDER Quick solder remover

Size	Price
1/32" 5 ft	1 10V 15c
1/16" 5	1 35V 20c
1/8" 5 1.40 ea.	3 35V 25c
1/4" 2 1/2	10 50V 30c
	22 35V 30c

KEPCO Ferroresonant power supply.

Input 110V 3A

Output 24V 8A

Factory Price \$206

Our Price \$80

LAMBDA Precision Power Supply

Model LXS-EE-5-0V

5V 45A Factory Price \$600

Our Price \$100

DIP PLUGS

Pin Count	Price
14-pin	3.25 6.00 55.00
16-pin	3.50 6.50 60.00
40-pin	9.50 18.00 150.00

THE KIM-1 MICROCOMPUTER SYSTEM

- * 6502 - 8 bit MPU with powerful instruction set. 13 addressing modes, multiple interrupts, full 65K byte address range.
- * 2 MCS 6530 chips each with 1024 bytes of ROM, 64K bytes of RAM, 151/0 pins, and an interval timer.
- * The KIM-1 monitor and operating programs are stored permanently in the 1048 ROM bytes provided.
- * Comes with keyboard and alpha-numeric display.
- * TTY and cassette interface
- * Completely assembled and tested and documented.
- * Including KIM-1 user manual, 6500 programming manual, and 6500 hardware manual.

ALL THESE FOR JUST \$235.00

KIM SUPPORT

Part	Price
6102	8.00
6502	11.95
6520	10.00
6527	9.25
6530	15.95
6530 007	15.95
6530 003	15.95
6530 004	15.95
6530 005	15.95

AUDIOLITE TRANSDUCERS

Manufactured by "GULTON INDUSTRIES" for Producing audible sound. With a very simple one X'istor C. Ideal for smoke detector & Morse code practice. \$1.75 ea. 10/\$14.00

TIME BASE MINI KIT

Includes MM5369 I.C.

3.5795 MHz X'ytal

Trimmer Cap.

\$3.45

STATIC RAMS

Part	Price
2102	1.50
2102 (950)	1.75
2102 (250)	1.75
11014	1.00
21011	2.95
2102	1.75
2111-1	3.95
2114-3	11.00
2126	11.10
2113	11.00
31011	2.50
3107	3.95
4004	12.95
4004A	12.95
4004B	11.00
4004C	9.95
7489	3.25
74S201	4.50
9012	4.75
9013	17.00
9014	21.00
9015	1.84
9100SPC	1.85

Wire Wrap Wire Special Purchase

500 ft. roll @ 5.00

White only

WIRE-WRAP TOOLS

Hobby Wrap - 30

Hobby Wrap - BW-630

Battery OP. (less batt.)

\$30.95

VHF Modulator

For TV Game or Computer

Modulates Video Input to a RF output (ch. 3)

Supply voltage 5V

\$4.50 ea.

ERIE MINI CERAMIC TRIMMER CAP.

||
||
||

REMOTE CONTROL TRANSMITTER & RECEIVER



* CAN BE USED AS REMOTE CONTROL FOR TV
* USE IT FOR YOUR OWN GARAGE DOOR OPENER
* TRANSMITTERS IN PAPER, JERKY, AND 1/2 INCH
* TRANSMITTERS OF USE FOR REMOTE CONTROL APPLICATIONS
* TRANSMITTERS USE A 1/2 VOLT BATTERY
* SCHEMATIC INCLUDED

\$19.95

Custom Cables & Jumpers

Part No.	Cable Length	Connectors	Price
DB25P-4-P	4 Ft.	2-DB25P	\$15.95 ea
DB25P-4-S	4 Ft.	1-DB25P/1-25S	\$16.95 ea
DB25S-4-S	4 Ft.	2-DB25S	\$17.95 ea

Dip Jumpers			
DJ14-1	1 ft	1-14 Pin	\$1.59 ea
DJ16-1	1 ft	1-16 Pin	1.79 ea
DJ24-1	1 ft	1-24 Pin	2.79 ea
DJ14-1-14	1 ft	2-14 Pin	2.79 ea
DJ16-1-16	1 ft	2-16 Pin	3.19 ea
DJ24-1-24	1 ft	2-24 Pin	4.95 ea

For Custom Cables & Jumpers, See JAMECO 1979 Catalog for Pricing

CONNECTORS

Part No.	Description	Price
DB25P (as pictured)	PLUG (Meets RS232)	\$2.95
DB25S	SDCKET (Meets RS232)	\$3.50
DB51226-1	Cable Cover for DB25P or DB25S	\$1.75

PRINTED CIRCUIT EDGE-CARD			
156	Spacing-Tin Double Row Out	Bridged Contacts	Fits 054 to 070 P.C. Cards
15/30	PINS (Solder Eyelet)		\$1.95 ea
18/36	PINS (Solder Eyelet)		\$2.49 ea
22/44	PINS (Solder Eyelet)		\$2.95 ea
50/100 (.100 Spacing)	PINS (Wire Wrap)		\$6.95 ea
50/100 (.125 Spacing)	PINS (Wire Wrap)	R681-1	\$6.95 ea

MINI-BUZZER

Part No.	Price
1-24	\$1.95 ea
25-49	\$1.75 ea
50-99	\$1.49 ea

SONALERT AUDIBLE SIGNAL DEVICE

Use as a warning device or Audible Reminder

- Turns on and off with low power transistor, SCR or IC
- Can be battery operated 6-28 volts
- Solid State - No moving parts
- Panel mounts in 1 1/2" round hole
- Black Plastic case includes MGT nut
- Operating Volts (DC): 6 (Min) - 28 (Max)
- Current MA: 3 (Min) - 14 (Max)
- 8BA: 68 (Min) - 80 (Max)
- Frequency: 2900Hz ± 500

Part No. **#SC628**
\$7.50 each

AC Wall Transformer

Ideal for use with clocks, power supplies or any other type of AC application.

Part No.	Input	Output	Price
AC 250	117V/60Hz	12 VAC 250mA	\$3.95
AC 500	117V/60Hz	12 VAC 500mA	\$4.95

Regulated Power Supply

- Uses LM 309K
- Heat sink provided
- P.C. board construction
- Provides a solid 1 amp @ 5V
- Includes components, hardware and instructions
- Sizes: 3-1/2" x 5" x 2" high

Part No. **JE200** \$14.95

INSTRUMENT/CLOCK CASE

This case is an injection molded unit that is ideal for uses such as DVM, COUNTER, or CLOCK cases. It has dimensions of 4 1/2" in length by 4" in width by 1-9/16" in height. It comes complete with a red bezel.

Part No. **IN-CC** \$3.49 each

MICROPROCESSOR COMPONENTS

8088A/8088A SUPPORT DEVICES			MICROPROCESSOR MANUALS		
8080A	CPU	\$ 9.95	M-280	User Manual	\$7.50
8212	8-Bit Input/Output	3.25	M-COP1802	User Manual	7.50
8214	Priority Interrupt Controller	5.95	M-2650	User Manual	5.00
8216	8-Directional Bus Driver	3.49			
8224	Clock Generator/Driver	3.49			
8226	Bus Driver	3.49			
8228	System Controller/Bus Driver	5.95	2513(214D)	Character Generator(Upper case)	\$9.95
8238	System Controller	5.95	2513(3021)	Character Generator(lower case)	9.95
8251	Prog. Comm. 1.0 (USART)	7.95	2516	Character Generator	10.95
8253	Prog. Interval Time	14.95	MM5230M	2048-Bit Read Only Memory	1.95
8255	Prog. Periph. I/O (PPH)	9.95			
8257	Prog. DMA Control	19.95			
8259	Prog. Interrupt Control	15.95			

8800/8800 SUPPORT DEVICES		
MC6800	MPU	\$14.95
MC6800CP	MPU with Clock and Ram	24.95
MC6810AP	128K Static Ram	5.95
MC6821	Periph. Inter. Adapt (MC6820)	7.49
MC6828	Priority Interrupt Controller	12.95
MC6800LB	1024-Bit ROM (MC6800-8)	14.95
MC6850	Asynchronous Comm. Adapter	7.95
MC6852	Synchronous Serial Data Adapt.	9.95
MC6860	0-600 bps Digital MODEM	12.95
MC6862	2400 Bps Modulator	14.95
MC6880A	Quad 3-Store Bus. Trans (MC8726)	2.25

MICROPROCESSOR CHIPS - MISCELLANEOUS		
Z801780C	CPU	\$19.95
Z80A1780 1	CPU	24.95
CDP1802	CPU	19.95
8035	8-bit MPU w/clock, RAM, I/O lines	19.95
P8085	CPU	13.95
TMS9900UL	16-Bit MPU w/hardware multiply & shift	49.95

SHIFTS REGISTERS		
MM500H	Dual 25 Bit Dynamic	\$ 5.50
MM503H	Quad 50 Bit Dynamic	5.50
MM504H	Dual 16 Bit Static	5.50
MM506H	Dual 100 Bit Static	5.50
MM510H	Dual 54 Bit Accumulator	8.50
MM5016H	500-512 Bit Dynamic	8.50
25041	1024 Dynamic	3.95
2518	Hex 32 Bit Static	4.95
2522	Dual 132 Bit Static	2.95
2524	512 Static	9.95
2525	1024 Dynamic	2.95
2527	Dual 256 Bit Static	2.95
2528	Dual 250 Static	4.00
2529	Dual 240 Bit Static	4.00
2532	Quad 80 Bit Static	2.95
2533	1024 Static	2.95
3341	Fifo	6.95
74LS670	4K4 Register File (TriState)	1.95

UART'S		
A.Y.S-1013	38K BAUD	\$ 9.95

MICROPROCESSOR MANUALS		
M-280	User Manual	\$7.50
M-COP1802	User Manual	7.50
M-2650	User Manual	5.00

ROM'S		
2513(214D)	Character Generator(Upper case)	\$9.95
2513(3021)	Character Generator(lower case)	9.95
2516	Character Generator	10.95
MM5230M	2048-Bit Read Only Memory	1.95

RAM'S			
1101	256X1	Static \$14.99	
1103	1024X1	Dynamic 9.99	
2101(8101)	256X4	Static 3.95	
2102	1024X1	Static 1.75	
2103	1024X1	Static 1.95	
2111(8141)	256X4	Static 3.95	
2112	256X4	Static MOS 4.95	
2114	1024X4	Static 450ns 9.95	
2144	1024X4	Static 450ns low power 10.95	
2144-3	1024X4	Static 300ns low power 10.95	
2144-3	1024X4	Static 300ns low power 11.95	
2114-3	256X4	Static 7.95	
5280(2107)	496X1	Dynamic 4.95	
7489	16X4	Static 1.75	
74S200	256X1	Static Tristate 4.95	
93421	256X1	Static 2.95	
UPD414	4K	Dynamic 16 pin 14.95	
(M41427)	16K	Dynamic 16 pin 14.95	
MS4044	4K	Static 14.95	
45L	45L	1024X4	14.95
TM5495	2117	16.384X1	9.95
MM5262	2KX1	Dynamic	4/1.00

EPROM'S		
1702A	2048	FAMOS \$5.95
TM52516	16K*	EPROM(int. 2716) 49.95
(2716)		*Requires +5V power supply
MS5232	4KX8	EPROM 89.95
2708	8K	EPROM 10.95
UPD16 T.J	16K*	EPROM 29.95
*Requires 3 voltages: -5V, -5V, +12V		
5203	2048	FAMOS 14.95
6301-176111	1024	Tristate Bipolar 3.49
6300-176021	256	Open C Bipolar 2.95
82523	32X8	Open Collector 3.95
82S115	4096	Biosram 19.99
82S123	32X8	Tristate 3.95
74185	216	TTL Open Collector 9.95
74186	512	TTL Open Collector 3.95
74S287	1024	Static 2.95

NEW!! IN STOCK... POWERACE

ALL-CIRCUIT EVALUATORS WITH POWER

- 1680 solderless, plug-in tie points - will hold up to 18 14-pin DIP's.
- Breadboard elements accept all DIP sizes including RTL, TTL and CMOS devices. TIO-5's and discrete with leads up to .032" dia.
- All connections to/from switches, indicators, power supplies and meters are made via solderless, plug-in, tie-point blocks on control panels.
- Interconnect with any solid 20 to 30 AWG wire.
- Breadboard elements are mounted on ground plane - ideal for high-frequency and high-speed low-noise circuits.
- Short-circuit-proof fused power supplies.
- Operate on 110 to 130 VAC at 60 Hz.
- Space-age compact styling and high-grade components permit convenient, organized and quick prototyping.

All models are 7 1/2" wide 11 1/2" deep and 4 0/8" high (rear) 0.75" high (front) and weigh approx. 2.5 lbs.

POWERACE 101 - General purpose model for prototyping all types of circuit. **\$ 84.95**

#923101 **\$ 84.95**

POWERACE 102 - Complete digit prototyping lab with built-in logic probe. **\$114.95**

#923102 **\$114.95**

POWERACE 103 - Triple-output power supply for prototyping both linear and digit circuits. **\$124.95**

#923103 **\$124.95**

BK PRECISION **3 1/2-Digit Portable DMM**

- Overload Protected
- 3 High LED Display
- Battery or AC operation
- Auto Zeroing
- 1mv, 1V, 0.1 Ohm resolution
- Overrange reading
- 10 ma input impedance
- DC Accuracy 1% typical
- Ranges: DC Voltage 0-1000V AC Voltage 0-1000V
- Freq. Response 50-400 HZ
- DC/AC Current 0-100mA
- Resistance 0-10 meg ohm
- Size 6 1/2" x 4 1/2" x 5 1/8"

Model 2800 \$99.95

Accessories: AC Adapter BC-28 \$9.00, Rechargeable Batteries BP-26 20.00, Carrying Case LC-28 7.50

ESB ELECTRONICS CORPORATION **100 Mhz 8-Digit Counter**

- 20 Mhz-100 Mhz Range
- LED Display
- Crystal controlled prescaler
- Fully Automatic
- Portable - completely lighter adapter and external self-contained
- Size - 1.75" x 7.38" x 5.83"

MAX-100 \$134.95

Accessories For MAX 100: Mobile Charger/Eliminator use power from car battery Model 100 - CLA \$3.95, Charger/Eliminator use 110 V AC Model 100 - CAI \$9.95

ESB Mini-Max 6 Digit 50MHz Frequency Counter

- Guaranteed frequency range of 100 Hz to 50 MHz
- Full 6 digit display with anti-glare window
- Fully automatic - range, polarity, slope, trigger. Input level switching not required.
- Lead-zero blanking - All zeros to the left of the first non-zero digit are blanked. Kilo Hertz and Mega Hertz decimal points automatically light up when the unit is turned on.
- Built-in input overvoltage protection
- Use 9V Battery or 110/220V power.
- Complete with mini antenna.
- Lightweight - Only 8oz.

MINI-MAX \$89.95

Part No. Description Price
MM-A4 Antenna \$ 3.95
MM-C5 Carrying case 5.95
MM-IPC Input cable with clip leads 3.95
MM-AC2 110V adapter 9.95
MM-AC3 220V adapter 9.95

The Incredible "Pennywhistle 103"

\$139.95 Kit Only

The Pennywhistle 103 is capable of recording data to and from audio tape without critical speed requirements for the recorder and it is able to communicate directly with another modem and terminal for telephone "hamming" and communications. In addition, it's free of critical adjustments and is built with non-precision, readily available parts.

Data Transmission Method... Frequency-Shift Keying, full-duplex (half-duplex selectable), 300 Baud

Maximum Data Rate... Asynchronous Serial (return to mark level required between each character)

Data Format... Switch selectable: Low (normal) = 1070 space, 1270 mark, high = 225 space, 225 mark

Receive Channel Frequencies... 2025 Hz for space, 2225 Hz for mark

Transmit Channel Frequencies... 2025 Hz for space, 2225 Hz for mark

Receive Sensitivity... -46 dbm acoustically coupled

Transmit Level... -15 dbm nominal. Adjustable from -6 dbm to -20 dbm

Receive Frequency Tolerance... Frequency reference automatically adjusts to allow for operation between 1800 Hz and 2400 Hz

Digital Data Interface... EIA RS-232C or 20 mA current loop (receiver is optoisolated and non-polar)

Power Requirements... 120 VAC, single phase 10 Watts.

Physical... All components mount on a single 5" by 9" printed circuit board. All components included

Requires a VOM, Audio Oscillator, Frequency Counter and/or Oscilloscope as well

TRS-80 16K Conversion Kit

Expand your 4K TRS-80 System to 16K. Kit comes complete with:

- * 8 each UPD416 (16K Dynamic Rams)
- * Documentation for conversion

TRS-16K \$115.00

Special Offer - Order both your TRS-16K and the Super R' MOD II Interface kit together (retail value \$144.95) for only **\$139.95**

COMPUTER CASSETTES

- 6 EACH 15 MINUTE HIGH QUALITY C-15 CASSETTES
- PLASTIC CASE INCLUDED
- 12 CASSETTE CAPACITY
- ADDITIONAL CASSETTES AVAILABLE #C-15-52.50 ea

CAS-6 \$14.95 (Case and 6 Cassettes)

SUP 'R' MOD II

UHF Channel 33 TV Interface Unit Kit

- Wide Band B/W or Color System
- Converts TV to Video Display for home computers, CCTV camera, Apple II, works with Cromeco Dazzler, SOL-20, IRS-80, Challenger, etc.
- MOD II is pretuned to Channel 33 (UHF)
- Includes coaxial cable and antenna transformer.

MOD II \$29.95 Kit

RS-232 CONTROL CENTER

Plug in your modem, computer prom programmer, terminal, printer, etc. and selectively control data flow.

- Same Contour as "Pennywhistle 103"
- Totally self-contained
- Includes 2 master ports and 3 slave ports

Part No. **RS-232CC** \$89.95 kit only

CASSETTE CONTROLLER

Ideal for use with the TRS 80 and others

* Plug/Jack Interface to any computer system requiring remote control of cassette functions

The CC100 controls cassette motor functions, monitors tape location with its internal speaker and requires no power. Eliminates the plugging and unplugging of cables during computer loading operation from cassette.

#CC-100 \$29.50

63-Key Unencoded Keyboard

This is a 63-key, terminal keyboard newly manufactured by a large computer manufacturer. It is unencoded with SPST keys, unattached to any kind of PC board. A very solid molded plastic 13 x 4" base suits most application. **IN STOCK \$29.95 each**

Hexadecimal Unencoded Keypad

19-key pad includes 1-10 keys, ABCDEF and 2 optional keys and a shift key. **\$10.95/each**

Jameco ELECTRONICS

MAIL ORDER ELECTRONICS - WORLDWIDE
1021 HOWARD AVENUE, SAN CARLOS, CA 94070
ADVERTISED PRICES GOOD THRU FEBRUARY

PHONE ORDERS WELCOME (415) 592-8097

7400 TTL

SN7400N	18	SN7470N	29	SN74100N	89
SN7401N	18	SN7471N	35	SN74101N	89
SN7402N	18	SN7472N	35	SN74102N	89
SN7403N	18	SN7473N	35	SN74103N	89
SN7404N	18	SN7474N	35	SN74104N	89
SN7405N	20	SN7475N	35	SN74105N	89
SN7406N	20	SN7476N	35	SN74106N	89
SN7407N	20	SN7477N	35	SN74107N	89
SN7408N	20	SN7478N	35	SN74108N	89
SN7409N	20	SN7479N	35	SN74109N	89
SN7410N	20	SN7480N	35	SN74110N	89
SN7411N	20	SN7481N	35	SN74111N	89
SN7412N	20	SN7482N	35	SN74112N	89
SN7413N	20	SN7483N	35	SN74113N	89
SN7414N	20	SN7484N	35	SN74114N	89
SN7415N	20	SN7485N	35	SN74115N	89
SN7416N	20	SN7486N	35	SN74116N	89
SN7417N	20	SN7487N	35	SN74117N	89
SN7418N	20	SN7488N	35	SN74118N	89
SN7419N	20	SN7489N	35	SN74119N	89
SN7420N	20	SN7490N	35	SN74120N	89
SN7421N	20	SN7491N	35	SN74121N	89
SN7422N	20	SN7492N	35	SN74122N	89
SN7423N	20	SN7493N	35	SN74123N	89
SN7424N	20	SN7494N	35	SN74124N	89
SN7425N	20	SN7495N	35	SN74125N	89
SN7426N	20	SN7496N	35	SN74126N	89
SN7427N	20	SN7497N	35	SN74127N	89
SN7428N	20	SN7498N	35	SN74128N	89
SN7429N	20	SN7499N	35	SN74129N	89
SN7430N	20	SN7500N	35	SN74130N	89
SN7431N	20	SN7501N	35	SN74131N	89
SN7432N	20	SN7502N	35	SN74132N	89
SN7433N	20	SN7503N	35	SN74133N	89
SN7434N	20	SN7504N	35	SN74134N	89
SN7435N	20	SN7505N	35	SN74135N	89
SN7436N	20	SN7506N	35	SN74136N	89
SN7437N	20	SN7507N	35	SN74137N	89
SN7438N	20	SN7508N	35	SN74138N	89
SN7439N	20	SN7509N	35	SN74139N	89
SN7440N	20	SN7510N	35	SN74140N	89
SN7441N	20	SN7511N	35	SN74141N	89
SN7442N	20	SN7512N	35	SN74142N	89
SN7443N	20	SN7513N	35	SN74143N	89
SN7444N	20	SN7514N	35	SN74144N	89
SN7445N	20	SN7515N	35	SN74145N	89
SN7446N	20	SN7516N	35	SN74146N	89
SN7447N	20	SN7517N	35	SN74147N	89
SN7448N	20	SN7518N	35	SN74148N	89
SN7449N	20	SN7519N	35	SN74149N	89
SN7450N	20	SN7520N	35	SN74150N	89
SN7451N	20	SN7521N	35	SN74151N	89
SN7452N	20	SN7522N	35	SN74152N	89
SN7453N	20	SN7523N	35	SN74153N	89
SN7454N	20	SN7524N	35	SN74154N	89
SN7455N	20	SN7525N	35	SN74155N	89
SN7456N	20	SN7526N	35	SN74156N	89
SN7457N	20	SN7527N	35	SN74157N	89
SN7458N	20	SN7528N	35	SN74158N	89
SN7459N	20	SN7529N	35	SN74159N	89
SN7460N	20	SN7530N	35	SN74160N	89

Jameco New Kits

Digital Stopwatch Kit

- Use Interall 7205 Chip
- Plated thru double-sided P.C. Board
- LED display (red)
- Times to 59 min. 59.99 sec. with auto reset
- Quartz crystal controlled
- Three stopwatches in one
- Single event, split (cumulative) and taylor (sequential timing)
- Size: 2.15" x 90"

JE900 \$39.95

6-Digit Clock Kit

- Bright 308 m common cathode display
- Uses MM5314 clock chip
- Switches for hours, minutes and hold functions
- Hours easily viewable to 20 feet
- Simulated walnut case
- +115 VAC operation
- 12 or 24 hour operation
- Includes all components, case and wall transformer
- Size: 6.34" x 3.1-1.8" x 1.74"

J301 \$19.95

ALSO AVAILABLE:

JE200 5v lamp power supply \$14.95 JE2206B Function Generator \$19.95
 JE730 4-digit clock kit 14.95 JE747 Jumbo 6-digit clock kit 29.95

TELEPHONE/KEYBOARD CHIPS

AY-5-9100	Push Button Telephone Dialer	\$14.95
AY-5-9200	Rotary Dialer	14.95
AY-5-9500	CMOS Clock Generator	4.95
AY-5-2376	Keyboard Encoder (88 keys)	14.95
74C225	Keyboard Encoder (16 keys)	7.95
74C292	Keyboard Encoder (16 keys)	9.95

ICM CHIPS

ICM7045	CMOS Precision Timer	24.95
ICM7046	CMOS LED Stopwatch Timer	19.95
ICM7207	Oscillator Controller	7.50
ICM7208	Seven Decade Counter	19.95
ICM7209	Clock Generator	6.95

NMOS READ ONLY MEMORIES

MCM6571	128 X 9 X 7 ASCII Shifted with Greek	13.50
MCM6574	128 X 9 X 7 Math Symbols & Pictures	13.50
MCM6575	128 X 9 X 7 Alphametric Chart	13.50

MISCELLANEOUS

TL074CN	Quad Low Noise Bi-Fet Op Amp	2.49
TL094CN	Switching Regulator	4.49
TL496CP	Simple Switching Regulator	1.75
11C90	Onvite 10/11 Prescaler	19.95
95K90	Hi-Speed Onvite 10/11 Prescaler	11.95
AN53	Top-Darlington Opio-Isolator	3.95
MKS0240	Top Gate Field Generator	17.50
SD0206CH	5MHz 2-phase MOS clock driver	3.75
TL1006	27 red num num display w/writep logic chip	10.50
MM5320	TV Camera Sync Generator	14.95
MM5321	4 1/2 Digit DPM Logic Chip	5.95
LD110/111	3 1/2 Digit A/D Converter Set	25.00/set

LITRONIX ISO-LIT 1

Photo Transistor Opio-Isolator (Same as MCT 2 or 4N25)

2/99c

SN 76477

SOUND GENERATOR
Generates Complex Sounds
Low Power Programmable

3.95 each

TV GAME CHIP AND CRYSTAL

AY-3-8500-1 and 2 01 MHZ Crystal (Chip & Crystal)
Includes score display, 6 games and select angles, etc.

7.95/set

20% Discount 100 pcs combined order 25% -1000 pcs combined order

C/MOS

CD4000	23	CD4070	53
CD4001	23	CD4071	23
CD4002	23	CD4072	49
CD4006	1.19	CD4073	1.39
CD4007	2.25	CD4074	1.39
CD4008	49	CD4075	23
CD4010	49	CD4076	23
CD4011	23	CD4077	99
CD4012	25	CD4078	2.49
CD4013	39	CD4079	14.95
CD4014	1.39	CD4080	14.95
CD4015	1.19	CD4081	4.95
CD4016	49	CD4082	19.95
CD4017	1.19	CD4083	14.95
CD4018	1.39	CD4084	14.95
CD4019	49	CD4085	14.50
CD4020	1.19	CD4086	3.50
CD4021	1.39	CD4087	3.95
CD4022	1.19	CD4088	3.95
CD4023	23	CD4089	1.29
CD4024	79	CD4090	2.95
CD4025	23	CD4091	1.29
CD4026	2.25	CD4092	1.29
CD4027	69	CD4093	2.25

DISCRETE LEADS

XC556R	red	5/51	.125" dia.	XC209R	red	5/51
XC556G	green	4/51	XC209G	green	4/51	
XC556Y	yellow	4/51	XC209Y	yellow	4/51	
XC556C	clear	4/51	XC209Y	green	4/51	

TIMEX T1001

LIQUID CRYSTAL DISPLAY
FIELD EFFECT

4 DIGIT 5" CHARACTERS
THREE ENUNCIATORS
2.00" x 1.20" PACKAGE
INCLUDES CONNECTOR

T1001-Transmissive \$7.95
T1001A-Reflective 8.25

EXAR

XR205	\$3.40	XR2206KA	14.95	XR2264	1.50
XR215	4.40	XR2206KB	19.95	XR2264	4.25
XR220	1.55	XR2206KC	19.95	XR2267	2.99
XR-L555	1.50	XR2206KD	19.95	XR3403	1.25
XR555	3.99	XR2206KE	19.95	XR4136	1.25
XR556	9.99	XR2206KF	19.95	XR4151	1.50
XR567CT	1.25	XR2206KG	19.95	XR4202	3.60
XR1310P	1.30	XR2206KH	19.95	XR4212	2.05
XR1466CN	3.85	XR2206KI	19.95	XR4558	5.75
XR1488	1.39	XR2206KJ	19.95	XR4739	1.15
XR1489	1.39	XR2206KL	19.95	XR4741	1.47

DISPLAY LEADS

TYPE	POLARITY	MT	PRICE	TYPE	POLARITY	MT	PRICE
MAN 1	Common Anode-red	370	2.95	MAN E730	Common Anode-red = 1	560	99
MAN 2	5 + 7 Dgt Matrix-red	300	4.95	MAN E740	Common Cathode-red D-D	560	99
MAN 3	Common Cathode-red	125	2.5	MAN E750	Common Cathode-red = 1	560	99
MAN 4	Common Cathode-red	187	1.95	MAN E760	Common Cathode-red	560	99
MAN 5	Common Anode-green	300	1.25	MAN E780	Common Cathode-red	560	99
MAN 7Y	Common Anode-yellow	300	99	DL701	Common Anode-red = 1	300	99
MAN 7Z	Common Anode-yellow	300	99	DL704	Common Cathode-red	300	99
MAN 7A	Common Cathode-red	300	1.25	DL707	Common Cathode-red	300	99
MAN 8Z	Common Anode-yellow	300	99	DL729	Common Cathode-red	500	1.49
MAN 8Y	Common Anode-yellow	300	99	DL746	Common Anode-red = 1	630	1.49
MAN 3620	Common Anode-orange = 1	300	99	DL747	Common Anode-red	600	1.49
MAN 3630	Common Anode-orange = 1	300	99	DL749	Common Cathode-red = 1	630	1.49
MAN 3640	Common Cathode-orange	300	99	DL752	Common Cathode-red	600	1.49
MAN 4510	Common Anode-yellow	400	99	FD333	Common Cathode-red	110	35
MAN 4540	Common Cathode-orange	400	99	FD338	Common Cathode-red	110	35
MAN 4710	Common Anode-red	400	99	FD702	Common Cathode-red	250	69
MAN 4730	Common Anode-red = 1	400	99	FD358	Common Cathode-red	250	69
MAN 4740	Common Cathode-red	400	99	FD359	Common Cathode-red	257	75
MAN 4810	Common Anode-yellow	400	99	FD363	Common Cathode-red	257	75
MAN 4840	Common Cathode-yellow	400	99	FD507	Common Anode-red (FD505)	500	99
MAN 5610	Common Anode-orange-D-D	560	99	5082-7730	Common Anode-red	300	1.30
MAN 5630	Common Anode-orange = 1	560	99	HDSF-3400	Common Cathode-red	800	2.10
MAN 5640	Common Cathode-orange-D-D	560	99	HDSF-3403	Common Cathode-red	800	2.10
MAN 5650	Common Cathode-orange = 1	560	99	5082-7300	4 + 7 seg. Digit-Red/HPD	600	9.95
MAN 5660	Common Anode-yellow	560	99	5082-7302	4 + 7 seg. Digit-L/HPD	600	19.95
MAN 5680	Common Cathode-orange	560	99	5082-7304	4 + 7 seg. Digit-Heavymetal	600	22.80
MAN 6710	Common Anode-red-D	560	99				

DIODES

TYPE	VOLTS V	PRICE	TYPE	VOLTS V	PRICE
1N746	3.3	400m	1N4002	100 PIV 1 AMP	12 1.00
1N751	5.1	400m	1N4003	200 PIV 1 AMP	12 1.00
1N752	6.3	400m	1N4004	400 PIV 1 AMP	12 1.00
1N753	6.8	400m	1N4005	600 PIV 1 AMP	10 1.00
1N754	6.2	400m	1N4006	800 PIV 1 AMP	10 1.00
1N755	6.8	400m	1N4007	1000 PIV 1 AMP	10 1.00
1N756	6.2	400m	1N4008	800 PIV 2 AMP	6 1.00
1N757	9.0	400m	1N4009	75 10m 15 10m	15 1.00
1N758	12.0	400m	1N4010	75 10m 15 10m	12 1.00
1N759	8.2	400m	1N4011	75 25m 15 10m	15 1.00
1N760	5.1	400m	1N4012	75 10m 15 10m	15 1.00
1N761	5.1	400m	1N4013	75 10m 15 10m	15 1.00
1N762	5.1	400m	1N4014	75 10m 15 10m	15 1.00
1N763	5.1	400m	1N4015	75 10m 15 10m	15 1.00
1N764	5.1	400m	1N4016	75 10m 15 10m	15 1.00
1N765	5.1	400m	1N4017	75 10m 15 10m	15 1.00
1N766	5.1	400m	1N4018	75 10m 15 10m	15 1.00
1N767	5.1	400m	1N4019	75 10m 15 10m	15 1.00
1N768	5.1	400m	1N4020	75 10m 15 10m	15 1.00
1N769	5.1	400m	1N4021	75 10m 15 10m	15 1.00
1N770	5.1	400m	1N4022	75 10m 15 10m	15 1.00
1N771	5.1	400m	1N4023	75 10m 15 10m	15 1.00
1N772	5.1	400m	1N4024	75 10m 15 10m	15 1.00
1N773	5.1	400m	1N4025	75 10m 15 10m	15 1.00
1N774	5.1	400m	1N4026	75 10m 15 10m	15 1.00
1N775	5.1	400m	1N4027	75 10m 15 10m	15 1.00
1N776	5.1	400m	1N4028	75 10m 15 10m	15 1.00
1N777	5.1	400m	1N4029	75 10m 15 10m	15 1.00
1N778	5.1	400m	1N4030	75 10m 15 10m	15 1.00
1N779	5.1	400m	1N4031	75 10m 15 10m	15 1.00
1N780	5.1	400m	1N4032	75 10m 15 10m	15 1.00
1N781	5.1	400m	1N4033	75 10m 15 10m	15 1.00
1N782	5.1	400m	1N4034	75 10m 15 10m	15 1.00
1N783	5				



PTS 8001 Component Analyzer

Solid state component tester works in or out of circuit. Simple hook-up to any standard oscilloscope. High, medium and low range switch for matching the impedance to the component being tested. Dealer Net \$54.95

See the Yellow Pages for the PTS Servicenter Nearest You or Contact:



PTS ELECTRONICS, INC.

P.O. Box 272 Bloomington, IN 47401 812-824-9331

CIRCLE 66 ON FREE INFORMATION CARD

12V 8A POWER SUPPLY \$44.50

Handles 12A with 50% duty cycle. Hams and CBers use it for powering mobile transceivers in the home, techs use it for a bench supply, hi-fi stores use it to power car stereo equipment, and computer owners use it to power bunches of floppy disc drives. Features crowbar over-voltage protection, foldback current limiting, adjustable output 11-14V, custom heavy-duty transformer, RF suppression, and easy assembly (all parts except xfrmr/filter caps/diodes mount on circuit board). With complete assembly instructions. Does not include case.

TRS-80 CONVERSION KIT \$109 (3/\$320)

Includes DIP shunts, 250 ns chips for 4 MHz operation, and 1 year guarantee. Upgrades 4K TRS-80 to 16K, or populates Memory Expansion Module — our novice level instructions show you how. Also suitable for APPLE computers.

H8 COMPATIBLE 12K X 8 MEMORY BOARD UNKIT \$200

Comes with sockets and bypass caps pre-soldered in place for easy assembly. Fully static, buffered, and includes on-board regulation. With easy-to-follow instructions.

MEMORY SPECIAL: 2101-L1 (high speed/low power) 1K STATIC RAM NOW ONLY 99¢ EACH (sorry, only good for orders of 10 or more)

GODBOUT

BILL GODBOUT ELECTRONICS
BOX 2355, OAKLAND AIRPORT, CA 94614

TERMS: Orders under \$15 add \$1. Cal res add tax. VISA/Mastercharge® (\$15 min) call (415) 562-0636, 24 hrs. Allow 5% shipping, excess refunded. COD OK with street address for UPS.

SEND FOR OUR FREE FLYER CIRCLE 28 ON FREE INFORMATION CARD

REGULATED POWER SUPPLIES

POWER SYSTEMS # PS1111
115-230V 50/60 cy. in VAC at 35A out.
6" x 16 1/2" x 15 1/2" 26 lbs. shipping weight. \$85.00

POWER SYSTEMS # PS1106
115-230V 50/60 cy. In 12 VAC at 15A out.
5" x 16 1/2" x 5" 19 lbs. shipping weight. \$75.00

C/MOS (DIODE CLAMPED)

4001	18	4019	37	4049	35	74C74	45
4002	18	4020	90	4050	35	74C83	115
4006	95	4021	90	4053	110	74C86	40
4007	18	4022	90	4055	125	74C93	75
4009	37	4023	18	4056	70	74C151	140
4010	37	4024	75	4071	18	74C160	105
4011	18	4025	18	4076	97	74C161	105
4012	18	4027	37	4570	70	74C174	105
4013	29	4028	80	74C00	22	74C175	105
4014	75	4029	95	74C02	22	74C192	120
4015	75	4030	33	74C04	24	74C193	120
4016	29	4035	97	74C08	22	74C901	48
4017	90	4042	65	74C10	27	74C902	48
4018	90	4046	135	74C73	65	74C914	120

PRINTED CIRCUIT BOARD

4 1/2" x 6 1/2" SINGLE-SIDE DEPOXY BOARD 1.16" thick, unclamped \$52.60
S 60 ea

7 WATT LD-65 LASER DIODE IR \$89.95

2N 3820 P FET \$ 45
2N 5457 N FET \$ 45
2N2646 UJT \$ 45
ER 900 TRIAC DIODES 4 \$1.00
2N 6028 PNP UJT \$ 65

MINIATURE MULTI-TURN TRIM POTS
100, 1K, 2K, 5K, 10K, 20K, 50K, 100K,
200K, 500K, 1Meg, 2Meg \$.75 each 3/\$2.00

CHARGED COUPLE DEVICES
CCD 201C 100x100 Image Sensor \$96.00
CCD 202C 100x100 Image Sensor \$145.00

VERIPAX PC BOARD \$4.00
This board is a 1/16" single sided paper epoxy board, 4 1/2" x 6 1/2" DRILLED and ETCHED which will hold up to 21 single 14 pin IC's or 8, 16 or LSI DIP IC's with buses for power supply connector.

FP 100 PHOTO TRANS \$ 50
RED, YELLOW, GREEN or AMBER
LARGE LED'S 2" \$ 61.00
TIL-118 OPTO-ISOLATOR \$ 75
MCT-6 OPTO ISOLATOR \$ 80
**1 WATT ZENERS: 3.3, 4.7, 5.1, 5.6, 9.1, 10,
12, 15, 18, or 22V** 6/\$1.00
MC6860 MODEM CHIP \$9.95
MCM 6571A 7 x 9 char'cter gen \$10.75

Silicon Power Rectifiers

PRV	1A	3A	15A	50A	175A	240A
100	06	14	30	60	3 7/8	5.00
200	07	20	35	1 1/5	4.25	6.50
400	09	25	50	1 40	6.50	9.50
600	11	30	70	1 60	8.50	12.50
800	15	35	90	2 30	10.50	16.50
1000	20	45	110	2 75	12.50	20.00

SAD 1024 A REGICOM 1024 stage analog 8 1/4" wide shift register. \$14.95
IN 4148 IN 9141 15 \$1.90

RS232 CONNECTORS OB 25P male \$2.25
OB 25S female \$2.95
HOOPS \$1.00

REGULATORS

309K \$ 1.20 340K-12,15
723 \$.50 50 or 24V \$.95
LM 376 \$.60 340T-5, 6, 8, 12
320T 15, 35 90 2.30 10.50 16.50
5, 12, 15 78 MG \$1.35
or 24 \$1.25 79 MG \$1.35

TRANSISTOR SPECIALS

2N6233 NPN SWITCHING POWER \$ 1.95
MRF-8004 a CB RF Transistor NPN \$.75
2N3772 NPN S: TO 3 \$ 1.00
2N1546 PNP GE TO-3 \$.75
2N4908 PNP S: TO 3 \$ 1.00
2N6056 PNP S: TO 3 Darlington \$ 1.70
2N5086 PNP S: TO 92 \$ 4.5 1.00
2N3137 NPN S: RF \$.55
2N3919 NPN S: TO 3 RF \$ 1.50
2N1420 NPN S: TO 5 \$ 3/5 1.00
2N3767 NPN S: TO 66 \$.70
2N2222 NPN S: TO 18 \$ 5 1.00
2N3055 NPN S: TO 3 \$.50
2N3904 NPN S: TO 92 \$ 6/5 1.00
2N3906 PNP S: TO 92 \$ 5 1.00
2N5296 NPN S: TO 220 \$.50
2N6109 PNP S: TO 220 \$.55
2N3638 PNP S: TO 18 \$ 5 1.00
MPSA 13 NPN S: 4/5 1.00

TTL IC SERIES

7400	-13	7447	-65	74151	-61
7401	-13	7448	-68	74152	-61
7402	-13	7446	-58	74154	-94
7403	-13	7445	-55	74155	-65
7404	-13	7473	-28	74161	-55
7405	-13	7474	-28	74163	-55
7406	-16	7475	-45	74164	-85
7407	-20	7476	-30	74165	-95
7408	-18	7480	-31	74170	-168
7409	-18	7483	-65	74173	-120
7410	-13	7485	-87	74174	-95
7411	-18	7486	-28	74175	-85
7412	-13	7489	-125	74176	-75
7413	-36	7490	-42	74177	-75
7414	-60	7491	-58	74180	-65
7416	-22	7492	-43	74181	-190
7417	-25	7493	-43	74190	-100
7420	-13	7494	-67	74191	-100
7425	-25	7495	-65	74192	-79
7426	-22	7496	-65	74193	-79
7427	-19	7497	-90	74194	-80
7430	-13	74107	-28	74195	-50
7432	-22	74121	-29	74196	-86
7437	-21	74122	-38	74279	-55
7438	-21	74123	-45	74298	-90
7440	-13	74125	-40	53375	1.80
7441	-70	74126	-40	75491	5.00
7442	37	74150	-94	75492	5.00

DATA CASSETTES 1/2 HR \$.95
22:44 Pin Solder Tail 156' Conn. \$1.95

MM 5387AA new clock chip which will directly drive LED'S 12/24 hrs., 1 supply & alarm \$5.95

NO. 30 WIRE WRAP WIRE SINGLE STRAND 100' \$1.40

ALCO MINIATURE TOGGLE SWITCHES
MTA 106 SPDT \$.95
MTA 206 DPDT \$ 1.70
MTA 206 P DPDT CENTER OFF \$ 1.85
MSD 206 P DPDT CENTER OFF LEVER SWITCH \$ 1.85

Full Wave Bridges DIP SOCKETS

PRV	2A	6A	25A	8 PIN	17 24 PIN	35
100	.75	1.25	2.00	14 PIN	20 28 PIN	40
400	.95	1.50	3.00	16 PIN	22 40 PIN	60
600	1.20	1.75	4.00	18 PIN	25	

SANKEN AUDIO POWER AMPS
S: 1010 G 10 WATTS \$ 7.80
S: 1020 G 20 WATTS \$15.70
S: 1050 G 50 WATTS \$28.50

TANTULUM CAPACITORS

22UF 35V 5 51 00	68UF 35V 4 51 00
47UF 35V 5 51 00	100UF 10V 5 25
68UF 35V 5 51 00	22UF 25V 5 40
10UF 35V 5 51 00	15UF 35V 3/51 00
2.2 UF 20V5 4 51 00	30UF 6V 5/51 00
3.3UF 20V 4 51 00	47UF 20V 5 35
4.7UF 15V 5/51 00	68UF 15V 5 50
	100UF 10V 5 40

74LS SERIES

74LS00	19	74LS02	170	74LS138	25
74LS01	19	74LS03	70	74LS139	30
74LS02	21	74LS04	58	74LS14	75
74LS03	21	74LS05	58	74LS15	75
74LS04	21	74LS06	62	74LS16	120
74LS05	21	74LS07	62	74LS17	170
74LS06	21	74LS08	62	74LS18	170
74LS07	21	74LS09	79	74LS19	170
74LS08	21	74LS10	80	74LS20	170
74LS09	21	74LS11	80	74LS21	170
74LS10	21	74LS12	80	74LS22	170
74LS11	21	74LS13	80	74LS23	170
74LS12	21	74LS14	80	74LS24	170
74LS13	21	74LS15	80	74LS25	170
74LS14	21	74LS16	80	74LS26	170
74LS15	21	74LS17	80	74LS27	170
74LS16	21	74LS18	80	74LS28	170
74LS17	21	74LS19	80	74LS29	170
74LS18	21	74LS20	80	74LS30	170
74LS19	21	74LS21	80	74LS31	170
74LS20	21	74LS22	80	74LS32	170
74LS21	21	74LS23	80	74LS33	170
74LS22	21	74LS24	80	74LS34	170
74LS23	21	74LS25	80	74LS35	170
74LS24	21	74LS26	80	74LS36	170
74LS25	21	74LS27	80	74LS37	170
74LS26	21	74LS28	80	74LS38	170
74LS27	21	74LS29	80	74LS39	170
74LS28	21	74LS30	80	74LS40	170
74LS29	21	74LS31	80	74LS41	170
74LS30	21	74LS32	80	74LS42	170
74LS31	21	74LS33	80	74LS43	170
74LS32	21	74LS34	80	74LS44	170
74LS33	21	74LS35	80	74LS45	170
74LS34	21	74LS36	80	74LS46	170
74LS35	21	74LS37	80	74LS47	170
74LS36	21	74LS38	80	74LS48	170
74LS37	21	74LS39	80	74LS49	170
74LS38	21	74LS40	80	74LS50	170
74LS39	21	74LS41	80	74LS51	170
74LS40	21	74LS42	80	74LS52	170
74LS41	21	74LS43	80	74LS53	170
74LS42	21	74LS44	80	74LS54	170
74LS43	21	74LS45	80	74LS55	170
74LS44	21	74LS46	80	74LS56	170
74LS45	21	74LS47	80	74LS57	170
74LS46	21	74LS48	80	74LS58	170
74LS47	21	74LS49	80	74LS59	170
74LS48	21	74LS50	80	74LS60	170
74LS49	21	74LS51	80	74LS61	170
74LS50	21	74LS52	80	74LS62	170
74LS51	21	74LS53	80	74LS63	170
74LS52	21	74LS54	80	74LS64	170
74LS53	21	74LS55	80	74LS65	170
74LS54	21	74LS56	80	74LS66	170
74LS55	21	74LS57	80	74LS67	170
74LS56	21	74LS58	80	74LS68	170
74LS57	21	74LS59	80	74LS69	170
74LS58	21	74LS60	80	74LS70	170
74LS59	21	74LS61	80	74LS71	170
74LS60	21	74LS62	80	74LS72	170
74LS61	21	74LS63	80	74LS73	170
74LS62	21	74LS64	80	74LS74	170
74LS63	21	74LS65	80	74LS75	170
74LS64	21	74LS66	80	74LS76	170
74LS65	21	74LS67	80	74LS77	170
74LS66	21	74LS68	80	74LS78	170
74LS67	21	74LS69	80	74LS79	170
74LS68	21	74LS70	80	74LS80	170
74LS69	21	74LS71	80	74LS81	170
74LS70	21	74LS72	80	74LS82	170
74LS71	21	74LS73	80	74LS83	170
74LS72	21	74LS74	80	74LS84	170
74LS73	21	74LS75	80	74LS85	170
74LS74	21	74LS76	80	74LS86	170
74LS75	21	74LS77	80	74LS87	170
74LS76	21	74LS78	80	74LS88	170
74LS77	21	74LS79	80	74LS89	170
74LS78	21	74LS80	80	74LS90	170
74LS79	21	74LS81	80	74LS91	170
74LS80	21	74LS82	80	74LS92	170
74LS81	21	74LS83	80	74LS93	170
74LS82	21	74LS84	80	74LS94	170
74LS83	21	74LS85	80	74LS95	170
74LS84	21	74LS86	80	74LS96	170
74LS85	21	74LS87	80	74LS97	170
74LS86					

We're Expanding . . . We're Growing with our Biggest

"ONE PENNY GETS YOU TWO"

*** Buy any \$1 item on this page and choose 2nd item for only one penny!**

HOW TO ORDER

When ordering, always use catalog number, type, no., the name of the magazine you are ordering from and the month

PLESSEY CAPS

10 for \$1 20 for \$1.01

Mid .0015 .068 Mid .01 .015 .12 1.00
 .047 .22

Half and full postage stamp size, white ceramic. Vertical ntc. Units unmarked so please order only same values per item. All units by Cat. No. 5399A

ONE DOLLAR PLUS A PENNY GETS YOU TWO TWO DOLLARS PLUS A PENNY GETS YOU TWO

- | | |
|---|--|
| <ul style="list-style-type: none"> <input type="checkbox"/> 50 IF TRANSFORMERS, ass't sizes (#3596) 1.00 <input type="checkbox"/> 30 RADIO AND TV KNOBS, ass't styles, sizes (#217) 1.00 <input type="checkbox"/> 50 TUBULAR CAPACITORS, ass't values and sizes (#219) 1.00 <input type="checkbox"/> 50 LOW NOISE RESISTORS, 1/2W, 1% (#220) 1.00 <input type="checkbox"/> 40 POWER RESISTORS, 3.5, 7, 15, axial, pop sizes (#228) 1.00 <input type="checkbox"/> \$25 SURPRISE, all kinds of parts in a pak (#294) 1.00 <input type="checkbox"/> 12 PANEL SWITCHES, rotary, slides, toggle, etc. (#295) 1.00 <input type="checkbox"/> 50 COILS AND CHOKES, 1/2, parasitic, II, etc. (#297) 1.00 <input type="checkbox"/> 50 TERMINAL STRIPS, up to 4 solder lugs (#334) 1.00 <input type="checkbox"/> 50 PRECISION RESISTORS, 1/4W, 1%, axial (#363) 1.00 <input type="checkbox"/> 50 MICA CAPACITORS, ass't values (#373) 1.00 <input type="checkbox"/> 10 SETS REC. PLUGS AND JACKS, 1/8" (#424) 1.00 <input type="checkbox"/> 50 DISC CAPACITORS, ass't values long leads (#437) 1.00 <input type="checkbox"/> 20 TRANSISTOR ELECTRO'S, ass't up and a/l (#453) 1.00 <input type="checkbox"/> 75 HALF WATERS, resistors, color coded, ass't (#454) 1.00 <input type="checkbox"/> 35 SILVER MICAS, red base, axial, ass't (#455) 1.00 <input type="checkbox"/> 5-50 AMP RECT., ass't volts up to 25, stud. (#471) 1.00 <input type="checkbox"/> 100 GERMANIUM DIODES, axial leads, u-test (#482) 1.00 <input type="checkbox"/> 4 LOOPS TICS, antenna, various shapes, sizes (#487) 1.00 <input type="checkbox"/> 100 PRINTED CIRCUIT 1/2 WATT RESISTORS, ass't (#1960) 1.00 <input type="checkbox"/> 12 TRANSISTOR SOCKETS, ass't npn and pnp types (#651) 1.00 <input type="checkbox"/> 50 3 AMP SILICON RECTIFIERS, axial, ass't V (#865) 1.00 <input type="checkbox"/> 50 POLYSTYRENE CAP S, plastic coated, prec. (#1052) 1.00 <input type="checkbox"/> 10 ME 2 BAND TRIMMERS, 10K, 100K, 1M, 10M (#1222) 1.00 <input type="checkbox"/> 10 PROXIMITY REED SWITCHES, ass't sizes (#1258) 1.00 <input type="checkbox"/> 8 2915 UHF TO 10 TRANSISTORS (#1423) 1.00 <input type="checkbox"/> 4 DUAL GATE MOSFETS, 3N121, 3N187, etc. (#1444) 1.00 <input type="checkbox"/> 75 MOLEX CONNECTOR TUBES, 1/2, 3/4, 1" (#1408) 1.00 <input type="checkbox"/> 50 ONE QUARTER WATERS, metallic film, resistors (#1853) 1.00 <input type="checkbox"/> 50 ONE AMP ZER DIODES, ass't axial, u-test (#1964) 1.00 <input type="checkbox"/> 5-PC-263 THREE WATT PCB BOARDS, for arqs (#2013) 1.00 <input type="checkbox"/> 5-MICRO MINI SLIDE SWITCHES, SPOT (#238) 1.00 <input type="checkbox"/> 5 MINI MOTOR VOLT. for hobby arqs (#2555) 1.00 <input type="checkbox"/> 50 LM4000 RECTIFIERS, ass't to 800V, u-test (#2594) 1.00 <input type="checkbox"/> 15 PRINTED CIRCUIT BOARDS, ass't sizes, hobby (#2010) 1.00 <input type="checkbox"/> 2 MERCURY SWITCHES, silent touch, SPST (#2823) 1.00 <input type="checkbox"/> 6 ITS A SWAP, 9 VOLT BATTERY, for hobby arqs (#3252) 1.00 <input type="checkbox"/> 8 1400 VOLT "RED BALL" RECTIFIERS, axial 1 AMP, U2590 1.00 <input type="checkbox"/> 20 1N4148 SWITCHING DIODES, 4.5, axial (#3000) 1.00 <input type="checkbox"/> 6-10 AMP QUADRACS, w/trigger diode up 600V (#3020) 1.00 <input type="checkbox"/> 5 MICRO HEAT SINKS, ass't sizes, u-test (#3031) 1.00 <input type="checkbox"/> 40 SQUARE DISC STYLE CHOKES, color coded (#3203) 1.00 <input type="checkbox"/> 30 TRANSISTORS T092 2N4400 series, u-test (#3291) 1.00 <input type="checkbox"/> 4 TRANSISTORS TRANSFORMERS, audio, inter, etc. mini (#3295) 1.00 <input type="checkbox"/> 15 PRINTED CIRCUIT BOARDS, ass't sizes, hobby (#3296) 1.00 <input type="checkbox"/> 6 UTILITY AC OUTLET JACKS, 1/4, 3/4, 1" (#3582) 1.00 <input type="checkbox"/> 20 N CABLE, 1 cond. shielded, 1/4, for phone (#3653) 1.00 <input type="checkbox"/> 7-2N3085 HOBBY MPN TRANSISTORS, DO, 30 (#3771) 1.00 <input type="checkbox"/> 10-10P 30 WATT T-10 TRANSISTORS, 100, 200, 300 (#3772) 1.00 <input type="checkbox"/> 50 TUBE SOCKETS, 4.5, 6.7 pin tubes, ass't (#3839) 1.00 <input type="checkbox"/> 1-10 AMP POWER TAB QUADRAC, 200 PRV, T0220, 2/trigger (#1590) 1.00 <input type="checkbox"/> 10 BULLET RECTIFIERS, 2 amp, 200V, axial (#418) 1.00 <input type="checkbox"/> 2-MANA READOUT, RED, com. amp. size (#430) 1.00 <input type="checkbox"/> 10-READOUTS, WA, 2, com. amp. size, LED, the claw, RED (#3338) 1.00 <input type="checkbox"/> 8-LEDs, ass't sizes and shapes, red, green, yellow, amber (#3859) 1.00 <input type="checkbox"/> PHOTO FLASH ELECTRO. CAP. 600 MF 360V (#397) 1.00 <input type="checkbox"/> 2-CIRCUIT BREAKERS, glass sealed, axial, rated 1 amp (#3958) 1.00 <input type="checkbox"/> MICRO MINI DOUBLE SPST, 2 amp, 100V, 1/4 (#3964) 1.00 <input type="checkbox"/> 5-BC CRYSTALS, orig. used in synthesizer, ass't freq. HC-18/holder (#5051) 1.00 <input type="checkbox"/> 4-PUSH BUTTON, SPST, PANEL, N.C. 125V 1 A (#5289) 1.00 <input type="checkbox"/> 10 INSTRUMENT KNOBS, ass't styles and colors, w/ shaft (#5121) 1.00 <input type="checkbox"/> 4-TAPE HEADS, various types and mounting (#5122) 1.00 <input type="checkbox"/> 2-TANTALUM ELECTRO'S, TEARDROP style, 2.2uF 25V (#5205) 1.00 <input type="checkbox"/> 2-INLINE FUSE HOLDERS, complete w/ 5 amp fuse (#5213) 1.00 <input type="checkbox"/> 30-4" CABLE TIES, non-slip white plastic (#5217) 1.00 <input type="checkbox"/> 30pc. HEAT SINKS, ass't sizes, 50% shrinkable (#5248) 1.00 <input type="checkbox"/> 20 TOROIDs, ass't sizes, some with coils (#431) 1.00 <input type="checkbox"/> 15-15V ZENERS, 400mw, axial, glass case (#404) 1.00 <input type="checkbox"/> 2-ALUMINUM HEAT SINKS, for T0-220 (#5338) 1.00 <input type="checkbox"/> 2-5, 1V, 5V, 10V, 20V ZENERS, DO, 40 (#5340) 1.00 <input type="checkbox"/> 3-SKINNY TRIM POTS, PRECISION, ass't styles, values (#338) 1.00 <input type="checkbox"/> 60pc. PRECUT, PRETINNED WIRE, various lengths and colors (#1971) 1.00 <input type="checkbox"/> 60-MINI RESISTORS, for PC appl., var. 1/4W, color coded (#2235) 1.00 <input type="checkbox"/> 8-TRANSISTOR RADIO EARPHONES, 8 ohm, 1/2 (#2946) 1.00 <input type="checkbox"/> 2-50 OHM AUDIO TAPS, plastic wrap in mounting (#5124) 1.00 <input type="checkbox"/> 10-1/2 MEG OHM POTs, audio taper, "snap-in" mt. (#5125) 1.00 <input type="checkbox"/> 50-1 AMP ZENERS, wide ass't. of values, untested (#1964) 1.00 <input type="checkbox"/> 12-SCR'S & TRIACS, 10 AMP, ass't values, untested (#5048) 1.00 <input type="checkbox"/> 3-QUADRACT, 3V, 1000 prime, 50, 100, 200V, T0-220 (#5048) 1.00 <input type="checkbox"/> 20-MINI RECTIFIERS, 1/4 AMPs, 25V, epoxy, axial (#5374) 1.00 <input type="checkbox"/> 5-1N4007 1000V MINI RECTIFIER, epoxy case, axial leads (#2383) 1.00 <input type="checkbox"/> 75-MOLEX CONNECTOR TYPE M1538-4, makes 14 to 40 pin sockets (#1609) 1.00 <input type="checkbox"/> 2-T.V. CHEATER CORDS, for AC power w/ 6 cable (#552) 1.00 <input type="checkbox"/> 10-T.V. CHEATER CORD JACKS, for use with above (#5520) 1.00 <input type="checkbox"/> 1-1 AMP 200V MINI RECTIFIER, 1N4003, epoxy, axial (#2379) 1.00 <input type="checkbox"/> 2-1.5V SILVER OXIDE WATCH BATTERIES, 3/4 (#5063) 1.00 <input type="checkbox"/> 3-LED WATCH HEADS, 3V, 1000 prime, 50, 100, 200V, T0-220 (#5066) 1.00 <input type="checkbox"/> 10-IC DICE CHIP, complete circuitry, ass't values (#5065) 1.00 <input type="checkbox"/> 2-100KHz MARKER CRYSTALS, capacity 104.067, 104.092, or 114.000 KHz (#3896) 1.00 <input type="checkbox"/> 12-1.5V LAMP AND SOCKET SET, 200ma, T2 9V (#3986) 1.00 <input type="checkbox"/> 10-ICA PHONO JACKS, brass, mono, 1/4 (#5119) 1.00 <input type="checkbox"/> 10-COAXIAL PIN HEAD LEADS, RED (#5617) 1.00 <input type="checkbox"/> 4-5-DIGIT 7-SEGMENT READOUTS, in the pak case (#5616) 1.00 <input type="checkbox"/> 4-1/2" BLOCK TRIM POTS, 5K to 200K (#2536) 1.00 <input type="checkbox"/> 12-1V TUBE SOCKETS, 1/2, 3/4, 1" (#2654) 1.00 <input type="checkbox"/> 1-VOLTAGE REGULATOR, T0202 case, 12V (#1900) 1.00 <input type="checkbox"/> 1-3 DIGITS ON A DIP, LED, red, OL 33 (#1887) 1.00 <input type="checkbox"/> 3-MMS262 2K DYNAMIC RAM, specialty type (#459) 1.00 <input type="checkbox"/> 10-2N1111 1/2 WATT TRANSISTORS, 100, 200, 300 (#3374) 1.00 <input type="checkbox"/> 2-15W MINI POWER TRANSISTORS, 220V, npn, T066 (#2797) 1.00 <input type="checkbox"/> 4-24 PIN IC SOCKETS (#2168) 1.00 <input type="checkbox"/> 1-MMS312 DIGITAL CLOCK CHIP, 100K (#1529) 1.00 <input type="checkbox"/> 1-MMS724 FUNCTION CALCULATOR CHIP, 100K (#2036) 1.00 <input type="checkbox"/> 1-MMS202 ERASABLE PROM, 100K (#1525) 1.00 <input type="checkbox"/> 3-10 AMP 25V BRIDGE RECT., comb style (#2447) 1.00 <input type="checkbox"/> 10-2N3657 HF TRANSISTORS, T0106, 2N5133, 337 1.00 <input type="checkbox"/> 10-LINEAR SWITCHING TRANSISTORS, 2N2905, npn, T03 (#3374) 1.00 <input type="checkbox"/> 50-2 AMP CYLINDRICAL RECT., up to 1K, u-test (#4066) 1.00 <input type="checkbox"/> 5-OPEN-FACE READOUTS, LED, red, some segs missing mostly duals (#3952) 1.00 <input type="checkbox"/> 10-2N2222 or equiv., T0-18 metal case (#1992) 1.00 <input type="checkbox"/> 40 TERMINAL STRIPS, 1/2, 3/4, 1" (#20 wire) (#3955) 1.00 <input type="checkbox"/> 10 DATA ENTRY SWITCHES, SPST, lamp, 125V norm open (#3961) 1.00 <input type="checkbox"/> 10 FLUORESCENT OVERFLOW READOUT TUBES, w/ leads (#3228) 1.00 <input type="checkbox"/> 10 2N3704 T092 TRANSISTORS (#3003) 1.00 <input type="checkbox"/> 1 2N5001 80V TRANSISTORS STUD. (#2800) 1.00 | <ul style="list-style-type: none"> <input type="checkbox"/> 100-CAPACITOR SPECIAL, disc, mylar, lytic, more (#2738) 2.00 <input type="checkbox"/> 10-VOLTAGE REGULATORS, hobby LM320, 340, T0-3 (#3330) 2.00 <input type="checkbox"/> 30-PANEL SWITCHES, slides, rotaries, mod, etc. (#3268) 2.00 <input type="checkbox"/> 50-RESISTOR SPECIAL, 1/4 to 1W, carbon, metal (#3054) 2.00 <input type="checkbox"/> 200-HALF WATERS, resistors, carbon, metal (#3046) 2.00 <input type="checkbox"/> 100-NATIONAL IC BONANZA, linear, 7400s ROM5 (#2860) 2.00 <input type="checkbox"/> 15-LM340T VOLTAGE REGULATORS, 5 to 24V, T0-220 (#2635) 2.00 <input type="checkbox"/> 100-POLYSTYRENE CAPS, ass't values, voltage, HI Q (#2729) 2.00 <input type="checkbox"/> 30-HERMISTORS, resistors that change with temp (#4089) 2.00 <input type="checkbox"/> 20-BRIDGES, untested, 2, 4, 6, amp, full wave (#4022) 2.00 <input type="checkbox"/> 15-MIXED READOUTS, hobby, untested, 127, 3, 8, etc. (#3619) 2.00 <input type="checkbox"/> 150-QUARTER WATERS, resistors, metal film, marked (#3413) 2.00 <input type="checkbox"/> 100-P-ELASTIC TRANSISTORS, untested, T0-92 (#2604) 2.00 <input type="checkbox"/> 200-PREFORMED RESISTORS, 1/4, 1/2, 1W, 1%, 2% marked (#2608) 2.00 <input type="checkbox"/> 600-DIPPED MYLARS, shiny finish, ass't values (#2597) 2.00 <input type="checkbox"/> 30-VOLUME CONTROLS, audio, linear, ass't values (#3458) 2.00 <input type="checkbox"/> 300-SILICON SIGNAL DIODES, micro, glass, zeners too 50% yield (#2628) 2.00 <input type="checkbox"/> 30-MMS3262 2K RAMS, hobby, untested (#3940) 2.00 <input type="checkbox"/> 10-PUSH SWITCHES, push-to-break, spst, alarms (#5289) 2.00 <input type="checkbox"/> 150-400V DIODES, silicon, untested, 50% yield (#5284) 2.00 <input type="checkbox"/> 150-CLASS ZENERS, 400 MW, untested, better than 50% yield (#2740) 2.00 <input type="checkbox"/> 75-CARBON FILM RESISTORS, 1/4, 1/2 watt, 5 & 10%, marked, ass't (#3534) 2.00 <input type="checkbox"/> 250-UNMARKED CAPACITORS, polystyrene, molded, pop values (#3088) 2.00 <input type="checkbox"/> 200-LM340T VOLTAGE REGULATORS, 5 to 24V, T0-220 (#2635) 2.00 <input type="checkbox"/> 30-PC TRIM POTENTIOMETERS, thumbwheel, screwdriver ass't (#3458) 2.00 <input type="checkbox"/> 15-3.50V VOLUME CONTROLS, ass't values, duals, singles (#3057) 2.00 <input type="checkbox"/> 75-4" CABLE TIES, plastic, like "TY-wrap" (#5218) 2.00 <input type="checkbox"/> 100-400V DIODES, silicon, untested, 50% yield (#3250) 2.00 <input type="checkbox"/> 100-TERMINAL STRIPS, 2 or 3 lugs up (#3128) 2.00 <input type="checkbox"/> 30-NE-ZNEON LAMPS, all 100% good (#2613) 2.00 <input type="checkbox"/> 40-N-1 SHIELDED CABLE, 1 cond, miles, phone, (#3577) 2.00 <input type="checkbox"/> 2 SOUND TRIGGERS, sound triggers ser w/amp (#3625) 2.00 <input type="checkbox"/> 10-IC CRYSTAL 5, for phase lock loop, NARM, HC/18 (#5050) 2.00 <input type="checkbox"/> 20 DATA ENTRY PUSH SWITCHES, spst, norm open, for keyboards (#5278) 2.00 <input type="checkbox"/> 75-SN7400 TTL ICs, untested 50%+ yield, pop types (#2419) 2.00 <input type="checkbox"/> 100-MINI DIP ICs, linear, untested 50%+ yield, pop types (#3245) 2.00 <input type="checkbox"/> 30-LM380 AUDIO IC's, 2 watts on a-dip 50%+ yield (#5284) 2.00 <input type="checkbox"/> 75-LINEARS, OP AMPS, untested 50%+ yield, amp-dips minidips (#2416) 2.00 <input type="checkbox"/> 100-TTL & LINEAR MIXED, with 7400s, 50%+ yield (#2431) 2.00 <input type="checkbox"/> 150-PREFORMED DISC CAPACITORS, mark-d values, ass't (#2605) 2.00 <input type="checkbox"/> 100-CALCULATOR KEYBOARDS, 20 keys and up (#3524) 2.00 <input type="checkbox"/> 200-FACTORY RECT DIODES, zeners, rect, signal, untested (#5369) 4000% 2.00 <input type="checkbox"/> 40-AXIAL ELECTROs, ass't values & capacitance (#3227) 2.00 <input type="checkbox"/> 40-UPRIGHT ELECTROs, ass't values & capacitance (#3226) 2.00 <input type="checkbox"/> 150-RED DISC SPECIAL, Erie, mostly marked, pop values (#5341) 2.00 <input type="checkbox"/> 20 "WATCH GUTS", LED, who knows how good (#5267) 2.00 <input type="checkbox"/> 10-1000V 1 AMP RECTIFIERS, 1N4007 (#2384) 2.00 <input type="checkbox"/> 100-MOLEX IC CONNECTORS, for 14, 16, 18, 40 sockets (#3324) 2.00 <input type="checkbox"/> 25-POWER TAB TRANSISTORS, T0-202, 30 watts (#2425) 2.00 <input type="checkbox"/> 10-10V USH MICRO TOGGLE SWITCHES, spst (#5636) 2.00 <input type="checkbox"/> 10-MICRO TOGGLEs, spst, dpdt, for panel, etc. (#5636) 2.00 <input type="checkbox"/> 50-2 AMP METAL CASE AXIAL RECTs, up to 1KV (#4006) 2.00 <input type="checkbox"/> 25-SCRs, TRIACS, TRANSISTORS, T0-66 case (#552) 2.00 <input type="checkbox"/> 20 PLESSEY O. 1MF 100V 1" sq. ceramic (#5633) 2.00 <input type="checkbox"/> 10-TV-FM 300 OHM TWIN LEAD SPLICERS (#5547) 2.00 <input type="checkbox"/> 2-9V NIMH BATTERY CHARGER 110vac 1A (#4098) 2.00 <input type="checkbox"/> 4 MIKE HOLDERS, for CB's and other mobile rigs (#5634) 2.00 <input type="checkbox"/> 10 PLESSEY CAPS, 1MF 100V 1" sq. ceramic (unmarked) (#5633) 2.00 <input type="checkbox"/> 100 PLESSEY CAPS, mixed values 1" sq. (unmarked) (#5613) 2.00 |
|---|--|

25 AMP BRIDGE RECTIFIERS

Order by Cat. No. 2273 & voltage

V	Each	IC SALE
50	\$1.95	2 for \$1.96
100	1.49	2 for 1.70
200	1.99	2 for 2.00
400	2.25	2 for 2.51
800	2.50	2 for 2.51

ZENERS!

Order by Cat. No. 5210A & voltage & wattage

Watt	1 Watt	5 Watt	10 Watt	15 Watt
1.8V	1 for \$1.01	1 for \$1.01	1 for \$1.01	1 for \$1.01
2.7V	1 for \$1.01	1 for \$1.01	1 for \$1.01	1 for \$1.01
3.6V	1 for \$1.01	1 for \$1.01	1 for \$1.01	1 for \$1.01
4.7V	1 for \$1.01	1 for \$1.01	1 for \$1.01	1 for \$1.01
5.6V	1 for \$1.01	1 for \$1.01	1 for \$1.01	1 for \$1.01
6.8V	1 for \$1.01	1 for \$1.01	1 for \$1.01	1 for \$1.01
8.2V	1 for \$1.01	1 for \$1.01	1 for \$1.01	1 for \$1.01
10V	1 for \$1.01	1 for \$1.01	1 for \$1.01	1 for \$1.01
12V	1 for \$1.01	1 for \$1.01	1 for \$1.01	1 for \$1.01
15V	1 for \$1.01	1 for \$1.01	1 for \$1.01	1 for \$1.01

LYTIC KLINIC ELECTRO'S

Order by Cat. No. #3269 and value

UF	10	15	20	30	40	50	60	70	80	100	150	200	300	400
10	10	15	20	30	40	50	60	70	80	100	150	200	300	400

WE'RE OVERLOADED WITH BRAND NEW IC'S

Order by type number

IC	1	2	3	4	5	6	7	8	9	10
SN7401	1.18	1.19	1.20	1.21	1.22	1.23	1.24	1.25	1.26	1.27

2 AMP METAL SILICON CYLINDER RECTIFIERS

Order by Cat. No. B04 & voltage

V	50V	100V	200V	400V
50V	1 for \$5.50	2 for \$6.60	3 for \$7.70	4 for \$8.80

LED WATCH GUTS

2 for \$1.96

Factory lay grounds. In they want. Who knows. A sure digital technicians' friend. The complete cuts are there.

LEDS!

YOUR CHOICE 5 for \$1.00 IC SALE 10 for \$1.01

Order by Cat. No.

Color	1	2	3	4	5	6	7	8	9	10
RED	1795	1802	1948	2136	2137	2190	1795	1802	1948	2136

POLY PAKS®

P.O. BOX 942-R2 SO. LYNNFIELD, MA 01940

Terms: Add Postage Rated; Net 30
 Phone: (617) 245-3828
 Retail: 16-18 Del Carmine St.
 MINIMUM ORDER: \$8 Wakefield, MA

"BEEM-O-LITE" LASER DIODES \$0.89

1N4000 Epoxy Rectifiers

Cat. No.	Type	Volts	10 for	20 for	50 for
2377	1N4001	50	10 for \$7.25	20 for \$7.76	50 for \$8.27
2378	1N4002	100	10 for \$9.20	20 for \$9.71	50 for \$10.22
2379	1N4003	200	10 for \$1.19	20 for \$1.20	50 for \$1.21
2380	1N4004	400	10 for \$1.39	20 for \$1.40	50 for \$1.41
2381	1N4005	600	10 for \$1.59	20 for \$1.60	50 for \$1.61
2382	1N4006	800	10 for \$1.79	20 for \$1.80	50 for \$1.81
2383	1N4007	1000	10 for \$1.99	20 for \$2.00	50 for \$2.01

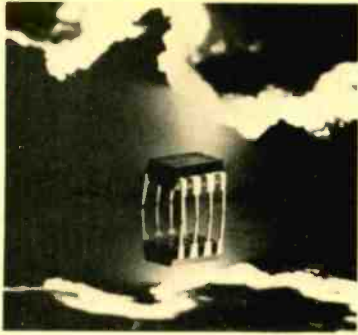

THE NEW HOBBY WORLD CATALOG

Your source for factory prime, professional quality equipment. Computers, add-on boards, IC's, sockets, resistors, supplies, tools, test equipment,

books, and more. Shop your buy list at Hobby World. You'll find what you want, and at a solid savings. For example, look at this month's specials:

NEW FROM CALIFORNIA COMPUTER SYSTEMS! 16K STATIC RAM KIT, MODEL XVI.

IEEE S-100 compatible, requires only +5 Volts. 450 ns, fully buffered. Bank switching capability, Phantom Line, wait state, addressable in 4K blocks.

HOBBY WORLD PRICE ONLY \$265 KIT, \$27 BARE BOARD

16K MEMORY ADD-ON FOR APPLE, TRS-80 OR EXIDY SORCERER

HOBBY WORLD PRICE ONLY \$98 (specify when ordering)

**C-10 DATA CASSETTES - PERFECT FOR TRS-80
PRICE ONLY \$2 EACH! 10 for \$17.50**

SEND ME A FREE CATALOG!

Name _____

Address _____

City _____

State _____

Hobby World
19355 Business Center Dr #6
Northridge CA 91324

TELEPHONE ORDERS
Inside Cal 213 886 9200
Outside Cal 800 423 5387

CIRCLE 44 ON FREE INFORMATION CARD

CATCH-A-PULSE II LOGIC PROBE

10 Nsec SPEED AT 4 to 15V LEVELS

Compatible with DTL, TTL, CMOS, MOS, and Microprocessors using a 4 to 15V power supply. Thresholds automatically programmed. Automatic resetting memory. No adjustment required. Visual indication of logic levels, using LEDs to show high, low, bad level or open circuit logic and pulses. Highly sophisticated, shirt-pocket portable (protective tip cap and removable coil cord). Eliminates need for heavy test equipment. A definite savings in time and money for engineer and technician.

Pat. Pend.
Dealer inquiries welcome

ONLY \$44.95

- 10 Nsec pulse response
- Open circuit detection
- Replaceable tip & cord
- High input impedance
- Pulse stretching
- Multi-family

SPECIAL PAK-II \$51.95

Includes a standard coiled cord, coiled cord with micro hooks, adapter for using CATCH-A-PULSE on logic families whose power supply is 15V to 25V. Shipping add \$2.00 per probe.

AE ELECTRONICS
Box 19299, San Diego CA 92119
(714) 447-1770

CIRCLE 11 ON FREE INFORMATION CARD

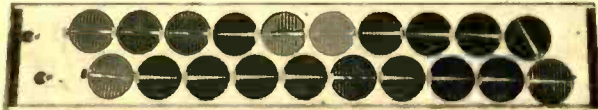

Solar cell panels, used, OK condition

20 cell panel, 2" cells 6 volt 1/2 amp	\$ 75.00
36 cell panel, 12 volt 1/2 amp	100.00
24 cell panel, 8 volt .45 amp	85.00
10 half cell panel, 5 volt 1/4 amp	50.00
5 cell panel, 2.5 volt 1/2 amp	40.00
Single 3.5 inch cell, 1 amp, .45 volt	8.50
Solar power kit, 3.5 inch cell, motor, propellor..	\$ 10.25
ULTRASONIC room alarm, intrusion detection with full data for hookup	40.00

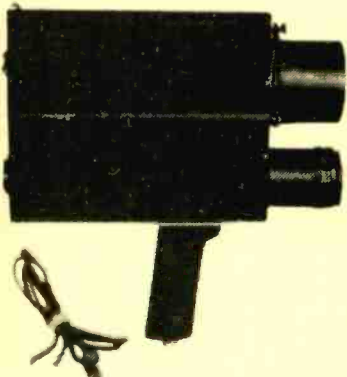

SEE IN THE DARK
IR viewer complete ready to operate. Guaranteed by the manufacturer. Portable, runs on lantern battery. New, see in total darkness. No shipments to Calif. Comes complete with built in IR source and adjustable focus lens.
SPL-21 \$199.00

All items FOB Lynn, Mass. Send for free 64 page catalog jam packed with goodies.

Meshna Inc., PO Box 62, E. Lynn, Mass. 01904

CIRCLE 32 ON FREE INFORMATION CARD

INTEGRATED ELECTRONICS

540 Weddell Drive, #4, Sunnyvale, CA 94086 (408)734-8470

SN6477 Complex Sound Generator \$3.50

This is a programmable sound effect generator capable of producing a wide variety of sounds from high to low frequency. Using this chip & a small number of inexpensive parts, a variety of projects may be built. Spec shs & application notes \$1.00

TL500 Analog Processor \$8.50

The TL500 contains all the active analog elements for an automatic zeroing and automatic polarity. It is a 13-bit dual-slope A/D converter that has true differential inputs. It requires 3 caps. & 2 resistors with no special matching or tolerances. It is designed for use with the TL502. Spec sheet \$.25

TL502 Digital Panel Meter L.D. \$5.50

This is a 4 1/2-digit Digital Panel Meter L.D. that is designed to interface with the TL500 analog processor. It provides base drive for external PNP digit & segment drivers providing direct interface with 7-segment display. Spec sheet \$.25

LD130 A/D Converter \$5.50

Single-reference voltage, auto zero and auto polarity. It is designed for Digital Voltmeters, Panel Meters, Digital Thermometers, Microprocessor Interfaces to Analog Signals, & General Instrumentation. 34-pg. Spec & Application notes \$2.50

MM5865 Programmable Stopwatch \$7.50

7-function Universal Timer and Stopwatch. Start/stop with elapse time, start/stop accumulative event time, split, sequential total elapse time, rally total elapse time, program up and down count. It uses 32.8 KHz crystal or external clock. Spec sheet & 10-page Application notes \$1.50

32.8 KHz Crystal \$4.00

Minimum order \$5.00 US currency. Check or money order only. Add 5% to cover shipping and handling charges. Calif. residents add 6% sales tax. Santa Clara County residents add 6.5% sales tax.

CIRCLE 48 ON FREE INFORMATION CARD

KITS • KITS • KITS

NEW . . . PRE-DRILLED PCB'S FOR ALL 100 SERIES KITS

Perforated Boards **NOT INCLUDED** w/100 Series



103 MINI-WINK NEON FLASHER. Random flash pattern. Interesting displays. 6 neon lamps. AC operated.

103	\$2.95
103A (103 w/PCB)	4.60
103B (103 w/PCB,CASE)	6.85



110 ELECTRONIC WHOOPER SIREN. Powerful wailing sound. Dual oscillator circuit. Use with any alarm circuit. Battery not included.

110	\$4.95
110A (110 w/PCB)	6.50
110B (110 w/PCB,CASE)	9.60



117 TUNABLE ELECTRONIC ORGAN. Tunable 7-note scale. Play sing-a-long favorites. Battery not included.

117	\$6.95
117A (117 w/PCB)	8.90
117B (117 w/PCB,CASE)	12.00



120 SIREN/CODE OSCILLATOR. Loud, piercing alarm. Practice Morse code. Battery not included.

120	\$4.20
120A (120 w/PCB)	5.55
120B (120 w/PCB,CASE)	8.65



104 VARIABLE STROBE LIGHT. Great for parties and photography. Variable flash rate. AC operated.

104	\$9.95
104A (104 w/PCB)	14.20
104B (104 w/PCB,CASE)	19.70



126 PROGRAMMABLE DOORBELL. Adjustable rate and pitch for 15 musical notes. Play favorite tunes. 6 IC's. Uses existing transformer and switch.

126	\$16.95
126A (126 w/PCB)	23.70
126B (126 w/PCB,CASE)	29.20

Perforated Boards **NOT INCLUDED** w/100 Series

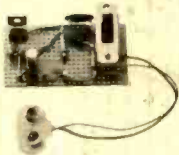

109 AUTO/HOME BURGLAR ALARM. Use with car horn or models 110 or 124 sirens. Latching circuit. Battery not included.

109	\$2.25
109A (109 w/PCB)	3.40
109B (109 w/PCB,CASE)	5.00

114 AUDIO AMPLIFIER. High sensitivity, high gain, use as intercom, PA amp, phone pick-up and others, push-pull output. Battery not included.

114	\$6.35
114A (114 w/PCB)	8.90
114B (114 w/PCB,CASE)	12.00



102 6/9 VOLT SUPPLY. 100mA. Battery eliminator, dual range output switch, neon pilot lamp. AC operated.

102	\$3.95
102A (102 w/PCB)	5.30
102B (102 w/PCB,CASE)	7.25

119 MOTOR SPEED CONTROL. Adjust motor speed to suit application. SCR controlled, use as light dimmer. AC operated.

119	\$3.95
119A (119 w/PCB)	5.50
119B (119 w/PCB,CASE)	7.75



123 ELECTRONIC TIMER. Turns appliances on and off, adjustable control, 2 minutes to 1 hour. 1 IC, AC operated.

123	\$8.95
123A (123 w/PCB)	11.40
123B (123 w/PCB,CASE)	13.65

540 BINARY CLOCK. Handcraft tomorrow's timepiece today. Watch constantly changing patterns of LED's as they display Binary Time. This unique clock piece enhances the learning of Digital Logic and the Binary Coding System, as well as offering a beautifully styled conversation piece.

10 TTL INTEGRATED CIRCUITS • VOLTAGE REGULATOR • 43,000 PULSATING LIGHT PATTERNS • FAST, SLOW AND HOLD CONTROLS • 115VAC 50 or 60Hz.



\$39.95 Complete with 80 page manual

536 8-TRANSISTOR AM RADIO. Experience jewel-like clarity in sound. The best superheterodyne kit circuit available. SEPARATE LOCAL OSCILLATOR for high sensitivity and excellent selectivity. Unique IF Transformer mounting system. 9V battery required (not included).



\$16.45 Complete with 88 page manual

Perforated Boards **NOT INCLUDED** w/100 Series



124 WARBLING SIREN. Two-tone oscillating siren. Loud and penetrating, 2 IC's. For automobile or other 12 volt systems.

124	\$5.65
124A (124 w/PCB)	7.10
124B (124 w/PCB,CASE)	10.20



105 FISH CALLER. Clicking sound imitates distressed fish. Adjustable speed. Battery not included.

105	\$2.95
105A (105 w/PCB)	4.10
105B (105 w/PCB,CASE)	5.70



107 COLOR ORGAN CONTROL — 3 CHANNEL. Over 200W per channel. Separate sensitivity control. Hi-mid-lo frequency response. AC operated.

107	\$9.20
107A (107 w/PCB)	11.85
107B (107 w/PCB,CASE)	14.95



118 TV SCRAMBLER. Tunable to all VHF stations. 30 foot range. Battery not included.

118	\$1.95
118A (118 w/PCB)	2.90
118B (118 w/PCB,CASE)	4.50



122 COMPUTER SOUND EFFECTS GENERATOR. Produces weird, spacey sounds. 4 IC's. Control tone, rate and blip or glide. Battery not included.

122	\$14.95
122A (122 w/PCB)	19.40
122B (122 w/PCB,CASE)	24.90

We accept:
VISA,



MASTER CHARGE BANK AMERICARD,
CALL TOLL FREE

800-824-5136

IN CALIFORNIA CALL 800-852-7631
ASK FOR OPERATOR 318

DO NOT SEND CASH • NO COD • ORDER BY PHONE OR MAIL

CALIF. RESIDENTS ADD 6% SALES TAX.

MINIMUM ORDER \$10.00

WE PAY POSTAGE AND HANDLING

IN U.S.A. OVERSEAS COUNTRIES:

ADD 15% OF TOTAL FOR POSTAGE.

SEND CHECK OR MONEY ORDER TO:

Graymark International, Inc.

1751 McGaw Avenue Dept. 2 Irvine, CA 92714 (714) 540-5480

**ALL
NEW**

Real-State-of-the-Art

TWO NEW AC•DC•BATTERY PORTABLE COUNTERS

OPTO-8000.1A 10Hz to 600 MHz — FREQUENCY COUNTER

- Precision TCXO time base 0.1 PPM Stability 17-40°C
- Super Sensitivity with preamps in both HI-Z & 50 Ohm inputs <10mV to 50MHz, 25 mV @ 150 MHz <50mV to 600MHz
- Auto Decimal Point • Aluminum Case • Socketed IC's
- Three position attenuator: X1, X10, X100 (avoids false counting)

#OPTO-8000.1A	Factory Assembled	\$329.95
#OPTO-8000.1AK	Kit Form	\$279.95
#NI-CAD-80	NI-CAD Battery Pack	\$ 19.95

OPTO-7000 10 Hz to 600 MHz MINIATURE COUNTER

- XTAL (TCXO) Time Base ± 0.08 PPM/°C
- Aluminum Case • HI-Z & 50 Ohm inputs
- 1 Sec. & 1/10 Sec. Gate times • Auto Dec. Pt.
- Built-in Prescaler and Preamps Standard

#OPTO-7000	Factory Assembled - 1 Year-Guar ..	\$139.95
#OPTO-7000K	Kit Form.....	99.95
#AC-70	AC Power Pack.....	4.95
#NI-CAD-70	NI-CAD Battery Pack	19.95
#TCXO-70	Precision TCXO Time Base <0.1PPM, 17-40°C	79.95

ACCESSORIES

PROBES:

#P-100	50 Ohm, 1X	\$13.95
#P-101	Lo-Pass	16.95
#P-102	H1-Z, 2X	16.95
# AP- 8015	UHF Counter Preamp 20 MHz to 600 MHz 15-50 DB Gain (Not Shown) ..	\$49.95/Kit \$39.95

#D-450 Antenna

Rubber Duck RF Pick-up 450 MHz ... \$12.50

#D-146 Same as above

146.5MHz

#RA-BNC Right-Angle BNC Adapter for
above Antenna

2.95

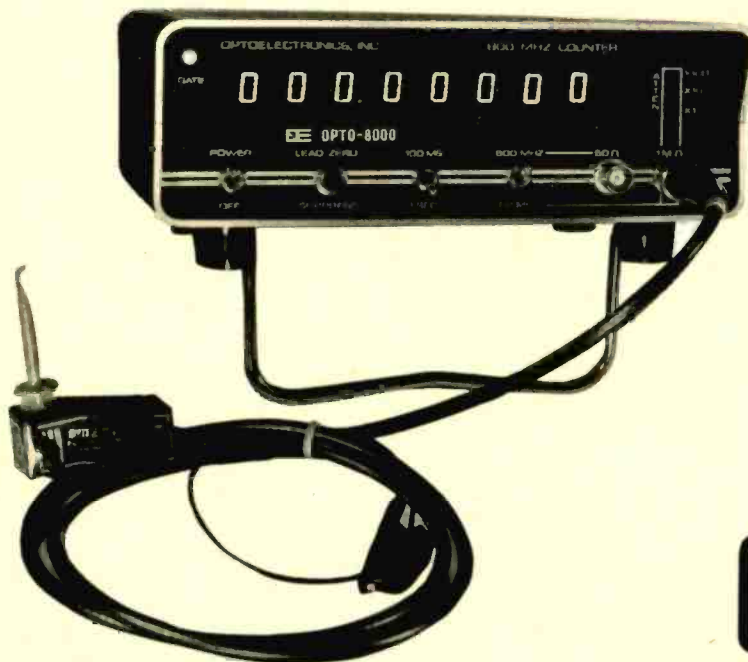

OPTOELECTRONICS, INC.

5821 NE 14 Avenue
Ft. Lauderdale, FL 33334
Phones: (305) 771-2050 771-2051

Phone orders accepted

ORDER FACTORY DIRECT — PHONE OR MAIL

TERMS: Orders to U.S. and Canada, add 5% to maximum of \$10.00 per order for shipping, handling and insurance. To all other countries, add 10% of total order. Florida residents add 4% state tax. C.O.D. fee: \$1.00. Personal checks must clear before merchandise is shipped.

SAVE

COMPUTER INTERFACES & PERIPHERALS

SAVE

For free catalog including parts lists and schematics, send a self-addressed stamped envelope.

APPLE II SERIAL I/O INTERFACE *

Part no. 2

Baud rate is continuously adjustable from 0 to 30,000 • Plugs into any peripheral connector • Low current drain. RS-232 input and output • On board switch selectable 5 to 8 data bits, 1 or 2 stop bits, and parity or no parity either odd or even • Jumper selectable address • SOFTWARE • Input and Output routine from monitor or BASIC to teletype or other serial printer. • Program for using an Apple II for a video or an Intelligent terminal. Also can output in correspondence code to interface with some electrics. Board only — \$15.00; with parts — \$42.00; assembled and tested — \$62.00.



T.V. TYPEWRITER

Part no. 106

• Stand alone TVT • 32 char/line, 16 lines, modifications for 64 char/line included • Parallel ASCII (TTL) input • Video output • 1K on board memory • Output for computer controlled cursor • Auto scroll • Non-destructive cursor • Cursor inputs: up, down, left, right, home, EOL, EOS • Scroll up, down • Requires +5 volts at 1.5 amps, and -12 volts at 30 mA • All 7400, TTL chips • Char. gen. 2513 • Upper case only • Board only \$39.00; with parts \$145.00

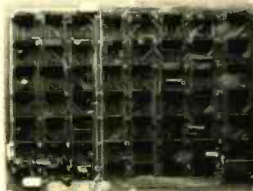

8K STATIC RAM

Part no. 300

• 8K Altair bus memory • Uses 2102 Static memory chips • Memory protect • Gold contacts • Wait states • On board regulator • S-100 bus compatible • Vector input option • TRI state buffered • Board only \$22.50; with parts \$160.00

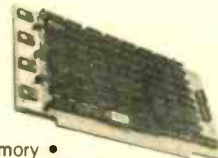

MODEM *

Part no. 109

• Type 103 • Full or half duplex • Works up to 300 baud • Originate or Answer • No coils, only low cost components • TTL input and output-serial • Connect 8 ohm speaker and crystal mic. directly to board • Uses XR FSK demodulator • Requires +5 volts • Board \$7.60; with parts \$27.50



TIDMA *

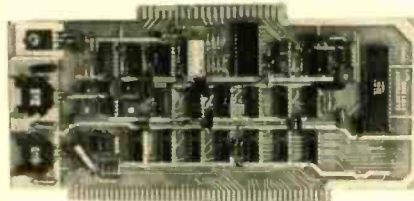

Part no. 112

• Tape Interface Direct Memory Access • Record and play programs without bootstrap loader (no prom) has FSK encoder/decoder for direct connections to low cost recorder at 1200 baud rate, and direct connections for inputs and outputs to a digital recorder at any baud rate. • S-100 bus compatible • Board only \$35.00; with parts \$110.00

RF MODULATOR *

Part no. 107

• Converts video to AM modulated RF, Channels 2 or 3. So powerful almost no tuning is required. On board regulated power supply makes this extremely stable. Rated very highly in Doctor Dobbs' Journal. Recommended by Apple. • Power required is 12 volts AC C.T., or +5 volts DC • Board \$7.60; with parts \$13.50



DC POWER SUPPLY *

Part no. 6085

• Board supplies a regulated +5 volts at 3 amps., +12, -12, and -5 volts at 1 amp. • Power required is 8 volts AC at 3 amps., and 24 volts AC C.T. at 1.5 amps. • Board only \$12.50; with parts excluding transformers \$42.50



RS 232/TTY * INTERFACE

Part no. 600

• Converts RS-232 to 20mA current loop, and 20mA current loop to RS-232 • Two separate circuits • Requires +12 and -12 volts • Board only \$4.50, with parts \$7.00



TAPE INTERFACE *

Part no. 111

• Play and record Kansas City Standard tapes • Converts a low cost tape recorder to a digital recorder • Works up to 1200 baud • Digital in and out are TTL-serial • Output of board connects to mic. in of recorder • Earphone of recorder connects to input on board • No coils • Requires +5 volts, low power drain • Board \$7.60; with parts \$27.50



UART & BAUD RATE GENERATOR *

Part no. 101

• Converts serial to parallel and parallel to serial • Low cost on board baud rate generator • Baud rates: 110, 150, 300, 600, 1200, and 2400 • Low power drain +5 volts and -12 volts required • TTL compatible • All characters contain a start bit. 5 to 8 data bits, 1 or 2 stop bits, and either odd or even parity • All connections go to a 44 pin gold plated edge connector • Board only \$12.00; with parts \$35.00 with connector add \$3.00

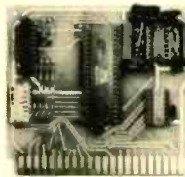

RS 232/TTL * INTERFACE

Part no. 232

• Converts TTL to RS-232, and converts RS-232 to TTL • Two separate circuits • Requires -12 and +12 volts • All connections go to a 10 pin gold plated edge connector • Board only \$4.50; with parts \$7.00 with connector add \$2.00



ELECTRONIC SYSTEMS

Dept. RE-9 P.O. Box 21638, San Jose, CA. USA 95151

To Order:

Mention part number and description. For parts kits add "A" to part number. In USA, shipping paid for orders accompanied by check, money order, or Master Charge, BankAmericard, or VISA number, expiration date and signature. Shipping charges added to C.O.D. orders. California residents add 6.5% for tax. Outside USA add 10% for air mail postage, no C.O.D.'s. Checks and money orders must be payable in US dollars. Parts kits include sockets for all ICs, components, and circuit board. Documentation is included with all products. All items are in stock, and will be shipped the day order is received via first class mail. Prices are in US dollars. No open accounts. To eliminate tariff in Canada boxes are marked "Computer Parts." Dealer inquiries invited. 24 Hour Order Line: (408) 226-4064



* Circuits designed by John Bell

AMAZING EARADIO

THIS IS PROBABLY THE WORLD'S SMALLEST RADIO. IT WEIGHS ONLY 1/2 OUNCE AND IS KNOWN BEHIND THE EAR. CONTAINS AN IC AND SEVERAL DISCRETE DEVICES TO GIVE AN EQUIVALENT OF 12 TRANSISTORS. THE RADIO HAS A T.R.F. DESIGN OPERATING FROM 1 STANDARD 1.5V HEARING AID BATTERY (INCLUDED). IT PROVIDES GOOD VOLUME TO EARPHONE ON SEVERAL STATIONS IN METROPOLITAN AREAS. DOESN'T REQUIRE ANY ANTENNA, GROUND OR OTHER ADDITIONAL WIRES - FULLY SELF CONTAINED & TUNABLE. SIZE: 1 1/8" x 1 1/4" x 3/8".

\$5.95

Crystal 14.04 Mhz Oscillator
IC clock oscillator
C23289 \$1.98

SEND FOR YOUR FREE 1979 CATALOG

LIQUID CRYSTAL MATCH DISPLAY \$1.25
SLIDE SWITCH \$3.00
MICRO-MINIATURE ROTARY SWITCH 1 POSITION \$1.00
LASER 200 VOLT 3 AMP \$1.00

Electronic Warning Flasher Kit

This battery operated device continuously emits bursts of intense light. Great safety device for bicycle riders, skiers, hikers, boaters & campers. Comes complete w/ all electronic parts, quality glass epoxy P.C. board & easy to understand instructions. Uses high-output xenon flash tube which flashes 2 times per second when batteries are fresh. Operates continuously for 12 hours on 2 alkaline "C" batteries. You need only to supply the batteries and, if desired, a battery holder & case.

C23207 \$6.95
(3 for \$18.00)

Strobe Light Kit
COMPLETE strobe kit with strobe light and complete parts including long life PC board and instructions. Order on 17 VAC. \$7.50

6 MV TRIGGER COILS 2 for \$1
required to "fire" xenon flash tubes
6 for \$1.00

Green Neon
Same as NE2 but glows GREEN. Operates on 120V.
6 for \$1.00

PHOTOFL/AM CAPS
350 mf 330V 100
720 mf 360V 150
1600 mf 360V \$2.25

CALCULATOR BOARDS
WITH DISPLAY LESS KEYBOARD AND CASE (AS IS) \$1.50

STROBE TUBE ASST.
Brand new factory prime strobe tubes. Assortment of 5 strobe tubes w/ schematics
C23280 \$3.00

MINIATURE REFLECTOR
Approx. size: 1-7/16" L x 7/8" W x 3/4" D.
C23227 \$1.00

CHANEY electronics

- Minimum order \$5.00
- Please include \$1 for postage
- Visa, MC and COD accepted.
- Phone orders are welcome.

P.O. BOX 27038, DENVER, CO. 80227 Ph: (303) 781-5750
Send for our FREE GIANT CATALOG of unique items!!!

ADVERTISING INDEX

RADIO-ELECTRONICS does not assume any responsibility for errors that may appear in the index below.

Free Information Number Page

33 Active Electronics 101

— Advance Electronics 26, 79 & 83

16 Advanced Computer Products 118

— A M C Sales 98

19 American Antenna Cov. 4

63 Antenna Incorporated 22 & 23

62 A P Products, Inc. 81

11 A V R Electronics 114

— Karel Barta 100

56 B & K Precision Dynascan Co. 86

— Bullett Electronics 100

— Burdex Security Co. 98

51 C F R Associates 102

— Chaney Electronics 122

— CIE-Cleveland Institute of Electronics 18-21

— Command Productions 106

25 Continental Specialties Cov. 3

41 The Cooper Group Electronics Division 7

— C R E I - Div. of McGraw Hill Continuing Ed. 70-73

— Dage Scientific Instruments 98

64 Davis Electronics 87

14 Delta Electronics 106

70 Diamondback Electronics 108

59 Digi - Key 119

— DRC-Digital Research Corporation 102

26 E I C O 96

35 Electronics 85

23 Electronics Book Club (Tab Books). 25

— Electronic Development Lab 102

40 Electronic Supermarket 100

71 Electronic Systems 117

— Electro - Voice, Inc. 82

— E M C - Electronics Measurements 95

29 Enterprise Development 96

46, 47 & 72 Fluke 32 & 75

42 Fordham Radio Supply 120

13 Formula International 104 & 105

— Fowler Alarms 98

— Fuji - Svea 99

— Gavin Instruments 95

— G. E. - General Electric 27

— Gilfer Shortwave 106

28 Godbout Electronics 112

— Golden Enterprises 98

7 Gould Cov. 2

17 Grantham College of Engineering 92

36 Graymark 115

100 Heath 88-91

69 Hickok Electrical Instruments 17

44 Hobby World 114

48 I E Intergrated 114

— Indiana Home Study 102

— Information Unlimited 97

60 International Crystal Mfg. Co. 87

24 International Instrumentation 108

9, 10 James Electronics 35, 110 & 111

4 Jensen Tools & Alloys 92

3 Kester Solder 84

— Lakeside Industries 100

52 McKay Dymek 14

32 Meshna 114

— Millco Industries 98

27 M T I-Mobile Training Institute 95

5 National Camera Supply 94

— National Radio Inst. (NRI) Div. of McGraw Hill 8-11

— National Technical Schools 28-31

58 Netronics 93

43 New-Tone Electronics International 108

15 Ohio Scientific 1

— Olson 98

6 Optoelectronics 116

67 P A I A 93

54 Panavise 96

61 Platt Luggage 16

34 Poly Paks 113

37 Pomona 36

38 President Electronics Cov. 2

66 P T S Electronics 112

45 Quest 121

8 Quimtronix 106

— Radio Shack 103

39 Ramsey Electronics 107

— R C A 76 & 77

22 Rye Industries 16

— Sabtronic 15

31 Schober Organ 75

2 Shure Brothers 33

57 Soar 85

21 Solid State Sales 112

68 Southwest Technical Products 94

— Speakerlab, Inc. 97

— Starshine 13

— Tasco 98

18 Trinico International 109

12 Tri-Star 102

— Tri-Tek 97

— Trumbull 97

55 Vector 24

49 Viz Mfg. 34

20 Wersi Electronics 122

30 Zemco 5

Now, more than ever ... Men who KNOW say...



IS THE ANSWER

HELP NATESA HELP YOU BY DOING YOUR PART

Are YOU the operator of an ethical, professional caliber tv-radio-home electronics service business?

Write for details on how you can gain great benefits and participate in the destinies of this great industry.

NATESA
5908 South Troy Street
Chicago, Illinois 60629

MOVING?

Don't miss a single copy of **Radio-Electronics**. Give us:

Six weeks' notice

Your old address and zip code

Your new address and zip code

ATTACH LABEL HERE

name (please print) _____

address _____

city state zip code _____

Mail to: **Radio-Electronics**
SUBSCRIPTION DEPT., P.O. BOX 2520,
BOULDER, COLO. 80322

How to be in 16 places at once. Logically.



Meet CSC's Logic Monitor LM-1. The fastest, most efficient way to check digital DIP IC's. A self-powered, precision instrument that automatically senses and displays the static and dynamic states of every node on any DIP up to 16 pins *at once*. Instantly. Accurately. And *safely*. Speeds design and testing on all types of DTL, TTL, HTL and CMOS logic.

Use LM-1 to trace signals through counters, shift registers, gating networks, flip-flops, decoders ... any type of circuit or system, even with mixed logic families. Cutting minutes—often hours—from design, development, debugging, production testing, QC, field service and repair.

Nothing could be simpler to use. Just clip it over any DIP up to 16 pins, and the LM-1 does the rest. Precision plastic guides and unique flexible web

insure positive connections between non-corrosive nickel-silver contacts and IC leads. Each contact connects to a single "bit" detector with high-intensity LED readout, activated when the applied voltage level exceeds a fixed 2V threshold. Logic "1" (high voltage) turns LED on; Logic "0" (low voltage or open circuit) keeps LED off. A power-seeking gate network automatically locates supply leads and feeds them to the Logic Monitor's internal circuitry.

Very clever. Very portable. Very effective. And very reasonable, at \$59.95* Order today.

NEED MORE INFORMATION? CALL 203-624-3103 to order, or for the name of your local distributor. Prices slightly higher outside USA.

CONTINENTAL SPECIALTIES CORPORATION

Corporate Headquarters:
Continental Specialties Corporation
70 Fulton Terrace, Box 1942, New Haven, CT 06509
351 California St., San Francisco, CA 94104
(415) 421-8872, TWX 910-372-7992



Europe, Africa, Mid-East: CSC UK LTD.
Shire Hill Industrial Estate, Units 1 and 2
Saffron Walden, Essex CB 11 3AQ
Telephone: SAFFRON WALDEN 21682
Telex: 817477

©1978, Continental Specialties Corporation. *Manufacturer's suggested retail. Prices, subject to change without notice.

CIRCLE 25 ON FREE INFORMATION CARD

New, K40 Magnamount: Grips like a grapple, actually improves transmission.



We double guarantee it.*

Exclusive Octopole Construction.



That's eight magnets set in eight different directions to give you a magnetic seal so complete and powerful, your antenna would stay up there if you could squeeze between two semis passing each other at 180 miles an hour. That's magnetic octopower.

* GUARANTEE I

Placed on the roof of a vehicle; properly tuned, the K40 Magnamount is guaranteed to transmit a further distance than a standard K40 without the Magnamount or you will receive a prompt and full refund from your K40 dealer who installed and tuned the Magnamount K40 for you.

* GUARANTEE II

Materials and workmanship are guaranteed for a full 12 months. Any part that fails to perform satisfactorily will be replaced absolutely free.

Exclusive K40 Flux Harmonics for Greater Transmission.

The magnetic radiation pattern was designed to match the K40 antenna radiation for greater distance than the standard K40. See our guarantee.

The facts: Physics and Physical.

1. Magnamount is a bigger, stronger magnet—in fact it's 8 bigger, stronger, magnets.
2. It doesn't just hold the K40 antenna, it helps it transmit further.
3. Remember the law of reciprocity. The antenna that transmits better, receives better.
4. It provides a flatter, lower SWR because the Magnamount is capacitance grounded.
5. It puts your $\frac{5}{8}$ wave K40 antenna securely in place in the most advantageous place to work against a ground plane—high and free from obstruction. That's square in the middle, right up on top.

\$15.95 buys it.

(SUGGESTED RETAIL)

K40 Magnamount.

American Antenna 1945 South Street Elgin, Illinois 60120

This professional CB equipment available only through Registered K40 Dealers!

CIRCLE 19 ON FREE INFORMATION CARD