

PROJECTS—CB—HI-FI—SERVICING

\$1.00 ■ JULY 1977

Radio-Electronics®

THE MAGAZINE FOR NEW IDEAS IN ELECTRONICS

make life easier
WORKBENCH ACCESSORIES
 give you a third hand

try your luck!
ELECTRONIC SLOT MACHINE
 you can build

all about
ANTI-COLLISION SYSTEMS
 for your car

clear the air
CB NOISE BLANKERS
 how they work

- PLUS:**
- ★ **What is TIM Distortion**
 - ★ **Hi-Fi Lab Test Reports**
 - ★ **Fisher RS-1080 Receiver**
 - ★ **Jack Darr's Service Clinic**
 - ★ **Equipment Reports**
 - ★ **Computer Corner**



A
GERNSBACK
 PUBLICATION



3C9196 DRK 6450M090 14 A JUN78
 LLOYD DARKNELL DR
 1480 HAYLEWOOD DR
 CA 95129

screen
OCK
 s to any set



THE NEW REVOLUTION FROM DISCWASHER.

DiscTraker is a revolutionary pneumatic damping device that provides a critical protective cushion so badly needed with state-of-the-art tonearms and cartridges.

- effectively reduces tonearm/cartridge resonance at low frequencies.
- drastically and listenably reduces record-warp resonance (woofer flutter).
- allows badly warped records to be played with fidelity and without record wear or stylus damage.
- applicable to any tonearm.
- patented in all industrialized countries.

DiscTraker greatly enhances the performance of fine record playback systems; another example of Discwasher's leadership and innovative technology.



DiscTraker™

 **discwasher[®], inc.**
1407 N. Providence Rd.
Columbia, Missouri 65201

CIRCLE 65 ON FREE INFORMATION CARD

Telephone Answering Breakthrough



The new Ford Code-A-Phone 1400 answering computer.

Let a new remote control answering computer free you from your next telephone call.

It's a telephone answering computer. The Ford Code-A-Phone 1400 has the first large-scale integration of solid-state componentry—a major change in telephone answering systems since the first mass consumer models appeared five years ago. This means more features, lower cost and greater dependability. Here are some of its exciting features:

Forget about tapes There are no tapes to buy. The Ford unit has a special polymer-based magnetic tape that will record over 25,000 phone calls without replacement. That's over five solid years of use. There are no cassette tapes to buy, wear out or replace.

Forget about microphones When you want to change or record your message, just press a red button, record your message and let go. The message (any length up to 20 seconds) will record and be immediately ready to playback since the message tape does not have to recycle. There are no separate microphones or level controls since the built-in microphone automatically adjusts to your voice.

Forget about touching it You can adjust your unit to answer on either one or four rings. When the unit is set on four rings and you reach the phone before the 1400 answers, you will not activate the unit. But let us say you're outside or indisposed. No problem. Code-A-Phone will automatically answer after four rings. This means that your unit can always be "alive" in the four-ring position so you never have to remember to set it whenever you leave your home or office.

Forget about going home Just bring your optional remote control pager with you. If you want your messages while you're on vacation or away, call your number and the coded pager will remotely signal your unit to playback all your messages.

Forget about service If you've owned a telephone answering device for more than a year, there's a good chance that it's been in for service at least once. The Code-A-Phone, however, is solid state and built with the same heavy duty components used in commercial units. It should dependably stand up to years of heavy usage. (Ford Industries is the world's largest supplier of telephone answering equipment for the Bell system.) If service is ever required, there are over 200 authorized service centers plus a service-by-mail center. There's also a toll-free "Help-Line" number to call 24 hours a day for advice or suggestions, and your unit has a limited ninety day parts and labor warranty.

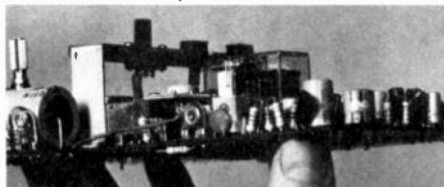

The entire printed circuit-board with its integrated circuits is easily replaceable and contains the "Brains" required to control the audio amplifier and tape transport system.

PLENTY MORE FEATURES

Code-A-Phone has a monitor feature—you can listen to the caller leave his message and pick up the phone to intercept the call. If you want to skip over a message on the tape, just tap a button and it fast-advances to the start of the next call. It has a selectable erase feature that lets you erase a specific message or the entire tape if you wish.

KNOW HOW MANY CALLS

With other answering machines, you never know how many calls you receive until you play them back. With Code-A-Phone you have a call counter—a device that displays the exact number of calls you've received when you arrive home. If you now own another answering machine, you can really appreciate this convenient and exclusive feature.



Hold the small pocket-sized remote-control pager up to any telephone in the world and you can playback all your messages.

Code-A-Phone is the first really versatile answerer that works equally well at home or in the office. It's perfect for the busy or working housewife who spends little time at home. And, if she's home and just plain busy when the phone rings, she can always call back later without offending the caller.

The executive can now leave his office, call from the field and get all his messages. An inefficient operator at a telephone answering service may offend your customers by putting them on hold. Code-A-Phone, however, takes your message quickly—without delay.

There are very few people who haven't left a message on a telephone answering machine, and callers really appreciate the convenience.

NO PHONE COMPANY TARIFFS

Code-A-Phone is equipped with an FCC-registered interconnect device so your unit is actually welcome on your phone line. The 1400 comes with a four-pronged plug so you just plug it into your phone jack. If you don't have a phone jack, just call your phone company and tell them you are purchasing an approved Code-A-Phone and that you want a four-pronged jack for your phone. They'll know exactly what you want and charge you around \$12 for the installation, depending on where you live. If you have a multi-line phone, they can install a jack to tie into any or all of the lines you wish. There are no additional monthly charges.

STANDING BEHIND A PRODUCT

JS&A lets you use the 1400 in your home or office for one full month. Use it to screen your calls, take messages while you're gone or as a back up system when you're busy. Use the remote pager and retrieve calls while you're out. See how easy it is to change the message in seconds, and see how much it uncompliments your life. Use it under your everyday conditions at home or at your office and then decide after one month whether or not you want to keep it. If you decide to keep it, you'll own the best. If not, return your unit for a full and prompt refund. There is no risk. Even if you already own a phone answerer, it would pay for you to see how much better the Code-A-Phone performs.

JS&A is America's largest single source of space-age products and a substantial company—assurance that your purchase is protected.

The Code-A-Phone comes in two models: the Remote Control unit for \$259.95 called the 1400 and the same unit without the pager but with all the other features for \$179.95 called the 1200. Simply select the unit you want and send your check for the correct amount to the address shown below. Credit card buyers may phone in their orders by calling our toll-free number below. (Illinois residents add 5% sales tax.) There are no postage and handling charges.

By return mail, you'll receive a Code-A-Phone complete with all connections and instructions (extra pagers are available for remote unit) plus your ninety day limited parts and labor warranty. The unit measures 3 1/4" x 8 1/2" x 12" and weighs six pounds.

Code-A-Phone compares to units that sell for much more but do not have the simplicity and the advanced electronics. Don't be confused. Code-A-Phone is the finest telephone answerer you can buy at any price and is years ahead of all other conventional systems.

JS&A gives you everything you could possibly expect from a telephone answering system: 1) A unit years ahead of every other unit at a very reasonable price. 2) A service network that covers the United States with repair centers and free telephone assistance. 3) The chance to buy a unit in complete confidence, knowing that you may return it without being penalized with a postage and handling charge if it's not exactly what you want. You can't lose.

Computer technology has even touched the telephone answerer. Now is the best time to get the finest system available. Order your Code-A-Phone without obligation, today.

JS&A NATIONAL SALES GROUP

Dept. RA One JS&A Plaza
Northbrook, Ill. 60062 (312) 564-9000

CALL TOLL-FREE... 800 323-6400
In Illinois call... (312) 498-6900

©JS&A Group, Inc. 1977

At 55 mph, CB ought to be as easy to use as a push-button radio.

SBE Key/Com 1000, an entirely new experience in CB radio that has a micro-computer as its heart. A keyboard entry control system lets you do things no other CB radio can do. And do it as easily as operating a push-button radio.

With keyboard entry, you can tell the computer to do something as simple as change channels. Or as sophisticated as remembering any 10 channels you select... Channel searching for locating active channels... Automatic transfer to priority channels of your choice... Periodic channel 9 monitoring...



CONTROL PANEL
SBE KEY/COM 1000

Instant keying for emergency channel communication... And more.

Naturally, you get full legal power, a large, bright LED channel readout, and all the other controls you'd expect from a luxury SBE mobile CB.

The Key/Com 1000 is waiting for you at your SBE dealer. Go see it... the one CB radio with a brain.

Better Communications through Creative Technology



For information write:
SBE, Inc.,
220 Airport Blvd.,
Watsonville, CA 95076

INTERNATIONAL OFFICES: E. S. Gould Marketing Co. Ltd., Montreal, Canada/Linear Systems S.A. Geneva 1, Switzerland



CIRCLE 25 ON FREE INFORMATION CARD

Radio-Electronics®

THE MAGAZINE FOR NEW IDEAS IN ELECTRONICS

Electronics publishers since 1908

JULY 1977 Vol. 48 No. 7

BUILD ONE OF THESE

- 35 **On-Screen TV Clock (Cover Story)**
Connect it to your set for a digital readout of the time.
by Fred Blechman
- 39 **Electronic Slot Machine**
A digital readout of your winnings plus illuminated display symbols makes this a great addition to your game room.
by Gregory W. Hart
- 44 **Automotive Anti-Collision Systems**
An in-depth look at these systems, with enough information for the advanced hobbyist to build one. by Martin B. Weinstein

CB RADIO

- 60 **Automatic Noise Blankers**
A look at how these circuits improve performance.
by Robert F. Scott

HI-FI STEREO

- 47 **TIM DISTORTION**
A new clue to explaining the difference between solid-state sound and vacuum-tube sound. by Len Feldman
- 50 **R-E Lab Test Report**
Fisher RS-1080 AM/FM Receiver

GENERAL ELECTRONICS

- 4 **Looking Ahead**
Tomorrow's news today. by David Lachenbruch
- 22 **Computer Corner**
The vectored interrupt
by David G. Larson, Jon Titus and Peter R. Rony
- 53 **Digital Multimeters**
What you should know before you buy or use one.
by Charles Gilmore
- 56 **Extra Hands For The Hobbyist**
Workbench accessories make PC board assembly easier and more pleasurable. by Earl Savage K4SDS
- 63 **State-of-Solid-State**
New Telephone Dailer IC. by Karl Savon

TELEVISION

- 26 **Equipment Report**
Polaris CT-751 Curve Tracer
- 58 **Step-By-Step Troubleshooting**
Sync-Separator circuits. by Jack Darr
- 66 **Service Clinic**
Focus Troubles. by Jack Darr
- 76 **Clinic Questions**
R-E's Service Editor solves technician problems

DEPARTMENTS

- | | |
|------------------------------|------------------------|
| 88 Advertising Index | 80 New Books |
| 12 Advertising Sales Offices | 78 New Products |
| 14 Letters | 85 Next Month |
| 6 New & Timely | 89 Reader Service Card |

ON THE COVER

Another great construction project from **Radio-Electronics**. This one updates your TV set with an on-screen digital readout of the time. The clock is built around a character generator from National Semiconductor that provides you with a choice of either a 4- or 6-digit readout of the time. Get started today; turn to page 35.

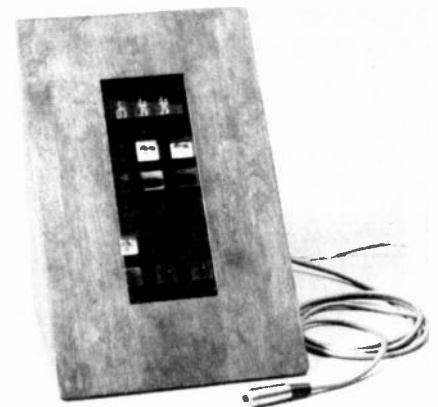

ELECTRONIC SLOT MACHINE you'll want to build. Digital readout of the score plus realistic odds makes this a great addition to your game room. Construction details start on page 39.

Radio-Electronics, Published monthly by Gernsback Publications, Inc., 200 Park Avenue South, New York, NY 10003. Phone: 212-777-6400. Second-class postage paid at New York, NY and additional mailing offices. One-year subscription rate: U.S.A., U.S. possessions and Canada, \$8.75. Pan-American countries, \$10.25. Other countries, \$10.75. Single copies \$1.00 © 1977 by Gernsback Publications, Inc. All rights reserved. Printed in U.S.A.

Subscription Service: Mail all subscription orders, changes, correspondence and Postmaster Notices of undelivered copies (Form 3579) to Radio-Electronics Subscription Service, Box 2520, Boulder, CO 80322.

A stamped self-addressed envelope must accompany all submitted manuscripts and/or artwork or photographs if their return is desired should they be rejected. We disclaim any responsibility for the loss or damage of manuscripts and/or artwork or photographs while in our possession or otherwise.

As a service to readers, Radio-Electronics publishes available plans or information relating to newsworthy products, techniques and scientific and technological developments. Because of possible variances in the quality and condition of materials and workmanship used by readers, Radio-Electronics disclaims any responsibility for the safe and proper functioning of reader-built projects based upon or from plans or information published in this magazine.

looking ahead

First 1978 TV's: General Electric was first to demonstrate its new 1978 TV-set models, and they're highlighted by the addition of a random-access digital remote tuner linked to the set by infra-red light rather than ultrasonics. The calculator-like remote tuner uses an 82-channel digital frequency synthesizer, using phase-locked-loop (PLL) circuitry with a quartz crystal reference to select VHF and UHF channels. The tuning panel also contains volume, off-on and mute controls, and adds about \$140 to the price of the set as compared with a mechanically tuned non-remote version.

G-E has also extended the VIR "broadcast-controlled" color feature to more sets in its line, and most of its color sets without VIR have a different automatic color system, which G-E hints is directly competitive with RCA's ColorTrak and Zenith's Color Sentry.

RCA chooses: Once again, RCA and Zenith find themselves on opposite sides of the fence. You'll recall that Zenith chose to market the new Sony-developed Betamax system that records two hours on the same cassette. (*Radio-Electronics*, May 1977.) Now RCA has selected a different, non-compatible system, but one that can cram four hours of recording onto a single cassette not much larger than that used in the Betamax.

RCA's system is the VHS, developed by Japan Victor Co. (JVC) as the leading contender against Betamax. However, the version picked has been re-engineered by JVC's parent company, Matsushita Electric, and the tape speed cut in half and track width reduced, with a special noise-reduction circuit added to maintain a signal-to-noise ratio comparable to that of the shorter-playing machine. This is believed to have been accomplished in a manner similar to Sony's speed-reduction program—in fact, Matsushita and Sony are both members of a patent-pooling consortium for home videocassette recorders.

The machine that RCA will introduce late this summer has outstanding tape economy. Since the half-inch tape loafs along at about 0.66 inches-per-second, it uses only about 8.35 square feet of tape per hour in the four-hour mode (it has a two- and four-hour switch), as compared with 10.3 square feet for the two-hour Betamax.

When marketing of the two new machines begins in earnest this fall, it should result in a battle royal, keyed by the ancient Zenith-RCA rivalry. Prices hadn't been announced at presstime, but it's logical to expect the machines to list at \$1,000 or more—at least until competition brings them down. Meanwhile, other manufacturers are choosing up sides, and will offer one system or the other—either manufacturing them themselves or buying the decks, as RCA and Zenith plan to do.

In the Sony "Beta format" camp are Sony, Zenith, Sanyo, Toshiba, Pioneer and Sony subsidiary Aiwa. Siding with Matsushita are RCA, Matsushita's

subsidiaries Panasonic and JVC, Hitachi, Mitsubishi (MGA) and Sharp. Uncommitted U.S. TV manufacturers include Magnavox and Sylvania, expected to make up their minds soon, and G-E, which may wait till the dust settles.

If you've already bought a one-hour Betamax, Sony is expected to help you extend its recording time with the offer of a two-cassette changer. Although two of Matsushita's American subsidiaries—JVC and Panasonic—are expected to offer the VHS machine here, the third, Quasar, is continuing to market a third system that it calls The Great Time Machine with a two-hour recording time per cassette but incompatible with the other two systems.

Games via cable: Subscribers to Manhattan Cable TV now have the opportunity to match skill with each other in video games, thanks to an enterprising non-profit group called Experimental TV Cooperative (ETC). "The Game Show" is presented once a week on the cable system's public-access channel and lets viewers use Touch-Tone telephones in their homes to operate the games. Here's how it works: The viewer calls the phone number displayed on the screen and he's asked what extra game he wishes to play. After instructions on playing, the playing field is superimposed on the screen, and the caller competes against other callers.

In the game of pinball, the telephone's "1" button activates the right flipper, the "3" the left flipper. In Pong, pressure on "1" moves the paddle down, "3" moves it up. ETC President Dan Fodor, a studio engineer, designed and built the circuitry for the remote game-playing. It processes the frequency tone from the Touch-Tone phone and translates it from a digital to an analog signal for Pong—changes in voltage drive the paddle up or down. In pinball, the digital signal is used without conversion to analog. Other possibilities are being studied, and Fodor says he hopes to develop more complicated games using more Touch-Tone buttons.

And another one: One American and two German manufacturers have tentatively decided to build a completely different type of home videocassette recorder, but it's not expected to be available before 1979, if then. The manufacturers are Bell & Howell in the U.S. and BASF and Robert Bosch (Blaupunkt) in Europe. The system, developed by BASF, is called LVR (Longitudinal Video Recording). It uses 1/4-inch tape with 28 parallel video tracks, moving past a stationary head at 120 inches-per-second. When one track has made a complete pass of the head, the tape reverses and the head is switched to the next track. After all 28 passes are completed, two hours of recording have been made in a single cassette. Claimed advantages of the system are simplicity and low cost. It's believed the LVR may not be offered as a competitor to Beta and VHS.

DAVID LACHENBRUCH
CONTRIBUTING EDITOR

TUNER SERVICE CORPORATION

SUBSTITUNER



\$4995
U.S.A. ONLY

WITH CABLES

ONE YEAR GUARANTEE

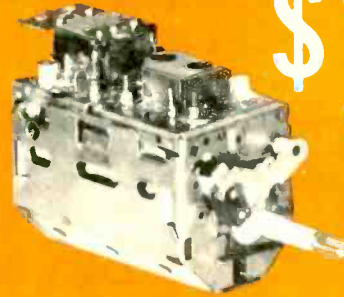

\$1095
U.S.A. ONLY

Major Parts and Shipping Charged at Cost

FEATURES

- A UHF Tuner with 70 channels which are detented and indicated just like VHF channels.
- A VHF Hi Gain Solid State Tuner.
- AC Powered.
- 90 Day Warranty.

Demonstrate the **SUBSTITUNER** to your customers and show improved reception with their TV sets.

You may place your order through any of the Centers listed below.

PROVIDES YOU WITH A COMPLETE SERVICE FOR ALL YOUR TELEVISION TUNER REQUIREMENTS.

TUNER REPAIRS

VHF OR UHF ANY TYPE.....(U.S.A.) \$10.95
UHF/VHF COMBINATION.....(U.S.A.) \$17.95

MAJOR PARTS AND SHIPPING CHARGED AT COST

- FAST, EFFICIENT SERVICE AT ANY OF THE CONVENIENTLY LOCATED SERVICE CENTERS LISTED BELOW.
- ONLY ORIGINAL FACTORY PARTS USED
- All tuners ultrasonically cleaned, repaired and realigned.

EXACT REPLACEMENT

- Exact Replacement Tuners are available at a cost of \$14.95 and up. (U.S.A. Only)
- Send in your original tuner for comparison purposes to any of the Centers listed below.

UNIVERSAL REPLACEMENT

- UNIVERSAL REPLACEMENT TUNER \$13.95..... (U.S.A. Only)
- This price buys you a complete new tuner built specifically for this purpose.
- All shafts have a maximum length of 10 1/2" which can be cut to 1 1/2".
- Specify heater type parallel and series 450 mA or 600 mA.

FLASH

NOW AVAILABLE—TUNER SERVICE PARTS CATALOG

OF ALL SARKES TARZIAN VHF AND UHF TUNERS, INCLUDING EXPLODED VIEW DRAWINGS. OVER 200 PAGES. ORDER YOUR COPY TODAY. SEND \$2.50 WITH ORDER TO BLOOMINGTON HEAD OFFICE.



WATCH US GROW

| | | | |
|----------------|----------------------------------|-------------------------------------|-------------------|
| HEADQUARTERS | BLOOMINGTON, INDIANA 47401 | 537 South Walnut Street | Tel. 812/334-0411 |
| ARKANSAS | LITTLE ROCK, ARKANSAS 72204 | 4200-C Asher Ave. | Tel. 501/661-0383 |
| ALABAMA | BIRMINGHAM, ALABAMA 35212 | 5823 1st Avenue, North | Tel. 205/592-9158 |
| CALIFORNIA | NORTH HOLLYWOOD, CALIF. 91601 | 10654 Magnolia Boulevard | Tel. 213/759-2722 |
| | SAN MATEO, CALIF. 94402 | 600 S. Airport Boulevard | Tel. 415/348-3292 |
| | MODESTO, CALIF. 95351 | 123 Phoenix Avenue | Tel. 209/521-8051 |
| FLORIDA | TEMPA, FLORIDA 33606 | 1505 Cypress Street | Tel. 813/253-0324 |
| | FT. LAUDERDALE, FLORIDA 33309 | 3516 N.W. 10th Avenue | Tel. 305/566-4882 |
| GEORGIA | ATLANTA, GEORGIA 30310 | 646 Evans Street S.W. | Tel. 404/758-2232 |
| ILLINOIS | URBANA, ILLINOIS 61801 | 908 E Main Street | Tel. 217/384-2052 |
| | SKOKIE, ILLINOIS 60076 | 5170 West Brown Street | Tel. 312/675-0230 |
| INDIANA | INDIANAPOLIS, INDIANA 46204 | 112 West St. Clair Street | Tel. 317/632-3493 |
| KENTUCKY | LOUISVILLE, KENTUCKY 40205 | 2244 Taylorsville Road | Tel. 502/452-1191 |
| LOUISIANA | SHREVEPORT, LOUISIANA 71064 | 2423 Southport Ave. | Tel. 818/221-3027 |
| MASSACHUSETTS | SPRINGFIELD, MASSACHUSETTS 01108 | 405 Dickason Street | Tel. 413/788-8206 |
| MISSOURI | ST. LOUIS, MISSOURI 63132 | 9577 Page Avenue | Tel. 314/429-0633 |
| NEVADA | LAS VEGAS, NEVADA 89102 | 1114 South Casino Center Blvd. | Tel. 702/384-4235 |
| NEW JERSEY | RENTON, NEW JERSEY 08633 | 1139 Pennsylvania Avenue | Tel. 609/393-0999 |
| | JERSEY CITY, NEW JERSEY 07307 | 454 Central Avenue | Tel. 201/792-3730 |
| NEW YORK | ROCHESTER, NEW YORK 14615 | 37 Pullman Avenue | Tel. 716/647-9180 |
| NORTH CAROLINA | GREENSBORO, NORTH CAROLINA 27405 | 2914 East Market Street | Tel. 819/273-6276 |
| OHIO | CLEVELAND, OHIO 44109 | 4525 Pearl Road | Tel. 216/741-2314 |
| OREGON | PORTLAND, OREGON 97210 | 1732 N.W. 25th Ave., P.O. Box 10141 | Tel. 503/222-9059 |
| PENNSYLVANIA | PITTSBURGH, PENNSYLVANIA 15209 | 515 Grant Avenue | Tel. 412/821-4004 |
| TENNESSEE | MEMPHIS, TENNESSEE 38111 | 3158 Barron Avenue | Tel. 901/458-2355 |
| TEXAS | DALLAS, TEXAS 75211 | 11540 Garland Road | Tel. 214/327-8413 |
| CANADA | ST. LAURENT, QUEBEC H4N-2L7 | 305 Decarie Boulevard | Tel. 514/748-8803 |
| | CALGARY, ALBERTA T2H-1Y3 | P.O. Box 5823, 5th "A" | Tel. 403/243-0971 |

IF YOU WANT TO BRANCH OUT INTO THE TV TUNER REPAIR BUSINESS, WRITE TO THE BLOOMINGTON HEADQUARTERS ABOUT A FRANCHISE.

CIRCLE 1 ON FREE INFORMATION CARD

Movie makers seek injunction against video recorder sales

MCA's Universal Studios and Walt Disney Productions are seeking a court order to stop the sales of Sony Betamax color TV recorders. The grounds: By selling machines capable of recording copyright material, Sony is unlawfully inducing the public to violate copyright law.

The suit seems odd because the law has recognized the individual's right to copy broadcast material ever since tape recorders came on the market. Sony counsel asserts that the movie makers, in licensing their productions for transmission "over the public airwaves," have given implicit consent to have them recorded for private noncommercial use.

According to Sony spokesmen, the film makers are attempting to enforce their copyright not to protect their material, but to pre-empt the market in audio-visual playback disc machines (in which MCA has a substantial investment) and to deprive the public of a technological advance which MCA has been unable to achieve.

The issue is important since Betamax is probably only the first of several video recorders that may appear in the near future. For example, Zenith plans to introduce a system based on Sony technology this year. RCA also has a record-playback system in the works, using Matsushita VHS (Video Home System) video cassette

recorder/players built to RCA specifications. Both these items will probably appear late this summer.

If the movie makers succeed in their first strike against the video recorder, it is possible the matter may be carried as far as the Supreme Court, if necessary.

Scientists get atomic fusion with carbon dioxide LASERS

Researchers at the Los Alamos, NM laboratory have achieved fusion reactions on a small scale by bombarding fusion-fuel pellets with carbon dioxide (gas) LASER beams.

The pellets contain a mixture of deuterium and tritium, which join to form helium, giving off great amounts of energy in the process.

Obtaining energy by atomic fusion instead of by fission would have several advantages. A fusion plant would not produce the wide range of radioactive byproducts generated by fission plants; thus, containing radiation hazards would be simpler. The fuel supply would also be practically inexhaustible.

It had been thought previously that the carbon-dioxide type of gas LASER could not be used to produce fusion, that its beams would penetrate too deep into the fuel pellet before its heating effects would be felt. Experiments were therefore made with the much more costly and less efficient glass LASER. However, experiments

demonstrated that the heating effect of a carbon dioxide LASER does actually take place near the pellet's surface. Thus the gas LASER, which is ten times as efficient while only one-fourth as expensive as a glass LASER, can be used.

The present experimental system has two converging beams, each delivering 200 joules of energy to the pellet in about one-billionth of a second. (200 joules is roughly the amount of energy required to lift 150 pounds one foot, or to raise 50 grams of water one degree Celsius.) It is expected that the power of each beam can be increased to 900 joules, and that more than two beams can be converged on the fusion fuel.

National organization offers service manager certification

A certification exam and qualification program for consumer electronics service shop owners, managers and operators has been developed by NESDA, the National Electronic Service Dealers Association.

Called the Certified Service Manager (CSM) program, the examination will test the business knowledge and management skills of service managers and operators in such areas as customer relations, advertising and promotion, record keeping, financial understanding, demographics of the service business, personnel management, product sales, safety and shop layout and design.

Approval of the program was given at the NESDA House of Representatives meeting in Indianapolis in January.

Radio Commission tells boatmen how to get help when in trouble

The Radio Technical Commission for Marine Services has issued, in cooperation with the FCC, a 72-page handbook to help boat owners with marine radios use their equipment efficiently when they are in difficulties. "Knowing how to use your radiophone in an emergency could save your life or your boat," advises the Commission.

US Coast Guard ships and stations listen for calls on Channel 16 (156.8 MHz), the distress, safety and calling channel in the VHF/FM band, and on 2182 kHz in the medium-frequency band, which is now single sideband. Citizens band radios are not marine radiotelephones, and the Coast Guard does not monitor CB frequencies.

There are three emergency calls. Most urgent is MAYDAY (French: *m'aidez*, help me), used only if a vessel or its occupants is in "grave and imminent danger." The boatman, after checking to see that his

Continued on page 12

SMOKEY IN THE SKY



NUMBER ONE AIR BEAR is the handle of this good buddy, who combines CB with his regular work as a policeman and his hobby of flying and aircraft. (The gyrocopter he is flying is one that he made himself.)

We've just made the impossible... a professional 3½ digit DMM Kit for less than \$60.



The Sabtronics Model 2000 is an impossible \$59.95! And that price still includes phenomenal accuracy, range and professional features.

This all-new bench/portable multimeter, reading to ± 1999 , has a basic accuracy of $0.1\% \pm 1$ digit, and has five functions giving 28 ranges, 100% overrange and overload protection. So you know it's no toy!

Besides, what toys are as automatic as the 2000? With automatic overrange indication, automatic polarity, even automatic zeroing!

Yet the 2000 is easy to assemble. We send you all the parts you need, even the high-impact case. We also send you clear, step-by-step assembly instructions.

So you end up with a professional quality 3½ digit DMM for the unheard-of price of less than \$60. From Sabtronics, specialists in digital technology. And manufacturers of the impossible.

Order yours today!



Made in U.S.A.

sabtronics 
INTERNATIONAL INC.

P.O. Box 64683 Dallas, Texas 75206 (214) 389-7310

GUARANTEE:

Our guarantee to you; examine the 2000 DMM kit for 10 days. If you're not satisfied, return it unassembled for a full refund of purchase price.

SPECIFICATIONS:

DC volts in 5 ranges: $100\mu\text{V}$ to 1000V.
AC volts in 5 ranges: $100\mu\text{V}$ to 1000V.
DC current in 6 ranges: 10nA to 2A.
AC current in 6 ranges: 10nA to 2A.
Resistance in 6 ranges: 1Ω to $20\text{M}\Omega$
Input Impedance: $10\text{M}\Omega$
Display: 9mm (.36") LED.
Power requirements: 4.5 VDC to 6.5 VDC
(4 "C" cells - not included).
Size: 8"W x 6.5"D x 3.0"H.
(203W x 165D x 76H mm).

To: Sabtronics International, Inc.
P.O. Box 64683, Dallas, TX 75206

RE-7

Please send me _____ Sabtronics Model 2000 DMM kit(s) at
\$59.95 each. _____ subtotal

Shipping and Handling, \$3.50 per unit* _____ subtotal

Texas Residents Add Sales Tax _____

TOTAL enclosed _____

Name _____

Street Address _____

City _____

State _____ Zip _____

*USA only. Canada, \$4.50. All Other Countries, \$9.00

CIRCLE 28 ON FREE INFORMATION CARD

Learn to service Communications /CB equipment at home...with NRI'S COMPLETE COMMUNICATIONS COURSE

Learn design, installation and maintenance of commercial, amateur, or CB communications equipment.

The field of communications is bursting out all over. In Citizens Band alone, class D licenses grew from 1 to over 2.6 million in 1975, and the FCC projects about 15 million CB'ers in the U.S. by 1979. That means a lot of service and maintenance jobs . . . and NRI can train you at home to fill one of those openings. NRI's Complete Communications Course covers all types of two-way radio equipment (including CB), AM and FM



Transmission and Reception, Television Broadcasting, Microwave Systems, Radar Principles, Marine Electronics, Mobile Communications, and Aircraft Electronics.

The course will also qualify you for a First Class Radio Telephone Commercial FCC License or you get your tuition back.

Learn on your own 400-channel digitally-synthesized VHF transceiver.

You will learn to service all types of communication equipment, with the one unit that is designed mechanically and electronically to train you for CB, Commercial and Amateur communications: a digitally-synthesized 400-channel VHF transceiver and AC power supply. This 2-meter unit gives you "Power-On" training. Then we help you get your FCC Amateur License with



special instruction so you can go on the air.

The complete course includes 48 lessons, 9 special reference texts, and 10 training kits. Included are: your own electronics Discovery Lab, Antenna Applications Lab, CMOS Frequency Counter, and an Optical Transmission System. You'll learn at home, progressing at your own speed, to your FCC license and into the communications field of your choice.

NEW CB SPECIALIST COURSE NOW OFFERED



NRI now offers a special course in CB Servicing. You get 37 lessons, 8 reference texts, your own CB Transceiver, AC power supply and multi-meter . . . for hands-on training. Also included are 14 coaching units to make it easy to get your commercial radio telephone FCC license—enabling you to test, install, and service communications equipment.

NRI offers you five TV/Audio Servicing Courses

NRI can train you at home to service TV equipment and audio systems. You can choose from 5 courses, starting with a 48-lesson basic course, up to a Master Color TV/Audio Course, complete with designed-for-learning 25" diagonal

solid state color TV and a 4-speaker SQ™ Quadraphonic Audio System. NRI gives you both TV and Audio servicing for hundreds of dollars less than the two courses as offered by another home study school.

All courses are available with low down payment and convenient monthly payments. All courses provide professional tools and "Power-On" equipment along with NRI kits engineered for training. With the Master Course, for instance, you build your own 5" wide-band triggered sweep solid state oscilloscope, digital color TV pattern generator, CMOS digital frequency counter, and NRI electronics Discovery Lab.



™ Trademark of CBS Inc.

NRI's complete computer electronics course gives you real digital training.

Digital electronics is the career area of the future . . . and the best way to learn is with NRI's Complete Computer Electronics Course. NRI's programmable digital computer goes far beyond any "logic trainer" in preparing you to become a computer or digital technician. With the IC's in its new Memory Kit, you get the only home training in machine language programming . . . experience essential to trouble shooting digital computers. And the NRI programmable computer is just one of ten kits you receive, including a TVOM and NRI's exclusive electronics lab. It's the quickest and best way to learn digital logic and computer operation.

You pay less for NRI training and you get more for your money.

NRI employs no salesmen, pays no commissions. We pass the savings on to you in reduced tuitions and extras in the way of professional equipment, testing instruments, etc. You can pay more, but you can't get better training.

More than one million students have enrolled with NRI in 62 years.

Mail the insert card and discover for yourself why NRI is the recognized leader in home training. No



salesman will call. Do it today and get started on that new career.

APPROVED UNDER GI BILL
if taken for career purposes Check box or card for details



NRI SCHOOLS
McGraw-Hill Continuing Education Center
3939 Wisconsin Avenue,
Washington, D.C. 20016

Hugo Gernsback (1884-1967) founder
M. Harvey Gernsback, KOD-6694
editor-in-chief and publisher
Larry Steckler, KTX-3644, CET, editor
Robert F. Scott, CET, W2PWG,
KXK-8533, technical editor
Arthur Kleiman, KTZ-3288,
managing editor

Jack Darr, CET service editor
Leonard Feldman
contributing high-fidelity editor
Karl Savon, semiconductor editor
David Lachenbruch, contributing editor
Rudolph F. Graf, contributing editor
George Whalen, contributing editor
Vincent P. Ciconia, production manager
Dale Allinson, production assistant
Harriet I. Matysko, circulation director
Shella Wertling, circulation assistant
Arline R. Bailey, advertising coordinator

Cover design by Louis G. Rubsamen
Cover photo by Walter Herstatt

Radio Electronics is a member of the
Institute of High Fidelity and is indexed in
Applied Science & Technology Index and
Readers Guide to Periodical Literature.



Radio-Electronics magazine is published
by Gernsback Publications, Inc.
200 Park Ave. S., New York, NY 10003
(212) 777-6400

President: M. Harvey Gernsback
Vice President: Larry Steckler
Treasurer: Carol A. Gernsback
Secretary: Bertina Baer

ADVERTISING SALES

EAST
Stanley Levitan, KZA-5580
Radio-Electronics
200 Park Ave. South
New York, NY 10003
(212) 777-6400

MIDWEST/Texas/Arkansas/Okla.
Ralph Bergen, KXD-8396
Jim Reilly
The Ralph Bergen Co.
6319 N. Central Ave.
Chicago, IL 60646
(312) 792-3646

**PACIFIC COAST
Mountain States**
Jay Eisenberg, KYF-3277
J.E. Publishers Representative Co.,
8732 Sunset Blvd.,
4th Floor,
Los Angeles, CA 90069
(213) 659-3810
Sales Mart Building
1485 Bayshore Blvd., Box 140
San Francisco, CA 94124
(415) 467-0125

SOUTHEAST
J.E. Publishers Representative Co.,
214-387-2424

radio is on the right frequency, and that there is a break in the traffic, calls MAYDAY three times, gives his craft's name three times and his call sign once. He then gives his message, first telling where he is in relation to known land points. For example:

"MAYDAY, MAYDAY, MAYDAY. This is Blue Duck, Blue Duck, Blue Duck, WA-1234. MAYDAY, Blue Duck; Dungeness Light bears 185 degrees magnetic, distance two miles. Struck submerged object. Need pumps, medical assistance and tow. Three adults, two children aboard. One person compound fracture of arm. Estimate can remain afloat two hours. Blue Duck is a 32-foot cabin cruiser, blue hull, white deck house. Over."

PAN, the next most urgent call, is used when the safety of a vessel or its crew is threatened, as in the case of a man overboard. The SECURITY emergency call is used for an important weather or navigational warning.

NATESA Annual Convention will be held August 25-28

The 28th annual NATESA convention will take place at Carson's Nordic Hills Resort in Itasca, IL (between O'Hare Airport and Chicago) from Thursday, August 25 through Sunday, August 28. A full program of service business management and a "New in Technology" seminar will be blended with a program of interesting tours for the ladies and a visit to an area TV plant.

A single fee of \$25 covers all functions. A special block of rooms (at a cost of \$33 single and \$38 double) have been reserved on a first-come first-served basis. As in the past, meals from Friday breakfast through Sunday brunch are being sponsored by major set manufacturers.

For details, write NATESA, 5908 Troy St., Chicago, IL 60629.

NESDA estimates more than 200,000 electronic service technicians

The number of electronic service technicians in the United States at the beginning of 1977 was 207,212, an increase of 5%, reports National Electronic Service Dealers Association in its annual Electronic Service Industry Business & Manpower Survey. The number of consumer electronics firms also increased, from 66,000 to 70,526, a gain of 6% over 1976.

The NESDA estimate is compiled from official state and city license board records. Since the participating license boards serve a population of 58,920,000, or about 28% of the total population, the extended figures are somewhat arbitrary.

Nevertheless, they are useful in accounting for the demographic features of the service industry. For example, it was determined that:

1. Nearly 50% of the businesses are owner-operated, one-man shops.

2. Nearly 50% engage in product sales.

3. Many licensed technicians spend the greater part of their time in sales or management duties.

4. A majority of the businesses hire part-time service technicians to supplement their technical labor force.

5. Many businesses are operated by a technician who holds a full-time job elsewhere.

6. Because license fees are low (\$10 in Indiana, for example) many carry a license rather than let it lapse, even though little or no time is devoted to service work.

EIA to run electronics seminars for high school instructors

Sixteen consumer electronics seminars in 14 states are being offered to high school and vocational instructors by the service committee of the Electronic Industries Association (EIA). The courses are designed to help teachers upgrade their curriculum in consumer electronic product service techniques; they emphasize diagnosis and repair of the latest consumer electronic solid-state and other products. Several schools also feature CB service techniques. College credit is offered for completion of the course.

Locations and dates are: Los Angeles Valley College, Van Nuys, CA, August 8-19; University of Northern Colorado, Greeley, CO, July 5-15; Morehead State University, Morehead, KY, July 18-29; Louisiana Vocational & Technical Institute, Shreveport, LA, June 27-30; Macomb County Community College, Warren, MI, June 20-23 and June 27-30; Bemidji State University, Bemidji, MN, July 5-9 and August 1-12; Appalachian State University, Boone, NC, June 20-July 1; East Tennessee State University, Johnson City, TN, July 18-29; Prince William County Schools, Manassas, VA, late summer; Peninsula Community College, Port Angeles, WA, June 20-July 1; Fairmont State College, Fairmont, WV, June 20-July 1; Milwaukee Area Technical College, Milwaukee, WI, July 11-22.

The summer seminar program is sponsored by the Consumer Electronics Show, the industry's biannual trade show, in cooperation with the Electronic Industries Association, Consumer Electronics Group. For a copy of the seminar schedule and contact names and telephone numbers write EIA/Consumer Electronics Group, 2001 Eye Street, N.W., Washington, DC 20006.

FREE

THE NEW HEATHKIT CATALOG
 the world's largest selection of
 fun-to-build, money-saving
 electronic kits!

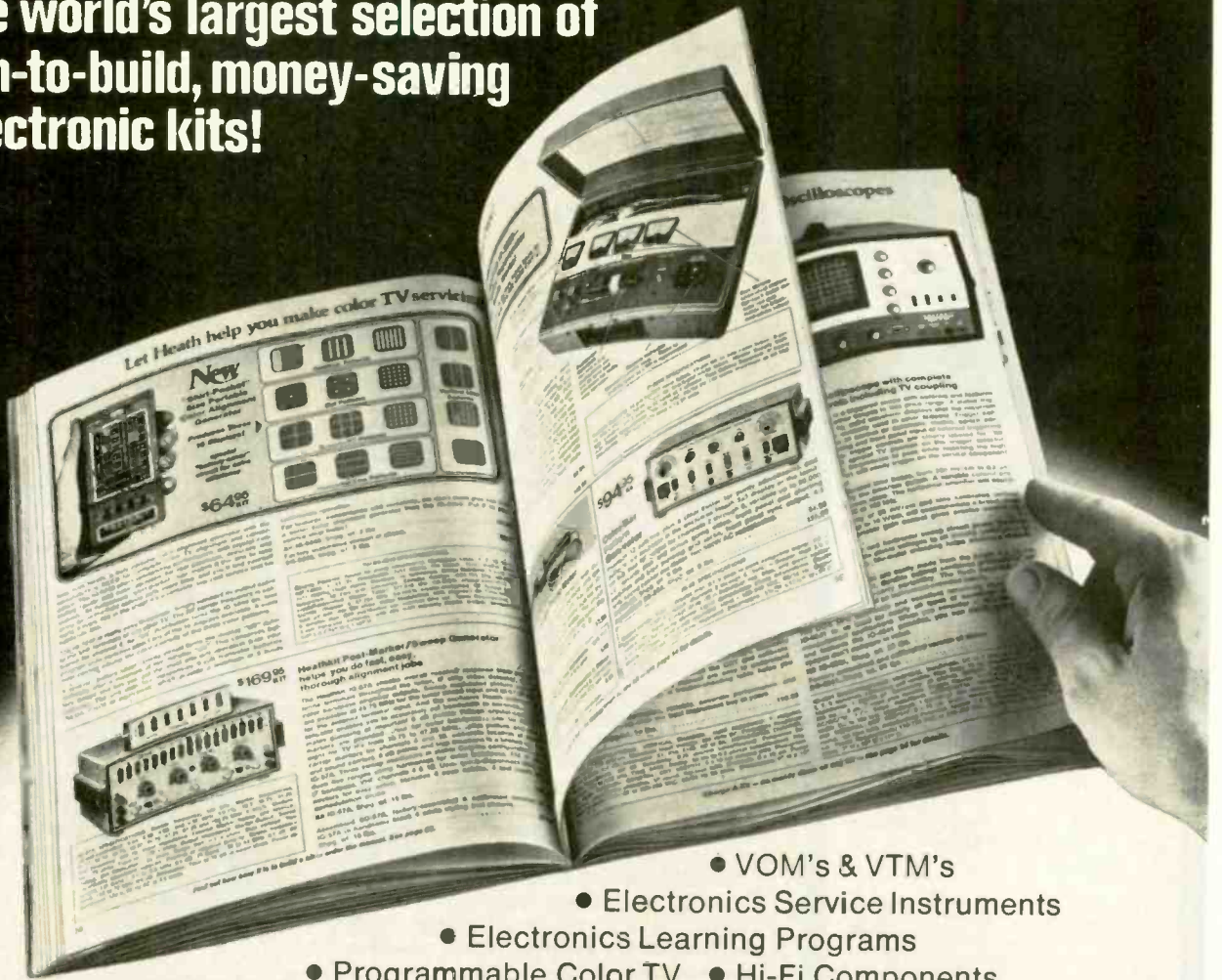

- VOM's & VTM's
- Electronics Service Instruments
- Electronics Learning Programs
- Programmable Color TV • Hi-Fi Components
- Amateur Radio • Radio Control Modeling Equipment
- Digital Clocks & Weather Accessories • Marine, Auto & Aircraft Accessories

Read about the nearly 400 electronic kits you can build and service yourself. The famous Heath assembly manuals guide you every step of the way, and our quality design assures top performance from every kit you build.

Send for your copy today!

Heath Co., Dept. 20-31
 Benton Harbor, Michigan 49022

| | | |
|---|---------------------|---|
| HEATH | Schlumberger | Heath Company, Dept. 20-31 Benton Harbor, Michigan 49022 |
| <p>Please send me my FREE Heathkit Catalog. I am not on your mailing list.</p> | | |
| <p>Name _____</p> | | |
| <p>Address _____</p> | | |
| <p>City _____ State _____ Zip _____</p> | | |
| | | CL-602B |

CIRCLE 100 ON FREE INFORMATION CARD

THE INSTANT DIGITAL CB TESTER



Now one unit
does it all.

The Hickok Model 388 CB in-line Tester hooks up to any CB transmitter and tells you everything you need to know, instantly, digitally.

Push a button to switch from in-line to front panel input and it becomes a high sensitivity 7 digit frequency counter for measuring any frequency from 10Hz to 55MHz.

Add a pair of wires, and you can power it from any 12V source for in-the-car or other remote operations.

MODEL 388 \$379
MODEL 388X \$525

Model 388 has a 10ppm (.001%) time base accuracy.

Model 388X contains a precision TCXO with 1ppm accuracy.

Part of the

HICKOK
Comm Line

the full line of professional
CB service instruments.

HICKOK
the value innovator

INSTRUMENTATION & CONTROLS DIVISION
THE HICKOK ELECTRICAL INSTRUMENT CO.
10514 Dupont Avenue • Cleveland, Ohio 44108
(216) 541-8060 • TWX: 810-421-8286

CIRCLE 7 ON FREE INFORMATION CARD

letters

TELEPHONE ACCESSORIES

In my two articles on telephone accessories ("Turn-On Appliances Via Long Distance" appearing in the April 1977 issue and "Amplifier For Hands-Off Telephone" appearing in the May 1977 issue), you omitted a reference stating that these articles were extracts from my book *Telephone Accessories You Can Build*. This book is published by the Hayden Publishing Company, 50 Essex St., Rochelle Park, NJ 07662, and priced at \$3.95.

Any readers who found these articles of interest will find many more related projects in my book.

JULES GILDER

VIDEO GAME SCREEN BURN

The "burning in" of television game outlines on the phosphor screen could be reduced by incorporating a circuit in the game to slowly move the entire image around the screen. (Older types of TV camera tubes used in studio cameras such as the RCA TK-14 and TK-42 use a device called an orbiter, which either electronically moves the scanning or optomechanically moves the image.) The movement must be slow enough to be relatively unnoticeable, especially from play to play, and be of sufficient amplitude to displace the image slightly more than the maximum image line width. Additional hardware and/or software will be required to implement this system.

In a hardware game system, counters and a variable delay would move the image down one-scan-line-per-n vertical sweeps. The same counter could control a variable delay in horizontal positioning; however, another counter would allow more random positioning. When the image reaches the lower position limit, the counting (hence the positioning) is reversed. A software game system must accomplish the same steps, and therefore the hardware counters and delays could be used. A complete positioning cycle will likely have a period of about ten seconds, requiring long delay-timing loops and the associated memory requirements.

Although the increased hardware or software required would result in higher cost, the end result should be beneficial to both manufacturer and consumer.

TOM SCHULTZ
Kernersville, NC

I work with commercial-type video games, and up until the last couple of years all manufacturers used just any portable black-and-white TV that would suit their purposes. In every case the picture-tube screens had impressions of the games' outlines burned in.

In all the latest models, a 23-inch Motorola or Ball Brothers monitor is used,

these are built for game manufacturers. (The Motorola model number is XM501/XM701.) With these monitors, screen-burn is still very evident. In our case though, since the monitor is not used for regular broadcast viewing, screen-burn is not a big problem.

I don't know how to stop screen-burn. If customers are going to play the video game for long periods of time, perhaps they should turn the brightness down or buy a low-priced black-and-white TV to use just for the games.

I feel it is not the manufacturers' fault that the screen-burn was noticed on the picture tubes. However, I feel they should have warned consumers.

A.W. SCHILDMEIER
Anderson, IN

OUTSIDE BURGLAR ALARM

I have been enjoying *Radio-Electronics* for many years, especially the articles relating to the fabrication of burglar alarms using SCR's and IC's. Every car, home and office needs effective burglar protection, and your publication fills a great need in a burglar-conscious world.

Many readers would appreciate information on how to construct and hook up a peripheral wire which could be buried around the edges of a property and would indicate the presence of any intruder. We also need information on a short-range FM transmitter, activated when a car parked outside the house is disturbed, which would register data at a receiver inside the house.

We would also appreciate more articles on pulsers or flashers that produce an interrupted warning noise or light rather than continuous operation; these should be adaptable to alarms, etc.

R. A. MATTMUELLER
Arlington, VA

SETTING THE METER MOVEMENT STRAIGHT

Your series "All About Analog Voltmeters" is very good. However, the discussion on the meter movement in the March issue should be clarified. A taut-band meter movement is a D'Arsonval meter movement too. A D'Arsonval meter movement is one with a coil that moves through a strong magnetic field supplied by a permanent magnet. "Taut-band" refers to the method of suspending the moving coil.

In a taut-band meter movement, the moving coil is suspended by two thin metal ribbons, one on each side of the coil. These ribbons provide the restoring torque for the coil and the electrical connections to the coil.

continued on page 16



Nobody can replace all our replacements.

When it comes to replacement tubes, nobody has as many types as Sylvania—from power amplifiers to Nuvistors.

We've got them for domestic and foreign TVs, radios and stereos, plus a full line for industrial applications.

So, when you need replacement tubes come to the place that has everything—your Sylvania distributor.

You'll find he's irreplaceable.

GTE SYLVANIA

Yes you can

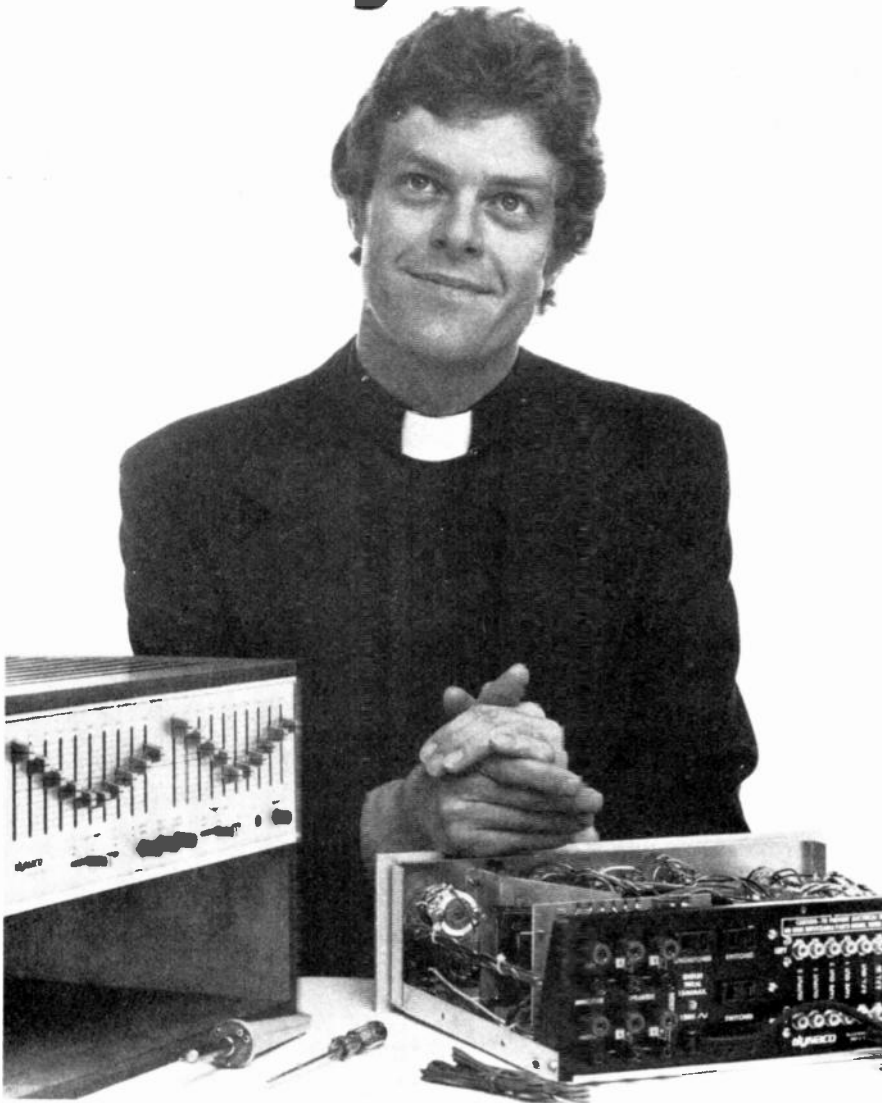

build a dynakit.

Even 'churchmice' want the finest high fidelity, but when funds are scarce you take things into your own hands. We did and built Dynakits. It was surprisingly easy, the simple step-by-step instructions in their illustrated manual didn't let us go astray. A few evenings of my time and the church had a music system of the finest quality — and a saving of over \$600. My only question—when 'work' is so much fun, is it sinful?

Write for free 24 page catalog of Dynakits and Dynaco components and loudspeakers.



Dept. A-3, Box 88
Blackwood, NJ 08012

dynaco
dynakit

CIRCLE 29 ON FREE INFORMATION CARD

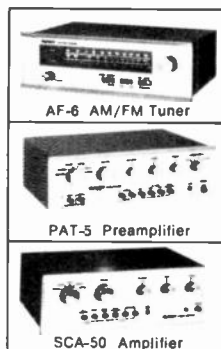

LETTERS

continued from page 14

The other method of suspending the moving coil is called pivot-and-jewel. Two tiny pivots, one on each side of the coil, ride in jeweled bearings. The restoring torque and electrical connection to the coil in a pivot-and-jewel meter movement are provided by hairsprings connected to the moving coil.

The major advantage of a taut-band meter movement is elimination of friction. While this does not necessarily improve accuracy, it does allow repeatable measurements. The repeatability of a measurement can be very important when trying to match components or balance circuits.

Another way to improve repeatability of measurements is to add a mirror to the dial. The addition of a mirror does not necessarily improve accuracy or resolution, but it does help eliminate a human reading error, parallax. Parallax error is caused by not looking at the meter from directly in front of it. By lining up the reflected image of the pointer directly behind the pointer, this error can be eliminated. Thus, a mirror dial may be needed if component matching and circuit balancing are required.

GLENN A. LITTLE, Project Engineer
Triplet Corp.
Bluffton, OH

NEW ENERGY SOURCE?

Cut a one-inch square each from an aluminum and a steel pop can. Put a small button magnet at their center. (You may have to tape the magnet to the aluminum.) The magnet will attract a steel ball bearing from about one-quarter inch away through the aluminum, but it will not attract the ball through the steel sheet.

Today we can use a very low power signal to rapidly change germanium or silicon from a conductor to a nonconductor and vice versa. The magnetic bubble memory is now a reality. If we could find some other material that we could change from magnetic (steel) to nonmagnetic (aluminum) with a low power signal, we could solve our energy crisis.

When the ball moves to the magnet, which is behind the aluminum, the ball has energy and today's magnets last for decades.

JOHN W. ECKLIN
Alexandria, VA



How's the reception now?

VACO.



Super Case II No. 70380



Super Zip No. 70390

Meet the Super Family!

Our original Super Case was such a success that you asked for more. So here they are!

Super Case II includes 45 professional problem-solving tools from screwdrivers and nutdrivers to hex keys, testers, wire cutters, wrenches and pliers . . . plus a super-handy solderless connector kit complete with crimping tool. Super Zip is a compact zipper case assortment of 36 of our most popular tools and components. All professional quality. And all with a full lifetime warranty.

For a full color brochure on all three SUPER CASES, just write:

Vaco Products Company, 510 N. Dearborn St.,
Chicago, Illinois 60610.

Introductory Feature with Super Case II



As a special introductory bonus, we're including the super-size No. 4900-63 metal box solderless terminal kit (complete with crimping tool) in place of the standard service kit. Super!

CIRCLE 57 ON FREE INFORMATION CARD

The better the training the better you'll

Send for
FREE
illustrated
career
guide

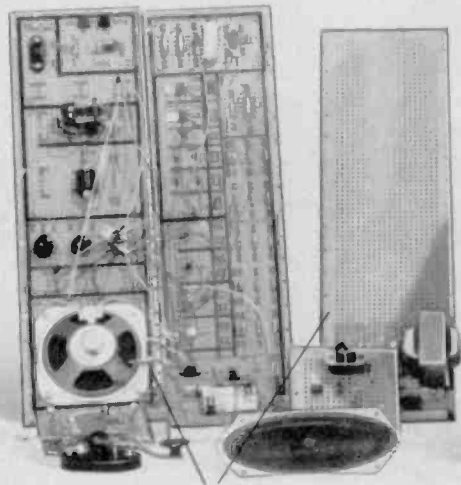
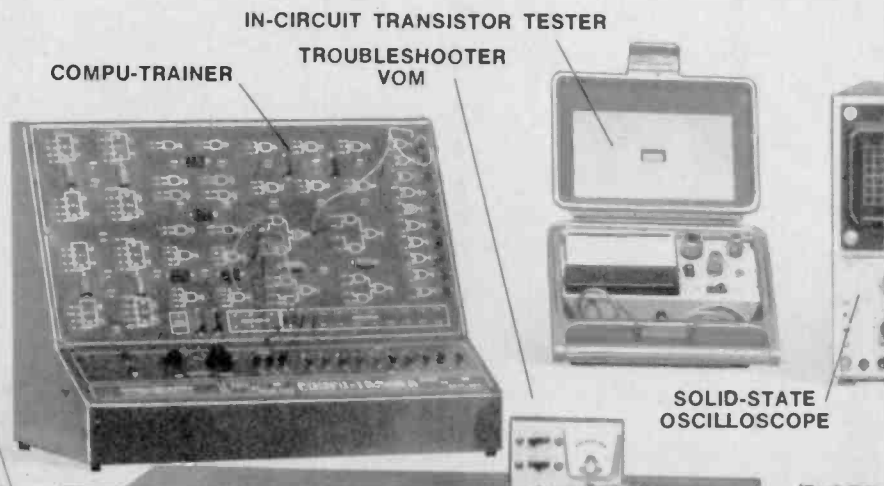
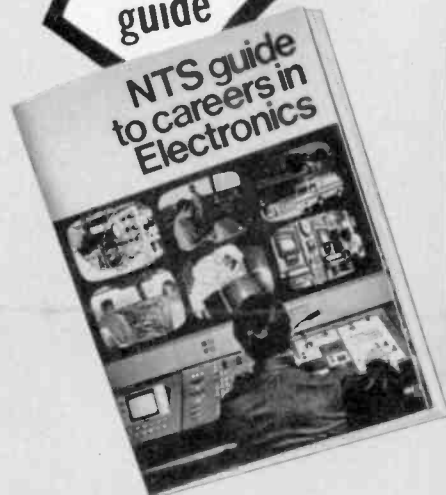

ELECTRO-LAB

(Simulated TV Reception)

As an NTS student you'll acquire the know-how that comes with first-hand training on NTS professional equipment. **Equipment you'll build and keep.** Our courses include equipment like the NTS/Heath GR-2001 computerized color TV (25" diagonal) with varactor diode tuning and digital read-out channel selection; (optional programming capability and digital clock avail.)

Also pictured above are other units — 5" solid state oscilloscope, vector monitor scope, solid-state stereo AM-FM receiver with twin speakers, digital multi-meter, and more. It's the kind of better equipment that gets you better equipped for the electronics industry.

This electronic gear is not only designed for training; it's field-type — like you'll meet on the job, or when you're making service calls. And with NTS easy-to-read, profusely illustrated lessons you learn the theory behind these tools of the trade.

Choose from 12 NTS courses covering a wide range of fields in electronics, each complete with equipment, lessons, and manuals to make your training more practical and interesting.

Compare our training; compare our lower tuition. We employ no salesmen, pay no commissions. You receive all home-study information by mail only. All Kits, lessons, and experiments are described in full color. Most liberal refund policy and cancella-

and the equipment be equipped.

COMPARE OUR
KITS AND LESSONS.
COMPARE OUR
TUITION.



tion privileges spelled out. Make your own comparisons, your own decision. Mail card today, or clip coupon if card is missing.

NO OBLIGATION. NO SALESMAN WILL CALL

APPROVED FOR VETERAN TRAINING
Get facts on new 2-year extension

NATIONAL TECHNICAL SCHOOLS

TECHNICAL-TRADE TRAINING SINCE 1905
Resident and Home-Study Schools
4000 So. Figueroa St., Los Angeles, Calif. 90037

NATIONAL TECHNICAL SCHOOLS
4000 South Figueroa St., Los Angeles, Calif. 90037 Dept. 206-077

Please send FREE Color Catalog and Sample Lesson.
NO OBLIGATION. NO SALESMAN WILL CALL.

Color TV Servicing Electronics Technology
 B & W TV and Radio Servicing Computer Electronics
 Electronic Communications Basic Electronics
 FCC License Course Audio Electronics Servicing

NAME _____ AGE _____

ADDRESS _____ APT # _____

CITY _____ STATE _____

Please fill in Zip Code for fast service _____

Check if Interested in G.I. Bill Information.
 Check if interested ONLY in classroom training in Los Angeles.



TUN-O-POWER OUTLASTS 3 CANS OF ORDINARY TUNER SPRAY



AND TUN-O-POWER KEEPS TUNERS WORKING BETTER, LONGER!

A one second blast of TUN-O-POWER has more cleaning and lubricating power than a three to five second blast of any ordinary tuner spray. That's why one can of TUN-O-POWER outlasts three cans of ordinary spray.

DRY TEFLON MAKES THE DIFFERENCE

Economy isn't TUN-O-POWER's only advantage. It works better too. Ordinary tuner cleaner-lubricants are made with petroleum based grease. Grease attracts dust and gunks up.

TUN-O-POWER is made with dry TEFLON. It keeps contacts clean and corrosion-free, while maintaining smooth-as-silk detent action.

Try it. You'll love it.

CHEMTRONICS
INCORPORATED

45 HOF FMAN AVE., HAUPPAUGE, N.Y. 11787 • (516) 582 3322

CIRCLE 71 ON FREE INFORMATION CARD

computer corner

JONATHON TITUS, PETER RONY,
AND DAVID LARSEN*

THIS MONTH, WE WILL DISCUSS COMPUTER interrupts, with emphasis upon the hardware and software associated with the vector interrupt. The three signals that you use in vector interrupt circuits include INT (input pin-14 on the 8080A), INTE (output pin-16), and INTA (not available on the 8080A but derived externally with additional logic).

The interrupt operation proceeds as follows: An interrupting device supplies a positive-going clock pulse to the INT (interrupt request) input of the microprocessor. The microprocessor recognizes the interrupt request either at the end of the current instruction being executed or while the CPU is in the halt state. Once an interrupt request is recognized, the CPU is inhibited by an internal flip-flop from recognizing another interrupt request. This internal flip-flop can be set (enabled) or cleared (disabled) with the aid of microcomputer instructions: The interrupt flip-flop is disabled (mnemonic DI) by instruction 363, and it is enabled (mnemonic EI) by instruction 373.

When cleared, the interrupt enable flip-flop inhibits interrupts from being accepted by the CPU. The flip-flop is automatically cleared when an interrupt is accepted; it is also cleared by the RESET input-signal applied at pin-12 of the 8080A IC. Output pin-12 (INTE, or interrupt enable) indicates the logic-state of the interrupt enable flip-flop.

An INTA (interrupt acknowledge) control signal is generated by applying the INTA (interrupt acknowledge) and DBIN (data bus in) control signals to a two-input NAND gate (Fig. 1). A logic 1 at DBIN (output pin-17 on the 8080A) indicates to external devices that

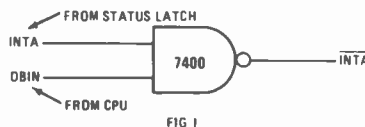

the data bus is in the input mode. The INTA control signal is a positive clock-pulse that is generated as a status output with the aid of a status latch connected to the 8080A microprocessor. The interesting aspect of the INTA control signal is that it permits you to "jam" an interrupt-vector instruction byte directly into the instruction register within the 8080A. This can only be done during an interrupt, but nevertheless it is a unique and highly interesting operation that is possible with the

8080A microprocessor.

A simple circuit that demonstrates how a single-byte instruction can be jammed into the instruction register is shown in Fig. 2. Assuming that the interrupt enable flip-flop has been previously enabled by instruction 373, the interrupting device must supply a

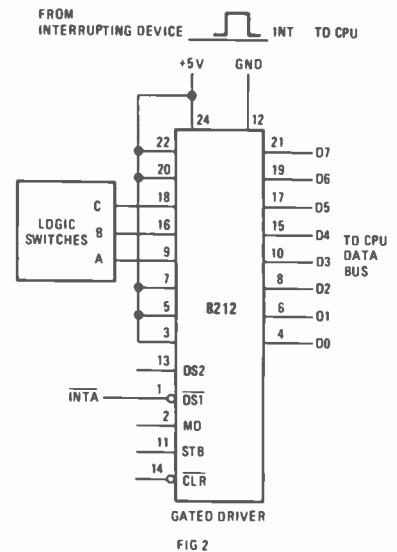

logic 1 input at INT in order to generate an interrupt request. The microcomputer finishes the current instruction, and then generates the interrupt acknowledge signal, INTA, that jams the desired vector instruction-byte on the data bus and into the instruction register. Although any instruction byte can be jammed into the instruction register during an interrupt, usually the eight following instructions are used to produce a useful result:

| | Call the subrou- Instruction Mnemonic | line that starts at: |
|-----|--|-----------------------|
| 307 | RST 0 | HI = 000 and LO = 000 |
| 317 | RST 1 | HI = 000 and LO = 010 |
| 327 | RST 2 | HI = 000 and LO = 020 |
| 337 | RST 3 | HI = 000 and LO = 030 |
| 347 | RST 4 | HI = 000 and LO = 040 |
| 357 | RST 5 | HI = 000 and LO = 050 |
| 367 | RST 6 | HI = 000 and LO = 060 |
| 377 | RST 7 | HI = 000 and LO = 070 |

continued on page 24

*This article is reprinted courtesy American Laboratories. Dr. Rony, Department of Chemical Engineering, and Mr. Larsen, Department of Chemistry, are with the Virginia Polytechnic Institute & State University. Mr. Titus is president of Tychon, Inc.

For tomorrow's needs, two new Fluke counters—today.



The 1910A and 1911A: counters with confidence in your future.

You can't always plan for tomorrow's measurement needs. That's why you should select the *Fluke* 1910A or 1911A counter—and receive frequency, period, period averaging, totalize—and many other new features—for as little as \$395!*

Stack up the features—not the instrument.

Most counters available at this price offer frequency only. If you need more, you have to move up to a higher-priced line. With *Fluke*, there are no future units to buy, stack, or gather dust.

If you've considered a counter that doesn't offer traditional *Fluke* quality and capability, it doesn't stack up. The new multi-function 1910A/1911A are very simple to use—not simpleminded. Extras like autoranging to fill all the digits. Automatic or manual range selection. Measurements are displayed clearly and accurately—the first time. And, any range or function control you select will automatically reset your counter.

Trigger-level control at these prices? You bet, and it adds to your performance. Self-check. Pack it anywhere (with the battery option). Want to print out data that's hard to refute? Look at the -02 option that allows you to connect the 1910A/1911A to your printer.

Consider the alternatives.

Select the 1910A for true multi-function value, or the 1911A for wider frequency (250 MHz, 50Ω!) applications. Once you've examined the best in this price range, you'll

agree you need to plan for your future with *Fluke*.

Please call 800-426-0361 toll-free for technical data and the name of the *Fluke* office or representative close to you. Or, write: John *Fluke* Mfg. Co., Inc., P.O. Box 43210, Mountlake Terrace, WA 98043. In Europe: *Fluke* (Nederland) B.V., P.O. Box 5053, Tilburg, The Netherlands. Phone: (013) 673973. Telex: 52237.

*U.S. Price Only.

The Good vs. The Good

| Feature | Fluke 1910A | vs. | 2nd choice | Fluke 1911A | vs. | 2nd choice |
|--------------------------|-------------------|-----|-----------------|-------------------|-----|-----------------|
| • Price: | \$395* | vs. | \$295 | \$495* | vs. | \$495 |
| • Range: | 125 MHz | vs. | 80 MHz | 250 MHz | vs. | 225 MHz |
| • Sensitivity: | 15 mV /25 mV | vs. | 25 mV /50 mV | 15 mV /30 mV | vs. | 25 mV /50 mV |
| • Trigger-level control: | Yes! | vs. | (sorry) | Yes! | vs. | (sorry) |
| • Autoranging: | Yes! | vs. | (sorry) | Yes! | vs. | (sorry) |
| • Battery Option: | Yes! | vs. | (sorry) | Yes! | vs. | (sorry) |
| • Multi-function: | f, p, pa, tot. | vs. | f only | f, p, pa, tot. | vs. | f only |

The first sixty-four memory locations are reserved for interrupt *service routines* or *pointers*. These are extremely short programs, often consisting of only a single jump instruction, that tell the 8080 microcomputer what to do or where to go for a specified interrupt condition. Such routines precede the main program and associated subroutines in memory. If interrupts or restart instructions are not used, this portion of memory does not have any special significance.

Figure 3 is probably the simplest priority-encoder interrupt circuit that can be used with an 8080 microcomputer. The Intel 8212 IC is used as an 8-bit three-state buffer that inputs the instruction byte into the instruction register. The 74148 8-line-to-3-line priority-encoder IC has the following truth table:

| Inputs | | | | | | | | Outputs | | | |
|--------|---|---|---|---|---|---|---|---------|---|---|----|
| 0 | 1 | 2 | 3 | 4 | 5 | 6 | 7 | C | B | A | E0 |
| X | X | X | X | X | X | X | 0 | 0 | 0 | 0 | 1 |
| X | X | X | X | X | X | 0 | 1 | 0 | 0 | 1 | 1 |
| X | X | X | X | X | 0 | 1 | 1 | 0 | 1 | 0 | 1 |
| X | X | X | X | 0 | 1 | 1 | 1 | 0 | 1 | 1 | 1 |
| X | X | X | 0 | 1 | 1 | 1 | 1 | 1 | 0 | 0 | 1 |
| X | X | 0 | 1 | 1 | 1 | 1 | 1 | 1 | 0 | 1 | 1 |
| X | 0 | 1 | 1 | 1 | 1 | 1 | 1 | 1 | 1 | 0 | 1 |
| 0 | 1 | 1 | 1 | 1 | 1 | 1 | 1 | 1 | 1 | 1 | 1 |
| 1 | 1 | 1 | 1 | 1 | 1 | 1 | 1 | 1 | 1 | 1 | 0 |

The letter X means that the logic state is irrelevant.

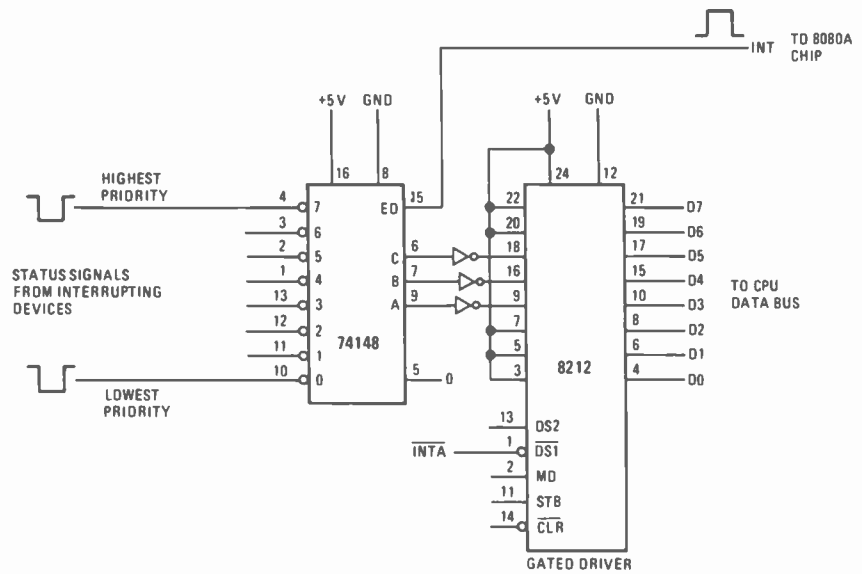

FIG. 3

The purpose of the circuit in Fig. 3 is to input the restart instruction, 3Y7, into the microcomputer. Five of the eight inputs to the 8212 IC are tied to a logic-1 state. The remaining three bits supply the encoded vector-address of the restart subroutine. By virtue of its truth table, the 74148 priority encoder provides eight priority levels. The inputs to this IC should be latched. The IC provides the three-bit binary output that corresponds to the highest valued priority input that is at a logic-0 state. The inverters

invert this information to supply the three-bit "Y" component of the restart instruction.

If there is a logic 0 at any of the inputs to the 74148 IC, a logic-1 output will be generated at the E0 output (pin 15). This output serves as the input to the interrupt request pin, INT, on the 8080A chip. Upon receiving an interrupt request, the microcomputer responds with an interrupt acknowledge output, INTA, that strobes the selected highest-priority restart instruction into the instruction register.

R-E

Treat yourself to a new direct reading DVM today.



DVM35
POCKET PORTABLE
ANALOG REPLACEMENT
3-digit, 1% DCV,
Battery or AC
Only \$134



DVM36
LAB ACCURATE
POCKET PORTABLE
3½ digit, .5% DCV,
Battery or AC
Only \$158

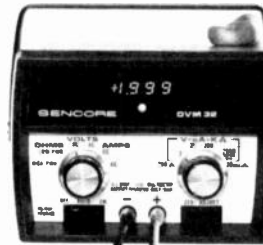

DVM32
BENCH & FIELD MASTER
3½ digit, .5% DCV,
Battery or AC
Only \$198



DVM38
"PRIME" STANDARD
AT YOUR FINGERTIPS
3½ digit, .1% DCV,
Auto-Ranging
Only \$348

A COMPLETE LINE OF DVMs TO FILL YOUR EVERY NEED OR WANT.

You can be sure more times in more circuits, under more adverse conditions, with greater versatility, accuracy, and meter protection than any other digital multimeters on the market today; and for less money too. 10 Day Free Trial: Try any of these famous DVMs for 10 days. If the DVMs in use don't prove exactly what we say, return them to your Sencore FLPD Distributor.

Want more information? We would like to tell you all about the Sencore DVMs by sending you a 24-page Sencore News, a six-page brochure, and the name of your nearest Sencore Distributor today... simply write or circle reader's service number.

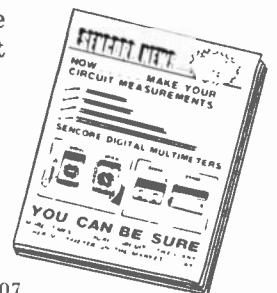

3200 Sencore Drive, Sioux Falls, SD 57107

Understanding Digital Electronics

New teach-yourself courses

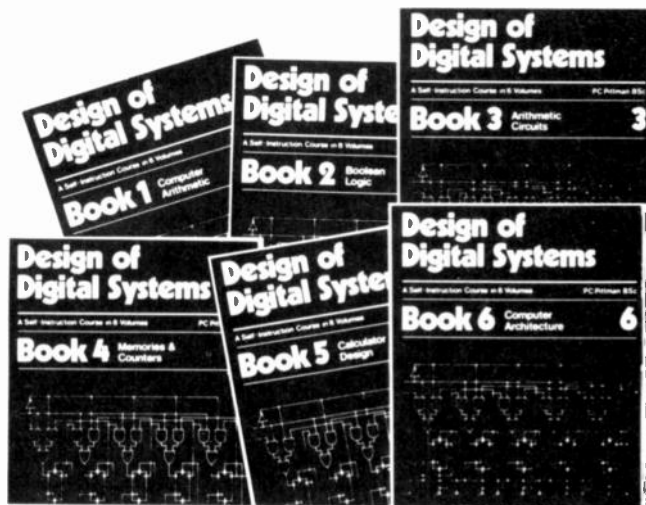

Design of Digital Systems is written for the engineer seeking to learn more about digital electronics. Its six volumes — each 11-1/2" x 8-1/4" — are packed with information, diagrams and questions designed to lead you step-by-step through number systems and Boolean algebra to memories, counters and simple arithmetic circuits, and finally to a complete understanding of the design and operation of calculators and computers.

The contents of Design of Digital Systems include:

Book 1 Octal, hexadecimal and binary number systems; conversion between number systems; representation of negative numbers; complementary systems; binary multiplication and division.

Book 2 OR and AND functions; logic gates; NOT, exclusive-OR, NAND, NOR and exclusive-NOR functions; multiple input gates; truth tables; De Morgans Laws; canonical forms; logic conventions; Karnaugh mapping; three-state and wired logic.

Book 3 Half adders and full adders; subtractors; serial and parallel adders; processors and arithmetic logic units (ALUs); multiplication and division systems.

Book 4 Flip flops; shift registers; asynchronous and synchronous counters; ring, Johnson and exclusive-OR feedback counters; random access memories (RAMs) and read only memories (ROMs).

Book 5 Structure of calculators; keyboard encoding; decoding display data; register systems; control unit; program ROM; address decoding; instruction sets; instruction decoding; control program structure.

Book 6 Central processing unit (CPU); memory organization; character representation; program storage; address modes; input/output systems; program interrupts; interrupt priorities; programming; assemblers; computers; executive programs; operating systems and time sharing.



Digital Computer Logic and Electronics is designed for the beginner. No mathematical knowledge other than simple arithmetic is assumed, though the student should have an aptitude for logical thought. It consists of four volumes — each 11-1/2" x 8-1/4" — and serves as an introduction to the subject of digital electronics. Everyone can learn from it — designer, executive, scientist, student, engineer.

Contents include: Binary, octal and decimal number systems; conversion between number systems; AND, OR, NOR and NAND gates and inverters; Boolean algebra and truth tables; De Morgans Laws; design of logic circuits using NOR gates; R-S and J-K flip flops; binary counters, shift registers and half adders.

In the years ahead the products of digital electronics technology will play an important part in your life. Calculators and digital watches are already commonplace. Tomorrow a digital display could show your automobile speed and gas consumption; you could be calling people by entering their name into a telephone which would automatically look up their number and dial it for you.

These courses were written by experts in electronics and learning systems so that you could teach yourself the theory and application of digital logic. Learning by self-instruction has the advantages of being faster and more thorough than classroom learning. You work at your own pace and must respond by answering questions on each new piece of information before proceeding.

After completing these courses you will have broadened your career prospects and increased your fundamental understanding of the rapidly changing technological world around you.

The six volumes of Design of Digital Systems cost only: **\$19⁸⁸**

And the four volumes of Digital Computer Logic and Electronics cost only: **\$14⁸⁸**

But if you buy both courses, the total cost is only: **\$29⁹⁰**

a saving of over: **\$5⁰⁰**

SEVEN-DAY MONEY-BACK GUARANTEE: If you are not satisfied with your Cambridge course, return it within 7 days for a full refund.

To order your books, complete the order form below and send it together with your check or money order to GFN Industries, Inc., 6 Commercial Street, Hicksville, N.Y. 11801.

To: GFN INDUSTRIES, INC.

6 COMMERCIAL STREET, HICKSVILLE, NY 11801

Please send me:

___ Sets of Design of Digital Systems \$19.88 _____

___ Sets of Digital Computer Logic & Electronics \$14.88 _____

___ Sets of both courses \$29.90 _____

Sales tax (N.Y. residents) _____

Shipping and handling \$2.50 per set _____

Enclosed is check / mo (payable to GFN Industries, Inc.)

Total \$ _____

Name _____

Address _____

City/State/Zip _____

Prices include overseas surface mail postage.

SA6B

equipment report

Polaris CT-751 Cobra Curve Tracer

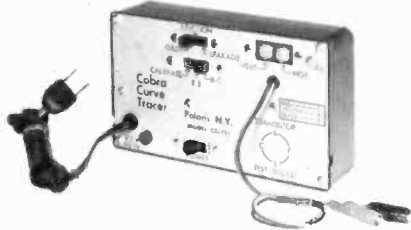

CIRCLE 70 ON FREE INFORMATION CARD

I HAVE ALWAYS BEEN FOND OF CURVE TRACERS for transistor testing—they show you a definite pattern. The Polaris Co., 2862 Fulton St., NY 11207, has come up with a compact and versatile unit, their model CT-751. All you need is a scope, and any old scope will do. Only three connections are needed: to the vertical and horizontal scope inputs, and ground. The scope is set to EXTERNAL SWEEP.

The Cobra's controls are simple and easy

to operate. There are two slide switches at the top of the panel, with the POWER switch at the bottom. Scope connections are made to three screw terminals in the upper right corner. In addition to a miniature transistor socket, there are three color-coded clip leads (with the colors and connections plainly marked on the panel).

Calibration is easy. Just set the slide switch to the CALIBRATE position and adjust the scope controls to get a diagonal line on the screen that runs about half the width of the screen (not critical). This line can slant either way; it makes no difference.

Now you're ready to go. With a known transistor, insert the transistor leads into the socket or clip to the test leads to the transistor. Set the two switches to the JUNCTION and B-E positions. If the transistor is good, you'll see a sharp right-angle pattern on the scope. This may go from the center of the screen to the right and down, or from the left and up. Again, it makes no difference—all you want to see is the "angle." This indicates this junction is good. Now, set the lower slide-switch to the B-C position: the angle should flip 180°, just opposite to what it was.

If this happens, both junctions in the transistor are good. If you get a vertical line in either position, the junction is shorted. A horizontal line shows it's open (or that one of the clip leads has fallen off).

You can use this test to identify the leads of an unknown transistor. Just hook them up in any order and try the switches. If you get horizontal or vertical lines, swap two of the leads and try again. If you can find a hook-up that will give you the normal "flip" reaction, you can identify the transistor terminals from the colors.

Gain can be checked by setting the switches to GAIN and B-C. A horizontal trace with a "droop" will be seen. The longer the trace before the droop, the higher the gain. For leakage, set the switches to LEAKAGE and B-C. Very high leakage is shown by a vertical line.

You can check any kind of diode on the model CT-751—rectifiers, Zeners, tunnel diodes, SCR's, and LED's. Use only the black (emitter) and yellow (base) leads. Set the switches to JUNCTION and B-E. Hook up the diode with the anode to the yellow lead and

continued on page 32

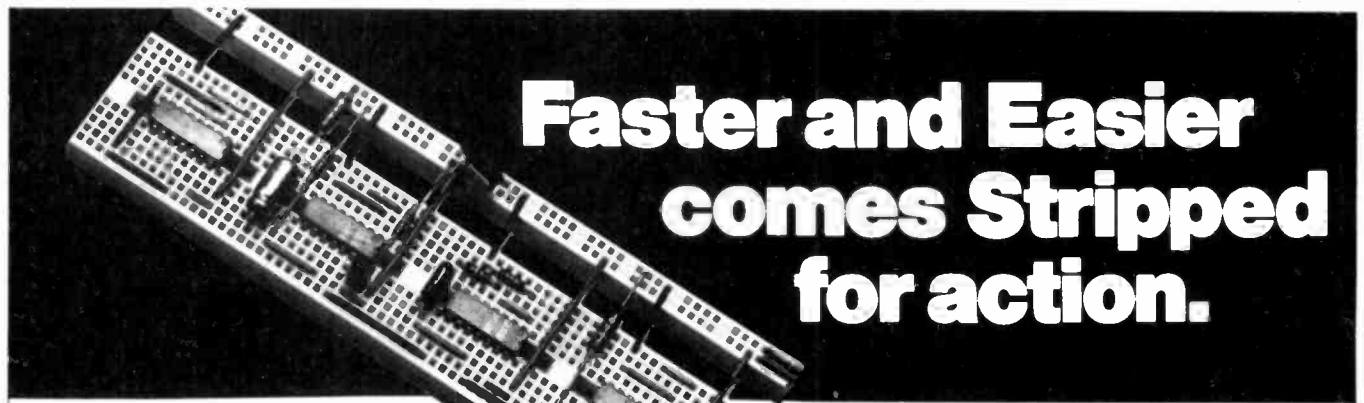

Faster and Easier comes Stripped for action.

A P Terminal Strips and Distribution Strips give you full-performance solderless breadboards in ten comfortably priced building-block sizes. Electronic components plug right into the spring-clip terminals behind each hole. Hookup wire jumpers between terminals complete your circuit. Terminal Strips are groups of 4-tie-point or 5-tie-point terminals. Distribution Strips are interconnected groups of 4-tie-point terminals. They're both faster and easier to use.

Order from your A P distributor today. For the name of the distributor nearest you call Toll-Free 800-321-9668.

Send for our complete A P catalog, The Faster and Easier Book.



TERMINAL STRIPS

| Part No. | Model No. | Terminals | Tie Points | Price each |
|----------|-----------|-----------|------------|------------|
| 923273 | 217L | 34 | 5 | \$ 4.75 |
| 923291 | 154R | 54 | 4 | \$ 6.00 |
| 923269 | 234L | 68 | 5 | \$ 8.50 |
| 923265 | 248L | 96 | 5 | \$10.00 |
| 923289 | 264R | 128 | 4 | \$10.00 |
| 923261 | 264L | 128 | 5 | \$12.50 |

DISTRIBUTION STRIPS

| Part No. | Model No. | Terminals | Tie Points | Price each |
|----------|-----------|-----------|------------|------------|
| 923285 | 206R | 12 | 4 | \$ 2.00 |
| 923281 | 209R | 18 | 4 | \$ 2.25 |
| 923277 | 212R | 24 | 4 | \$ 2.50 |
| 923293 | 606R | 36 | 4 | \$ 3.50 |

Faster and Easier is what we're all about.

A P PRODUCTS INCORPORATED

Box 110 • 72 Corwin Drive • Painesville, Ohio 44077 216/354-2101 TWX: 810-425-2250

CIRCLE 5 ON FREE INFORMATION CARD

Security is Mallory.

With Mallory Security Products on the job, intruders get the message loud and clear, anyplace, anytime.

For the few dollars they cost, here are mighty effective ways to signal forced entry of a building, home, apartment, office, automobile.

Put the Mallory CA3 Intrusion Alarm in your living room, for instance. It'll easily pass for a radio or stereo tuner while transmitting a 20-foot ultrasonic wavelength field. One that will detect the slightest intruder movement and activate an alarm. This compact area-and-perimeter device comes with solid-state



circuitry and big reliability. And a wide variety of indoor and outdoor warning accessories to choose from—

bells, horns, sirens, rotating red lights, tape switches, many more. For automobile security, install the Mallory ABA1 Car Alarm with entry sensing and instant siren alert for doors, hood and trunk. It comes as an easy-to-install kit, complete with switches, wire, keys, warning decals.

From any angle, Mallory Security Products mean protection. See your Mallory distributor. Or send for our Security Products Bulletin No. 9-654.

Mallory Distributor Products Company. A division of P. R. Mallory & Co. Inc., Box 1284, Indianapolis, Indiana 46206. (317) 856-3731.



Mallory CA3 Intrusion Alarm and ABA1 Car Alarm.

MALLORY

Capacitors • Controls • Fastening Devices • Resistors • Security Products • Semiconductors • Solderless Terminals • Switches

CIRCLE 49 ON FREE INFORMATION CARD

At CIE, you get electronics career training from specialists.

If you're interested in learning how to fix air conditioners, service cars or install heating systems – talk to some other school. But if you're serious about electronics, come to CIE – The Electronics Specialists.

John E. Cunningham

**Special Projects Director
Cleveland Institute of Electronics**



My father always told me that there were certain advantages to putting all your eggs in one basket. "John," he said, "learn to do one important thing better than anyone else, and you'll always be in demand."

I believe he was right. Today is the age of specialization. And I think that's a very good thing.

Consider doctors. You wouldn't expect your family doctor to perform open heart surgery or your dentist to set a broken bone, either. Would you?

For these things, you'd want a specialist. And you'd trust him. Because you'd know if he weren't any good, he'd be out of business.

Why trust your education and career future to anything less than a specialist?

You shouldn't. And you certainly don't have to.

FACT: CIE is the largest independent home study school in the world that specializes exclusively in electronics.

We have to be good at it because we put all our eggs in one basket: electronics. If we hadn't done a good job, we'd have closed our doors long ago.

Specialists aren't for everyone.

I'll tell it to you straight. If you think electronics would make a nice hobby, check with other schools.

But if you think you have the cool—and want the training it takes—to make sure that a sound blackout during a prime time TV show will be corrected in seconds—then answer this ad. You'll probably find CIE has a course that's just right for you!

At CIE, we combine theory and practice. You learn the best of both.

Learning electronics is a lot more than memorizing a laundry list of facts about circuits and transistors. Electronics is interesting because it's based on some fairly recent scientific discoveries. It's built on ideas. So, look for a program that starts with ideas—and builds on them.

That's what happens with CIE's Auto-Programmed® Lessons. Each lesson uses world-famous "programmed learning" methods to teach you important principles. You explore them, master them completely... before you start to apply them!

But beyond theory, some of our courses come fully equipped with the electronics gear to actually let you perform hundreds of checking, testing and analyzing projects.

In fact, depending on the course you take, you'll do most of the basic things professionals do every day—things like servicing a beauty of a Zenith color TV set... or studying a variety of screen display patterns with the help of a color bar generator.

Plus there's a professional quality oscilloscope you build and use to "see" and "read" the characteristic waveform patterns of electronic equipment.

You work with experienced specialists.

When you send us a completed lesson, you can be sure it will be reviewed and graded by a trained electronics instructor, backed by a team of technical specialists. If you need specialized help, you get it fast... in writing from the faculty specialists best qualified to handle your question.

People who have known us a long time, think of us as the "FCC License School."

We don't mind. We have a fine record of preparing people to take... and pass... the government-administered FCC License exams. In fact, in continuing surveys nearly 4 out of 5 of our graduates who take

the exams get their Licenses. You may already know that an FCC License is needed for some careers in electronics—and it can be a valuable credential anytime.

Find out more! Mail this card for your FREE CATALOG today!

If the card is gone, cut out and mail the coupon.

I'll send you a copy of CIE's FREE school catalog, along with a complete package of independent home study information.

For your convenience, I'll try to arrange for a CIE representative to contact you to answer any questions you may have.

Remember, if you are serious about learning electronics... or building upon your present skills, your best bet is to go with the electronics specialists—CIE. Mail the card or coupon today or write CIE (and mention the name and date of this magazine), 1776 East 17th Street, Cleveland, Ohio 44114.



Patterns shown on TV and oscilloscope screens are simulated.

CIE **Cleveland Institute of Electronics, Inc.**
 1776 East 17th Street, Cleveland, Ohio 44114
 Accredited Member National Home Study Council

YES... John, I want to learn from the specialists in electronics—CIE. Send me my FREE CIE school catalog—including details about troubleshooting courses—plus my FREE package of home study information. **RE-13**

Print Name _____

Address _____ Apt. _____

City _____

State _____ Zip _____

Age _____ Phone (area code) _____

Check box for G.I. Bill information: Veteran Active Duty

Mail today!

cathode to black. If it's good, you'll see the angle pattern. If the vertical part of the trace slants, this diode has excessive forward resistance. If the horizontal part slants, it has too much reverse leakage. Germanium diodes will sometimes show higher leakage, but silicon diodes should show a very sharp angle.

This test can come in very handy for those very small glass diodes that you need a microscope to see the color coding. Hook the diode up. If you see a vertical line (conducting or short) reverse the leads. If you get

a good angle now, the diode is hooked up black lead to cathode, yellow to anode. Tunnel diodes will make a "lazy-S" pattern; this is due to the negative-resistance characteristic of these diodes. SCR's can also be tested: red lead to anode, black to cathode and yellow to gate. You'll see an angle pattern with a small loop near the bend, showing that the SCR is being gated-on. (All these patterns are shown in the instruction manual.)

Junction FET's may also be checked, but it is not recommended that IGFET's or other MOS devices be tested. Several IC's can be checked, especially the transistor arrays and diode arrays, if the basing is known. Phototransistors, photodiodes and photocells can also be checked on the model CT-751.

This unit can also be used for in-circuit transistor and diode testing. The patterns you get will depend on how much shunt impedance there is across the junctions in the circuit. In general, a thin vertical line indicates a short and a horizontal line indicates an open circuit. If you can get a good angle on any one of the junctions in-circuit, the transistor is apt to be good. Some will show almost the same patterns as the out-of-circuit tests; others will show only a slight "bend" in the trace.

Small capacitors can be checked in- or out-of-circuit. Use the black and yellow leads, and set the switch to B-E. If the capacitor is good, the pattern will become an ellipse. Very large capacitors will show an almost perfect vertical line.

Variable resistors larger than 6,000 ohms can also be checked. They should show a slanting line. Moving the control shaft should make the line move smoothly from vertical toward horizontal. If the control is noisy, the trace will jitter.

While playing with this instrument, we found another very handy feature. You can check many iron-core inductors—power transformers, vertical output transformers, audio output transformers, filter chokes, etc. If the inductor is good, you will see an ellipse. The higher the inductance, the nearer to perfectly round. If one of the windings on the transformer is shorted, you'll see only a vertical line. Use the largest winding for best results. For example, on an autotransformer vertical output, the primary makes a good ellipse. Short the leads to the yoke winding and the display should be a thin vertical line. To check low-inductance windings, the horizontal gain of the scope may have to be increased. You'll see a long, thin ellipse, but if it is definitely an ellipse, this inductor is good.

The model CT-751 is a very compact, versatile little instrument that saves a lot of time and won't take up too much space on the bench. **R-E**



Sharp Enough To Cut A Human Hair... Tough Enough To Cut Piano Wire

A precision cutting tool with muscle to match. Perfectly mated cutting edges, hand honed, scientifically hardened. Jaw-opener coiled spring, a great help on repetitive jobs. Drop forged, fine polished, top quality steel. Blue dipped plastic comfort grips. In brief, the extras that reward you for insisting on hand tools by CHANNELLOCK.

CHANNELLOCK, INC., Meadville, Pa. 16335

CHAN NEL LOCK

No. 436 GS Diagonal Cutter

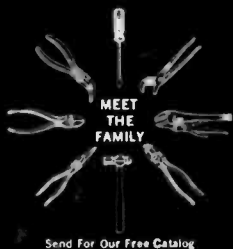

Send For Our Free Catalog

CIRCLE 11 ON FREE INFORMATION CARD

NATESA warns that TV games may complicate tube warranties

As every technician knows, phosphor picture tube faces can be damaged if a fixed pattern at fairly high intensity is left on the tube. Oscilloscopes have also been damaged when a line or dot has been etched into the tube face.

Video games now being used with TV sets raise this potential for damage. As competition increases, it's possible that inferior game design will require increasing the brilliance for adequate viewing. This will also help cause such damage.

This puts service people in a vulnerable position in cases of tubes damaged by etching. Manufacturers' policies on replacing within-warranty tubes in which game-etched faces are the only defect differ widely.

NATESA believes servicers must, in all cases needing within-warranty picture tube replacement, inform set owners that this replacement will depend on the policy of the picture tube producer or marketer. Since in many cases, defective CRT's are simply accepted by the warrantor subject to later inspection and approval, servicers are cautioned not to deliver sets in such cases, unless the warrantor issues irrevocable credit. **R-E**

Go with Realistic[®] no matter how you go!

Realistic CB is for people on the move. Whether you're driving an unfamiliar road, hiking away from camp, or working in the field, reliability is a prime concern with your walkie-talkie or mobile set. So come to Radio Shack — leading the way in quality CB since 1959.



walkin' and talkin'

Realistic's TRC-190 has exclusive range-boost: Grip the side-panels and your body adds extra signal power to the antenna system. Three watts input, with a high-low power switch to save on batteries during short-range use. Built-in automatic noise limiter, ceramic IF filter, IC audio circuitry — all for clean, low-interference sound. Adjustable squelch. Battery/RF meter. Built-in mike, speaker, plus a jack for optional push-to-talk mike. Power and antenna jacks so you can use the TRC-190 as a base or mobile station. Includes batteries, crystals for Channel 14, and you can add up to 5 more channels. Just 84.50*.

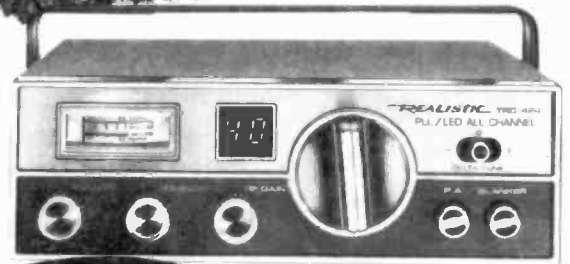

ridin' and talkin'

The TRC-424 is our finest 40-channel set, and the built-in quality is obvious. Phase-locked loop circuitry for ultra-precise frequency control. Switchable noise blanker — the surest way to reduce pulse interference. Delta-tuning helps get off-channel signals. Adjustable RF gain and squelch. Channel selection is easier than ever with the large LED digital readout — one glance is all it takes. Add an external speaker and you've got a mobile public address system, too. with S/RF meter, dynamic plug-in mike, mounting bracket and power cables. First-class CB is even better when you can afford it! Get the new Realistic TRC-424. Just 169.95*.



These two credit cards honored at most Radio Shacks. *Prices may vary at individual stores and dealers.

Radio Shack[®]

A TANDY COMPANY • FORT WORTH, TEXAS 76107
OVER 5000 LOCATIONS IN NINE COUNTRIES

The \$99.95 mystery...



B&K-PRECISION's new 3 1/2 digit DMM

For over two years, our competition has been trying to figure out how B&K-PRECISION could sell a full-feature 3-digit DMM for only \$99.95. They've dissected it, analyzed it, and some even asked us how we did it. Well, they can start all over because we did it again!

B&K-PRECISION's new Model 2800 portable DMM features 3-1/2 digit display, auto-zeroing and 100% overrange reading for only \$99.95. Basic DC accuracy is 1%. Twenty-two ranges read up to 1000 volts DC or AC, 1000mA and 10 megohms.

All ranges are well protected against overloads. Even if you should accidentally apply +1000VDC to the 2800 while switched to an ohms range, no instrument damage will result. All DC and AC voltage ranges are protected up to ± 1000 volts DC or AC. The current ranges receive the double protection of diodes and a series fuse.

For accurate in-circuit resistance measurements, the 2800 measures with high- or low-power ohms ranges. At low-power ohms, less than 0.2 volt is developed across the measured resistance. To forward bias semiconductor junctions, the high-power ohms ranges develop about 2 volts.

B&K-PRECISION also has a full complement of optional accessories for the 2800. Accessories include a carrying case, wire tilt stand, AC adapter/charger, high-voltage probe, direct/isolation probe NiCad Batteries and 10-amp current shunt.

The B&K-PRECISION 2800 may be a mystery to our competitors, but for you—it takes all the mystery out of which DMM to buy.

See your local distributor for immediate delivery.

B&K PRECISION DYNASCAN CORPORATION

6460 West Cortland Avenue, Chicago, Illinois 60635 • 312/889-9087

In Canada: Atlas Electronics, Ontario • International Sales: Empire Exporters, Inc., 270 Newtown Road, Plainville, LI, NY 11803

HERE'S A DIGITAL CLOCK YOU CAN BUILD that displays its numerals on a TV screen. If you own any black-and-white or color TV, you can build the on-screen TV digital clock described here, available in kit form for \$29.95, and install it in your TV.

How it works

The schematic is shown in Fig. 1. The MM5318 (IC3) is a Digital Clock IC with multiplexed BCD (Binary Coded Decimal) outputs. A transformer-powered full-wave rectifier (D1 and D2) provides an unregulated 12-volt DC output that is filtered by C1, C2 and R10. A low-voltage 60-Hz signal is fed into pin 19 of the MM5318 as the timebase signal. Line voltage transients are removed from this signal by R9, D3 and D4. Pin 13 is either connected to ground for a 12-hour display format, or +12 VDC for a 24-hour display. Switches S2, S3 and S4 are for time-setting.

The outputs of the MM5318 are fed directly to IC4, an MM5841 TV Time/Channel Generator IC. (Note: The channel display feature is not used in this project.) This IC contains counters, shift registers, ROM's (Read-Only Memories) and many other circuit functions for displaying the numerals on the TV screen. The video signal is available at pin 15 of IC4 and is applied to the TV set through C10, R14, Q3 and R15. (Specific data for this and all other IC's used in this project is available from National Semiconductor Corporation, 2900 Semiconductor Drive, Santa Clara, CA 95051.)

Three gates of IC1, a 74COO CMOS (Complementary-Metal-Oxide-Silicon) IC quad 2-input NAND gate, and C5, R11 and R12 form an external oscillator for the MM5841. This oscillator controls the height of the displayed digits. Another 74COO, IC2, together with C8, C9, R13 and R18, provides timing and gating to control how often and for how long the digits are displayed. Potentiometer R18 determines display interval, and S1 allows you to "call-up" the display on command.

To display the digital characters on the TV screen, the circuit must synchronize with the TV scan. This is done by connecting the TV Clock vertical and horizontal sync inputs to the proper points in your TV circuitry, as described later. Transistors Q1 and Q2 feed these synchronizing pulses to the MM5841 where they trigger outputs on pins 16, 17, 20 and 21. Trimmer R16 controls the horizontal position of the digits on the TV screen, while R17 controls the vertical position.

Construction

This entire project can be built on a perforated board and hand-wired, but the circuit layout and lead lengths

Build this Digital On-Screen TV Clock

This digital clock displays either 4 or 6 digits of time on the screen of your TV set in either the 12- or 24-hour format

FRED BLECHMAN

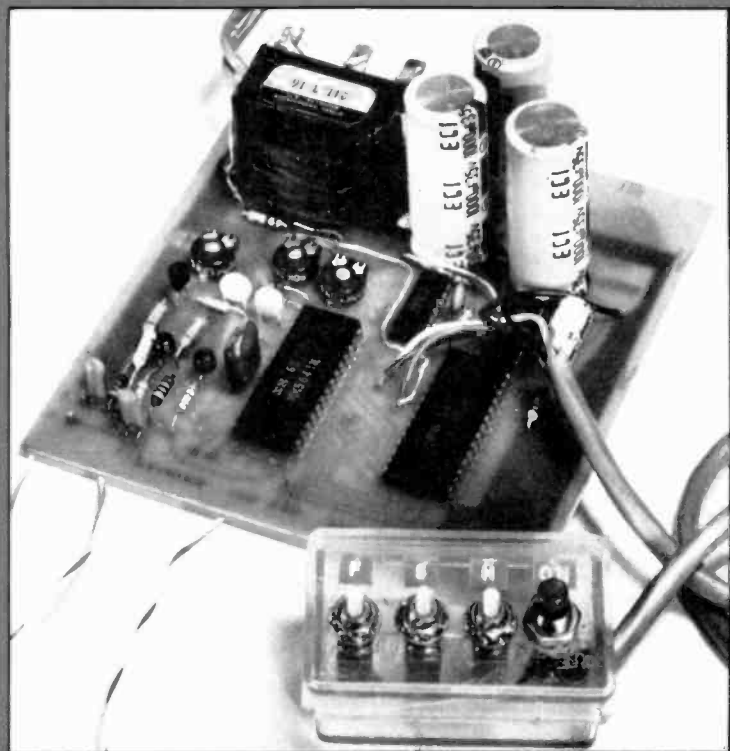

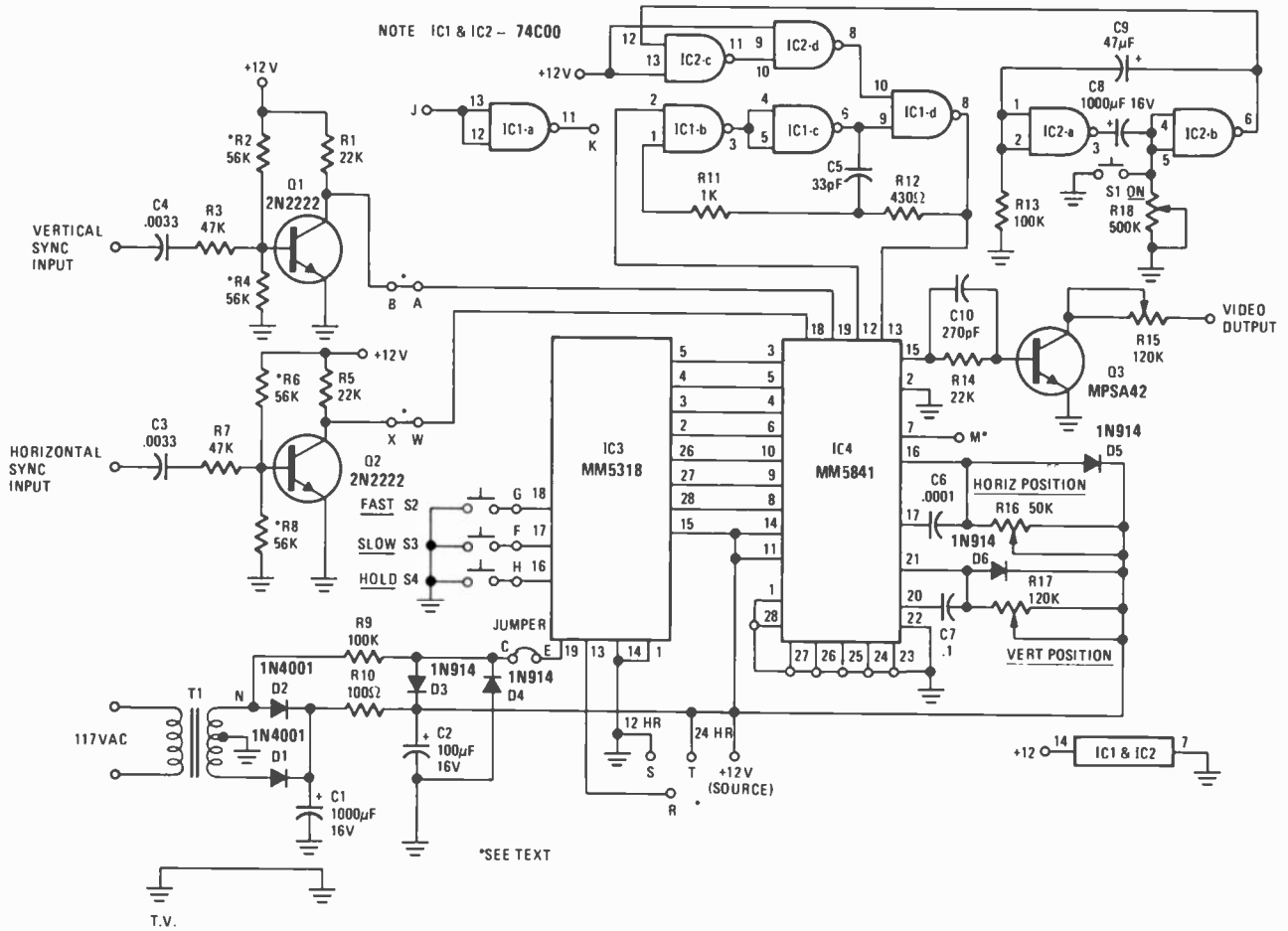

FIG. 1—ON-SCREEN DIGITAL CLOCK requires vertical and horizontal sync pulses from TV circuitry.

would be critical at these frequencies. It is better to use a printed circuit board; the foil pattern is shown in Fig. 2.

Using the PC board and the parts layout shown in Fig. 3, assembling this

project is easy. Carefully identify each resistor and be very sure to observe polarity when installing the diodes and those capacitors that are polarized. The transistors must be installed with the flat

sides as shown.

Start by installing the components on the PC board. Do not install R2, R4, R6 or R8 at this time; they will be installed later. Next mount the transformer to the PC board with two No. 6-32 \times $\frac{3}{8}$ screws and nuts. Solder power diodes D1 and D2 (be careful not to confuse these with the smaller signal diodes) to the two top outside lugs of the transformer, with the cathodes (banded end) soldered into the PC board holes below. Various jumper wires are needed to complete the wiring and select options. Most jumpers are on top of the board. Run a jumper wire from the upper center transformer terminal to the PC board hole below. Also add jumper wires from the two bottom transformer terminals to the holes below them. Jumper point N on the PC board to the junction of D2 and the transformer terminal. (If your transformer is not the one specified in the parts list, you can determine the proper connections by referring to the schematic and the PC board layout.) Jumper points E and C on the PC board. Jumper IC2 pin 13 and IC2 pin 9 to +12V. There are convenient +12V holes in the board near R16 and just above C2.

On the bottom of the board, IC4 pin 11 should be jumpered or shorted to the

R-E TRIES IT

The On-Screen TV Digital Clock was tested by connecting it to a Heathkit GR-25 color TV receiver. The performance was completely satisfactory. When first connected, the time display was located in the center of the screen. There was some de-focusing from right to left with the seconds digits as sharp as you would want, the minutes slightly out of focus and the hours badly blurred.

The positioning pots were adjusted to place the display in the upper right corner of the screen. Next, we experimented with the video output (whiteness) control to see what effect it had on the display. By backing off the control, we reduced the distortion in the display so all digits were equally sharp and bright without a trace of color.

Connections

After reading the input-signal requirements, we studied the wave-

forms available at various points in the GR-25 and examined the chassis for possible connecting points on the top side of the PC board. Both grids of the vertical multi-vibrator were driven by sawtooth waves with a fast falltime. We installed R2—as instructed in the article—and tacked the vertical sync lead on to pin 2 of the 6GF7 vertical multi-vibrator.

A reversed sawtooth with a fast risetime was present at the junction of the two horizontal phase detector diodes. Since this was a test point, it proved to be a convenient spot to pick up the horizontal sync signal. Resistor R8 was installed on the clock PC board as directed.

The clock's video output was fed into the set's video output circuit through test point TP7 at the output of the video amplifier. Since, in this set, this point is also connected to a terminal on the SERVICE switch, this would be an equally convenient point to feed in the video.

PARTS LIST

All resistors are 1/4-watt, 10% or better, unless otherwise noted

- R1, R5, R14—22,000 ohms
- R2, R4, R6, R8—56,000 ohms
- R3, R7—47,000 ohms
- R9, R13—100,000 ohms
- R10—100 ohms
- R11—1000 ohms
- R12—430 ohms
- R15, R17—120,000-ohm trimmer, horizontal PC mount
- R16—50,000-ohm trimmer, horizontal PC mount
- R18—500,000-ohm, horizontal PC mount
- C1, C8—1000 μ F, 16-volt, electrolytic
- C2—100 μ F, 16 volt, electrolytic
- C3, C4—.0033 μ F, disk or Mylar
- C5—33 pF, disk
- C6—1000 pF, disk or Mylar
- C7—0.1 μ F, Mylar
- C9—47 μ F, 16 volt, electrolytic
- C10—270 pF, disk
- Q1, Q2—2N2222 or equal
- Q3—MPSA42 (Motorola) or HEP S0027
- D1, D2—1N4001 or equal
- D3-D6—1N914 or equal
- IC1, IC2—74C00 Quad 2-Input NAND Gate
- IC3—MM5318 Digital Clock (National)
- IC4—MM5841 TV Time/Channel Generator (National)
- S1-S4—SPST pushbutton switch
- T1—117-volt primary; 16 volt, 150 mA, secondary. (Signal Transformer No. 241-3-16 or equal)

The following parts are available from Interfab, 27963 Cabot Rd., Laguna Beach, CA 92677: A complete kit of parts, including PC board, for \$29.95 plus \$1 shipping. Order No. DC-12 TV Clock Module. A PC board is available separately for \$4.25 plus 50¢ shipping. California residents add state and local taxes as applicable.

printed-circuit trace (+12V) that runs between pins 11 and 12. Also, using a single bare wire that "snakes" from point-to-point, connect IC4 pins 1, 22, 23, 24, 25, 26, 27 and 28 (numbered 1-8 on the PC board) to ground near point 8.

Now you have to select some options. Do you want 4 digits (hours and minutes) or 6 digits (hours, minutes and seconds) to appear on the screen? For 4 digits, jumper point M (pin 7, MM5841) to ground. For 6 digits, jumper M to +12V. Do you want a 12 or a 24-hour display format? Jumper point R (pin 13, MM5318) to ground (point S) for a 12-hour format, or to +12V (point T) for a 24-hour display.

Four switches are used, and they can all be mounted on a single panel or in a small plastic box. Switch S1 should be readily accessible since it is used to manually call-up the display. It is a pushbutton type switch; if you want to be able to leave the clock display on for extended periods, use a slide or toggle SPST switch instead. The other switches are used for time setting and can be less

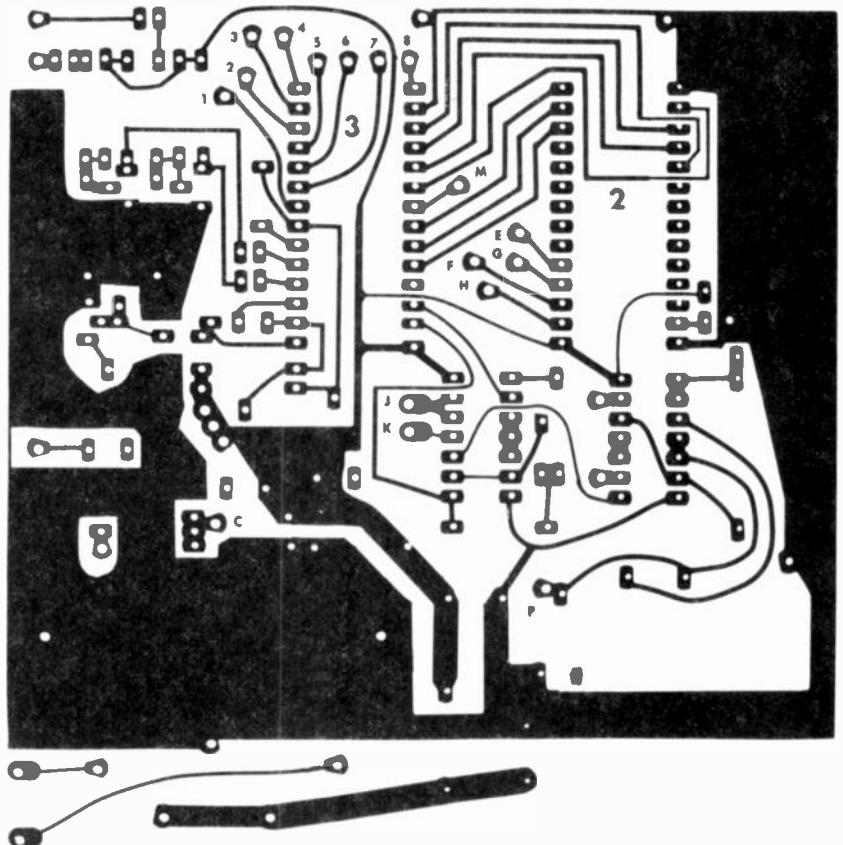

FIG. 2—FOIL PATTERN shown actual size.

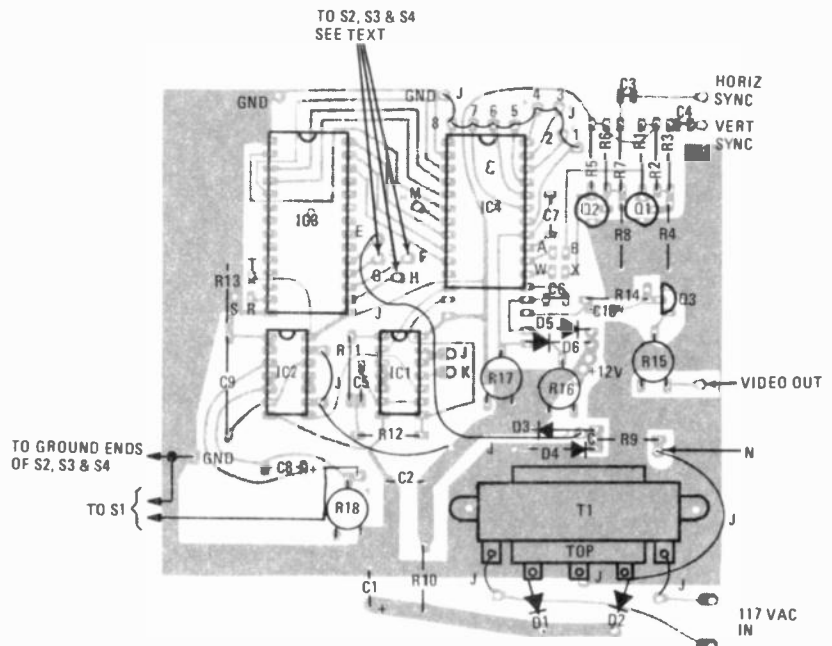

FIG. 3—COMPONENT PLACEMENT diagram.

accessible—you might even want to hide them behind a panel to prevent tampering. Using multiconductor or ribbon cable, wire one side of all switches to ground. Then wire the other switch terminals as follows: S2 to point G; S3

to point F; S4 to point H. These are pins 18, 17 and 16, respectively, of the MM5318.

Installation

Installing the TV Digital Clock into

your TV involves both physical and electronic connections. **Caution:** When installing this project in your TV set, remember that most TV's have a "hot" chassis wired directly to one side of the AC line. Make sure the chassis is at ground potential before you start working on it.

To begin with, you must connect the TV Clock board to a constant source of 117-VAC 60-Hz power—it must be powered even when the TV is off. You *could* do this by running a separate line cord to a wall socket, but it really makes

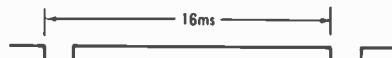

FIG. 4—PULSE TRAIN required at pin 19 of IC4.

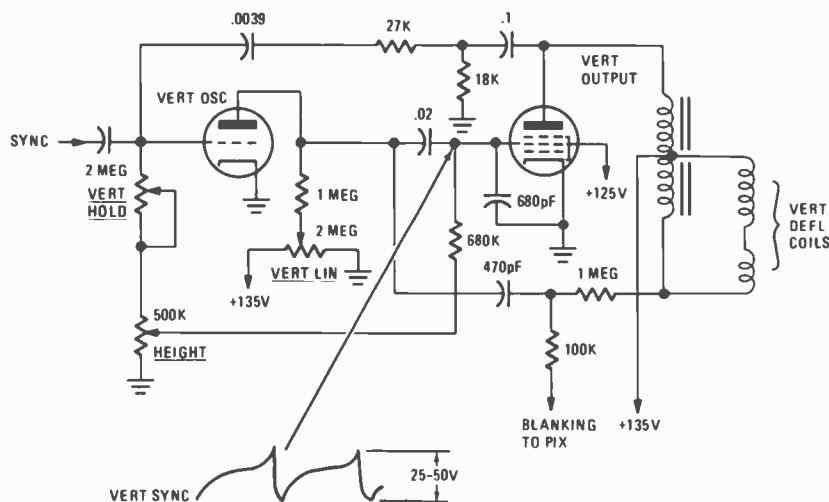

FIG. 5—TYPICAL VERTICAL AMPLIFIER showing location of vertical sync pulses.

more sense to connect the TV Clock board to the points in the TV where the AC power enters. Wire these points to the 117-VAC input pads on the TV Clock PC board. Also, be sure to connect a wire from the TV Clock board ground to the TV set ground.

Vertical sync can be taken from the vertical oscillator or vertical amplifier. You are looking for either a positive-going sync pulse with a fast risetime or a negative-going sync pulse with a fast falltime used for vertical retrace. A positive-going sync pulse requires R4 to be installed; a negative-going pulse requires R2. The pulse needed at point A (IC4, pin 19) is shown in Fig. 4. This results from a positive-going pulse fed into C4. Fig. 5 shows a typical vertical amplifier circuit. If you can't locate a positive-going pulse with a fast risetime (there's one there someplace!) and the output signal from Q1 is the inversion of the one shown in Fig. 4, there's a spare inverter section (IC1-a) at points J and K on the PC board. Use R2 and jumper B to J and K to A to invert the signal. If you find the preferred signal with a fast risetime, use R4 and jumper B to A directly.

Similarly, the horizontal sync is taken from the horizontal oscillator, with a typical TV circuit shown in Fig. 6. Look for a positive-going pulse with a fast risetime used for horizontal retrace, and install R8. Figure 7 shows the input needed at point W (IC4, pin 18) resulting from a signal with a fast risetime fed into C3. If you can't locate a signal with a fast risetime right away, keep looking, since there's only one spare inverter on the Clock PC board! If you used a positive-going signal for the vertical sync, then you can use a negative-going signal and inverter here, jumpering X to J and K to W, and installing R6 instead of R8. It's simpler, however, to find a positive-going horizontal signal and use R8 with a jumper

Using the TV Clock

With the TV set in operation, press switch S1. The digital time should appear somewhere on the screen for approximately 4 to 6 seconds, as determined by the time constant of R13 and C9. The time will appear automatically every 1 to 8 minutes, determined by C8 and the setting of potentiometer R18. Adjust R18 to a comfortable interval. To adjust the location of the display on the screen, hold down S1 and adjust

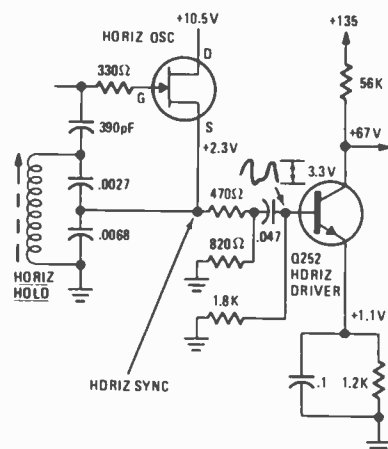

FIG. 6—TYPICAL HORIZONTAL OSCILLATOR showing location of horizontal sync pulses.

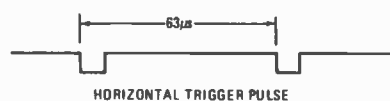

FIG. 7—PULSE TRAIN required at pin 18 of IC4.

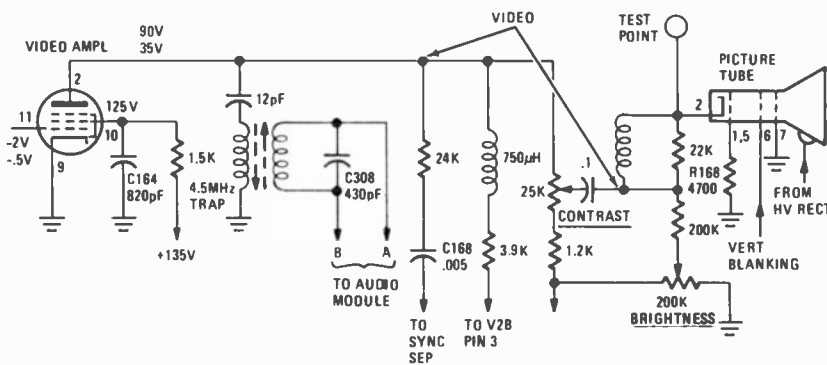

FIG. 8—TYPICAL VIDEO AMPLIFIER showing points where video from clock can be inserted.

directly from X to W, and ignore the spare inverter.

Now check your TV to see if it's operating normally and that no distortion is present as a result of this conversion.

The video output of the TV Clock circuit can be connected to the plate of the video amplifier or even on the brightness control. A typical video amplifier circuit is shown in Fig. 8. Use an oscilloscope to select a point where white images are noted by a decrease in voltage. The point of the tie-in should not have a DC voltage greater than 250 volts.

potentiometer R17 to control the vertical position of the display, and potentiometer R16 for the horizontal position. The brightness (whiteness) of the display is adjusted by R15.

To set the time, use a known time standard, such as the number provided by your phone company. Pressing S2 advances the hours once a second, pressing S3 advances the minutes once a second, and pressing S4 "freezes" the display until it's released. Simply advance the time slightly ahead of real time, and depress S4 to hold the count until the real time "catches up" with the displayed time.

Build This Electronic Slot Machine

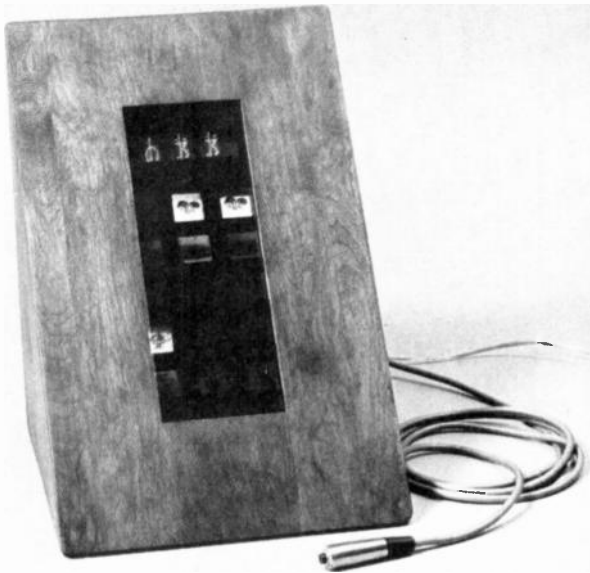

Here's a device that will make a nice addition to your den. It has, in addition to the display symbols, a 3-digit readout of the running tabulation of all winnings

GREGORY W. HART

ANYONE LOOKING FOR A UNIQUE AND CHALLENGING project will find this Electronic Slot Machine well worth the time and energy. Costing only \$50 to \$60 for parts, this digital project yields a form of entertainment that few people have access to.

One of the primary considerations in designing this project was that it must lend itself entirely to those of us endowed with vast quantities of natural laziness. This being the case, the arm that is normally pulled to initiate a "play" is replaced with a remote pushbutton switch. The numerical readout of an internal accumulator keeps a running tabulation of all winnings and automatically decrements each time the PLAY pushbutton is depressed.

The actual display consists of 35-mm slides (unmounted) of whatever object you wish to use. The standard display symbols used in slot machines are: cherries, oranges, plums, bells, and the word jackpot. Also watermelons, lemons, genies, and others are often used. The slides are arranged in 3 columns of 5 slides each. Each slide is mounted over an individual lamp for illumination.

To start, a RESET pushbutton located on the back panel is depressed. This presets the numerical readout to a count of 10. With the slot machine reset, a PLAY lamp located above the display-symbols lights and a play cycle can be initiated by depressing the PLAY pushbutton. During the play cycle, one slide in each column lights sequentially—one

slide in the first column, then one slide in the second column and finally, a third symbol in the last column. At this point, if the combination of symbols results in a payoff, the numerical readout is incremented accordingly. The PLAY lamp lights automatically to enable another play cycle.

When the power is first turned on, the digital circuitry quickly assumes a quiescent state and the readout displays some large number. It is necessary to clear the accumulator and preset a count of 10 by depressing the RESET pushbutton.

How it works

Referring to the block diagram shown in Fig. 1 and the complete schematic shown in Fig. 2, the RESET pushbutton

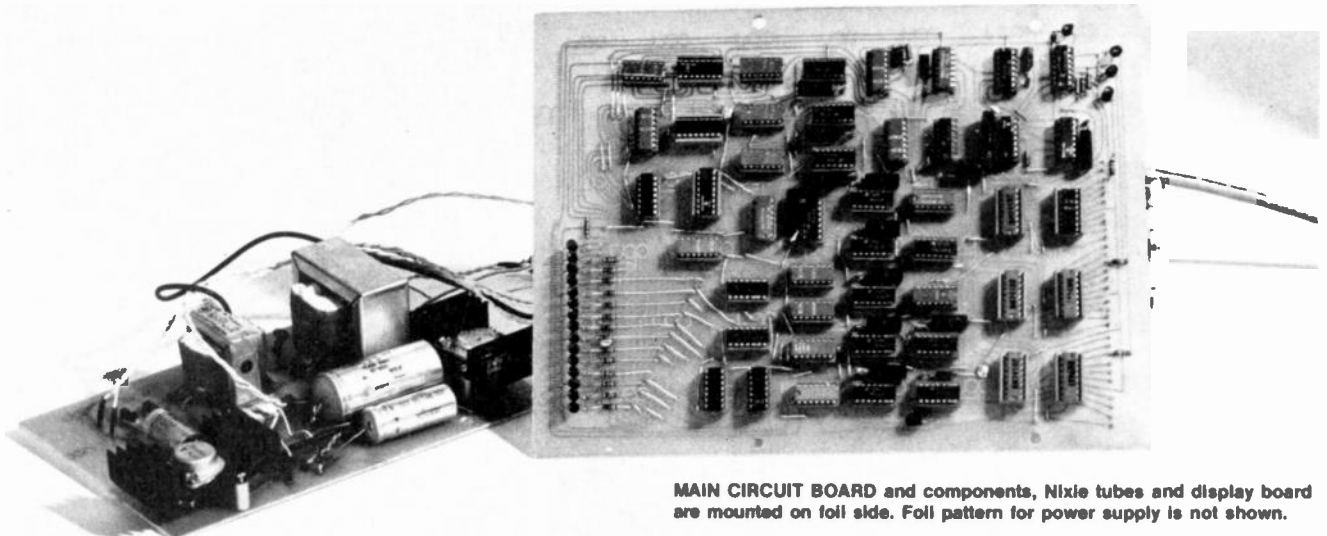

MAIN CIRCUIT BOARD and components, Nixie tubes and display board are mounted on foil side. Foil pattern for power supply is not shown.

triggers reset one-shot IC3. The output of the reset one-shot clears the up-down counters IC42, IC43 and IC44. The accumulator is comprised of these three up-down counters. The readout is now 0-0-0. The output of the reset one-shot triggers one-shot (IC4) to generate a delay, which insures that the accumulator is reset before the payoff sequence is initiated. The trailing edge of the delay-pulse triggers a payoff one-shot (IC34) that gates ten pulses into the up-down counters, setting the accumulator to 0-1-0. Each time a play cycle is completed, the accumulator is decremented by 1. After the RESET pushbutton is depressed, ten play cycles can be completed with no payoffs before a 0-0-0 is displayed and the play cycle is disabled.

With the slot machine reset, the PLAY lamp is on and the PLAY pushbutton can initiate a play cycle when depressed. The PLAY pushbutton triggers IC1. The output of IC1 enables five other circuits. Simulating a coin being played, IC1 decrements the accumulator by one count, resulting in a readout of 0-0-9. The three wheel-spin one-shots (IC9, IC10 and IC11) are also triggered at this time. The wheel-spin one-shots allow the display to give the appearance of

All resistors are 1/4-watt, 10%, unless otherwise noted

R1, R4, R13-R27, R35, R43-1,000 ohms
 R2-10,000 ohms
 R3, R5-33,000 ohms
 R6, R7, R11-20,000 ohms
 R8-300 ohms
 R9-1100 ohms
 R10-13,000 ohms
 R12-27,000 ohms
 R28-3900 ohms
 R29, R30, R32-12,000 ohms
 R31-17,000 ohms
 R33-36,000 ohms
 R34-130,000 ohms
 R36-15,000 ohms
 R37, R39, R41-240,000 ohms
 R38, R40, R42-510 ohms
 C1, C10, C11-100 μ F, 6 V, electrolytic
 C2, C3, C7-C9, C14, C15, C16-220 μ F, 6 V, electrolytic
 C4, C5-10 μ F, 6V, electrolytic
 C6, C18-1.6 μ F, 6V, electrolytic
 C12, C13-150 μ F, 6V, electrolytic

PARTS LIST, MAIN BOARD

C17-2.2 μ F, 35 V, electrolytic
 Q1-Q19-2N3417 or equivalent
 IC1-IC5, IC9-IC11, IC31-IC37, IC40-74121 monostable multivibrator
 IC6, IC20, IC22-IC25-7410 triple 3-input NAND gate
 IC7, IC8, IC18, IC19, IC21, IC26-IC30, IC41-7400 quad 2-input NAND gate
 IC12-IC14, IC39-7490 decade counter
 IC15-IC17-7442 BCD-to-decimal decoder
 IC38-7430 8-input NAND gate
 IC42-IC44-74192 synchronous decade up/down counter
 IC45-IC47-7441 BCD-to-decimal decoder
 Lamps 1-16-6-volt miniature, Sylvania, G-E, Hudson, Tung-Sol type 328, 337, 345, 380 or 381
 Display tubes 1-3-0-9 type Nixies
 Misc.-35-mm slides, cabinet, printed circuit board, lamp display board, hardware, two pushbutton switches.

spinning wheels. The time duration is set so that they stop in sequence, each being on longer than the previous one by a few seconds.

The oscillator enable one-shot (IC2) enables IC8-a, which allows the pulses to enter the three decade counters IC12.

IC13 and IC14. These counters have their decoded outputs connected to the odds-determining gates IC18 to IC21. The gates are wired to give a predetermined number of chances for each display symbol to light. The output of the oscillator enable one-shot also dis-

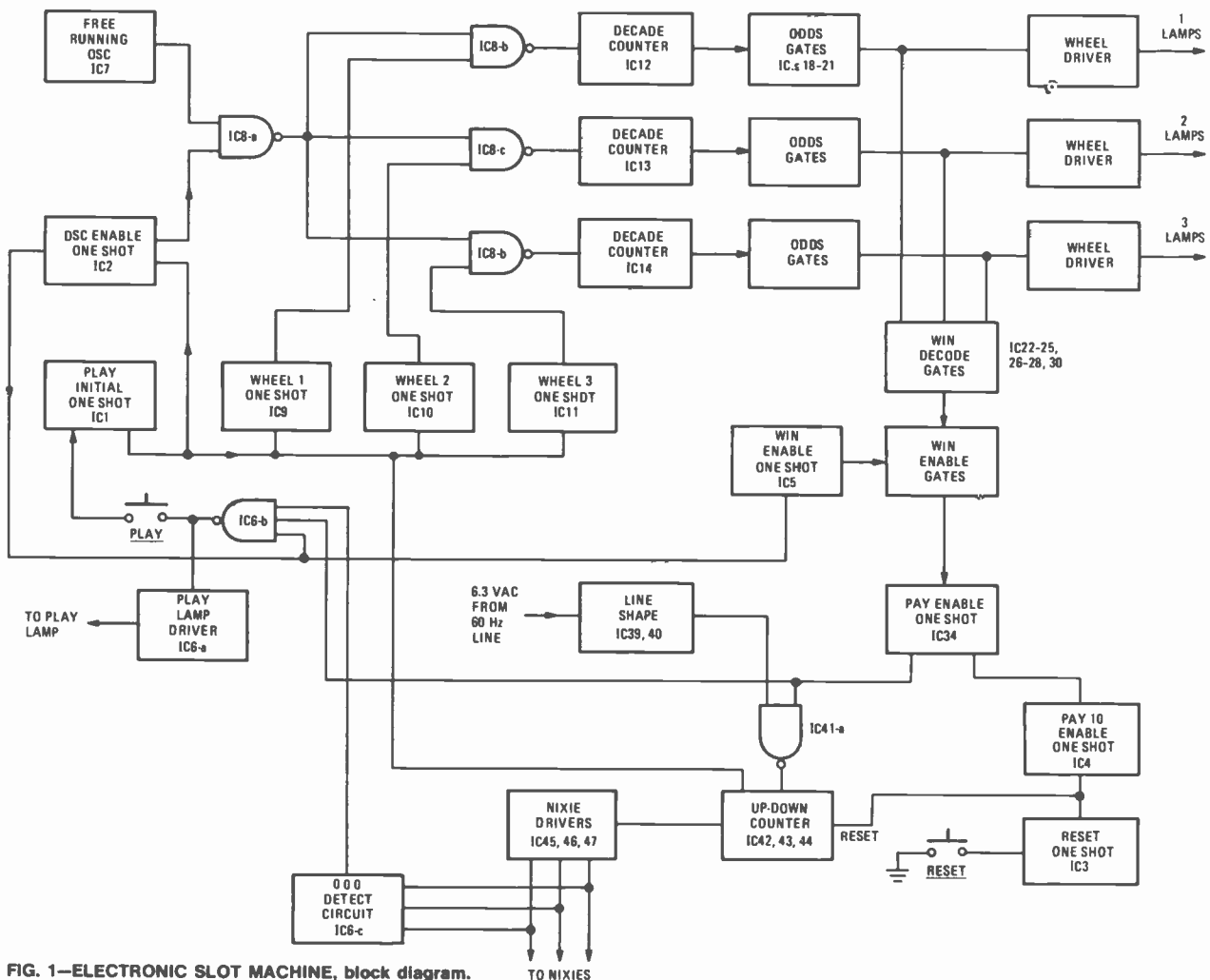

FIG. 1-ELECTRONIC SLOT MACHINE, block diagram.

IC1 11 18 18 40 41 5 VOLTSPIN16 CNDPMB
 IC4 47 5 VOLTSPIN5 CADPMB12
 IC5 9 47 14 5 VOLTSPIN16 CADPMB 8
 7 14 20 5 VOLTSPIN5 CADPMB 7 10
 ALL 74121 10 V BRAYTONS CHARGED 1085 PMS 0 11
 RESISTORS PINS 14

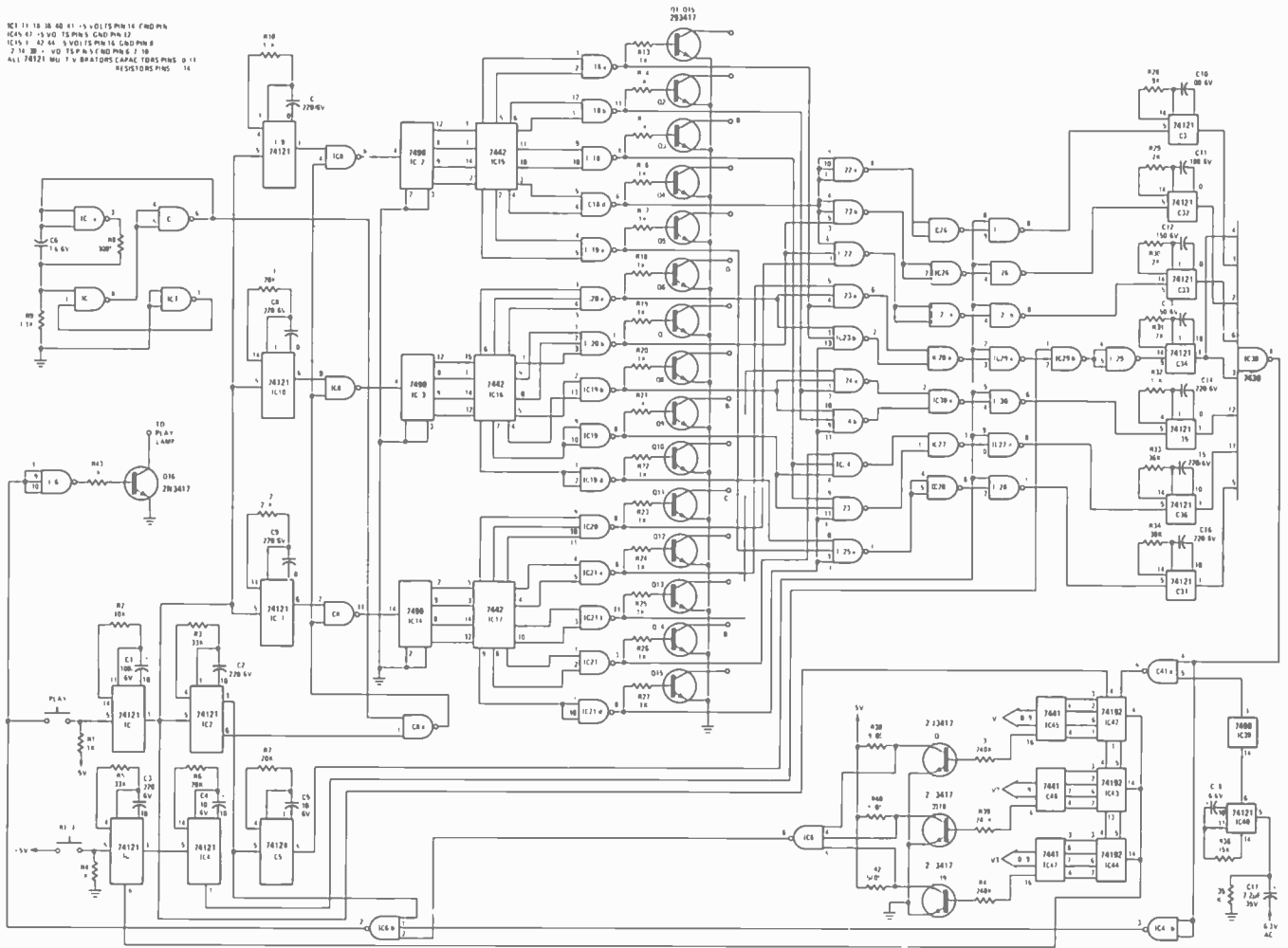

FIG. 2—THE COMPLETE SCHEMATIC. Numbers inside boxes in Fig. 1 refer to the IC's in this diagram.

| Payoff | Wheel 1 | Wheel 2 | Wheel 3 | Odds Out of 1000 Chances |
|--------|---------|------------|------------|--------------------------|
| 2 | Cherry | not Cherry | not Cherry | 200 |
| 5 | Cherry | Cherry | not Cherry | 60 |
| 8 | Cherry | Cherry | Cherry | 18 |
| 10 | Orange | Orange | Orange | 12 |
| 10 | Orange | Orange | Jackpot | 6 |
| 15 | Lemon | Lemon | Lemon | 8 |
| 15 | Lemon | Lemon | Jackpot | 4 |
| 20 | Bell | Bell | Bell | 4 |
| 20 | Bell | Bell | Jackpot | 2 |
| 100 | Jackpot | Jackpot | Jackpot | 2 |

ables the PLAY lamp to indicate that a cycle is in progress and the PLAY push-button will have no effect if depressed.

The outputs of the odds gates feed the inputs of gates IC22-IC25, IC26-IC28 and IC30. These gates determine if a winning combination is displayed after the wheels have stopped. On the trailing edge of the oscillator enable output, the win-gate enable IC5 is triggered to generate a narrow strobe pulse that enables all the win combination lines to see if any winning combination exists. If there is no winning combination, the PLAY lamp will light and the machine will be ready for a new cycle to be

initiated. If a winning combination does exist, the appropriate number of pulses are gated into the accumulator.

Construction

Construction is straight-forward. The main circuit board (Fig. 3) is assembled first. Over one hundred jumpers are to be installed, as shown in Fig. 4. This number could have been reduced by using a double-sided circuit board, but the added cost and effort did not justify its use. After all the jumpers are in place, install the IC sockets or Molex type pins, then mount the components. The power supply may be laid out on a

separate PC board or in spare places in the cabinet. Mount the regulator and pass transistor on small heat sinks for cooling.

The display can be fabricated from whatever materials are available. I used a PC board because it is sturdy and easy to work with. After piecing the display together in egg-carton fashion with the squares the size of 35-mm slides, holes are drilled in the center of each square through the back panel to accommodate the lamps. The lamps can then be press-fitted into the holes and the flanges soldered to the foil of the back panel, eliminating all wires connecting to the common supply bus of the lamps. When all circuits are wired it is ready to test. First check the power supply output voltages before connecting it to the main circuit board. If all voltages check out, then connect the power supply to the machine and check its operation. If the same combination repeats numerous times, it may be necessary to alter the values of the oscillator components slightly. They are C6, R8 and R9. The payoff rates are adjusted with the timing resistors as described previously.

The payoffs are shown in Table I along with the corresponding odds. The payoffs are the same as many real

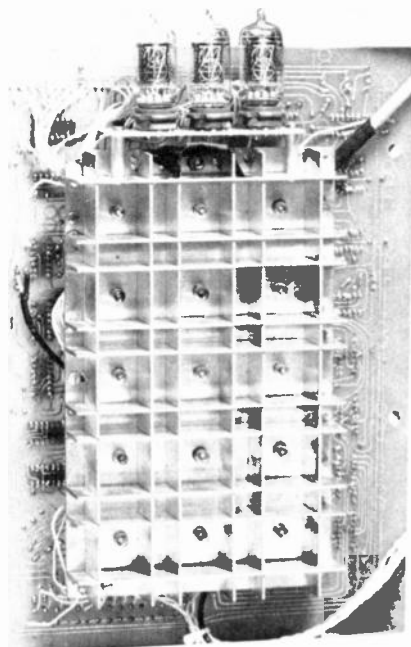

MAIN CIRCUIT AND DISPLAY BOARD, foil side view.

machines while the odds are far better. Due to the large value tolerances in electrolytic capacitors such as those used for the payoff one-shots, resistors R28-R34 will have to be changed to obtain the payoffs listed in the table. (A variation of 20-30% from the capacitance values listed is not uncommon.) In addition to the payoff one-shots, the wheel one-shots and oscillator enable one-shot (IC9, IC10, IC11 and IC22, respectively) may also need to be fine-adjusted to obtain a satisfactory pulse duration.

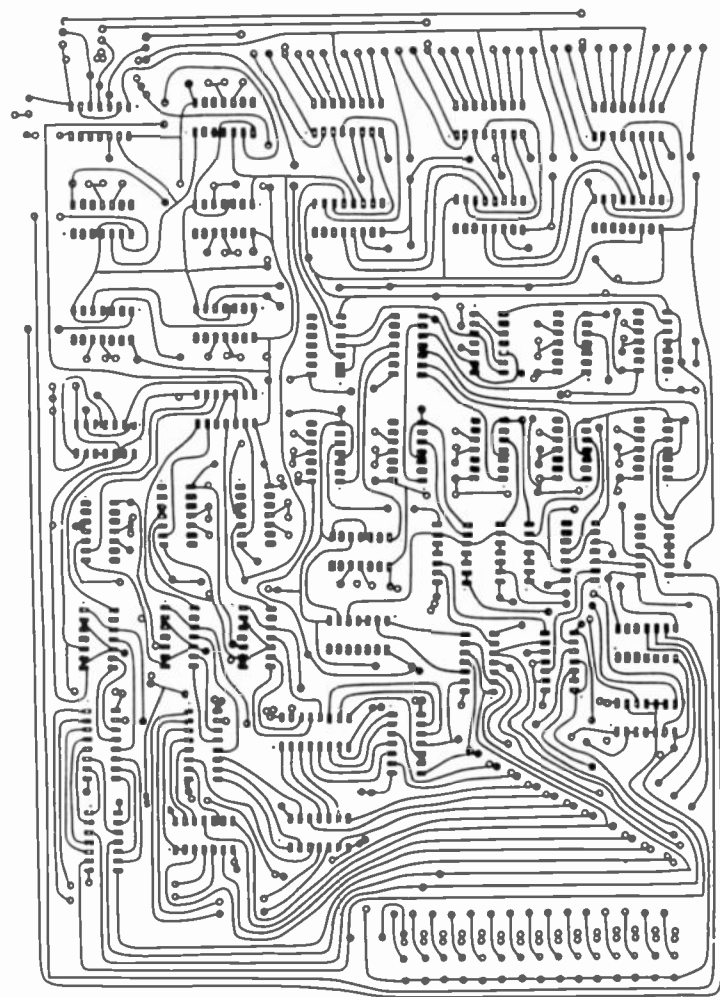
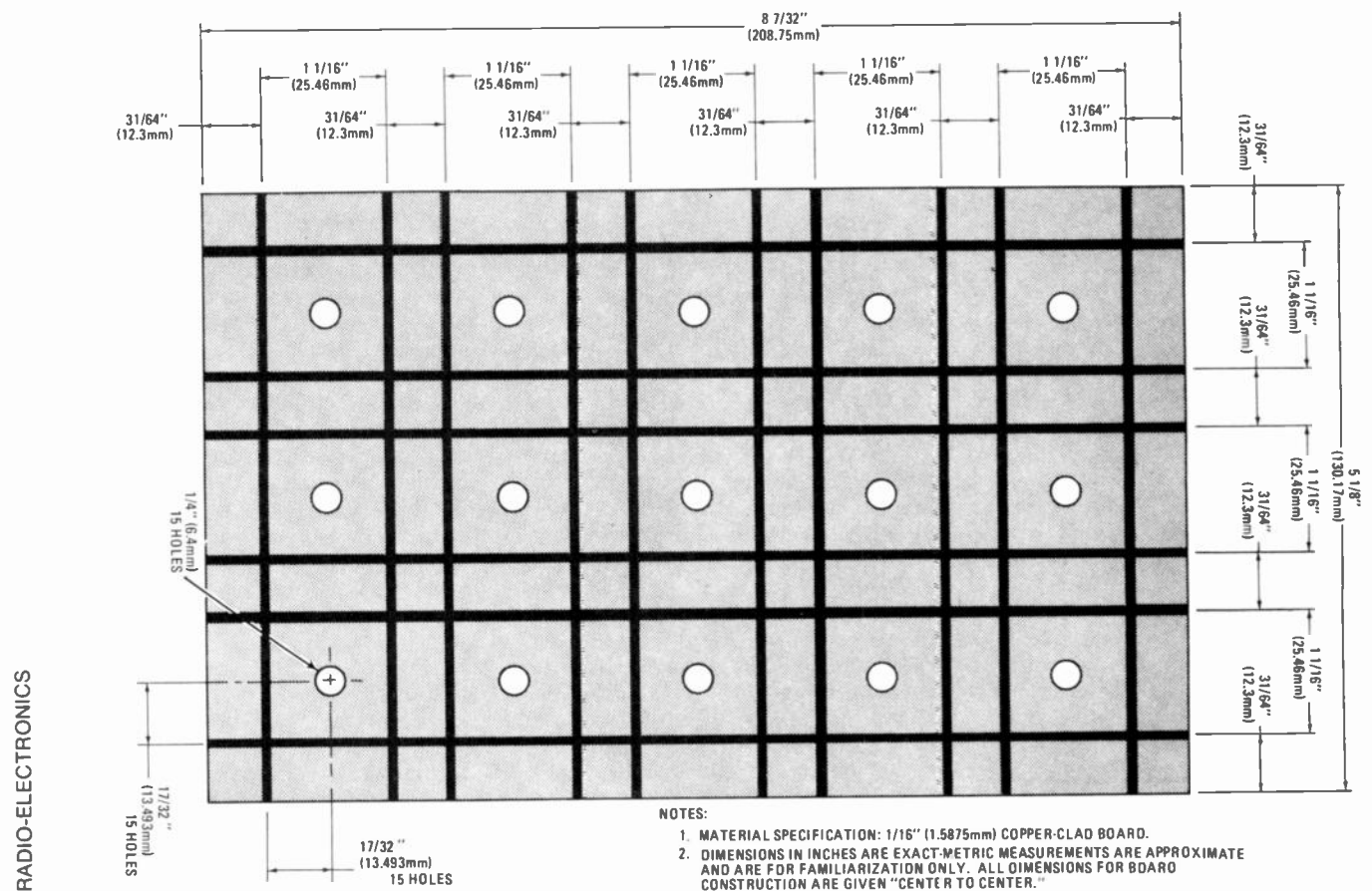

FIG. 3—PRINTED CIRCUIT LAYOUT for the Electronic Slot Machine, shown half size.



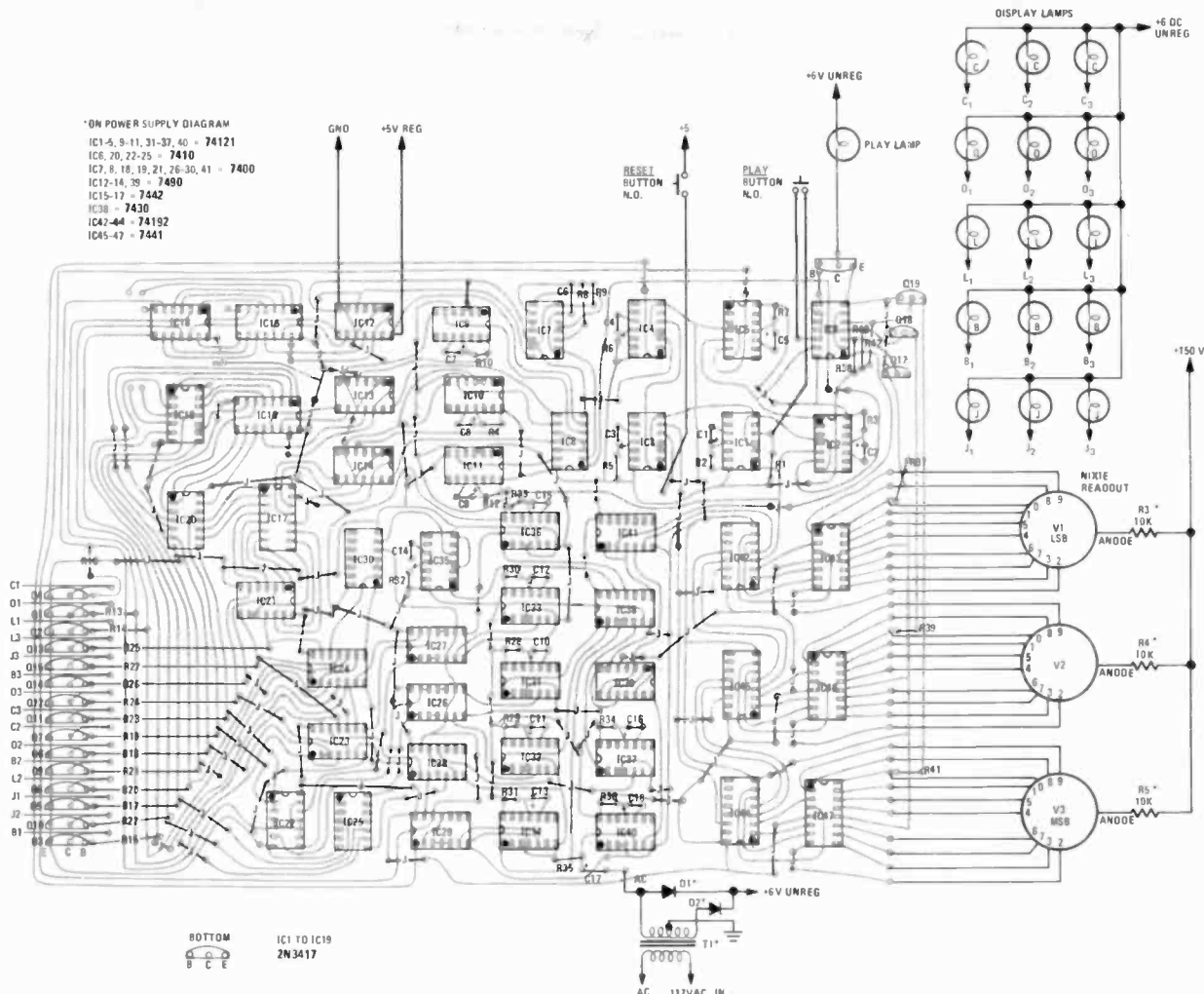

FIG. 4—THE BOARD LAYOUT, showing jumpers and leads to components mounted on panel.

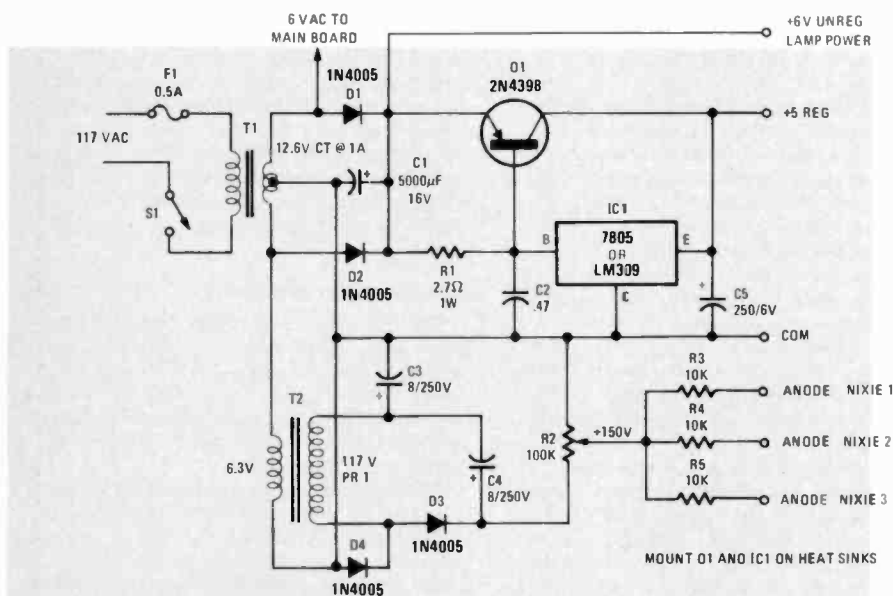

FIG. 5—THE POWER SUPPLY circuit.

PARTS LIST, POWER SUPPLY

- R1—2.7 ohms, 1 W
- R2—100,000 ohms, 1/2 W pot (fixed resistors may be substituted)
- R3—R5—10,000 ohms, 1/4 W
- C1—5,000 µF, 16 V, electrolytic
- C2—0.47 µF, 50-V disc
- C3, C4—8 µF, 250 V, electrolytic
- C5—250 µF, 6 V, electrolytic

- IC1—7805 or LM309, 5 V, 1A voltage regulator
- D1—4—1N4005 or similar
- Q1—PNP 2N4398 or equivalent
- F1—fuse, 1/2 A
- S1—SPST power switch
- T1—transformer, 12.6 V center tapped, 1 A
- T2—transformer, 6.3 V, 0.6 A

To check the payoff it is necessary to trigger the payoff one-shots manually or the play cycle would have to be initiated many times. The one-shots are triggered by momentarily applying a ground to pin 5 of the circuit to be tested and observe the accumulator to note the payoff. Simply increase the resistor for more counts or decrease for less.

The remote PLAY switch should be located no more than a few feet from the machine. Use grounded shielded cable because of the normally high input of the play one-shot.

The schematic shows a potentiometer on the high-voltage output. This control is used to set the brilliance of the display tubes. Adjust it for minimum setting needed to prolong the life of the tubes. After the control is set, it can be replaced with fixed resistors if desired.

Many extra features can be added, such as a lamp to indicate a jackpot, or an audible alarm to indicate a jackpot or any payoff. A mechanical arm can be constructed or a slot to accept coins could be made, which would cause a play cycle each time a coin was deposited. A word of caution on the use of coins: it is illegal to gamble in most states and a heavy fine or imprisonment could result if the slot were used for other than hobby purposes.

R-E

How To Design

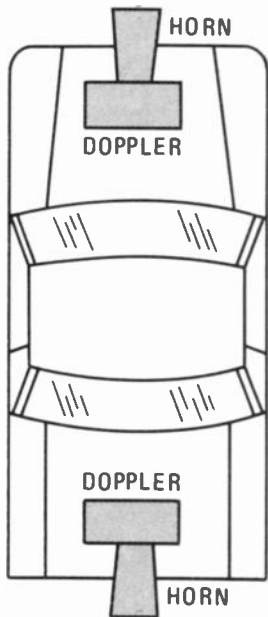

Automotive Anti-Collision Systems

Part I—An in-depth look at the different types of systems and the various design considerations, with enough information for the advanced hobbyist to build his own

MARTIN BRADLEY WEINSTEIN

WITH JUST A LITTLE INSIGHT INTO THE PROBLEMS and technologies involved, it is now altogether possible for the average electronics hobbyist to design and construct a relatively sophisticated automotive anti-collision system at reasonable cost.

We're going to take a look at the history of electronics in collision-avoidance systems; at how the various present-day technologies can be put to use and at some of the hardware that is available today. We will define the problems that are encountered when designing collision-avoidance systems and take a look at fully active systems that almost drive your car for you. Finally, we will look at what goes into designing a personal system for our own use and at constructing some of the hardware we'll need.

The history of collision avoidance

Every car today carries the original piece of hardware designed specifically to reduce the chance of a collision: the horn. But operation of the horn is entirely too dependent on operator judgment, and does little to enhance his awareness of conditions around him. Similarly, the headlight and other lamps nevertheless assumes that all other drivers on the road are competent.

But more interesting things started happening in the late 1960's and early 1970's. Researchers at Bendix, Ford, Sylvania, RCA and elsewhere were working on approaches to the collision-avoidance problem using RADAR's, LASER's and ultrasonics.

In these days before fuel embargos, the major threat to the future of the automobile was a lack of roadscape. Since anti-collision devices were designed to avoid collisions, their main objective was to permit a greater traffic density. Thus, the same roads could handle more cars.

The Ford plan

Ford Motors established a Transportation Research and Planning Office to analyze America's transportation needs into the twenty-first century, to coordinate other corporate studies and to administer their development and execution. They saw a need for what would eventually become an Automatic Highway.

Here, some form of mechanical or electronic control, centrally located, would coordinate conventional vehicular traffic (for automobiles equipped as required by legislation with the necessary interfacing and control equipment) to move smoothly at high speed even when closely spaced.

Before the boldly optimistic Automatic Highway could be achieved, however, two other plans seemed likely candidates for interim development. These were called Automatic Headway Control (AHC) and Minigap. Both were designed to avoid rear-end collisions and make long-haul driving a little less of a chore.

AHC used a cruise-type speed control, a RADAR and an on-board computer. It kept the vehicle at the preset speed until the RADAR saw the car ahead getting too close. Then, under computer control, the brakes would be applied to slow the vehicle and maintain a safe following distance. The prototype, unfortunately, was not a very smooth-operating system. It would pull the car forward at full speed, apply full braking, and keep repeating this jerky process as long as there was a car ahead.

Under Minigap, whole trains of cars are linked up electronically to a specially-equipped lead vehicle, specifically designed to travel the freeways just to let you leave the driving to them.

But credit is certainly due Ford's Elec-

tronic Systems Research Department for getting so far so soon. Ford, by the way, also worked with an infrared diode LASER and a side-by-side solid-state infrared semiconductor sensor. It was mounted near the rear of the vehicle and pointed backwards. A tricycle, toddler or terrier, for example, would reflect the low-power LASER back to the sensor and trigger a buzzer. The system was activated with the ignition key inserted and the transmission in Reverse, Park or Neutral. The buzzer would sound for three seconds and a warning lamp would light up until the obstacle disappeared. The system was designed for an effective range of about 10 feet.

The Sylvania approach

The Sylvania Wakefield Development Laboratory, meantime, was working on another approach. Since LASER and RADAR systems must first illuminate their targets with RF or light, they are called active systems. Sylvania was looking at using ultrasonics in a passive system.

The Sylvania system generated no ultrasonics of its own, as some SONAR's and, more specifically, SODAR's used in such applications do. Instead, it concentrated on listening for the ultrasonic sounds generated by such vehicle functions as tire against roadway, engine operation and exhausts.

One natural advantage of the Sylvania approach is, of course, that trees and billboards and stop signs and guard rails and such don't generate ultrasonics, so they can't cause false triggering. They can cause false triggering in RADAR and LASER systems, as well as in active ultrasonic systems.

The prototype was designed to be installed in a tail-light assembly or sideview mirror pod, facing towards the rear of the car to

detect oncoming vehicles. While it would respond to vehicles travelling at about 35 MPH or faster, its maximum range was only about 25 feet. A little math shows that even its best-case warning for a situation where the vehicle in which the system is installed is stopped is under a half second before a collision occurs. For a situation where both vehicles are in motion with a relative velocity of just under 1 MPH, this response improves to almost 20 seconds. So clearly, where the threat is the worst, the system is worst-suited to warn of it.

The RCA RADAR system

One of the more technically sophisticated, if bulkier designs to come along was proposed and prototyped by RCA. It involved a 9-GHz vertically-polarized transmitter, an 18-GHz horizontally-polarized receiver and a special license-plate-size reflector. The reflector included microstrip diode filters and acted as a frequency doubler, retransmitting the vertically-polarized 9-GHz signal as a horizontally-polarized 18-GHz signal.

The transmitted signal was about 100 mW with a 4 to 5-degree beamwidth to restrict coverage to the same lane. The electronics package was $17 \times 8 \times 2$ inches and designed for mounting at the center front of the car.

One advantage of the RCA design was the immunity it demonstrated against false triggering from such objects as trees and signs. And the frequency doubling scheme also minimized mutual interference from oncoming vehicles similarly equipped.

The system was intended to provide both relative speed and relative distance, with speedometer information fed into a signal processor to reduce the chance of false triggering from stationary vehicles.

The system involved several disadvantages, however. For one, the electronics package was too big to be practical. If placed high, it blocks necessary air flow to the vehicle cooling system. Higher, it blocks the driver's vision. Lower and it blocks the front license plate required in many states and becomes susceptible to stones, gravel and other road hazards.

Furthermore, at 100 mW, the RCA RADAR is two to five times as powerful as many similar aircraft altitude RADAR's. Granted, the earth is a bigger target than a car, but RADAR altimeters have to work over several miles, not just the 100 yard range of the RCA system. The unavoidable spectrum cluttering at 9- and 18-GHz would certainly have unwelcome side effects. So this very ambitious, very sophisticated approach appears to be an unfortunate example of overkill.

Bendix ASC system

Adaptive Speed Control (ASC) is the Bendix system that ties together a cruise-type speed control with what Bendix and the National Highway Traffic Safety Administration call the Automotive RADAR Brake, or simply RADAR Brake.

The Bendix system is the most difficult to outline, but only because it has gone through a great deal more development. In fact, Bendix has just been contracted by the NHTSA to construct two prototype RADAR-brake-equipped vehicles for actual driver tests.

While several different microwave frequencies have been used during the course of

Bendix RADAR brake development, a few salient points have emerged that are common to all approaches.

The systems have all been designed for a minimum 300-ft operating range. Both range and range rate (relative speed) information is determined through a combination of AM and FM modulation of the transmitted signal and some very sophisticated analysis of the return echo. The systems have been developed to limit the possibility of mutual interference to one occurrence in every hundred million encounters (roughly once in a lifetime).

And probably most important, the system designs call for only aiding the driver—warning him first that the collision is oncoming, and then only in the absence of an override signal or an affirmative driver reaction (like hitting the brakes himself) will the system engage braking itself. When it does, it brakes hard to discourage driver dependence on the system.

Much of the technical and human factors that will be considered here on the subject of electronic design for collision avoidance is with the support and insight engendered by the people and publications Bendix so kindly provided.

The state-of-the-art

The purpose of this article is to provide you, as an individual hobbyist, with insight to get you started building if not at least thinking about your own electronic anti-collision system. So far, though, we've looked at what large corporate and government efforts have provided. Now we have to look at what we can do on our own, affordably. And for that matter, just what we can do on our own, period.

As we discuss the various hardware approaches to sensing, analysis and control, we will from time to time refer to specific pieces of equipment and their approximate prices. You are, however, encouraged to investigate any other competing merchandise you can find, and to share new information as well as project ideas with other readers by submitting it to: "Letters to the Editor" Radio-Electronics, 200 Park Ave. South, New York, NY 10003.

We will deal, specifically, with infrared diode LASER, Doppler RADAR, ultrasonic SODAR, control and display interfacing, and microcomputer analysis. But, as in any design problem, a definition of the problem is our first requirement.

The operating environment

The rigors of environment within a car can make many modern technologies unusable or very difficult to use without special precautions. Equipment in a passenger compartment in a Northern climate might experience a temperature range from -40°C (-40°F) to 80°C (175°F). Consider that exterior temperatures tend to hit -10 or -20°F at least once or twice a winter up North. And on days when it's 90°F in the shade, the glass windows of your car tend to make things even worse. True, a system may not have to operate at quite those extremes. Nevertheless, designing for a temperature range less than -20°F to 140°F (-30 to 60°C) may be unwise. Under the hood, temperatures can reach 300°F (150°C).

Passenger compartment vibrations are in a range from roughly 10 to 60 Hz at 5 g's or less. Shock acceleration, however, can reach

30 g's sustained over 10 milliseconds. These are quite severe, however, and a design that permits operation against a 10-g shock should be adequate.

Also, consider the environmental difficulties exterior to your car. Fog can disperse, diffuse, reflect and otherwise inhibit systems based on visible light. Infrared systems see through most fogs and mists, so your system should include infrared light if any. The LASER that we will discuss assumes infrared operation.

RADAR's too can be inhibited by atmospheric, like raindrops and snowflakes. As the object size approaches the RADAR's microwave wavelength, it presents a viable target and a return echo.

Bendix, in their recommendations, suggested that the 36-GHz RADAR they first tried (because of favorable antenna size and comparative ease of beam shaping) was too susceptible to backscatter returns. They found an additional 6 dB of noise immunity to this clutter by going to a longer-wavelength 22.125-GHz RADAR. Our RADAR system will operate near 10.525 GHz. And, of course, there's the problem of making the installation waterproof.

Stopping the car

Just how sensitive a collision-avoidance system has to be depends on just how much reaction time it has available. That includes not only the time it needs to recognize a threat and react to it, but also, of course, how long it takes to bring your car to match-speed, often a full stop. And that's different for every car, every road and every kind of weather.

Worst-case analysis is no good here. The difference between good brakes on a good dry road and sloppy brakes on a bad, icy road can be a factor of five. Nor can we assume the maximum speed you will ever go to be 55 MPH. Typical coefficients of friction for dry, wet and icy surfaces are 0.825, 0.3, and 0.15, respectively. To give you an idea of just how much "friction" that is, assuming a top-notch braking system capable of stopping at 90% of the maximum surface coefficient of friction, a vehicle travelling at 50 MPH would take 120, 300 and 600 feet, respectively, to come to a full stop on dry, wet or icy roads.

Vehicle speed

Your speed can do more than just tell you how fast you're going. In conjunction with a PROM lookup-table, it can tell you how far your car will travel under full braking before coming to a complete stop. When added to the relative speeds of the car in front of you and the car behind you, the same PROM can tell you their braking distances, too.

Your vehicle's speed can also be used as the basis for a notch filter to help eliminate returns from overhead signs, bridges, guard rails and such. This can be done through software in a microcomputer-based system or through analog reformatting, analog-to-digital or other conversion techniques in less "intelligent" systems. Remember, Doppler microwave RADAR's compare their received and transmitted frequencies and output a difference signal. This signal represents 31.4 Hz-per-MPH of relative velocity. If your vehicle is doing between 10 and 60 MPH, relative to stationary objects, a Doppler will output 314 to 1884 Hz. This is in the low audio range and easily filterable.

Your vehicle speed can be coupled with other data for useful outputs unrelated to collision avoidance. Coupled to a fuel flow gauge, miles per gallon is an easy first output. And when connected to the fuel tank gauge, a plethora of outputs become available. Imagine for example a video display in your car reading: LOW FUEL! ONLY 1.5 GAL LEFT. AT 45 MPH AND 15.6 MPG, YOU HAVE 23.4 MILES 31 MINUTES TO EMPTY.

Vehicle speed data

The easiest way of obtaining speed information is from the type of generating transducer available through Quest Electronics (P.O. Box 4430, Santa Clara, CA 95054). It is, in fact, a small generator that fits into the speedometer cable line either at the transmission or at the speedometer, depending on the car. It generates a voltage related to speed that can be coupled to a 566 Voltage Controlled Oscillator to produce a frequency related to speed. Proper clocking and latching of that frequency gives a direct BCD latched output that can be bused, displayed, or queried by software.

Sometimes, though, it isn't desirable to display every mile-per-hour increment. Where speeds can change rapidly, as in the 0 to 15 MPH range, readouts that occur only every several MPH (0,2,5,8,10,12,15, for example) may be less confusing. Or simply leaving the original equipment speedometer installed and operating in conjunction with the digital display, if used, may offer a more suitable alternative.

The BCD speed information (in 1-MPH increments) can be used to address a Braking Distance Look-Up PROM directly. The PROM can then be made to output in tens of feet, BCD, in its four least significant bits (assuming an 8-bit PROM word length), and in hexadecimal hundreds of feet in its four most significant bits. This permits an output range from 0 to 1590 feet, in 10-foot increments, more than enough at even illegal highway speeds.

The stopping-distance information listed in the table below indicates a driver reaction

| SPEED IN MPH | DRIVER REACTION DISTANCE* | VEHICLE BRAKING DISTANCE | TOTAL STOPPING DISTANCE |
|--------------|---------------------------|--------------------------|-------------------------|
| 20 | 22 | 22 | 44 |
| 25 | 27.5 | 34.5 | 62 |
| 30 | 33 | 50 | 83 |
| 35 | 38.5 | 67.5 | 106 |
| 40 | 44 | 88 | 132 |
| 50 | 66 | 138 | 193 |
| 60 | 66 | 199 | 265 |
| 70 | 77 | 293 | 370 |

*BASED ON 3/4 SECOND REACTION TIME
DISTANCES IN FEET

time of 0.75 seconds and a vehicle braking distance of approximately 0.055 times the square of the vehicle speed (speed in MPH, distance in feet).

The use of a data selector and three separate lookup tables is strongly recommended. One table would indicate braking conditions under the penalties of an icy highway, one for wet roads and one for dry. Logic outputs from Schmitt triggers hooked to temperature and humidity sensors just inside the car's front bumper could drive the data selector/demultiplexers directly or through an addressed data bus. The block diagram for the

stopping-distance circuit is shown in Fig. 1.

It is recommended that the results of the PROM lookup be latched, either through specific gate hardware or in RAM, so that the entire system can be strobed regularly, rather than continuously queried.

In any discussion here of stopping distance, it is interesting to note the approach taken in the Bendix ASC system. A system

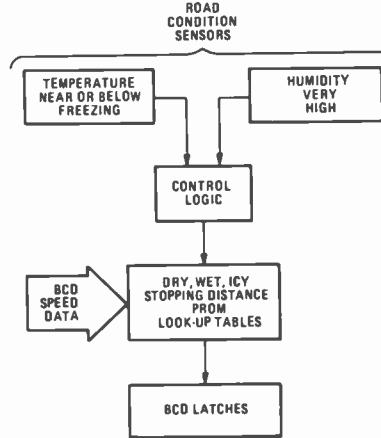

FIG. 1—STOPPING DISTANCE circuit. Speed information is used to address PROM's that contain digitalized stopping distance charts. Parallel memories are included for braking distance under various road conditions (i.e., dry, wet or icy.) Road condition sensors determine which parallel memory will be selected.

voltage determined just how the ASC would react. A positive control voltage caused acceleration; a zero control voltage indicated the system was at its desired distance from the nearest vehicle and at the desired speed and maintained that speed; a negative control voltage backed the throttle off; and a more negative control voltage initiated braking.

The system control voltage, E, was determined by the formula

$$E = (R - R') + 3R'$$

Where R is the actual distance from the nearest vehicle in feet; R* is the desired distance from the nearest vehicle in feet; and R' is the range rate (relative velocity, defined as positive when the vehicle ahead is faster and pulling away, negative if he's getting closer). In addition, R*, the desired distance from the nearest vehicle range, was defined as fifty feet greater than the number of miles-per-hour the equipped vehicle is traveling. So, for example, if an ASC vehicle is traveling at 45 MPH, its desired R* is 95 feet.

LASER sensors.

The first thing we want to know about the geography external to our vehicle is whether or not an obstacle is present and if one is, where. To accomplish this, a number of small LASER retroreflective sensor modules can be placed strategically around the vehicle. One suggested arrangement is shown in Fig. 2.

A pair of LASER's at each side is aimed low. One, side-facing, is intended to determine whether or not a curb or similar barrier is immediately adjacent. The other, forward facing, is aimed at the wheel path. This is intended to look for unusually abrupt surfaces, as occur at more severe chuckholes.

The other 12 LASER units are aimed at about thigh level. These look specifically for adjacent vehicles. Returns from these sensors are compared, in some cases, with returns

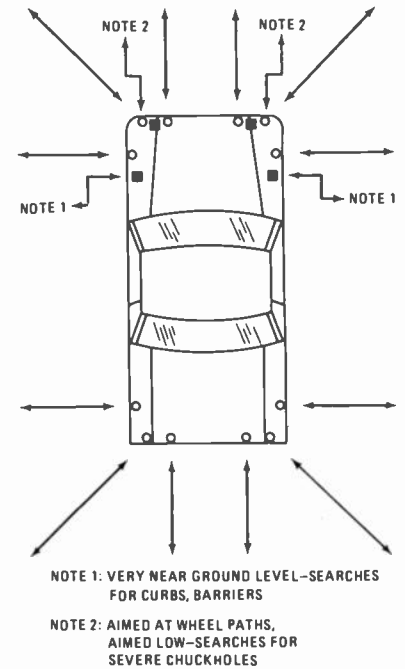

FIG. 2—LASER SENSOR PLACEMENT. Infrared LASER's are modulated and decoded to prevent false triggering. The LASER's are placed and aimed strategically about the vehicles body so that any adjacent vehicle will be detected by at least one LASER.

from other sensors to determine the validity of a blip.

The units themselves are infrared diode LASER's. Infrareds were chosen because of their necessary ability to see through most fogs, rains and snows. The LASER is modulated at an audio rate generated by the Voltage Controlled Oscillator section of a phase-locked-loop. (The block diagram of a basic LASER system is shown in Fig. 3.) The infrared photodetector at the PLL input is then sensitive only to this particular infrared

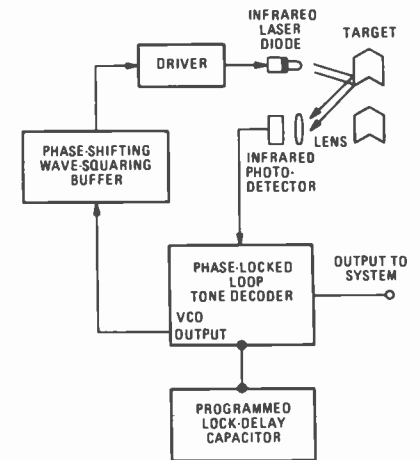

FIG. 3—LASER MODULE uses a 567 PLL tone-decoder IC to modulate the infrared diode. Infrared photodetector receives the modulated infrared if there is an object present to reflect it.

LASER return. Furthermore, the phase-locked-loop can be programmed to delay before indicating. This filters out fleeting returns from picket fences, telephone poles and the like. The 16 LASER PLL outputs are assigned to two 8-bit addresses for software interrogation.

continued next month

TIM Distortion— how it affects your system

Why does a tube amplifier sound better than a transistorized one? The answer lies in the recent discovery of a new type of distortion

LEN FELDMAN
CONTRIBUTING HI-FI EDITOR

JUST WHEN THE AUDIO INDUSTRY WAS smugly settling back with the knowledge it had succeeded in reducing harmonic distortion and intermodulation distortion to almost unmeasurable (and certainly inaudible) levels, our self-satisfaction was rudely interrupted by the discovery of a new form of distortion called TIM (Transient Intermodulation Distortion). Not that its discovery came as a surprise. Audio experts had long been puzzled by the fact that two amplifiers having identical frequency response, identical harmonic and intermodulation distortion and even identical power output capabilities still sounded different—even when connected to identical loudspeakers. Obviously, we weren't measuring everything that needed to be measured.

Gradually, the puzzle began to be pieced together. Some of the pieces related to that elusive difference between the sound of tube-type amplifiers and latter-day solid-state amplifiers. Strangely, the best of the old tube amplifiers never was able to boast the low percentages of THD and IM claimed by the new generation of transistorized equipment and yet, to many ears, they still sounded better. Terms such as "warmer" sound were used (the warmth, in this case, having nothing whatever to do with the heat generated by those energy-wasting tube filaments) to denote the special nature of tube

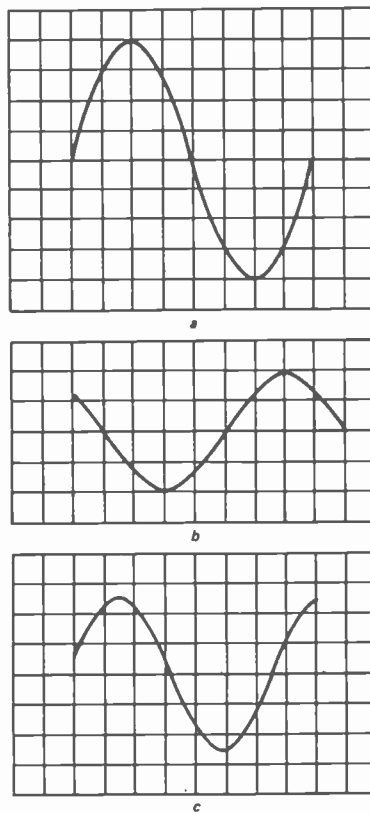

FIG. 1—SINUSOIDAL SIGNAL applied to the input of an amplifier is shown in *a*. Feedback signal is half the amplitude of the input signal and delayed by an additional 45° as shown in *b*. Resultant input to first stage of amplifier is shown in *c*.

sound. It was thought at first that the difference in transfer characteristics between tubes and linear solid-state devices was responsible in some subtle way for the differences in sound perceived by critical listeners. But designers were able to make solid-state amplifiers which, when tested with steady-state signals at least, displayed exactly the same transfer characteristics and overload waveforms as did the earlier tube amplifiers; and still the audible differences persisted.

As early as June, 1972, Matti Otala of Finland began publishing papers on TIM (*Journal of The Audio Engineering Society*, Vol. 20, No. 5), and he as well as others have been investigating this phenomenon ever since. Studies seem to correlate the relationship between a high TIM level and the poor sound quality we have been attributing to certain amplifier designs for many years.

What Is TIM

As most readers know, solid-state amplifiers use negative feedback to improve frequency response and reduce harmonic distortion. Solid-state amplifiers in the past were designed with greater amounts of feedback than in earlier tube designs. This practice stemmed in part from the fact that earlier transistors were limited in bandwidth capability and the application of

huge amounts of feedback helped to flatten frequency response and extend it to beyond audible limits.

In general, the feedback signal is subjected to a finite time-delay caused by reactive components and by the transit time of the amplifying devices themselves, so that the feedback signal arrives at the input somewhat delayed in time. As shown in Fig. 1, if a pure sinewave is fed to an amplifier and the delay amounts to as much as 45° of lag between the input signal and feedback signal, the *net* signal will still be perfectly sinusoidal in shape.

To illustrate this, let's assume that the sinewave in Fig. 1-a is the input signal, and that the out-of-phase feedback signal is one-half the amplitude of the original signal and is shown in Fig. 1-b. In this case, if the feedback signal is exactly 180° out-of-phase with the input signal, the input would be reduced in amplitude by 6-dB. However, due to the reactance of the feedback loop, the feedback signal is delayed by an *additional* 45° . The feedback signal is now 225° out-of-phase with the input signal. Because of the additional 45° phase shift, the *net* input signal is now reduced by something less than 6 dB (Fig. 1-c) but it still retains its *exact* sinusoidal shape—somewhat displaced in time from the original input. The feedback has not fully performed its function, but neither has it introduced any new form of distortion beyond any that already existed in the original input waveform.

Now let's consider what would happen under the same circumstances if the input signal had been a step-function, such as a squarewave. *Musical* signals have often been compared to such steep-rising functions, especially when the music contains a high degree of transient information or fast instrument attack-times.

Figure 2 shows a squarewave input signal of the same frequency used in our earlier sinewave example. Again, for simplicity, we are assuming that circuit and feedback delay is the same as in the earlier example. The input signal is shown in Fig. 2-a and the time-displaced feedback signal (which should have uniformly reduced the net input level by half) is shown in Fig. 2-b. Because of the step-function nature of the waveform, the net input amplitude has actually *increased* in the positive going direction by 6 dB for the first eighth of a cycle. This is because the instantaneous amplitude of the feedback signal is in-phase with the input signal and adds to it rather than subtracting from it, as shown in Fig. 2-c.

Even if the step function we had selected were a short-term nonrepetitive one (as in music), while the net input amplitude might not have increased initially, the desired input-signal ampli-

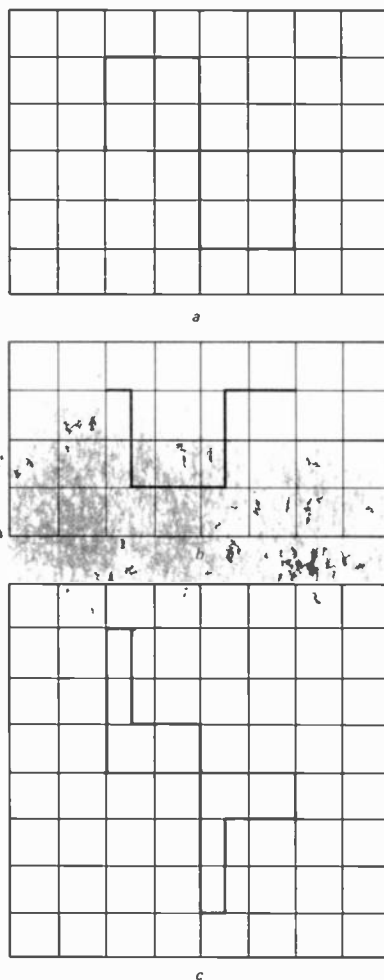

FIG. 2—SQUAREWAVE SIGNAL applied to the input of an amplifier is shown in a. Feedback signal is shown in b. Resultant input to the first stage of amplifier is shown in c.

tude reduction that the feedback should have accomplished would not have taken place because of the time-delayed feedback.

For example, if the amplifier in question had an input sensitivity of 1 volt for full-rated output and if a properly reduced input signal (by feedback) were well within that limit, the absence of feedback could drive the amplifier well beyond its clipping level for that short period of time. Remember, too, that in our examples we used a very moderate 6-dB feedback, whereas in practical situations the loop feedback might well be 40 dB or even more. If, in the presence of non-time-delayed feedback, a given input signal was enough to drive an amplifier to, say, its rated output of 20 watts, absence of the required 40 dB of feedback for however short a time period would, in theory, require that the same amplifier produce an instantaneous peak-power output of 200,000 watts—something it obviously cannot do.

In Fig. 3 we have artificially created this kind of situation. A step-function was fed into an amplifier where the feedback network produced a time-delay so that the sharp, positive-going

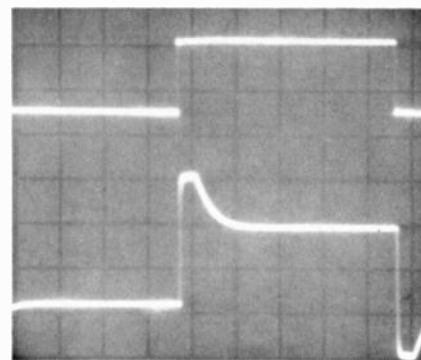

FIG. 3—SQUAREWAVE input signal is shown in upper trace. Lower trace shows output of amplifier in which feedback signal was greater than 180 out-of-phase.

leading edge of the waveform was not subjected to the required feedback. We see that the leading edge of the waveform drives the amplifier severely into clipping, even though a short time later, the amplitude is reduced by the late-arriving feedback to an acceptable nonclipping level. (The lower trace of Fig. 3 is the amplifier output; the upper trace is the input signal.)

In an actual music-listening situation, things become a lot more complicated. For one thing, we are not dealing with simple step-function signals, but with complex signals in which step-functions

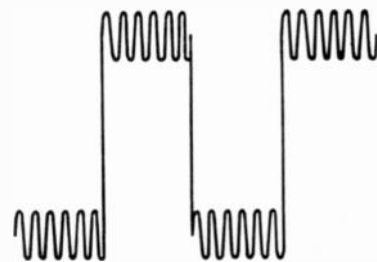

FIG. 4—TIM TEST SIGNAL consists of a 6-kHz tone superimposed on a 500-Hz squarewave.

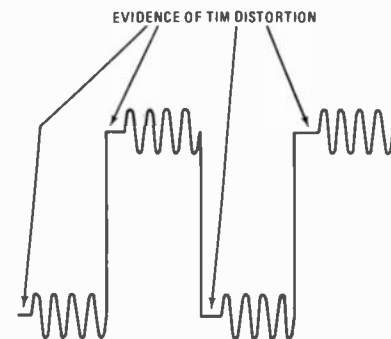

FIG. 5—TIM DISTORTION appears as distortion in the 6-kHz tone after a transition of the squarewave.

at one frequency may be mixed with other sinusoidal signals or step-functions at higher frequencies. One means of detecting the presence of TIM would be to use an input signal consisting of a 500-Hz squarewave mixed with a 6000-Hz tone whose amplitude is one-fourth or one-fifth that of the lower frequency squarewave signal. Figure 4 shows such

a TIM test signal. If this TIM test signal is applied to an amplifier and levels are adjusted so that the peak power output is somewhat lower than the amplifier can deliver on a continuous sinewave basis, evidence of TIM would appear as shown in Fig. 5. During the fast risetime and falltime of the 500-Hz squarewave, the momentary absence of properly out-of-phase feedback has "blurred" the first cycle of the superimposed 6000-Hz signal, because the amplifier has been driven into clipping.

Another method of viewing TIM has been proposed using a spectrum analyzer. Again, the basic squarewave/sinewave composite signal is used as a test

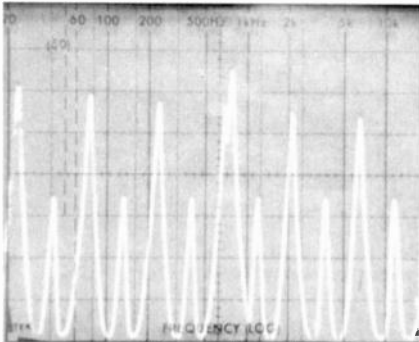

FIG. 6—TIM TEST SIGNAL displayed on spectrum analyzer. The 6-kHz tone appears in the center of the screen while other components are odd-harmonics of the squarewave.

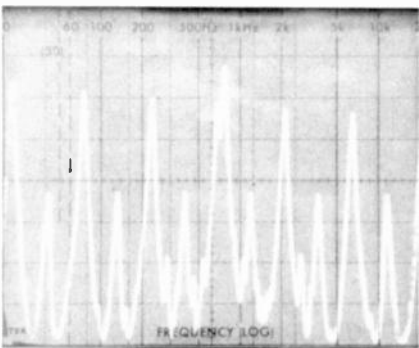

FIG. 7—OUTPUT OF AMPLIFIER fed with TIM test signal. Spectrum analyzer shows additional sideband components resulting from TIM distortion.

signal fed to the amplifier. The test signal shown in Fig. 4 was fed to a spectrum analyzer. The result is shown in Fig. 6, which shows the odd harmonics of the squarewave component of the test signal while at the center of the screen we see the 6000-Hz component.

Figure 7 shows a partial spectrum analysis of the output waveform that reveals sideband components to either side of the 6-kHz center-spike which were not present in Fig. 6. These extraneous components are indicative of TIM, although they do not easily lend themselves to numerical interpretation. In both Figs. 6 and 7, linear frequency sweep was used, and the frequency notations appearing at the top of the screen should be ignored.

A single number for TIM

While several methods for detecting TIM have been described, no single method lends itself to its quantization. It would be desirable to express TIM as a number, in much the same way as we do with harmonic or intermodulation distortion. A relatively simple way to come up with a meaningful TIM number has been suggested by the engineering staff of Lux Corporation of Japan. In this proposal, the same sort of combination squarewave/sinewave test signal is used. The same squarewave source (onto which the higher-frequency sinewave is superimposed) is also applied to a unity-gain inverter stage. The test signal is then fed to one channel of a stereo amplifier, while the inverted squarewave is fed to the opposite and identical channel. Outputs from both channels are then combined in a summing network (which may be made up of passive components), adjusted so that the out-of-phase squarewave components are cancelled as perfectly as possible. What remains is the 6-kHz component that contains distortion every time the rapid step-function of the composite test signal took place. This residual 6-kHz signal is then simply fed to a

conventional harmonic distortion analyzer and its distortion content is read as a simple percentage. The entire suggested setup is shown in Fig. 8.

Using this suggested method of TIM measurement, Lux Corporation has already introduced an amplifier with a published TIM specification of 0.05%.

This first attempt at quantifying TIM may not be perfect. Obviously, if the noninverting and inverting amplifier channels are not completely identical, differences in the shape of the out-of-phase squarewave components of the two signals will prevent perfect squarewave cancellation, and non-TIM related distortion components will affect the analyzer's reading. Nevertheless, the approach is fairly simple and can be duplicated in reasonably well-equipped test and service laboratories for at least a "first look" at TIM in a quantitative way. R-E

Service agencies are warned on warranty service contracts

With the new California warranty legislation, and pending warranty bills in other states, service agency contracts will probably be revised to keep within the new laws. But states NATESA (National Alliance of Electronic and Television Service Associations): "We are appalled with the wording of some contracts servicers are being asked to sign, and caution all service agencies to study such contracts, and possibly seek legal counsel before signing."

Among the "potentially dangerous clauses" is an agreement "... to adhere to service policies as set forth from time to time ..." The servicer agrees, in other words, to conditions the warrantor may set up at a future date.

Another dubious clause is "... use only genuine parts." This could force the servicer to stock a complete line of resistors, capacitors, etc., carrying the brand name of each warrantor who insisted on it, rather than using such parts out of the servicer's stock, as is present practice. It could also mean long delays in completing service, while parts were back-ordered.

The servicer is even asked to agree "to indemnify and hold the product warrantor blameless against any demand, claim suit by any action or omission for the service station ... or otherwise." The "otherwise" could cover an almost infinite range of cases. Such provisions, NATESA warns, would put the entire "monkey" on the servicer's back.

Some clauses on agreed rates, worded so as to be subject to a wide range of interpretation, could result in real financial trouble for the servicer.

The NATESA warning concludes it is not the intent of servicers that warranty service agency contracts should not protect the interests of the warrantor. "We believe they should protect the interests of the product purchaser and the servicer as well. Servicers should not sign contracts that do not provide such tri-partite protection."

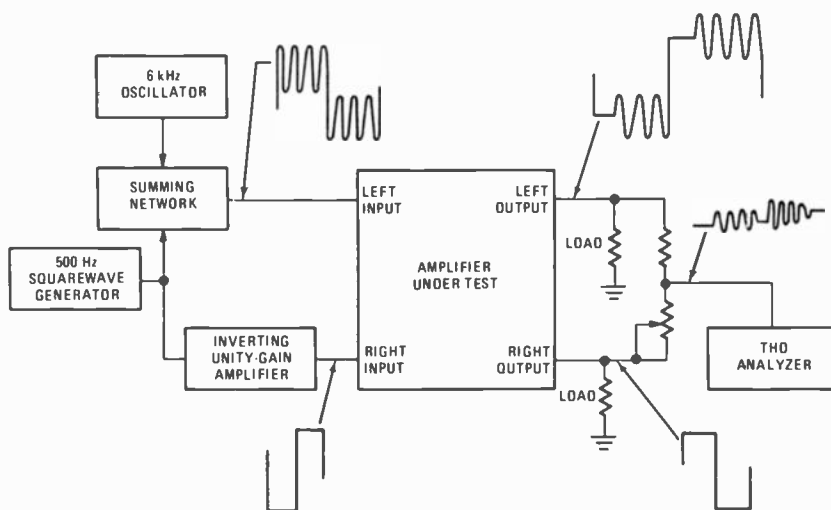
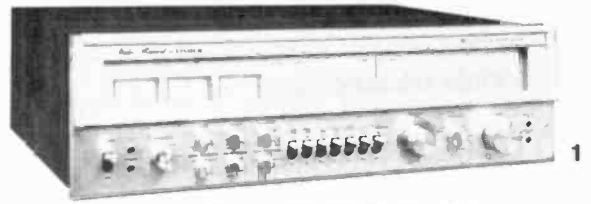

FIG. 8—TEST SETUP for measuring TIM distortion.

Radio-Electronics

Tests Fisher

RS-1080 AM/FM Stereo Receiver



CIRCLE 99 ON FREE INFORMATION CARD

LEN FELDMAN
CONTRIBUTING HI-FI EDITOR

FISHER CORPORATION, HAVING COMPLETED ITS corporate reorganization, has now undertaken the job of recapturing its proper share of the high-fidelity component market. The company recently introduced a new line of receivers as part of its long-famed "Studio Standard" line, the most powerful and expensive being the model RS-1080 shown in Fig. 1. The design is new, including a light-colored front panel using a gold background behind the slightly sloped dial-area cutout and dark-colored frequency calibration numerals for easy visibility. Above the blue frequency numerals is a series of red indicator words that illuminate to denote program source, activation of the FM decoding feature and reception of a stereo FM signal. A 0-to-100 linearly calibrated logging scale below the FM and AM frequency scales helps pinpoint favorite stations.

To the left of the frequency scales, but within the dial opening area, are three separate meters: one for AM and FM signal strength; a center-of-channel FM tuning meter and a multipath indication meter that is adjusted for a minimum indication while orienting an outdoor FM antenna.

All controls are located across the bottom of the panel: A toggle-type power on/off switch, a SPEAKER selection switch (that selects one or two out of three pairs of speakers or headphones only); BASS, TREBLE and BALANCE controls; an extra BASS SELECTOR switch plus an associated BASS RANGE boost control; and a TAPE MONITOR switch with positions for two tape decks and for dubbing from one deck to another. Seven small toggle switches come next, centered on the lower portion of the panel. These switches take care of tone-control defeat, mono/stereo mode selection, low- and high-cut filter switching, loudness circuit, FM muting and Dolby decoder switching. A master VOLUME control calibrated in discrete dB steps has an illuminated pointer for easy viewing of volume settings. There is also a program selector switch, followed by a large station tuning knob (coupled to a highly effective flywheel/dial pointer) and a pair of jacks for possible connection of a third tape deck.

A hinged, pivotable AM ferrite-bar antenna on the rear panel (Fig. 2) swings down and out to disclose the external AM, 75-ohm coaxial and 300-ohm antenna terminals as well as the phono and auxiliary input jacks. Chassis ground terminals are located below, while centered on the rear panel are the two

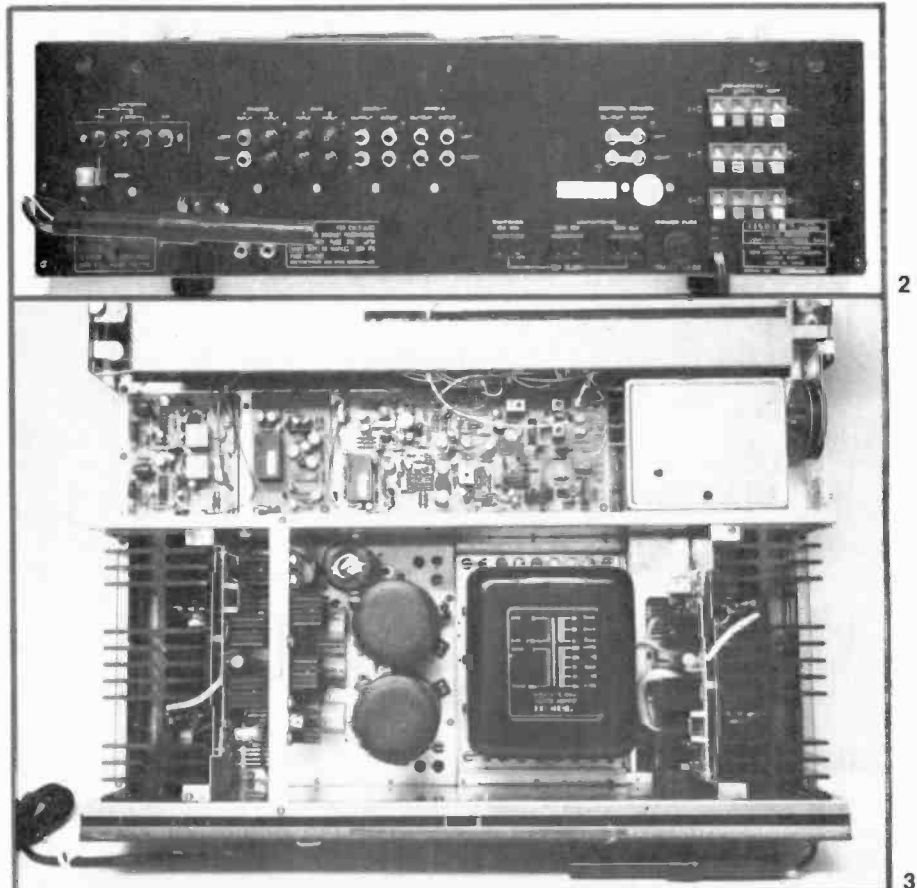

MANUFACTURER'S PUBLISHED SPECIFICATIONS

FM TUNER SECTION:

Usable Sensitivity: Mono: 1.7 μ V (9.8 dBf); Stereo: 4.3 μ V (17.9 dBf). **50-dB Quieting Sensitivity:** Mono: 2.5 μ V (13.2 dBf); Stereo: 34 μ V (35.8 dBf). **Signal-to-Noise Ratio:** Mono: 72 dB; Stereo: 70 dB. **Distortion:** Mono: 0.15% at 1 kHz, 0.15% at 100 Hz, 0.18% at 6 kHz; Stereo: 0.25% at 1 kHz, 0.3% at 100 Hz, 0.4% at 6 kHz. **Capture Ratio:** 0.8 dB. **Selectivity:** 75 dB. **Image Rejection:** 100 dB. **Spurious Rejection:** 100 dB. **AM Suppression:** 65 dB. **Stereo Separation:** 1 kHz: 50 dB; 10 kHz: 36 dB. **Subcarrier Rejection:** 70 dB. **SCA Rejection:** 66 dB.

AM TUNER SECTION:

Sensitivity: 280 μ V (Internal Antenna). **Selectivity:** 45 dB. **S/N Ratio:** 55 dB. **Image Rejection:** 70 dB. **IF Rejection:** 80 dB.

POWER AMPLIFIER AND PREAMPLIFIER SECTION:

Power Output: 170-watts minimum continuous watts per channel, 20 Hz to 20 kHz, 8-ohm loads. **Total Harmonic Distortion:** 0.1%. **Damping Factor:** 30. **Input Sensitivities:** Phono 1 & 2: 2.0 mV; Aux and Tape: 150 mV. **Phono Overload:** 300 mV. **S/N Ratio:** Phono: 70 dB; Aux and Tape: 82 dB; Residual at minimum volume: 100 dB. **Tone Control Range:** Bass: ± 12 dB at 100 Hz; Treble: ± 12 dB at 10 kHz. **Filter Response:** Low Cut: -5 dB at 30 Hz; High Cut: -6 dB at 5 kHz.

GENERAL SPECIFICATIONS:

Power Requirements: 120 volts, $\pm 10\%$. 60 Hz, 1000-watts maximum. **Dimensions:** 23³/₄ W \times 16¹⁵/₁₆ D \times 7³/₈-inches H. **Weight:** 65 lbs. **Suggested Retail Price:** \$899.95.

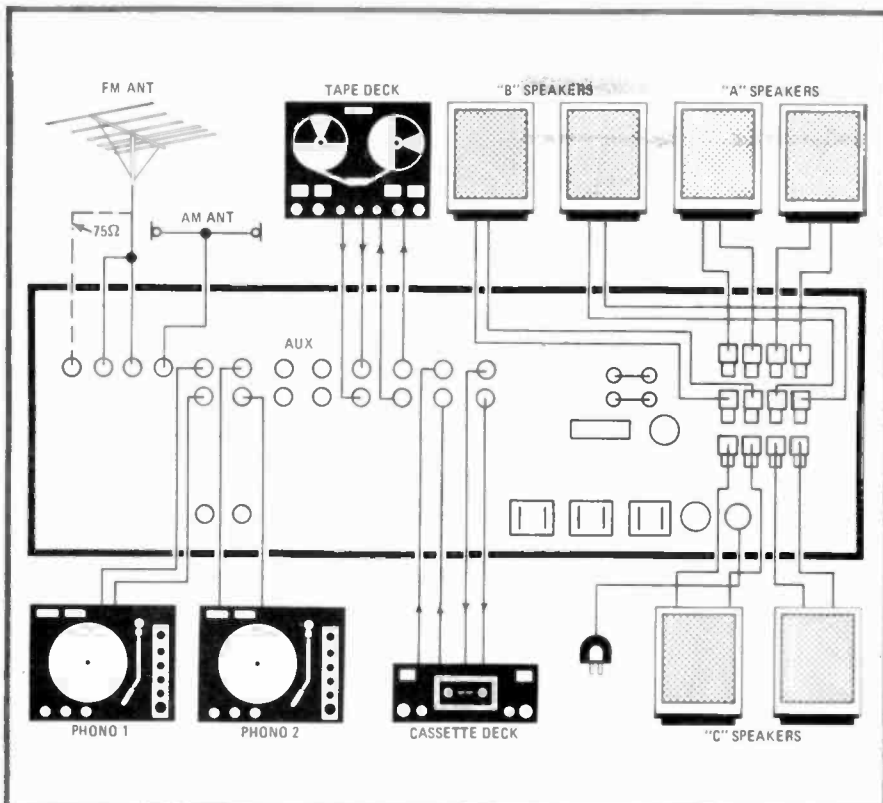

TABLE I
RADIO-ELECTRONICS PRODUCT TEST REPORT

Manufacturer: Fisher

Model: RS-1080

FM PERFORMANCE MEASUREMENTS

| | R-E Measurement | R-E Evaluation |
|---|-----------------|------------------|
| SENSITIVITY, NOISE AND FREEDOM FROM INTERFERENCE | | |
| IHF sensitivity, mono (μV) (dBf) | 1.7 (9.8) | Excellent |
| Sensitivity, stereo (μV) (dBf) | 16.0 (29.3) | Fair |
| 50-dB quieting signal, mono (μV) (dBf) | 2.7 (13.8) | Excellent |
| 50-dB quieting signal, stereo (μV) (dBf) | 33.0 (35.6) | Excellent |
| Maximum S/N ratio, mono (dB) | 77 | Superb |
| Maximum S/N ratio, stereo (dB) | 70 | Excellent |
| Capture ratio (dB) | 0.9 | Superb |
| AM suppression (dB) | 65 | Excellent |
| Image rejection (dB) | 100 + | Excellent |
| IF rejection (dB) | 95 | Excellent |
| Spurious rejection (dB) | 100 | Excellent |
| Alternate channel selectivity (dB) | 77 | Very good |
| FIDELITY AND DISTORTION MEASUREMENTS | | |
| Frequency response, 50 Hz to 15 kHz ($\pm\text{dB}$) | +0. -2.0 | Fair |
| Harmonic distortion, 1 kHz, mono (%) | 0.11 | Very good |
| Harmonic distortion, 1 kHz, stereo (%) | 0.12 | Excellent |
| Harmonic distortion, 100 Hz, mono (%) | 0.10 | Excellent |
| Harmonic distortion, 100 Hz, stereo (%) | 0.20 | Good |
| Harmonic distortion, 6 kHz, mono (%) | 0.06 | Superb |
| Harmonic distortion, 6 kHz, stereo (%) | 0.22 | Very good |
| Distortion at 50 dB quieting, mono (%) | 0.75 | Excellent |
| Distortion at 50 dB quieting, stereo (%) | 0.55 | Very good |
| STEREO PERFORMANCE MEASUREMENTS | | |
| Stereo threshold (μV) (dBf) | 16.0 (29.3) | Poor (see text) |
| Separation, 1 kHz (dB) | 53 | Superb |
| Separation, 100 Hz (dB) | 46 | Excellent |
| Separation, 10 kHz (dB) | 38 | Excellent |
| MISCELLANEOUS MEASUREMENTS | | |
| Muting threshold (μV) (dBf) | 20 (31.2) | Poor (see text) |
| EVALUATION OF CONTROLS, DESIGN, CONSTRUCTION | | |
| Control layout | | Excellent |
| Ease of tuning | | Very good |
| Accuracy of meters or other tuning aids | | Excellent |
| Usefulness of other controls | | Excellent |
| Construction and internal layout | | Very good |
| Ease of servicing | | Very good |
| Evaluation of extra features, if any | | Excellent |
| OVERALL FM PERFORMANCE RATING | | Very good |

pairs of tape-out and tape-in jacks. Preamp-out/main amplifier-in jacks, three sets of piano-key spring-loaded speaker terminals and one switched plus two unswitched AC receptacles are at the right of the rear panel.

The internal layout is shown in Fig. 3. Power amplifier modules are mounted adjacent to symmetrically positioned massive heat sinks on either side of the large power transformer and electrolytic filter capacitors. Figure 4 shows the variety of associated equipment that can be used with this receiver.

Circuitry

Eleven separate major circuit boards are used. A five-gang variable capacitor is used in the FM front end, which also uses two dual-gate MOSFET RF stages, a dual-gate MOSFET mixer and a local oscillator with a separate buffer stage. The phase-linear IF section of the receiver has solid-state pretuned ladder-type filter circuits followed by a double-tuned quadrature detector. The stereo multiplex decoder contains a phase-locked-loop circuit. The circuit for driving the multipath meter also uses a phase-locked-loop arrangement.

Each preamplifier-equalizer circuit uses a differential amplifier input, followed by single-ended push-pull output stages. The familiar Baxandall tone control circuitry is preceded and succeeded by buffer amplifier stages. Complementary push-pull output stages in the main amplifier section of the receiver contain four power transistors in each channel, two of which are paralleled for the positive and negative halves of the drive circuit. A separate protector circuit assembly using a power relay protects speakers from possible damage.

FM performance measurements

Results of our FM measurements are listed in Table I. Evidently, the stereo threshold settings, as well as the signal strength required to overcome the otherwise effective

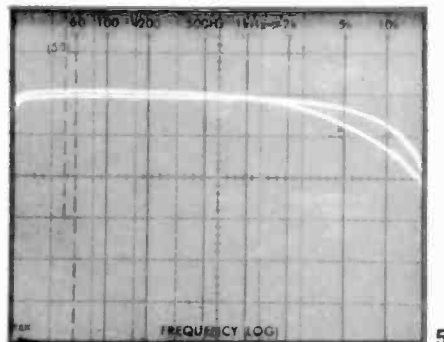

muting circuit of this tuner section, were somewhat misadjusted. Signal strengths required were considerably higher than specified. In all other respects, however, the tuner section performed well, providing 50 dB of quieting with only 2.7 μV (13.8 dBf) of signal applied in mono and 33 μV (35.6 dBf) for the same quieting in stereo. Signal-to-noise in mono was 77 dB, while in stereo the best quieting was 70 dB—as good as many high-priced receivers are able to do in mono. Total stereo harmonic distortion was almost as low as in mono for all but the highest audio test frequencies, with readings of 0.12% at 1 kHz, 0.2% at 100 Hz and a very low 0.22% at the higher 6-kHz test point.

Figure 5 shows the frequency response

(including de-emphasis) for the normal, 75- μ s de-emphasis circuit (lower curve) and for the built-in 25- μ s de-emphasis associated with the Dolby circuitry. The sharp rolloff above 18 kHz illustrates the effectiveness of the low-pass filter to remove any residual 19-kHz carrier products at the output.

Figure 6 displays the excellent overall separation characteristics of the stereo multi-

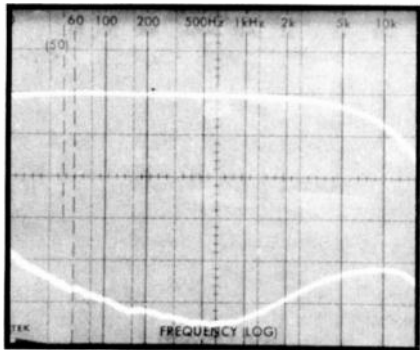

6

plex section of the receiver. Vertical divisions on the scope face correspond to 10 dB; the upper trace represents the desired-channel output, while the lower trace shows the attenuated output from the opposite channel.

Amplifier section

The power amplifiers delivered 182 watts per channel, at mid-band frequencies, with both channels driving 8-ohm loads. Even at 20 Hz, the amplifiers delivered a bit more than their rated 170 watts-per-channel and, at actual rated output, distortion for a 1-kHz signal was a mere 0.0085%. Table II lists these and other amplifier and preamplifier section measurements. The phono preamplifier section was virtually impervious to overload, showing audible distortion with input signals as high as 330 mV, as against 300 mV claimed.

The BASS and TREBLE tone control range is shown in Fig. 7. The extra bass control selector and range controls referred to earlier

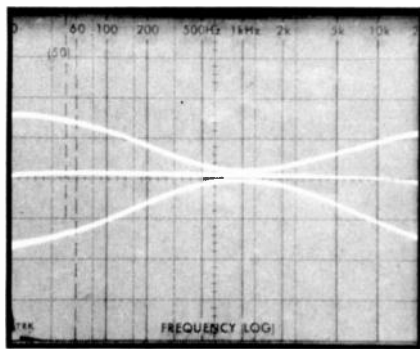

7

introduce controllable amounts of bass boost at selectable frequencies of either 45 Hz or 80 Hz. Figure 8 shows the maximum amount of boost available at these center frequencies. However, it should be understood that by adjusting the bass range control, any degree of lower-bass boost up to and including the curves shown can be introduced. This bass-boost circuit is extremely useful in compensating for loudspeakers that are somewhat deficient in bass at their lower octaves and does not seriously affect upper bass or mid-range frequencies.

While the low-frequency filter was designed with a slope of 12 dB-per-octave (see

Fig. 9), the designers chose to limit the slope of the high-frequency filter to a more moderate 6 dB-per-octave. This filter is less

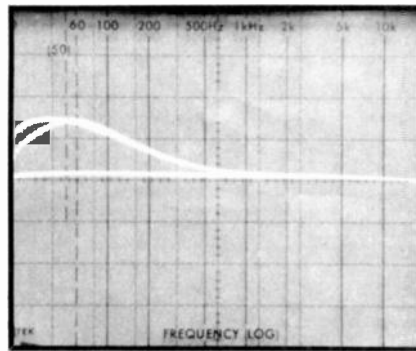

8

effective in removing hiss and scratch than a more steeply sloped high-frequency filter. However, Fisher engineers maintain that too steep a slope at the high end of the response curve tends to cause audible distortion in musical fidelity when the latter filter is used.

Summary

Our overall product analysis for this high-

powered receiver, along with summary comments, will be found in Table III. In general, the unit performed well both as a high-

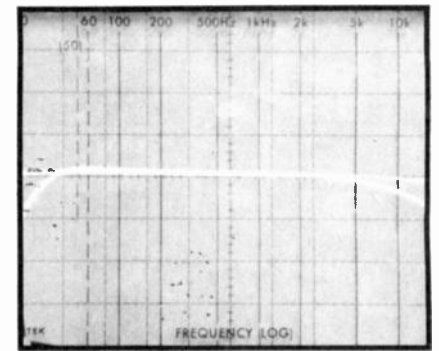

9

powered preamplifier/amplifier component and in its AM and FM tuner functions. The Model RS-1080 seems well worth its suggested selling price and ranks high among the ever-expanding new group of superpowered receivers. R-E

Table III appears on page 84.

TABLE II
RADIO-ELECTRONICS PRODUCT TEST REPORT

Manufacturer: Fisher

Model: RS-1080

AMPLIFIER PERFORMANCE MEASUREMENTS

| | R-E Measurement | R-E Evaluation |
|--|--------------------|-------------------|
| POWER OUTPUT CAPABILITY | | |
| RMS power channel, 8-ohms, 1 kHz (watts) | 182 | Very Good |
| RMS power/channel, 8-ohms, 20 Hz (watts) | 173 | Very Good |
| RMS power/channel, 8 ohms, 20 kHz (watts) | 170 | Good |
| RMS power/channel, 4-ohms, 1 kHz (watts) | 193 | |
| RMS power/channel, 4-ohms, 20 Hz (watts) | 187 | |
| RMS power/channel, 4-ohms, 20 kHz (watts) | 175 | |
| Frequency limits for rated output (Hz-kHz) | 13-20 | Good |
| DISTORTION MEASUREMENTS | | |
| Harmonic distortion at rated output, 1 kHz (%) | 0.0085 | Excellent |
| Intermodulation distortion, rated output (%) | 0.02 | Very Good |
| Harmonic distortion at 1-watt output, 1 kHz (%) | 0.06 | Excellent |
| Intermodulation distortion at 1-watt output (%) | 0.05 | Excellent |
| DAMPING FACTOR, AT 8 OHMS | 35 | Good |
| PHONO PREAMPLIFIER MEASUREMENTS | | |
| Frequency response (RIAA \pm dB) | + 0.5 | Good |
| Maximum input before overload (mV) | 330 | Superb |
| Hum/noise referred to full output (dB) (at rated input sensitivity) | 70 | Very good |
| HIGH LEVEL INPUT MEASUREMENTS | | |
| Frequency response (Hz-kHz, \pm dB) | 13-22, \pm 1 dB | Good |
| Hum noise referred to full output (dB) | 85 | Very good |
| Residual hum noise (min. volume), (dB) | 95 | Very good |
| TONAL COMPENSATION MEASUREMENTS | | |
| Action of bass and treble controls | See Fig. 7 | Good |
| Action of secondary tone controls | See Fig. 8 | Excellent |
| Action of low-frequency filter(s) | See Fig. 9 | Excellent |
| Action of high-frequency filter(s) | See Fig. 9 | Good |
| COMPONENT MATCHING MEASUREMENTS | | |
| Input sensitivity, phono 1 phono 2 (mV) | 2.2/2.2 | |
| Input sensitivity, auxiliary input(S) (mV) | 200 | |
| Input sensitivity, tape input(s) (mV) | 200 | |
| Output level, tape output(s) (mV) | 200 | |
| Output level, headphone jack(s) (V or mW) | 280 mV | |
| EVALUATION OF CONTROLS, | | |
| DESIGN, CONSTRUCTION | | |
| Adequacy of program source and monitor switching | | Very good |
| Adequacy of input facilities | | Very good |
| Arrangement of controls (panel layout) | | Excellent |
| Action of controls and switches | | Excellent |
| Design and construction | | Excellent |
| Ease of servicing | | Very good |
| OVERALL AMPLIFIER PERFORMANCE RATING | | Very good |

Here's a rundown of the important facts that every user and potential purchaser of digital multimeters should know.



What You Should Know About DMM's

CHARLES M. GILMORE*

THERE ARE A GREAT MANY DIGITAL MULTIMETERS on the market, everything from pocket size to expensive lab-grade instruments. It is important for every potential purchaser of these instruments to know what makes one instrument different from another as well as every user to know the little nuances that come into play when taking readings.

General features

Often the features are what make one instrument stand out from another. The potential DMM buyer should have a good knowledge of an instrument's features and how he can use them. The purchaser often needs to make a tradeoff between features, so careful consideration of one feature against another is in order if he is to gain maximum use from the DMM investment.

The digits. One of the strange terms developed by the DMM manufacturers is an expression "half digit." It is perfectly clear what a three-digit DMM is, and what a four- or two-digit "machine" (as they are sometimes referred to) is, but a three-and-one-half-digit machine sounds like something run through a saw. The term "half digit" has been coined to indicate a DMM with 100% overrange capability. This is also referred to as "1999" (three-and-one-half-digit) capability. In a similar manner, the term three-and-three-quarter-digit machine has come to mean a DMM with 3999 capability. Whenever terms such as these are used, it is wise to inspect the specifications very carefully to determine their exact meaning. Good specifications give a numerical upper limit to each

*Manager Design Engineering, Heath Co., Benton Harbor, MI

of the instrument's ranges, and also specify overrange capability.

The resolution of the instrument is directly limited by the number of digits in the display. A three-and-one-half-digit DMM has a resolution of one part in two thousand or 0.05%. For example, the 1-volt range has a full-scale value of 1999 millivolts, and the resolution is one millivolt. Four-and-one-half-digit machines have resolutions of one part in twenty thousand or 0.005%, but unless the noise is very low, this resolution may not be useable; there may be instability in the last few digits at all times. The two-and-one-half-digit instrument has a resolution of one part in two hundred, or 0.5%.

A two-and-one-half-digit or a three-digit DMM should be considered as a replacement for a good analog multimeter, as far as accuracy and resolution are concerned. Accuracy generally lies between 0.5% and 1.5% with 0.5% resolution or more. The three-and-one-half and four-digit machines generally have accuracies between 0.5% and 0.05%, with 0.05% resolution. Such resolution and accuracy generally suffice for even the most exacting service work and home experiment. Four and one half digits or more generally indicate an accuracy of 0.05% or better with 0.005% resolution and should be considered laboratory instrumentation.

Power sources. Most DMM's today offer battery as well as power-line operation. A few, either the very exotic or the very inexpensive, do not. The battery is often an option at extra cost, especially if the batteries are rechargeable. In a few DMM's the batteries are required for operation, as the AC supply/charger does not have the current capability to operate the DMM alone.

When considering battery operation, note the type of cells used. Replacing an odd-sized cell may be both difficult and expensive. Rechargeable cells that are physically and electrically interchangeable with zinc-carbon or alkaline cells have an advantage. Temporary substitution permits portable operation, even if the batteries were not charged the night before. All cells have a finite life expectancy, and today none are particularly cheap. Therefore, if there is no need for a portable instrument, and expense is a consideration, battery operation may not be worth the price. Battery operation is not confined to field use; even in the bench situation, it may be an advantage in making a voltage measurement with the DMM floating at a potential above the allowable common-mode voltage of the instrument.

For truly portable operation, the operating time from a full charge is an important specification. For extremely constant use, an operating time of eight hours may be needed from a single overnight charge. If the DMM is to be operated intermittently during the course of a working day, and is to be kept on a charger overnight, an operating time of four to six hours will be quite satisfactory and probably cheaper.

Status indication. Digital multimeters have many modes of operation. With either an autoranging instrument, or one being operated at some distance from the user, some form of status indication is convenient. Status indication displays the DMM function and range being used. Usually this takes the form of lighted indicators in the display window. Overrange decimal point and polarity are the most frequently included status indicators. Be certain these three indications are easily

understood. Blinking or blanking of the display is frequently used to indicate an overrange condition. Illuminated + and - symbols most frequently indicate the polarity of the DC measurements.

The **sample rate** specification indicates the number of conversions in one second. Commonly this figure is about three to five per second. With seven-segment displays, sample rates in excess of five per second may create readings that are difficult to read.

Warm-up time. Many instruments specify a period of time required before the instrument is within its specifications. Quick warmup may cost extra, but if high accuracy and rapid portability are requirements, as in certain types of service work, it may be a feature worth paying for.

Operating temperature range. The accuracy specifications of a DMM have a temperature dependency. This is usually specified in one of three ways. First, a temperature range over which the DMM may be operated within its published specifications may be stated. Second, the DMM may be given an accuracy specification at 25°C, and a derating figure for temperatures other than 25°C. Third, the permissible operating temperature range of an instrument regardless of accuracy is important. Cold climates may find the instrument kept in an unheated portion of a service truck. The instrument with an operating temperature range of zero degrees Centigrade and above may well not operate on a moderate winter day!

Size and weight. The physical characteristics of a DMM make it portable. They also contribute to price and complexity. Again, keep the intended application in mind to make the best cost/value tradeoffs.

Displays. The light-emitting diode (LED) is one of the most popular displays in use with DMM's. Other displays in use are the ten-character neon display (Nixie)[®], the seven-segment neon display, fluorescent display, and liquid crystal display (LCD). LED's are popular because of their good brightness, excellent contrast and low cost. Neon displays, both ten-character and seven-segment, have the highest brightness but at a slight increase in cost, combined with the requirement for a high-voltage power supply. Neons also tend to generate some slight RF noise. Fluorescent displays have never been too popular, although they generally require less power than LED's or neon. Fluorescents are subject to interference from static electricity and have poor contrast. Extremely low-power operation make LCD's popular. They also have a potentially low cost, but also, however, have the lowest contrast ratio. Certain types of LCD's don't wash out in direct sun light, but most will freeze at moderate temperatures and become completely useless. The life expectancy of LCD's is one hundredth or less that of the neon or LED displays.

When considering displays, size must be given some thought. DMM displays will run from 0.1 inch high to displays with a character height of 0.6 inches or more. Often the user is never more than the length of the test leads from his DMM. In such case, small displays are no hindrance, and permit a smaller, more portable design. On the other hand, if readings may be required at a greater distance, larger displays are necessary. Again, the instrument's use must be considered.

Specifications

The number of specifications associated with the DMM is extensive. Unfortunately, many of the variations from DMM to DMM are the subtly specified nuances that make all the difference to the user when the instrument is on the workbench.

The DC voltmeter

Ranges. One of the first questions facing the potential buyer is defining full scale on a particular multimeter. They are specified one of two ways: either with full scale being a multiple of 10 (1, 10, 100, 1000, etc.) with usable overrange capability specified as a percentage (typically 100%); or full scale is specified as the maximum possible reading encompassing all usable ranges (often 1.999). For example, a DMM may be specified as having 1 volt full scale with 100% overrange, thus indicating useful operation to 2 volts, or the same DMM may be simply specified as having a 2 volt full scale. These ranges are further limited, as the full indicated capability of the meter may not be useful on the highest voltage range. For example, a DMM with a 1999 full scale may not be able to read over 1000 volts DC and even lower on AC, even though 1999 volts is apparent at first glance. This is usually due to the danger of voltage breakdown of internal components.

Accuracy. Specifications differ by manufacturer as well as by the accuracy of the meter being specified. A meter specified with very high accuracy will have more sophisticated accuracy specifications as compared to those of the meter with limited accuracy. Simple accuracy specifications are given as " \pm % of full scale, ± 1 digit." The "plus/minus one digit" portion of the specification is caused by an error in the digital counting circuits, the "plus/minus percentage of full scale" includes ranging and A/D conversion errors.

One of the most sophisticated specifications is " \pm % of reading, \pm % of full scale, ± 1 digit." Such a specification is usually confined to instruments in the 0.05 to 0.01% class.

An additional specification may qualify the accuracy of the instrument at temperatures other than 25°C. Temperature specifications are of two forms: either a temperature coefficient, per cent per degree centigrade, with which the user may calculate the exact deviation from the 25-degree specification, knowing the ambient temperature; alternatively, accuracy is specified over a complete temperature range such as 15°C to 35°C.

Other limitations may be placed on the accuracy of the instrument. These include the effects of line voltage variations, humidity, altitude and time. These limitations are of little interest to the person making general use of the multimeter. However, some manufacturers, not knowing where their instruments will be used, issue all-encompassing specifications. One thing you can be sure of—the more inclusive the specifications, the higher the cost of the instrument!

Input impedance. Most DMM's have a 10-megohm DC input impedance. A few have an input impedance of one megohm. Input impedance may have a tolerance specified. This is important when using the meter with an external multiplier resistor. Some voltmeters offer very high input impedance on the lowest DC input ranges. Input im-

pedances on such DMM's may be in the 100 to 1,000 megohm range.

Response time. This consists of two factors: first, the basic cycle rate of the A/D converter; second, the time required to charge capacitances in the input circuits. This time may be long if there is input filtering. Response time is the number of seconds required for the instrument to settle to its rated accuracy. In lieu of response time, some manufacturers simply give the number of conversions per second.

Protection. Specifications indicate the amount of line frequency AC overload each range will tolerate without damage. This is especially important when using the instrument in industrial or semi-industrial applications, where accidental contact with 120 or 240-volt AC is quite possible.

Normal mode rejection ratio. NMRR indicates the amplitude of AC (usually line frequency) interfering signal impressed on the DC being measured that will affect the least significant digit (see Fig. 1). The ratio

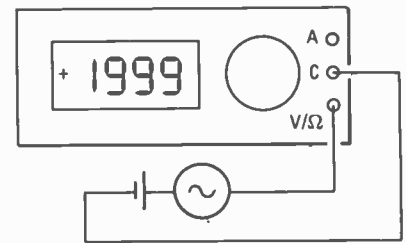

FIG. 1—TEST SETUP FOR NMRR (Normal Mode Rejection Ratio). Amplitude of the AC series signal is increased until the least significant digit of the display is changed.

of the interfering signal to the voltage represented by the least significant digit is usually expressed in decibels (dB). For example, an instrument reading 100.0 millivolts DC is specified to have 60 dB NMRR. The least significant digit indicates 100 microvolts. Thus 100 mV (100 millivolts) will not affect the reading in the least significant digit; any signal greater than 100 mV may. NMRR depends upon the instrument timing and may have to be adjusted for changes in power-line frequencies: 50, 60 or 400 Hz.

Common Mode Rejection Ratio. CMRR specifies the instrument's ability to reject signals applied between earth ground and a point common to the high and low input terminals of the instrument. There is no CMRR specification if the instrument's low terminal is at earth ground. Fig. 2 indicates

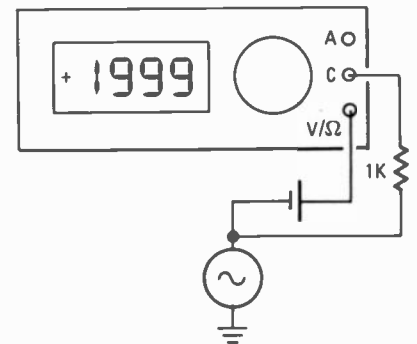

FIG. 2—COMMON MODE REJECTION ratio is measured in much the same way as NMRR. Neither terminal of the meter may be grounded during the measurement.

the common method of measuring CMRR. The one kilohm resistor in series with the low terminal is generally included with any CMRR specification. This resistor represents a typical source resistance of DC signals under actual measurement conditions. Current flowing in the common mode path flows through the 1,000-ohm resistance. The voltage generated across the resistor is converted to a normal mode signal, which is rejected by the instrument's NMRR. Occasionally CMRR is given less the NMRR. Generally, the CMRR includes NMRR. As with NMRR, CMRR is given at power-line frequencies. CMRR worsens with increasing frequency.

DC CMRR, or the floating capability of an instrument, is often limited by the breakdown voltages of the input circuitry. This specification indicates the greatest DC potential the low terminal of the voltmeter may have above earth ground.

The AC voltmeter

Range specifications are identical in nature to those given for the DC voltmeter. The high-voltage range may have an upper voltage limit considerably less than expected from a front panel reading; 750 volts is common.

Accuracy. AC voltmeter accuracy is generally given in the same way as the DC voltage accuracy. However, accuracies are normally



DMM, Heathkit IM-2202

only for measurements of sinusoidal signals with less than a specified amount of harmonic distortion (usually $\frac{1}{2}\%$). AC to DC converters, which are normally average or peak responding but RMS reading, require this limitation; if other than sinusoidal waveforms are measured, the accuracy specification no longer holds. This is not true if the instrument employs a true RMS converter. These are not common and are very expensive. The normal range for AC accuracy is 0.5% to 1% for the average or peak responding RMS calibrated instruments.

Most AC voltmeters specify frequency response, indicating the instrument's ability to measure high-frequency signals, and the expected inaccuracies over a specified frequency range. The limits to AC frequency response are normally from 20 Hz to 10 kHz or 50 kHz, depending on the instrument.

Input impedance specifications of the DMM should include not only the resistive value to be expected (usually 1 or 10 megohms), but also the value of capacitance between the input terminals. This is generally about 100 pF.

Response time. AC voltmeter response time includes all time specified in the DC voltmeter as well as the response time of the AC converter. AC response time may be six to ten times greater than in the DC voltmeter.

Input protection indicates the amount of

voltage overload which may be applied to any range without damage. A separate DC limit may be indicated to cover input coupling capacitor breakdown. Overloads from sources outside the specified frequency range of the instrument may not have as great a protection range.

Common mode rejection ratio. AC CMRR is defined and measured in the same manner as it is for the DC voltmeter.

Noise. Some of the very good voltmeters indicate the RMS value of noise contributed by the converter, the input amplifier, and any other source within the instrument. A noise specification is required only on very high resolution, sensitive instruments.

Ammeters

Ranges. Ammeter ranges are given as full scale readings, and may include an overrange specification. A number of instruments do not have extensive ammeter ranges; other meters commonly extend to 1 ampere full scale. Some instruments have DC capabilities only. Ammeter ranges vary extensively, so these specifications must be carefully read. All ammeter ranges have full overrange capability, therefore, a 1-ampere meter usually gives 2-ampere capability.

Accuracy. Ammeter accuracies will be slightly lower than those of the associated voltmeter, as the accuracy of the shunt must be included. The ammeter accuracy may be further degraded with high-current shunts.

Voltage drop. When inserted into the circuits, the ammeter shunt causes a maximum voltage drop when measuring full-scale currents somewhat larger than the full-scale value of the lowest voltmeter range of the instrument. This may be as much as 10 or 20% higher than the voltage range, to cover resistance in series with the shunt, especially on the highest current ranges where the shunt value is usually 0.1 ohm. On very low current ranges, the shunt resistance is relatively high. For example, a 200 pA range on a 200-mV meter will have a 100-ohm shunt.

Protection. Most DMM's have a fuse in series with the ammeter shunts that opens if the maximum current is exceeded. It is wise to note fuse types. A few DMM's use very unusual fuses, and keeping a few spares on hand may save time and trouble.

Response time. The ammeter response time should be similar to that of the corresponding voltmeter.

The ohmmeter

Ranges. The lowest ohmmeter range on most DMM's is higher than expected. Usually the first range is 100 ohms. A 100-ohm range will give 0.1 to 1 ohm resolution. The upper limit of the ohmmeters found in DMM's is either 1 or 10 megohms, 10 megohms being more desirable. Ohmmeter ranges are found in decade steps between 100 and 16 megohms. All ranges have full overrange capability, so a 10-megohm meter normally gives 20 megohm capability.

Accuracy of the ohmmeter measurements is related to the accuracy of the DC voltmeter and the precision of the constant-current sources. The accuracy specification may be somewhat reduced for measurements on the uppermost range, but for most ranges the error is no greater than twice the DC error.

Measurement currents. Some DMM manufacturers only specify the current applied by each resistance range to the unknown resistance, while others specify both the current

and the maximum open-circuit voltage applied to the circuit being tested. Some DMM's have special low voltage ranges that do not forward-bias semiconductor junctions.

Response Time. Resistance measurements normally have a response time close to that of the DC voltmeter. The uppermost range, however, may have a response time considerably slower than that of the other ranges.

Protection of the ohmmeter is important, as the constant-current generator is easily damaged if a high external voltage reaches it. Protection may differ for AC and DC, and may vary to some extent with the resistance range being protected. Protection against the power line is especially desirable. Accidental contact with this high potential is not at all uncommon, and a DMM without 120-volt AC ohmmeter protection is vulnerable to extensive damage. Many DMM ohmmeter circuits employ a very small fuse as part of the protection. Once again, this fuse may be difficult to locate and obtaining a few spares is wise.

Applications, error sources

An applications section on DMM's seems almost extraneous. After all, the instrument measures current, voltage and resistance. While this is true, there are a few special situations in which the DMM is used that are worth discussion.

Probably the first impression after using the DMM is the feeling: "How did I ever get along without this instrument?" This attitude results from increased convenience. A three-and-one-half-digit, autopolarity machine rarely needs range changes when working with most circuits. One range, such as the 20-volt one, gives all the resolution required. Without having to reach for the polarity switch, there is nothing to do but take measurements.

For example, a three-and-one-half-digit machine on the 10-volt range has a full-scale reading of 19.99 volts. Most power supplies of modern analog circuits can easily be checked to the nearest 10 millivolts, and the base-emitter voltage drop of transistors still checks to two significant figures (again the nearest 10 millivolts). Such measurements give more than necessary resolution. Semiconductor measurements with 10-millivolt resolution are in the range of voltage for a forward-biased diode that changes with temperature.

Needless to say, the DMM is not without its pitfalls. Erroneous actions based on DMM readings, assuming more accuracy than exists, or readings with too much resolution are frequent. For example, instructions in one Heathkit oscilloscope manual directs the kit builder to adjust a control until voltage on the collector of each of two deflection transistors is equal; then to adjust another control to set both collectors at 100 volts. A number of kit builders have found this task particularly frustrating and next to impossible. The reason: a DMM was being used which had far more resolution than called for. Adjustments were being made to the nearest few tenths of a volt which need only have been made within a few volts. Adding a factor of ten to the setability of a control can make the difference between one that is simple and one that is difficult to adjust.

In a similar case, an error is often made when a voltage is not exactly the value that is

continued on page 82

Extra Hands For The Hobbyist

Built from commonly available parts, these devices will make printed-circuit board assembly easier and more pleasurable

WHEN ARE TWO HANDS AND TEN FINGERS NOT ENOUGH? WHEN ARE two eyes and tri-focal glasses not enough? . . . Right!—when you are working on solid-state circuits.

As parts have undergone the change from small and miniature to sub-mini and even micro, my normal-size fingers and otherwise adequate eyes have caused more and more problems. I just can't seem to be able to hold a board, a part on that board, solder and an iron all at the same time. I can't see those minute solder bridges or what's happening on one side of the board while making adjustments on the other. [In fact, I never could see around corners!]

Does all this sound familiar to you? Have you looked

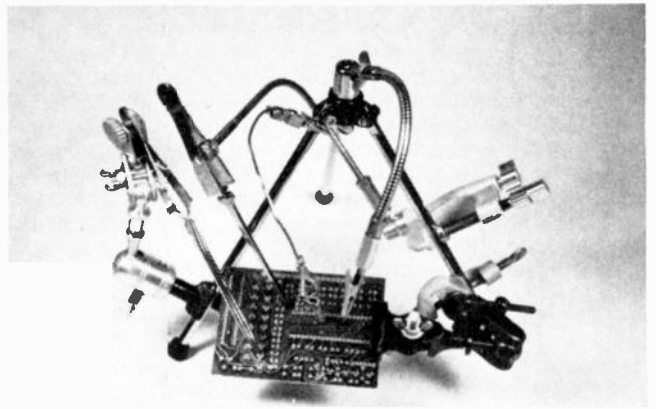

EARL R. SAVAGE, K4SDS

longingly at some of those expensive construction aids that have limited use potential? Well your frustration is over. On these pages you will find a system of aids that is as inexpensive or as expensive as you choose to make it. Best of all, it is endlessly versatile.

This system is based upon the fact that a thread size of $\frac{1}{4} \times 20$ has become standard in a number of applications. As you will see, I have raided photography, science laboratory and plumbing supply houses as well as hardware stores to find parts for the system. Because of the same-size threads, all the parts are completely interchangeable. Just a few of the possible combinations are shown here.



FIG. 1—BASE SUPPORTS for the holders and viewers.

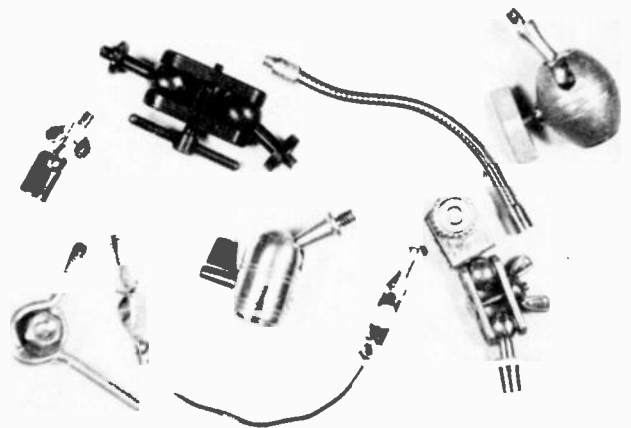

FIG. 3—FLEXIBLE JOINTS allow exact positioning of parts.

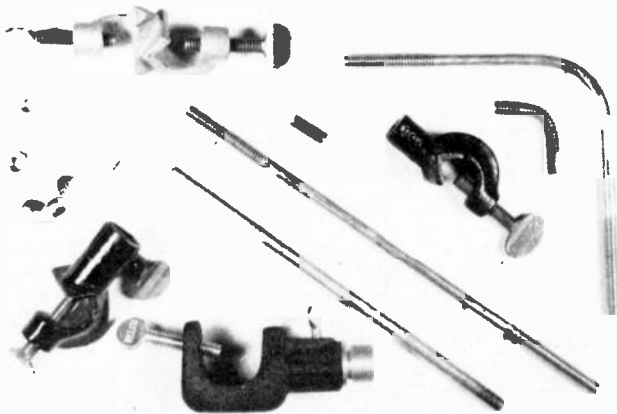

FIG. 2—CONNECTORS for attaching various components of the system.

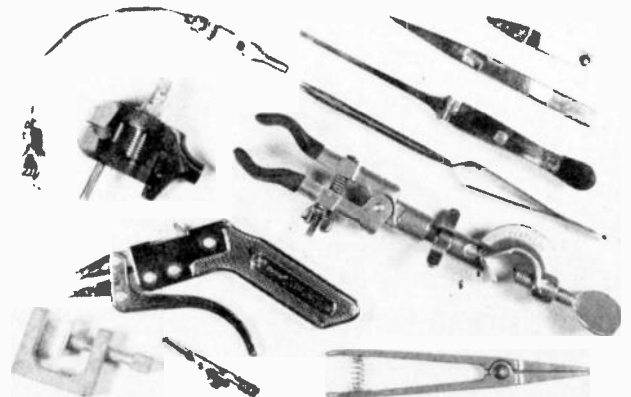

FIG. 4—HOLDING DEVICES firmly grasp just about any type of part or tool.

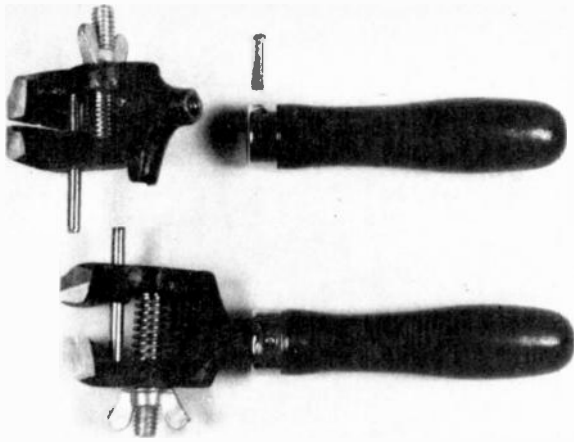

FIG. 5—PIN VISE is converted into PC board holder by drilling and tapping.

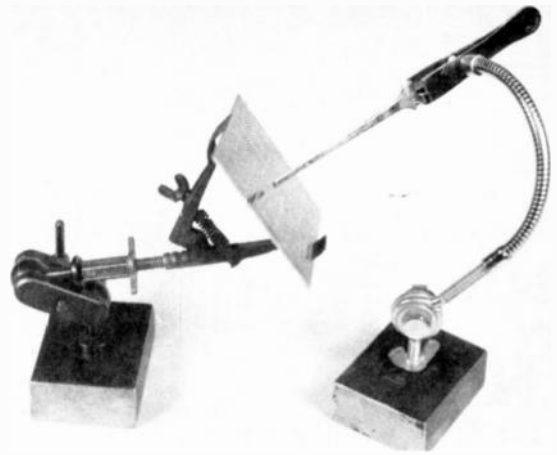

FIG. 7—PC BOARD HOLDER is built from a test-tube holder.

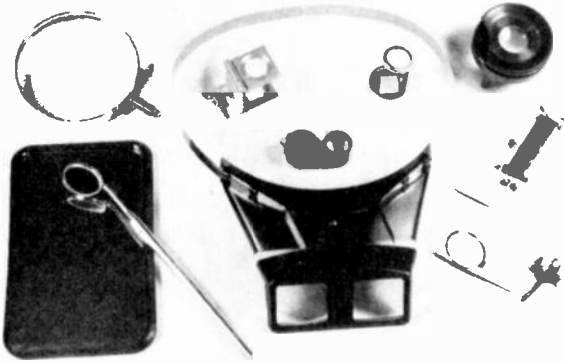

FIG. 6—VIEWING DEVICES are a great aid when doing close-up work.

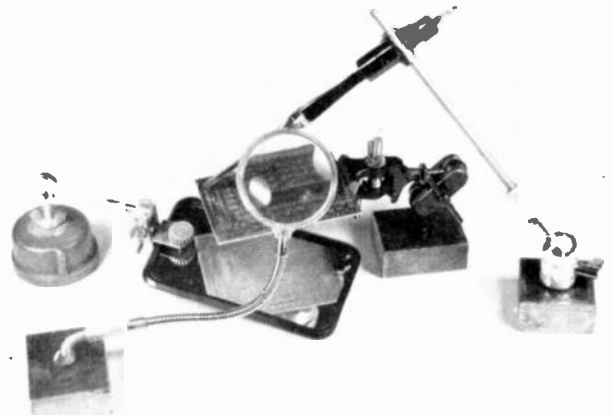

FIG. 8—TYPICAL SYSTEM is one of the many possibilities.

My system began several years ago and has grown as I discovered new and useful parts. Undoubtedly, I have only begun to explore the possibilities. Once you get started, you will turn up many additional useful components and combinations.

Each holder and viewer consists of certain basic parts: base, connectors, joints, and the holder or viewer, itself. Let's look at each of these and then at some of the many ways they can be put together.

Bases

Several types of bases are shown in Fig. 1. The C-clamps and photography clamps (with universal joints) are very useful. They can be attached to the top of the workbench or shelf, to the lip of a cabinet or chassis, or even to a brick on the bench. The tripod with its universal head has a wide base and can be placed on any surface.

The most useful bases are of the homebrew variety. One is a rectangular block of metal cut to about $2.5 \times 5 \times 7$ centimeters, then drilled and tapped with $\frac{1}{4} \times 20$ threads. Lead blocks may be cast for this purpose. The other is a pipe cap also drilled and tapped. Pipe caps are available in many sizes and may be filled with lead to increase weight and stability.

Connectors

The connectors shown in Fig. 2 come from a variety of sources. Some are pieces of laboratory apparatus that will not only clamp on rods and the like but are, themselves, threaded with our standard $\frac{1}{4} \times 20$.

The rods are made from sawed-off bolts, threaded rod stock and bathroom tank float rods. Various types of nuts should be in your collection. The "connecting nut," just to the right of the hexagon nut, is especially useful. It is about 3-cm long and

threaded all the way through.

Flexible joints

A joint of one kind or another must be used in each assembly or the device would be of very limited value. Several types are shown in Fig. 3. The simplest is, of course, a piece of heavy wire between two alligator clips.

Two different ball-and-socket joints and three tripod heads are also shown. They will permit movement in any direction. The small flexible rod is extremely useful.

Of special interest is the joint in the lower left corner of Fig. 3. It is made with two standard eye-bolts, two of washers and a bolt. This joint is quite inexpensive and versatile but not as convenient to use as a ball-and-socket or tripod head.

Holding devices

A number of different types of devices for holding wires and small parts are shown in Fig. 4. Several require special comment. One of the larger self-closing tweezers has been drilled and tapped on one side of the handle.

The PC board holder was made from a pin vise. Figure 5 shows how this was done. The handle was removed by pulling the holding pin. After the projecting shank of the vise was sawed off, the new base was drilled and tapped. When attached to a universal joint, this holder will position a board or other large component in any conceivable manner.

Viewing devices

Many kinds of viewing devices are of help to the hobbyist. A few of these are shown in Fig. 6. The 8×14 -cm mirror is very useful for watching the results on one side of a board or panel while working on the other side. The small dental mirror will often prevent your having to disassemble equipment to check an otherwise inaccessible spot or part.

continued on page 83

Step-by-step TV Troubleshooters Guide

THERE ARE MANY, MANY CIRCUITS IN A MODERN color-TV chassis. If we are to service them as fast as possible, we must *know* each one of them, and what they do. We also have to know what they do when they're not working. These are the "fault-reactions," and are the key clues to the location of the trouble. One of the most important (and one that the customer notices quickest if it goes bad!) is the sync separator. Like all the others, if we pick it out of the schematic and look at it all alone, it is not very complicated. It has a very simple purpose: it clips off the sync pulses from the TV signal and distributes them to the two sweep oscillators. That's all.

Most of them are now called "sync separators." At first, they were called "sync clipper" which is really more descriptive. A composite video signal is shown in Fig. 1. The bottom 75 percent of its amplitude is the video signal; the top 25 percent is the sync. The sync-separator literally clips off the top 25 percent which is nothing but sync. The "sync porches" shown are at the black level; above that level the picture tube is cut off. (Actually, most sync separators are set to clip just a little *above* the black level. This keeps the video out of the sync, and vice versa. More on this later.) The video signal used for this is usually picked off somewhere in the video output stage. You may find that the *video* portion is slightly compressed; that's all right since we're going to throw it away anyhow. The sync must *never* be compressed. Fig. 1 shows the "clip-line" for proper sync-separation.

How do we clip the sync off? We feed the video signal into a stage which is *biased* so that it won't conduct at all until the signal reaches a certain level. Let's say the grid signal has a P-P amplitude of 50 volts and we want only the top 12.5 volts of it. So, we simply put a negative bias of -37.5 volts on the grid of the sync separator tube. The tube will remain deep in cutoff until the signal reaches a voltage high enough to make the grid positive, or $+37.5$. Now, it will conduct only during the sync interval and neatly clip off the top 25 percent of the signal. Most sync-separators will amplify the signal; so we'll find a "composite sync" output that will run somewhere around 35-40 volts P-P in tube stages. Figure 2 shows this waveform at a 30-Hz sweep rate. Remember it. We said "tube"; transistors do exactly the same thing. Only the DC voltages are different as well as the polarity. Transistors are excellent sync-separators due to their characteristics. They love to clip!

The smaller pulses in Fig. 2 are the horizontal sync. The larger ones are the vertical sync. These can be hard to see in some cases, but look for them. They'll usually make a notch in the top of the composite sync waveform.

Having clipped off the two syncs, we now have to get them to the proper sweep oscillators—vertical and horizontal. This is easy; we

take advantage of the fact that we have a very low-frequency sync, at 60 Hz for vertical, and a high-frequency sync at 15,750 Hz for horizontal. These can be separated quite simply. (In fact, the actual "separation" of the syncs into individual parts is done in the sync-separator output circuit, by the components shown in Fig. 3.)

The vertical sync is cleaned up by feeding it through an RC network. This is an integrator. (If you want to go far enough back into basics, the vertical sync pulse is actually made up of quite a few horizontal sync pulses! This circuit puts them back together so that the output is one clean sync pulse at the vertical frequency.) It does that by developing a charge on the shunt capacitors and discharging through the resistors. The high-frequency horizontal sync pulses see a very low impedance in the shunt capacitors, so they are grounded.

The horizontal sync is even simpler. All we

reference pulse from the oscillator output. If the phase is different (oscillator trying to go off-frequency) the phase detector develops a small DC correction voltage. This is applied to the oscillator to pull it back in phase. It doesn't take a great deal of sync *voltage* to make it work.

The vertical sync is different. The oscillator is actually fired or triggered by the sync itself. The oscillator will have a stage with a gradually rising voltage curve. The sync comes in on this curve so that it fires the oscillator just a split microsecond before it would normally trigger itself. This makes the oscillator lock with the sync. In the absence of sync, it can free-wheel.

This gives us one of our key reactions to help us locate the cause of the trouble. If a fault in the sync-separator causes a loss of sync *amplitude*, you will see this show up as a *vertical* sync problem long before the horizontal sync is affected at all. It's possible to

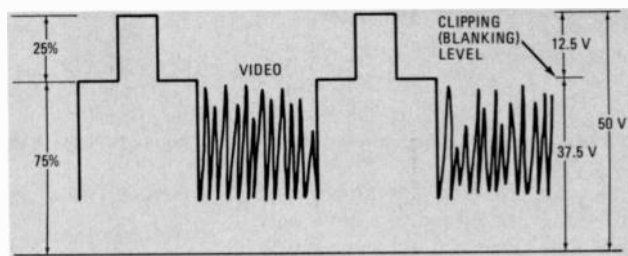

FIG. 1—A TYPICAL VIDEO SIGNAL. The figures at left are normal sync/video percentages; those at the right are typical bias voltages that might be used to make the sync-separator stage clip off the sync.

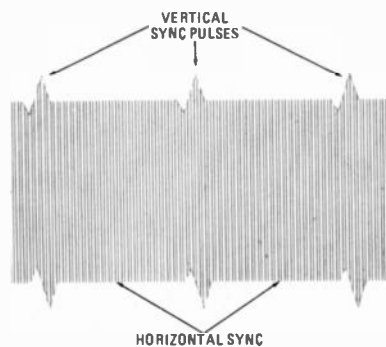

FIG. 2—THE COMPOSITE WAVEFORM at the sync separator output.

do is feed it through a very small coupling capacitor that offers a very high-impedance to the low-frequency vertical sync, which doesn't get through. We get *enough* of the horizontal sync through to do the job. This is how it works, when it's working. Now let's see what can happen to it and what symptoms it causes when it's not working. Knowing the fault reactions is very important in finding out what's wrong.

Normal reactions.

We have two different types of reaction in the vertical and horizontal sync circuits. The horizontal sync "works on phase." It's fed into a phase detector where it's compared to

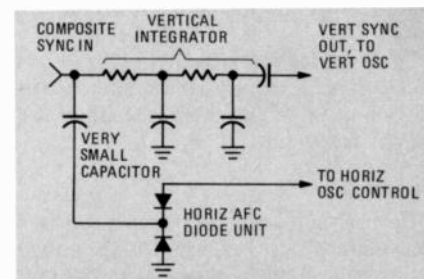

FIG. 3—LOW AND HIGH-PASS circuits channel the vertical and horizontal sync pulses to their respective oscillators.

lose so much vertical sync that the picture won't even try to lock, yet the horizontal oscillator will be quite stable.

This is one of the easier ones. A weak tube, a leaky transistor, an off-value resistor or leaky capacitor, and you can lose sync amplitude. In older sets with separate parts in the integrator, the shunt capacitors usually leaked and pulled down the sync amplitude. The newer type integrators can do the same thing if they're defective, so check them if this kind of trouble is found.

Since the horizontal sync circuits are so simple (one little coupling capacitor), loss of horizontal sync is also pretty simple. If the coupling capacitor isn't open, the conductors on the PC board may have a hairline crack somewhere between the sync-separator out-

Faults in the horizontal and vertical sync circuits can be isolated quickly if you know the symptoms and follow a logical step-by-step troubleshooting procedure.

JACK DARR
SERVICE EDITOR

put and the center tap of the AFC diode unit. A good quick-check for this is to take the diode unit out and check on the center terminal for the horizontal sync pulses. Cold solder joints are a good cause for this, too!

Let's pause for a moment. Note that I have frequently mentioned the use of a scope. This is because the scope is the *only* instrument you can use in these circuits to actually *measure* and verify the presence of the syncs. The DC voltages are important, of course, but the scope is the only instrument that will tell you exactly what is happening and where the trouble is. There are several eyeball tests that are very handy, which we'll get to soon, but for the final analysis and fault-location you *must* use a scope (until someone develops an IC instrument with a readout that says, in a sweet recorded voice, "You have 27.9 volts of vertical sync at this test point, with a slight distortion of the top!..")

Typical symptoms

The Well-Calibrated Eyeball can be quite

abled. Ground the grid of the output stage after turning the brightness down. Now you can see if you are getting any vertical sync at all through the integrator. Polarity of the vertical sync is determined by the point where it is fed into the oscillator. If it goes to a grid, it's usually positive going; to a plate, negative going.

If the integrator output is too low, lift one of the legs and the ground. It can be checked with an ohmmeter. Normal resistance end to end will be somewhere around 180K, give or take a few. From either end to the ground terminal, a very high resistance. A low resistance reading here indicates leakage in the shunt capacitors. Too much resistance end-to-end indicates a bad resistor. If the integrator goes up to 2-3 megohms, you'll lose sync amplitude.

Caution: *before* making any tests for vertical sync, check the vertical size and linearity controls. If these are set so that the raster is overscanned too much, you'll have a case of "fake sync trouble." This distorts the

one going upward very fast is "flipping." Try this on a working set and you'll see. If you can make the picture go upward very *slowly*, once again you have no vertical sync at all. Start with the composite sync: if it's present check the integrator.

Horizontal sync

The horizontal sync has a different kind of reaction. Most of the troubles in horizontal sync turn out to be due to bad parts in the oscillator or AFC. If you do have one of the rare cases where there is a loss of the horizontal sync pulse, the reaction will be like this: the oscillator will make a single picture. The hold control will make this "set up" and maybe even hold for a few seconds. However, when you move the horizontal hold control even a little bit in either direction, out you go. Normal reaction should be a good hold for quite a bit of rotation of the hold control before it falls out.

Make this check. Kill the horizontal AFC by grounding the AFC grid of the oscillator, or the AFC diode unit in transistor sets. Now, adjust the horizontal hold control until you get a single straight-sided picture that will hold momentarily, though it will drift slowly from side to side. This tells you that the horizontal oscillator *is* able to run on frequency, and is reasonably stable. Take the ground off the AFC and the picture should lock in tight and hold for quite a bit of rotation of the hold control. Check for stability by changing channels; this interrupts the horizontal sync. However, if the picture falls *out* of sync when you put the AFC back, there is an AFC problem.

Unbalanced AFC diode units cause most of these problems. It's faster to take the old one out and put in a new one. If this clears it up, fine. There are three types of AFC diode units—common-cathode, common-anode and series. It is much better to use an exact duplicate of the original! If it gets worse after you replace the diodes, make sure that you got the correct type! The first two are not polarized; the series type definitely is!

Odd sync problems

If the sync seems to be fairly steady, but the picture jitters in either direction, you could have a fault in the sync separator. Once again you'll have to use the scope. This can be caused by incorrect clipping action, which lets some of the *video* signal get through with the sync. Sync must always be clean pulses; the video signal is constantly varying and it is this variation in the sync that causes the jitter. Check all DC voltages on the sync separator. If the set uses a noise-canceller circuit, check the setting of the control. If it is set too tight, instead of punching out noise pulses, it punches out most of the sync as well. Set it completely off and see if that helps.

Thermal drift of resistors in the sync-separator stage can cause problems like "It

continued on page 81

TROUBLESHOOTING CHART—Sync circuits

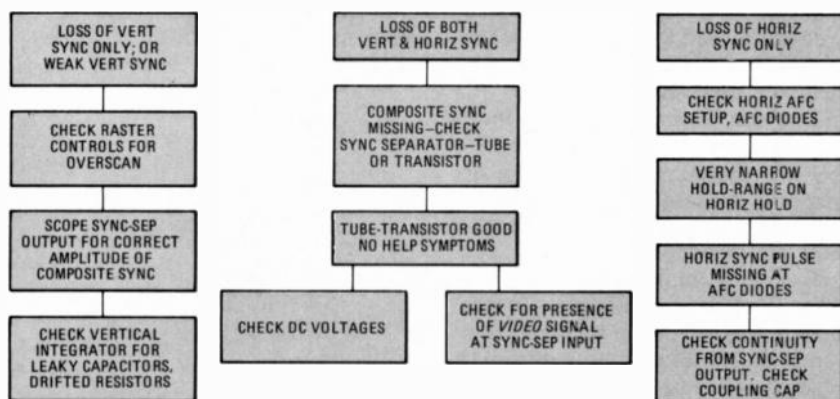

a help. Look at the picture and move the two hold controls to see what they do. If both controls have the normal effects on the picture, the sweep oscillators are *working*. If you have only *one* picture visible, but it floats up, down or sidewise without locking, you have lost all sync. Since this is obviously a complete loss of both the horizontal and vertical sync, you check the only stage that handles both of them at once—the sync separator.

If the vertical sync is weak and unstable but the horizontal sync is good, this could be due to a loss of sync amplitude. Scope the sync-separator output and check the P-P voltage. This isn't shown on all schematics, but a ballpark figure for tube sets is something like 35–40 volts P-P. If this voltage is up to normal or close, the vertical sync is OK at the integrator input. Follow it through to the integrator output. This can be done much more easily if the vertical oscillator is dis-

abled. Ground the grid of the output stage after turning the brightness down. Now you can see if you are getting any vertical sync at all through the integrator. Polarity of the vertical sync is determined by the point where it is fed into the oscillator. If it goes to a grid, it's usually positive going; to a plate, negative going.

Eyeball test. With the vertical hold control, roll the picture slowly downward. When the blanking bar gets to a point about two inches from the bottom of the screen (minimum), the picture should snap into sync momentarily then keep on rolling. That snap indicates that vertical sync *is* present. If the picture rolls smoothly on through the bottom without even slowing down, there is no vertical sync.

Second clue: Due to the nature of the waveform, the picture should lock-in when the hold control is turned the opposite way, until you reach the "break-out" point. It should then go upward very rapidly. This is common terminology; because of this reaction a picture going down is "rolling," and



Automatic Noise Blankers— How they work

Many circuits have been developed and incorporated into CB transceivers to automatically reduce noise. Here's an in-depth look at several of these circuits and how they work

ROBERT F. SCOTT
TECHNICAL EDITOR

IN AN EARLIER ISSUE, WE DISCUSSED AUTOMATIC noise limiters and described typical circuits as used in CB radios. We saw how noise—either “hash” or hiss on one hand and impulse-type noise pulses on the other—is limited in audio circuits so it does not exceed the level of audio signals resulting from the detection of RF carriers with an average percentage of modulation.

Figure 1-a is a representation of a 100% modulated carrier with superimposed noise pulses. For the convenience of illustration, the noise pulses are held down to about twice the level of the modulated carrier. Actually, noise may be hundreds or thousands of times stronger than the desired signal.

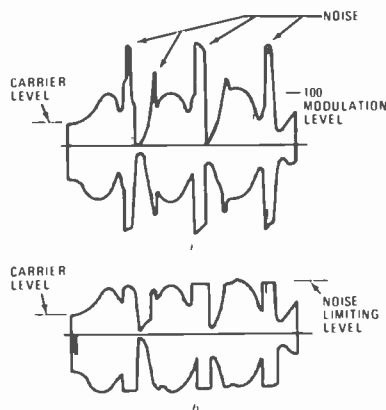

FIG. 1—NOISE PULSES superimposed on a 100% modulated carrier is shown in a. Noise limiter adjusted to clip at 100% modulation level clips noise peaks so they do not exceed audio signal as shown in b.

Figure 1-b shows how a noise limiter—adjusted to clip at the 100% modulation level—clips noise peaks so they do not exceed the amplitude of the audio signal recovered from the incoming Citizens band signal.

The automatic noise limiter is most effective in combatting hiss and “hash” which are composed of continuously overlapping random pulses of the type generated by neon signs, small electric motors and power-line leakage. The automatic noise limiter circuit is usually set to a level corresponding to 70-80% modulation. Remember, however, that the interference cannot be completely eliminated, it is simply limited to a level where it does not make the average incoming signal totally unreadable.

Impulse noise is generally produced by electrical circuits. The noise peaks often have very high amplitudes with durations seldom exceeding 50 to 60 microseconds. The repetition rate may vary from spasmodic to a continuous 400-Hz.

In addition to having an adverse effect on signal readability, high-amplitude noise pulses develop AGC action that desensitizes the receiver. In some cases, when the noise level is high, receiver sensitivity is reduced until only the strongest signals can be received.

Although the duration of the average impulse-type noise pulse may be less than 25 microseconds and seldom exceeds 60 μ s, some pulses are of longer duration. One unfortunate characteristic of impulse noise is that a very narrow

pulse is delayed and broadened as it is passed through highly selective circuits. The greater the circuit selectivity, the more the pulse is stretched and delayed.

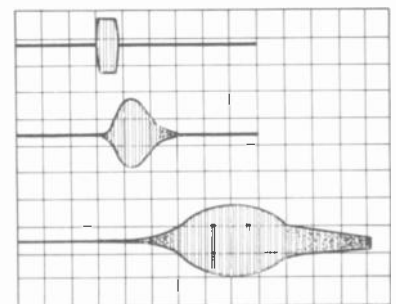

FIG. 2—IMPULSE-TYPE NOISE PULSE is shown in upper trace. Middle trace shows noise pulse after it is amplified by IF amplifier with a 5-kHz bandwidth. Lower trace shows effect of IF amplifier with a 2-kHz bandwidth.

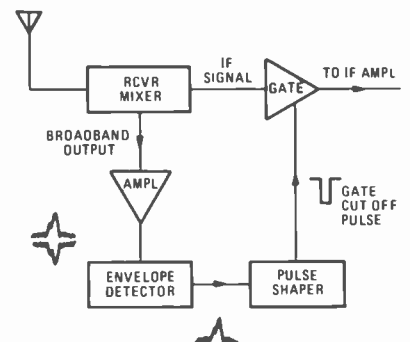

FIG. 3—NOISE BLANKER uses a gate in series with the IF signal. Gate opens for duration of noise pulse.

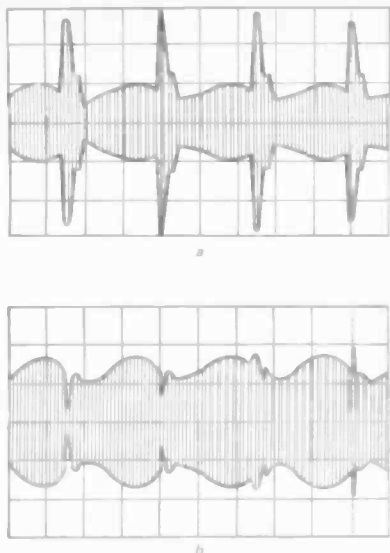

FIG. 4—NOISE PULSES superimposed on carrier is shown in a. Output of IF amplifier with noise blanker operating is shown in b.

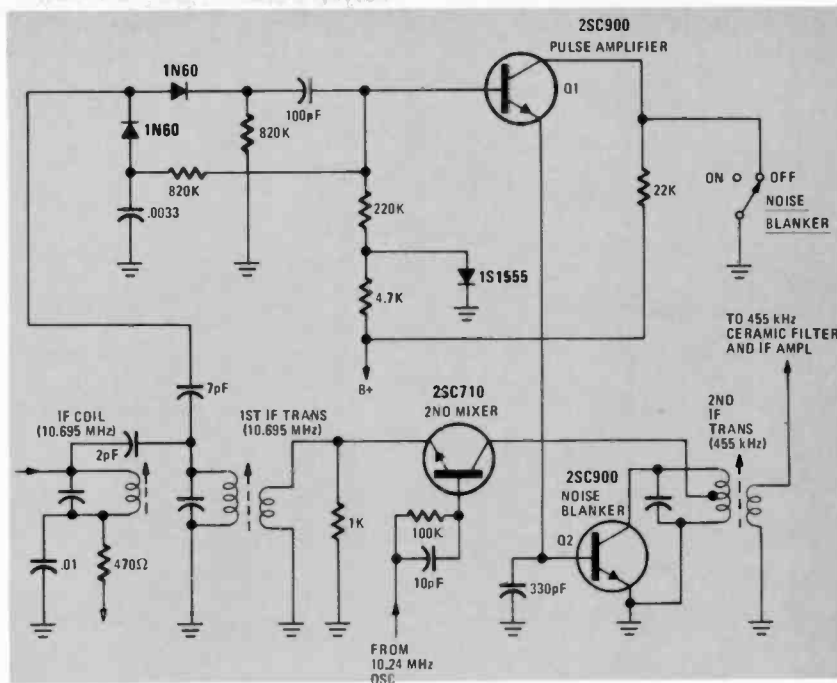

FIG. 5—NOISE BLANKER CIRCUIT used in the Midland model 13.882C.

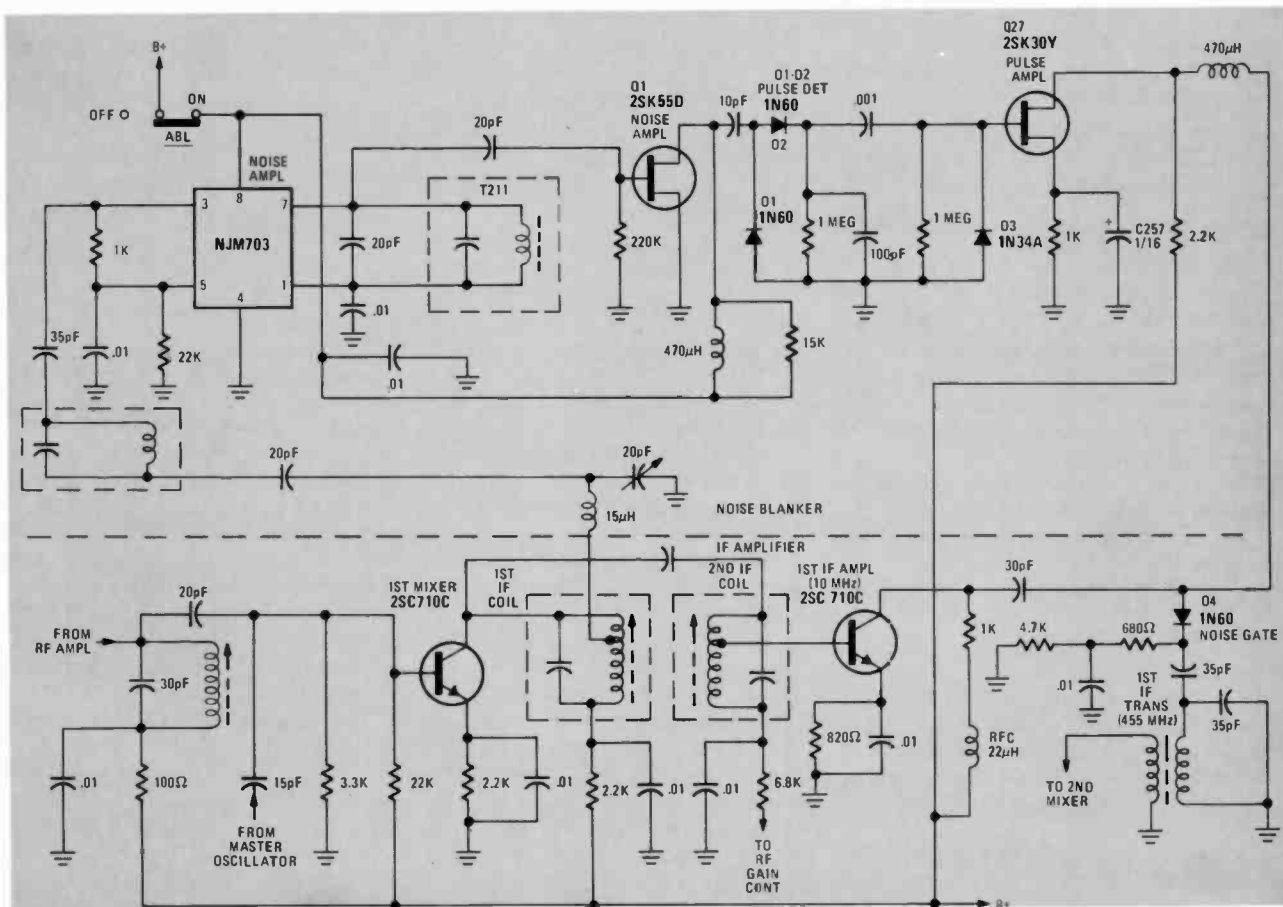

FIG. 6—NOISE BLANKER CIRCUIT used in the Pace model CB145.

This is caused by amplifier overload and ringing in the tuned circuits.

Figure 2 is a representation of an impulse-type noise pulse (top trace) as it is delayed and lengthened by IF amplifiers with 5- and 2-kHz bandwidths. We can see that as selectivity is increased, the pulses are lengthened.

How noise blankers work

The noise blanker—also called an RF or IF noise silencer—is most effective when combatting impulse-type noise. It is a concept developed by J. J. Lamb and described in the technical press early in 1936. Basically, the noise blanker (Fig. 3) taps off a portion of the

incoming signal close to the receiver input—before it gets to the highly selective IF circuits. Filters and detectors extract the noise peaks which are shaped and amplified. The pulses are then polarized so as to open a gate in series with the IF signal path for the duration of the noise pulse.

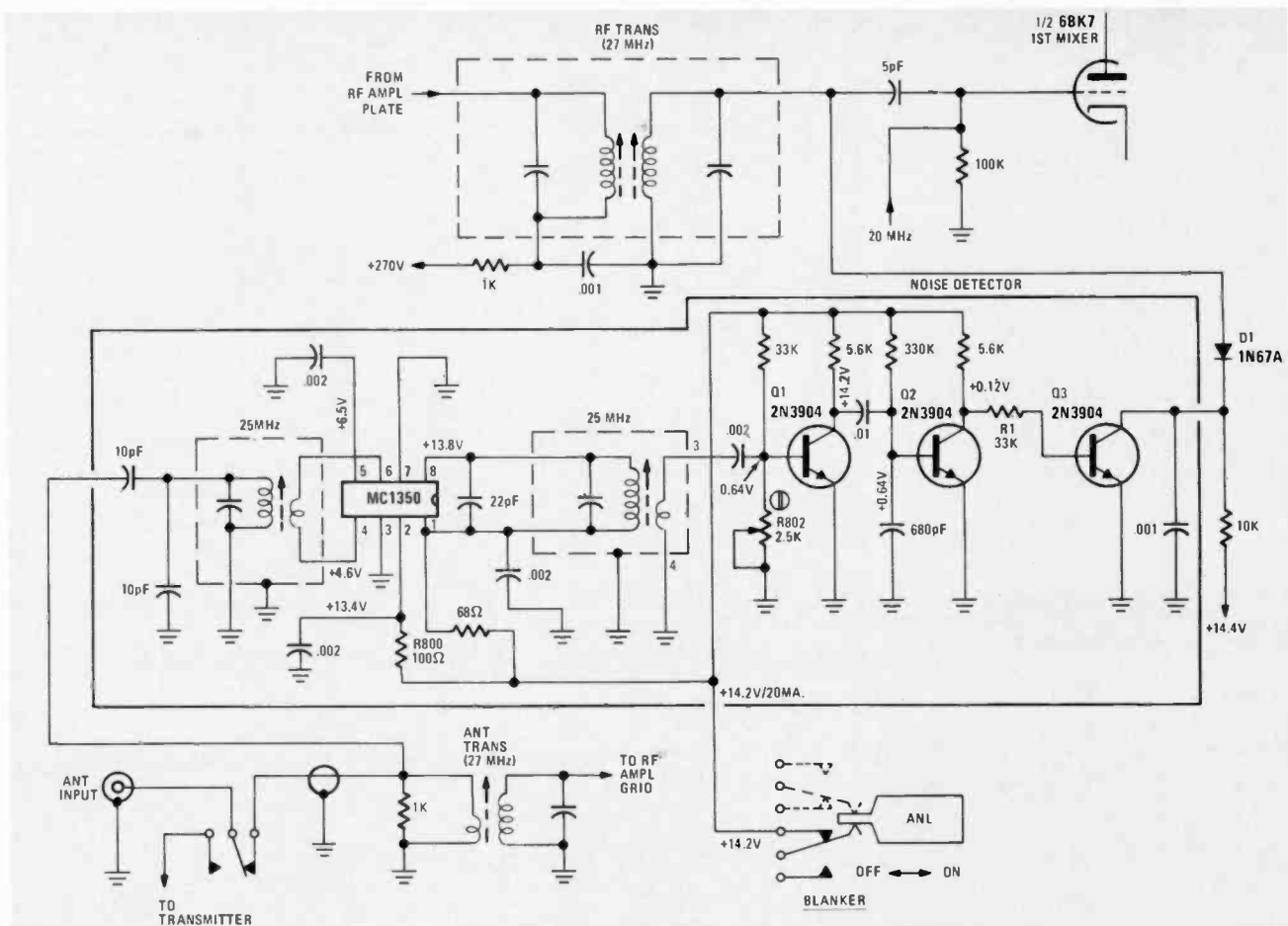

FIG. 7—NOISE BLANKER CIRCUIT used in the Tram model D201.

The duration of the individual noise pulse is very short compared to the interval between pulses. Thus, the receiver is silenced or muted during the noise period. The upper trace in Fig. 4 represents a modulated carrier with high-amplitude noise pulses superimposed. Figure 4-b represents the signal at the output of the IF amplifier with the noise blander operating.

Practical noise blankers

The noise blander used in the Midland model 13.882C is one of the simplest that we've seen (Fig. 5). It is connected between the outputs of the first and second mixers. The composite IF signal and noise voltages are picked up at the output of the first mixer. A voltage doubler-type detector strips the noise pulses off the incoming signal and shapes them to feed them to Q1, the noise pulse amplifier. Q1 is biased so it conducts only during the duration of each noise pulse. As it does, Q2 is driven to conduction so it appears as a momentary short circuit across the primary of the first IF transformer.

In this application, the noise signal is tapped off a wideband 10.695-MHz IF transformer whose selectivity is not great enough to appreciably delay or

broaden the noise pulses.

Figure 6 shows the noise blander used in the Pace model CB145 transceiver. The signal at the collector of the first mixer is the IF composed of 23 discrete frequencies centered around 10 MHz. A portion of this signal is amplified in the first IF amplifier and then fed to the 1N60 noise-gate diode (D4) in series with the primary of the 455-kHz IF transformer.

A portion of the signal at the first mixer is passed through L-C filter networks to accentuate the noise and then fed to the noise-amplifier IC where it is amplified still further. Noise amplifier Q1 feeds the noise signal to a voltage-doubler-type pulse detector.

The noise information is detected and shaped and fed to the anode of noise gate D4. When a negative-going noise pulse reaches D4, the diode cuts off for the duration of the pulse so that noise on the IF carrier cannot be further amplified and detected to adversely affect readability and receiver sensitivity.

A pre-IF noise blander

The Tram model D201 base transceiver uses the noise blander in Fig. 7. Noise is picked off the antenna input

and is detected, amplified and rectified to develop signals that ground the input to the first mixer.

Noise is picked up from the primary of the antenna transformer and fed through a capacitance network and a 25-MHz RF transformer to the NC1350 IC used as a high-gain 25-MHz amplifier. The amplified 25-MHz noise signal is fed to the base of Q1. This transistor is normally biased to cutoff by the voltage drop across the 2.5K potentiometer in its base circuit. Positive-going noise pulses turn on Q1 and turn off Q2 so its collector swings to V_{∞} (+14 volts DC). This 14 volts, dropped through R1, is fed to the base of Q3. Transistor Q3 turns on instantly and the voltage on its collector drops to zero.

Normally D1 is back-biased and is not conducting. As Q3's collector approaches zero, the reverse bias is removed from the noise-gate diode. Diode D1 now appears as a closed switch that shunts all signals to ground through transistor Q3 for the duration of the noise pulse.

By detecting the noise pulse at the antenna terminals, ahead of the selective and high-gain circuits in the receiver, noise-pulse delay and duration are kept to a minimum. R-E

State of SOLID STATE

An in-depth look at a telephone dialer circuit built around two IC's from Motorola, a voice actuated switching circuit for CB transceivers and a single IC switching regulator

KARL SAVON
SEMICONDUCTOR EDITOR

DIGITAL TECHNIQUES ARE NOT ONLY AT WORK IN SOPHISTICATED telephone switching centers but are finding their way into home and office telephone equipment as well. Off-the-shelf integrated circuits can be wired into a standard telephone to convert it to keypad operation. Not the same as *Touch-Tone*, the system simulates the sequential pulsing of the dial mechanism it replaces. Redialing capability is built in and expansion to repertoire and many other features are possible.

Binary to phone-pulse converter

The new Motorola MC14408/MC14409 IC's take a parallel binary or BCD input and produce a chain of output pulses compatible with conventional telephone circuits. Parallel input data originates from digital control electronics, keypads or memory circuitry. The number of output pulses is equal to the normal 1-2-4-8 weighting of the 4-bit binary input with one exception. Input codes 0001 (1_{10}) through 1001 (9_{10}) produce one through nine output pulses, respectively. The exception is 0000. This does not produce zero pulses but transforms to ten pulses corresponding to the operation of the zero on a telephone dial.

Figure 1 shows the MC14408/MC14409 pulse-converter wired to the companion MC14419 2-of-8 keypad-to-binary encoder. The MC14419 scans a keypad with up to four rows and four columns of switches and converts contact closures to the appropriate 4-bit encoded outputs.

The pulse converter has an on-chip oscillator that is tuned by an external L-C network. The oscillator frequency determines the dialing rate. When adjusted to 16 kHz, the oscillator output is divided for a 10 pulse-per-second dialing rate. Doubling the frequency to 32 kHz doubles the dialing rate to 20 pulses-per-second. One of the two oscillator pins is the clock output that drives the clock input of the MC14419.

Keypad switches mechanically oscillate or bounce when they are closed. There is a time interval measured in tens of milliseconds after the initial switch closure during which the contact status is indeterminate. Debounce circuitry must be used to delay the sensing of the switch to ensure reliable operation. Time delays are conventionally generated by monostable timing circuits or by defining time intervals with digital frequency divider chains. Driving the clock input of the

keyboard-to-binary encoder with the output from the pulse-converter oscillator provides the necessary debouncing.

Valid input data is indicated by a positive going pulse on IC2 pin 3. When IC1 switches this lead high, IC2 reads the data encoded on the four input lines. The four-bit word is entered into a memory register. Classified as a FIFO (First In, First Out) memory, the digits are recalled and transmitted in the same sequence in which they were entered. The digits are stored until a new number is keyed in. When redialing the number, the stored number is recalled and transmitted without reentering it. If the called number is busy or the call is interrupted, IC2 pin 10 is switched low causing the redial operation. The pulse on pin 3 enters each digit up to a maximum of 16. If more than 16 digits are entered, the circuit ignores them.

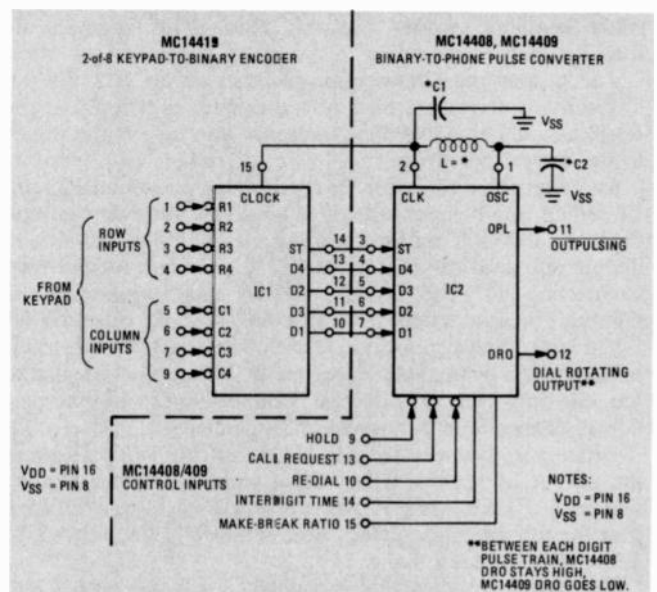

FIG. 1—PHONE DIALER uses two IC's to drive a standard rotary-dial telephone line from a keypad.

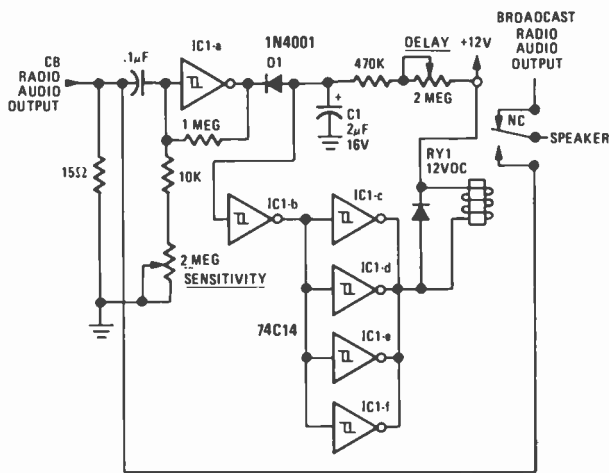

FIG. 2—AUTOMATIC VOICE ACTUATED SWITCHING circuit switches car speaker from broadcast radio to CB transceiver when a CB call comes in.

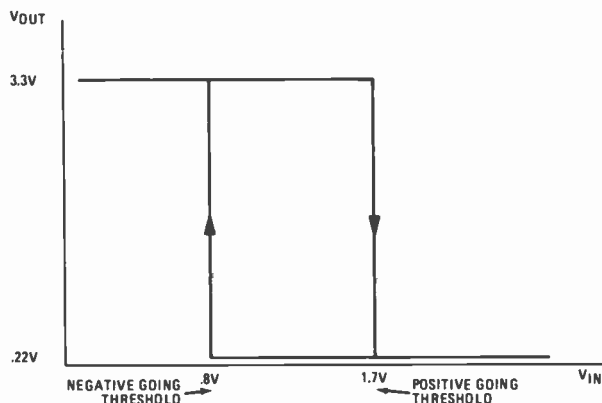

FIG. 3—HYSTERESIS CHARACTERISTIC of Schmitt trigger.

One possible feature prompted by the redialing capability is an automatic resequencing arrangement. External logic can be designed so reception of a busy signal will continually trigger redialing until the call is completed.

The MC14408/MC14409 IC's include a facility for controlling the interdigit pauses. Raising the voltage on pin 9 inserts pauses between the digit pulse-groups. The pause does not take effect until any in-progress digit pulsing is completed. More complex systems use this feature to lengthen the interdigit pauses according to specific requirements.

The output pulse-train appears inverted on IC2 pin 11. Typically, it drives the base of a transistor that replaces the telephone dial contacts. This transistor also inverts the pulses to the correct polarity.

Interdigit timing is controlled by the logic level on IC2 pin 14. When pin 14 is at a logic 0 level, the interval between digits is 300–400 milliseconds at the 10 pulse-per-second dialing rate and 150–200 ms at the 20 pulse-per-second rate. Connecting pin 14 to V_{DD} (the positive supply) increases the interdigit interval to 800–900 and 400–450 ms, respectively.

The make-break ratio (duty cycle of the output pulse-train) is determined by the voltage on pin 15. When pin 15 is tied to V_{DD} , the duty-cycle is 33 percent. Connecting pin 15 to a logic 0 level changes the duty-cycle to 39 percent.

Differences between the MC14408 and MC14409 relate to the output of pin 12. This output indicates that a dialing sequence is taking place. The MC14408 keeps pin 12 high over the full dialing sequence while the MC14409 switches to a low level between digits.

The power supply voltage is connected between pins 16 and 8 and can be 3–6 volts over the –40 to +85 degree Celsius temperature range. Current drain of the CMOS (Motorola

CMOS) is low, under 550 microamperes with a 5-volt supply.

The circuits are packaged in plastic or ceramic DIP's. Quantity pricing is \$6.98 for plastic and \$9.08 for the ceramic package in quantities of 100 to 999 units. More information is available from Motorola Inc., Integrated Circuit Division, Technical Communications Group, 3501 Ed Bluestein Blvd., Austin, TX 78721.

AVASC system

Mobile CB'ers often want to monitor a channel while listening to their broadcast receiver, tape deck or whatever. Project Support Engineering has developed an automatic voice actuated switching circuit (AVASC).

Figure 2 is the schematic of the unit which connects between the CB and the audio output terminals of the broadcast radio, and the automobile speaker. It gives priority to the CB set by disconnecting the broadcast radio whenever the audio output from the CB radio is above a variable threshold.

The six inverter-like symbols in Fig. 2 are the six Schmitt triggers in the single 74C14 hex Schmitt trigger IC. Inside each of the triangular symbols is a representation of the two-state hysteresis characteristic of the Schmitt trigger circuit. Figure 3 shows this characteristic. The output voltage is either 0.22 or 3.3 volts over the full input voltage range except for the short regenerative switching times (vertical traces). Between the 1.7-volt positive-going threshold and the 0.8-volt negative-going threshold, the output can be either of its two stable states depending on the previous input.

Assume the output voltage is high and input increases towards 1.7 volts along the upper horizontal line in Fig. 3. When the input equals or exceeds 1.7 volts, the device switches and forces the output low as indicated by the arrow on the vertical line on the right. Once this state is reached, the output will not return to the high state until the input drops to 0.8 volts along the lower horizontal and leftmost vertical lines.

Referring back to Fig. 2, the first Schmitt trigger (IC1-a) detects the audio output of the CB receiver. Feedback around the stage is a convenient method of controlling input sensitivity. The SENSITIVITY control varies the amount of feedback. Sensitivity is adjusted similar to squelch so that noise is just below the trigger level. CB receiver squelch will actually take care of the noise problem making this a noncritical adjustment.

The output of the first stage is rectified by D1 and stored in capacitor C1. Notice that the polarity of D1 is such that detected signals pull the capacitor voltage toward ground. To delay the circuit recovery, the diode acts as a peak detector and the capacitor is returned to the +12-volt supply through the 2-megohm DELAY potentiometer and 470,000-ohm resistor. The delay circuit keeps the CB output connected to the speaker from 0–15 seconds after the circuit is activated so that pauses or drop outs do not result in truncated syllables. The peak detector action pulls the capacitor quickly towards ground and then rises more slowly when the detector diode is back-biased. Increasing the resistance of the DELAY control decreases the charge rate and increases the time delay before the circuit switches back to the car radio.

From capacitor C1, the signal moves on to IC1-b and then the paralleled group of the four remaining Schmitt triggers. Relay RY1 is driven by the increased current capacity of the paralleled devices. The relay coil is connected to the positive supply and pulls in when the outputs of IC1-c through IC1-f are low.

Suggested retail price for the AVASC unit is \$29.95 and inquiries should be directed to Project Support Engineering, 750 N. Mary Ave., Sunnyvale, CA 94086.

Microcomputer update

Ohio Scientific Instruments has formally released their

prototyping and development systems for the MOS Technology 6502 and Motorola 6800 microprocessors. The line includes CPU, 4K RAM, I/O, video graphics, floppy disk and prototyping boards.

The \$29 *model 400* (board and documentation only) is an 8 × 10-inch board that can be equipped with a microprocessor, 1024 bits of RAM, and a front panel in its minimum configuration. It can be expanded to include 512 bits of ROM, an RS232 or TTY interface, and a I/O Peripheral Interface Adapter. The \$139 *model 412-A* version has a 6502 microprocessor, eight 2102 memories, a monitor PROM and a teletype interface.

The *model 420* Memory Board is equipped with 4096 of either 8- or 12-bit words built up from 2102 memory IC's.

They also have a unique learning plan in which you start out with their *model 315* Computer Trainer and then trade it in for a kit of computer system boards. The company is developing high-level languages, subroutines and games. For more information, write Ohio Scientific Instruments, 11679 Hayden Street, Hiram, OH 44234.

New modules have been added to TI's Microprocessor Learning System. A total of four modules are now available including the basic microprogrammer.

The *LCM-1001* Microprogrammer Module uses Texas Instruments 4-bit slice parallel-processor with manual stepping and LED monitor indicators. Macroinstructions are stored in the *LCM-1002* Controller Module. Each macroinstruction is made up of 8 or 16 microinstructions. Instructions are stored in a 256 × 20-bit PROM distributed on 5 IC's. The *LCM-1002* has a memory data register, instruction register and a program counter. Random Access Memory is contained in the *LCM-1003* Memory Module. The read/write memory is organized into 1024 12-bit words. The third add on is the *LCM-1004* Input/Output Module with four 4-bit input and four 4-bit output ports.

Details are available from Texas Instruments Incorporated, Inquiry Answering Service, P.O. Box 5012, M/S 308, Dallas, TX 75222.

Switching regulators

Switching regulators have long been recognized among the most efficient methods to regulate power. Practical systems tend to get complicated and once again the integrated circuit has come to the rescue.

Silicon General's SG1524 has all the control circuitry for a switching regulator on the single 16-pin IC. Figure 4 shows the block diagram of the device. The IC has an internal 5-volt reference regulator. An externally tuned R-C oscillator is the timebase for the system and provides pulse outputs for driving external switching transistors. A second signal from the oscillator is sawtooth shaped to form an input to the comparator.

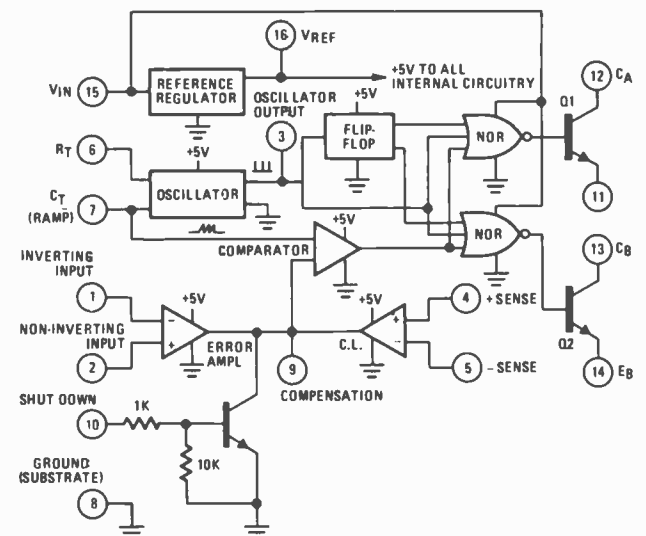

FIG. 4—SWITCHING REGULATOR control circuitry is contained in a single IC.

As the output voltage of the regulator tries to change in response to load variations, the pulse width of the signal modulating Q1 and Q2 changes to correct for the load variation. Two transistors can be driven by the pulse steering flip-flop so single-ended or push-pull circuits are accommodated.

In a typical system, the SG1524 produces 5 volts at 5 amperes with a 75-percent efficiency and 0.2-percent line and load regulation. Current drain of the IC itself is under 10 mA. Price of the 0–70°C version is \$6.75 in 100-piece quantities and is in distributor stock. For more information, write Silicon General, 7382 Bolsa Ave., Westminster, CA 92683. R-E

ARCING ACROSS CAPACITOR

I keep getting an arc across C123 in this Admiral 14K2086-9 chassis. This is the capacitor on the bottom of the high-voltage winding of the flyback. I replaced it with a 0.004 but it still arcs over.—S.G., Franklin, NC.

Your best bet would be to replace the capacitor with either an Admiral part or an exact replacement; for example, Centralab's GAP-402 should do. Also, check the high-voltage rectifier tube just for luck.

(Feedback: "It was a bad 3DF3 high-voltage rectifier tube. I got an exact replacement part for C123, and all is rosy now.")

METER CAUSES HIGH-VOLTAGE LOSS

After finding several other problems in a Philco 3CR41 hybrid (some other technician had been at it), I tried to check the horizontal output tube cathode current. When I put the milliammeter in series, I lost the high voltage and everything.

Found the problem in the low-voltage regulator circuit. Are these really critical? Still don't know why my meter killed the high voltage.—G.B., APO, Seattle, WA.

The easy one first; your milliammeter killed the high voltage because it needs something like a 0.5 μF bypass capacitor across it. In quite a few sets, the inductance of the meter coil is evidently enough to upset this circuit.

Second question: Yes. All of the low-voltage supplies in these hybrid sets are critical. That's why they use the regulator circuits. Operation is directly proportional to the value of the low DC voltages, especially in sets with solid-state horizontal output stages.

VIDEO DETECTOR FAILURE

The video detector diode goes out after about a week of operation on this G-E. I've checked everything I can think of with no success. I seem to remember reading something about this a good while ago.—J.M., Nashville, TN.

You did read this, and this is the

place. I ran into the same problem quite a while ago, in the same set. The cure is to replace the diode with a high-voltage RCA type 125844.

You'll find the same problem in some small solid-state Truetone sets, too. In these, the detector diode is inside the last IF shield can. (Never did find out why these diodes blew out!)

BOOST-BOOST VOLTAGE LOW

I have a weird problem. My B + voltage in this set ought to be +1100 volts, and it's only about +700 volts. The boost voltage is normal at about +850 volts and the high voltage and sweep are OK. I don't understand it.—P.Q., Detroit, MI.

I don't either, but here's a suggestion. Check to make sure that you have installed that boost rectifier correctly. If it's backward, you'll get just this symptom. (If you have done this, you owe me fifty cents royalty; I invented this trick several years ago.)

(Feedback: "Here's fifty cents.")

R-E's Service Clinic

Focus troubles

Out-of-focus circuits

JACK DARR
SERVICE EDITOR

THE CLINIC MAILBAG HAS BEEN PACKED lately with quite a number of problems that are obviously in the focus circuitry. Oddly enough, checking my reference books shows little coverage on this. This is a very important part of the set. Even more important, focus problems can cause symptoms that can mislead you.

Example: If you lose the focus voltage completely, the raster will be absent though the high voltage will probably still be up to an acceptable level. If you forget this fact, you may be running around checking the picture tube bias voltages and so on for some time.

While we're here, let's clear up a common misconception. This is "I get good focus on a close-up shot but on a long shot it's not focused." This isn't possible. All the focus voltage does is focus the *raster*. If you can see the horizontal scanning lines sharp and clear, the focus circuitry is good. It makes no difference whether the picture is a closeup or long shot. If you hear this complaint from the customer, check the *raster*; if the scan-lines are sharp at all times, there's no focus problem. The discrepancy between a closeup and long shot is due to the lens of the TV camera.

With that out of the way, let's look at the two major circuits used to obtain the focus voltage in color TV sets. The old original circuits use a small rectifier tube; 1V2, etc. The rectifier tube is fed from the high-voltage pulse developed at the plate of the horizontal-output tube. This pulse has an amplitude of at least 5-6 kV. The pulse is rectified and filtered and used as the source for the focus voltage. Normal should be between 4500 and 5500 volts. Figure 1 shows a typical circuit. Focus voltage on most of the larger picture tubes must be from 16.8- to 20-percent of the high voltage.

Here's a handy-dandy clue that is obtained with two simple measurements. Since the high voltage and focus are always fed from the *same source* (the pulse from the horizontal-output tube), if you find a set that does have high-voltage but no focus voltage, you can instantly eliminate everything but the focus circuit itself, which has about 6 components. This works the other way, too. If you have normal focus voltage but no high voltage, you have a problem

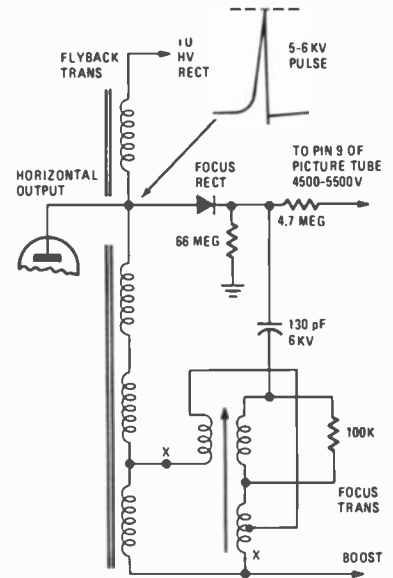

FIG 1

in high-voltage rectifier alone; only about 3 components here. This will apply to practically all tube and hybrid sets, and to many solid-state sets.

The focus coil shown in Fig. 1 should really be called a focus transformer, but no one does. This circuit works by comparing the phase relationship of two pulses in the windings, it holds the focus voltage *down* to the proper value. One set of pulses is taken directly from the flyback. So, if you find a set with all the symptoms of a shorted flyback, such as high cathode-current in the horizontal-output stage, and so on, be sure to check the focus coil *before* you replace the flyback. The test is easy. Disconnect the two leads going to the flyback (marked "X" in Fig. 1), turn it on and recheck the current. If the current goes down and the high voltage goes up—the focus transformer is shorted. The focus voltage will rise to about 5500 volts and the chances are you'll have a pretty well focused raster.

One of the more common troubles is burning up of the focus-rectifier tube socket. Some of these are very hard to fix; the optimists riveted them in. Now there is a fast-fix for this. Clear up the mess and cut the heater leads. Tape these well and put them away. If there is a contact or two left on the socket, move the plate supply lead to it. If not, install

continued on page 68

This column is for the service technician's problems—TV, radio, audio or industrial electronics. We answer all questions submitted by service technicians on their letterheads individually, by mail, and the more interesting ones will be printed here.

If you're really stuck, write us. We'll do our best to help you. Don't forget to enclose a stamped, self-addressed envelope. If return postage is not included we cannot process your question. Write: Service Editor, Radio-Electronics, 200 Park Avenue South, New York, NY 10003

IF YOU'RE NOT DESIGNING WITH A CSC PROTO-BOARD, LOOK AT ALL YOU'RE MISSING.

Utility—Models are available with or without built-in regulated power supplies (fixed or adjustable).

Economy—Eliminate heat and mechanical damage to expensive parts. Save money by re-using components.

Versatility—Use with virtually all types of parts, including resistors, capacitors, transistors, DIP's, TO-5's, LED's, transformers, relays, pots, etc. Most plug in directly, in seconds.

Durability—All Proto-Board models are carefully constructed of premium materials, designed and tested for long, trouble-free service.

Expandability—Proto-Board units can be instantly interconnected for greater capacity.

Visibility—All parts are instantly and easily visible, for quick circuit analysis and diagramming.

Speed—Assemble, test and modify circuits as fast as you can push in or pull out a lead. Save hours on every project.

Adaptability—Use in design, packaging, inspection, QC, etc. Works with most types of circuits, in many, many applications.

Flexibility—Use independently, or in conjunction with other accessories, such as scopes, counters, CSC Proto-Clip™ connectors, Design Mate™ test equipment, etc. One Proto-Board unit can serve a thousand applications.

Accessibility—All parts are instantly and easily accessible, for quick signal tracing, circuit modifications, etc.

Variety—A wide variety of models are available with capacities ranging from 630 to 3060 solderless tie-points (6 to 32 14-pin DIP's), to fit every technical and budget requirement.



Whatever type of electronic circuits you work with, you can do more in less time with CSC's solderless Proto-Board systems. As fast and easy as pushing in or pulling out a lead, you can design, test and modify circuits at will. Components plug into rugged 5-point terminals, and jumpers, where needed, are lengths of #22 AWG solid wire. In the same time you took to read this ad, you could be well on your way to assembling a new circuit. For more information, pick up your phone and call your dealer—or order direct.

CSC PROTO-BOARD SOLDERLESS BREADBOARDS

| MODEL NUMBER | NO. OF SOLDERLESS TIE-POINTS | IC CAPACITY (14-PIN DIP'S) | MANUFACTURER'S SUGG. LIST | OTHER FEATURES |
|--------------|------------------------------|----------------------------|---------------------------|--|
| PB-6 | 630 | 6 | \$15.95 | Kit—10-minute assembly |
| PB-100 | 760 | 10 | 19.95 | Kit—with larger capacity |
| PB-101 | 940 | 10 | 29.95 | 8 distribution buses, higher capacity |
| PB-102 | 1240 | 12 | 39.95 | Large capacity moderate price |
| PB-103 | 2250 | 24 | 59.95 | Even larger capacity only 2¢ per tie-point |
| PB-104 | 3060 | 32 | 79.95 | Largest capacity lowest price per tie-point |
| PB-203 | 2250 | 24 | 75.00 | Built-in 1% regulated 5V 1A low-ripple power supply |
| PB-203A | 2250 | 24 | 120.00 | As above plus separate +2-amp +15V and -15V internally adjustable regulated power supplies |

See your CSC dealer or call 203-624-3103 (East Coast) or 415-421-8872 (West Coast) 9 AM to 5 PM local time. Major credit cards accepted. Add \$2.50 for shipping and handling in the U.S. and Canada on direct orders of \$50.00 or less; \$3.00 for orders over \$50.00. On all foreign orders add 15% to cover shipping and handling.

CONTINENTAL SPECIALTIES CORPORATION



EASY DOES IT

44 Kendall Street, Box 1942
New Haven, CT 06509 • 203-624-3103 TWX 710-465-1227
West Coast office: Box 7809, San Francisco, CA
94119 • 415-421-8872 TWX: 910-372-7992

Canada: Len Finkler Ltd; Ontario
Mexico: ELPRO, S.A., Mexico City, 5-23-30-04

© 1976 Continental Specialties Corp.
Prices and specifications subject to change without notice.

CIRCLE 41 ON FREE INFORMATION CARD

FREE EICO CATALOG

358 Ways To Save On Instruments, CB, Burglar Alarms, Automotive & Hobby Electronics!

The more you know about electronics, the more you'll appreciate EICO. Every EICO product is designed to provide you with the most pleasure and quality performance for your money. The fact that more than 3 million EICO products are in use attests to their quality and performance.

"BUILD-IT-YOURSELF" and save up to 50% with our famous electronic kits.

For the latest EICO Catalog and name of nearest EICO Distributor, check reader service card or send 50¢ for fast first class mail service.

EICO—283 Malta Street, Brooklyn, N.Y. 11207

Leadership in creative
electronics since 1945.



CIRCLE 59 ON FREE INFORMATION CARD

SERVICE CLINIC *continued from page 66*

a terminal strip. Now, just hook in one of the solid-state focus rectifiers and away you go. The only thing to watch is clearance from ground so that it won't arc. It also helps to install the new rectifier with the right polarity.

The solid-state rectifiers are used in all solid-state sets and quite a few hybrids. These are made of a great many tiny selenium diodes stacked on one another in a very small tube. It is possible for a number of these diodes to short or develop leakage. If this happens, the focus voltage will go away down although the high voltage will stay up. This gives you the typical symptom of no raster, but great globs of fuzzy color moving around on the screen. You'll probably find the focus voltage down to around 2,000 volts. The globs of color are the objects in the picture, very badly defocused.

One more problem that can be a fooler. If the picture defocuses (loses the scanning lines) *only* in white or highlight areas that gets worse as brightness is raised, this is not a focus problem. It's quite apt to be a very weak picture tube; brightness is apt to be quite low at the same time. For a definite test, read the

focus voltage. (I should have said this before, but focus voltage should always be read with a high-voltage probe, so that you do not load the circuit too much.) Check the picture tube for emission.

Some time ago, while looking for a cheaper way (or trying to get around a patent) another focus circuit showed up. This was pretty simple in theory; a huge voltage-divider was connected right across the high-voltage supply to ground, and tapped off the focus voltage. A good sized variable resistor was included so the focus voltage could be varied. To avoid loading the high voltage supply, these resistors are up into hundreds of megohms; 250–400 megohms is typical with a 15-megohm variable for adjustment. In some, high-value fixed resistors were added below the focus control, with instructions to jumper across them if the focus voltage couldn't be set high or low enough. If this circuit is "designed in", OK; however, I wouldn't recommend doing this in cases where you can't get the focus voltage right. The divider is almost sure to be defective if the high voltage is correct. Figure 2 shows this.

The first of these were made up of small resistors in series. (One friend assured me with a straight face that they contained 27 million 470-ohm resistors

RCA's SK line—Top of the Line in quality— is getting bigger, and bigger, and bigger!

The quality line keeps growing — RCA's comprehensive line of replacement transistors, rectifiers, thyristors and integrated circuits is now growing at the rate of 20 new SKs every month. That means there will be around 580 RCA types available by the end of the year — bringing the total of domestic or foreign semiconductors that can be replaced by a high quality RCA SK to over 130,000.

Get your 1977 Replacement Guide Supplements — As the new SKs become available, we'll issue monthly supplements to your Replacement Guide. New applications will cover consumer, TV, Hi-Fi, CB and industrial (power control). RCA Distributors will be able to offer you more selective performance and price choice. Call-backs are all but eliminated because every RCA SK is manufactured to the original OEM quality.

Stay up-to-date. See your RCA Distributor about the new SKs and Supplements. If you don't have the 1977 SK Replacement Guide, ask him for a copy, or write, enclosing \$1.50 (check or money order) to: RCA Distributor and Special Products Division, PO Box 85, Rummel, NJ 08078.

RCA

SK Replacement
Semiconductors



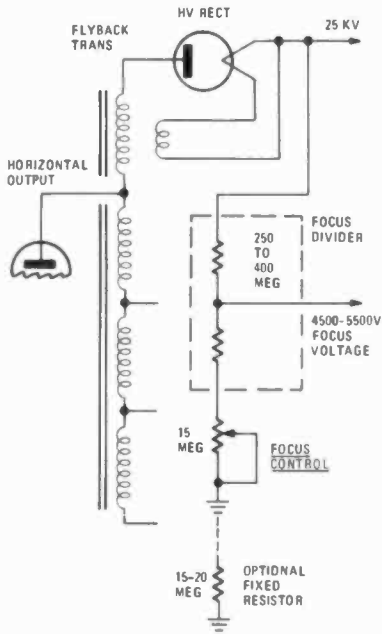

FIG 2

in series.) If some of these break down and burn, the total resistance of the divider changes and away goes your focus voltage. It may be high or low depending on where the fault is in the divider. Replacement is always best. If you add fixed resistors to get the focus right, you're just asking for a callback;

that divider will continue going farther off value.

How much focus?

One reader had a problem in the focus circuit. He had about 20 kV of high voltage, and the focus read about 1.5 kV. (His was a small set using a 10VABP22 picture tube.) For some reason the focus voltage was not given on the schematic; it used a divider and was marked "Do Not Measure." This is nonsense since it can always be read with a high-voltage probe, just like the high voltage. Anyhow, the 10VABP22 tube spec's showed 20 kV for typical operation, with focus voltage between 3200 and 4300 volts. So, this one was easy; didn't even have to wipe off the crystal ball. I recommended replacing the focus divider resistor. If you run into a similar situation, with an unfamiliar picture tube, check the spec's in the book to make sure.

Intermittent focus

The focus circuit is normally considered a "dry circuit"—no current flow. There is a very small current in the 66-megohm resistor used in the older circuit, and a small current through the focus divider. However, the picture tube's focus electrode acts like a grid—

continued on page 74

MATHEMATICS ELECTRONICS ENGINEERING MATHEMATICS ADVANCED MATHEMATICS

These unusual courses are the result of many years of study and thought by the President of Indiana Home Study, who has personally lectured in the classroom to thousands of men, from all walks of life, on mathematics, and electrical and electronic engineering.

You will have to see the lessons to appreciate them!

NOW you can master mathematics and electronics and actually enjoy doing it!

WE ARE THIS SURE:—you order your lessons on a money-back guarantee.

In plain language, if you aren't satisfied you don't pay, and there are no strings attached.

Write today for more information and your outline of courses.

You have nothing to lose, and everything to gain!

**The INDIANA
HOME STUDY INSTITUTE**

P.O. BOX 1189

PANAMA CITY, FLA 32401

C RCLE 18 ON FREE INFORMATION CARD

If you can't go to college for your career in electronics —read this!

CREI brings college-level training to you with eight educational advantages, including special arrangements for engineering degrees

The best way to qualify for top positions and top pay in electronics is obviously with college-level training. The person with such training usually steps more quickly into an engineering level position and is paid considerably more than the average technician who has been on the job several years.

A regular college engineering program, however, means several years of full-time resident training—and it often means waiting several years before you *can even start your career*. This, of course, is difficult if you must work full time to support yourself and your family.

If your career in electronics is limited without college-level training, take a look at the advantages a CREI home study program can offer you.

1. Convenient Training

CREI brings the college to you. Through the convenience of home study, you receive exactly the same level of training you will find in any college or university offering programs in electronic engineering technology. With CREI, however, you can “go to college” whenever you have spare time at home or on the job.

2. Specialized Programs

With CREI, you enjoy the advantage of *specialized* training. That is, your program will include only those courses directly applicable to your career in electronics. We omit such courses as English, social studies and other subjects, which are usually required in resident schools. Therefore, with CREI, you move ahead faster to the more interesting and useful part of your training.

3. Practical Engineering

CREI programs give you a *practical engineering* knowledge of electronics. That is, each part of your training is planned for your “use on the job.” By using your training, you reinforce the learning process. And by demonstrating your increased knowledge to your employer, you may qualify for faster career advancement.

4. Engineering Degrees

CREI offers you a number of special arrangements for earning engineering degrees at recognized colleges and universities. You can earn college credit while you are taking your CREI program or apply later, whatever is best for your career plans.

Career Training at Home

5. Unique Laboratory

Only CREI offers you the unique Electronic Design Laboratory Program. This complete college laboratory makes learning advanced electronics easier and it gives you extensive practical experience in many areas of engineering, including design of electronic circuits. No other school offers this unique program. It is a better "Lab" than we have found in many colleges. And the professional equipment included in the program becomes yours to keep and use throughout your professional career.

6. Wide Program Choice

CREI gives you a choice of specialization in 14 areas of electronics. You can select exactly the area of electronics best for your career field. You can specialize in such areas as computer electronics, communications engineering, microwave, CATV, television (broadcast) engineering and many other areas of modern electronics.

7. Prepared by Experts

Experts in industry and technical organizations of government develop CREI programs. Each part of your training is developed by a recognized expert in that area of electronics. That means you get the most up-to-date and practical instruction for your career.

8. Industry Recognition

That CREI training is recognized by industry and government is evident from the fact CREI provides training to advanced technical personnel in over 1,700 technical organizations. Many subsidize the training of their employees with CREI. If there is any question about the advantages of CREI training for you, ask your employer or any engineer to evaluate the outline of a CREI program for you.

Other Advantages

Of course, there are many other advantages to CREI training. For example, throughout your training, CREI's staff gives you personal instruction for each step of your program. And in many industrial areas, both in the U. S. and abroad, CREI Field Service Representatives provide a number of important personal services for your training and your career.

FREE Book

There isn't room here to give you all of the facts about career opportunities in advanced electronics and now CREI prepares you for them. So we invite you to send for our free catalog (if you are qualified). This fully illustrated, 80 page catalog describes in detail the programs, equipment and services of CREI.

Qualifications

You may be eligible to take a CREI college-level program in electronics if you are a high school graduate (or the true equivalent) and have previous training or experience in electronics. Program arrangements are available depending upon whether you have extensive or minimum experience in electronics.



Send for this **FREE Book**
describing your opportunities
and **CREI college-level**
programs in electronics

Mail card or write describing qualifications to

CREI **CAPITOL
RADIO
ENGINEERING
INSTITUTE**

McGraw-Hill Continuing Education Center
3939 Wisconsin Avenue Northwest
Washington, D.C. 20016

Accredited Member National Home Study Council

GI Bill

CREI programs are approved for training of veterans and servicemen under the G.I. Bill.



*** SAVE GAS! SAVE on TUNE-UPS!**
MODERNIZE and Bring Your Car "UP-TO-DATE"
 with the MOST EFFICIENT Ignition ever Invented!



ALLISON
XR-700

* The "XR-700" is a COMPLETELY NEW Ignition System that replaces the inefficient Breaker-Points and Condenser with a highly RELIABLE, Invisible "Infra-red" Light-Beam which CONTROLS the Latest design Solid-State POWER MODULE. This new "Patented" Invention produces the HIGHEST ENERGY, Longest Duration Spark of ANY Ignition System manufactured TODAY!

* CUSTOMERS REPORT: "THE XR-700 MORE THAN PAYS FOR ITSELF ...and KEEPS ON SAVING MONEY with..."

- ★ INCREASED "GAS-MILEAGE" up to 30%!
- ★ ELIMINATING COSTLY "TUNE-UPS!"
- ★ IMPROVED ENGINE PERFORMANCE!
- ★ QUICKER STARTING IN ANY WEATHER!
- ★ FASTER ACCELERATION...SMOOTHER RUNNING!
- ★ PLUGS LAST UP TO 4-TIMES and LONGER!"

* THE XR-700 has NO moving parts to wear out...never needs adjustment! Engineered to DUTLAST Your Car...So RELIABLE... So PERFECTED...that we give you a LIFETIME WARRANTY... "FREE Repair or Replacement" for as long as you OWN the Unit... even if you change Cars, we will supply the necessary Parts FREE.

* FITS ALL ENGINES...Domestic or Foreign...4, 6 or 8-Cylinder
 * EASY INSTALLATION...Completely Factory ASSEMBLED!

Thousands sold at \$59.95

*** NOW...ONLY.. \$39.95** (Cal. Res. add Tax)

THAT'S EVERYTHING... INCLUDING POSTAGE & INSURANCE

* SAVE! ORDER FACTORY DIRECT!
 Send Check or M/O, State Car Make, Year and No. of Cylinders.

* MASTERCARD or BANKAMERICARD Cardholders
 Order by TOLL FREE PHONE (800) 423 6525 Ext. 3

CALL or WRITE for FREE BROCHURE



America's Oldest and Largest Manufacturer
 of Opto-Electronic Ignition Systems. ©

ALLISON AUTOMOTIVE CO.

1267 - BL, East EDNA PL., COVINA, CAL. 91722

CIRCLE 17 ON FREE INFORMATION CARD

SERVICE CLINIC

continued from page 69

all it needs is a high potential to develop the correct field.

You can have intermittents here too, as in any other circuit. The key clue will be defocusing of the scanning lines. Check the focus voltage at the source to see if there is any variation. One possible cause of this is burning of the series resistor used between the focus-voltage source and the picture tube—ballpark value is about 4.7 megohms. There is normally a very small drop across this, mainly due to meter loading. However, if this breaks down and

almost opens up, it can cause problems. This is easy to check, by taking a reading from pin 9 on the picture tube socket to the focus voltage source. If it's high, change it.

Another oddball is intermittent loss of focus, though there is no change in the supply. In one case, this happened at intervals of almost exactly 1.5 seconds. If you run into this, pull the socket off the picture tube and check the focus pin which is usually pin 9. If this shows a light-greenish powdery substance, look out. Check the socket contact and clean it. This is some kind of weird oxide that forms on conductors carrying a high voltage. It is mildly corrosive and will cause a high (and variable) resistance

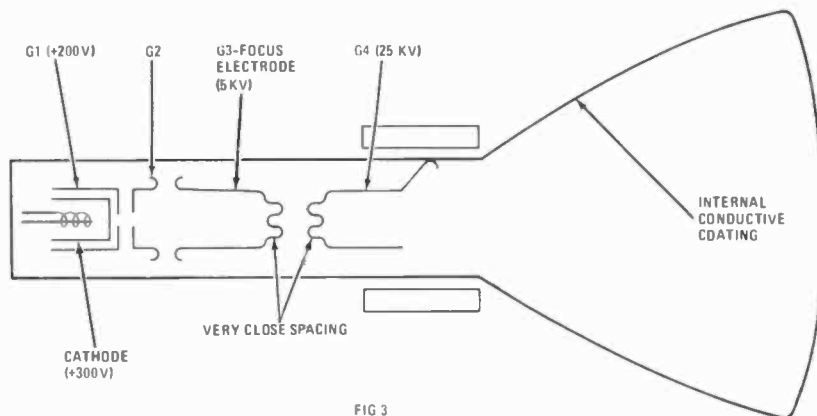

FIG 3

IN WIRE-WRAPPING  HAS THE LINE.....

MODEL WD-30



PATENT PENDING

WIRE DISPENSER

- 50 FT. ROLL OF 30 AWG. KYNAR® WIRE-WRAPPING WIRE
- CUTS THE WIRE TO LENGTH
- STRIPS 1 INCH OF INSULATION

AVAILABLE IN FOUR COLORS

- WD-30-B BLUE WIRE
- WD-30-Y YELLOW WIRE
- WD-30-W WHITE WIRE
- WD-30-R RED WIRE

\$345
EACH

MINIMUM BILLING \$25.00
 ADD SHIPPING CHARGE \$1.00
 NEW YORK STATE RESIDENTS
 ADD APPLICABLE TAX

©KYNAR PENNWALT

OK MACHINE & TOOL CORPORATION

3455 Conner St., Bronx, N.Y. 10475 (212) 991-6600 / Telex 125091

CIRCLE 22 ON FREE INFORMATION CARD

between the socket contact and the base pin. If you can't clean up the socket contact, you should replace the socket. This was the cause of the 1.5-second flashing just referred to, and it has been known to cause other focus problems.

High focus voltage

Speaking of oddballs, some of you may remember a Clinic a while back. It dealt with a case in my own shop. There was intermittent loss of focus, and I read more than 10 kV on the focus on two different voltmeters with high-voltage probes. (The first thing I suspected was my meter.) I wrote this up and asked for ideas on where the double focus voltage was coming from. I got a lot of answers. There were quite a few different solutions, all of them entirely possible.

It turned out that the 66-megohm glass-film resistor was open with definite signs of arcing between 2 or 3 turns of the spiral. However, the same symptom showed up with this resistor completely out, and then with a new resistor. All other parts checked out by substitution. Some time during the proceedings, the trouble disappeared, and after cooking, the set was sent home and is still working.

Later, after the column was published, I discovered something about the construction of color picture tubes that I honestly did not know. (Of course, this takes in a wide area, but I had never had occasion to look it up—found it while looking for something else, as usual.) Figure 3 shows the design of the electron guns in the standard color picture tube. G1 is the control grid, G2 the screen and G3 the focus "grid". I knew what the DC voltages should be on these. Now, here's the one I didn't know. Look at G4, which is very closely spaced to G3. The DC voltage on G4 is 25,000 volts! I was always under the vague impression that the high voltage was applied only to the shadow mask, screen and inner dag coating.

So, here was a very likely explanation of the source of the high voltage on the focus. There was a particle short between G4 and G3; somehow, I accidentally managed to blow it off or knock it loose. Aren't they simple after we find out what happened? Thanks very much to all of the nice guys who wrote in about that.

So there you are. In cases where you seem to have high-voltage problems, always remember to check the focus voltage. You can do it at the same time you're reading the high voltage since you should always use the high-voltage probe anyway.

One more thing. The newer sets using voltage triplers and quadruplers for the high voltage usually pick off the focus voltage from a tap on the tripler. The same tests still apply. R-E

Readers Questions on next page

MEET OUR FAMILY OF ELECTRONIC TEST ACCESSORIES



The 1977 edition of our family album of electronic test accessories (illustrated above) is yours for the asking.

Our new general catalog has grown to 82 pages. It describes and illustrates every one of the 600-plus members of the ITT Pomona Electronics family, including 28 new items that have been added for the first time this year.

You'll find this comprehensive catalog will be your best single source for high quality test accessories in every phase of electronic testing. For your free copy, circle the reader service number listed below, or write:

ITT POMONA ELECTRONICS

1500 East Ninth St., Pomona, Calif. 91766
Telephone (714) 623-3463. TWX: 910-581-3822



CIRCLE 3 ON FREE INFORMATION CARD

LEARN AVIATION ELECTRONICS



**at the School
of Aeronautics,
Florida Institute
of Technology.**

**Prepare for a REAL job in just
2 years and earn a COLLEGE
DEGREE at the same time.**

**FAA publications identify that
by 1977 the AVIATION IN-
DUSTRY will need 230% MORE
AVIONICS TECHNICIANS.**

**Half the costs of airplanes to-
day is in electronics, including
navigation systems . . . in-
struments . . . communica-
tions systems . . . and con-
trol systems.**

**We teach you in our labora-
tories . . . classrooms . . .
and on our aircraft the theory
of radio communications and
how to flight check and repair
all related equipment.**

**Our placement record of grad-
uates is 100%. . . Make
your time and money spent
REWARDED by a job in your
field.**

**The SCHOOL OF AERONAU-
TICS operates one of the larg-
est flight training programs in
the WORLD and we are an
"accredited University".**

**Classes starting September
. . . January . . . June.**

**To learn more about our avia-
tion electronic programs,
check the reader service card
or write direct to:**

**The School of Aeronautics,
Florida Institute of Tech-
nology, P.O. Drawer 1839,
Melbourne, Florida 32901
Att: Director of Admissions**

RADIO-ELECTRONICS

CIRCLE 23 ON FREE INFORMATION CARD

reader questions

IF FAILURE

I'm having trouble keeping an RF-oscillator/IF network in a model 60HPB1 Chevrolet automobile radio. I've changed it three times in two months. Tried different makes, no good. Dealer checked voltage in the car and says it's OK. I've about had it!—C.B., Antigo, WN.

I can see why: this can be highly nonhabit-forming. Frankly, I have no good idea as to the cause, but I suspect that the car's electrical system is causing transients. Could be a dirty slip-ring in the alternator or even a loose connection somewhere. Transistorized circuits dislike any kind of transients.

You might try adding a good sized iron-core hash-choke and a couple of capacitors in the battery lead to the set. This might help hold down the transient voltages. Just for luck, scope the car's DC supply while turning things off and on, running the motor at various speeds, etc. to see.

HORIZONTAL HASH

This RCA KCS-156AA chassis has me stopped. I haven't had much experience yet. I get a loud buzz in the speaker and the horizontal oscillator is very unstable. If I turn the hold control full counterclockwise, I lose the high voltage. I checked things and found that the +170-volt line reads correctly, and there is an AC component at the same frequency as horizontal sweep. The horizontal oscillator won't come to the right frequency and the waveform is distorted. What section of the circuitry should I check now?—V.H., APO, NY.

No more tests needed. You have found the trouble. The presence of a horizontal-frequency signal on the DC supply means that one of the filter capacitors is very, very open. The resulting feedback through the DC power supply is messing up your horizontal oscillator and also causing the buzz in the sound. Replace the filter capacitors.

HORIZONTAL DRIVE LOSS

I keep losing the horizontal drive on this little Sony Micro-TV. The emitter-follower shorts and away we go. However, I can feed external drive to the horizontal output and get high voltage, sweep, etc. The emitter-follower transistor is marked 2D65 on the schematic. Can't find an exact duplicate that will work. Is there something that I might have overlooked?—G.P., Boca Raton, FL.

Doesn't look as if you missed much of anything. However, there is some confusion in the schematic. The transistor marked Horizontal Drive is connected

FREE

 burglar —
fire
alarm catalog

**over 900
systems,
detectors,
controls,
sounders,
tools, locks,
supplies**

TO PROTECT HOMES, BUSINESSES, INDUSTRY

Huge selection of hard-to-find security equipment from stock. 64 fact-filled pages loaded with 100's of highest quality professional alarm products, technical notes, diagrams.

ONE-STOP SUPERMARKET SELECTION INCLUDES:

ultrasonics, radar, infrared, undercarpet mats, magnetic contacts, smoke & heat detectors; Controls; Alarms; bells, sirens, phone dialers, lights, guard panels. Large selection of tools, relays, wire, holdup alarms, books. Fills need for industry, alarm cos., businesses, homes, institutions. Order your copy today. (Outside U.S. send \$1.00.)



mountain west alarm
4215 n. 16th st.
phoenix, az. 85016
(602) 263-8831

CIRCLE 9 ON FREE INFORMATION CARD

CONFUSED BY ELECTRONIC IGNITION CLAIMS ?

The
**PROOF is in
PERFORMANCE!**



Amazing MEGASPARK, the advanced-design Opto-Electronic Breakerless Ignition System, FITS ANY CAR! Replaces points and condenser — gives longer spark plug life. Increases performance, mileage and driving satisfaction while cutting fuel and maintenance costs dramatically. Learn the facts and don't settle for less than the best. Models from \$29.50 to \$64.50

The only unit that gives you all these features:

- LIFETIME WARRANTY
- DIFFERENTIAL AMPLIFIER CIRCUITRY
- FULL INTERNAL VOLTAGE REGULATION
- AUTOMATIC OVERCURRENT PROTECTION

Rush name and address for FREE information package including catalog and discount offer. Or call toll-free 24-hours 800-648-4711, Ext. 22.

MEGASPARK™

by



Ignition Systems Inc.

2547 8th Street
Berkeley, CA 94710
(415) 845-3584

CIRCLE 15 ON FREE INFORMATION CARD

as a diode. The DC voltages (0.2 volt) from base-to-emitter indicate that this one should be a germanium type. The number probably should be 2SD65. Try a new one here; if this is bad it could be killing your emitter followers.

(Feedback: "Bingo. Actually, I took the audio driver transistor, which is a 2SD64, tried it and the thing works fine. Subbed G-E-59 for the audio transistor, and it works too.")

AFC DIODES ACTING UP

Here's one for your dog files. An Electrohome C-7 came in with the classic symptoms of AFC trouble. So I checked the AFC diodes. Fine. Checked all the other parts, comparison pulse, sync, etc, no dice. Came coffee time and I pulled the cheater cord. My VTVM was still hooked to the AFC grid of the horizontal oscillator.

When the cord was pulled, the voltage should have dropped to zero. Instead, it went to 4 volts and stayed there. Coffee postponed; sat there and scratched my head. It finally dawned on me. It had to be those diodes. I clipped each one and checked. The voltage on the AFC grid disappeared but one of the diodes read 4 volts. It was acting like a battery! A new AFC diode unit fixed the set. I wonder if things like this could be behind some of those horizontal dogs that we run into? I have since seen one other AFC diode unit, of a well-known make, do the same thing.

Thanks to Ed Pugh, of Grenfell, Saskatchewan, Canada, for this wild, weird one.

HIGH-VOLTAGE PROBLEM

I've had a Heath IO-104 scope since 1974. The problem is repeated failures in the +1400-volt supply. The rectifier diodes and the filter capacitors short out. These have been replaced several times with the same results. Please help.—A.E.B., Palma de Mallorca, Spain.

The answer to this kind of problem would be a generous dose of *derating*. The diodes can be replaced with something like a color TV solid-state focus rectifier that has a rating of 8000 volts. These are typically rated at 2.0 mA, and the CRT beam current in a scope shouldn't be more than about 250 μ A maximum.

The 1800-volt capacitors used aren't rated high enough. An 1800-volt type used on a 1400-volt supply doesn't leave too much margin; only 400 volts, and this obviously isn't enough. You could put two in series, but I dislike this on general principles. Try something like a 2000- or 2500-volt type. With the low current drain from this supply, the capacitor may not have to be that big. A great many similar power supplies use only 0.05 μ F filter capacitors.

(Feedback: "The scope is now working. Thanks!") **R-E**

Touch and Trigger

Stable, Automatic displays without fiddling

As shown, the PM 3212 has an impressive combination of features that add up to unbeatable all around performance.

25 MHz/2mV, comprehensive triggering, brightness and portability add up to an impressive value at \$ 1155.00 including probes.

And more . . . a sharp display, double insulated power supply, battery option, versatile X-Y operation, Auto, AC, DC, TV, Level Control and Composite Triggering, and the usual Philips plus; a front panel layout based on user efficiency.

Bright display with small spot size through 10 kV CRT. Continuously variable illumination of internal graticule.

Auto triggering provides a baseline in the absence of a signal and derives trigger from pk-pk signal amplitude to insure stable triggering from a variety of signal and gain setting conditions.

DC coupled triggering prevents loss of display under varying duty cycle signals. Vital for digital measurements.

Solid TV triggering at the touch of a button. Automatic line or frame sync down to maximum sensitivity.

Add function for A-B displays with composite triggering on A-B signal to display signals with high offsets.

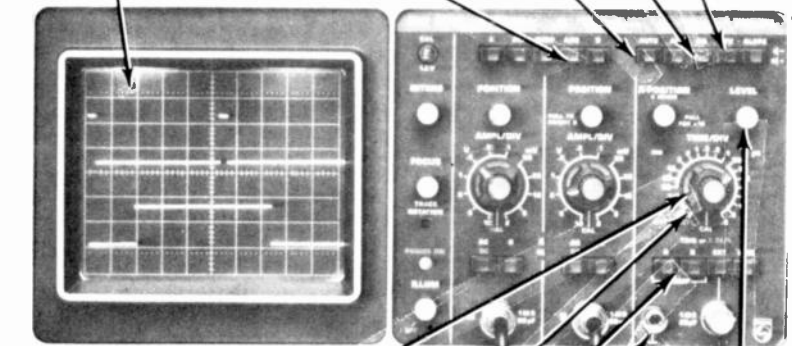

Time base vernier overlaps range settings to avoid double writing of digital signals.

20 nS maximum sweep speed with 10x magnifier.

Separate source triggering and composite for phase and timing measurements on asynchronous signals and no probe switching.

Full level of control of trigger point.

All trigger sources can be used for the horizontal channel for versatile X-Y displays.



PM 3212 priced at \$ 1155.00 includes cover and probes. Pouch shown is optional.

Use our free HOT LINE number 800 631-7172
New Jersey residents, call (201) 529-3800 collect.

Philips Test & Measuring Instruments, Inc.

In the U.S.:
85 McKee Drive
Mahwah, New Jersey 07430
Tel. (201) 529-3800

In Canada:
Ontario, Canada

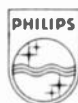

PHILIPS

CIRCLE 78 ON FREE INFORMATION CARD

new products

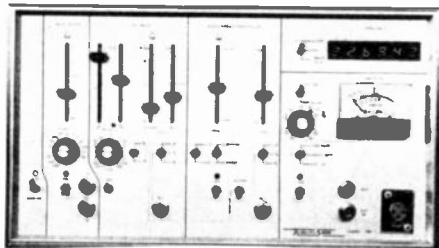

MODEL 101 AUDIO TEST SYSTEM consists of two sine/square/triangle function generators, pulse generator, frequency counter and AC voltmeter. As a system it will generate a frequency response plot on an X-Y recorder or scope.

Time base generator offers symmetrical or independent control of the positive and negative sides of the ramp providing a duty cycle of 1% to 99%. Frequency range is .002 Hz to 100k Hz. Amplitude is 16 Vpp into 500 Ohms with ± 5 VDC offset. The time base output drives the X axis of an X-Y recorder. Manual mode provided for setup.

Audio sweep generator provides manual frequency adjustment or log/linear sweep of 20 Hz to 20k Hz. Blanking mode provides zero reference line on an X-Y recorder or tone burst. Amplitude is 16 Vpp into 500 Ohms or 10 Vpp into 8 Ohms.

Pulse generator frequency range is .002 Hz to 800k Hz. Pulse width is adjusted independent of frequency from 4 seconds to 40 nanoseconds. Outputs are complementary TTL.

AC Voltmeter has full scale sensitivities from 1 mV to 250 V. Fast/slow, peak/true RMS and log/linear modes are provided. Output drives Y axis of X-Y recorder.

Frequency counter is 6 digit, line triggered, and reads either internal or external. Sensitivity is 100 MV peak at 20k Hz. 1/1/2 sec. update. 50/60 Hz.

Dimensions: 8x14x3. Shipping weight: 9 lbs. \$650. Stock to 30 days. Warranty: 1 year, 3-year \$60.

IDENTITY SOUND

1894 Commercenter W #105
San Bernardino, Ca 92408
(714) 889 7823

CIRCLE 20 ON FREE INFORMATION CARD

2 Great New Experimenter's Project Books!

BUILD-IT BOOK OF DIGITAL ELECTRONIC TIMEPIECES



A data-packed guide to building modern timekeeping devices—rugged shipboard clocks, second-splitting digital IC chronometers, decorator digital clocks, a precision timer, a frequency/period meter, a tide and moon clock, automatic alarm setter, etc.—including full-size PC board layouts. Full of projects that bring you lab-quality time measurement—a clock with strobe, scan, and numerous signal output capabilities; control accessories; a flashing-light alarm for the hard-of-hearing; a primary standard of frequency; date, time, & interval capability for your microcomputer; giant displays; multi-city clocks, etc. 295 p., 209 ill.

Paper \$6.95; Hardbound \$9.95 Order No. 905

DISPLAY ELECTRONICS



Contains over 70 projects using arrays and displays, light-emitting diodes, infrared-emitting diodes, photodiodes, liquid crystals, phototransistors, light-activated SCRs, fiber optics, electroluminescence, etc...with detailed instructions on how to build 2-color displays, LED transmitters, receivers, digital counters, electroluminescent panels, AC/DC indicators, photodetectors, oscillators, modulators, voltage-level indicators, IC tester, light-controlled switch, a character generator, an LED VU meter, flashers, burglar alarms, a Xenon strobe light, a microcomputer with binary and octal readouts, and several sophisticated games. 252 p., 195 ill.

Paper \$5.95; Hardbound \$8.95 Order No. 861

SEND NO MONEY! We'll invoice you on 10-DAY FREE TRIAL.

TAB BOOKS DEPT RE-77
BLUE RIDGE SUMMIT, PA. 17214

CIRCLE 8 ON FREE INFORMATION CARD

More information on new products is available from the manufacturers of items identified by a Free Information number. Free Information Card follows page 88.

STEREO RECEIVER, Model AR-1515 has an output of 70 watts, minimum RMS, per channel into 8 ohms with less than 0.08% total harmonic distortion from 20-20,000 Hz. FM sensitivity is 1.8 mV, and selectivity is 100 dB. Hum and noise are 65 dB below full output in the phono mode,



and 80 dB below full output on high level sources. The AR-1515 is \$549.95 in kit form. The unit offers digital frequency readout with AM and FM broadcast frequencies displayed in 1/2-inch LED's.—Heath Co., Dept. 350-07, Benton Harbor, MI 49022

CIRCLE 50 ON FREE INFORMATION CARD

ELECTRONIC MULTIPLE-PLAY MANUAL TURNTABLE, Model 1000 incorporates two motors; a smooth-running 24 pole 300 rpm synchronous motor to drive the turntable, and a second motor to control the cue and change cycle. The turntable stops rotating when cued or in cycle to facilitate reading the record label and provide more precise cueing control. The unit has an optional remote control that duplicates



all of the functions performed by the touch buttons on the unit plate, including cue, pause, reject, and change of records. Other features include electronic speed control using frequency to control speed through a Wien bridge oscillator; the B.I.C. tone-arm system, refined with a new CD-4 position on its anti-skating control; and computer-designed shock mounts \$279.95.—British Industries Co., Westbury, NY 11590

CIRCLE 72 ON FREE INFORMATION CARD

CPU CARD is based on the Z-80 microprocessor. The fastest known available version has a clock rate of 4 MHz. The card is designed as an

easy way for the user to apply the Z-80 IC to his circuitry. The card is plug-compatible with

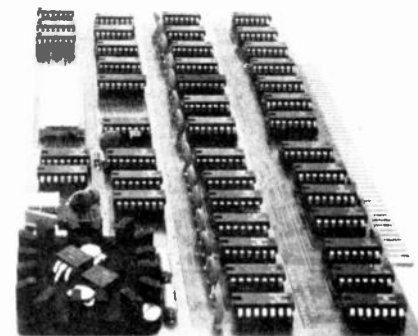

existing microcomputers. Priced at \$295.00 in kit form, or \$395.00 assembled.—Cromemco, 2432 Charleston Rd., Mountain View, CA 94043.

CIRCLE 73 ON FREE INFORMATION CARD

INSTANT CHILLER, Stock No. 1669-30S, contains 30 ounces of this manufacturer's popular minus 62 chilling spray. Priced at only 50¢ more



than the 15-ounce product. Includes a free, 24-inch extension spray nozzle.—Tech Spray, P.O. Box 949, Amarillo, TX 79105.

CIRCLE 74 ON FREE INFORMATION CARD

SWEEP/FUNCTION GENERATOR, model 390. This new 0.2-Hz to 200-kHz instrument is the practical answer to many of the signal-source needs of design labs, schools, audio repair

shops and hobbyists. The *model 390* generates discrete sine, square, and triangle waveforms in either linear or logarithmic sweep with a choice of slow, medium, or fast rates. Has a 50-ohm

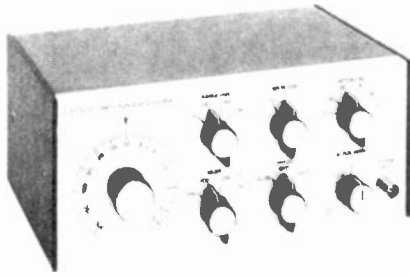

output impedance and complete attenuation controls. Calibrated tuning dial has a 1,000 to 1 range over any one of four frequency ranges. Attenuator: 0 to 62 dB with switching in 10-dB steps and potentiometer vernier. Priced at \$169.95.—Eico Electronic Instrument Co., Inc., 283 Malta St., Brooklyn, NY 11207.

CIRCLE 75 ON FREE INFORMATION CARD

OCTAVE EQUALIZER (stereo). *Model SE-10* has 10 slide controls for each channel, one control for each octave of frequency. The equalizer

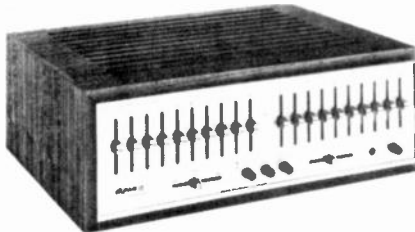

uses eight IC's, 2 FET's, and 5 transistors plus an IC-regulated power supply and offers independent channel gain control from -12 dB to +6 dB. There is a low-impedance (600-ohm) output and 16 operational amplifiers in the four low-frequency sliders of both channels. The kit is \$249.00; assembled, \$349.00. Wood cabinet is optional.—Dynaco, Coles Rd., Box 88, Blackwood, NJ 08012.

CIRCLE 76 ON FREE INFORMATION CARD

CITIZENS BAND RECEIVER TEST SET, model 980. has a fully leveled RF output for selecting the present 40 channels. The large, bright LED readout displays the channels selected. The output attenuator is continuously adjustable from 0.03 microvolt to 20 millivolts, calibrated in

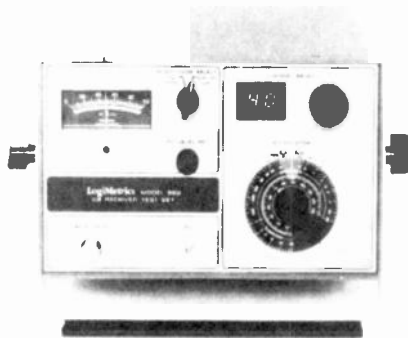

both voltage and dBm, with an accuracy of ± 1 dB. Leakage level from the box is less than 0.1 microvolt. The attenuator has a continuous 5-watt reverse-power handling capability to eliminate damage due to inadvertent transmitter keying. Priced at \$1,195.—LogiMetrics, Inc., 121-03 Dupont St., Plainview, NY 11803.

CIRCLE 77 ON FREE INFORMATION CARD

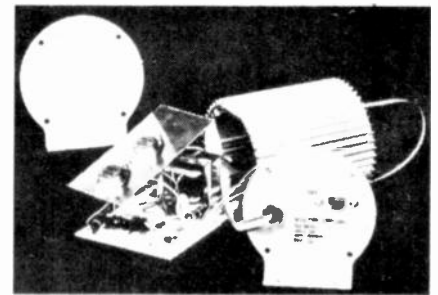

FROM KIT TO CAR IN 80 MINUTES!

Electronic ignition is "in." Update your car with the TOPS in power, efficiency and reliability — the TIGER SST capacitive discharge ignition (CD).

The TIGER delivers everything other CD's promise — and more: quicker starting, more power, more gas mileage, tune-ups eliminated, lifetime plugs and points, reduced repairs and pollution.

The TIGER can be built and installed in your car in 80 minutes. The TIGER is unique!

The TIGER comes with a switch for TIGER or standard ignition for 12V negative ground only.

Simpli-Kit \$21.95
POST PAID U.S.A.

WE ACCEPT:

Mastercharge or BankAmericard.
Send check or money order with order to:

Tri-Star Corporation

DEPT. FF, P.O. Box 1727
Grand Junction, Colorado 81501

CIRCLE 6 ON FREE INFORMATION CARD

Pulse and function generators for today's digital world

Here are two new digital wave-form generators for today's logic designers and digital troubleshooters..

They're ideal for teaching, experimenting, or servicing digital-address TV tuners, binary digital instruments, digital clocks, small computers, calculators, TV games...practically anything digital.

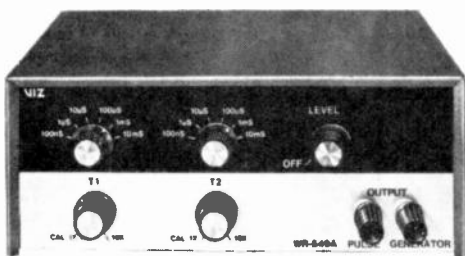

**Pulse generator
WR-549A \$119.00**



**Function generator
WR-550A \$139.00**

- Pulse width adjustable from 100 nsec to 0.1 sec within 5Hz-5MHz range
- Output voltage adjustable from 0-15V at 600Ω, 0-6V at 50Ω
- On and off time independently adjustable
- Sine, sawtooth, and square-wave output 1Hz to 1MHz
- 4Vpp fixed-output for TTL and CMOS
- 10-V adjustable dc offset plus sweep
- Peak-to-peak output 0-20V at 600Ω

See them at your VIZ distributor.

**VIZ Test
Instruments Group
of VIZ Mfg. Co.**

335 E. Price St., Phila., PA 19144

Formerly

Instruments

© VIZ
6642

CIRCLE 42 ON FREE INFORMATION CARD

NMOS MICROCOMPUTER KIT, Educator II, is an 8-bit microcomputer system in kit form. The *Educator II* contains an NMOS 8-bit MPU, PIA, 128 x 8-bit static RAM; two TTL 512 x 4-bit ROM's and a TTL clock circuit. The NMOS components are the HEP versions of the popular M6800 microcomputer products. *Educator II* uses the full instruction set and address modes of the MC6800 MPU. The clock frequency is approximately 625 kHz. An executive program, residing in the ROM's, contains routines for examining and modifying memory locations and MPU registers, servicing interrupts, transferring programs to and from cassette tapes, searching tapes for specific programs and a routine to test the finished kit. The executive uses 14 bytes of RAM for a scratchpad; the remaining 114 bytes are for user programs. An optional 128 x 8-bit RAM can be added to the PC board for larger user

programs. Included with the kit is a comprehensive construction/instruction manual. *Educator*



It retails for \$169.95.—**Motorola Semiconductor Products, Inc.**, Box 20924, Phoenix, AZ 85036
CIRCLE 79 ON FREE INFORMATION CARD

new books

MOS DIGITAL IC's, by George Flynn. Howard W. Sams Co., Inc., 4300 W. 62 St., Indianapolis, IN 46206. 176 pp. 8 1/2 x 5 1/4 in. Softcover \$5.95.

The reader will find a wide range of information about MOS and CMOS devices, from basic construction and theory of operation to circuit applications in MOS Digital IC's. The book deals primarily with specific devices that are available off the shelf from many manufacturers and distributors. A wide cross section of devices is included to provide insight into other IC's that use similar circuits and/or logic.

Beginning with MOS basics, the book continues through CMOS NAND and NOR gates, CMOS and PMOS applications, NMOS devices, and finally into certain complex MOS IC's. Charts and tables of currently available CMOS units are given in five appendices. The book is liberally illustrated with circuits, block diagrams, logic truth tables and diagrams of time sequences.

WIND/SOLAR ENERGY, by Edward M. Noll. Howard W. Sams & Co., Inc., 4300 W. 62 St., Indianapolis, IN 46206. 208 pp. 8 1/4 x 5 1/4 in. Softcover \$7.95.

This book is an introduction to the practical use of sunlight in the construction of solar power supplies and the conversion of wind energy to electricity. Several practical supplies are described in detail. More elaborate yet moderate installations are discussed, and methods of making your house or small business more self-sufficient are described in terms of electrical needs. This book includes an appendix that lists addresses of suppliers and sources of material and information concerning solar power and related subjects. **R-E**

Less Bread, More Box.



New, complete Breadboarding/Interfacing Station.
Only \$241.50!

We took our economy Breadbox IV kit and did a complete design number on it... to add accessories and give you far more hardware for the buck.

For example: It plugs directly into your Altair/Imesai buss without special adapters... Gives you almost 3,000 connections for breadboarding... Power supplies (+5 & +/- 15V) built in... Available in kit or assembled format. All that for just \$241.50 each in kit form.

And to top it off, monitor the buss with LED or 7 segment displays, add an LR-6/K LED indicator outboard - 4 individual LED's with driving circuits (\$10.00 each). And LR-4/K seven segment display outboard with driver/decoder (\$19.00 each).

So bug out to your local computer store now and save substantial bread on this E&L deal. Or write us for the store nearest you.

*Suggested resale price (U.S.A.).
Dealer inquiries invited.

E&L®

E&L INSTRUMENTS, INC.

61 First Street, Derby, Conn. 06418
(203) 735-8774 Telex No. 96 3536

FREE catalog

of over

2000
small tools,
measuring
instruments,
and supplies



National Camera
25
1952-1977
SILVER ANNIVERSARY

National Camera
2000 West Union Ave., Dept. G61
Englewood, Colo., U.S.A. 80110

CIRCLE 19 ON FREE INFORMATION CARD

STEP-BY-STEP

continued from page 59

works fine for about an hour and then the picture falls out or begins to jitter, etc." To speed up locating these parts, try heating and cooling all resistors in the sync circuitry. This will save all that waiting time. No normal part will be affected by this; if heating or cooling any of the resistors causes a change in the picture, change it. You can apply heat by holding the tip of a soldering iron on the body of the part. You can cool them with spray-coolant. Don't get too enthusiastic with the heat on transistors! You can overheat them and cause damage. Just a little heat is enough. Cooling them doesn't seem to do any particular damage. You will often find thermal transistors: which will get hot, then go bad. Some of them will come back when cooled!

Sync clipping

It is possible for the AGC setting to cause sync problems. If there is something wrong in the AGC or video stages, you can clip off the sync instead of the video. Needless to say, this will show up instantly on the scope. In all cases of oddball troubles, be sure to scope the video signal applied to the input of the sync separator. Too many of us overlook this. If you suspect AGC problems, clamp the AGC with a bias box and see if this won't clear up the trouble. **R-E**

CASTLE

THE TUNER PIONEERS

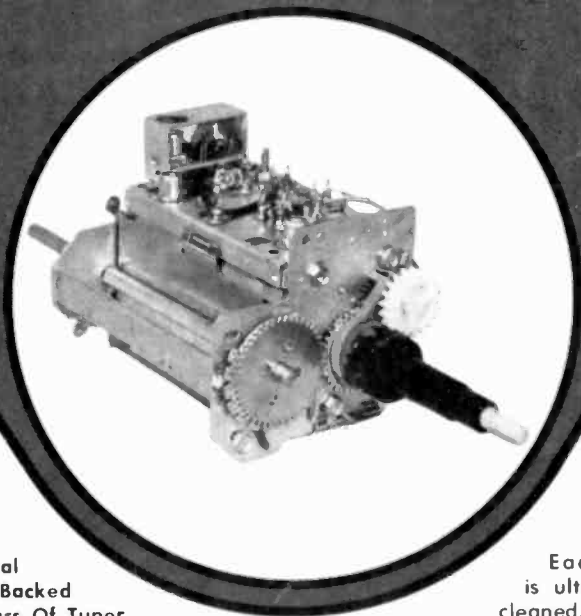

Professional Expertise Backed By 25 Years Of Tuner Service Experience . . .
 Castle has been in the business of repairing TV tuners longer than anyone. When you send your customers' defective tuners to Castle, you can be assured of receiving reliable, quality service.

Each tuner is ultrasonically cleaned. Our technicians analyze the defects, document the repair performed and return the tuner to you in a protective package. Workmanship and parts are backed by a one year limited warranty.



You can build a better organ than you can buy!

A magnificent Schober Electronic Organ

What a marvelous way to put your special talents to work! With our Schober Electronic Organ Kits and your skill, you can build yourself some very special satisfaction, and a lifetime of great music!

Schober Organs are literally far superior to comparably-priced "ready-made" units. You could actually pay twice as much and get no better organ . . . and miss the fun of assembling it yourself. A PC board at a time, component by component, you'll assemble your own "king of instruments." And when you're done, you'll wish there was more to do. And there is! For then, Schober will help you learn to play, even if you've never played a note before!

Schober Organ Kits range from \$650 to \$2850, and you can purchase in sections to spread costs out . . . or have two-year time payments.

Just send the coupon for the fascinating Schober color catalog (or enclose \$1 for a record that lets you hear as well as see Schober quality.)

The Schober Organ Corp., Dept. RE-164
 43 West 61st Street, New York, N.Y. 10023

Please send me Schober Organ Catalog
 Enclosed please find \$1.00 for 12-inch L.P. record of Schober Organ music

NAME _____
 ADDRESS _____
 CITY _____ STATE _____ ZIP _____

CIRCLE 39 ON FREE INFORMATION CARD

Consider Castle's Services

**TUNER REPAIR
 \$12.95**

Any make or model. Tubes and transistors extra. Send defective tuners directly to Castle. Remove all accessories.

U/V COMBO... \$20.95

**CASTLE REPLACEMENT TUNERS
 \$17.95**

In-stock replacement tuners, engineered by Castle for a wide variety of makes and models, provide original or improved performance. Purchase outright—no exchange required.

**TUNER EXCHANGE/REBUILDING
 VHF \$21.95 UHF \$17.95**

When the original tuner is unfit for repair and a stock replacement is not available, the tuner can be exchanged for an exact replacement, rebuilt to original specifications, or tailored to a custom order.

All prices are f.a.b. our plant.



CASTLE TUNER SERVICE

CHICAGO, IL 60645
 5744 North Western Avenue
 Phone 312-728-1800

SAN JOSE, CA 95112
 466 Reynolds Circle
 Phone 408-289-1117

CIRCLE 55 ON FREE INFORMATION CARD

Put Professional Knowledge and a
COLLEGE DEGREE
in your Electronics Career through
HOME STUDY

Earn Your DEGREE

by correspondence, while continuing your present job. No commuting to class. Study at your own pace. Learn from complete and explicit lesson materials, with additional assistance from our home-study instructors. Advance as fast as you wish, but take all the time you need to master each topic. Profit from, and enjoy, the advantages of directed but self-paced home study.

The Grantham electronics degree program begins with basics, leads first to the A.S.E.T. degree, and then to the B.S.E.E. degree. Our *free* bulletin gives complete details of the program itself, the degrees awarded, the requirements for each degree, and how to enroll. Write for *Bulletin R-77*.

Grantham College of Engineering
2000 Stoner Avenue
P. O. Box 25992
Los Angeles, CA 90025

Worldwide Career Training thru Home Study

DIGITAL MULTIMETER
continued from page 55

expected. For example, the output voltage of a regulated power supply is specified to be 15 volts plus or minus 0.5% (75 millivolts). On inspection, with a DMM, the voltage is found to be low; 14.90 volts. Here is a case for concern if circuits powered by this supply are not meeting specifications.

However, it is well to do a little thinking before immediately repairing or adjusting the supply. First, is the problem the circuit is showing likely to be caused by a power supply 25 millivolts below spec.? The likelihood is not. Therefore, the real problem must be determined first. Once the major problem is discovered and repaired, all specifications can be checked. If all specs are fine, it may be that readjusting the power supply to its correct voltage will do no more than throw off the calibration. The product may well have been initially calibrated and adjusted with the low power supply.

The caution being implied in both examples above may be stated as "Don't overuse your DMM!" DMM's are like calculators in this respect. Most of the electronics we work with is designed about ten per cent tolerances. When needed, the DMM has high accuracy and resolution, but when it is not needed, learn to disregard it.

Peaking and zeroing are two adjustments common to electronic circuits, especially those employing tuned circuits. Peaking or zeroing with a digital instrument is not easy. The analog meter gives a very good idea of trend. On the other hand, to use a digital meter for this purpose the mind must act

somewhat like a digital computer. First, it must take one reading, then a second. Second, it must compare the two readings and determine which of the two is the larger. Then and only then can one know if the adjustment is in the right direction.

Often the resolution of the DMM shows the strangest things. Some of these are good, and some bad. The DMM with one millivolt resolution easily shows voltage drops across a printed circuit foil. Perhaps this voltage drop is the culprit. Then again, perhaps the circuit will completely ignore this minute voltage, and so should you. As noted before, the DMM often exposes variations in semiconductor components with temperature. Unless the circuits being analyzed are extremely critical in nature, few if any problems occur from this source.

Circuit loading becomes much more noticeable when the DMM is used. A DMM with 10 megohms input impedance will load a 50-kilohm circuit by 0.5%, unnoticeable on the analog voltmeter, but a sizable change with 0.05% resolution.

AC measurements are especially susceptible to erroneous readings. Frequently, the accuracy of the AC measurement is an order of magnitude (factor of ten) less than the resolution of the instrument. For instance, a reading may be taken to the nearest 10 millivolts; however, the accuracy may be only 100 millivolts. As noted in specifications, the total harmonic distortion of the sinusoidal signal being measured must be low to insure the rated accuracy. Remember, the eye can just notice distortion of 3% or more on an oscilloscope, so don't be fooled by a clean-looking sine wave. **R-E**



Clever Kleps

Test probes designed by your needs—Push to seize, push to release (all Kleps spring loaded).

- Kleps 10.** Boathook clamp grips wires, lugs, terminals. Accepts banana plug or bare wire lead. 4 3/4" long. \$1.39
 - Kleps 20.** Same, but 7" long. \$1.49
 - Kleps 30.** Completely flexible. Forked-tongue gripper. Accepts banana plug or bare lead. 6" long. \$1.79
 - Kleps 40.** Completely flexible. 3-segment automatic collet firmly grips wire ends, PC-board terminals, connector pins. Accepts banana plug or plain wire. 6 1/4" long. \$2.59
 - Kleps 1.** Economy Kleps for light line work (not lab quality). Meshing claws. 4 1/2" long. \$.99
 - Pruf 10.** Versatile test prod. Solder connection. Molded phenolic. Doubles as scribing tool. "Bunch" pin fits banana jack. Phone tip. 5 1/2" long. \$.89
- All in red or black - specify. (Add 50¢ postage and handling). Write for complete catalog of - test probes, plugs, sockets, connectors, earphones, headsets, miniature components.

Available through your local distributor, or write to:
RYE INDUSTRIES INC.
133 Spencer Place, Mamaroneck, N.Y. 10543

In Canada: Rye Industries (Canada) Ltd.
CIRCLE 37 ON FREE INFORMATION CARD

FOR HOME AND INDUSTRY PRODUCTS

WORLD'S MOST PRACTICAL SOLDER HANDLING TOOLS

SOLDERING + DESOLDERING + RESOLDERING =

SOLDER Ability ELEMENTARY TO ELITE

ESPECIALLY DESIGNED FOR YOU!

ADJUSTABLE VACUUM STROKE

US140

UNIVERSAL SOLDAPULL®

DESOLDERING TOOL

Compact tool for convenient tool box storage. Precision molded plastic barrel and low-mass plunger creates rapid vacuum impulse with negligible recoil. Three position plunger adjusts loading span to fit large or small hands. Ample vacuum for most circuit board desoldering requirements.

contact your local DISTRIBUTOR inquiries invited

Covered by U.S. and Foreign Patents and Pending Applications

FEATURE FOR FEATURE - A LOT OF TOOL FOR THE MONEY!

EDSYX 144 PAGE TRAINING MANUAL NEW! OVER 1,000 ILLUSTRATIONS FANOVISION

15200 ARMINSTER ST., VAN NUYS, CALIF. 91410
24 HR. PHONE SERVICE (714) 339-2224, L.A. (213) 777-9115
CABLE: EDDYVEX VAN TELEX: 65-1489

CIRCLE 21 ON FREE INFORMATION CARD

WORKBENCH ACCESSORIES

continued from page 57

Subminiature connections and solder bridges can be seen easily with a magnifying lens. Some fit on eyeglasses; some fit like an eyeshade; some are hand held and some will attach to the connectors.

Putting it all together

By this time it should be obvious that the one great advantage of this system is versatility. There is no end to the odds and ends of pieces you will find to add to the system. There is no limit to the different ways you will discover to put them together. Figure 7 shows a PC board holder made from an old test-tube clamp. It will also hold a small chassis or other similar part—even a pencil soldering iron.

Figure 8 shows an involved but not useless set-up. The PC board is held firmly while the tweezers hold a wire or part to be soldered. The magnifying glass lets you really see what's going on and the mirror provides an unobstructed view of the reverse side. All this and you still have two hands to do the work!

That's just how easy and useful this system is. Pick up some parts and assemble the holders and viewers you need. Stop calling on wife, children and friends only to hassle them because they don't hold things in the right place and motionless. Be independent: Hold your own! R-E



HIGH BLOOD PRESSURE. Treat it...and live.

The National High Blood Pressure Education Program,
U.S. Department of Health, Education, and Welfare.

SYSTEM 5000

The New Programmable Clock Kit from Digital Concepts. \$29.95

SYSTEM 5000 is the programmable clock kit that makes it building a new experience. The system has been designed to meet a variety of particular requirements and tastes, and programming techniques are used to create a truly innovative timepiece. Numerous functions and features are provided for maximum flexibility and adaptability, and any or all can be used to construct many different types of time keeping and timing devices.

SYSTEM 5000 is not a simple LED time of day clock, but a full feature digital timing system. Programming is accomplished by connecting the appropriate jumpers and switches to produce the desired system configuration. Complete assembly and programming manuals are included.

SYSTEM 5000 has a fluorescent readout panel with four 0.5 numerals that brighten and dim automatically according to the ambient light. This unique digital display provides optimum readability at all times from almost any viewing angle.

SYSTEM 5000 can be built as a desk clock, alarm clock, calendar clock or all of these in one full feature timepiece. The Duplicate Time Register can monitor elapsed time or another Time Zone such as GMT. A ten minute "10" reminder capability is included for Radio Station use. A quartz time base is available for high precision stability and uninterrupted operation of the AC time standard. SYSTEM 5000 can automatically control AC or DC accessories up



to 700 Watts by adding the optional relay. Plug-in readout or stereo to construct a full function clock radio that puts you to sleep with gentle music and wakes you to music, a tone, or both. The system will also control TV's, small appliances, or other accessories. SYSTEM 5000 can be used to construct timers for a variety of applications. It is ideal for automatic process timers and controllers in laboratories, workshops, and engineering facilities. SYSTEM 5000 includes all components, speaker, tape time setting switches, and comprehensive instruction and programming manuals. Case B switches for programming additional functions are not included but available as options. \$29.95

FEATURES AND SPECIFICATIONS

Timekeeping Functions

- Time of Day Register
- Duplicate Time Register
- True 24 Hour Alarm
- Duplicate 24 Hour Alarm
- 10 Minute Snooze on Alarms
- True Four Year Calendar
- One Hour Dwell Counter

Display

- Bright 1/2 Digit Fluorescent Panel
- Automatic Brightness Circuit
- 12 or 24 Hour Display Format
- PM/AM Power Failure Indication
- 1 Hr. Accuracy Indicator
- Power On Clear
- Direct Drive Eliminates All RF!

General

- Forward or Reverse Time Setting
- Repeat and Count Interval Controls
- Seconds Display
- Single 9 Volt Battery Pack-up
- 700 Watt Relay (Optional)
- 50 or 60 Hz, 11 Vac, 1 Watt
- 1.5" H x 4" W x 4" D

RELAY OPTION — \$4.00

Includes 700 watt relay and all interface components. Will control AC or DC accessories such as appliances, stereos, etc.

QUARTZ TIME BASE OPTION — \$6.95

Generates precise 60 Hz. buffered output with exceptional stability, reliability, and accuracy. Direct interface to SYSTEM 5000 and most other clocks. Includes Quartz Crystal, IC Driver, trimmer, compact G-10 board of necessary components, instructions, and installation directions.

SWITCH OPTION — \$3.75

Contains 4 stack SPST push buttons, 2 stack DPDT push buttons and 2 stack SPST slide switches. Program all main features.

CASE OPTION — \$11.00

This deluxe, hand finished solid walnut 13.8" x 16.5" cabinet forms an ideal housing for the completed system. Includes an alarm and standard blue faceplate, extra faceplate, ruler or gage and \$1.00 on cabinet dimensions. 5"1/2" x 6" x 1-3/4"



See details, first of many, more 100% for fast delivery. Add \$5.00 not incl. to cover shipping and insurance. 722



ORDER THIS EXCITING KIT TODAY AND PUT ELECTRONIC TIMEKEEPING TO WORK FOR YOU!

digital concepts

Digital Concepts Corporation • 247 Route 46
Saddle Brook, New Jersey 07662 • (201) 845-7101

CIRCLE 58 ON FREE INFORMATION CARD



UNIVERSAL TEST RIG

DOES IT
ALL

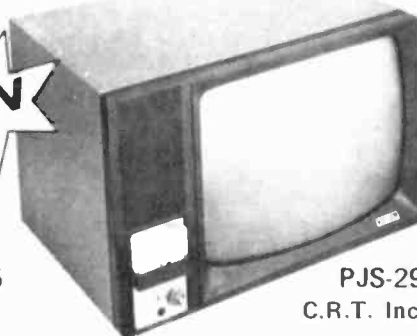

\$229.95

PJS-298
C.R.T. Included

- 33KV Leaded Glass CRT
- 40KV Meter
- Build-In Speaker
- Obsolete-Proof

The PJS-298 Universal Test Rig for tube and Solid State TVs designed for servicing high voltage chassis. Built-in speaker for convenient audio checking, 40KV-50Ua sensitivity meter constant monitoring of the anode voltage. Up-dating is accomplished by means of plug-in modules. (Extension cables included).

FOR FAST TROUBLE SHOOTING

"FERRET" TV MINI-ANALYZER



\$99.95
SG-785

- VHF/UHF Subber
- I.F. - Video Trouble Shooter
- Convergence Generator
- Dots and Cross-Hatch Patterns

The "FERRET" is a multi-functional instrument for fast, efficient trouble-shooting and adjustment of all Color and B&W tvs. It is ideal for both shop and field work. (Cables included.)

Telematic 2849 Fulton St., Brooklyn, N.Y. 11207

CIRCLE 51 ON FREE INFORMATION CARD

THE PAIA 8700 COMPUTER/CONTROLLER

An exceptional price on an applications oriented 6503 based micro-processor system

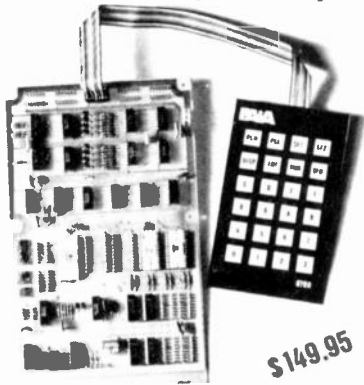

\$149.95

THE IDEAL, LOW COST SOLUTION TO IMPLEMENTING THOSE WILD COMPUTER BASED CONTROL SYSTEMS YOU'VE BEEN DREAMING OF!

PAIA software currently available or under development includes: Music synthesizer interface; Home applications package including: multi-zone fire/burglar alarm, real time clock, energy saving heat/air conditioning control, computer generated "door-bell"; Model road road controller and more.

8700 COMPUTER/CONTROLLER KIT \$149.95
(requires 5v. @ 1.2A.; 12v. @ 150 ma.)

Shipped direct from PAIA (add \$3.00 postage)

Also available at FULL LINE computer stores

DETAILS IN OUR FREE CATALOG

PAIA • DEPT. 7-R • 1020 W. Wilshire Blvd. • Oklahoma City, OK 73116

CIRCLE 10 ON FREE INFORMATION CARD

R-E TESTS FISHER RS-1080

continued from page 52

TABLE III

RADIO-ELECTRONICS PRODUCT TEST REPORT

Manufacturer: Fisher

Model: RS-1080

OVERALL PRODUCT ANALYSIS

| | |
|-------------------------|-----------|
| Retail Price | \$899.95 |
| Price Category | High |
| Price/Performance Ratio | Very good |
| Styling and Appearance | Excellent |
| Sound Quality | Excellent |
| Mechanical Performance | Very good |

Comments: In designing and marketing a high-powered receiver, Fisher did not concentrate solely on audio power, but created a well-balanced full-featured receiver that, in many ways, rivals the performance obtainable from separate components costing considerably more. The unusual circuit driving the separate multipath meter more effectively minimizes multipath interference through careful orientation of one's outdoor FM antenna than do dual-purpose meters or even those extra scope output jacks intended for connection to a separate oscilloscope. Built-in Dolby decoding (including the correct 25 μ s de-emphasis characteristic) adds to the value of the receiver, particularly if there are such programs broadcast in your listening area. The extra bass-boost control, with its variable center frequencies of 45 Hz and 80 Hz, helps enormously in bringing out that last octave of bass from speakers that could not be improved using a conventional bass-boost control without disturbing upper-bass and lower mid-tones.

Our sole criticism of measured performance was of factory settings of the stereo threshold and the muting threshold, both of which, we later learned, were not set within manufacturer's limits (but easily could have been). We would hope that ours was the rare case rather than typical.

The RS-1080 has more than enough power output for driving even the most inefficient loudspeaker system. Sound from records was particularly good, with musical transients coming through uncolored and with little apparent distortion. The front panel is engineered for easy use, despite the many control features provided—a good job of human engineering. Of course, any receiver of this power output had to be big—so big that shelf-mounting it would be impractical unless you own shelves that are over 18" deep, and capable of supporting its 65-pound weight.

EIGHT INSTRUMENTS IN ONE

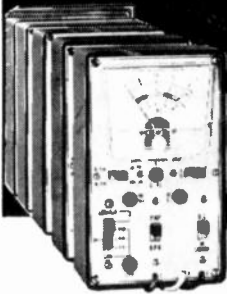

- Out-of-Circuit Transistor Analyzer
- Dynamic In-Circuit Transistor & Radio Tester
- Signal Generator
- Signal Tracer • Voltmeter
- Milliammeter
- Battery Tester
- Diode Checker

Transistor Analyzer Model 212

Factory Wired & Tested—\$28.84
Easy-to-Assemble Kit—\$19.21

YOU DON'T NEED A BENCH FULL OF EQUIPMENT TO TEST TRANSISTOR RADIOS! All the facilities you need to check the transistors themselves — and the radios or other circuits in which they are used — have been ingeniously engineered into the compact, 6-inch high case of the Model 212. It's the transistor radio troubleshooter with all the features found only in more expensive units. Find defective transistors and circuit troubles speedily with a single, streamlined instrument instead of an elaborate hook-up.

Features:

Checks all transistor types — high or low power. Checks DC current gain (beta) to 200 in 3 ranges. Checks leakage. Universal test socket accepts different base configurations. Identifies unknown transistors as NPN or PNP.

Dynamic test for all transistors as signal amplifiers (oscillator check), in or out of circuit. Develops test signal for AF, IF, or RF circuits. Signal traces all circuits. Checks condition of diodes. Measures battery or other transistor-circuit power-supply voltages on 12-volt scale. No external power source needed. Measures circuit drain or other DC currents to 80 milliamperes. Supplied with three external leads for in-circuit testing and a pair of test leads for measuring voltage and current. Comes complete with instruction manual and transistor listing.

EMC, 625 Broadway, New York 12, N. Y.

Send me FREE catalog of the complete value-packed EMC line, and name of local distributor.

NAME _____ RE-7

ADDRESS _____

CITY _____ ZONE _____ STATE _____

EMC

ELECTRONIC MEASUREMENTS CORP.
625 Broadway, New York, N. Y. 10012



LBO-505 5" SOLID STATE, DUAL TRACE, DUAL CHANNEL OSCILLOSCOPE

Here's the one scope that is useful for every servicing need... and has laboratory grade performance and accuracy to see you through the toughest jobs! One look at the host of Leader-developed features will prove its value again and again: Triggered and automatic sweep — AC or DC coupling on each channel — DC to 15MHz bandwidth with 4cm deflection — 10mVp-p/cm vertical sensitivity

LEADER AVAILABLE AT

**ADVANCE
ELECTRONICS**

54 West 45 Street, New York, N. Y. 10036 212-687-2224

CIRCLE 46 ON FREE INFORMATION CARD

next month

AUGUST 1977

■ Videocube

It's an RF modulator that interfaces a video game or microcomputer directly to the antenna terminals of your TV set. This easy to build device meets FCC type acceptance specifications.

■ Build The Ultimate Digital Clock

This one includes a countdown timer, alarm, date and time, with a simultaneous readout of all four functions. The timer can easily be interfaced to a relay for controlling appliances.

PLUS:

Repairing Antique Radios

Build An Inexpensive Logic Probe

Jack Darr's Service Clinic



INTERNATIONAL FM 2400CH

FREQUENCY METER for testing mobile transmitters and receivers



- Tests Predetermined Frequencies 25 to 1000 MHz
- Extended Range Covers 950 MHz Band
- Pin Diode Attenuator for Full Range Coverage as Signal Generator
- Measures FM Deviation

The FM-2400CH provides an accurate frequency standard for testing and adjustment of mobile transmitters and receivers at predetermined frequencies.

The FM-2400CH with its extended range covers 25 to 1000 MHz. The frequencies can be those of the radio frequency channels of operation and/or the intermediate frequencies of the receiver between 5 MHz and 40 MHz.

Frequency Stability: $\pm .0005\%$ from $+50^{\circ}$ to $+104^{\circ}$ F.

Frequency stability with built-in thermometer and temperature corrected charts: $\pm .00025\%$ from $+25^{\circ}$ to $+125^{\circ}$ (.000125% special 450 MHz crystals available).

Self-contained in small portable case. Complete solid state circuitry. Rechargeable batteries.

FM-2400CH (meter only)\$595.00
 RF crystals (with temperature correction) ... 24.00 ea.
 RF crystals (less temperature correction) 18.00 ea.
 IF crystalscatalog price

PRINTED CIRCUIT KITS MAKE CARDS QUICKLY



ONLY Vector kits contain:

- Positive photo-resist coated AND uncoated copper laminate—no messy photo-reversal—no spraying, dipping, or baking.
- 4 types of art aids: rub transfers, ink, tape, cut and peel—use 1 or all.
- 1:1 circuit art rub transfers—IC sets, pads, lines, connectors, symbols, letters, and numbers.
- Everything included—just add water and sunlamp or bright sunshine.
- Liquid etchant and developer—no dry chemical mixing problems. AND
- Process choices—make circuit on copper and etch for 1 card. Make circuit on film, expose, develop and etch for 1 or many cards.



+ mylar film + sunlamp + developer & etchant = 1 or many PC's
 + card + etchant = 1PC

32XA-1 kit makes 7 PC cards, \$28.00, 32X-1 starter kit makes 2 cards, \$11.50

Vector Electronic Co., 12460 Gladstone Av., Sylmar, CA 91342
 Visit us at NEPCON Booth 6062.

510177

CIRCLE 62 ON FREE INFORMATION CARD



International Crystal Manufacturing Company, Inc.
 10 North Lee Oklahoma City Oklahoma 73102

CIRCLE 40 ON FREE INFORMATION CARD

Olson[®] ELECTRONIC PARTS AND ACCESSORIES



\$1 Ea.
BA-341
NICKEL CADMIUM
"AA" Pen-Lite Cells
• Rechargeable

Ideal for radios, calculators, etc. 1.2 Volt.

| | REG. | SALE |
|--|-------|------|
| 60 Min. Cassette, Pkg. of 3, TA-879 . . . | 1.49 | .87 |
| ZV. RED I.E.D., Pkg. of 5, PL-233 | 1.99 | .59 |
| 40 Min. 8-Track Tape, TA-907 | .69 | .39 |
| Elect. Cap. Kit, 50 Asst., CO-407 | 5.00 | 1.70 |
| Black Light Bulb, XM-291 | 1.00 | .49 |
| CB Converter for Car, CB-417 | 14.99 | 9.99 |
| Resistors 1/2-1 watt, Pkg. 100, RR-077 . . | 1.79 | .79 |
| Volume Controls, 12 Asstd. VC-274 . . . | 1.00 | .49 |
| Empire 999 Mag. Phono Cart. PC-188 . . | 9.99 | 6.99 |
| 3-6V DC Hobby Motors, 5 Asstd. MO-333 | 2.00 | .59 |
| Solder Terminal Strips, 40 Asstd. XM-501 | 1.30 | .50 |
| Double Face Foam Tape 1/4"x52", TA-903 | 1.00 | .80 |
| 1/4 RPM Tuning Motor, 117 VAC, MO-277 . | .49 | .30 |

Olson[®] electronics

260 S. FORGE ST.
DEPT. L.Z AKRON, OHIO 44327

NAME _____
ADDRESS _____
CITY _____ STATE _____
ZIP _____ Send Olson Cat

ENCLOSE POSTAGE AND SALES TAX
CIRCLE 69 ON FREE INFORMATION CARD

COMPUTER KITS!

8K EconoRAM II™ \$163.84
Under 1¢ per bit! Configured as two independent 4k blocks for maximum flexibility. Full buffering, tri-state outputs drive the S-100 bus or any bidirectional bus, low power Schottky support ICs plus selected RAMs give low power operation, zips along at 450 ns or better (use 1 wait state with S-80). Low profile sockets included for all IC's. Plate through, double sided epoxy glass board.

10 Slot Motherboard \$ 85
Includes 10 edge connectors, use as [MSA] add-on or for stand alone system. Active, regulated terminations minimize crosstalk, overshoot, and other bus problems. Epoxy glass board, quality parts, S-100 compatible, heavy power traces.

18 Slot Motherboard \$ 118
Same features as above, but with 18 slots + edge connectors.

NEW 4K EconoROM \$265
ASSEMBLER, EDITOR, MONITOR FOR THE 8080

Improved listing, bigger and better--SP and PSW are now implemented for greater user facility. Very low power, quality board, sockets for all IC's, and so on. Find out what moved Jay Bell, editor of Print-Out, to write

"Without a doubt, this board is the best buy I have made for my Altair 8800 out of the \$5000 I've spent."

PRINT-OUT, September 1976

DEALER INQUIRIES INVITED

GODBOUT

BILL GODBOUT ELECTRONICS
BOX 2355, OAKLAND AIRPORT, CA 94614

TERMS: Add 5% orders under \$10. Allow up to 5% for shipping; excess refunded. We require street address for COD orders. BankAmericard / MasterCard (\$15 minimum) call 415-562-0636, 24 hrs. Cal res add tax.

CIRCLE 27 ON FREE INFORMATION CARD

market center

CLASSIFIED COMMERCIAL RATE (for firms or individuals offering commercial products or services) \$1.40 per word (no charge for zip code) . . . minimum 15 words.

NONCOMMERCIAL RATE (for individuals who want to buy or sell personal items) 85¢ per word . . . no minimum.

ONLY FIRST WORD AND NAME set in bold caps. Additional bold face (not available as all caps) at 10¢ per word. Payment must accompany all ads except those placed by accredited advertising agencies. 5% discount for 6 issues, 10% for 12 issues within one year, if paid in advance. All copy subject to publisher's approval. Advertisements using P.O. Box address will not be accepted until advertiser supplies publisher with permanent address and phone number. Copy to be in our hands on the 26th of the third month preceding the date of the issue (i.e., August issue closes May 26). When normal closing date falls on Saturday, Sunday or a holiday, issue closes on preceding working day.

BUSINESS OPPORTUNITIES

\$400.00 per day possible locating illegal wire-taps/bugs. We show you how! Complete course \$10.00. **GOLDEN ENTERPRISES**, Box 1282-RE, Glendale, AZ 85311

HIGHLY PROFITABLE ONE-MAN ELECTRONIC FACTORY

Investment unnecessary, knowledge not required, sales handled by professionals. Ideal home business. Write today for facts! Postcard will do. **Barta-BS**, Box 248, Walnut Creek, CA 94597.

WANTED

QUICK cash . . . for electronic equipment, components, unused tubes. Send list now! **BARRY**, 512 Broadway, New York, NY 10012, 212 WALKER 5-7000

PLANS & KITS

BUILD YOUR OWN SPEAKERS AND SAVE UP TO 50%

Send for our free fact-packed 44 page catalog manual and learn how to assemble your own multi-element stereo speakers from scratch or from kits. Our catalog includes chapters on design, construction, covers, enclosures, midranges, woofers, tweeters and horns. Write us today.

SPEAKERLAB
Dept RE-A, 5500 35th N E
Seattle, Washington 98105

BUILD your own 5v 3amp ttl supply. Save up to \$30.00. Plans detail surplus outlets, circuit and cabinet construction. Send \$2.95. **R. ALLEN**, Box 27182, Honolulu, HI 96827

MUSIC SYNTHESIS ANALOG PRODUSSING PLANS & KITS CIRCUIT THEORY PARTS AND COMPONENTS

FREE!!! INFORMATION SEND A SELF ADDRESSED STAMPED ENVELOPE, DONT DELAY DO IT NOW

C.F.R. associates
WEST OFFICE FAX
NEWTON MA
603-552-0173



ORGAN KITS KEYBOARDS

THE ULTIMATE IN DESIGN AND SOUND

DEMO RECORD AND BROCHURE \$1.00

Wurlitzer reproductions

DEVTRONIX ORGAN PRODUCTS, Dept. 4B
5872 Amapola Dr. • San Jose, CA 95129

TANK-TV game, complete construction plans—\$10.00; P.C. board—\$55.00; kits—\$195.00; free information. Plus many more games. **ADVANCED ELECTRONICS**, P. O. Box 133, Corvallis, OR 97330

FREE KIT Catalog

STOP! Take a minute & let us send our latest kit catalog. If you like, send us the name & address of a friend who may also be interested and we'll include to you our booklet "How to build electronic thermometer"

contains TEST & EXPERIMENTER'S EQUIP.

DAGE SCIENTIFIC INSTRUMENTS
BOX 1054R LIVERMORE CA 94550

BI-LINEAR amplifier, broadband, 60-150 watt mobile. Construction plans, \$3.00. **WILSON**, Box 5516-FG, Walnut Creek, CA 94596

EDUCATION & INSTRUCTION

TELEPHONE bugged? Don't be Watergated! Countermeasures brochure \$1.00. **NEGEYE LABORATORIES**, Box 547-RE, Pennsboro, WV 26415

GRANTHAM's FCC License Study Guide—377 pages, 1465 questions with answers/discussions—covering third, second, first radiotelephone examinations. \$13.45 postpaid. **GSE PUBLICATIONS**, 2000 Stoner, Los Angeles, CA 90025

F.C.C. EXAM MANUAL

PASS FCC EXAMS! Memorize, study—Test! Answers for FCC 1st and 2nd class Radio telephone licenses. Newly revised multiple choice questions and diagrams cover all areas tested in FCC exams, plus Self-Study Ability Test. \$9.95 postpaid. Money-back guarantee.



COMMAND PRODUCTIONS P.O. BOX 26348 E
RADIO ENGINEERING DIV. SAN FRANCISCO, CAL. 94126

BURGLAR/fire alarm experts needed for cars, homes, industry. Learn high-profit systems installation at home spare time. Simple, quick, complete. Free information by mail. No salesmen. **SECURITY SYSTEMS MANAGEMENT SCHOOL** (homestudy), Dept. 7339-077, Little Falls, NJ 07424

FORDHAM

BEST BUYS

SENCORE TEST EQUIPMENT

Sencore TF40 Pocket Cricket Portable Transistor & FET Tester

One simplified, safe test for all transistors and FETs. 99.9% reliable with complete leakage test on meter. And the Pocket Portable is the only one that has it. No set-up information is needed. Total test takes seconds. Identifies transistor polarity, FET or bipolar transistor. Identifies all 3 leads everytime. Includes test tone indicator.



CB41 Portable CB Performance Tester

Tests SWR, RF power and % modulation. Tells if a CB rig is getting out as far as possible . . . if it needs servicing.



CB42 Total CB Automatic Analyzer

The complete CB service bench, simplified for quick troubleshooting and performance testing. Performs 12 receiver tests; 12 transmitter tests. Single digital readout for all tests. Combines five units in one: 1) Frequency Counter; 2) RF-IF Generator; 3) Audio Generator; 4) Digital RF Wattmeter; and 5) special CB Tester.

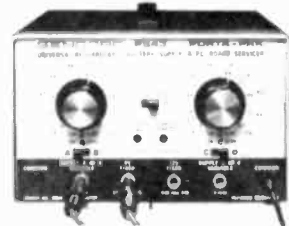

PS43 Port-A-Pak Power Supply/Battery Eliminator

Combines advantages of rechargeable batteries with an AC operated supply for any 12 volt service need.

FOR PRICING AND TO PLACE YOUR ORDER:

Call collect for Mr. Louis (516) 752-0050
Master Charge, BankAmericard and C.O.D.'s accepted

FORDHAM

RADIO SUPPLY CO., INC.
855R Conklin St.
Farmingdale, N.Y. 11735

YOUR ONE STOP DISCOUNT CENTER

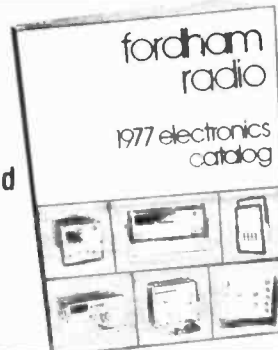

FREE

148 page catalog of over 3000 items . . . test equipment, CB, tools, tubes, components and a full line of electronic supplies

Try this exciting new hobby! Build your own electronic concert organ. It's easy. No technical knowledge required. Just follow the clearly pictured instructions of the famous Wersi do-it-yourself system. Choose from seven different models. Send \$2.00 (refundable) with coupon for colorful 104 page catalog.

WERSI



Wersi Electronics, Inc.
Dept. 24, Box 5318
1720 Hempstead Road
Lancaster, PA 17601

Enclosed is \$2.00 for my copy of your 104 page catalog.

Name _____
Address _____
City _____ State _____ Zip _____

CIRCLE 54 ON FREE INFORMATION CARD

PARTS

LOWEST PRICES-CMOS/TTL
7400 .16 7490 .65
82S06 256X1 RAM \$1.00
ORGAN/SYNTH KEYBOARD
NEW! 4 OCTAVE \$75.00
COMP. POWER SUPPLIES
1N914/4148 - 20/\$1.00
MIN TOG SWITCH -\$1.00
RESISTORS & CAPACITORS
AT EQUALLY LOW PRICES
BLANK CIRCUIT BOARD
SING/DOUBLE SIDE-BLUE
3"X4" .72-4"X6" \$1.44
ETCH/TINNING CHEMICALS
AUDIO KITS AND PARTS

SERVICES

CIR. BOARD FABRICATION
C. BOARD COOKBOOK-6.50
METAL FAB. & SUPPLIES
CUSTOM AUDIO DESIGN

SEND 13¢ STAMP FOR
1977 CATALOG

UTEP

DEP. 3 · BOX 26231
S. L. C., UT. 84125

CIRCLE 63 ON FREE INFORMATION CARD

ADVERTISING INDEX

RADIO-ELECTRONICS does not assume any responsibility for errors that may appear in the index below.

Free Information Number Page

| | | |
|-----|--|-----------|
| 46 | Advance Electronics | 84 |
| 17 | Allison | 74 |
| 65 | American Audioport | Cover 11 |
| 5 | AP Products | 26 |
| 68 | B&K-Division of Dynascan | 34 |
| 55 | Castle Electronics | 81 |
| 11 | Chanellock | 32 |
| 71 | Chemtronics | 22 |
| | CIE-Cleveland Institute of Electronics | 28-31 |
| 2 | Cobra-Div. of Dynascan | Cover 1V |
| 41 | Continental Specialties | 67 |
| | CREI-Div. of McGraw-Hill Continuing Education | 70-73 |
| 58 | Digital Concepts | 83 |
| 29 | Dynaco | 16 |
| | E&L Instruments | 80 |
| | Eastern Industrial | Cover III |
| 26 | Edmund Scientific | 106 |
| 21 | Edsyn | 82 |
| 59 | EICO | 68 |
| | EMC-Electronic Measurements | 84 |
| 20 | Fidelity Sound | 78 |
| 23 | Florida Institute of Technology | 76 |
| 35 | Fluke | 23 |
| 45 | GFN Communications | 25 |
| 60 | Grantham College of Engineering | 82 |
| | GTE Sylvania-Consumer Renewal | 15 |
| 100 | Heath | 13 |
| 7 | Hickok Electrical Instruments | 14 |
| 15 | Ignition Systems | 76 |
| 18 | Indiana Home Study | 69 |
| 40 | International Crystal | 85 |
| | JS&A | 1 |
| 49 | Mallory | 27 |
| 9 | Mountain West Alarm Supply | 76 |
| 19 | National Camera Supply | 80 |
| | National Radio Institute (NRI)-Div. of McGraw-Hill Continuing Education Center | 8-11 |
| | National Technical Schools | 18-21 |
| 22 | OK Machine & Tool | 74 |
| 10 | PAIA | 84 |
| 78 | Phillips Test & Measuring Division | 77 |
| 3 | Pomona Electronics | 75 |
| | Radio Shack | 33 |
| | RCA Distributor & Special Products | 68-69 |
| 37 | Rye Industries | 82 |
| 25 | SBE | 2 |
| 28 | Sabtronics International-Div. of Euray Trading | 7 |
| 39 | Schober Organ | 81 |
| 14 | Sencore | 24 |
| 8 | TAB Books | 78 |
| 51 | Telematic-Div. of UXL | 83 |
| 6 | Tri-Star | 79 |
| 1 | Tuner Service | 5 |
| 42 | VIZ Mfg. | 79 |
| 57 | Vaco | 17 |
| 62 | Vector Electronics | 85 |

MARKET CENTER

| | | |
|----|------------------------|-----|
| 47 | Active Electronics | 92 |
| | American Used Computer | 92 |
| 53 | AVR Electronics | 102 |
| 34 | Babylon Electronics | 98 |
| | Karel Barta | 86 |
| | CBS Enterprise | 102 |
| | CFR Associates | 86 |

Free Information Number Page

| | | |
|-------|-----------------------------|-------|
| | Command Productions | 86 |
| | Cornell Electronics | 96 |
| | Dage Scientific Instruments | 86 |
| 38 | Delta Electronics | 102 |
| | Devtronix Organ Products | 86 |
| 67 | Digi-Key | 93 |
| 48 | Fordham Radio Supply | 87 |
| 31 | Formula International | 105 |
| 27 | Godbout Electronics | 86 |
| | Information Unlimited | 102 |
| 30 | International Electronics | 101 |
| 12,13 | James Electronics | 94-95 |
| | Lab Science | 96 |
| | Lakeside Industries | 96 |
| 61 | Lin | 102 |
| 52 | Meshna | 98 |
| 43 | New-Tone | 100 |
| 69 | Olson | 86 |
| 33 | Optoelectronics | 97 |
| 36 | Page Digital Electronics | 92 |
| | Parasitic Engineering | 96 |
| 64 | Printronic | 96 |
| 24 | Poly Paks | 99 |
| 32 | Quest | 96 |
| 56 | Radio Hut | 103 |
| 66 | SD Sales | 91 |
| 4 | JB Saunders | 104 |
| 44 | Solid State Sales | 100 |
| | Speakerlab | 86 |
| 16 | Trico Electronics | 98 |
| 63 | Utep | 88 |
| 54 | Wersi Electronics | 88 |

MOVING?

Don't miss a single copy of **Radio-Electronics**. Give us:

Six weeks' notice

Your old address and zip code

Your new address and zip code

ATTACH LABEL HERE

name (please print) _____
address _____
city state zip code _____

Mail to: Radio-Electronics
SUBSCRIPTION DEPT., P.O. BOX 2520,
BOULDER, COLO. 80322

S. D. SALES CO.

P.O. BOX 28810 - c
DALLAS, TEXAS 75228

JUMBO LED CAR CLOCK

\$16.95 KIT

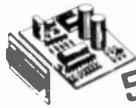

50,000 Satisfied Clock Kit Customers Can't Be Wrong!

ALARM OPTION - \$1.50
AC XFMR - \$1.50

The Hottest Selling Kit We Ever Produced!

You requested it! Our first D.C. operated clock kit. Professionally engineered from scratch. Not a makeshift kluge as sold by others.

- Features:
- A. Bowmar Jumbo .5 inch LED array.
 - B. MOSTEK - 50250 - Super Clock Chip
 - C. On board precision crystal time base.
 - D. 12 or 24 hour Real Time Format.
 - E. Perfect for cars, boats, vans, etc.
 - F. P.C. Board and all parts (less case) included.

Specials!

3.579545
MHZ Time
Base Crystal
\$1.25

39 MFO
16V Mallory
Electrolytic
15 for \$1.

28 PIN IC
Sockets
3/\$1.00
11,000 MFO
50WVDC
Computer
Grade
Cap. \$3.

1702A 2K EPROM

We tell it like it is! We could have said these were factory new, but here is the straight scoop. We bought a load of new computer gear that contained a quantity of 1701 A's in sockets. We carefully removed the parts, verified their quality, and are offering them on one heck of a deal. First come, first served. Satisfaction Guaranteed! U. V. Erasable. (2.3 US access time.) **NEW PRICE!**

\$2.95 each

2/\$10.

UP YOUR COMPUTER!

21L02-1 1K LOW POWER 500 NS STATIC RAM
Time is of the essence!

And so is power. Not only are our RAM's faster than a speeding bullet but they are now very low power. We are pleased to offer prime new 21L02-1 low power and super fast RAM's. Allows you to STRETCH your power supply farther and at the same time keep the wait light off!

8 for \$12.95

60HZ Crystal Time Base

\$5.95

FEATURES:

- A. 60HZ output with accuracy comparable to a digital watch.
- B. Directly interfaces with all MOS clock chips.
- C. Super low power consumption (1.5MA typ.)
- D. Uses latest MOS 17 stage divider IC.
- E. Eliminates forever the problem of AC line glitches.
- F. Perfect for cars, boats, campers, or even for portable clocks at ham field days.
- G. Small size; can be used in existing enclosures.

Kit includes Crystal, Driver IC, PC board, plus all necessary parts and specs. At last count -- over 20,000 sold!

S.D. Sales Exclusive!

\$12.95 S. D. Sales Exclusive! \$12.95

MOS 6 DIGIT UP-DOWN COUNTER

40 PIN DIP. Everything you ever wanted in a counter chip. Features: Direct LED segment drive, single power supply (12 VDC TYPE), six decades up/down, pre-loadable counter, separate pre-loadable compare register with compare output, BCD and seven segment outputs, internal scan oscillator, CMOS compatible, leading zero blanking, 1MHZ. count input frequency. Very limited quantity!

IC's from XEROX

| | | | |
|------------|------------|--------------------|---------------------------|
| 7400 - 9c | 7430 - 9c | 7493 - 26c | 1402A-Shift Regulator-50c |
| 7402 - 9c | 7440 - 9c | 74121 - 22c | MH0025CN - 55c |
| 7404 - 9c | 7437 - 10c | 74123 - 32c | |
| 7406 - 11c | 7438 - 10c | 74151 - 22c | |
| 7407 - 11c | 7451 - 9c | 74156 - 22c | |
| 7410 - 9c | 7474 - 16c | 74193 - 35c | |
| 7416 - 13c | 7475 - 24c | 8233 - 35c | |
| 7420 - 9c | 7486 - 16c | Intel - 1302 - 45c | |

IC'S REMOVED FROM
PC BOARDS
ALL TESTED:
FULL SPEC.

1000 MFD
Filter Caps
Rated 35 WVDC Up-
right style with PC
leads Most popular va-
lue for hobbyists. Com-
pare at up to \$1.19 ea
from franchise type e-
lectronic parts stores

4/\$1.00

SLIDE SWITCH
Assortment
Our best seller. Includes
miniature and standard
sizes; single and multi-
position units. All new,
first name brand. Try
one package and you'll
reorder more! Special!

12/\$1.00

POWER RESISTOR
15 OHM
25W
BY
CLAROSTAT

75¢ ea.

RESISTOR
ASSORTMENT
1/4W 5% & 10%. PC
leads. A good mix of
values.

200/\$2.

P.C. LEAD
DIODES
1N4148/1N914
100/\$2.00
1N4002 1A
100 PIV

40/\$1.

Transistor Grab
Bag no. 1
Just received a good,
mixed lot of National
TO92 plastic transis-
tors PNP & NPN, even
a few FET's. 40 to 50%
Yield. Untested. Asst.

500/\$3.

DISC CAP
ASSORTMENT
PC leads. At least
10 different val-
ues. Includes:
.001, .01, .05
plus other stan-
dard values.

60/\$1.00

\$9.95 KIT

P.C. Board - \$3.00
AC XFMR - \$1.50
Do not confuse with Non-Alarm
kits sold by our competition!
Eliminate the hassle -
avoid the 5314!

SIX DIGIT ALARM CLOCK KIT

WE MADE A FANTASTIC KIT EVEN BETTER. REDESIGNED TO TAKE ADVANTAGE OF THE LATEST ADVANCES IN I.C. CLOCK TECHNOLOGY. FEATURES: LITRONIX DUAL 1/2" DISPLAYS, MOSTEK 50250 SUPER CLOCK CHIP, SINGLE I.C. SEGMENT DRIVER, SCR DIGIT DRIVERS. GREATLY SIMPLIFIED CONSTRUCTION. MORE RELIABLE AND EASIER TO BUILD. KIT INCLUDES ALL NECESSARY PARTS (except case). P.C.B. OR XFMR OPTIONAL. **NEW! WITH JUMBO LED READOUTS!**

MOTOROLA SCR
2N4443. 8 AMP 400 PIV.
P.C. Leads. \$3/\$1.00
FAIRCHILD - TBA 641
4W. Audio power Amp. Just
out! In special heat sink DIP.
One super audio IC.
\$1.50 with data
AC LINE FILTER
Rated 3 AMPS - 115/230V
50 to 400 HZ.
Noise Proof Your Computer
\$3.00 each

GRAB BAG NUMBER 2
Mixed Motorola TO-18 case met-
al transistors. About 60% yield.
PNP & NPN. Untested. A good
assortment! 100 for \$3.00
PRICES SHOWN SUBJECT
TO CHANGE WITHOUT
NOTICE.



Price Cut!
~~\$15.95~~
\$12.

COMPUTER POWER SUPPLY

A very fortunate purchase. One of the best industrial quality REGULATED supplies we have seen. High performance, small size. Input is 120VAC 60HZ. Has the following regulated outputs: -5VDC@800MA; -15VDC@1.25AMP; -25VDC@180MA. Sold at a fraction of original cost. Do yourself a favor and order NOW.

AMD - 1702A

Factory Prime Units - Brand New - 1.5 Micro-seconds Access Time. - \$4.95 each
10 FOR \$40. **HUGE FACTORY DIRECT PURCHASE!**

TERMS:

MONEY BACK GUARANTEE.
NO COD'S. TEXAS RESIDENTS
ADD 5% SALES TAX. ADD
5% OF ORDER FOR POSTAGE
& HANDLING. ORDERS
UNDER \$10.00 ADD 75c.
FOREIGN ORDERS: U. S.
FUNDS ONLY!

Call your Bankamericard or
Master Charge order in on our
continental United States toll
free Watts:

1-800-527-3460

Texas Residents Call Collect:

214/271-0022

CHEAP DC SUPPLY
Actually an AC adapter for calculators.
5VDC-no load. 5VDC@200MA.
4VDC@375MA

\$2. ea.

S.D. SALES CO.
P.O. BOX 28810 - C
DALLAS, TEXAS 75228

Orders over \$15. - Choose \$1. FREE MERCHANDISE!

CIRCLE 66 ON FREE INFORMATION CARD

| TTL 7400N | | |
|-----------|------|----------------|
| SN7400N | 13 | SN74125N .40 |
| SN7401N | 11 | SN74126N .40 |
| SN7402N | 14 | SN74128N .59 |
| SN7403N | 14 | SN74132N .69 |
| SN7404N | 17 | SN74136N .59 |
| SN7405N | 17 | SN74141N .88 |
| SN7406N | 25 | SN74142N 3.70 |
| SN7407N | 25 | SN74143N 3.98 |
| SN7408N | 17 | SN74144N 3.98 |
| SN7409N | 17 | SN74145N .69 |
| SN7410N | 14 | SN74147N 1.58 |
| SN7411N | 20 | SN74148N 1.19 |
| SN7412N | 21 | SN74150N .95 |
| SN7413N | 39 | SN74151N .61 |
| SN7414N | 64 | SN74153N .61 |
| SN7416N | 21 | SN74154N .95 |
| SN7417N | 29 | SN74155N .70 |
| SN7420N | 14 | SN74156N .64 |
| SN7421N | 20 | SN74157N .59 |
| SN7422N | 20 | SN74159N 2.50 |
| SN7423N | 25 | SN74160N .85 |
| SN7425N | 25 | SN74161N .85 |
| SN7426N | 22 | SN74162N .85 |
| SN7427N | 25 | SN74163N .85 |
| SN7428N | 28 | SN74164N .98 |
| SN7430N | 14 | SN74165N .97 |
| SN7432N | 23 | SN74166N 1.09 |
| SN7433N | 30 | SN74167N 2.75 |
| SN7437N | 21 | SN74170N 1.69 |
| SN7438N | 21 | SN74172N 8.75 |
| SN7440N | 14 | SN74173N 1.24 |
| SN7442N | 37 | SN74174N .94 |
| SN7443N | 68 | SN74175N .84 |
| SN7444N | 85 | SN74176N .77 |
| SN7445N | 65 | SN74177N .76 |
| SN7446AN | 70 | SN74178N 1.19 |
| SN7447AN | 67 | SN74179N 1.49 |
| SN7448N | 69 | SN74180N .67 |
| SN7450N | 14 | SN74181N 1.94 |
| SN7451N | 14 | SN74182N .59 |
| SN7453N | 14 | SN74184N 1.75 |
| SN7454N | 14 | SN74185AN 1.74 |
| SN7460N | 14 | SN74186N 6.95 |
| SN7470N | 26 | SN74188N 2.98 |
| SN7472N | 25 | SN74190N 1.04 |
| SN7473N | 29 | SN74191N 1.04 |
| SN7474N | 29 | SN74192N .84 |
| SN7475N | 46 | SN74193N .84 |
| SN7476N | 30 | SN74194N .89 |
| SN7480N | 35 | SN74195N .54 |
| SN7481AN | 95 | SN74196N .87 |
| SN7482N | 55 | SN74197N .73 |
| SN7483AN | 65 | SN74198N 1.64 |
| SN7484AN | 1.50 | SN74199N 1.64 |
| SN7485N | 84 | SN74221N 1.14 |
| SN7486N | 30 | SN74246N 1.95 |
| SN7489N | 1.85 | SN74247N 1.70 |
| SN7490AN | 43 | SN74248N 1.75 |
| SN7491AN | 59 | SN74249N 1.75 |
| SN7492AN | 44 | SN74251N 1.05 |
| SN7493AN | 44 | SN74265N .85 |
| SN7494AN | 69 | SN74278N 1.99 |
| SN7495AN | 67 | SN74279N .57 |
| SN7496N | 65 | SN74283N 1.39 |
| SN7497N | 2.50 | SN74284N 4.50 |
| SN74100N | 97 | SN74285N 4.50 |
| SN74104N | 42 | SN74290N .85 |
| SN74105N | 42 | SN74293N .83 |
| SN74107N | 28 | SN74298N 1.64 |
| SN74109N | 47 | SN74351N 1.92 |
| SN74110N | 52 | SN74365N .65 |
| SN74111N | 69 | SN74366N .65 |
| SN74116N | 1.50 | SN74367N .65 |
| SN74120N | 1.40 | SN74368N .65 |
| SN74121N | 34 | SN74390N 1.40 |
| SN74122N | 38 | SN74393N 1.40 |
| SN74123N | 48 | SN74490N 1.90 |

| TTL LOW POWER SCHOTTKY | | |
|------------------------|------|------------------|
| SN74LS00N | .23 | SN74LS174N 1.25 |
| SN74LS01N | .23 | SN74LS175N 1.25 |
| SN74LS02N | .23 | SN74LS181N 3.30 |
| SN74LS03N | .23 | SN74LS190N 1.80 |
| SN74LS04N | .28 | SN74LS191N 1.80 |
| SN74LS05N | .28 | SN74LS192N 1.80 |
| SN74LS08N | .23 | SN74LS193N 1.80 |
| SN74LS09N | .23 | SN74LS194AN 1.30 |
| SN74LS10N | .23 | SN74LS195AN 1.30 |
| SN74LS11N | .23 | SN74LS196N 1.40 |
| SN74LS12N | .25 | SN74LS197N 1.40 |
| SN74LS13N | .65 | SN74LS221N 1.30 |
| SN74LS14N | 1.35 | SN74LS240N 2.50 |
| SN74LS15N | .23 | SN74LS241N 2.40 |
| SN74LS20N | .23 | SN74LS242N 2.40 |
| SN74LS21N | .23 | SN74LS243N 2.40 |
| SN74LS22N | .23 | SN74LS244N 2.50 |
| SN74LS26N | .37 | SN74LS247N 1.30 |
| SN74LS27N | .27 | SN74LS248N 1.30 |
| SN74LS28N | .30 | SN74LS249N 1.30 |
| SN74LS30N | .23 | SN74LS251N 1.50 |
| SN74LS32N | .33 | SN74LS253N 1.50 |
| SN74LS33N | .37 | SN74LS257N 1.40 |
| SN74LS37N | .37 | SN74LS258N 1.40 |
| SN74LS38N | .37 | SN74LS261N 2.95 |
| SN74LS40N | 27 | SN74LS266N .55 |
| SN74LS42N | 89 | SN74LS279N .75 |
| SN74LS47N | 1.10 | SN74LS283N 1.35 |
| SN74LS48N | 1.10 | SN74LS290N 1.30 |
| SN74LS49N | 1.10 | SN74LS293N 1.30 |
| SN74LS51N | .23 | SN74LS295AN 1.75 |
| SN74LS54AN | .23 | SN74LS298AN 1.75 |
| SN74LS55N | .23 | SN74LS324AN 2.25 |
| SN74LS63N | 1.75 | SN74LS352AN 1.45 |
| SN74LS73N | .45 | SN74LS353AN 1.70 |
| SN74LS74N | .45 | SN74LS365AN .69 |
| SN74LS75N | .65 | SN74LS366AN .69 |
| SN74LS76N | .45 | SN74LS367AN .69 |
| SN74LS78N | .45 | SN74LS368AN .69 |
| SN74LS83AN | 1.39 | SN74LS375AN .75 |
| SN74LS85AN | 1.60 | SN74LS386AN .59 |
| SN74LS86N | .48 | SN74LS395AN 1.95 |
| SN74LS90N | .89 | SN74LS670AN 2.75 |
| SN74LS91N | 1.15 | |
| SN74LS92N | 1.15 | |
| SN74LS93BN | .85 | |

| | | |
|----------------|------|--|
| CD4024BE | 67 | |
| CD4025BE | 17 | |
| CD4026BE | 1.39 | |
| CD4027BE | .39 | |
| CD4028BE | .75 | |
| CD4029BE | .79 | |
| CD4030BE | .37 | |
| CD4033BE | 1.60 | |
| CD4034BE | 2.95 | |
| CD4035BE | .99 | |
| CD4040BE | .99 | |
| CD4041BE | .67 | |
| CD4042BE | .63 | |
| CD4043BE | .45 | |
| CD4044BE | .45 | |
| CD4046BE | 2.45 | |
| CD4047BE | 2.45 | |
| CD4049BE | .37 | |
| CD4050BE | .37 | |
| CD4051BE | 1.15 | |
| CD4052BE | 1.15 | |
| CD4053BE | 1.19 | |
| CD4055BE | 1.29 | |
| CD4060BE | 1.40 | |
| CD4066BE | .59 | |
| CD4068BE | .24 | |
| CD4069BE | .24 | |
| CD4070BE | .24 | |
| CD4071BE | .24 | |
| CD4072BE | .29 | |
| CD4073BE | .29 | |
| CD4075BE | .29 | |
| CD4076BE | 1.05 | |
| CD4078BE | .24 | |
| CD4081BE | .24 | |
| CD4082BE | .29 | |
| CD4085BE | .75 | |
| CD4086BE | .75 | |
| CD4052BE | 1.15 | |
| CD4501BE | .52 | |
| CD4510BE | 1.05 | |
| CD4511BE | 1.25 | |
| CD4512BE | 1.15 | |
| CD4514BE | 2.50 | |
| CD4515BE | 2.10 | |
| CD4516BE | 1.50 | |
| CD4518BE | .90 | |
| CD4519BE | .79 | |
| CD4520BE | .79 | |
| CD4522BE | 1.98 | |
| CD4526BE | 1.50 | |
| CD4527BE | 1.50 | |
| CD4528BE | 1.20 | |
| CD4531BE | 1.25 | |
| CD4539BE | 1.20 | |
| CD4555BE | .75 | |
| CD4556BE | .75 | |
| CD4585BE | 1.80 | |
| 74C01 | 1.20 | |
| 74C160/40160PC | 1.50 | |
| 74C161/40161PC | 1.50 | |
| 74C162/40162PC | 1.50 | |
| 74C163/40163PC | 1.50 | |
| 74C174/40174PC | 1.40 | |
| 74C175/40175PC | 1.40 | |
| 74C192/40192PC | 1.50 | |
| 74C193/40193PC | 1.50 | |
| 74C195/40195PC | 1.40 | |

CMOS

| | |
|----------|------|
| CD4000BE | .09 |
| CD4001BE | .18 |
| CD4002BE | .13 |
| CD4006BE | .99 |
| CD4007BE | .17 |
| CD4008BE | .80 |
| CD4009BE | .37 |
| CD4010BE | .37 |
| CD4011BE | .18 |
| CD4012BE | .17 |
| CD4013BE | .37 |
| CD4014BE | .89 |
| CD4015BE | .89 |
| CD4016BE | .37 |
| CD4017BE | .94 |
| CD4018BE | .99 |
| CD4019BE | .42 |
| CD4020BE | 1.04 |
| CD4021BE | .99 |
| CD4022BE | .89 |
| CD4023BE | .18 |

MOS AND BI-POLAR MEMORIES

| | | |
|---------------|---|--------|
| C 1702A | (1 Microsecond) | 8.95 |
| 8080A | 256 X 8 EPROM | |
| C 1702A | (1.5 Microsecond) | 5.95 |
| 256 X 8 EPROM | | |
| C2708 | 1K X 8 EPROM (450 NS) | 34.95 |
| 8080A | 8 Bit MOS Cpu (2 Microseconds) | 14.95 |
| 2102-1P | 1K Static Ram 1024 X 1 (450 NS) | 2.50 |
| 3342PC | Quad 64 Bit Static Shift Register | 4.50 |
| 3347PC | Quad 80 Bit Static Shift Register | 4.50 |
| 3341APC | 4 X 64 MOS Flo 1 Mhz Shift Register | 4.50 |
| TMS017NC | Decimal Arithmetic Processor | 10.00 |
| LCM1001 | Microprocessor Learning Module | 149.95 |
| TMS4024NC | 64 X 9 Flo | 8.95 |
| TMS4050NL | 4K Dynamic Ram Plastic 300NS (18 Pin) | 6.95 |
| TMS4060NL | 4K Dynamic Ram Plastic 300NS (22 Pin) | 6.95 |
| A55-1013P | 8 Bit Uart | 6.95 |
| Semi 4804A | 4K Static Ram 1024 X 4 (450 NS) Single 5V Supply | 14.95 |
| 93415PC | 1K Ram 40 NS Open Collector | 11.00 |
| 93425PC | 1K Ram 40 NS Tri-State | 11.00 |
| AM2901DC | 4 Bit Bi-Polar Microprocessor Slice | 31.50 |
| AM2902PC | Carry Look Ahead Register | 3.18 |
| AM2905PC | Quad 2 Input Bus Transceiver | 8.10 |
| AM2907PC | Quad Bus Transceiver with Tri-State Receiver and Parity | 7.00 |
| AM2909PC | 4 Bit Cascadable Microprogram Sequencer | 7.15 |
| AM2918PC | Quad Deregister with Standard and Tri-State Outputs | 4.32 |
| F8 Kit | 8 Bit Microprocessor Evaluation Kit With Software | 185.00 |

TEXAS INSTRUMENTS DATA BOOKS

| STK NO. | DESCRIPTION | PRICE |
|---------|---------------------------------------|-------|
| LCB1011 | Understanding Solid State Electronics | 2.95 |
| LCB1891 | Software Design for Microprocessors | 12.95 |
| LCC4041 | Power Data Book | 3.95 |
| LCC4112 | TTL Data Book | 4.95 |
| LCC4131 | Transistor and Diode Data Book | 4.95 |
| LCC4151 | Linear and Interface I.C. Data Book | 3.95 |
| LCC4200 | Semiconductor Memories Data Book | 2.95 |
| LCC4230 | Optoelectronics Data Book | 2.95 |
| LCC4241 | Linear Control Circuits Data Book | 2.95 |

FAIRCHILD DATA BOOKS

| | |
|--|------|
| Power Data Book | 3.00 |
| Bi-Polar Memory Data Book | 2.50 |
| Linear Integrated Circuit Data Book | 2.95 |
| Low Power Schottky and Macrologic TTL | 1.75 |
| Interface Data Book | 1.00 |
| Raytheon Linear Integrated Circuit Data Book | 1.50 |
| SolidStateScientific CMOS 'B' Series Data Book | 2.50 |
| Unitrode Semiconductor Data Book | 4.95 |

1977 IC UPDATE MASTER MANUAL
Brand new, complete integrated circuit data selector from all manufacturers. 1264 page master ref. guide to the latest IC's including microprocessors and consumer circuits. 17,000 cross references for easier sourcing of hard to get parts. \$29.95 with free update service.

"ONLY MAJOR MANUFACTURERS SUPPLIED"
"This is a partial listing. Our complete catalogue lists many more device types & series which are available" "Our quality cannot be surpassed".

Active Electronic Sales Corp.

P.O. BOX 1035 FRAMINGHAM, MASSACHUSETTS 01701

Telephone Orders & Enquiries (617) 879-0077 New Fall Catalogue is Now Available on Request

MINIMUM ORDER \$10.00 ADD \$1.00 TO COVER POSTAGE & HANDLING

NOW IN CANADA 2 Locations Canadian customers add an additional 30% for duty and handling. All federal and provincial sales taxes extra.

5647 Ferrier St. Montreal, Quebec Tel.(514) 735-6429 44 Faeken Dr-Unit 25 Rexdale, Ontario Tel.(416) 677-4287

FOR SALE

CANADIAN discount and factory clearouts catalog. Top brand stereo equipment, calculators, test gear, CB & communications, telephones. Factory dumps—government surplus, Amazing bargains. Unusual items. Rush \$1. ETCO-RE, 521 5th Ave., NYC, 10017

FREE catalog. IC's, Semi's. CORONET ELECTRONICS, 649A Notre Dame W., Montreal, Que., Canada, H3C-1H8. US Inquiries.

COMPUTER WAREHOUSE STORE

★ ONE DAY SHIPMENT ★

GREEN PHOSPHOR VIDEO MONITOR
\$150 + \$25 Shipping & Handling

16 Mhz bandwidth, Standard Raster Scan, 24 lines x 80 char.

THOUSANDS OF KITS AND PERIPHERALS

SPECIAL DISCOUNTS!
If you buy used equipment peripherals at the same time you buy our kit(s):
20% off Kit Price if over \$900
10% off Kit Price if over \$250
5% off Kit Price if over \$95 (\$200 Maximum Discount)

SEND \$1 FOR OUR CATALOG
Describes complete line of KITS & Units, "All About Hobby Microcomputers", Largest selection of Computer Books, Microprocessor Comparison Chart and MUCH MORE

POWERFUL, adjustable, regulated, three output power supply and 900 easily removable parts in complete Cartrivision television recorder electronic assembly with documentation. Perfect for microprocessor, IC, transistor, television, CB radio applications. \$21.45. Free brochure.

MADISON ELECTRONICS, INCORPORATED, 369, D101, Madison, AL 35758. Satisfaction guaranteed.

RECONDITIONED test equipment. \$0.50 for catalog. **WALTER'S TEST EQUIPMENT**, 2697 Nickel, San Pablo, CA 94806

WIREWRAP

Cut & Stripped #30 Kyner Wire In Red, Yellow, Blue, White, Green or Orange. All lengths overall. 1" strip on each end.

| | 100 | 500 | 1000 | 1.0 | 10-20 | 25-50 | 100-1000 |
|-------------|------|------|------|-----|-------|-------|----------|
| 3" | .82 | 2.80 | 4.71 | | | | |
| 3 1/2" | .86 | 2.81 | 8.12 | 8 | .44 | .46 | .36 |
| 4" | .90 | 3.00 | 5.82 | 14 | .38 | .37 | .365 |
| 4 1/2" | .94 | 3.21 | 5.93 | 18 | .42 | .41 | .38 |
| 5" | .98 | 3.42 | 6.04 | 22 | .40 | .40 | .40 |
| 5 1/2" | 1.02 | 3.63 | 6.15 | 24 | .40 | .40 | .40 |
| 6" | 1.08 | 3.83 | 6.18 | 26 | .40 | .40 | .40 |
| 6 1/2" | 1.10 | 4.04 | 7.57 | 100 | .40 | .40 | .40 |
| 7" | 1.14 | 4.24 | 7.98 | | | | |
| 7 1/2" | 1.16 | 4.45 | 8.39 | | | | |
| 8" | 1.23 | 4.65 | 8.80 | | | | |
| Add: inches | .10 | .41 | .82 | | | | |

On 250 R. Rolls \$4.00 10/330 (ms)

HOBBY WRAP TOOL

We also Stock:
• Wire Wrap Boards
• 7400 & 74LS00 IC's
• Processor Support Chips
Call or Write for catalog (213) 797-4002 or 797-4007



\$34.95

With Free Wire

250 3/8" \$2.50
250 7" \$2.50
250 3 1/2" \$2.50
100 4" \$2.50
100 4 1/2" \$2.50
100 5" \$2.50
100 6" \$2.50

Orders under \$10 or COD's add \$1.00, other orders shipped UPS ppd. Bank Americard and Master Charge.

Hand Wrap UnWrap Strip Tool \$9.95 with \$2 free wire.

Page Digital Electronics

1701 East Orange Grove Blvd
Pasadena, California 91104

DON'T FORGET OUR DISCOUNTS WHEN COMPARING PRICES PRICE BREAKTHROUGH ON 74LS'

| | | | | | | | | | |
|--------|-----|--------|----|---------|-----|---------|-----|---------|-----|
| 74LS00 | 28 | 74LS30 | 28 | 74LS90 | 57 | 74LS157 | 75 | 74LS248 | 79 |
| 74LS01 | 28 | 74LS32 | 33 | 74LS92 | 57 | 74LS158 | 75 | 74LS249 | 79 |
| 74LS02 | 28 | 74LS37 | 33 | 74LS93 | 57 | 74LS160 | 102 | 74LS253 | 84 |
| 74LS03 | 28 | 74LS38 | 33 | 74LS97 | 39 | 74LS161 | 102 | 74LS257 | 75 |
| 74LS04 | 29 | 74LS40 | 28 | 74LS109 | 39 | 74LS162 | 102 | 74LS268 | 79 |
| 74LS05 | 29 | 74LS42 | 67 | 74LS112 | 39 | 74LS163 | 102 | 74LS269 | 39 |
| 74LS08 | 29 | 74LS47 | 77 | 74LS113 | 39 | 74LS164 | 102 | 74LS283 | 79 |
| 74LS09 | 29 | 74LS48 | 77 | 74LS114 | 39 | 74LS168 | 114 | 74LS290 | 65 |
| 74LS10 | 28 | 74LS51 | 28 | 74LS125 | 49 | 74LS169 | 114 | 74LS293 | 65 |
| 74LS11 | 28 | 74LS54 | 28 | 74LS126 | 49 | 74LS170 | 173 | 74LS365 | 67 |
| 74LS12 | 28 | 74LS55 | 28 | 74LS132 | 81 | 74LS173 | 134 | 74LS366 | 67 |
| 74LS13 | 47 | 74LS57 | 39 | 74LS136 | 39 | 74LS174 | 136 | 74LS367 | 67 |
| 74LS14 | 102 | 74LS58 | 28 | 74LS139 | 73 | 74LS175 | 84 | 74LS368 | 67 |
| 74LS15 | 28 | 74LS59 | 53 | 74LS139 | 73 | 74LS190 | 118 | 74LS386 | 39 |
| 74LS20 | 28 | 74LS76 | 39 | 74LS151 | 75 | 74LS191 | 118 | 74LS670 | 234 |
| 74LS21 | 28 | 74LS78 | 39 | 74LS153 | 75 | 74LS196 | 86 | 74LS95 | 77 |
| 74LS22 | 28 | 74LS83 | 79 | 74LS161 | 110 | 74LS197 | 86 | 74LS97 | 77 |
| 74LS26 | 33 | 74LS86 | 39 | 74LS155 | 75 | 74LS247 | 79 | 74LS98 | 77 |
| 74LS27 | 33 | | | 74LS156 | 75 | | | 74LS99 | 77 |

INTEGRATED CIRCUITS - TTL, CMOS, LINEAR & MOS

| | | | | | | | | | |
|------|----|-------|------|-------|------|------|------|-----------|-------|
| 7400 | 21 | 7476 | 32 | 74181 | 215 | 4012 | 23 | 4520 | 114 |
| 7401 | 21 | 7480 | 70 | 74182 | 79 | 4013 | 40 | 4527 | 1.68 |
| 7402 | 21 | 7482 | 70 | 74184 | 219 | 4014 | 96 | 4528 | .88 |
| 7403 | 21 | 7485 | 70 | 74185 | 219 | 4015 | 96 | 4529 | 1.23 |
| 7404 | 21 | 7485 | 89 | 74188 | 50 | 4016 | 40 | 2102-1 | .99 |
| 7405 | 21 | 7486 | 28 | 74189 | 350 | 4017 | 1.05 | 8080A | 24.95 |
| 7406 | 25 | 7489 | 219 | 74190 | 123 | 4018 | 1.05 | CA3046 | .75 |
| 7407 | 25 | 7490 | 44 | 74191 | 123 | 4019 | 1.23 | LM309 | .75 |
| 7408 | 21 | 7491 | 70 | 74192 | 88 | 4020 | 1.14 | LM309C | 1.80 |
| 7409 | 21 | 7492 | 44 | 74193 | 88 | 4021 | 1.14 | LM324A | 1.28 |
| 7410 | 21 | 7493 | 44 | 74194 | 88 | 4022 | .96 | LM340T-5 | 1.25 |
| 7411 | 21 | 7494 | 44 | 74185 | 88 | 4023 | .28 | LM340T-6 | 1.25 |
| 7412 | 21 | 7495 | 70 | 74196 | 88 | 4024 | .84 | LM340T-8 | 1.25 |
| 7413 | 25 | 7496 | 70 | 74197 | 88 | 4025 | .23 | LM340T-12 | 1.25 |
| 7414 | 89 | 74100 | 1.28 | 74198 | 1.49 | 4026 | 1.68 | LM340T-15 | 1.25 |
| 7415 | 25 | 74102 | 39 | 74198 | 1.49 | 4027 | .80 | LM340T-18 | 1.25 |
| 7417 | 25 | 74109 | 33 | 74251 | 1.09 | 4028 | .89 | LM340T-24 | 1.25 |
| 7420 | 21 | 74121 | 35 | 74279 | .55 | 4029 | 1.14 | LM3900M | .88 |
| 7421 | 25 | 74122 | 44 | 74365 | .67 | 4030 | .23 | LM3900PM | .89 |
| 7423 | 33 | 74133 | 60 | 74366 | .67 | 4033 | 1.31 | MC1456V | 1.00 |
| 7425 | 35 | 74125 | 40 | 74367 | .67 | 4034 | 3.50 | MC1458V | .53 |
| 7426 | 25 | 74126 | 40 | 74368 | .67 | 4035 | 1.14 | MC3302P | 1.15 |
| 7427 | 33 | 74132 | 70 | 8093 | .40 | 4040 | 1.14 | NE531T | 1.24 |
| 7428 | 28 | 74141 | 84 | 8094 | .40 | 4041 | .79 | NE540T | 2.08 |
| 7430 | 21 | 74145 | 70 | 9095 | .67 | 4042 | .79 | NE555V | .48 |
| 7432 | 25 | 74147 | 1.63 | 8096 | .67 | 4043 | .70 | NE568A | .88 |
| 7433 | 30 | 74148 | 1.30 | 8097 | .67 | 4044 | .70 | NE568B | 3.83 |
| 7437 | 29 | 74150 | 1.16 | 8098 | .67 | 4046 | 1.86 | NE5613 | 3.83 |
| 7438 | 25 | 74151 | 70 | 75150 | 1.16 | 4049 | .40 | NE562B | 3.83 |
| 7440 | 21 | 74153 | 65 | 75450 | .88 | 4050 | .40 | NE565A | 1.25 |
| 7442 | 53 | 74154 | 1.23 | 75451 | .61 | 4051 | 1.26 | NE566V | 1.28 |
| 7443 | 63 | 74155 | 70 | 75452 | .61 | 4052 | 1.26 | NE597 | 3.48 |
| 7445 | 70 | 74156 | 70 | 75453 | .61 | 4053 | 1.26 | uA709CV | .44 |
| 7446 | 70 | 74157 | 70 | 75454 | .61 | 4060 | 1.58 | uA710CA | .44 |
| 7447 | 70 | 74160 | 88 | 75491 | .81 | 4064 | .79 | uA711CA | .53 |
| 7448 | 70 | 74161 | 88 | 75492 | .81 | 4071 | .23 | uA773CA | .60 |
| 7450 | 21 | 74162 | 88 | 75493 | 1.09 | 4072 | .23 | uA773CA | .75 |
| 7451 | 21 | 74163 | 88 | 75494 | 1.19 | 4073 | .23 | uA741CV | .44 |
| 7453 | 21 | 74164 | 88 | 8255 | 2.19 | 4075 | .23 | uA747CA | .70 |
| 7454 | 21 | 74165 | 1.15 | 4000 | -.23 | 4081 | .23 | uA748CV | .49 |
| 7459 | 21 | 74166 | 1.26 | 4001 | -.23 | 4082 | .23 | uA7805CU | 1.25 |
| 7460 | 21 | 74170 | 2.84 | 4002 | -.23 | 4502 | .79 | uA7806CU | 1.25 |
| 7470 | 30 | 74173 | 1.42 | 4006 | -.23 | 4510 | 1.14 | uA7812CU | 1.25 |
| 7472 | 30 | 74174 | 98 | 4007 | -.23 | 4511 | 1.05 | uA7812CU | 1.25 |
| 7473 | 30 | 74175 | 93 | 4008 | .79 | 4514 | 2.80 | uA7815CU | 1.25 |
| 7474 | 30 | 74176 | 79 | 4009 | .44 | 4515 | 2.80 | uA7816CU | 1.25 |
| 7475 | 49 | 74177 | 79 | 4010 | .44 | 4516 | 1.23 | uA7874CU | 1.25 |
| | | 74180 | 70 | 4011 | .23 | 4518 | 1.14 | | |

NEW

Battery wire wrapping tool
Model BW-630

\$34.95
ONLY \$34.95 for the unit
COMPLETE WITH BIT AND SLEEVE

WIRE WRAPPING WIRE IN BULK
Red or Black 30 ga. Rymor

| | |
|-------|---------|
| 100' | \$2.00 |
| 500' | \$8.50 |
| 1000' | \$15.00 |

LED DUAL DIGITS

PRICED PER PAIR OF 2 DIGITS

| | |
|----------------|-------------|
| MSN373 0.3" CC | \$2.20/Pair |
| MSN374 0.3" CA | \$2.20/Pair |
| MSN384 0.5" CC | \$2.60/Pair |
| MSN384 0.5" CA | \$2.60/Pair |
| MSN783 0.7" CC | \$3.00/Pair |
| MSN784 0.7" CA | \$3.00/Pair |

ALL LEADS BROUGHT OUT FOR EASE OF APPLICATION

0.3" Digits Actual Size 0.85" x 0.8"

0.7" Digits Actual Size 1.25" x 1.7"

0.5" Digits Actual Size 1.05" x 1.0"

SILICON DIODES

| | | | |
|--------|-------|--------|--------|
| 1N4001 | 84/10 | 5.50/C | \$49/M |
| 1N4002 | 84/10 | 5.90/C | \$51/M |
| 1N4003 | 68/10 | 5.90/C | \$52/M |
| 1N4004 | 70/10 | 5.95/C | \$54/M |
| 1N4005 | 82/10 | 7.05/C | \$63/M |
| 1N4006 | 90/10 | 7.75/C | \$69/M |
| 1N4007 | 99/10 | 8.60/C | \$77/M |
| 1N4148 | 40/10 | 3.50/C | \$29/M |

Double Digit Discounts Save You Even More!

1/2 WATT ZENER DIODES

| | |
|-----------------------|-----------------------|
| 1NS2268 3.3v 15 111/C | 1NS2368 7.5v 15 111/C |
| 1NS2278 3.6v 15 111/C | 1NS2378 8.2v 15 111/C |
| 1NS2288 3.9v 15 111/C | 1NS2388 8.7v 15 111/C |
| 1NS2298 4.3v 15 111/C | 1NS2398 9.1v 15 111/C |
| 1NS2308 4.7v 15 111/C | 1NS2408 10v 15 111/C |
| 1NS2318 5.1v 15 111/C | 1NS2418 11v 15 111/C |
| 1NS2328 5.6v 15 111/C | 1NS2428 12v 15 111/C |
| 1NS2338 6.0v 15 111/C | 1NS2438 13v 15 111/C |
| 1NS2348 6.7v 15 111/C | 1NS2448 14v 15 111/C |
| 1NS2358 6.8v 15 111/C | 1NS2458 15v 15 111/C |

BUY A-P PRODUCTS & BISHOP GRAPHICS FROM DIGI-KEY

PLESSEY SAMPLER
An Assortment of Metallized Polyester Capacitors
300 Caps. 18 Values **\$26.00**

LED LAMPS

| | | |
|-----------------|----|--------|
| MSL5D3 T-1 1/4" | 18 | \$15/C |
| MSL5D6 T-1 1/4" | 18 | \$15/C |

MA1003 CAR CLOCK

NEW - FOR CAR OR BOAT!

The MA1003 bright green fluorescent display offers a brilliance that cannot be achieved by LED displays, a feature that sold Ostrant!

12 Hour Only
12 Volt DC
Crystal Time Base
Bright Green Digits
Assembled and Tested

NEW!

0.3" Digits Actual Size 1.75" x 3.05" **MA1003 \$24.95**

Includes 3 Push Button Switches

NEW!

MA1002 0.5" High Digits

Actual Size: 1.375" x 3.05"

| | | |
|--------------------------------|---------------|---------|
| MA1002A | 12 Hour AM-PM | \$10.50 |
| MA1002C | 24 Hour | \$10.50 |
| SPECIAL TRANSFORMER & SWITCHES | | \$3.45 |

ABOUT OUR CLOCKS

The MA1002 and MA1003 series clock modules by National Semiconductor are fully assembled and tested clocks using a 3 digit LED display and an MOS integrated circuit on the same board. Simply connect switches and our special transformer and you have a fully functioning clock.

The MA1003 clock module is a fully assembled and tested 12 hour clock using a high brightness green fluorescent display and crystal time base making it perfect for car, boat or other portable use. It operates directly from 12 volt DC so no transformer is needed. Our price includes three push button switches for setting the time.

| | | |
|-------------|------------------------------------|---------|
| MA1002A | 12 LED 12 Hour AM-PM Clock Module | \$10.50 |
| MA1002A SET | Module with Transformer & Switches | \$13.95 |
| MA1002C | 12 LED 24 Hour Clock Module | \$10.50 |
| MA1002C SET | Module with Transformer & Switches | \$13.95 |
| MA1003 | 12 Volt Car Clock with Switches | \$24.95 |
| MA1010A | 84" LED 12 Hour AM-PM Clock Module | \$13.00 |
| MA1010A SET | Module with Transformer & Switches | \$16.45 |
| MA1010C | 84" LED 24 Hour Clock Module | \$13.00 |
| MA1010C SET | Module with Transformer & Switches | \$16.45 |

RADIAL ELECTROLYTICS

| | | | | | |
|------------|-------|-------------|-------------|--------------|---------|
| 47/50V .08 | 65/10 | 22/50V .12 | 100/10 | 330/25V .23 | 1.86/10 |
| 1/50V .08 | 65/10 | 100/10V .09 | 75/10 | 470/10R .21 | 1.71/10 |
| 22/50V .08 | 65/10 | 100/10V .10 | 77/10 | 470/16V .23 | 1.81/10 |
| 33/50V .08 | 65/10 | 100/16V .11 | 85/10 | 470/25V .29 | 2.35/10 |
| 47/35V .08 | 65/10 | 100/25V .13 | 110/10 | 1000/10V .24 | 1.96/10 |
| 47/50V .08 | 68/10 | 100/50V .21 | 100/50V .21 | 1000/16V .29 | 2.35/10 |
| 10/16V .08 | 65/10 | 220/10V .13 | 106/10 | 1000/25V .42 | 3.33/10 |
| 10/25V .08 | 65/10 | 220/16V .15 | 116/10 | 2200/10V .50 | 3.96/10 |
| 10/50V .10 | 75/10 | 220/25V .21 | 171/10 | 2200/16V .54 | 4.30/10 |
| 22/16V .08 | 67/10 | 220/50V .29 | 235/10 | 2200/25V .58 | 4.67/10 |
| 22/25V .09 | 70/10 | 330/10V .15 | 116/10 | 3300/16V .89 | 7.14/10 |
| | | 330/16V .21 | 166/10 | | |

AXIAL ELECTROLYTICS

| | | | | | |
|-------------|--------|-------------|--------|-------------------|---------|
| 47/10V .11 | 90/10 | 33/25V .14 | 115/10 | 330/16V .29 | 2.35/10 |
| 1/30V .11 | 90/10 | 33/50V .19 | 152/10 | 330/25V .32 | 2.54/10 |
| 3.3/35V .12 | 95/10 | 47/16V .14 | 115/10 | 470/16V .32 | 2.55/10 |
| 3.3/50V .12 | 100/10 | 47/25V .17 | 130/10 | 470/25V .37 | 3.00/10 |
| 4.7/25V .11 | 90/10 | 47/50V .21 | 117/10 | 1000/10V .26 | 1.85/10 |
| 4.7/35V .12 | 95/10 | 100/10V .14 | 113/10 | 1000/16V .39 | 3.15/10 |
| 4.7/50V .12 | 100/10 | 100/16V .17 | 130/10 | 1000/25V .56 | 4.50/10 |
| 10/25V .12 | 100/10 | 100/25V .20 | 155/10 | 2200/10V .50 | 3.96/10 |
| 10/50V .14 | 115/10 | 100/50V .29 | 230/10 | 2200/16V .62 | 4.95/10 |
| 22/16V .12 | 100/10 | 220/10V .18 | 142/10 | 2200/25V .79 | 6.36/10 |
| 22/25V .13 | 105/10 | 220/16V .20 | 155/10 | 3300/16V .95 | 7.63/10 |
| 22/50V .17 | 132/10 | 220/25V .28 | 235/10 | 4700/16V 1.09 | 8.70/10 |
| 33/16V .12 | 100/10 | 220/50V .40 | 325/10 | 1000/115V 9.19/10 | |
| | | 330/10V .14 | 116/10 | | |

MA1010 0.84" High Digits

Actual size: 1.75" x 3.75"

SEND FOR OUR FREE CATALOG
WE STOCK A WIDE VARIETY OF PARTS NOT IN THIS AD PLUS MANY SPECIALLY PRICED BARGAINS!

| | | |
|--------------------------------|---------------|---------|
| MA1010A | 12 Hour AM-PM | \$13.00 |
| MA1010C | 24 Hour | \$13.00 |
| SPECIAL TRANSFORMER & SWITCHES | | \$3.45 |

WIRE-WRAPPING TOOL

\$5.95
Wraps, Unwraps & Strips 30 ga. Wire

1/2 & 1/4 WATT 5% CARBON FILM RESISTORS

\$c each in multiples of 5 per value
\$1.70/100 & \$12.00/1000 at same value

1 ohm thru 1.0 megohm

HARDWARE

| | | |
|----------------|------|--------|
| 2-56 1/4 Screw | 99/C | 7.20/M |
| 2-56 1/2 Screw | 99/C | 7.65/M |
| 4-40 1/4 Screw | 55/C | 3.60/M |
| 4-40 1/2 Screw | 60/C | 4.05/M |
| 6-32 1/4 Screw | 65/C | 4.40/M |
| 6-32 1/2 Screw | 75/C | 4.85/M |
| | | |

7400N TTL

| | | |
|------------|---------------|---------------|
| SN7400N 16 | SN7400NA 25 | SN74154N 1.00 |
| SN7401N 16 | SN7401NA 25 | SN74155N 99 |
| SN7402N 21 | SN7402NA 30 | SN74156N 99 |
| SN7403N 16 | SN7403NA 25 | SN74157N 1.25 |
| SN7404N 24 | SN7404NA 32 | SN74158N 99 |
| SN7405N 24 | SN7405NA 30 | SN74159N 1.25 |
| SN7406N 20 | SN7406NA 27 | SN74160N 1.25 |
| SN7407N 29 | SN7407NA 32 | SN74161N 1.00 |
| SN7408N 25 | SN7408NA 30 | SN74162N 1.00 |
| SN7409N 25 | SN7409NA 32 | SN74163N 1.10 |
| SN7410N 18 | SN7410NA 25 | SN74164N 1.10 |
| SN7411N 30 | SN7411NA 30 | SN74165N 1.25 |
| SN7412N 33 | SN7412NA 39 | SN74166N 1.10 |
| SN7413N 45 | SN7413NA 50 | SN74167N 1.25 |
| SN7414N 70 | SN7414NA 80 | SN74168N 1.25 |
| SN7415N 35 | SN7415NA 40 | SN74169N 1.00 |
| SN7416N 35 | SN7416NA 40 | SN74170N 2.10 |
| SN7417N 35 | SN7417NA 40 | SN74171N 8.95 |
| SN7418N 35 | SN7418NA 40 | SN74172N 1.50 |
| SN7419N 35 | SN7419NA 40 | SN74173N 1.25 |
| SN7420N 31 | SN7420NA 35 | SN74174N 1.25 |
| SN7421N 33 | SN7421NA 39 | SN74175N 1.25 |
| SN7422N 49 | SN7422NA 55 | SN74176N 30 |
| SN7423N 37 | SN7423NA 40 | SN74177N 30 |
| SN7424N 29 | SN7424NA 35 | SN74178N 30 |
| SN7425N 29 | SN7425NA 35 | SN74179N 30 |
| SN7426N 29 | SN7426NA 35 | SN74180N 1.95 |
| SN7427N 37 | SN7427NA 40 | SN74181N 2.00 |
| SN7428N 42 | SN7428NA 45 | SN74182N 1.95 |
| SN7429N 32 | SN7429NA 35 | SN74183N 1.95 |
| SN7430N 36 | SN7430NA 40 | SN74184N 1.95 |
| SN7431N 31 | SN7431NA 35 | SN74185N 1.95 |
| SN7432N 27 | SN7432NA 30 | SN74186N 1.95 |
| SN7433N 27 | SN7433NA 30 | SN74187N 6.00 |
| SN7434N 25 | SN7434NA 30 | SN74188N 3.95 |
| SN7435N 25 | SN7435NA 30 | SN74189N 1.19 |
| SN7436N 25 | SN7436NA 30 | SN74190N 1.25 |
| SN7437N 25 | SN7437NA 30 | SN74191N 1.25 |
| SN7438N 25 | SN7438NA 30 | SN74192N 1.25 |
| SN7439N 25 | SN7439NA 30 | SN74193N 8.95 |
| SN7440N 25 | SN7440NA 30 | SN74194N 1.25 |
| SN7441N 89 | SN7441NA 1.09 | SN74195N 1.25 |
| SN7442N 59 | SN7442NA 1.15 | SN74196N 7.75 |
| SN7443N 75 | SN7443NA 9.00 | SN74197N 1.25 |
| SN7444N 75 | SN7444NA 9.00 | SN74198N 1.25 |
| SN7445N 81 | SN7445NA 4.50 | SN74199N 1.75 |
| SN7446N 81 | SN7446NA 4.50 | SN74200N 5.99 |
| SN7447N 69 | SN7447NA 2.35 | SN74201N 9.00 |
| SN7448N 79 | SN7448NA 3.00 | SN74202N 1.79 |
| SN7449N 76 | SN7449NA 2.50 | SN74203N 6.00 |
| SN7450N 77 | SN7450NA 2.75 | SN74204N 6.00 |
| SN7451N 27 | SN7451NA 30 | SN74205N 6.00 |
| SN7452N 27 | SN7452NA 30 | SN74206N 7.50 |
| SN7453N 27 | SN7453NA 30 | |
| SN7454N 20 | SN7454NA 25 | |

CMOS

| | | | | |
|-------------|-------------|-------------|-------------|-------------|
| CD4001 25 | CD4002 25 | CD4003 1.85 | CD4004 2.50 | CD4005 1.85 |
| CD4006 2.50 | CD4007 2.50 | CD4008 1.50 | CD4009 5.99 | CD4010 5.99 |
| CD4011 25 | CD4012 25 | CD4013 47 | CD4014 56 | CD4015 67 |
| CD4016 47 | CD4017 1.35 | CD4018 1.35 | CD4019 1.49 | CD4020 1.25 |
| CD4021 1.35 | CD4022 1.25 | CD4023 1.35 | CD4024 1.40 | CD4025 1.25 |
| CD4026 1.40 | CD4027 6.99 | CD4028 1.65 | CD4029 2.90 | CD4030 65 |
| LM3001 80 | LM3002 80 | LM3003 80 | LM3004 1.00 | LM3005 1.00 |
| LM3006 1.00 | LM3007 1.00 | LM3008 1.00 | LM3009 1.10 | LM3010 1.10 |
| LM3011 1.10 | LM3012 1.10 | LM3013 1.10 | LM3014 1.10 | LM3015 1.10 |
| LM3016 1.10 | LM3017 1.10 | LM3018 1.10 | LM3019 1.10 | LM3020 1.10 |
| LM3021 1.10 | LM3022 1.10 | LM3023 1.10 | LM3024 1.10 | LM3025 1.10 |
| LM3026 1.10 | LM3027 1.10 | LM3028 1.10 | LM3029 1.10 | LM3030 1.10 |

LINEAR

| | | | | |
|--------------|--------------|--------------|--------------|--------------|
| LM7331N 1.65 | LM7332N 1.65 | LM7333N 1.65 | LM7334N 1.65 | LM7335N 1.65 |
| LM7336N 1.65 | LM7337N 1.65 | LM7338N 1.65 | LM7339N 1.65 | LM7340N 1.65 |
| LM7341N 1.65 | LM7342N 1.65 | LM7343N 1.65 | LM7344N 1.65 | LM7345N 1.65 |
| LM7346N 1.65 | LM7347N 1.65 | LM7348N 1.65 | LM7349N 1.65 | LM7350N 1.65 |
| LM7351N 1.65 | LM7352N 1.65 | LM7353N 1.65 | LM7354N 1.65 | LM7355N 1.65 |

74LS00 TTL

| | | | | |
|-----------|-----------|-----------|-----------|-----------|
| 74LS00 29 | 74LS01 29 | 74LS02 29 | 74LS03 29 | 74LS04 29 |
| 74LS05 29 | 74LS06 29 | 74LS07 29 | 74LS08 29 | 74LS09 29 |
| 74LS10 29 | 74LS11 29 | 74LS12 29 | 74LS13 29 | 74LS14 29 |
| 74LS15 29 | 74LS16 29 | 74LS17 29 | 74LS18 29 | 74LS19 29 |
| 74LS20 29 | 74LS21 29 | 74LS22 29 | 74LS23 29 | 74LS24 29 |
| 74LS25 29 | 74LS26 29 | 74LS27 29 | 74LS28 29 | 74LS29 29 |
| 74LS30 29 | 74LS31 29 | 74LS32 29 | 74LS33 29 | 74LS34 29 |
| 74LS35 29 | 74LS36 29 | 74LS37 29 | 74LS38 29 | 74LS39 29 |
| 74LS40 29 | 74LS41 29 | 74LS42 29 | 74LS43 29 | 74LS44 29 |
| 74LS45 29 | 74LS46 29 | 74LS47 29 | 74LS48 29 | 74LS49 29 |
| 74LS50 29 | 74LS51 29 | 74LS52 29 | 74LS53 29 | 74LS54 29 |
| 74LS55 29 | 74LS56 29 | 74LS57 29 | 74LS58 29 | 74LS59 29 |

CLOCK CHIPS
MM5330 6 Digi. BCD Outputs, Reset Pin \$9.95
MM5331 6 Digi. BCD Outputs, 12 or 24 Hour 4.95
MM5332 4 Digi. BCD Outputs, 1 PPS Output 4.95
MM5334 6 Digi. 12 or 24 Hour, 50 or 60 Hz 4.95
MM5336 4 Digi. Alarm, 1 PPS Output 6.95
MM5318 Video Clock Gen. For Use With (MM5814-895) 9.95
CT7001 6 Digi. Calendar, Alarm, 12 or 24 Hour 4.95

DATA HANDBOOKS
7400 Pin out & Description of 7400 Series ICs \$2.95
CMOS Pin out & Description of 4000 Series ICs \$2.95
Linear Pin out & Functional Description of Linear ICs \$2.95
ALL THREE HANDBOOKS \$6.95

TimebandSM by FAIRCHILD

Watches

Men's & Ladies

- Solid State
- Displays hour, minute, second, month & day
- Snap-out battery replacement
- Free set of replacement batteries
- Choose LED or LCD styles
- One year factory warranty

T701 Black Bracket LED \$19.95

LADIES LED

T731 White w/Bracket \$24.95

T736 Yellow w/Bracket \$34.95

T311 White w/strap \$34.95

T310 Yellow w/strap \$39.95

CHANNEL F™

FAIRCHILD VIDEO ENTERTAINMENT SYSTEM

- Freeze Action • Speed Option
- Automatic time and scorekeeping
- Battery-Free AC operation
- Dual controls with 8-way action
- Built-in Pro Hockey and Tennis games
- Easy hook-up on any B/W w/ Color TV
- Factory warranty

\$159.95

Channel F — additional cartridges — \$19.95 ea.

- #8112 - Desert Fox/Shooting Gallery
- #8113 - Blackjack (1 or 2 players)
- #8114 - Spiffire (1 or 2 players)
- #8115 - Space War
- #8111 - Tic-Tac-Toe/Shooting Gallery/Doodle/Quadra-Doodle

DISCRETE LEADS

| | | | |
|-------------------|-------------------|-------------------|-------------------|
| KC209 Red 10/51 | KC211 Red 10/51 | KC212 Red 10/51 | KC213 Red 10/51 |
| KC209 Green 4/51 | KC211 Green 4/51 | KC212 Green 4/51 | KC213 Green 4/51 |
| KC209 Orange 4/51 | KC211 Orange 4/51 | KC212 Orange 4/51 | KC213 Orange 4/51 |

SPECIAL * KC556 Red \$100/\$8.00 1000/\$60.00 — SPECIAL *

DISPLAY LEADS

| | | | | | |
|-------|-------|-------|-------|-------|-------|
| UL107 | UL108 | UL109 | UL110 | UL111 | UL112 |
| UL113 | UL114 | UL115 | UL116 | UL117 | UL118 |

ATARI GAME BOARDS

Over 80 each reusable IC's \$6.95 ea.
 ONLY 500 EA AVAILABLE
 Diods, Caps, Crystals, Switch etc.

Over 100 each reusable IC's \$9.95 ea.
 ONLY 500 EA AVAILABLE
 Diods, Caps, Crystals, Switches, LEADS, etc.

PH 5082-7300 Multi-Digit Series

• 1/2" Ht. • Common Cathode • Dig. Package
 • 3 to 5 volts @ 5 mls per segment
 • 8 segment Monolithic • Red Display

| | |
|---------|----------|
| 2 Digit | \$ 7.99 |
| 3 Digit | \$ 8.99 |
| 4 Digit | \$ 9.99 |
| 5 Digit | \$ 11.99 |

50 PCS. RESISTOR ASSORTMENTS \$1.25 PER ASST.

| | | | | | | | | | | | | | | | | | | | | | | | |
|---------|-------|--------|--------|--------|--------|--------|--------|--------|--------|--------|--------|--------|--------|--------|---------|---------|---------|---------|---------|---------|---------|---------|-----|
| ASST. 1 | 5 ea. | 10 OHM | 12 OHM | 15 OHM | 18 OHM | 22 OHM | 27 OHM | 33 OHM | 39 OHM | 47 OHM | 56 OHM | 68 OHM | 75 OHM | 82 OHM | 100 OHM | 120 OHM | 150 OHM | 180 OHM | 220 OHM | 270 OHM | 330 OHM | 390 OHM | |
| ASST. 2 | 5 ea. | 10 OHM | 12 OHM | 15 OHM | 18 OHM | 22 OHM | 27 OHM | 33 OHM | 39 OHM | 47 OHM | 56 OHM | 68 OHM | 75 OHM | 82 OHM | 100 OHM | 120 OHM | 150 OHM | 180 OHM | 220 OHM | 270 OHM | 330 OHM | 390 OHM | |
| ASST. 3 | 5 ea. | 1.0K | 1.5K | 1.8K | 2.2K | 2.7K | 3.3K | 3.9K | 4.7K | 5.6K | 6.8K | 8.2K | 10K | 12K | 15K | 18K | 22K | 27K | 33K | 39K | 47K | 56K | 68K |
| ASST. 4 | 5 ea. | 10K | 12K | 15K | 18K | 22K | 27K | 33K | 39K | 47K | 56K | 68K | 75K | 82K | 100K | 120K | 150K | 180K | 220K | 270K | 330K | 390K | |
| ASST. 5 | 5 ea. | 1M | 1.2M | 1.5M | 1.8M | 2.2M | 2.7M | 3.3M | 3.9M | 4.7M | 5.6M | 6.8M | 8.2M | 10M | 12M | 15M | 18M | 22M | 27M | 33M | 39M | 47M | |

JAMES ELECTRONICS

1021-A HOWARD AVE. SAN CARLOS, CA. 94070
 PHONE ORDERS WELCOME — (415) 592-8097
 All Advertised Prices Good Thru July

WIRE WRAP CENTER

HOBBY-STRIP TOOL-BW-630

- Battery Operated (Size C)
- Weighs ONLY 11 Ounces
- Wraps 30 AWG Wire onto Standard DIP Sockets (.025 inch)
- Complete with built-in bit and sleeve

\$34.95

(batteries not included)

WIRE-WRAP KIT — WK-2-W

WRAP • STRIP • UNWRAP

- Tool for 30 AWG Wire
- Roll of 50 Ft. White or Blue 30 AWG Wire
- 50 pcs each 1" x 2" x 3" & 4" lengths — pre-stripped wire.

\$11.95

WIRE WRAP TOOL WSU-30

WRAP • STRIP • UNWRAP \$5.95

WIRE WRAP KIT — 30 AWG

25 ft. mm. \$1.25 50 ft. \$1.95 100 ft. \$2.95 1000 ft. \$15.00
SPECIFY COLOR — White - Yellow - Red - Green - Blue - Black

Plastic Push Button Switch

1" 18 AWG Solid Wire - 5' Long
 .50 (white) X .50 (high) %-.27 Thread
 .8 AMP @ 14 Volt - 1 AMP @ .10 Volt

| | | | |
|---------|------------------|-----|-------|
| J-18P-1 | Push On-Push Off | 1-9 | 10-Up |
| J-18B-2 | Normally Open | 59 | 49 |
| J-18B-3 | Normally Closed | 59 | 49 |

DIP SWITCHES

SPST Single Action

- #206-4 (8 pin dip) 4 switch unit \$1.75 ea.
- #206-7 (14 pin dip) 7 switch unit \$1.95 ea.
- #206-8 (16 pin dip) 8 switch unit \$2.25 ea.

TV GAME CHIP SET — \$18.50

Includes AY-3-8500-1 chip and 2 010 mhz crystal — if purchased separately would cost \$21.90

ZENERS — DIODES — RECTIFIERS

| TYPE | VOLTS | W | PRICE | TYPE | VOLTS | W | PRICE |
|--------|-------|-----------|-------|--------|-------|------------|--------|
| 1N4746 | 3.3 | 400mm | 4/10 | 1N4001 | 50 | PIV 1 AMP | 10/100 |
| 1N751A | 5.1 | 400m | 4/10 | 1N4006 | 800 | PIV 1 AMP | 10/100 |
| 1N522 | 5.6 | 400m | 4/10 | 1N4007 | 1000 | PIV 1 AMP | 10/100 |
| 1N753 | 6.2 | 400m | 4/10 | 2N1620 | 50 | 200m | 6/100 |
| 1N524 | 6.8 | 400m | 4/10 | 1N4134 | 35 | 100m | 12/100 |
| 1N680 | 6.8 | 400m | 4/10 | 1N4135 | 75 | 25m | 20/100 |
| 1N525 | 7.5 | 400m | 28 | 1N4738 | 6.2 | 1w | 28 |
| 1N456 | 25 | 40m | 6/10 | 1N4742 | 12 | 1w | 28 |
| 1N458 | 150 | 7m | 6/10 | 1N4743 | 15 | 1w | 28 |
| 1N458A | 180 | 100 | 6/10 | 1N4745 | 100 | PIV 35 AMP | 1.60 |
| 1N4000 | 50 | PIV 1 AMP | 12/10 | 1N1814 | 100 | PIV 35 AMP | 1.70 |
| 1N4001 | 50 | PIV 1 AMP | 12/10 | 1N1815 | 150 | PIV 35 AMP | 1.50 |
| 1N4003 | 200 | PIV 1 AMP | 12/10 | 1N1816 | 200 | PIV 35 AMP | 1.80 |
| 1N4004 | 400 | PIV 1 AMP | 12/10 | 1N1818 | 400 | PIV 35 AMP | 3.00 |

SCR AND FW BRIDGE RECTIFIERS

| | | | |
|-----------|-------------|---------------|--------|
| C360 | 15A @ 400V | SCR | \$1.95 |
| C38M | 35A @ 200V | SCR | 1.95 |
| 2N2328 | 1.6A @ 200V | SCR | .50 |
| MDA 980-1 | 12A @ 200V | FW BRIDGE REC | 1.95 |
| MDA 980-3 | 12A @ 200V | FW BRIDGE REC | 1.95 |

TRANSISTORS

| | | | |
|--------|--------|--------|--------|
| 2N2002 | 451.00 | 2N2003 | 451.00 |
| 2N2004 | 451.00 | 2N2005 | 451.00 |
| 2N2006 | 451.00 | 2N2007 | 451.00 |
| 2N2008 | 451.00 | 2N2009 | 451.00 |
| 2N2010 | 451.00 | 2N2011 | 451.00 |

CAPACITOR CORNER

| | | | | | | | | | |
|-------|----|----|----|-------|-----|----|-----|----|-----|
| 10 pF | 05 | 04 | 03 | 001uF | 1.9 | 10 | 49 | 50 | 100 |
| 22 pF | 05 | 04 | 03 | 002uF | 05 | 04 | 035 | 0 | |

CRYSTALS

THESE FREQUENCIES ONLY

| Part # | Frequency | Case Style | Price |
|--------|--------------|------------|--------|
| CY14 | 1.000 MHz | HC33/U | \$5.95 |
| CY24 | 2.000 MHz | HC33/U | \$5.95 |
| CY3A | 4.000 MHz | HC18/U | \$4.95 |
| CY7A | 5.000 MHz | HC18/U | \$4.95 |
| CY12A | 10.000 MHz | HC18/U | \$4.95 |
| CY14A | 14.31818 MHz | HC18/U | \$4.95 |
| CY19A | 18.000 MHz | HC18/U | \$4.95 |
| CY22A | 20.000 MHz | HC18/U | \$4.95 |
| CY30B | 32.000 MHz | HC18/U | \$4.95 |

XR-2206KB KH \$29.95 Special XR-2206KA KH \$19.95

EXAR

| WAVEFORM GENERATORS | THIMERS |
|------------------------|----------------------|
| XR 205 \$8.40 | XR-556CP \$ 5.39 |
| XR 2206CP 3.48 | XR-3209 1.55 |
| | XR-556CP 1.85 |
| | XR-2556CP 3.20 |
| STEREO DECODERS | MISCELLANEOUS |
| XR 1310CP \$3.20 | XR-2211CP \$6.70 |
| XR 1310EP 3.20 | XR-1336 99 |
| XR 1800CP 3.20 | XR-1468 3.85 |
| XR 2567 2.99 | XR-210 5.20 |
| | XR-215 6.60 |
| | XR-567CP 1.95 |
| | XR-2208 5.20 |
| | XR-567CT 1.70 |

CONNECTORS
PRINTED CIRCUIT EDGE-CARD

156 Spacing-Tin-Double Read-Out
Bifurcated Contacts — Fits 054 to .070 P.C. Cards

| | | |
|------------------------|----------------------|--------|
| 15/30 | PINS (Solder Eyelet) | \$1.95 |
| 18/36 | PINS (Solder Eyelet) | \$2.49 |
| 22/44 | PINS (Solder Eyelet) | \$2.95 |
| 50/100 (.100 Spacing) | PINS (Solder Eyelet) | \$6.95 |

25 PIN-D SUBMINATURE

| | | |
|-------|--------|--------|
| DB25P | PLUG | \$3.25 |
| DB25S | SOCKET | \$4.95 |

3 1/2 DIGIT DVM KIT

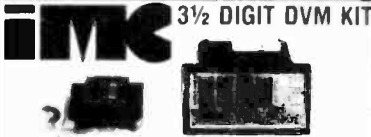

This 0-2 VDC .05 per cent digital voltmeter features the Motorola 3 1/2 digit DVM chip set. It has a 4 LED display and operates from a single 5V power supply. The unit is provided complete with an injection molded black plastic case complete with Bezels. An optional power supply is available which fits into the same case as the 0-2 VDC allowing 117 VAC operation.

- | | |
|------------------------------|---------|
| A. 0-2V DVM with Case | \$49.95 |
| B. 5V Power Supply | \$14.95 |

Etching Kits

| | | |
|----------|--|-------------|
| 32 X A-1 | P.C. Etch Materials Kit enough for 5 circuit boards | \$29.95 ea. |
| 27 X A-1 | Etched Circuit Kit Complete kit — only add water | \$ 9.95 ea. |
| 3662 | 6.5 X 4.5 X 1/16 Epoxy glass P-Pattern-44 P.C. Tabs-spaced 156 | \$ 6.95 ea. |
| 8800V | Universal Microcomputer Processor plugboard — Epoxy Glass — complete with heatsink and mounting hardware 5.313 X 10 X 1/16 copper clad | \$19.95 ea. |

1/16 VECTOR BOARD

| Part No. | P-Pattern | L | W | Price | 1-2-Up |
|--------------------------|------------------|------|-------|-------|--------|
| PHENOLIC | 64P44 062 X 14P | 4.50 | 6.50 | 1.72 | 1.54 |
| FR-04Y | 169P44 029 X 14P | 4.50 | 17.00 | 3.69 | 3.52 |
| GLASS | 64P44 062 | 4.50 | 6.50 | 7.01 | 1.86 |
| | 84P44 062 | 4.50 | 8.50 | 2.56 | 2.31 |
| FR-04Y GLASS COPPER CLAD | 169P44 062 | 4.50 | 17.00 | 5.04 | 4.53 |
| | 189P44 062 | 4.50 | 17.00 | 9.23 | 8.26 |
| | 169P44 062CT | 4.50 | 17.00 | 6.80 | 6.12 |

HEAT SINKS

| | | |
|---------|--|--------|
| 205-CB | Beryllium Copper Heat Sink with Black Finish for TO 5 | \$.25 |
| 291-36H | Aluminum Heat Sink for TO-220 Transistors & Regulators | \$.25 |
| 680-75A | Black Anodized Aluminum | \$1.60 |

HEXADECIMAL ENCODER 19-KEY PAD

- 1-0
- A-F
- Return Key
- Optional Key (Period)
- Key

\$10.95 each

63 KEY KEYBOARD

This keyboard features 63 unencased SMT keys unattached to any kind of P.C.B. A very solid molded plastic 13 x 4 base suits most applications.

\$19.95

JOYSTICK

These joysticks feature four potentiometers, that vary resistance proportional to the angle of the stick. Sturdy metal construction with plastics components only at the movable joint. Perfect for electronic games and instrumentation.

Special *5K Pots \$4.95
*100K Pots \$7.95

MICROPROCESSOR COMPONENTS

| | | | |
|---------------------------------|---------|-------------------------------------|---------|
| 8080A CPU | \$19.95 | 8228 System Controller - Bus Driver | \$10.95 |
| 8212 8 Bit Input/Output | 4.95 | MC6800L 8 Bit MPU | 35.00 |
| 8214 Priority Interrupt Control | 15.95 | MC6820L Periph. Interface Adapter | 15.00 |
| 8216 Bi-Directional Bus Driver | 6.95 | MC6810A1 128 x 8 Static RAM | 6.00 |
| 8224 Clock Generator/Driver | 10.95 | MC6830L7 1024 x 8 Bit ROM | 18.00 |
| CDP1802 w/ user manual | 39.95 | Z80 CPU | 49.95 |

| 8080 | Super 8088 | 21.95 | 1101 | 256 x 1 | Static | \$ 1.49 | |
|-------|------------|-------|--------|----------|----------|------------|------|
| 8080A | Super 8088 | 19.95 | 2101 | 256 x 4 | Static | 5.95 | |
| | | | 2102 | 1024 x 4 | Static | 1.75 | |
| | | | 2107 | 5280 | 4096 x 4 | Dynamic | 4.95 |
| | | | 7489 | 16 x 4 | Static | 3.49 | |
| | | | 8101 | 256 x 4 | Static | 6.95 | |
| | | | 8111 | 256 x 4 | Static | 6.95 | |
| | | | 8989 | 16 x 4 | Static | 3.49 | |
| | | | 91102 | 1024 x 4 | Static | 2.25 | |
| | | | 74200 | 256 x 4 | Static | 6.95 | |
| | | | 93421 | 256 x 4 | Static | 2.95 | |
| | | | MM5262 | 2K x 1 | Dynamic | 2 for 1.35 | |

| SR 5 | Price | RAM'S | Price |
|-------------------|-----------------|--------------|--------------------------------|
| 9504 1024 Dynamic | \$ 3.95 | 5203A 3048 | Famos \$ 9.95 |
| 2518 Hex 32 BIT | 7.00 | 5203B 2048 | Famos 14.95 |
| 2519 Hex 40 BIT | 4.00 | 82573 32 x 8 | Open C. 5.00 |
| 2524 512 Dynamic | 2.49 | 82573 32 x 8 | Tri-state 7.95 |
| 2525 1024 Dynamic | 6.00 | 74529 1024 | Static 3.95 |
| 2527 Dual 256 BIT | 3.95 | 8601 256 x 4 | Static 3.95 |
| 2529 Dual 512 BIT | 4.00 | 9718 | 64 x 1 2.95 |
| 2532 Quad 80 BIT | 3.95 | 5801 1 | 1024 Tri-State Buffer 3.49 |
| 2533 1024 Static | Special \$ 9.95 | 6330 1 | 256 Open Collector Buffer 2.95 |
| 3341 F40 | 8.95 | 6331 1 | 256 Tri-State Buffer 2.95 |
| 74L562 16 x 4 | REG. 3.95 | | |

SPECIAL REQUESTED ITEMS

| | | | | | | | |
|-----------------|---------|---------|-------|---------|-------|-------------|-----------|
| AY 3-8500-1 | \$16.95 | CD4506 | 6.75 | 825143 | 25.00 | 8197 | 2.00 |
| MC3081P | 3.50 | CD4508 | 6.50 | 5841 | 9.95 | 9386 | 6.95 |
| MC4016P (74+16) | 7.50 | CD4515 | 6.50 | 5841 | 9.95 | 9386 | 6.95 |
| MC14583 | 3.50 | CD4520 | 2.70 | MK50240 | 17.50 | MC1408L7 | 9.95 |
| MC14582 | 14.50 | MCM6571 | 17.50 | 11C90 | 19.95 | LD110 LD111 | 25.00 set |
| CD4029 | 9.95 | MCM6574 | 17.50 | 82002CH | 3.75 | AY 5-8190 | 17.50 ea |
| CD4070 | 95 | MCM6575 | 17.50 | TL308 | 10.50 | 95980 | 13.95 |

PARATRONICS
Featured on February's Front Cover of Popular Electronics

Logic Analyzer Kit MODEL 100A \$189.00/Kit

- Analyzes any type of digital system
- Checks data rates in excess of 8 million words per second
- Trouble shoot TTL, CMOS, DTL, RTL, Schottky and MOS families
- Displays 16 logic states up to 8 digits wide
- See ones and zeros displayed on your CRT, octal or hexadecimal format
- Tests circuits under actual operating conditions
- Easy to assemble — comes with step-by-step construction manual which includes 80 pages of logic analyzer operation

• Some applications are:
— Troubleshooting microprocessor address, instruction, and data flow
— Examine contents of ROMs
— Tracing operation of control logic
— Checking counter and shift register operation
— Monitoring I/O sequences
— Verifying proper system operations during testing

BUGBOOK
Continuing Education Series

- BUGBOOK I & II - Basic concepts of TTL Logic — over 90 experiments \$17.00/set
- BUGBOOK III - Introduces UART — recommended for RTTY enthusiast \$5.00/book
- BUGBOOK III - Explores 8080 chip — Introduces Mark 80 Microcomputer \$15.00/book

555 TIMER APPLICATIONS SOURCEBOOK WITH EXPERIMENTS — over 100 design techniques \$6.95/book

CMOS-M-DESIGNERS PRIMER AND HANDBOOK
a complete CMOS instruction manual \$6.00

Introducing Offer — all 3 books (worth \$49.95) SPECIAL - \$42.95

CONTINENTAL SPECIALTIES

| | | |
|-----------------------------|--------------------------------------|--------------------------------|
| PROTO BOARD 6 | Other CS Proto Boards | PROTO CLIPS |
| \$15.95 (6" long X 4" wide) | PB100 - 4.5" x 6" \$ 19.95 | 14 PIN \$4.50 |
| | PB101 - 5.8" x 4.5" 29.95 | 16 PIN 4.75 |
| | PB102 - 7" x 4.5" 39.95 | 24 PIN 8.50 |
| | PB103 - 9" x 6" 59.95 | DESIGN MATES |
| | PB104 - 9.5" x 8" 79.95 | DM1 - Circuit Designer 54.95 |
| | PB203 - 9.75 x 6 1/4 x 2 1/4 75.00 | DM2 - Function Generator 69.95 |
| | PB203A - 9.75 x 6 1/4 x 2 1/4 120.00 | DM3 - RC Bridge 59.95 |
| | (includes power supply) | |
| | Logic Monitor \$84.95 | |
| | for DTL, RTL, TTL or CMOS Devices | |

QT PROTO STRIPS

| QT type | #holes | price |
|---------|-----------|-------|
| QT-595 | 590 | 12.50 |
| QT-596 | bus strip | 7.50 |
| QT-475 | 470 | 10.00 |
| QT-478 | bus strip | 2.25 |
| QT-355 | 350 | 8.50 |
| QT-356 | bus strip | 2.00 |
| QT-185 | 180 | 4.75 |
| QT-125 | 120 | 1.75 |
| QT-85 | 80 | 3.25 |
| QT-75 | 70 | 3.00 |

Experimental 300 \$ 9.95
Experimental 600 \$ 10.95

\$5.00 Minimum Order — U.S. Funds Only Spec. Sheets - 25c — Send 35c Stamps for 1977A Catalog
California Residents — Add 8% Sales Tax Dealer Discount Available — Request Pricing

James ELECTRONICS
1021-A HOWARD AVE., SAN CARLOS, CA. 94070
PHONE ORDERS WELCOME — (415) 592-8097
All Advertiser Prices Good Thru July

Timeband
Digital Alarm Clocks

• 24-hour alarm
• Doze Button
• 100% Solid State
• Large Red LED Display
• 8" digits
• AM/PM Indicator
• Seconds display at touch of button
• Power failure indicator
• One year factory warranty

C-500 Ivory Case \$16.95
C-8211 Woodgrain Case \$19.95

DIGITAL AUTO INSTRUMENT SEVEN DIFFERENT INSTRUMENTS!
MEETS OR EXCEEDS ORIGINAL AUTOMOTIVE SPECS
Please specify which one of the seven meters you want when ordering — these do not all come in one unit. Each meter must be bought separately.

| | |
|--|-------------------------------------|
| TACHOMETER 1-9900 RPM 4, 6 or 8 Cylinders | SPEEDOMETER 0-99 MPH |
| WATER TEMP 100-250° F | OIL PRESSURE 0-80 PSI |
| FUEL LEVEL 3 Percentage Low Fuel Indicator | Oil TEMP 200-350° F |
| BATTERY MONITOR 11 Volts From 11-15 VDC | BRIGHT YELLOW ORANGE 1 FLD DISPLAY! |

Kit includes case, bracket and all components — complete. Nothing else to buy! 12 Volt NEG GND. DIMENSIONS: 4 1/2 x 4 x 2 KIT: \$49.95 ASSEMBLED: \$59.95

DIGITAL STOPWATCH

- Bright 6-Digit LED Display
- Times to 59 minutes 59.99 seconds
- Crystal Controlled Time Base
- Three Stopwatches in One
- Times Single Event — Split & Taylor
- Size 4 1/2 x 2 1/5 x .90 (4 1/2 ounces)
- Uses 3 Penner Cells

Kit — \$39.95
Assembled — \$49.95
Heavy Duty Carry Case \$5.95

Stop Watch Chip Only (7205) \$19.95

ELECTRONIC 'PENDULUM' CLOCK

- Swing Pendulum
- 7 Hours and Minutes Display
- 12 or 24 Hour Mode
- Time Set Push Buttons
- Alarm Feature

Kit-unfinished \$59.95
(case unassembled)
Assembled-stained \$69.95
(case assembled)

QUARTZ DIGITAL AUTO CLOCK OR ELAPSED TIMER!

Elapsed Timer: Hrs, Mins and Secs
12 or 24 Hr Capacity
Simple Reset Start Pushbutton Control

Complete kit includes mounting bracket, case and all components, nothing else to buy. Features MM5314 chip (Large 4 LED's Accuracy better than .1 min. per mo. internal battery backup 12 volt non-polar. internal).

DIMENSIONS: 4 1/2 x 4 x 2
12 or 24 HOUR MODE

Kit: \$29.95
Assembled: \$39.95

JE700 CLOCK

The JE 700 is a low cost digital clock but is a very high quality unit. The unit has features a transformer wound case with dimensions of 6 x 2 1/4 x 1. It utilizes a MAX72 high brightness readout, and the MM5314 clock chip.

12 or 24 Hour \$17.95
115 VAC

DIGITAL CLOCK KIT — 3 1/2 INCH DIGITS

| | |
|---------------------|---------------------------|
| 4 DIGIT KIT \$49.95 | 4 DIGIT ASSEMBLED \$59.95 |
| 6 DIGIT KIT \$69.95 | 6 DIGIT ASSEMBLED \$79.95 |

This clock features big 3 1/2" high digits for viewing in offices, auditoriums, etc. Each digit is formed by 31 bright 0.2" LED's. The clock operates from 117 VAC, has either 12 or 24 hr. operation. The 6 digit version is 2 7/8" x 3 1/4" x 1 1/2" and the 4 digit is 1 7/8" x 3 1/4" x 1 1/2". Kits come complete with all components, case and transformer.
Specify 12 or 24 Hour When Ordering

JE803 PROBE

The Logic Probe is a unit which is for the most part interchangeable in trouble shooting logic families. TTL, DTL, RTL, CMOS. It derives the power & needs to operate directly off of the circuit under test drawing a scant 10 mA max. It uses a MAX3 readout to indicate any of the following states by these symbols: (0), 1, (LOW), 0, (PU), 1, 0, 1. The probe can detect high frequency pulses to 45 MHz. It can be used at MOS levels or circuit damage will result.

\$9.95 Per Kit
printed circuit board

T*L 5V 1A Supply
This is a standard TTL power supply using the well known LM309K regulator IC to provide a solid 1 AMP of current at 5 volts. We try to make things easy for you by providing everything you need in one package, including the hardware for you.
\$9.95 Per Kit

PARTS! CORNELL TUBES!

FREE Send For FREE CORNELL'S New Color Catalog 48 Pgs. New Items IN LOTS OF 100 IN 24 HOURS

33¢ per tube **36¢** per tube

ORDER FREE IF NOT SHIPPED IN 24 HOURS

4215 E. UNIVERSITY AVE. SAN DIEGO, CALIF. 92105

C2708, 8K eprom: \$35.00; C1702A: \$7.50. Programming: C2708—\$20.00; C1702A—\$5.00. Send HEX or OCTAL listing. COM2502 UART \$6.95; MM5330, 4 1/2-digit DVM chip: \$9.75. LH0070CH-1: \$4.50. NSL4944 AC/DC universal LED: \$.75. Liquid crystal, 3 1/2-digit, .4" display: \$6.95. Free catalog. **ELECTRONIC DISCOUNT SALES**, 138 N. 81st Street, Mesa, AZ 85207

NEGATIVE ION generator (dual stage) \$275.00. Complete kit—\$165.00. Detailed construction plans—\$10.00. **GOLDEN ENTERPRISES**, Box 1282RE, Glendale, AZ 85311

MAKE professional-quality PC boards with silk-screen techniques. Complete step by step information, \$4.95 Postpaid. **TERRATRONIC RESEARCH**, Box 513J, Quincy, IL 62301

FERRIC chloride etching liquid. Pints, quarts, gallons. Send sase. **BOB'S ELECTRONICS**, Box 393-R, Bay City, MI 48707

EC-101 CURVE TRACER

STILL BY FAR THE LOWEST COST FULL FUNCTION CURVE TRACER ON THE MARKET. ATTACHES TO YOUR SCOPE IN SECONDS. USED BY EDUCATORS, PROFESSIONALS AND HOBBYISTS ALL OVER THE WORLD. 30 DAY MONEYBACK GUARANTEE.

lab science STILL ONLY \$39.50 C.O.D. RES. ADD 3 1/2% SALES TAX

PO BOX 172, BOULDER, COLO. 80506

NAME brand digital/analog test equipment. Discount prices. Free catalog. **SALEN ELECTRONICS**, P.O. Box 82, Skokie, IL 60076

Introducing **Equinox 100** computer kit



EQUINOX 100

THE FRONTRUNNER. Equinox 100: the 8080 CPU/S-100 Bus computer kit that's years in front of Altair* and IMSAI in design, function, and front panel programming capability. At \$699, it's clearly The Frontrunner. Write for free specs to **PARASITIC ENGINEERING** P.O. Box 6314, Albany California 94706 *Altair is a trademark of MITS, Inc.

CARBON film resistors—1/4W, 5% (1-4M7 ohms) 3.5¢ each. 50¢ value—.80\$. Postage, handling \$1.00. Send 25¢ for catalog, sample, specifications. **COMPONENTS CENTER**, Box 134R, New York, NY 10038

PICTURE TUBE MACHINE

We buy and sell **NEW** and **USED CRT** rebuilding machinery. **COMPLETE TRAINING.** Buy with **CONFIDENCE** from the **ORIGINAL MFR.**

For complete details send name, address, zip to:

LAKESIDE INDUSTRIES 3520 W. Fullerton Ave. Chicago, Ill. 60647 Phone: 312-342-3399

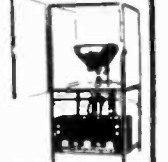

NEW!

The PTX Test Board

Look at these features!

- Solid printed circuit board.
- Numbered tie points and colored plugs for easier connections.
- All parts can be reused.

Good for all breadboarding uses from simple hobby projects to microprocessor applications. Greater capacity than other similar boards. Handles 10 IC's in different sizes; (14, 16, 24, 28, and 40 pin DIL). The PTX kit includes: Board, plugs, sockets & eyelets. Only \$36.25—Order # 141

ALSO NEW!

A complete package for the Experimenter including the above PTX kit and these 3 specially selected books: Basic Digital Electronics Course, OP AMP Circuit Design and Applications, Optoelectronics Guidebook—with tested projects (Electronic dice, logic probe and much, much more) All for only \$49.95—Order # 511

Other books of interest!

Programming Microprocessors—Order #985—\$6.95
Microprocessor/Microprogram. Handbook—Order #785—\$6.95
Computer Programming Handbook—Order #752—\$8.95
Master Handbook of 1001 Practical Electronic Circuits—Order #800—\$9.95
All items are postpaid.
N.Y. City and State residents add tax.

PRINTRONIX

1361 Flatbush Ave., Bklyn, N.Y. 11210

Please send: _____ # 141 _____ # 511
_____ # 985 _____ # 785 _____ # 752 _____ # 800

Total check or money order _____

Name: _____
Address: _____
City: _____ State: _____ Zip: _____

P.O. Box 4430E Santa Clara, CA 95054 (408) 988-1640

Quest ELECTRONICS

Same day shipment. First line parts only. Factory tested. Guaranteed money back. Quality IC's and other components at factory prices.

INTEGRATED CIRCUITS

| | | | | | | | | |
|--------|---------|------|---------|------|--------|------|--------|-------|
| 74001L | 741527N | 34 | LM10124 | 1.70 | CD4001 | 25 | 74C00 | 79 |
| 74002 | 741528N | 41 | LM1043A | 4.50 | CD4002 | 25 | 74C04 | 33 |
| 74003 | 741529N | 28 | LM1051 | 4.50 | CD4003 | 1.35 | 74C10 | 215 |
| 74004 | 741530N | 19 | LM1070 | 1.15 | CD4004 | 2.5 | 74C14 | 28 |
| 74009 | 741532N | 35 | LM1077 | 4.50 | CD4010 | 53 | 74C24 | 2.35 |
| 74100 | 741534N | 44 | LM1078 | 4.50 | CD4011 | 2.0 | 74C32 | 1.5 |
| 74101 | 741535N | 65 | LM1080A | 1.00 | CD4012 | 1.25 | 74C37 | 1.40 |
| 74114 | 741537N | 1.10 | LM1081 | 4.50 | CD4013 | 1.85 | 74C43 | 1.40 |
| 74119 | 741538N | 1.10 | LM1083 | 1.60 | CD4014 | 1.25 | 74C83 | 1.40 |
| 74129 | 741541N | 1.10 | LM1084 | 4.50 | CD4015 | 1.25 | 74C85 | 2.0 |
| 74130 | 741542N | 1.10 | LM1085 | 1.60 | CD4016 | 50 | 74C93 | 1.40 |
| 74131 | 741543N | 1.10 | LM1086 | 1.60 | CD4017 | 1.00 | 74C154 | 3.00 |
| 74132 | 741544N | 1.10 | LM1087 | 1.60 | CD4018 | 1.25 | 74C190 | 1.40 |
| 74133 | 741545N | 1.10 | LM1088 | 1.60 | CD4019 | 2.00 | 74C192 | 2.40 |
| 74134 | 741546N | 1.10 | LM1089 | 1.60 | CD4020 | 1.25 | 74C203 | 2.0 |
| 74135 | 741547N | 1.10 | LM1090 | 1.60 | CD4021 | 1.25 | 74C209 | 3.75 |
| 74136 | 741548N | 1.10 | LM1091 | 1.60 | CD4022 | 1.40 | 74C268 | 1.50 |
| 74137 | 741549N | 1.10 | LM1092 | 1.60 | CD4023 | 2.5 | 74C284 | 1.95 |
| 74138 | 741550N | 1.10 | LM1093 | 1.60 | CD4024 | 85 | 74C295 | 10.50 |
| 74139 | 741551N | 1.10 | LM1094 | 1.60 | CD4025 | 75 | 74C325 | 10.50 |
| 74140 | 741552N | 1.10 | LM1095 | 1.60 | CD4026 | 3.85 | 74C367 | 10.50 |
| 74141 | 741553N | 1.10 | LM1096 | 1.60 | CD4027 | 1.0 | 74C369 | 7.5 |
| 74142 | 741554N | 1.10 | LM1097 | 1.60 | CD4028 | 1.70 | 80V9 | 7.5 |
| 74143 | 741555N | 1.10 | LM1098 | 1.60 | CD4029 | 1.70 | 80V10 | 7.5 |
| 74144 | 741556N | 1.10 | LM1099 | 1.60 | CD4030 | 4.2 | 80V11 | 7.5 |
| 74145 | 741557N | 1.10 | LM1100 | 1.60 | CD4031 | 2.00 | 80V12 | 7.5 |
| 74146 | 741558N | 1.10 | LM1101 | 1.60 | CD4032 | 2.00 | 80V13 | 7.5 |
| 74147 | 741559N | 1.10 | LM1102 | 1.60 | CD4033 | 2.00 | 80V14 | 7.5 |
| 74148 | 741560N | 1.10 | LM1103 | 1.60 | CD4034 | 2.00 | 80V15 | 7.5 |
| 74149 | 741561N | 1.10 | LM1104 | 1.60 | CD4035 | 2.00 | 80V16 | 7.5 |
| 74150 | 741562N | 1.10 | LM1105 | 1.60 | CD4036 | 2.00 | 80V17 | 7.5 |
| 74151 | 741563N | 1.10 | LM1106 | 1.60 | CD4037 | 2.00 | 80V18 | 7.5 |
| 74152 | 741564N | 1.10 | LM1107 | 1.60 | CD4038 | 2.00 | 80V19 | 7.5 |
| 74153 | 741565N | 1.10 | LM1108 | 1.60 | CD4039 | 2.00 | 80V20 | 7.5 |
| 74154 | 741566N | 1.10 | LM1109 | 1.60 | CD4040 | 2.00 | 80V21 | 7.5 |
| 74155 | 741567N | 1.10 | LM1110 | 1.60 | CD4041 | 2.00 | 80V22 | 7.5 |
| 74156 | 741568N | 1.10 | LM1111 | 1.60 | CD4042 | 2.00 | 80V23 | 7.5 |
| 74157 | 741569N | 1.10 | LM1112 | 1.60 | CD4043 | 2.00 | 80V24 | 7.5 |
| 74158 | 741570N | 1.10 | LM1113 | 1.60 | CD4044 | 2.00 | 80V25 | 7.5 |
| 74159 | 741571N | 1.10 | LM1114 | 1.60 | CD4045 | 2.00 | 80V26 | 7.5 |
| 74160 | 741572N | 1.10 | LM1115 | 1.60 | CD4046 | 2.00 | 80V27 | 7.5 |
| 74161 | 741573N | 1.10 | LM1116 | 1.60 | CD4047 | 2.00 | 80V28 | 7.5 |
| 74162 | 741574N | 1.10 | LM1117 | 1.60 | CD4048 | 2.00 | 80V29 | 7.5 |
| 74163 | 741575N | 1.10 | LM1118 | 1.60 | CD4049 | 2.00 | 80V30 | 7.5 |
| 74164 | 741576N | 1.10 | LM1119 | 1.60 | CD4050 | 2.00 | 80V31 | 7.5 |
| 74165 | 741577N | 1.10 | LM1120 | 1.60 | CD4051 | 2.00 | 80V32 | 7.5 |
| 74166 | 741578N | 1.10 | LM1121 | 1.60 | CD4052 | 2.00 | 80V33 | 7.5 |
| 74167 | 741579N | 1.10 | LM1122 | 1.60 | CD4053 | 2.00 | 80V34 | 7.5 |
| 74168 | 741580N | 1.10 | LM1123 | 1.60 | CD4054 | 2.00 | 80V35 | 7.5 |
| 74169 | 741581N | 1.10 | LM1124 | 1.60 | CD4055 | 2.00 | 80V36 | 7.5 |
| 74170 | 741582N | 1.10 | LM1125 | 1.60 | CD4056 | 2.00 | 80V37 | 7.5 |
| 74171 | 741583N | 1.10 | LM1126 | 1.60 | CD4057 | 2.00 | 80V38 | 7.5 |
| 74172 | 741584N | 1.10 | LM1127 | 1.60 | CD4058 | 2.00 | 80V39 | 7.5 |
| 74173 | 741585N | 1.10 | LM1128 | 1.60 | CD4059 | 2.00 | 80V40 | 7.5 |
| 74174 | 741586N | 1.10 | LM1129 | 1.60 | CD4060 | 2.00 | 80V41 | 7.5 |
| 74175 | 741587N | 1.10 | LM1130 | 1.60 | CD4061 | 2.00 | 80V42 | 7.5 |
| 74176 | 741588N | 1.10 | LM1131 | 1.60 | CD4062 | 2.00 | 80V43 | 7.5 |
| 74177 | 741589N | 1.10 | LM1132 | 1.60 | CD4063 | 2.00 | 80V44 | 7.5 |
| 74178 | 741590N | 1.10 | LM1133 | 1.60 | CD4064 | 2.00 | 80V45 | 7.5 |
| 74179 | 741591N | 1.10 | LM1134 | 1.60 | CD4065 | 2.00 | 80V46 | 7.5 |
| 74180 | 741592N | 1.10 | LM1135 | 1.60 | CD4066 | 2.00 | 80V47 | 7.5 |
| 74181 | 741593N | 1.10 | LM1136 | 1.60 | CD4067 | 2.00 | 80V48 | 7.5 |
| 74182 | 741594N | 1.10 | LM1137 | 1.60 | CD4068 | 2.00 | 80V49 | 7.5 |
| 74183 | 741595N | 1.10 | LM1138 | 1.60 | CD4069 | 2.00 | 80V50 | 7.5 |
| 74184 | 741596N | 1.10 | LM1139 | 1.60 | CD4070 | 40 | M16 | 2.00 |
| 74185 | 741597N | 1.10 | LM1140 | 1.60 | CD4071 | 40 | M17 | 2.00 |
| 74186 | 741598N | 1.10 | LM1141 | 1.60 | CD4072 | 40 | M18 | 2.00 |
| 74187 | 741599N | 1.10 | LM1142 | 1.60 | CD4073 | 40 | M19 | 2.00 |
| 74188 | 741600N | 1.10 | LM1143 | 1.60 | CD4074 | 40 | M20 | 2.00 |
| 74189 | 741601N | 1.10 | LM1144 | 1.60 | CD4075 | 40 | M21 | 2.00 |
| 74190 | 741602N | 1.10 | LM1145 | 1.60 | CD4076 | 40 | M22 | 2.00 |
| 74191 | 741603N | 1.10 | LM1146 | 1.60 | CD4077 | 40 | M23 | 2.00 |
| 74192 | 741604N | 1.10 | LM1147 | 1.60 | CD4078 | 40 | M24 | 2.00 |
| 74193 | 741605N | 1.10 | LM1148 | 1.60 | CD4079 | 40 | M25 | 2.00 |
| 74194 | 741606N | 1.10 | LM1149 | 1.60 | CD4080 | 40 | M26 | 2.00 |
| 74195 | 741607N | 1.10 | LM1150 | 1.60 | CD4081 | 40 | M27 | 2.00 |
| 74196 | 741608N | 1.10 | LM1151 | 1.60 | CD4082 | 40 | M28 | 2.00 |
| 74197 | 741609N | 1.10 | LM1152 | 1.60 | CD4083 | 40 | M29 | 2.00 |
| 74198 | 741610N | 1.10 | LM1153 | 1.60 | CD4084 | 40 | M30 | 2.00 |
| 74199 | 741611N | 1.10 | LM1154 | 1.60 | CD4085 | 40 | M31 | 2.00 |
| 74200 | 741612N | 1.10 | LM1155 | 1.60 | CD4086 | 40 | M32 | 2.00 |
| 74201 | 741613N | 1.10 | LM1156 | 1.60 | CD4087 | 40 | M33 | 2.00 |
| 74202 | 741614N | 1.10 | LM1157 | 1.60 | CD4088 | 40 | M34 | 2.00 |
| 74203 | 741615N | 1.10 | LM1158 | 1.60 | CD4089 | 40 | M35 | 2.00 |
| 74204 | 741616N | 1.10 | LM1159 | 1.60 | CD4090 | 40 | M36 | 2.00 |
| 74205 | 741617N | 1.10 | LM1160 | 1.60 | CD4091 | 40 | M37 | 2.00 |
| 74206 | 741618N | 1.10 | LM1161 | 1.60 | CD4092 | 40 | M38 | 2.00 |
| 74207 | 741619N | 1.10 | LM1162 | 1.60 | CD4093 | 40 | M39 | 2.00 |
| 74208 | 741620N | 1.10 | LM1163 | 1.60 | CD4094 | 40 | M40 | 2.00 |
| 74209 | 741621N | 1.10 | LM1164 | 1.60 | CD4095 | 40 | M41 | 2.00 |
| 74210 | 741622N | 1.10 | LM1165 | 1.60 | CD4096 | 40 | M42 | 2.00 |
| 74211 | 741623N | 1.10 | LM1166 | 1.60 | CD4097 | 40 | M43 | 2.00 |
| 74212 | 741624N | 1.10 | LM1167 | 1.60 | CD4098 | 40 | M44 | 2.00 |
| 74213 | 741625N | 1.10 | LM1168 | 1.60 | CD4099 | 40 | M45 | 2.00 |
| 74214 | 741626N | 1.10 | LM1169 | 1.60 | CD4100 | 40 | M46 | 2.00 |
| 74215 | 741627N | 1.10 | LM1170 | 1.60 | CD4101 | 40 | M47 | 2.00 |
| 74216 | 741628N | 1.10 | LM1171 | 1.60 | CD4102 | 40 | M48 | 2.00 |
| 74217 | 741629N | 1.10 | LM1172 | 1.60 | CD4103 | 40 | M49 | 2.00 |
| 74218 | 741630N | 1.10 | LM1173 | 1.60 | CD4104 | 40 | M50 | 2.00 |
| 74219 | | | | | | | | |

SPECIAL PRICING!

PRIME - HIGH SPEED RAM

21L02-3 400 NS

LOW POWER - FACTORY FRESH

1-24 \$1.95 ea 100-199 \$1.60 ea
25-99 1.75 ea 200-499 1.45 ea

OVER 500 PCS. **1.39** ea.

PRINTED CIRCUIT BOARDS FOR CT-7001 Kits sold separately with assembly info. PC Boards are drilled Fiberglass, solder plated and screened with component layout.

Specify for 7001 B, C or X - \$7.95

5-DIGIT LED CLOCK CALENDAR KIT

DATE-TIME-SNOOZE ALARM & MORE... KIT 7001

FOR THE BUILDER THAT WANTS THE BEST. FEATURING 12 OR 24 HOUR TIME - 29-30-31 DAY CALENDAR. ALARM, SNOOZE AND AUX. TIMER CIRCUITS

Will alternate time (8 seconds) and date (2 seconds) or may be wired for time or date display only, with other functions on demand. Has built-in oscillator for battery back-up. A loud 24 hour alarm with a repeatable 10 minute snooze alarm, alarm set & timer set indicators. Includes 110 VAC/60Hz power pack with cord and top quality components throughout.

KIT 7001B WITH 6 - 5" DIGITS \$39.95
KIT 7001C WITH 4 - 6" DIGITS & 2 - 3" DIGITS FOR SECONDS \$42.95
KIT 7001X WITH 6 - 6" DIGITS \$45.95

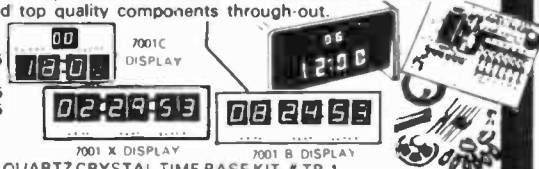

KITS ARE COMPLETE (LESS CABINET)
ALL 7001 KITS FIT CABINET I AND ACCEPT QUARTZ CRYSTAL TIME BASE KIT # TB-1

5-DIGIT LED CLOCK KIT #850-4

12/24 HR. OPERATION BIG 4" DIGITS - 50/60 HZ OPERATION.

KIT INCLUDES

- INSTRUCTIONS
- QUALITY COMPONENTS
- 50 or 60 Hz OPERATION
- 12 or 24 HR OPERATION
- 6 LED Readouts (FND-359 Red, com. cathode)
- 1 MM5314 Clock Chip (24 pin)
- 13 Transistors
- 3 Switches
- 6 Capacitors
- 5 Diodes
- 9 Resistors
- 24-Molex pins

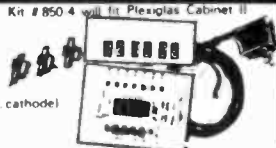

\$11.95 QTY. 1-5
\$10.95 QTY. 6-11
\$9.95 QTY. 12 ea OR MORE

"Kit #850-4 will furnish a complete set of clock components as listed. The only additional items required are a 7-12 VAC transformer, a circuit board and a cabinet, if desired."

PRINTED CIRCUIT BOARD FOR KIT #850-4, SCREEN PRINTED DRILLED AND SOLDER PLATED FIBERGLASS \$2.95
MINI-BRITE RED LED'S (FOR COLON IN CLOCK DISPLAY) Pkg. of 5-\$1.00
MOLDED PLUG TRANSFORMER 115/10 VAC (WITH CORD) \$2.50
NOTE: Entire Clock may be assembled on one PC Board or Board may be cut to remove display.

MOBILE LED CLOCK

12/24 HR 4" DIGITS!

MODEL 12 VOLT AC or #2001 DC POWERED

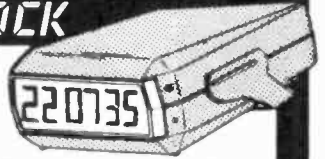

- 6 JUMBO 4" RED LED'S BEHIND RED FILTER LENS WITH CHROME RIM
- SET TIME FROM FRONT VIA HIDDEN SWITCHES - 12/24-Hr. TIME FORMAT
- STYLISH CHARCOAL GRAY CASE OF MOLDED HIGH TEMP. PLASTIC
- BRIDGE POWER INPUT CIRCUITRY - TWO WIRE NO POLARITY HOOK-UP
- OPTIONAL CONNECTION TO BLANK DISPLAY (Use When Key Off in Car, Etc.)
- TOP QUALITY PC BOARDS & COMPONENTS - EXCELLENT INSTRUCTIONS
- MOUNTING BRACKET INCLUDED

KIT #2001 COMPLETE KIT (Less 9V Battery) **29.95** EA
3 OR MORE **\$27.95** EA
115 VAC Power Pack #AC-1 **\$2.00** EA
ASSEMBLED UNITS WIRED & TESTED (LESS 9V BATTERY) **\$39.95** EA
3 OR MORE **\$37.95** EA
Wired for 12 hr. or if NOT SPECIFIED OTHERWISE

PLEXIGLAS CABINETS

Great for Clocks or any LED Digital project. Clear-Red Chassis serves as Bezel to increase contrast of digital displays.

CABINET I
3"H, 6 1/4"W, 5 1/2"D Black, White or Clear Cover

CABINET II
2 1/2"H, 5"W, 4"D \$6.50 ea.

RED OR GREY PLEXIGLAS FOR DIGITAL BEZELS
3"x6"x1/8" 95¢ ea. 4/93

SEE THE WORKS Clock Kit

Clear Plexiglas Stand

- 6 Big 4" digits
- 12 or 24 hr. time
- 3 set switches
- Plug transformer
- All parts included

Plexiglas is Pre-cut & drilled
Kit #850-4CP
Size: 6"H, 4 1/4"W, 3"D
\$23.50 ea. 2/94.5

A SUPER CLOCK!

JUMBO DIGIT CLOCK

A complete Kit (less Cabinet) featuring six 5" digits MM5314 IC 12/24 Hr. time, 50/60 HZ., Plug Transformer, Line Cord, Switches, and all Parts. (Ideal Fit in Cabinet I) Kit #5314-5
\$19.95 2/38.

WITH PC BOARDS

JUMBO DIGIT CONVERSION KIT \$9.95 ea.
Convert small digit LED clock to large 5" displays. Kit includes 6 LED's, Multiplex PC Board & easy hook-up info.
Kit #JD-1CC For common Cathode Kit #JD-1CA for common Anode

TELEPHONE FORMAT KEYBOARD

By Chromerics #EF-21360
2-1/4"x3-1/2"
5/32" thick

\$4.95
6/28.

60 HZ. XTAL TIME BASE
Will enable Digital Clock Kits or Clock-Calendar Kits to operate from 12V DC
1"x2" PC Board
Power Req. 5-15V (2.5 MA. TYP.)
Easy 3 wire hookup
Accuracy: ± 2PPM
#TB-1 (Adjustable)
Complete Kit **\$4.95** ea
Wir & Cal **\$9.95**

25 AMP BRIDGE \$1.95 ea
3/55.00

NEW LSI TECHNOLOGY

FREQUENCY COUNTER KIT

8 LARGE .4" RED LED DIGITS

Kit #FC-50 • 8 IC's • XTAL TIME BASE
A truly "State of the Art" counter using quality components throughout.

KIT INCLUDES: DETAILED INSTRUCTIONS, XTAL, TOP QUALITY FIBERGLASS DOUBLE SIDED PC BOARD, IC'S WITH SOCKETS AND ALL PARTS LESS POWER SUPPLY AND CABINET.

50 MHZ COUNTER KIT #FC-50 **\$69.95**

5 VOLT REGULATED 1 AMP POWER SUPPLY KIT #PS-02 \$9.95
350 MHZ PRESCALER KIT #PSL-350 23.95
650 MHZ PRESCALER KIT #PSL-650 \$29.95
CABINET (& MTG HARDWARE) #CAB III \$19.95
[CABINET WILL HOUSE #FC-50, #PS-02, AND A PRESCALER]

Fairchild Super Digit FND-359

4" Char. Mt. RED Com. Cath. Direct pin replacement for popular FND-70.
95¢ ea, 10/\$8.50
100/\$79.00

SET OF 6 FND-359 WITH MULTIPLEX PC BOARD \$6.95

NYLON WIRE TIES
8" TIE-WRAP 100/\$1.95
4" TIE-WRAP 100/\$1.75

PLUG TRANSFORMERS
12VAC at 150MA \$2.50
12VAC at 500MA 3.50
7VAC at 1.75 VA \$3.50

SCHOTTKY TTL

| | |
|--------|-------|
| 74500 | \$ 35 |
| 74501 | 40 |
| 74504 | 55 |
| 74505 | 60 |
| 74509 | 55 |
| 74510 | 40 |
| 74520 | 50 |
| 74522 | 45 |
| 74540 | 45 |
| 74550 | 45 |
| 74551 | 55 |
| 74560 | 85 |
| 74564 | 55 |
| 74574 | 85 |
| 74575 | 1.75 |
| 74578 | 1.50 |
| 74585 | 95 |
| 745107 | 95 |
| 745112 | 95 |
| 745113 | 1.40 |
| 745114 | 95 |
| 745133 | 75 |
| 745134 | 75 |
| 745138 | 1.75 |
| 745139 | 1.50 |
| 745151 | 1.95 |
| 745153 | 1.95 |
| 745155 | 1.95 |
| 745156 | 1.95 |
| 745157 | 1.80 |
| 745158 | 2.50 |
| 745174 | 2.50 |
| 745175 | 2.50 |
| 745181 | 2.95 |
| 745182 | 1.95 |
| 745251 | 2.75 |

PRESCALE
11C90DC \$15.95
95H90 9.95

VOLTAGE REGULATORS
LM 309 H TO 5 \$ 95
LM 309 K TO 3 1.25
7805 TAB 95
7812 TAB 1.25
7812 TO 3 1.50
7815 TO 3 1.25
7815 TAB 1.25
7815 TO 5 1.25
7824 TO 3 1.25
723 DIP 75
723 TO 5 75

PROM
1702 E Prom \$8.95
5203 E Prom \$8.95

SPECIAL IC'S
7207A INTERSIL
7208 INTERSIL
MC14553 MOT \$ 9.95
MC14410 MOT \$12.50
2513 SIG \$ 9.95

IC SOCKETS
PINS 1 24 25 100
8 25 25 20
14 25 22 20
18 28 25 23
18 31 28 24
24 50 45 40
28 60 55 50
40 75 70 65

XTAL
5-24288MHZ \$4.95
3-579545 MHZ \$1.95

MOLEX PINS
\$0.95
Reel of 1000
100 for \$1.25

TRANSISTORS

| | | |
|----------|---------|---------|
| 2N2222 A | TO 18 | 3/41.00 |
| 2N2712 | TO 98 | 5/31.00 |
| 2N3415 | TO 9 | 5/31.00 |
| 2N3704 | TO 92 | 5/31.00 |
| 2N4400 | TO 92 | 5/31.00 |
| 2N4125 | TO 92 | 5/31.00 |
| 2N4249 | TO 92 | 5/31.00 |
| 2N4437 | TO 92 | 5/31.00 |
| 2N6027 | PLT | 2/31.00 |
| 2N5457 | N J-Fet | 2/31.00 |

DIODES
IN 4002 1A 100 PIV 12/51.00
IN 4005 1A 600 PIV 11/51.00
IN 4007 1A 1000 PIV 10/51.00
RECTIFIER 2.5A 1000 PIV 4/51.00
IN 914 SIL SIGNAL 20/51.00
IN 4148 SIL SIGNAL 20/51.00
DYAC 28V 4/51.00

LINEAR
555 TIMER 2/51.00
556 DUAL TIMER 95
565 PLL 95
566 FUNCTION GEN. 1.75
567 TONE DECODER 1.75

TRANSISTOR SOCKET TO-5/18 GOLD PINS 5/51.00

OP AMPS

| |
|-----------|
| 3/41.00 |
| 5/31.00 |
| 701 TO-5 |
| 709 DIP |
| 709 TO 5 |
| 741 DIP |
| 741 M-DIP |
| 741 TO 5 |
| 747 TO 5 |

DISCRETE LED'S
JUMBO RED
100 FOR \$1.00
100 FOR \$9.50

PC TRIM POTS
25K 6/31.00
4.7K 6/31.00

SPECTROL 10K 10 TURN 95¢
4/33.00

CMOS
4001 \$.20
4002 .20
4010 .40
4011 .20
4013 .40
4015 .95
4016 .40
4023 .20
4025 .20
4027 .40
4028 .85
4030 .35
4042 .75
4044 .60
4046 1.75
4049 .40
4050 .40

AUTO BURGLAR ALARM KIT

AN EASY TO ASSEMBLE AND EASY TO INSTALL ALARM PROVIDING MANY FEATURES NOT NORMALLY FOUND KEYLESS ALARM HAS PROVISION FOR PDS & GROUNDING SWITCHES ON SENSORS WILL PULSE HORN RELAY AT 1/2 RATE OR DRIVE SIREN RT PROVIDES PROGRAMMABLE TIME DELAYS FOR EXIT, ENTRY & ALARM PERIOD. UNIT MOUNTS UNDER DASH - REMOTE SWITCH CAN BE MOUNTED WHERE DESIRED. CMOS RELIABILITY RESISTS FALSE ALARMS & PROVIDES FOR ULTRA DEPENDABLE ALARM (DO NOT BE FOOLED BY LOW PRICES! THIS IS A TOP QUALITY COMPLETE KIT WITH ALL PARTS INCLUDING DETAILED DRAWINGS AND INSTRUCTIONS OR AVAILABLE WIRED AND TESTED)

KIT #ALR-1 **\$9.95**
#ALR-1WT WIRED & TESTED **\$19.95**

VARIABLE REGULATED 1 AMP POWER SUPPLY KIT

- VARIABLE FROM 4 TO 14V
- SHORT CIRCUIT PROOF
- 723 IC REGULATOR
- 2N3055 PASS TRANSISTOR
- CURRENT LIMITING AT 1 Amp

KIT IS COMPLETE INCLUDING DRILLED & SOLDER PLATED FIBERGLASS PC BOARD AND ALL PARTS (Less TRANS-FORMER) Kit #PS-01 **\$8.95**
TRANSFORMER 24V CT will provide 300MA at 12V and 1 Amp at 5V. \$3.50

DIGITAL CLOCK IC'S

| | |
|-----------|---------|
| MM5312 | \$ 4.95 |
| MM5314 | 3.95 |
| MM5375 AB | 3.95 |
| CT-7001 | 7.95 |
| CT-7002 | 13.95 |
| MM5369 | 2.50 |

LED DRIVERS
7447 \$ 95
7448 95
75491 65
75492 65
8268 2.50

7-SEG LED

COMMON CATHODE
COLOR MT DECP PREA
FND 359 RED 4' RHDP \$ 95
FND 503 RED 5' RHDP \$1.35
DL 750 RED 6' LHDP \$2.95
XAN 654 GREEN 6' NDP \$1.95
XAN 654 RED 6' NDP \$1.95

COMMON ANODE
DL 747 RED 6' LHDP \$1.95
XAN 72 RED 3' LHDP \$1.25
XAN 72 RED 3' LHDP \$1.25
XAN 81 YELLOW 3' RHDP \$1.75
XAN 351 GREEN 3' RHDP \$1.50
XAN 362 ORANGE 3' LHDP \$1.50
XAN 652 RED 6' NDP \$1.95
XAN 652 RED 6' NDP \$1.95



OPTOELECTRONICS, INC.

BOX 219 • HOLLYWOOD, FLA. 33022 • (305) 921-2056
STORE: 823 S. 21 AVE.

WE PAY ALL SHIPPING IN CONTINENTAL USA - OTHERS ADD 5% (10% FOR AIRMAIL)
SEE OUR BOOTHS AT THE ATLANTA HAMFESTIVAL - JUNE 18-19, 1977

ORDER BY PHONE OR MAIL
COD ORDERS WELCOME
Orders Under \$15 Add \$1.00 Handling
Fla. Res. Please Add 4% Sales Tax.

CARBON FILM RESISTORS

IN STOCK- A FULL LINE OF QUALITY 1/4W 5% RESISTORS
STANDARD VALUES FROM 2.7 ohm to 4.7Mohm

5 for .25 10 for .40 100 for \$1.60 1000 for \$14.
(no mix of values) 100 per value for 1000 price

free intel data catalog
new 77 928 page
WITH \$25. PREPAID ORDER

SUPER LED'S

This family of LED's are mounted on a TO-5 header with a 6/32 threaded stud to secure to a heat sink. TWO AMPERES max. continuous current rating (with heat sink). LED's can be pulsed at up to 25A with low duty cycle. Data supplied w/order.

ME2 Infra Red w/low lens
ME5 Infra Red w/high lens
MV4 Visible Red with low lens
MV4H Visible Red with high lens

\$2.99 ea.

150 Mhz PRESCALER

Use your low frequency counter to measure VHF or UHF frequencies. This kit will divide the input signal by ten (10 or 100 with 650MHz option)
Kit contains drilled circuit board, 2 MC10131 IC's, all parts needed and instructions.

150/170MHz KIT\$12.95
650MHz option W/IC90 IC.....\$29.95
-requires 5v at app. .2A power supply and case are not part of kit---

RESISTOR ASSORTMENTS
100 assorted values of 1/4W or 1/2W most 5% w/PCB cut leads.. specify w/1/4W \$1.00

25K Trimmer

Printed Circuit Board Type
Each \$2.20
10 for \$1.50

HP
5082-4557
Bright Yellow LEDs w/panel clips 3 / \$1.00

SPECIALS
747 dual 741 OP-AMPS \$6.55
14 pin DIP 10/\$5

NE2 Neon Lamps \$0.60

2N3773
TO-3 power transistors removed from computer boards, 160V NPN 16A, full leads \$1 ea. 10/\$9

COMPUTER DISPLAY TERMINAL
\$180.00

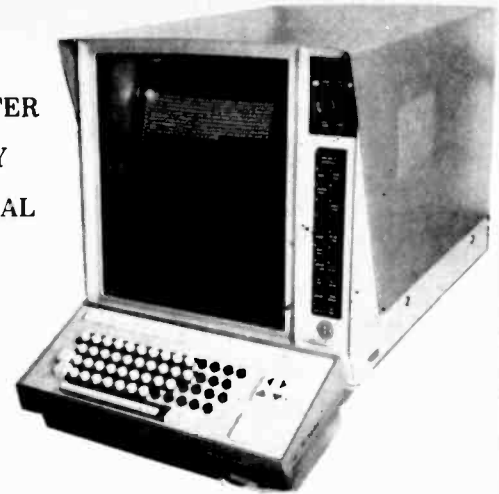

Unused computer terminals in original factory boxes. Made for airline ticketing & seating reservations. 17 inch B/W CRT in modernistic housing. 41 lines of data, 52 characters per line, generated by diode matrix (graphic) technique. Self contained power supply. Keyboard, free standing, reed switches, 54 data keys, 28 special keys. Logic unit (not shown) 1024 by 6 bit core memory, printer I/O interface, communications I/O interface. Due to several years storage, though unused, you may have to tinker, clean contacts on circuit boards, etc. We furnish free with each, one operational manual, one book of schematics. Sold "as is", all sales final. The price is a give-away. Check with order please (for immediate shipping certify your check. Shipped truck (238 lbs) you pay shipping on arrival. These have been interfaced by local customers with KIM-1 and IMSAI (no doubt can be interfaced with many others.

\$180.00

JOHN MESHNA JR, PO BOX 62, E.LYNN MASS 01904

CIRCLE 52 ON FREE INFORMATION CARD

Transistor Sale!

MPS56 PNP PWR. 80V 2A TAB \$4.10 10/3.50
TIP31A NPN PWR. 60V 3A TAB \$4.10 10/3.50
D41D1 PNP PWR. 30V 1A TAB \$3.10 10/2.50
*D40C1 NPN PWR. DARL. TAB \$4.10 10/3.50

2N2222 NPN SW. 40V TO-92 \$.20 10/1.75
2N3565 NPN GP 30V TO106 \$.15 10/1.25
*2N3640 PNP SW 12V TO106 \$.15 10/1.35
*2N3646 NPN SW 15V TO106 \$.15 10/1.35
2N3440 NPN GP 250V TO-5 \$.60 10/5.00
2N4400 NPN GP 50V TO-92 \$.20 10/1.75
2N4248 PNP GP 40V TO-92 .15 10/1.35
2N5964 NPN SW 150V TO-92 .20 10/1.75

*Leads cut for PCB. All transistors are full spec. and guaranteed.

5 WATT AUDIO AMPLIFIER

IC audio power amplifier kit. A complete kit including a drilled circuit board, 706 Fairchild IC with heat sink, and all parts to make a complete high gain (46db) power amplifier. Kit operates from single power source of 6-16VDC and drives a 4 ohm spkr.

\$8.95 each. --- 2 (stereo) for \$16.50
does not include a case or power supply

ONE AMP OP-AMP

General purpose operational amplifier in an eight pin TO-3 package. Similar to the National LH0021. Ideal for servo drive or power supply etc. use.. Data included

\$4.50 each five for \$20.

DIP TRIM POT

12 turn trimpots in a DIP package. 1/2" x 1/4" x 1/4". 5k and 200k only.... (DALE)

\$5.65 ea. 10/\$4.95

20¢ ea. 10/\$1.50
\$12.50/c. CLEARX
DUAL CDS PHOTO CONDUCTIVE CELL

Diode Array

10-1N914 SILICON SIGNAL DIODES IN ONE PACKAGE. 20 LEADS ALTERNATELY SPACED .1". NO COMMON CONNECTIONS.

25¢ ea. Ten for \$2.25

POTTER BRUMFIELD

Type KHP Relay
4 PDT 3A Contacts
24VDC COIL
650 ohms
120VAC
10.5MA

\$1.60 ea.

High Quality PCB Mounting IC Sockets
wire wrap sockets 8 pin \$.19
14 pin \$.19
16 pin \$.21
24 pin \$.55
28 pin \$.70
40 pin \$ 1.10

MOLEX
530 \$4.75 1k \$8.50
2k \$16.50 5k \$7.50

FULL WAVE BRIDGE RECTIFIERS

FULLY TESTED COSMETIC REJECTS (SCRATCHES)

500V 25A \$1.75 ea 10/\$15.
100V 25A \$1.35 ea 10/\$12

SEND A STAMP FOR OUR FLYER LISTING

more money-saving bargains!

Orders under \$7.00 add \$1.00 postage and handling. Residents of Cal! add sales tax. Orders shipped promptly. \$10 minimum on C.O.D.s.

MAIL ORDERS TO PO BOX 41778, SACRAMENTO CA. 95841

Phone (916)334-2161

27V trigger diodes for SCR or TRIACS \$0.25 ea

TRIACS

RCA 8W 500+ W house marked \$59¢ each

MINIATURE TOGGLE SWITCH
SPDT \$1.00
DPDT \$1.25
DPDT Center off \$1.25

PUSH BUTTON SWITCH
Red, White, green and yellow 30¢ ea. 4/\$1.00

TRANSFORMERS
All inputs 110 V AC
40 V C.T. 10A \$14.50
30V C.T. 20A \$13.50
20V C.T. 10A \$8.00
24V 1 3A \$3.50
2.4 6 3.9 12V 1A 4 in 1 \$3.50
28V C.T. 0.6A \$2.00

ZENER DIODES
5V 1/4W 12
14V 1/4W 12
15V 1/4W 10
IN2979 15V 10W 2.50
IN3079 24V 1W 1.25
IN3002 75V 10W 2.50

COMPUTER GRADE CAPACITORS
18,500µF 80V \$4.50
91,000µF 20V \$4.00
100,000µF 5V \$2.50
1,000µF 200 50V \$1.00

TANTALUM CAPACITORS
1µ 35V 15
1µ 10V 15
3.3µ 35V 20
10µ 50V 35
22µ 35V 25

RECTIFIERS RCA House Mark
IN4001 06 100V 3A 40
IN4002 07 60V 5A 75
IN4003 08 MOTOROLA
IN4004 09 (IN1202A) 65
IN4005 10 (IN1612) 75
IN4006 12 MDA962-2 1.80
IN4007 14 Bridge 100V 12A

MINIATURE SLIDE SWITCH
DPDT .20 each
10 for \$1.75
100 for \$15.00

POWER SUPPLY KITS
5V 10A with OVP (less Case, X'former, Rect & Cap) \$7.95
2-20V 1.3A continuously adjustable with current limiting includes Transformer, P.C. Board, 2N3055, Heat sink, and everything but the case \$19.95

BOURNS MINIATURE TRIMMERS
3292X 2K 55¢ ea. or 10 for \$5.00
330PP 2K 75¢ ea. or 10 for \$6.75

4" MUFFIN FAN - Slightly Used - \$5.00
All in perfect Condition Satisfaction Guaranteed

INTER-COM BOARD
Fully assembled.
Works on 9-15V D.C.
2 speakers make it work.
With Schematic
ONLY \$3.00

THIS MONTH'S SPECIALS!
SN7400 \$1.12
LM741 OH To-5 \$1.30
MH0026C (5 MHz Clock Driver) 2.95
AY-5-36001 (Keyboard Encoder by C.I.) with Spec. Sheet 10.50
LM340T-12 80
LM340T-5 80
AN214-4.5W Power I.C. with Spec. 2.95

PANEL METERS
2 1/2" X 2 1/2"
50µA \$3.50 150µA \$3.00
100µA \$3.00 300µA \$3.00
1 1/2" X 1 1/2" - 50µA \$4.00

L.E.D.
0.25" Red 25¢ 10 for \$2.00
0.25" Green 30¢ 10 for \$2.50
0.125" Red 20¢ 10 for \$1.75
0.5" FND503 C.C. \$1.00
0.5" FND507 C.C. \$1.00
0.8" FSC8000 C.C. \$7.50

MODULAR POWER SUPPLY
5V @ 32A 115V AC Input with OVP (New) \$69.50
24V @ 12A 115V AC input (used) \$37.95
28V 3A (used) \$19.95

I.C. SOCKETS
14 Pin Lo Pro \$3.30
14 Pin Standard Gold 35
14 Pin Wire Wrap Gold 45
16 Pin Lo Pro 35
16 Pin Wire Wrap Gold 50
22 Pin Lo pro 45
24 Pin Lo pro Open Frame 45
24 Pin Standard-Gold 100
40 Pin Lo pro Open Frame 55

TERMS: Money Back Guarantee
CALIF. RESIDENTS ADD SALES TAX
Please add \$1.00 for postage inside Cal! \$2.00 for Out of State. (Overseas add 10% of order)
Minimum Order \$5.00 C.O.D. \$20.00 (\$1.00 handling)
STORE HOURS: Mon-Sat 10-7 Sun 10-3

TRICO ELECTRONIC SUPPLIES
2669 W. LINCOLN AVE. ANAHEIM, CA. 92801
PHONE 714/821-0234

RADIO-ELECTRONICS

CIRCLE 34 ON FREE INFORMATION CARD

CIRCLE 16 ON FREE INFORMATION CARD

POLY PAK'S IS THE "BARREL KIT KING" OF THE WORLD!

Poly Pak's EXCLUSIVE SURE-FIRE WAY TO FIGHT BARREL KITS

Buy 10 BARREL KITS AND CHOOSE THE 11TH KIT Free

Test 'em yourself 'n save! Includes 100% material, too! INFLATION! Each kit carries a money-back guarantee.

| | | | | | | | | | | | | | | | | | | | | | | | | | | | | | | | | | | | | | | | | | | | | | | | | | | | | | | | | | | | | | | | | | |
|---|---|---|--|---|---|--|---|---|---|--|--|---|--|--|---|---|---|--|--|--|--|--|---|--|---|--|--|--|---|---|--|---|---|---|--|---|---|---|---|---|---|---|--|--|---|---|---|--|--|--|--|--|---|---|--|---|--|--|--|--|--|--|---|--|---|
| BARREL KIT #230 SHIELDED CABLE READOUTS 50 for \$1.98 For mikes, stereo 1-cond. plus shield, 22 ga. vinyl jacket. Wt. 1 lb. 7R3577 | BARREL KIT #230 HALF INCH READOUTS 7R3625 15 for \$1.98 From factory to you... Includes Fairchild FND-500 & 507's | BARREL KIT #225 SOUND TRIGGERS 3 for \$1.98 "Hand clap" sensitizes crystal mike amplifier, triggers SCR. Cat. No. 7R3625 | BARREL KIT #221 IC SOCKETS 8 for \$1.98 Mfr. unloads Four 14-pin, four 18-pin. Solder tall. Cat. No. 7R3621 | MIXED READOUTS 15 for \$1.98 Barrels of untested 177, 33, 6" 7-seg, like FND-387, 600, 503, MAN-3's. Buy a buy! No. 7R3619 | BARREL KIT #200 MINI BLOCK CAPACITORS 50 for \$1.98 "Unbelievable! Worth \$60. High precision submini caps for all applications. Cat. No. 7R3528 | BARREL KIT #203 CALCULATOR KEYPADS 10 for \$1.98 It's true! 20-key, 4-function keypad... Wt. 12 oz. Cat. No. 7R3524 | BARREL KIT #210 A/GLOWIN' PANELS 3 for \$1.98 4" x 1" panels that glow blue-green with 110V AC. Use for mite lites, indicators, etc. Cat. No. 7R3550 | 100 for \$1.98 KIT #202 PLUGS, SOCKETS Distributor unloads! Includes AC, DC, RF, audio, 4-9 pin, all kinds. Wt. 1 lb. Cat. No. 7R3527 | BARREL KIT #201 6V INDICATORS 15 for \$1.98 Text lamp manufacturer dumps inventory! Worth \$50 ea. Like strain-glass heat SCR. Cat. No. 7R3526 hobby | BARREL KIT #200 9 DIGIT READOUT MODULES 5 for \$1.98 Unloads from factory driver chips beneath epoxy. Cat. No. 7R3515 | BARREL KIT #198 TRANSISTORS & DARLINGTONS 50 for \$1.98 Motorola dumps 1,000,000 TO-18's in barrels. Includes PNPs. Cat. No. 7R3533 | BARREL KIT #191 CARBOFILM RESISTORS 800+ for \$1.98 Sound, approx. 7 x 1/2" water. Ass't values. Unmarked. Cat. No. 7R3445 | BARREL KIT #188 400 Parts \$1.98 Includes resistors, caps, transformers, rectifiers, diodes, etc. for pc work. Preferred, dumped into barrels by factories. 100% - Cat. No. 7R3401 | BARREL KIT #187 AUDIO IC'S 30 for \$1.98 National & Sony 2 to 4 watters, LM-350, LM-377, 2277, etc. DIPs, some with heat sinks. Untested. Cat. No. 7R3392 | BARREL KIT #185 PC BOARDS 400 parts \$1.98 80 transistors, 60 parts, 50 transformers, 200 diodes, etc. Cat. No. 7R3388 | BARREL KIT #184 1/4-WATT METAL FILM RESISTORS 150 for \$1.98 100% metal film resistors. Long leads. 7R3413 | BARREL KIT #182 JUMBO RED LEDS 15 for \$1.98 100% material, user cancellation from factory dumps, 3V 10 mils. For 100's of projects, red lens. Cat. No. 7R3369 | BARREL KIT #198 TRANSISTORS & DARLINGTONS 50 for \$1.98 Motorola dumps 1,000,000 TO-18's in barrels. Includes PNPs. Cat. No. 7R3533 | BARREL KIT #181 PNP PLASTIC TRANSISTORS 25 for \$1.98 2N3904's with some 2N3906's of 100% material. TO-92. Preferred. Cat. No. 7R3343 1 oz. | BARREL KIT #160 V. REGULATORS 10 for \$1.98 No. 7R3330 LM309KC TO-3 V.R.'s barreled. Bot by the pound, Hobby | BARREL KIT #159 MODULAR SWITCHES 25 for \$1.98 Centralab switches, TV-makers excess Dipit, 6-pin, etc. Brand new. Cat. No. 7R3150 | BARREL KIT #158 MAGNIFIED MAN-3'S 20 for \$1.98 neg readout, with built-on magnifier. Factory discontinued line. 100% material. Cat. No. 7R3325 1 oz. | BARREL KIT #155 MOLDED CAPACITORS 75 for \$1.98 Ass't. size voltages, red, green, yellow, blue plastic caps, axial leads. 1 lb. 7R3311 | BARREL KIT #154 CLOCK CHIPS 20 for \$1.98 We gathered an assortment of clock chip, alarm, calendar, beepers, etc. known! All mixed! Cat. No. 7R3308 | BARREL KIT #144 RCA PHONO PLUGS 40 for \$1.98 1,000,000 RCA phono plugs for this one. You hi-fiers know what they are. 100% material. 7R3293 | BARREL KIT #145 MINI TRANSFORMER 15 for \$1.98 Ass't. outputs, inter-stage and audio. 100% - Wt. 1 lb. 7R3294 | BARREL KIT #118 MINI SCRS 50 for \$1.98 UNBELIEVABLE! TO-92 plastic SCRS in barrels. Dumps from factory. Includes all voltages up thru 200 prev. 7R3135 | BARREL KIT #117 OPTICAL FIBERS 20-ML 7R3208 200 FT. \$1.98 Fiber optic cable. Bulk supply purchase! High quality. Most commonly used size (720-mil). CLEAR | BARREL KIT #115 MOLEX SOCKETS 200 for \$1.98 Calculator maker dump! We cut a zillion of 'em. | BARREL KIT #99 PHOTO ELECTRIC CELLS 10 for \$1.98 Ass't. GE types, CDS types. Mixed by factory. Big job for us to separate. 100% good. Cat. No. 7R3052 | BARREL KIT #93 HOBBY LEDS 40 for \$1.98 747's, 747's, singles, tri-plex, etc. 33 to 0.6. High from factory. All mixed! have fun! 7R2859 | BARREL KIT #81 SUBMINI RESISTORS 200 for \$1.98 By upright type, color coded. 1% watt. Ass't. values. Come to us in a barrel. Cat. No. 7R2746 100% good. | BARREL KIT #76 1-WATT ZENERS 100 for \$1.98 Factory same as 400-mw's. Never-in-sea again offer. 6, 10, 12, 15V, under 1500' temp. Cat. No. 7R2741 Untested | BARREL KIT #73 CAPACITOR SPECIAL 100 pcs. \$1.98 mica, molded, plastic, electrolytic, etc. 500's 100% good Cat. No. 7R2738 | BARREL KIT #71 NATIONAL IC BONANZA 100 for \$1.98 Types 2000, 100 series, TTL, ROMs, registers, dual & single chips. Unmarked. Cat. No. 7R2860 Untested | BARREL KIT #68 2 WATERS 100 for \$1.98 100% good. Suppliers throw 'em in the barrel. It's a 1/2 oz. min. All marked. Cat. No. 7R2735 | BARREL KIT #65 MIXED READOUTS 10 for \$1.98 Factory returns... such numbers as MAN-4's, MAN-7's, MAN-1's, 11 barrels & no time to separate. Hobby. Cat. No. 7R2733 Untested. | BARREL KIT #61 POLYSTYRENE CAPS 100 for \$1.98 Finest caps made. As a gamble we bought 10 barrels from factory, mixed values. 100% good. Cat. No. 7R2729 | BARREL KIT #58 PNP HIGH POWER TRANSISTORS 20 for \$1.98 Popular germanium TO-3 case 7R2618 100% good | BARREL KIT #54 & DIGIT READOUTS 10 for \$1.98 Become a lifetime! All we got was 1 barrel - the "findor digit" types. Multi-plexed. Cat. No. 7R2722 | BARREL KIT #51 MIXED READOUTS 10 for \$1.98 Factory returns... such numbers as MAN-4's, MAN-7's, MAN-1's, 11 barrels & no time to separate. Hobby. Cat. No. 7R2733 Untested. | BARREL KIT #50 PNP HIGH POWER TRANSISTORS 20 for \$1.98 Popular germanium TO-3 case 7R2618 100% good | BARREL KIT #35 NEON LAMPS 30 for \$1.98 Famous NE-2's. All prime, but factory made millions and barreled 'em. Your advantage. Cat. No. 7R2613 | BARREL KIT #33 RECTIFIERS 100 for \$1.98 Made mostly by Corning. The finest resistor made. Mostly 1/2 watters, 1% to 5% tol. & a barrel of value. Cat. No. 7R2609 | BARREL KIT #30 PREFORMED DISCS 150 for \$1.98 Hi-Pi mfr's shelf inventory but he dumped 'em in barrel. Preferred, for PC use. Mixed values too! 7R2605 | KIT #26 PLASTIC TRANSISTORS 100 for \$1.98 Type TO-92 (TO-18), all manufacture thru variety of 2N 2's. Cat. No. 7R2604 | BARREL KIT #25 METAL CAN TRANSISTORS 100 for \$1.98 Includes TO-5, TO-1, TO-18, etc. assorted 2N numbers, unmarked, etc. Cat. No. 7R2603 Untested. | BARREL KIT #20 LONG LEAD DISCS 100 for \$1.98 Primo, marked only. Long leads. Cat. No. 7R2598 100% good | BARREL KIT #19 DIPPED MYLARs 60 for \$1.98 Finest capacitors made, shmy (in fact) in factories. Dumping 'em in barrels. Cat. No. 7R2597 100% good | BARREL KIT #17 LIME/4 & 740 DIPS 100 for \$1.98 Hobby Untested. Marked an, unmarked, internal numbers of the factory stock. Cat. No. 7R2431 | BARREL KIT #15 TRANSISTORS 60 for \$1.98 All 4 lewlers, TO-18 case, includes, variety of values, types, big ones. Cat. No. 7R2429 | BARREL KIT #14 PRECISION RESISTORS 200 for \$1.98 Marked and unmarked 1/2, 2 watt. No. 7R2428 | BARREL KIT #13 SCRS, TRIACS, QUADRACS 40 for \$1.98 Raw factory stock! All the 10 amp types. Cat. No. 7R2419 Untested. | BARREL KIT #12 PLASTIC TRANSISTORS 100 for \$1.98 Types TO-92 (TO-18), all manufacture thru variety of 2N 2's. Cat. No. 7R2604 | BARREL KIT #11 LIME/4 & 740 DIPS 100 for \$1.98 Hobby Untested. Marked an, unmarked, internal numbers of the factory stock. Cat. No. 7R2431 | BARREL KIT #10 ROMS-REGISTERS 75 for \$1.98 Untested Hobby. 2- to 10 pin devices, marked, internal factory numbers, etc. Cat. No. 7R2424 | BARREL KIT #9 PREFORMED DISCS 150 for \$1.98 Hi-Pi mfr's shelf inventory but he dumped 'em in barrel. Preferred, for PC use. Mixed values too! 7R2605 | BARREL KIT #8 SUBMINIATURE TRANSFORMERS 75 for \$1.98 Amazing, includes 45kV, one antenna, who knows? Cat. No. 7R2422 100% good | BARREL KIT #7 VOLUME CONTROL 30 for \$1.98 All 4 lewlers, TO-18 case, includes, variety of values, types, big ones. Cat. No. 7R2429 | BARREL KIT #6 SCRS, TRIACS, QUADRACS 40 for \$1.98 Raw factory stock! All the 10 amp types. Cat. No. 7R2419 Untested. | BARREL KIT #5 SCRS, TRIACS, QUADRACS 40 for \$1.98 Raw factory stock! All the 10 amp types. Cat. No. 7R2419 Untested. | BARREL KIT #4 RECTIFIERS 100 for \$1.98 1N1000 series. May include 500, 100, 200, 100, 600 800 and 1000 volters. 7R2417 | BARREL KIT #3 1N4148/914 SWITCHING DIODES 100 for \$1.98 Inexpensive switching diodes at these prices! Cat. No. 7R2418 Untested. | BARREL KIT #2 LINEAR OP AMPS DIPS 75 for \$1.98 in 8 pin packages, 741's, 703's, 560 series, 541 includes... 7R2416 hobby | BARREL KIT #1 SN7400 DIP IC'S 75 for \$1.98 Marked 14 and/or with 16 pin dips, may include gates, registers, flip flops, counters. 7R2415 Untest Hobby |
|---|---|---|--|---|---|--|---|---|---|--|--|---|--|--|---|---|---|--|--|--|--|--|---|--|---|--|--|--|---|---|--|---|---|---|--|---|---|---|---|---|---|---|--|--|---|---|---|--|--|--|--|--|---|---|--|---|--|--|--|--|--|--|---|--|---|

Digital Clocks BASIC KITS!

Designed for the economy-minded. Includes: all components except for transformer, case & line cord.

4 DIGIT FLOURESCENT

\$9.95

.57" Bright Blue Digits

The brightest clock model uses 4 segment GE tube readouts. Includes famous MMS316 clock chip and a minimum of components! Easy and fun to build, perfect for the new hobbyist! 12 hour display, 124 hour cycle, AM-PM indicator. Options include clock radio timer, 60 minute sleep timer, and snooze. PC board not included. Easy to breadboard, with instruction manual not included. Requires 12 V transformer, see our 92CU1412. Cat. No. 7R3791 4 Digit Fluorescent Basic Kit \$9.95 Cat. No. 7R3792 Components for Alarm Option 2.99

Same famous design as our KRONOS BEEPIN' TIME MACHINES!

6 DIGIT BEEPER ALARM

\$12.95 .35" LED RED DIGITS

Easy and fun to build! 6 digit display time in hours, minutes and seconds, 12 hour format, 24 hour cycle, 7 minute snooze. Uses famous 2MS07AB and a minimum of components. Controls for slow and fast set, and reset to zero. Includes all necessary components except for case, line cord, PC board. Requires 12V transformer, see our Catalog 92CU1412. PC boards available, write our call for information. Wt. 8 oz. Cat. No. 7R3793 6 Digit LED alarm clock basic kit.

COMPLETE KIT: includes case, transformer and line cord. Cat. No. 7R3505..... \$19.95

4 DIGIT \$12.95

Same as our 4 DIGIT LED ALARM CLOCK BASIC, except with .5" digits, displays hours and minutes, blinking colon, date seconds. Wt. 8 oz. Cat. No. 7R3794

COMPLETE KIT: includes case, transformer, and line cord. Cat. No. 7R3507..... \$19.95

| | | | | | | | | | | | | | | | | | | | | | | | | | | |
|---|---|---|---|--|--|---|---|---|--|--|--|--|--|---|---|--|---|--|--|--|--|--|--|---|--|---|
| BARREL KIT #58 PNP HIGH POWER TRANSISTORS 20 for \$1.98 Popular germanium TO-3 case 7R2618 100% good | BARREL KIT #54 & DIGIT READOUTS 10 for \$1.98 Become a lifetime! All we got was 1 barrel - the "findor digit" types. Multi-plexed. Cat. No. 7R2722 | BARREL KIT #51 MIXED READOUTS 10 for \$1.98 Factory returns... such numbers as MAN-4's, MAN-7's, MAN-1's, 11 barrels & no time to separate. Hobby. Cat. No. 7R2733 Untested. | BARREL KIT #50 PNP HIGH POWER TRANSISTORS 20 for \$1.98 Popular germanium TO-3 case 7R2618 100% good | BARREL KIT #35 NEON LAMPS 30 for \$1.98 Famous NE-2's. All prime, but factory made millions and barreled 'em. Your advantage. Cat. No. 7R2613 | BARREL KIT #33 RECTIFIERS 100 for \$1.98 Made mostly by Corning. The finest resistor made. Mostly 1/2 watters, 1% to 5% tol. & a barrel of value. Cat. No. 7R2609 | BARREL KIT #30 PREFORMED DISCS 150 for \$1.98 Hi-Pi mfr's shelf inventory but he dumped 'em in barrel. Preferred, for PC use. Mixed values too! 7R2605 | KIT #26 PLASTIC TRANSISTORS 100 for \$1.98 Type TO-92 (TO-18), all manufacture thru variety of 2N 2's. Cat. No. 7R2604 | BARREL KIT #25 METAL CAN TRANSISTORS 100 for \$1.98 Includes TO-5, TO-1, TO-18, etc. assorted 2N numbers, unmarked, etc. Cat. No. 7R2603 Untested. | BARREL KIT #20 LONG LEAD DISCS 100 for \$1.98 Primo, marked only. Long leads. Cat. No. 7R2598 100% good | BARREL KIT #19 DIPPED MYLARs 60 for \$1.98 Finest capacitors made, shmy (in fact) in factories. Dumping 'em in barrels. Cat. No. 7R2597 100% good | BARREL KIT #17 LIME/4 & 740 DIPS 100 for \$1.98 Hobby Untested. Marked an, unmarked, internal numbers of the factory stock. Cat. No. 7R2431 | BARREL KIT #15 TRANSISTORS 60 for \$1.98 All 4 lewlers, TO-18 case, includes, variety of values, types, big ones. Cat. No. 7R2429 | BARREL KIT #14 PRECISION RESISTORS 200 for \$1.98 Marked and unmarked 1/2, 2 watt. No. 7R2428 | BARREL KIT #13 SCRS, TRIACS, QUADRACS 40 for \$1.98 Raw factory stock! All the 10 amp types. Cat. No. 7R2419 Untested. | BARREL KIT #12 PLASTIC TRANSISTORS 100 for \$1.98 Types TO-92 (TO-18), all manufacture thru variety of 2N 2's. Cat. No. 7R2604 | BARREL KIT #11 LIME/4 & 740 DIPS 100 for \$1.98 Hobby Untested. Marked an, unmarked, internal numbers of the factory stock. Cat. No. 7R2431 | BARREL KIT #10 ROMS-REGISTERS 75 for \$1.98 Untested Hobby. 2- to 10 pin devices, marked, internal factory numbers, etc. Cat. No. 7R2424 | BARREL KIT #9 PREFORMED DISCS 150 for \$1.98 Hi-Pi mfr's shelf inventory but he dumped 'em in barrel. Preferred, for PC use. Mixed values too! 7R2605 | BARREL KIT #8 SUBMINIATURE TRANSFORMERS 75 for \$1.98 Amazing, includes 45kV, one antenna, who knows? Cat. No. 7R2422 100% good | BARREL KIT #7 VOLUME CONTROL 30 for \$1.98 All 4 lewlers, TO-18 case, includes, variety of values, types, big ones. Cat. No. 7R2429 | BARREL KIT #6 SCRS, TRIACS, QUADRACS 40 for \$1.98 Raw factory stock! All the 10 amp types. Cat. No. 7R2419 Untested. | BARREL KIT #5 SCRS, TRIACS, QUADRACS 40 for \$1.98 Raw factory stock! All the 10 amp types. Cat. No. 7R2419 Untested. | BARREL KIT #4 RECTIFIERS 100 for \$1.98 1N1000 series. May include 500, 100, 200, 100, 600 800 and 1000 volters. 7R2417 | BARREL KIT #3 1N4148/914 SWITCHING DIODES 100 for \$1.98 Inexpensive switching diodes at these prices! Cat. No. 7R2418 Untested. | BARREL KIT #2 LINEAR OP AMPS DIPS 75 for \$1.98 in 8 pin packages, 741's, 703's, 560 series, 541 includes... 7R2416 hobby | BARREL KIT #1 SN7400 DIP IC'S 75 for \$1.98 Marked 14 and/or with 16 pin dips, may include gates, registers, flip flops, counters. 7R2415 Untest Hobby |
|---|---|---|---|--|--|---|---|---|--|--|--|--|--|---|---|--|---|--|--|--|--|--|--|---|--|---|

Terms: Add postage. Rated: net 30. Phone: Wakefield, Mass. (617) 245-3829. Retail: 16-18 Del Carmine St., Wakefield, Mass.

POLY PAKS
P.O. BOX 942R LYNNFIELD, MA. 01940

MINIMUM ORDER — \$6.00

Send for FREE SUMMER CATALOG

C.O.D.'s MAY BE PHONED

CB SPECIALS-R.F. DRIVERS-R.F. POWER OUTPUTS-FETS

Table listing electronic components with part numbers and prices.

JAPANESE TRANSISTORS

Table listing Japanese transistors with part numbers and prices.

OEM SPECIALS

Table listing OEM specials with part numbers and prices.

SILICON UNIJUNCTIONS

Table listing silicon unijunctions with part numbers and prices.

INTEGRATED CIRC.

Table listing integrated circuits with part numbers and prices.

RECTIFIERS

Table listing rectifiers with part numbers and prices.

POWER-TRANSISTORS HIGH-VOLT. TV. TYPE

Table listing power-transistors with part numbers and prices.

ALL PARTS GUARANTEED

N.J. residents add 5% sales tax. Minimum order \$5.00. All orders add \$1.00 postage. Dealers write or phone for discount prices.



New-Tone Electronics, P.O. Box 1738 A, Bloomfield, N.J. 07003, Phone: (201) 748-6171

748-6172, 748-6173

CIRCLE 43 ON FREE INFORMATION CARD

Table listing various electronic components like EPROMs, character generators, and diodes.

Table listing printed circuit board components, laser diodes, and transistors.

Table listing tantalum capacitors, MOS devices, TTL IC series, and regulators.

Table listing full wave bridges, audio power amps, linear circuits, and triacs.

SOLID STATE SALES, P.O. BOX 74D, SOMERVILLE, MASS. 02143 TEL. (617) 547-4005

WE SHIP OVER 95% OF OUR ORDERS THE DAY WE RECEIVE THEM

CIRCLE 44 ON FREE INFORMATION CARD

INTERNATIONAL ELECTRONICS UNLIMITED

10% OFF WITH \$25 ORDER
15% OFF WITH \$100 ORDER

THESE DISCOUNTS APPLY TO TOTAL OF ORDER - SPECIALS INCLUDED

| | | | | | |
|------|-----|-------|------|-------|------|
| 7400 | .13 | 7451 | .17 | 74153 | .89 |
| 7401 | .16 | 7453 | .17 | 74154 | 1.20 |
| 7402 | .15 | 7454 | .17 | 74155 | .97 |
| 7403 | .15 | 7460 | .30 | 74156 | .97 |
| 7404 | .16 | 7464 | .35 | 74157 | .99 |
| 7405 | .19 | 7465 | .35 | 74158 | 1.79 |
| 7406 | .20 | 7470 | .30 | 74160 | 1.23 |
| 7407 | .20 | 7472 | .30 | 74161 | .97 |
| 7408 | .18 | 7473 | .35 | 74162 | 1.39 |
| 7409 | .19 | 7474 | .29 | 74163 | 1.09 |
| 7410 | .16 | 7475 | .49 | 74164 | .99 |
| 7411 | .25 | 7476 | .30 | 74165 | .99 |
| 7413 | .43 | 7483 | .68 | 74166 | 1.25 |
| 7414 | .65 | 7485 | .88 | 74170 | 2.10 |
| 7416 | .35 | 7486 | .40 | 74173 | 1.49 |
| 7417 | .35 | 7489 | 2.25 | 74174 | 1.23 |
| 7420 | .16 | 7490 | .43 | 74175 | .97 |
| 7422 | .30 | 7491 | .75 | 74176 | .89 |
| 7423 | .29 | 7492 | .48 | 74171 | .84 |
| 7425 | .27 | 7493 | .44 | 74180 | .90 |
| 7426 | .26 | 7494 | .78 | 74181 | 2.45 |
| 7427 | .29 | 7495 | .79 | 74182 | .79 |
| 7430 | .20 | 7496 | .79 | 74184 | 1.90 |
| 7432 | .23 | 74100 | .90 | 74185 | 2.20 |
| 7437 | .25 | 74105 | .44 | 74187 | 5.75 |
| 7438 | .25 | 74107 | .37 | 74190 | 1.15 |
| 7440 | .15 | 74121 | .30 | 74191 | 1.25 |
| 7441 | .89 | 74122 | .38 | 74192 | .95 |
| 7442 | .59 | 74123 | .65 | 74193 | .85 |
| 7443 | .73 | 74125 | .54 | 74194 | 1.25 |
| 7444 | .73 | 74126 | .58 | 74195 | .74 |
| 7445 | .73 | 74132 | .89 | 74196 | 1.25 |
| 7446 | .81 | 74141 | 1.04 | 74197 | .73 |
| 7447 | .79 | 74145 | 1.04 | 74198 | 1.73 |
| 7448 | .79 | 74150 | .97 | 74199 | 1.69 |
| 7450 | .17 | 74151 | .79 | 74200 | 5.45 |

| | | | | | |
|-------|------|-------|------|-------|------|
| 74100 | .29 | 74151 | .29 | 74190 | 1.40 |
| 74102 | .29 | 74155 | .29 | 74191 | 1.20 |
| 74103 | .23 | 74171 | .29 | 74193 | 1.50 |
| 74104 | .29 | 74172 | .45 | 74195 | 1.50 |
| 74106 | .29 | 74173 | .56 | 74198 | 2.25 |
| 74110 | .29 | 74174 | .56 | 74164 | 2.25 |
| 74120 | .29 | 74178 | .75 | 74165 | 2.30 |
| 74130 | .29 | 74185 | 1.09 | | |
| 74142 | 1.39 | 74186 | .65 | | |

| | | | | | |
|--------|-----|--------|------|---------|------|
| 74LS00 | .36 | 74LS32 | .30 | 74LS95 | 2.09 |
| 74LS02 | .36 | 74LS40 | .45 | 74LS107 | .59 |
| 74LS04 | .36 | 74LS42 | 1.40 | 74LS164 | 2.20 |
| 74LS08 | .38 | 74LS74 | .59 | 74LS193 | 2.20 |
| 74LS10 | .36 | 74LS90 | 1.30 | 74LS197 | 2.20 |
| 74LS20 | .36 | 74LS93 | 1.30 | | |

| | | | | | |
|-------|-----|-------|-----|--------|-----|
| 74H00 | .25 | 74H22 | .25 | 74H61 | .25 |
| 74H01 | .25 | 74H30 | .25 | 74H62 | .25 |
| 74H04 | .25 | 74H40 | .25 | 74H74 | .39 |
| 74H08 | .25 | 74H50 | .25 | 74H101 | .58 |
| 74H10 | .25 | 74H52 | .25 | 74H102 | .58 |
| 74H11 | .25 | 74H53 | .25 | 74H103 | .60 |
| 74H20 | .25 | 74H55 | .25 | 74H106 | .72 |
| 74H21 | .25 | 74H60 | .25 | 74H108 | .72 |

| | | | | | |
|------|-------|-------|------|-------|------|
| 300 | \$.71 | 373 | 2.42 | 723 | .62 |
| 301 | .29 | 376 | .68 | 733 | .89 |
| 302 | .53 | 380 | 1.10 | 739 | 1.07 |
| 304 | .80 | 380-8 | 1.25 | 741 | .32 |
| 305 | .71 | 381 | 1.75 | 747 | .71 |
| 307 | .26 | 382 | 1.75 | 748 | .35 |
| 308 | .89 | 531 | 2.95 | 1458 | .62 |
| 309K | 1.35 | 540 | 2.95 | 1800 | 2.48 |
| 310 | 1.07 | 550 | .79 | 3900 | .49 |
| 311 | .95 | 555 | .45 | 7524 | .71 |
| 313 | 1.13 | 556A | 1.19 | 7525 | .90 |
| 1201 | 1.39 | 560 | 3.39 | 8038 | 4.25 |
| 320A | 1.39 | 562 | 3.39 | 8064 | 2.25 |
| 322 | 1.70 | 565 | 1.18 | 75150 | 1.75 |
| 324 | 1.52 | 566 | 1.95 | 75451 | .35 |
| 319 | 1.58 | 567 | 1.95 | 75452 | .35 |
| 340K | 1.69 | 709 | .26 | 75453 | .35 |
| 340T | 1.49 | 710 | .35 | 75491 | .71 |
| 372 | 2.93 | 711 | .26 | 75492 | .80 |

| | | |
|---------|---------------------------------|-------|
| 372 | AF-IF Strip Detector DIP | 2.93 |
| 546 | AM Radio Receiver Subsystem DIP | .75 |
| 1310 | FM Stereo Demodulator DIP | 2.90 |
| 1496 | Balanced Modulator-Demodulator | .99 |
| 1800 | Stereo multiplexer DIP | 2.40 |
| ULN2208 | FM Gain Block 3db (typ) mDIP | 1.18 |
| ULN2209 | FM Gain Block 4db (typ) mDIP | 1.35 |
| 2513 | Character Generator 64kbx25-DIP | 10.20 |
| 3046 | Transistor Array DIP-14 | .73 |

| | | | |
|---------------------------|-------|--------|-----|
| Solder Tail - low profile | | | |
| 8 pin | \$.17 | 24 pin | .42 |
| 14 pin | \$.20 | 28 pin | .59 |
| 16 pin | .22 | 40 pin | .69 |
| 18 pin | .29 | | |

WIRE WRAP - gold plate
14 pin .49

SPECIAL SUMMER SALE (GOOD THRU AUGUST)

DIGITAL

| | |
|-------|-------|
| 7400 | \$.09 |
| 7410 | .13 |
| 7438 | .17 |
| 7453 | .14 |
| 74181 | 1.95 |
| 74123 | .49 |
| 74153 | .69 |
| 74154 | .99 |
| 74C00 | .13 |

LINEAR

| | |
|--------------|-------|
| 301 mDIP | \$.23 |
| 311 mDIP | |
| or 14 pin.69 | |
| 340T 6V | 1.09 |
| 723 DIP | .49 |
| 741 mDIP | .25 |
| 1458 mDIP | .53 |
| 75453 mDIP | .27 |

LED

| | |
|-----------------|-------|
| RED LED .190" | \$.10 |
| WHITE LED | |
| (RED EMIT.) | |
| RL2-03.160" | .14 |
| DL 702 RED C.C. | |
| .30" LHD | .99 |

SHIFT REGISTERS

| | |
|------|--------|
| 2511 | \$1.49 |
| 2527 | 1.95 |
| 2532 | 2.29 |

KEYBOARD

20 KEYS
2 SLIDE SW
3" x 3"



\$.69

CALCULATOR CHIP

| | |
|------|------|
| 5738 | 1.95 |
|------|------|

UNIVERSAL BREADBOARD

Accommodates 8, 14, 16, 4, 28 & 40 pin IC's. 2 triple rows of 27 holes for DIP IC's. Additional space for transistors, resistors & capacitors. Very versatile & simple to use 1/16" phenolic with silver plated copper circuits. 3 3/16" x 5 1/16".

\$.89

LED's

| | | |
|---------|--------------------|--------|
| DL 10A | RED CA .27" LHD | \$1.89 |
| DL 707 | RED CA .30" RHD | 1.49 |
| DL 507 | RED CA .50" RHD | 1.49 |
| FND 359 | RED CC .375" RHD | .89 |
| DL 702 | RED CC .30" LHD | 1.39 |
| NSN 74R | RED CC .30" RHD | 1.49 |
| DL 500 | RED CC .50" RHD | 1.49 |
| MAN5 | GREEN CA .27" LHD | 1.39 |
| MAN8 | YELLOW CA .27" LHD | 1.39 |
| MAN82 | YELLOW CA .3" LHD | 1.89 |
| MAN66 | RED CA .6" LHD | 2.19 |
| DL747 | RED CA .6" LHD | 2.39 |

DISCRETE LEADS

| | | |
|--------------------------|----------------|-----|
| ME4 | LENS DIA. EACH | |
| INFRARED CLEAR DOME | .170" | .29 |
| MV10B | | |
| CLEAR DOME | .170" | .25 |
| MV50 | | |
| CLEAR - AXIAL | .09" | .12 |
| RED - AXIAL | .09" | .12 |
| MSL100 | | |
| RED | .19" | .12 |
| RL209 | | |
| RED DIFF. SUBMINIATURE | .12" | .12 |
| RLT-T 1-03 | | |
| WHITE DIFF. SUBMINIATURE | .124" | .15 |
| NO FLOOD | | |
| RLC-200 | | |
| RED DIFF. CURRENT REG. | | |
| CONST. BRIGHTNESS | | |
| 4.5-12.5V | .190" | .25 |
| RL-4403 | | |
| RED DIFF. FULL FLOOD | .190" | .15 |

SHIFT REGISTERS

| | | | |
|---------------|-------------------------------|--------|-------------|
| 2502 | 1024 bit MULT DYN | 16 pin | EACH \$3.75 |
| 2504 | 1024 bit MULT DYN | 8 pin | 3.75 |
| 2511 | Tri-State Dual 50-100-200 bit | | |
| STATIC 14 pin | | | |
| 2518 | Hex 32-bit STATIC | 16 pin | 2.95 |
| 2519 | Hex 40-bit STATIC | 16 pin | 2.95 |
| 2527 | Dual 256 bit STATIC | 8 pin | 2.95 |
| 2532 | Quad 80 bit STATIC | 16 pin | 3.95 |
| 5013 | 1024 bit accum. Dynamic | 8 pin | 1.75 |
| 5016 | 500/512 bit Dynamic | 8 pin | 1.59 |

EDGE CONNECTOR

ECCO MODULAR UNIT 6/99¢
6 PIN 3 POSITION
WIRE WRAP, GOLD PLATE



CALCULATOR DISPLAY

| | | |
|-----------|-------------|-----|
| 9 MAN 3 M | ON IC BOARD | 99¢ |
|-----------|-------------|-----|

CENTRAL PROCESSING UNIT

| | |
|-------|---------|
| 8008 | \$19.95 |
| 8080A | \$19.95 |

TV GAME CHIP

| | | |
|----------------------------------|--|---------|
| AY-3-8500-1 | | \$24.95 |
| Six games with scoring and sound | | |

2708

| | |
|-------------|---------|
| 1 x 8K EROM | \$29.95 |
|-------------|---------|

2102

| | |
|--------------------------|--------|
| 1024X1 STATIC RAM 16 PIN | \$1.29 |
|--------------------------|--------|

UART

| | |
|----------|--------|
| AY51013A | \$6.95 |
|----------|--------|

74S200

| | |
|-----------------------|--------|
| 256 BIT RAM TRI-STATE | \$3.25 |
|-----------------------|--------|

7489

| | |
|-----------------------|------------|
| 64 bit ROM TTL 16 pin | \$1.75 ea. |
|-----------------------|------------|

RESISTOR KIT

Carbon film - 5%
1/4 WATT 01255
1/2 WATT 01505
455 resistors, 44 values
supplied in a 15 drawer, 60 compartment storage cabinet - table or wall mount. Ready to use.



| R | QTY. | R | QTY. | R | QTY. | R | QTY. | R | QTY. |
|-----|------|------|------|------|------|------|------|------|------|
| 1.5 | 5 | 68 | 5 | 2.2K | 20 | 33K | 20 | 330K | 10 |
| 3.3 | 5 | 220 | 10 | 2.7K | 10 | 39K | 10 | 470K | 10 |
| 6.8 | 5 | 270 | 5 | 3.3K | 10 | 47K | 10 | 680K | 10 |
| 10 | 10 | 330 | 10 | 3.9K | 10 | 68K | 10 | 2.2M | 5 |
| 15 | 5 | 470 | 20 | 4.7K | 20 | 100K | 20 | 3.3M | 5 |
| 22 | 5 | 680 | 10 | 6.8K | 10 | 150K | 10 | 4.7M | 5 |
| 33 | 5 | 1.0K | 20 | 22K | 10 | 220K | 10 | | |
| 47 | 10 | 1.5K | 10 | 27K | 10 | 270K | 5 | | |

MM 5330

| | |
|-----------------------|--------|
| 4 1/2 DIGIT DVM LOGIC | \$6.95 |
|-----------------------|--------|

LH 0070

| | |
|-------------------|--------|
| BCD BUFFERED REF. | \$6.95 |
|-------------------|--------|

LF 13300D

| | |
|--------------------------------------|---------|
| DUAL SLOPE A/D ANALOG BUILDING BLOCK | \$12.95 |
|--------------------------------------|---------|

MM 5616

| | |
|------------------------|--------|
| QUAD BI-LATERAL SWITCH | \$1.25 |
|------------------------|--------|

Data included with order on request. Add \$.30 ea. if item is priced below \$1.00

FREE CATALOG AVAILABLE ON REQUEST

Satisfaction guaranteed. Shipment will be made postage prepaid within 3 days from receipt of order. Payment may be made with personal check, charge card (include number and exp. date), or money order. Phone Orders - BoIA and M/C card or C.O.D.

Add \$1.00 to cover shipping and handling if order is less than \$10.00. California residents add sales tax. Include shipping expense for orders shipped out of U.S. and Canada approx. 10% of order.

INTERNATIONAL ELECTRONICS UNLIMITED
VILLAGE SQUARE, P.O. BOX 449
CARMEL VALLEY, CA 93924 USA
PHONE (408) 659-3171

SUPER VALUE!

- ICS Socketed
- Push button Switches on Main PC Board
- Open chassis for Easy Assembly

2 IN 1 DMM-COUNTER



Size 10W x 3-1/2H x 9D

Meter: Auto polarity and overrange indicator. 11 Meg. Ohm input impedance. Four overlapping ranges on AC-DC volts and current to 1KV and 1 AMP and five ranges on ohms to 1 Meg. Ohm. 500% overrange capability, except current. Accuracy: $\pm 1\%$, ± 1 count DC, $\pm 1.5\%$, ± 1 count AC and Ohms. Counter: Same as FCC-8.

CAPACITANCE COUNTER

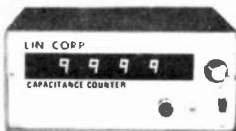

Size 7W x 3H x 8D

$\pm 1\%$ ± 1 count (± 1 pfd. below 100 pfd.) Four ranges from pico farads to several thousand microfarads. Features crystal timebase reference for stability. Auto-cycling.

FCM-8
8 DIGIT
250 MHz KIT
\$219.95

NOW, IT IS
A DREAM TO
MEASURE
YOUR
CAPACITORS.
\$89.95
KIT

- Deluxe Metal Cabinet
- Complete Step-by-step Instruction & Diagrams
- .3 in. 7-Seg. LED Readouts

FREQUENCY COUNTER

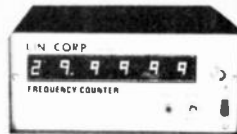

Size 7W x 3H x 8D

Perfect for CBers, hams, hobbyists, technicians. Hi Z input, 50MV sensitivity. Frequency 10 Hz to over 30 Mhz. (FC-6) and 100 Hz to over 250 Mhz. (FC-6H). Crystal timebase. 5 ppm.



Size 10W x 3-1/2H x 9D

Hi Z input. Sensitivity 50 millivolts at 250 Mhz. Readout Hz., Khz., or Mhz. Resolution 1 Hz. to 10 Mhz. and 10 Hz above Crystal time base — 5 ppm.

FC-6
30 MHz KIT
\$89.95

FC-6H
250 MHz KIT
\$129.95

FCC-8
8 DIGIT
250 MHz KIT
\$149.95

Add \$2.50 Shipping/Handling Each
California Residents Add 6% Sales Tax



LIN CORP. 15311 S. Broadway, Gardena, California 90248 (213) 532-8809

CIRCLE 61 ON FREE INFORMATION CARD

A Logical Solution to your Digital Logic Problems!



THE NEW CATCH-A-PULSE® LOGIC PROBE!

- Multi-family
- Open circuit detection
- High input impedance
- Pulse stretching
- 60 Nsec pulse response
- Replaceable tip and cord

Compatible with RTL, DTL, TTL, CMOS, MOS, and Micro-processors using a 3.5 V to 15V power supply. Thresholds automatically programmed for multi-logic family operation. Automatic resetting memory for single or multi-pulse detection. No adjustment required. Visual indication of logic levels, using LEDs to show high, low, bad level or open circuit logic and pulses. Highly sophisticated, shirt-pocket portable (protective cap over tip and removable coiled cord). Eliminates need for heavy test equipment. A definite plus in time and money for engineer and technician.



\$29.95
Plus \$1.75 shipping & handling
No C.O.D. out of the U.S.A.
Calif. residents add 6% sales tax
AVR Electronics
Box 26205
San Diego Ca 92126
(714) 566 1570
Dealer inquiries invited

Pat. Pend

Dealer inquiries invited

CIRCLE 53 ON FREE INFORMATION CARD

TV HOCKEY/SOCCER GAME

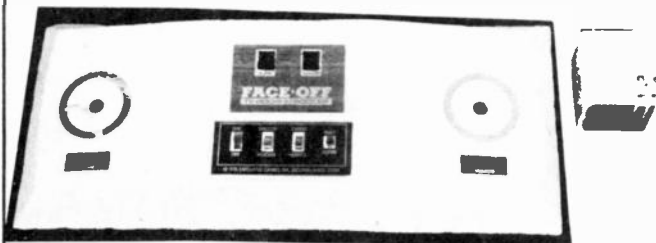

TV Hockey/Soccer game, 2 levels of skill, LED scoring. Appears on your TV set on channel 3. Sold in dept. stores for \$89.50. Pre-tested, guaranteed. About 15 min. to assemble. Complete with VIDEO CUBE interface. Joystick control.

STOCK NO.5495R \$27.50 2/50.00

TV TENNIS GAME BOARD



These logic boards are from a TV tennis game. They contain all the ICs needed, 23 low power Schottky, 3 CMOS, and a 555 timer. These chips are NOT soldered, so that they may be removed by just pulling them off. We sell the boards for the parts, but it is possible to finish the game, as we provide a circuit diagram, and next month will list the additional parts we have to complete the game.

STOCK NO.5516R Tennis board with circuit diagram 3.50 3/10.00

PROGRAMMABLE TRANSFORMER. Eleven 5 V. @ 10A. secondaries. Many voltage combinations possible. Complete data supplied. 4 1/2" x 4 3/4" x 3 3/4" Wt. 13 lbs.

STOCK NO.6544M 1 \$16.95 ea. 2/30.00

BAC & Mastercharge accepted. Include sufficient postage. Excess refunded. Minimum order \$5.00, credit card \$15.00.

Visit our retail outlets. DELTA ELECTRONIC HOBBIES, 5151 Buford Hwy. Doraville, (Atlanta) Ga. DELTA ELECTRONICS, Warehouse Outlet, 590 Commonwealth Ave. Boston, Mass.



DELTA ELECTRONICS

P.O. BOX 1, AMESBURY, MASS. 01913
Tel. (617) 388-4705

CIRCLE 38 ON FREE INFORMATION CARD

For
faster
service

USE
ZIP
CODE

on
all
mail

ELECTRONICS manufacturers stock reduction many items. Free inventory list, will sell bulk or small quantities. VARAXON ELECTRONICS, 1319 Mecklenburg Rd., Ithaca, New York 14850, 607-272-3344

NEW 60/600MHZ PORTABLE COUNTER

- Large 7-seg. LED display
- CMOS. Full instruction
- Small—ideal for field use
- Portable battery operated
- with 12 aa batteries & charger
- Verify communications frequencies
- Internal crystal 10.0001" ONLY
- Input overload protection
- 1 Hz resolution in low range
- 1 meg. input sensitivity 50 mw
- 50 ohm input sensitivity 100 mw
- Size 2" x 2.75" x 1.5"



A 500 MHz PRECISION POINT-TO-POINT ANALYZER --- NOT A KIT
CBS ENTERPRISES, P.O. BOX 1366 COCOA BEACH, FLA. 32931

FREE catalog. Solar cells, NiCad's, kits, calculators, digital watch modules, ultrasonics, strobes, LED's, transistors, IC's, unique components. CHANEY'S, Box 27038, Denver, CO 80227

AMAZING ELECTRONIC PROJECTS and PRODUCTS:

Lasers Super Powered, Burning, Cutting, Rifle, Pistol, Pocket. See in Dark—Shotgun Directional Mike—Unscramblers—Giant Tesla—Stunwand—TV Disrupter—Energy Producing, Surveillance, Detection, Electrifying, Ultrasonic, CB, Auto and Mech. Devices, Hundreds More—All New Plus INFO UNLTD PARTS SERVICE, Catalog \$1. Information Unlimited, Box 626, Lord Jeffery Court, Amherst, N.H. 03031.

JIGS, detectors and terminations, to fit all sweep generators for better TV alignment and trouble shooting. Shielded, insulated, unbreakable, with BNC fittings. New and replacement cables to fit all brands. For free brochure write Irving Tjomsland, dba TEST ANALYST, Box 6121, Huntington Beach, CA 92646

BACK issue magazines. Over 200 titles, 1890 to 1977. Send stamped envelope. Free list. EVERYBODY'S BOOKSHOP, Dept. RE, 317 West 6th, Los Angeles, CA 90014

MANUALS for Govt. surplus radios, test sets, scopes. List 50¢ (coin). BOOKS, 7218 Roanne Drive, Washington, D.C. 20021

Radio Hut

Money back guarantee. NO COD'S. Texas residents add 5% sales tax. Add 5% of order for postage and handling. Orders under \$15.00 add 75 cents. Foreign orders add 10% for postage.

For your convenience, call your BankAmericard or Master Charge orders in on our Toll Free Watts Line: 1-800-527-2304. Texas residents call collect: 1-214-271-8423.



P. O. Box 64783
Dallas, Texas 75206



Memorex computer boards with IC's, diodes, transistor, etc. 5 Boards containing 100 - 200 IC's
ONLY \$ 4.25

| BRIDGE RECTIFIERS | | |
|-------------------|-----|------|
| 6 Amp | 50V | 1.10 |
| 10 Amp | 50V | 1.25 |
| 25 Amp | 50V | 1.39 |

RESISTORS

Over 50,000,000 in stock

| | |
|-----------|----------|
| *330 ohm | 22K ohm |
| 470 ohm | 27K ohm |
| **680 ohm | 33K ohm |
| 1K ohm | 39K ohm |
| 1.2K ohm | 43K ohm |
| 2.2K ohm | 47K ohm |
| 3.3K ohm | 82K ohm |
| 4.7K ohm | 100K ohm |
| 6.8K ohm | 150K ohm |
| 10K ohm | 220K ohm |
| 20K ohm | |

*1.8W only
**1.2W only

All resistors are P.C. Lead that are not pull offs
100 min. order for each value

NO MIX 100/99

MK 5005

4 digit counter/latch decoder; 7 segment output only. 24 pin dip with specs.

\$ 8.00 EACH

UNSCRAMBLER KIT for all Scanners

- Tunes easily
 - Full instructions included
 - Easy to install
 - 3 1/2" x 3 1/2" x 1 1/2"
- Only \$19.95**

PLASMA DISPLAY KIT

Kit Includes: 12 digit display .4" Character Power supply for display above Complete specs for hookup.

Line cord Not Included. **ONLY \$ 3.95**

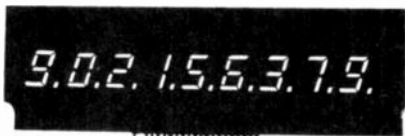

SPECIAL DEVICES

| | |
|----------|-------|
| 82S23 | 2.19 |
| 2513 | 10.00 |
| MK4102-1 | .99 |

PROJECT CASES

| Small | Med | Large |
|----------|----------|----------|
| \$1.50 | \$2.00 | \$2.75 |
| D 2 1/2" | D 2" | D 2 1/2" |
| W 4 3/4" | W 4 7/8" | W 7" |
| H 1 7/8" | H 3 1/2" | H 4" |

All cases have a sloped front, white with black wrinkle finish

REGULATORS

| | |
|------|------|
| 7805 | 7818 |
| 7806 | 7824 |
| 7808 | 7905 |
| 7812 | 7912 |
| 7815 | 7915 |

Your Choice \$.95

READOUTS



| | |
|------------------------------|---------|
| FND70 .4"C.C. | .59 |
| FND800 .8"C.C. | 1.69 |
| T1 6 digit array C.C. | 3/1.00 |
| MAN 8 .3"CA Yellow | .89 |
| LT767 .7" C.C. 4 digit stick | \$ 3.95 |

WATERGATE SPECIAL

Telephone Relay automatically starts and stops tape recorder. No batteries required. Kit complete with drilled P.C. Board. Parts and Case **ONLY \$ 10.95**

VARIABLE POWER SUPPLY KIT NO. 1

- * Continuously variable from 5V to 20V
 - * Excellent regulation up to 500 mil.
 - * 4400 Mfd of filtering
 - * Drilled fiberglass PC Board
 - * One hour assembly
 - * Kit includes all components
 - * Case Included
- ONLY \$10.95**



VARIABLE POWER SUPPLY KIT NO. 2

Same as above but with 1 amp output, also with case. **ONLY \$13.95**

CLOCK KIT

Kit includes

- LT701 clock module
- Power Supply
- Punched Case
- 12 or 24 hour operation

Complete except for line cord

| | |
|--------|---------------|
| LT701E | 12 hour clock |
| LT701G | 24 hour clock |

ONLY \$ 14.95

BATTERY CLIPS

Standard 9V battery clip with 4-1/2" tinned leads. **25/\$1.00**

TRANSISTORS - DIODES

| | |
|---------------------------|---------|
| *MJE1103 | 3 00 |
| MJ3001 | 1 00 |
| 2N2272 | 6 00 |
| *2N2169 | 6 00 |
| *2N2905 | 4 00 |
| *2N2907 | 15 00 |
| *2N3906 | 6 00 |
| *2N4400 | 6 00 |
| *2N4443 SCH | 3 00 |
| 1N4004 | 15 00 |
| 1N4007 | 10 00 |
| 1N4148 (1N4147) 20 00 | |
| 3N201 VHF Pre-amp | 80 |
| D40C1 Power Darl - 8x1.00 | |

*House numbered and P.C. Lead

T T L

| | | | |
|-------|-----|-------|------|
| 7400 | 17 | 7473 | 21 |
| 7401 | 17 | 7474 | 35 |
| 7402 | 17 | 7475 | 55 |
| 7403 | 17 | 7476 | 35 |
| 74H04 | .25 | 7480 | 45 |
| 7404 | .17 | 7483 | 76 |
| 7406 | .25 | 7485 | 89 |
| 7408 | .17 | 7486 | 35 |
| 7409 | .17 | 7490 | 71 |
| 7410 | .17 | 7491 | 71 |
| 7411 | .25 | 7492 | 71 |
| 7413 | .45 | 7493 | 67 |
| 7420 | .17 | 7494 | 90 |
| 7421 | .17 | 7495 | 71 |
| 7423 | .35 | 7496 | 85 |
| 7425 | .27 | 74100 | 96 |
| 7426 | .25 | 74121 | 31 |
| 7427 | .17 | 74123 | 61 |
| 7430 | .25 | 74125 | 44 |
| 7432 | .30 | 74141 | 71 |
| 7437 | .35 | 74145 | 97 |
| 7438 | .35 | 74151 | 71 |
| 7440 | .17 | 74153 | 81 |
| 7442 | .60 | 74154 | 97 |
| 7443 | .60 | 74161 | 91 |
| 7444 | .65 | 74163 | 105 |
| 7446 | .85 | 74164 | 105 |
| 7447 | .81 | 74174 | 91 |
| 7448 | .81 | 74175 | 140 |
| 7450 | .20 | 74180 | 76 |
| 7451 | .17 | 74181 | 2.25 |
| 7453 | .17 | 74181 | 1.20 |
| 7454 | .17 | 74192 | 1.20 |
| 7470 | .35 | 74193 | 95 |
| 7472 | .21 | 74195 | 85 |

HARDWARE

New, includes 2-56, 4-40, 6-32 and 8-32 screws and nuts. A very usable selection.
1/2 pound \$1.50
1 pound \$2.60

L S

| | |
|---------|------|
| 74LS00 | .25 |
| 74LS02 | .25 |
| 74LS04 | .30 |
| 74LS08 | .25 |
| 74LS10 | .25 |
| 74LS11 | .32 |
| 74LS20 | .31 |
| 74LS21 | .33 |
| 74LS22 | .33 |
| 74LS27 | .30 |
| 74LS30 | .31 |
| 74LS32 | .33 |
| 74LS37 | .40 |
| 74LS38 | .35 |
| 74LS74 | .49 |
| 74LS90 | .85 |
| 74LS132 | .90 |
| 74LS138 | .89 |
| 74LS139 | .89 |
| 74LS155 | .90 |
| 74LS157 | 1.00 |
| 74LS162 | 1.39 |
| 74LS163 | 1.39 |
| 74LS175 | 1.09 |
| 74LS193 | 1.09 |
| 74LS258 | 1.09 |
| 74LS367 | .70 |
| 74LS368 | .70 |

CMOS SALE

| | | | |
|--------|------|--------|------|
| 4020 | .85 | 4046 | .90 |
| CD4000 | .16 | CD4040 | 1.00 |
| CD4001 | .16 | CD4041 | .69 |
| CD4002 | .16 | CD4042 | .59 |
| CD4007 | .16 | CD4043 | .60 |
| CD4009 | .45 | CD4044 | .59 |
| CD4010 | .45 | CD4047 | .59 |
| CD4011 | .16 | CD4049 | .35 |
| CD4012 | .16 | CD4050 | .35 |
| CD4013 | .29 | CD4051 | .90 |
| CD4014 | .75 | CD4053 | .90 |
| CD4015 | .75 | CD4056 | 1.00 |
| CD4016 | .29 | CD4058 | .90 |
| CD4017 | .80 | CD4060 | 1.00 |
| CD4018 | .80 | CD4066 | .69 |
| CD4019 | .39 | CD4069 | .30 |
| CD4021 | .90 | CD4071 | .16 |
| CD4022 | .90 | CD4076 | .99 |
| CD4024 | .70 | 74C04 | .29 |
| CD4025 | .19 | 74C107 | .29 |
| CD4027 | .39 | CD4116 | .39 |
| CD4028 | .75 | CD4507 | .40 |
| CD4029 | .99 | CD4512 | .50 |
| CD4030 | .16 | CD4516 | .85 |
| CD4034 | 2.30 | CD4518 | .85 |
| CD4035 | .99 | CD4520 | .85 |

ORDER BY PHONE. Charge your order to BankAmericard or Master Charge.

USE OUR TOLL FREE WATTS

1-800-527-2304

60 Hz L(•)(•)K

Crystal Time Base Kit - Kit enables a MOS clock circuit to operate from a DC power source. Ideal for car, camper, van, boat, etc.

60Hz output with an accuracy of .005% (typ.) Low power consumption 2.5 ma (typ.). Small size will fit most any enclosure. Single MOS IC oscillator/divider chip 5-15 volts DC operation.

ONLY \$ 5.95

2 for \$10.00

RADIO HUT GUARANTEE

If you are not satisfied with any of our products NO MATTER WHAT THE REASON we offer you a full money back guarantee if the product or products are returned within 14 days after you receive them.

All Orders Processed Same Day!

If We Have An Out-Of-Stock Item, You Are Notified Immediately.

Remember !! Our prices in May and June Radio-Electronics are still good.

MODU-CLOCK

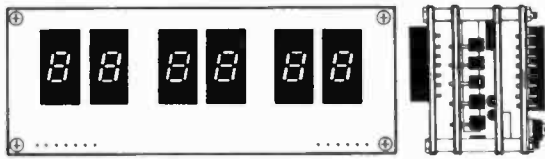

* High quality printed circuit board project. --No parts included.

THOUSANDS SOLD NATIONALLY !!!

DESIGN UTILIZES:
8-Digit LED (Mean 7, DL 707, etc.)
MM5314 Clock Chip
Can be built for AC or DC operation
Drilled, etched and plated boards
CMOS timebase option.

The ultimate 8-digit clock project. Unique architecture allows versatile construction. All boards are 1.5" x 4" and mount behind each other. All connections are brought to the board's edges.

AC Version: Readout Board
DC board set: Clock Board
Power Board
Complete Instructions and Parts List. **\$4.95**

AC/DC Version: Readout Board
DC board set: Clock Board
Power Board
Timebase board
Complete Instructions and Parts List. **\$5.95**



DIGIT-MODULE STRIP

DM-6 STRIP
5 digit strip for use with FND 500/507 LED readouts. Dim.
1" x 3.5" **\$2.25/strip**

DECADE COUNTER MODULE

DCM-1



Versatile decade counter board. Utilizes a 7447 decoder-driver and a 7490 decade counter. Directly drives common anode LED readouts. Designed to be used in conjunction with our DM-5 and DM-8 digit modules. All connections brought to board's edge. **ONLY 70¢ ea 10 for \$6.00**

6 DIGIT READOUT BOARDS

Multiplexed connections for clocks, counters, etc. Corner holes for mounting.

Part No. Use with Price Dim.
DB-63 FND 357 \$2.25 1.5" x 4"
DB-67 DL-707, MM5314 type etc. 1.5" x 4" \$2.25
DB-65 FND 500/507/510 \$3.00 1.5" x 5"

DIGIT-MODULES

Versatile boards for mounting and wiring LED displays. For clocks, counters, timer etc.

Part No. Use with Price Dim.
DM-5 FND 500/507 50 7" x 1"
DM-8 FND 800/807 70 1" x 1.5"

WIRE DISPENSER

- 50 FT. ROLL OF 30 AWG. KYNAR WIRE-WRAPPING WIRE
 - CUTS THE WIRE TO LENGTH
 - STRIPS 1 INCH OF INSULATION
- AVAILABLE IN FOUR COLORS

WD-30-B BLUE WIRE
WD-30-Y YELLOW WIRE **\$3.45 EACH**
WD-30-W WHITE WIRE
WD-30-R RED WIRE

COOKBOOKS

● CMOS COOKBOOK by Don Lancaster, pub. Howard W. Sams Company. Another winner from Don Lancaster, author of the famous RTL and TTL Cookbooks. The CMOS Cookbook details the application of CMOS, the low power logic family suitable for most applications presently dominated by TTL. The book follows the style of the original Cookbooks. Eight chapters cover all facets of CMOS logic, and the work is prefaced by 100 pages detailing the characteristics of most CMOS circuits. The CMOS Cookbook is required reading for every serious digital experimenter. \$9.95

● TVT COOKBOOK by Donald Lancaster, describes the use of a standard television receiver as a microprocessor CRT terminal. Explains and describes character generation, cursor control and interface information in typical, easy-to-understand Lancaster style. This book is a required read for both the microcomputer enthusiast and the amateur RTTY operator who desires a quiet alternative to noisy teletype machines. \$9.95

● TTL COOKBOOK by Donald Lancaster. Explains what TTL is, how it works, and how to use it. Discusses practical applications, such as a digital counter and display system, events counter, electronic stopwatch, digital voltmeter, and a digital tachometer. 336 pages. 5 1/2 x 8 1/2; softbound. \$8.95

● IC OP-AMP COOKBOOK by Walter G. Jung. Covers not only the basic theory of the IC op amp in great detail, but also includes over 250 practical circuit applications, liberally illustrated. 592 pages. 5 1/2 x 8 1/2; soft bound \$12.95

RUBBER FEET

3M BRAND



Model: 86 66
12 per. 75¢ 12 per. 55¢

ALARM CLOCK MODULE

displays Hours, Minutes, and Seconds

FEATURES:

- GIANT .7 INCH RED LED READOUTS
- COMPLETE FACTORY TESTED MODULES
- SPECIAL TRANSFORMER
- SECONDS DISPLAY
- BRIGHTNESS CONTROL
- 12 OR 24 HOUR OPTION
- SLEEP AND SNOOZE TIMERS
- PRESETTABLE 59 MINUTE SLEEP TIMER
- 9 MINUTE SNOOZE ALARM
- AM - PM INDICATOR
- COMES COMPLETE WITH 6 PAGE INSTRUCTION BOOKLET



NEW!!!

SATISFACTION GUARANTEED!!!!

THE ULTIMATE CLOCK PROJECT !!

\$12.95

8 for \$4

New TTL Data Book. Only \$4.95

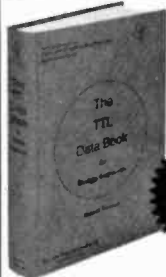

The TTL Data Book, second edition. **\$4.95**

Five more valuable reference aids.

- The Optoelectronics Data Book, 368 pages. \$2.95.
- The Semiconductor Memory Data Book, 272 pages. \$2.95.
- The Transistor and Diode Data Book, 1,248 pages. \$4.95.
- The Linear Control Circuits Data Book, 356 pages. \$2.95.
- The Power Semiconductor Data Book, 818 pages. \$3.95.

The newest edition of the TTL Data Book for Design Engineers. Detailed specifications on over 900 TTL device types. Standard TTL, high technology Schottky-clamped TTL. Pin assignment drawings of all TTL types. The most complete book on TTL logic written by the same company that invented the IC.

A must for every scientist, engineer, and technician!!!!

SATISFACTION GUARANTEED!!!!

Catalog-In-A-Box™

JBS EXCLUSIVE!

NEW!!!

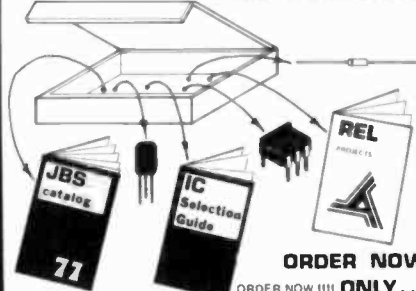

Each CATALOG-IN-A-BOX™ Contains:

- Samples of transistors, IC's, caps, resistors. Worth over \$1.00 in merchandise.
- JBS GIANT full-line catalog with outstanding buys on electronics.
- IC selection guide. Handy selection and pricing guide for digital and linear IC's.
- REL projects catalog.

Just send \$2.00 cash, check or M.O. for immediate delivery. No minimum order for CATALOG-IN-A-BOX™.

\$2.00

ORDER NOW!!

Limit One Per Customer Please. ORDER TODAY !!! You must be satisfied or your money back.

Our Third Big Year Serving The Scientist, Engineer, OEM Manufacturer And Hobbyist.

Highest Quality Merchandise! Fastest Service!

Customer Satisfaction Guarantee

We specialize in fast, prompt service with total customer satisfaction!! All items are guaranteed for 30 days from date of shipment, providing that no user inflicted damage has occurred.

STORE HOURS: 9:30 5:30 Weekdays
8:30 3:00 Saturdays

JBS
ELECTRONICS, inc.
3050 VALMONT BOULDER, COLO. 80301
(303) 442-1212

TERMS

ALL PRICES SUBJECT TO CHANGE WITHOUT NOTICE
ALL MERCHANDISE SUBJECT TO PRIOR SALE
POSTAGE & HANDLING ADD \$1
3 1/2% STATE TAX (COLD. RES.)
MINIMUM ORDER \$5.00
NO COD'S

© COPYRIGHT 1977 JBS



TV Games

FCC Approved

Direct Sales Only

\$38.50

USES 6 C SIZE BATTERIES (Not Included)

FEATURES:

- 4 Games—Tennis, Hockey, Racquet Handball and Single Handball
- Auto counter display on the screen

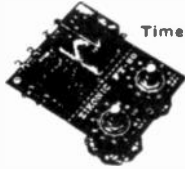

TIMER KIT

Time Controlled from 1-100sec. Ideal to be used as time delay unit for burglar alarm, photo service, and other purposes. Max. loading 110V, 2 AMP. Supply voltage 12-18V D.C.

FT-80 ELECTRONIC IC TIMER

\$11.50 each

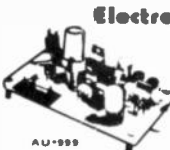

Electronic Police Siren Kit

Ideal for use as an alarm unit.

High output up to 5 watt at 12V DC supply. Can be used with horn-type speaker.

AU-999 POLICE ALARM UNIT

\$14.00 EACH

COLOR ORGAN KIT

Music on Light in Colour!



MC-520 MINI MUSIC COLOR UNIT

Operates in low voltage (9V-24V DC). Can control up to 100 low voltage light bulbs. Light bulbs change colors to the tones of music. Connect to the speaker output of the amplifier.

\$10.50 PER KIT

Don't move!

LIGHT CONTROL SWITCH KIT



RC-102

Can control TV, radio, lights or can be used with the Police Siren Kit to form a burglar alarm system.

\$4.50 EACH

POWER SUPPLY KIT

0-35V D.C. REGULATED



035 POWER SUPPLY

Uses UA723 and ZN3055 Power TR output can be adjusted from 0-35V, 2 AMP. Complete with PC board and all electronic parts.

\$9.50 each

SOUND CONTROL SWITCH KIT



RC-103

Now you can turn your lights, radio, or even TV on with sound. Sensitivity can be adjusted. Operating voltage from 9-18V DC. It is a lot of fun to build one.

\$5.50 each

0.7" Led Clock Module

4 Digits Alarm Clock



\$13.50 EACH

LT701E, 60 Hz 12 hr. display.
LT701G, 60 Hz 24 hr. display.

Power Supply 12V AC Ideal for panel clock, desk clock, or auto clock with our time base kit.

MA1003, 12V DC CLOCK MODULE



\$25.50 EA.

Built in X'TAL controlled time base. Protected against automotive volt transients. Automatic brightness control with 0.3" green color display. Display turnoff with ignition "OFF".

COMPLETE ALARM CLOCK

- 4 Digits 0.5" LED with brightness control
- 12 Hour display with AM/PM indication
- True 24 hour alarm with repeatable snooze
- Power failure indication for power interrupt



MODEL EC 400

(Not A Kit)

Only **\$22.50**

ON SALE **\$17.50 ea.**



CLOCK KIT

MOST POPULAR MMS314 KIT

WITH A NEW CASE!!

Features 12/24 Hour Display 50/60 HZ Input 6 Digits Readout Kit Includes Grey Color Plastic Case MM5314 Clock Chip PC Boards and Transformer, 6 Green Color 0.3" Tube Readouts, All other transistor Drivers and other Components.

Special Only \$14.95 ea.



MODEL OC

ALARM CLOCK

only **\$19.50**

Kit Includes TI Alarm clock chip, LD8132 0.5" Green readouts, PC board with all electronic parts, speakers, transformer and specially designed case.

SW AUDIO AMP KIT



USE 2 LM380 with Volume Control POWER SUPPLY 6VDC

only **\$5.00 ea.**

TV GAME MODULATOR UNIT



FCC Approved For channel 3 and 4 With Osc. CEM

ONLY **\$4.50**



TI-AY3-8500-1 (28 pin Dip) 6 Game, TV Game Chip With Data Tennis, Squash, hockey, practice and two shooting

Special Only **\$11.00**

NI-CD RECHARGEABLE BATTERIES

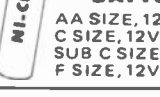

AA SIZE, 12V \$1.25 ea.
C SIZE, 12V \$1.50 ea.
SUB C SIZE \$1.50 ea.
F SIZE, 12V \$2.50 ea.

AUTO ALARM KIT



The Comlighter Auto Alarm is an electronic self controlled auto protection system normally mounted within the glove box of an automobile. Two minutes after turning off the ignition the alarm automatically turns itself "on". When the auto is re-entered the horn will sound after a 10-45 second entry delay. The automobile owner, by inserting the ignition key will activate the alarm. Once activated the alarm will sound for two minutes before automatically turning off. The alarm then resets and is ready to again protect the vehicle from unwanted entry.

FEATURES: Simple installation. 5 wires. Automatically turns on when auto is parked. Adjustable entry time. Extended "P" time to allow for unattended exit from vehicle. Numerous applications include protection of boats campers, trailers motorcycles, trucks. Cannot be deactivated by hot wiring an auto. Can not be turned off without ignition key. Neg. drive ground only.

ONLY **\$10.00 PER KIT**



NATIONAL MM 5369 17 STAGE PROGRAMMABLE OSC/DIVIDER generate A 60 Hz reference Frequency with a 3.58 MHz Color TV X TAL in Mini. DIP Package

ONLY **\$2.25 each**

19 KEY HEXADECIMAL KEYBOARD



STANDARD SIZE KEY TOPS

WITH UNENCODED SPST KEYS

ONLY **\$9.95 EACH**

Sub Mini Size PANEL METER

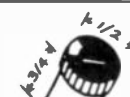

500 UA

ONLY **1.20 EA.**

150UA METER



only **\$1.50 ea.**

50 UA PANEL METER

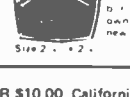

only **\$3.80 ea.**

ELECTRONIC SWITCH KIT

CONDENSER TYPE

Touch on Touch Off use 7473 I.C. and 12V relay **\$5.50 each**



FM WIRELESS MIC KIT

Transmit range up to 100 ft.

Easy to assemble

(Mic included)

\$4.50 each

Sub-Mini Size Condenser Microphone **\$2.50 each** FET Transistor Built-in

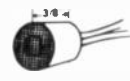

SIGMA 78RE1, 12DC RELAY

400 COIL SPDT

\$1.30 ea. or 10 for \$10.00

ALL BRAND NEW UNITS



COMPUTER GRADE CAPACITOR



5600 MFD, 60V, \$2.20 EA.
15500 MFD, 75V, \$4.95 EA.
39000 MFD, 12V, \$2.00 EA.

COMPUTER KEYBOARDS



Standard Teletype Keyboards with gold plated contact switches. All switches are independent and allow you to connect into any form of output.

63 Keys — **19.50**
60 Keys — **14.50**

QUARTZ CRYSTALS



1MHz Computer Crystals \$4.25 ea
3.58 MHz Color TV Crystals \$1.25 ea
Use with Nation MM 5369 to make a perfect time base for clock

SAE DIP SWITCHES



Part No. 1004 692 4 - SPST SW
100R 692 8 - SPST SW

4 Toggle SPST Switches 0.5" x 0.5" x 0.5" 8 pins Only \$1.50 ea
8 Toggle SPST Switches on a DIP 16 pins Only \$2.60 ea

SUBMINIATURES TOGGLE SWITCHES



SPDT On/Off \$1.30 ea
DPDT On/Off \$1.50 ea
SPDT On/Off \$1.75 ea

Mini Size Rocker Type Also Available at the Same Price

QUAD VOLUME CONTROL



4 100K VO potentiometers in one unit very resistant and proportional to the angle of the shaft. Perfect for electronic games or radio receivers.

only **\$7.50**

Knob for Joystick 50¢ ea.

PUSH-BUTTON SWITCH



N/Open Contact. Color: Red, White, Blue, Green, Black. **4/\$1.00**

LARGE QTY AVAILABLE

SOLID STATE ELECTRONIC BUZZER



Mini Size 1.3" x 1.3" x 0.5" Supply voltage 1.5V - 12V Ideal for Alarm or Tone Indicator **\$1.50 each or 2/\$2.50**

MINIMUM ORDER \$10.00. California residents add 6% sales tax and \$1.50 postage.

All orders add 10% postage for out of state. Overseas countries add 15% of total order for postage.

SEND CHECK OR MONEY ORDER TO:

FORMULA INTERNATIONAL INC.

12603 CRENSHAW BOULEVARD • HAWTHORNE, CALIFORNIA 90250

For more information please call (213) 679-5162

STORE HOURS 10-7 Monday - Saturday



AMAZING & HARD-TO-FIND SCIENCE BUYS! ALTERNATE ENERGY SPACE AGE • HOBBIES

SUPER POWER FOR ANY AM RADIO



Antenna assist has pulled in stations up to 1000 miles' off! No wires, clips, grounding. Solid state—no elec. batts., tubes.
No. 72,095EH \$19.95 Ppd.
ULTRA SELECT-A-TENNA (OVER 1000' MILES)
No. 72,147EH\$24.95
SUBJ. TO LOCAL COND.

SAVE 50%! 8 x 20 MONOCULAR



Top quality Spy Scope, a \$30 value, now \$14.95! Special purchase saves you 50%. 100% coated optics; 393 ft. field of view. Only 2 oz.—stores in pocket, purse, glove box.
No. 1568EH .. \$14.95 Ppd.

ELECTRONIC DIGITAL RAIN GAUGE



never needs emptying measures rain up to 100-ft. away by tenths of an inch up to 999.9" and empties itself. Push indoor counter's reset button, start new counting period. Req. 9v batt. (not incl.)
No. 72,165EH \$49.95 Ppd.

NASA-CHOSEN FOR APOLLO/SOYUZ



The Astronauts used this super 20x60 binocular (modified) to view Earth! Big 60 mm objective lenses; 173-ft. field of view at 1000 yds. Relative brightness, 9.0. Fully coated optics, more!

No. 1556EH(9 1/2" x 8 1/2"; 47.5 oz) \$99.95 Ppd.

WORLD'S LARGEST SOLAR CELL...

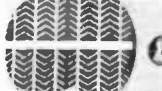

the most powerful silicon, cheapest dollar per watt! 4" dia. giant can put out 1 full watt, over 2 amps of current at 45v. Rated 100mW/cm² light intens. at 45v.

No. 42,314EH...(TAB LEADS).....\$29.95 Ppd.
No. 42,270EH...(1 AMP 1/2 W 3" DIA.).....\$17.95 Ppd.

BUILD ALPHA MONITOR: \$37.50!



All you need w/ your basic electronics knowledge (excl. 9v tr. batt.) for port. biofeedback unit, an aid to relaxation, concentration. 5 microvolt sensitivity; self-cont.

No. 61,069EH (KIT)\$37.50 Ppd.
No. 71,809EH (FULLY ASSEMBLED).....\$59.95 Ppd.

ELECTRONIC COUNT-DOWN STOPWATCH



Hand-held 5-oz digital stopwatch counts up, down, sounds alarm—w/full range LED display (9 hrs., 59 mins., 59 secs.) Has start/stop (time-out/reset) buttons. Accurate alarm clock! 3 AA batts.

No. 1692EH(2.8 x 4.3 x 1.1).....\$49.95 Ppd.

15% EFFICIENT SOLAR CELL!



Largest, most powerful ever for terrestrial use, to build solar panels where max. power per unit area is req. Output up to 12w per sq. ft. Produces 8A @ 45 v.; .38w output. 2" x 2" sq. 2.0Z.

No. 42,514EH.\$39.95 Ppd.

CAN'T SLEEP, RELAX? TRY THIS!

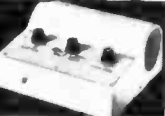

Electronic sound conditioner simulates 4 kinds of soothing sounds of ocean surf & rain; "white" sound helps mask unwanted noise. Medical tests proved analgesic effects!
No. 71,997EH \$89.95 Ppd.

QUALITY DETECTOR UNDER \$40



Our fully transistorized BFO unit can locate a quarter at 18". Powerful 6 trans-oscillator-amplifier circuit. Comp. to others priced 50% more! Aluminum, just 2 lb.
No. 80,222EH \$39.95 Ppd.

EDMUND SCIENTIFIC CO.

300 Edscorp Bldg., Barrington, N.J. 08007 • (609) 547-3488
America's Greatest Science • Optics • Hobby Center



THERE IS NO OTHER TELESCOPE LIKE IT! THE NEW EDMUND 4 1/4", f/4 NEWTONIAN WIDE FIELD REFLECTOR TELESCOPE

Clear, bright, spectacular wide angle views of stars, moon, comets... easy to use... portable!

IN SECONDS YOU'RE SCANNING THE ASTOUNDING UNIVERSE, able to see and study the breath-taking cosmos as perhaps you never have before—awesome vastness, unbelievable orderliness, stark silent beauty. All the fascinating heavenly mysteries are yours to enter and explore. This new reflector telescope makes it easy for everyone to span a thousand light-years to space-age enjoyment of the heavens and outdoors. No complicated set up! Just insert the eyepiece, focus, and its big 3 1/2" field of view gives you more stars in a single view than any other type of telescope. Bright, crisp, finely resolved images to capture your interest and imagination. It's probably the easiest to use telescope ever—over your shoulder, in your lap, on a tripod. Or just rotate the spherical base on its own mount for use on a table, car hood. Take it anywhere (only 17", 10 lb.). Top quality optical system: 4 1/4" f/4 parabolic primary mirror (1/4 wave, 17" F.L.); prealigned 1/4 wave diagonal on a coated optical window seals optics from moisture and dust. 28mm Kellner eyepiece (gives 15X, higher without other eyepiece or Barlow). Fast focusing (25' to infinity)! Bright Scharfartian red (doesn't impair night vision), adj. carrying strap. A first scope must be an ideal second scope!

There is no other telescope like it. NO. 2001EH \$149.95 Ppd.

FOR GREATER RELAXATION, CONCENTRATION, listen to your Alpha and Theta brainwaves!



COMPARES WITH UNITS SELLING FOR \$150 UP.

No. 1689EH

Do-It-Yourself Kit #61069EH \$37.50 ppd.
Low Cost 'Starter' Unit #71809EH \$59.95 ppd.

Do it with an amazing biofeedback monitor. This ultra-sensitive sensor detects brain signals, lets you monitor (hear and see!) your Alpha and Theta brainwaves. Great aid to relaxation, concentration. This portable (8 x 3 x 4") lightweight (24 oz.) metal unit has a unique electrode headband to slip on or off in seconds without messy creams or solutions. Hooked to amplifier, it filters brainwaves, and signals an audible beep for each Alpha or Theta wave passed. You get both audio and visual (L.E.D.) feedback with this reliable, completely safe unit. It operates on two 9v transistor batteries, offers features comparable to many costlier models. A comprehensive instruction booklet is included.

No. 1689EH JUST \$99.95 Ppd.

"SEE" MUSIC IN PULSATING COLOR



The Edmund 3-Channel Color Organ \$18.50

COMPLETELY ASSEMBLED! LESS THAN HALF THE PRICE OF OTHER MODELS!

Create your own audio "light show", add a new dimension to your music listening pleasure with the bargain-priced Edmund 3-Channel Sound To Light Control.

Lets you modulate 3 independent strings of colored lamps with the intensity of your music. They flash and vary in brightness related to the music's rhythm, pitch and volume—a pulsating light performance to music! You get volume and frequency sensitivity to a peak rating of 300 watts per channel. Just plug in your favorite colored flood or spotlight, and turn on! Great price, too. This high quality, fully assembled unit in metal housing, with 3 individually controlled circuits, is priced at less than half that of others. Complete instructions are included with this terrific value.

ASSEMBLED \$18.50 Ppd.
NO. 42,309EH

UNASSEMBLED, IN KIT FORM \$15.95 Ppd.
No. 42,336EH ONLY

GIANT FREE 164 PG. CATALOG



4,000 UNUSUAL BARGAINS FOR HOBBYISTS, SCHOOLS, INDUSTRY

COMPLETE AND MAIL COUPON NOW

EDMUND SCIENTIFIC CO. 300 Edscorp Bldg., Barrington, N. J. 08007

Send me the following:

Stock No. Quantity Price Ea.

| Stock No. | Quantity | Price Ea. |
|-----------|----------|-----------|
| | | |
| | | |
| | | |

SEND FREE 164 PG. CATALOG "EH"

Charge my American Exp BankAmericard Master Chg.

Interbank No. _____

Card No. _____

Expiration Date _____

30-DAY MONEY-BACK GUARANTEE. You must be satisfied or return any purchase in 30 days for full refund.

Add handling charge \$ _____ 1.00
Enclosed is _____ check, _____ M.O. in amount of \$ _____

Signature _____

Address _____

City, State, Zip _____

Super Savings

CB TRANSCEIVER
PORTABLE CB ANTENNA
UNIVERSAL LOCK MOUNT
OUTDOOR REFLEX HORN

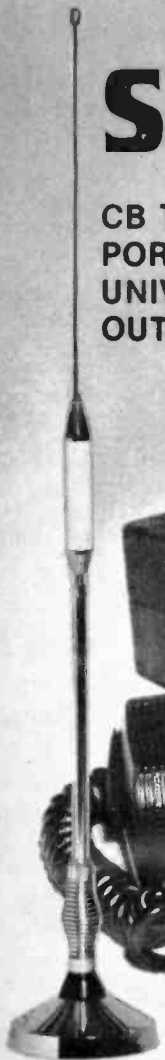

\$ 9.95



\$49.95



\$3.95



\$3.45

direct from factory

Celebrate!
Enjoy Year round
pleasure with these
special factory offerings
in top quality CB equipment.
Buy the Deluxe CB Transceiver and
all the trimmings, or pick any accessory
you want. Our specials include...

Deluxe CB Transceiver

- RF gain - Delta Tuning
- 23 Channel Mobile Radio
- ANL switch - Squelch Control
- 'S' - RF output meter
- CP - PA switch
- On-the-Air indicator
- Special Price \$49.95 (Retail \$129.95)
- Ask about our 40 Channel fcr...\$69.95

CT-8 5" Outdoor Reflex Horn

- Available in black or copper color
- 10 watt power rating
- 3 ohm voice coil impedance
- 5 inch horn opening
- Special Price \$3.95 (Retail \$9.95)

Gs-10 CB Universal Lock Mount

- Easy to install
- Built-in lock
- Universal Slide mount
- Positive or Negative ground
- Special Price \$3.45 (Retail \$3.95)

Mobile CB Antenna

- Powerful heavy duty magnet...
mount anywhere on car.
- Water proof coil-Center load
- For 23 or 40 channel
- Stainless steel whip, chrome plate
- Frequency range 26.965 - 27.255 mhz.
- Stand up to 100 mph.
- Special Price \$9.95 (Retail \$17.95)

Call Toll Free: 800-323-0661

Visa (BAC), Master Charge, Ck. or MO accepted.
On Accessories add \$1.00 for Shipping/Handling
On Transceiver add \$2.00 for Shipping/Handling
Illinois Residents add 5% Sales Tax

ejc

EASTERN INDUSTRIAL CORP. INC.

1380 Jarvis Ave.
Elk Grove Village, Illinois 60007
(312) 640-8737
Call Toll Free 800-323-0661

Introducing the mobile that can move you out of the world of the ordinary and into the world of the serious CB'er. The Cobra 138XLR Single Sideband. Sidebanding puts you in your own private world. A world where there's less congestion. More privacy. More time to talk.



It's all possible because instead of 40 channels you get your choice of 120 channels. Both AM and SSB. And instead of 4 watts of legal power you get 12 watts of legal power. So you get almost double the range of AM.

With the 138XLR Single Sideband there's less background noise and less interference. So there's cleaner, clearer reception. Because like all Cobras, the 138XLR SSB is engineered to punch through loud and clear. Even in crowded metropolitan areas.

And like all Cobras it comes equipped with such standard features as an easy-to-read LED channel indicator. Switchable noise blanking and limiting. An RF/signal strength meter. And Cobra's exclusive DynaMike gain control. You'll find the 138XLR SSB wherever Cobras are sold. Which is almost everywhere. Because Cobra's got a nationwide network of dealers and Authorized Service Centers offering sales, installation, service and advice. So come on in. And move on up.



Punches through loud and clear.

Cobra Communications Products
DYNASCAN CORPORATION
 6460 W. Cortland St., Chicago, Illinois 60635

Write for color brochure
 EXPORTERS: Empire • Plainview, NY • CANADA: Atlas Electronics • Toronto

UPWARD MOBILITY.



CIRCLE 2 ON FREE INFORMATION CARD