

4-CHANNEL DIGITAL SCOPE HAS NO CRT

75c ■ APR. 1975

Radio-Electronics

THE MAGAZINE FOR NEW IDEAS IN ELECTRONICS

**BURGLAR ALARM
CIRCUITS**
Build Them With
COSMOS IC's

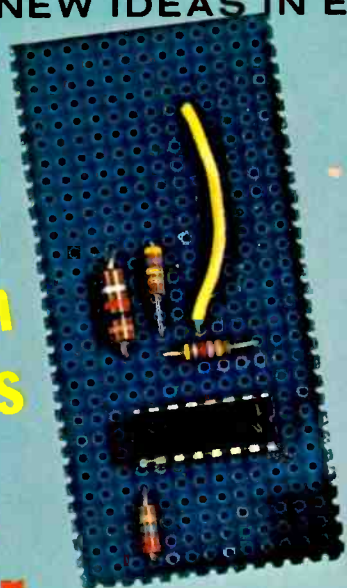

EXTRA AUDIO SIGNALS
You Never Bargained For

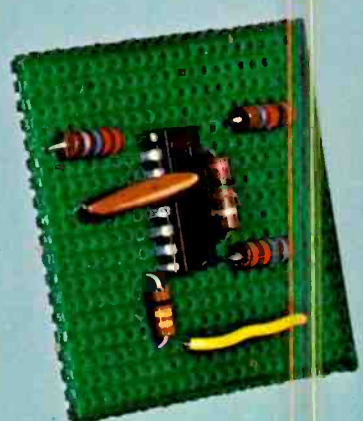

IC UPDATE
Pseudo-Random Circuits

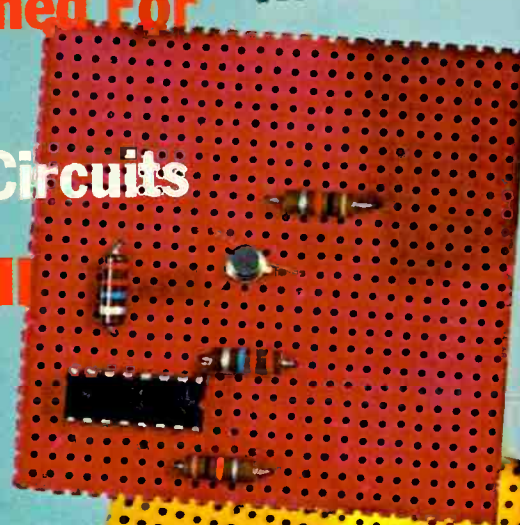

TV TYPEWRITER II
Final Details

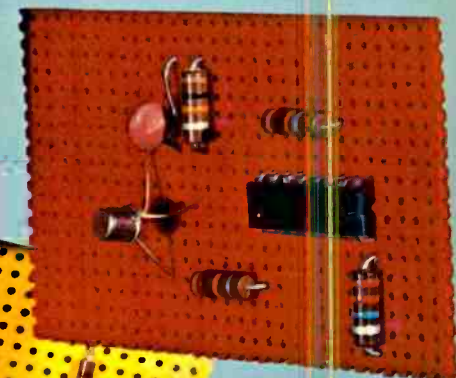

TICK TIMER
Build It Tonight

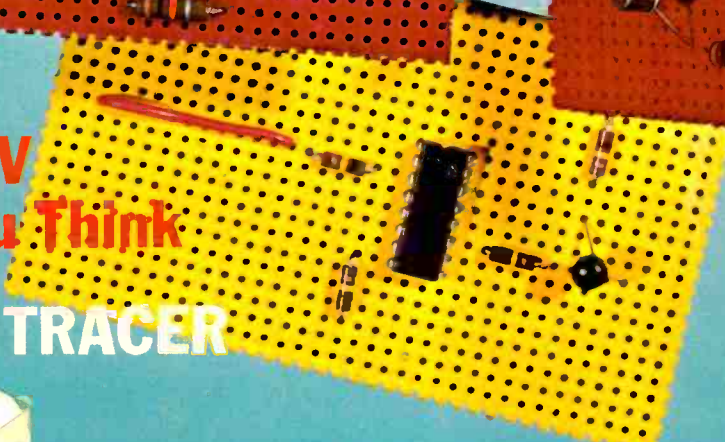

ADD CCTV TO MATV
It's Easier Than You Think

USING THE CURVE TRACER

961296 0LS B024597 MAR76 1 A
4 04
M M DELSCHLAGER
BOX 245
9RMONS MILLS NJ 08019



Troubleshooting Charts
★ **Jack Darr's Service Clinic**
Equipment Reports ★ **R-E's Replacement Transistor Directory**

Tops all of ours and all of theirs too

the Sansui 881

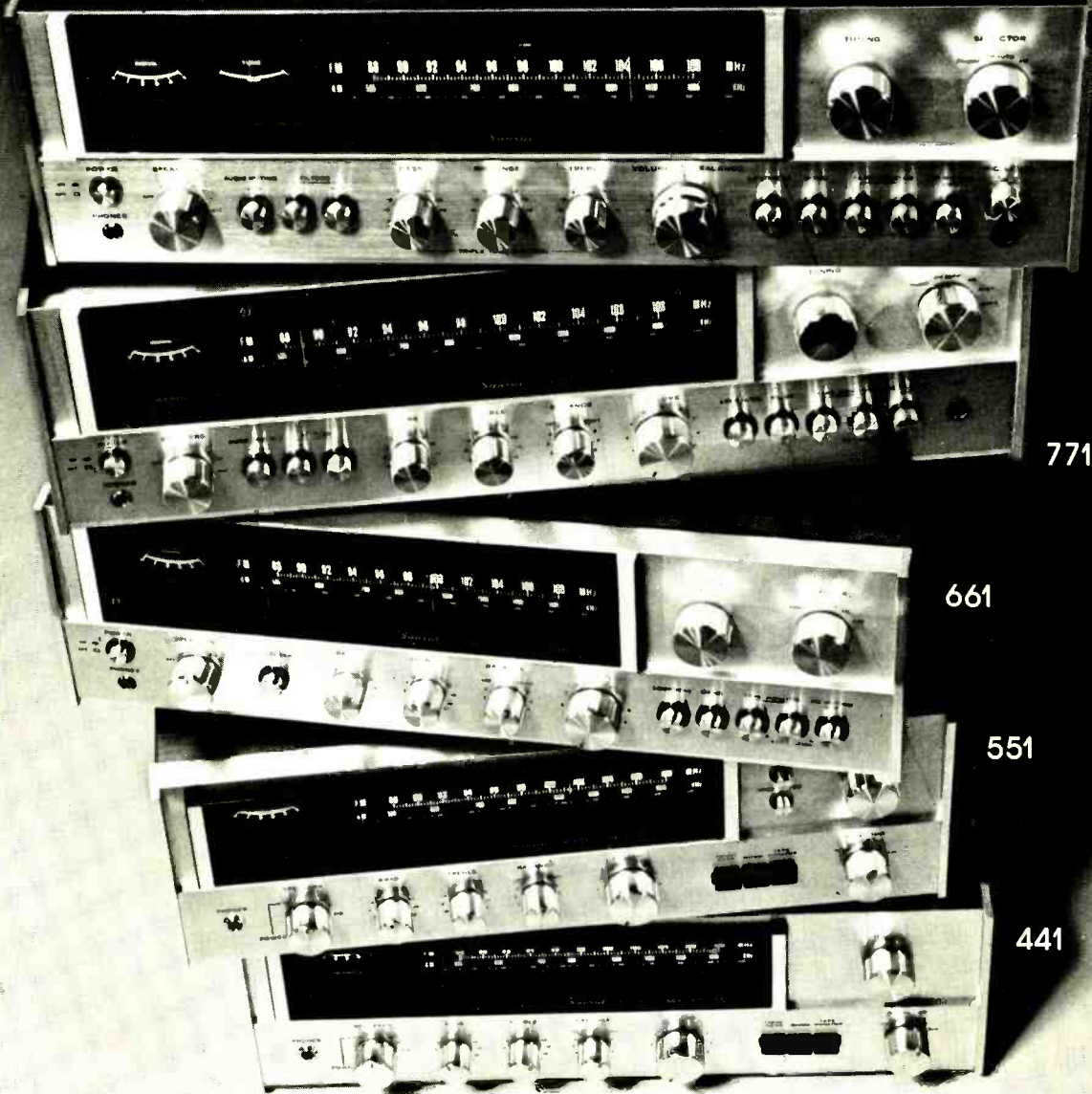

771

661

551

441

SANSUI 881 is our finest hour.

The most advanced model in the long line of our already famous AM/FM stereo receivers and it's not only our best, it's the best on the market today.

Specs: 63 watts per channel minimum RMS into 8 Ohm load from 20 Hz to 20 KHz with no more than 0.3% total harmonic distortion. 1.8 microvolts sensitivity.

Hear the SANSUI 881 at your nearest SANSUI franchised dealer – and be sure to pick up your free copy of "The Sounds of SANSUI" or write directly to us.

Woodside, New York 11377 • Gardenia, California 90247 • SANSUI ELECTRIC CO. LTD. Tokyo, Japan
SANSUI AUDIO EUROPE S.A. Antwerp, Belgium • ELECTRONIC DISTRIBUTORS (Canada) B.C.
Circle 1 on reader service card

SANSUI ELECTRONICS CORP.

Sansui

Circle 93 on reader service card →

ANOTHER DIMENSION

has been added to the world famous family of

Simpson®

260®

VOLT-OHM-MILLIAMMETERS



The pacesetters for over 40 years and still going strong!

Still the leader...
the time honored, ever popular

Simpson 260 SERIES 6

- Fast, accurate measurements of 28 time-proven ranges.
- Direct dial reading of Amp-Clamp ranges
- External access battery and fuse compartment
- Clip-type fuse holder and extra fuse
- Optional 5 kV slip-on safety probe
- Multi-purpose, test leads with combination probe and alligator clips
- Only 2 batteries . . . one 9-volt NEDA 1604 and one 1.5-volt "D" cell NEDA 13F. Batteries supplied.
- Rugged taut band movement, varistor protected

RANGES:

DC Volts:	0-0.25; 0-1; 0-2.5; 0-10; 0-50; 0-250; 0-500; 0-1000
AC Volts:	0-2.5; 0-10; 0-50; 0-250; 0-500; 0-1000
DC Microamperes:	0-50 (250 MV Drop)
DC Milliamperes:	0-1; 0-10; 0-100; 0-500
DC Amperes:	0-10 (250 MV Drop)
AC Amperes:	Up to 250 with optional Model 150 Amp-Clamp Adapter
DB Scale (1 MW 600 Ω Reference):	-20 to +10; -8 to +22; -6 to +36; +20 to +50
Resistance:	Rx1; Rx100; Rx10K



- 260-6, complete with batteries, test leads and manual \$75.50
- 260-6M, with mirror scale \$78.50
- 260-6RT, in Roll Top Case \$84.00
- 260-6MRT, with mirror scale, in Roll Top Case \$87.00

AND THE EQUALLY POPULAR, VERSATILE, CIRCUIT OVERLOAD-PROTECTED 260-6P



Reset pushbutton releases when overload exists. Will not reset until overload condition is eliminated.

- 260-6P, complete with batteries, test leads and manual \$115.00
- 260-6PM, with mirror scale . . \$118.00
- 260-6PRT, in Roll Top Case . \$124.00

And a broad line of Simpson Accessories are available for the Simpson 260 Family of VOMS

Model 150
Amp-Clamp
Catalog No. 00532
complete with No.
00533 test lead
\$29.50



30 kV DC
Probe
Catalog No.
00509 . \$22.00



Grip-Tip
Extension
Probe
Catalog No.
00118 . . \$4.75



Vinyl
Ever-Redy
Case
Catalog No.
00805 . \$20.50



Vinyl Sheath
Case
Catalog No.
01818 . \$16.75



The World Famous Simpson 260 Family Of VOMS Is Available

www.americanradiohistory.com

And NOW...
for the special needs of the
**solid state
electronics industry**

Simpson 260 SERIES 6 XL



260-6XL, complete with batteries,
test leads and manual. \$90.00
260-6XLM, with mirror scale. \$93.00

**AND THE CIRCUIT OVERLOAD-PROTECTED
260-6XLP**

Reset pushbutton releases when over-
load exists. Will not reset until over-
load condition is eliminated.

260-6XLP, complete with batteries,
test leads and manual \$125.00
260-6XLMP, with mirror scale \$128.00



5 kV DC
Probe
Catalog No.
00506 . . \$5.25



5 kV AC
Probe
Catalog No.
00505 . . \$5.25



- X** for extra ranges and features
- L** for low-power ohms capabilities
- X** Extra shock and drop resistant construction
High impact, custom-molded panel and case
- X** 33 ranges with extra voltage, current,
resistance and low-power ohms functions
- XL** Extra large viewing area with color-keyed scales
 - Direct dial reading of Amp-Clamp ranges
 - External access battery and fuse compartment
 - Clip-type fuse holder and extra fuse
 - Optional 5 kV slip-on safety probe
 - Multi-purpose, test leads with
combination probe and alligator clips
 - Only two batteries . . . one 9-volt NEDA 1604 and
one 1.5-volt "D" cell NEDA 13F. Batteries supplied.
 - Rugged taut band movement, varistor protected

RANGES:

- DC Volts: **X** 0-0.250; 0-1; 0-2.5; 0-10; 0-25;
0-100; 0-250; 0-500; 0-1000
- AC Volts: **X** 0-2.5; 0-10; 0-25; 0-100; 0-250;
0-500; 0-1000
- DC Microamperes: 0-50 (250 MV Drop)
- DC Milliamperes: **X** 0-0.5; 0-5; 0-50; 0-500
- DC Amperes: **X** 0-5 (250 MV Drop)
- AC Amperes: 6 ranges from 0-5 to 0-250 with
optional Model 150 Amp-Clamp
adapter
- DB Scale (1 MW 600 Ω
Reference): **X** -20 to +10; -9 to +21;
-1 to +29; +11 to +41;
+19 to +49
- Resistance (Standard
Power): **X** Rx1 (6 Ω center scale), Rx100 (6000 Ω
center scale), Rx1K (60000 Ω
center scale), Rx10K (600,000 Ω
center scale)
- Resistance (Low
Power): **XL** Rx1 (20 Ω center scale), Rx10 (200
 Ω center scale). Max. open circuit
voltage only 100 mV! Max.
measuring power only 0.125 mW!

At Leading Electronic Distributors,



SIMPSON PRODUCTS encompass a broad range of: Analog and Digital Panel Meters, Pyrometers, Elapsed Time Meters, Meter Relays and Controllers, Events Counters, Volt-Ohm-Milliammeters, Digital Instruments, Microtesters, Electronic Multimeters, Temperature Testers, Illumination Level Meters, Photo Tachometers, Noise and Sound Level Meters, Electrical Safety and Microwave Leakage Testers, Cathode Ray Oscilloscopes, Insulation Resistance Testers, Clamp Type Ammeters and VOA's, Chart Recorders, Signal Generators, Automotive Test Equipment, Digital Frequency Counters and Timers, Portable Secondary Standards, R-L-C Bridges, Custom Engineered Instruments and other Special Testing Apparatus.



Over 40 years of integrity in design, quality construction and easy availability has established Simpson as the leading supplier of highest quality test and measuring instruments. Through the years servicemen and technicians have become accustomed to expect long life and trouble-free performance from all Simpson products.

Electronic and electrical equipment distributors throughout the world carry Simpson products in stock for immediate delivery. Though seldom required, parts, repair service and calibration, when needed, are available through a large network of Authorized Service Stations.

For complete details on the entire Simpson 1975 product line, write for new 60-page Catalog 4400 or call your nearest Simpson Representative.

SIMPSON ELECTRIC COMPANY

853 Dundee Avenue, Elgin, Illinois 60120 • (312) 697-2260

CABLE: SIMELCO • Telex: 72-2416

IN CANADA: Bach-Simpson, Ltd., London, Ontario

IN ENGLAND: Bach-Simpson (U.K.) Ltd., Wadebridge, Cornwall

IN INDIA: Ruttonsha-Simpson Private, Ltd., Vikhroli, Bombay

KATY INDUSTRIES



INDUSTRIAL
EQUIPMENT
GROUP

The first in a new series of Audel® Service Guides— “SERVICING RCA FOR 1975”

SERVICING RCA FOR 1975

by Stan Prentiss, is the forerunner of an entirely new series of specialized service manuals, developed by the Audel Division of Howard W. Sams & Co., Inc., to guide you in servicing the new products of the leading TV manufacturers.

Here under one cover is the first comprehensive directory of detailed servicing data and information for all '75 models of RCA Color TV, black and white TV, stereo, tape recorders, and radio. It is a complete guide for troubleshooting, schematics, replacement parts lists, and service tips, with full and accurate identification of all integrated circuits used, specific circuit writeups, and pertinent RCA training material. Invaluable for servicemen and do-it-yourselfers alike.

No. 21155 \$12.95

SERVICING RCA FOR 1975 will be followed shortly by 1975 service guides for other leading electronic home entertainment manufacturers.



TELEVISION

HOME TV-FM ANTENNAS

by Paul Lawrence and Hansen Elroy

Tells and shows how to select the right antenna for the location, how to install, control, and adjust it for best reception. 208 pages, softbound.

No. 21076 \$5.95

KNOW YOUR OSCILLOSCOPE 3rd Edition

by Paul C. Smith

Revised by Robert G. Middleton

Explains the many applications of oscilloscopes, their circuits and functions, accessories, proper adjustments, and maintenance. 168 pages, softbound.

No. 21102 \$4.95

CLOSED-CIRCUIT TELEVISION

HANDBOOK 3rd Edition

by Leon A. Wortman

Covers the use of CCTV in industry, education, medicine, and commerce. Includes equipment requirements, use of cassette and cartridge recorders and portable recorder units in CCTV. 288 pages, softbound.

No. 21097 \$7.95

HOW TO USE VIDEO TAPE RECORDERS

by Harry Kybett

Video tape recorders are increasingly used in education, the medical profession, sales, and industry. This operational guide covers the problems and maintenance of vtr, and shows how to use vtr to record, play back, edit and copy. 264 pages, softbound.

No. 21085 \$6.95



RADIO

FIRST-CLASS RADIOTELEPHONE LICENSE HANDBOOK 4th Edition

by Edward M. Noll

This best-seller is designed to help you acquire a first-class radiotelephone license and prepare you for the responsibility of operating and maintaining broadcast equipment. Covers transmitter, equipment, studio, master control, and remote equipment, and includes recently revised FCC rules and regulations. 416 pages, softbound.

No. 21144 \$7.50

examination, and provides the practical data needed to maintain two-way radio equipment efficiently. All material is based on the FCC Study Guide and Reference Material. 448 pages, softbound.

No. 21111 \$7.50

SECOND-CLASS RADIOTELEPHONE LICENSE HANDBOOK 5th Edition

by Edward M. Noll

Prepares the reader to pass FCC license

CB RADIO ANTENNAS 3rd Edition

by David E. Hicks

A complete guide for those who want to improve the "reach" of their CB radio equipment. No prior knowledge of antenna design and installation is needed to understand and follow this guide. 136 pages, softbound.

No. 21100 \$4.50

ELECTRONICS

LIGHT-BEAM COMMUNICATIONS

by Forrest M. Mims, III

Covers the principles of light-beam communication, light sources and detectors, components, and optical communication systems. Discusses its early history, rapid development since the advent of the laser, and the potential for this relatively new method of communication. 160 pages, softbound.

No. 21147 \$4.95

UNIQUE IC OP-AMP APPLICATIONS

by Walter G. Jung

Many analog functions call for unique op-amp devices that allow applications not possible with standard op-amps. This book divides these unique op-amp applications into four general categories and explains and illustrates the operation of each. 144 pages, softbound.

No. 21163 \$4.95

AUTOMOTIVE

SOLID-STATE IGNITION SYSTEMS

by Rudolf F. Graf and George J. Whalen

An invaluable guide for the car owner who wants to install and service his own solid-state ignition system, as well as for the professional serviceman. Covers all types of solid-state ignition systems available today. 136 pages, softbound.

No. 21049 \$4.50



Order from your Electronics Parts Distributor, or mail to Howard W. Sams & Co., Inc.

Send books checked at right. \$_____ enclosed. Please include sales tax where applicable. Canadian prices slightly higher.

Send FREE 1975 Sams Book Catalog.

Name _____

Address _____

City _____ State _____ Zip _____

- 21155
- 21076
- 21102
- 21097
- 21085
- 21144
- 21111
- 21100
- 21147
- 21163
- 21049



HOWARD W. SAMs & CO., INC.

4300 West 62nd Street, Indianapolis, Indiana 46206

Circle 2 on reader service card

APRIL 1975 1E

Introducing a TV set only a TV technician could love.

Ultra-portable CK3000 Test Jig.

Under 25 lbs.—easy to tote from job to job.
The handle's not just for show!

Ready to use. Fully pre-tested.
A complete unit including 13V in-line
slotted-mask CRT with x-ray
inhibiting glass.

30kV and more. A must for today's
sets. Anode meter's big 50 μ A
movement makes it easy to monitor
voltages to 35kV—more than in any
TV set you'll meet.

Accessories included:

Two 70° adapters; two
90° extensions; six
yoke-programmer
plugs; audio leads;
four convergence
ballast plugs; Set-Up
and Instruction
Manuals.

The big book. CK3000
Set-Up Manual lists
over 7000 models, 49
brands. And we're
constantly updating
it. Just mail the
registration card.

Adapters. You can
buy kits for the seven
most popular brands
and discrete adapters for
42 more. Many old adapters
can be used, too—don't throw
them away!



**Patented yoke
programmers** let you
match CK3000's yoke
to six different
deflection outputs.
Three for tube and
hybrid, two for
transistor sweep, one
for SCR sweep.

**Dual focus connec-
tions.** Built-in alternate
focus supply for
testing both 4.5kV
and the new Black-
Matrix 7.1kV.

See the CK3000 Test Jig at your Sylvania distributor's now!

GTE SYLVANIA

Radio-Electronics®

THE MAGAZINE FOR NEW IDEAS IN ELECTRONICS

More than 65 years of electronics publishing

APRIL 1975 Vol. 46 No. 4

BUILD ONE OF THESE

- 33 **COSMOS Burglar Alarm Circuits**
Use COSMOS IC's to build a variety of burglar alarms. *by R. M. Marston*
- 40 **Accented Tick Timer**
Solid-state timer is ideal for photo darkrooms. It's easy to build. *by Frank H. Tooker*
- 61 **TV Typewriter II**
Part III—Final instructions for completing your personal computer terminal. *by Ed Colle*

STEREO HI-FI AUDIO

- 38 **Audio Signals You Never Heard Before**
Audio rectification can be a real problem. Learn how it happens and what you can do about it. *by Len Feldman*

GENERAL ELECTRONICS

- 4 **Looking Ahead**
Tomorrow's news today. *by David Lachenbruch*
- 43 **Understanding Pseudo-Random Circuits**
Useful in music synthesizers, here's a look at the circuits that generate these sequences. *by Don Lancaster*
- 70 **R-E's Replacement Transistor Guide**
2N5784 through 2N6011. *compiled by Elizabeth & Robert F. Scott*

TEST EQUIPMENT

- 14 **Equipment Report**
Hickok model 246 color bar generator.
- 20 **Equipment Report**
Telequipment D61 dual-trace scope.
- 22 **Equipment Report**
Castle "Master Subber" Mark V signal circuit analyst.
- 24 **Equipment Report**
Leader LCG-395 universal color bar generator
- 50 **4-Channel Digital Scope**
Portable unit uses LED display array to analyze digital signal chains. *by James B. Vice*
- 58 **Using The Curve Tracer**
More ways to use curve tracers effectively. *by Charles Gilmore*

TELEVISION

- 36 **Add CCTV To MATV Systems**
It isn't difficult, once you know how to do it. *by James E. Kluge*
- 68 **Step-By-Step Troubleshooting Charts**
IC's in vertical and horizontal countdown circuits. *by Stan Prentiss*
- 73 **Service Clinic**
Electronic organs. *by Jack Darr*
- 76 **Reader Questions**
R-E's service Editor solves reader problems.

DEPARTMENTS

- | | |
|-----------------------|-------------------------|
| 106 Advertising Index | 92 New Literature |
| 93 Books | 79 New Products |
| 16 Letters | 90 Next Month |
| 6 New & Timely | 109 Reader Service Card |

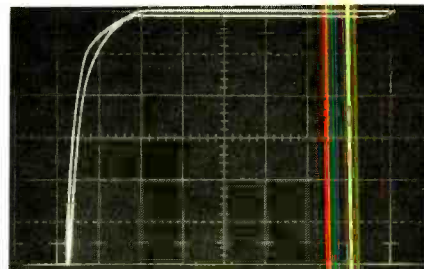

TYPICAL WAVEFORM PRODUCED BY A CURVE TRACER shows reverse characteristics of a small-signal silicon diode. It's just one of several interesting curve-tracer applications. ... see page 58

Hugo Gernsback (1884-1967) founder
M. Harvey Gernsback
editor-in-chief and publisher
Larry Steckler, CET, editor
Robert F. Scott, W2PWG, CET,
technical editor
Arthur Kleiman, associate editor
Jack Darr, CET service editor
I. Queen, editorial associate
Leonard Feldman
contributing high-fidelity editor
David Lachenbruch, contributing editor
Karl Savon, semiconductor editor
Barbara Schwartz, editorial assistant
Vincent P. Cicenia, production manager
Sarah Martin, production assistant
Harriet I. Matysko, circulation director
Arline R. Bailey, advertising coordinator
Advertising Sales Offices, see page 106

Cover photo by Walter Herstatt
Cover design by Louis G. Rubsamen



Radio-Electronics is a member of the Institute of High Fidelity and is indexed in Applied Science & Technology Index and Readers Guide to Periodical Literature.



Radio-Electronics, Published monthly by Gernsback Publications, Inc., 200 Park Avenue South, New York, NY 10003. Phone: 212-777-6400. Second-class postage paid at New York, NY and additional mailing offices. One-year subscription rate: U.S.A., U.S. possessions and Canada, \$8.75. Pan-American countries, \$10.25. Other countries, \$10.75. Single copies 75c. © 1975 by Gernsback Publications, Inc. All rights reserved. Printed in U.S.A.

Subscription Service: Mail all subscription orders, changes, correspondence and Postmaster Notices of undelivered copies (Form 3579) to Radio-Electronics Subscription Service, Boulder, CO 80302.

A stamped self-addressed envelope must accompany all submitted manuscripts and/or artwork or photographs if their return is desired should they be rejected. We disclaim any responsibility for the loss or damage of manuscripts and/or artwork or photographs while in our possession or otherwise.

As a service to readers, Radio-Electronics publishes available plans or information relating to newsworthy products, techniques and scientific and technological developments. Because of possible variances in the quality and condition of materials and workmanship used by readers, Radio-Electronics disclaims any responsibility for the safe and proper functioning of reader-built projects based upon or from plans or information published in this magazine.

looking ahead

50-in-one

Peter Goldmark's latest gadget is a system which permits the transmission of 50 — count 'em 50 — visual and aural programs in the bandwidth of a single television channel. At press time, there had been no announcement of the system, known as RTS, but we've learned that it allows the multiplexing of 50 slow-scan "slide" programs with full audio for transmission on a television channel via microwave or broadcast. With a reduced number of programs, an FM subcarrier (SCA) could be used to send audio-visual information. Goldmark's company, Goldmark Communications Inc., is promoting the system for education and aiming it primarily at networks of community colleges. It's understood that the pilot project will be at Piedmont Central Community College in Charlotte, N.C.

For better UHF

More than 60% of Public Broadcasting stations are in the uhf band, so it's only natural for Public Broadcasting Service to be concerned about the problems — and future — of uhf. PBS President Hartford Gunn has urged educational television stations to mount a concerted campaign to help make uhf equal to vhf at both the transmitter and receiver levels. uhf, he noted, has achieved complete parity with vhf in Great Britain and other European countries, and the same could be accomplished here with proper legislation and FCC rules.

Gunn cited a special survey conducted for PBS by Hazeltine Research, which found that the addition of rf amplification and PIN diode attenuators to home receivers could effect an im-

provement comparable to doubling the transmitter power. The cost to manufacturers, he said, would be about three dollars per set, translating to nine dollars at retail. He urged public broadcasters to appeal to the FCC and Congress to mandate better receivers. At the same time, he called attention to a recent study of the PBS Engineering Committee, which recommended a minimum uhf station operating power of two megawatts and antenna height of not less than 1,000 feet above average terrain. These minimums, he said, are met by only six of 135 public TV stations surveyed.

Sony's home projector

A home version of Sony's industrial-educational projection television system is definitely scheduled for marketing in the United States this fall. Like the current non-consumer version, it's expected to use a 12-inch Trinitron receiver as the projection source, but instead of the two-piece (projector and screen) approach, it's mounted in a single furniture-styled cabinet that looks like a secretary desk. The screen is in the upper portion and the TV projector and optical system are concealed in the hinged lower part when not in use. The screen is expected to measure about 30 by 40 inches, and the price will be between \$2,500 and \$3,000. The Sony unit will be the third projection color set on the consumer market. The others are the Advent Video-Beam two-piece system with a 52 by 69-in. screen and on assembled by Muntz Elman Manufacturing, which has a picture about the same size as the Sony.

Television injuries

Did you know that an esti-

mated 14,000 Americans checked into hospital emergency rooms in the year ending last June 30 with "television-related" injuries? That's the total projected by the Consumer Product Safety Commission on the basis of 710 actual cases reported through the National Electronic Injury Surveillance System. When you think of "television-related" injuries, you may conjure up visions of shocks, fires and implosions. But in the vast majority of cases reported, there was nothing wrong with the set at all. In fact, 97 percent of the injuries resulted from people bumping into television sets, dropping them on toes, and so forth. Nearly half of the victims were children under five.

In another development, the Consumer Product Safety Commission disagreed with Consumers Union on the question of safety of slide switches, commonly found on many brands of television. CU had rated one such set not acceptable on the grounds that someone pushing a coin or some other metal object into the slot could get a potentially lethal shock. The safety commission disagreed, a spokesman noting that the set in question met UL safety standards and that the commission had never received a report of injury from slide controls, which have been used in television sets for six years.

Latest on home VTR

The dream of a popular-priced home videotape recorder remains a dream. Various plans by manufacturers to introduce such an instrument have repeatedly been postponed — partly because of the unpropitious economic conditions today and partly because of extremely high costs. But this doesn't prevent the development of new home VTR systems, and we're seeing about

one new idea a month.

This month's new system represents an attempt by major Japanese manufacturers to establish a "standard," with complete interchangeability of tapes. The new system — being promoted by Matsushita (Panasonic), Toshiba, Hitachi, Mitsubishi and Sharp — is a variation of the standard cartridge videotape recorder used for industrial and educational purposes. The previous drawback of the Japanese system had been the ability to record only one-half hour on a cartridge. The proposed new home system squeezes a full hour of playing time into the same single-reel cartridge of half-inch tape. It will be submitted this spring to the Electronic Industries Association of Japan for listing as a standard. Sony has been pushing for a different half-inch-tape system, but there have been no reports so far that any other Japanese or American manufacturers plan to adopt it. The new Sony system, originally scheduled for sale this year, no longer seems to have a definite timetable.

Calculator suit

Brewing for a long time, a major patent and anti-trust suit has erupted in the calculator industry. Bowmar Instruments has filed a \$240-million triple-damage action against its chip supplier Texas Instruments, charging that TI went into competition with it in producing hand-held calculators using its confidential trade secrets. It also accuses TI of selling below cost to injure competitors and refusing to sell certain components to Bowmar and others. TI said the charges were "totally without merit."

by DAVID LACHENBRUCH
CONTRIBUTING EDITOR

The new Mallory CA3 Intrusion Alarm.

Reliable.



(And inconspicuous.)

This area-and-perimeter device creates and transmits an ultrasonic wavelength field for detection up to a distance of 20 feet. And because of its modern design and walnut-grain finish, the CA3 is attractive and inconspicuous enough to pass as a radio or stereo tuner.

Virtually any movement by an intruder (or a break in the perimeter circuit) activates the built-in horn and the remote outlet for two minutes. An automatic

reset handles the possibility of a new or renewed intrusion. And special CA3 circuitry guards against false alarms from line transients and insects. A variety of companion indoor or outdoor accessory devices is available.

The Mallory CA3 Ultrasonic Intrusion Alarm. From the manufacturer of the most complete line of do-it-yourself security products. Another sound reason to see your Mallory distributor today.

MALLORY

MALLORY DISTRIBUTOR PRODUCTS COMPANY

a division of P. R. MALLORY & CO. INC.
Box 1284, Indianapolis, Indiana 46206; Telephone: 317-856-3731

Batteries • Capacitors • Controls • Security Products • DURATAPE® • Resistors • Semiconductors • SONALERT® • Switches • Timing Devices and Motors
DURACELL® DURATAPE® and SONALERT® are registered trademarks of P. R. Mallory & Co. Inc.

Circle 3 on reader service card

Computer uncomplicates scoring at national gymnastic contest

Contestants and spectators at the NCAA 32nd National Gymnastics Championships, knew the exact scores and standings of individuals, teams and schools at all times during the meet, for the first time in 32 annual contests. An IBM 370/168 computer with a remote terminal on the gymnasium floor was the reason for the breakthrough.

The competition, which included 43 universities represented by more than 180 performers, requires some 5,000 scores to be tabulated during the competitive events. In pre-computer days,



SILENCE WAS AN ADVANTAGE of the Tektronix computer display terminal that was set up on the gymnasium floor of the NCAA National Gymnastics Championships at Penn State University. The gymnasts were able to perform absolutely without distraction, and the records of their performance were transmitted across the campus to the computer at the University's Computation Center.

this called for a small army of score-keepers who worked all night—and sometimes several days—to total the scores, calculate the final standings and make up the tabulations.

The scoring is complicated by the necessity of showing the standings of individuals, teams and universities, all separately. Since some competitors are eligible for team medals only, others for individual events only, some for an all-around medal and a few eligible for

any combination of these, a second degree of complication is introduced.

The 370/168 was programmed with APL language, a tool excellently adapted to the collection and analysis of the complex scoring. The computer could on command immediately print out the standings in any given event, the team totals at any time and the complete record of any individual's performance during the meet, showing everything he had competed in and his standing in each event.

The computer was linked by telephone line to a terminal—a Tektronix 4013 computer display terminal—on the gymnasium floor. Three other terminals—Datel 1030's, which give a hard copy printout—kept the press, the coaches and the contestants abreast of the situation at all times.

DR. ADLER CITED BY CHICAGO IEEE



DR. ROBERT ADLER, FAMED INVENTOR and Zenith's vice president and director of research, was given the Outstanding Technical Paper award by the Chicago section of the IEEE, for a paper entitled "An Optical Video Disc Player for NTSC receivers."

Dr. Adler is best known to the television world for his invention of the ultrasonic remote control and the gated-beam tube for sound and color demodulation, as well as a widely used synchronizing circuit that improves color reception and a system of projection television that uses a laser beam modulated by ultrasonic diffraction.

Among his other inventions are a high-frequency magnetostrictive oscillator and electro-mechanical filter and the low-noise beam-type amplifier known as the Adler tube.

New Marine backpack transceiver will have 280,000 radio channels

A far cry from the famous "walkie-talkie" of 30 years ago—which had a

useful range of only a few miles ("reliable" or minimum range, only 3 miles)



"MANPACK" COMBAT RADIO HAS 280,000 channels to select from. Using groundwave transmission for distances of a few thousand yards and skywave transmission for possible ranges in the thousands of miles, it will normally be used for distances ranging from local up to a few hundred miles.

and operated on a single frequency—the new "Manpack" radio offers the operator a choice of some 280,000 high-frequency channels, and can communicate over thousands of miles. (Normal working range would be from 50 to about 300 miles, plus short-range local traffic).

The new AN/PRC-104, being developed by the Hughes Aircraft Co. for the Marine Corps, is only 12½ inches wide, 11½ high and 2½ thick. Its weight is 12½ pounds including battery, about one-third that of the famous SCR-300 walkie-talkie of 1944. It is so nearly automatic as to be called a "hands-off" transceiver. "The radioman simply goes into the transmit-receive mode, selects his frequency and hits the press-to-talk switch. Then the antenna is tuned, the set aligned, and the transmitter comes up immediately to full power," explains a Hughes communications manager.

The new Manpack is a single-sideband transceiver, producing 20 watts peak output power but using less than 5 watts average power. The battery operates 16 hours without recharging.

Production will be in two stages, a first step in which 37 radios and 10 vehicular mounts will be delivered to the Marine Corps for testing, then 5,000 sets to be delivered after the results of the Marine Corps' testing are incorporated into the equipment design and manufacture. (continued on page 12)

TUNER SERVICE CORPORATION

SUBSTITUNER



INTRODUCING
AT JUST

\$39.95
U.S.A.
ONLY

WITH CABLES

ONE YEAR
GUARANTEE



STILL ONLY

\$9.95
U.S.A.
ONLY

ALL PARTS
INCLUDED

EXCEPT TUBES
AND TRANSISTORS

PROVIDES YOU WITH A COMPLETE SERVICE
FOR ALL YOUR TELEVISION TUNER REQUIREMENTS.

FEATURES

- A UHF Tuner with 70 channels which are detented and indicated just like VHF channels.
- A VHF Hi Gain Solid State Tuner.
- AC Powered.
- 90 Day Warranty.

Demonstrate the **SUBSTITUNER** to your customers and show improved reception with their TV sets.

You may place your order through any of the Centers listed below.

REPAIR

VHF OR UHF ANY TYPE (U.S.A. ONLY) \$ 9.95
UHF/VHF COMBINATION (U.S.A. ONLY) \$15.00

- IN THIS PRICE ALL PARTS ARE INCLUDED. Tubes, transistors, diodes, and nuvistors are charged extra. This price does not include mutilated tuners.
- Fast, efficient service at our conveniently located Service Centers.
- All tuners are ultrasonically cleaned, repaired, realigned, and air tested.

REPLACE

UNIVERSAL REPLACEMENT TUNER \$12.95 (Canada \$15.95)

- This price buys you a complete new tuner built specifically by Sarkes Tarzian Inc. for this purpose.
- All shafts have a maximum length of 10 1/2" which can be cut to 1 1/2".
- Specify heater type parallel and series 450 mA. or 600 mA.

CUSTOMIZE

- Customized tuners are available at a cost of only \$15.95. With trade-in \$13.95. (Canada \$17.95 and \$15.15)
- Send in your original tuner for comparison purposes to Franchises listed below.



HEADQUARTERS	BLOOMINGTON, INDIANA 47401	537 South Walnut Street	Tel. 812-334-0411
ARIZONA	TUCSON, ARIZONA 85713	P.O. Box 4534, 1528 S. 6th Ave.	Tel. 602-731-9243
CALIFORNIA	NORTH HOLLYWOOD, CALIF. 91601	10654 Magnolia Boulevard	Tel. 213-743-2720
	BURLINGAME, CALIF. 94010	1324 Marston Road	Tel. 415-347-5728
	MODESTO, CALIF. 95351	123 Phoenix Avenue	Tel. 209-571-8051
FLORIDA	TAMPA, FLORIDA 33606	1505 Cypress Street	Tel. 813-253-0324
	HIALEAH, FLORIDA 33013	906 East 25th Street	Tel. 305-836-7078
GEORGIA	ATLANTA, GEORGIA 30310	938 Gordon Street S.W.	Tel. 404-719-2232
ILLINOIS	CHAMPAIGN, ILLINOIS 61820	405 East University Street	Tel. 217-356-6400
	CHICAGO, ILLINOIS 60621	737 West 55th Street	Tel. 312-873-5556-7
	SKOKIE, ILLINOIS 60076	5110 West Brown Street	Tel. 312-675-0230
INDIANA	HAMMOND, INDIANA 46323	6833 Grand Avenue	Tel. 219-845-2676
	INDIANAPOLIS, INDIANA 46204	112 West St. Clair Street	Tel. 317-632-3493
KENTUCKY	LOUISVILLE, KENTUCKY 40208	2920 Taylor Boulevard	Tel. 502-634-3334
LOUISIANA	SHREVEPORT, LOUISIANA 71104	3025 Highland Avenue	Tel. 318-867-7745
MARYLAND	BALTIMORE, MARYLAND 21215	5505 Reisterstown Rd., Box 2624	Tel. 301-355-1186
MISSOURI	ST. LOUIS, MISSOURI 63132	10530 Page Avenue	Tel. 314-425-0633
NEVADA	LAS VEGAS, NEVADA 89102	1412 Western Avenue No.	Tel. 702-381-4235
NEW JERSEY	TRENTON, NEW JERSEY 08638	901 North Olden Avenue	Tel. 609-395-0999
	JERSEY CITY, NEW JERSEY 07307	547-49 Tonnele Ave., Hwy. 1 & 9	Tel. 201-793-3730
OHIO	CINCINNATI, OHIO 45216	7450 Vine Street	Tel. 513-821-5080
	CLEVELAND, OHIO 44109	4525 Pearl Road	Tel. 216-741-2314
OREGON	PORTLAND, OREGON 97210	1732 N.W. 25th Avenue	Tel. 503-223-9059
TENNESSEE	GREENEVILLE, TENNESSEE 37743	1215 Snapps Ferry Road	Tel. 615-531-8451
	MEMPHIS, TENNESSEE 38111	3158 Barron Avenue	Tel. 901-451-2355
TEXAS	DALLAS, TEXAS 75218	11540 Garland Road	Tel. 214-327-8413
VIRGINIA	NORFOLK, VIRGINIA 23513	3295 Santos Street	Tel. 804-351-2518
CANADA	ST. LAURENT, QUEBEC		
	CALGARY, ALBERTA		

WATCH US
GROW

IF YOU WANT TO BRANCH OUT INTO THE TV TUNER REPAIR BUSINESS,
WRITE TO THE BLOOMINGTON HEADQUARTERS ABOUT A FRANCHISE.

Circle 4 on reader service card

Where do the pros get their training?



Almost half of the successful TV servicemen have home study training and with them, it's NRI 2 to 1. It's a fact! Among men actually making their living repairing TV and audio equipment, more have taken training from NRI than any other home study school. More than twice as many!

Not only that, but a national survey,* performed by an independent research organization, showed that the pros named NRI most often as a recommended school and as the first choice by far among those who had taken home study courses from *any* school. Why? Perhaps NRI's 60-year record with over a million students...the solid training and value built into every NRI course...and the designed-for-learning equipment originated by NRI provide the answer. But send for your free NRI catalog and decide for yourself.



25" Diagonal Color TV... Professional Instruments

As a part of NRI's Master Course in TV/Audio servicing, you build a big-screen solid state color TV with every modern feature for great reception and performance. As you build it, you perform stage-by-stage experiments designed to give you actual bench experience while demonstrating the interaction of various stages of the circuitry. And your TV comes complete with console cabinet, an optional extra with other schools. Likewise, NRI's

Widest Choice of Courses and Careers.

NRI doesn't stop with just one course in TV/Audio servicing. You can pick from five different courses (including an advanced color course for practicing technicians) so you can fit your training to your needs and your budget. Or you can go into Computer Technology, learning on a real, digital computer you build yourself. Communications with famous Johnson transceiver. Aircraft or Marine Electronics. Mobile radio, and more.

Free Catalog... No Salesman Will Call.

Send the postage-paid card for our free color catalog showing details on all NRI electronics courses. Lesson plans, equipment, and career opportunities are fully described. Check card for information on G.I. benefits. No obligation, no salesman will call. Mail today and see for yourself why the pros select NRI two to one!

If card is missing, write to:



Two Famous Educators... NRI and McGraw-Hill.

NRI is a part of McGraw-Hill, world's largest publishers of educational material. Together, they give you the kind of training that's geared for success...practical know-how aimed at giving you a real shot at a better job or a business of your own. You learn at home at your convenience, with "bite-size" lessons that ease learning and speed comprehension. Kits designed to give you practical bench experience also become first-class professional instruments you'll use in your work.

instruments are a cut above the average, including a 3½ digit precision digital multimeter, triggered sweep 5" oscilloscope, and integrated circuit TV pattern generator. They're top professional quality, designed to give you years of reliable service. You can pay hundreds of dollars more for a similar course and not get a nickel's worth extra in training and equipment.

*Summary of survey results upon request.



NRI SCHOOLS
McGraw-Hill Continuing Education Center
3939 Wisconsin Avenue,
Washington, D.C. 20016

International ©
SERVICEMASTER

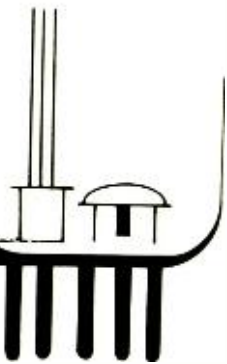

The Money Making line with over 2000 types.

- The most complete range of domestic and foreign consumer and industrial receiving tubes in the world. Classic and antique, too.

- Complete range of replacement Semiconductors.

- Discounted to give you higher profit margins

- Quality your customers can depend on.

For the name of your local distributor call (516) 293-1500

Or write,

International Components Corporation

105 Maxess Road,
Melville,
New York 11746

See us at NewCom
booths #D20 & D22
May 5-8

Dr. Lewis M. Hull honored by Radio Club of America

The Armstrong Medal for outstanding contributions to the radio art was awarded to Dr. Lewis Hull by the Radio Club of America, world's oldest radio club, at its 65th anniversary meeting and banquet November 15.

Dr. Hull pioneered in radio reception and in aircraft radio. Numerous firsts, such as single control for receivers, automatic volume control and the auto-



Dr. Lewis Hull

matic noise suppressor, were developed under his direction. He was a leader in aircraft radio design and production, and in the early part of World War II practically every US combat plane was equipped with Dr. Hull's radios.

The Sarnoff Citation for significant contributions in electronic communication was given to Jack R. Poppele, former vice president of WOR and the Mutual Broadcasting System and later director of the Voice of America. Designer and builder of WOR, he and Dr. de Forest threw the switch that put it on the air in 1922. He then served as its Chief Engineer for 30 years. A Fellow and director of the Radio Club, he is also president of the Veteran Wireless Operators Association and of the de Forest Pioneers.

Dr. George Bailey, for years leader of the world's amateurs as president of the American Radio Relay League and the International Amateur Radio Union and later Executive Secretary of the IEEE, was made an Honorary Member of the Club. He is one of the seven members to hold that distinction.

The meeting was addressed by William M. Nicol, Director of Telecommunication of improved public safety communications of the British Home Office, London, England, who discussed the communication both nationally and in-

ternationally.

Besides the honors to Hull, Poppele and Bailey, 20 members of the Club were raised to the rank of Fellow. Among them were Norman Chalfin, author of a number of articles in this magazine, and Gerald F. J. Tyne, the historian of the vacuum tube, who described the making of early Audions for the readers of **Radio-Electronics**.

Ladies' electronic wrist watch tells time in two sentences

A new digital watch module, now in limited production at Hughes Aircraft Company's microelectronic products division, is called the first designed for ladies-size watches.

The solution of the size problem is unique. Instead of a four-digit display reading out the hour and minute, the new watch has a two-digit display, showing first the hour, then a second later, the minute.

As in earlier Hughes watch modules, the new model has a 768-kHz crystal oscillator, considered more accurate than the 32-kHz type used in most electronic watches. The integrated circuitry consists of CMOS (complementary metal oxide semiconductor) chips, and contains the equivalent of more than 1,500 transistors.

No Hughes watches will appear on the market. Hughes sells the modules to watch manufacturers, and the two-digit ladies' watches may soon be expected to appear under several of the better well-known brands.



TWO "POINTS IN TIME" ARE SHOWN in this interesting photo. The small wrist watch first shows the hour (above). The lower part of the picture, presumably photographed about a second later, indicates the minute.

R-E

GENERAL ELECTRIC INTRODUCES THE 4-MINUTE HALF HOUR

GE's Latest In-Line Deflection and Convergence System hailed by TV technicians.

General Electric's latest in-line system* makes it possible to converge a color set in three to four minutes, as opposed to the standard time of ten to 30 minutes. It was enthusiastically received at state conventions, where TV technicians and shop owners called it an important advancement in serviceability.



"Saves 30 minutes in convergence, compared to standard Delta convergence."
Dick Regner, RRR TV, Pearland, Texas

TV Receiver Products Dept., Portsmouth, Va.



"G.E.'s . . . convergence system is great. They should have called it the 'time saver'."
Sidney J. Sabel, Sabel's T.V. Service, Houston, Texas

"Easy to converge, little return to readjust controls."
Charles Miller, Miller's TV Service, Virginia Beach, Va.

"Time saving. Very flexible. More control."
G. F. Hill, Bay Area TV & Communication, Seabrook, Texas

"Beats the heck out of other systems!"
E. B. Swanson, E. B. Swanson Company, Crosby, Texas

Another feature that met with enthusiastic approval was the fact that a technician requires no additional training to converge the set for a sharp, clear picture. A simple control location guide is included inside the set.

"... simple convergence is extremely important. Will make training to technicians very easy."
Gary Gray, Master TV & Appliance Co., Roanoke, Va.

"It's a serviceman's dream. Easy. Simple. The way to go!"
Ira Evans, Evans TV, Freeport, Texas

"Fantastic! Great! I wish everyone would go to it."
David Christian, Whitehill Elec., Kannapolis, N.C.

"Very simple. Easy to do without previous instructions."
Earl Asher, Asher TV, Denton, Texas

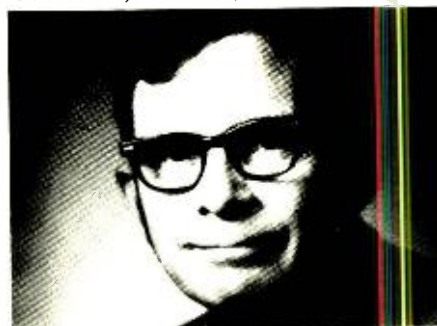

"Greatest improvement in convergence in 15 years."
Bill Nichols, Radio & TV Service, Inc., Petersburg, Va.

* This latest in-line deflection and convergence system is in all GE 13" and 17" (diagonal) YA solid state chassis sets.

**We're making it
our business to make
your business easier.**

GENERAL  ELECTRIC

Circle 6 on reader service card

ARROW AUTOMATIC STAPLE GUNS

CUT WIRE & CABLE INSTALLATION COSTS

without cutting into insulation!

SAFE! Grooved Guide positions wire for proper staple envelopment! Grooved Driving Blade stops staple at right depth of penetration to prevent cutting into wire or cable insulation!

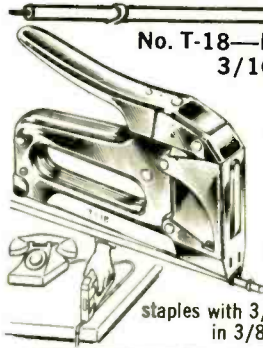

No. T-18—Fits wires up to 3/16" in diameter.

BELL, TELEPHONE, THERMOSTAT, INTERCOM, BURGLAR ALARM and other low voltage wiring.

Uses T-18 staples with 3/16" round crown in 3/8" leg length only.

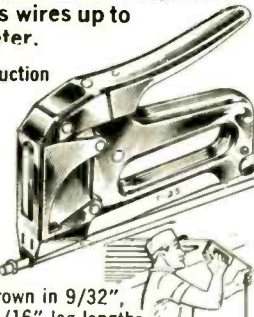

No. T-25—Fits wires up to 1/4" in diameter.

Same basic construction and fastens same wires as No. T-18.

Also used for RADIANT HEAT WIRE

Uses T-25 staples with 1/4" round crown in 9/32", 3/8", 7/16" and 9/16" leg lengths.

T-18 and T-25 staples also available in Monel and with beige, brown and ivory finish at extra cost.

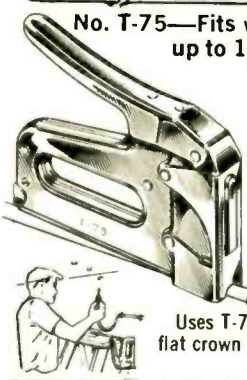

No. T-75—Fits wires and cables up to 1/2" in diameter.

RADIANT HEAT CABLE, UF CABLE, WIRE CONDUIT COPPER TUBING or any non-metallic sheathed cable.

Also used as DRIVE RINGS in stringing wires.

Uses T-75 staples with 1/2" flat crown in 9/16", 5/8" and 7/8" leg lengths.

Arrow Automatic Staple Guns save 70% in time and effort on every type of wire or cable fastening job. Arrow staples are specially designed with divergent-pointed legs for easier driving and rosin-coated for greater holding power! All-steel construction and high-carbon hardened steel working parts are your assurance of maximum long-life service and trouble-free performance.

Ask your Electrical Supply Dealer or write for further details.

ARROW FASTENER COMPANY INC
Saddle Brook, New Jersey 07863
**"Pioneers and Pacesetters
For Almost A Half Century"**

Circle 7 on reader service card

equipment report

Hickok model 246 deluxe color bar generator



Circle 113 on reader service card

TEST EQUIPMENT IS GETTING MORE compact all the time. Unlike the circus, that says "bigger and better," they get "smaller and better." The use of IC's has been helpful in two ways, especially in the area of signal generators. The newest item in this line is the Hickok model 246 deluxe color bar generator. Only 8 by 3 inches, 6 inches deep, it has sixteen patterns instead of the five of older models.

For convergence work, there are three cross-hatch patterns; 15 by 21 bar, 7 by 11, and a single "crosshair" pattern—one vertical and one horizontal line, crossing in the center of the screen. For dots, the same counts, with the last being a single dot. Vertical line patterns have 21, 11 and one bar; the same for horizontal line patterns. These have 15, 7, and one in the middle. These single-line and dot patterns are most useful for finding that "center-dot" and adjusting the centering controls.

For any adjustment, alignment work or signal-tracing in the color section, the standard gated-rainbow 10-bar pattern can be used. The rainbow pattern without gating is also available. There's also a three-bar pattern, consisting of the R-Y, B-Y and G-Y bars, equally spaced.

For making grey-scale adjustments, a blank-raster pattern is provided. You name it, and there's a pattern in there that you need.

The rf-carrier output can be tuned to Channel 2, 3 or 4 with a simple screwdriver adjustment on the front panel. Output is balanced 300 ohm, with clips on a long lead. For signal-tracing and other testing, a composite video signal is also available. This may be modulated with any of the test-patterns. Amplitude of this is ± 2.0 volts p-p. The polarity and signal level can be adjusted by a slide control. The color level can also be adjusted from 0 to the standard 200%.

To make signal-tracing through the

color stages easier, two trigger output pulses can be used for a positive locking of the scope patterns. The horizontal pulse has a pulse-width of 10 μ s, the vertical pulse a width of 190 μ s. Amplitude of the pulses is +10 volts. This can even be used as external sync with re-current-sweep scopes, with good results.

If you like to use dots, but are getting old and dim-sighted (like me!) you can make the dots bigger. Just set the DOT ADJ. control on the front panel until the dot is big enough to see.

The last item on the front panel is the gun-killer switches. These are very handy for making both purity and convergence adjustments. The leads, with insulation-piercing clips, are permanently connected and stowed in the handy compartment on the top of the case. The same compartment contains the power supply and line cord, RF output cable, and there's still room for alignment tools and other things.

That's about all of the dull statistics. The interesting thing about this type of instrument is its construction. IC design is very well suited to this kind of instrument. IC's generate very sharp, clean pulses, count up or down in frequency, and make special pulses of every conceivable shape. The model 246 uses a crystal at 378-kHz, and a frequency-divider IC counts down from this to develop the various patterns. A 3.563795 MHz crystal, with a tolerance of 0.01%, is used to generate the signal for the rainbow display. So, all the patterns are rock-steady.

Most of the work in the model 246 Deluxe color generator is done by a very special MOS IC, developed by Hickok just for the purpose. It doesn't look too impressive; just an ordinary 16-pin DIP. Inside, however, is a complete outfit of all the digital logic circuits needed for these many functions. This has the equivalent of, 1,000 transistors! Two more stock linear IC's are used for generating the chroma signal and for the rf output amplifiers. Some plain old transistors fill out the list for such things as the dc regulator in the power supply. Incidentally, the dc power supply isn't even on the chassis; it's the black blob on the end of the line cord! This keeps any possible magnetic fields away from both generator and TV set. This has a dual-polarity output of +6.8 volts and -6.8 volts dc, tightly regulated.

Despite the many functions and parts used, this instrument is really "conservative." Its full power consumption is a tremendous ONE WATT! **R-E**

410 to 1 you'll find the devices you need here.

Over 103,200 devices can be replaced by 250 RCA SK Series types. That's 410 to 1! Best ratio in the industry. Which means the odds are, SK is your best, fastest way to get what you need. With minimum inventory. And RCA provides the top quality you'd expect from a top manufacturer of OEM devices. Same strict AQL standards, same strict Director of Quality Assurance. Get SK devices and your free 1975 SK Series Replacement Guide from your local RCA distributor.



It's OK if it's **sk**

Circle 8 on reader service card

The
Professional
Line
Wanted by
the most
Discerning
Audiophiles



SX824

There is a distinct difference between tape equipment mass-produced by a consumer manufacturer and tape equipment built by a professional audio manufacturer. At Crown International this distinct difference involves five things: over-engineering, rugged construction, hand-crafting, exhaustive testing and conservative rating. After 26 years, Crown is the only remaining original U.S. tape equipment manufacturer still marketing professional quality to discerning audiophiles.

The Crown tape equipment line is designed for audio pros who make their living by recording, to whom an equipment failure at a taping session means money out the window. After four years, when many hi-fi models are traded in, Crown decks still produce recordings with truer fidelity than most new hi-fi decks. No wonder Crowns enjoy such high resale value.

At Crown, each active electronic component, each circuit module and each completed unit is tested from every angle. A tape deck undergoes over 100 hours cumulative testing. Finally, each unit is accompanied by its individual hand entered proof-of-performance report.

For free product data on Crown professional monaural, stereo and quadraphonic tape decks and players, write Crown, Box 1000, Elkhart, Indiana, 46514.



CROWN

Made Only in America

Circle 9 on reader service card

letters

COMPUTER NEWSLETTER

A few of us in Denver are forming a support group of experimenters in micro-processors, their peripherals and programs. We are interested in providing a clearinghouse distribution service with particular emphasis on the Mark-8 Mini-computer and TV Typewriter. As many are aware, support from manufacturers to the individual experimenter is practically non-existent and comprehensive information exchange is difficult among individuals. We hope that a clearinghouse library service will help alleviate this situation.

The first major areas of interest are: Programs, Programming Aids, Circuits (Extensions and Modifications), Peripherals (TV Typewriter, Cassette Drives, Floppy Disk, etc.), BASIC Compiler Development, Suppliers of Parts and Literature, General Information. Others (as suggested).

We expect to produce a monthly newsletter containing abstracts of what is available and general information. Anyone with an interest in or a contribution/suggestion for the clearinghouse should send a stamped self-addressed envelope to: The Digital Group Clearinghouse, P.O. Box 6528, Denver, CO 80209.

We hope this service will prove valuable and rewarding to all participants.
THE DIGITAL GROUP
CLEARINGHOUSE
Denver, CO

STARLIGHT SCOPE

I really enjoyed the article on the Infrared Viewer in the August issue of **Radio-Electronics**. I have been building similar viewers since about 1971. I am glad to know that there are other people that are interested in the same things that I am.

Fortunately I have been in situations where I could obtain more modern versions of infrared image converter tubes. The 6032 tube is an antique now, but it is available and at a reasonable price.

If you want to see in the dark, the only way to go is with image intensifier tubes that can amplify low light levels like starlight or moonlight. In my quest for better IR tubes, I discovered a company in Van Nuys, California that has surplus image intensifier tubes for sale. The tubes are larger than the 6032. They have 40-mm fiber-optic face plates on both ends of the tube and are about the size of a soft drink can. The fiber optics remove some of the optical distortion inherent in the older tubes with curved photocathode windows.

The image intensifier tubes were originally used in a night vision device

called an Owl Eye. They were used during the Viet Nam war for seeing in the dark. I have built two starlight scopes using these tubes and the results have been amazing. I thought that the IR viewers were good, but the starlight scopes are a thousand times better. Even on the darkest night, there is enough light for the tubes to amplify and make the scene being viewed look like daylight. Really amazing!

Anyway, I thought maybe some of your other readers might be interested in trying to build a viewer that uses starlight or moonlight instead of infrared. The company that has the tubes for sale is: Starlight Engineering, P.O. Box 7426, Van Nuys Main Post Office, Van Nuys, CA 91406.

KEN LAWLER
Glendale, CA

Thanks for the news, Ken; and while we're on the subject we've received a call from McNeal Electric Equipment Company, 4736 Olive, St. Louis, Mo. 63108. They state that they will supply a kit of parts, SS-8722 that contains 30 1/2-watt carbon resistors for the infrared viewer. It includes 24 100-megohm units; 5 22-megohm units and 1 100K unit. Total price is \$3.00 including postage.
—Editor

CB

Your attention is invited to a copy of the article from the October 1974 issue of the official publication of the International Associations Chiefs of Police, *The Police Chief* entitled "State Highway Patrol and CB'ers Work Together in Ohio." I am sure that your readers will find the article to be of interest.

While the Citizens Radio Service has many problems, there are millions of citizens who use it properly and regularly for good purposes. And also, the potential of Citizens Band emergency channel-9 is unlimited, especially as more and more local groups and police agencies monitor and respond to calls on channel-9.

After all the information about the bad aspects of Citizens band radio that have been publicized, it is only fair that the public and others such as Hams be informed of some of the good points. A lot is made over the actions of the CB'ers who violate the law, but (as with other things in our daily life) very little is said of the majority of law-abiding citizens who do things the way they are supposed to do.

Actually, even Hams could consider Citizens radio for their own use for contacts with their families, for contacts from their car in highway emergencies
(continued on page 18)

change tips... change temperatures

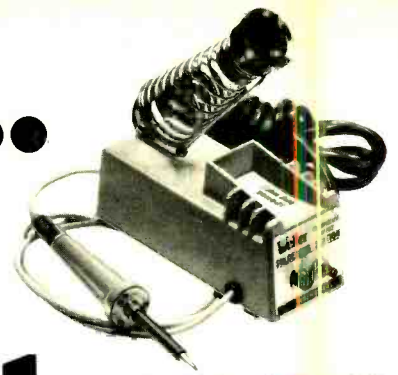

Weller[®] CONTROLLED OUTPUT SOLDERING STATION

...has interchangeable brains in the form of a ferromagnetic sensor mounted in the tip that controls iron temperature through unique "closed-loop" circuit. Change tips...change temperatures. A Weller exclusive! It's that simple. 600, 700, or 800° F...your choice. Switching tips is always easy because Weller's exclusive triple-plated construction prevents oxidation and "freezing"...assures quick interchangeability. And nobody offers as many tip options. Over 50 combinations of configuration, reach, and temperature, one just right for optimum soldering action and maximum tip life on any job.

UL-listed and OSHA-compliant, Weller's Model WTCP-L has its own built-in transformer...24 volt output for operator safety. Non-sinking holder supports and shields the comfort-grip, pencil iron when not in use. Grounded tip guards against static-discharge damage to sensitive workpiece circuitry. Base contains handy, tip-cleaning sponge and receptacle plus off/on switch and red indicator light. And non-burnable silicone power cord prevents annoying self-damage.

Weller's WTCP-L Station has all the functional features you need for today's sophisticated soldering...at the most attractive price. No fancy extras that only add to cost. Also available as WTCP-2 for low-temperature service. See it...*get it*...at your local distributor. Ask, too, about DS-100 de-soldering units. Or request technical information.

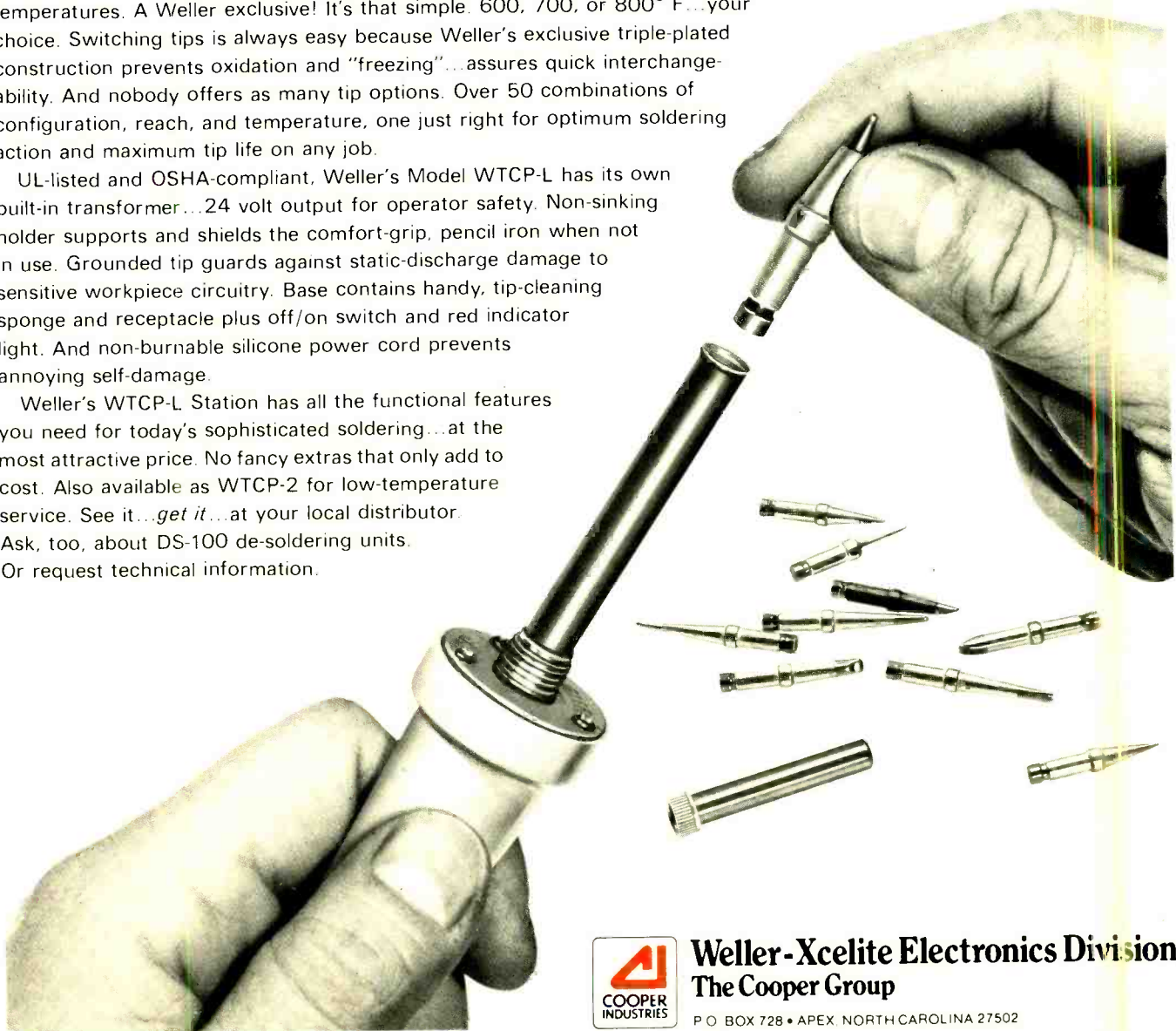

Weller-Xcelite Electronics Division
The Cooper Group

P.O. BOX 728 • APEX, NORTH CAROLINA 27502

Circle 10 on reader service card

CHEMTRONICS INFLATION-FIGHTER SPECIAL!

**SUPER
FROST-AID**

ONLY **50¢** A CAN



When you buy a can of Tun-O-Power and a can of Tun-O-Wash at the regular price.

**AVAILABLE FROM
PARTICIPATING
DISTRIBUTORS**

CHEMTRONICS
INCORPORATED
45 HOFFMAN AVE., HAUPPAGE, N.Y. 11787
Our business is improving yours.



Circle 11 on reader service card

LETTERS

(continued from page 16)

and especially for monitoring at their home to provide a service to the general public. No matter how efficient ham radio is and how useful it is, the hams can't talk to the average citizen while the CB'er can.

The day is coming soon when every automobile will be equipped with a two-way radio at the factory.

W. S. DAWSON
Portsmouth, VA

ELECTRONIC MUSIC

Interest in electronic music has grown and because of my wide experience in the medium—both theoretical and practical—I am starting a new journal entitled **Analog Sounds**. The new journal is based in the art of music and concerns the effect on the art of applied electronics. It will cover a range of subjects including discussions of method, procedure and practical techniques for making music.

Radio-Electronics has been a great stimulus to me in the development of my own creative work with the electronic medium. To help spread the word, I intend including with each issue of **Analog Sounds** an accumulative directory of relevant articles published in electronic magazines, including yours. This directory will take the form of a subject index with abstracts.

Analog Sounds is a quarterly journal depending solely on readers for support. Anyone interested in further information should contact me.

JACOB MEYEROWITZ
Editor

Analog Sounds
145 West 55th Street
Apt. 6-F
New York, NY 10019

R-E

OLD SCOPE FOR COLOR TV?

I've got an old scope, in good working order, a 1957 kit model. Do you think it will do for color TV work? Don't know what it will do up around 4-5 MHz.—J.T., Commodore, Pa.

I'd say yes. Get a working color TV set, feed a color-bar pattern into it, and check the critical patterns. Compare these to the ones shown on the schematic. They don't have to be identical, but as long as you know what they look like, fine!

These critical patterns would be: Red, green and blue grids on picture tube; output of burst amplifier; output of 3.58-MHz oscillator, and output of bandpass amplifiers (through detector probe). If you can see a "bar" on the 3.58-MHz oscillator, you do *not* have to be able to see individual cycles. All you need to know is the p-p voltage. If you can get a good clean pattern at the video detector output, at horizontal frequency, it should do nicely.

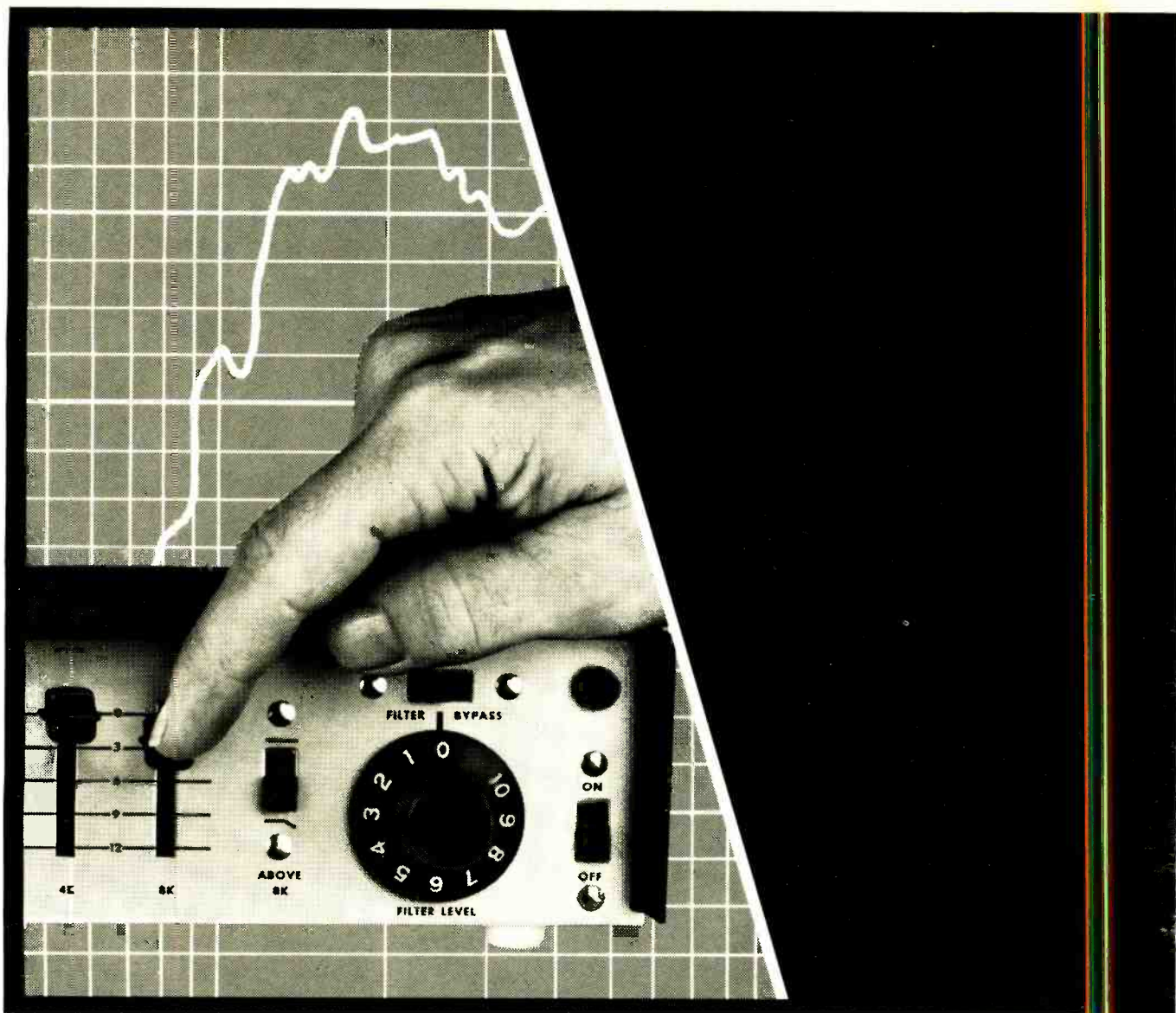

The Gain Mutiny.

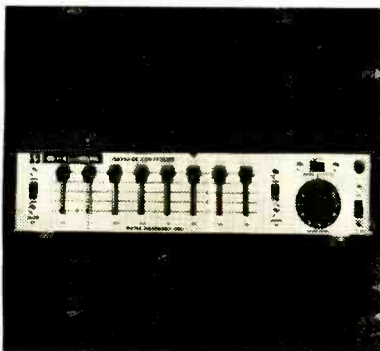

The gain limitation on most P.A. systems is often dictated by the ring threshold—that is, the point at which feedback sets in. Shure's M610 Feedback Controller suppresses these "ringleaders" before things have a chance to get out of hand. You can achieve significantly higher gain levels before feedback when you add the M610 to any existing system. Its versatile set of filters and roll-off switches smooths out the peaks and valleys in the system's frequency response, allowing you to shape the response to match the characteristics of any room. And, it will fit into a standard 19" audio equipment rack panel with its optional mounting kit. It might just be the easiest way ever for keeping feedback sources in line.

Shure Brothers Inc.
222 Hartrey Ave., Evanston, IL 60204
In Canada: A. C. Simmonds & Sons Limited



Manufacturers of high fidelity components, microphones, sound systems and related circuitry.

Circle 12 on reader service card

Are you,
of all people,
still opening
your garage

the
hard
way?

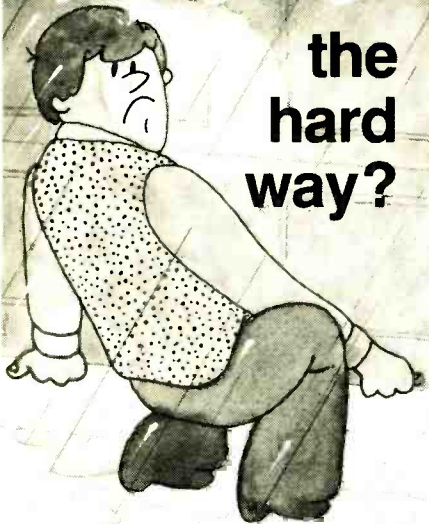

Anybody who's into electronics

certainly should be getting the everyday convenience and family security of automatic garage door operation... especially now, with Perma Power's great Electro Lift opener... made to fit in the trunk of your car, designed for easy handling and simple do-it-yourself installation. Available now at a surprisingly low price from your distributor.



P.S. Show off your opener to your friends and neighbors. You'll probably be able to pay for yours with what you make installing openers for them.

Perma Power

Chamberlain Manufacturing Corporation
Perma Power Division
845 Larch Avenue, Elmhurst, Illinois 60126
Telephone (312) 279-3600

Circle 13 on reader service card

equipment reports

Telequipment D61 dual-trace scope

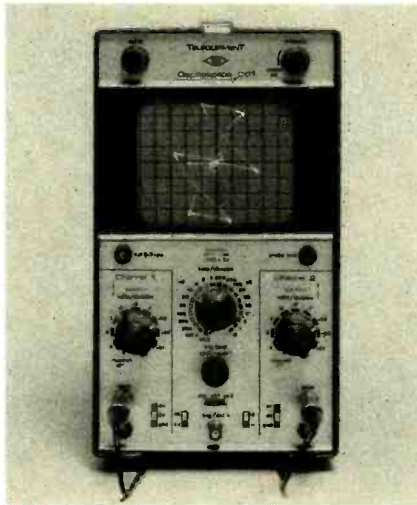

Circle 94 on reader service card

"TEKTRONIX" IS A MUCH-RESPECTED NAME in the field of "oscilloscopy," especially in the lab scopes and special units. So, when they put out another line of oscilloscopes, especially for electronics service technicians, these are apt to be pretty good. An example of this is the Telequipment line, originally from England. The model D61 is a good example of these new-generation test instruments. It's a compact, versatile instrument, with a response making it suitable for lab work, and special features for use in entertainment electronics servicing, particularly in color TV, stereo, quadriphonic, and so on.

This is a dual-trace, triggered sweep type, with identical vertical amplifiers having a bandwidth of up to 10 MHz, ac or dc. Risettime is 35 ns. You can do all of the standard tricks such as displaying two signals at once, from a single trigger source. You can also use both channels for making vectorscope patterns; you simply switch Channel 2 to act as the horizontal amplifier. The high bandwidth makes very good vectorscope patterns. As usual, I found this out the hard way. I was trying to make a flower by feeding the blue into the EXT. HORIZONTAL. Didn't work. So, I took a really drastic step; I read the instruction book. A flip of the switch and wham. Easy.

The triggered sweep can be used in NORMAL or AUTOMATIC modes, or externally triggered. A special "TV" position uses a sync-separator to lock video waveforms firmly. It locks on the vertical sync

pulse for any setting of the TIME/DIV switch up to 100 μ s/div, and horizontal sync pulses from 50 μ s/div on up to 0.5 μ s/div. (This switching is automatic.) Positive or negative pulses can be selected by the switch, for best lock.

The TIME/DIV (horizontal sweep speed) switch works from 500 ms/div up to 0.5 μ s/div (That's one-half of a microsecond.) By pulling the TIMES-5 multiplier switch, the waveform is expanded 5 times for checking any part you need to see. This will give you sweep-speeds up to 100 ns/div (A nanosecond is 1/1000 of a microsecond.) The trigger is free-running in the AUTO position. You do see a horizontal line on the screen to tell you that the thing's working. For those hard-to-hold waveforms, external triggering can be used. For color TV, this is simple: just plug a plain test lead into the EXT TRIG jack, and place it near the deflection yoke cable. This will give you solid lock on anything. All you need is a minimum of 100 mV of pulse.

For either single- or dual-trace work, the trigger-selector switch will trigger the sweep on either the Channel 1 signal, the Channel 2 signal or on the external trigger pulse. For single-trace work, you move the Channel 2 trace off the screen (usually down) and set the trigger selector to Channel 1. This gives you the full height of the screen for p-p voltage readings, probably the most useful of any in TV work.

With modern construction, the matter of test-probe *adaptability* becomes very important. There are so many tight places that you've got to get into. The D61 uses the well-known "Tektronix probes." These are standard 10:1 low-capacitance type, compensated. There's a jack on the panel for instant checking of this calibration, and another for checking the volts/div calibration. The probe body isn't much bigger than a fountain pen: it has a *very* sharp pointed tip (result of actual experiment!)

Four special push-on tips are included. One is a plain, fixed hook tip, so that you can hang the light-weight probe to circuit points. The next is a spring-loaded retractable-hook type. This grips leads and connections firmly. The third is a special test-tip for any kind of IC's. It has a U-shaped cutout in the end, with another very sharp point centered in the U. With this, you can get the pattern on any pin of any IC without danger of shorting to adjacent pins. (With the dc position of the vertical amplifier switch,

(continued on page 22)

The New **NDC** Communications Frequency Counter



\$149⁵⁰

Mobile or Base Operation

THE NDC COMMUNICATIONS FREQUENCY COUNTER operates on 12 VDC or 115 VAC (with optional ac-dc converter). FIVE GIANT LED READ OUTS for easy day and night time clarity. Read out can be seen in bright sun light. FULLY SOLID STATE CONSTRUCTION on printed circuit boards that can withstand hard abuse and shocks. The counter contains a 10MHz TIME BASE for precision accuracy. The counter is easily connected via two SO-239 coax connectors.

FREQ RANGE: 1Hz- 99.999MHz

DISPLAY 5 .6" LED

INPUT IMPEDANCE: 1 Meg ohm 40pf

SENSITIVITY: 1 volt in communications mode. With accessory probe 1 microvolt.

• OTHER USES AND ACCESSORIES

In addition of being a communications counter, the counter can be used as a precision frequency counter for servicing or measuring unknown frequencies. Two optional accessories are available. Option probe NDC # 1174P converts the counter to a highly sensitive counter capable of reading any signal of one microvolt or more. In addition a 0-300 MHz prescaler is available which converts top counting range to 300 MHz.

• ACCESSORY PRICES:

NDC test probe	\$39.95
NDC 300 MHz prescaler	\$49.95
NDC 12 volt 6 amp regulated power supply	\$21.95

• GUARANTEE

The NDC COMMUNICATIONS FREQUENCY COUNTER is manufactured with premium parts, and is guaranteed unconditionally for 1 year against failure of parts or workmanship.

AVAILABLE FROM YOUR LOCAL DEALER OR FACTORY DIRECT

NATIONAL DIGITAL COMPUTER CO.

7502 MONTEREY WAY, SCOTTSDALE, ARIZ. 85251 (602) 994-5110

Circle 14 on reader service card

EQUIPMENT REPORT

(continued from page 20)

you can read logic highs and lows if you want to!)

Last but not least is a simple but very useful one; an insulating cylinder that will let you go right into an open BNC jack and read the signal. Due to the very small center connection of these jacks, this is very hard to do with an ordinary prod. The cables on the standard model are 4.5 feet long; another model is available with a 6-foot cable. The coax used is of a special type, very flexible and made for hard use.

The *D61* is all solid state. The CRT is the only tube used. It is a flat-faced 8 x 10 cm type, with a P31 phosphor; a light green and very bright, due to the use of 3.5 kV accelerating voltage. The amplifier circuitry uses innumerable discrete transistors. FET inputs give the vertical amplifiers a very high sensitivity and high impedance.

The acid test of any scope, of course, is "How does it work on the bench?" The *D61* passes with flying colors. I used it on quite a few sets, including one Hairy Monster with a difficult color-sync problem. Just to see if I could do it, I put the red-grid waveform on one trace, and the blue on the other, and then aligned the color stages. It worked (Using keyed rainbow source).

For the dual-trace mode, special base-lines are provided on the graticule. These are dotted lines. The regular center base-

line is a solid line. The vertical attenuators are calibrated from .01 to 5 volts/cm. With the 10:1 low-cap probes, it gives you a useful range (single channel) from 100 mV/cm to 50 v/cm; since the graticule is 8 cm high, you can read waveforms with a maximum of 400 volts p-p.

Controls are well-located and very easy to use. The vertical centering control, for each channel, is the center knob of a dual; the outer knob is the VOLTS/DIV switch. The TIME/DIV switch's outer knob controls the sweep-speed, and its inner knob is the horizontal positioning for both channels. The switch, intensity and focus controls are above the crt. Once set up, you seldom have to touch these. The rest of the controls are grouped so that they can be very easily adjusted with one hand. The probes plug into jacks at the very bottom of the panel, out of the way.

The triggering of the *D61* is very solid; even my pet test waveform, the flat-topped comb from a keyed-rainbow color-bar generator, locks in firmly. This one has so many almost equal-amplitude peaks that it's tough to hold; the *D61* grabbed it and held it!

With some of the things they're throwing at us now—IC's, modules, digital equipment, and so on and on, we are going to need good test equipment to handle them rapidly and accurately. The *Tequipment D61* fits this description very well. By the way, I was very pleasantly surprised when I compared the price of this instrument to others of sim-

ilar spec's. One of the fringe benefits of this job is getting to work with a lot of fine test-equipment. I certainly got my jollies out of this one. **R-E**

Castle "Master Subber" Mark V TV Signal Circuit Analyst



Circle 95 on reader service card

THE FASTEST AND EASIEST WAY TO FIND trouble in TV circuits is to feed in a normal test signal, then note the output. Normal output means that this stage is good. No output or abnormal output means that you've found the trouble. This is also the oldest way; we were using it with John F. Rider's "Servicing By Signal Tracing" back in the late 1930's! For any kind of signal testing in color or B/W TV, an instrument like (continued on page 24)

More for your money - \$199.00* - than any other Color Bar/Pattern Generator

Superpulse — Provides a big, fat square pulse for easy CRO tracing in the set, and a white window pattern for quick checks of gray-scale tracking, smearing, and ringing right on the TV screen.

Bar Marker — Identifies color bars, 3, 6, 9 — a "must" on overscanned sets.

IF Output — at 45.75 MHz for troubleshooting in mixer and IF stages. Excellent for servicing "modular" solid-state sets.

The RCA WR-515A offers time and money-saving returns in fast diagnosis and adjustment in both home TV or commercial/industrial broadcast installations, including VTR's and video monitors. More details at any of the more than 1,000 RCA Distributors worldwide. Or, write: RCA Electronic Instrument Headquarters, 415 S. Fifth Street, Harrison, N.J. 07029.

Specialists demand the best tools of their trade.

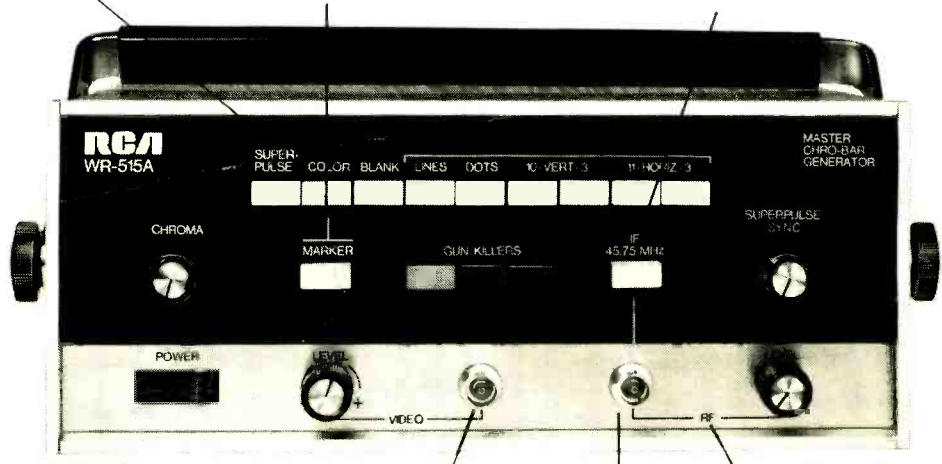

*Optional Price

Video Output — 2 volts, max. "+" and "-" at 75 ohms for commercial/industrial closed-circuit TV.

75- and 300-Ohms Output — at both RF and IF. Snap-on BNC heads for fast impedance changes. RF works into MATV, CATV systems.

100% Digital ICs — Computer-type counters need no adjustments — ever! Patterns stay locked-in.

Circle 15 on reader service card



Famous in All 50 States!

Archer® "Color Supreme" Antennas by Radio Shack

U.S. PAT. NO. 3,560,987

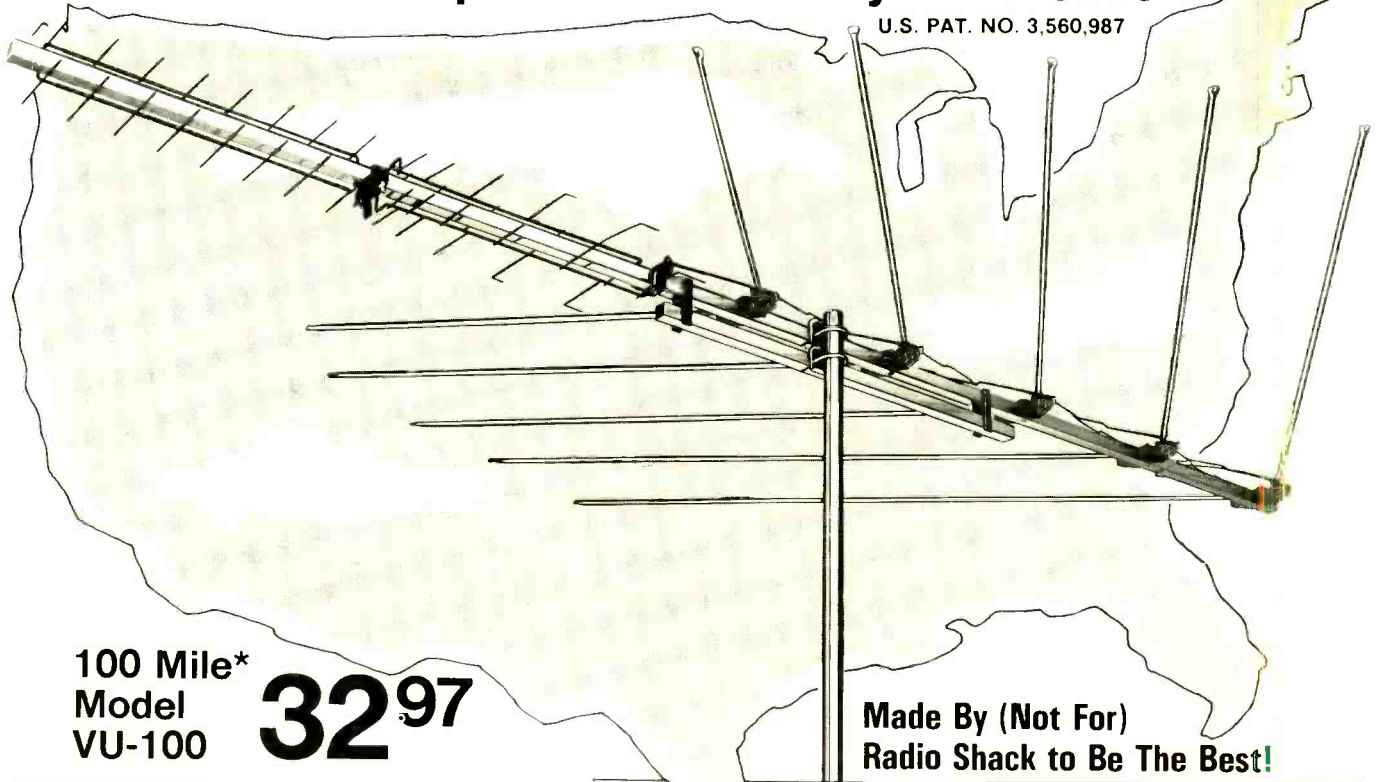

100 Mile*
Model
VU-100 **32⁹⁷**

Made By (Not For)
Radio Shack to Be The Best!

FREE New 1975 Radio Shack Catalog

OVER 2000 PRODUCTS
EXCLUSIVES ON EVERY PAGE
BEAUTIFUL FULL COLOR

Stereo • Quadraphonic • Phonographs
TV Antennas • Radios • Citizens Band
Kits • Recorders • Tape • Tools
Auto Tune-Up • Electronic Parts
Test Instruments • More!



164 pages of the finest in home and hobby electronics. Respected brand names like Realistic, Micronta, Archer, Science Fair — and they're available only at Radio Shack stores and dealers nationwide! See what's really new in electronics by getting this catalog now.

SEND FOR YOURS TODAY!
FILL OUT COUPON BELOW

1975 Mail to Radio Shack, P. O. Box 1052, 503
Catalog Ft. Worth, Texas 76101. (Please print)

Name _____ Apt. No. _____

Street _____

City _____

State _____ ZIP _____

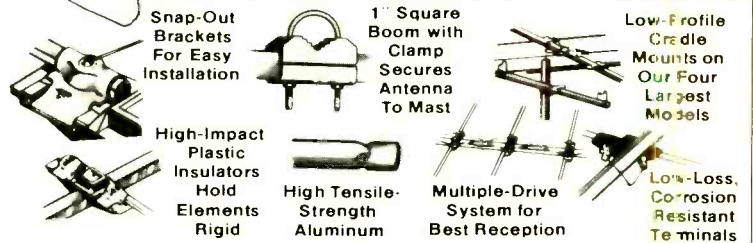

Radio Shack's 3-in-1 UHF/VHF/FM Color Supreme Antennas — so good they're patented! You get unrivaled picture quality, superior FM even in rough signal locations. The "Sweep-Design" VHF elements enhance signal pickup and transfer. The special "Hi-Q" drive and parasitic systems capture more signals for the sharpest pictures on every UHF channel. And the gold bonded finish fights corrosion and rust to keep your antenna looking and working like new. U-bolt assembly maintains proper alignment. Pre-assembled for quick set-up — save on dealer installation prices.

There's a Color Supreme to Meet Your Reception Needs — Near or Far

Model	Range in Miles*			Boom Length	No of Elements	Only
	VHF	UHF	FM			
VU-60	60	40	40	40"	12	12 ⁹⁷
VU-75	75	50	50	50"	14	17 ⁹⁷
VU-90	90	60	60	80"	23	26 ⁹⁷
VU-100	100	90	90	100"	32	32 ⁹⁷
VU-110	110	90	90	120"	34	42 ⁹⁷
VU-150	150	90	90	150"	35	51 ⁹⁷

*Ranges based on reception over flat, open terrain

Radio Shack's the Place to Shop for TV Antennas --
Everything in Installation, Hardware, Accessories



Radio Shack®

A TANDY CORPORATION COMPANY
OVER 3000 STORES • 50 STATES • 7 COUNTRIES
Retail prices may vary at individual stores

Circle 16 on reader service card

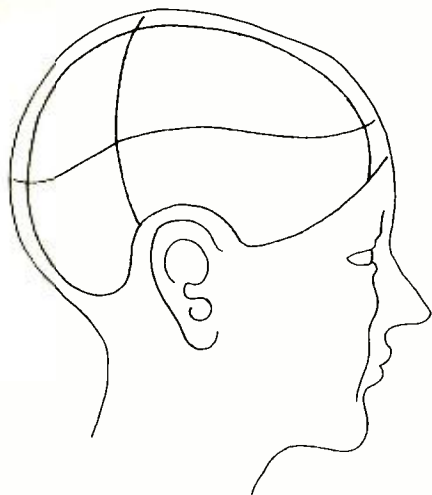

'GET INTO YOURSELF'

Discover your Alpha Brainwaves with this professional Biofeedback System.

Lowest Cost Brainwave Monitor

EICO introduces a price breakthrough in the fantastic new field of brainwave biofeedback... a completely safe, battery operated, biofeedback system that offers features and sensitivity comparable to professional models costing much more.

You Will Be Amazed At What You Hear

The BW-300 will detect your alpha brainwaves (which occur when you are totally relaxed) and produce a tone varying in frequency according to your mental state.

100% Solid State Circuitry

Reliable All Solid State IC Circuit Design features an active filter that isolates alpha brainwaves and a high-gain low-noise amplifier providing 5-microvolt sensitivity for easy alpha recognition. The BW-300 is supplied with stethoscopic earphones, electrodes headband, contact cream and instructions.

KIT 3495
WIRED 59.95

FREE EICO CATALOG

For latest EICO Catalog on Test Instruments, Automotive and Hobby Electronics, Eicocraft Project kits, Burglar-Fire Alarm Systems and name of nearest EICO Distributor, check reader service card or send 50¢ for fast first class mail service.

EICO—283 Malta Street, Brooklyn, N.Y. 11207

Leadership in
creative electronics



Circle 17 on reader service card

EQUIPMENT REPORT

(continued from page 22)

Castle TV's "Master Subber Mark V" is invaluable.

The original Tuner Subbers were and are very useful. They will check out tuner and i.f. troubles. The *Master Subber Mark V*, will provide normal test signals for every signal-circuit in the set! It is a deluxe Tuner Subber, with 40-MHz i.f. output. This will check the tuner and i.f. stages. There's more: it also has not one but two video signal outputs, positive and negative going sync. So, you can match any type of detector circuitry. With a color program on the input, these signals also have the color information, so that this can be used for checking out bandpass amplifiers, demodulators, etc. (Want a fixed pattern instead of a TV station signal? Just feed rf output of your color-bar generator into input of Master Subber!) These video outputs can be up to 7 volts peak; so they will drive almost any video amplifier stage.

Check the sound stages? Sure. The unit has a 4.5-MHz sound i.f. output; this checks the sound i.f. and FM limiter stages. There is also an audio output, up to 500 mV., for direct testing of audio stages after the detector. This is also fed to a small built-in speaker in the Master Subber's cabinet; it has its own volume control, so that you can turn it off if you don't need it.

This instrument can be used to check antennas. By hooking it to the leadin, you can tell instantly whether you have a suitable signal-level. This can be done in two ways; one, listen to the TV sound from the built-in speaker. Two, watch the video-carrier level meter on the front panel. If you want to, you can calibrate the reading of this meter, at a certain

setting of the MASTER GAIN control, with a field-strength meter. If this is set to a certain reading at 1000 microvolts (standard level for most CATV systems), you can also check CATV and MATV systems. This is very useful in cases where that old question "Is it the set or the antenna?" arises. In strong-signal areas, where the set's on rabbit-ears, etc., you can check, just the same. The MASTER SUBBER has its own built-in monopole antenna which telescopes into the case.

All of these functions are built into a compact plastic case, no bigger than the original Tuner Subber. Power is supplied by two 9-volt alkaline batteries, or by a 120-Vac plug-in power supply; this automatically disconnects the internal batteries when used. A LED pilot light tells you when it's on.

One essential thing with an instrument like this is the correct output cables, so that it can be hooked to any type of set with no trouble. They are here. Four separate "Mastermatch-coupler" cables are included, some with "RCA Phono jack" terminations, both male and female, others with alligator clips (color coded), and so on. If greater length is needed, one can be plugged into another to reach hard to get-at places.

Dame Fortune makes it easy for me to test test equipment! This time, she provided me with an elderly Motorola B/W with indeterminate problems. Subbing the tuner didn't help. Subbing the video didn't help. I checked the sound. Something finally worked! The trouble eventually turned up in the contrast control on the video output stage! So, I got a chance to use all of the many functions of this versatile instrument at once, and it worked to perfection. All parts of any TV set, color or B/W, tube or solid state, or modular, can be checked quickly and accurately with "real TV" signals. Very useful indeed.

Leader LCG-395 universal color bar pattern generator

Circle 96 on reader service card

THE LATEST OFFERING FROM LEADER Electronics Corp. is a bar-dot generator with some interesting features. Built with IC's, this compact instru-

ment provides the service technician with some unusual and quite handy patterns.

The color-bar pattern (see Fig. 1) is basically the standard 10-bar keyed rainbow. However, the color-bar pattern is unusual in that it's divided into thirds. Across the top of the screen is

(continued on page 30)

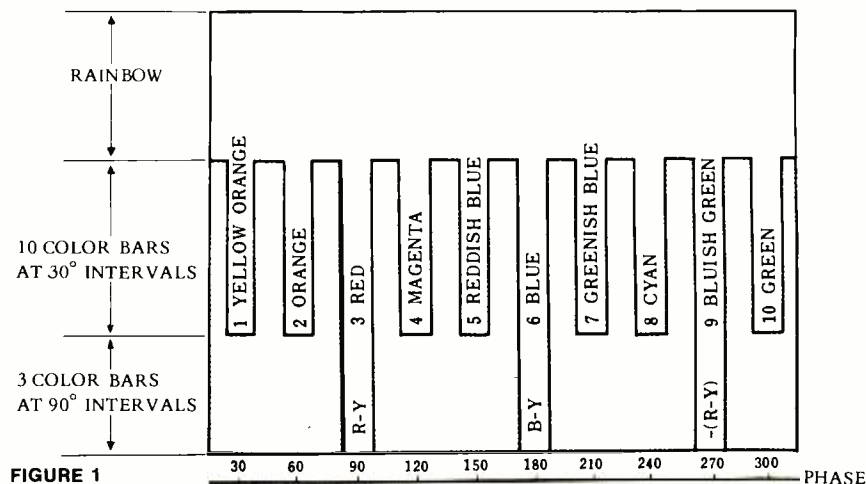

FIGURE 1

PHASE

TeleMatic

PROFESSIONAL TEST RIG SYSTEM TRS 330

For SERVICING MOST OF TODAY'S TV'S

TUBE AND SOLID STATE

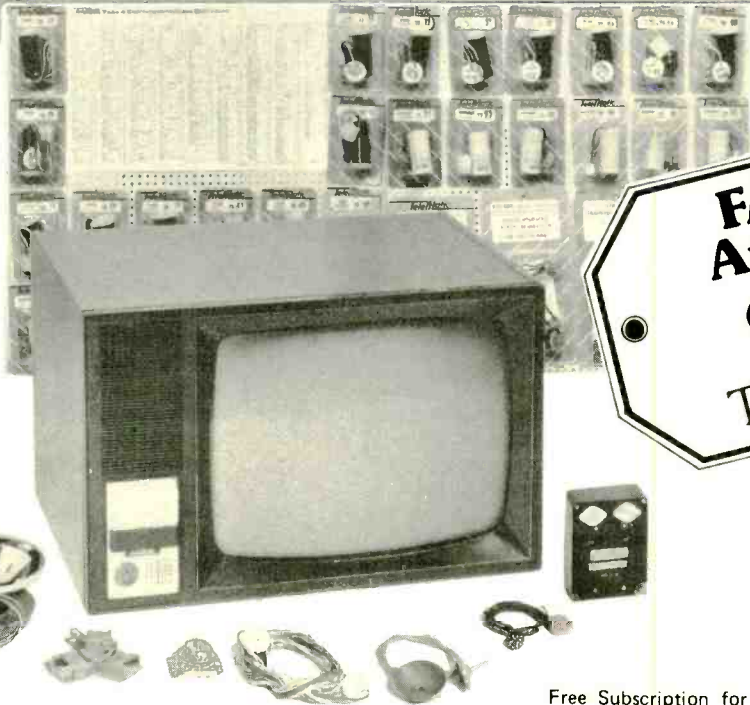

**FACTORY
Authorized
\$30.90
Tube Allowance**

SAVE HOURS WITH THIS PROFESSIONAL SYSTEM. SIMPLEST TO USE. INCORPORATES STATIC CONVERGENCE. NO COMPLICATED ADJUSTMENTS REQUIRED. YOU ARE PREPARED TO SERVICE MOST OF TODAY'S TUBE AND SOLID STATE TV'S WITH THE SYSTEM'S POPULAR ASSORTMENT OF ADAPTORS.

Free Subscription for Reference Material to thousands of TV Chassis

TeleMatic COMBO-DEAL STD 440

**VHF/SUB UHF/SUB
ALL CHANNEL
TUNERS**



TeleMatic Sub-Tuners save hours of guesswork by rapidly pinpointing trouble in the antenna, UHF or VHF Tuners, or I.F. Stages. Powered by popular transistor batteries.

COMBO-DEAL STD 440

KT-730	VHF/SUB	\$45.00
KTU-745	UHF/SUB	16.95
REGULAR PRICE		\$61.95
SAVE (On deal)		12.00
SPECIAL ONLY		\$49.95

Send literature and name of my distributor.
Telematic 2245 Pitkin Ave., Brooklyn, N.Y. 11207

NAME _____
ADDRESS _____
CITY _____ STATE _____ ZIP _____

Circle 18 on reader service card

**Polaris
40 KV
DUAL RANGE
Probe**

Current & Voltage Reading
For Today...
And Tomorrow

MODEL **\$29.95**
851

RANGE NO. 1: 40,000 VOLTS DC
RANGE NO. 2: 0-400 MA DC

Send literature and name of my distributor.

Polaris New York
2862 FULTON STREET
BROOKLYN, N.Y. 11207

Name _____
Address _____
City _____ State _____
Zip _____

exciting new projects for '75

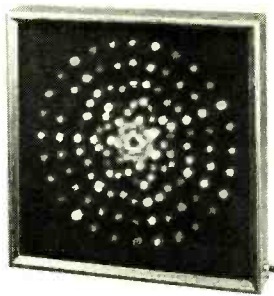

NEW Heathkit Color Organ

"Kaleidoscopic" light show you hang on a wall. 4 filters separate sound into 4 bands; each controls 35 brilliantly colored lights — red for bass, blue for low midrange, green for upper midrange, amber for treble — 140 lights in all, pulsating in time to music of your hi-fi. Wide 25 db dynamic range; great for any type of music. Walnut-grain vinyl-clad case, 23" x 23" x 4 1/2". On/off/sensitivity control.

Kit TD-1006 79.95*



NEW Portable Digital Multimeter

Professional performance at a budget price. 26 ranges resolve voltages to 100 μ V, currents to 100 nA, measures AC & DC current up to 2 A, resistance from 100 to 1000K ohms. Big, bright 3 1/2-digit readout with automatic over-range & polarity indications. Built-in reference standards for easy field calibration. With rechargeable batteries & AC line cord.

Kit IM-2202 179.95*



NEW DC-10MHz Oscilloscope

A great scope—a great value! Perfect for TV servicing. 10 mV vertical input sensitivity, time bases from 200 ms/cm to 200 ns/cm, internal or external digital triggering, two input channels. Mu-metal shielded tube with 8x10 cm graticule.

Kit IO-4530 299.95*

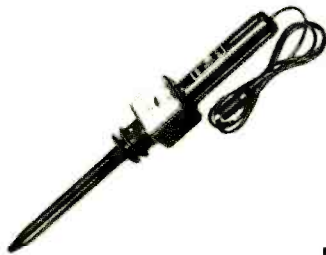

NEW 40 kV Metered Probe

Ideal for high-voltage TV measurements—up to 40 kV with \pm 3% accuracy. On/off switch.

Kit IM-5210 17.95*
Assembled SM-5210 24.95*



NEW Emergency Car Strobe Light

Highly visible amber flash warns other drivers when your car stalls or breaks down. Non-marring magnetic base, 12' cord, plug fits cigarette lighter. For 12 VDC.

Kit GD-1026 29.95*



NEW Windshield Wiper Delay

Provides exactly the wiper speed you need for safe driving in any weather, from light mist to heavy rain. Works with most 12 VDC positive or negative ground cars.

Kit CH-1068 14.95*



NEW AM/FM Digital Clock Radio

Electronic digital clock with standby battery power to keep time (without display) during power interruptions, electronic "beep" alarm with adjustable volume, 5 μ V FM sensitivity, quality sound. Less batteries.

Kit GR-1075 129.95*

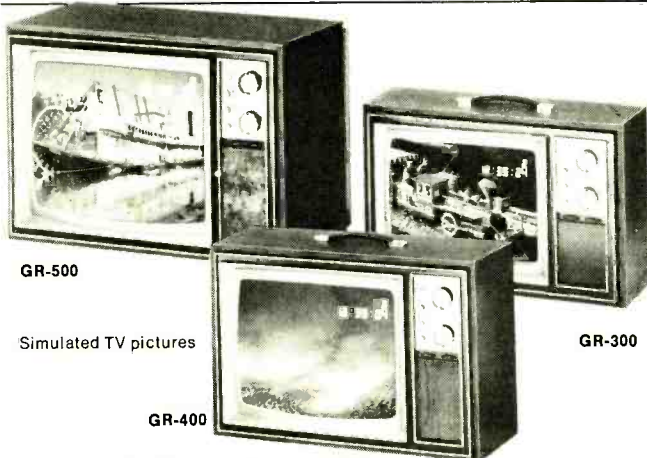

GR-500

Simulated TV pictures

GR-400

GR-300

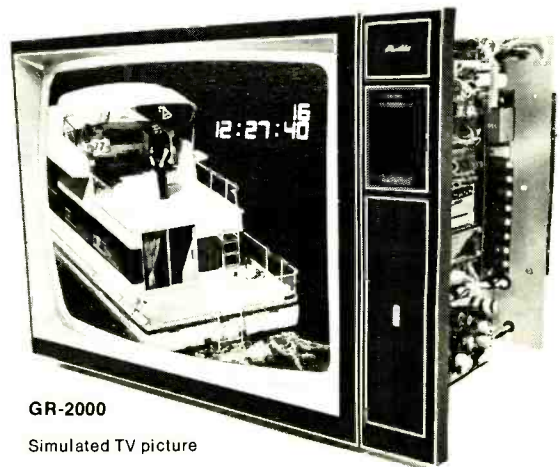

GR-2000

Simulated TV picture

15, 17 & 19" (diagonal) Color TVs with On-Screen Digital Readout

Advanced Heath engineering and outstanding picture quality. All feature on-screen channel readout & optional plug-in clock modules. In-line picture tubes with slotted shadow masks provide exceptionally bright, sharp pictures. In the GR-400 and 500, black matrix tubes improve contrast. And here's something new—static toroid yoke & magnet assemblies never require convergence & fixed LC filters eliminate instrument IF alignment. GR-300 & 400 come with walnut veneer cabinets; cabinets for the GR-500 start at \$39.95.*

Kit GR-300 (15" diag.), with cabinet 449.95*
Kit GR-400 (17" diag.), with cabinet 489.95*
Kit GR-500 (19" diag.), less cabinet 499.95*
Kit GRA-2000-1, Digital Clock Module 29.95*

Highly Acclaimed GR-2000 Digital-Design Color TV

The set that brought TV into the digital age—and still one of the finest made. Tuning is totally digital solid-state & the channel number appears right on the big, 25" (diagonal) screen. The optional clock module also displays the time on the screen. For the ultimate in convenience, add the optional wireless remote control. Can be custom mounted; optional cabinets start at \$119.95*.

Kit GR-2000, less cabinet 669.95*
Kit GRA-2000-1, Digital Clock Module 29.95*

at traditional Heathkit savings

There are 350 more in the new FREE Heathkit catalog!

Who can build our kits? Anybody!

For over 27 years we've made superb electronic equipment that anyone can build—even with no prior knowledge of electronics or kit building. Famous Heathkit assembly manuals guide you step by step, showing you exactly what to do—even how to solder like a pro.

And we back every Heathkit purchase with people. Expert technical consultants at the factory and trained service personnel from coast to coast are ready to help every step of the way. Thousands of Heath customers will tell you — **we won't let you fail!**

When you're finished, you'll own one of the finest products available—kit or assembled. But don't take our word for it, independent reviewers consistently praise their quality.

You'll enjoy the satisfaction—and savings—of building a useful product with your own hands. And for years to come, you'll enjoy its unexcelled quality and performance. Build it yourself—with a little help from Heath.

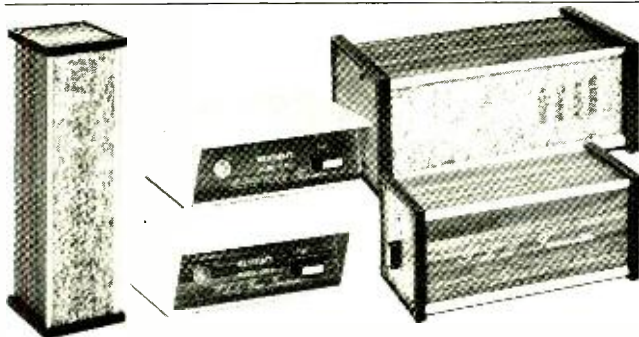
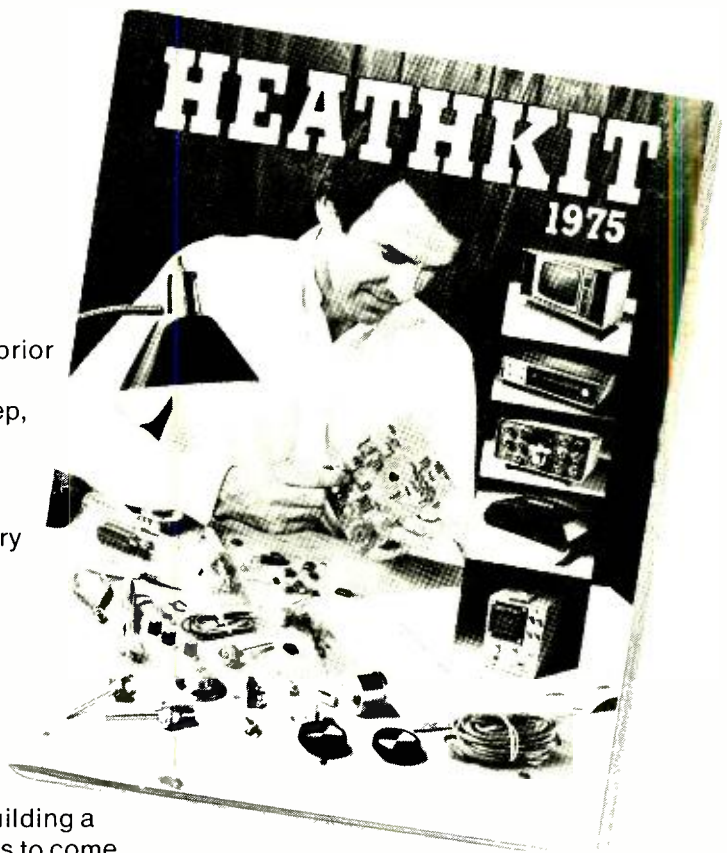

NEW Heathkit/Delta Home Security System

Everything you need for a complete home security system. Remote detectors connect to Central Processor through your home's electrical wiring. Inputs for ultrasonic intrusion detector, heat & smoke detectors plus "panic button" & remote on/off switch. Central Processor features built-in speaker; output for an external speaker. Sounds alarm during power failure.



NEW Valu-System Stereo & 4-Channel Components

Budget-priced systems with component-quality sound. Pick your own system — an AM/FM stereo receiver, \$139.95*; an AM/FM stereo receiver with 8-track player, \$179.95*; a 4-channel 8-track player, \$169.95* or a 4-channel AM/FM receiver with 8-track player, \$239.95*. Add speakers (just \$34.95* per pair) and our \$44.95 ceramic changer, and you get our 5% system discount. A whole stereo system (shown above) starts at just \$208.86*. See them in the new Heathkit Catalog.

Send for your free 1975 Heathkit Catalog today!

Your free 1975 Heathkit Catalog describes the world's largest selection of electronic kits. You'll find kits for every interest, every age, every budget. Choose from digital-design color TVs, stereo and 4-channel hi-fi components, fishing and boating electronics, model radio-control equipment, amateur radio kits, digital clocks, weather instruments, shortwave and digital clock radios, treasure finders, automotive tune-up tools, service instruments, and educational kits. See why you get more for your money when you build it yourself — send for your free copy today.

HEATH Schlumberger		
Heath Company Dept. 20-04 Benton Harbor, Michigan 49022		
Name _____		
Address _____		
City _____	State _____	Zip _____
<small>PRICES & SPECIFICATIONS SUBJECT TO CHANGE WITHOUT NOTICE. *MAIL ORDER PRICES; F.O.B. FACTORY.</small>		CL-430

Circle 100 on reader service card

... here Today!

"IGNITION OF THE FUTURE" ALLISON "OPTO-ELECTRIC"

★ The BEST...the ULTIMATE...
of ALL the Ignition Systems!

● (We challenge ANYONE
to dispute this Fact)

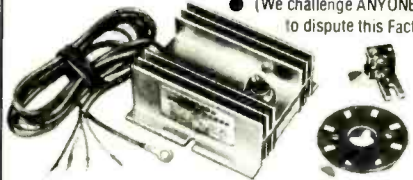

● Never wears out or needs any Maintenance!



● Does more than Pay for itself in
GAS SAVINGS

...it gives you Maximum Power
with continuous PEAK PERFORMANCE

...while reducing Maintenance
and Operating Costs!



● The Allison OPTO-ELECTRIC System eliminates the Points and Condenser, replacing them with an OPTO-ELECTRONIC TRIGGER, using a Light-Emitting Diode and Photo transistor. As there are NO moving parts in rubbing contact, Timing adjustments are PERMANENT! The only "TRUE" Electronic Ignition...that you can buy for under \$100.

● Gives 40-Times more Timing Accuracy than ANY system using "Mechanical" Breaker-Points! UNLIMITED RPM! "Electronically-Controlled" DWELL automatically supplies HIGHEST Performance at both Low and High speeds. Spark strength does not fall off at high RPM. POSITIVE SPARK helps eliminate "Misfire" for faster acceleration and improved Engine Performance! Smoother running (No timing fluctuation as with Magnetic Units). Easier Starting under any condition! Sparkplugs LAST 3 to 10-Times LONGER.

All SOLID-STATE Components. UNAFFECTED By Temperature, Moisture, or Vibration! Highest grade materials Guarantee you solid, Dependable Performance.

★ Perfect Timing and Dwell never change.

Pays for itself! Eliminates ignition Tune-Ups forever!
"INFINITE LIFE"...Once installed...Never needs replacing.

● PERFECT TIMING INCREASES Engine Efficiency and Gas Mileage. SAVES Precious Fuel! Allison gives you MAXIMUM Engine Efficiency 100% of the time...and that's the name of the game for BETTER Gas Mileage and Economy.



★ PROVEN RELIABILITY!

Dyno Tested up to 15,000 RPM.
Road and Race Proven.
(Opto-Electric Systems won at
INDY Two years in a row!)

● QUICK AND EASY INSTALLATION

★ If you want the BEST, and SAVE! This is IT!

● ORDER with CONFIDENCE...

SATISFACTION GUARANTEED!

1-YEAR FACTORY WARRANTY.

Only \$49.95
COMPLETE.

● As you can see, you're not taking any
chances at all...Send your Order Today.

State Make, Year, Engine Size. (Calif. Res. add Tax).
(So New...it's Sold ONLY FROM FACTORY DIRECT).

You may use your MASTER CHARGE or BANKAMERICARD.
Send us (1) Your Number, (2) Interbank No., (3) Exp. Date.

● Before buying any other Type ignition system...

Send Postcard for our FREE BROCHURE.

★ If you have already installed a C-D ignition system,
Modernize and Increase its Efficiency...

CONVERT YOUR "C-D" UNIT TO BREAKLESS!
Opto-Electric "TRIGGER UNIT"...Only \$34.95

● Our BEST Salesmen are the Owners
and users of our ALLISON System!



ALLISON
AUTOMOTIVE COMPANY

1269 - L, East EDNA PL., COVINA, CAL. 91722

EQUIPMENT REPORT

(continued from page 24)

an unkeyed rainbow pattern. The center of the screen contains the standard 10-bar keyed rainbow, and the lower third of the screen is a spaced three-bar pattern with R-Y, B-Y, and R-Y (Cyan or light green) color-bars. It sounds odd, but in use it can be very handy.



There is a white raster pattern for setting grey-scale and checking for hum bars in the video. Next comes another new pattern called a "window". It's a white rectangle in the middle of a black border and is used for checking the display pulses (sag, overshoot, ringing). After this, a "staircase" pattern which contains a black bar across the top third of the screen. The rest of the screen is made up of five equal-size vertical bars, of 20, 40, 60, 80 and 100% (white) modulation. This can be used for checking video response and contrast.

The convergence pattern (See Fig. 2) has some handy features. It's a

overscanned in either direction, etc. For the final touch, there is a small set of 6 dashes in the lower right corner. This is a "corner marker" which tells you whether the deflection yoke is hooked up with the right polarity. If this marker isn't in the lower right corner, something needs reversing.

A set of gun-killer leads, switches and clips are provided. All of the gun-killer and pattern-selector switches are generous-sized bushbuttons. The RF output may be taken from either 300-ohm balanced or 75-ohm unbalanced jacks. Output signal level is controlled by the RF adjustment. RF output can be set to Ch. 5 or Ch. 6 by a selector switch on the front panel. This switch also provides for the use of a 40-MHz video i.f. output for direct injection into the i.f. input, a useful feature for checking the tuner.

A 75-ohm video signal is also available at a front panel jack. Polarity and level (max. 10 mV) of this signal can be set by the VIDEO CONTROL. A trigger signal for signal tracing with a scope is also provided for on the front panel. This can be of either horizontal or vertical frequency, or a composite. This has an open-circuit voltage of about 3 V p-p.

The last control on the front panel is marked "Brightness". It does control the brightness of all patterns except for the staircase, which is fixed. It also acts as a "color" control for the color-bar pattern, with the normal range of 0-200% saturation.

The LCG-395 is a compact instrument, only 3" high by 8" wide, with a

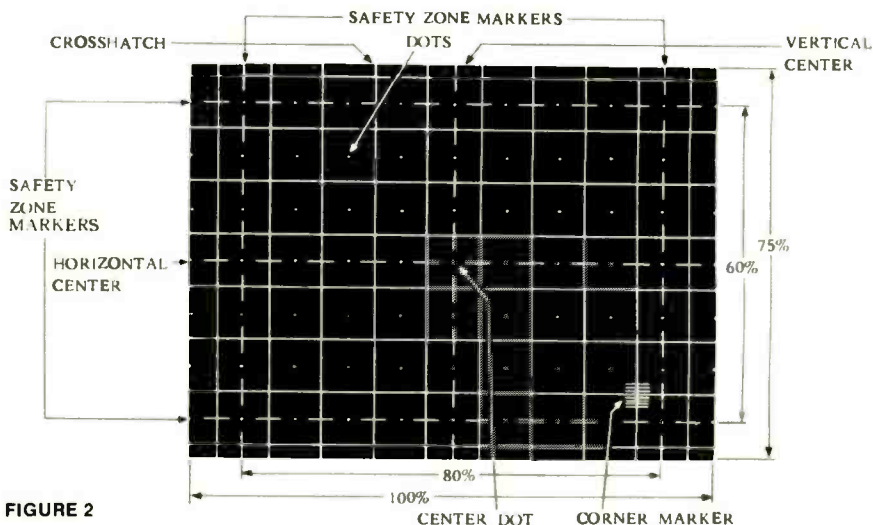

FIGURE 2

crosshatch with 10 horizontal and 7 vertical bars. This is only the beginning! Inside this is another pattern made up of dashed lines. There is a horizontal and vertical cross with a "center dot". Around the edges of the pattern is a "safety zone" dashed-line pattern. This shows you instantly whether the raster is centered, linear,

heavy bail-type handle that serves as a stand for bench use. Long standoffs are provided on the back, for storing the line cord or for use as legs if you want to use it in a vertical position. All controls on the panel are clearly marked, with lines going to the associated jack. All pushbuttons are big enough for easy use.

R-E

Why You Should Buy Telequipment

Telequipment products are designed to meet the needs of the cost-conscious buyer without sacrificing reliability or general utility.

The Telequipment line of Tektronix oscilloscopes combines low price with a number of features not usually found in other oscilloscopes of the same price range. Features such as calibrated sweep rate and vertical step attenuators, variable controls, triggered sweep, probe-calibrated outputs, illuminated graticule and TV-field or line triggering, make these instruments versatile and easy to use.

The 10 MHz, dual trace, D61 is exceptionally easy to operate and low priced at only \$545. Its stable triggering characteristics, front panel simplicity, and versatility make it an excellent choice for industrial and educational applications. X-y analysis vector capability and TV line or frame triggering also make it especially well suited for service shops.

The Telequipment line, in addition, includes the S51B, a single-trace, 3 MHz oscilloscope with either automatic or normal trigger modes—at \$325, the lowest priced oscilloscope offered by Tektronix—and is excellent for use in audio to medium frequency applications. In addition, there's the DM 64, a 10 MHz dual-channel, bistable storage oscilloscope for \$1195, and more . . .

. . . The D67 oscilloscope at \$1125 combines dual trace, the 25-MHz bandwidth at 10 mV/div, FET inputs, regulated power supplies, and all solid-state circuits with delayed-sweep capability—a combination of features seldom found in a low-priced oscilloscope. The D66 offers all of these features except delayed sweep at an even lower price, \$875. Both feature a SUM mode with normal/invert capability that improves display of small signals in the presence of common mode noise. The easy-to-operate CT71 curve tracer enhances the line providing a dynamic semiconductor measurement capability by displaying characteristic curves of transistors, FETS, and diodes.

Available at only \$895, it is well suited for industrial application and student labs.

For more information about Telequipment instruments, contact your local Tektronix Field Office, or write Tektronix, Inc., Beaverton, Oregon 97077. In Europe, write Tektronix Limited, P.O. Box 36, St. Peter Port, Guernsey, Channel Islands. In Canada, write Tektronix Canada Ltd., Quebec, Canada.



TEKTRONIX®

committed to
technical excellence

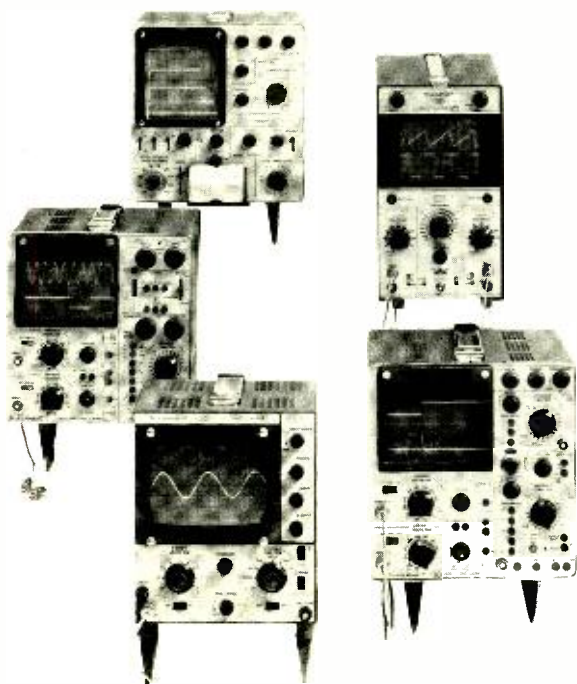

Circle 20 on reader service card

Circle 30 on reader service card for demonstration

Another advance in tube technology from RCA

RCA, the leading manufacturer of receiving tubes, offers you advanced types to satisfy the needs of the replacement market. We can do this because RCA has unique design capability that comes only with years of tube design and manufacturing experience. This means that when you install RCA-made tubes, you're selling quality tubes with the newest and best innovations in design and performance.

A dynamic approach to receiving tube technology, geared to the rigorous demands of the replacement market, RCA's exclusive, new 6MJ6/6LQ6/6JE6C brings added reliability to horizontal deflection cir-

cuits, the most critical in your customer's set. Manufactured exclusively by RCA, this new rugged horizontal output tube with the integral envelope-top-cap assembly, which totally eliminates loose top-cap problems, represents another significant advance in tube technology from RCA.

You can be certain that RCA will continue to lead the way in the receiving tube business. After all, *your* tube business is *our* tube business and we expect to share this high volume business with you for a long time to come.

See your RCA distributor for all of your tube needs.

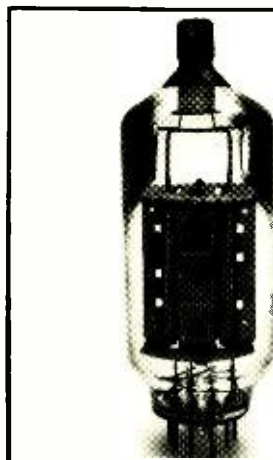

Rugged Features of the 6MJ6/6LQ6/6JE6C

- Integral-Envelope-Top-Cap Assembly
- Rigid Cage
- Stable grid alignment
- Excellent Heat Dissipation

RCA

RCA/Electronic Components/Harrison, N.J. 07029



20 easy-to-build COSMOS burglar alarms - part 1

These burglar alarm circuits are simple yet very effective. Many options exist for each circuit, so the final circuit you build is entirely your own choice.

by R. M. MARSTON

A BURGLAR ALARM IS THE MOST VALUABLE piece of equipment that the electronics buff can build for use in the home. It helps give the owner peace-of-mind when the house is empty, and gives a high degree of protection against theft of property or damage. It may even help protect the owner's life.

The requirements of the ideal burglar alarm system are stringent. The system must be immune to giving false alarms. It must be battery powered and consume negligible standby current. It must be capable of driving almost any type of alarm generator (bell, siren, etc.). Finally, the system must be versatile enough to meet the differing needs of individual owners. It should, for example, be capable of providing either self-latch or auto-turn-off operation, and have provisions for incorporating 'panic' and other facilities.

In Part 1 of this series, we show how you can use modern COS/MOS (COMplementary-Symetry Metal-Oxide Silicon) digital integrated circuits to build tailor-made burglar alarms which meet all of the requirements outlined above. These alarms can be as simple or as complex as you want to make them. Later in the article we'll show how you can make your own 10-watt alarm-call generators to use in place of alarm bells or sirens, and we'll give advice on how to select alarm sensor installations to suit your own home.

Basic alarm circuits

The simplest and most widely used type of burglar alarm circuit consists of a number of switches or other sensor devices wired to doors, windows,

etc.,. The output of these sensor devices are used to trigger an alarm bell via a self-latching relay. The sensor devices may be the normally-open (N.O) type of switches or reed-relays which activate the alarm when they are momentarily closed, or they may be normally-closed (N.C) type of switches or lengths of wire or foil which activate the alarm when they are momentarily opened or broken.

Figure 1 shows a practical burglar alarm circuit using a normally-open type of sensor. During normal operation, when switch S2 is in the STANDBY position and sensor switch S1 is open, the relay is de-energized. When S1 is momentarily closed, it connects the relay coil (RY1) directly across the supply lines, and the relay is energized. As the relay contacts RY1-2 close and activate the alarm generator, contacts RY1-1 close and short out sensor switch S1, thus latching the alarm generator on. Any number of normally open sensor switches can be wired in parallel with S1 and used to activate the alarm system from different parts of the house.

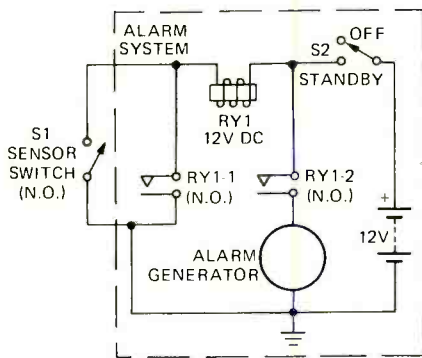

FIG. 1—BASIC BURGLAR ALARM CIRCUIT using normally-open sensor switches.

The advantages of the Fig. 1 circuit are that it is simple, virtually immune to giving false alarms, consumes zero standby current, and is capable of driving any type of alarm generator via relay contacts RY1-2. The disadvantages of the circuit are that it can be simply disabled by cutting the leads connecting S1 to the input of the alarm system, and the system lacks versatility.

An alternative basic type of burglar alarm circuit is in Project 1. This is a practical burglar alarm circuit using normally-closed sensor switches. During normal operation, when switch S2 is in the STANDBY position, the base-emitter junction of transistor Q1 is shorted out by sensor switch S1 so Q1 is cut-off and the relay is de-energized. A standby current of 1-mA flows through resistor R1 under this condition. When sensor switch S1 is momentarily opened, base current flows into Q1 via R1, driving the transistor into conduction and energizing the relay. When the relay is energized, contacts RY1-2 close and activate the alarm generator, and contacts RY1-1 close and short the relay directly

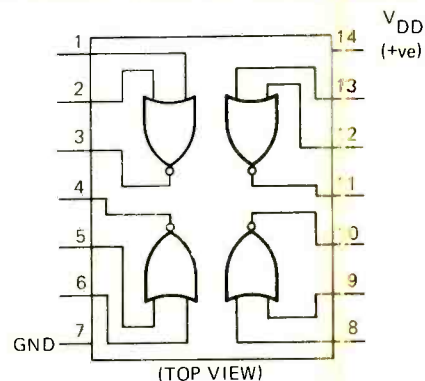

FIG. 2—PIN CONNECTION diagram of the CD4001AE quad 2-input NOR gate IC.

across the supply lines, thus latching the alarm generator on. Any number of n.c. sensor switches can be wired in series with S1 and used to activate the alarm from different parts of the house.

The major advantages of the Project 1 circuit are that it is simple, virtually immune to giving false alarms, can drive any type of alarm generator, and is difficult to disable—since it can be disabled only by shorting out the sensor switches or the leads connecting S1 to the input of the alarm system. The greatest disadvantage of the system is that it consumes an appreciable standby current (1-mA). A less serious disadvantage is that the basic circuit is lacking in versatility, although it should be noted that the design can be made to function simultaneously as both a make-to-operate and a break-to-operate alarm by simply wiring normally closed sensor switches in series with S1 and normally open sensor switches in parallel with relay contacts RY1-1.

Finally, Project 2 shows the practical circuit of a simple COS/MOS-aided relay burglar alarm that can be activated by both normally open and normally closed contact sensors. The COS/MOS IC used in this circuit (and all the remaining circuits described in this article) is a CD4001AE quad 2-input NOR gate, manufactured by RCA. The basic circuit and pin connections of this IC are shown in Fig. 2. Each of the four gates of this IC feature a near-infinite input impedance, virtually zero standby current, and a low output impedance. In the Project 2 circuit, only one of the gates is used, and is connected as a simple inverter. All the unused inputs of the remaining three unused gates are tied to ground, as indicated in the diagram.

The circuit in Project 2 works as follows. During normal operation, when switch S3 is in the STANDBY position and sensor switch S1 is closed and sensor switch S2 is open, the input of gate A is held close to the positive voltage level via the voltage divider R1 and R2, so the output of the gate is at ground potential, and transistor Q1 is cut-off and the relay is de-energized. A standby current of only a microamp or so flows in the circuit under this condition (via R1-R2, and via the leakage resistance of Q1).

When sensor switch S1 is momentarily opened or sensor switch S2 is momentarily closed, the input of gate A is pulled to ground potential via R2 or S2, and the output of gate A immediately switches to the positive rail voltage and drives transistor Q1 into conduction and energizes the relay via resistor R3. When the relay is energized, contacts RY1-2 close and acti-

1. BASIC BURGLAR ALARM CIRCUIT

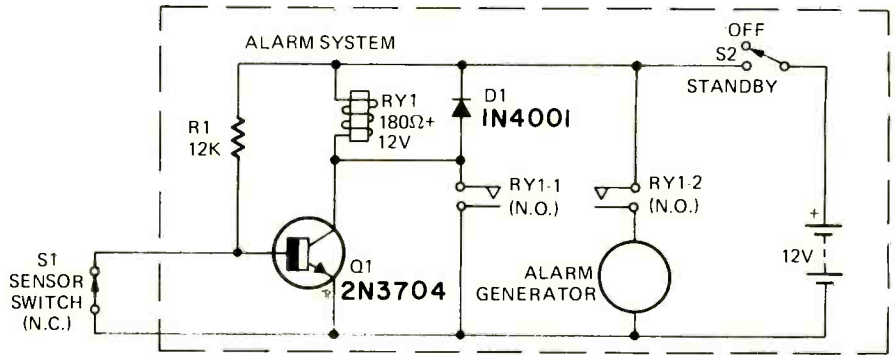

2. ALARM CIRCUIT USING COS/MOS LOGIC

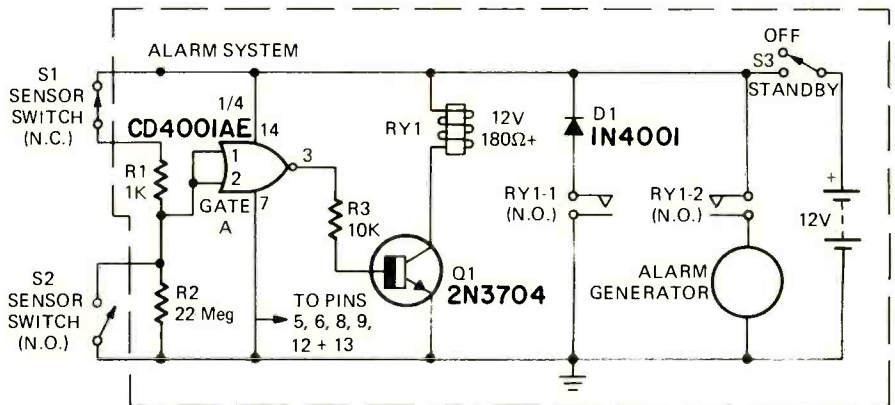

3. SIMPLE SELF-LATCHING BURGLAR ALARM

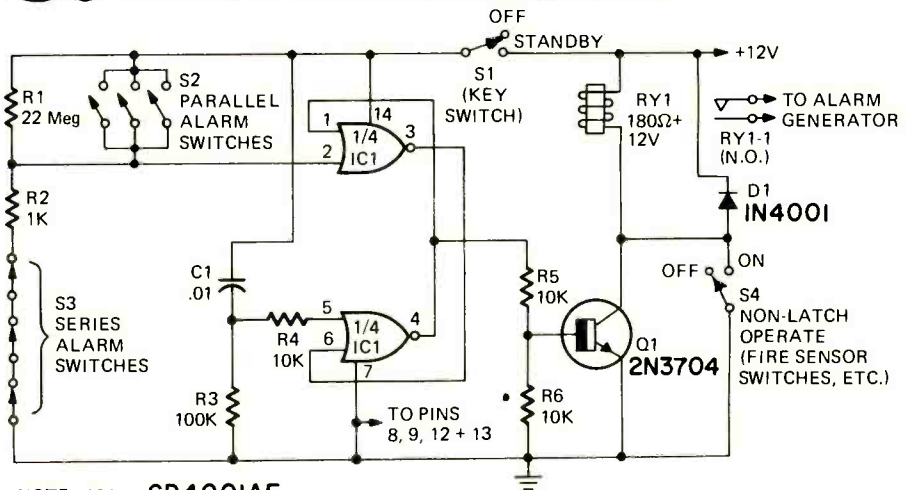

NOTE: IC1 = CD4001AE

uate the alarm generator and contacts RY1-1 close and short the relay directly across the supply lines, thus latching the alarm generator on. Any number of n.c. sensor switches can be wired in series with S1, and any number of n.o. switches can be wired in parallel with S2. The advantages of the Project 2 cir-

cuit are that it is reasonably simple, virtually immune to giving false alarms, is difficult to disable, can drive any type of alarm generator, and is very versatile. Its versatility comes from the fact that gate A can readily be used in a variety of modes, and forms only one quarter of the number of available gates in the CD4001AE COS/MOS

4. AUTO-TURN-OFF BURGLAR ALARM

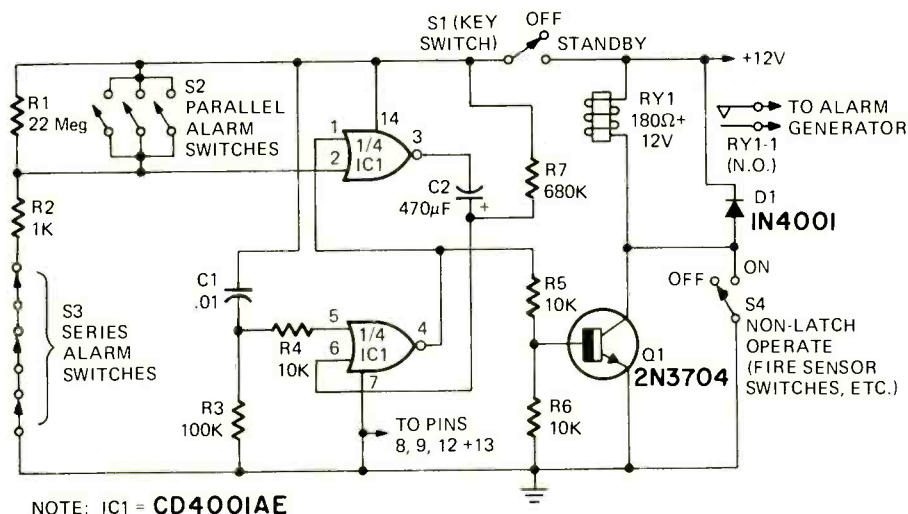

tion of this bistable is such that its output (taken from pin 4) goes low and self-latches when a positive voltage or pulse is applied to pin 5, and its output goes high and self-latches when a positive voltage or pulse is applied to pin 2. Power is applied to the bistable and to the alarm sensor switches (S2 and S3) via key-operated switch S1.

Assume, then, that alarm sensor S2 is open and S3 is closed. When key-switch S1 is first set to the STANDBY position, pin 2 is held low by the voltage divider R1 and R2, and a brief positive voltage pulse is fed to pin 5 from the supply line via C1 and R3-R4. Consequently, the output of the bistable automatically goes low as soon as S1 is closed. Under this condition, zero base drive is applied to transistor Q1, so Q1 is cut-off, the relay is de-energized and the alarm generator is off. The circuit draws a typical current of about 1- μ A in this standby mode. Half of this current flows through the supply lines via R1 and R2, and the other half flows via the leakage resistance of transistor Q1.

The alarm can be activated by opening any one of series-connected sensor switches S3, or by closing any one of parallel-connected sensor switches S2. Under this condition, pin 2 of the bistable goes close to the positive supply voltage and the bistable changes mode and its output locks into the high state and switches the alarm generator on via transistor Q1 and the relay. The alarm then stays on indefinitely, and can be turned off only by opening key switch S1.

The auto-turn-off circuit of Project 4 is similar to that of Project 3, except that in this case the two gates of the IC are connected as a simple monostable multivibrator. The action of this monostable is such that its output goes to the low state when a positive voltage or pulse is applied to pin 5, but goes high for a pre-set period when a positive-going voltage transition is applied to pin 2. The value of this pre-set period is determined by the time constant of R7 and C2, and equals approximately four minutes (0.5 s. per μ F of C2) with the C2 value shown. At the end of this period, the output of the monostable automatically switches back to the low state. Note that the monostable can be triggered only by a positive-going transition voltage applied to pin 2, and its action is not influenced by constant high or low voltages that may be applied to this pin.

Thus, the output of the monostable automatically goes low as soon as key switch S1 is set to the STANDBY position.

5. AUTO-TURN-OFF ALARM WITH "PANIC" FACILITY

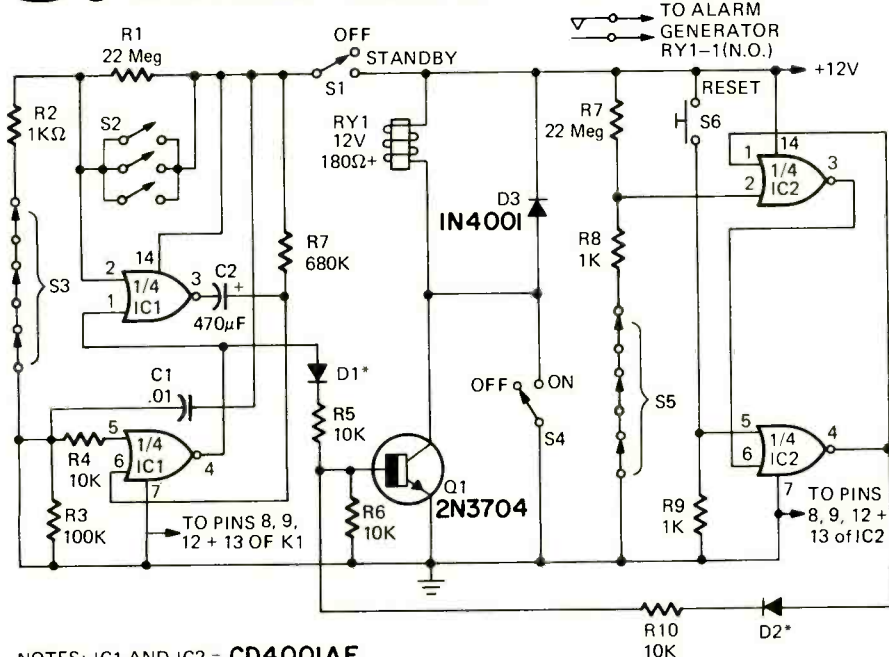

- S1 = KEY SWITCH
S2 = N.O. ALARM SWITCHES, IN PARALLEL
S3 = N.C. ALARM SWITCHES, IN SERIES
S4 = N.O. FIRE-SENSOR SWITCHES
S5 = N.C. 'PANIC' BUTTONS, IN SERIES
S6 = N.O. 'RESET' BUTTON FOR PANIC ALARM

package. The four available gates can readily be interconnected to act in a variety of gate, logic, time delay, and multivibrator modes, and can be used to give a variety of useful alarm facilities.

The Project 2 circuit has no significant disadvantages, and forms the basis of all the practical alarm projects described in the remaining parts of this article.

Practical COS/MOS alarm circuits

A practical alarm system may be of

either the self-latching type, which turns on as soon as it is activated and then remains on indefinitely, or it may be of the auto-turn-off type, which turns on as soon as it is activated but then turns off again automatically after a pre-set period. COS/MOS alarm systems of both these types are shown in Projects 3 and 4.

The self-latching operation of the Project 3 circuit is obtained by wiring two of the 2-input NOR gates of a CD4001AE IC so that they act as a simple bistable multivibrator. The ac-

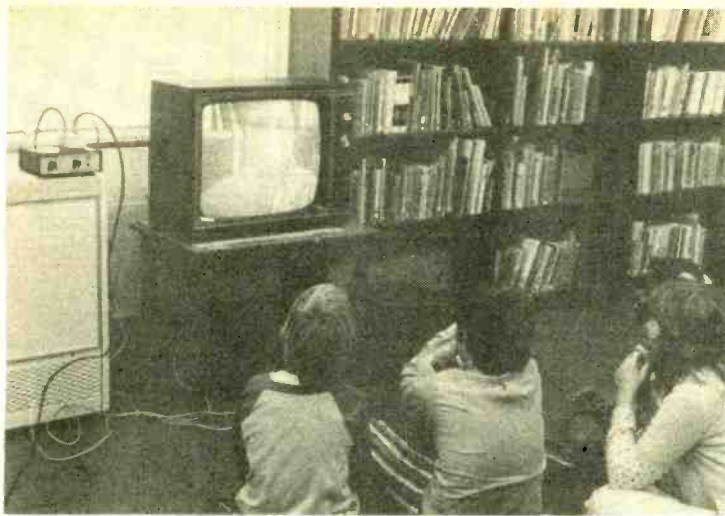

Add CCTV to MATV

Adding closed circuit television to an MATV system is not difficult. Here's how to do it.

by **JAMES E. KLUGE**
TECHNICAL EDITOR
WINEGARD COMPANY

IT'S EASY TO ALLOW FOR FUTURE EXPANSION of, say, an apartment or condominium complex from 500 to 1,000 units. Judicious over-specification in the design of its MATV system can take care of most future expansion requirements. But the MATV designer who must plan a system capable of many more functions than mere distribution of off-the-air signals has a problem. Fortunately, he also has help—if he knows where to look.

Several manufacturing companies have taken a penetrating look at the potentials of MATV and CATV systems and have provided components to take advantage of those potentials. These components accept video and audio signals from almost any source, such as a TV camera, videotape or film chain, FM tuner, tape or record player and convert this input into a complete television signal. To accomplish this, the minimum components are an audio-video modulator and a sub-channel converter. A switcher can be added if multiple inputs are to be accepted.

Signal path

Let's follow a hypothetical signal from its origin through the system until it shows up on the TV screen. Winegard Company components are used for convenience, although others are available.

A low-cost TV camera can monitor, say, the swimming pool and adjacent area. If sound is desired, any standard microphone may be used. These video and audio signals are input to a Model IV-505 Audio-Video Modulator which combines them to produce a complete 6-MHz sub-channel television signal. This sub-channel lies in the range between 18 and 48 MHz to avoid interference with standard frequencies on the trunkline.

The IV-505 introduces this sub-

channel signal into the trunkline system via an institutional-type wall tap. When it reaches the head-end, the sub-channel signal is picked off by a Model SVC-601 Converter/Strip Amplifier which converts it to the standard frequency of an unused vhf channel and reintroduces the signal into the trunkline system for distribution.

So, to check on whether little Susie Smith is at the pool, all her mother has to do is flip the TV tuner to, say, Channel 10.

There are two basic ways to handle multiple video inputs. The first way is to use a separate set of components (IV-505, SVC-601) for each camera and microphone. This gives separate sub-channel conversion for separate vhf channel display. This is more expensive, both in terms of money spent on components and use of available vhf channels, but it does allow simultaneous coverage of different areas, such as pool and tennis courts.

Programming can be originated at any point within such a multiple dwelling complex, just as long as there is an institutional-type tap nearby. Obviously, such a set-up has dramatic potential for two-way communication within CATV systems, too.

The second way would be to use a pair of switchers (VS-401 Video Selector) for sequential coverage of up to four areas in a single sub-channel for single vhf channel display. Of course, if tenants can tolerate pictures without "live" sound, a single VS-401 could provide for sequential coverage of up to four areas, and background music could be fed directly into the IV-505 from another source such as a tape deck.

The beauty of the whole concept is that no additional trunkline is needed. The IV-505 feeds audio or video inputs right into the existing trunkline. So what was previously merely an MATV distribution system becomes a

closed circuit TV system on selected vhf channels.

Is it worth it

Why would anyone want to turn an existing MATV system into an in-house closed circuit network? There are three sets of pressures on the MATV industry today. All three come from outside the industry, and they are just now beginning to be felt.

One pressure comes from the so-called "communications explosion," which is far from being over. Developments in the late 60's were only the initial shock wave, and the main blast is yet to come. During the last decade, the general public's relationship with the rest of the world has been drastically altered in unforeseeable ways. As a result, the demand for communication seems nearly insatiable. The more information we get, the more we want.

Another pressure is the growing acceptance of multiple unit housing, the very thing that has made the MATV industry as big as it is today. Vast numbers of Americans have suddenly realized that they can achieve the lifestyle they want for a lot less money than they figured. This realization has sparked a widespread upheaval in housing patterns, as the construction industry is well aware.

There was a time when you had to have millions (and live near the country club) to enjoy luxuries like private swimming pools, tennis courts, golf courses and recreational areas, all on your grounds. Throw in garage parking, social centers, barber and beauty shops, plus a private security force to watch over all these, and it sounds like some millionaire's estate. Yet these conveniences, once the exclusive property of the very rich, today are enjoyed by a large number of middle-class Americans.

Promoters of these multiple-unit



WINEGARD'S MODEL VS-401 video selector is designed to switch one of four video inputs to a single output.



WINEGARD'S MODEL SVC-601 converter strip amplifier mounts directly on the Ultra-Plex power panels.

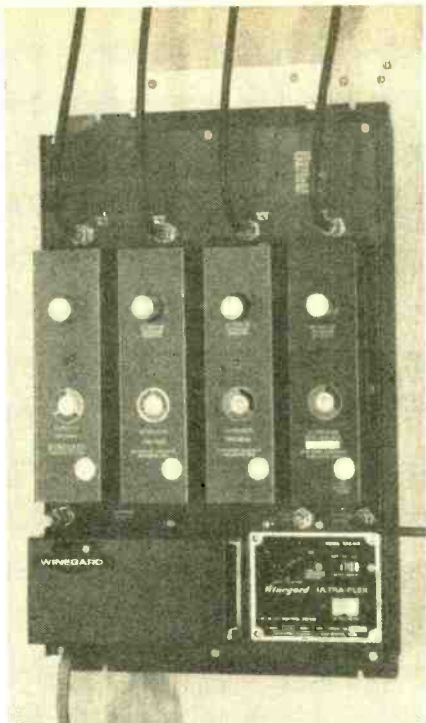

WINEGARD'S MODEL DSX-415 Ultra-Plex deluxe 4-strip power panel supplies power for the Ultra-Plex plug-in modules.

housing complexes have offered an extravagant variety of inducements to prospective renters. What more can they offer in order to fill their apartments and keep them filled?

An obvious answer is the extended use of existing MATV systems for their tenants convenience. A couple of years ago, this might not have been practical, but a third development has made it economically feasible.

That third development is the cost of video cameras, which keeps edging lower and lower. Only a few years ago, you couldn't touch a decent TV camera for under a thousand dollars. Today, a camera with the same capabilities can be had for around \$100. This trend makes it practical for MATV system owners to provide their tenants with a wide variety of services through their TV receivers.

These services can include the monitoring of critical areas, such as entrances, swimming pool, restaurants and shops; entertainment, including replay of earlier programming at a more convenient time, as well as tapes on every conceivable subject drawn from extensive libraries developed for the purpose; and capsule information about the environment that the apartment dweller must cope with. Although it won't supplant regular news shows, such capsule information would contain such items as the weather, stock market news, traffic conditions and headline news stories, all recycled at a rapid rate.

This amounts to "in-house" origination, and it implies that the system

should have the capability for distributing the desired signals on channels not occupied by standard broadcast.

The equipment

Since the locally introduced signal has to "swim upstream" to get to the head end for distribution, it must not interfere with off-the-air signals coming "downstream." That's why the IV-505 translates the signal it receives from cameras, VTR's or audio equipment to one of three sub-channels between 18 and 48 MHz before introducing it into the trunkline.

Subchannel A covers 42 to 48 MHz and will convert to any vhf channel except 4 and 6. Subchannel C covers 30 to 36 MHz and converts to any vhf channel except 3, 4, 12 and 13. Subchannel E covers 18 to 23 MHz and converts to any vhf channel except 2, 5, 6, 10, 11, 12 and 13. None of these sub-channels will cause interference in the vhf range, particularly at the modulator's output of 58 dBmV on the +12 Vdc level.

The SVC-601 converter/strip amplifier that accepts the modulator's output and up-converts it to one of these vhf channel frequencies plugs right into the Ultra-Plex power panel at the head end. Once the sub-channel and vhf channel have been specified, the only further adjustment is in the agc threshold control. It allows output levels to be set between 46 and 57 dBmV, to bring the output into alignment with other vhf channels in the distribution system.

The simple addition of a video selec-

tor (Model VS-401) makes available any one of four video inputs to the modulator, achieving great programming flexibility.

So, even though an Ultra-Plex MATV system may have been designed originally only for top-quality off-the-air signal distribution, it can be quickly expanded to add closed-circuit capabilities with these few modular components.

This kind of product isn't exclusive with Winegard, of course. Several other manufacturers have similar components in their lines. What sets Winegard's apart is the way it can be integrated into the Ultra-Plex modular system inexpensively and at any future time.

At the time that Winegard introduced their Ultra-Plex line, the plug-in modules such as band separators and strip amplifiers seemed like the logical way for the designer and installer to get maximum results with minimum effort. It is generally recognized that it is better to separate channels or bands and to process the signals separately before recombining them for distribution via the coax system. What Ultra-Plex did was to turn this expensive design approach into an economical one, given the high cost of time and materials. And it opened the door for using every channel in the vhf range, with less chance of cross-modulation and more control over the signal level delivered to the individual receiver.

Each IV-505 modulator accepts any standard video output from cameras or video tape recorders, and audio from most dynamic microphones, AM-FM tuners, tape recorders and record players. Its output is crystal controlled (.005%) on one of three factory tuned subchannel frequencies. The choice of vhf channel for the output determines which of the subchannels in the 18 to 48-MHz range must be used. Controls include an audio mode selector, video level control (75 to 100% modulation) and audio level control.

The SVC-601 converter/strip amplifier converts the modulator's output to a specified vhf channel frequency. Its agc system provides constant output level of 0.7 volt (57 dBmV) with input level variance up to 14 dB. This output level is adjustable between 46 and 57 dBmV. It also accepts a plug-in 15 dB booster for cases where high losses are incurred in returning sub-channel signals to the head end.

The converter/strip amplifier plugs in directly to the DSX-250 or DSX-415 Ultra-Plex power panels. The audio-video modulator takes uhf type PL-259 video input connectors, Amphenol 70 Series audio input connectors and 75-ohm F type output connectors. R-E

Audio Signals You

Here's an audio problem that you may causing it. The problem is called audio picked-up, rectified and amplified by audio

by **LEN FELDMAN**

CONTRIBUTING HIGH-FIDELITY EDITOR

RECENTLY, A FRIEND OF MINE ASKED ME to appear on his weekly radio show in New York to discuss audio in general and events at the recently held New York Hi-Fi Show in particular. Since the show is taped in advance (as most talk shows these days are), I suggested that we do the taping at my laboratory and that my friend simply bring along two of his favorite microphones, since I had the necessary tape recording equipment with which to make a Dolbyized master tape of the interview. We had followed this practice on many previous occasions and were so confident of the results that, satisfied with the content of the interview, we never even bothered to play back the tape before my radio host left for his own studio to incorporate the interview into his hour-long musical show.

It was only after I heard the show on the air that I learned that my friend had to painstakingly re-do his "track", carefully fitting in and synchronizing his questions with my previously recorded answers. The extra work had taken him several hours and, much to his credit, even I could not detect the fact that his questions and my answers had been recorded days apart. Such are the miracles of modern tape recording. More recently, he gave me the original master tape and when I listened to it, I understood why he had to "fake" the session in that way. On his voice track (and ONLY on his voice track), there appeared almost continuously the garbled voice of my next door neighbor who is a dedicated radio amateur operator. While completely unintelligible, the raucous interference was no more than about 10-dB below the desired program material we had recorded. The youngster next door invited me to check out his equipment. Doing so revealed no illegal radiations and, in fact, his little station was a model of good radio amateur practice. All of which leads me to the subject called "audio rectification"—one of the most troublesome forms of interference common to a great many hi-fi audio systems. It manifests itself in the form of received radio signals when listening to your phonograph and has also been known to occur when using hearing aids, public ad-

dress sound systems and even electronic organs. At a recent meeting of the audio sub-committee of the EIA (Electronic Industries Association), a proposed draft of a consumer products engineering bulletin was circulated which deals with this problem.

As the bulletin points out, because of the proliferation in the past few years of rf transmitting equipment (AM, FM, TV, radar, radio amateur, Citizens band, etc.), cases of audio rectification are becoming too frequent, and the cost of correction too high, to ignore this interference in the original design of audio equipment.

As defined by the EIA bulletin, audio rectification is rf energy from any sort of transmitter being received by an element in an audio amplifier. This rf energy is then rectified by the audio amplifier in any non-linear active element such as a vacuum tube, transistor or integrated circuit. The rectified signal is then amplified by the remainder of the audio amplifying circuits and appears as an unwanted signal at the speaker's output terminals.

FCC recognition of the problem

The Federal Communications Commission has been aware of this growing problem for some time, but so long as the source of rf energy (be it a transmitter or any other device which emits rf) is operating "within specs", the solution must be sought by the owners of the audio equipment. Some years ago, the FCC issued a brief bulletin which included two schematics showing possible additions that might be made to audio circuits to cut-down the audio rectification problem. The first

of these diagrams is reproduced in Fig. 1 and applies primarily to tube equipment.

This early bulletin suggests such modifications as bypassing the speaker output terminals to chassis ground with 0.01 μF disc capacitors, lowering of the input resistance (R_1) to the first tube stage and bypassing that resistor with a small disc capacitor (about 500 pF), adding a series 75K resistor (R_2) in series with the grid to form a sort of simple low-pass filter network. Additional suggestions in this bulletin applying to ac-dc equipment include the addition of a 0.001- μF disc capacitor from the heater line to the chassis and bypassing both sides of the 120-volt ac power line with 0.01- μF disc capacitors.

Suggestions for transistorized audio equipment plagued with audio rectification problems are contained in the diagrams of Figs. 2-a and 2-b from the FCC bulletin. A 250-pF capacitor or a low pass filter "pi" section consisting of two 250-pF capacitors and a series rf choke (I'd suggest about 5 to 7 μH if the interference frequency is between 30 and 110-MHz, and about 1.5 μH if the frequency is between 80 and 200-MHz—Editor) is inserted in the base circuit of the first transistor stage. In the case of stereo equipment, the modification would have to be made in each channel.

Suggestions from the EIA

The Electronic Industries Association bulletin delves more deeply into the subject of audio rectification and methods used to alleviate the problem. As they point out, circuitry unprotected

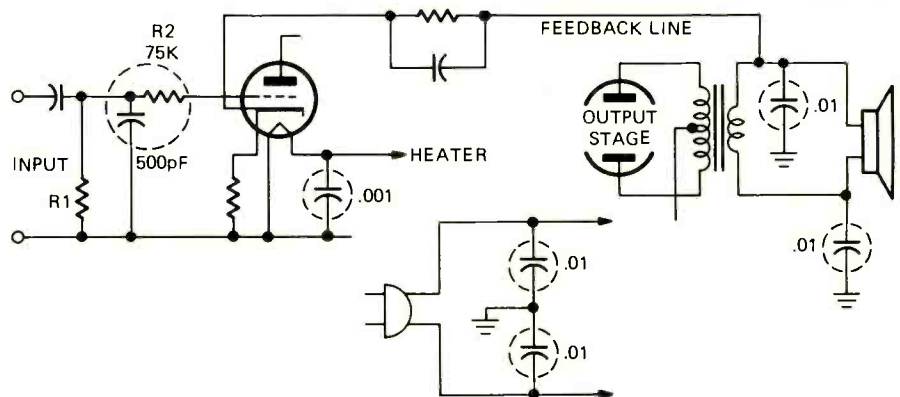

FIG. 1—FCC SUGGESTIONS of additional components to be added to tube amplifiers (circled components) to reduce interference from audio rectification of rf signals.

BUILD

A Tick Timer

NO MATTER WHAT OTHER TYPES OF timers a photography enthusiast may have in his darkroom, if he does any exposure manipulation of enlargements (dodging or printing-in), he needs a tick timer to get his best results.

A tick timer is a device which produces an audible tick or click at precisely one-second intervals. It enables a darkroom worker to time the exposure intervals accurately without taking his eyes from what he is doing, thereby avoiding "spill-over" of the projected image into areas where it is undesired.

Do you like to go out on the streets with your camera and take pictures at night, as many of us do occasionally? If so, you know that night exposures can be a minute or more. Timing the exposures with a wrist watch and a small flashlight, while manipulating the camera shutter and at the same time keeping a wary eye open for the chance of an oncoming car with its bright headlights, can be almost too much at times. Take this accented tick timer along and let it do the exposure timing for you. It's battery operated and completely portable. Without fiddling with the wristwatch and flashlight to occupy and often frustrate you, you'll not only have a more enjoyable time, you'll probably end up with a batch of better pictures as well!

What's an accented tick timer?

The difficulty with the common tick

timer is identical to that of a dripping faucet—it's monotonous. Especially when you're working with a tricky exposure which requires concentration, it's easy to lose count, or to be in doubt as to whether the count is still accurate or not. And, of course, the longer the interval, the more likely it is that something like this will occur.

The timer described in the present article has been designed especially to overcome this difficulty. It provides accented ticks at regularly repeated intervals. Each 10th tick is made louder. So, if you've missed a tick, or think you have, your count can be corrected or assured at the conclusion of the 10-second interval. Furthermore, with an accented tick timer operating in the darkroom (if the count runs longer than 10 seconds (the usual case), it isn't necessary to count individual ticks until near the end of the count.

This timer produces an audible tick every second with the tenth tick emphasized. Construction is simple and it has many applications in photography

by FRANK H. TOOKER

Suppose a particular exposure requires 35 seconds, for example. Keeping in mind that the louder ticks occur at 10-second intervals and the quieter ones at 1-second intervals, you simply begin the count and the exposure at the first louder tick. Count off the next 3 louder ticks (for the 30 seconds), then the next 5 quieter ticks for a total of 35 seconds.

How it works

The ticks of the electronic tick timer are current pulses made audible by a speaker. The unijunction transistor (UJT) is an excellent pulse generator. In fact, it's especially useful in this application because it synchronizes easily and because a UJT pulse-generator circuit is quite insensitive to variations in the power-supply potential. The accented tick timer operates from a 9-volt battery, but even when the battery potential

PARTS LIST

All resistors 1/2-watt 10% unless noted

- R1—100,000 ohms, linear taper potentiometer
- R2, R7—33,000 ohms
- R3—100 ohms
- R4, R8—300 ohms trimmer, linear taper
- R5, R9—2,200 ohms
- R6—100,000 ohms trimmer, linear taper
- R10—220 ohms
- C1, C4—10- μ F, 12-volt electrolytic
- C2—100- μ F, 12-volt electrolytic
- C3—.0022- μ F, 100-volt Mylar
- Q1, Q3—2N2646 Unijunction
- Q2, Q4—2N697 silicon
- B1—9-volt battery (see text)
- S1—spst slide switch
- SPKR—3 1/2-inch square intercom type speaker, 45-ohm V.C. (Quam 3A07Z45)
- MISC—5 in. \times 4 in. \times 3 in. utility cabinet, screen wire for speaker grill, battery holder and connector, hardware and solder.

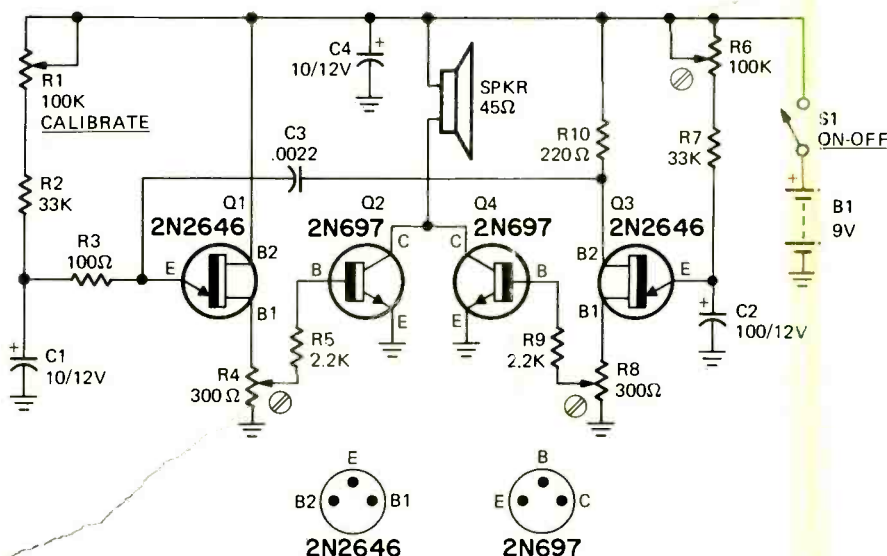

FIG. 1—COMPLETE SCHEMATIC diagram. Circuit delivers a 1-Hz signal to the speaker with every tenth pulse accentuated.

Never Bargained For

have run across but weren't sure what was rectification. Its caused by rf signals being circuits. Here's an article on the causes and possible solutions.

from television and radio station interference is the main source of audio rectification. Interference can enter the affected unit by some portion of the equipment acting as an antenna and some other component acting as a detector. The form of interference may

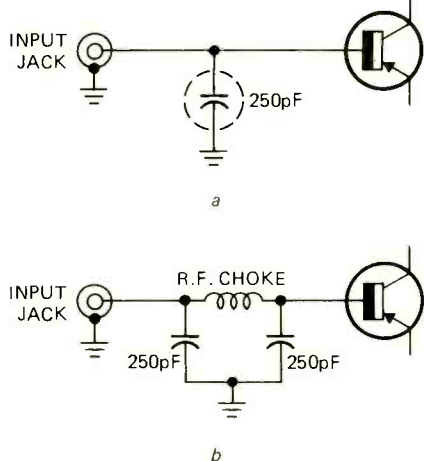

FIG. 2—SIMPLE BYPASS SCHEMES suggested by FCC for transistorized audio equipment.

range in frequency from as low as 50 kHz to as high as 1 GHz and may even include noise pulses from electric thermostats.

Determining the interference frequency

If interference is identified as audible voice or music over the speaker system, usually the offending AM station can be identified and its frequency thereby determined. If the interference is garbled and unintelligible (as was the case in our recording session) chances are it comes from a single-sideband (SSB) transmission—usually a local amateur radio operator. The frequency will usually be 3 MHz or higher. In the case of interference from FM transmissions, no actual sound will be heard but you may notice a decrease in volume of the desired program (records, tapes, etc.) whenever the interference takes place. Most FM transmissions (both amateur and commercial) are at a frequency above 30 MHz. Interference from a TV transmission is identifiable as a buzzing sound which changes its characteristics with time.

Isolating the problem

Most audio rectification occurs in

the audio detector or preamplifier section of a stereo component system or tape deck.

As a good first test, turn the master volume control down to its minimum position. If the interference is still present, the interference is occurring after the volume control, if not, it is being picked up ahead of the volume control.

RF interference ahead of the volume control

Some problem areas to consider are poor grounds, poor solder joints, electrolytic capacitors, long unshielded cables and the ac power lines themselves. Electrolytic capacitors that have been in use for several years may develop a high internal resistance. Paralleling a new capacitor across the suspected one is a good way to check this out. When multiple ground connections cannot be avoided in a system hook-up, interference due to resonance of loops formed by the shielded cables can be minimized by reducing contact resistance, shifting the position of the contact, or even changing lead lengths. Suspicious solder joints can often be the cause of audio rectification and should be carefully resoldered. Unshielded cables between components of a system or to extension speaker systems often act as excellent antennas for bringing the unwanted signal inside the chassis. Try replacing these with shielded cables.

If pickup is via the ac power lines, a line filter may solve the problem. One recommended circuit is shown in Fig. 3. Note that while 0.01- μ f capacitors have been shown, these may or may not be safe for use across power lines, in terms of leakage current. *Only components certified as being safe for use in power line wiring should be employed.*

RF interference after the volume control

When the volume control is in its minimum position and the interference is still heard, some form of rf filter will be required in the audio amplifier itself. Shown in Fig. 4 is an example of the type of filter circuitry that has been proven effective in transistor audio circuitry. Values for the L, C and R components have been deliberately omitted because circuitry varies from product to product. The important

thing to remember is that these values should be selected so that there is no significant change in gain or frequency response. A small ferrite bead can often be substituted for L1 in the circuit of Fig. 4. Such beads, available in different inductance equivalent values, are simply threaded onto the bare wire leads of a component and act as finite inductances in the circuit. In the case

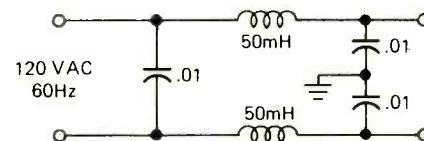

FIG. 3—POWERLINE RF FILTERING circuit suggested in new EIA bulletin on audio rectification.

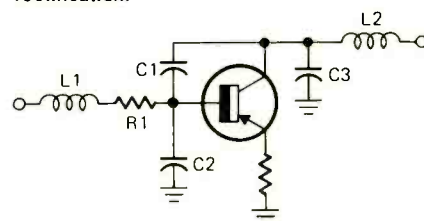

FIG. 4—SUGGESTED RF FILTERING CIRCUITRY for use at input stage of audio equipment. Capacitors C1, C2, C3, series chokes L1 and L2 and series resistor R1 can be added separately or in combination.

of the diagram shown, the bead would be placed physically between the junction of C1-C2 and the base of the transistor shown.

All capacitors used in any of the circuits shown should be of the ceramic type, as these are better rf bypassing devices than paper types. Leads should be kept as short as possible and all ground connections should be soldered as close to the associated transistor stage as possible. It has been found that in areas of high rf energy, the inductor approach (used in a series connection) is more effective in blocking the transmission of such rf energy than is the shunt capacitor or series resistor approach.

Since interference may enter an amplifier via the output (especially in hi-fi amplifiers which invariably include a major feedback loop as part of the power amplifier design), speaker leads which are resonant to a particular frequency tend to aggravate the situation. For example, an 8-foot length of speaker cable will be resonant to incoming rf

(continued on page 77)

SHORTER SEQUENCE LENGTHS

STAGES	LENGTH	STAGES	LENGTH
2	3	10	1023
3	7	11	2047
4	15	12	4095
5	31	13	8191
6	63	14	16,383
7	127	15	32,767
8	255	16	65,535
9	511	17	131,071

TABLE I—RANDOM SEQUENCE LENGTHS

SEQUENTIAL STATES FOR n=6
(sequence length = 63)

000000 (0)	011100 (28)	000111 (7)	001000 (8)
100000 (32)	101110 (46)	100011 (35)	100100 (36)
110000 (48)	010111 (23)	110001 (49)	110010 (50)
111000 (56)	101011 (43)	011000 (24)	011001 (25)
111100 (60)	110101 (53)	101100 (44)	001100 (12)
111110 (62)	011010 (26)	110110 (54)	100110 (38)
011111 (31)	001101 (13)	011011 (27)	010011 (19)
101111 (47)	000110 (6)	101101 (45)	101001 (41)
110111 (55)	000011 (3)	010110 (22)	010100 (20)
111011 (59)	100001 (33)	001011 (11)	101010 (42)
111101 (61)	010000 (16)	100101 (37)	010101 (21)
011110 (30)	101000 (40)	010010 (18)	001010 (10)
001111 (15)	110100 (52)	001001 (9)	000101 (5)
100111 (39)	111010 (58)	000100 (4)	000010 (2)
110011 (51)	011101 (29)	100010 (34)	000001 (1)
111001 (57)	001110 (14)	010001 (17)	(000000) ((0))

TABLE II—THE SEQUENTIAL STATES for the circuit n=6 in Fig. 1. The first (input) register stage is on the left, the last (output) on the right. Numbers in parentheses are the decimal equivalents of the binary words.

REGISTER CONNECTIONS FOR LONGER SEQUENCES

STAGES	SEQUENCE LENGTH	FEED EXCLUSIVE-NOR GATE FROM OUTPUTS
17	131,071	14 and 17
18	262,143	11 and 18
20	1,048,575	17 and 20
21	2,097,151	19 and 21
22	4,194,303	21 and 22
23	8,388,607	18 and 23
24	16,766,977	19 and 24
25	33,554,431	22 and 25
26	67,074,001	21 and 26
27	133,693,177	19 and 27
28	268,435,455	25 and 28
29	536,870,911	27 and 29
30	1,073,215,489	23 and 30
31	2,147,483,647	28 and 31

TABLE III—HOW TO CONNECT FOR SEQUENCES UP TO 31

in a proper circuit to generate a new one or zero in unique response to the state the register is now in.

The logic for maximal length takes nothing but exclusive NOR gates and turns out to be unique. Any logical combination of outputs to drive the input will give us some sequence length. The problem with the majority of connections is that they only generate a very short (or maybe only a 1-bit!) sequence, and that the states going through the register do not have the random-looking properties that we need.

What we have to do is find the magic combination of logic and feedback that will generate the maximal length sequence for a given stage length. To do this takes a bunch of high-level math,

but it has to be done only once. Circuits that will do that are shown in Fig. 1 for register lengths of 2 through 16.

Some more details

Let's actually build a real 63-bit sequence circuit. It's shown in Fig. 2. We use the first six stages of a 74164, one-half of a 7486 quad EXCLUSIVE-OR gate with the two sections cascaded to form an EXCLUSIVE-NOR, the usual 5-volt supply and decoupling, and a variable-speed clock made up from a MC1555 or 555 timer.

Every time the circuit is clocked, it advances one count and generates a pseudo-random sequence of 63 of its 64 possible states. The clock frequency determines how fast the states will change,

while the sequence time will be 1/63rd the clock frequency if you run the circuit continuously. We can use the serial bit stream or we can use the digital words that show up in parallel on the register outputs. Or, as we'll shortly see, these are easy to convert to analog "noise" or discrete, randomly varying analog levels.

The two cascaded EXCLUSIVE-OR circuits form an EXCLUSIVE-NOR or comparator. If both inputs are the same, a "1" is output. If the inputs are different, a "0" is output. Thus our feedback circuit looks at stage 5 and stage 6 to see what they were before the new clock arrives. The output of the EXCLUSIVE-NOR then sets up what stage 1 is to be after clocking, determined by whether the logic levels on stage 5 and 6 are the same or different.

For instance, in the 63-word sequence of Fig. 1 (n=6), if 5 and 6 are both 0's, a "1" gets entered into the first stage on the next clocking. What was in the first stage goes to the second; the second to the third, and so on. If 5 is a 1 and 6 is a 0, a "0" goes to stage 1 on the next clocking. The same thing happens if 5 is a 0 and 6 is a 1. Finally, if 5 and 6 are both 1's, a 1 is sent to the first stage on the next clocking.

In this manner, the entire pseudo-random sequence is built up. To see how beautifully it works, set up a table like that of Table II for some of the shorter sequences of Fig. 1—say the 15-word sequence of n=3.

All 63 states are shown in Table II. As you can see, any short-term group of bits in the middle jumps around in a very nearly random manner: If you count the number of sequential 1's and 0's you get and work up a distribution curve, it turns out to be a rather chunky approximation to a random probability curve. As we add more and more register stages, the curve smooths out, and the more stages, the better the randomness. For any circuit, the maximum number of sequential 1's or 0's we can get has to be equal to or less than the register length. Obviously we get far more short bursts out than long ones. If you go through all the statistical math, you find that you do have very nearly a truly random behavior on a short-term basis, only one that nicely repeats every time we ask it to. In fact, things turn out even better than random noise, since you get the randomness over one sequence length, while "true" noise would theoretically take forever to be truly random. Longer sequences behave even better.

Available sequences

There are usually at least four possible maximal length sequences for any stage length. Circuits to get all four are shown in Fig. 3. If we take the circuit we have and invert the input, we get an inverted sequence in which all the ones are zeros and vice versa. Or, instead of looking at what's going to happen next, we can look to see what already did happen and get a backwards sequence. Finally, we can both look backwards and invert to get a backwards sequence with interchanged ones and zeros. All four circuits have essentially the same random-

The better the training the better you'll

Send for
FREE
illustrated
career
guide

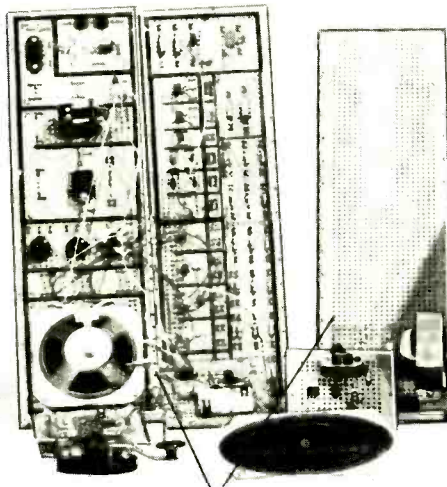
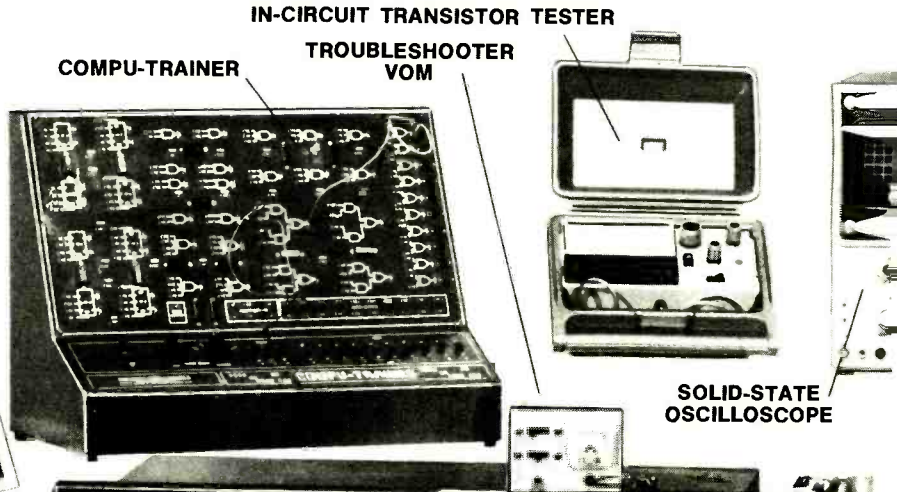
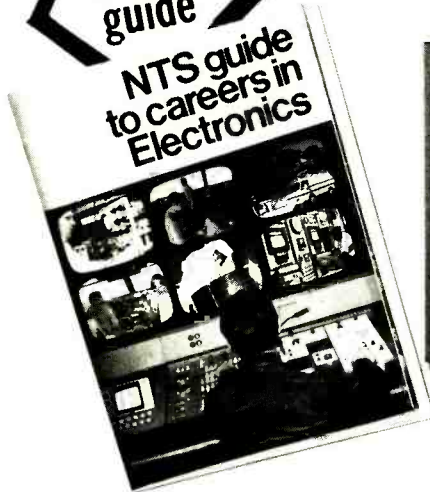

As an NTS student you'll acquire the know-how that comes with first-hand training on NTS professional equipment. **Equipment you'll build and keep.** Our courses include equipment like the **NTS/Heath Digital GR-2000 Solid State color TV** with first-ever features like silent varactor diode tuning; digital channel selection, (with optional digital clock), and big 315 sq. in. ultra-rectangular screen.

Also pictured above are other units — 5" solid state oscilloscope, vector monitor scope, solid-state stereo AM-FM receiver with twin speakers, digital multimeter, and more. It's the kind of better equipment that gets you better equipped for the electronics industry.

This electronic gear is not only designed for training; it's field-type — like you'll meet on the job, or when you're making service calls. And with NTS easy-to-read, profusely illustrated lessons you learn the theory behind these tools of the trade.

Choose from 12 NTS courses covering a wide range of fields in electronics, each complete with equipment, lessons, and manuals to make your training more practical and interesting.

Compare our training; compare our lower tuition. We employ no salesmen, pay no commissions. You receive all home-study information by mail only. All Kits, lessons, and experiments are described in full color. Most liberal refund policy and cancella-

and the equipment be equipped.

COMPARE OUR
KITS AND LESSONS.
COMPARE OUR
TUITION.

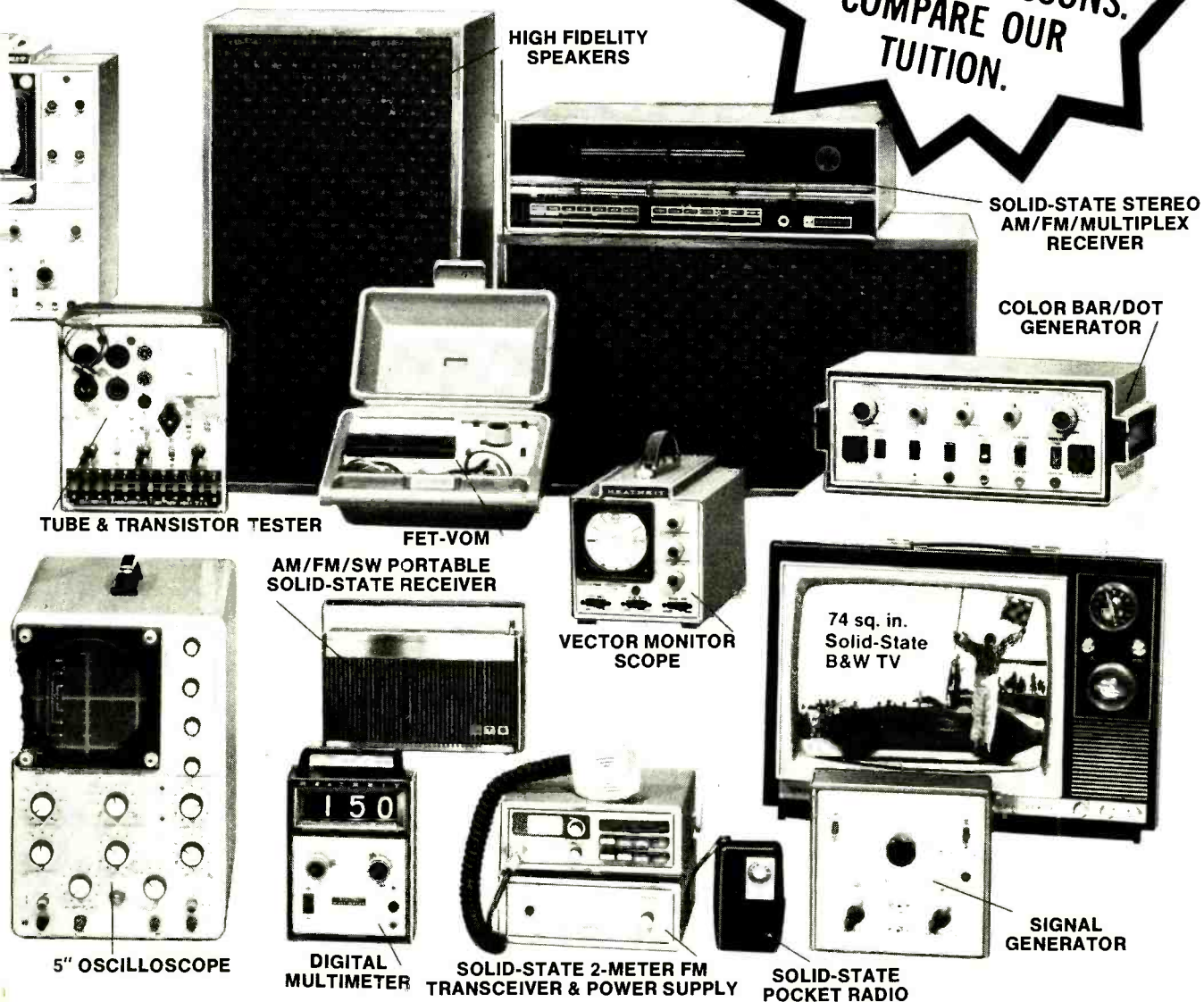

tion privileges spelled out. Make your own comparisons, your own decision. Mail card today, or clip coupon if card is missing.

NO OBLIGATION. NO SALESMAN WILL CALL

APPROVED FOR VETERAN TRAINING

Get facts on new 2-year extension

NATIONAL TECHNICAL SCHOOLS

TECHNICAL-TRADE TRAINING SINCE 1905
Resident and Home-Study Schools
4000 So. Figueroa St., Los Angeles, Calif. 90037

NATIONAL TECHNICAL SCHOOLS Dept. 206-045
4000 South Figueroa St., Los Angeles, Calif. 90037

Please send FREE Color Catalog and Sample Lesson.
NO OBLIGATION. NO SALESMAN WILL CALL.

- | | |
|---|--|
| <input type="checkbox"/> Color TV Servicing | <input type="checkbox"/> Electronics Technology |
| <input type="checkbox"/> B & W TV and Radio Servicing | <input type="checkbox"/> Computer Electronics |
| <input type="checkbox"/> Electronic Communications | <input type="checkbox"/> Basic Electronics |
| <input type="checkbox"/> FCC License Course | <input type="checkbox"/> Audio Electronics Servicing |

NAME _____ AGE _____

ADDRESS _____ APT # _____

CITY _____ STATE _____

Please fill in Zip Code for fast service _____

- Check if interested in G.I. Bill information.
 Check if interested ONLY in classroom training in Los Angeles.

ness properties. Which one you use depends on how you like to start the circuit and what output polarity you want. In electronic music, it's handy to use all four, for you can get a sequence, the sequence played backwards, or the sequence played on an inverted scale or on an inverted scale *and* backwards.

The disallowed state

One little detail we have to watch for is the unused state. If you ever get into the 11111 state with the normal circuit, it will stay there forever! The backwards version will also stick in 11111, while either inverted (complementary) sequence sticks in 00000. So, we must never allow this state to occur. It's easy to reset or preset our register or otherwise make sure we also start our sequence on a *known valid* portion of the sequence. By the way, this is true of almost all counters and sequential circuits in general. You have to investigate all the disallowed or "don't care" states to make sure none of them are self-perpetuating.

One other little detail is that we obviously must get an additional 1 or 0 (or one less zero or one) since our code

is always an odd number of bits long. This missing 1 or 0 will tend to skew the random distribution slightly and will tend to shift the bias on an analog conversion scheme slightly. This is easily avoided by compensating bias resistors, and the longer sequences have almost negligible skew and randomness bias.

Converting to analog

Figure 4 shows two different ways to convert the digits to numbers. In 4-a, we use an integrator or low-pass filter on the serial bit stream, and the output of the integrator is an analog voltage that varies in a random manner. The short-term output is noise that behaves just like white noise up to the filter's cutoff frequency or at least up to a good fraction of it. A cutoff frequency of 1/20 the clock frequency is recommended, particularly for longer sequences. A different possibility is shown in Fig. 4-b.

Here we directly D/A convert the parallel digital words to an analog signal. With this circuit, you get analog levels that jump to some new random value, once every clock cycle.

To find the time the sequence repeats,

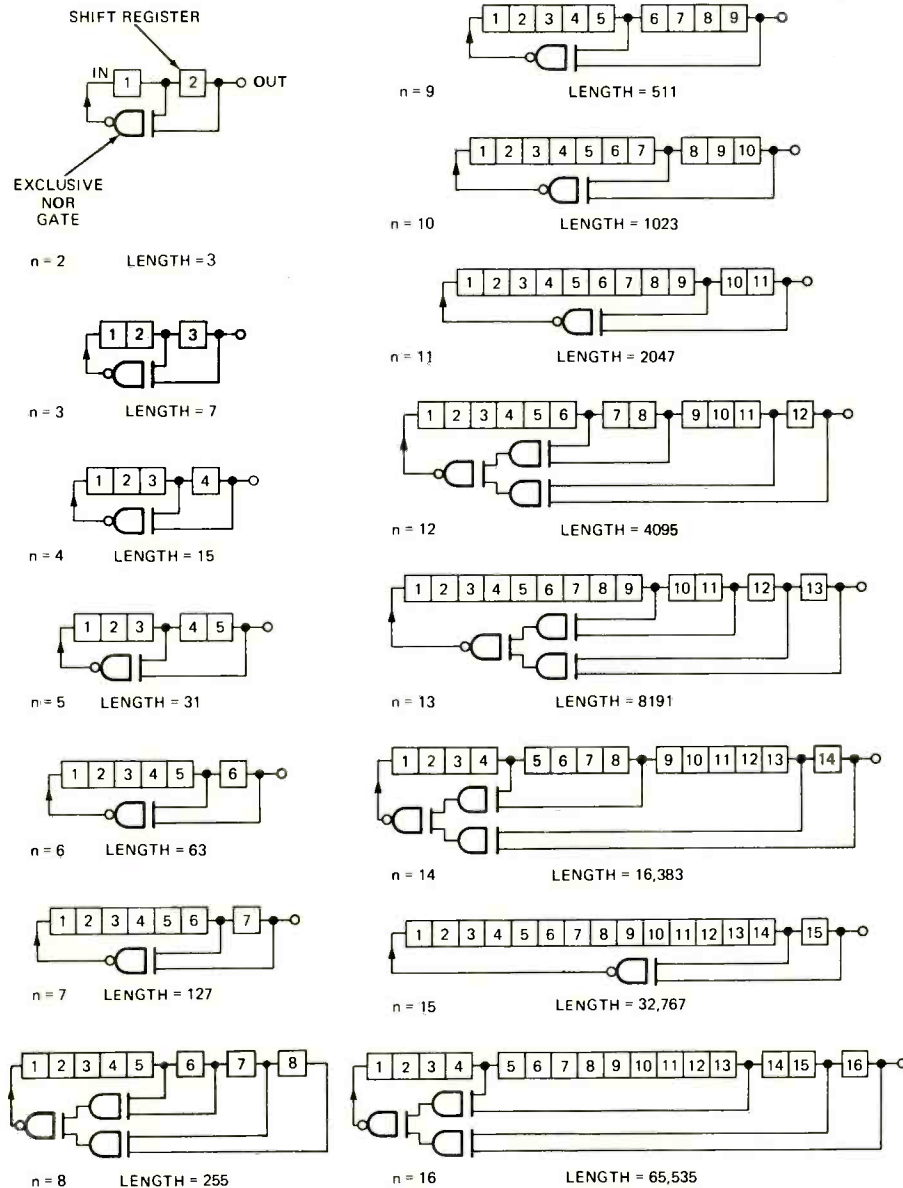

FIG. 1—PSEUDO-RANDOM CIRCUITS that produce sequences from 3 to 65,535 words.

just divide the clock frequency by the sequence, the repeat time will be 100-, using a 100-kHz clock and a length 16 sequence, the repeat time will be 100,000/65,535 or about 1.5 times per second. If you are using the 63-note sequence for electronic music at 3 notes per second, it repeats once every 21 seconds. A 127-note sequence would be good for 42 seconds, and so on. As an extreme example, if you used a 48-stage MECL shift register and a 100-MHz clock, it would take around 3 million seconds or over half a year to repeat. At lower clock frequencies, it would take decades or even centuries!

The serial conversion circuit of Fig. 4-a works best when the clock is at least 20 times the filter's cutoff frequency as determined by the capacitor values. Thus, for high-quality audio testing and requirements of this type, you use as long a register length and as fast a clock as you can.

Applications

Let's briefly turn to the things you can do with a pseudo-random sequence generator.

For audio testing and communications, you normally use a very fast clock and a sequence that repeats perhaps 30 times a second, so you can get a stable oscilloscope display. The filtering then gives you random signal variations that duplicate the effect of random combinations of voice or communications data or signal levels. Commercial instruments are available (Hewlett-Packard, among others) that do just this. The net result of the testing is that you simulate the real operating conditions in a realistic man-

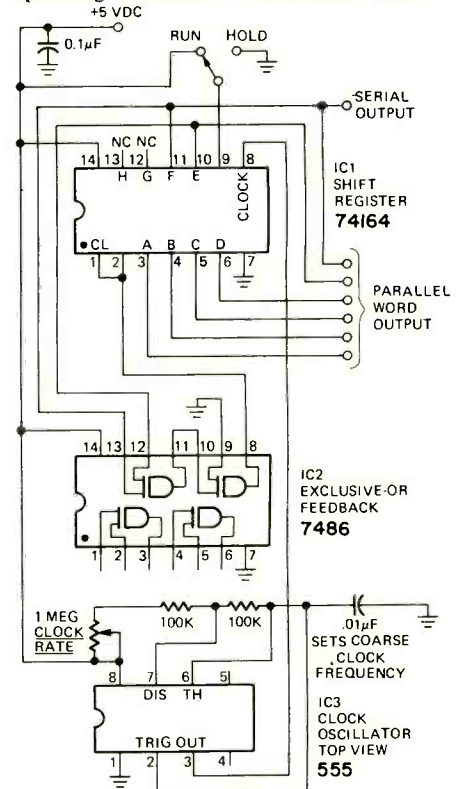

NOTE:
REPEAT FREQUENCY = $\frac{\text{CLOCK FREQUENCY}}{\text{SEQUENCE LENGTH}}$

FIG. 2—THIS LENGTH-63 CIRCUIT uses 6 stages ($n=6$).

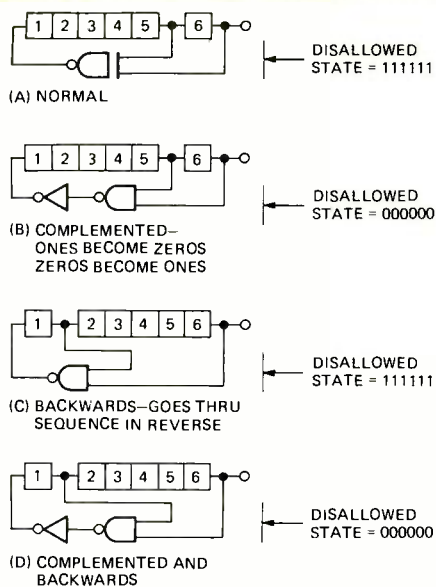
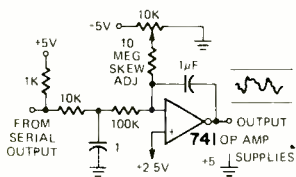
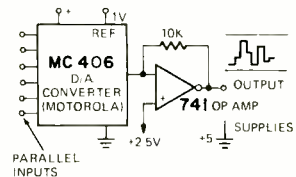

FIG. 3 — FOUR POSSIBLE SEQUENCES for any n can be made by rearranging the circuit.



COMPONENT VALUES VARY WITH APPLICATION (A) USING SERIAL OUTPUT TO GET ANALOG PSEUDO NOISE



VALUES AND CONNECTIONS VARY WITH APPLICATION (B) USING PARALLEL OUTPUTS TO GET RANDOM OUTPUT LEVELS

FIG. 4—ANALOG OUTPUT CIRCUITS.

ner but also in a way that lets you see the results as a stable display.

Electronic music uses are relatively obvious. By interchanging the outputs in a programmable manner, you can use one basic sequence generator to build a fantastic number of tunes and can obtain them frontwards, backwards, normal scale or inverted. Some of these combinations will be dull and others will be simply phase-shifted replicas of others, but the number of unique and interesting variations remaining are still a bunch. Figure 5 shows one possible electronic music composer. By adding random rhythm and pause combinations, you can end up with an essentially infinite number of variations. You can also use pseudo-random sequences to generate timbre waveforms for electronic music.

Secure computer communications encode the data to be transmitted onto a pseudo-random sequence that is locked to a replica at the far end. Usually, the sequence length is very long, days, months, even years. Cryptography and other security schemes are other applications of this type. As with any code, regardless of its complexity, it can be broken. The object of any code game is to make cracking the code so complex,

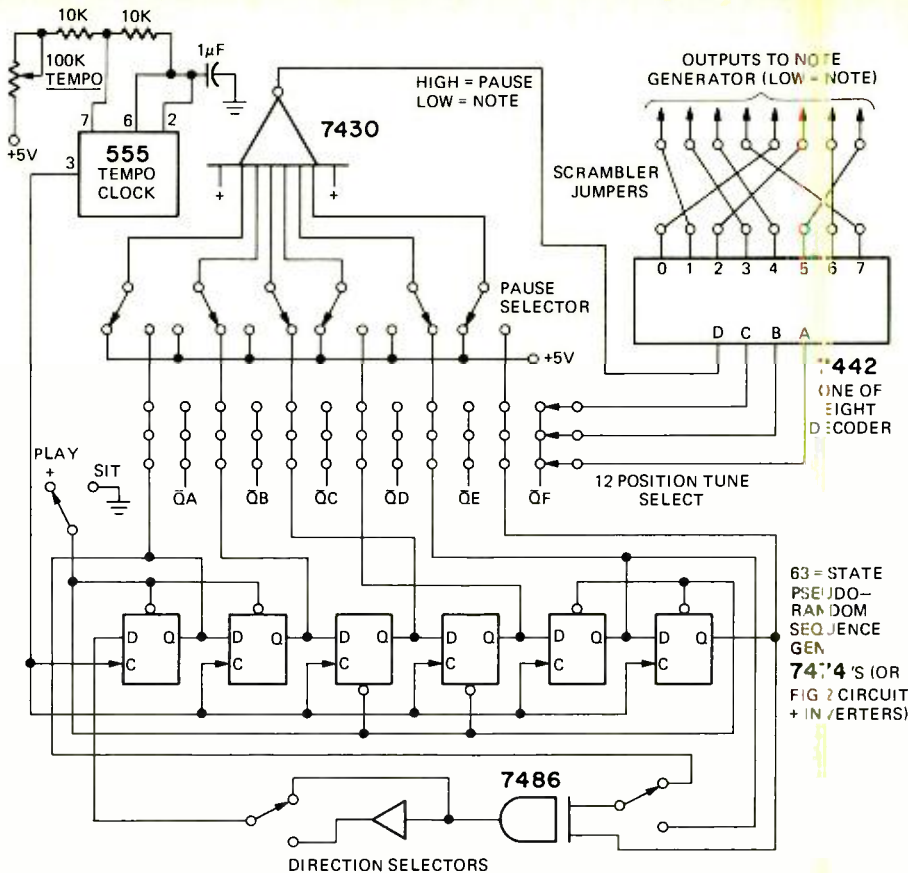

FIG. 5—POSSIBLE MUSIC COMPOSER.

make it take so long, or make it so expensive that the cost of cracking exceeds or at least severely diminishes the value of the information to be gained. So, as with all codes, the pseudo-random technique is a reasonably effective deterrent, not a fail-safe and foolproof route to security.

To encode or decode data, two EXCLUSIVE-NOR gates are used, one at each end of our secure line. Remember that the output of an EXCLUSIVE-NOR is the same if the inputs are identical and different if they differ. So, if our pseudo-random generator happens to be in a "1" state, input data 1's stay ones and 0's stay zeros, e.g. they are transmitted without "error." On the other hand, if our pseudo-random generator happens to be in a "0" state, the 0's become 1's and 1's become 0's; we say the data is *complemented*. Since the line now consists of a random mixture of good and bad data, it appears to be garbage to anyone monitoring in the middle. At the other end, we simply add a new pseudo-random generator *identical in length and sequence* to the original; once again, it inverts when zero and passes when one; and all the data straightens back out again. Figure 6 shows the circuit.

Autocorrelation is a very complex subject, but it dramatically illustrates the power of pseudo-random sequences. Suppose we have a sequence length of 63 and that a 1 is +1 volt and 0 is -1 volt. If we multiply the code by itself on a bit-by-bit basis, we would get +63 volts out. On the other hand, if we multiply the code by a delayed replica of itself or a random string of ones and zeros, we will probably get a very low value,

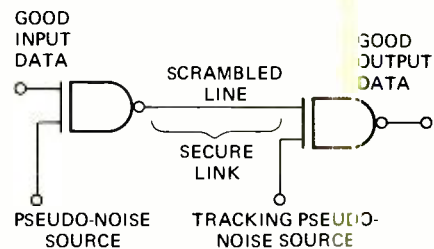

FIG. 6—A PSEUDO-RANDOM CODE or data scrambler for privacy or cryptography.

maybe +1 or -1 out. Thus when the code matches itself, you get a very strong output signal; otherwise you get very little. Only the Barker codes can give you perfect + and -1 *sidelobe* levels; the mismatch and noise level produced in a pseudo-random code is higher, but still has a very useful sidelobe level.

This tremendous build-up of signal buys you a signal-to-noise improvement and the ability to extract a signal deeply buried in uncontrollable noise.

Longer sequences

The schematics for sequences longer than 16 get rather cumbersome to draw, so they are shown in table form in Table III. The lengths are shown up to 31 stages, which is a sequence length of 2,147,483,647. That should be long enough for just about anything. Note that this sequence can be built up with only four of the 74164 shift registers. Sequence 19 is omitted because it takes more than one exclusive OR gate to build it. There are likewise other possible maximally long or nearly maximal sequences for lengths 17, 21, 22, 23, 25, 27, 28, 29 and 31, but one should be enough for each length.

R-E

IN A KIT

4-Channel Storage

Using LED indicators, this has full storage triggering. The LED matrix with 16

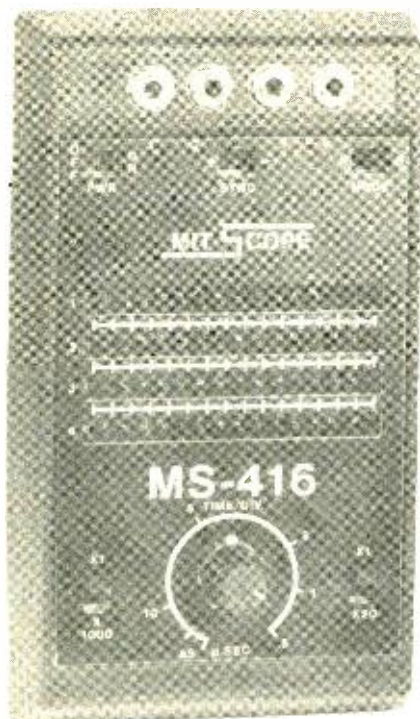

THE MS-416 has a time-base range of .5 μ s to 200 ms that will cover most digital circuit needs.

WITH THE RAPID INCREASE IN INTEGRATED circuit technology, more and more electronic equipment is being designed around digital circuitry. These new circuits are full of complex timing sequences and elusive pulses. Elusive because the pulses occur one-time and one-time only.

There are many three- and four-channel oscilloscopes on the market which can handle complex timing relationships. But they are generally very expensive, cumbersome instruments and are usually found only in very well-equipped labs.

Another instrument sometimes used in testing digital circuitry is the logic probe. Many logic probes have built-in pulse catchers for those one-time pulses. However, they are inadequate for most circuit testing and nearly useless in complex timing situations.

As a result, a new instrument has been developed. It is called the MS-416, and it incorporates the best features of both the oscilloscope and the logic probe.

The MS-416 is an inexpensive, four channel, hand-held, digital logic oriented scope with full memory capability. The time-base range from .5 μ s to 200ms will cover most digital circuit needs. With four channels, extensive timing relationships can be easily observed. Signals are displayed on a 4 \times 16 LED matrix; 4 channels, with 16 LED's per channel.

In addition to the normal mode of operation, the MS-416 can be switched into storage operation at any time during

The MS-416 is available in kit form for \$127.50, or assembled for \$189.50, from MITS, Inc., 6328 Linn, N.E., P.O. Box 8636, Albuquerque, NM 87108.

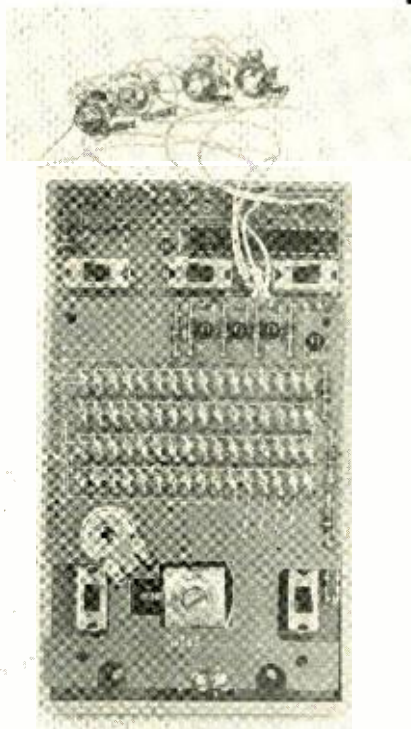

INTERIOR VIEW of the MS-416. Calibration of the unit is a simple one setting operation.

testing and will "remember" the information present on all four channels of its display. It will hold this information until it is switched back to normal operation or turned off. The storage mode also serves as an excellent pulse catcher for those elusive one-time pulses. The MS-416 will wait until the pulse occurs and then hold it in its memory as long as it is desired.

Together with positive- or negative-edge triggering, an auto-sweep mode for steady-state logic measurements and a Ni-Cad battery supply, the MS-416 becomes quite a versatile piece of equipment.

Circuit operation

The MS-416 consists basically of eight interconnecting circuits. The block diagram in Fig. 1 shows a power supply, a memory, a clock oscillator, a counter, a decoder, a mode select circuit, a sync circuit and a display.

The complete schematic of the MS-416 is shown in Fig. 2. The power supply will run on 117 Vac with an ac adapter. Using the adapter (a standard 9V unit), the supply is regulated by D1, a 5.1 V Zener diode. C1 provides filtering, and a separate filtering network (R6 and C2) is used for the clock oscillator IC-g. When the power switch S1 is in the OFF position, the adapter is used to charge the Ni-Cads through R1 and R2. To run on Ni-Cads, simply unplug the adapter, which shorts the A and C contacts of the ac jack, and switches the unit on. In battery operation, the supply is essentially unregulated to eliminate unneces-

sary current drain. It takes approximately 14 hours to charge the batteries, and with a full charge they will power the unit for about 1½ hours of continuous use.

The memory consists of a 64-bit RAM (Random Access Memory), Am31L01 (IC-a). The signal inputs are buffered through IC-b and the inverted signal is fed directly into the four word bit inputs of the RAM. Each word consists of 4 bits, one bit for each channel.

The 4 bit word is selected by the binary outputs of the counter (IC-c) connected to the four address inputs of the RAM. The RAM is addressed simultaneously with the 4 \times 16 decoder (IC-f). As the 16 words are addressed one at a time, the signal present at each of the 4 inputs is written into the memory and fed, inverted, to the RAM outputs. The chip-enable input of the RAM is pulsed high at the end of each 16 count, disabling the memory while the counter resets. This will cycle continuously as long as the unit is in the normal operation mode, and the mode select circuit holds the RAM in the Write mode. In the storage mode, the mode select circuit switches the read/write input of the RAM to Read after one full 16 count. The signals present on the RAM inputs will then be continuously displayed as long as the unit is in the store mode.

The clock oscillator uses four inverter gates of IC-g, along with two variable resistors (R4 and R5), and two capacitors (C3 and C4) to produce the variable frequency signal used for the time-base. Switch S4 selects either a 620-pF capacitor (C3) for the X1 range or a .68 μ f capacitor (C4) for the X1000 range as part of the time constant for the oscillator. A 50-ohm trim pot R5 is used for calibration, and a 5K ohm linear taper pot is used to vary the time constant to select the initial sweep rate for the time-base. Switch S5 either sends the clock signal to IC-e in the X1 position or, in the X20 position, sends it through IC-j for a divide by 10 and IC-h for a divide by 2 before sending it to IC-e. Using S4, S5 and R4 you can produce a time-base from 0.5- μ s. to 200 ms. The final signal is fed through a NAND

Digital Scope

4-channel digital scope capability and automatic readout is a 4 X 16 LED's per channel.

by JAMES B. VICE

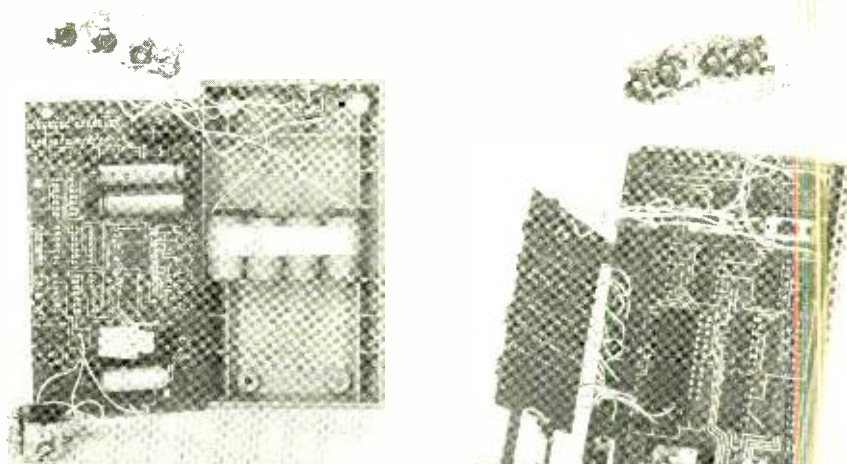

INTERIOR VIEW of the MS-416. The main circuit board is swung away to show the underside of the main board and the batteries.

INTERIOR VIEW of the MS-416. The display board is swung away to reveal the main printed circuit board.

gate and an inverter gate to the counter.

The counter is a 7493 4-bit binary counter (IC-c) operated in the ripple-through configuration (series of flip flops), providing simultaneous divisions of 2, 4, 8 and 16 of the clock frequency on its four outputs. The outputs are fed to both the 4 x 16 decoder and the RAM address inputs, keeping the two synchronized. The divide by 16 output, pin 11, is also fed to the clock inputs of the flip-flops (IC-d) in the sync and mode select circuits. As the 7493 counts up, the d output goes high on the 9 count and falls after the 16 count. This falling edge is used to toggle the flip-flops.

The decoder is an Am93L11 4-line to 16-line decoder/demultiplexer. As the counter feeds information into the decoder's four binary coded inputs, its outputs 0 through 15 are strobed low sequentially at the rate determined by the clock oscillator frequency. These outputs are fed through transistors to the display. The decoder is disabled at the end of each 16 count by the same signal that resets the counter.

The mode select circuit consists of switch S3 and one flip-flop of IC-d. In

the normal mode of operation, the clear input of the flip-flop is held low by S3 to ground, keeping the flip-flop in the clear state. This prevents the clock input of the flip-flop, which is connected to the D output of the counter, from having any effect while in the normal mode. When S3 is switched to store, the clear input goes high so that when the signal on the counter D output falls after the 16 count, the flip-flop will toggle. The flip-flop is connected so that it latches, and it will stay latched until S3 is returned to the normal position. When the flip-flop latches, the Q output goes high, switching the RAM to the Read mode. Simultaneously, the Q output goes low and is used to block the signals on the input buffer (IC-b) and to block pulses from the sync circuit at pin 10 of IC-e. When S3 is switched back to normal the flip-flop immediately goes back to its clear state.

The sync circuit is both the most complex and the most important circuitry in the unit. It consists of a 9601 retriggerable one-shot (IC-k), four NAND gates of IC-e, two inverter gates of IC-g and one flip-flop of IC-d. The signal for the

sync is taken from the output of the channel one buffer (pin 3 IC-b). The sync signal is fed to S2 and one gate of IC-e which is connected as an inverter. The input to the one-shot is taken from S2. In this manner, switch S2 is used to select either the rising edge or falling edge of the input signal for synchronizing the MS-416.

The one-shot has an output pulse duration of approximately 160 ns. The Q output of the one-shot is fed into pin 5 of one NAND gate of IC-e where it is gated together with the Q output of one flip-flop of IC-d.

This gate is used to prevent any one-shot pulses from passing while the counter is counting up. The output of the NAND gate is again fed into one input of another NAND gate where it is gated together with the Q output of the mode select flip-flop. The output of this gate goes through an inverter gate of IC-g and to the clear input of the sync flip-flop. The clock input of the sync flip-flop is connected to the D output of the counter; therefore, when the signal on the counter falls after the 16 count, the flip-flop toggles.

This causes several things to happen at once. The Q output of the flip-flop is connected to another NAND gate of IC-e, together with the clock signal, and then through another inverter to the counter. The NAND gate serves to block the clock pulses from reaching the counter while it is being reset. The Q output of the flip-flop is used to reset the counter, disable the decoder and disable the RAM. It is also used to set conditions at pin 4 of IC-e to allow the next one-shot pulse to pass. When the next one-shot pulse occurs, it will pass through to clear the sync flip-flop, starting the entire sequence over again.

The display consists of 64 RL-50 LED's arranged in a 4 x 16 matrix; along with associated driving circuitry (Q1 through Q20 and resistors R8 through R15). Transistors Q17 to Q20

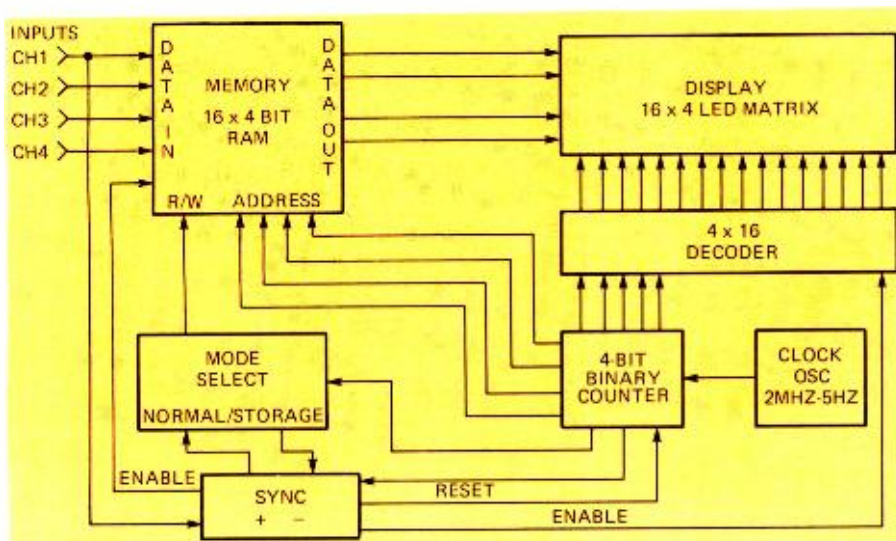

FIG. 1—MS-416 BLOCK DIAGRAM. The trigger circuits are synchronized to the channel-1 signal.

(CS4410's) are switched on and off with the information from the RAM outputs. Transistors Q1 to Q16 (EN2907's) are pulsed low at their bases one at a time by the decoder outputs, providing a path to ground for the LEDs. Each output word from the RAM consists of four bits, each bit corresponds to one channel, and each of the decoder outputs corresponds to one RAM address. The RAM address and the decoder output are changed at whatever rate is predetermined by the clock oscillator frequency. As an example; if the counter is at its 2nd count, the RAM will be at its 2nd address and Q2 will be turned on. If there is a positive signal on the RAM output to Q18 at this time, then LED D23 will light for however long the clock frequency determines.

There is also an auto-sweep circuit for measuring high or low steady-state conditions. Since the sync circuit requires a pulse to function, a steady-state condition has no effect and is never seen. Switch S6 allows the unit to measure these signals by switching the clock oscillator signal into the other A input of the one-shot. This allows the sync to be continuously triggered. When not in auto-sweep operation, S6 holds the input to the one-shot at V_{cc} .

How's it's made

The MS-416 is built around two double sided PC boards with plated-through holes. As the unit is quite compact, the builder must be sure that all components are installed as close as possible to the boards and all excess component leads

and IC pins are cut off as short as possible without damaging the connection. The boards are assembled one at a time and then wired together after all the components have been installed on the component side of the boards. (There are five components mounted on the opposite side. These will be mentioned later).

The first step in construction is to install switches S1 to S5 on the main board. These are the only components on the boards that are not installed flat against the boards.

The next step is to install the integrated circuits. Orient them correctly according to the component layout, and be sure to push them down as flat against the board as possible.

At this point it is best to install the

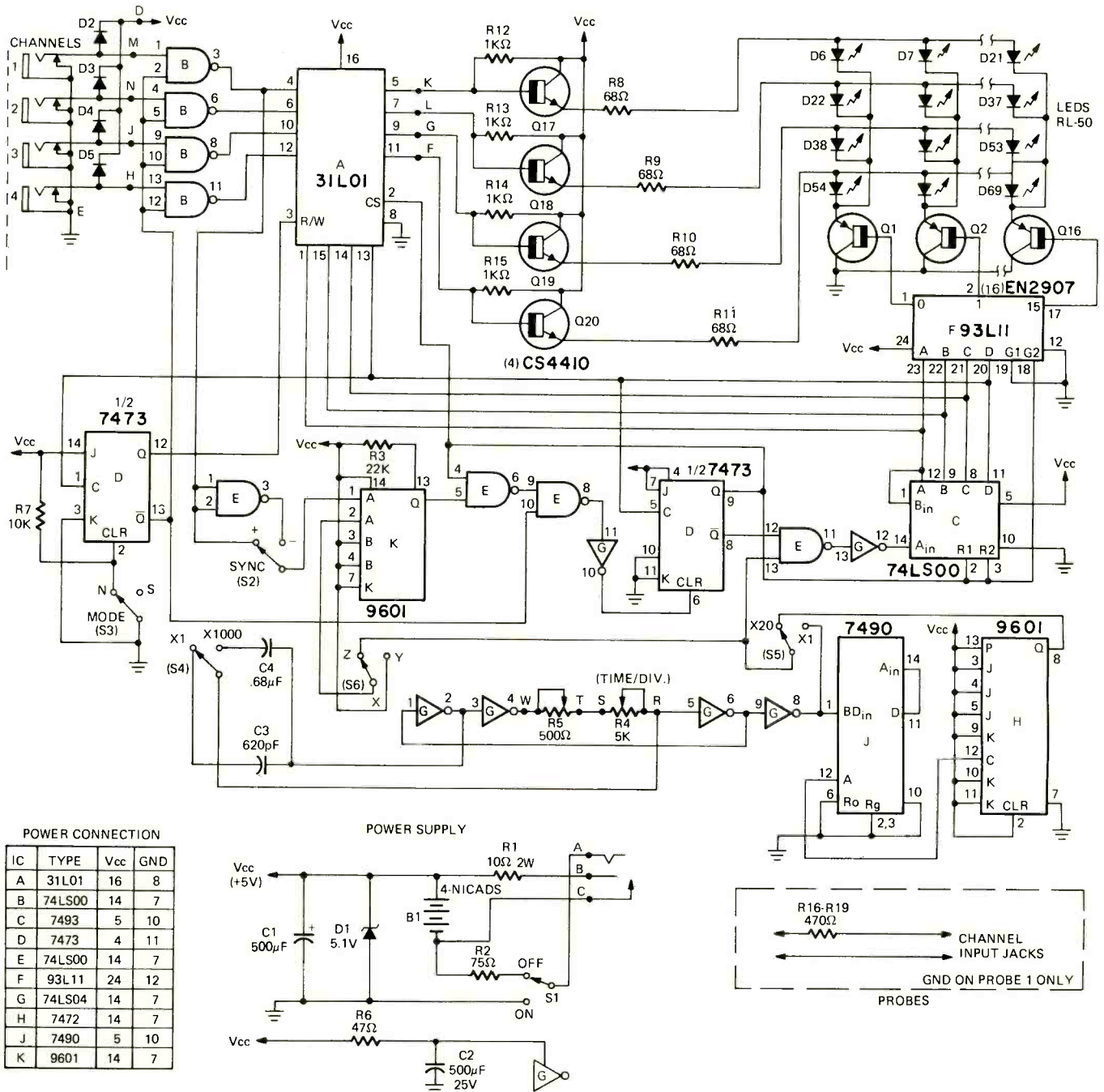

FIG. 2—COMPLETE SCHEMATIC DIAGRAM of the MS-416. Power can be supplied with an optional 117-Vac adapter.

components that go on the back side of the board (R1 and capacitors C1 through C4). Be sure that the polarity on C1 and C2 are correct.

Install Zener diode D1, and make sure polarity is right.

Resistors R2, R3, R6 and R7 are installed next and then transistors Q1 through Q16. Be sure the base-emitter-collector leads of the transistors are properly aligned. This finishes the main board for the time being.

Assemble the LED board in the following manner. Resistors R8 through R15 and transistors Q17 through Q20 are installed on the LED board in the same manner as those on the main board.

The next step requires the greatest care and takes the most amount of time. LED's D6 through D69 are installed. Be sure to align them in straight rows and columns. It is helpful when doing this to draw lines on the PC board with a ballpoint pen and follow these lines while installing the LED's.

The 500-ohm trim pot, R5, is now installed after bending its three leads downward. Insulate the body of the pot from any copper foil on the board by placing a small piece of tape placed directly underneath it. This finishes assembly on the LED board.

Wire the 5K potentiometer, R4, to the main board. Switch S6, located on the pot is also wired to its respective pads on the board. Insert these wires from the back of the board and solder them on the component side.

The two boards can now be wired together. The pads to be connected are marked the same on both boards to make wiring easier.

Finally, the case top and case bottom are assembled. The four input jacks and diodes D2 through D5, along with the

front panel fasten to the case top. It is best to wire the jacks before installing them in the case. The Ni-Cads and the ac jack are installed in the case bottom. Be sure battery polarity is correct. Wire the components in the top and bottom cases to the rest of the circuitry, and you are ready to calibrate the unit.

Calibration is easy

Calibrating the MS-416 is a simple, one-setting operation. In this method, a frequency meter or oscilloscope is needed; although instructions are included with the kit that show how you can set it up without special test equipment, but are less accurate.

For the most accurate calibration, switch S4 should be in the X1000 position and S5 in the X1 position. The TIME/DIV pot R4 should be set in its fully clockwise position. Connect your test instrument ground to the ground on the ac jack and your test probe to the switch terminal on R4 which connects with pad Z on the main board. Connect the unit to the ac adapter and turn the power switch to ON.

Adjust trim pot R5 until the clock oscillator frequency reads exactly 2kHz. Once this frequency is set, the unit requires no further calibration.

The unit can now be completely assembled using the hardware supplied with the kit, and the knob installed on R4. This is done by turning R4 fully clockwise and aligning the pointer on the knob with the .5μs marking of the TIME/DIV scale on the front panel.

Using the MS-416

Although the inputs to the MS-416 are protected against overload, remember this is a digital logic oriented instrument; therefore, you should not measure sig-

nals which exceed digital logic voltage levels. In most digital logic, the maximum voltage for a logic "0" is 0.8 volt, the minimum voltage for a logic "1" is 2 volts. The maximum input voltage from the unit you are testing should not exceed 5.5 volts.

When measuring a signal, keep in mind that the sync operates from the channel one input and therefore this channel must be used if you are using less than all four channels. It is best to attach the probe with the ground lead to the channel one jack as a reminder. (Four probes are also supplied with the kit.)

The display of the MS-416 is interpreted in much the same manner as a conventional oscilloscope. The settings on R4 and switches S4 and S5 determine the TIME/DIVISION of the sweep, and each of the 16 LED's in each channel represent one division. Synchronizing from channel one, the signals are displayed showing the logic levels ("1"=LED on, "0"=LED off) and their respective timing relationship.

Turning the TIME/DIV knob fully counter-clockwise to AS (auto-sweep) allows the measurement of steady-state conditions by lighting the entire channel for a logic "1", or blanking the entire channel for a logic "0".

For storage operation simply switch the mode switch to "S" at any time, and the next sweep will store any information present.

If you wish to catch that elusive one-time pulse, simply place the unit in the proper conditions for usual storage operation, setting the mode switch to "S" before you place your probe on the test point you wish to measure. As soon as a pulse comes along it will be "caught" in the memory and held there as long for as you wish.

R-E

Portable record player introduces new ideas

A new portable two-speed record player operates without the need for the conventional on-off switch, and uses



a hither-to-unknown method of changing speeds. The player simply puts on the record and turns the spindle in a

clockwise direction to start the machine.

The new automatic speed changer operates around a "Magic Ring," a one-piece component made of Celcon (Celanese) plastic, which surrounds a spindle shaft centered within a shallow cupped base. This part acts as a weight sensor, and selects a speed of either 33½ or 45 rpm according to the weight of the record.

The center post of the "Magic Ring" is also the off-on switch. Turning it clockwise starts the machine. It is also the shaft of the volume control, and continuing to turn it brings up the volume.

Inventor and designer of the new-idea player is Art Tateishi, president of Seabreeze Products of Canada, a Toronto company which makes the unique player.

Industrial Research Institute honors zone-melting inventor

W. G. Pfann, who invented the zone melting technique for producing the high-purity metals that make modern transistors and integrated circuits possible, has been awarded the second Annual Achievement Award of the Industrial Research Institute.

The Bell Labs was given a sculpture symbolizing creativity in industrial research,

and was cited for "his vision and leadership in recognizing the requirements for ultra-high purity materials. This foresight resulted in his research on zone melting and refining and crystal growth techniques.



W. G. PFANN, BELL LABS SCIENTIST, center, receives the award, a sculptured work of art, entitled "Man and Technology," from Dr. N. Bruce Hannay, I.R.I. president, right. The presentation address was given by Dr. William P. Slichter, at left in the photo.

Bell & Howell Schools announces two ways to learn new skills in electronics without ever going to class or giving up your job!

Pick the one

Here are two fascinating home-learning adventures that say, "Don't envy the man with skills in electronics... become one!"

If you had to drop everything and go off to school to learn new skills in electronics, there's a chance you might not do it. But Bell & Howell Schools' excellent home training has already proved to tens of thousands that you don't have to drop anything...except the idea that classrooms are the only place you can learn!

You can keep your job, your paycheck and your way of life while you're learning. Because these programs allow you to pick the training schedule that best fits in with your other activities. It's *that* convenient.

I. AUDIO/ELECTRONICS

The first learn-at-home program including 4-channel technology. Explore this totally unique sound of the 70's as you experiment with testing equipment and build a sound center featuring Bell & Howell's superb quadraphonic equipment!†

Learn about 4-channel sound—without a doubt the most impressive technical advancement in sound realism in years. A development by which separately-recorded channels literally wrap a room in sound.

And now, for the first time, you can also discover this latest achievement in audio electronics with a fascinating learn-at-home program that explores the whole area of audio technology including 4-channel sound reproduction. A program that could lead you in exciting new directions with professional skills and technical know-how.

You actually build and experiment with Bell & Howell's high-performance 4-channel audio center...including amplifier and FM, FM-Stereo tuner.

Understanding today's audio technology requires practical experience with high caliber equipment. And with the Bell & Howell amplifier and tuner, you've got the technological tools you need to gain the knowledge and skills that could open up opportunities for

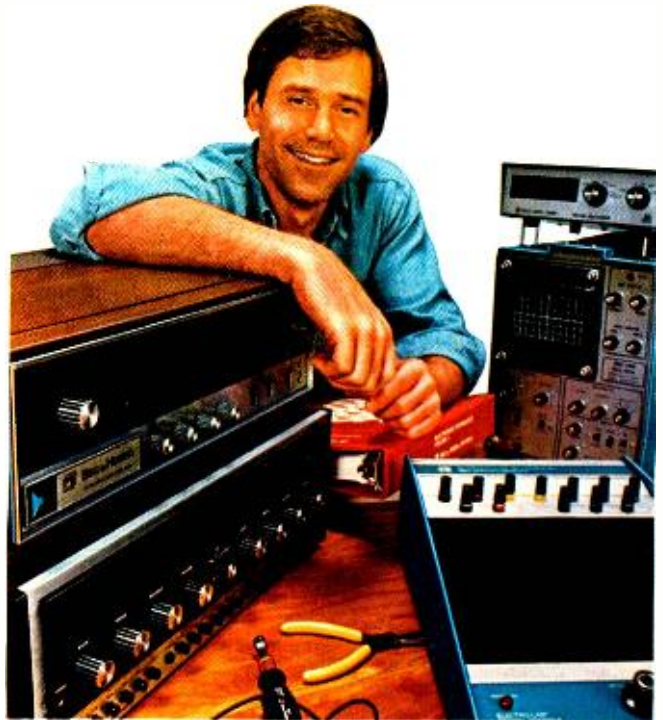

you in the audio field. Of course, we cannot offer assurance of income opportunities.

The sophisticated amplifier gives you the circuitry you need to conduct the comprehensive experiments necessary to master audio technology. Like signal tracing low level circuits, troubleshooting high power amplifier stages, and checking the operation of tone control circuits.

You'll investigate the technology behind this amplifier's full logic, 4-channel decoder and learn how full logic decoding produces outstanding front to back separation.

The tuner you build has both superior performance specs and state-of-the-art features such as: all solid state, FET front end for superior sensitivity, crystal IF filters for wide bandwidth, and a superior stereo multiplex circuit for excellent stereo separation.

You cover the full range of electronic fundamentals.

But make no mistake. This learn-at-home program is not just about 4-channel sound. It covers the full range of electronic fundamentals leading to understanding audio technology. So when you finish, you'll have the occupational skills to become a full-service technician, with the ability to work on the full range of audio equipment such as tape recorders, cassette players, FM antennas, and commercial sound systems. Get complete information on this unique program by checking the appropriate box on the card—mail it today!

† Cabinets and speakers available at extra cost.



you want!



Simulated TV picture/test pattern.

II. HOME ENTERTAINMENT ELECTRONICS

Gain new skills in Home Entertainment Electronics in an unusual learn-at-home program that includes the new generation color TV you build yourself!

This is the first program of its kind to include the study of digital electronics. And what better or more exciting way to learn about it than to actually build and test a 25" diagonal color TV employing digital electronics?

You'll probe into the digital technology behind all electronic tuning and channel numbers that appear on the screen. An on-screen digital clock that shows the time to the second. You'll also gain a better understanding of the exceptional color clarity of the Black Matrix picture tube, as well as a working knowledge of "state-of-the-art" integrated circuitry and the 100% solid-state chassis.

As you build this remarkable, new generation color TV, you'll not only learn how advanced integrated circuitry works, but how to detect and troubleshoot problems in any area.

Sound good? Then mail the postage-paid card today for more details.

Whichever program you choose, you'll get to build and experiment with your own electronics laboratory.

"Hands on" working experience with the latest equipment is the key to Bell & Howell Schools' home training. That's why in both programs we start you off with a set of equipment called the Lab Starter Kit, including a fully-assembled volt-ohm meter designed to help you experiment with and better understand basic electronic principles. So you don't just read about electronic principles, you actually make them work!

Next, in step-by-step fashion, you'll assemble Bell & Howell's exclusive



Electro-Lab[®] electronics training system. It includes a special design console that enables you to assemble test circuits. A digital multimeter for accurately measuring voltage, current and resistance. And a solid-state "triggered sweep" oscilloscope which will allow you to analyze the functioning of tiny integrated circuits. Putting these instruments together will give you experience in wiring, soldering and assembling. Then, further on, you'll use the lab equipment for experience in electronic testing, troubleshooting and circuit analyzing.

We try to give more personal attention than other learn-at-home programs.

Both of these programs are designed so that you can proceed through them smoothly, step by step. However, should you ever run into a rough spot, we'll be there to help. While many schools make you mail in your questions, we have a Toll-Free Phone-In Assistance Service for questions that can't wait. Bell & Howell Schools also holds In-Person "Help Sessions" in 50 major cities at



various times throughout the year. There you can talk shop with your instructors and fellow students and receive additional assistance.

Get details on one or both of Bell & Howell Schools' home-learning adventures...

Mail the postage-paid card today for more information!

Taken for vocational purposes, these programs are approved by the state approval agency for Veterans' Benefits.

*Electro-Lab[®] is a registered trademark of the Bell & Howell Company.

74E

If card is missing, write:

An Electronics Home Study School
DEVRY INSTITUTE OF TECHNOLOGY

ONE OF THE



BELL & HOWELL SCHOOLS

4141 Belmont, Chicago, Illinois 60641

all about curve tracers

This article tells what to look for when purchasing a curve tracer; how to test different solid-state devices, and how to interpret the resulting waveforms

by CHARLES GILMORE*



LAST MONTH WE COVERED THE FUNDAMENTALS of curve tracers and started discussing the testing of diodes.

This month we will complete testing and look into testing of bipolar and field-effect transistors.

The curve tracer can examine curves of the reverse-biased diode as well as the forward biased diode. When the diode is reverse biased, theoretically no current flows. However, as shown in Fig. 6, there is current flow once the reverse breakdown voltage of the diode is reached. When the unknown diode is being used as a replacement part in a circuit, the reverse breakdown voltage

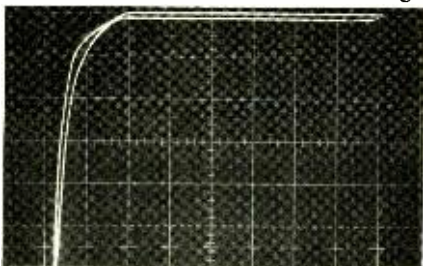

FIG. 6—THE REVERSE CHARACTERISTICS of the 1N4149 silicon small-signal diode. Settings are: cathode series limiting resistance, 10,000 ohms; horizontal sensitivity, 20 volts/cm; vertical sensitivity, 0.5 mA/cm. Note that some looping is caused by internal heating of the diode during sweep and by stray capacitances.

should be measured. Once the diode's reverse breakdown voltage has been determined, the circuit parameters will tell you if it can be used as a replacement part. Some diodes tend to show a fairly large reverse current before they reach reverse breakdown. This leakage current can make the diode an unsuitable replacement. Generally, with small signal diodes the leakage currents are so small that they are unnoticeable on most curve tracers.

The Zener diode is simply a diode whose reverse breakdown characteristics are known and controlled. Figure

7 shows the characteristics of a 1N750 Zener diode. Poor regulation in a Zener-regulated circuit can be caused by too high dynamic resistance when the Zener is conducting. The dynamic resistance of the Zener diode can be computed in

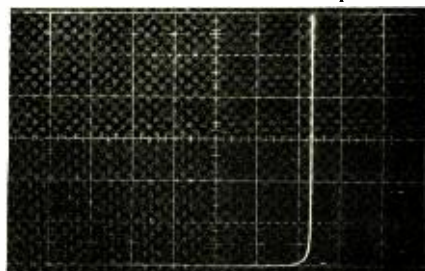

FIG. 7—THE REVERSE CHARACTERISTICS of the 1N709A silicon Zener diode. The diode is rated at 6.2 volts \pm 5% at a Zener current of 25 mA. The curve tracer settings are: cathode series limiting resistance, 5000 ohms; horizontal sensitivity, 1 volt/cm; vertical sensitivity, 5 mA/cm. Note that the Zener curve passes through 6.4 volts at the horizontal line representing 25 mA.

exactly the same manner as the forward dynamic resistance of a diode. By referring to the manufacturer's data on the Zener diode, we can learn at what current the Zener voltage is specified and over what current ranges the dynamic impedance of the Zener is specified. When measurements are made "in circuit," the dynamic resistance of the diode is increased by the resistance of other circuit elements in series with the measurement.

The curve tracer is ideal for determining tunnel diode characteristics. As shown in Fig. 8, the characteristics of the tunnel diode are quite unique and you can readily identify the device by them. When using the tunnel diode, the limiting resistor may have to be adjusted to prevent oscillation. Tunnel diodes have a negative resistance region, where the current *decreases* as the voltage *increases*. Given the prop-

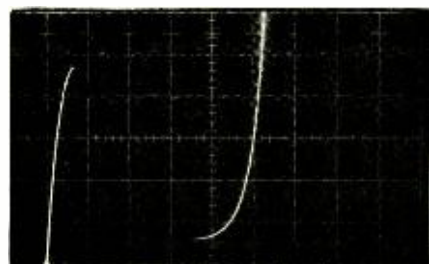

FIG. 8—THE FORWARD CHARACTERISTICS of a GE TD-716 tunnel diode. Settings are: anode series limiting resistance, 5000 ohms; horizontal sensitivity, 0.1 volt/cm; vertical sensitivity, 1 mA/cm. Note the area of trace between the peak current and the valley current is almost impossible to see. If this area of the display contains scrolls, read just the value of series limiting resistance and the sweep voltage to get a trace without scrolling.

er conditions, the negative resistance sustains oscillation.

When the display has been properly adjusted and there is no oscillation (identified by looping or scrolls on the trace), some of the frequently specified characteristics on a tunnel diode can be readily measured. These are: the peak voltage at the start of the tunneling region (V_p); the valley voltage at the end of the tunneling region (V_v); the peak current at the start of the tunneling region (I_p); and the valley current at the end of the current tunneling region (I_v). Once these parameters are known, the average value of negative resistance can be computed as $(V_v - V_p)$ divided by $(I_p - I_v)$. When tunnel diodes are displayed on the curve tracer, the region between the peak and valley voltages, that is, the region of negative resistance, is frequently quite dim.

The diac or trigger diode, that is frequently used in series with the gate of a Triac or SCR to fire the device, has the characteristic curve shown in

*Design Engineer Heath Company, Benton Harbor, Mich.

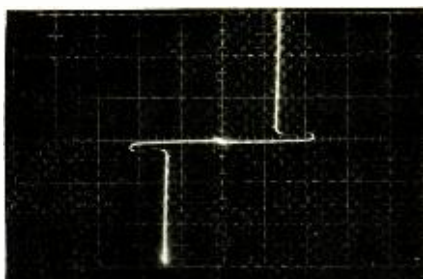

FIG. 9 — THE FORWARD AND REVERSE CHARACTERISTICS of a diac or trigger diode. A double exposure shows both forward and reverse curves in one photograph. Curve tracer settings for reverse measurements are the same as for the forward measurements except the polarity of measurement has been reversed. The curve tracer settings are: series limiting resistance, 5000 ohms; horizontal sensitivity, 20 volts/cm; vertical sensitivity 2.0 mA/cm. Note the match between the forward and reverse breakover voltages.

Fig. 9. Two curves are shown for the diac, a bi-directional device, as the diac has similar characteristics in the forward bias and reverse bias directions. The forward blocking voltage indicated on the display is that voltage where the horizontal line stops and a fine trace swings back to the high current point, showing low forward voltage drop. As the sweep voltage is decreased, the current through the diac is reduced until it finally stops abruptly. This point gives a measurement of the holding current.

2. The bipolar transistor — A large number of characteristics of npn and pnp transistors can be measured with a curve tracer. All measurements applicable to npn devices also apply to pnp devices. The only difference is in the initial set-up. To measure npn devices, the collector or sweep voltage must be positive, and often this is shown on the curve tracer as the npn position. The base or stepping generator must also be in the positive current or npn position. (Note that at this time we use a current generator, as a transistor is a current-operated device). Transistors can be easily damaged if the voltage output of the stepping generator is used.

If an unknown device is found and a curve tracer is used to checkout the characteristics of the device, including pnp or npn, the beam may be initially placed in the center of the curve tracer display. Very moderate levels of sweep voltage and step current are applied first, with a midrange setting of the steps per family control, in the npn direction and then in the pnp direction. One test will yield a family of curves, the other a straight line. The test yielding the family of curves identifies the device. Be sure to keep both the base current and the collector sweep voltage well within the reverse breakdown ratings of the transistor. If incorrect settings are used

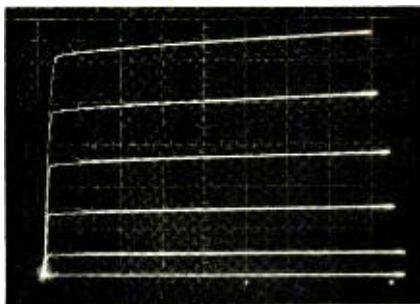

FIG. 10—A FAMILY OF SIX CURVES generated by a 2N3393 silicon npn general-purpose small-signal transistor. Settings are: step generator, 0.01 mA/step; collector series limiting resistance, 100 ohms; horizontal sensitivity, 2 volts/cm; vertical sensitivity, 1 mA/cm. At a collector voltage of 8 volts, the current change indicated by curves three and four is 1.3 mA. As this was caused by a step of 0.01 mA of base current, the beta of this device at this particular operating point is $1.3/0.01 = 130$.

and the device is forced beyond the breakdown characteristics of its junctions, it could be damaged.

One transistor parameter we frequently measure is dc gain or beta, abbreviated h_{FE} . To a reasonable approximation, the beta of the transistor is the ratio of the collector current to the base current.

Each curve that the curve-tracer gives us represents the collector characteristics for a different base current. DC beta can be readily determined at various collector current and voltage levels. The curves in Fig. 10 show that the spacing between curves caused by the various base steps is not uniform, indicating the beta of the transistor is not uniform for large variations in collector current or voltage. Therefore, beta should be measured as the change in collector current from one step to another, caused by the change in base current from one step to another. Beta measured in this manner is often referred to as the ac beta or the h_{FE} of the device. This is a better way to check a transistor because the test is made near the operating current and voltage for the device. However, this is not the high-frequency beta of the device, and does not represent the beta of the device at a few kilohertz or higher.

Once we know that a replacement transistor has enough beta, we must find out if its voltage breakdown characteristics allow it to operate successfully in the circuit. The characteristics in question are the collector to emitter voltage breakdown, V_{CE} , and the collector to base voltage breakdown, V_{CB} . The curves in Fig. 11 show the area of collector breakdown, defined as the area where the collector current becomes independent of the base current and begins to rise very sharply.

Voltage breakdown measurements must be made as rapidly as possible or

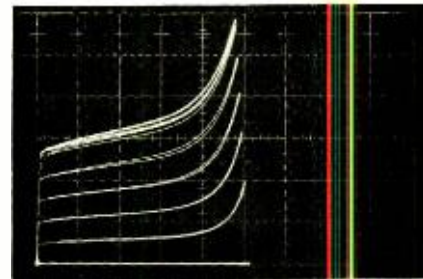

FIG. 11—A FAMILY OF CURVES for the 2N3393 showing collector breakdown. Collector current becomes independent of the base current as the collector voltage exceeds the 30 to 40-volt region. Settings are: step generator, 0.01 mA/step; collector series limiting resistance, 200 ohms; horizontal sensitivity, 10 volts/cm; vertical sensitivity, 5 mA/cm.

excessive power dissipation in the transistor caused by the high collector currents and voltages used in the procedure may damage the device being tested.

To detect collector-to-base and base-to-emitter breakdowns, connect the base-collector or base-emitter terminals of the transistor to the curve tracer as though you were checking an ordinary two-terminal diode for reverse-breakdown characteristics. Do not connect the unused lead of the transistor.

When a transistor is used in relatively high-impedance circuits, the amount of leakage current may be important. This leakage current is often specified in two different forms: I_{CEO} , the collector-emitter current with the base open; and I_{CES} , the collector-emitter current with the base shorted.

To measure I_{CEO} , connect the collector and emitter leads to the curve tracer terminals and leave the base lead open. Then increase the sweep

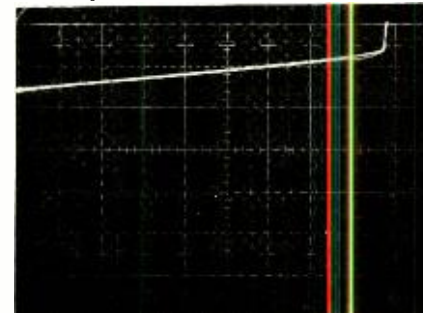

FIG. 12—A MEASUREMENT OF I_{CEO} on a 2N398A germanium pnp transistor. Curve tracer settings are: collector series limiting resistance, 1000 ohms; horizontal sensitivity, 2 volts/cm; vertical sensitivity, 0.5 mA/cm. The step generator is not used, as the base lead is open. Germanium transistors generally have higher leakage currents than silicon. Leakage on this particular device is 800 mA with a collector-emitter voltage of 18 volts.

voltage far as possible, without exceeding breakdown, and measure the leakage current as shown in Fig. 12. If the leakage current is quite small, you may have to use the magnifier on the curve tracer to see this current. Fre-

quently, it will not be measurable at all. If I_{CES} is to be determined, short the base lead to the emitter lead and make the measurement in the same way as for I_{CEO} .

Transistors that are used in digital circuits have a few additional special characteristics, as they specify that the device may be used as a switch. When a transistor is used as a switch, the collector-to-emitter voltage when the transistor is saturated (that is, drawing its maximum collector current) is very important. For instance, if we wanted to use a transistor in a common-emitter circuit to drive the input of a series 7400 TTL gate, we would need a logic zero of at least 0.4 volt. This means that the collector-emitter voltage of less than 0.4 of a volt when sinking a maximum current of 1.6 mA from the input of the gate plus its own collector current.

To determine whether this transistor will properly drive its gates, use a curve tracer to measure $V_{CE(sat)}$ or the collector-emitter saturation voltage. Figure 13-a shows the curves of an npn 2N2369 that is often used in such applications. Note that the saturation voltage increases as the collector current increases. Figure 13-b shows the same transistor, but here the base current is 100 times larger.

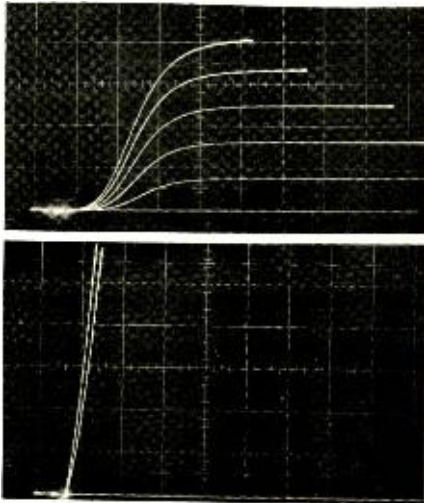

FIG. 13 — SATURATION VOLTAGE ON A 2N2369 switching transistor. a). The transistor is operated at moderate levels of base drive. Settings are: step generator, 0.02 mA/step; collector series limiting resistance, 50 ohms; horizontal sensitivity, 0.1 volts/cm; vertical sensitivity, 2 mA/cm. **b).** The transistor operates at high levels of the base drive, as might be found in a switching circuit. Settings are: step generator, 2 mA/step; collector series limiting resistance, 50 ohms. Horizontal sensitivity, 0.1 volt/cm; vertical sensitivity, 2 mA/cm.

In some critical applications, temperature has a great effect on transistor characteristics. One way to determine if a transistor will or will not cause problems in a circuit is to operate the transistor in a curve tracer, using collector voltages and currents that repre-

sent those of the anticipated application. Once a family of curves has been established, heat the transistor (a soldering iron, or even finger heat may be sufficient) and note any variations in these curves. With "looping", shown in Fig. 14, the characteristics of the transistor have actually changed

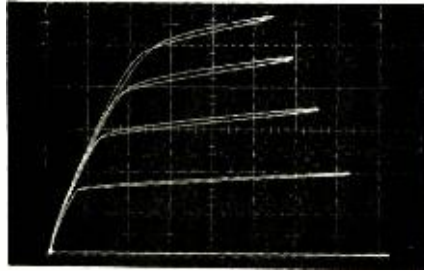

FIG. 14—THERMAL LOOPING CAUSED BY INTERNAL HEATING of the transistor. Transistor is a 2N3393, that has 200 mW dissipation. The curve tracer settings are: step generator, 0.1 mA/step; collector series limiting resistance, 100 ohms; horizontal sensitivity, 5 volts/cm; vertical sensitivity, 20 mA/cm. At the center of the display, the point where there is distinct thermal looping, represents a collector-emitter voltage of 20 volts at a current of 60 mA. This yields a power of 1.2 watts.

between the time the sweep makes the deflection from the left hand to the right hand side of the screen and its return.

In Fig. 15, we can see that with increasing collector voltages this effect can be carried to the limit, and

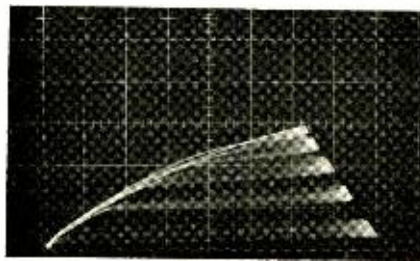

FIG. 15—THERMAL RUNAWAY CAUSED BY EXCESSIVE internal heating of the transistor. The entire characteristics of this transistor were changing as this photograph was being taken (one second exposure). The transistor was destroyed a short time later. Settings are: step generator, 0.1 mA/step; collector series limiting resistance, 50 ohms; horizontal sensitivity, 5 volts/cm; vertical sensitivity, 50 mA/cm.

the curves shown in Fig. 15 represent thermal runaway. At this stage, the transistor parameters are no longer under the control of the base current, but have completely succumbed to device heating. A transistor subjected to this test may be damaged quite rapidly, so work quickly.

When testing transistors on a curve tracer, setups should be made carefully, always starting with low initial voltages and currents, as semiconductor devices can be easily damaged. Curve tracers can produce large voltages and large currents, especially when compared to the limit parameters on small signal semiconductors.

You can destroy a transistor within the first few sweeps of an improperly set-up curve tracer.

Certain hazardous conditions exist when making measurements. Transistors can get very hot when their parameters are exceeded and severe burns can result from touching the cases of both power transistors and small-signal transistors that have been used beyond their limits.

Curve tracers can produce exceptionally high voltages to insure breakdown of most junctions; they also have fairly large current capabilities. The net result is power supplies that are potentially lethal. It is altogether too easy for a person to come in contact with leads on devices that are under test, especially those which have metal cans. *Be sure to reduce the sweep voltage to zero before connecting or disconnecting the device from its test socket or leads.*

When intermittent tests for transistor breakdown are desired, the A-B switch is an excellent way to rapidly control the curve tracer. To compare devices, a "standard" transistor can be left in one socket and the second socket used to interchange transistors that are being compared or sorted.

The user must remember when making in-circuit tests, that parameters may not be exactly as expected, due to other components in the circuit such as resistors and large capacitors. To make exact parameter measurements on a transistor, remove it from the circuit.

3. Field-effect transistors—Like the bipolar transistor, the field-effect transistor has two major categories of different polarity devices. Unlike the bipolar device, field-effect transistors are voltage operated devices. Initial set ups for measuring field-effect devices include changing the step generator from the current mode to the voltage mode. Today there are six major categories of field-effect devices. Their set ups are shown in the setup table (see May 75 issue). A special note should be made of enhancement-mode field-effect devices, as some curve tracers can not provide the combination of sweep polarity and step generator voltage polarity to properly display their characteristics. One method to overcome this, for example with the n-channel enhancement type, would be to use a positive collector sweep voltage and a negative step voltage. This step voltage must be offset by some positive voltage so the most negative step produces a zero gate to source voltage. One way to do this is to place a battery or an adjustable power supply in series with the gate (the base terminal) of the curve tracer.

(to be continued)

IN THE FEBRUARY 1975 AND MARCH 1975 issue of **Radio-Electronics**, we presented a general description of the TV Typewriter II, some foil patterns, the schematic of the main board and began a technical description.

This month the series will conclude with the construction details.

When the character counter reaches character slot 33, the 2⁵ and 2⁰ bits go to a one which in turn disable the "DOT CLOCK" until a new character line is started. Being in the 33rd character position also enables the video blanking circuit through IC12-c and IC5-b. Since the dot clock is stopped, the video generation ceases after the 33rd character until a new video line is started.

Now that we know how to get the data from the 2513 character generator data inputs to the screen, lets see how the incoming data is put into and accessed from memory. We must first have some means of inputting data to the TV typewriter which in most cases will be a standard keyboard/encoder with a seven-bit ASCII output. The input device must also provide some kind of a "data ready" line to tell the terminal when new data has been applied to the data input terminals. For a keyboard/encoder this is called a "keypressed strobe" line and gives us a pulse whenever a key has been depressed.

Although the seven data inputs are set up for positive logic, the "keypressed strobe" line may be either positive or negative going since NAND gate IC32-a has been provided as an optional inverter. When the "keyboard strobe" pulse reaches the "clock" input of IC9-a, it toggles forcing IC36-b, IC37-a, IC37-b, IC38-a, IC38-b, IC39-a and IC39-b to latch onto the new ASCII data provided at the data inputs, which is in turn fed to the data input terminal of the RAM memory but not loaded.

You must remember that the memory is constantly being readdressed and read and that the address of memory at the time of the "keypress strobe" is completely arbitrary and is most likely not the place where we want to store the character. Keep in mind also that we will want to input special control characters which will command the typewriter to perform a certain function but at the same time not write these control characters into memory.

The latched input character is fed to the function decode circuitry where it is determined whether or not a control function is being input. If it is, such as any input with bits 6 and 7 equal to zero or a rubout with all bits set to 1, the output of IC32 will go high forcing the output of IC11-b low

TV TYPEWRITER II

by ED COLLE

Build this new TV Typewriter. It has many new features including plug-on option boards



resetting IC9-a and preparing IC36-a to dump the input control character on the next load pulse for the "dot registers" IC23 and IC24 from IC25. Note the next time the "clock" input on IC36-a goes high it clears all of the data input latches IC36 through IC39. If on the other hand, the character is a printable character, IC32-b will stay low forcing IC11-b low thus eliminating IC9-a's clear command allowing the Q output to go to a one when toggled by the keyboard strobe. On the next "load pulse", IC16-b is clocked high. The high output of IC9-a and IC16-b are now AND'ed and prepare IC16-a to be switched on the next load pulse from IC25. When IC16-a toggles, its Q output goes high setting up one of the two inputs to NAND gate IC15-b and it then waits for a "compare" command from AND gate IC3-d. The input from IC12-d is AND'ed at the same gate just to eliminate false counts after the character counter has reached a count of 33.

The compare circuit will be discussed in detail later, but basically it determines and acknowledges when the memory is indexed to the position in which we want to store the character being processed. When the compare is confirmed, IC3-d goes high forcing IC3-b high, which forces IC15-b low. This makes IC10-a go high generating a write pulse for the memory, thus loading the character at the proper position. At the onset of

the next load pulse IC3-c goes high forcing IC11-b low which resets IC9-a and dumps the input latches, leaving the ASCII code for a blank or space stored. IC16-a and IC16-b both reset on the following load pulse.

Each input character requires 3 "load pulse" time or 4.5 μ s to load. Because of this requirement and the fact that only 9 load pulses per character can be guaranteed; 540 characters per second is the maximum input rate. The first 102 lines are selected twice per frame so the write speed on the 3/8 of each page will be doubled or 1800 characters per second.

The cursor and compare circuits are very interrelated since the circuitry must know where the cursor is positioned on the screen and when the memory is indexed to match with the cursor location so the cursor will blink in the right location. Since the character we will be entering through the keyboard will be entered in the cursor's position, the cursor counter also provides the address of the character we want to load into memory. The memory location of the cursor or character to be loaded into memory is stored in a 10-bit counter made up of IC35, IC27-a, IC34 and IC27-b. IC35 holds the data for the first sixteen horizontal character locations on a line and IC27-b sets if the location is on lines 17 through 32. The number of one of the 16 vertical page lines is stored in IC34, and IC27-b holds the bit addressing one of the two pages of memory.

IC41 and IC42 are two 4-bit comparators that tell us when the data on two sets of its inputs is identical. The required 9th-bit compare is provided by IC40-c and IC40-d. The comparators are cascaded to generate one output telling whether two independent 9-bit addresses are equal, the address being that of the cursor and the location presently indexed. It is not necessary to perform a compare on the tenth or page bit because we will never be writing to or blinking the cursor on the page that is not currently accessed. The comparator circuitry monitors the address of the cursor counter and the outputs of the character counter, IC21 and IC14, and the line counter, IC7, and generates a high "compare" output when there is a match.

The cursor itself is generated by turning on all 35 of the character dots when AND gate IC17-c sees both a "compare" match and inactive blanking. The several times per second blanking is generated by the timer IC8 operating as an astable oscillator.

The cursor is positioned by incrementing and decrementing the up/down cursor counters IC35, IC27-a and IC34, which have full wrap around in each location and automatically

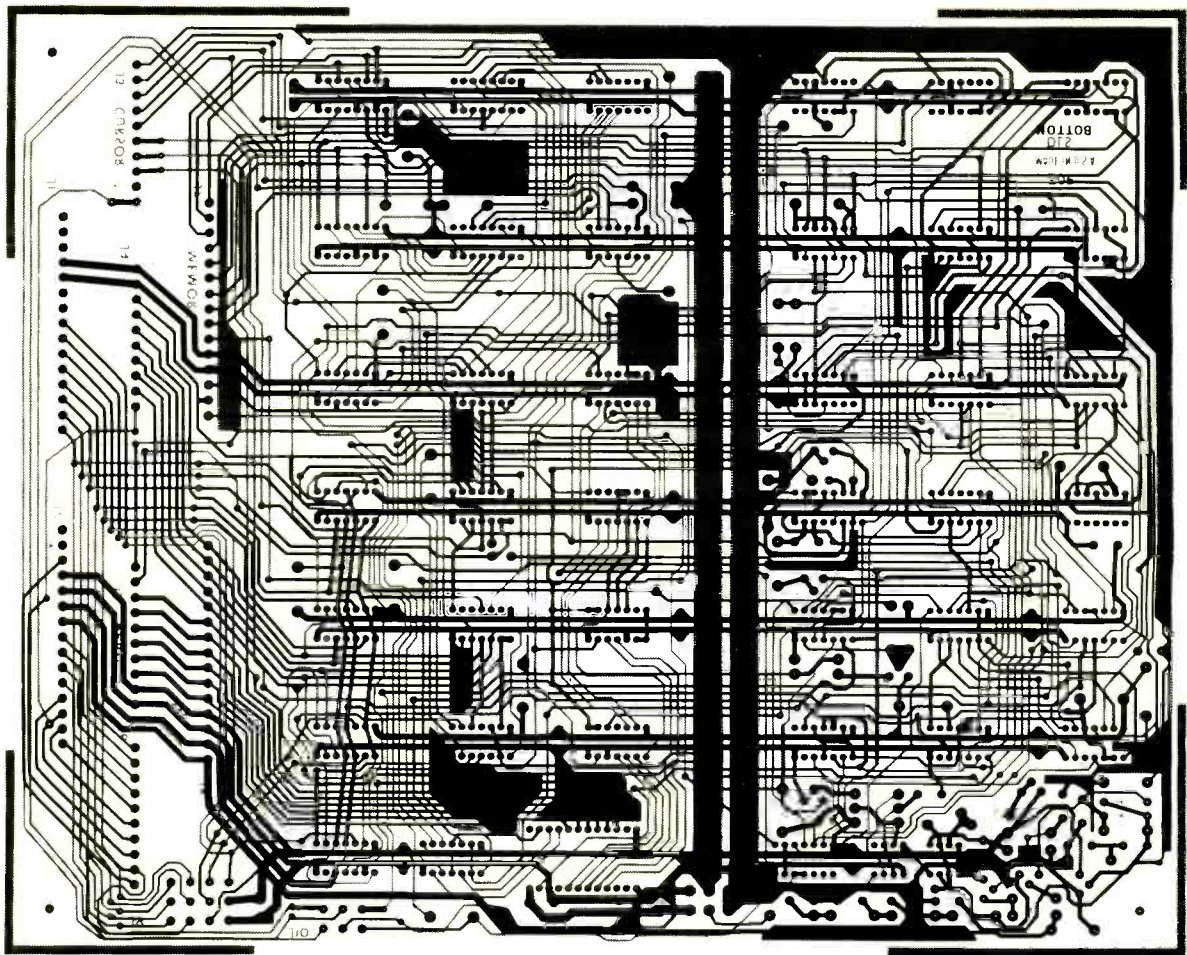

MAIN CIRCUIT BOARD foil patterns shown half-size. Above is an X-Ray view of the double sided board. The component layout is shown below.

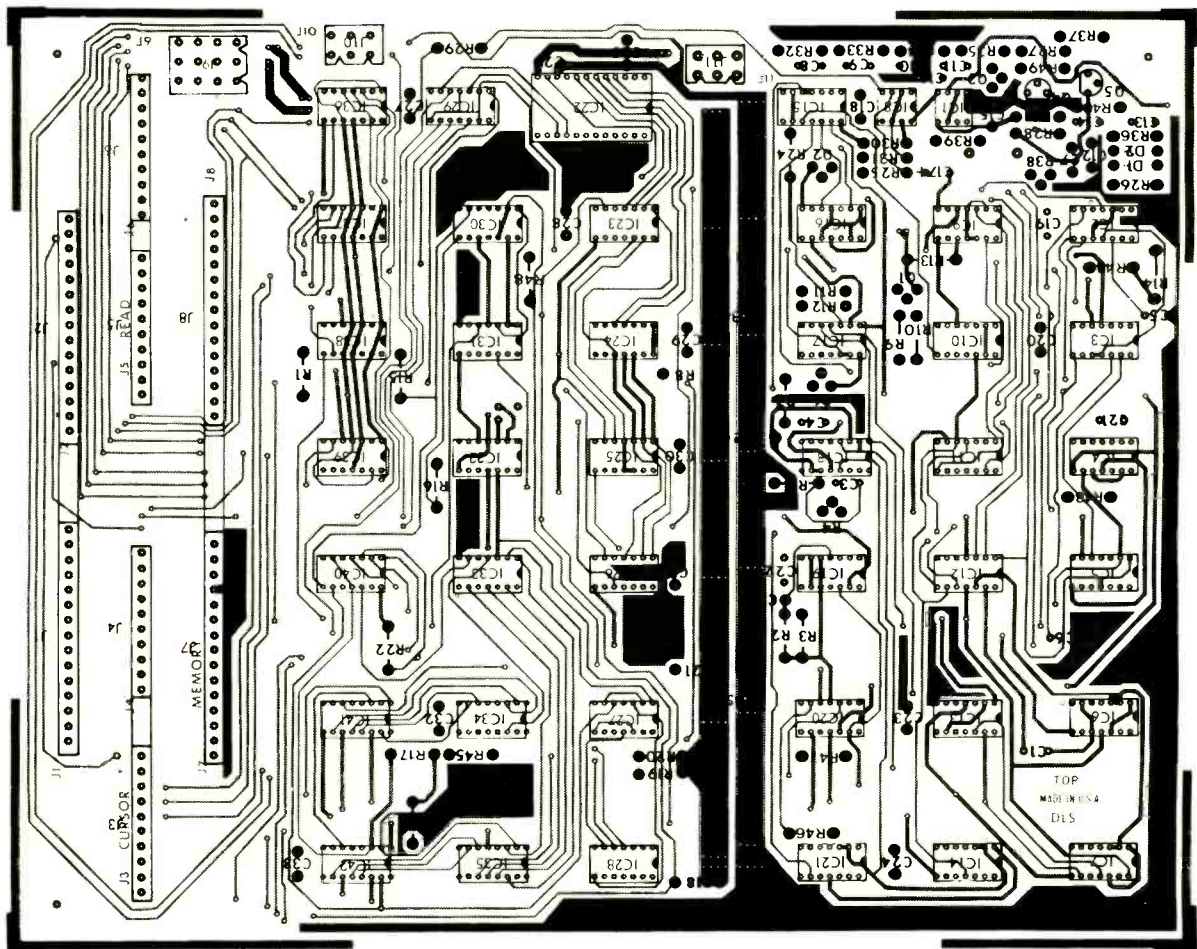

change pages as required. Although most of the actual cursor control circuitry is provided on the main board, the optional cursor control board is necessary to provide the switch debouncing necessary for reliable operation.

There are several cursor positioning functions provided. IC35 pin 5 and IC35 pin 4 move the cursor location one position forward and one location backward respectively. IC34 pin 5 and IC34 pin 4 move the cursor one location down and one location up respec-

tively. IC35 pin 14 generates a carriage return and IC34 pin 14 generates a return to line 1 which means together they generate a home-up. IC34 and IC35 are responsible for line feed. The interconnected gating allows combinations to be performed with only one control command.

The erase functions have been provided for as well and do not require the optional cursor control board. Erase from the cursor position to the end of the line is initiated by setting the preset input of IC9-b low, and erase from the cursor to the end of frame is initiated by setting the preset input of IC2-a low. If either of these two latches is set, it allows IC2-b to toggle at the onset of the next compare when the row counter reaches line nine. This generates a "memory load" command which loads a space or blank from the input latches into memory. IC2-b will

reset on the first 33rd character indication from IC14 after latch IC2-b is set thus completing an erase to end of line (EOL). IC2-a will reset on the first blanking pulse from IC4-b after latch IC2-b is set, thus completing an erase to end of frame (EOF). The resetting of either causes IC2-b to reset and return it to its initial state.

Assembly is not difficult

It cannot be emphasized enough that the best guarantee for initial and future trouble-free operation is to be extremely careful when putting the unit together.

The circuit board will be more rugged and reliable if the IC's are soldered in place on the board as shown in the photographs, but those with little experience in digital circuits, or electronic assembly might be wise to invest in some sockets; particularly for the memory IC's.

Install all of the integrated circuits, resistors, diodes, capacitors and then transistors before soldering anything. Note the components are to be mounted on the top side of the board, and the top side is marked "TOP". Double check everything to make absolutely sure all parts have been installed in their proper location and oriented correctly. Check carefully to be sure you haven't inadvertently oriented an integrated circuit incorrectly. This is easy to do and almost impossible to correct after soldering without ruining either the integrated circuit or the PC board, or both. When you are sure that everything has been installed correctly, then you may solder all of the component connections on the bottom of the board. All of the connections should be soldered regardless of whether or not there are electrical connections to the pad. This helps insure that none of the integrated circuits or component leads get bent and inadvertently short out to near-by foil conductors.

Now is the time to carefully check the entire board to be sure that all connections where applicable have been soldered. Make sure also that there are no solder bridges, or improperly installed components.

Follow the same procedure for assembling the memory board as you did for the main circuit board. The memory integrated circuits are MOS devices which are very intolerant of static electricity so be sure to take appropriate precautions. Here again be sure to check over the board very carefully after assembly to be sure there are no mistakes.

Attach all of the wires to the connector plugs for the power supply, J11, output, J10, and keyboard, J9. Use the connector drawing to show the appropriate pin connection for each of the
(continued on page 87)

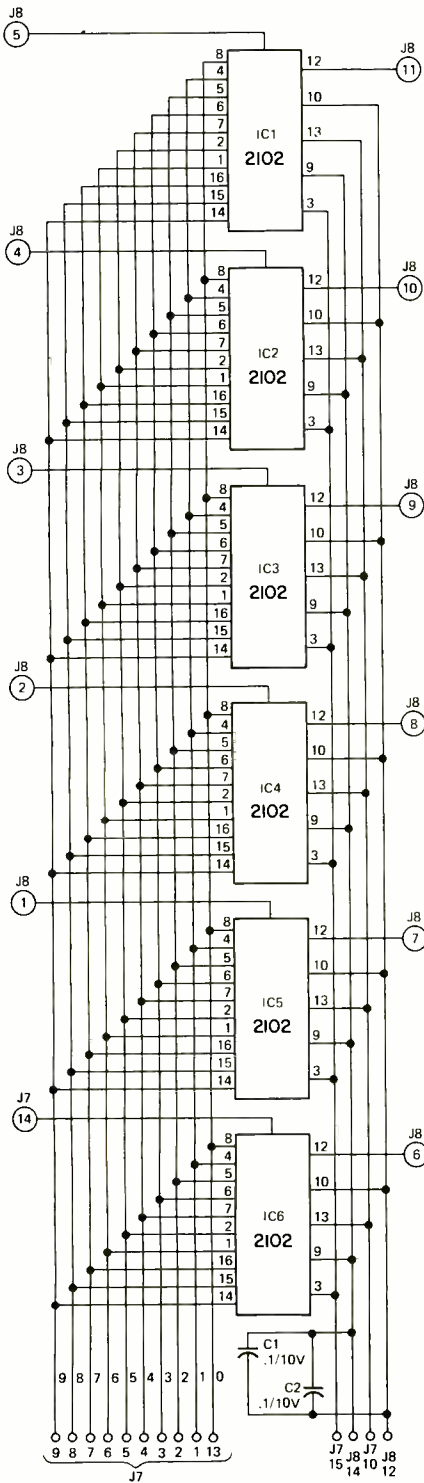

SCHEMATIC DIAGRAM of the memory circuit is shown.

J11 POWER SUPPLY

- PIN 1 -12 VDC
- PIN 2 +5 VDC
- PIN 3 GROUND
- PIN 4 -5 VDC
- PIN 5 12 VAC REF
- PIN 6 GROUND

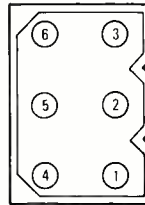

J10 OUTPUT

- PIN 1 PAGE 2
- PIN 2 PAGE 1
- PIN 3 VIDEO OUTPUT
- PIN 4 START READ
- PIN 5 GROUND
- PIN 6 CURSOR ON/OFF

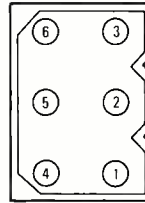

J9 KEYBOARD/ ENCODER

- PIN 1 BIT 1
- PIN 2 +5 VDC
- PIN 3 GROUND
- PIN 4 BIT 2
- PIN 5 BIT 3
- PIN 6 -12 VDC
- PIN 7 BIT 4
- PIN 8 BIT 5
- PIN 9 READ ENABLE
- PIN 10 KEY PRESSED
- PIN 11 BIT 7
- PIN 12 BIT 6

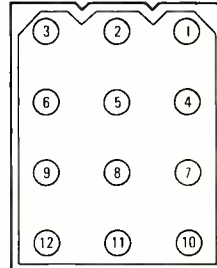

PIN LOCATION guide for the input and output jacks.

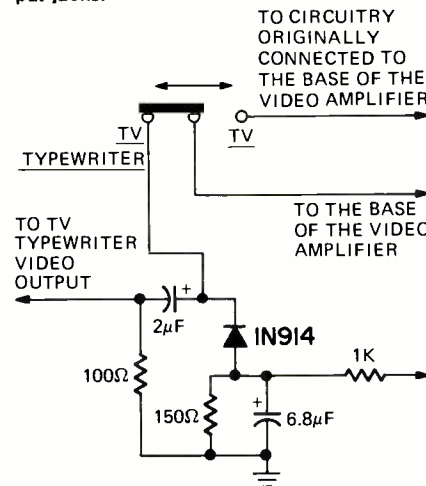

SWITCHING CIRCUIT permits normal operation of TV receiver or as TV Typewriter display.

CREI—the only home-study college-level training

and now

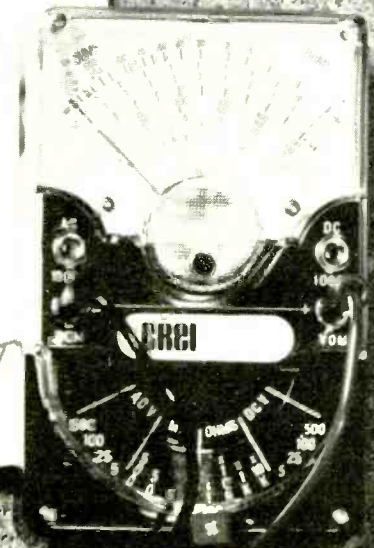
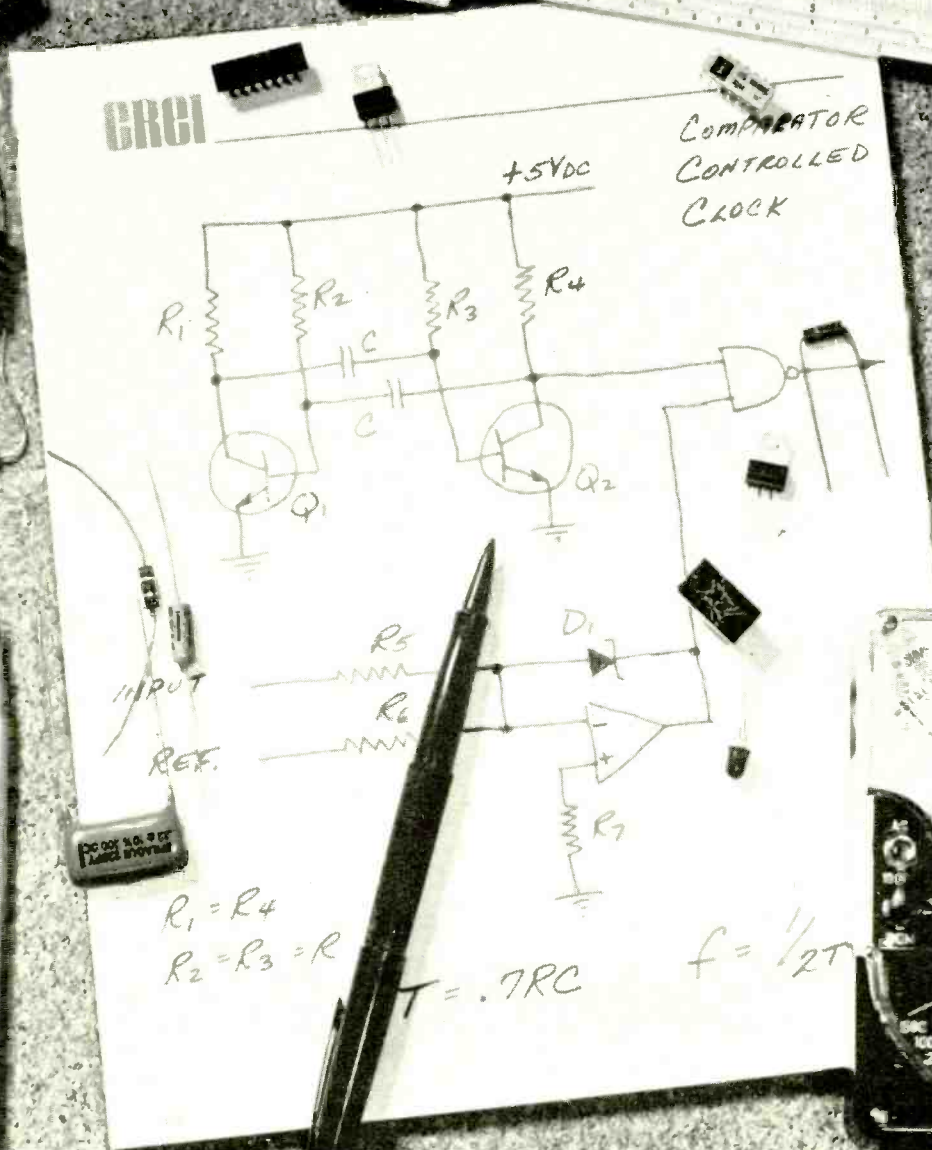
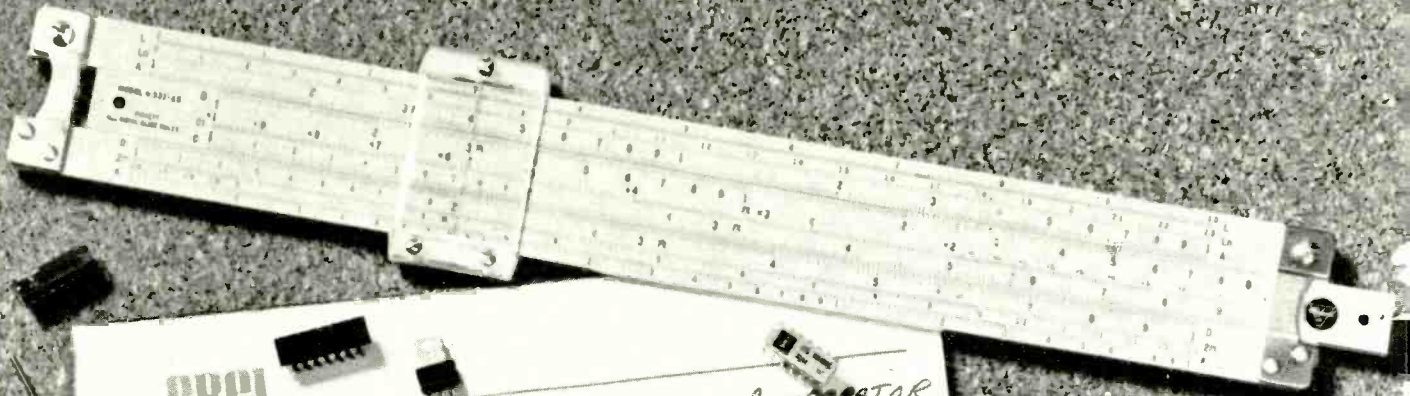

program which gives you in electronic circuit design

only CREI offers you a complete college-level Electronic Design Laboratory to speed your learning

Electronic circuit design—source of all new development in the application of electronics to new products and services. Without this skill, we would be unable to monitor the heartbeat of men in space. Without it, the computer revolution would never have occurred. And we would have yet to see our first TV show. *Yet, only CREI teaches electronic circuit design at home.*

ELECTRONIC CIRCUIT DESIGN

A key skill which paces our nation's progress in countless fields—from pollution control to satellite tracking to modern medicine to exploring the ocean's depths. And beyond. A skill which *you* must have to move to the top in advanced electronics.

CREI programs open up new worlds of opportunity for you.

In addition to electronic circuit design, CREI provides you with a full advanced electronics education in any of thirteen fields of specialization you choose. Communications, computers, space operations, television, nuclear power, industrial electronics—to mention just a few of the career fields for which CREI training is qualifying. With such preparation, you will have the background for a career which can take you to the frontiers of the nation's most exciting new developments. And around the world.

This free book can change your life. Send for it.

If you are a high-school graduate (or equivalent) and have previous training or experience in electronics, then you are qualified to enroll in a CREI program to move you ahead in advanced electronics.



Send now for our full-color, eighty page book on careers in advanced electronics. In it, you will find full facts on the exciting kinds of work which CREI programs open up to you. And full facts on the comprehensive courses of instruction, the strong *personal* help, and the professional laboratory equipment which CREI makes available to you. All at a surprisingly low tuition cost.

And when you have it, talk with your employer about it.

Tell him you're considering enrolling with CREI. He'll undoubtedly be happy to know you are planning to increase your value to him. *And he may offer to pay all or part of your tuition cost.* Hundreds of employers and government agencies do. Large and small. Including some of the giants in electronics. *If they are willing to pay for CREI training for their employees, you know it must be good.*

Send for Advanced Electronics today. You'll be glad you did.

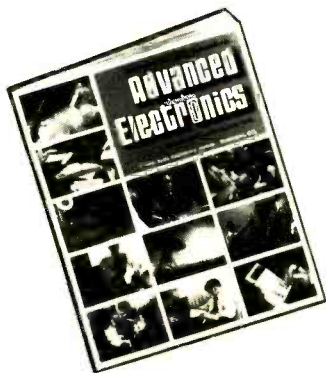

CREI Dept. E-1404F
3939 Wisconsin Avenue
Washington, D.C. 20016

Rush me your FREE book describing my opportunities in advanced electronics. I am a high school graduate.

Name _____ Age _____

Address _____

City _____ State _____ ZIP _____

If you have previous training in electronics, check here

Employed by _____

Type of Present Work _____

Veterans and servicemen, check here for G. I. Bill information

CREI

**CAPITOL
RADIO
ENGINEERING
INSTITUTE**

WASHINGTON, D.C. 20016

Step-by-step TV Troubleshooters Guide

With the increasing number of manufacturers using integrated circuits in their television receivers, it's important for the service technician to know how these devices work.

by STAN PRENTISS

EVEN THOUGH SYLVANIA'S NEW GT-MATIC has a unique 31.5 kHz IC oscillator, other sections can develop an interesting problem or two. I was all set to do a narrative on Sylvania's well-engineered E03, E04, and E05 chassis (all pretty much the same except the E04 has electronic tuning) when the night before story time, my E05 popped its circuit breaker with the switch off. At least it popped first with the switch on then repeated continuously with the switch off. And, as any service technician familiar with semiconductors can tell you, this means only one possible thing—a

short! How fortunate that this receiver is completely guarded by a circuit breaker. On the other hand, what do you do with a dead set? Well, like Sherlock Holmes, you look for clues.

Trouble tips

Most of us are blessed with two eyes, and an ohmmeter is a common electronic tool. So let's not rush off and tear up the set. Go back and consider your basic symptom: that the circuit breaker trips no matter what position the off-on switch is in. This means that the fundamental

problem has to be in some circuit that isn't really controlled by the off-on switch—and that, of course, is the picture-tube filament transformer that's on all the time. Refer to the schematic diagram of the power supply in Fig. 1. With switch S502-b in the OFF position, R504 limits the picture-tube heater voltage to about 4.8 volts. With S502-b in the ON position (closed), heater voltage measures a full 6.3 Vac, plus +36 Vdc connected through R506 (150K) to reduce heater to cathode arcs.

With ac applied to the 120 V interlock,

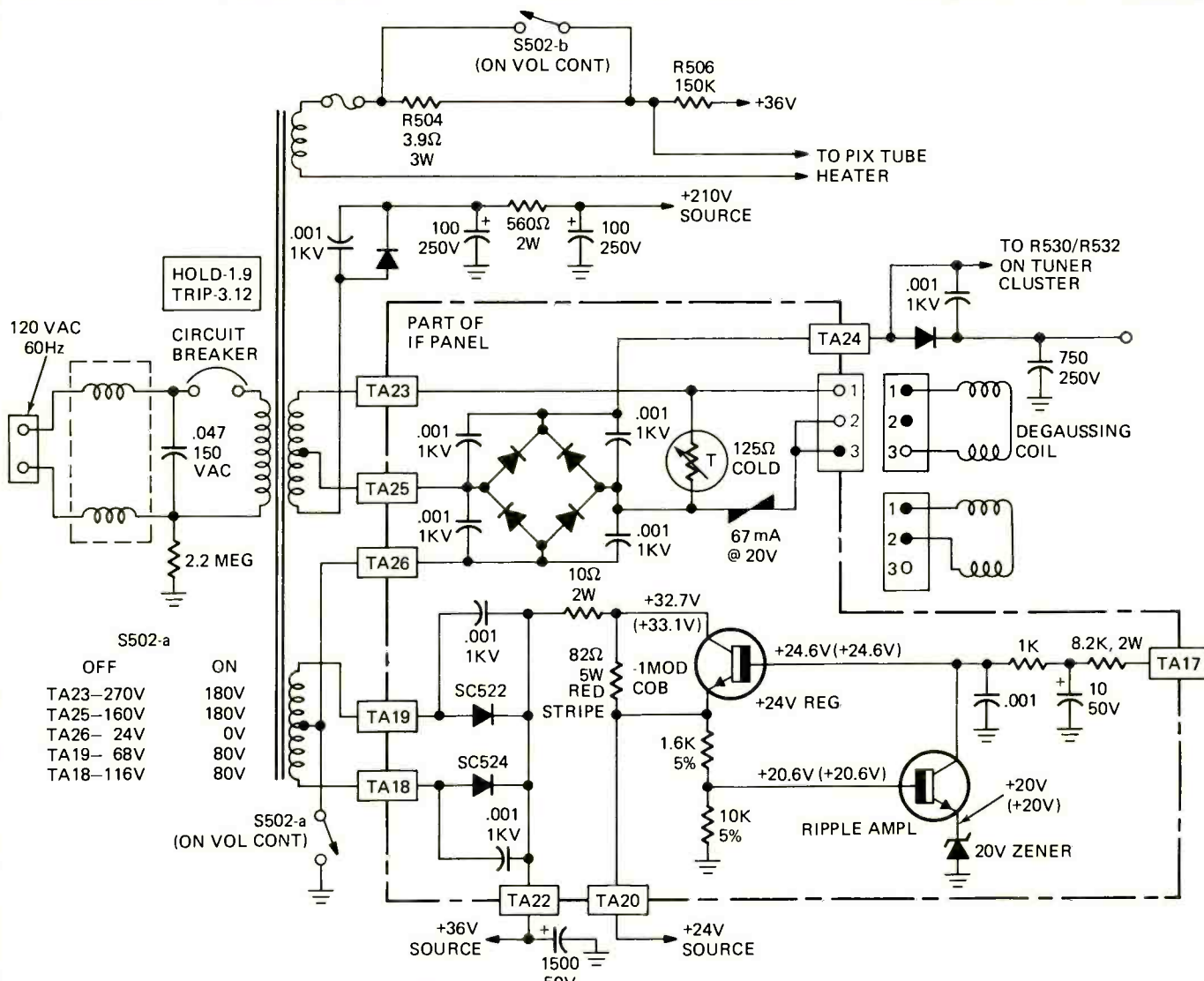

FIG.1—POWER SUPPLY schematic of Sylvania's E03 and E05 chassis.

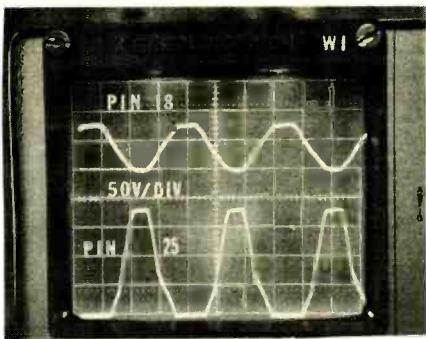

FIG. 2—WAVEFORMS OF POWER SUPPLY shown in Fig. 1. Upper waveform is taken from TA-18, while lower waveform is at TA-25. The scope is set at 50V/div.

the power transformer hums a few seconds before the circuit-breaker pops. Does this indicate a bad transformer? Usually no—basically it's a sign that too much current is flowing and setting up vibrations in the transformer laminations. This is often caused by other circuit faults.

Trouble shooting

Unfortunately, a few initial ohmmeter checks at terminals TA18 through TA26 and a random front-to-back check of sev-

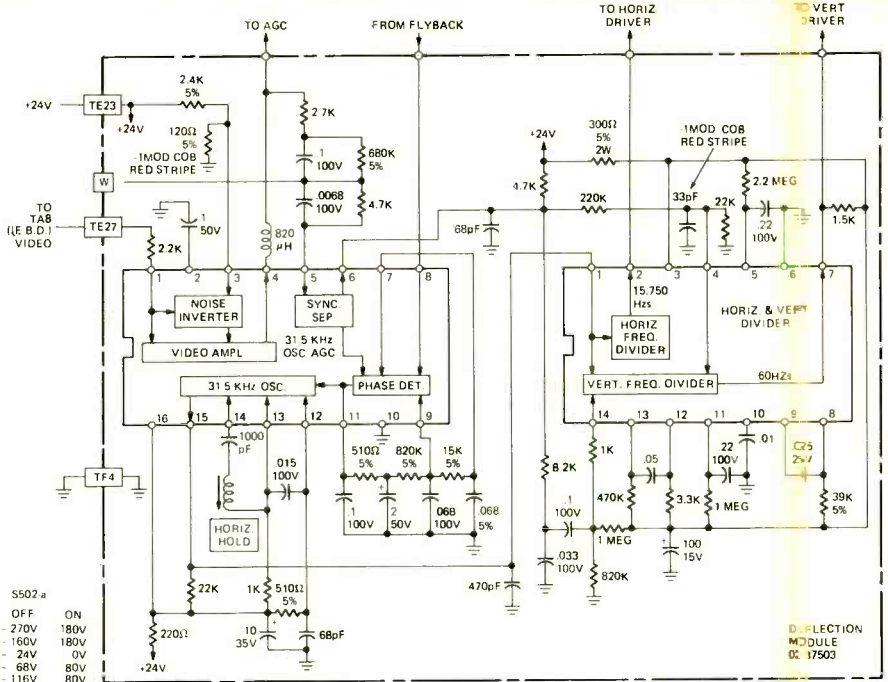
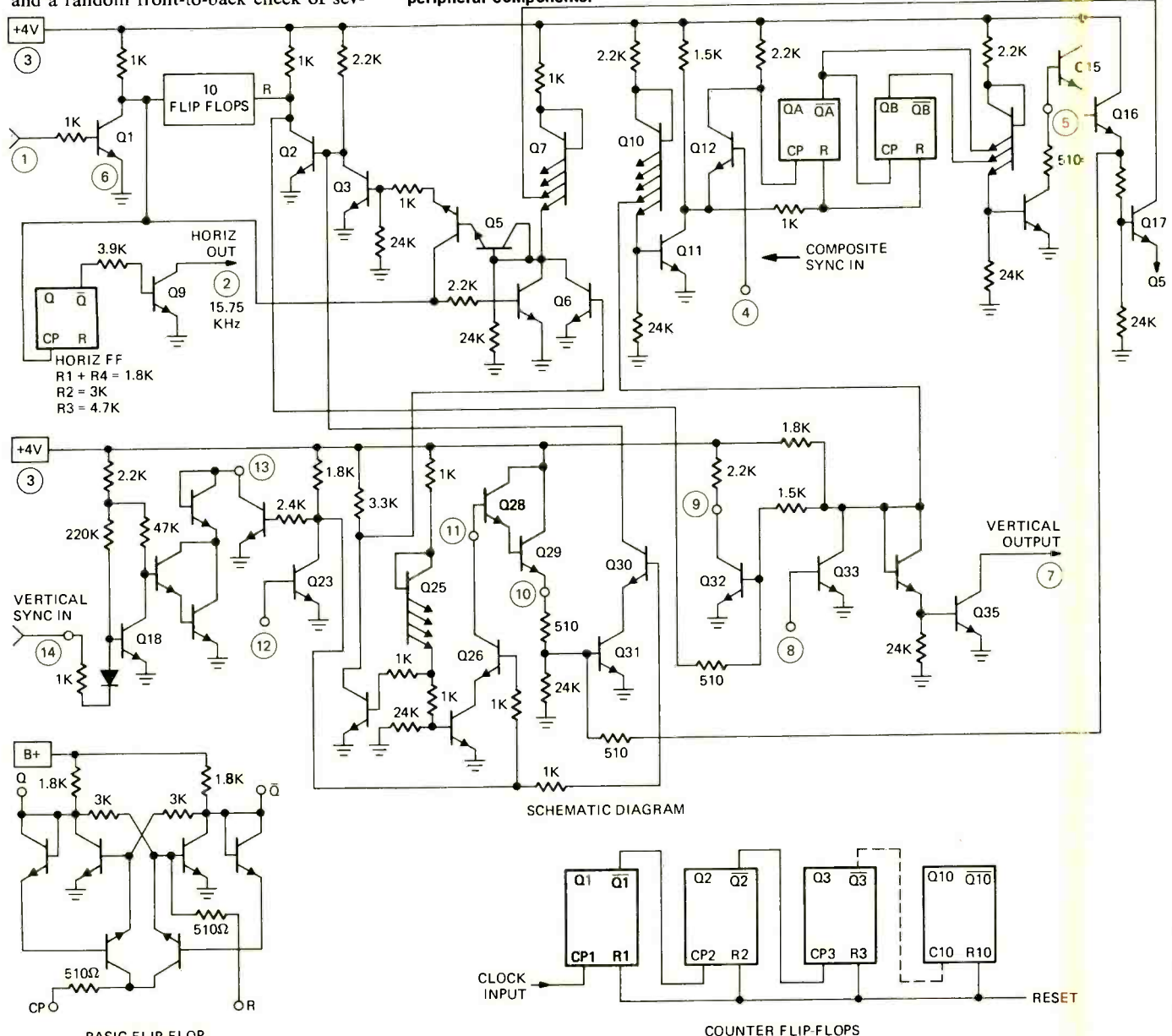
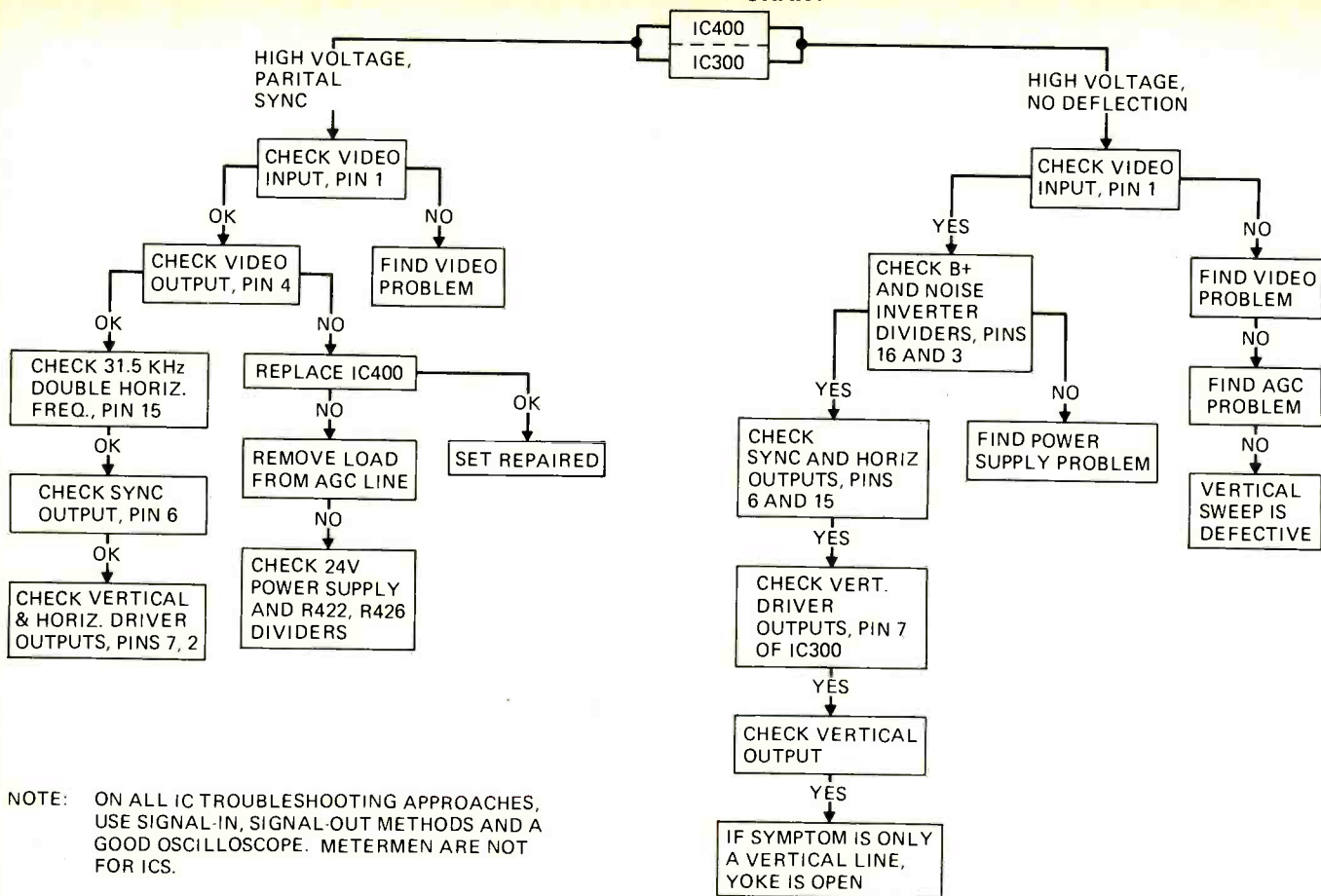

FIG. 3—IC300 and IC400 vertical and horizontal countdown IC's, block diagram and peripheral components.



TROUBLESHOOTING CHART



NOTE: ON ALL IC TROUBLESHOOTING APPROACHES, USE SIGNAL-IN, SIGNAL-OUT METHODS AND A GOOD OSCILLOSCOPE. METERMEN ARE NOT FOR ICs.

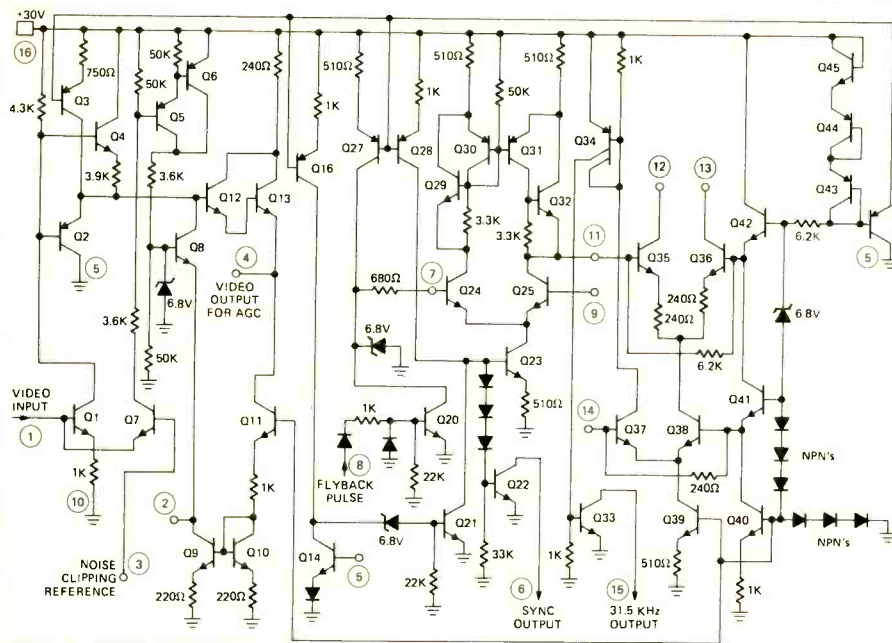

FIG. 4—IC400 SCHEMATIC DIAGRAM.

eral diodes revealed nothing. Disconnecting the picture-tube heater connections and applying power wasn't helpful either. With S502 on or off, the circuit-breaker still tripped. So, when all's said and done, you have one of two conditions—either the transformer is shorted, or there are problems somewhere across the 150K resistor that ties the +36 V source to the picture-tube heater. There is one sure way to find out, however, but you've got to be extremely careful. Specs on the circuit breaker says that it trips at 3.12 amps. Supposing that the transformer is all right. Put a 4 or 5 ampere fuse in place of the

circuit breaker and watch for smoke. With the set plugged in, wisps of telltale burning aren't long in coming.

In this case, smoke was quicker than the eye. It took a minute or two of probing before diode SC522, half of the full-wave rectifier for the 36 volt source, was discovered burned in two. Since ohmmeter checks revealed no low readings to ground at any of the power board's critical points, we can assume SC522 had developed leakage. Even though the centertap of the winding feeding it was open through S502-a, this diode (at least) was passing

(continued on page 78)

R-E's Substitution guide for replacement transistors

PART XXV

by ROBERT & ELIZABETH SCOTT

- ARCH**—Indicates the Archer brand of semiconductors sold only by Radio Shack and Allied Radio stores. Allied Radio Shack, 2725 W. 7th St., Ft. Worth, Texas 76107
- DM**—D. M. Semiconductor Co., P.O. Box 131, Melrose, Mass. 02176
- G-E**—General Electric Co., Tube Product Div., Owensboro, Ky. 42301
- ICC**—International Components, 10 Daniel Street, Farmingdale, N.Y. 11735
- IR**—International Rectifier, Semiconductor Div., 233 Kansas St., El Segundo, Calif. 90245
- MAL**—Mallory Distributor Products Co., 4760 Kentucky Ave., Indianapolis, Ind. 46241
- MOT**—Motorola Semiconductors, Box 2963, Phoenix, Ariz. 85036
- RCA**—RCA Electronic Components, Harrison, N.J. 07029
- SPR**—Sprague Products Co., 65 Marshall St., North Adams, Mass. 01247
- SYL**—Sylvania Electric Corp., 100 1st Ave., Waltham, Mass. 02154
- WOR**—Workman Electronic Products, Inc., Box 3828, Sarasota, Fla. 33578
- ZEN**—Zenith Sales Co., 5600 W. Jarvis Ave., Chicago, Ill. 60648

Radio-Electronics has done its utmost to insure that the listings in this directory are as accurate and reliable as possible; however, no responsibility is assumed by Radio-Electronics for its use. We have used the latest manufacturers material available to us and have asked each manufacturer covered in the listing to check its accuracy. Where we have been supplied with corrections, we have updated the listing to include them. The first part of this Guide appeared in March 1973.

	ARCH	DM	G-E	ICC	IR	MAL	MOT	RCA	SPR	SYL	WOR	ZEN
2N5784	NA	TS-3002	NA	ICC-S3002	NA	NA	HEP-S3002	SK 3024	RT-154	NA	WEP-WS3002	NA
2N5785	NA	TS-3010	GE-86	ICC-S3010	NA	NA	HEP-S2010	SK 3024	RT-154	NA	WEP-WS3003	ZEN 207
2N5786	RS276-2025	T-242	GE-28	ICC-242	NA	PTC 142	HEP-242	SK 3024	RT-154	ECG 186	WEP-242	NA
2N5787	NA	NA	NA	NA	NA	NA	NA	NA	NA	ECG 5400	NA	NA
2N5788	NA	NA	NA	NA	NA	NA	NA	NA	NA	ECG 5401	NA	NA
2N5789	NA	NA	NA	NA	NA	NA	NA	NA	NA	ECG 5402	NA	NA
2N5790	NA	SR-1005	NA	ICC-R1005	NA	NA	HEP-R1005	NA	NA	ECG 5404	NA	NA
2N5804	NA	T-707	NA	ICC-707	NA	PTC 118	HEP-707	NA	NA	ECG 162	WEP-707	ZEN 204
2N5805	NA	T-707	NA	ICC-707	NA	PTC 118	HEP-707	NA	NA	ECG 162	WEP-707	ZEN 204
2N5806	NA	SR-1473	NA	ICC-R1473	NA	NA	HEP-R1473	SK 3509	NA	ECG 5543	NA	NA
2N5807	NA	SR-1475	NA	ICC-R1475	NA	NA	HEP-R1475	SK 3509	NA	ECG 5545	NA	NA
2N5808	NA	NA	NA	NA	NA	NA	NA	SK 3509	NA	ECG 5546	NA	NA
2N5809	NA	NA	NA	NA	NA	NA	NA	SK 3509	NA	ECG 5547	NA	NA
2N5810	RS276-2009	T-53	GE-20	ICC-53	NA	PTC 136	HEP-53	NA	RT-100	ECG 123A	WEP-53	ZEN 102
2N5811	RS276-2021	T-51	GE-67	ICC-51	NA	PTC 127	HEP-51	NA	RT-101	ECG 129	WEP-51	ZEN 101
2N5812	RS276-2009	T-736	GE-63	ICC-736	NA	PTC 123	HEP-736	NA	RT-109	ECG 128	WEP-736	ZEN 120
2N5813	RS276-2021	T-716	GE-67	ICC-716	NA	PTC 127	HEP-716	NA	RT-115	ECG 159	WEP-716	ZEN 107
2N5814	RS276-2009	T-736	GE-20	ICC-736	NA	PTC 136	HEP-736	NA	RT-100	ECG 128	WEP-736	ZEN 120
2N5815	RS276-2021	T-716	GE-67	ICC-716	NA	PTC 127	HEP-716	NA	RT-115	ECG 159	WEP-716	ZEN 107
2N5816	RS276-2009	T-736	GE-20	ICC-736	NA	PTC 136	HEP-736	NA	RT-100	ECG 128	WEP-736	ZEN 120
2N5817	RS276-2021	T-716	GE-67	ICC-736	NA	PTC 127	HEP-736	NA	RT-100	ECG 128	WEP-736	ZEN 107
2N5818	RS276-2009	T-736	GE-63	ICC-736	NA	PTC 136	HEP-736	NA	RT-100	ECG 128	WEP-736	ZEN 120
2N5819	RS276-2021	T-716	GE-67	ICC-716	NA	PTC 127	HEP-716	NA	RT-115	ECG 159	WEP-716	ZEN 107
2N5820	RS276-2018	T-243	GE-63	ICC-243	TR-25	PTC 136	HEP-243	SK 3024	RT-114	ECG 128	WEP-243	NA
2N5821	RS276-2025	T-242	GE-67	ICC-242	TR-28	PTC 127	HEP-242	SK 3025	RT-115	ECG 129	WEP-242	NA
2N5822	RS276-2018	T-243	GE-63	ICC-243	NA	PTC 136	HEP-243	NA	RT-114	ECG 128	WEP-243	NA
2N5823	RS276-2025	T-242	GE-67	ICC-242	NA	PTC 127	HEP-242	NA	RT-115	ECG 129	WEP-242	NA
2N2824	RS276-2013	T-729	GE-62	ICC-729	NA	PTC 121	HEP-729	NA	RT-109	ECG 123A	WEP-729	ZEN 115
2N5825	RS276-2013	T-729	GE-62	ICC-729	NA	PTC 121	HEP-729	NA	RT-109	ECG 123A	WEP-729	ZEN 115
2N5826	RS276-2013	T-728	GE-62	ICC-728	NA	PTC 121	HEP-728	NA	RT-109	ECG 123A	WEP-728	ZEN 114
2N5827	RS276-2013	T-728	GE-62	ICC-728	NA	PTC 121	HEP-728	NA	RT-109	ECG 123A	WEP-728	ZEN 114
2N5828	RS276-2013	T-738	GE-62	ICC-738	NA	PTC 123	HEP-738	NA	RT-109	ECG 123A	WEP-728	ZEN 121
2N5829	NA	NA	NA	NA	NA	NA	NA	NA	NA	NA	NA	NA
2N5830	RS276-2008	TS-0005	GE-20	ICC-S0005	NA	NA	HEP-S0005	SK 3018	RT-114	ECG 123A	WEP-712	NA
2N5831	RS276-2008	TS-0005	NA	ICC-S0005	NA	NA	HEP-S0005	NA	NA	NA	WEP-712	NA
2N5832	RS276-2008	TS-0005	NA	ICC-S0005	NA	NA	HEP-S0005	NA	NA	ECG 194	WEP-712	NA
2N5833	RS276-2008	TS-0005	NA	ICC-S0005	NA	NA	HEP-S0005	NA	NA	ECG 194	WEP-712	NA
2N5834	NA	TS-3031	NA	ICC-S3031	NA	NA	HEP-S3031	NA	NA	ECG 189	WEP-WS3031	NA
2N5838	NA	T-707	NA	ICC-707	NA	PTC 118	HEP-707	NA	NA	ECG 162	WEP-707	ZEN 204
2N5839	NA	T-707	NA	ICC-707	NA	PTC 118	HEP-707	NA	NA	ECG 162	WEP-707	ZEN 204
2N5840	NA	T-707	NA	ICC-707	NA	PTC 118	HEP-707	NA	NA	ECG 162	WEP-707	ZEN 204
2N5844	NA	T-715	NA	ICC-715	NA	NA	HEP-715	NA	RT-115	ECG 159	WEP-715	ZEN 106
2N5845	NA	TS-0004	GE-20	ICC-S0004	NA	PTC 136	HEP-S0004	NA	RT-114	NA	WEP-516	ZEN 127
2N5847	NA	NA	NA	ICC-S0006	NA	NA	HEP-S0006	NA	NA	ECG 194	WEP-717	NA
2N5848	NA	NA	NA	ICC-S0007	NA	NA	HEP-S0007	NA	NA	NA	WEP-735	NA
2N5851	NA	T-720	NA	ICC-720	NA	PTC 121	HEP-720	NA	RT-105	ECG 108	WEP-720	ZEN 109
2N5852	NA	T-720	NA	ICC-720	NA	NA	HEP-720	NA	RT-105	ECG 108	WEP-720	ZEN 109
2N5853	NA	TS-5005	NA	ICC-S5005	NA	PTC 121	HEP-S5005	NA	NA	ECG 183	WEP-WS5005	NA
2N5854	NA	TS-5005	NA	ICC-S5005	NA	NA	HEP-S5005	NA	NA	ECG 183	WEP-WG 5005	NA
2N5855	NA	TS-3031	NA	ICC-S3031	NA	PTC 141	HEP-S3031	NA	RT-115	ECG 189	WEP-WS 3031	NA
2N5856	NA	TS-3020	NA	ICC-S3020	NA	PTC 144	HEP-S3020	NA	RT-114	ECG 188	WEP-WS3020	NA
2N5857	NA	TS-3031	NA	ICC-S3031	NA	PTC 141	HEP-S3031	NA	RT-115	ECG 189	WEP-WS 3031	NA
2N5858	NA	T-714	NA	ICC-714	NA	PTC 144	HEP-714	NA	RT-144	ECG 190	WEP-WS3021	NA
2N5859	NA	TS-3002	NA	ICC-S0002	NA	PTC 143	HEP-S0002	NA	RT-102	ECG 192	WEP-735	NA
2N5860	NA	TS-3002	NA	ICC-S0002	NA	NA	HEP-S0002	NA	RT-102	ECG 192	WEP-735	NA
2N5861	NA	TS-3002	NA	ICC-S0002	NA	NA	HEP-S0002	NA	RT-102	ECG 192	WEP-735	NA
2N5864	NA	TS-3012	NA	ICC-S3012	NA	NA	HEP-S3012	NA	NA	NA	NA	NA
2N5865	NA	TS-3012	NA	ICC-S3012	NA	PTC 141	HEP-S3012	NA	NA	NA	NA	NA
2N5867	NA	TS-5007	NA	ICC-S5007	NA	NA	HEP-S5007	NA	RT-153	ECG 185	WEP-WS 5007	ZEN 211
2N5868	NA	TS-5005	NA	ICC-S5005	NA	NA	HEP-S5005	NA	NA	ECG 180	WEP-WS 5005	NA
2N5869	NA	TS-5003	NA	ICC-S5003	NA	NA	HEP-S5003	NA	RT-152	ECG 184	WEP-WS 5003	ZEN 210
2N5870	NA	TS-5004	NA	ICC-S5004	NA	NA	HEP-S5004	NA	NA	ECG 182	WEP-WS 5004	NA
2N5871	NA	TS-5002	NA	ICC-S5002	NA	NA	HEP-S5002	NA	NA	ECG 183	WEP-WS 5005	NA
2N5872	NA	TS-5005	NA	ICC-S5005	NA	NA	HEP-S5005	NA	NA	ECG 180	WEP-WS 5005	NA
2N5873	NA	TS-5001	NA	ICC-S5001	NA	NA	HEP-S5001	NA	NA	ECG 181	WEP-WS 5004	ZEN 209
2N5874	NA	TS-5004	NA	ICC-S5004	NA	NA	HEP-S5004	NA	NA	ECG 184	WEP-WS5004	NA
2N5875	NA	T-248	NA	ICC-248	NA	NA	HEP-248	NA	RT-165	ECG 219	WEP-WS 7001	NA
2N5876	NA	T-248	NA	ICC-248	NA	NA	HEP-248	NA	RT-165	ECG 219	WEP-WS 7001	NA
2N5877	NA	T-247	NA	ICC-247	NA	NA	HEP-247	NA	RT-131	ECG 130	WEP-247	NA
2N5878	NA	T-247	NA	ICC-247	NA	NA	HEP-247	NA	RT-131	ECG 130	WEP-247	NA
2N5879	NA	T-248	NA	ICC-248	NA	NA	HEP-248	NA	RT-165	ECG 130	WEP-WS 7001	NA
2N5880	NA	T-248	NA	ICC-248	NA	NA	HEP-248	NA	RT-165	ECG 130	WEP-WS 7001	NA
2N5881	NA	T-247	NA	ICC-247	TR-21	NA	HEP-247	SK 3024	RT-114	ECG 128	WEP-247	NA
2N5882	NA	T-704	NA	ICC-704	TR-21	NA	HEP-704	SK 3024	RT-114	ECG 128	WEP-704	NA
2N5883	NA	TS-7001	NA	ICC-S7001	NA	NA	HEP-S7001	NA	RT-148	NA	NA	NA

NA=NOT AVAILABLE

(turn page)

	ARCH	DM	G-E	ICC	IR	MAL	MOT	RCA	SPR	SYL	WOR	ZEN
2N5884	NA	TS-7001	NA	ICC-S7001	NA	NA	HEP-S7001	NA	RT-148	ECG 180	WEP-WS7001	NA
2N5885	NA	TS-7000	NA	ICC-S7000	NA	NA	HEP-S7000	NA	RT-149	ECG 181	WEP-WS7000	NA
2N5886	NA	TS-7000	NA	ICC-S7000	NA	NA	HEP-S7000	NA	RT-149	ECG 181	WEP-WS7000	NA
2N5887	NA	T-743	NA	ICC-643	NA	PTC 120	HEP-643	NA	NA	ECG 131	WEP-643	NA
2N5888	NA	T-643	NA	ICC-643	NA	PTC 120	HEP-643	NA	NA	ECG 131	WEP-643	NA
2N5889	NA	T-642	NA	ICC-642	NA	PTC 120	HEP-642	NA	NA	ECG 131	WEP-642	NA
2N5893	RS276-2006	T-642	NA	ICC-642	IRTR-50	PTC 120	HEP-642	SK 3082	RT-127	ECG 131	WEP-642	NA
2N5897	RS276-2006	T-643	NA	ICC-643	IRTR-50	PTC 120	HRP-643	SK 3052	RT-127	ECG 131	WEP-643	NA
2N5901	NA	T-643	NA	ICC-643	NA	PTC 120	HEP-643	NA	NA	ECG 131	WEP-643	NA
2N5910	NA	T-52	NA	ICC-52	NA	PTC 131	HEP-52	NA	NA	ECG 139	WEP-52	NA
2N5911	NA	NA	NA	NA	NA	NA	NA	NA	NA	NA	NA	NA
2N5913	NA	TS-3008	NA	ICC-S3008	NA	PTC 158	HEP-S3008	NA	RT-114	NA	NA	NA
2N5914	RS276-2009	NA	NA	ICC-S3005	NA	NA	HEP-S3005	NA	NA	NA	NA	NA
2N5915	NA	NA	NA	ICC-S3006	NA	NA	HEP-S3006	NA	NA	NA	NA	NA
2N5916	RS276-2009	NA	NA	ICC-S3005	NA	NA	HEP-S3005	NA	NA	NA	NA	NA
2N5917	RS276-2009	NA	NA	ICC-S3005	NA	NA	HEP-S3005	NA	NA	NA	NA	NA
2N5920	NA	NA	NA	NA	NA	NA	NA	NA	NA	NA	NA	NA
2N5922	NA	NA	NA	ICC-S3005	NA	NA	HEP-S3005	NA	NA	NA	NA	NA
2N5923	NA	NA	NA	ICC-S3005	NA	NA	HEP-S3005	NA	NA	NA	NA	NA
2N5924	NA	NA	NA	ICC-S3006	NA	NA	HEP-S3006	NA	NA	NA	NA	NA
2N5925	NA	NA	NA	ICC-S3006	NA	NA	HEP-S3006	NA	NA	NA	NA	NA
2N5926	NA	NA	NA	NA	NA	NA	NA	NA	NA	NA	NA	NA
2N5927	NA	NA	NA	NA	NA	NA	NA	NA	NA	NA	NA	NA
2N5943	NA	TS-3008	NA	ICC-3008	NA	NA	HEP-S3008	NA	RT-114	NA	NA	NA
2N5947	RS276-2009	NA	NA	ICC-S3005	NA	NA	HEP-S3005	NA	NA	NA	NA	NA
2N5949	NA	NA	NA	NA	NA	PTC 151	NA	SK 3116	RT-176	ECG 132	NA	NA
2N5950	NA	NA	NA	NA	NA	PTC 151	NA	SK 3116	RT-176	ECG 132	NA	NA
2N5951	NA	NA	NA	NA	NA	PTC 151	NA	SK 3116	RT-176	ECG 132	NA	NA
2N5952	NA	NA	NA	NA	NA	PTC 151	NA	SK 3116	RT-176	ECG 132	NA	NA
2N5953	NA	NA	NA	NA	NA	PTC 151	NA	SK 3116	RT-176	ECG 132	NA	NA
2N5954	NA	T-241	NA	ICC-241	NA	NA	HEP-241	SK 3085	RT-153	ECG 175	WEP-241	NA
2N5955	NA	T-241	NA	ICC-241	NA	PTC 137	HEP-241	SK 3085	RT-153	ECG 175	WEP-241	NA
2N5956	NA	T-241	NA	ICC-241	NA	PTC 137	HEP-241	SK 3085	RT-153	ECG 175	WEP-241	NA
2N5961	NA	TS-0007	NA	ICC-S0007	NA	NA	HEP-S0007	NA	NA	NA	WEP-735	NA
2N5962	NA	T-728	NA	ICC-728	NA	NA	HEP-728	NA	RT-109	ECG 123A	WEP-728	ZEN 114
2N5963	NA	T-737	NA	ICC-737	NA	NA	HEP-737	NA	RT-109	ECG 199	WEP-735	NA
2N5964	NA	TS-0005	NA	ICC-S0005	NA	PTC 150	HEP-S0005	NA	NA	ECG 194	WEP-712	NA
2N5965	NA	TS-3021	NA	ICC-S3021	NA	PTC 150	HEP-S3021	NA	RT-159	ECG 191	WEP-WS3021	ZEN 208
2N5970	NA	T-704	NA	ICC-704	NA	PTC 119	HEP-704	NA	RT-131	ECG 130	WEP-704	NA
2N5971	NA	T-704	NA	ICC-704	NA	PTC 140	HEP-704	NA	RT-131	ECG 130	WEP-704	NA
2N5972	NA	T-704	NA	ICC-704	NA	NA	HEP-704	NA	RT-131	ECG 130	WEP-704	NA
2N5973	NA	TS-7000	NA	ICC-S7000	NA	NA	HEP-S7000	NA	RT-149	ECG 181	WEP-WS7000	NA
2N5974	NA	TS-5002	NA	ICC-S5002	NA	NA	HEP-S5002	NA	NA	ECG 183	WEP-WS5005	NA
2N5975	NA	TS-5005	NA	ICC-S5005	NA	NA	HEP-S5005	NA	NA	ECG 180	WEP-WS5005	NA
2N5976	NA	TS-5005	NA	ICC-S5005	NA	NA	HEP-S5005	NA	NA	ECG 180	WEP-WS5005	NA
2N5977	NA	TS-5001	NA	ICC-S5001	NA	NA	HEP-S5001	NA	NA	ECG 182	WEP-WS5004	ZEN 209
2N5978	NA	TS-5004	NA	ICC-S5004	NA	NA	HEP-S5004	NA	NA	ECG 182	WEP-WS5004	NA
2N5979	NA	TS-5004	NA	ICC-S5004	NA	NA	HEP-S5004	NA	NA	ECG 182	WEP-WS5004	NA
2N5980	NA	TS-5002	NA	ICC-S5002	NA	NA	HEP-S5002	NA	NA	ECG 183	WEP-WS5005	NA
2N5981	NA	TS-5005	NA	ICC-S5005	NA	NA	HEP-S5005	NA	NA	ECG 180	WEP-WS5005	NA
2N5982	NA	TS-5005	NA	ICC-S5005	NA	NA	HEP-S5005	NA	NA	ECG 180	WEP-WS5005	NA
2N5983	NA	TS-5001	NA	ICC-S5001	NA	NA	HEP-S5001	NA	NA	ECG 182	WEP-WS5004	NA
2N5984	NA	TS-5004	NA	ICC-S5004	NA	NA	HEP-S5004	NA	NA	ECG 182	WEP-WS5004	NA
2N5985	NA	NA	NA	ICC-S5004	NA	NA	HEP-S5004	NA	NA	ECG 182	WEP-WS5004	NA
2N5993	NA	NA	NA	ICC-S3007	NA	NA	HEP-S3007	NA	NA	NA	NA	ZEN 209
2N5995	NA	NA	NA	ICC-S3006	NA	NA	HEP-S3006	NA	NA	NA	NA	NA
2N5996	NA	NA	NA	ICC-S3007	NA	NA	HEP-S3007	NA	NA	NA	NA	NA
2N5998	NA	TS-0002	NA	ICC-S3002	NA	PTC 123	HEP-S3002	NA	RT-114	NA	WEP-WS3002	ZEN 126
2N5999	NA	TS-3027	NA	ICC-S3027	NA	PTC 127	HEP-S3027	NA	RT-115	ECG 211	WEP-WS3027	NA
2N6000	NA	TS-0004	GE-20	ICC-S0004	NA	PTC 123	HEP-S0004	NA	RT-114	NA	WEP-56	ZEN 127
2N6001	NA	T-51	NA	ICC-51	NA	PTC 127	HEP-51	NA	RT-101	ECG 129	WEP-51	ZEN 101
2N6002	NA	T-736	NA	ICC-736	NA	PTC 123	HEP-736	NA	RT-109	ECG 128	WEP-736	ZEN 120
2N6003	NA	T-716	NA	ICC-716	NA	PTC 127	HEP-716	NA	RT-115	ECG 159	WEP-716	ZEN 107
2N6004	NA	TS-0004	GE-20	ICC-S0004	NA	PTC 123	HEP-S0004	NA	NA	NA	WEP-56	ZEN 127
2N6005	NA	T-716	NA	ICC-716	NA	PTC 127	HEP-716	NA	RT-115	ECG 159	WEP-716	ZEN 107
2N6006	NA	T-736	NA	ICC-736	NA	PTC 123	HEP-736	NA	RT-109	ECG 128	WEP-736	ZEN 120
2N6007	NA	T-716	NA	ICC-716	NA	PTC 127	HEP-716	NA	RT-115	ECG 159	WEP-716	ZEN 107
2N6008	NA	TS-0004	NA	ICC-S0004	NA	PTC 123	HEP-S0004	NA	NA	NA	WEP-56	ZEN 127
2N6009	NA	TS-3028	NA	ICC-S3028	NA	PTC 127	HEP-S3028	NA	NA	ECG 211	WEP-WS3027	NA
2N6010	NA	TS-3020	NA	ICC-S3020	NA	PTC 123	HEP-S3020	NA	NA	ECG 188	WEP-WS3020	NA
2N6011	NA	TS-3027	GE-67	ICC-S3027	NA	PTC 127	HEP-S3027	NA	NA	ECG 211	WEP-WS3027	NA

*Indicates a dual transistor for high-speed switching, diff amplifier etc. Likely to be a matched pair. Use two of the type specified, matching when necessary, on a curve tracer or lab-type transistor checker.

NA=NOT AVAILABLE

(continued next month)

RE's Service Clinic

Servicing Electronic Organs

They are not as difficult as they look

by JACK DARR
SERVICE EDITOR

ELECTRONIC ORGANS AREN'T HARD TO repair. Any radio-TV shop can find and fix troubles, using only standard TV test equipment. Although they look complicated, they use only standard audio circuits; tone generators, wave-shaping networks, power amplifiers. (Actually, they don't look as complicated as the back view of one of the big stereo-theater consoles, with remote controls!) Tube and transistor electronic organs use the same basic circuits, with the usual differences.

Most organs use the master oscillator-frequency divider system. A tunable oscillator circuit, generally a Hartley, generates the highest frequency note. This is then fed to a series of frequency dividers. This is possible because of an inherent characteristic of music. Each note is exactly one-half of the frequency of the same note in the octave above it. Example: middle A is 440 Hz. The next higher A is 880 Hz and the next lower A is 220 Hz.

The first electronic organs used vacuum-tube circuits (and many, many tubes! 12AX7's all over the place!) Figure 1 shows a typical divider circuit using one-half of a 12-AX7. The master oscillator output is

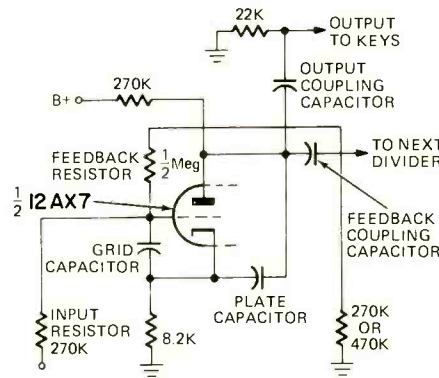

Figure 1

shaped into a rounded-corner sawtooth. The peaks of this are used to sync the divider stage. The time-constant is designed so that this stage delivers one output sawtooth for every two sync-pulses from the stage before it. So, it divides by two.

The transistor organs use a circuit that's a natural for frequency division. This is a bistable multivibrator, or flip-flop. This circuit divides by two with the greatest of ease; the first sync-pulse from the preceding stage makes

it flip, then the next one makes it flop. To divide by two, we take the output from flop, and there you are. Figure 2 shows a typical flip-flop, as used in Magnavox transistor organs.

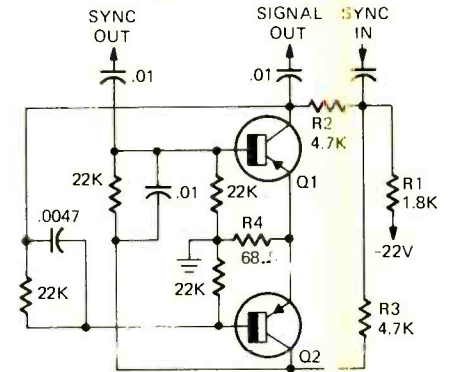
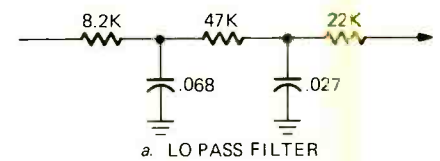

Figure 2

The basic signal in both electronic organs is the sawtooth. This gives the characteristic organ sound. The output of the tube divider is a sawtooth, and the flip-flop output is usually almost a square wave. This can easily be shaped into the desired sawtooth.

This is done in the voicing circuits. These are wave-shaping networks, some including amplifiers. Figure 3 shows some of the typical filters used. The low-pass circuit of Fig. 3-a is used to produce the Flute; the high-pass filter of Fig. 3-b is used for the violin



a. LO PASS FILTER

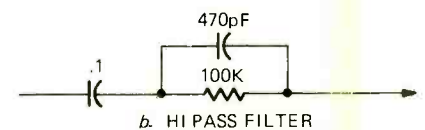

b. HI PASS FILTER

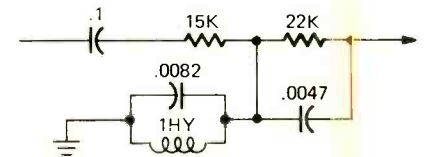

c. RESONANT FILTER

Figure 3

and viola tones, and the resonant filter of Fig. 3-c for such tones as horn and reed. From the output of the voicing unit, we go to an audio amplifier.

The keyboards of an organ aren't

This column is for your service problems—TV, radio, audio or general and industrial electronics. We answer all questions individually by mail, free of charge and the more interesting ones will be printed here.

If you're really stuck, write us. We'll do our best to help you. Don't forget to enclose a stamped, self-addressed envelope. If return postage is not included, we cannot process your question. Write: Service Editor, Radio-Electronics, 200 Park Ave. South, N.Y. 10003.

MATHEMATICS ELECTRONICS

We are proud to announce two great new courses for the electronic industry.

These unusual courses are the result of many years of study and thought by the President of Indiana Home Study, who has *personally* lectured in the classroom to *thousands* of men, from all walks of life, on mathematics, and electrical and electronic engineering.

You will have to see the lessons to appreciate them!

NOW you can master mathematics and electronics and actually *enjoy* doing it!

WE ARE THIS SURE: you sign no contracts—you order your lessons on a money-back guarantee.

In plain language, *if you aren't satisfied you don't pay*, and there are no strings attached.

Write today for more information and your outline of courses.

You have nothing to lose, and everything to gain!

The INDIANA HOME STUDY INSTITUTE

DEPT. RE-475, P.O. BOX 1189
PANAMA CITY, FLA 32401

Circle 21 on reader service card

called keyboards; they're called manuals. In older models, the top one is the Swell manual and the lower one the Great manual. Some later units call the top one the Solo and the lower the Accompaniment. The different voices are controlled by tabs, and guess what they're called. Tabs! Incidentally, for the complete novice, when you start to check out an organ by playing it, be sure that at least *one* tab is in the ON position for each manual. In some organs, if they are all up or off, you may not hear anything when a key is pushed down. (The preceding data is included so that you'll have a better chance of knowing *what* the organist is talking about when she calls you for service! You gotta speak the language.)

To make a first check for trouble, turn the organ *on*. Check to see that one tab is down, for example, the flute or diapason on the top, and the horn on the lower manual. (The tabs are in two groups of 5 or 6, one for each manual). Now, look under the organ; you'll see a foot-pedal. To us, it's a volume control, but they call it an expression pedal. The pedals control the bass, and look like a big wooden keyboard! Now, run up and down the keyboard and see if each note sounds, and how it sounds. You'll be able to tell, even if you're no more

musical than I am.

One common trouble is a defective frequency divider. The clue to this is when higher notes sound all right, for example the two high A's. However, the third A may sound the same (frequency) as the second! In most cases, the third note will have a *bubbling* sound. Check the *third* divider, or whichever one is bubbling. This type of trouble in tube organs is most often due to leaky capacitors or resistors which have changed value, thus upsetting the time-constants of the stage. When one note bubbles, all of the same notes lower than it will burble too.

To check the voicing circuits, put each tab down, by itself, and run up and down the keyboard. Each one should have a definite effect on the sound. If you lose the sound completely when any tab is pushed down, check for a broken wire, open transistor in the bus amplifier, etc.

If you have any doubts as to whether any master oscillator isn't working, check it with a scope. In some organs, such as the Magnavox transistor organ, you can connect a jumper lead with a 100K resistor in series to the audio amplifier input. Touching this to the signal-output leads of any tone generator will produce this tone in the speaker, if it is working. You are by-

(continued on page 76)

10MHz 5" scope
with easier calibration
and voltage measurement



Model 1465 \$428

Here are some B&K extra touches. Besides DC-to-10MHz bandwidth, triggered sweep, automatic sync, 16.6mV/cm vertical sensitivity, DC-coupled amplifier and front-panel Vectorscope capability, Model 1465 also has 5X magnification to increase sweep speed to 0.2usec/cm for complex waveform analysis. And Cali-Brain®, which collapses horizontal sweep to let you measure instantaneous peak-to-peak voltage easily while simultaneously displaying the full-scale voltage range. Now in stock at your local distributor or write Dynascan.

B&K PRODUCTS OF
DYNASCAN
1801 W. Belle Plaine Ave.
Chicago, IL 60613 • (312) 327-7270

Circle 22 on reader service card

You'd probably expect a
portable oscilloscope as rugged and
reliable as this one to cost a lot.

You'd be wrong.

Introducing the B&K Model 1403 3" Solid-state oscilloscope. It's so compact, reliable, and inexpensive that it's the perfect scope for most on-the-line monitoring applications. Look at its specs: DC to 2MHz bandwidth at 20mV/cm. Recurrent sweep speeds from 10Hz to 100k Hz. New wide-angle CRT to reduce case depth to a minimum. Direct-deflection terminals for waveforms up to 150 MHz. Weighs only 8½ pounds. And has a smoked acrylic graticule for trace sharpness and easy reading. All the reliability and accuracy you need in a monitor scope—at a surprisingly low price.

Contact your distributor, or write
Dynascan Corporation.

\$189⁰⁰



B&K Very good equipment at a very good price.
Dynascan Corporation.
1801 West Belle Plaine Avenue, Chicago, Illinois 60613

Circle 23 on reader service card

Introducing the expensive curve tracer that doesn't cost a lot.

The B&K Model 501A.

It's a lab-quality instrument that provides fast analysis of all semiconductors including J-FET's, MOS-FET's, signal and power bipolar transistors, SCR's, UJT's and diodes.

You can test transistors in circuit for GO/NO GO condition. Badly distorted curves will indicate the stage where a defective transistor or other faulty component exists.

The 501A is complete—with scope graticule and FP-3 probe for fast, one-handed in-circuit testing. It generates true current and voltage steps, with 3% accuracy, for measuring beta at all current levels. And it has a sweep up to 100 volts and 100 milliamperes.

With the 501A, curves are displayed on an auxiliary scope screen. And you can hook it up to any scope—old or new.

All three controls can be set in quick-test positions to test and evaluate 90% of all solid-state devices without manufacturer's data sheets.

The 501A won't burn out either the semiconductors or itself.

With all these features, you'd think the 501A was an expensive curve tracer. But look at the price.

For complete technical data, call your B&K distributor. Or write Dynascan Corporation.

\$163⁰⁰

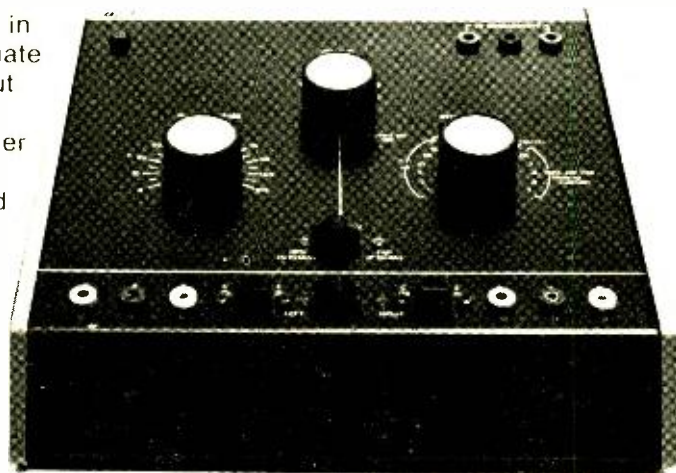

Very good equipment at a very good price. **B&K**

Product of Dynascan Corporation
1801 West Belle Plaine Avenue, Chicago, Illinois 60613

Circle 24 on reader service card

SERVICE CLINIC

(continued from page 74)

passing the voicing circuits.

Electronic organs have a true vibrato effect. Although guitar amplifiers use the terms vibrato and tremolo interchangeably, in music they are not. (They do sound a lot alike, though!) Vibrato is a periodic variation in the frequency (pitch) of a note, and tremolo is a periodic variation in its volume. Organs get a true vibrato by feeding a slowly-varying dc voltage (about 6-8 Hz) to the base of the master oscillator. This causes a small change in the frequency.

This is easy to check. Just hold any key down, and turn the vibrato switch on. You'll hear it. Some have a vibrato control; if you don't hear the vibrato, check to see that this isn't turned all the way off. The vibrato oscillator is just a very low-frequency multivibrator. You can identify it by the very large capacitors and resistors used for coupling. In fact, you can often check a vibrato oscillator with a dc voltmeter; the needle will vibrate visibly. A scope will usually show an almost straight line moving up and down.

All in all, after you get used to the things, they're not at all hard to service. You can do anything except tune

them. This is seldom needed, but when it is, a complicated strobe instrument is the only way. For normal repairs, just sit down at the keyboard and start looking for the Lost Chord. (I found it once, but I lost it again.) Just push the keys and find out what is working and what isn't! then look in the back to find out why. As the old saying goes, "Try it! You'll like it!" **R-E**

reader questions

ELECTROLYTIC BLOWS

The customer said there was a Bang, and this Truetone WEG-2297-A27 went out. When I turned it on, I got a weird raster, with a dark spot in the center. Opening it up, I found that a small electrolytic capacitor on the high-voltage sweep module had exploded. It's connected to the cathode of the 6GK6 horizontal output. I replaced it, and the new one exploded, too! I have no schematic on this set. What's causing this?—G.W., Waldron, AR.

Schematic on this one is in Sams 1216-3. This capacitor is apparently

6GK6A/EL509
HORIZ OUTPUT
FLYBACK

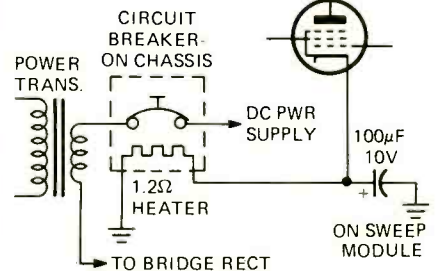

used to bypass the horizontal output tube cathode. It returns to ground through a little heater in the *circuit breaker*. If this heater is open, the pulse voltage will blow this little capacitor; 100-µF, 10V. Check from pin 2 of the sweep module to ground for not more than 1.3 ohms.

SCOPE PROBLEM

In an old Supreme 546 scope, I get about 1/2 inch vertical deflection without input. Focus control has practically no effect. What does this?—E.S., New Ringgold, Pa.

Probably a resistor changed value in that long network from the negative high-voltage supply. Most likely one, that 470,000-ohm unit between the focus control and the focus pin on the 3AP1 base. *(continued on page 94)*

INTERNATIONAL FM 2400CH

FREQUENCY METER for testing mobile transmitters and receivers

- Tests Predetermined Frequencies 25 to 1000 MHz
- Extended Range Covers 950 MHz Band
- Pin Diode Attenuator for Full Range Coverage as Signal Generator
- Measures FM Deviation

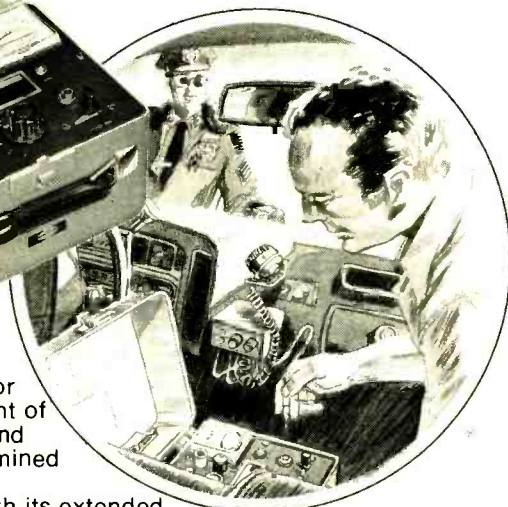

The **FM-2400CH** provides an accurate frequency standard for testing and adjustment of mobile transmitters and receivers at predetermined frequencies.

The FM-2400CH with its extended MHz. The range covers 25 to 1000 frequencies can be those of the radio frequency channels of operation and/or the intermediate frequencies of the receiver between 5 MHz and 40 MHz.

Frequency Stability: ± .0005% from +50° to +104°F.

Frequency stability with built-in thermometer and temperature corrected charts: ± .00025% from +25° to +125° (.000125% special 450 MHz crystals available).

Self-contained in small portable case. Complete solid state circuitry. Rechargeable batteries.

- FM-2400CH** (meter only) \$595.00
- RF crystals** (with temperature correction) ... 24.00 ea.
- RF crystals** (less temperature correction) 18.00 ea.
- IF crystals** catalog price

Write for catalog!



Circle 28 on reader service card

AUDIO SIGNALS

(continued from page 39)

frequencies of about 30 MHz. The EIA bulletin, like the earlier FCC bulletin, suggests bypassing the output circuit to ground with ceramic capacitors. A properly stabilized audio amplifier can withstand fairly large values of capacitance across the speaker terminals without oscillating, and the low impedance of the output circuit precludes any loss in high-frequency response because of such capacitive bypassing. Nevertheless, if you have doubts about the relative stability of your amplifier under conditions of such capacitive loading, the best thing to do is to observe the output at the speaker terminals on an oscilloscope. Do this for several positions of the master volume control while musical program material is being played and watch for any evidence of high frequency "blips" superimposed on the low-frequency audio waveforms. Normally, the value of capacitance needed to eliminate rf interference at this point should be low enough so as not to cause oscillation, but it's a good idea to check this out before you discover that some super-audible high-frequency oscillation has burned out the tweeters in your speaker systems.

There is no single solution to the

problem of audio rectification in hi-fi component equipment, and we have suggested just a few things that may help. Undoubtedly, many readers have been plagued with these kinds of interferences and may have worked out unique solutions to specific problems. Perhaps those of you who have faced and solved the problems of interference would like to share your solutions with others. If so, please tell us how you solved the problems, preferably naming the equipment involved, and we'll devote more space to this subject in a future article.

R-E



"Would you go for a malfunction in my electronic calculator?"

CHEAP ENOUGH TO DO ONLY ONE TV. Yours.



29.95 ppd

LITEK INC. model 43

TV DOT/G.H. GEN.

Up to 1.0 volts RF output (300 μ A) on channels 2 to 4 (adjustable). 9 x 9 display. This is a complete 4-wire module with instructions - nothing else to buy.



Size is 4" x 4". Use it naked or panel mount it inside your TV using the switch on back side of PC board, or place in an enclosure with battery box & AC convertor jack and use as a test instrument.

1 yr guarantee

We replace at no cost if this unit fails at any time.

Please ship _____ unit(s) @ \$29.95 POSTPAID

CASH, CHECK, OR MONEY ORDER ENCLOSED

BANKAMERICARD MASTERCARD

CARD # _____

Expiration date _____

4 digit bank number (MC Card only) _____

SIGNATURE _____

NAME _____

ADDRESS _____

CITY/ST _____

ZIP _____

Litek Inc 2143-1 Wyandotte Mt. View CA 94043

Circle 29 on reader service card

You don't have to buy a new car to get an electronic ignition.

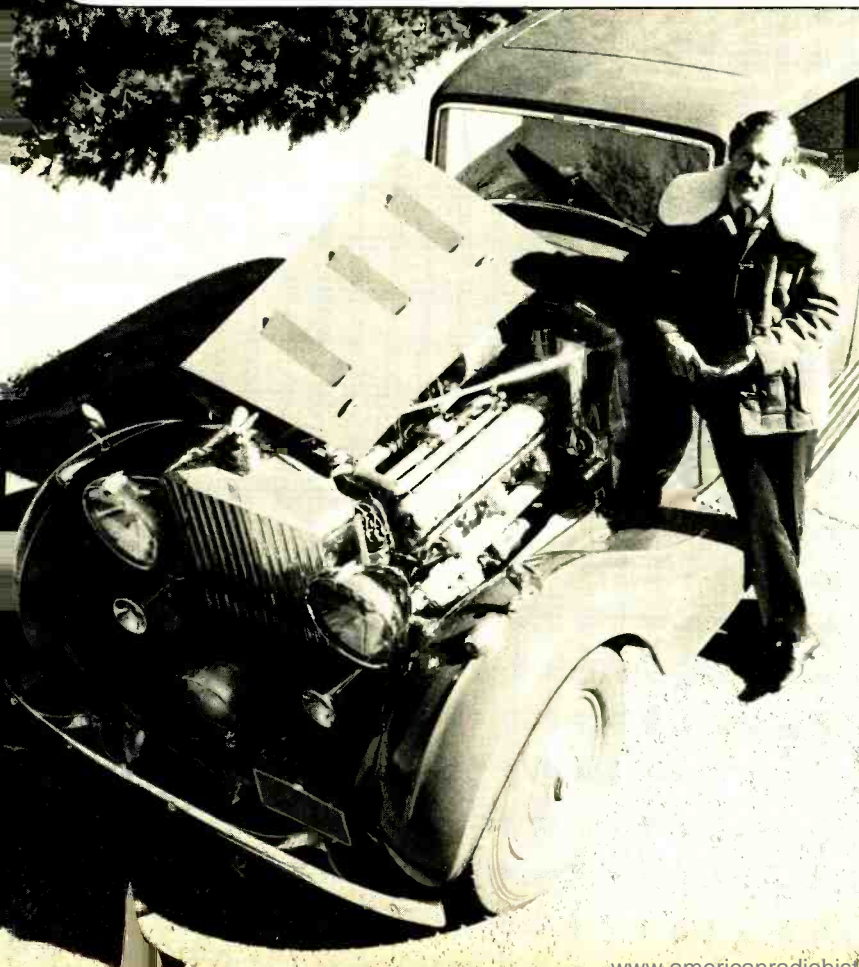

Let's face it. After 37 years, even a Phantom III can use a lift. That's why I put a Delta Mark Ten B Capacitive Discharge Ignition on my Phantom . . . to give her a spark I'd pit against any '75 model car. I went to Delta because they aren't Johnny-come-latelys. Delta's been making electronic ignition systems for over a decade.

Whatever kind of car you drive, you can give it the same great Delta performance I gave mine.

- Mark Ten B Capacitive Discharge Ignition Systems are manufactured by Delta Products, Inc., a company with a conscience, and with a proven record of reliability both in product and in customer relations.

- The Mark Ten B really does save money by eliminating the need for 2 out of 3 tune-ups. Figure it out for yourself. The first tune-up or two saved pays for the unit, the rest is money in your pocket. No bunk!

- Because the Mark Ten B keeps your car in better tune, you actually can save on expensive gasoline.

- With a Mark Ten B, spark plugs stay clean and last longer . . . fouling is virtually eliminated.



I want to know more about Mark Ten B CDI's. Send me complete no-nonsense information on how they can improve the performance of my car.

Name _____

Address _____

City _____ State _____ Zip _____



DELTA PRODUCTS, INC.

P.O. Box 1147, Dept. RE, Grand Junction, Colo. 81501
303-242-9000

Mark Ten B,
assembled \$64.95 ppd
Mark Ten B, kit \$49.95 ppd

Standard Mark Ten,
assembled \$49.95 ppd
Deltakit® \$34.95 ppd

Circle 61 on reader service card

TROUBLED BY TRIGGERED SCOPES?



The Hickok Model 512 Dual Trace Oscilloscope eliminates the set-up and precision problems you've had to accept using other triggered scopes.

It's easy to set up

- Simplified color-coded front panel controls.
- Beam finder quickly locates off-scale traces.
- Foolproof triggering to 15 MHz.

It gives you superior performance

- 10 MHz response flat within 3dB. Excellent pulse response.
- Unique automatic VITS sync separator.

Hickok industrial lab quality and construction

Glass epoxy PC boards used throughout. Regulated power supply.

Plus, our exclusive two-year warranty.

Ask to see the Hickok Model 512 or single trace Model 511 at your Hickok distributor or contact us for more information.

\$67500

complete with probes and accessories

HICKOK
the value innovator

INSTRUMENTATION & CONTROLS DIVISION
THE HICKOK ELECTRICAL INSTRUMENT CO.
10514 Dupont Avenue • Cleveland, Ohio 44108
(216) 541-8060 • TWX: 810-421-8286

Circle 62 on reader service card

STEP-BY-STEP

(continued from page 70)

enough current to open the circuit breaker. In replacing SC522, I noted that its part No. had been changed to another diode from 13-17174-2 to 13-29165-2-45. The +36-volt bus supplies both the horizontal driver and the push-pull audio outputs.

Operationally, you'll find there is 2 Vp-p ripple at the output cathode connections of the two diodes; but don't be alarmed, that's normal. Figure 2 shows the normal waveforms that should appear at TA18 and TA25, with the receiver plugged in and switched on. Each at 50V/div., the top waveform is TA18 and the bottom TA25—ac volts only. Then on Fig. 1, you'll see a list of the ac p-p inputs to the power rectifiers; S502-a both on and off.

Sylvania's effective sync IC's

This article was supposed to be about some nifty circuits in the GT-Matic. These circuits contain IC's. You may not necessarily want to specialize in integrated circuits, but the day is coming, and soon, when a working knowledge of what they are and what they do can mean technical survival. In Fig. 3, the video amplifier, noise inverter, 31.5-kHz oscillator, sync separator, and phase detector are all shown in the IC400 block diagram. The IC400 block diagram shows you "who and what," but it does not tell you "how" it works.

Figure 4 shows the schematic diagram of the IC400 integrated circuit. Video enters pin 1 and the emitter of Q7 in negative phase. The video is inverted by Q1 and buffered by Q4 before it is applied to the base of Q12 (Q2 and Q3 are bias sources, with Q3 a base dc reference from point "S"). Without noise, the video signal is amplified by the Darlington configuration (Q12 and Q13) for a video age output.

Video output is through pin 4 for agc and is also returned through an RC bias network (Fig. 3) to the base of Q14 (Fig. 4), permitting only positive sync tips to forward bias this transistor, whose active load is Q16. Sync is inverted and amplified through a coupling Zener to Q21, where it is again inverted and applied both to the base of sync output Q22, and the base of current source Q23. Q28 is an active load. At the same time, a flyback comparison pulse is diode-coupled to the base of Q20 (pin 8), is inverted and appears at the base of Q24. Transistors Q24 and Q25 form a differential amplifier, which compares sync and flyback phase. Any difference voltage is fed to the base of Q35 as a correctional voltage. Transistors Q35, Q36, Q37, Q38, and Q39 (the constant current generator) all form a stable 31.5 kHz oscillator. The load resistors connect to pins 12 and 13 (see fig. 3), and the L420 oscillator (horizontal hold) coil is connected between pins 13 and 14. Output is through multiple collector Q34, to Q33, and pin 15.

Count down IC300

A stable 31.5-kHz signal has been developed which is independent of station-generated sync and flyback phase

comparison. It's now necessary to establish the precise 59.94-Hz field and 15,734-Hz line repetition rates that all television receivers must have for compatible vertical and horizontal deflection.

The 31.5 kHz output from IC 400 enters pin 1 of IC300 (Figs. 3 and 5), is amplified and inverted by transistor Q1, and routed both to the count down group of 10 flip flops (one of which is shown at the lower left corner of Fig. 5), and also to a single divide-by-two flip flop at the base of Q9. The IC400 31.5-kHz is now halved to 15,734 Hz and amplified by Q9 as the horizontal repetition rate drive pulse which, in turn, energizes the horizontal driver.

The chain of 10 flip flops are what digital logic people call a ripple counter since each stage drives another, and all succeeding stages operate at half the frequency of their driver or clocking stage. This means that 10 dividers will divide by 2^{10} or 1024. However, all that's needed is a line count of 525 (262.5 lines for each field), and something additional for possible sync correction. So at the 9th flip flop, the count down from 31.5 kHz amounts to just about 60 Hz, and that's the frequency needed.

There are 10 flip flops in the chain instead of 9, however, so something must turn off the counter following the 9th flip flop. This is done by the gating circuits at the top right and center of Fig. 5. The vertical sync signal comes in at pin 14 and applied to the base of Q18. Also, composite sync is applied to pin 4 and the base of Q12. Without doing a complete timing diagram which would be surprisingly tedious, detected interlace pulses will operate the QA-QB flip flops so that Q15 thru Q17 will gate Q7. When this occurs the Q5, Q3, group resets the 10 flip flops at point R. This produces the sought-after 525 count that induces normal sync output at Q35 as Q32 turns on and Q33 turns off. The positive output pulse at Q33 also cuts off Q10, which causes Q11 to stop conducting and the QA-QB pair of flip flops in the 525 line reset counter are reset.

When no interlace signals are detected, the vertical sync input chain takes over, as well as Q25, Q26, Q28 etc. When reset fails to occur at 525 lines, coincident pulses arrive from Q23 (vertical sync input), Q29, and Q16 (the 525 counter): so that Q30 and Q31 become an AND gate. When this occurs, Q2 is cut-off and produces a reset signal at point R as the collector voltage of Q2 rises toward the 4V source supply. At this point, the maximum count is 541, and the counter runs at such a rate until an interlace signal is again detected. Such gating is necessary where there are unusual noise or electrical interruptions, or where composite video originates from a source other than a broadcasting station that has no interlace sync. This could be a closed-circuit camera, some community cable systems, or other local varieties of signal origination which do not have broadcast quality transmitters. Counter flip flops at the bottom of Fig. 5 show how all 10 FF's of the count down chain are connected.

R-E

new products

More information on new products is available from the manufacturers of items identified by a Reader Service number. Use the Reader Service Card inside the back cover.

IC MULTIMETER, PM2503, features voltage range protection up to 2 kV, automatic polarity with indication and linear scales for all ranges. Minimum 10 megohm input impedance provides virtually no-load measurements at 3% worst case accuracy. Circuitry allows linear scales to be used for all measurements except dB. Other features include: separate readings of dc and ac components of measured signals, pushbutton ac/dc



selection, single rotary switch for range selection and V-ohm on the same input sockets.

Has ac/dc current ranges of 1 μ A to 1A, ac/dc voltage ranges of 100 mV to 1 kV and resistance ranges (also with linear scales) of 100 ohms to 10-megohms. Plastic housing is lined with layer of conductive material connected to meter's ground for protection against induced rf. Core construction of meter movement guards against stray magnetic fields. No zeroing or infinity adjustments are required; uses standard 9-volt batteries to supply 1000 working hours before replacement. \$169.00—comes complete with measuring leads and spare fuses incorporated inside.—**Philips Test & Measurement Instruments, Inc.**, 400 Crossways Park Drive, Woodbury, NY 11797.

Circle 31 on reader service card

AUTOMATIC TURNTABLE, model 351 features industry's widest umbrella spindle that eliminates double record drop, record hang-ups or slanting of unbalanced records. Contains bi-directional viscous-damped cueing and counterbalanced pickup arm that operates on a horizontal and vertical gimbal bearing system. This system assures minimal friction in both vertical and horizontal planes. Slide-in cartridge adaptor facilitates cartridge change.

Other features include an anti-skate device for both spherical and elliptical stylus settings, gravity stylus pressure adjustment that contains no variable springs and a 4-

pole synchronous motor. Complete with uni-planar design wherein most moving parts have been placed on single horizontal plane. Tracking is $\frac{1}{4}$ gram. Unit comes equipped with a Shure M91E cartridge, ellip-



tical diamond stylus, walnut grain base and smoke-tinted hinged protective dustcover. Supplied with rotating manual spindle that eliminates record hole wear. When stub spindle is used, record plays once automatically, arm returns to rest position and turntable shuts off. \$160.00—**Glenburn Corp.** 787 Susquehanna Avenue, Franklin Lakes, NJ 07417.

Circle 32 on reader service card

RECORD CLEANER, model AT6008. Use on CD-4 discs as well as conventional 2-channel recordings and matrix 4-channel records. Comprised of velvet-surfaced cleaning unit



with handle, storage base, cleaning brush, special cleaning solution and solution applicator. Foam-backed velvet surface, together with the cleaning solution, loosens and collects dust and dirt from entire depth of record grooves. Special feature is the rotating handle which permits a fresh cleaning surface to be provided continually as the cleaner is moved across the record.

Cleaning solution is applied with special applicator to a reservoir atop the cleaner from which it is dispensed gradually to the velvet surface below; this feature avoids the

BENCH PERFORMANCE IN YOUR POCKET



The Hickok Model 239 color bar generator has an exclusive MOS LSI chip which provides 9 Rock Stable patterns and low battery drain.

- Simplified operation with 2 matrix slide switches.
- Crystal controlled chroma and timing oscillators.
- RF adjustable Channels 2-4.
- Powered by 2 standard 9v batteries.

Plus our unique 2-year warranty.

The Hickok Pocket Model 239 or our deluxe bench Model 246 are values you have to see to appreciate. See them at your Hickok distributor or contact us for more information.

\$11500

HICKOK

the value innovator

INSTRUMENTATION & CONTROLS DIVISION
THE HICKOK ELECTRICAL INSTRUMENT CO.
10514 Dupont Avenue • Cleveland, Ohio 44108
(216) 541-8060 • TWX 810-421-8286

Circle 63 on reader service card

excessive application of liquid. \$7.95. — Audio-Technica U.S., Inc., 33 Shiwasssee Avenue, Fairlawn, OH 44313.

Circle 33 on reader service card

SOLID-TUBE, R-3DS3. Silicon solid-state plug-in rectifier tube replaces vacuum tube rectifier types 3DR3 and 3DS3. Emits no X-radiation, creates no heat and since it has



no filament, it makes an ideal substitute in cases where the filament or flyback transformer is faulty.—Electronic Devices, Inc., 21 Gray Oaks Avenue, Yonkers, NY 10710.

Circle 34 on reader service card

CASSETTE DECK, model CD-1669. ANRS—Automatic Noise Reduction System—reduces tape hiss to an inaudible level without af-



fecting the quality of the music. Accommodates tapes recorded with other noise-reduction systems. Has automatic ANRS detection.

Features include Super Cronios ferrite heads for longer life, two tape-select switches for bias and equalization, solenoid operated controls. Hysteresis synchronous motor drives the capstan and a dc motor drives the reels for accurate speed and decreased wow and flutter. Indicator lights show deck's function and peak-level indicator flashes a warning when over-recording takes place. Auto stop and auto play rewinds and restarts the deck automatically. There is independent input select switch for improved linearity. \$499.95—JVC America, Inc., 50-35 56th Road, Maspeth, NY 11378.

Circle 35 on reader service card

SMOKE ALARMS, SDA-2 & SDA-3 are for use in homes, apartments and businesses and are easily installed.

SDA-2 operates from standard electrical current. Has a built-in pilot light to indicate it is functioning. SDA-3 is powered by 12.6-



volt Duracell mercury-cadmium battery (30A-116). Battery triggers smoke alarm when it approaches end of useful life thus calling attention to the need for a replacement battery. Each alarm is 6½ in. in diameter and 3 in. thick. SDA-2 \$61.60; SDA-3 \$81.00.—Mallory Distributor Products Co., 4760 Kentucky Avenue, Indianapolis, IN 46241.

Circle 36 on reader service card

ELECTRONIC COUNTERS, 5381A and 5382A. Lab-quality counter makes possible precise alignment of the crystal filters and high-Q i. f. strips found in costly stereo receivers, assuring they will operate in the home the way they did in the design lab. Similar satisfactions can be found from setting the SCA



trap precisely at 67 kHz. Sensitive inputs have protection against overload; in their wide-open settings, they will take 200 volts (peak ac + dc) without harm.

Both units operate on external precision time-base through a built-in rear connector

BARGAIN BONANZA OF EDLIE HIGHEST QUALITY KITS ONLY NEW PRODUCTS

- (A128) 13 MINIATURE ELECTROLYTIC CONDENSERS \$1.00 Axial & upright, popular values.
- (A150) 15 HI-FI KNOBS \$1.00 Every one superb! Purchased from Harmon Kardon, Fisher, etc.
- (A127) 20 ASST. VOLUME CONTROLS \$1.00 Assorted ohmages, some with switches.
- (A158) 2 NORTONICS TAPE HEADS \$1.00 One stereo, one mono.
- (A153) CHASSIS MYSTERY \$1.19 Take a chance! Could be a tape recorder, radio, walkie talkie, etc.
- (A156) 60 DISC CAPACITORS \$1.00 Asst. capacitances from .0001 to .1, most 600v, Z5U, NPO, N750, etc.
- (A147) 4 lb. GRAB BAG SPECIAL \$1.00 Full of exotic and exciting electronics parts.
- (A140) TAPE RECORDER SPARE PARTS KIT \$2.95 Contains dozens of parts used in most tape recorders including: pilot lamp, capacitors, resistors, jacks, level meter, switches, volume controls, transistors, and MUCH MORE.
- (A155) TUBE BONANZA! \$1.00 20 asst. popular tubes, untested.



(A293) SEVEN SEGMENT LED's \$1.00 14 pin DIP tested.

- (A223) 10 ASST. LED's \$1.00 Tested.
- (A178) 2 BATTERY MOTORS Misc. \$1.00

- (A242) 3 LED's \$1.00 Yellow or green (specify).
- (A001) 5 RED LED's Tested. \$1.00
- (A266) 2N3055 Si, NPN \$1.00 TO-3 case, audio, power, 115v, 100vbc, NFE 20-70.
- (ALSS32) 10 ZENER DIODES \$1.19 1w, 3-30v, under 1v forward characteristic.



(A253) 7 AMP POWER TRANSISTOR \$1.49 Si NPN. Similar to SK3054. 9v, 90w.

- (ALSS24) 25 ZENER DIODES \$1.19 400mw, 4-20v. Under 1v forward characteristic.
- (ALSS23) 25 POWER TRANSISTORS \$1.19 Outstanding value! Asst. cases and types, up to 15w, RF to 2 mHz.
- (A167) 10 MINIATURE POTENTIOMETERS \$1.00 For transistor applications.
- (A175) 70 ½w CARBON RESISTORS \$1.00 All Std. makes & EIA values. Some 5%.
- (A154) 150 CUT LEAD RESISTORS \$1.00 Carbon, all leads long enough for soldering.
- (A149) 20 POLYSTYRENE TOP GRADE CAPACITORS \$1.00 Popular sizes.
- (A159) 15 TRIMMER CAPACITORS \$1.00 Includes duals and singles.
- (A132) 20 DUAL POTENTIOMETERS \$1.00 Asst. ohmages, originally for Hi-Fi stereo and TV.
- (A131) 13 ELECTROLYTIC CONDENSERS \$1.00 FP types, tubulars, some multiple sections.
- (A138) 10 SLIDE SWITCHES \$1.00 All types: DPDT, SPST, etc.
- (A134) 8 ROTARY SWITCHES \$1.00 Some multiple gang.
- (A145) 50 TIE LUGS \$1.00 From 2 lugs up.

- (A125) 4 TRANSFORMERS \$1.00 Some power, filament, output, worth up to \$10 each.
- (144) TRANSISTOR REPAIR KIT \$1.00 Various and sundry parts used to repair all transistorized devices.
- (A143) 20 RUBBER FEET \$1.00 For bottom of cabinets.
- (A164) 4 ROLLS OF WIRE \$1.00 Approx. 25 ft. per roll, 20-28ga.
- (A148) 4 ROCKER SWITCHES \$1.00 Assorted.
- (A137) 10 INSTRUMENT KNOBS \$1.00 Made for industry by Ratheon, etc. All high grade.
- (A141) 6 RCA JACK STRIPS \$1.00 From 2-6 per strip.
- (A142) 50 PRECISION RESISTORS \$1.00 All 1%, ½w and 1w, low and high ohmages.
- (A161) 50 CERAMIC AND MICA CONDENSERS \$1.00 Runs the gamut of sizes.
- (A162) 25 CORNING GLASS RESISTORS \$1.00 Silicon insulated, most 10% tolerance, 2-7 watts.
- (A170) 4 RELAYS \$1.00 Asst. types, 6-110v, some worth up to \$10.
- (A168) 12 TRANSISTORS \$1.00 Asst. Not rejects, fully guar.
- (A171) 5 CRYSTALS \$1.00 Popular bands, asst. holders.
- (A182) 2 TUNING METERS \$1.00 Misc., miniature.

- (A177) 50 TIE LUGS \$1.00 From 2 lugs up.

MONEY BACK GUARANTEE
Terms: Minimum order \$4.00. Include postage. Either full payment with order or 20% deposit, balance C.O.D.

WRITE FOR FREE VALUE PACKED CATALOG

BONUS FREE CAPACITOR KIT With Every \$5 Purchase

EDLIE ELECTRONICS, INC., 2700-L HEMPSTEAD TPKE., LEVITTOWN, N.Y. 11756

Circle 64 on reader service card

that works at levels from 250 mV to 25 V. 80-MHz model 5381A \$249.00; 225-MHz model 5382A \$450.00. High-stability temperature-compensated oscillator adds \$100.00. Each weighs 4.75 lbs; power may be from 100 to 240 V; neither has battery option.—Hewlett-Packard Co., 1501 Page Mill Road, Palo Alto, CA 94304.

Circle 37 on reader service card

SOLDER/DESOLDER/RESOLDER DEVICE, Vented Tunnel Tip can be used with 90% of the soldering irons now being used in industry. Can solder, desolder and resolder all with the same tip. Features total solder flow control, total solder removal even in plated through holes, no need for additional desoldering aids, no more waste of precious



copper desoldering braid, minimum thermal risk to sensitive components and one hand operation. Production tool as well as printed circuit board salvage tool.

Unit is a hollow bored and vented soldering tip that operates by instant capillary action in two basic modes. Expulsion of accumulated solder within the unit may be performed by simple hand flicking motion. For 1/8 in., pencil iron 10T14-125T threaded tip; for 3/16 in., pencil iron 10T14-187P plug tip. Less than \$2.00.—Gunmaster Industries Corp., 170 Old Country Road, Mineola, NY 11501.

Circle 38 on reader service card

now available for the telephone experimenter
COMPLETE CONSTRUCTION PLANS

TELEPHONE PLANS: \$3.00 each.
Answering Device, Automatic Dialer, "Black Box", Call Diverter, Call Limiter, Conference Bridge, Central Dial Exchange, Melodic Ringing Generator, Recorder-Actuator, Remote Control, Schematics, Speakerphone, Teletalk Burglar Alarm, Voice Scrambler, Dial/Tone Converter, Tone/Dial Converter.
MISC. PLANS: \$6.00 each.
Biofeedback Conditioner, Multifrequency Encoder Network, Horticulture Simulator, Dodecahedron Speaker Enclosure, Photographic Pinhole Camera.

ALL OF THE CONSTRUCTION PLANS ABOVE: \$24.95 AIRMAILED.

LEARN THE SECRETS OF YOUR TELEPHONE



Have you ever wondered what lies behind that telephone dial? Now you can learn the tricks of the telephone trade. Get the inside story of telephone systems—their quirks and flaws, and remain up to date on vital occurrences within the telephone industry. TELEPHONE ELECTRONICS' LINE is a publication designed for the telephone enthusiast. Phone threats and experimentation, containing interesting articles which offer a wealth of hard to find information. Technical theory is also discussed, among the following items: **Current News Items • Code Numbers Illustrations • Games • Facts • Plans Projects • History • Comics • Stories Facts previously Tel. Co. confidential is now published in TEL!**

One year subscription rate: United States \$6.00, Canadian & foreign \$8.00.

ALL OF THE CONSTRUCTION PLANS ABOVE PLUS A ONE YEAR SUBSCRIPTION TO TELEPHONE ELECTRONICS LINE: \$29.95 AIRMAILED.

THE LEGAL ASPECTS OF INTERCONNECTION

\$9.95 AIRMAILED

The complete reference book to your **LEGAL RIGHTS** as a telephone subscriber. Study toll evasion, tariffs, wiretapping, customer provided equipment, and many more!

ALL OF THE CONSTRUCTION PLANS ABOVE AND A ONE YEAR SUBSCRIPTION TO TEL PLUS "THE LEGAL ASPECTS OF INTERCONNECTION": \$49.00 AIRMAILED.

TELETRONICS COMPANY OF AMERICA
22035 BURBANK BLVD., WOODLAND HILLS CA 91364 USA

Circle 65 on reader service card

20 MHz "MINI-SCOPE" ON THE GO!



- Battery or AC powered
- Weighs only 5 1/2 lbs.
- DC - 20 MHz bandwidth
- 10 mV/div sensitivity
- Rack mountable
- 100 nsec/div sweep rate
- Thousands already in use

If you need a lab quality portable scope, but don't feel like lugging the weight around—or lack the space, then consider Model PS910B. This battery operable, high performance "visual trouble-shooting tool" is a natural for servicing today's technology, at the plant or in the field. It is designed to operate from internally mounted standard "C" size battery cells, and it triggers like a lab scope. Whether you are servicing analog circuitry or digital logic, the PS910B is the "mini-scope" for you!

AVAILABLE NOW FOR ONLY **\$645**

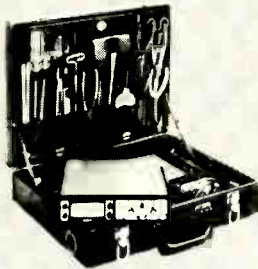

FITS IN A BRIEFCASE

INTERESTED? Call Hal Wardein at (714) 279-8572, or write to us at 7170 Convoy Court, San Diego, California 92111. For local ordering information, dial TOLL-FREE 800-645-9200; in N.Y. State call collect (516) 294-0990.

From a Leader in Mini-Portable Oscilloscopes



Circle 66 on reader service card

Now...the most enjoyable do-it-yourself project of your life—a Schober Electronic Organ!

You'll never reap greater reward, more pride and proud accomplishment, more benefit for the whole family, than by assembling your own Schober Electronic Organ.

You need no knowledge of electronics, woodwork or music. Schober's complete kits and crystal-clear instructions show you—whatever you are, whatever your skill (or lack of it)—how to turn the hundreds of quality parts into one of the world's most beautiful, most musical organs, worth up to twice the cost of the kit.

Five superb models with kit prices from \$575 to around \$2,300, each an authentic musical instrument actually superior to most you see in stores, easy for any musically minded adult to learn to play, yet completely satisfying for the accomplished professional. And there are accessories you can add any time after your organ is finished—lifelike big auditorium reverberation, automatic rhythm, presets, chimes, and more.

Join the thousands of Schober Organ builders—owners who live in every state of the Union. Often starting without technical or music skills, they have the time of their lives—first assembling, then learning to play the modern King of Instruments through our superlative instructions and playing courses.

Get the full story FREE by mailing the coupon TODAY for the big Schober color catalog, with all the fascinating details!

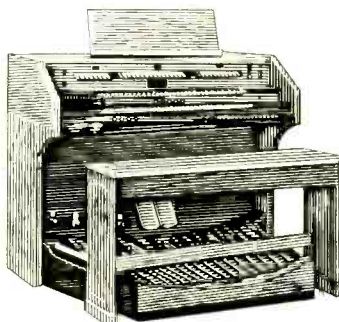

The Schober Organ Corp., Dept. RE-137
43 West 61st Street, New York, N. Y. 10023

- Please send me Schober Organ Catalog.
- Enclosed please find \$1.00 for 12-inch L.P. record of Schober Organ music.

NAME _____
ADDRESS _____
CITY _____ STATE _____ ZIP _____

Circle 67 on reader service card

Hunting for
a better job?

CIE will
help you get
the license
you need



A Government FCC License can help you qualify for an exciting, rewarding career in ELECTRONICS, the Science of the Seventies. Read how you can prepare at home in your spare time to pass the FCC Licensing examination.

If you're out to bag a better job in Electronics, a Government FCC License can give you a shot at job opportunities with *real* futures.

According to the U.S. Office of Education Bulletin (4th Edition): "The demand for people with technical skills is growing twice as fast as for any other group, while jobs for the untrained are rapidly disappearing." There are new openings every year in many different industries for electronics specialists. And you don't need a college education to qualify.

But you *do* need knowledge . . . knowledge of electronics fundamentals. And one of the nationally accepted methods of measuring this knowledge . . . is the licensing program of the FCC (Federal Communications Commission).

Importance of an FCC License and CIE's Warranty of Success

If you want to work in commercial broadcasting . . . television or AM or FM broadcasting . . . as a broadcast engineer, federal law requires you to have a First Class Radiotelephone License. Or if you plan to operate or to maintain mobile two-way communications systems, microwave relay stations or radar and signaling devices, a Second Class FCC License is required.

But even if you aren't planning a career which involves radio transmission of any kind, an FCC "ticket" is valuable to have as Government certification of certain technical skills. It's a job credential recognized by some employers as evidence that you really know your stuff.

So why doesn't everyone who wants a good job in Electronics get an FCC License?

It's not that simple. To get an FCC License, you must pass a Government licensing exam.

A good way to prepare for your FCC License exam is to take one of the CIE career courses which include FCC License preparation. We are confident you can successfully earn your license, if you're willing to put forth an effort, because the vast majority of CIE students have. In fact, based on continuing surveys, close to 9 out of 10 CIE graduates have passed their FCC exams!

That's why we can offer this time-tested Warranty of Success: when you successfully complete any CIE career course which includes FCC License preparation, you will be able to pass the Government FCC Examination for the License for which the course prepared you or you will be entitled to a full refund of an amount equal to the cash price of tuition for CIE's Course No. 3, "First Class FCC License," in effect at the time you enrolled. This warranty is good from the date you enroll until the last date allowed for completion of your course.

CIE HAS CAREER COURSES THAT INCLUDE "HANDS ON" TRAINING

ELECTRONICS TECHNOLOGY with LABORATORY Courses . . . takes beginner from fundamentals to skills required of technician or engineering assistant. Includes Experimental Electronics Laboratory for "hands on" training.

COLOR TV MAINTENANCE and REPAIR . . . several CIE courses combine electronics theory with the actual construction, testing and troubleshooting a big screen, stolid state color TV.

With CIE you learn at home

With CIE, you learn in your spare time at home . . . or wherever else is convenient. No classroom time, ever. No one to make you go too fast . . . or too slow. With CIE's Auto-Programmed® Lessons you'll pick up facts, figures, and electronics theories you may have considered "complicated" . . . even if you've had trouble studying before.

You can have attractive job opportunities

There have already been many exciting developments and breakthroughs in Electronics and some people might assume there will be no new frontiers . . . no new worlds to conquer. Not so.

Electronics is still growing. In nearly every one of the new and exciting fields of the Seventies you find electronics skills and knowledge in demand. Computers and data processing. Air traffic control. Medical technology. Pollution control. Broadcasting and communications. Once you have the solid technical background you need, you can practically choose the career field you want . . . work for a big corporation, a small company or even go into business for yourself.

Yes, Electronics can be the door to a whole new world of career opportunities for you. And CIE training can be your key.

Send for FREE school catalog

Discover the opportunities open to people with electronics training. Learn how CIE career courses can help you build new skills and knowledge and prepare you for a meaningful, rewarding career. We have courses for the beginner, for the hobbyist, for the electronics technician, and for the electronics engineer. Whether you are just starting out in Electronics or are a college-trained engineer in need of updating (or anywhere in between), CIE has a course designed for you.

Send today for our FREE school catalog and complete package of career information. For your convenience, we will try to have a representative call to assist in course selection. Mail reply card or coupon to CIE . . . or write: Cleveland Institute of Electronics, Inc., 1776 East 17th Street, Cleveland, Ohio 44114. Do it TODAY.

APPROVED UNDER G. I. BILL

All CIE *career* courses are approved for educational benefits under the G.I. Bill. If you are a Veteran or in service now, check box for G.I. Bill information.

CIE Cleveland Institute of Electronics, Inc.

1776 East 17th Street, Cleveland, Ohio 44114
Accredited Member National Home Study Council

Cleveland Institute of Electronics, Inc.

1776 East 17th Street, Cleveland, Ohio 44114

Please send me your FREE school catalog and career information package today.

I am especially interested in:

- Electronics Technician
- FCC License Preparation
- Color TV Maintenance
- Mobile Communications
- Industrial Electronics
- Electronics Engineering
- Other _____

Print Name _____

Address _____ Apt. _____

City _____

State _____ Zip _____ Age _____

Check box for G.I. Bill information.

- Veteran
- On Active Duty

RE-53

Circle 68 on reader service card

EXAR

IC'S AND KITS

NOW AVAILABLE FROM:
JAMES ELECTRONICS

FUNCTION GENERATOR KIT

Introductory Offer

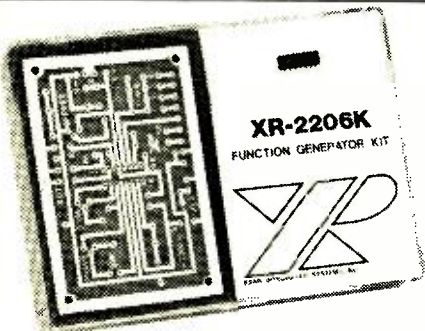

The Function Generator Kit features sine, triangle and square wave; THD 0.5% typ.; AM/FM capability.

XR-2206KA

Includes monolithic function generator IC, PC board, and assembly instruction manual.

\$19.95

XR-2206KB

Same as XR-2206KA above and includes external components for PC board.

\$29.95

MONOLITHIC IC'S

TIMERS

XR-555CP	Monolithic Timer	\$1.10
XR-320P	Precision Timer	1.55
XR-556CP	Dual-555 Timer	1.85
XR-2556CP	Dual Timing Circuit	3.20
XR-2240CP	Programmable Counter/Timer	4.80

PHASE LOCKED LOOPS

XR-210	FSK Demodulator	5.20
XR-215	High Frequency PLL	6.60
XR-567CP	Tone Decoder (mini DIP)	1.95
XR-567CT	Tone Decoder (TO-5)	1.70

STEREO DECODERS

XR-1310P	PLL Stereo Decoder	3.20
XR-1310EP	PLL Stereo Decoder	3.20
XR-1800P	PLL Stereo Decoder	3.20

WAVEFORM GENERATORS

XR-205	Waveform Generator	8.40
XR-2206CP	Monolithic Function Generator	5.50
XR-2207CP	Voltage-Controlled Oscillator	3.85

OTHER EXAR IC'S

XR-1468CN	Dual \pm 15V Tracking Regulator	3.85
XR-1488N	Quad Line Driver	5.80
XR-1489AN	Quad Line Receiver	4.80
XR-2208CP	Operational Multiplier	5.20

Satisfaction Guaranteed. \$5.00 Min.
Order—1st Class Mail No Charge/
California Residents Add 6% Sales Tax

JAMES

P.O. BOX 822, BELMONT, CA. 94002
PHONE ORDERS - (415) 592-8097

TV TYPEWRITER II

(continued from page 63)

plugs and note that each of the connectors is indexed to allow them to be plugged in only one way. J10 and J11, however, are physically the same type of connector so use a felt tipped pen to mark one of the two sets to prevent yourself from inserting one of the plugs into the wrong jack. Try to keep all of the wires in the connector harnesses as short as possible and be sure the ground and +5v wires between the power supply and the main board are 18 gauge or heavier.

The power supply must be capable of supplying 5 Vdc, 2A at 5% regulation or better; -12 Vdc, 200 mA; and -5 Vdc, 15 mA. You can either build your own from scratch or purchase one from the source supplying the TV typewriter kits. You must make absolutely sure all of the power leads are wired correctly to the connector; otherwise you can cause a lot of damage when the power is applied.

Now its time to get out the television or monitor you plan to use. Although the actual modifications necessary will vary from set to set, the modifications shown will probably be satisfactory for most small screen transistor portables. The TV typewriter's output must be connected to the input of the television's video amplifier, which is located between the last video i.f. stage and the video output circuit. When you break the circuit right at the input to the video amplifier, you will probably have to provide a dc bias circuit for the stage since in most cases it is supplied by the now disconnected video i.f. amplifier. The circuit in Fig. 2 is for the Motorola 9TS-469 Q set used with the prototype. A switch and BNC connector were provided to allow either TV typewriter or normal television viewing.

A dc restoration circuit was also added to keep the screen intensity from changing as a function of the density of dots displayed.

Check the power supply to be sure the voltages are OK and that wiring to the connector is correct. Go back now to the main PC board and wire in the correct keyboard jumper. If your keyboard has a positive "keypress strobe" pulse, wire terminal 3 to terminal 1, and if it has a negative "keypress strobe" pulse, wire terminal 3 to terminal 2. These pads are just adjacent IC32 and are numbered on the top side of the board. If the keyboard has a 1 microsecond or less strobe pulse, either of the two positions will work properly.

Plug the "memory" board onto the main board using the set of connectors marked "memory." Be sure the top

SUPER BUYS!

FAMOUS MAKE, NEW JOBBER-BOXED TUBES 80% OFF LIST

<input type="checkbox"/> 1B3	5 for \$5.00	<input type="checkbox"/> 6HA5	5 for \$4.80
<input type="checkbox"/> 1V2	5 for \$3.00	<input type="checkbox"/> 6HB7	5 for \$4.85
<input type="checkbox"/> 2AV2	5 for \$3.95	<input type="checkbox"/> 6HQ5	5 for \$6.35
<input type="checkbox"/> 3A3	5 for \$5.05	<input type="checkbox"/> 6HV5	5 for \$11.80
<input type="checkbox"/> 3AT2	5 for \$4.90	<input type="checkbox"/> 6JC6	5 for \$5.65
<input type="checkbox"/> 3GK5	5 for \$4.85	<input type="checkbox"/> 6JE6	5 for \$11.15
<input type="checkbox"/> 3HA5	5 for \$4.80	<input type="checkbox"/> 6JS6	5 for \$9.30
<input type="checkbox"/> 3HM5	5 for \$4.80	<input type="checkbox"/> 6JH8	5 for \$5.55
<input type="checkbox"/> 4B26	5 for \$4.70	<input type="checkbox"/> 6KA8	5 for \$6.15
<input type="checkbox"/> 5GH8	5 for \$5.90	<input type="checkbox"/> 6KE8	5 for \$7.65
<input type="checkbox"/> 6AX4	5 for \$5.05	<input type="checkbox"/> 6KM6	5 for \$11.25
<input type="checkbox"/> 6AY3	5 for \$5.05	<input type="checkbox"/> 6KN6	5 for \$9.85
<input type="checkbox"/> 6BK4	5 for \$9.35	<input type="checkbox"/> 6KT8	5 for \$6.85
<input type="checkbox"/> 6CG3	5 for \$4.95	<input type="checkbox"/> 6KZ6	5 for \$5.15
<input type="checkbox"/> 6CG8	5 for \$5.40	<input type="checkbox"/> 6LB6	5 for \$10.75
<input type="checkbox"/> 6CJ3	5 for \$4.70	<input type="checkbox"/> 6LQ6	5 for \$11.15
<input type="checkbox"/> 6DQ6	5 for \$6.75	<input type="checkbox"/> 8FQ7	5 for \$3.75
<input type="checkbox"/> 6DW4	5 for \$4.70	<input type="checkbox"/> 12BY7	5 for \$4.50
<input type="checkbox"/> 6EA8	5 for \$4.95	<input type="checkbox"/> 12GN7	5 for \$7.00
<input type="checkbox"/> 6EH7	5 for \$4.80	<input type="checkbox"/> 17JZ8	5 for \$4.50
<input type="checkbox"/> 6EJ7	5 for \$4.50	<input type="checkbox"/> 21GY5	5 for \$6.30
<input type="checkbox"/> 6FQ7	5 for \$3.75	<input type="checkbox"/> 23Z9	5 for \$6.00
<input type="checkbox"/> 6GF7	5 for \$6.65	<input type="checkbox"/> 31LQ6	5 for \$10.15
<input type="checkbox"/> 6GH8	5 for \$3.95	<input type="checkbox"/> 33GY7	5 for \$8.05
<input type="checkbox"/> 6GJ7	5 for \$3.40	<input type="checkbox"/> 36MC6	5 for \$11.40
<input type="checkbox"/> 6GM6	5 for \$5.25	<input type="checkbox"/> 38HE7	5 for \$9.20
<input type="checkbox"/> 6GU7	5 for \$5.25	<input type="checkbox"/> 38HK7	5 for \$9.00
<input type="checkbox"/> 6GY6	5 for \$4.35	<input type="checkbox"/> 42KNG	5 for \$9.15

20-2.5 Amp. 1000 PIV (IR)	\$3.00
100-2.5 Amp. 1000 PIV (IR)	\$11.95
RCA DAMPER DIODES 120818 Ea. \$1.50
4-6500 PIV FOCUS RECT. \$2.00
5-13.5 KV FOCUS RECT. \$3.00
25-1N34A-CRYSTAL DIODES \$2.00
HEP 9001-DUAL DIODES CARDED	..10 for \$2.98

AUDIO PHONO EQUIP.

10 RCA PHONO PLUGS \$1.00
5 Ass't'd STEREO CART. \$5.95
BSR-SC5MD-EV5540D-Cart. (Bulk) \$1.50
SONOTONE 8-T—Cart. (Bulk) \$1.25
BSR TC8S—Cart. \$1.25

COLOR FLYBACKS

MAGNAVOX 361461-2L \$7.95
RCA—136640 \$6.95
RCA—137545 \$6.95

COLOR YOKES

MAGNAVOX 361340 \$3.95
MAGNAVOX 361380-4 \$6.95
EQUIV. DY 95AC-Y109 (Univ.) \$6.95
SILVERTONE 80-56-4G \$5.95
JAP YOKE \$4.50
70%—(21" CRT) \$5.50

BLACK & WHITE YOKES

THORDARDSON—Y-105 (UNIVERSAL) \$7.95
THORDARDSON—Y-130 ZENITH \$7.95

ANTENNA EQUIPMENT

2-Set Coupler Each ONLY \$1.49
4-Set Coupler Each ONLY \$1.89
6-ANT. CLOTHESPINNS \$1.00

ZENITH

VOLTAGE TRIPLER—212-109 Ea. \$4.95
VOLTAGE TRIPLER—212-136 \$4.95
CONV. DIODE PAK—212-72 2 for \$1.00

CONTROLS RESISTORS

50 Ass't'd MALLORY CONTROLS \$2.59
50 Assorted W.W. Res. \$2.69
100 Assorted Carbon Resistors \$1.69

CONDENSERS CANS

200-80-Mfd. 350V 3 for \$1.79
200 Mfd. 80 Mfd.—350 Volts 3 for \$1.79
500 Mfd. 25 Volts (P.C.) 5 for \$1.00
90% COLOR CRT BOOSTERS 3 for \$11.50

SEND FOR FREE CATALOG

TUBES UP TO 80% OFF
MINIMUM ORDER \$15.00

SEND CHECK OR M.O.

TV TECH SPECIALS

P.O. BOX 603
KINGS PARK, L.I., NEW YORK 11754
PHONE 516-269-0805

Circle 70 on reader service card

side of the memory board faces in toward the main PC board. It must not be plugged on the other way.

Connect the power supply, keyboard and television to the main board and after making a final check for errors, apply power. If you haven't made any mistakes and have a little luck, the unit will work first off. The only adjustments are the oscillator frequency adjustment pot, R38, the left margin control, R4 and the horizontal character size control, R6. The phase-locked oscillator should lock in over most of the range of the control R38, but may vary from unit to unit. An out of lock condition will be indicated by a slight vertical roll and a jittery character presentation. The other two controls should be set to give the best display.

If the unit doesn't work, first check the power supply voltages to make sure they are OK and then use an oscilloscope to see whether or not there is a video output signal. If not, start checking from the phase-locked oscillator with your scope and try to locate the problem from there.

If you don't have any problems and everything seems to work correctly then go ahead and connect up the control switches. For maximum flexibility the page-select switch, available at jack J10, should be a spdt center off switch; (continued on page 90)

WHAT SINGLE ELECTRONIC MACHINE CAN BE USED TO PERFORM/CONTROL ALL THE FOLLOWING TYPES OF SERVICES?

- Send morse code
- Control repeater stations
- Operate as a calculator
- Receive/send/buffer data between a wide variety of communication devices

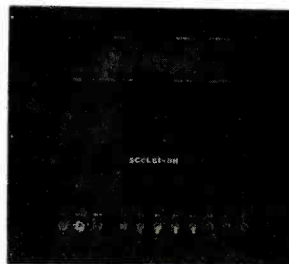

- Monitor instruments
- Control machines
- Sort/compile data
- Test other devices
- Play games

The SCELBI-8H MINI-COMPUTER can!

If you want to be really "state of the art" you should find out about the extraordinary flexible SCELBI-8H MINI-COMPUTER. This is a true digital mini-computer at a LOW price you may find hard to believe! It is all solid state and conservatively designed to provide years of service. It is a fully programmable machine.

We have a complete line of peripheral units available to use with the SCELBI-8H. Such as an interface that turns an oscilloscope into a complete alpha-numeric display system, low cost keyboard and TTY interfaces, and an interface that turns a low cost audio tape cassette unit into a "Mag-Tape" storage system.

In addition to the hardware we have a large selection of programs ready to "load and go." Programs such as Editors, Assemblers, Calculator packages, I/O routines for ASCII and Baudot machines and SCELBI interfaces, Data manipulating routines, Games, and more on the way!

Fully tested card sets for the SCELBI-8H start as low as \$399.00!* Complete computers (card set plus chassis kit) as low as \$529.00.* And for the real "do it yourself buffs" we now offer "unpopulated" p.c. card sets starting as low as \$109.00!* (*Domestic prices.)

Literature available by request:

SCELBI COMPUTER CONSULTING, INC.

1322 Rear—Boston Post Road, Milford, CT. 06460

Phone (203) 874-1573

Circle 72 on reader service card



WHAT'S AN "EBM"???

A new kind of electronics and electromechanical "encyclopedia" containing over a half-million words and more than a thousand charts, tables and circuit diagrams.

An applications handbook: from integrated circuits and electronic displays to hardware and gears.

A "practices" manual covering soldering, painting, plating, wiring, construction, assembly, etc.

A reference handbook of data, formulas and tables including calculator operations.

A "high density" Tdoc publication, packed with the equivalent of more than one dozen "paperbacks".

A looseleaf bench manual in a rugged polyethylene binder, easily expanded and up-dated.

A foundation-stone of the growing Tdoc system of guaranteed electronics publications.

BankAmericard
Master Charge
Tel. Orders 24 hours
Available Only By Mail
\$19.95 PP TECHNICAL DOCUMENTATION BOX 340 CENTREVILLE, VA 22020
US-Can. 703-830-2535

Circle 71 on reader service card

NEW! MINI-BREADBOARD BUDGET KIT FOR THE ECONOMY-MINDED EXPERIMENTER...

Proto 100 Board

Patent Pending
Made in USA



Here's a low cost, big 10 IC capacity breadboard kit with all the quality of QT Sockets and the best of the Proto Board series. Complete down to the last nut, bolt 'n screw. Includes 2 QT-35S Sockets; 1 QT-35B Bus Strip; 2 5-way binding posts; 4 rubber feet; screws, nuts, bolts and easy assembly instructions. Order off-the-shelf today from CSC or local distributor. Charge: BAC, MC, AX. Write for free catalog. Free English/Metric Slide Rule with each order. Dealer inquiries invited.

Complete Kit:
19⁹⁵

Add \$1.50 shipping/handling.
Foreign orders add 15%.
Prices subject to change

CSC Continental
Specialties Corp.
Box 1942, New Haven, CT 06509 • 203/624-3103
W. Coast Off.: Box 7809, S. Fran., CA 94119 415/363-4207
Canada: Available thru Len Finkler Ltd., Ontario

Circle 73 on reader service card

DELUXE DIGITAL COLOR CONVERGENCE GENERATOR

NOW AT A PRICE EVERYONE CAN AFFORD

ROCK SOLID PATTERNS
ALL IC COUNTDOWN CIRCUITS
QUARTZ CRYSTAL OSCILLATORS
2 FULL YEARS' WARRANTY



MODEL SG-200 **\$7995**
reg. \$99.95

10 Patterns: Full & Gated Rainbow, 4 Crosshatch, 4 Dot, Die Casted 1/8" Aluminum Case.

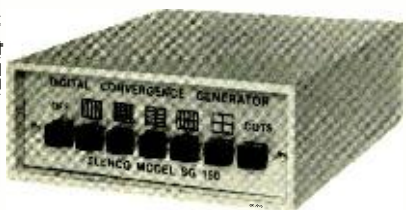

MODEL SG-150 **\$5995**
reg. \$74.95

10 Patterns: B&W Bars, White Field, 4 Crosshatch, 4 Dot.



MODEL SG-100
ONLY **\$4795**
reg. \$59.95

2 Patterns: 20 x 16 Crosshatch, 320 Dots, weight only 17 oz.

SPECIAL PRICE LIMITED TIME ONLY
FULL 15 DAYS MONEY BACK GUARANTEE

ELENCO ELECTRONICS INC.
8744 W. North Ter., Niles, Ill. 60648

312-825-3797

MODEL SG-_____

- My check or money order enclosed.
 COD—Add \$2.50 mailing & handling.

NAME _____

ADDRESS _____

CITY _____ STATE _____ ZIP _____

DISTRIBUTORS' INQUIRIES INVITED

Circle 74 on reader service card

COSMOS BURGLAR ALARMS

(continued from page 35)

tion. Under this condition, the relay is de-energized and the alarm generator is off. The circuit consumes a typical standby current of 1- μ A. The alarm can be activated by opening any one of series-connected sensor switches S3 or by closing any one of parallel-connected sensor switches S2. Under this condition, a positive-going transition appears on pin 2 of the monostable and its output switches into the high mode for a pre-set period and drives transistor Q1 into conduction, thus energizing the relay and turning the alarm generator on. At the end of this period, the output of the monostable goes low again, independent of the states of S2 and S3, and the alarm generator turns back off. The circuit can then be reset either by opening and then closing S1 or by setting all S2 and S3 switches back to their original positions.

Note in the Projects 3 and 4 circuits, that power is permanently applied to the Q1-RY1 components, even when S1 is in the OFF position. This enables the alarm to be activated in the non-latching mode at all times via a normally open temperature-sensing switch such as a thermostat, so that these circuits can also function as a permanently alert fire alarm system. Any number of normally open switches can be wired in parallel with S4.

A weakness of the Projects 3 and 4 circuits is that they give the owner no protection against intruders who may break into the house in daylight hours when the main alarm system is switched off. Protection against this type of intrusion can be obtained by scattering a number of series-connected normally closed 'panic' buttons around the house, so that a permanently-alert self-latching alarm system can be activated at any time. This facility can readily be added to the Projects 3 and 4 circuits. Project 5 shows how it can be wired into the auto-turn-off system of Project 4.

In Project 5, part of IC2 is wired as a simple bistable multivibrator circuit that is permanently connected to the supply lines. The output of the bistable is connected to the base of transistor Q1, via diode D2 and resistor R10, so that Q1, the relay and alarm generator can be turned on via the bistable. Diode D1 is wired in series with R5 of the main alarm system so that the two sections of the circuit do not interact adversely. The output of the bistable is normally latched into the low state, so the relay and alarm generator are normally off. If any of series-connected panic buttons S5 are momentarily opened, the bistable im-

FREE ALARM SYSTEM CATALOG



Controls



Detectors



Sirens

Full line of professional burglar and fire alarm systems and supplies. 96 pages, 450 items. Off-the-shelf delivery.



mountain west alarm
4215 n. 16th st.
phoenix, az. 85016
(602) 263-8831

Circle 75 on reader service card

RGS ELECTRONICS

008A MICROCOMPUTER KIT

8008 CPU, 1024 x 8 memory; memory is expandable. Kit includes manual with schematic, programming instructions and suggestions; all ICs and parts supplied except cabinet, fuses and hardware. Includes p.c. boards

*\$375.00
MANUAL ONLY, \$25.00
(No Discount on Manual)

008A-C AUDIO CASSETTE ADAPTER KIT

Kit includes all ICs, p.c. board, power supply, schematic and instructions. Will interface most audio cassette recorders to the 008A Microcomputer. NOT intended to interface with any other computer.

*\$50.00

008A-K ASCII KEYBOARD INPUT KIT

Kit includes keys, p.c. board, ICs, power supply, schematic and instructions. This kit is intended to interface ONLY with the RGS Electronics 008A Microcomputer

*\$75.00

TRANSISTORS

NPN General purpose TO-92 \$.08;\$5.95/100
PNP General purpose TO-92 \$.08;\$5.95/100
Other transistors and JFETS available at our usual low prices; all are tested, good units. Specs available in our flyer.

RGS ELECTRONICS, 3650 Charles St. Ste K,
Santa Clara, CA 95050 (408) 247-0158

We sell many ICs and components not listed in this ad, included most of the 7400 series; send a stamp for our free flyer.

TERMS OF SALE: All orders prepaid; we pay postage on all U.S. orders. Handling charge of \$1.00 on U.S. orders under \$10.00, foreign orders under \$25.00. California residents please include sales tax. Please include name, address, and zip code on all orders and flyer requests. *DISCOUNTS: 10% OFF ORDERS OVER \$25.00 - 20% OFF ORDERS OVER \$250.

PRICES SUBJECT TO CHANGE WITHOUT NOTICE.

Circle 76 on reader service card

mediately changes state and its output locks into the high state and drives relay RY1 and the alarm generator on. Once the alarm generator has been turned on, it can be reset to the OFF state by closing RESET switch S6.

This panic facility can be added to the Project 3 circuit by simply wiring diode D1 in series with R5, and adding IC2 and its associated circuitry.

Other points to note about the Project 3 through Project 5 circuits are as follows:

1. **The relay** used in each circuit can be any 12-volt type with a coil resistance of 180 ohms or greater, and with one or more sets of n.o. contacts.

2. **Timing capacitor C2** of the Projects 3 through 5 circuits must have a reasonably low leakage resistance, otherwise the alarms may fail to turn off at the end of their pre-set periods. The best way to find out if the capacitor is suitable is to simply put it in the circuit and check that it works OK under operating conditions.

3. **The three circuits** can drive any types of alarm generators (bells, sirens, electronic generators, etc.) via the relay contacts RY1-1. Note, however, that these alarm generators must be operated from their own power supplies, otherwise they may interfere with the electronic functioning of the actual systems. *(continued next month)*

**For
faster
service**

**USE
ZIP
CODE**

**on
all
mail**

PTS ELECTRONICS, INC.

RCA	ZENITH	
MAA001A	9-83	} \$ 5.95
MAB003A	9-87	
MAD001	9-88	
MAL001B	9-90	
MAN002		} \$ 7.95
	9-48	
	9-57	
	9-70	
	9-82	
	9-89	
	9-91	} \$ 9.95
	9-103	
	150-214	
MAC002A	9-27	
MAC002B	9-27X	
MAE001B	9-69	
MAG001B	9-86	
MAH001A	9-92	
	9-97	

**THE LEADER
IN
TUNER SERVICE
NOW OFFERS
FAST 8 HOUR
MODULE
REPAIR**

IF-SUBCH.-MODULES \$12.50

(Prices include all parts; shipping add.)

**1 YEAR
GUARANTEE!**

For fastest service, send faulty unit to:

PTS ELECTRONICS

"Precision Tuner Service"



P.O. Box 272, Bloomington, Ind. 47401 • Tel. 812-824-9331

Circle 77 on reader service card

CMOS MICROLAB

- * LEARN HOW DIGITAL CIRCUITS WORK
- * VERIFY DESIGNS QUICKLY
- * IDEAL TEACHING AID

The CMOS Microlab makes it possible to quickly check, or understand a variety of digital circuits. Battery operation makes the Microlab super convenient. Use it anywhere. Indicator lamps are all LED types that are rugged and will never burn out. Included in the Microlab are four (4) flip-flops, four (4) dual input NOR gates, four (4) dual input NAND gates, two (2) four input NAND gate and an inverter. No external signal sources are needed in most cases. Connections are made with reliable, easy to use push-on type connectors on the jumper wires. The entire instrument is "goof-proof". No possible combination of connections, no matter how wrong, can damage the circuit.

The kit is housed in a 5 x 7 x 3 break resistant impact plastic case. Powered by four (4) standard "D" cells. (Not included in kit)

#CMOS Complete Microlab Kit.....\$34.50 PPD

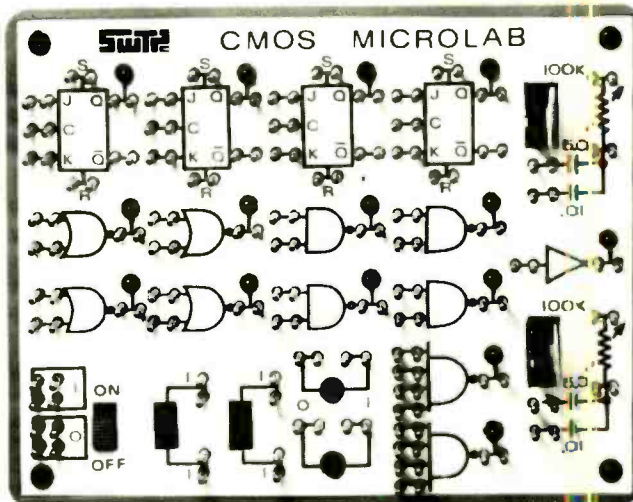

Southwest Technical Products Corp.
219 W. Rhapsody
San Antonio, Texas 78216

Circle 78 on reader service card

THE NEW DIGITAL VOLKSMETER

World's lowest priced digital multimeter. Designed to be a more accurate replacement of delicate pointer-type meters.



LM-3

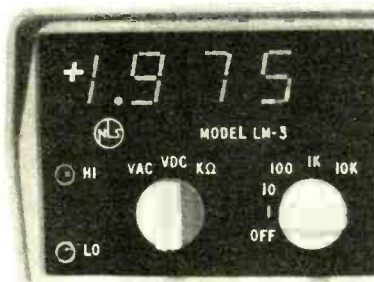

\$99.95

Features Include:

- Rugged - ideal for field service use
- Auto polarity - no more lead reversing or switching
- Three digits with 100% over-range and 1% accuracy on all functions
- 13 ranges: 4 vac, 4 vdc & 5 resistance
- 1 millivolt resolution with 500 volts and 20 megohms full scale
- Small Size: 1.9"H x 2.7"W x 3.9"D

Options Include:

- Rechargeable batteries with charger unit - \$15
- Leather case - \$16
- High voltage probe - \$30
- Current shunts - \$6 each

Call our distributor, the G.S. Marshall Co., for more information.

For immediate delivery, fill in below and mail direct to NLS.

NON-LINEAR SYSTEMS, INC.
Box N, Del Mar CA 92014
PH (714) 755-1139 - TWX 910-322-1132

Special offer of \$99.95 with your check and coupon. Single unit price of \$110 C.O.D. or valid purchase order.

One year guarantee.

Name _____

Company _____

Address _____

City _____ State _____ Zip _____

California Residents Add 6% Sales Tax

Offer expires in 90 days

123 567 89 10 11 12 ★ 2345 67 89 10 11 12

Circle 79 on reader service card

TV TYPEWRITER II

(continued from page 87)

then when either of the two pages are selected, the cursor will always remain on the same page even when the end of frame is reached. In the center position, the cursor will alternately jump from one page to the other as the end of frame is reached. As with all of the other switch connections to follow, the inputs are all tied high with pull up resistors so all switching should be done by grounding the appropriate terminal.

The cursor ON/OFF terminal, available on jack J10, if left unconnected will always cause the cursor to blink in the next character position to be typed. However, the blinking cursor may be turned off at any time by grounding the "CURSOR ON/OFF" pin on jack J10.

For maximum manual cursor control, the optional cursor control board should be used, however, the home-up (move cursor to upper left hand corner), erase to end of line (EOL) and erase to end of frame (EOF) are available at the pins to be used for the cursor control board. Temporarily grounding pin 10 of IC9-b will generate an erase of end of line, and temporarily grounding pin 4 of IC2-a will generate and erase to end of frame and grounding pin 12 of IC32-d will force a "home up."

R-E



12 REASONS YOUR CAR NEEDS TIGER CDI

Instant starting in any weather - Eliminates tune-ups - Increases gas mileage - Increases horsepower 15% - Improves acceleration and performance - Spark plugs last up to 70,000 miles - Reduces engine maintenance expense - Amplifies spark plug voltage to 45,000 volts - Maintains spark plug voltage to 10,000 RPM - Reduces exhaust emissions - Dual ignition switch - An Unconditional LIFETIME GUARANTEE - Installs in 10 minutes on any car with 12 volt negative ground - No rewiring - Most powerful, efficient and reliable Solid State Ignition made.

SATISFACTION GUARANTEED or money back

TIGER 500 assembled \$53.95

TIGER SST assembled \$42.95

Post Paid in U.S.A.

Send check or money order with order to:

Tri-Star Corporation

P. O. Box 1727 B
Grand Junction, Colorado 81501

DEALER INQUIRIES INVITED

Circle 80 on reader service card

PAIA

ELECTRONICS, INC.
INTRODUCES
THE
GNOME
MICRO-SYNTHESIZER
KIT

#3740 GNOME KIT \$48.95
plus shipping
4 lbs.

THE GNOME FILLS A VARIETY OF NEEDS:

- TO THE SEASONED PERFORMER It's the extra voice that completes a composition while leaving expensive equipment free for more demanding tasks
- TO THE BEGINNER It's a low cost introduction to synthesizers that won't be obsolete when more expensive instruments are purchased
- TO THOSE IN BETWEEN the GNOME's portability and ease of operation make it great for toy boxes, sound effects or just for fun

PAIA'S FREE CATALOG features the GNOME and other electronic music kits. Check our Reader Service Number or Write PAIA Electronics, Dept. R 1020 W Wilshire Blvd. Okla. City, OK 73116

Circle 81 on reader service card

FREE catalog

over 2000

unique tools,
handy kits,
precision
instruments,
technical
supplies.

Our 23rd year of service to the World's finest craftsmen and technicians.

A carefully selected and tested assortment of unique, hard-to-find tools, clever gadgets, precision instruments, bargain kits. One-stop shopping for the technician, craftsman, hobbyist, lab specialist, production supervisor. Many tools and measuring instruments available nowhere else. One of the most unusual and complete tool catalogs anywhere. Get your copy of the NC FLASHER today.

National Camera 2000 West Union Ave. Dept. GBA
Englewood, Colorado, 80110
Phone (303) 759-1893

Circle 82 on reader service card

next month

MAY 1975

■ Understanding Tape and Bias

Matching the bias to the tape and getting it right will improve the performance of any tape recorder. See why it works and how to do it.

■ Electronic Ignition — 1975

A study of several of the latest circuits and how they work.

■ Servicing MATV Systems

Finding a fault in an MATV system isn't always easy. But there are ways to speed the job. Let an expert show you how.

■ Using The Curve Tracer

Final installment shows how to test semiconductors with a curve tracer, and what the results mean.

■ New Power Supply Kits From Heath

Eight new power supplies, in kit form. Four with digital readouts, 4 with analog meters. See how they work and what you can use them for.

PLUS

Equipment Reports

Jack Darr's Service Clinic

Radio-Electronics Replacement Semiconductor Guide

May issue goes on sale April 17, 1975

Put Professional Knowledge and a COLLEGE DEGREE

in your Electronics Career through

HOME STUDY

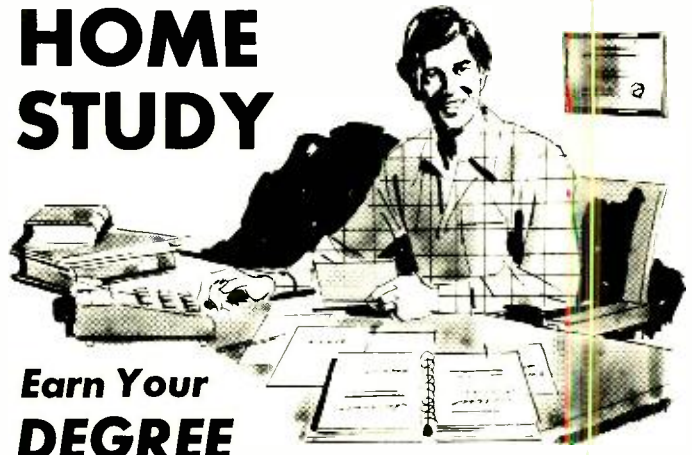

Earn Your DEGREE

by correspondence, while continuing your present job. No commuting to class. Study at your own pace. Learn from complete and explicit lesson materials, with additional assistance from our home study instructors. Advance as fast as you wish, but take all the time you need to master each topic. Profit from, and enjoy, the advantages of independent study.

The Grantham correspondence degree program in electronics is comprehensive. It begins with basics, written in very simple language, and continues through the B.S.E.E. degree level. Throughout the entire program, heavy emphasis is placed on clear explanations written in great detail, progressing from the simple to the complex, in easy steps.

Our free bulletin gives complete details on the curriculum, the degrees awarded, the requirements for each degree, and how to enroll.

GRANTHAM SCHOOL OF ENGINEERING

2000 Stoner Ave., Los Angeles CA 90025

● Telephone (213) 477-1901 ●

Worldwide Career Training thru Home Study

Mail the coupon below for free bulletin.

Grantham School of Engineering RE 4-75
2000 Stoner Ave., Los Angeles, CA 90025

I have been in electronics for _____ years. Please mail me your free bulletin which gives details concerning your electronics degree programs.

Name _____ Age _____

Address _____

City _____ State _____ Zip _____

Circle 83 on reader service card

INVENTORY DISCOUNT SALE

- RCA COLOR BAR GENERATOR**
 - with basic patterns
 - with AC and battery power supply

Reg. Price \$89.90

Our Price \$69.50



Model WR-508B Mini Chro-Bar

- CASTLE MEZZER Field Strength Meter**

Reg. Price \$119.95

Our Price \$102.00



Model FSM-V

- CASTLE TUNER SUBBER MARK IV**
Reg. Price \$45.95 **Our Price \$36.50**

- SOLDERING IRON 30 WATTS**
Pencil type \$1.95

LARGE DISCOUNTS ON ALL TEST EQUIPMENT

Free Catalog of Each Manufacturer



TUBES

ICC/International Servicemaster

<input type="checkbox"/> 1B310 for \$11.00	<input type="checkbox"/> 6EH710 for \$10.50
<input type="checkbox"/> 1K310 for \$11.00	<input type="checkbox"/> 6EJ710 for \$10.00
<input type="checkbox"/> 1V210 for \$ 6.50	<input type="checkbox"/> 6JC610 for \$12.50
<input type="checkbox"/> 2AV210 for \$ 9.00	<input type="checkbox"/> 6JE610 for \$25.00
<input type="checkbox"/> 3A310 for \$11.00	<input type="checkbox"/> 6KD610 for \$25.00
<input type="checkbox"/> 3AT210 for \$11.00	<input type="checkbox"/> 8CG710 for \$ 8.50
<input type="checkbox"/> 6BK410 for \$20.00	<input type="checkbox"/> 17BF1110 for \$17.00
<input type="checkbox"/> 6CG310 for \$11.00	<input type="checkbox"/> 17JZ810 for \$10.00
<input type="checkbox"/> 6CG710 for \$ 8.50	<input type="checkbox"/> 23Z910 for \$13.00
<input type="checkbox"/> 6DW410 for \$10.00	<input type="checkbox"/> 33GY710 for \$18.00
<input type="checkbox"/> 6EA810 for \$11.00	<input type="checkbox"/> 38HE710 for \$20.00
<input type="checkbox"/> 6GH825 for \$20.00	

Complete line of RCA and Raytheon tubes also available.

PARTS

- Replacement Rods, 4 Sections, Extending to 38"12 for \$9.00
- Varco Cartridge; CN75, TN4Beach \$1.95
- BSR Cartridge; SX1H, 5X5Heach \$1.75
- Electrical Tape, 3/4" x 66'10 rolls for \$4.99
- Telematic CR 250 90° Color Booster.5 for \$20.00
- Thorardson Y94, Y105, Y130each \$9.00
- 25 ft. Speaker Cable
RCA Plug to RCA Plug4 for \$3.90
- Speaker; 6x9, 10 oz., Cloth Rolleach \$4.95
- 6x8 Grilleeach \$6.69
- AC Adapter; 6, 7, 5, 9V, 300maeach \$3.95

FREE CATALOG

Minimum order \$50.00. Send check or money order. Add \$1.00 for shipping and insurance.

FORDHAM

RADIO SUPPLY CO., INC.

558 Morris Ave., Bronx, N.Y. 10451
Tel: (212) 585-0330

new lit

All booklets, catalogs, charts, data sheets and other literature listed here with a Reader Service number are free. Use the Reader Service Card inside the back cover.

COMMUNICATIONS EQUIPMENT CATALOG. 30-page catalog has four sections: CB, marine, scanning monitor and business/industry. Each section includes 2-way communications for Citizens radio service operations, scanning receivers for monitoring emergency broadcasts and other 2-way radios for business and marine use. Contains many illustrations, detailed specifications, a list of accessories and prices. — **Pace Communications**, 24049 South Framp-ton Avenue, Harbor City, CA 90710.

Circle 39 on reader service card

COMPONENTS CATALOG. 36-page catalog lists IC's, linear IC's, semi-conductors, hybrid audio amplifiers, keyboards, capacitor kits, transformers, panel meters, bread-boarding devices, switches, connectors, adapters, power panels and strips and much more. Prices are listed as well as photo-graphs. Order form is in middle of catalog. — **K A Electronic Sales**, 1220 Majesty Drive, Dallas, TX 75247.

Circle 40 on reader service card

ELECTRONIC INSTRUMENTS CATALOG. 36-page catalog describes frequency counters, auto ranging counters, multimeters, portable volt-ohm meters, vtvm's, oscilloscopes, solid-state oscilloscopes, substitution boxes and accessories, function generator, TV alignment generators, audio and sine/square wave generators, high and low voltage supplies, reference and low voltage supplies, pro-grammable chart recorders, record and modules, modules and accessories, lab sta-tions, digital designers, plug-in circuit cards and ph meters. Many illustrations and prices. — **Heath Co.**, Benton Harbor, MI 49022.

Circle 100 on reader service card

TEST EQUIPMENT CATALOG 60-T. 16-page catalog contains full range of the company's products from general multi-purpose vom's through laboratory and special feature testers to general purpose portables, temperature testers and accessories. Features two new vom's—model 310, type 3 and model 615. Prices are given for all test equipment and accessories. Also contains a selection guide chart designed to help select a tester for specific requirements. — **Triplet Corp.**, Dept. PR, Bluffton, OH 45817.

Circle 42 on reader service card

PRODUCT SELECTION GUIDE. 11-page cat-alog describes, illustrates and lists principal specifications for the company's current products. Prices are included. Contains 4 3/4-digit multimeters, 10-MHz oscilloscope and modified static card readers with interface electronics along with other equipment. — **Hickok Electrical Instrument Co.**, 10514 Du-pont Avenue, Cleveland, OH 44108.

Circle 43 on reader service card

NEW

from endeco



The Pencil Soldering Iron with Operating Light, 2 Heats and On/Off Switch

\$10.95 NET



Model 540S Soldering Iron Length 8 1/2" Weight 2 oz.

- Light shows when it's on
- 2 heats—20w and 40w— for any job
- Ironclad tips for longer life
- Cool, unbreakable polycarbonate handle
- Burn-resistant neoprene cord
- Converts to a desoldering iron with low cost attachment

The Pencil Desoldering Iron with Operating Light, and On/Idle/Off Switch

\$15.95 NET



Model 510 Desoldering Iron Length 8 1/2" Weight 3 1/2 oz.

- Light shows when it's on
- Operates at 40w; idles at 20w for longer tip life
- 8 tip sizes available to handle any job
- Cool, unbreakable polycarbonate handle
- Burn-resistant neoprene cord
- Exclusive new bracket insures alignment, prevents damage

New kits also available!

- Soldering Kits • Desoldering Kits
- Soldering/Desoldering Kits

To locate your nearest distributor call toll-free 800-645-9200



5127 EAST 65TH ST.
INDIANAPOLIS,
INDIANA 46220
PHONE 317/251-1231

enterprise development corporation

Circle 85 on reader service card

Circle 84 on reader service card

new books

COLOR TV TROUBLE FACTBOOK, Second Edition, by the Editors of Electronic Technician/Dealer. TAB Books, Blue Ridge Summit, PA 17214. 348 pp. 8½ x 5¼ in. Hardcover \$8.95.

This book contains an indexed reference guide to color set troubles and recommended solutions. Manufacturers' service notes and production-change data are all numerically arranged by manufacturer and model. Service tips, troubleshooting data and special problem-solving aids for all the more popular U.S. and Canadian makes and models are included.

Of particular importance are the many model production changes not likely to be documented in manufacturers' manuals. This book contains a detailed accounting of such changes where they might logically affect set performance and where the service technician might replace a factory component with an unsuitable substitute.

The practicing TV service technician should be able to save many hours of troubleshooting time using this guide book. A complete cross-reference index is provided to put all the information at the reader's fingertip for easy and fast access. In all, over 600 specific items are included.

PHOTOFACT TELEVISION COURSE, Fourth Edition, by the Howard W. Sams Editorial Staff. Howard W. Sams & Co., Inc., 4300 West 62nd Street, Indianapolis, IN 46268. 208 pp. 10¾ x 8¼ in. Softcover \$6.95 (in Canada \$8.35).

This book is a complete course in black-and-white television. Step-by-step and supported by numerous schematics, the text describes the functions of important circuits.

Television principles, operations and servicing procedures are covered in depth. Included is an extensive glossary of terms, questions and answers and exercises. If you are just entering the field of television servicing or engineering, this book should prove invaluable. Experienced television technicians will find it a useful, authoritative reference source.

TRANSISTOR SUBSTITUTION HANDBOOK NO. 14, by the Howard W. Sams Engineering Staff. Howard W. Sams & Co., Inc., 4300 West 62nd Street, Indianapolis, IN 46268. 152 pp. 10¾ x 8¼ in. Softcover \$2.95 (in Canada \$3.75).

This latest edition contains easy-to-read large type. The transistors are arranged in numerical and alphabetical order. Types recommended by the manufacturers of general purpose replacement transistors are included at the end of each list of substitutes. Additional data on these general-purpose replacement types, the manufacturer, the polarity, the material and the recommended applications are also included.

This is a valuable source of information for anyone concerned with transistor replacement, industrial, commercial or home-entertainment devices.

TV BENCH SERVICING TECHNIQUES, by Art Margolis. TAB Books, Blue Ridge Summit, PA 17214. 227 pp. 8½ x 5¼ in. Hardcover \$7.95; Softcover \$4.95.

The text explains the setup of a typical efficient shop, outlines shop repair methods and provides troubleshooting procedures for each section of color and black & white receivers.

Assuming only a basic knowledge of electronics on the part of the reader, the book examines the basic operation of tube-type, solid-state and modular receivers and tells how to cope with the fundamental inherent characteristics of each type—from a troubleshooting standpoint. Also included are detailed instructions for picture-tube tests and repairs and color setup adjustments, including purity, convergence and high voltage.

THE COMPLETE SHORT-WAVE LISTENER'S HANDBOOK, by Hank Bennett. TAB Books, Blue Ridge Summit, PA 17214. 288 pp. 8½ x 5¼ in. Hardcover \$9.95; Softcover \$6.95.

For those persons searching for an extremely interesting and exciting hobby, this handbook will introduce them to short-wave listening. It is very easy to read and understand, even for those who know nothing about electronics or the art of tuning in distant stations.

This book is designed to acquaint the reader with the basics of the SWL hobby. It covers receivers, antennas, frequencies, radio-wave propagation, harmonics, Q codes, where to tune for various type signals, how to keep a log book and how to prepare and send reception reports. It contains a thorough guide to stations of the world by general continental area and frequency. **R-E**

DO-IT-YOURSELF grabber

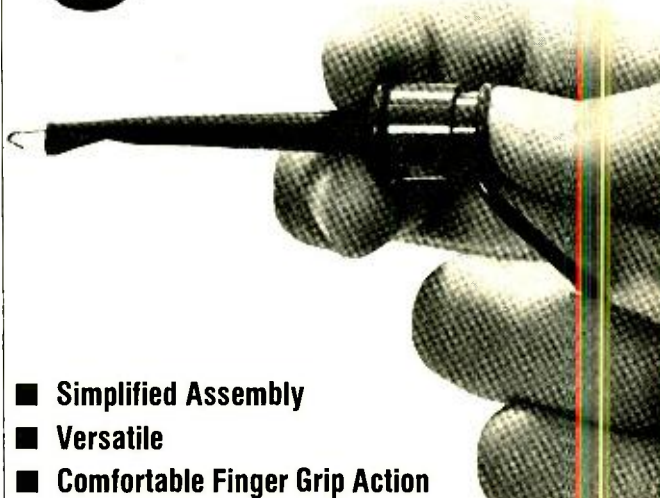

- Simplified Assembly
- Versatile
- Comfortable Finger Grip Action
- Completely Field Serviceable
- Molded of Tough Lexan*

**Model 3925
Mini Test Clip**
Shown Actual Size

This test clip with gold plated hook is excellent for rapid testing of components and Wire Wrap pins. Clip is completely insulated to point of connection. Build any combination of test leads with wire up to .090 dia. Easy and comfortable to operate. Molded of rugged Lexan to resist melting when soldering. Write for literature and prices.



MODEL 3925
hooks onto components or slips over square Wire-Wrap pins

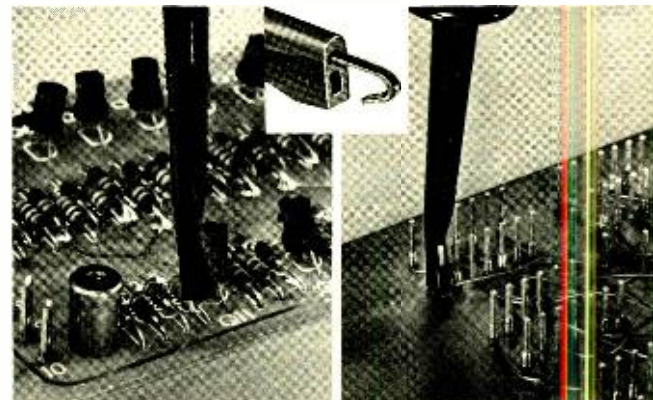

AVAILABLE ONLY THROUGH ELECTRONIC PARTS DISTRIBUTORS



POMONA ELECTRONICS

A Division of ITT

1500 East Ninth St., Pomona, Calif 91766

Circle 86 on reader service card

Cut out this coupon and you may cut out a new career as a two-way radio technician.

Take advantage of the growth in electronic communications. Become a two-way radio technician. The need for qualified people has never been greater and opportunities are nationwide. Thousands have increased their knowledge of two-way radio through the 40-Lesson MTI home-study course.

Simply fill in this coupon and mail it to us. We'll send you information on how you can learn more about this specialized field, at home.

I am interested in cutting out a new career as a two-way radio technician. Please send full details of the MTI course.

Name _____

Address _____

City/State/Zip _____

I am a veteran or serviceman



MOTOROLA TRAINING INSTITUTE

103 College Hill Road, Summerville, Pennsylvania 17093

Circle 87 on reader service card

ENJOY OLD RADIO-TV

A FLICK OF THE SWITCH your new 1930-1950 book

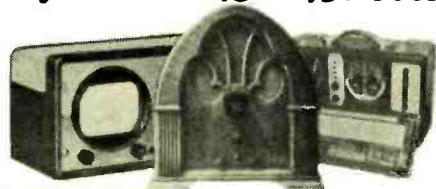

A FLICK OF THE SWITCH is your time trip through the golden days of radio broadcasting and into the dawn of television. Revisit "cathedral" radios, old Ham days and many more. Discover the rewards of collecting. Over 1,000 pictures make this book the 1930-1950 collector's reference. Order your copy of this 260-page book now! \$9.95 hard-cover, \$6.95 handbook.

Other valuable books are Vintage Radio (1887-1929) \$7.95 hard-cover, \$5.95 handbook; Radio Collector's Guide (1921-1932) \$4.95; 1927 Radio Encyclopedia \$12.95 hard-cover, \$9.95 soft-cover; 1926-1938 Radio Diagrams \$7.00. Also, we'll furnish any pre-1951 diagram for \$3.50.

Send today to Vintage Radio, Dep't R, Box 2045, Palos Verdes Peninsula, CA., 90274. Postage paid. Cal. residents add 6% tax.

_____ \$ _____
 _____ \$ _____
 _____ \$ _____

TOTAL _____

Name _____

Address _____

City _____ St. _____ Zip _____

FREE Radio Age Guide with each order FREE



VINTAGE RADIO SERIES

CLINIC QUESTIONS

(continued from page 76)

DELAYED INSTANT-ON

The sound comes on instantly, in this RCA CTC-62. Owner says that the picture used to come on instantly, too. Now, it takes from 20 to 30 seconds to light up. Plays perfectly after it comes on. Only thing wrong is that it won't "Instant-On" any more. I'm lost.—G.C., Shreveport, La.

If the set works perfectly after it does light up, it's OK. In this chassis, the horizontal oscillator is left on, at reduced voltage, all the time. (See circuit in *Radio-Electronics* Dec. 1973, page 38.) The INSTANT-ON switch does not turn the dc voltage supply off, but it apparently "turns it down." The OFF-ON switch, in ON position, connects the ground side of the ac line to ground. The hot side stays connected at all times.

IN OFF position, the ground side of the ac line goes to ground through the degaussing coil and a thermistor, and a 2.7-ohm resistor. Since nothing is wrong but the Instant-On, this circuit must be open. Degaussing coil unplugged, etc.

INTERMITTENT FUSE-BLOWING

The 6146 tube plates get red hot and the fuse blows, in this high-powered RCA amplifier. It's used in a PALcommunication system. No dead shorts, no shorted tubes. Any suggestions will be very welcome! It's intermittent!—W.J.M., Phoenix, Ariz.

Most likely cause for the kind of intermittent fuse-blowing you've got here would be intermittent failure of the bias supply for the 6146 output tubes. This is a fixed bias, coming from a tap on the power transformer secondary, through a diode restifier and filter, and probably through a variable resistor for adjustment. You could have an intermittent filter capacitor, a wire-short to ground, or something like that. Look for possible shorts where the bias lead crosses sharp metal edges; I had one of those not too long ago.

PALE PICTURE, POOR AGC

I've got a very pale picture, and odd agc action on this Truetone 2DC3916. No snow on the screen without antenna. I subbed the tuner; no help. I.f. tubes check OK. Voltages good. What's doing this?—M.D.O., Mena, Ark.

Pull the 8JV8 video output tube. Read the resistance from the control grid to ground. Reverse the ohmmeter prods. You should have a fairly low resistance; 150 ohms or so, one way and a high resistance, 3000 ohms or more, the other. If you read about 10 ohms one way and 30 ohms the other, the video detector diode is leaking. This is inside the last i.f. can, and it's not easy to get at. Use one of the small glass 1N60's; nothing else will fit.

HV REGULATION

I can't adjust the high voltage, on this Zenith, 6Z8C50 chassis. Here are the voltages I got around the 6HV5 high-voltage regulator. What do you think it is?—O.W., Hatfield, Ark.

I think your regulator isn't regulating! Note that grid voltage. You have +200 volts, and you ought to have +350. The cathode voltage is OK, at +390. So, the regulator grid is about 150 volts farther negative than it should be. This tube is cut off completely; it isn't conducting. Check some resistors, and possibly that VDR. One of them must be away off value.

SLOW FOCUS?

It takes about 5 minutes for this RCA CTC-15 to come into focus. This isn't normal, is it?—A.G., Oakland, N.J.

Nope. My CTC-15 comes on, focused, in 30 seconds. You have one of two possibilities; either the focus or the high voltage is a little slow warming up. Focus voltage must be a percentage (about 20%) of the high voltage at any given time. Read both focus voltage and the high voltage at turn-on, and you'll know where to look.

R-E

SOUND DOLLAR BUYS

FREE \$1 BUY WITH EVERY 10 YOU ORDER
Only applies to "\$1" Buys

FREE GIFT WITH EVERY ORDER
CANADIANS: Ordering is easy—we do the paperwork—try a small order

RCA 110° FLYBACK TRANSFORMER

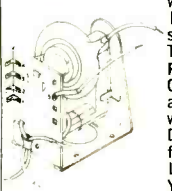

We scooped the Market. Latest type standard for all 110° TV's (Blk. & Wht.). RCA's design of large Coil produces 18KV—assuring adequate width Incl. Schematic Diagram application for any TV. List price \$13.90 **3⁹⁵** Your price 10% off in lots of 3.

- 110° TV DEFLECTION YOKE for all types TV's Incl schematic **4⁹⁵**
- "COMBINATION SPECIAL" RCA 10° FLYBACK plus 110° DEFLECTION YOKE **6⁹⁵**
- 90° FLYBACK TRANSFORMER for all type TV's (Blk. & Wht.) **2⁹⁵**
- 90° TV DEFLECTION YOKE for all type TV's (Blk. & Wht.) **3⁹⁵**
- 70° FLYBACK TRANSFORMER for all type TV's (Blk. & Wht.) **2⁰⁰**
- 70° TV DEFLECTION YOKE for all type TV's (Blk. & Wht.) **2⁰⁰**
- OLYMPIC & SHARP FLY-BACK Part #8FT592 Equip. Stancor #HO-108—Thordarson #Fly339 **3⁹⁵**
- 90° COLOR YOKE For all Rectangular 19 to 25" Color CRT's **7⁹⁵**
- 70 COLOR YOKE For all round color CRT's DELMONICO NIVICO COLOR FLYBACK Part #A2041-B **8⁹⁵**

SARKES TARZIAN TUNER



41mc
Latest Compact Model good for all 41 mc TV's. BRAND NEW —

Best TUNER "SARKES TARZIAN" ever made — last word for stability, definition & smoothness of operation. An opportunity to improve and bring your TV Receiver up-to-date. Complete with Tubes **7⁹⁵**

- WESTINGHOUSE FM TUNER #476-V-015D0 1 Transistor **3⁹⁹**
- WESTINGHOUSE FM TUNER (12DT8 Tube) **1⁰⁰**
- UHF TUNER—Transistor Type Used in all TV sets **3⁹⁵**
- G.E. UHF TUNER—TRANSISTOR TYPE Model #85X4 **3⁹⁵**
- ADMIRAL TV TUNER Model #94C393-1 (2HA5-4LJ8) Model #T94C141-3 (Transistor) **7⁹⁵**
- PHILCO TV TUNERS Model-76-13983-3 (5GJ7-3HQ5) **4⁹⁵**
- WELLS GARDNER TUNER Part #7.A 120-1 (4GS7-2HA74J8) **7⁹⁵**
- G.E.—TV TUNER (2GK5-4LJ8) Model #EP 86x11 **7⁹⁵**
- PHILCO UHF/VHF TUNER Transistorized **9⁹⁵**
- GE TV TUNER ET 86x196, (6GK5-6BL8) **5⁹⁵**
- UNIVERSAL TV Antenna Back of set mounting... 5 section rods **2⁹⁹**
- BLUE LATERAL Magnet Assy. Replacement for most color TV's **1⁷⁹**
- COLOR CONVERGENCE Assy. Universal type—good for most sets **2⁴⁹**
- COLOR-TV RECTIFIER—Used in most color sets—6500 kv 3 for **1⁹⁵**
- 2 COLOR-TV CRT SOCKETS Wired leads, for all color TV's **1⁰⁰**
- 3—RCA 110° CRT SOCKETS Wired leads, for all TV's **1⁰⁰**
- RMS-9 ELEMENT COLOR OUTDOOR ANTENNA Model HA-9 VHF/UHF **8⁹⁵**
- 4—Polarized CHEATER CORD Grey **1⁰⁰**
- 70° COLOR TUBE BRIGHTNER **3⁹⁵**
- 90° COLOR TUBE BRIGHTNER **4⁹⁵**
- 2—Colorized Quartz-Crystal For most color TV sets 3579, 545 KC **1⁸⁹**
- 5 ASST GLOBAL VARISTOR Popular replacements for most COLOR TV **1⁰⁰**
- UHF or VHF Matching Trans. Simple Pool-proof installation **1⁰⁰**

WESTINGHOUSE ALL TRANSISTOR HOME/OFFICE MESSAGE CENTER

Leaves messages for other for replay... Built in speaker/microphone for talk-into convenience... Records up to 3 minutes of messages... Illuminated signal shows when a message is waiting. Control adjusts playback volume without affecting recording volume... Capstan Drive: **7⁹⁵**
BRAND NEW SOLD AS IS

- ### KLEPS "CLEVER" TEST PRODS
- "Third-hand" test prods. reach into out of way places - Insulated - cannot slip - accommodates bare wire or banana plug—no soldering.
- PRUF 10—Versatile Test Probe **89^c**
 - KLEPS 10—Boathook Clamp 4 3/4" long **1³⁹**
 - KLEPS 20—Boathook Clamp 7" long **1⁴⁹**
 - KLEPS 30—flexible-forked Tongue 6" long **1⁷⁹**
 - KLEPS 40 FLEXIBLE-PC Board Terminals 6 1/4" long **2⁵⁹**
 - KLEPS I-ECONOMY **99^c**

- 5-10K-2 WATT BIAS POTS Used in solid state application **1⁰⁰**
- VU 1" PANEL METER 0-20 db Scale **1²⁹**
- 250—ASST SOLDERING LUGS best types and sizes **1⁰⁰**
- 250—ASST WOOD SCREWS (finest popular selection) **1⁰⁰**
- 250—Asst Self Tapping SCREWS #6, #8, etc. **1⁰⁰**
- 100—ASST 6/32 SCREWS and 100—6/32 HEX NUTS **1⁰⁰**
- 100—ASST 8/32 SCREWS and 100—8/32 HEX NUTS **1⁰⁰**
- 100—ASST 2/56 SCREWS and 100—2/56 HEX NUTS **1⁰⁰**
- 100—ASST 4/40 SCREWS and 100—4/40 HEX NUTS **1⁰⁰**
- 100—ASST 5/40 SCREWS and 100—5/40 HEX NUTS **1⁰⁰**
- 500—ASSORTED RIVETS most useful selected sizes **1⁰⁰**
- 300 ASSORTED WASHERS most useful selected sizes **1⁰⁰**
- 100—ASST RUBBER BUMPERS for cabinet bottoms—other uses **1⁰⁰**
- 100—ASST RUBBER GROMMETS best sizes **1⁰⁰**
- 15—DIPPED MYLAR CAP. .01—600V **1⁰⁰**
- 15—DIPPED MYLAR CAP. .033—600V **1⁰⁰**
- 15—DIPPED MYLAR CAP. .033—1000V **1⁰⁰**
- 15—DIPPED MYLAR CAP. .047—400V **1⁰⁰**
- 15—Molded Tubular Capacitors .056—400V **1⁰⁰**
- 15—DIPPED MYLAR Condensers .0039 400V **1⁰⁰**
- TACHOMETER 2 1/4" Sq. Panel Meter 1-VDC. full scale 33 Ohm coil resistance 0-6000 R.P.M. **2⁰⁰**
- 1—CASSETTE type dynamic Mike with universal plugs—200 Ohms **2⁹⁹**
- 10—SETS PHONO PLUGS & PIN JACKS RCA type **1⁰⁰**
- 8—MINI PILOT BULBS With 8" Leads—6.3V 30MA (5000 Hrs) **1⁰⁰**
- 8—MINI PILOT BULBS With 12" Leads—6.3V, 150MA (5000 Hrs.) **1⁰⁰**
- 32"—TEST PROD WIRE DELUXE QUALITY red & black **1⁰⁰**
- 10—MINI ELECTROLYTIC Cond For Transistor & miniature work **1⁰⁰**
- DELUXE PILLOW SPEAKERS With plug & volume control **2⁴⁹**
- 2—12BH7 RCA TUBES **1⁰⁰**
- 10—ASST DIODE CRYSTALS 1N34, 1N48, 1N60, 1N64, etc. **1⁰⁰**
- 6—Top Brand Silicon RECT. 1 amp., 1000 PIV **1⁰⁰**
- 5—PNP TRANSISTOR general purpose, TO-5 case **1⁰⁰**
- 5—NPN TRANSISTORS general purpose, TO-5 case **1⁰⁰**
- 25—ASSORTED TRANSISTORS big factory scoop—solid as-is **1⁰⁰**
- 5—9 VOLT MOTORS Excellent for hobbyist **1⁰⁰**
- 2—ELECTROLYTIC CONDENSERS Axial leads—500—25V **1⁰⁰**
- KANDU—Printed Circuit Kit Trace & Etch your own circuits—easy to use instructions **9⁹⁵**

SUB-LIGHTS

A safe decorative lighting system turns aquariums into underwater wonderlands. Complete Sub-Light Kit contains 12 bulbs, Hanger Assy., Suction cup, Telescoping channel guide. Add. Sub-light available **6⁹⁸**
Red, Blue, Clear

- TRANSISTOR RADIO asst type good, bad, broken, as-is, potluck **1⁵⁰**
- TAPE RECORDER assorted types good, bad broken, as-is, potluck **4⁰⁰**
- 200 ASST. 1/2 W RESISTORS Top Brands, Short Leads, Excellent Selection **1⁰⁰**
- 75—ASST 1/4 WATT RESISTORS stand, choice ohmages, some in 5% **1⁰⁰**
- 100—ASST 1/2 WATT RESISTORS stand, choice ohmages, some in 5% **1⁰⁰**
- 70—ASST 1 WATT RESISTORS stand, choice ohmages, some in 5% **1⁰⁰**
- 35—ASST 2 WATT RESISTORS stand, choice ohmages, some in 5% **1⁰⁰**
- 50—PRECISION RESISTORS asst. list-price \$50 less 98% **1⁰⁰**
- 20—ASSORTED WIREWOUND RESISTORS, 5, 10, 20 watt **1⁰⁰**
- 10—ASST SLIDE SWITCHES SPST, SPDT, DPDT, etc. **1⁰⁰**
- 25—SYLVANIA HEAT SINKS For Transistors **1⁰⁰**
- 20—ASSORTED TV COILS I.F. VDEO, sound radio, etc. **1⁰⁰**
- 1—ELECTROLYTIC COND. 200/300/100/100 MFD—25V **1⁰⁰**
- 1—ELECTROLYTIC COND 100 MFD—300V **1⁰⁰**
- 2—ELECTROLYTIC COND 20/20 MFD-450V **1⁰⁰**
- 2—ELECTROLYTIC Condensers 100/75 mfd-300V, 70 mfd-25V **1⁰⁰**
- 2—ELECTROLYTIC Condensers 300 mfd-200V **1⁰⁰**
- 300/60 mfd-150V **1⁰⁰**
- 4—ELECTROLYTIC COND 75/30mfd-150V **1⁰⁰**
- ELECTROLYTIC CONDENSERS 200/200 mfd.—200V **1⁰⁰**
- 2—ELECTROLYTIC COND 1500 mfd—35V **1⁰⁰**
- 300 mfd.—200V **1⁰⁰**
- 2—ELECTROLYTIC CONDENSERS 80/100/60 MFD-160V **1⁰⁰**
- 2—ELECTROLYTIC COND 200/30/4—mfd—350V **1⁰⁰**
- 3—ELECTROLYTIC COND 100 mfd.—100V, 50 mfd.—75V **1⁰⁰**
- 2—ELECTROLYTIC COND 40 mfd.—500V, 40 mfd.—400V **1⁰⁰**
- 5—AC LINE CORDS Approved 6' **1⁰⁰**
- 4-50' HANKS Hook-Up Wire assorted colors **1⁰⁰**

KNOB SPECIAL

- 100—Assorted RADIO KNOBS All standard types \$20 value **1⁰⁰**
- 50—TV KNOBS—POPULAR TYPES Mostly Selector & Fine Tuning **1⁰⁰**
- 20—Vertical Linearity KNOBS Long shank... Front mount assortment **1⁰⁰**
- 20—Vertical Linearity KNOBS Side mount... Standard sizes **1⁰⁰**
- 25—Knurled Shaft KNOBS Hard to get. Best selection **1⁰⁰**
- 25—Clock & Radio KNOBS most popular types **1⁰⁰**

ANY 6 KITS FOR \$5

Test Equip. Special Discount Prices

BK TELCO Leader SENCORE

SHANNON MYLAR RECORDING TAPE

3"	— 225'	.19	CASSETTE C-60	.59
3 1/4"	— 600'	.78	CASSETTE C-90	1.19
5"	— 600'	.82	CASSETTE C-120	1.97
5"	— 900'	.90	8-Track — 64 Min.	1.29
5"	— 1200'	1.49	8-Track — 80 Min.	1.59
5"	— 1800'	1.89	8-Track — Cleaner	1.49
7"	— 1200'	.97		
7"	— 1800'	1.32	3" TAPE REEL	.09
7"	— 2400'	1.99	3 1/4" TAPE REEL	.12
7"	— 3600'	3.49	5" TAPE REEL	.29
			7" TAPE REEL	.35

MARKET SCOOP COLUMN

<input type="checkbox"/>	CO-AX CABLE RG59U (Black)	2 ⁶⁹
<input type="checkbox"/>	250'—\$10, 100'—\$4.50, 50'—\$2.50	
<input type="checkbox"/>	IC4 and IC3 Integrated Circuit	1 ⁰⁰
<input type="checkbox"/>	Used in Scott-Fisher etc.	
<input type="checkbox"/>	15—ASSORTED IC'S For Experimenters	1 ⁰⁰
<input type="checkbox"/>	Silicon NPN HV TRANSISTOR	
<input type="checkbox"/>	RCA—SK 3021—Hep-240	1 ⁰⁰
<input type="checkbox"/>	RCA—SK 3026—Hep-241	1 ^{ea.}
<input type="checkbox"/>	Transistor Specials—Your Choice	
<input type="checkbox"/>	SK3006, SK3018, SK3020	1 ⁰⁰
<input type="checkbox"/>	SK3122, SK3124	1 ^{ea.}
<input type="checkbox"/>	Transistor Specials—Your Choice	1 ⁹⁸
<input type="checkbox"/>	SK3009, SK3024, SK3040	
<input type="checkbox"/>	5—DUAL DIODE—MOST POPULAR TYPES Common cathode or Series connected	2 ⁵⁰
<input type="checkbox"/>	2—ELECTROLYTIC CONDENSERS Axial leads—1000 Mfd — 25V	1 ⁰⁰
<input type="checkbox"/>	4 — TV ALIGNMENT TOOLS most useful assortment #1	1 ⁰⁰
<input type="checkbox"/>	4 — TV ALIGNMENT TOOLS For Color TV #2	1 ⁴⁹
<input type="checkbox"/>	6 — TV COLOR ALIGNMENT TOOLS Most popular type	2 ⁷⁹
<input type="checkbox"/>	TV TWIN LEAD-IN 300 ohm 500'—\$7.100—\$1.50, 50'—\$1.00	1 ⁰⁰
<input type="checkbox"/>	100' GREY SPEAKER WIRE	2 ⁰⁰
<input type="checkbox"/>	2 Cond. mini jug, 101 uses	
<input type="checkbox"/>	WAHL—CORDLESS SOLDER IRON Complete with Auto Charger - Fast Heating - Lock pad	19 ⁹⁵
<input type="checkbox"/>	5—Audio Output TRANSFORMER Sub-min for Trans Radios	1 ⁰⁰
<input type="checkbox"/>	5—I.F. Coil TRANSFORMERS 456-ke for Transistor Radios	1 ⁰⁰
<input type="checkbox"/>	6" UNIVERSAL SPEAKER Top quality Special buy	1 ⁵⁹
<input type="checkbox"/>	12" UNIVERSAL SPEAKER Top Quality... Large Magnet	5 ⁹⁹
<input type="checkbox"/>	10" PHILCO SPEAKER Top Quality... Large Magnet	3 ⁹⁵
<input type="checkbox"/>	8" UNIVERSAL SPEAKER Large Magnet—Special Buy	2 ⁹⁹
<input type="checkbox"/>	3" UNIVERSAL TWEETER 1 oz. Magnet	1 ²⁹
<input type="checkbox"/>	2 1/2"x4" SPEAKER Special Buy 10 for \$5	69 ^c
<input type="checkbox"/>	4"x6" "QUAM" 16 OHM SPK. Large magnet... Special Buy (10 for \$15.00)	1 ⁷⁹
<input type="checkbox"/>	UTAH 8"—HEAVY DUTY 0 Oz. SPEAKER Ceramic Type—8 Ohm	4 ⁵⁰
<input type="checkbox"/>	1—6"x9" Heavy Duty 10 Oz. Speaker Ceramic Type... 8 Ohm	4 ⁵⁰
<input type="checkbox"/>	1—5"x7" UNIVERSAL SPK. (10-20-40 OHM Imped.)	2 ⁹⁵
<input type="checkbox"/>	3 SPEAKER—7 WAY SELECTOR SWITCH Wall Mount	1 ⁰⁰
<input type="checkbox"/>	STEREO MICROPHONES FL 1979/01 Made in Holland SET	6 ⁵⁰
<input type="checkbox"/>	CONVERGENCE RECTIFIER—For COLOR TV 4 Cell—Used in RCA—Philco, etc. TV DAMPER DIODE Single—Replace RCA part #120818 Dual—RCA part #135935	\$2.29 \$3.95
<input type="checkbox"/>	COLOR POWER TRANS. — Good for most sets 26R150 List Price—\$36.75	6 ⁹⁵
<input type="checkbox"/>	TUBE & CONTINUITY CKR. Model FT425 (Tests fuses, heaters, lamps, etc.)	1 ⁹⁸
<input type="checkbox"/>	VARCO Stereo Cartridge—CW-72 With mounting bracket, flipover needle	2 ⁹⁵
<input type="checkbox"/>	RONETTE Stereo Cartridge latest dual sapphire flipover type	2 ⁰⁰
<input type="checkbox"/>	Stereo Headphones Hi-Fi Quality... Complete with Stereo plug	5 ⁹⁵
<input type="checkbox"/>	10—STANDARD TRANSISTORS NPN & PNP 2N404, 2N410, etc.	1 ⁰⁰
<input type="checkbox"/>	25' Shielded MIKE CABLE Grey 25/1	1 ⁸⁹
<input type="checkbox"/>	MERCURY COMPACT TUBE TESTER Model #990 Miniature-sized Specs Saver Full sized in performance	49 ⁹⁵
<input type="checkbox"/>	TELMATIC Tuner-Mate KT-730 Portable "Substi-Tuner" Instant Tuner Check	42 ⁵⁰
<input type="checkbox"/>	TELEMATIC Test Jig Model—EJ-190—Master Rigs—Combo Rigs—Econo Rigs	49 ⁹⁵

IMMEDIATE DELIVERY... Scientific light packing for safe delivery at minimum cost. HANDY WAY TO ORDER... Send check or money order, add extra for shipping. Lists of new offers will be returned in your order. Please specify refund on shipping overpayment desired: CHECK POSTAGE STAMPS MERCHANDISE (our choice) with advantage to customer

BROOKS RADIO & TV CORP., 487 Columbus Ave., New York, N.Y. 10024 TELEPHONE: 212-874 5600

Circle 88 on reader service card

NEW! Build your own Circuits & Save with VeroBoard® kits

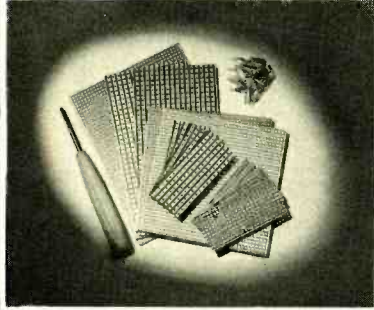

Simple and easy to use — no etching or drilling. The BK-6 kit contains six assorted VEROBOARDS, two with 0.2x0.2 matrix and four with 0.156x0.1 matrix.

\$8.95

The BK-P15 contains 15 assorted boards from a mini 1"x2½" to a maxi 3¼"x5". Eight boards have 0.1x0.1 matrix with 0.52 and 0.40 diameter holes and seven with 0.15x0.15 matrix. This kit contains a complete set of terminal pins.

\$12.95

All kits include a spot face cutter and easy-to-follow instructions.

VEROBOARDS are made of quality synthetic resin bonded paper laminate, copper clad on one side with a tensile strength of 11,000 lbs/sq. in. Build any circuit in three easy steps.

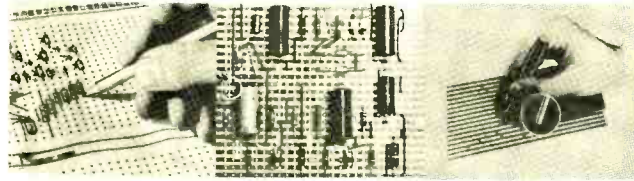

1 Layout plan on 1" grid paper 2 Insert and solder components 3 Use precision spot face cutter supplied to remove copper to break circuits.

"See Veroboards at IEEE Booths 1718-1720"

SEND CHECK OR MONEY ORDER
N.Y. RESIDENTS ADD SALES TAX

vero

Vero Electronics, Inc.

171 Bridge Road, Hauppauge, N.Y. 11787
Tel.: 516-234-0400 TWX: 510-227-8890

Circle 89 on reader service card

BUILD A TICK TIMER

(continued from page 41)

over-tighten the mounting screws and make certain there are no sharp ends of the screen wire extending inwardly, to poke through the speaker cone. Locate the board assembly with its potentiometers toward the side of the cabinet, rather than toward the center, to make them easily accessible. Be sure there is sufficient clearance to prevent short-circuiting the potentiometer bodies to the metal cabinet, when the back/sides part is slipped into place.

Calibration

When the unit has been completely assembled, and checked for possible errors, turn switch S1 to OFF and install the battery. An ordinary transistor battery will suffice for casual operation of the timer, but if you contemplate using it often or for long periods, an alkaline battery such as the Mallory MN1604B, will give better service.

Set potentiometers R1 and R6 at maximum resistance in the circuit. Set potentiometer R4 at about mid-position, and potentiometer R8 at the grounded end of its rotation. Turn switch S1 to ON, and after a brief pause, ticks should be heard from the speaker. There will be no accented ticks,

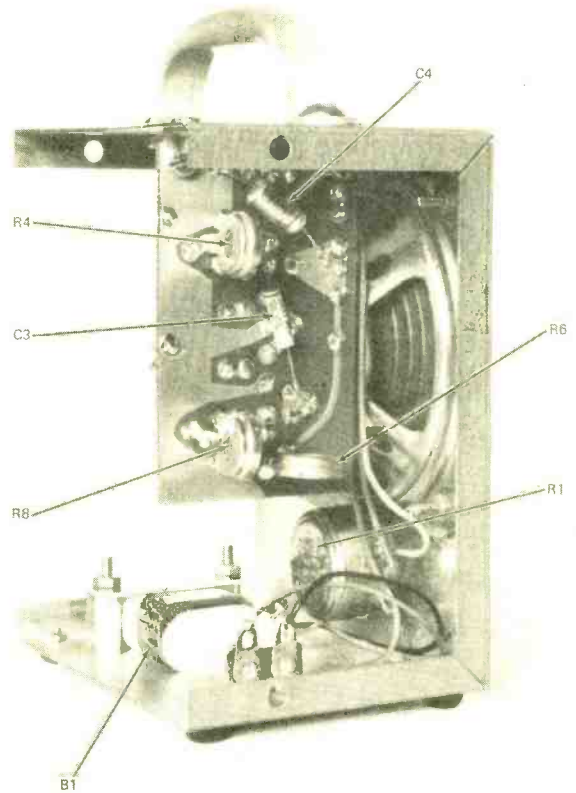

FIG. 3—COMPONENT LAYOUT from toll side of circuit board.

since this part of the setup has been momentarily disabled by the pre-setting of R8. Adjust potentiometer R1, the front-panel control, until the ticks occur at exactly one tick per second.

With R1 properly set, rotate R4 to the grounded end of its rotation and advance R8 to about mid-position. Now the 1-second ticks will not be heard. Adjust potentiometer R6, the 10-second rate control, to where a tick is heard from the speaker once every 12 to 13 seconds. The extra 2 to 3 seconds makes this generator run slowly enough to enable it to be synchronized with the pulses from the 1-second generator.

With R6 adjusted as described, turn the timer off and solder capacitor C3 in place. Switch the timer on again, and



Clever Kleps

Test probes designed by your needs — Push to seize, push to release (all Kleps spring loaded).

Kleps 10. Boathook clamp grips wires, lugs, terminals. Accepts banana plug or bare wire lead. 4¾" long. \$1.39

Kleps 20. Same, but 7" long. \$1.49

Kleps 30. Completely flexible. Forked-tongue gripper. Accepts banana plug or bare lead. 6" long. \$1.79

Kleps 40. Completely flexible. 3-segment automatic collet firmly grips wire ends, PC-board terminals, connector pins. Accepts banana plug or plain wire. 6¼" long. \$2.59

Kleps 1. Economy Kleps for light line work (not lab quality). Meshing claws. 4½" long. \$.99

Prof 10. Versatile test prod. Solder connection. Molded phenolic. Doubles as scribing tool. "Bunch" pin fits banana jack. Phone tip. 5½" long. \$.89

All in red or black - specify. (Add 50¢ postage and handling).

Write for complete catalog of - test probes, plugs, sockets, connectors, earphones, headsets, miniature components.

Available through your local distributor, or write to:

RYE INDUSTRIES INC.

128 Spencer Place, Mamaroneck, N.Y. 10543

In Canada: Rye Industries (Canada) Ltd.

Circle 90 on reader service card



advance potentiometer R4 to where the 1-second ticks are heard from the speaker. If you've been fortunate, every 10th tick will be louder. You may find, however, that every 9th or every 11th tick is being emphasized. If you're getting 9-second intervals, advance R6 slightly, to put a little more resistance in the circuit, and recheck performance. On the other hand, if you're getting 11-second intervals, R6 should be adjusted to put a little less resistance in the circuit. With R6 set as previously described, very little readjustment should be needed.

Adjust potentiometer R4 to where the 1-second ticks are heard distinctly but not too loudly. Then adjust R8 to where every 10th tick is obviously emphasized. Put the back/sides cover in place. The timer is now ready for use.

In using the instrument, it will be noted that the first louder tick, after the unit is switched on each time, is always later than normal. In my setup, the first emphasized tick occurs at 14 seconds. All louder ticks after the first one will be at the required 10-second intervals. **R-E**

OVERVOLTAGE RELAY

Vacuum-tube handbooks point out that 10% overvoltage cuts tube heater life in half. Cathode-ray tubes in oscilloscopes and TV receivers are expensive, often indispensable and—in some areas—replacements are not readily available. This overvoltage relay circuit was developed to protect voltage-sensitive devices by interrupting the power when the line voltage rises only a few volts above normal.

The V_z rating of Zener diode D2 is chosen by trial and is below the normal rms supply voltage by a little more than the dc operating voltage of RY1. Diodes D1 and D2 carry the coil current of RY1. D1 should have a PIV rating greater than the peak ac voltage ($2.8 E_{rms}$, if E_{in} is a sine wave). Electrolytic capacitor C1 is made large enough so RY1 does not chatter. The total resistance of R1 is chosen so V_c —the voltage across C1—approximates the rms voltage, not the peak voltage. R1-a is a pot or adjustable resistor for fine adjustment of the tripping voltage.

To energize the device protected by this overvoltage relay, close RY2's contacts manually or by pressing an optional momentary switch (S1) connected across the relay contacts. If the supply voltage is normal, RY2 will remain energized through the normally closed contacts of RY1. If the line voltage is too high, RY1 is energized so the RY2 contacts open to prevent power from flowing to the protected device.

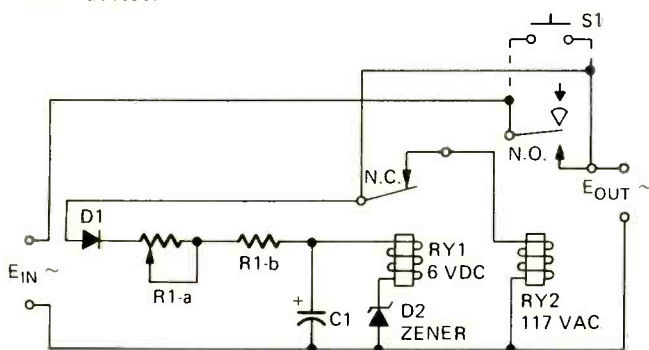

When adjusted for a 115-volt, 60-Hz normal supply; with RY1 rated at 6 volts dc and V_z selected as 100 volts, the overvoltage protector consistently shuts off at 120 volts without false triggering. The span between the normal and tripping voltages can probably be made smaller by selecting RY1 for a lower operating voltage.

R1 and C1 and the current ratings of D1 and D2 depend on the coil voltage and current of RY1. The greater the sensitivity of RY1, the lower the power wasted in the protector circuit. Diode D1 should have a PIV rating of 300 volts or more.—A.H. Taylor

Accuracy like a VTVM... Convenience like a VOM...

NEW BATTERY-OPERATED FET SOLID-STATE VOLT-OHMMETER #116

Easy-to-build KIT

\$36.90 =116K

Factory-Wired & Tested

\$49.49 =116W

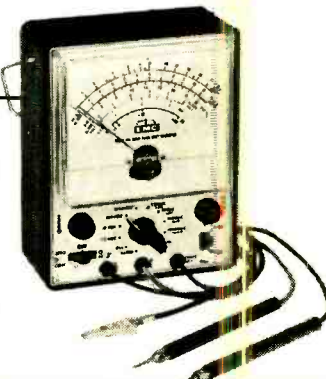

Now you can get all the benefits of a VTVM (laboratory accuracy, stability and wide range) but with its drawbacks gone: no plugging into an AC outlet, no waiting for warm-up, no bulkiness. New Field Effect Transistor (FET) design makes possible low loading, instant-on battery-operation and small size. Excellent for both bench and field work.

Compare these valuable features:

- High impedance low loading: 11 megohms input on DC, 1 megohm on AC
- 500-times more sensitive than a standard 20,000 ohms-per-volt VOM
- Wide-range versatility: 4 P-P AC voltage ranges: 0-3.3, 33, 330, 1200V; 4 RMS AC voltage ranges: 0-1.2, 12, 120, 1200V; 4 DC voltage ranges: 0-1.2, 12, 120, 1200V; 4 Resistance ranges: 0-1K, 0-100K, 0-10 meg., 0-1000 meg.; 4DB ranges: -24 to +56DB.

Sensitive easy-to-read $4\frac{1}{2}''$ 200 micro-amp meter. Zero center position available. Comprises FET transistor, 4 silicon transistors, 2 diodes. Meter and transistors protected against burnout. Etched panel for durability. High-impact bakelite case with handle useable as instrument stand. Kit has simplified step-by-step assembly instructions. Both kit and factory-wired versions shipped complete with batteries and test leads. $5\frac{1}{4}''$ H x $6\frac{3}{4}''$ W x $2\frac{7}{8}''$ D. 3 lbs.

Send FREE catalog of complete EMC line and name of nearest distributor.

RE-4

Name _____
Address _____
City _____
State _____ Zip _____

EMC

ELECTRONIC MEASUREMENTS CORP.
625 Broadway, New York, N.Y. 10012

for only \$1.00

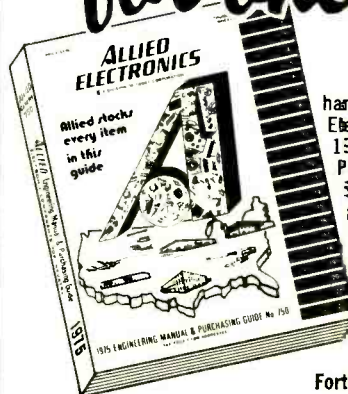

... to cover postage and handling, you can get Allied Electronics' famous 362 page 1975 Engineering Manual & Purchasing Guide, valued at \$5. Use it to order hard-to-get electronics parts and supplies — one or a thousand. Cash in on one of the best investments you'll ever make! Fill in coupon below and mail with \$1.00 today to Allied Electronics, Dept. RE, 401 East 8th Street, Fort Worth, Texas 76102.

NAME _____
ADDRESS _____
CITY _____
STATE _____ ZIP _____

ALLIED ELECTRONICS

A DIVISION OF TANDY CORPORATION

APRIL 1975

Quality Electronic Components

SPECIAL SAVINGS DISCOUNT ON LINEAR AND DIGITAL INTEGRATED CIRCUITS
 Deduct 4% from the total of your I.C. order if it exceeds \$25.00 based on single list prices. 7% for \$50.00 or more, 10% for \$100.00 or more. Additional large quantity discounts offered.

7400N	25c	7445N	81c	7495N	90c	74193N	\$1.17	4027AE	67c
7401N	25c	7446N	81c	7496N	81c	74198N	\$2.75	4028AE	\$1.09
7402N	25c	7447N	81c	74107N	32c	74199N	\$2.75	4029AE	\$1.42
7403N	25c	7448N	90c	74121N	36c	4000AE	30c	4030AE	50c
7404N	25c	7450N	23c	74122N	45c	4010AE	30c	4035AE	\$1.67
7405N	25c	7451N	23c	74123N	\$1.08	4002AE	30c	4034AE	\$3.34
7406N	25c	7453N	23c	74141N	99c	4006AE	\$1.50	4035AE	\$1.42
7407N	25c	7454N	23c	74150N	\$1.44	4007AE	30c	4040AE	\$1.67
7408N	25c	7459N	25c	74151N	90c	4008AE	\$1.17	4041AE	92c
7409N	25c	7460N	23c	74153N	81c	4009AE	67c	4042AE	84c
7410N	25c	7470N	36c	74154N	\$1.44	4010AE	67c	4043AE	67c
7411N	25c	7472N	36c	74155N	81c	4011AE	30c	4044AE	67c
7413N	25c	7473N	32c	74156N	81c	4012AE	30c	4046AE	\$2.51
7416N	25c	7474N	32c	74157N	72c	4013AE	35c	4049AE	58c
7417N	25c	7475N	54c	74158N	\$1.53	4014AE	\$1.67	4050AE	58c
7418N	25c	7476N	36c	74160N	\$1.26	4015AE	\$1.17	4051AE	\$1.50
7420N	25c	7480N	72c	74161N	\$1.17	4016AE	63c	4052AE	\$1.50
7421N	25c	7482N	72c	7462N	\$1.26	4017AE	\$1.34	4053AE	\$1.50
7423N	72c	7483N	72c	74163N	\$1.26	4018AE	\$1.67	4054AE	\$1.67
7426N	25c	7485N	\$1.40	74164N	\$1.35	4019AE	58c	4066AE	\$1.00
7430N	25c	7486N	32c	74165N	\$2.45	4020AE	\$1.67	4071AE	30c
7437N	25c	7489N	\$4.47	74166N	\$2.00	4021AE	\$1.50	4072AE	30c
7438N	25c	7490N	50c	74175N	\$1.00	4022AE	\$1.25	4073AE	30c
7440N	25c	7491N	81c	74183N	81c	4023AE	30c	4075AE	30c
7441N	\$1.17	7492N	50c	74181N	\$2.25	4024AE	\$1.00	4081AE	30c
7442N	65c	7493N	50c	74182N	90c	4025AE	30c	4082AE	30c
		7494N	81c	74192N	\$1.26	4026AE	\$1.67		

555V MINIDIP TIMER	82.5c	558V MINIDIP DUAL AMP	75.0c
565A DIP PLL	\$3.38	567V MINIDIP DECODER	\$3.38
741V MINIDIP OP AMP	50.0c	723A DIP VOLTAGE REG	82.5c
748V MINIDIP OP AMP	42.0c	747A DIP DUAL AMP	97.5c
L129 5 VOLT REG	\$1.80	LM3900 DIP QUAD AMP	60.0c
L131 15 VOLT REG	\$1.80	LM309 12 VOLT REG	\$1.80
		LM309K 5 VOLT REG	\$1.75

MINIATURE ALUMINUM ELECTROLYTIC CAPACITORS — AXIAL LEAD TYPE —

-40°C plus 85°C Tolerance, 10 plus 50% (greater than 4.7 µF) -10 plus 75% (4.7 µF or less)									
1 µF/50V	14c	12c	11c	33 µF/16V	15c	12c	11c	330 µF/16V	35c
2.2 µF/50V	14c	12c	11c	33 µF/25V	17c	15c	12c	330 µF/25V	44c
3.3 µF/35V	14c	12c	11c	47 µF/16V	17c	14c	13c	470 µF/16V	37c
4.7 µF/25V	14c	12c	11c	47 µF/25V	19c	15c	14c	470 µF/25V	49c
10 µF/16V	14c	12c	11c	100 µF/16V	19c	15c	14c	1000 µF/16V	49c
10 µF/25V	14c	12c	11c	100 µF/25V	24c	19c	17c	1000 µF/25V	60c
22 µF/16V	14c	12c	11c	220 µF/16V	24c	19c	17c	2200 µF/16V	75c
22 µF/25V	15c	13c	12c	220 µF/25V	25c	20c	24c		

1N4001 50 PIV 12/51	100/36	1000/548	1N4005 600 PIV 8/31	100/39	1000/570
1N4007 1000 PIV	6/51	100/511	1000/588		

1N4148 (1N914 equiv.)	12/51	100/57	1M/550	5M/520
-----------------------	-------	--------	--------	--------

100/51	500/54	2000/58	5000/538	20	50.000/5275
--------	--------	---------	----------	----	-------------

DATALIT-704	\$1.00	DATALIT-707	\$1.50
-------------	--------	-------------	--------

2-56 1/4 Screw	90c/c	2-56 1/2 Screw	98c/c
4-40 1/4 Screw	96c/c	4-40 1/2 Screw	96c/c
6-32 1/4 Screw	92c/c	6-32 1/2 Screw	86c/c
8-32 3/8 Screw	\$1.05/c	8-32 5/8 Screw	\$1.35/c
2-56 Hex Nut	\$1.45/c	2 Lock Washer	45c/c
4-40 Hex Nut	\$1.45/c	4 Lock Washer	45c/c
6-32 Hex Nut	\$1.45/c	6 Lock Washer	45c/c
8-32 Hex Nut	\$1.50/c	8 Lock Washer	45c/c

6 AMP SPST N.O.	CONTACTS	10
5V	\$2.00	\$1.50
6V	\$2.00	\$1.50
12V	\$2.00	\$1.50
24V	\$2.00	\$1.50

100 pf/500V	7c	5.5c	4.5c	3.6c	8 pin Solder	27c	21c
220 pf/500V	7c	5.5c	4.5c	3.6c	14 pin Solder	29c	23c
470 pf/500V	7c	5.5c	4.5c	3.6c	16 pin Solder	32c	25c
.001/500V	7c	5.5c	4.5c	3.6c	18 pin Solder	34c	26c
.0022/500V	7c	5.5c	4.5c	3.6c	24 pin Solder	54c	42c
.0047/500V	7c	5.5c	4.5c	3.6c			1
.01/500V	10c	7.5c	6.3c	5.0c	8 pin W.W.	38c	30c
.01/25V	5c	3.5c	3.0c	2.4c	14 pin W.W.	50c	39c
.022/25V	6c	4.0c	3.5c	2.7c	16 pin W.W.	54c	42c
.047/25V	9c	6.0c	5.3c	4.2c	18 pin W.W.	88c	68c
1/25V	12c	9.0c	7.5c	6.0c	18 pin W.W.	99c	80c

5 each of the 85 standard 10% values (2.2-22M) 1/2 W Resistors (425 pcs.)	Sorted by value \$12/set 2-4 are \$11/set 5-9 are \$10/set.
5 each of the 70 standard 10% values (10-5.6M) 1/4 W Resistors (350 pcs.)	Sorted by value \$12/set 2-4 are \$11/set 5-9 are \$10/set.

EN918	10-106	21c	18.5c	16.5c	2N3645	10-105	20c	17.5c	16.0c
EN930	10-106	21c	18.5c	16.5c	2N3646	10-106	22c	19.0c	17.5c
EN222	10-106	21c	18.5c	16.5c	2N3904	10-92	22c	19.0c	17.5c
EN2369A	10-106	21c	18.5c	16.5c	2N3906	10-92	22c	19.0c	17.5c
EN2907	10-106	21c	18.5c	16.5c	2N4124	10-92	22c	19.0c	17.5c
2N2712	10-98	18c	16.0c	14.5c	2N4126	10-92	22c	19.0c	17.5c
2N3918A	10-98	22c	19.0c	17.5c	2N4401	10-92	22c	19.0c	17.5c
2N3392	10-98	22c	19.0c	17.5c	2N4403	10-92	22c	19.0c	17.5c
2N3393	10-98	22c	19.0c	17.5c	2N5087	10-92	22c	19.0c	17.5c
2N3394	10-98	22c	19.0c	17.5c	2N5089	10-92	22c	19.0c	17.5c
2N3563	10-106	20c	17.5c	17.5c	2N5129	10-106	19c	17.0c	15.0c
2N3565	10-106	20c	17.5c	16.0c	2N5133	10-106	19c	17.0c	15.0c
2N3638	10-105	20c	17.5c	16.0c	2N5134	10-106	19c	17.0c	15.0c
2N3638A	10-105	20c	17.5c	16.0c	2N5137	10-106	19c	17.0c	15.0c
2N3640	10-106	20c	17.5c	16.0c	2N5138	10-106	19c	17.0c	15.0c
2N3641	10-105	20c	17.5c	17.5c	2N5139	10-106	19c	17.0c	15.0c
2N3643	10-105	20c	17.5c	16.0c	2N3055	10-3	\$1.00	95c	85c

FIELD EFFECT TRANSISTORS

MPF102	10-92	44	.380	.350	2N5457	10-92	.47	.420	.375
--------	-------	----	------	------	--------	-------	-----	------	------

NPN DARLINGTON TRANSISTOR

MPS-A13	10-92	Min. DC Current Gain of 5,000 at 10mA	36	320	290
---------	-------	---------------------------------------	----	-----	-----

Send for Free Catalog or Mail Readers Service Card
 COD ORDERS ACCEPTED FOR SAME DAY SHIPMENT
 CALL 218-681-6674
 Orders Less than \$10.00 add 50c Service Charge—Others Postpaid
 "Only Quality Components Sold!"

DIGI-KEY CORPORATION
 P.O. Box 126 Thief River Falls, MN 56701

Market Center

CLASSIFIED COMMERCIAL RATE (for firms or individuals offering commercial products or services) **\$1.40 per word** . . . minimum 15 words.

NONCOMMERCIAL RATE (for individuals who want to buy or sell personal items) **85c per word** . . . no minimum.

FIRST WORD AND NAME set in bold caps at no extra charge. Additional bold face at 10c per word. Payment must accompany all ads except those placed by accredited advertising agencies. 10% discount on 12 consecutive insertions, if paid in advance. All copy subject to publisher's approval. Advertisements using P.O. Box address will not be accepted until advertiser supplies publisher with permanent address and phone number. Copy to be in our hands on the 26th of the third month preceding the date of the issue (i.e. August issue closes May 26). When normal closing date falls on Saturday, Sunday or a holiday, issue closes on preceding working day.

WANTED

QUICK cash . . . for electronic equipment, components, unused tubes. Send list now! **BARRY**, 512 Broadway, New York, NY 10012, 212 Walker 5-7000

PLANS & KITS

EM synthesizer concept-features universal compatibility, modular construction. For complete information send SASE or 25c to: **CFR ASSOCIATES**, POB F, Newton, NH 03858

FREE catalog. Most unusual electronic kits available. Music accessories, surf, wind synthesizers, wind chimes, many others. **PAIA ELECTRONICS**, Box B14359, Oklahoma City, OK 73114

CONVERT any television to sensitive, big-screen oscilloscope. Only minor changes required. No electronic experience necessary. Illustrated plans \$2.00. **SANDERS**, Dept. A-25, Box 92102, Houston, TX 77010

NEW organ kit builders manual \$3.00. Circuits, block diagrams, details on diode keyed IC divider and independent oscillator designs. Many new kits and models. Keyboards also for synthesizers. Manual cost refundable with purchase. **DEVTRONIX ORGAN PRODUCTS**, Dept. B, 5872 Amapola Dr., San Jose, CA 95129

EDUCATION & INSTRUCTION

SHORTCUT to success: Highly effective, profitable short courses (75 courses). Study at home. Diploma awarded. Our 29th year! Free literature. **CIEE—E**, Box 20345, Jackson, MS 39209.

TELEPHONE bugged? Don't be Watergated! Countermeasures brochure \$1.00. **NEGEYE LABORATORIES**, Box 547-RE, Pennsboro, WV 26415

F.C.C. EXAM MANUAL	
PASS FCC EXAMS! Memorize, study—Tests—Answers for FCC 1st and 2nd class Radio-telephone licenses. Newly revised multiple choice questions and diagrams cover all areas tested in FCC exams, plus Self Study Ability Test. \$9.95 postpaid. Money-back guarantee.	
COMMAND PRODUCTIONS	P.O. BOX 26348 E
RADIO ENGINEERING DIV	SAN FRANCISCO, CAL 94176

TV tuner repairs—Complete course details, 12 repair tricks. Many plans. Two lessons, all for \$2. Refundable, **FRANK BOECK**, Box 3236 (Enterprise), Redding, CA 96001.

ELECTRONICS book discounts. Save! Free selected, reviewed list. **T/DOC**, Box 340, Centerville, VA 22020

LEARN design techniques. Electronics monthly newsletter. Digital, linear construction projects, design theory and procedures. Sample copy \$1.00. **VALLEY WEST**, Box 2119-A, Sunnyvale, CA 94087

MANUALS for Govt. surplus radios, test sets, scopes, list 50c (coin). **BOOKS**, 7218 Roanne Drive, Washington, DC 20021

FOR SALE

ELECTRONIC parts! New! Solid state devices! Free flyer: **DARKE ELECTRONICS**, Box 2460, Dartmouth, Nova Scotia B2W 4A5 U.S. Inquiry.

ELECTRONIC Ignition: Capacitor, transistor, pointless. Auburn sparkplugs. Information 10c. **ANDERSON ENGINEERING**, Epsom, NH 03234

FREE catalog. IC's, Semi's. **CORONET ELECTRONICS**, 649A Notre Dame W., Montreal, Que., Canada, H3C-1H8 US Inquiries.

MOVING?	
Don't miss a single copy of Radio-Electronics . Give us:	ATTACH LABEL HERE
Six weeks' notice	
Your old address and zip code	
Your new address and zip code	

name (please print) _____
 address _____
 city state zip code _____
 Mail to: **Radio-Electronics SUBSCRIPTION DEPT., BOULDER, COLO. 80302**

C-MOS

4000AE	48	45
4001AE	48	40
4002AE	48	40
4004AE	5.85	5.85
4006AE	3.50	3.00
4007AE	48	42
4008AE	2.90	2.70
4009AE	87	86
4010AE	55	54
4011AE	48	45
4012AE	48	45
4013AE	95	85
4014AE	2.80	2.50
4015AE	2.80	2.50
4016AE	1.00	90
4017AE	2.60	2.50
4018AE	2.80	2.60
4019AE	95	85
4020AE	2.80	2.60
4021AE	2.70	2.50
4022AE	2.70	2.50
4023AE	4.45	4.45
4024AE	1.80	1.60
4025AE	48	45
4026AE	8.40	7.90
4027AE	1.20	1.00
4028AE	2.20	2.00
4029AE	4.00	2.90
4030AE	1.00	90
4033AE	3.40	2.90
4035AE	2.80	2.75
4040AE	2.80	2.60
4041AE	1.20	90
4042AE	2.80	2.60
4043AE	2.80	2.60
4044AE	2.80	2.60
4047AE	3.10	3.00
4048AE	1.45	1.35
4049AE	1.10	90
4050AE	1.05	90
4051AE	3.35	2.90
4052AE	2.15	2.05
4053AE	2.90	2.80
4055AE	2.70	2.60
4056AE	3.45	3.41
4060AE	3.30	3.00
4066AE	1.80	1.60
4069AE	80	70
4071AE	50	45
4076AE	2.70	2.50
4081AE	48	42
4510AE	2.70	2.50
4516AE	2.90	2.80
4518AE	3.30	3.00
4520AE	3.30	3.00
4901AE	48	42

**WAVEFORM GENERATOR****XR205K KIT Only \$28.00**

Here's a highly versatile lab instrument at a fraction of the cost of conventional units. Kit includes two XR205 IC's, data & application notes, PC board (etched & drilled, ready for assembly) and detailed instructions.

DUAL LOW NOISE OP AMP

LM333N
V_{io} = 6mV
I_b = 1000 nA
Noise = 1.5dB
\$2.20

DISPLAYS

OPCA	
SLA1	Red 2.25
SLA11	Green 3.50
SLA21	Yellow 3.50
SLA7	Red 1.60
LITRONIX	
DL80	Red 6.00
DL81	Red 6.00
DL10	Red 6.00
DL10A	Red 4.00
DL101	Red 4.00
DL57	Red 9.90
DL61	Red 12.00
DL33	Red 4.00
DL44	Red 6.00
DL402	Red 4.00
DL701	Red 3.40
DL704	Red 2.25
DL707	Red 2.35
DL714	Red 2.50
XCITON	
XAN72	Red 2.00
XAN52	Green 2.00

LEDs
.205" dia.
205 Red \$25
205 Yellow 35
205 Green 35
.160" dia.
215 Red 25
215 Yellow 30
215 Green 30
.200" dia.
220 Red 25
220 Yellow 30
220 Green 30
LOW PROFILE
225 Red \$25
225 Yellow 30
225 Green 30
225 Orange 30
5053 Red 35
5053 Yellow 40
5053 Green 40
5053 Red \$30
MV5053

7400N TTL

7400N	.16	7444N	1.05	7496N	.85	74161N	1.28
7401N	.23	7445N	1.04	74100N	1.45	74162N	1.50
7402N	.22	7446N	1.10	74104A	1.25	74163N	1.48
7403N	.22	7447N	1.10	74105N	.45	74164N	1.78
7404N	.21	7448N	.17	74107N	.45	74165N	1.78
7405N	.21	7449N	.17	74109N	.92	74166N	1.54
7406N	.36	7451N	.53	74110N	.72	74170N	2.60
7412N	.52	7456A	.37	74111N	.92	74171N	1.54
7408N	.23	7454N	.26	74114N	.92	74174N	1.48
7409N	.23	7455N	.37	74115N	.92	74175N	1.80
7410N	.18	7460N	.25	74118N	1.51	74176N	1.54
7411N	.27	7462N	.37	74119N	1.80	74180N	1.05
7412N	.52	7466A	.37	74121N	.54	74181N	3.49
7413N	.72	7465N	.37	74122N	.51	74182N	7.86
7414N	2.25	7470N	.30	74123N	.90	74185N	2.29
7415N	.37	7471N	.49	74125N	.64	74188N	2.86
7416N	.37	7472N	.33	74126N	.64	74189N	2.29
7417N	.37	7473N	.41	74128N	1.32	74190N	1.45
7420N	.18	7482N	.98	74132N	2.06	74191N	1.45
7421N	.60	7475N	.70	74136N	.92	74192N	1.49
7422N	.27	7476N	.45	74140N	2.50	74193N	1.29
7423N	.48	7478N	.55	74141N	1.19	74193N	1.29
7425N	.36	7480N	.60	74145N	1.12	74194N	1.35
7426N	.37	7481N	1.19	74147N	2.95	74195N	.89
7427N	.31	7482N	.98	74148N	2.49	74196N	2.88
7428N	.31	7483N	.98	74150N	.99	74197N	.88
7430N	.20	7484N	3.02	74151N	.84	74198N	2.09
7432N	.27	7485N	2.50	74152N	5.25	74199N	2.09
7433N	.62	7486N	.41	74153N	1.05	74200N	.95
7437N	.41	7489N	2.50	74154N	1.48	74212N	1.75
7438N	.35	7489N	.70	74155N	1.08	74218N	1.75
7439N	1.05	7491N	1.15	74156N	1.18	74278N	2.95
7440N	1.77	7492N	.84	74157N	1.18	74279N	1.10
7441N	.95	7493N	.71	74158N	1.44	74293N	.95
7442N	.95	7494N	1.29	74160N	1.50	74298N	2.55
7443N	.95	7495N	.85				



CALCULATORS
(Limited Qty.)
\$19.00

1024-BIT N-Channel RAM

2601-1	11.40
2601-21	11.40
2602B	8.00
2602-1B	8.00
2602-2B	8.00
MK4102P	11.40
7552-IC	8.00
7552-2CPE	8.00

9300 SERIES

9300PC	1.00
9301PC	1.20
9304PC	1.50
9306PC	2.90
9308PC	6.50
9309PC	1.60
9310PC	1.50
9311PC	2.30
9312PC	1.20
9314PC	1.30
9316PC	1.50
9318PC	2.30
9321PC	1.20
9322PC	3.00
9324PC	2.00
9325PC	2.95
9326PC	2.50
9327PC	3.00
9328PC	3.00
9329PC	4.10
9342PC	1.15
9343PC	1.75
9366PC	1.75

1-AMP RECTIFIERS

1N4001	1.00	70D	60.00
1N4002	1.10	70D	70.00
1N4003	1.20	90D	80.00
1N4004	1.30	90D	90.00
1N4005	1.40	110D	100.00
1N4006	1.50	120D	110.00
1N4007	1.60	130D	120.00

PHASE-LOCKED LOOPS

LM567CM Mini Dip 2.10

DECODED READ/WRITE RAM

P1103 \$6.20

PREMIUM QUALITY COMPONENTS

We've been buying and selling top quality components for nearly ten years. Our annual volume exceeds \$3 million. We handle only original parts, from the world's leading manufacturers and our customers include some of the largest and most quality-conscious companies. Now you can take advantage of our component buying skills and power and select from a broad range of advanced circuits.

**SCHOTTKY TTL**

74S00N	.45	74S74N	1.30	74S161N	4.70
74S02N	.80	74S78N	6.10	74S162N	4.70
74S04N	.75	74S86N	6.10	74S175N	3.30
74S04N	.75	74S112N	2.20	74S181N	10.20
74S08N	.80	74S113N	1.50	74S189N	5.10
74S10N	.75	74S132N	3.60	74S194N	3.30
74S11N	.65	74S133N	90	74S195N	3.30
74S20N	.80	74S138N	2.40	74S251N	4.40
74S30N	.80	74S139N	2.40	74S253N	2.40
74S32N	.80	74S140N	90	74S257N	2.40
74S40N	.80	74S151N	2.40	74S258N	2.40
74S51N	.80	74S153N	2.40	74S260N	90
74S64N	.80	74S157N	2.40	74S280N	5.70

LOW POWER TTL

74L00N	.34	74H00N	.34	74H53N	.36
74L02N	.34	74H01N	.34	74H54N	.36
74L03N	.39	74H04N	.38	74H55N	.36
74L04N	.39	74H05N	.37	74H60N	.36
74L10N	.34	74H08N	.40	74H61N	.36
74L20N	.39	74H10N	.36	74H62N	.36
74L42N	1.62	74H11N	.36	74H71N	.80
74L51N	.34	74H20N	.36	74H72N	.74
74L73N	.74	74H21N	.36	74H73N	.90
74L74N	.89	74H22N	.36	74H74N	.87
74L90N	1.62	74H30N	.36	74H76N	.90
74L93N	1.74	74H40N	.36	74H101N	.80
74L95N	1.62	74H50N	.36	74H102N	.80
		74H51N	.36	74H103N	1.10
		74H52N	.36	74H106N	.95

BIPOLAR MEMORY

C3101	6.50
P3101	4.90
C3101A	7.30
P3101A	5.80
IM5501CPE	7.30
IM5501CPE	5.80
MM5560D	7.30
MM5560D	5.80
DM5599N	5.80
93403PC	5.80

MOS-LSI

P1101A	6.90	C2102-2	8.00
1402A1	8.50	P2102-2	6.00
1403A1	5.40	2515K	3.30
1403AN	8.00	2512K	5.50
1403AN	5.40	2521V	4.00
1404A1	8.00	2524V	3.90
1404AN	5.40	2525V	5.30
1405A	4.10	2533V	8.50
1506	4.00	3341PC	8.20
1507	4.00	MM5025N	20.00
1602	33.00	MM5026N	20.00
1702	33.00	MM5027N	20.00
C2102	8.00	MM5055N	5.50
P2102	6.00	MM5056N	5.50
C2102-1	8.00	MM5057N	5.50
P2102-1	6.00	MM5058N	5.50

COMPUTER INTERFACE

DM8820N	2.40
DM8820AN	6.90
DM8830N	2.40
DM8831N	5.20
DM8832N	6.00
N8T26B	4.40
9600PC	1.30
9601PC	1.20
9602PC	2.10
9614PC	2.40
9615PC	2.40
9616DC	5.00
9617PC	3.50
9620PC	4.00
9621PC	4.00

PORTABLE 4 1/2 DIGIT MULTIMETER FOR \$299. A 10 MHz COUNTER OPTION FOR \$50.

TWO-PHASE MOS CLOCK DRIVER

MH0026CN \$5.50

FM STEREO DEMODULATOR

XR1310 \$3.90

MINIMUM ORDER: \$10.00
Add \$1.00 to cover postage and handling
SEND CHECK OR MONEY ORDER (NO C.O.D.) TO:
California residents add 6% sales tax.

HYBRID POWER AMPLIFIERS

SI-1010G	10W	\$6.90	
SI-1020G	20W	9.90	
SI-1030G	30W	18.70	
SI-1050G	50W	25.90	
2N173	2.15	2N3445	5.00
2N512B	2.90	2N3563	.15
2N677C	5.50	2N3565	.19
2N697	.25	2N3567	.19
2N711	.50	2N3569	.17
2N718	.40	2N3642	.19
2N736	1.50	2N3643	.14
2N1377	1.50	2N3645	.15
2N1483	1.20	2N3657	9.00
2N1534	1.00	2N3684	1.25
2N1540	1.10	2N3702	.18
2N1591	1.75	2N3707	.17
2N1924	1.30	2N3731	.18
2N1934	9.40	2N3725	.36
2N2102	6.00	2N3731	2.00
2N2219	3.0		

DYNACO—A-R, transistors, repairs-boards & units, speaker service. Send for prices & details. BEAR ELECTRONICS, 177-R Hillcrest Road, Mt. Vernon, NY 10552

A NEW INVENTION

Adds resistance scales to your ohmmeter. Patent #3805151. If your ohmmeter now has, for example, Rx10 and Rx1K scales add Rx100 and Rx10K etc. Whatever the combination add scale or scales in a similar manner. Models offered for sale are recommended for 1½ or 3 volt ohmmeters and not for VTVM or FET meters. Designed to use 9E Bats. not included but test leads are. Send \$12.75, N.Y. residence include sales tax, to: J.E.M. Mfg. 19 Phyllis Dr., Bethpage, N.Y. 11714

RADIO & TV tubes 36c each. One-year guarantee. Plus many unusual electronic bargains. Free catalog. **CORNELL**, 4217-E University, San Diego, CA 92105

COMPUTERS! You can build them large and fast or small and economical. Design procedure and construction manual \$3.00. Free info. **DIGITRONICS CO.**, 667 East 1700 South, Orem, UT 84057

DIGITAL electronics! Complete schematics, parts lists, theories—Discrete Component Digital Clock, \$3.00. Increase technical competence, hobby skills—Complete course in Digital Electronics is highly effective, \$10.00. Free literature. **DYNASIGN**, Box 60R2, Wayland, MA 01778

LIQUID Crystal. 3½-digit wristwatch display. New, with instructions for building wristwatch. Final close-out. Less than original, factory wholesale price, \$5.50 each. Two for \$10. **TRICOUNTY WINSLOW, Inc.**, Box 5885, Grand Central Station, New York, NY 10017

COMPLETE construction plans—Telephone: answering device, automatic dialer, "black boxes", call diverter, call limiter, conference bridge, central dial exchange, melodic ringing generator, recorder-actuator, remote control, schematics, speakerphone, Telemark burglar alarm, voice scrambler, \$3.00 each. **Electronic-Biofeedback** conditioner, horticulture stimulator, multifrequency encoder network (Speeds telephone dialing 500%!). \$5.00 each. **One year subscription:** Telephone electronics line (Tel) \$3.00. Super illustrated catalog of plans, many more, 50 cents. **All of the construction plans above plus a years subscription to tel and catalog:** 24.95. **TELETRONICS COMPANY OF AMERICA**, P.O. Drawer 3450, Hollywood, CA 90028

CATALOG

GOVERNMENT SURPLUS ELECTRONIC EQUIPMENT

For 1975

FREE UPON REQUEST! Write for Copy of Catalog W-75 Now!
Address: Attention Dept. RE

FAIR RADIO SALES

1016 E. EUREKA • Box 1105 • LIMA, OHIO • 45802

NEW Canadian Magazine, "Electronics Workshop", \$5.00 yearly, sample \$1.00. **ETHCO**, Box 741 "A", Montreal

SURPRISE! Build inexpensively, the most unusual test instruments, futuristic gadgets using numerical readouts! Catalogue free! **GBS**, Box 100B, Greenbank, WV 24944

QUALITY military and industrial surplus electronics. Send 25c for last 3 of our monthly picture flyers. It's different! U.S. only. **STARTRONICS**, Box 17127, Portland, OR 97217

SHOTGLASS. As seen in *Esquire*. Glasscone column speaker. \$129.50 each. F.O.B. moneyback guarantee. **TACHYON**, TM, Box 1012, Roselle, IL 60172

RECONDITIONED test equipment. \$0.50 for catalog. **WALTER**, 2697 Nickel, San Pablo, CA 94806

JAPANESE transistors, wholesale prices, free catalog. **WEST PACIFIC ELECTRONICS**, Box 25837, W. Los Angeles, CA 90025.

BUILD A "SPACE-AGE" TV CAMERA!!

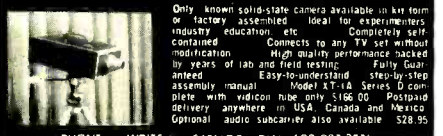

Only known solid-state camera available in kit form or factory assembled. Ideal for experimenters, industry, education, etc. Completely self-contained. Connects to any TV set without modification. High quality performance backed by years of lab and field testing. Fully guaranteed. Easy-to-understand step-by-step assembly manual. Model XT-1A Series D complete with vidicon tube only \$169.00. Postpaid delivery anywhere in USA, Canada and Mexico. Optional! audio subcarrier also available \$28.95.

PHONE or WRITE for CATALOG DIAL 402-987-3771
BOX 453-RE **ATV Research** DAKOTA CITY NEBR 68731

TV ping pong game. Plays through your set's antenna terminals; plans \$3.25. Four channel **digital oscilloscope**; plans \$4.50. **ARS SYSTEMS**, Box 1922A, Sunnyvale, CA 94088

POWER supplies. Regulated 5 volts, 1 amp. Tested, guaranteed, \$19.95. Free specs available. **MULLERS**, Rt. 4 Box 371, Auburn, ME 04210

CONVERT any transistorized TV tuner to a tuner substituter. Plans \$2.00. \$35.00 for completed and tested super substituter. **RADIO TELEVISION TRAINING**, Box 279, RE-35, Syracuse, NY 13206

COMPONENTS 8038CC, \$5.75. AY5-1013A UART \$13.95. AY5-1008 receiver \$7.95. Crystal time base kit, 5Vdc input, 60Hz TTL output, \$9.75 postpaid. Latest flyers, 10c stamp. **TRI-TEK**, 6522 N43 ave., Glendale, AZ 85301

LOGIC probe. LED readout indicates TTL, DTL, CMOS logic levels. Hand held unit powered from logic supply. High impedance input. Guaranteed. \$8.95 postpaid. **VALLEY WEST**, Box 2119-S, Sunnyvale, CA 94087

INTEL 8008
Eight Bit Microprocessing Chip (With Documentation) **\$79.50**

MINIATURE TRIM POTS
5K, 10K, 25K, 50K, 100K **\$7.50 ea.** 3/\$2.00

MULTI-TURN TRIM POTS
Similar to Bourns 3010 style, 3/8" x 3/8" x 1 1/2"; 50, 100, 500, 2000, 5000, 10,000 ohms. **\$1.50 ea.** \$3/\$4.00

LIGHT ACTIVATED SCR's
TO-18, 200V 1A **\$1.75**

PRINTED CIRCUIT BOARD
4 1/2" x 6 1/2" single sided epoxy board, 3/16" thick, unetched **\$5.00 ea.** 5/\$2.20

MC14435 AND MC1405L
A two piece 3 1/2 Digit A/D Converter System for panel meters and dvm's. **\$39.95**

TIS 73 N FET\$5.00
2N4891 UJT\$5.00
ER900 TRIGGER DIODES4/\$1.00
2N6028 PROG. UJT\$7.75

VERIPAX PC BOARD
This board is a 1/8" single sided paper epoxy board, 4 1/2"x6 1/2" (standard veripax), DRILLED and ETCHED which will hold up to 21 single 14 pin IC's or 8, 16 or LSI DIP IC's with busses for power supply connections. Is also etched for 22 pin connector. **\$5.25**

FLV 100 VISIBLE LED\$5.00
ME-4 IR LED\$4.00
MT-2 PHOTO TRANS\$6.00
GREEN CAP OSL-16 LED\$6.00
RED CAP OSL-3 LED\$4.00
14 PIN DIP SOCKETS\$4.00
16 PIN DIP SOCKETS\$5.00

10 WATT ZENERS
3.9, 4.7 OR 5.6 V\$7.50 EA.
.4 WATT ZENERS
3.9, 5.6, 6.8 OR 12 V\$3.00 EA.

Silicon Power Rectifiers

PRV	1A	3A	12A	50A
100	.06	.14	.30	.80
200	.07	.20	.35	1.15
400	.09	.25	.50	1.40
600	.11	.30	.70	1.80
800	.15	.35	.90	2.20
1000	.20	.45	1.10	2.60

REGULATED MODULAR POWER SUPPLIES
+ -15VDC at 100ma\$24.95
115VAC INPUT\$24.95
5VDC AT 1A, 115VAC INPUT\$19.95
12V .6A\$24.95

IN 414814/\$1.00

Terms: FOB Cambridge, Mass. Send Check or Money Order. Include Postage. Minimum Order \$5.00.

TRANSISTOR SPECIALS

2N256 PNP GE TO-3\$.50	74C 02\$.55	CD 4022\$2.10
2N404 PNP GE TO-54/\$1.00	74C 165\$3.50	CD 4023\$.53
2N3919 NPN Si TO-3 RF\$1.50	CD 4001\$.53	CD 4024\$2.15
MPSA13 NPN Si TO-923/\$1.00	CD 4002\$.53	CD 4025\$.50
MPS3393 NPN Si TO-924/\$1.00	CD 4006\$3.60	CD 4026\$5.00
2N3767 NPN Si TO-66\$.70	CD 4007\$.60	CD 4027\$1.20
2N2222 NPN Si TO-185/\$1.00	CD 4009\$.80	CD 4028\$2.75
2N3055 NPN Si TO-3\$1.00	CD 4010\$.53	CD 4029\$4.80
2N3904 NPN Si TO-924/\$1.00	CD 4011\$.53	CD 4030\$.53
2N3906 PNP Si TO-924/\$1.00	CD 4012\$.53	CD 4035\$2.30
2N5296 NPN Si TO-220\$.50	CD 4013\$1.00	CD 4042\$2.75
2N6109 PNP Si TO-220\$.55	CD 4015\$3.35	CD 4046\$3.75
2N3866 NPN Si TO-5 SIFR POWER\$.75	CD 4016\$1.05	CD 4047\$3.60
MJ2252 NPN Si TO-66\$.90	CD 4017\$2.70	CD 4050\$1.05
2N3638 NPN Si TO-55/\$1.00	CD 4019\$1.20	CD 4055\$3.20
2N2218A NPN Si TO-54/\$1.00				

CAPACITORS

6V 30UF TANT5/\$1	MAN-1, Red or Yellow\$2.50	Full Wave Bridges	
20V 4.7UF TANT5/\$1	LED READOUT\$1.75	PRV 2A 6A 25A	
6.8 UF 35V TANT3/\$1	MAN-3 READOUT\$2.00	200 .95 1.25 4.00	
50V 220UF ELECT\$.40	MAN-4 READOUT\$2.00	400 1.15 1.50 5.00	
10uf 12V ELEC5/\$1.00	SLA 3\$4.50	600 1.35 1.75 6.00	
		MAN-7\$1.00		

5311 — CLOCK CHIP 6 DIGIT BCD HOLD COUNT, OUTPUT STROBE **\$6.75**
5314 — CLOCK CHIP 6 DIGIT HOLD COUNT, OUTPUT STROBE **\$6.75**
5316 — ALARM CLOCK CHIP **\$6.75**

2513 — 64x7x5 CHARACTER GEN. **\$9.95**
2516 — 64x6x8 STATIC CHARACTER GEN. **\$9.95**

SANKEN AUDIO POWER AMPS
Si 1010 G 10 WATTS\$ 6.40
Si 1025 E 25 WATTS\$17.95
Si 1050 E 50 WATTS\$24.95

4 WATT IR LASER DIODE\$7.95

LINEAR CIRCUITS
LM 309K 5V 1A REGULATOR\$1.50
723 — 40 + 40V REGULATOR\$.58
301/748-Hi Per. Op. Amp.\$.30
LM 320 — 5 or —15 V REG.\$1.75
LM 376 — V to 37V POS REG.\$.58
741C or 741C OP. AMP.\$.31
709C OPER. AMP.\$.25
340T-5, 12, 15, 18, 24V POS. REG. TO-220\$1.75
101 OPER. AMP. HI PERFORM.\$.75
LM 308 Oper. Amp., Low Power **\$1.05**
747 — DUAL 741\$.75
537 — PRECISION OP. AMP.\$2.60
LM 3900 — QUAD OP. AMP.\$.49
LM 324 — QUAD 741\$2.20
560 — PHASE LOCK LOOP\$2.50
561 — PHASE LOCK LOOP\$2.50
565 — PHASE LOCK LOOP\$2.50
567 — TONE DECODER\$2.85
703 — RF-IF AMP.\$.41
LM370 — AGC SQUELCH AMP.\$1.15
555 — 2 μs — 2 HR. TIMER\$.88
1456 OP. AMP.\$.95
1458 DUAL OP. AMP.\$.60
LM 380 — 2W AUDIO AMP.\$1.39
LM 377 — 2W Stereo Audio Amp. **\$2.50**
LM 381 — STEREO PREAMP\$1.69
LM 382 — DUAL AUDIO PREAMP **\$1.69**
LM 311 — HI PER. COMPARATOR **\$.95**
LM 319 — Dual Hi Speed Comp. **\$1.15**
LM 339 — QUAD COMPARATOR **\$1.15**

TTL IC SERIES

74L0030	747645
740017	748061
740117	748399
740217	7485130
740317	748648
740421	749070
740521	7491110
740637	749275
740737	749371
740823	749585
741017	749685
741127	8220150
741245	7410745
741373	7412155
741637	7412391
741737	7412565
742017	7412670
742627	7415099
742731	7415185
743017	74153105
743227	74154149
743741	74157119
743835	74163149
744017	74164179
744195	74165179
744295	74173155
7445105	74175180
7446110	74177150
7447110	74181350
7448110	74192145
745017	74193130
747233	7419589
747341	75324175
747441	75491110
747571		

8038C IC VOLTAGE CONTROLLED OSCILLATOR\$4.95

TRIACS

PRV	1A	10A	25A	1.5A	6A	35A
100	.40	.70	1.30	.40	.50	1.20
200	.70	1.10	1.75	.60	.70	1.60
400	1.10	1.60	2.60	1.00	1.20	2.20
600	1.70	2.30	3.00			3.00

SOLID STATE SALES
P.O. BOX 740
SOMERVILLE, MASS. 02143 TEL. (617) 547-4005

WE SHIP OVER 95% OF OUR ORDERS THE DAY WE RECEIVE THEM

10% OFF

ON ORDERS OVER \$25.00

TTL



	Ea.		Ea.		Ea.
7400	\$.19	7447	\$1.15	74141	\$1.23
7401	.19	7448	1.15	74145	1.15
7402	.19	7450	.24	74150	1.09
7403	.19	7451	.27	74151	.89
7404	.22	7453	.27	74153	1.29
7405	.22	7454	.39	74154	1.59
7406	.39	7460	.19	74155	1.19
7407	.39	7464	.39	74156	1.29
7408	.25	7465	.39	74157	1.29
7409	.25	7472	.36	74161	1.39
7410	.19	7473	.43	74163	1.59
7411	.29	7474	.43	74164	1.89
7413	.79	7475	.75	74165	1.89
7415	.39	7476	.47	74166	1.65
7416	.39	7483	1.11	74173	1.65
7417	.39	7485	1.39	74175	1.89
7420	.19	7486	.44	74176	1.65
7422	.29	7489	2.75	74177	.99
7423	.35	7490	.76	74180	1.09
7425	.39	7491	1.29	74181	3.65
7426	.29	7492	.79	74182	.89
7427	.35	7493	.79	74184	2.69
7430	.22	7494	.89	74185	2.19
7432	.29	7495	.89	74190	1.59
7437	.45	7496	.89	74191	1.59
7438	.39	74100	1.65	74192	1.49
7440	.19	74105	.49	74193	1.39
7441	1.09	74107	.49	74194	1.39
7442	.99	74121	.57	74195	.99
7443	.99	74122	.53	74196	1.85
7444	1.10	74123	.99	74197	.99
7445	1.10	74125	.69	74198	2.19
7446	1.15	74126	.79	74199	2.19
				74200	7.95

LOW POWER TTL

74L00	.33	74L51	.33	74L90	1.69
74L02	.33	74L55	.33	74L91	1.45
74L03	.33	74L71	.33	74L93	1.69
74L04	.33	74L72	.49	74L95	1.69
74L06	.33	74L73	.69	74L98	2.79
74L10	.33	74L74	.69	74L164	2.79
74L20	.33	74L78	.79	74L165	2.79
74L30	.33	74L85	1.25		
74L42	1.69	74L86	.69		

HIGH SPEED TTL

74H00	.33	74H21	.33	74H55	.39
74H01	.33	74H22	.33	74H60	.39
74H04	.33	74H30	.33	74H61	.39
74H08	.33	74H40	.33	74H62	.39
74H10	.33	74H50	.33	74H72	.49
74H11	.33	74H52	.33	74H74	.59
74H20	.33	74H53	.39	74H76	.59

8000 SERIES TTL

8091	.59	8214	1.69	8811	.69
8092	.59	8220	1.69	8812	1.10
8095	1.39	8230	2.59	8822	2.50
8121	.89	8520	1.29	8830	2.59
8123	1.59	8551	1.65	8831	2.59
8130	2.19	8552	2.49	8836	.49
8200	2.59	8554	2.19	8880	1.33
8210	3.49	8810	.79		

9000 SERIES TTL

9002	.39	9309	.89	9601	.99
9301	1.14	9312	.89	9602	.89

Data sheets supplied on request
Add \$.50 ea. for items less than \$1.00

CMOS

74C00	.39	74C74	1.15	74C162	3.25
74C02	.55	74C76	1.70	74C163	3.25
74C04	.75	74C107	1.50	74C164	3.50
74C08	.75	74C151	2.90	74C173	2.90
74C10	.65	74C154	3.50	74C195	3.00
74C20	.65	74C157	2.19	80C95	1.50
74C42	2.15	74C160	3.25	80C97	1.50
74C73	1.55	74C161	3.25		

APRIL SPECIALS

5001	12 DIG 4 funct fix dec	\$2.95	1103	256 bit RAM MOS	\$2.95
5002	Same as 5001 exc btry pwr	4.95	5260	1024 bit RAM	2.95
5005	12 DIG 4 funct w/mem	6.95	5261	1024 bit RAM	2.95
5725	8 DIG 4 funct chain & dec	2.25	5262	2048 bit RAM	7.95
5736	18 pin 6 DIG 4 funct	4.45	2102	1024 bit static RAM	6.95
5738	8 DIG 5 funct K & Mem	4.95	5203	UV Eras.	19.85
5739	9 DIG 4 funct (btry sur)	4.95	HP50827414	4 digit common cathode Fits 14 pin DIP - .11 bubble lens	2.75
5311	28 pin BCD 6 dig mux	4.95	MAN 7	Red 7 seg .270"	.99
5312	24 pin 1 pps BCD 4 dig mux	4.95	MAN 66	Red .6" spaced seg	3.50
5313	28 pin 1 pps BCD 6 dig mux	4.95	MAN 6	Red .6" solid seg	3.95
5314	24 pin 6 dig mux	4.95	MAN 1	Red 7 seg .27"	1.50
5316	40 pin alarm 4 dig	5.95	MAN 2	Red alpha num. .32"	3.39

74C00	\$.29	\$25/100	74L00	\$.25	\$20/100	7454	\$.25	\$20/100
74C02	.49	40/100	74L02	.25	20/100	7460	.15	10/100
74C04	.59	50/100	74L03	.25	20/100	7490	.59	50/100
74C10	.59	50/100	74L04	.25	20/100	7493	.59	50/100
74C20	.59	50/100	74L06	.25	20/100	8836	.19	15/100
74C73	1.15	100/100	74L10	.25	20/100	380	1.19	50/100
74C107	1.25	110/100	74L51	.25	20/100	565	1.95	50/100
74C160	2.75	250/100	74L72	.35	30/100	2N3933	TO-72	1.29
74C164	2.95	260/100	74L73	.49	40/100	40636	TO-3	1.55
80C97	1.25	110/100	74L74	.39	30/100			

MEMORIES w/data

1101	256 bit RAM MOS	\$1.75
1103	1024 bit RAM MOS	4.95
5203	2048 bit eras. PROM	24.95
5260	1024 bit RAM low power	3.95
7489	64 bit RAM TTL	2.75
8223	Programmable ROM	3.95

CALCULATOR & CLOCK CHIPS w/data

5001	12 DIG 4 funct fix dec	3.95
5002	Same as 5001 exc btry pwr	7.95
5005	12 DIG 4 funct w/mem	8.45
MM5725	8 DIG 4 funct chain & dec	2.79
MM5736	18 pin 6 DIG 4 funct	4.95
MM5738	8 DIG 5 funct K & Mem	7.95
MM5739	9 DIG 4 funct (btry sur)	6.95
MM 5311	28 pin BCD 6 dig mux	6.95
MM 5312	24 pin 1 pps BCD 4 dig mux	6.95
MM 5313	28 pin 1 pps BCD 6 dig mux	7.95
MM 5314	24 pin 6 dig mux	8.95
MM 5316	40 pin alarm 4 dig	8.95

LED & OPTO ISOLATORS

MV10B	Red TO 18	\$.25 ea
MV50	Axial leads	.20
MV5020	Jumbo Vis. Red (Red Dome)	.25
	Jumbo Vis. Red (Clear Dome)	.25
ME4	Infra red diff. dome	.60
MAN1	Red 7 seg. .270"	2.50
MAN2	Red alpha num. .32"	4.95
MAN4	Red 7 seg. .190"	2.15
MAN5	Green 7 seg. .270"	2.95
MAN6	.6" high solid seg	4.95
MAN7	Red 7 seg. .270"	1.35
MAN8	Yellow 7 seg. .270"	3.95
MAN64	4" high solid seg	3.50
MAN66	.6" high spaced seg	4.65
DL707	Red 7 seg. .3"	2.65
MCD2	Opto-iso diodes	1.09
MCT2	Opto-iso transistor	.69

DTL

930	S 17	937	S 17	949	S 17
932	17	944	17	962	17
936	17	946	17	963	17

4000 SERIES - RCA EQUIVALENT

CD4001	55	CD4013	1 20	CD4023	55
CD4009	85	CD4016	1 25	CD4025	55
CD4010	85	CD4017	2 95	CD4027	1 35
CD4011	55	CD4019	1 35	CD4030	95
CD4012	55	CD4022	2 75	CD4035	2 85

LINEAR CIRCUITS



300	Pos V Reg (super 723)	TO-5	\$.79
301	Hi Perf Op Amp	mDIP TO-5	.32
302	Volt follower	TO-5	.59
304	Neg V Reg	TO-5	.79
305	Pos V Reg	TO-5	.79
307	Op AMP (super 741)	mDIP TO-5	.29
308	Micro Pwr Op Amp	mDIP TO-5	.99
309K	5V 1A regulator	TO-3	1.50
310	V Follower Op Amp	TO-5 mDIP	1.19
311	Hi perf V Comp	mDIP TO-5	1.05
319	Hi Speed Dual Comp	DIP	1.29
320	Neg Reg 5.2, 12, 15	TO-3	1.25
322	Precision Timer	DIP	1.15
324	Quad Op Amp	DIP	1.89
339	Quad Comparator	DIP	1.69
340T	Pos Volt Reg (5V-6V-8V-12V-15V-18V-24V)	TO-220	1.75
370	AGC/Squelch AMPL	TO-5 or DIP	1.15
372	AF-IF Strip detector	DIP	.79
373	AM/FM/SSB Strip	DIP	3.25
376	Pos. V Reg	mDIP	.59
377	2w Stereo amp	DIP	2.69
380	2w Audio Amp	DIP	1.29
380 B	6w Audio amp	mDIP	1.25
381	Lo Noise Dual preamp	DIP	1.69
382	Lo Noise Dual preamp	DIP	1.69
550	Prec V Reg	DIP	.79
555	Timer	mDIP	.99
560	Phase Locked Loop	DIP	2.75
562	Phase Locked Loop	DIP	2.75
565	Phase Locked Loop	DIP TG 5	2.65
566	Function Gen	mDIP TO-5	2.50
567	Tone Decoder	mDIP	2.95
709	Operational AMPL	TO-5 or DIP	.29
710	Hi Speed Volt Comp	DIP	.39
711	Dual Difference Comp	DIP	.69
723	V Reg	DIP	.79
739	Dual Hi Perf Op Amp	DIP	1.19
741	Comp Op AMP	mDIP TO-5	.35
747	Dual 741 Op Amp	DIP or TO-5	.79
748	Freq Adj 741	mDIP	.39
1304	FM Mulp Stereo Demod	DIP	1.19
1307	FM Mulp Stereo Demod	DIP	2.15
1458	Dual Comp Op Amp	mDIP	.69
1800	Stereo multiplexer	DIP	2.75
LH2111	Dual LM 211 V Comp	DIP	1.89
3065	TV-FM Sound System	DIP	.69
3075	FM Det-LMTR & Audio preamp	DIP	.79
3900	Quad Amplifier	DIP	.39
7524	Core Mem Sense AMPL	DIP	.79
7534	Core Mem Sense Amp	DIP	.79
8864	9 DIG Led Cath Drrr	DIP	2.50
75451	Dual Peripheral Driver	mDIP	.39
75452	Dual Peripheral Driver	mDIP	.39
75453	(351) Dual Periph. Driver	mDIP	.39
75491	Quad Seq Driver for LED	DIP	.79
75492	Hex Digit Driver	DIP	.89

SHIFT REGISTERS

MM 5013	1024 bit accum. dynamic	mDIP	\$1.95
MM 5016	500/512 bit dynamic	mDIP	1.75
MM 5058	1024 bit static	DIP	3.95
SL-54025	Dual 64 bit static	DIP	1.50

Shipment will be made via first class mail - postage paid in U.S., Canada and Mexico - within three days from receipt of order. Minimum order - \$5.00. California residents add sales tax.

INTERNATIONAL ELECTRONICS UNLIMITED
P.O. BOX 1708 MONTEREY, CA. 93940 USA
PHONE (408) 659-3171



CURTIS INDACHRON TIMER \$1.95
0-10,000 Hour Dial, Chemical Action. Works On 5V DC. 1 1/2" x 3/4" x 1/4". Adhesive Backed.

74S206 MEMORY IC—SCHOTTKY \$3.25
256 X 1 TTL Bipolar Ram Hi-Speed
3 Chip-Enable Lines. Full Data Furn.10 for \$27.00

SEVEN SEGMENT READOUTS
H-P 5082-7730 7-Segment LED Readout .3 Digit \$1.75
DL-707 The Universal LED Readout1.95
MAN-1 By Monsanto—Late Version2.50
MAN-2 By Monsanto—Straight Leads2.75
MAN-3 Monsanto—Straight Leads75
MAN-4 Monsanto1.95
XMN-101 XCITON85
B7971 4" x 2" Nixie Alphanumeric—New1.75
2 Clock Schematics & Full Data4 for 6.50; 6 for 9.00
B7971 Socket—Used50

LEDR-8 8 Resistors in 16 Pin Dip—For All 7-Segments95
CA3081 7-Segment LED Drivers Comm. Emit. NPN95

LED'S
MV-507 for \$1.00 MV-50205 for \$1.00
MV-2 Green3 for \$1.00 NSL-100 Red5 for \$1.00

7400 IC'S
7400 7401 7402 7403 7404 7408 7410\$.16
7420 7430 7440 7450 7453 7454 746016
7441 7442 7445 7446 7447 7448 748398
7472 7473 747440 7475 7490 7492 749375
741375 7410748 741541.55
747645 7412155 741561.35
74892.65 7912395 741921.45
749588 7415195 741931.35
749688 741531.25 741951.25

74L—LO-POWER
00 02 03 04 10 20 30\$.32
0850 73, 7475 8660 90, 93, 951.50

7400 CMOS
74C0034 74C04, 74C1065 74C761.60
74C162 Decade Counter, 74C163 Binary Counter2.75

8263 Shift Register\$6.50
MCT-2 Optical Coupler—Monsanto75
8223 Rom-Programmable—32 & 8-Bit Words4.75
Optional Custom Programming—ADD6.00

LM301 Hi-Perf. Op-Amp, LM307 "Super 741" Op Amp35
LM709 Universal Op. Amp, LM741 "Standard" Op Amp35
Buy 10 of Any Group & Get a Big Asst. of Circuits10 for 3.00

565 PLL, 566 Funct. Gen., 567 Tone DecoderEach 2.75
555 Timer w/ Specs & Applications75
556 Dual Timer w/ Specs & Applications1.75
LM309K 5V. 1A. Regulator1.29
LM308 Ultra Hi-Imped. Op-Amp99
5314 Digital Clock Chip—With Data6.95
5316 Digital Alarm Clock Chip—With Data8.95
CA3047 Hi-Output Op-Amp50

ALL IC'S BY FIRST CLASS MAIL—NO EXTRA COST!
JTM ASSOCIATES
P.O. BOX 843 MANCHESTER, MO. 63011

Circle 101 on reader service card

DIGITAL/analog multimeters, logic probes—guaranteed lowest prices. Free catalog. **ELECTRO INDUSTRIES**, 4201 Irving Park, Chicago, IL 60641

FREE bargain catalog. LED's, transistors, IC's, PUT's, relays, xtals, unique micro-miniature components, misc. **CHANEYS**, Box 15431, Lakewood, CO 80215

A NEW INSTRUMENT TO USE WITH YOUR SCOPE
MULTITRACER



Use with your present Oscilloscope to trace Resistors, Capacitors, Transformers, Diodes, Transistors, Zeners, Triodes, most Semiconductors, IC's, etc. Also shows continuity in circuit and go/no go checks. Complete with diagrams and instructions. No internal scope connections. For medium or small production runs or for hobbyist, experimenter, engineer or ham.

ONLY \$19.95—CHECK OR MONEY ORDER WHY PAY MORE?

BOX 14, LESCO ELECTRONICS, SKOKIE, ILL. 60076

BUBBLE ETCHER
FAST ETCHING ACTION
\$12.00

TRUMBULL 833 BALRA DRIVE
EL CERRITO, CA 94530

INDIVIDUAL diagrams, servicing manuals, Radio-Television, Information. **SUPREME PUBLICATIONS**, 1760 Balsam, Highland Park, IL 60035

LED readouts—Wow! Jumbo 0.6" digit replaces Litronix DL-747, \$1.95—0.3", replaces DL-707, DL-704, (specify type) \$1.50—kit of 150 discrete LED's builds 3 1/2" 6-digit clock, \$25.00. Clocks described in Jan. '75 Radio-Electronics. Digital liquid crystal wrist-watch displays, \$3.95! All new, guaranteed. Bargain catalog, .50c **DIAMONDBACK ENGINEERING**, P.O. Box 194, Spring Valley, IL 61362

LOW-noise resistors—1/4W, 5% carbon film from 10 — 3.3 megohms for 3 1/2c each. Fifty of one value for \$1.25. 1N4148 diodes for 6c. 75c postage. Free samples/specifications. **COMPONENTS CENTER—RE**, Box 134, New York, NY 10038

MEMORY SYSTEM \$125.00

1024 core memory system, 1024 words memory, 8, 9, or 10 bits/word. Random access, with all logic, register, timing, control, core select and sense functions in one package. New, with 60 page booklet includes schematics. Measures only 9x4x1 inches. Good start for mini-computer.

STONE GEN. BOARD

3 Octave tone gen board from Magnus Organ. Unused, as is, with instructions & amp. \$9.95, two for \$18.00.

PIANO KEYBOARD \$9.95

For use with above organ or synthesizer, etc.

MULTI-USE XFMR \$8.95

Output 18 V @ 6 amp; 17 V @ 6 amps; 10 V @ 10 amp. Brand new. \$8.95 ea. 2 for \$15; 10 for \$50.

PHOTO-STROBE

Made for Instamatic but useful on any camera with instructions provided. Info also on trick uses: automotive strobe, slave strobe, automotive strobe, Psychedelic repetitive strobe, etc. Complete with charger & Nickel Cadmium batteries.

\$9.00 or 3 for \$24.00

Please add shipping cost on above FREE catalog

Meshna **SURPLUS ELECTRONIC MATERIAL**

P.O. BOX 62
E. LYNN MASS. 01904

Circle 103 on reader service card

AM FM STEREO MULTIPLEX CHASSIS



12"x5 1/2"x4 1/4"

AM/FM STEREO MULTIPLEX chassis, ready to go, requires 16 to 18 volta AC @ 2 amps. Ideal for custom installation. Each channel rated @ 15 watts. Has function switch, tuning control, volume control, balance, bass & treble controls. With pointer, but no escutcheon.

STOCK NO. R5247 \$26.50 ea. 2/50.00
STOCK NO. R9858 Transformer for above, \$3.75 2/7.00

BURROUGHS PANAPLEX DISPLAY



3 7/8"x13/16"

BURROUGHS PANAPLEX II, 12 digit display, BR13251 is a multi-digit segmented, thin panel display in a common envelope. Any or all digits may be used, along with right hand decimals. Characters are 0.25", and are ideal for clocks, counters, calculators etc. Compatible with DTL, TTL, CMOS. Display is neon glow discharge, and requires 160 VDC. We supply socket. 14 pages of data and applications.

STOCK NO. R5220 \$5.75 ea. 2/10.00

Include sufficient postage. Excess refunded. Send for new Catalog 13, just out, with many electronic bargains.

DELTA ELECTRONICS CO.
BOX 1, LYNN, MASSACHUSETTS 01903
Phone (617) 388-4705

Circle 102 on reader service card

For faster service

USE ZIP CODE

on all mail

GODBOUT

BILL GODBOUT ELECTRONICS
BOX 2673, OAKLAND AIRPORT, CA 94614

LINEAR VARIETY PACK—ONE EA. OF THE FOLLOWING IC'S: 555 TIMER, 741 OP AMP, 3900 QUAD OP AMP, 5558 DUAL OP AMP, 723 REGULATOR, 309K 5V 1A REGULATOR, 339 70 WATT RMS AMP TOP KIT—ALL OF THE ABOVE FOR \$3.95
KIT MONO FOR GUITAR OR PA, OR AS A 35W/CHANNEL STEREO AMP. 8 OHM OUT, SHORT CIRCUIT PROTECTED, NOISE & HUM DOWN 80 DB AT 70W OUT. KIT COMES LESS CHASSIS AND HARDWARE, U.S. PPD FOR \$49.95

DUAL TRACKING REGULATED SUPPLY—UNDER ±1V TO MORE THAN ±18V. PERFECT FOR OP AMPS AND BREADBOARDING. FULLY PROTECTED AGAINST INPUT AND OUTPUT SHORTS, AS WELL AS THERMAL OVERLOAD. KIT DOES NOT INCLUDE LINE CORD, HARDWARE, OR CHASSIS. DO YOUR BENCH A FAVOR FOR \$10.95 + SHIPPING

SAVE MORE KITS, READOUTS, RESISTORS, CAPACITORS, TRANSISTORS, & MORE... OUR FLYER (SEND STAMP + ADDRESS) TELLS ALL. SEND FOR IT! BE SURPRISED.

Include 50¢ handling on orders under \$10.00 CALIFORNIA RESIDENTS ADD sales tax.

LISTEN TO

Spectacular 4-Channel Sound!

Latest High-Quality
Quadrasonic
Performance
with the
Vista SQ-3 Decoder

EXCLUSIVE CBS
LICENSED CIRCUITRY,
SUPERB RESPONSE AND
CHANNEL SEPARATION

FULL LOGIC,
WAVE MATCHING AND
VARIABLE BLEND

KIT SQ-3 ALL NECESSARY
PARTS EXCEPT
CASE AND
+20V 75mA
POWER SUPPLY

\$55⁰⁰

Shipped prepaid in USA NY State add Tax
\$2.00 additional for CANADA

PHOTOLUME CORPORATION

118 East 28th STREET, New York, N.Y. 10016

Circle 104 on reader service card

CT 5001 CALCULATOR CHIP ea. 3.95

Close out sale while they last. w/data

8270 DIP 4-BIT SHIFT REGISTER

4-Bit Shift Register--parallel and
serial input and output; data entry
is synchronized with clock pulse.
ea. \$.50 10 for \$3.95

CARBON RESISTORS

Carbon Resistors 1/2 Watt 5% full prime,
all values in stock. 10 per value (min-
imum quantity). ten for \$4.45

FAIRCHILD "TRIMPOTS"

ea. only \$.89 10 for \$7.50
Brand new 20 turn precision trimmers. These
are prime parts mostly individually packed
in sealed envelopes. These values in stock:
50 OHM 1 K 5 K 25 K
500 OHM 2 K 10 K

POTTER BRUMFIELD

Type KHP Relay 4 PDT 5A Contacts
24 VDC (650 coil) ea. \$1.50 10/\$14.00
120 VAC (10.5 MA coil) ea. \$1.75 10/\$15.75

DIODE ARRAY

10 IN914 Silicon Signal Diodes in one
package, 20 leads spaced .1"; no common
connections. ea. \$.25 10 for \$2.25

IC SOCKETS PBC Mounting

8 pin--\$.22 24 pin--\$.75
14 " " --.26 40 " " --\$1.25
16 " " --.30

SEND FOR FREE FLYER!

C.O.D. PHONE ORDERS
ACCEPTED--\$10 MINIMUM
All parts surplus and tested; leads plated
with gold or solder. Orders for \$5 or more
are shipped prepaid; smaller orders add
55c. California residents add Sales Tax.
ICs shipped within 24 hours.

**BABYLON
ELECTRONICS**

P. O. Box 41727
Sacramento, Ca.
95841
(916) 334-2161

Circle 105 on reader service card

MiniMicroMart

Lowest Memory Prices

1101A	256 x 1		\$2.10
2202-3	1024 x 1	1500 ns	\$8.15
2102	1024 x 1	1000 ns	\$8.10
2102-2	1024 x 1	650 ns	\$9.15
2102-1	1024 x 1	500 ns	\$10.10
1103	1024	Dynamic	\$3.10

Less 10% - 8 or more, 15% - 32 or more,
20% - 100 or more

A.S.C.I.I. Computer Keyboard

Full 60 key ASCII Code Keyboard, plus space
bar, two key roll over, debounced, with latest
TTL and MOS encoder. a rare find, supply
limited. \$40.00

Universal Asynchronous Receiver/Transmitter COM 2502 UART

40 pin MOS ceramic. pin for pin with any stand-
ard version, and perfect for the UART TV type-
writer add on. Feb. R-E. supply limited. \$9.95.

TV Typewriter II, Feb. R-E, all IC's
w/memories, \$79.95.

Microprocessor Circuits

8008 CPU-IC	\$120 value	\$47.50
	w/8-1101A's	\$60.95
	w/8-2102's	\$103.95
8080 CPU-IC	\$320 value	\$169.95
	w/8-1101A's	\$179.95
	w/8-2102's	\$209.95

Mini Computer Kits

BASIC 8008-8080 Mini Kits \$169-\$289, w/PC
Boards, CPU, IC's, memory, write for details
IC KITS FOR ALL POPULAR MINIS-Mark 8-
Altair 8800-Scelbi.

NOTE: None of the above include power supply,
resistors, caps connectors, etc

Power Supply Kits

Components for any required supply.

Send stamped, self addressed envelope for
details on all of above and on many other items of
interest.

Mini Micro Mart

1618 James Street
Syracuse, New York 13203
(315) 422-4467

Circle 106 on reader service card

TTL			CMOS		
7400*	6/\$1.00	7488 4.00	CD4001	\$.55	
7401	23 7489*	2.25ea	CD4002	.55	
7402	23 7490*	.69ea	CD4007	1.25	
7403	6/1.00	7491* 1.00	CD4009	1.40	
7404	25 7492	.95	CD4010	.60	
7405	24 7493	.95	CD4011	.55	
7406	50 7494	.97	CD4012	.55	
7407	50 7495	.95	CD4013	1.50	
7408	25 7496	.95	CD4016	1.40	
7409	25 74100	1.50	CD4017	2.75	
7410*	6/1.00	74107 .47	CD4019	1.25	
7411	40 74121	.55	CD4020	1.50	
7412	40 74122	.47	CD4022	2.50	
7413*	.75 74123	1.05	CD4023	.55	
7416	45 74125	.60	CD4025	.55	
7417	45 74126	.80	CD4027	1.25	
7418	25 74141	1.15	CD4030	.60	
7420	23 74145	1.15	CD4035	2.75	
7421	27 74150	.95	CD4049	1.25	
7423	32 75151	1.20	CD4050	1.25	
7425	27 74153	1.50	74C00	.45	
7426	31 74154	1.25	74C02	.45	
7427	32 74155	1.30	74C04	.70	
7429	40 74156	1.30	74C20	.65	
7430	33 74157	1.55	74C74	1.15	
7432	26 74160	1.65	74C160	3.25	
7437	45 74161	1.65	74C161	3.25	
7438	50 74163	2.50	74C107	1.50	
7439	50 74164	2.50	74C151	2.90	
7440	23 74165	2.50	74C154	3.50	
7441	1.10	74166 1.75	74C163	3.25	
7442	1.05	74170 3.00	74C164	3.50	
7443	1.10	74173 1.75	74C173	2.90	
7444	1.15	74174 1.85	74C195	3.00	
7445	1.10	74175 1.85			
7446	1.25	74176 1.85			
7447*	.89	74177 .85			
7448	1.25	74180* 1.00			
7450	.25	74181 3.75			
7451	.27	74182 1.00			
7453	.27	74184 2.30			
7454	.40	74185 2.30			
7459	.25	74187 7.00			
7460	.25	74190 1.50			
7470	.45	74191 1.50			
7472	.41	74192* 1.25			
7473*	.39	74193* 1.25			
7474	.47	74194 1.50			
7475*	.75	74195 1.05			
7476*	.40	74196 1.25			
7480	.50	74197 1.05			
7482	1.75	74198 2.25			
7483	1.15	74199 2.25			
7485*	1.10	74200 7.00			
7486	.47	74250 5.00			
			(Zener)		
			DIODES		
			(Rectifier)		
			IN456	6/\$1	
			IN458	6/\$1	
			IN485A	5/\$1	
			IN746	4/\$1	
			IN752	4/\$1	
			IN1183	1.60	
			IN1184	1.70	
			IN1186	1.80	
			IN3600	6/\$1	
			IN4001	.09	
			IN4002	.10	
			IN4004	.10	
			IN4148	15/\$1	
			IN4154	12/\$1	
			IN4734	.28c	
			IN4735	.28c	
			IN5232	.28c	
			IN5234	.28c	
			IN5243	.28c	
			IN5282	5/\$1	

20% Discount for 100 pcs.
Combined 7400's
(Except Specials)

APRIL SPECIALS

8008 Processor \$49.95 8080 Micro Processor \$249.95
1101 256 x 1 RAM 2.25 N8T97 HEX Inverter 2.95
2102 1024 RAM 7.95 1702 2048 EROM 29.95
5203 2048 EROM 19.95 8111 256 x 4 N Channel 11.95

Miniature Aluminum Electrolytic Capacitors

MFD-VOLTS	1-	9-	99	100	MFD-VOLTS	1-	9-	99	100
47UF/50V	.14	.12	.11		47UF/25V	.19	.15	.14	
1UF/16V	.14	.12	.11		100UF/16V	.19	.15	.14	
1UF/50V	.15	.12	.11		100UF/25V	.24	.18	.17	
2.2UF/50V	.14	.12	.11		100UF/50V	.24	.18	.17	
3.3UF/25V	.14	.12	.11		220UF/16V	.24	.18	.17	
4.7UF/25V	.14	.12	.11		220UF/25V	.35	.25	.24	
10UF/16V	.14	.12	.11		470UF/16V	.37	.30	.27	
10UF/25V	.14	.12	.11		470UF/25V	.49	.39	.35	
10UF/50V	.14	.12	.11		1000UF/16V	.49	.39	.35	
22UF/16V	.14	.12	.11		1000UF/25V	.75	.60	.55	
22UF/25V	.15	.13	.12		2200UF/16V	.75	.60	.55	
47UF/16V	.17	.14	.13						

50 VOLT CERAMIC DISC CAPACITORS

001 mf.	5c	3.5c	3c	.033 mf.	6c	4c	3.5c
.0047 mf. <td>6c</td> <td>4c</td> <td>3.5c</td> <td>.047 mf. <td>6c</td> <td>4c</td> <td>3.5c</td> </td>	6c	4c	3.5c	.047 mf. <td>6c</td> <td>4c</td> <td>3.5c</td>	6c	4c	3.5c
.01 mf. <td>5c</td> <td>3.5c</td> <td>3c</td> <td>.1 mf. <td>12c</td> <td></td> <td>7.5c</td> </td>	5c	3.5c	3c	.1 mf. <td>12c</td> <td></td> <td>7.5c</td>	12c		7.5c
.022 mf. <td>6c</td> <td>4c</td> <td>3.5c</td> <td>100 pf <td>6c</td> <td>4c</td> <td>3.5c</td> </td>	6c	4c	3.5c	100 pf <td>6c</td> <td>4c</td> <td>3.5c</td>	6c	4c	3.5c

MPS-A05	5/\$1	TRANSISTORS	2N3905	4/\$1	
2N918	.25	2N2906A	4/\$1	2N3906	4/\$1
2N2219A	3/\$1	2N2907A	5/\$1	PN4249	4/\$1
2N2221A	4/\$1	2N3053	2/\$1	PN4250	4/\$1
2N2222A	5/\$1	2N3055	.95c	2N4409	5/\$1
2N2369	5/\$1	2N3725A	2/\$1	2N5129	.19
2N2369A	4/\$1	2N3903	5/\$1	2N5139	.19
2N2484	4/\$1	2N3904	4/\$1	C106B1-SCR	2/\$1

Cal. & Clk. Chips	IC Skts	5001	\$3.95	8 P	\$.22
		5005	5.95	14 P	.26
		5030	7.95	16 P	.29
		MM5311	5.95	18 P	.46
		MM5312	5.95	24 P	.68
		MM5313	5.95	28 P	.89
		MM5314	5.95	36 P	1.10
		MM5316	6.95	40 P	1.25

LINEAR

LM300H	\$.69	LM741H/N	\$.31
LM301H/N	.29	LM747N	.69
LM302H	.69	LM748N	.35
LM304H	.79	LM1303N	.79
LM305H/N	.89	LM1304N	1.00
LM307H/N	.35	LM1307N	.79
LM308H/N	1.05	LM1310P	3.95
LM309K	1.25	LM1458N	.69
LM310H/N	1.19	LM1496N	.99
LM311H/N	.95	LM1556V	1.85
LM318N	1.69	CA3013	1.70
LM319N	1.19	CA3023	2.15
LM320K*	1.50	CA3035	2.25
LM324N	1.85	CA3039	1.35
LM339N	1.95	CA3046	1.15
LM340K	1.89	CA3059	2.46
LM340T	1.75	CA3060	2.80
LM370N	1.05	CA3065N	.75
LM373N	2.05	CA3080	.85
LM3808	1.00	CA3083	1.60
LM380N	1.25	CA3086	.70
NE531T	3.00	CA3089	3.25
NE536T	3.00	CA3091	8.25
NE550N	.79	CA3123	1.



WE'RE NOT LION... QUALITY COMPONENTS

Hard-to-beat prices

BRIGAR electronics

Computer Grade Capacitors

Table with columns: QUAN, MFD, VDC, SIZE, EACH, BRAND, NEW. Lists capacitor specifications and prices.



100 CFM, Mfr. Howard Ind. Model # 1075-10-3369 115 VAC, 60 cycle, 20 watt, 3000 rpm.

Miniature Cooling Fan



Size: 4" blade, 3" deep. Complete with blade guard and mounted on a flat metal plate. Features low noise level, high volume of air. Great for cooling electronics and electrical equipment.

7000 units in stock BRIGAR SPECIAL \$4.95 each

INCANDESCENT LAMPS

GENERAL ELECTRIC # 387 LAMPS

28 volts, .04 amps. Bulb style - T 1-3/4, Base mid. flanged.

40,000 in stock, BRAND NEW BOXED 30¢ each

BRIGAR electronics

MAIL COUPON FOR

FREE! catalog

10 Alice Street, Binghamton, New York 13904

Tel.: 607-723-3111

SEND CHECK OR MONEY ORDER

MIN. ORDER \$10.00

Form for name, address, city, state, zip, and postage information.

Circle 108 on reader service card

LATE MODEL MAGNUS ORGAN COMPONENTS



R5244 3 Octave (37 note) integrated circuit tone generator board.

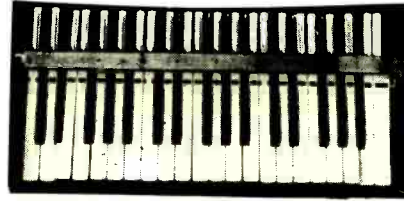

R5246 Late model 3 octave keyboard.



R5245 Amplifier

We have acquired a limited quantity of MAGNUS ORGAN components. The R5244 tone generator is made up of 19 ICs, and discrete components. The R5246 keyboard is a 3 octave keyboard used with the R5244 board. The R5245 amplifier is the matching amplifier for use with the tone generator, and is rated at 13 watts. The amplifier is complete except for the power transformer, (rectifiers & filters included on amplifier board.) Several pages of circuits and data included

- STOCK NO. R5244 Tone generator board 17.95
STOCK NO. R5245 Matching 13 watt amplifier 9.95
STOCK NO. R5246 3 Octave keyboard 19.95
STOCK NO. R5249 Transformer for amplifier board 3.75
One each of above four items 49.00

NOTE: Keyboard not sold separately. Sold only with tone board.

Include sufficient postage; Excess refunded. Write for new catalog 13, just of the press & loaded.



DELTA ELECTRONICS CO.

BOX 1, LYNN, MASSACHUSETTS 01903 Phone (617) 388-4706

Circle 102 on reader service card

Japanese Transistors

Large table listing various Japanese transistor models and their specifications.

SPRING CLEARANCE SALE!

OEM SPECIALS

Table of Transistor Specials, Metal Epoxy, and OEM Specials with part numbers and prices.

Motorola MK-20 Power Transistor Mounting Kit .75

Table for Motorola MK-20 kit, integrated circuits, and automotive ignition power IC.

CITIZEN BAND APPLICATION

Table for Citizen Band Application listing NPN Silicon 27 MH Band RF Power Transistors.

POWER TRANSISTORS

Table for Power Transistors listing High Voltage TV Transistors.

RECTIFIERS

Table for Rectifiers listing various diode models and prices.

EXTRA VALUES!

Table for Extra Values listing various electronic components like SCR's, diodes, and resistors.

SILICON UNIJUNCTIONS

Table for Silicon Unijunctions listing various diode models.

CMOS

Table for CMOS listing various integrated circuit models.

BRIDGES

Table for Bridges listing different types of bridges and their prices.

CHECK OR MONEY ORDER, NO CODS. INCLUDE 10% FOR POSTAGE AND HANDLING. MINIMUM ORDER \$5.00.



New-Tone Electronics P.O. BOX 1738 BLOOMFIELD, N.J. 07003

Circle 109 on reader service card

RADIO-ELECTRONICS

ALL PARTS GUARANTEED AND TESTED ON PRESETS. WRITE FOR FREE CATALOG AND LG. QUANTITY DISCOUNTS.

MICROPROCESSORS by Poly Paks

FLASH! For every order of \$15.00 or more
YOU RECEIVE A FREE DIVIDEND!!!!

10% INFLATION - FIGHTING DIVIDEND 10%

CHOOSE any item or group of items FREE that add up to 10% of your order
Minimum order \$15.00

Poly Paks—1st with Lowest Prices!
1st with Quantity Discounts!
1st WITH DIVIDENDS!

10%

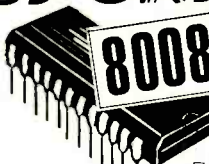

"THE COMPUTER ON THE CHIP"

Only \$79.95

Usually called "Microprocessor" — it is a p Channel Si gate MOS 8-bit Parallel Central Processor. A CPU Central Processing Unit on a chip. Features complete instruction decoding and control. Capability to address 16K x 8 bits of memory (RAM, ROM, SR). Build a micro-computer system when interfacing with other chips, such as 1101, 1103, 2102 (RAMS), etc. With spec sheets, 18-pin dip package. \$79.95

2102 1000-bit "static" Ram for above. \$9.95

16-BIT MICRO PROCESSOR BASIC SYSTEM

The lowest-priced 16-bit system! Outperforms the 8008. The CPU (Central Processing Unit) includes 4-MM5750's, called RALU's, and one MM6751 CROM. RALU — called Register and Arithmetic Logic Unit is a 4-bit control bus, and the CROM is a Control-and-Read-Only Memory. The four RALU's in parallel form a 16-bit unit. The RALU's are controlled by micro-instructions, stored in the CROM. With spec sheets.

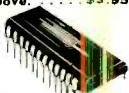

Only \$149.

RAYTHEON-RCA NATIONAL SIGNETICS

LINEAR IC'S

Buy 3 — Take 10%

CODE State 1st, 2nd, 3rd Choices of Case Styles *State Voltages 5 thru 24 (D) = Duals; (Q) = Quads

Type	Price	Type	Price
LM300	\$.69	LM566	2.65
LM301	.29	LM567	.85
LM302	.69	LM702	.49
LM304	1.50	LM703	.41
LM305	.89	LM703M	.41
LM307	.31	LM709	.25
LM308	1.05	LM710	.29
LM309H	1.05	LM711	.29
LM310	1.10	LM712 (D)	.61
LM311	.99	LM725	.69
LM318	1.75	LM733	1.75
LM319	1.19	LM741	.31
LM320*	1.25	LM741 (D)	.31
LM322	1.75	LM748	.69
LM324 (Q)	1.85	LM753	1.79
LM339 (Q)	1.45	LM1303	.79
LM340*	2.50	LM1304	1.00
LM341-T*	1.75	LM1307	.79
LM350	.69	LM1458 (D)	.69
LM370	1.05	LM1496	.99
LM371	1.05	LM1800	3.50
LM373	1.95	RC2556 (D)	2.25
LM374	1.95	CA3026	.69
LM376	1.49	CA3045	.69
LM377	2.50	CA3054	.59
LM380-8	1.10	CA3065	.59
LM380	1.39	CA3082	.59
LM381	1.69	LM3900	.49
LM382	1.69	RC4136 (Q)	1.95
LM531	1.95	RC4195	2.50
LM532	1.95	LM4250C	2.10
LM533	1.95	LM7520	.59
LM536	2.39	LM7521	.59
LM540	2.25	LM7522	.59
LM555	.88	LM7523	.59
LM558 (D)	.69	LM7524	.59
LM560	2.50	LM7525	.59
LM561	2.50	LM7528	.59
LM562	2.50	LM7529	.59
LM565	2.50	LM7535	.59

"GIANT DIGIT" READOUTS

3 for \$12. \$4.50 each

Mfr	Type	Color	Size
Opcoa	SLA-3	Green	0.7
"M"	MAN-6*	Yellow	0.7
Litronix	747	Red	0.6
Litronix	746**	Red	0.6

* All LED, fits standard 14-pin socket
** Plus or Minus 1



NATIONAL NUMERICAL DISPLAY PANEL



Type NDP1262 cold cathode gas discharge. 7-segment 8-digit symbols minus overflow and dot. Properly multiplexed. Like Burroughs Panalux-Two. Color: ORANGE. Used in calculators, equipment etc. Anode supply voltage 190 vdc. We have listed miniature power supply for them. With schematic. 3 x 1 1/4 x 3/2".

GAS DISCHARGE DISPLAY POWER SUPPLIES

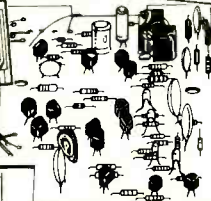

3 x 3" pc board power supply with brightness control for the NDP or any gas discharge tubes. Completely wired. As extra feature has calculator clock circuit. The transformer is the new Toroidal transformer itself worth our asking price. Only 1/2 x 1/2". Electrical specs 110 vac input, output. With spec sheet.

8 WATT STEREO AUDIO AMP

The factory "snipped" most of the cables to this compact wait stereo unit with aluminum end-plate on plate. It's easy to use because we have all the cables, marked ready to use. With power supply. 115 vac, 3 controls, LEFT and RIGHT VOLUME controls for two speakers for balancing and center TONE control. With knobs. 7 x 8 1/2 x 3 1/2. Hookup spec sheets.



35 WATT AUDIO AMPLIFIER BASIC \$3.98



"2001" BEEPIN' ALARM

GIANT DIGIT CLOCK KIT

"Alarmin'" low price. Uses famous "MK" Beepin' clock chip. That's right, can you imagine a clock chip that's within itself — B-E-E-P-I-N! It's the "tomorrow" chip today. Uses the famous all LED MAN-6 or equal readouts from the big "M" pieces. Minimum parts, in attractive walnut cabinet with black crackle tone. Giant "NO GLARE" red filtered panel. 19 minute Snooze Alarm. 3 push buttons and toggle SNOOZE ALARM. 3 push buttons and toggle SNOOZE ALARM. EASY TO BUILD! FUN! Instruction booklet. With rubber mounting on cabinet. Power 115VAC. Size 7 1/4 x 7 x 2 1/2". Wt. 2 lbs.

Only \$49.95

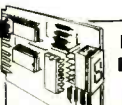

MITY DIGIT LED 'DCM'S'



Manufacturers as Monsanto's MAN-1, MAN-4, Litronix's SLA-1. The last 4 having character heights of 0.33 at no extra charge). Each kit includes 3x2" pc board with fingers for a PKEE edge connector, side-mounting dip socket, LED resistor, 3 IC's, and Molex connectors (THIS ELIMINATES SOLDERING YOUR IC'S) and 707* .33 h. Litronix booklet. INCLUDES P.C. EDGE CONNECTOR — FREE!

JUMBO 0.6" MITY DIGIT DCM

MAN-6. Same electrical specs as the MAN-1. Measures 1 x 7/8 x 1/8" encapsulated in red epoxy lens. Outperforms all reflective bar types. MORE BRILLIANT! Made for distance and wide-angle viewing. Fits into standard 14 pin DIP socket. Kit includes MAN-6, right angle IC socket, edge connector, pc board, assorted resistors and capacitors, SN7475, SN7447, SN7490, Molex sockets and booklet. \$9.95

555 TIMERS

2 u Seconds to 1-hr. (Mini DIP)

XENON FLASH STROBE TUBE



Sold elsewhere for several times our price. This tube is of extremely high intensity. This compact tube delivers a power strong burst of light when triggered. 2 to 3 kv trigger volts. Comes with hookup, schematic and guaranteed to flash. Ideal for slave photo flash, strobe light, auto daylight timing light, emergency flasher, aircraft warning light, etc. Flash duration 1 ms.

BIGGEST MAN-7 SALE \$1

"BLASTAWAY" ON IN4000 RECTIFIER PRICES

Type	PIV	Sale
IN4001	50 10 for 35c	
IN4002	100 10 for 35c	
IN4003	200 10 for 55c	
IN4004	400 10 for 65c	
IN4005	600 10 for 75c	
IN4006	800 10 for 85c	
IN4007	1000 10 for 95c	

MAN-5 as MAN-7 except green \$1.49
MAN-8 as MAN-7 except yellow \$1.49

"PROFESSIONAL" 60 WATT AM-FM MIX TUNER AMP

The finest built 60 watt tuner amp we've had for years. We call it THE AUDIOPHILE BUY OF THE YEAR! It compares to Fisher and H H Scott quality. Crisp hi's, organ type quality for the lows. Fine linear response using a pair of 35 watt style matched power tube transistors for each channel. Built-in preamp for using magnetic cartridges, black and chrome silver look molded panel with glass already attached to tuner. It's made to JUST SLIDE INTO CABINET! Push-button features for phono, am, fm, fm stereo, tape. Red "FM and TAPE" show on glass. You can't see dial plate behind glass til you press any of the above push buttons, and then the scale illuminates. Two separate rocker switches for POWER ON-OFF and AFC Controls. Modern slide volume, balance, bass and treble controls. With knobs for these and a black chrome trimmed 2" round for tuning. Balance controls indicate left and right speakers. Jack on panel for standard stereo headphones. Built-in AM and FM antennas. REAR CONNECTIONS: has two separate cables to plug into stereo, phono system, AC cable for interconnect power to turntable cable to connect to phono system for automatic shut-off. Separate bakelite panel that you can add an additional FM antenna for "souping up" signals, stereo jacks for playback and record for external tape decks, 4-WAY SPEAKER SYSTEM with switch to any channel individually for testing. Wt. 5 lbs.

69.95

BUY 10 IC'S TAKE 15% — BUY 100 TAKE 25%

Inflation-Fighting ECONOMY IC PRICES

Type	Sale	Type	Price	Type	Price
SN7400	.19	SN7438	.49	SN7481	1.25
SN7401	.19	SN7409	.19	SN7482	.99
SN7402	.24	SN7441	1.00	SN7483	1.19
SN7403	.19	SN7442	1.00	SN7486	.49
SN7404	.27	SN7443	1.00	SN7489	2.95
SN7405	.24	SN7444	1.00	SN7490	1.81
SN7406	.79	SN7445	1.00	SN7491	1.35
SN7408	.27	SN7446	1.10	SN7492	.99
SN7409	.27	SN7447	1.10	SN7495	.99
SN7410	.19	SN7448	1.45	SN7496	.99
SN7411	.31	SN7450	.27	SN74100	1.55
SN7412	.69	SN7451	.28	SN74104	1.25
SN7414	2.25	SN7453	.28	SN74105	.75
SN7415	.45	SN7455	.28	SN74106	.95
SN7416	.45	SN7462	.39	SN74107	.49
SN7417	.50	SN7464	.39	SN74108	.95
SN7420	.29	SN7465	.39	SN74112	.95
SN7422	.29	SN7472	.42	SN74113	.95
SN7423	.32	SN7472	.42	SN74114	.95
SN7425	.35	SN7473	.52	SN74121	.49
SN7426	.31	SN7474	.52	SN74122	.55
SN7427	.35	SN7475	.91	SN74123	1.09
SN7430	.24	SN7476	.52	SN74125	.65
SN7432	.28	SN7478	.79	SN74126	.89
SN7437	.45	SN7480	.59	SN74140	2.50



Money-Back GUARANTEE on all Items

7-SEGMENT OPCOA SLA-1 3 for \$6. REFLECTIVE LED READOUT \$2.50

Terms: add postage. Rated: net 30. Photo Orders: Wakefield, Mass. 01829. Retail: 16-18 Del Carmine St., Wakefield, Mass. (off Water Street) C.O.D.'S MAY BE PHONED.

20c CATALOG Fiber Optics, IC's, Sem's, Parts MINIMUM ORDER — \$4.00

POLY PAKS

P.O. BOX 942R, LYNNFIELD, MASS. 01940

VALU-PAK

VOLTAGE REGULATORS TO-3

1 AMP NEGATIVE ea. 10 pak	1 AMP POSITIVE ea. 10 pak
LM 320 5V \$1.95 \$17.50	LM 309K 5V \$1.25 \$10.00
LM 320 5.2V 1.95 17.50	7806 6V 1.50 13.00
LM 320 12V 1.95 17.50	7812 12V 1.95 17.50
LM 320 15V 1.95 17.50	7815 15V 1.95 17.50
	7824 24V 2.25 20.00

CALCULATOR CHIP A1030

North American Rockwell A1030
4 function & percent-on-chip
clock:8 digit floating or
fixed DP:full memory and con-
stant 42 pin staggered lead
DIP (unbent). ea. \$4.95 w/data



74S206 SCHOTTKY BIPOLAR

74S206 Schottky Bipolar 256x1
Random Access Memory.
ea. \$3.49 10 pak \$29.00

10 AMP FULL WAVE BRIDGE RECTIFIER

10 AMP Full Wave Bridge Rectifier
100 PRV Motorola MDA 762-2
ea. \$2.25 10 pak \$20.00



ea. \$1.75 10 pak \$6.95
Monsanto MCT 26 6 pin Dip

2N3055 NPN TRANSISTOR

2N3055 Transistor (power):PD-115W;
VCE-60V; HFE-50; FT-30K; Case-TO-3
ea. \$1.15 10 for \$6.95

DIP RC NETWORKS

14 and 16 pin IC packages containing
precision resistors and capacitors.
NO SCHEMATICS AVAILABLE
Sample indicates most contain 10 to
15R and 1 or 2C. Assortment of 8,\$1.

All Merchandise is new unused surplus
and is sold on a money back guarantee.

Five dollar minimum order. Free first
class postage on all orders. California
Residents please add sales tax.

Send stamp for free catalog. Write to:

VALU-PAK
box AF Carmichael, Ca. 95608

Circle 111 on reader service card



Japanese Transistors

ALL TRANSISTORS ORIGINAL FACTORY MADE

2SA12	.65	2SB439	\$1.05	2SC830	\$1.95
2SA15	.65	2SB463	1.75	2SC853	.95
2SA101	.80	2SB473	1.75	2SC859	.75
2SA102	.80	*2SB474	1.85	2SC875	1.65
2SA221	.65	2SB481	2.25	2SC876	1.50
2SA234	.80	*2SB492	1.25	2SC930	.75
2SA341	1.05	2SC281	.80	2SC936	1.55
2SA342	1.05	2SC367	1.15	2SC937	6.75
2SA350	.80	2SC369	1.15	2SC937	7.50
2SA607	2.45	2SC371	.80	2SC945	.65
*2SA634	1.50	2SC372	.80	2SC959	1.95
2SA636	2.45	2SC373	.80	2SC960	2.25
2SA640	.70	2SC374	.80	2SC971	1.15
*2SA643	.95	2SC394	.80	2SC1000	.75
*2SA683	.85	*2SC458	.80	*2SC1030	3.50
*2SA699A	1.45	*2SC460	.80	2SC1060	1.80
2SB22	.75	2SC461	.80	2SC1061	1.80
2SB54	.80	2SC491	2.75	*2SC1096	1.35
2SB56	.80	2SC535	1.05	2SC1098	1.30
2SB73	.80	*2SC536	.75	2SC1116	5.50
2SB75	.80	*2SC537	.75	*2SC1226A	1.35
2SB77	.80	2SC631	1.05	2SC1237	2.15
2SB156	1.05	2SC632A	1.15	2SC1317	.65
2SB171	.65	2SC633A	1.15	2SC1318	.80
2SB172	.65	2SC634	1.15	2SC1377	7.50
2SB173	.65	2SC644	.80	*2SC1383	.85
2SB175	.65	2SC694	.70	2SC1384	.85
2SB178	1.15	*2SC710	.75	2SD24	1.85
2SB185	.70	*2SC711	.80	*2SD72	1.35
2SB186	.70	2SC727	1.15	2SD77	1.05
2SB187	.70	2SC732	.80	2SD141	2.45
*2SB303	.75	2SC733	.80	2SD142	2.50
*2SB324	1.15	2SC734	.80	2SD178	2.05
*2SB337	2.25	2SC735	.80	2SD186	.80
2SB370	1.25	*2SC799	5.45	2SD218	4.25
2SB400	.80	*2SC828	.80	2SD234	1.65
*2SB405	1.15	*2SC828A	.85	*2SD235	1.35
*2SB415	1.20	*2SC829	.85	*2SD261	.90

• Kit TR24 \$23.44

Kit Contains 24 *Mark Transistors. You Save 20%.
ALL TRANSISTORS 100% TESTED. ORDERS LESS THAN
\$5.00 ADD 40c; \$5.01 to \$10.00 ADD 50c—OTHERS
POSTPAID. CALIF. RESIDENTS PLEASE ADD SALES TAX.
Write for Free Catalog—Over 500 Types Available
SEND ORDER AND MAKE CHECK OR MONEY ORDER TO:



West Pacific Electronics
P.O. BOX 25837
W. LOS ANGELES, CALIF. 90025

ADVERTISING INDEX

RADIO-ELECTRONICS does not assume responsibility for any errors which may appear in the index below.

READER SERVICE CARD NO. PAGE

19	Allied Electronics	97
	Allison Automotive	30
	Amperex	Cover III
7	Arrow Fastener	14
22,23,24	B & K Division of Dynascan Corp.	74, 75
	Bell & Howell Schools	54-57
88	Brooks Radio & TV Corp.	95
92	Castle TV Tuner Service Corp.	Cover IV
11	Chemtronics Inc.	18
68	CIE, Cleveland Institute of Electronics	82-85
73	Continental Specialties Corp.	87
	CREI, Division of the McGraw-Hill Continuing Education Center	64-67
9	Crown International	16
61	Delta Products Corp.	77
64	Edlie Electronics	80
91	Edmund Scientific Co.	108
17	EICO, Electronics Instrument, Inc.	24
74	Elenco Electronics	88
	EMC, Electronics Measurement Corp.	97
85	Enterprise Development Corp.	92
69	Exar	86
84	Fordham Radio Supply Co.	92
6	General Electric Co.	13
83	Grantham School of Electronics	91
	GTE Sylvania Electronic Components	2
100	Heath Co.	26-29
62,63	Hickok Electrical Instrument Co.	78,79
21	Indiana Home Study Institute	74
5	International Components Corp.	12
28	International Crystal Mfg. Co.	76
29	Litek, Inc.	77
3	Mallory Distributor Co.	5
87	MTI, Motorola Training Institute	94
75	Mountain West Alarm Supply Co.	88
82	National Camera Co.	90
14	National Digital Computer Co.	21
	National Technical Schools	44-47
79	Non-Linear Systems, Inc.	90
	NRI Training	8-11
81	PAIA Electronics	90
13	Perma Power	20
86	Pomona Electronics	93
77	PTS Electronics	89
16	Radio Shack	23
	RCA Electronic Components Picture Tubes	32
15	Test Equipment	22
8	RCA Solid State Division	15
76	RGS Electronics	88
90	RYE Industries	96
2	Sams & Co. Howard W.	1E
1	Sansui	Cover II
72	Scelbi Computer Consulting, Inc.	87
67	Schober Organ	81
12	Shure Bros.	19
93	Simpson Electric Co.	1A-1D
78	Southwest Technical Products	89

71	Technical Documentation	87
18	Telematic	25
65	Teletonics Company of America	81
20,30	Tektronix, Inc.	31
80	Tri-Star	90
4	Tuner Service Corp.	7
70	TV Tech Special	86
89	Vero Electronics	96
	Vintage Radio	94
66	Vu Data	81
10	Weller-Xcelite Electronics Division	17

MARKET CENTER

98	Ancrona Corp.	99
	ATV Research	100
105	Babylon Electronics	103
108	Brigar Electronics	104
	Command Productions	98
102	Delta Electronics	102, 104
97	Digi-Key	98
	Fair Radio Sales	100
99	Bill Godbout Electronics International Electronics Unlimited	101
107	James Electronics	103
	J.E.M. Mfg.	100
101	JTM Associates	102
	Lesco Electronics	102
103	Meshna Electronics, John Jr.	102
106	Mini Micro Mart	103
109	New-Tone Electronics	104
104	Photolume Corp.	103
110	Poly Paks	105, 107
	Solid State Sales	100
	Trumbull	102
111	Valu Pak	106
112	West Pacific Electronics	106

Radio-Electronics is published by Gernsback Publications, Inc. 200 Park Ave. S. New York, NY 10003 (212) 777-6400

President: M. Harvey Gernsback

Secretary: Bertina Baer

ADVERTISING SALES

EAST

Stanley Levitan, Sales Manager
Radio-Electronics
200 Park Ave. South
New York, NY 10003
(212) 777-6400

MIDWEST/Texas/Arkansas/Okla.

Ralph Bergen
The Ralph Bergen Co.
6319 N. Central Ave.
Chicago, IL 60646
(312) 792-3646

PACIFIC COAST/Mountain States

Jay Eisenberg
J.E. Publishers Representative Co.,
8732 Sunset Blvd.,
4th Floor,
Los Angeles, CA 90069
(213) 659-3810

Sales Mart Building
1485 Bayshore Blvd., Box 140
San Francisco, CA 94124
(415) 467-0125

"ALL LED" MONSANTO READOUTS

MAN-1 **MAN-3** **MAN-6** **MAN-64**

MONSANTO TYPE	CHAR. HT.	SALE EACH	Quantity Discounts
MAN-1	.27	\$3.50	3 for \$ 9.
MAN-2	.32*	4.95	3 for \$14.
MAN-3	.12	1.00	3 for \$ 2.50
MAN-6	.60	4.50	3 for \$12.
MAN-64	.40	3.50	3 for \$ 9.
MAN-7	.27	1.50	3 for \$ 3.

*85 LED matrix

POLY PAKS BLUE RIBBON Policy

INCLUDES

- Resistors
- Chip
- Transistors
- Drivers
- LED array

20-Years of Business INTEGRITY
 20-Years of Money-Back GUARANTEES
 20-Years of Economy! LOWEST PRICES!

THE SIMPLEST! FINEST! SMALLEST! 6-FUNCTION AC-DC CALCULATOR KIT! \$24.50

- Lightweight, pocket size
- Extra large display
- 6 functions plus, minus, times, percentage, constant
- Floating decimal
- Chain and Mix calculations
- True credit balance
- Simplified indexing
- Mark up and Mark down
- Constant multiplication and division
- AC adapter jack

Designed specifically for Poly Paks under the **Eastone** brand. **IMAGINE!** only $2\frac{1}{2} \times 1 \times \frac{1}{2}$ ". Slides easily into your vest pocket, brief case, or handbag. We hunted everywhere to find a calculator kit that can be small, do the many functions, with fine engineering design and **SIMPLE TO BUILD!** WHY? Because it has the fewest parts in a kit. Imagine the pc board! Only has the chip, 4 resistors, two transistors, two driver ic's with the 9 digit readout. **SIMPLE!** You bet it is. The entire kit is even packed in a multicolor attractively designed box that in itself tells the mini calculator story. Kit includes: attractive black case with red filter; Flex Key (type 20SK-66) 18 key keyboard that measures only $2\frac{1}{2} \times 2"$ with 2 switches, one for ON-OFF, one for K constant; MAIN pc board; readout board; famous Cal Tech 5030 26-pin calculator chip; two 75491 ic drivers; Hewlett Packard 9 digit array; ac jack; 9 Volt battery connector resistors; two transistors; back protective plate; necessary wire plugs; easy instructions. (Less 9 volt standard battery and AC adapter)

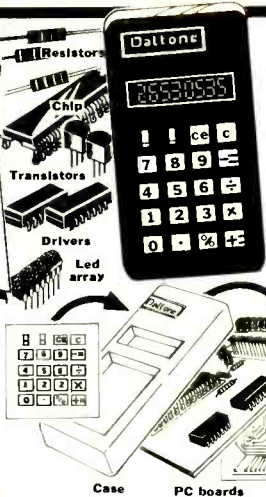

EASIEST KIT TO BUILD

WRISTWATCH LIQUID CRYSTAL DISPLAY \$9.95

3½ digit, 7-segment — only $1\frac{1}{16} \times 1\frac{1}{16} \times 1\frac{1}{4}$ ". Includes readout, socket, "slide-in-place" "crazie" slide face plate. Same display as found in \$200. units.

- GIANT SALE ON LED'S LIGHT EMITTING DIODE GaAs INDICATORS**
- 3-MV2, TO-18, dome, green, visible 1.00
 - 3-MV2, green small dome, green diff. lite 1.00
 - 3-MV3, micro-mini, axial green lens, green, lite 1.00
 - 3-MV3, visible, "coax pin pak", red, mini dome lens 1.00
 - 5-MV10B, visible, red, clear dome lens TO-18 1.00
 - 5-MV10C, visible, red, diffused, dome lens, TO-18 1.00
 - 8-MV50, axial leads, micro-mini dome, clear, red, TO-18 1.00
 - 3-MV52, micro-mini, axial green lens, green, lite 1.00
 - 3-MV53, micro-mini, axial yellow lens, yellow, lite 1.00
 - 5-MV54, micro-mini, axial leads, red lens, red, lite 1.00
 - 5-MV5012, red small dome lens, red, lite, TO-18 1.00
 - 5-MV5013, sm. dome, 2 hi red dome, soft red diff. lite, TO-18 1.00
 - 5-MV5020, jumbo clear dome, visible, red, TO-18 1.00
 - 5-MV5054, red jumbo dome lens, TO-18 red, upright 1.00
 - 5-MV5080, TO-18, micro-mini red dome, red, lite 1.00
 - 5-MV5080, TO-18, micro-mini flat clear lens, red, lite 1.00
 - 1-MV5094, red bi-polar, solid state lamp V to 110-115VAC-DC 1.98
 - 3-MV5222, green jumbo dome, green, lite, panel snap-in 1.00
 - 3-MV5252, micro-mini, green lens TO-18, green, lite 1.00
 - 3-MV5322, jumbo jumbo, yellow, lite, panel snap-in 1.00
 - 2-MT2, photo transistor, light sensor, TO-18 1.00

- COUPLERS**
 2-MCT2, 1500V isolation photo transistor 1.00
 2-MCD2, 1500V isolation photo diode 1.00

WORLD FAMOUS SEMI-KON Dollar Stretchers

- 1-5316 CLOCK CHIP, hobby \$1
- 2-5005 MEMORY CALCULATOR CHIPS, 28-pin HOBBY \$1
- 2-555 TIMING DIP \$1
- 10-741 OP AMPS, mini DIP HOBBY \$1
- 2-2N5296 35-WATT NPN PLASTIC TRANSISTORS, for NE-540 \$1
- 2-2N6109 40-WATT PNP PLASTIC TRANSISTORS, for NE540 \$1
- 10-1N82 GERMANIUM UHF diode, clip-in type \$1
- 2-EPOXY 2 AMP SILICON BRIDGES, RECT, 1000 V "comb. type" \$1
- 10-MOS FETS, SN187, SN200, SN128, TO-18, Fairchild \$1
- 5-SCRS & TRIACS up to 25 amps, 6-12-24 prv, studs too \$1
- 2-2N3819, Texas, N channel, 6500 umho TO-18 \$1
- 2-2N2646 UNIJUNCTIONS, plastic transistors, Texas \$1
- 50-SILICON, glass rectifiers, computer, axial leads \$1
- 50-GERMANIUM, glass rectifiers, silicon, axial leads \$1
- 60-1-AMP 1000 PIV epoxy, submini, silicon rectifiers \$1
- 50-1-W ZENERS, axial 4, 6, 9, 10, 12V rectifiers, et. \$1
- 4-2N3055, HOBBY, 40W npn silicon transistors, TO-3 \$1
- 30-3-AMP RECTIFIERS, silicon, epoxy, assorted V, axial \$1

- 1- PHOTO TRANSISTOR, with darlington amp filter, \$1
- 2- PHOTO TRANSISTORS, with darlington amp, 2N5777, GE, \$1
- 4- PHOTO CELLS, Clairex, pancake, 30K-70 ohms \$1

- 2-Sylvania 18,000V Matchstick TV rectifier, 4" x 1/8" with leads \$1
- 5-ERSO TRIGGER DIODES for SCRs & Triacs \$1
- 5-FETS 2N5457 N channel 5000 umhos, TO-92 plastic \$1
- 10-1N914 fast switch diodes, silicon, 4 nanoseconds \$1
- 6-2 AMP TRIAC 200 PRV, TO-5 \$1
- 50-1TT MICRO MINI RECTIFIERS silicon porcelain to 1KV \$1
- 50-WORLD'S SMALLEST RECT, 4000V, 1W, assorted volts \$1
- 4-6000 PIV 50 mil epoxy rectifiers, axial leads \$1
- 10-BENDIX 25 WATT "pellet" power transistors, silicon \$1
- 3-DARLINGTON, powers, plastic, HFE up to 60K, 6W, 30V \$1
- 10 POWER TABS, plastic includes Darlingstons, HI AMP, HI V \$1
- 1-2N5036 HI-PWR plastic trans 100 vceo, 7 amp 85 watts \$1
- 2-2N5295 35Watts, NPN, silicon, hobby 2N5295 \$1
- 4-2N6109 HOBBY, 40 watts, plastic powers, PNP \$1
- 5-PLASTIC 35W powers, npn, silicon, hobby 2N6121 \$1
- 5-PLASTIC 35W powers, npn, silicon, hobby 2N6124 \$1
- 2-MOS FETS, N channel 10K umos 3N128, TO-18, RCA \$1
- 2-MOS FETS, DUAL GATE, N chan. 3N187, TO-18, RCA \$1
- 2-MOS FETS, DUAL GATE, N chan. 3N140, TO-18, RCA \$1
- 4-RCA 2N3600 NPN. UHF transistors, tv-fm, TO-18, 1000mc \$1
- 2-MPCF-1000, Motorola MOS dual gate "The Claw" \$1
- 2-2N5655 200 hic, 250 vceo, power tab \$1

I.C. & LED HOBBY-ONICS

- 40- PHASE LOCK LOOP, hobby 565, 560, 561 \$1
- 10- TO-5 Case 536, 540, 545, 587, 741 \$1
- 10- LINEAR IC'S, 709, 710, 719, 741, TO-5 \$1
- 3-1-WATT AUDIO AMPLIFIERS, Westinghouse, TO-5 \$1
- 5- HOBBY MEMORY CELLS, 5N7481, up to 16-cell, DIP \$1
- 5-MOS REGISTER, 501 to 5017, TO-5, Mini-DIP \$1
- 10-"C" MOS IC'S, 74C and CD4000 series, DIP pak \$1
- 10-MINI DIP, 709, 710, hobby \$1
- 10-SIGNETIC OP AMP, 531, 533, 538, 550, 555, DIPs, TO-5 \$1
- 1- 5311-14 CLOCK ON A CHIP, 4-or-8 digit, 21-or-28 pin \$1
- 1- RCA CA-3000 OP AMPS, TO-5 case \$1
- 4-MMS736 6-Digit Calculator on a Chip, hobby \$1
- 10-FAIRCHILD-NATIONAL, 9000 Series ICs, dips, hobby \$1
- 5-IBM IC'S, with pc board, many parts, from computers \$1
- 5-AM RADIO-ON-A-CHIP, by Sprague, DIP, 07, hobby \$1
- 4-DUAL 2-WATT "Stereo-Amp-On-A-Chip", fallout/Sprague, west. \$1
- 2-OPCOA SLA-11*, like MAN-5, green, 1-or-more segs gone, \$1
- 2-OPCOA SLA-3H*, 0.7 charac. readout, 1-or-more segs missing \$1
- 5-MONSANTO opto isolators, no test, 1500V \$1
- 10-LED HOBBY SURPRISE, best type, factory rejects, no test \$1
- 2-OPCOA SLA-14, MAN-1, red, 33* charac. 1-or-more segs gon \$1
- 2-MONSANTO MAN-4, 18* charac. 1-or-more segs missing, red \$1
- 5-MONSANTO MAN-3, 12* charac. red. 1 or more segs missing \$1
- 2-3-DIT NATIONAL READOUT, some digits kod \$1
- 10-SPRAGUE DIPs, LINEAR OP AMPS, 2111 series 2120 series \$1

* UNTESTED GUARANTEED SATISFACTION

GET KEY THE PARTS! BASIC KIT #1

includes case, all-function Flex Key Keyboard, Cal Tech CT5002 calculator chip, 9 digit LED display with built-on individual magnifiers, plus sheets, 8-Digits... **\$16.95**

BASIC KIT #2 — same as Basic #1 except calculator chip is National 8-digit MM5726... **\$16.95**

BASIC KIT #3 — same as Basic #1 except calculator chip is National 6-digit MM5736 and 75492... **\$16.95**

12 DIGIT BASIC #4 — Key parts include: CT5001 chip, 4-3 digit readouts, factory etched PC board, case, carrying case, 2-resistor networks, decimal switch, Wild Rover Keyboard with ON-OFF switch diagrams. Sale **\$19.95**

8-DIGIT "TEXAS INSTRUMENT" BASIC KIT #5 — includes Texaskeyboard, 1KS149, standard 4-function. With T-I calculator chip TMS0128, p.c. board, case, lens, Microswitch (on-off), 9-digit array, includes diagram. **\$16.95**

6 & 8 DIGIT MINI CALCULATOR BASICS

"The key parts kits"
 *So small fits in ur palm!
 *Easiest basics around!
 *Requires approx. 6 more parts.

- KIT NO. 5030** — 6 functions. Includes mini case, with lens, HP nine digit readouts with multiple pc board, main pc board, min keyboard (with two switches, percent and constant) ac adapter, jack, 2-SN75491 drivers, CT5030 calculator chip with diagram. 8-Digits... **\$16.95**
- KIT NO. 5031** — 4 function, same as 5030 except uses CT5041 chip, 8-Digits... **\$16.95**
- KIT NO. 5736** — 4 function, like 5031 Uses National MM5736 6-Digits... **\$12.95**

"MEMORY LANE" Buy Any 3 - Take 10%

- 1101 256 Bit RAM MOS \$1.50
 - 1103 1024 Bit RAM MOS 4.50
 - 7489 64 Bit RAM MOS 4.50
 - 8223 Programmable ROM 2.95
 - MMS220 Pre-Programmable ROM 4.50
 - MMS262 1024 Bit RAM 6.50
 - MMS203 Erasable PROM 24.50
- Buy 3 - Take 10%**
- | Type | Volts | Each |
|------------|-------|---------|
| LM-340-05T | 5v | \$14.95 |
| LM-340-08T | 8v | \$14.95 |
| LM-340-12T | 12v | \$14.95 |
| LM-340-15T | 15v | \$14.95 |
| LM-340-18T | 18v | \$14.95 |
| LM-340-24T | 24v | \$14.95 |

INDUSTRIAL SPEED CONTROL \$4.95

A \$30 item from G.E. Model 533A (made for Xerox) that controls home, shop and industrial lighting. **\$4.95**
 A that controls home, shop and industrial lighting. A very elaborate circuit for controlling many electrical and electronic devices. Easily controls speeds of electric drills, brush type motors, etc. 115vac, rated at 1100 watts. With variable speed or dimming control. heavy-duty aluminum case, 3 x 2½ x 2. With diagram and hookups.

"C" MOS IC'S

- | Type | Sale |
|----------|------|
| CD4000AE | .53 |
| CD4001AE | .53 |
| CD4002AE | .53 |
| CD4003AE | .53 |
| CD4006AE | 3.75 |
| CD4007AE | .61 |
| CD4008AE | .75 |
| CD4009AE | .55 |
| CD4010AE | .55 |
| CD4011AE | .51 |
| CD4012AE | .53 |
| CD4013AE | 1.05 |
| CD4014AE | .50 |
| CD4019AE | 1.10 |
| CD4020AE | 3.25 |
| CD4022AE | 2.10 |
| CD4023AE | 1.10 |
| CD4024AE | 2.15 |
| CD4025AE | .53 |
| CD4026AE | 8.50 |
| CD4027AE | 2.75 |
| CD4031AE | 3.50 |
| CD4032AE | 4.50 |
| CD4033AE | 2.75 |
| CD4034AE | 1.10 |
| CD4035AE | 1.10 |
| CD4036AE | .80 |
| CD4037AE | 3.75 |

"BEEPER" AND "DATER" CLOCK ON THE CHIPS

Imagine a chip (MK50250) "Beeper" and audible alarm! All others are external. It also features internal brightness control. The CT7001 requires external triggering of alarm, date of the month and direct drive to LED readouts. Both require minimum current drain and voltages, for either 4 to 6 LED readouts, 12 or 24 hours, AM and PM.

- MK50250 BEEPER \$ 8.50
- CT7001 Alarm and Date \$9.95

- Sanken Watts Sale
 SI-1010G 10 \$ 8.88
 SI-1020G 20 14.95 SANKEN HYBRID
 SI-1030G 30 18.88 AUDIO POWER AMPS
 SI-1050G 50 29.95
- All amplifiers, flat within 1/2 db from 40 to 100,000. Each unit properly heat-sinked, with heavy-duty connecting tie lug connections. Single-ended pushout. Power supply required 24VDC. Output to 8 ohms. Order by Stock No.



Your Choice of VOLTS! \$4.95 **6-VOLT NICAD BATTERY POWER PAK**

Includes "AA" cell nicad batteries hooked up to give you 6-volts for all types of energy uses. The best batteries made. Rechargeable.

AC ADAPTERS & CHARGERS
 \$2.95 110 vac input, output for 5, 6, 7.5 and 12 volt calculators @ 200 milli. For nicads too!

Terms: add postage. Rated: net 30
 Phone Orders: Wakefield, Mass. (617) 245-3829
 Retail: 11-18 Del Gardine St., Wakefield, Mass.
 (off Water Street) C.O.D.'S MAY BE PHONED

POLY PAKS P.O. BOX 942R, LYNNFIELD, MA 01940

LIVE IN THE WORLD OF TOMORROW... TODAY!

And our FREE 180 PAGE CATALOG is packed with exciting and unusual values in electronic, hobby and science items — plus 4,500 finds for fun, study or profit... for every member of the family.

A BETTER LIFE STARTS HERE

3-CHANNEL COLOR ORGAN KIT

Easy to build low-cost kit needs no technical knowledge. Completed unit has 3 bands of audio frequencies to modulate 3 independent strings of colored lamps (i.e. "lows"-reds, "middles"-greens, "highs"-blues. Just connect hi-fi, radio, power lamp etc. & plug ea. lamp string into own channel (max. 300w ea.) Kit features 3 neon indicators, color intensity controls, controlled individ SCR circuits; isolation transformer; custom plastic housing; instructions.



Stock No. 41,831 EH \$18.95 Ppd.

AN ALPHA MONITOR FOR \$34.95*

Yes, because you built it! Use your ability to tune in your brainwaves, an aid to relaxation, concentration. Kit incs. everything you need (except 9v trans. batt.) to own a portable self-cont. BIOFEEDBACK unit for a pittance: steth. earphones, electrode headband, solid-state circuitry; 5 microvolt sensitivity, more! Compl. assembly instructions & op. manual. With basic electronics knowledge, you can do it!



No. 61,069 EH (KIT) \$34.95 Ppd.
No. 71,809 EH (FULLY ASSEMBLED) \$55.00 Ppd.

AM RADIO FITS IN/ON YOUR EAR!

Wear it inconspicuously everywhere. Listen as you work (lawn, yard, office), watch (game, beach) or wait. Instant music, news, sports. No gimmick, our 6/10 oz. Technological wonder has integrated circuit, 11 transistors, patented ferrite antenna/tuner/volume dial. Uses normal silver oxide hearing aid batt. (incl) for approx. 100 hrs. playing. New batt. to slip in avail. at drug stores (about 50c). No lengthy wires, bulky cases, or power-packs!



Stock No. 42,275 EH \$14.95 Ppd.

WHICH ARE YOUR CRITICAL DAYS?

Can Bio-rhythm tell you? We're not sure, but we're told that vast mood shifts are caused by your body's Internal Time Clock whose rhythms can be charted ahead to possibly warn you of "critical" days. Some are great, some blah. Maybe it's your physical, emotional & intellectual rhythms converging at the right or wrong time. Compute your cycles with our Bio-rhythm kit and judge for yourself. Incs Charting kit, metal Diagraft Calc. instrs.



Stock No. 71,949 \$11.50 Ppd.
1 YR. PERSONALIZED REPORT — BY COMPUTER \$15.95 Ppd.
Stock No. 19,200 (Send Birthdate)

RUN A WORKING STEAM ROLLER!



Authentic English hand-crafted model made of heavy-gauge metal, powered by steam so you can run it forward, backward, regulate speed, pull other models, lock roller and run engine independently. Just set steering or use the 12" extension steering rod and drive it yourself! The fun even includes a traditional black chimney for the exhaust, which can power the mighty whistle. To run, fill the safe vaporizing spirit lamp w/wood alcohol (not incl).

No. 71,934 EH (4 lb.: 10 1/4x6x7") \$35.00 Ppd.

TEST YOUR DEGREE OF ESP!



Which light comes on when you push the button — Star, Square, Triangle or Circle? If you've got ESP you or your subject will guess right, significantly. Solid state ESP Tester has guaranteed random circuit for accuracy — you can't beat the machine by memorizing! Run classic ESP, precognition, probability, telepathy experiments. Portable. Reg. 4 "D" batt.

No. 72,090 EH (6 1/4x3 3/4x2") \$29.95 Ppd.

EXTRA PADS TO RECORD 250 EXPERIMENTS
Stock No. 72,092 EH \$3.50 Ppd.

LOW COST 7X INFRA-RED VIEWER



New, great buy for Infra-red crime detection surveillance, security system alignment, I. R. detection, laser checking, nite wildlife study, any work requiring I. R. detection and conversion to visible spectrum. Self contained scope w/everything but I.R. light source works in any I.R. lit area: 6V or 12V power, 6032 I.R. converter tube, f/4.5 objective lens, adjustable triplet eyepiece, shockproof housing. See bright in dark! Under 4 lb., comparable to others at \$350.

No. 1648 EH (11x14 1/4x3") \$225.00 Ppd.
DELUXE—WITH I.R. LIGHT SOURCE No. 1659 EH \$275.00 Ppd.

NEW! KIRLIAN PHOTOGRAPHY KIT!

Experiment in the fascinating new field of "Kirlian electrophotography" — images obtained on film without camera or lens by direct recording of electric charge transmitted by animate & inanimate objects. Each "aura" differs—animate aura said to change corresponding to physical changes. Kit incs portable darkroom, double transformer isolated from power source; instructions.



No. 71,938 EH \$49.95 Ppd.

"HIGH VOLTAGE PHOTOGRAPHY" by H. S. Dakin
No. 9129 EH (60-PG.) PPBK BK.) \$5.00 Ppd.

DELUXE KIRLIAN PHOTOGRAPHY SET
NO. 72,053 EH \$399.00 Ppd.

3" ASTRONOMICAL REFLECTING TELESCOPE

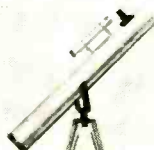

See stars, moon, planets close-up! 30 to 90X. Famous Mt. Palomar Type. Aluminized & overcoated 3" diameter f/10 primary mirror, ventilated cell. Fork type equatorial mount. Durable PVC tube. Includes 1" F.L. 30X Ramsden, Barlow lens to triple power, 3X finder telescopes, hardwood tripod.

FREE: "STAR CHART", "HOW TO USE" book.

No. 85,240 EH \$49.95 Ppd.

DELUXE 3" REFLECTOR TELESCOPE #80,162 EH \$79.95 Ppd.

4 1/4" REFLECTOR (45X to 135X) #85,105 EH \$149.50 FOB

4 1/4" REFLECTOR W/CLOCK DRIVE #85,107 EH \$189.50 FOB

6" REFLECTOR (48X to 360X) #85,187 EH \$249.50 FOB

6" REFLECTOR W/CLOCK DRIVE #85,086 EH \$285.00 FOB



MAIL COUPON FOR GIANT FREE CATALOG!

180 PAGES • MORE THAN 4500 UNUSUAL BARGAINS

Completely new 1975 edition. New items, categories, illustrations. Dozens of electrical and electromagnetic parts, accessories. Enormous selection of Astronomical Telescopes. Unique lighting and ecological items. Microscopes, Binoculars, Magnifiers, Magnets, Lenses, Prisms. Hard-to-get surplus bargains. Ingenious scientific tools. 1000's of components.

EDMUND SCIENTIFIC CO.
300 Edscorp Building, Barrington, N.J. 08007
Please rush Free Giant Catalog "EH".

Name _____
Address _____
City _____ State _____ Zip _____



COMPLETE AND MAIL WITH CHECK, M. O. OR CHARGE NO.
EDMUND SCIENTIFIC CO. 300 Edscorp Building, Barrington, N.J. 08007

How Many Stock No.	Description	Price Each	Total
<input type="checkbox"/>	PLEASE SEND GIANT FREE CATALOG "EH"		
<input type="checkbox"/>	Charge my BankAmericard *		
<input type="checkbox"/>	Charge my Master Charge * Add Handling Chg.: \$1.00, Orders Under \$5.00, 50¢, Orders Over \$5.00		
Interbank No. <input type="text"/>		I enclose <input type="checkbox"/> check <input type="checkbox"/> money order for TOTAL \$ <input type="text"/>	
My Card No. is <input type="text"/>		Signature _____	
Card Expiration Date _____		Name _____	
30-DAY MONEY-BACK GUARANTEE. You must be satisfied or return any purchase in 30 days for full refund. *\$15.00 minimum		Address _____	
		City _____ State _____ Zip _____	

Circle 91 on reader service card

**...and who has the broadest line
of industrial and power
replacement components in the business?**

Amperex Distributors, that's who!

...Broadest line? Broadest line!

...In stock? In stock!

...Name some –

RF Power Tubes, RF Power Transistors,
Industrial Magnetrons, Rectifier Tubes,
Transmitting Tubes, Industrial Receiving Tubes,
Photomultipliers, Silicon Rectifier Stacks,
Ignitrons, Trigger Tubes, SCR's, Industrial CRT's,
Radiation Counter Tubes, X-Ray Tubes,
Plumbicons,* Vidicons...

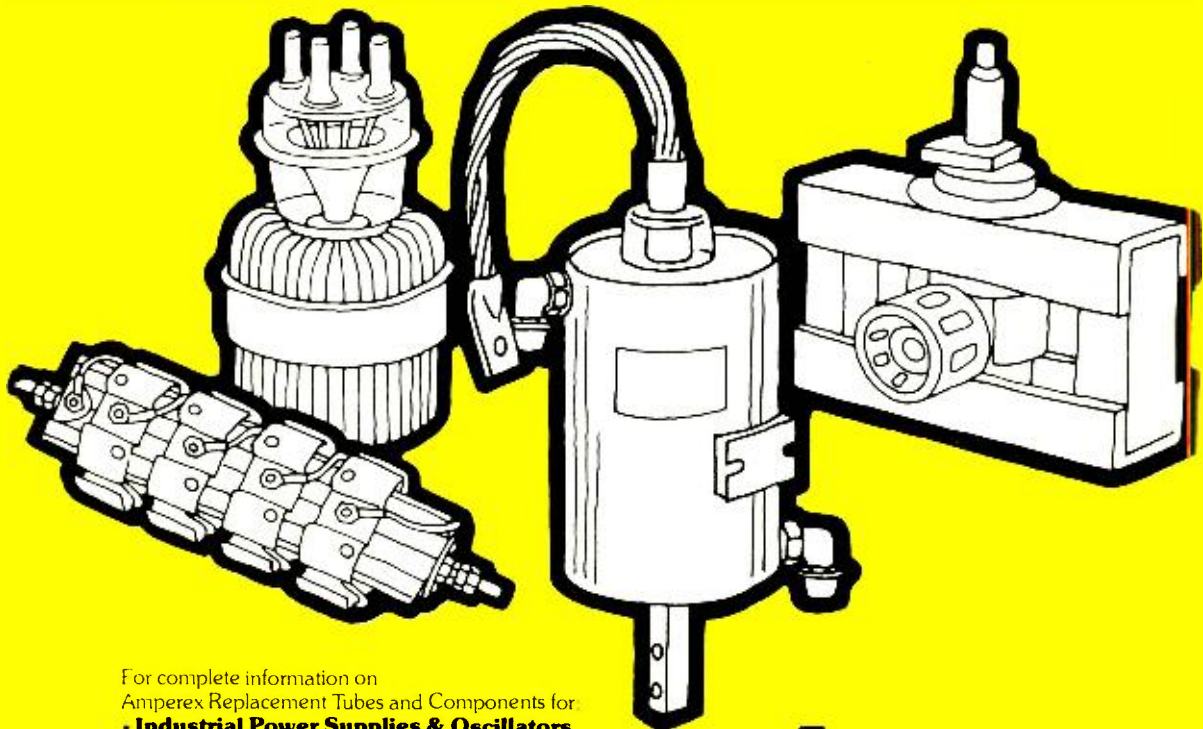

For complete information on
Amperex Replacement Tubes and Components for:
• **Industrial Power Supplies & Oscillators**
• **RF Communications Transmitters**
• **Radio & TV Broadcast Equipment**
• **Microwave Ovens & Commercial Radar Equipment**
• **Scientific Instruments...**

contact Bob Norris, Distributor Sales Operation,
Amperex Electronic Corporation, Hicksville, New York 11802.
Telephone: 516-931-6210.

*Registered trademark of N.V. Philips of the Netherlands

Amperex[®]

TOMORROW'S THINKING IN TODAY'S PRODUCTS

A NORTH AMERICAN PHILIPS COMPANY

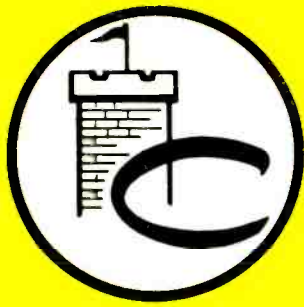

The Tuner People

*Pioneers of TV Tuner Overhauling
Originators of Complete TV Tuner Service*

Castle offers the following services to solve ALL your television tuner problems.

Universal Replacements from \$8.95

These universal replacement tuners are all equipped with memory fine tuning and uhf position with plug input for uhf tuner. They come complete with hardware and component kit to adapt for use in thousands of popular TV receivers.

STOCK No.	HEATERS	SHAFT		I.F. Snd.	PRICE
		Min.*	Max.*		
CR6P	Parallel 6.3v	1¾"	3"	41.25	8.95
CR7S	Series 600mA	1¾"	3"	41.25	9.50
CR9S	Series 450mA	1¾"	3"	41.25	9.50
CR6XL	Parallel 6.3v	2½"	12"	41.25	10.45
CR7XL	Series 600mA	2½"	12"	41.25	11.00
CR9XL	Series 450mA	2½"	12"	41.25	11.00

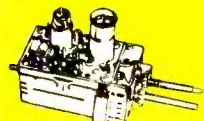
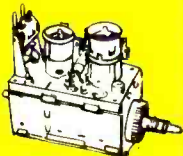
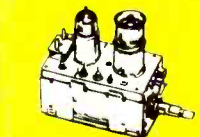
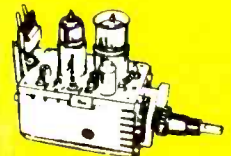
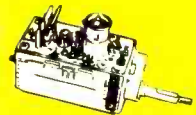
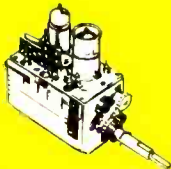
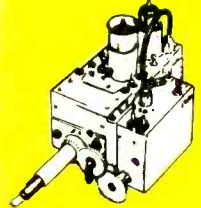
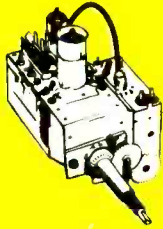

Castle Replacements

\$15.95

Castle custom replacements made to fit in place of original tuner. Purchase outright . . . no exchange needed. Write for current list of Castle replacements, or request the part number you require (use number on ORIGINAL TUNER ONLY; do not use service literature numbers). Available for many of the popular models of following manufacturers: Admiral, Curtis Mathes, Emerson, GE, Heathkit, Magnavox, Motorola, Muntz, Philco, RCA, Sears, Sylvania, Westinghouse, Zenith and many private labels.

Overhaul Service

\$9.95

This is the service pioneered by Castle! We are now in our third decade of serving the TV Service Industry

Service on all makes and models, vhf or uhf, including transistor and color tuners . . . one price \$9.95 Overhaul includes parts, except tubes and transistors.

Remember!

Castle overhaul service is as near as your post office

Simply send us the defective tuner complete; include tubes, shield cover and any damaged parts with model number and complaint. Your tuner will be expertly overhauled and returned promptly, performance restored, aligned to original standards and warranted for 90 days.

Dismantle tandem uhf and vhf tuners and send in defective unit only. Remove all accessories . . . or dismantling charge will apply.

Custom Exchange Service

\$17.95

When our inspection reveals that original tuner is unfit for overhaul, and it is not available from our stock of outright replacements, we offer to make a custom replacement on exchange basis. Charge for this service is \$15.95 for uhf tuner and \$17.95 for vhf tuner.

If custom replacement cannot be made we will custom rebuild the original tuner at the exchange replacement price.



All replacements are new or rebuilt. All prices are f.o.b. our plant. Add shipping and handling of \$1.25 on all prepaid orders. We will ship C.O.D.

CASTLE TV TUNER SERVICE, INC.

5715 N. Western Ave., Chicago, Ill. 60645 • Ph. 312-561-6354

Circle 92 on reader service card

www.americanradiohistory.com