



R202

60¢ APR. 1971

# Radio-Electronics

FOR MEN WITH IDEAS IN ELECTRONICS

## WHAT'S NEW IN CAR ELECTRONICS

### 24 aids for comfort and safety

CAR STEREO  
**Cartridge vs Cassettes**

BUILD  
**Low Fuel-Level Indicator**  
**Parking Light Operator**

FOR BEGINNERS  
**2 Easy Circuits**

MENTS  
**Semiconductors**

**VW's Fuel Injection Computer**  
(see page 33)

302572 DRK 0028A095 JUN73 0 A  
04 4  
L DARKNELL JR  
28 ARDEN CT  
REDWOOD CITY CA 94061

BERNSBACK  
PUBLICATION



# We have a boy

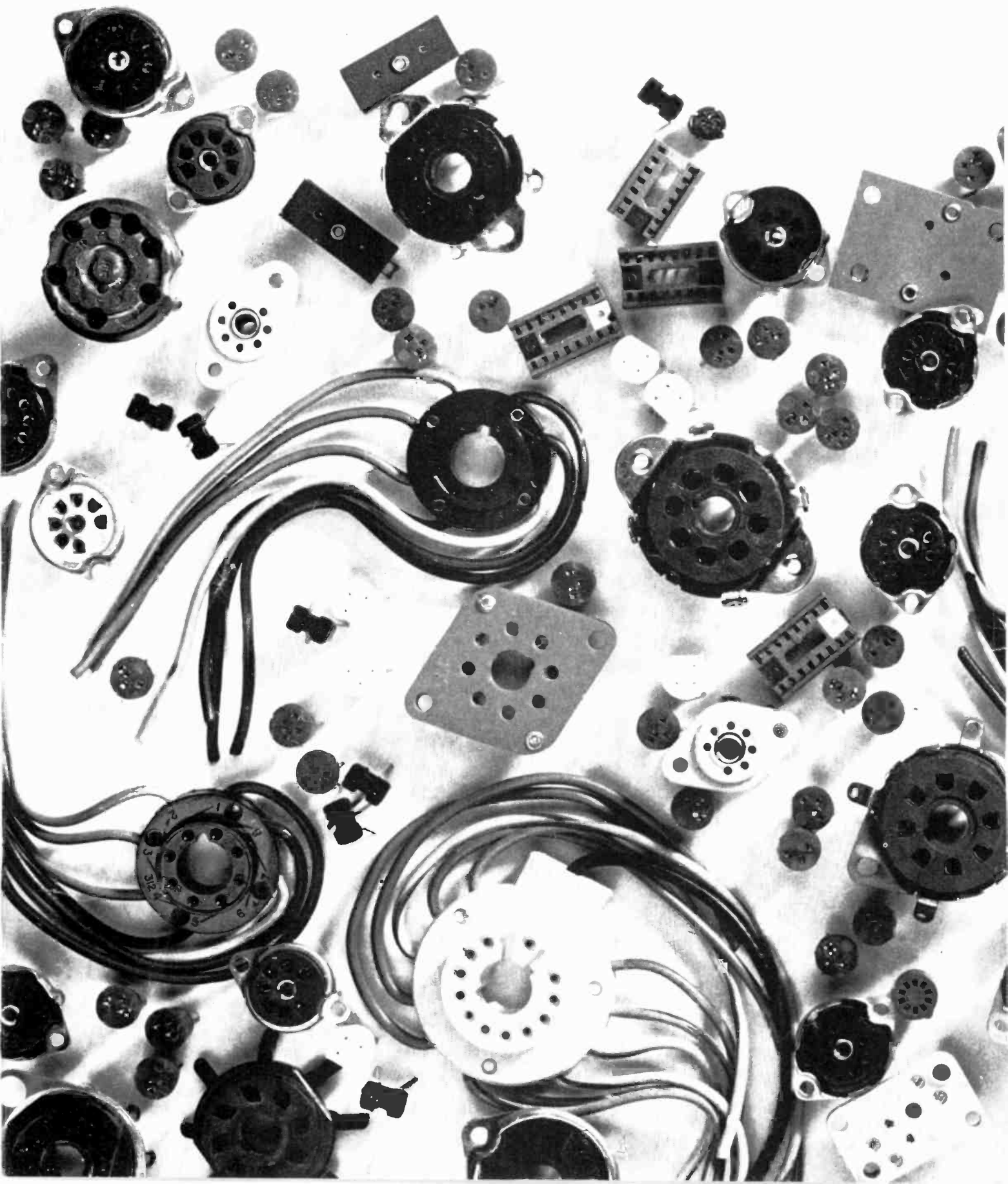

# for every girl.



We have a tremendous line of receiving tubes—over 1000 at last count.

We have 205 different black-and-white picture tubes.

We have the industry's most complete line of color picture tubes.

We have semiconductors of all kinds: transistors, FETs, diodes, rectifiers, SCRs, Zener diodes, linear ICs.

These are our boys.

They're easy to work with.

We've organized replacement pro-

grams (like our ECG semiconductor program), so that you can keep the least amount of stock on hand to replace the most number of parts.

We publish the Sylvania Technical Manual, which is practically a replacement encyclopedia (32,000 components!).

We have loads of specialized replacement literature. And we help you with any replacement problem.

See your Sylvania distributor and get to know the family.

**GTE SYLVANIA**

Electronic Components Group, 100 First Ave., Waltham, Mass. 02154.

# NEW & TIMELY

Volume 42 Number 4

RADIO-ELECTRONICS . . . FOR MEN WITH IDEAS IN ELECTRONICS

April 1971

## SERVICE AGENCIES BLAST PAY SCALE

LOS ANGELES, CALIF.—According to major servicing firms here, manufacturers' reimbursement rates for in-warranty repairs are generally lower than the actual costs of repairs. What is particularly galling, they say, is that these rates are substantially lower than what the manufacturer charges a consumer for identical repairs on bring-in service. Despite rising costs, the schedules of repayment have remained virtually unchanged.

For example, one manufacturer charges a walk-in consumer \$19.95 for repairs on a black-and-white set, but reimburses service agencies only \$7.50 for the same work.

According to Home Furnishings Daily, at Universal Television Company, a service firm, Jerry Canter, president, summed the problem up: "In these times of ex-

tended warranties, with the consumer receiving more attention, which he deserves, the service companies will be providing more service for a longer period of time, but will still be reimbursed at rates antiquated by today's condition."

An exception to the rule is RCA, which has been praised by most service firms here as having a fair and equitable system, perhaps one that should be expanded industry-wide. RCA charges consumers \$8.95 for the first half hour's work plus \$6.25 for each additional half hour. Service agencies are paid exactly what their published rates are for similar work.

Mr. Canter added, "If the consumer is to continue getting the service he's entitled to, some change must be made. It's really the manufacturer's responsibility to recognize what's happening." ★

## LASER RESEARCH YIELDS JEWELS



WALTHAM, MASS.—Dr. Roch Monchamp, manager of Raytheon Company's Crystal Materials Laboratory checks progress of a crystal being grown at 3578°F. An outgrowth of Raytheon's laser research, the Triamond crystals resemble diamonds in ap-

pearance and are almost as hard. These are cut and polished as jewels and marketed by Trifari. The mounted Triamond stones sell for about \$60.00 a carat in contrast to the \$1000 a carat that natural diamonds demand today. ★

## Fast Rate of Tape Sales Predicted

REDWOOD CITY, CALIF.—Donald V. Hall, vice president and general manager of Ampex Music, forecasts that US recorded retail tape sales will be up 19% in 1971. This is a conservative prediction, taking into account the fall-off in consumer spending due to the recession, and the persistence of tape piracy.

"8-track continues to be the market leader, accounting for 77% of 1970 sales," said

Mr. Hall. "Cassettes represent 18%, open reel tapes 4% and 4-track cartridges only 1%."

Mr. Hall expects increased sales of stereo cassette equipment for home and car in 1971. This, plus rapid improvements in cassette quality through Dolby noise-suppression techniques and the use of extended frequency tapes, will greatly improve the long-term potential of cassette music. ★

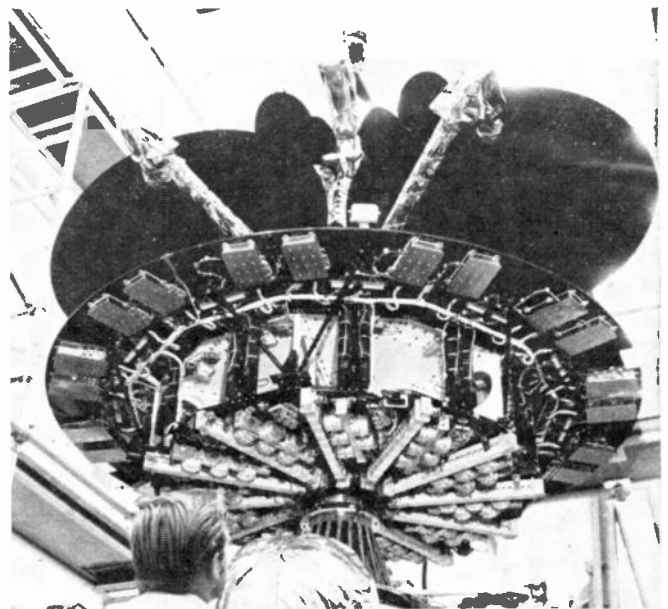

**SPACE DAM FOR INTEL SAT IV COMMUNICATIONS SATELLITE.** The multiplexer assembly (resembling spokes in a wheel) acts as a dam to separate the river of received signals into controlled streams of signal frequencies for this communications satellite built by Hughes Aircraft Company and an international team of contractors.

## TV SYSTEM MONITORS SHOPPING DISTRICT

MOUNT VERNON, N.Y.—The nation's first police-operated low-light-level television system provides around-the-clock, remote surveillance of Mount Vernon's shopping district, GTE Sylvania reports.

Two all-weather cameras transmit video signals to monitors, similar to home TV sets, at police headquarters. A police officer at the monitors, by remote control, is

able to rotate each camera 360 degrees, tilt it vertically 90 degrees, and zoom and focus its lens to detect and follow suspicious movements. The officer can alert mobile patrols to investigate accidents or incidents shown on the screens.

The heart of the closed circuit system, a 29-pound camera, contains a sensor that reacts to light levels too

(continued on page 6)

# Radio-Electronics

FOR MEN WITH IDEAS IN ELECTRONICS

April 1971 • Over 60 Years of Electronics Publishing

## AUTOMOTIVE ELECTRONICS

**What's New In Car Electronics . . . . . 33 . . . . .** Fred W. Holder  
*24 aids for comfort and safety*

**Stereo Tape In Your Car . . . . . 41 . . . . .** Eugene Walters  
*Cassette or Cartridge—both sound great*

**Low-Fuel Alarm . . . . . 44 . . . . .** R. M. Marston  
*Build it and know you're low before you're stranded*

**Automatic Parking Light Operator . . . 46 . . . . .** R. M. Marston  
*2-transistors turn lights on when the sun goes down*

## STEREO—HI-FI—AUDIO

**Mechanical Side Of Cassettes . . . . . 37 . . . . .** Larry Allen  
*How to fix them; step-by-step*

**Solid State Amplifier Design . . . . . 52 . . . . .** Mannie Horowitz  
*Stabilizing bipolar bias circuits*

## TELEVISION

**Equipment Report . . . . . 24**  
*Sencore SM-158 Speed Aligner*

**Equipment Report . . . . . 28**  
*RCA WR-514A Sweep Chanalyst*

**Kwik-Fix Troubleshooting Charts . . . 63 . . . . .** Forest H. Belt  
*Automatic brightness limiter*

**Color Killer Adjustments . . . . . 72 . . . . .** RCA TV Service Tips  
*Set-up procedure for CTC 38 through CTC 43 chassis*

**In The Shop & Service Clinic . . . . . 82 . . . . .** Jack Darr  
*Service Editor tips and solutions to reader problems*

## GENERAL ELECTRONICS

**Looking Ahead . . . . . 4 . . . . .** David Lachenbruch  
*Current happenings with future overtones*

**Home Appliance Electronics . . . . . 26 . . . . .** Jack Darr  
*The SCR in modern appliances*

**9 Experiments With Semiconductors . 48 . . . . .** Paul Franson  
*Fun with easy transistor projects*

**6 Easy Projects For Beginners . . . . . 60 . . . . .** Matthew Mandl  
*Circuit board experiments for fun*

## DEPARTMENTS

CB Casebook . . . . .	<b>87</b>	New Books . . . . .	<b>86</b>	New & Timely . . . . .	<b>2</b>
Coming Next Month . . . . .	<b>87</b>	New Literature . . . . .	<b>77</b>	Try This One . . . . .	<b>85</b>
Correspondence . . . . .	<b>16</b>	New Products . . . . .	<b>73</b>		



**Stereo tape is ready** for your car now, both cassettes and cartridges; two channels and four channels. Find out what's happening. . . . . see page 41

## ALARM



**Don't run out of gas.** Build this low-fuel alarm and be warned, before the tank runs dry. . . . . see page 44

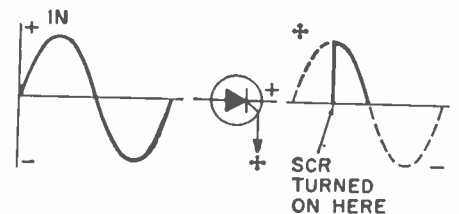
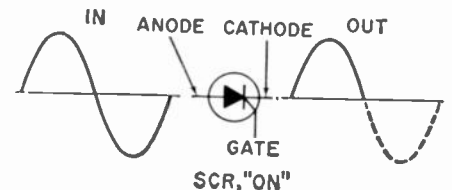

**SCR's are vital** to appliances. Jack Darr explains how they work in this month's Home Appliance Electronics column. . . . . see page 26

RADIO-ELECTRONICS, April 1971, Vol. 42, No. 4  
Published monthly by Gernsback Publications, Inc., at 200 Park Avenue South, New York, New York 10003.  
Editorial, Advertising, and Executive offices: 200 Park Ave. S., New York, N.Y. 10003. Subscription Service: Boulder, Colo. 80302.  
Second-class postage paid at New York City and additional mailing office. Printed in U.S.A. One-year subscription rate: U.S. and possessions, Canada, \$7. Pan-American countries, \$8. Other countries, \$8.50. Single copies 60¢.  
©1971 by Gernsback Publications, Inc. All rights reserved.  
POSTMASTER: Notices of undelivered copies (Form 3579) to Boulder, Colo. 80302.



Radio-Electronics is indexed in *Applied Science & Technology Index* (formerly *Industrial Arts Index*)

# LOOKING AHEAD

Volume 42 Number 4

RADIO-ELECTRONICS . . . FOR MEN WITH IDEAS IN ELECTRONICS

April 1971

by **DAVID LACHENBRUCH**  
CONTRIBUTING EDITOR

## Multi-sound TV—why not?

A very slight rekindling of interest in stereophonic sound for TV is being detected in the television manufacturing industry. Yes, it's an old chestnut which has repeatedly been debunked by experts (the screen is too small for "big" sound, etc.). But the fact remains, it's relatively simple, it works, and it would certainly improve television sound. For those who think stereo sound isn't appropriate to television, there's a simple remedy: Use a mono receiver.

Several years back, the FCC dismissed a proposal to establish stereo sound standards for television because of lack of interest by the broadcasting and manufacturing industries and the public. This was at a time when color television was booming and broadcasters and manufacturers just couldn't be bothered thinking about sound. With clearer perspective today, it's apparent that two-channel sound multiplexing could be a real asset to television. And a study of such a system need not be theoretical. A first-rate TV sound multiplexing operation is a going thing in Japan right now.

Japan's system goes beyond stereo. An FM-FM multiplex system, it provides three sound modes during special programs by NHK, the publicly-supported Japan Broadcasting Corp. Pushbuttons are labeled "Maru Channel," "Subchannel" and "Stereo," or sometimes "A," "B" and "Stereo." The "A" and "B" buttons are for programs with two discrete sound channels. During Expo 70, for example, NHK broadcast programs with both Japanese and English soundtracks to make English-speaking visitors feel at home. The choice of either A or B brings the appropriate sound channel to both loudspeaker systems. For stereo programs, an L + R L - R technique is used (similar to standard FM stereo broadcasting) to preserve compatibility on conventional television receivers.

Deluxe console receivers sold in Japan are completely equipped for stereo sound, with the decoding circuits and additional amplifier-speaker systems built in. For existing sets, a wide variety of adapters is available. The simplest sells for about \$24 and is designed to be used with two separate speakers. Many of them contain one speaker (using the TV set's speaker for the main channel) along with the additional circuitry. Others are designed for use with existing stereo hi-fi systems, including one, at \$85, which operates completely independently of the TV set. It's simply a TV-sound tuner with the appropriate multiplex circuitry and the three mode-selector buttons.

The advantages of such a multi-sound system over straight stereo, at very little extra cost, are obvious. TV stations in major population centers could add a foreign language soundtrack to some programs to accommodate large minority groups which don't speak English—for example, a simultaneous translation into Spanish of major Presidential addresses and news conferences. Although many foreign movies are shown on TV, most are dubbed into English. For purists (or linguists) who prefer the original soundtrack, it would be available at the push of a button. Two-channel sound has obvious attractions for educational TV. The same course could be provided with different audio tracks for students at different levels of advancement. Or a simplified version of programmed learning could be used—the telestudent being asked a question and told to push button A or B in response; he is then told whether his

answer is right or wrong and why.

All this is a bonus, of course. Stereophonic sound is the real payoff. If it's agreed that TV sound generally is poor, and that stereo sound is an improvement over mono, the result must be improved sound. Directionality of the sound is a relatively unimportant byproduct, particularly with television. One major salutary effect of a switch to stereo sound would certainly be a new preoccupation with sound quality by both television broadcasters and receiver manufacturers. The picture has always been the thing in the past. With stereo TV, sound would be given equal emphasis with the picture. Since the stereo sound is compatible, nobody with a conventional receiver has a thing to lose.

Most of the proposed home videoplayer systems have provisions for two soundtracks. If these systems should succeed, they will help force the issue. Stereo soundtracks are no good without stereo equipment to play them. If you're going to buy a stereo TV set to play videocassettes, why not also have broadcast stereophonic sound? The whole thing makes too much sense to be ignored.

## 4-channel stereo moving

Two quadraphonic stereo systems have now moved to the marketplace. The eight-track stereo cartridge is being produced in four-channel by RCA Records and others, and every major manufacturer of eight-track cartridge tape players is now producing, or tooling up for, quadraphonic playback equipment. In addition, Electro-Voice's compatible matrix system (RADIO-ELECTRONICS, Jan. 1971, page 2) has gotten off the ground rapidly. Decoders for use with component stereo systems are now on sale in many major cities at \$59.95. Three record companies are

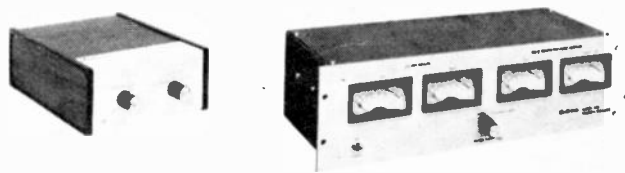

**FOUR-CHANNEL DECODER** model EVX-4 (left) is used to convert existing 2-channel stereo into 4 channels. It also decodes 4-channel material encoded by Electro-Voice Stereo 4 Encoder (right). The device puts four channels of sound into two recorded channels.

getting ready to offer discs encoded for E-V system playback—Enoch Light's Phase III, Ovation Records and Gold Crest Records. At press time, seven FM stereo stations had ordered encoding equipment, and one of them—WJIB-FM, Boston—was already broadcasting in the compatible 4-, 2- and single-channel mode. E-V plans to offer a single-chip integrated-circuit decoder to manufacturers for building into their stereo equipment. The price will be around three dollars. Of course, two more amplifier-speaker channels are also required. You'll be able to hear the compatible broadcasts also over WCRB-FM, Boston; KSL-FM, Salt Lake City; KSAN, San Francisco; WNEW-FM New York, and WDHA-FM, Dover, N.J.

## Kodak's TV gadget

Photography giant Eastman Kodak is taking a close look at color television as a possible display device for both home movies and educational and entertainment films. Ko-

(continued on page 14)





# RCA announces music for people on the move.

**RCA Car Tape Stereo. Cassette or Stereo 8.  
It's like listening to stereo at home.  
We've built in the same quality and fidelity.**



Cassette Play | Record 12R200



Cassette Play | Only 12R100  
Same as 12R200 less record feature



Stereo Speaker Kit 12R400

Two matched 5 3/4" speakers with cabinets and mounting hardware. Adaptable to flush or surface mounting. Wide range frequency response. High resistance to heat and moisture. Speaker characteristics are specifically matched to stereo units.

The new RCA Cassette 12R200 gives great stereo sound and it's also a dictating machine. Has safety interlock record control. Remote control mike with tangle-free cord. Easy front loading. Fast forward and rewind controls. Automatic pop-out cassette ejector. Special circuit ejects jammed cassettes, prevents tape tangling. 18 watts peak power. Easy do-it-yourself installation.



Stereo 8 12R300

The compact RCA Stereo 8 delivers 18 watts peak power. Easy instant front loading with dust door. Push-button program selector. Plays all 8 track stereo cartridges. Dramatic styling. Recessed tone and volume controls.

For every musical mood there's an RCA tape stereo system to transform any car into a concert. Rock. Folk. Classical. All units are backed by RCA's outstanding parts, service data, and warranty programs. See them at your RCA distributor or dealer now.

RCA Parts and Accessories, Deptford, N.J.

**MUSIC FOR PEOPLE  
on the MOVE**

**RCA Car Tape  
Stereo**

(continued from page 2)

low for human vision, and can easily detect and record a man one-half mile away even in extreme darkness. The unit also operates in bright sunlight.

"Growing demands on law enforcement agencies and plant security are expediting the need for low-light-level TV systems," said Kenneth L. Brinkman, Director of Sylvania's Electro-Optics Organization in Mountain View, California. "These systems provide improved security with no increase in personnel." ★

## Cards for Automatic Dialing

MURRAY HILL, N.J.—A new plastic card, the size of a standard credit card, may be used for "hands free" dialing on dial-card operated telephones.

The card may also be used to transmit information to a computer via telephone lines. "Someday they may be used to verify bank balances, order merchandise, or even pay bills," said Dan Miller, who together with Terry Prince, both of Bell Labs, designed the new cards. ★

## Hugo Gernsback Award Winners Announced

CLEVELAND, OHIO—The Cleveland Institute of Electronics announced its 1971 winner of the Hugo Gernsback Scholarship Award, a \$125.00 grant to a deserving student in the field. Lewis E. Barnhouse of Mansfield, Ohio, a twenty-five-year-old father and a telephone company worker, is one of eight winners, each enrolled in an electronics home study school.

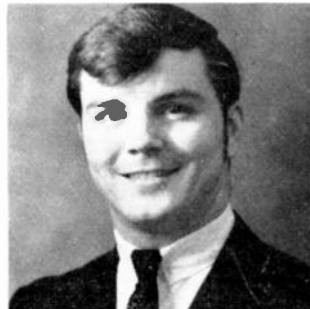

Mr. Barnhouse says "I thoroughly enjoy working with the elements of electronics . . . Practically every field of endeavor today depends either directly or indirectly upon some aspect of electronics." His award-winning essay details his original and colorful opinions on his new field. ★

WASHINGTON, D.C.—Garry W. Greenshields is the National Radio Institute's announced winner of the Hugo Gernsback Scholarship Award for 1971. The twenty-seven year old Canadian lives in Saskatoon with his wife. He is presently studying towards a Masters Degree in Educational Psychology while learning electronics in the home study course given by N.R.I.

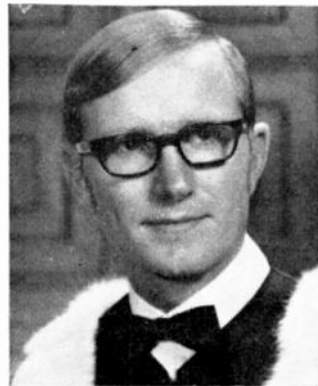

Mr. Greenshields, an honor student all through school and Royal Canadian Airforce training, says his hobbies include sports, especially football and judo, winemaking, making model airplanes of the radio control type, and electronics. ★

## COAL MINE SURVIVAL SYSTEM

ANNAPOLIS, MD.—A mobile shelter for emergency miner living during explosions in the mine has been developed for the Department of the Interior by Westinghouse, and is expected to be immediately



useful in coal mine rescue and emergency communications. The complete system design includes breathing apparatus, a communication and location subsystem, and a rescue subsystem.

The communications equipment is sensitive enough to pick up the "shock wave" caused by a miner's striking the wall or floor of a tunnel with a heavy object. Seismic (continued on page 12)

## Radio-Electronics

HUGO GERNSBACK (1884-1967)  
founder

M. HARVEY GERNSBACK,  
editor-in-chief and publisher

LARRY STECKLER, editor

Robert F. Scott, W2PVG  
senior technical editor

Jack Darr, service editor

I. Queen, editorial associate

Matthew Mandl, contributing editor

David Lachenbruch, contributing editor

James A. Gupton, Jr.,  
photographic electronics editor

Vincent P. Cienia, production manager

Barbara Rosefelt, production assistant

H. Matysko, circulation

Cover design by Marius Trinque  
Cover photo by Phil Koenig

RADIO-ELECTRONICS is published by Gernsback Publications, Inc. 200 Park Ave. South New York, N.Y. 10003 (212) 777-6400

President: M. Harvey Gernsback  
Secretary: Bertina Baer

ADVERTISING SALES  
EAST

Stanley Levitan, Eastern Sales Mgr.  
N.Y.C. (212) 777-6400

MIDWEST/Texas/Arkansas/Okla.

Ralph Bergen,  
6319 N. Central Ave.  
Chicago, Ill. 60646  
(312) 792-3646

PACIFIC COAST/Mountain States

J. E. Publishers Representative Co.,  
8560 Sunset Blvd., Suite 601  
Los Angeles, Calif. 90069  
(213) 659-3810

420 Market St. San Francisco, Calif.  
94111, (415) 981-4527

SOUTHEAST

E. Lucian Neff Associates  
25 Castle Harbor Isle  
Fort Lauderdale, Florida 33308  
(305) 566-5656

SUBSCRIPTION SERVICE: Send all subscription orders and correspondence to RADIO-ELECTRONICS, Subscription Department, Boulder, Colo. 80302

MOVING? For change of address, allow six weeks, furnishing both the old and new addresses and if possible attaching label from a recent issue below. Otherwise please print clearly your name and address exactly as it appears on your label.

ATTACH LABEL HERE

name (please print)

address

city state zip code

Mail to: RADIO-ELECTRONICS  
SUBSCRIPTION DEPT., BOULDER, COLO. 80302



# the most practical service tool ever devised!

## SENCORE POWER MONITOR

Here is an instrument that will pay for itself in time saved the first month you use it.



PM157 \$69.50

**A** IT IS A ZERO TO 1150 WATT WATTMETER

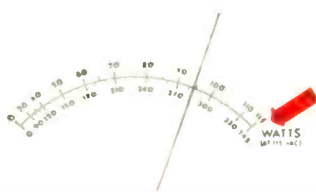

You will know whether or not you are dissipating too much power before you start changing expensive parts.

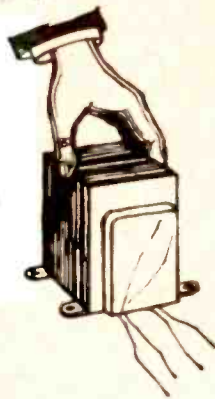

**B** IT IS AN AC LINE VOLTAGE MONITOR

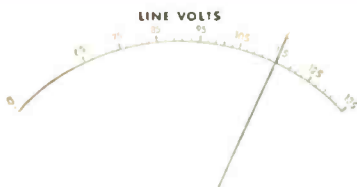

Calibrated right on the nose at 115 volts. How many times has your trouble simply been line voltage and you could have saved so much time?

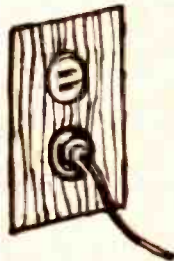

**C** IT IS AN AC AMMETER TO DETERMINE HOW MUCH LINE CURRENT IS BEING DRAWN

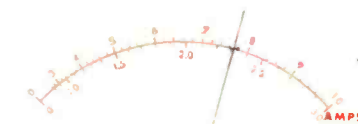

Up to 10 amps. A good check on fuses and other line protectors. How do you know that a circuit breaker is really bad?

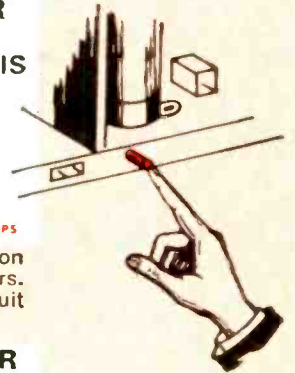

**D** IT IS A FUSE RESISTOR CHECKER WITH SPECIAL SCALES FOR EACH FUSE RESISTOR



You will know whether or not you are sending back a TV or radio set with an overloaded fuse resistor that will go out within hours.

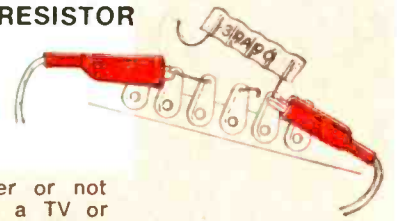

**E** IT IS PROTECTED BY A 10 AMPERE CIRCUIT BREAKER

Fully protected against shock hazard to appliance being tested, and is also safe for the operator. 8" x 6" x 5" 5 lbs.



## SENCORE

3200 SENCORE DRIVE, SIOUX FALLS, SOUTH DAKOTA 57107

Circle 2 on reader service card

# EXPERIENCE IS STILL YOUR BEST TEACHER

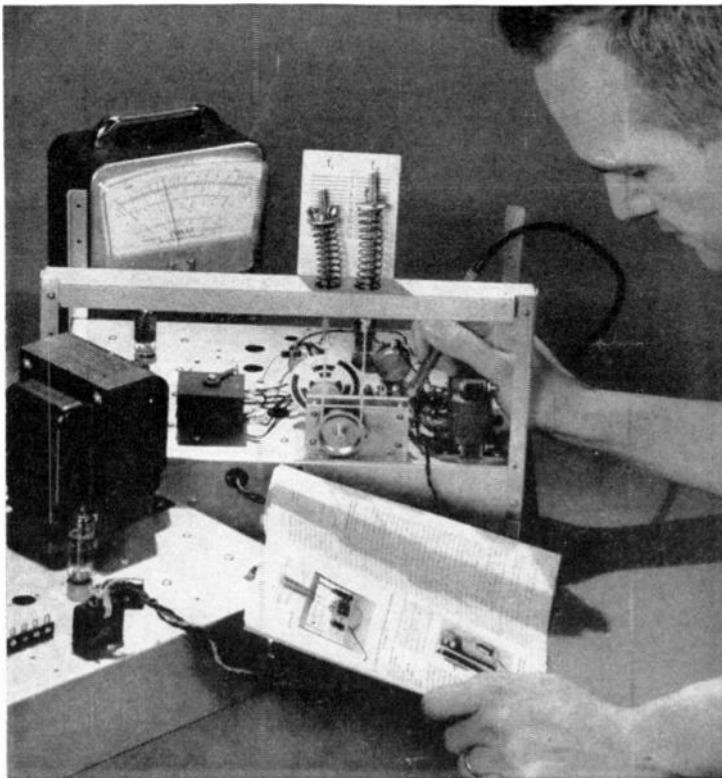

**NRI designed-for-learning training equipment gives you priceless confidence because your hands are trained as well as your head.**

**Learning Electronics at home the NRI way is fast and fascinating. Read opposite page.**



**OLDEST AND LARGEST  
SCHOOL OF ITS KIND**

Accredited by the Accrediting Commission of the National Home Study Council

# You get more for your money from NRI

—more value, more solid experience so essential to careers in Electronics. NRI's pioneering "discovery" method is the result of more than half a century of simplifying, organizing, dramatizing subject matter. In each of NRI's major courses you learn by doing. You demonstrate theory you read in "bite-size" texts programmed with NRI designed-for-learning professional lab equipment. Electronics comes alive in a unique, fascinating way. You'll take pleasure in evidence you can feel and touch of increasing skills in Electronics, as you introduce defects into circuits you build, perform experiments, discover the "why" of circuitry and equipment operation.

Almost without realizing it, the NRI discovery method gives you the professional's most valuable tool—practical experience. You learn maintenance, installation, construction and trouble-shooting of Electronic circuits of any description. Whether your chosen field is Industrial Electronics, Communications or TV-Radio Servicing, NRI prepares you quickly to be employable in this booming field or to earn extra money in your spare time or have your own full-time business. And you start out with training equivalent to months—even years—of on-the-job training.

## NRI Has Trained More Men for Electronics Than Any Other School

—By actual count, the number of individuals who have enrolled for Electronics with NRI could easily populate a city the size of New Orleans or Indianapolis. Over three-quarters of a million have enrolled with NRI since 1914. How well NRI training has proved its value is evident from the thousands of letters we receive from graduates. Letters like those excerpted below. Take the first step to a rewarding new career today. Mail the postage-free card. No obligation. No salesman will call. NATIONAL RADIO INSTITUTE, Electronics Division, Washington, D.C. 20016.



L. V. Lynch, Louisville, Ky., was a factory worker with American Tobacco Co., now he's an Electronics Technician with the same firm. "I don't see how the NRI way of teaching could be improved."



G. L. Roberts, Champaign, Ill., is Senior Technician at the U. of Illinois Coordinated Science Laboratory. In two years he received five pay raises. Says Roberts, "I attribute my present position to NRI training."



Don House, Lubbock, Tex., went into his own Servicing business six months after completing NRI training. This former clothes salesman just bought a new house and reports, "I look forward to making twice as much money as I would have in my former work."



Ronald L. Ritter of Eatontown, N.J., received a promotion before finishing the NRI Communication course, scoring one of the highest grades in Army proficiency tests. He works with the U.S. Army Electronics Lab, Ft. Monmouth, N.J. "Through NRI, I know I can handle a job of responsibility."

**APPROVED UNDER NEW GI BILL. If you served since January 31, 1955, or are in service, check GI line on postage-free card.**

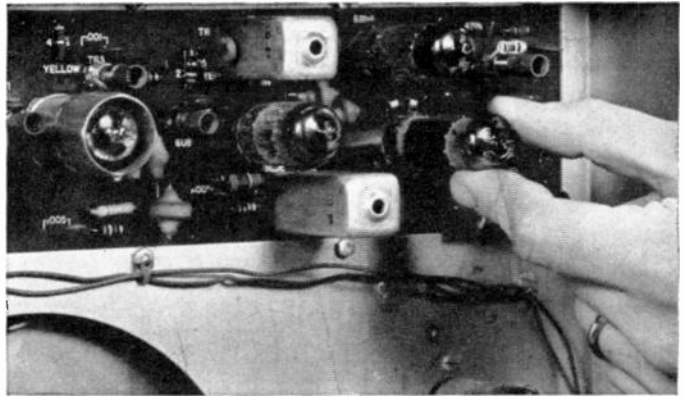

## COLOR TV CIRCUITRY COMES ALIVE

as you build, stage-by-stage, the only custom Color-TV engineered for training. You grasp a professional understanding of all color circuits through logical demonstrations never before presented. The TV-Radio Servicing course includes your choice of black and white or color training equipment.

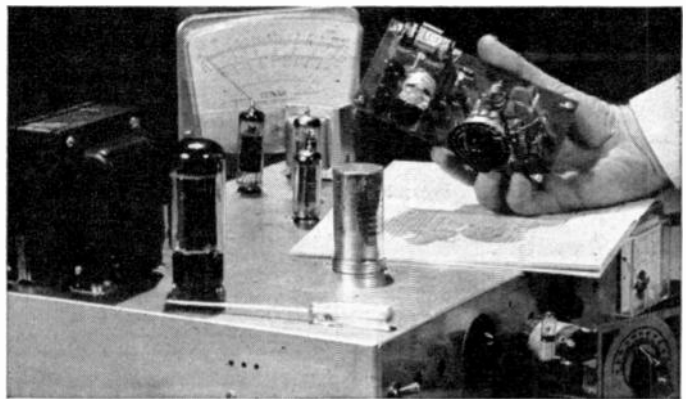

## COMMUNICATIONS EXPERIENCE

comparable to many months on the job is yours as you build and use a VTVM with solid-state power supply, perform experiments on transmission line and antenna systems and build and work with an operating, phone-cw, 30-watt transmitter suitable for use on the 80-meter amateur band. Again, no other home-study school offers this equipment. You pass your FCC exams—or get your money back.

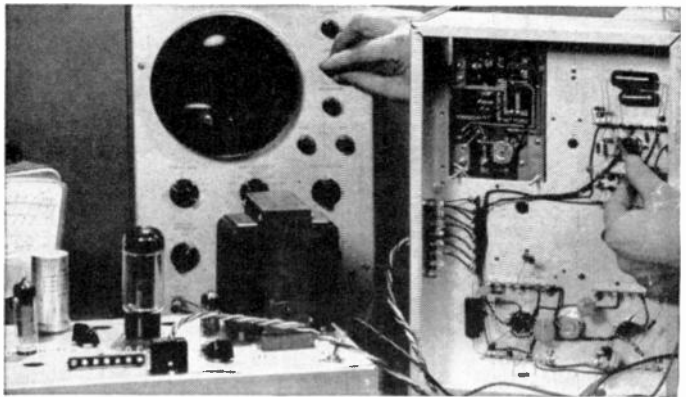

## COMPETENT TECHNICAL ABILITY

can be instantly demonstrated by you on completing the NRI course in Industrial Electronics. As you learn, you actually build and use your own motor control circuits, telemetering devices and even digital computer circuits which you program to solve simple problems. All major NRI courses include use of transistors, solid-state devices, printed circuits.



(continued from page 6)

signals are detected by as many as seven geophone arrays, of up to 19 geophones each, and then amplified and recorded, fed into an on-the-site computer, and analyzed.

sending signals to the surface. In this way rescue drilling operations will be pinpointed to specific areas.

Separate evaluations on the breathing apparatus and



Westinghouse engineers predict they will be able to come within thirty feet of the exact location.

Testing and evaluation of the equipment and shelter in simulated mine emergency conditions is planned. The seismic and voice communications devices will be used to locate and communicate with the party playing the role of "trapped" miners. Transmitters are capable of

survival shelter will be conducted in a non-operating, experimental mine, instrumented and equipped for mine explosion tests. ★

### ELECTRONICS UNDER THE HOOD

Detroit has been installing electronic devices in cars for several years now. 24 factory-installed devices are described in this issue. Turn to page 33 and see what they are.

## ELECTRONICS AT WORK WATCHING THE STARS

PALO ALTO, CALIF.—The birth of stars, the explosion



of supernovas, and the occurrence of star quakes all are under the continuous observation of scientists and astronomers armed with new electronic tools. At Lick Observatory and Lawrence Radiation Laboratory, astrophysicist Jerry Nelson is directing these studies.

The battery of instruments used includes the Hewlett-Packard atomic clock, so accurate that, if operated for

3,000 years, it would accumulate no more than one second error; a desk top correlator, an instrument with a built-in computer that finds weak signals by making thousands of comparisons of a signal against time-shifted versions of other signals until it finds similarities; and a signal averager which reveals an otherwise lost

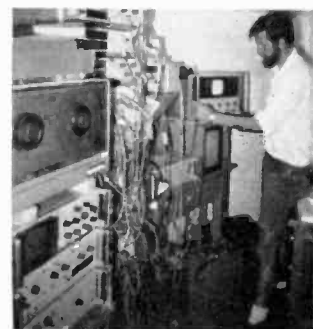

electronic signal by algebraically adding together many weak signals and the noise (continued on page 14)



### New Cortina2 Stereo Kits

The lowest-priced component quality high fidelity! EICO 3780 50-Watt Silicon Solid State FET AM-FM Stereo Receiver. Kit \$109.95, Wired \$169.95.

Separate Tuner, 50-Watt Amplifier, each: Kit \$69.95, Wired \$109.95.

## Express Yourself

IN CREATIVE ELECTRONICS  
Save up to 50% with EICO KITS & WIRED EQUIPMENT

### New EICOCRAFT®

The electronic science project kits for beginners, sophisticates, educators, 42 kits to date.

FM Wireless Mike \$9.95.



### 8 New

#### Eicocraft Kits

Automotive "LIGHT-GUARD" • "VARIVOLT" DC Power Supply • "MOODLITE" Light Dimmer Control • "VARASPEED" Motor Speed Control • "LIGHTSHOW" Sound/Lite Translator • "SUPER MOODLITE" Remote Control Dimmer • "ELECTROPLATER" From \$2.50 to \$14.95.



New "ELECTRIC FIESTA" Audio-Color Organ Kit \$14.95.

### New Automotive Electronics

EICO 889 Solid State Capacitive Ignition System.

Boost gas mileage up to 25%; life of points, plugs to 100,000 miles. Kit \$29.95, Wired \$39.95.

EICO 888 Solid State Universal Engine Analyzer. Tunes and trouble-shoots your car/boat engine, the totally professional way.

Kit \$54.95, Wired \$79.95.



### NEW SOLID STATE TEST INSTRUMENTS

The first and only solid state test equipment guaranteed for 5 years!

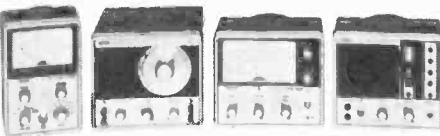

EICO 240 Solid State FET-TVM. Kit \$59.95, Wired \$79.95.

EICO 379 Solid State Sine/Square Wave Generator. Kit \$69.95, Wired \$99.95.

EICO 242 Solid State FET-TVOM. Kit \$69.95, Wired \$94.50.

EICO 150 Solid State Signal Tracer. Kit \$49.95, Wired \$69.95.

EICO 330 Solid State RF Signal Generator. Kit \$59.95, Wired \$89.95.

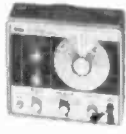

### New "Treasure Hunter"

Kit finds metals, pipes, several inches underground. Locates iron, steel, tin, gold, silver, copper, etc. Beep pitch increases as you near object.

Eico Model TH-30, battery-operated. \$29.95.

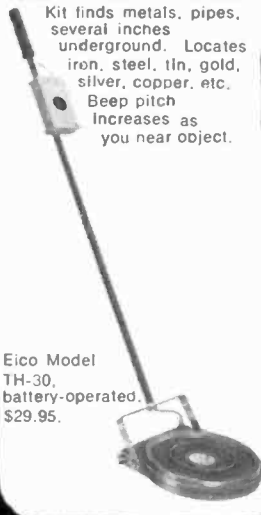

### SOUND N' COLOR

Now see the music you hear! Color Organs by EICO transform sound waves into moving synchronized color images. Model 3450 Giant (30" x 12" x 10") 4-Channels. Kit \$79.95, Wired \$109.95. Others from \$19.95.

Translators create audio-simulated light displays.

From Kit \$24.95, Wired \$39.95.

New Model 3477 Cube Strobe creates white light flashes in rhythm with audio with 3 colored lens filters. \$29.95.

### FREE 1971 SILVER ANNIVERSARY EICO CATALOG



Fill out Reader Service Card for FREE catalog of 200 best buys offered by 2500 local EICO dealers who give you top brands, technical counsel, off-the-shelf service.

25 Years of Leadership in Creative Electronics  
EICO Electronic Instrument Co., Inc.,  
283 Malta St., Brooklyn, N.Y. 11207.  
(212) 949-1100.



Circle 3 on reader service card



## Our hottest auto musician doesn't hit the "C" note.

A full feature AM/FM/FM Stereo Car Radio for less than 100 bucks is just one of the great deals you can offer your customers from the Channel Master Auto Lineup!

You can also offer an AM radio that's small enough to tuck into an ashtray or armrest...yet gutsy enough to fill a 10 passenger model with the finest sound. And a selection of standards in any AM or FM combination.

In the player section, you've got Stereo Cassette with FM/FM stereo and automatic reverse options, and a cartridge selection, likewise with options for every taste.

In short, you've got a compact, though hard hitting line that represents the most solid state of the art...packed with extras that cover every route with value!

That's the Channel Master Auto Line...engineered to strike happy notes anyway you want!

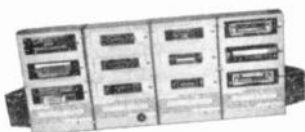

...and what a way to show them! A handsome modular display that brings the sound of life.

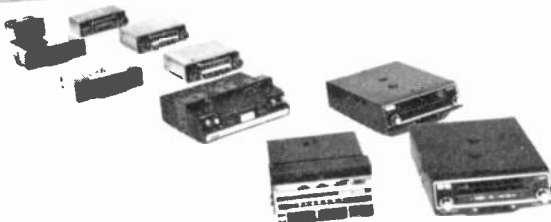

### **CHANNEL MASTER**

Div. of Avnet, Inc., Ellenville, N.Y. 12428

# TRUE TRIGGERED SWEEP OSCILLOSCOPE/VECTORSCOPE

## MODEL TO-50

- DC to 10 mhz frequency response
- .02 volt sensitivity
- Calibrated vertical attenuator
- Calibrated time base
- Supplied with combination Direct/Lo-Cap probe
- 5 X magnifier
- Automatic triggering mode
- 5" flat face tube edge-lit graticule

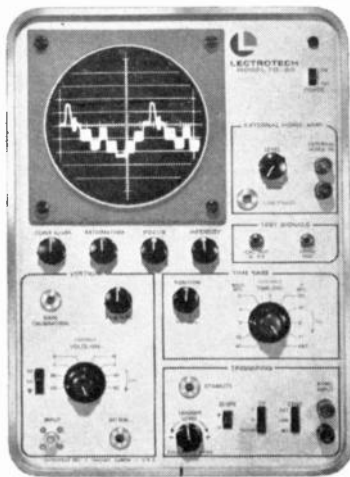

One Year Warranty  
Made in U.S.A. **339<sup>50</sup>**



See your distributor or write Dept. RE-4  
**LECTROTECH, INC.**  
4529 N. Kedzie Ave., Chicago, Illinois 60625

Circle 5 on reader service card

## LISTEN TO: *INSTANT!* POLICE, FIRE, & WEATHER REPORTS!

Perfect for  
Industrial, Commercial, Utility  
and Government Use  
**SONAR SENTRY  
VHF MONITOR RECEIVERS**  
ADJUSTABLE SQUELCH

Designed and engineered for simplicity of operation, compact enough to fit a shirt pocket yet powerful enough to deliver a clear clean signal — it's dependable • Operates on three crystal controlled VHF channels and tuneable broadcast band • Adjustable squelch • Completely solid state for long life use • Visible battery indicator to show battery condition at all times • Built in antenna • 5 7/8" H x 2 1/2" W x 1 1/8" D. Wt. 11 oz.

**\$49<sup>95</sup>**

With Battery & Earphone  
less Crystals  
Crystals \$5.00 ea.

MODELS  
**FR-103-SA**  
150-175 MHz

**FR-106-SA**  
(IN 4 FREQUENCIES)  
A-30-33MHz—B-33-38MHz  
C-38-44MHz—D-44-50MHz

**SONAR RADIO CORPORATION**  
73 Wortman Ave., Brooklyn, N.Y. 11207

Please send me information on VHF Monitor Receivers  
Dept. 270

Name .....  
Address .....  
City..... State..... Zip.....

Circle 6 on reader service card

## New & Timely

(continued from page 12)

that surrounds them.

With the new equipment tied together to form more sensitive and accurate measurement systems, scientists hope to re-evaluate existing theories. ★

### Call Buttons Unsafe

NEW YORK, N.Y.—Some automatic elevators might be death traps during a fire, according to a report issued by Deputy Mayor Timothy W. Costello. The type of call button which responds to the heat of a finger, not the pressure, could misoperate and activate the elevator and speed it to the center of the flames, instead of carrying passengers away from the fire.

The *New York Times* said that these disclosures come as a result of investigations into two office building fires in New York City which killed five. ★

### Skinny Records Sound Better

NEW YORK, N.Y.—The Dynaflex Record, made by RCA Records, with a thinner music groove area, is the first product of the conversion to a new process by the company.

According to Rocco Laginestra, president of RCA Records, the Dynaflex

Record virtually eliminates surface noises, blisters, ticks, imperfect groove molding and disc slippage on the turntable.

Rex Isom, RCA's chief engineer, who headed the team that researched and developed Dynaflex said, "When we began our research to find a method of reducing surface noise, we recalled that historically, the



transcription records for broadcasting prior to the tape era were made thin to provide the best possible sound quality." As it turned out, Mr. Isom remarked, "All our tests with thinner records have reaffirmed this phenomenon."

RCA Records claims that the rapid cooling of a thinner disc causes reduction in warpage at the time of manufacture, and that use of less compound creates more perfectly molded grooves. ★

## LOOKING AHEAD

(continued from page 4)

dak has been quietly talking to television set manufacturers about incorporating super-8 cartridge playback systems into television receivers or selling them as add-on devices. Kodak has even gone so far as to build its own prototype of a super-8 videoplayer. At press time, Kodak officials said the company had no plans actually to produce a videoplayer, but indicated that their thinking on this subject may change.

### World's largest

Who is the world's largest manufacturer of color television? Not RCA. Not Zenith. The indications overwhelmingly point to Matsushita Electric Corporation, whose sets are sold under the Panasonic brand name in the United States, under the National brand elsewhere. The company says it sold 1,760,000 color sets in the 12 months which ended last November 30, placing it ahead of any American manufacturer in terms of units, but possibly not in value of production. **R-E**



**very**

Engineers, technicians and experimenters depend on Leader instruments for sophisticated circuitry, advanced design parameters, and because feature-for-feature they're the best buy anywhere!

**accurate**

**very**

This budget priced RF Signal Generator is typically Leader! It offers 1% dial accuracy and wideband coverage to quickly locate any problems in color and B&W TV sets.

**sensitive**

**very**

20MVp-p/cm vertical sensitivity; triggered sweep; calibrated vertical input and time base combine to make this 5" Solid State Triggered Scope a professional performer. It's a great one!

**economical**

**very**

Leader developed this Vacuum Tube Voltmeter with the accent on stability and sensitivity, all with your economy in mind. AC/DC operation is switch selectable; input impedance is 11 megohms.

**Leader**

The ultimate in pattern stability is one reason why this Color Bar Generator is superb. Features binary frequency dividers; 15 patterns; 2 switch selectable frequencies.



LSG-11 \$44.50

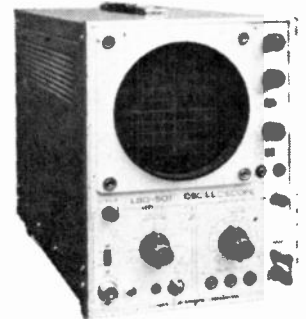

LBO-501 \$339.50

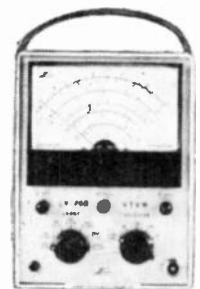

LV 76-B \$59.50

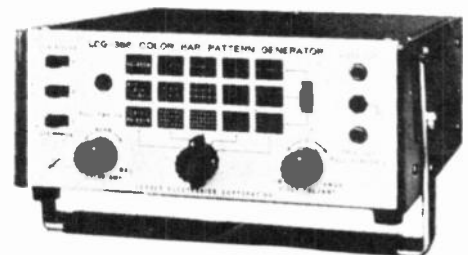

LCG-388 \$159.50

**Seeing is believing.**

**Leader**

INSTRUMENTS CORP.

37 - 27 Twenty-Seventh Street,  
Long Island City, N.Y. 11101 (212) 729-7410

Circle 7 on reader service card

Send for Catalog

REPEATED BY POPULAR DEMAND

# FREE! A CAN OF YOUR FAVORITE TUNER-SPRAY!

Of course, there's a catch. You have to buy a can of TUN-O-BRITE to get your free can. The whole idea is to get you to try TUN-O-BRITE. Because TUN-O-BRITE is so much better than ordinary tuner sprays that once you try it, you'll never settle for anything less.

## HOW TO GET YOUR FREE CAN

- 1 Buy a can of TUN-O-BRITE from your favorite distributor.
- 2 Send the empty can to Chemtronics and tell us what kind of tuner spray you want free.
- 3 We'll send you any 8 oz. can you request, FREE!

That's right, you can get a free can of TUN-O-BRITE or any competitive brand. So far, nobody has asked us for anything but TUN-O-BRITE, but we'll send you anything you want.

**CHEMTRONICS**  
 1260 RALPH AVE.  
 BKLYN., N.Y. 11236



ONLY ONE  
FREE CAN TO A  
TECHNICIAN

THIS OFFER  
EXPIRES  
MAY 15, 1971

Circle 8 on reader service card



## SWITCH TUBES

The article in the January 1971 issue, "Build A \$40.00 TV X-Ray Detector," specifies the 1B85 Geiger Tube currently costing more than \$16.00. The CK1026 costs less than \$5.00 and should work equally well in the circuits with no modification except possibly adjustment of high voltage to the CK1026 to conform to its characteristics. My experience indicates that the CK1026 is quite as good as the 1B85, and it is certainly cheaper. Hope this tip helps your readers.

LYMAN E. GREENLEE  
Anderson, Ind.

## CURRENT FLOW VERSUS ELECTRON FLOW

I have received several letters indicating that readers of my series, "Solid State Amplifier Design," do not thoroughly understand conventional current flow. Here is an attempt to explain the theories involved.

The "controversy" between electron flow and current flow is not really a controversy. Convention assumes *electrons* flow from a negative terminal on a battery to the positive terminal. At the same time, convention also assumed that *current* flows in the opposite direction. Current is defined as the ratio of change-in-charge to the change-in-time, or  $dq/dt$ . It refers to flow in either direction.

As to electron flow being the "real thing," or current flow being the "real thing," no one knows for certain. All we have is the theory of the atom. The effects on other factors by the atom makes it seem likely that electrons and other particles do exist. The *theory* seems to work. Tomorrow we may decide something different, and disprove all our theories. Joos, in his book "Theoretical Physics," expresses similar thoughts in the introduction, as do countless other philosophers of physics. Who can prove beyond a shadow of a doubt that the electron does exist? Everything seems to point to this, but who really knows?

I chose the conventional current  
(continued on page 22)

# Important New SAMS Books

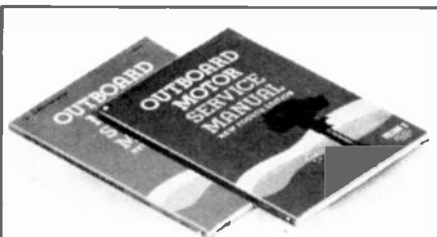

## Outboard Motor Service Manuals. 5th Ed.

Step-by-step repair and maintenance information for specific models in the most popular U. S. and foreign makes. Covers everything from tune-ups to complete overhauls. Each volume includes a special section on design fundamentals and operating principles. Profusely illustrated.

- Vol. 1. Motors under 30 H. P.  
Order 20791, only .....\$5.95
- Vol. 2. Motors over 30 H. P.  
Order 20792, only .....\$5.95
- 2-Volume Set.  
Order 20793, only .....\$10.50



## Snowmobile Service Manual. 4th Ed.

Completely updated to include virtually all 1969 and a number of 1970 models, as well as older machines in operation today. Covers specific models in 34 popular makes. Provides detailed instructions for tune-ups, and for every phase of repair and maintenance. Includes comprehensive section on snowmobile engine design and operating principles. Order 20825, only .....\$5.95

## TV Servicing Made Easy. 2nd Ed.

by WAYNE LEMONS. Fully updated to cover the latest advances in TV circuitry, including the new transistor and integrated circuits; also provides new data on tube-type sets, both black-and-white and color. Includes an entire new chapter on unusual color TV-circuits. Through the use of basic equipment and simple test procedures, this book shows how in-circuit checking helps diagnose and solve troubles quickly in tube-type or transistor-type TV receivers, either monochrome or color. Order 20811, only .....\$5.25

## ABC's of Short-Wave Listening. 3rd Ed.

by LEN BUCKWALTER. Completely updated to provide an introduction to the exciting world of short-wave listening, which includes international broadcasts, amateur voice and code operations, police and emergency transmissions, commercial aircraft and marine communications, and, now, signals from orbiting spacecraft. Describes the programs available; provides practical advice on receivers and antennas; explains how to get the most out of short-wave listening. Order 20797, only .....\$2.95

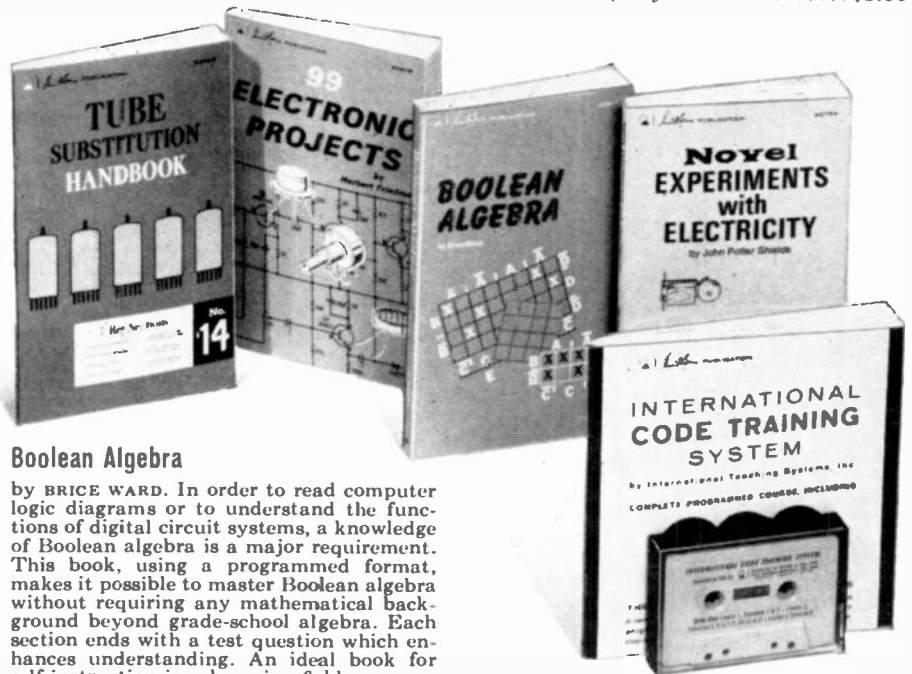

## Boolean Algebra

by BRICE WARD. In order to read computer logic diagrams or to understand the functions of digital circuit systems, a knowledge of Boolean algebra is a major requirement. This book, using a programmed format, makes it possible to master Boolean algebra without requiring any mathematical background beyond grade-school algebra. Each section ends with a test question which enhances understanding. An ideal book for self-instruction in a booming field. Order 20817, only .....\$5.50

## Novel Experiments With Electricity

by JOHN POTTER SHIELDS. This book clearly explains the fundamentals of electricity and magnetism, and introduces the reader to their fascinating properties through a series of novel experiments. These range from a ground telephone and electric arc to a miniature lightning generator and synchronous motor. The applications range from entertainment to security. Each experiment is easy to perform; parts costs are minimal. This is truly a rewarding book for the experimenter. Order 20794, only .....\$3.50

## Tube Substitution Handbook. 14th Ed.

The most complete, up-to-date guide available to DIRECT tube substitutions. Lists more than 12,000 direct substitutions in the following categories: American receiving tubes; picture tubes; miniature types; industrial types; communications and special-purpose tubes; foreign tubes. Instructions accompanying each section tell how to make proper substitutions. Includes valuable cross-reference between sections showing additional substitutes. An indispensable reference for everyone in electronics. Order 20829 only .....\$1.75

## 99 Electronic Projects

by HERBERT FRIEDMAN. The projects presented in this book provide both enjoyment and personal satisfaction for any electronics hobbyist. All of the circuits employ solid-state components of the hobby type, which are readily available at modest cost. The projects included are intended for practical use in the following fields: audio; automotive; home protection; CB, ham, and gwl; musical instrumentation; and more. Each project offers practical application and a rewarding building experience. Order 20818, only .....\$3.50

## International Code Training System

by INTERNATIONAL TEACHING SYSTEMS, INC. Unique text and records/or tape teach code faster, and with greater speed and accuracy, than any other method known. Special programmed charts make it unnecessary to memorize code characters the old-fashioned way. Practical exercises help develop sending and receiving speed up to 22 wpm!

- With three 33 $\frac{1}{3}$  rpm records.  
Order 20138, only .....\$7.50
- With pre-recorded tape cassette.  
Order 20812, only .....\$10.95

## HOWARD W. SAMS & CO., INC.

Order from your Electronic Parts Distributor, or mail to Howard W. Sams & Co., Inc., Dept. RE-041  
4300 W. 62nd St., Indianapolis, Ind. 46268

Send books checked at right. \$\_\_\_\_\_ enclosed (please include sales tax where applicable).

Send FREE 1971 Sams Book Catalog

Name \_\_\_\_\_  
PLEASE PRINT

Address \_\_\_\_\_

City \_\_\_\_\_ State \_\_\_\_\_ Zip \_\_\_\_\_

- |                                |                                |
|--------------------------------|--------------------------------|
| <input type="checkbox"/> 20811 | <input type="checkbox"/> 20138 |
| <input type="checkbox"/> 20797 | <input type="checkbox"/> 20812 |
| <input type="checkbox"/> 20829 | <input type="checkbox"/> 20791 |
| <input type="checkbox"/> 20818 | <input type="checkbox"/> 20792 |
| <input type="checkbox"/> 20817 | <input type="checkbox"/> 20793 |
| <input type="checkbox"/> 20794 | <input type="checkbox"/> 20825 |

Circle 9 on reader service card



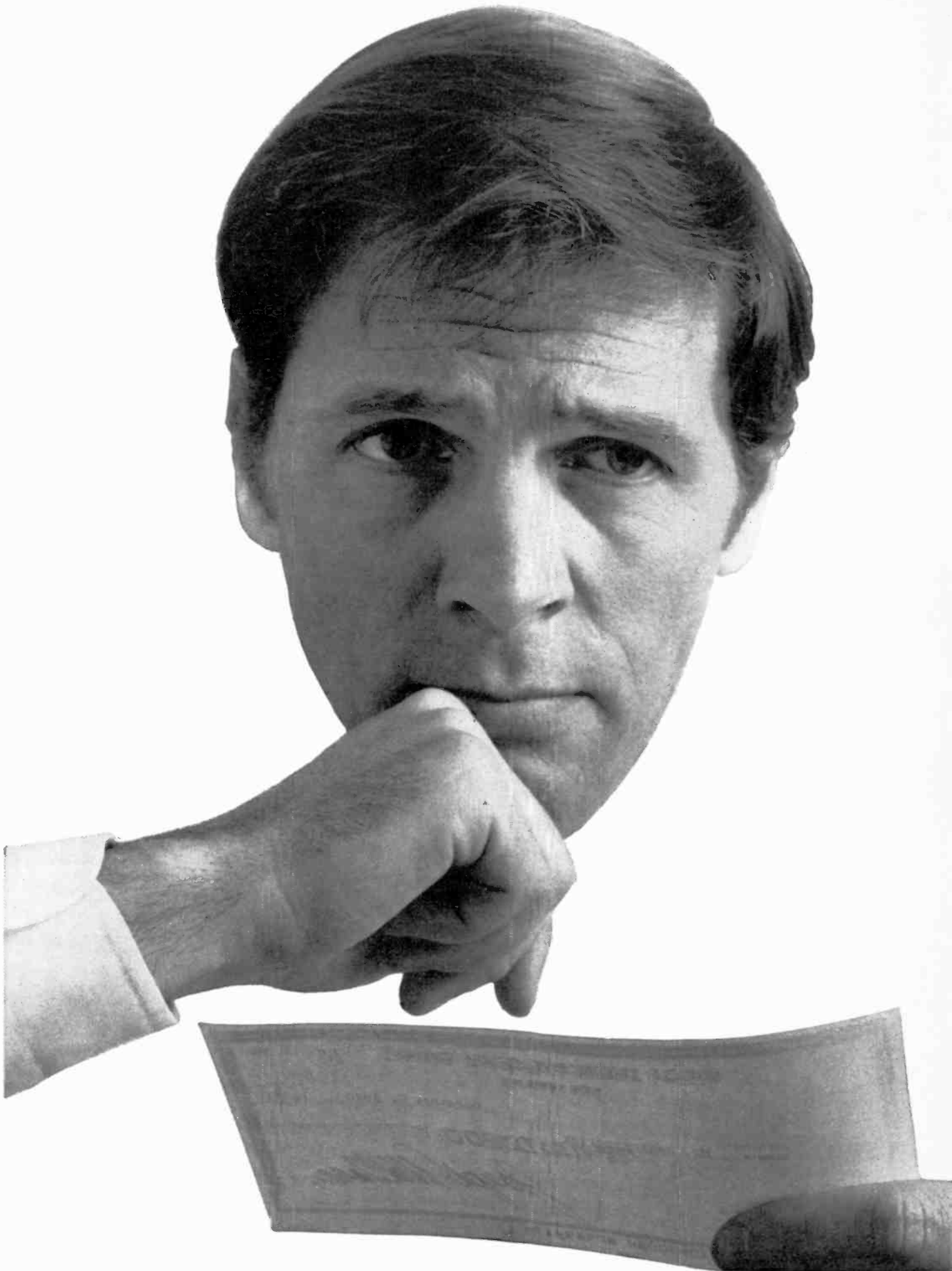

# Your paycheck says a lot about you

It tells you more than how much you make. It tells you how far you've come. And if your paycheck looks very much the same as it did last year, or the year before, it simply means that *you* look very much the same as *you* did last year and the year before.

But times change, and you should be changing with them. Old dull jobs are disappearing. New exciting ones are being created. There are challenging new fields that need electronics technicians...new careers such as computers, automation, television, space electronics where the work is interesting and the earnings are greater.

RCA Institutes has one of the nation's largest and most respected home study schools devoted to electronics. They can get you started even if you've had no previous training or experience. RCA Institutes has developed a faster, easier way for you to gain the skills and the knowledge you need for a fascinating, rewarding electronics career. And you don't have to quit work and go back to school. With RCA Institutes Home Study Plan you can do

both. You set your *own* pace depending on *your* schedule.

Check over these RCA benefits:

- You get Hands-On Training—over 300 experiments and as many as 25 kits with some programs.
- You get RCA's unique "Autotext" method of learning—individual programmed instruction, the *easy, faster, simplified* way to learn!
- You get the widest choice of electronics courses and programs—everything from Electronics Fundamentals right up to Solid State Technology and Communications Electronics.
- You get a selection of low-cost tuition plans!

Sounds great, and it is! For complete information, without obligation, send in the attached postage paid card...or return the coupon below. That will say a lot about you.

Veterans: Train under new GI Bill. Accredited Member National Home Study Council. Licensed by N.Y. State—courses of study and instructional facilities approved by the State Education Department.

## **RCA** Institutes

Home Study Dept. 758-004-1  
320 West 31st Street, New York, N. Y. 10001

Please rush me FREE illustrated catalog.  
I understand that I am under no obligation.

Name \_\_\_\_\_ Age \_\_\_\_\_  
(please print)

Address \_\_\_\_\_

City \_\_\_\_\_ State \_\_\_\_\_ Zip \_\_\_\_\_

Veterans: Check here

If reply card  
is detached—  
send this  
coupon today

**CORRESPONDENCE**

(continued from page 16)

flow for it is easier to think of this when discussing semiconductor circuits, because the symbol of the device indicates the direction of current flow, not electron flow. Just try and follow intricate descriptions of semiconductor circuits using electron flow and you will see the confusion it will generate in your mind! I have tried reading an otherwise excellent text on semiconductors, and found myself working hard to follow the perfect logic, because of this. In my own Sam's book, "Practical Design with Transistors," I have used conventional cur-

rent flow, and received only one mild objection from a reader, which seems to show that this method is easier to follow.

To use electron flow rather than current flow, I suggest you simply reverse the direction of the arrows. Use the convention easiest for you to conceive.

MANNIE HOROWITZ  
Brooklyn, N. Y.

**CORRECTION**

The Service Editor of this magazine NEVER makes mistakes! However, the gremlins got into Fig. 2-a and 2-b of my article, "Replacement

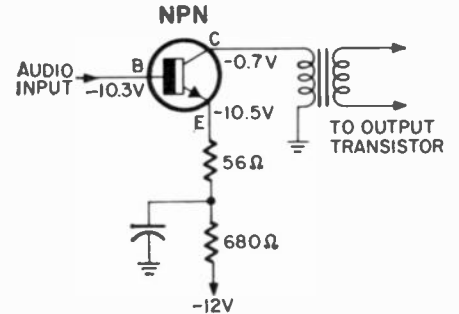
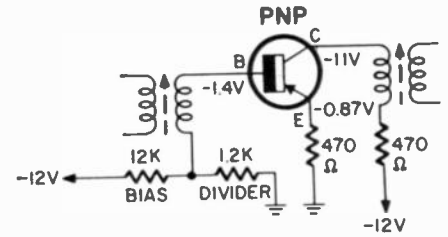

Transistors," in the February 1971 issue. The corrected version is shown above. In the original everything is right, but the transistor is drawn as an NPN. In the audio driver circuit, the transistor is drawn reversed, and the polarity of the applied voltage is also reversed! (If this circuit was hooked up with the emitter grounded, the polarities as shown would be right this is only for "grounded-collector" types.) Sorry about that, folks.

JACK DARR  
Mena, Ark.

Jack, you are so right! We goofed! Our apologies to you and especially to our readers.

**PANASONIC PARTS**

In your December 1970 "Service Clinic" column I noticed the problem of W. H. in Bethayres, Pennsylvania concerning a Panasonic 29KQ6 receiving tube.

Please tell your readers that we have a nationwide parts distributor program, where all Panasonic parts may be purchased. In the state of Pennsylvania our two distributors are:

Steinberg Electronics  
2520 N. Broad St.  
Philadelphia, Pa. 19132  
215/BA3-9400

and  
Triangle Electronics  
6580 Frankstown Ave.  
Pittsburgh, Pa. 15206  
412/441-9669

In addition, anyone wishing to order a part can always contact our Central Parts Depot at the address below.

JULIAN A. SMALKIN  
Matsushita Electric Corp.,  
10-16-44th Drive,  
Long Island City, N.Y. 11101. R-E

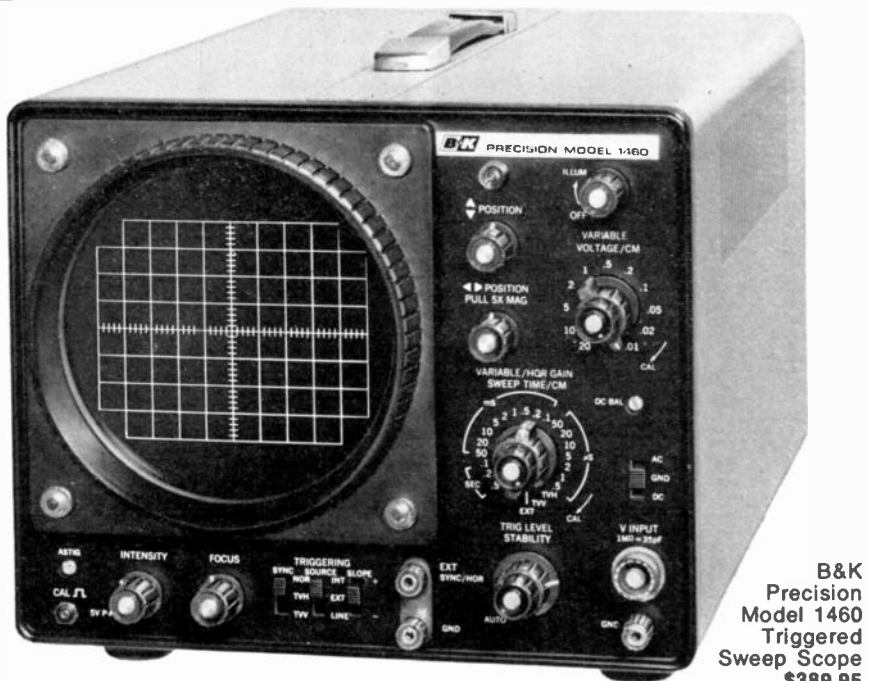

B&K Precision Model 1460 Triggered Sweep Scope \$389.95

**B & K Precision's new 1460 Triggered Sweep Scope...  
The one that's been worth waiting for.**

You won't believe how easy it is to sync TV-V and TV-H signals until you've actually tried it.

Trouble shooting complex TV circuits takes enough time without having to fiddle with dials and controls to adjust to the proper wave form.

That's why the new B&K Triggered Sweep Scope features the TV-H and TV-V positions. These are the two new positions you've always needed for quick one-knob selection of horizontal or vertical TV signals. Exclusive sync separator circuit. No complicated and time-consuming adjustments . . . just flick a single knob.

Fully automatic triggered sweep lets you view the entire complex TV signal or any part of it. Including the VITS (vertical interval test signal).

And the "back porch" of the horizontal sync pulse, with color burst information. All locked in rock steady.

All solid state with 6 FETS. Runs coolest. Vertical sensitivity (10mV/cm) and writing speed of 0.1 microsecond/cm (using 5X multiplier). Features usually found in expensive lab scopes. Complete with direct/10 to 1 probe. 19 sweep speeds and 11 voltage calibrated ranges, DC to 10 MHz.

Pinpoint your problems quickly and accurately with the new 1460 Triggered Sweep Scope. The only thing you'll have to adjust to is having more time on your hands. Ask your distributor or write for our free catalog.

There is a difference in test equipment—ours works!



Product of DYNASCAN CORPORATION  
1801 W. Belle Plaine / Chicago, Illinois 60613

Circle 10 on reader service card



# THE SANSUI QS-1 QUADPHONIC SYNTHESIZER®



**SANSUI QS-1**

## 4-CHANNEL SOUND FROM ANY 2-CHANNEL SOURCE Senses and recovers the ambient information hidden in your stereo discs, tapes and broadcasts

After having discovered that the ambient components of the original total sound field are already contained in hidden form, in conventional stereo records, tapes and broadcasts, Sansui engineers developed a method for sensing and recovering them. These subtle shifts and modulations, if re-introduced, breathtakingly recreate the total of the original sound as it existed in the recording or broadcast studio.

The heart of the Sansui Quadphonic Synthesizer\* is a combination of a unique reproducing matrix and a phase modulator. The matrix analyzes the 2-channel information to obtain separate direct and indirect components, then redistributes these signals into a sound field consisting of four distinct sources.

This type of phase modulation of the indirect components, applied to the additional speakers, adds another important element. It sets up a complex phase interference fringe in the listening room that duplicates the multiple indirect-wave effects of the original field. The result is parallel to what would be obtained by using an infinite number of microphones in the studio (M1 through Mn in the accompanying illustration) and reproducing them through a corresponding number of channels and speakers.

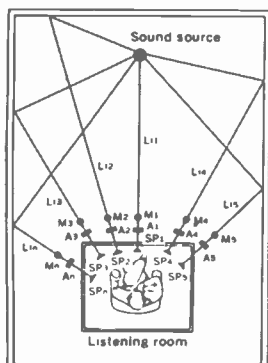
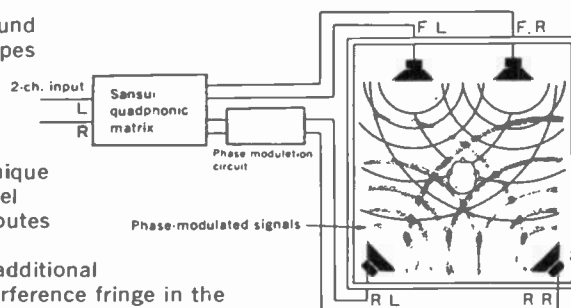

The startling, multidimensional effect goes beyond the four discrete sources used in conventional 4-channel stereo, actually enhancing the sense of spatial distribution and dramatically expanding the dynamic range. Also, the effect is evident anywhere in the listening room, not just in a limited area at the center. And that is exactly the effect obtained with live music! This phenomenon is one of the true tests of the Quadphonic system.

The Sansui Quadphonic Synthesizer QS-1 has been the talk of the recent high-fidelity shows at which it has been demonstrated throughout the country. You have to hear it yourself to believe it. And you can do that now at your Sansui dealer. Discover that you can hear four channels plus, today, with your present records and present stereo broadcasts. \$199.95.

\*Patents Pending



**SANSUI ELECTRONICS CORP.**

Woodside, New York • Gardena, California

SANSUI ELECTRIC CO., LTD., Tokyo, Japan • Frankfurt a M., West Germany  
Electronic Distributors (Canada), British Columbia

Circle 11 on reader service card

# EQUIPMENT REPORT

## Sencore SM-158 Speed Aligner

For manufacturer's literature, circle No. 21 on Reader Service Card.

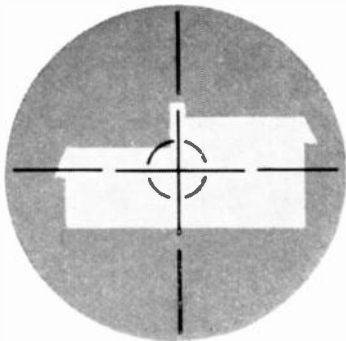

TONIGHT, YOUR  
PROPERTY COULD BE  
SOMEONE'S

# Target

PROTECT IT WITH  
DELTA ALERT!

Don't let unwanted visitors set their sights on your home or business. For total family and business safety get DeltAlert protection... before it's too late.

Enjoy new peace of mind with a reliable DeltAlert detection and alarm system. DeltAlert detects motion in 150 to 300 sq. ft. of critical space with a silent ultrasonic blanket... turning on lights automatically to drive away prowlers.

When the separate DeltaHorn is plugged into the DeltAlert unit, the intruder faces the additional obstacle of loud, ear-shattering noise. A built-in 20-second delay switch allows authorized persons to turn off the horn when entering the monitored area. The sturdy units, finished in handsome walnut veneer, are maintenance-free, economical and need no installation.

At home or work, proven economical security begins with DeltAlert alarm and detection protection.

DELTA ALERT  
10 3/8" x 3 1/4" h x 3 1/4" d  
\$69.95 ppd

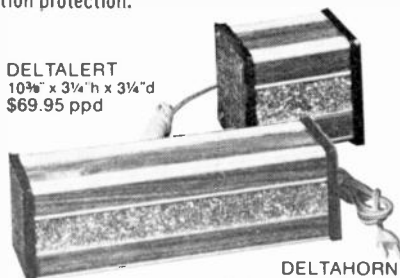

Made in U.S.A.

DELTA HORN  
3 1/4" w x 3 1/4" h x 3 1/4" d  
\$24.95 ppd

Order your DeltAlert Security System today!  
Superior Products At Sensible Prices



DP 70-26  
**DELTA PRODUCTS, INC.**

P.O. Box 1147 RE/Grand Junction, Colo. 81501  
(303) 242-9000

Please send me literature immediately:

Enclosed is \$ \_\_\_\_\_  Ship ppd.  Ship C.O.D.

Please send \_\_\_\_\_ DeltAlert(s) @ \$69.95 ppd.

Please send \_\_\_\_\_ DeltaHorn(s) @ \$24.95 ppd.

Name \_\_\_\_\_

Address \_\_\_\_\_

City/State \_\_\_\_\_ Zip \_\_\_\_\_

Circle 12 on reader service card

THE SENCORE SM-158 SPEED ALIGNER sweep and marker generator lives up to its name. It is a compact, easy-to-connect instrument and you can make those very important "Post-Repair Alignment checkup" tests in a very short time. You'll be surprised how much improvement can be made in the picture, color, etc., and how much happier your customers will be!

For the spec's., the SM-158 provides swept signals on i.f., rf and color frequencies: the last on a special "Chroma" setting for that all-important color-bandpass alignment test. This test can be made with the swept signal fed directly to the antenna terminals of the set. Saves the time needed to hunt up and connect to mixer test points.

Post-marker injection is used. Only the swept signal passes through the stages under alignment. All markers are added after the signal has been taken off at the set's video detector. So, there is no curve distortion due to the presence of marker frequencies. A maximum sweep of 15 MHz gives ample coverage for all circuits, rf or i.f.

The markers are generated by 8 crystal oscillators. These are on all of the key frequencies: pix carrier, sound carrier, the 3 color carriers, and those all-important, but too often overlooked ones, the 3 TRAP frequencies! The marker oscillators run on the i.f.'s: they will show up at the proper place on the curve, whether you're feeding the signal into the antenna or the i.f. The color markers will appear on the "color-slope" of the i.f. curve, during i.f. alignment. For the color-bandpass alignment, these are beat against a 45.75-MHz pix carrier and actually become the color carrier. 3.58 MHz, and the "band-limit" carriers at 3.08 and 4.08 MHz. This is done in the set's own video detector, so that the signal is actually processed exactly the same as a broadcast color signal.

The standard vertical marker pips can be used. By pulling out on the MARKER HEIGHT switch, they can be flipped to horizontal markers. These are often easier to see on steep slopes. Marker height can be adjusted to any height needed, without distorting the response curve.

For "speed alignment," only 3 connections are needed: rf matching pad to the antenna; direct probe to the video detector; and whatever bias is needed. The TV tuner can be set to channels 3, 4, 10 or 13 (this lets you check high-band and low-band re-

sponse of the tuner). By pushing buttons, the 45.75- and 42.17-MHz markers are displayed; the 41.25-MHz sound carrier can also be used. Set the fine-tuning until the 41.25-MHz marker is exactly in the "sound-notch" of the curve, and the other two markers should then be at the same height on opposite sides of the curve. If they're about 50% of maximum and the curve has a pretty good haystack shape, this set is in pretty good condition, at least as far as the tuner and i.f. are concerned.

For quick-checking the color bandpass, unhook the direct probe from the video detector and connect it to the output of the bandpass amplifier, using the detector connection. (Both in the same tiny box.) Incidentally, a good place for this is often on the COLOR control of the set. Check the schematic to make sure, though. By turning the switch to the "CHROMA" position, the color bandpass output curve will be displayed, with the three vital markers: the oscillator (3.58 MHz) and the band limit markers.

This test can give you key clues to the location of some previously very hard problems. If all markers are in their proper locations, you've eliminated the tuner and i.f. as possible causes of whatever picture-problems you have. In one actual case, while checking out the SM-158, we ran into a "picture good, but not good enough" symptom. (One of those 'Almost right but not quite' kind of things that bug us so often!)

Hooking the SM-158 up to the thing, we found the 45.75-MHz pix carrier nestling coyly about 20% up from the baseline of the curve! A quick twiddle of the input i.f. transformer on the tuner brought it up to its normal 50% height, and the picture was perfect.

In another, a "weak color" symptom was picked off with ease, by discovering a trap set to the wrong frequency, pulling the color markers too far down on the color-slope of the i.f. This reduced the amplitude of the color signals. Once again only a single adjustment, setting the trap to its proper frequency, brought the set back to very good performance.

To generate this "CHROMA" signal, a 45.75-MHz pix carrier is mixed with the three color markers in the set's own video detector. The overall shape of the bandpass output can be displayed, and any corrections needed

(continued on page 28)

# There is no substitute for training on real electronic equipment.

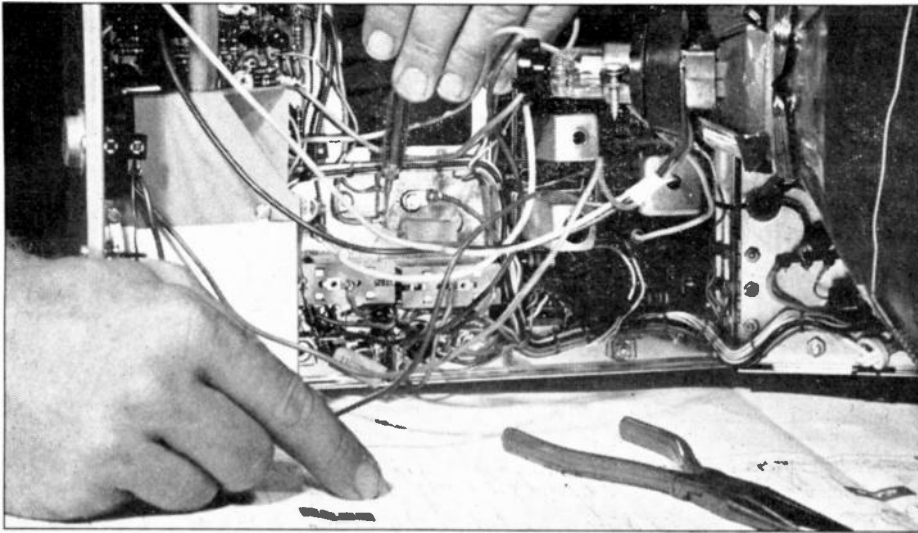

*It's just as easy to train on the type of equipment technicians actually use and service.*

*And it's a lot more practical. Take TV Servicing, for instance.*

*You'll have it all over the man whose only experience has been on a TV receiver designed strictly for training purposes.*

*NTS Project-Method courses in Electronics combine the latest, professional equipment with easy-to-grasp lessons, texts and manuals. You build your equipment a stage at a time, and then use the equipment on projects that duplicate actual servicing problems.*

*It's like getting on-the-job experience at home.*

*Here's just some of the equipment you get to keep, and what you will learn. You'll get all the details when you receive the NTS full-color catalog.*



Color TV  
295 sq. in.  
picture

## NTS COLOR AND B&W T.V. SERVICING

You receive a color TV with many unique features, including built-in self-servicing equipment so you can make all normal test operations. You also build an AM-SW radio, solid-state radio, F.E.T. Volt-Ohmmeter, and electronic tube tester. You learn trouble-shooting, hi-fi, multiplex systems, stereo and color TV servicing.

Solid-state  
B&W TV  
74 sq. in.  
picture  
(cabinet included)



The B&W TV receiver features the latest in solid-state circuitry, making your TV training the most modern, most advanced available.

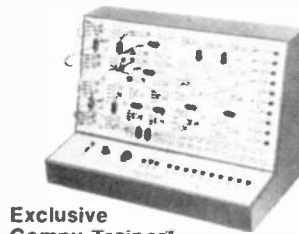

Exclusive  
Compu-Trainer™

## NTS ELECTRONIC & COMPUTER TECHNOLOGY

One of the 10 important kits included is this remarkable Compu-Trainer®—an NTS exclusive. It's a fully operational computer logic trainer—loaded with integrated circuits. It introduces you quickly to the how, what, and why of computers. You also receive a F.E.T. Volt-Ohmmeter and a 5" wide band oscilloscope.

Mail coupon today for free, full-color catalog that details every training program we offer. No obligation. No salesman will call.



5 watt AM  
transmitter  
receiver

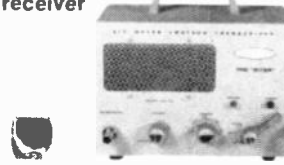

## NTS ELECTRONICS COMMUNICATIONS AND F.C.C.

Two exciting courses in the big-paying fields of transmitting and receiving. Either one qualifies you for your FCC First Class Radio-Telephone License. NTS assures you will pass this FCC exam within 6 months after successfully completing your course—or your tuition is refunded. You receive 14 kits to build an amateur phone 6 meter VHF transceiver plus NTS' exclusive 6 transistor solid-state radio and a fully transistorized volt-ohmmeter.

5"  
Oscilloscope

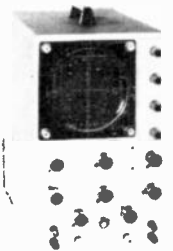

## NTS INDUSTRIAL & AUTOMATION ELECTRONICS

Let NTS put you into the age of electronic controls. Systems automation is rapidly becoming the emphasis of modern industry. NTS training equipment includes a 5" wide band oscilloscope. You also get the new exclusive NTS Electro-Lab—a complete workshop. Build five industrial controls to regulate motor speed temperatures, pressure, liquid level and much more.

Please rush Free Color Catalog and Sample Lesson, plus information on course checked below. No obligation. No salesman will call.

### National Technical Schools

4000 S. Figueroa St., Los Angeles, Calif. 90037

- |  |  |
|--|--|
| <input type="checkbox"/> Master Course in Color TV Servicing           | <input type="checkbox"/> Practical Radio Servicing               |
| <input type="checkbox"/> Color TV Servicing (For advanced Technicians) | <input type="checkbox"/> FCC License Course                      |
| <input type="checkbox"/> Master Course in B&W TV & Radio Servicing     | <input type="checkbox"/> Master Course in Electronics Technology |
| <input type="checkbox"/> Master Course in Electronics Communications   | <input type="checkbox"/> Industrial and Automation Electronics   |
|  | <input type="checkbox"/> Computer Electronics                    |
|  | <input type="checkbox"/> Basic Electronics Dept. 206-041         |

Name \_\_\_\_\_ Age \_\_\_\_\_

Address \_\_\_\_\_

City \_\_\_\_\_ State \_\_\_\_\_ Zip \_\_\_\_\_

- |   |   |
|---|---|
| <input type="checkbox"/> Check if interested in Veteran Training under new G.I. Bill. | <input type="checkbox"/> Check if interested only in Classroom Training at Los Angeles. |
|---|---|

## CLASSROOM TRAINING AT LOS ANGELES

You can take classroom training at Los Angeles in sunny Southern California. NTS occupies a city block with over a million dollars in facilities devoted exclusively to technical training. Check box in coupon.

## APPROVED FOR VETERANS

Accredited Member: National Association of Trade & Technical Schools; National Home Study Council.

## NATIONAL TECHNICAL SCHOOLS

World-wide training since 1905

4000 S. Figueroa St., Los Angeles, Calif. 90037

# If you design (or use) transistorized audio amplifiers

## ...check these Triad Transformers

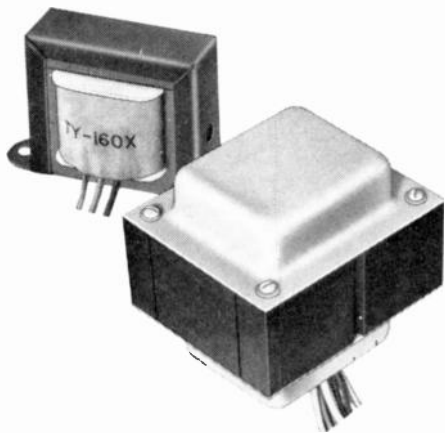

Developed specifically for Delco Radio, Triad's driver and power transformers help make maximum use of a minimum number of high-performance circuit components in 50- and 100-watt transistorized audio power amplifiers.

They're readily available now from your local Triad distributor... to speed your prototype work, to save shopping around for custom-made units, and to cut costs of special sampling.

The TY-160X driver, ideal for both 50- and 100-watt amplifiers, is a split-primary design with silicon steel core. It is constructed with an air gap between the E and I member for optimum signal linearity. Ratings are 50 mA DC primary current and primary inductance of 4 Hz at 10 mA DC.

An economical unit for 100-watt amplifier use, the Triad R-82B power transformer also has a laminated silicon steel core. A companion power transformer is also available for 50-watt design use.

See your distributor today... or send for more information on these and other Triad transformers designed to meet your specifications. Write: Triad Distributor Division, 305 N. Briant Street, Huntington, Indiana.

**Triad Distributor Division**  
of **Litton Industries**

Circle 13 on reader service card

# HOME APPLIANCE ELECTRONICS

by JACK DARR  
SERVICE EDITOR

## THE "SPEED CONTROL RESISTOR?"

A FRIEND AND I WERE LOOKING AT THE diagrams of some new appliances. Friend looks at something and says "SCR? Speed Control Resistor?"

I said, "No, but you're about as close as you could get and still be wrong. That's what it *does*, all right; but its real name is Silicon Controlled Rectifier.

"That sounds a little silly," says Friend. "You mean the rectifier is controlled by silicon?" And that's when the argument started. Since we're going to see quite a lot of these things in modern appliances, used for speed control, light dimmers, and even for switching, it'd be a good idea to try and work up a plain-language explanation of how they work.

Let's begin with a plain old silicon diode—yep, a rectifier. If we feed an ac voltage into it, we get half-wave rectification—one half-cycle of the ac voltage

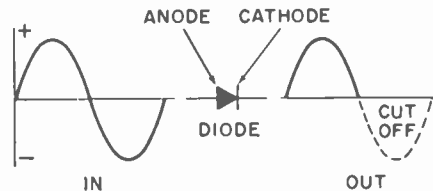

Fig. 1

is clipped off, as in Fig. 1. Since the power in an ac waveform includes both positive and negative half-cycles, the output would have only half of the input power.

If we wanted less than that, we could use a special type of diode; the SCR. The basic SCR is a single diode and works just like any other; *but—this one has a built-in switch*. It is called a "gate", and for good reason. When the gate is closed, the SCR will not conduct at all—in either direction. Fig. 2 shows what would happen if we "opened the gate"—connected a voltage to it so the SCR conducts at all times. This is called "turn-on".

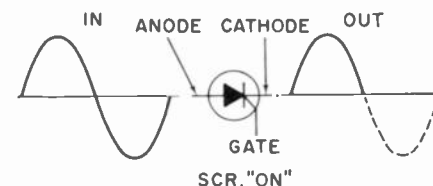

Fig. 2

So, a turned-on SCR works just like all diodes. Full-wave in, half-wave out. (Yes, I know it's dc!) If we want to use the gate as a power-output control, we add a trigger circuit, so that the gate

turns the SCR on at a given point during the positive half-cycle. Fig. 3 shows what we'd have if this was at the positive peak. There would be no current-flow at all until the point where the SCR turns on, and from there on the rest of

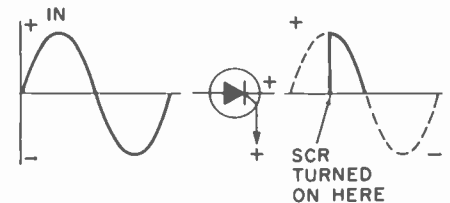

Fig. 3

the cycle would be of normal shape. In a circuit like this, we'd get about 1/4 of the total input power, since we've already clipped off a whole half-cycle.

This is fine (and is actually used in certain circuits such as battery chargers) but it's not too handy for such uses as speed control of electrical appliances with motors. So, we use a special SCR which is actually double; two SCR's connected in reverse parallel to form a Triac. Fig. 4 shows the symbol for this,

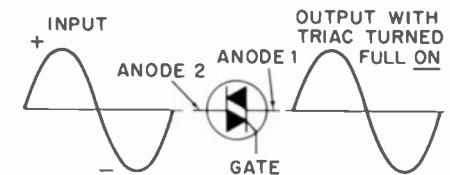

Fig. 4

and you can see the two diodes, one looking each way. This Triac also has a gate, which controls *both* diodes. Each one can be gated on when the applied polarity of the voltage is correct. In Fig. 4, the lower half of the Triac would conduct during the positive half-cycle, and the lower half during the negative half-cycle. (All diodes conduct when the anode is positive with respect to the cathode.) Fig. 4 shows what we'd have if the Triac were gated on at all times; the output is the same as the input.

To make this practical, we simply add a trigger circuit, which will vary the point where the Triac is gated on. So if we set the control to get half-speed, our output waveform would look something like Fig. 5. We're getting half of each input half-cycle in the output, and thus half the power.

(This is not precisely correct, but it's close enough to show how the thing works. Actually, since power depends on voltage *squared* divided by current, the

(continued on page 89)





# HOTTER THAN EVER!

## New Mark Ten B CD System With Exclusive VARI SPARK<sup>TM</sup> Circuitry.

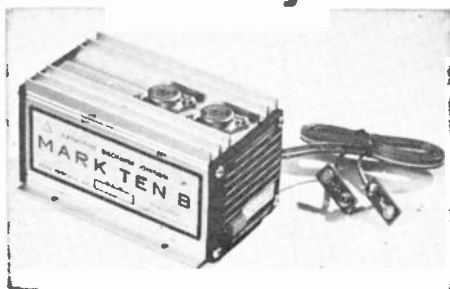

Delta, the world's oldest and largest manufacturer of Capacitive Discharge Ignition Systems, brings you the most dynamic improvement in ignition since the advent of the Kettering System.

By combining the new Vari Spark circuitry with the now famous Mark Ten system, Delta has formulated a new solid state ignition that drastically reduces combustion contaminants and restores power lost by the use of smog control devices. This completely sealed system, with handy switch for instant conversion, requires no rewiring—installs quickly. The Mark Ten B actually pays for itself in dollars saved.

#### Look At These Features:

- Eliminates 3 out of 4 tune-ups!
- Improves combustion, reducing contaminants.
- Installs in only 10 minutes.
- Instant starts in all weather.
- Dramatic increase in performance.
- Handy switch with redundant contacts for instant return to standard ignition.
- Two-piece housing with neoprene seals affording dust and moisture protection.
- Applicable to ANY 12-volt, negative-ground engine.

Mark Ten B Only **\$59<sup>95</sup>** ppd.  
(12v neg only)

Standard Mark Ten **\$44<sup>95</sup>**

"Delta Products, One Of America's  
Finest Names In Electronics"

Order today! DP 70-25

**DELTA PRODUCTS, INC.**

P.O. Box 1147 RE / Grand Junction, Colo. 81501  
(303) 242-9000

Please send me literature immediately:

Enclosed is \$ \_\_\_\_\_  Ship ppd.  Ship C.O.D.

Please send:

\_\_\_ Mark Ten B @ \$59.95

\_\_\_ Standard Mark Ten (Assembled) @ \$44.95

\_\_\_ 6 Volt: Neg. Ground Only \_\_\_ Positive Ground

\_\_\_ 12 Volt: Specify \_\_\_ Negative Ground

\_\_\_ Standard Mark Ten (Deltakit\*) @ \$29.95  
(12 Volt Positive Or Negative Ground Only)

Car Year \_\_\_\_\_ Make \_\_\_\_\_

Name \_\_\_\_\_

Address \_\_\_\_\_

City/State \_\_\_\_\_ Zip \_\_\_\_\_

Circle 12 on reader service card

### EQUIPMENT REPORT (continued from page 24)

can be made easily. (I.f. adjustments should ALWAYS be made first, of course, since this haystack curve is a composite of the i.f. color-slope response and the complementary slope of the color takeoff coil!) Color band-limit markers can be set to the specified positions, thus getting rid of those "color smear" and phase shift problems which can cause so much grief.

For sets specifying link alignment of the first i.f., such as RCA and others, the 39G26 Link-Loading and detector probe is used. This includes a voltage-quadrupler type detector, to give ample response with the very low level signals found here. Incidentally, all statements made previously will apply to tube or transistor, or hybrid sets. The same methods and connections are used.

The Sencore Sales and Engineering staff are working very hard to help technicians with alignment problems. They are holding "Alignment Workshops" at many places in the country, sponsored by local distributors. These

are limited to interested technicians, who want to perfect their techniques of finding and fixing alignment problems. The SM-158 is used, with actual i.f. boards from Admiral, Zenith and other color TV sets; actual i.f.'s from commercial chassis.

They have written up and worked out a very comprehensive "Workbook" showing each step in an actual alignment procedure. Each technician attending these meetings uses this, and then keeps it for future reference.

The SM-158 is all solid-state. No warmup is required; it's ready to go as soon as you turn it on. A MOSFET rf amplifier is used as an rf attenuator, and a FET constant current regulator avoids drift or variations in the output.

It's a very compact instrument, taking up very little room on the bench. Markers are pushbutton, color coded for fast identification. Controls have been kept to a minimum, and conveniently located. All probes, interconnecting cables, etc., are provided; all you need is a scope and a bias-box, and you're in business. **R-E**

## EQUIPMENT REPORT

### RCA WR-514A Sweep Chanalyst

For manufacturer's literature, circle No. 22 on Reader Service Card.

THE RCA WR-514A SWEEP CHANALYST is the "son" of a distinguished father. Some of us old timers' will remember the original RCA "Rider Chanalyst," the prototype of all of the signal-tracing instruments so popular at that time. Like father, like son; this one will do a great many things, and do them very well. So many things, in fact, that this short report will be able to give each one only a brief mention.

This is one of the new breed of sweep generators. Using the same reliable circuitry as its predecessor the WR-54, it also includes the post-marker adder, and a "Chroma Carrier Sweep" for setting up that most difficult of tuned stages, the chroma band-pass and takeoff coil. This one pretty little blue box thus holds three instruments: a WR-54 sweep generator, a WR-99 Marker generator, and a WR-70 Marker-Adder! (Not that it has the continuously-variable tuning nor wide range of the WR-99, but it does have all of the markers you'll need to do a fast and accurate job of sweep alignment on any make or model of color TV.)

Seven crystal-controlled markers are provided, any or all of which can be switched on simultaneously, to mark the vital areas of the response

curve: 41.25, 41.67, 42.17, and 42.67-MHz (these four are the "color-slope" markers so important in getting good color) 45.75 and 47.25 MHz. A separate 4.5-MHz marker crystal is also included; you'll see why soon.

The selector switch provides for rf sweep input on all 12 vhf channels. With this, the tuner can be checked on all channels, alone. A marker can be fed into the EXTERNAL MARKER jack for the picture carrier; by flipping the 4.5-MHz marker on, a beat will be generated exactly on the sound carrier frequency on all channels. This tuner output signal is read at the i.f. input; so, you get a positive check on rf, mixer and oscillator stages.

After the tuner is checked out, the i.f. curve can be displayed, by feeding the sweep signal to the mixer input. This will work on either tube or solid-state sets, or hybrids. The signal output is taken from the video detector, and fed through the post-marker adder circuit. By doing this, only the "pure" sweep signal passes through the i.f.'s. The markers are added after the signal has been detected, by a sampling circuit in the adder. So, the marker frequencies cannot cause undesirable beats on the curve, and

(continued on page 91)

# “Stop kidding yourself about your future in electronics.”

You've been working in electronics long enough to know the facts. Companies are more selective in hiring and promoting men now than ever before. The result: plenty of opportunities for men with good technical qualifications; almost none for those without them.

Make yourself one of the specialists who will enjoy good pay and excellent security in the years ahead. Supplement your experience with more education in electronics. You won't have to worry about automation or advances in technology putting you out of a job.

CREI Home Study Programs offer you a practical way to get more education without going back to school. You study at home, at your own pace, on your own schedule. And you study with the assurance that what you learn can be applied on the job immediately to make you worth more money to your employer.

You're eligible for a CREI Program if you work in electronics and have a high school education. Our FREE book gives complete information. Mail postpaid card for your copy today.

In-depth coverage of solid state electronics . . . including integrated circuits!

E1404B

## FREE BOOK

Please mail me FREE book describing CREI Home Study Programs. I am employed in electronics and have a high school education.

I am interested in:

- Electronic Engineering Technology
- Space Electronics
- Computers
- Nuclear Engineering Technology
- Industrial Electronics
- NEW! Electronics Systems Engineering
- NEW! Non-technical Course in Computer Programming



Name \_\_\_\_\_

Age \_\_\_\_\_

Address \_\_\_\_\_

City \_\_\_\_\_

State \_\_\_\_\_

Zip \_\_\_\_\_

Employed by \_\_\_\_\_

Type of Present Work \_\_\_\_\_

G.I. Bill

APPROVED FOR TRAINING UNDER NEW G.I. BILL



**“Stop kidding yourself about your future in electronics.”**



**Men without advanced technical education will find few opportunities in electronics in the years ahead. But industry will offer exciting work, good pay and excellent security to men who become specialists in these key areas:**

- Electronic Engineering Technology
- Aeronautical & Navigational
- Television
- Communications
- Nuclear Instrumentation & Control
- Missile & Spacecraft Guidance
- Radar & Sonar
- Nuclear Engineering Technology
- Automatic Control
- Industrial Electronics
- Computers
- Digital Communications
- Electronics Systems Engineering

Take the advice of men who know the electronics industry. Make yourself a specialist in one of the key areas of electronics. Then stop worrying about how cutbacks, layoffs and contract terminations will affect you and your family. If you have up-to-date specialized knowledge of electronics, you can look forward to security and excellent earnings when men with ordinary qualifications are let go.

But to become a specialist, you must supplement your experience in electronics with

more technical education. CREI Home Study Programs offer you an opportunity to get that additional education without going back to school.

You're eligible for a CREI Program if you work in electronics and have a high school education. Free book gives complete information. Mail postpaid card for your copy today.



APPROVED FOR TRAINING UNDER NEW G.I. BILL

FIRST CLASS  
Permit No. 288-R  
Washington, D.C.

**BUSINESS REPLY MAIL**  
No Postage Necessary If Mailed In The United States



**CREI, Continuing Education Division**  
McGraw-Hill, Inc.  
3224 Sixteenth Street, N.W.  
Washington, D.C. 20010

**Free book tells all about CREI programs. For your copy, tear out and mail postpaid card or write:**

CREI, Dept. E1404B,  
3224 16th St., N.W.  
Washington, D.C. 20010





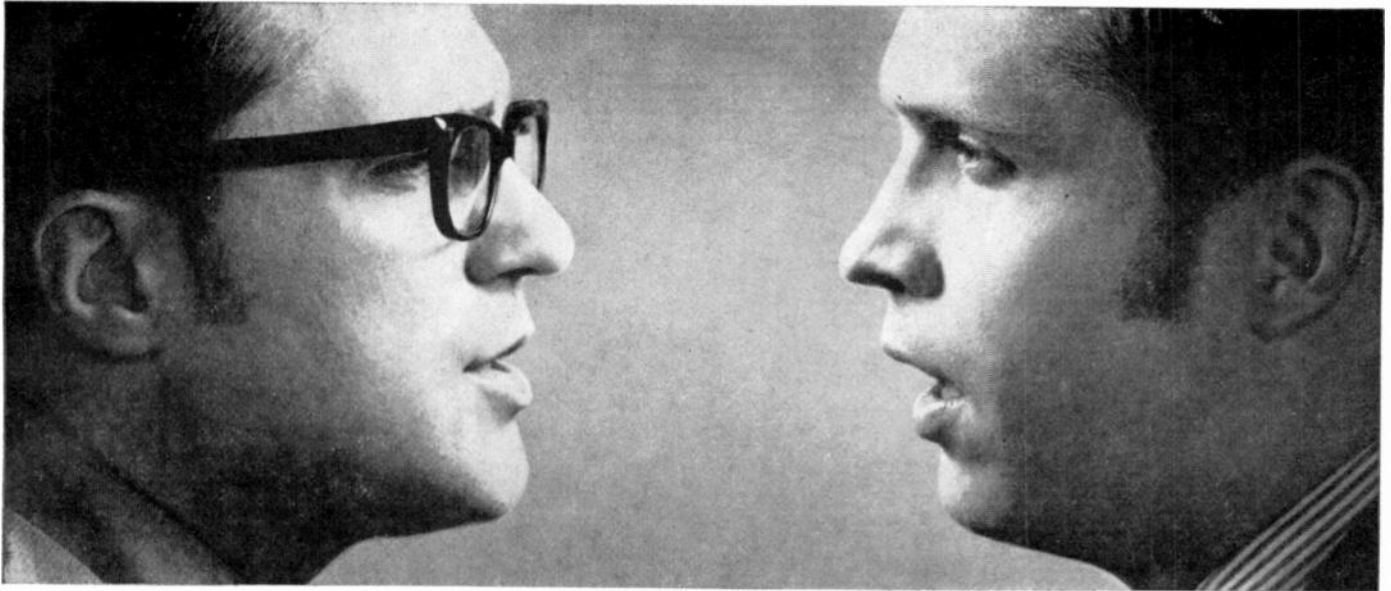

Why do you always use RCA SK Replacement Devices?

Because SK's are specifically designed and engineered for replacement use in home-entertainment equipment. RCA doesn't make SK types unless they're needed in the field and serve the professional.

Will I need a large inventory?

Not at all. Only 67 types cover a broad range of replacements in TV, hi-fi, and other entertainment equipment. It's the shortest line of product with the broadest range of replacement applications. That's just one of the reasons I like it.

What's another reason?

Quality — it's assured! SK's are tested with the finest dynamic testing equipment, operated by the same personnel who test other RCA power, signal, and IC devices. They're even tested again at the factory warehouse before shipment.

Are you saying RCA is the only source for reliable solid-state replacements?

No. But SK's are top quality, and the SK Replacement Guide is a truly reliable source for cross-reference information. RCA only cross references types where there is engineering assurance that the SK will do the job as well as, or better than, the original.

Seriously, is the SK Replacement Guide that great?

Better! It includes technical information on the line, plus a "Quick Selection Chart" which is unique in the industry. Now I can choose the proper SK replacement for almost every type made.

I'm sold! How can I go wrong with RCA SK's?

You can't. No one can!

**RCA**

RCA | Electronic Components | Harrison, N.J. 07029

# most wanted



Ungar's New,  
Feather-Light,  
Solid-State  
Solder Gun  
#6760

More pros are going after Ungar . . . and no wonder. It makes the others obsolete. The most advanced gun available for accurate, damage-free soldering of today's sophisticated circuitry.

Less than *five ounces light* . . . you get pinpoint accuracy without hand fatigue because advanced circuitry replaces the usual heavy transformer.

For safe, sure operation the gun is grounded with a 3 wire NEMA plug and cord. Now sensitive I.C.'s and densely packed components can be soldered with no stray currents or static damage.

You also get extra versatility — two heat ranges (500° and 900°F approx.) and your choice of three different thread-on tips that won't give or bend, day-in/day-out. And the tip locks to the exact job angle you need.

Exclusive bonuses? . . . Virtually shatterproof case, Ungar's guarantee of excellence, separately replaceable parts and it's U.L. listed.

Capture the finest solder gun yet and cash in on the rewards. It's at your nearest Ungar distributor now. Prove for yourself that in the age of solid-state Ungar *really* outguns the heavyweights. A Division of Eldon Industries, Inc.

**Ungar®**

Circle 15 on reader service card

# WHAT'S NEW IN CAR ELECTRONICS

by **FRED W. HOLDER**

SINCE 1952 WHEN GENERAL MOTOR'S GUIDE LAMP DIVISION introduced the vacuum tube headlamp dimmer, electronics has played an increasingly important role in the automobile. Its use has skyrocketed as the size and cost of electronic components came down. Today's political issues of pollution and safety will further increase the electronic sophistication of our autos during the 70's, say the experts.

Want to know where we are today? Read this *encyclopedia of automotive electronics* and find out! All the items listed are available as factory-installed equipment. All items are not available on any one car, however, but do present an accurate listing of what the car manufacturer is doing.

## **Alternator**

The alternator, itself, is not an electronic item. It does, however, use high-current, small-size, solid-state diodes from the electronic industry to rectify its alternating current output. Also, Motorola claims exclusive use of silicon diodes in place of the electro-mechanical isolation relay used with most alternator systems. Their isolation diode

assembly provides a solid-state device to illuminate the "tell-tale" warning light. An added benefit was the use of less current to excite the magnetic field of the alternator during starting operations.

## **Antenna**

The auto radio antenna has long been a problem. When fully extended, it may drag on the garage overhead and it is often bent or broken off. These problems were eliminated in 1969, at least on the Pontiac Grand Prix, when the radio antenna was encased in the windshield. Their antenna is always extended full length for maximum radio reception and it can't be bent or broken off.

## **Backlite defroster**

The backlite (rear window) defroster, an option on several Ford models, melts snow and ice to help keep the rear window frost-free. The heating unit is a silver-filled, ceramic, high-resistance, printed circuit. It is silk-screened onto the inside of the backlite. The switch for the unit is integrated with the heater controls on the instrument panel



## ***On the cover***

### **Fuel injection**

Electronic Fuel Injection (EFI) was first introduced in the United States on the 1968 Volkswagen fast-back and square-back models. The VW system was developed by Robert Bosch of Germany under Bendix patents. Although it's used widely on VW, Volvo, Saab, Citroen, Mercedes Benz, and Porsche, EFI has not yet been adopted by any of the U.S. auto makers. Experts, however, predict it will come into use within the next few years to meet emission control requirements. Several suppliers are working to develop EFI systems for American cars; Bendix claims theirs is ready to use.

EFI uses a computer, or control unit, to monitor engine operating conditions and determine the exact amount of fuel the engine needs at any given time. The primary controlling factors are manifold pressure and engine speed. The computer also monitors engine temperature, throttle position, and the starting circuit and modifies the information gathered on speed and manifold pressure. It generates an electronic pulse to open the injectors and spray a specific amount of raw fuel ahead of the intake valve. Developed as an emission control device, the system gave the added benefits of increased performance and economy.

# 24 aids for comfort and safety

and incorporates a reminder light to indicate when the unit is "on."

### Brakes

Electronic, anti-skid braking systems were first used as an optional item on the 1969 Thunderbird and Continental Mark III. The Sure-Track system, used by Ford Motor Company, was developed by Kelsey-Hayes. It's now standard equipment on the Mark III. Of course, other suppliers have anti-skid systems or are working to develop them. Bendix has adaptive braking for heavy-duty trucks and on one line of automobiles. Borg-Warner has a system for trucks and tractor trailers.

A skilled driver may simulate the action of anti-skid brakes by rapidly pumping the brake pedal during panic stops. He simply can't duplicate the high-speed action of the electronic control circuits used in these systems. The Ford system monitors the speed of the rear wheels and keeps the wheel brakes applied at the most effective torque without allowing the brakes to lock. The car stops straight

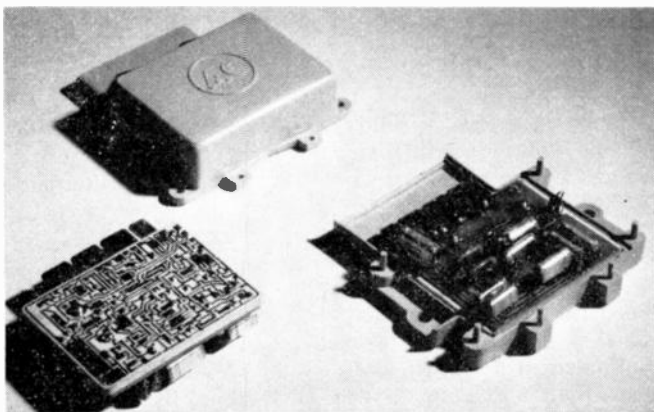

**ADJUNCT TO BRAKING IS ANTI-SPIN ACCELERATION** unit made by AC Spark Plug for Cadillac. Electronic assembly shown here monitors and compares rotational speed of front and rear wheels. When rear wheels start to turn faster than front wheels, the computer reduces engine speed to optimize torque at the rear wheels.

without skidding. This was, by the way, the goal of the system. An added benefit was shorter stops.

The Ford system has sensors at each rear wheel to provide electronic speed signals to a small electronic computer. The computer compares the signals to a pre-determined program and determines the optimum braking cycle. It, in turn, signals the vacuum-powered brake actuator to regulate the pressure of brake fluid at the rear wheels. During panic stops, the pressure is cycled on and off rapidly, up to five times a second: pretty fast for a beginner.

### Burglar alarm

One of the best ways to reduce the chances of having your car stolen, especially if you own an expensive or high-performance car, is to make sure you get a burglar alarm. Most of these devices are set up to trigger a siren under the hood if any of the doors, trunk or hood are opened; and to sound an alarm if someone tries to start the car.

### Delayed headlamp turn off

A new headlamp turn-off time delay was introduced as an option item for 1970 General Motors cars. The new electronic device was developed by Guide Lamp Division of General Motors. It keeps the headlights on for approximately 90 seconds after headlamp and ignition switches are turned off.

### Distributor modulator

In 1970 Ford introduced a new electronic distributor modulator to help control engine hydrocarbon emissions.

The modulator electronically prevents spark advance at speeds below 23 mph on acceleration and below 18 mph on deceleration. A temperature-sensitive, thermal switch deactivates the unit when outside temperatures drop below 58° F; the distributor then operates under normal vacuum advance control. The distributor modulator system is composed of four parts: (1) a speed sensor, (2) an electronic control amplifier, (3) a thermal switch, and (4) a three-way valve.

The control amplifier and solenoid assembly are mounted inside the passenger compartment on the dash panel. The speed sensor connects to the speedometer cable. The thermal switch is mounted near the front door hinge pillar on the outside of the cowl. The three-way valve, of course, connects into the distributor vacuum line.

### Environment control

Environment control through the use of heater and air conditioner have been with us for many years. Some of the newer systems available on the larger cars are a bit more sophisticated, however. In these systems, electronic controls



**FOUR-SEASON CLIMATE CONTROL** is directed by electronic sensors. Thermistors read internal temperatures and direct switching and blending of heater and air-conditioner outputs.

monitor the temperature inside the car and control the heater and air conditioner to maintain the desired temperature. One system, manufactured by Bendix, cools and then reheats outside air (above 40 degrees) to the proper temperature before it enters the car. The blower speed is automatically adjusted in five steps to meet cooling or heating needs. The duct doors are automatically shifted to direct cooling air into the car through the upper registers and warming air onto the floor through the heater outlets. When maximum cooling is needed, the outside vents are shut off and the air inside the car is recirculated.

### Guide-Matic

The Guide-Matic is an automatic headlamp beam selector, dimming lights automatically at the approach of another car and then returning them to bright when the traffic has passed. Developed by the Guide Lamp Division of General Motors, it is available as an option on a number of cars: Guide-Matic is sold to all auto makers and is available on top lines of the Big Three. The device was first used on 1952 Oldsmobiles and Cadillacs. At that time, it was called Autronic-Eye. The name has since been changed to Guide-Matic with the introduction of an improved, smaller design on 1960 model GM cars. In 1967, an improved solid-state design was introduced. The design has remained basically the same since that time. Usually, the sensor is on the hood; however, on some models it is located in the grill.

### Headlamp on-off device

The Twilight Sentinel was first introduced as an option for 1960 Buick models; it has since become available on several other cars. Developed and manufactured by Guide Lamp Division of General Motors, the device elec-



tronically turns on the lights at dusk and off at dawn. It has an adjustable feature to keep lights on for up to about three minutes at night if the ignition is turned off first. A back-up lamp option is available with the time delay circuits.

In the Twilight Sentinel, a photocell senses the light level and, at a preset level of light, turns on a transistor energizing a relay. This relay energizes a power relay; thus, supplying power to the headlights and taillights. When the headlight switch is turned off, after the ignition switch, current is supplied from the taillight circuit to the electronics so that the headlights stay on. A second transistor, which is normally biased off by a charged capacitor, will come into action and shut down the circuit when the capacitor has discharged. By adjusting the time constant of the RC network in the base circuit of this second transistor, the amount of time delay can be set to meet the needs of the individual owner.

A construction article that details how you can build your own version of this device appears on page 46 of this issue.

### Ignition

Transistorized ignition first became available as an option on the 1963 Ford models. A breakerless, transistorized ignition system was available on the 1964 GM models. In both of these systems, current was supplied through power transistors to the primary winding of the ignition coil. A signal from the distributor turns the transistors off, allowing the field of the coil to collapse. The result is a high voltage induced in the secondary winding of the coil to drive the spark plug.

General Motors later introduced their capacitance-discharge (C-D) ignition system as a factory option on the 1967 Pontiac and Oldsmobile. This system, manufactured by Delco-Remy, discharges a high voltage (300 volts) charge stored in a capacitor through the primary winding of the ignition coil and a triggered thyristor. The thyristor is triggered by a magnetic velocity pickup in the distributor. This system has significant advantages over the transistorized systems in that it produces higher peak voltages of shorter time duration and does not distort the waveform as speed increases.

### Ignition key alert

That's the buzzer that sounds when you open the car door and have forgotten to remove the ignition key. A simple pressure switch and buzzer do the work, but it sure makes it difficult to leave your keys in the car.

### Intermittent windshield wipers

The Ford intermittent windshield wipers permit a driver to adjust the wiper cycle to provide an electronically timed pause between each cycle. The length of the pause may be adjusted from two to ten seconds as needed to meet the car's speed, the traffic conditions, and the amount of precipitation. During acceleration, the time delay is bypassed to provide continuous high-speed wiper operation. Regular two-speed operation may also be selected by the driver.

### Low fuel alarm

A blinking light and buzzer set off when the fuel in your tank drops below the one- or two-gallon mark. Leaves you enough time to get to the next station. If you want to build one of these units for your existing car see the article starting on page 44.

### Radio

Today's AM/FM/multiplex, solid-state radio is a far cry from the old vacuum tube AM radio first introduced in the automobile. Delco, Bendix and Motorola supply large quantities of these ultra-modern solid-state radios to auto-makers all over the world.

### Rpm limiter

To protect their high performance Boss 302 4V engine during momentary "over rev" when a shift point is missed during rapid acceleration, Ford introduced a solid-state counting circuit that acts as an engine governor.

### Sequential turn signals

Sequential turn signals were originally electro-mechanical with an electric motor, gear train, and switching circuit. Subsequently, they were constructed from discrete, solid-state components and switching was accomplished

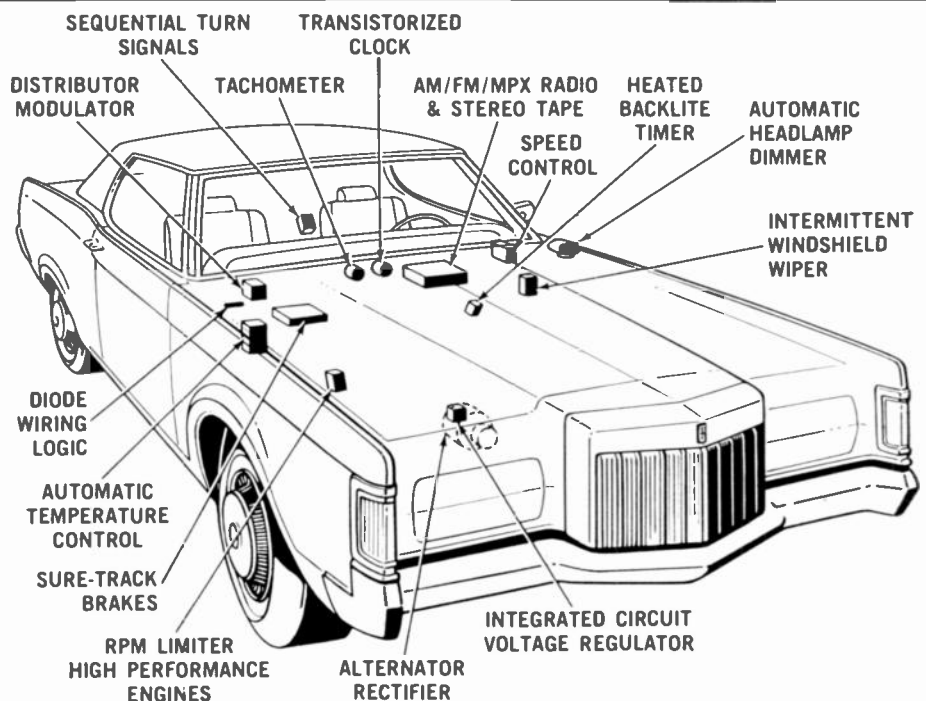

**THESE ELECTRONIC DEVICES** are available in cars made by the Ford Motor Company. Not all of these units shown are available on any one car, but represent the total electronics for cars that is available. One of these days, perhaps all this gear plus automatic guidance and anti-collision devices will be available in all models of all cars.

electronically. They are currently used on the Cougar and Thunderbird of the Ford line.

### Speed control

Automatic speed control systems have been available as electrovacuum systems for several years. In 1969, Ford offered an electronic automatic speed control system on the Ford and Mercury automobiles. This system, developed by the Bendix Automotive Electronics Division, uses a simplified computer to monitor and control the speed of the vehicle. The computer receives operator commands from the steering wheel controls and the brake switch, speed data from a tiny sensor connected to the speedometer cable, and throttle position data from a potentiometer connected to the throttle linkage.

When the desired speed is reached, the driver pushes a button and the computer takes over. The system will then maintain that speed until the brake pedal is pressed or the driver turns the system off. The driver may also command the system to accelerate or decelerate without applying his foot to the accelerator pedal or to the brake. A safety feature built into the system causes it to release control of the accelerator pedal if the speed difference between that ordered and the actual vehicle speed becomes too great; a condition occurring during braking.

### Tachometer

Electronic tachometers have been available for several years; they are generally furnished as an optional item. Two general types of triggering are used: ignition and alternator. The alternator type tachometer is primarily used for diesel and industrial applications, whereas the ignition type is used for passenger cars and gasoline vehicles. Various types of circuits may be used, but in most cases, the electrical pulse, used to trigger the device, is converted to a standard width pulse and used to drive an ammeter. The reading on the tachometer is then the average current flowing through the ammeter and, therefore, a measure of the engine speed.

### Tape stereo

According to a *Billboard Report*, July 19, 1969, Ford introduced the cartridge Stereo-8 tape system on their 1965 models. When Ford and Motorola teamed their efforts, they turned Ford's major 1966 models into stereophonic sound chambers. This "touched off one of the most



**STEREO TAPE** is an option on General Motors and other cars. In the dash mounting combines a radio and tape player in the same space originally filled by the radio alone.

exciting things to happen in the (stereo) business in a decade," according to Irving Tarr, RCA Victor's vice president of recording tape marketing. These systems are now offered on most, if not all, American-built car lines. They are all solid-state and, in some cases, contain integrated circuits. This year, cassette players with a record function became available and 4-channel cartridge units are coming.

### Throttle positioner

Ford introduced a solenoid throttle positioner in their

1970 product line. This device, supplied as a part of the carburetor assembly, provides for more powertrain applications. It decreases the idle rpm setting to prevent "dieseling" on shutdown. It increases the idle rpm setting, when the ignition is on, to reduce hydrocarbon emissions.

### Voltage regulators

The first electronic voltage regulator was used on American Motors cars in 1963. This was a transistorized model manufactured by Motorola. The main advantage of the solid-state regulator over previous regulators is their nonmechanical switching of the alternator's field current supply. Actually, the transistorized regulator is nothing more than an electronically-controlled, solid-state switch.

One of the first applications of microcircuits to the automobile was integration of the voltage regulator and the alternator. The integrated circuit (IC) voltage regulator offers many advantages over previous discrete component regulators. For example, they have an operational life of well over 100,000 miles, they simplify the car's electrical system wiring, they reduce system complexity, and they are impervious to all normal environmental hazards. The IC regulators are encased in thermosetting material with the rear surface left bare to contact the alternator case. The alternator case acts as a heat sink.

### X-amplifies of the future

The systems we've cited here are only the beginning. For example, Ford is currently testing Automatic Headway Control (AHC) and Minigap systems. AHC directs an invisible beam at the car ahead. Tail lights of the car ahead



**DIAGNOSTIC CONSOLE** feeds car performance characteristics into a computer at this Cadillac center in Brooklyn, N. Y. The computer compares operation with preset specifications and prints out a complete report. New BMW cars rolling off the line include built-in transducers connected to a jack positioned under the hood. Drive into a diagnostic center, plug in the tester and minutes later you find out how well your car is performing.

reflect the beam back to the receiver. A computer "reads" the signal and adjusts brakes and accelerator automatically to maintain a safe, pre-set following distance. Minigap, on the other hand, electronically links a number of cars into a highway caravan led by a specially built leader vehicle. Computers in the cars will take over control of brakes, accelerator, and steering. The motorist is freed from the driving task while he is "hooked up." What's more, these fast-moving caravans will be able to mix in the traffic flow with other vehicles.

These systems are still a few years into the future. Not so far away, however, are electronically controlled automatic transmissions, which Robert Bosch has in the works, and central computers to control and monitor your car's performance. So, get out your tool box and stand by to cash in on the automotive electronic boom! **R-E**

by LARRY ALLEN

# STEREO CASSETTES

## the mechanical side

Just read each easily digested frame of information. Then test your grasp of it by answering a multiple-choice question. If you choose correctly, you're guided automatically

to the next program capsule. If you miss, don't worry; programed extra information helps you to the correct answer.

With millions of cassettes around, there's inevitably thousands to be repaired. At least half—probably more—of those repair jobs will be mechanical. If you expect to share in the profits without a lot of aggravation, better bone up on what goes on inside the little machines.

There aren't many operations, even in a player/recorder. There are fewer in a play-only unit. If an AM/FM radio is part of it, there's a tiny bit of extra switching. But that's electronic, not mechanical.

You may already be familiar with the cassette cartridge. You can see it in Fig. 1. A 1/4-inch tape run between two reels inside the plastic case. The reel hubs have sprocket teeth so the reels can be driven without slippage.

At the front, three large square openings give access to the tape. The opening in the middle is where the record/playback head presses against the tape. There's a small felt pressure pad behind the tape.

The other two large square holes swap functions when the cartridge is flipped over. The one at the left gives access to the erase head in machines that record; the other accepts the pressure roller that holds the tape against the drive capstan.

Notice the four small round holes near the front edge (top view). The two center ones are positioning guides. The capstan shaft fits up through whichever of the outer holes is behind the opening into which the pressure roller fits. That places the capstan shaft behind the tape, so it can be pinched between capstan and pressure roller. Flip the cartridge over and the other outer hole takes the capstan, and the other square opening accepts the pressure roller.

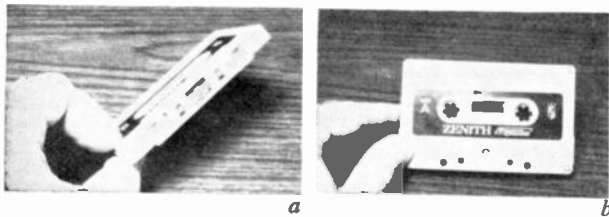

**FIG. 1—TYPICAL BLANK CASSETTE.** Guide holes near front hold it in position in the machine.

**Question:** If the tape in Fig. 1-b is moving from left to right as you're looking at it, into which square hole does the erase head fit?

- The left. Check your answer in Frame 11.
- The right. Frame 20 tells if you're correct.
- The center. Find out for sure in Frame 26.

3

Yes, that's what moves the cartridge-lift mechanism. The button pushes the slide backward and a lever lifts up one end of the arm. That shoves the front edge of the cartridge upward and you lift it out of the well. Proceed now to Frame 28.

4

Another nonsense answer. You might push down the PLAY button with your left index finger, but the finger doesn't transmit the motion of the PLAY button to the head-assembly plate. Reread Frame 28.

5

Negative. Wrong answer. The below-deck drive belt gets involved, but not in changing the direction of rotation. Go back to Frame 14 and try again.

6

Next I'll explain the drive system. The motor is dc, and power is applied through a switch the PLAY button turns on. (In some play-only machines, the motor is turned on by a Microswitch that is closed by the cartridge snapping into position.)

Beneath the deck, a rubber drive belt fits around a pulley on the motor shaft. The motor pulley is at the left in photo a of Fig. 5. The drive belt goes around a large, heavy flywheel (at the right).

Beside where the pencil is pointing in photo a, the drive belt also passes over a white plastic pulley wheel. When the PLAY button is pressed, this idler tightens the drive belt. It also has another purpose, explained later.

The heavy flywheel has a shaft poking through the deck to the top. That's the capstan. You can see it and the pressure roller in photo (b) of Fig. 5. The head-assembly plate is back in the STOP position. The pressure roller is mounted on the plate, so it's away from the capstan shaft.

Remember, the capstan fits up through a hole in the cartridge (explained in Frame 1). So, if there were a tape in photo b here, it would fit between the capstan and the pressure roller. When the PLAY button is pushed down, the head-assembly plate moves the pressure roller out against the capstan, as in photo c. With the motor running, a tape would be pulled along.

One finger in photo c is pointing to a shaft that comes from that white idler pulley in photo a. When the head-assembly plate moves forward, a notch at its corner moves that idler pulley. Its shaft, extending above-deck, is pushed over against the rubber rim of the takeup spindle. As it turns, it keeps the tape that's pulled by the capstan/pressure-roller wound up on the takeup reel.

When the STOP button is punched, the tape should

2 Not so. There's plenty of information to help you get the right answer to this question. Just reread Frame 21.

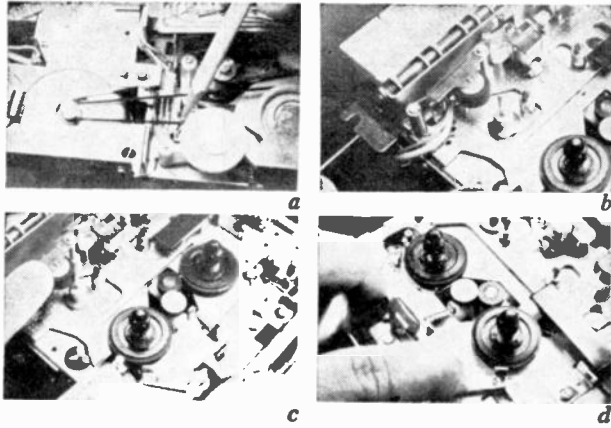

**FIG. 5—DRIVE SYSTEM** on one cassette machine. (a) MOTOR PULLEY, idler, and flywheel are connected by drive belt. (b) CAPSTAN IS FLYWHEEL SHAFT, and pressure roller is on head-assembly plate. (c) HEAD ASSEMBLY pulls pressure roller against capstan and takeup-drive shaft against takeup spindle. (d) BRAKES are spring-loaded.

stop instantly. To do that, a spring-loaded brake bar is allowed to come over against the rubber rims of both the takeup and the rewind spindle. The brake bar, with its brake shoes at the ends, is shown in photo *d* of Fig. 5.

**Question:** What does the white idler pulley in photo *a* of Fig. 5 do besides tighten the drive belt?

- Tightens the capstan pressure for tape movement. Go to Frame 23 to check your answer.
- Keeps the rewind spindle away from the pressure roller during playback. Check Frame 16 to see if this is right.
- Drives the takeup reel during recording and playback. Read Frame 14 before you go on.

**7** Not a chance. You must have missed at least one whole paragraph of Frame 17. It would be a good idea to go back and read the entire frame.

**8** Partly. That would be a mixed-up cassette. You'd be able to record on one side and not on the other. That's probably not what you want, so go back and read Frame 24 and learn what's right.

**9** Sure. Just slip the rear edge back against the tension spring and then snap the front edge down tightly. That was easy, wasn't it?

Getting the cassette back out could be a fingernail-breaker. But almost every machine includes a cassette

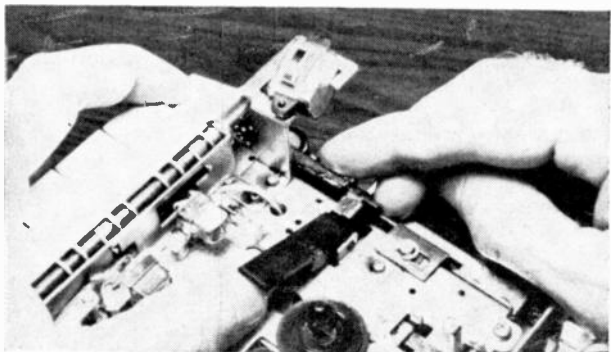

**FIG. 3—LIFTER BAR FLIPS UP** front edge of cassette, actuated by button on control panel of machine.

flipout button. On some it's a little round plunger-type button. On others, particularly the kind that records as well as plays, it's just another in the array of buttons on the control panel of the machine.

How one version works is illustrated in Fig. 3. The left hand in the picture has one finger on the "cassette up" button; it's at the end of the row.

The button moves a metal slide located along the side of the machine. The right hand is pointing it out. The slide works a lever that raises the black plastic lifter bar being held up by the left thumb. The lifter bar pushes up the front edge of the cassette so you can get hold to lift it out. In some machines, the lifter bar is so active it literally flips the cassette clear out of the well.

**Question:** How is the motion of the "cassette eject" button transferred to the lifter tab?

- By the thumb of the right hand. See Frame 22.
- By a metal slide. Look at Frame 3.
- By a rubber drive belt. Check Frame 15.

**10** That's 100 percent correct. A blank cartridge has the holes still covered, to disable the anti-record lockout. A prerecorded cartridge has holes; the lever falls into one of them and keeps the RECORD slide blocked. And, guess what . . . you've just finished this mini-course. R-E

**11** That's right. You're off to a good start. The tape must pass over the erase head before it reaches the record/playback head in the center position. Also, the pressure roller and capstan must pull, not push, the tape. Therefore they have to be in the right-hand hole if the tape is moving from the left to right.

Since the tape moves from left to right, the left-hand reel inside the cassette is considered the supply reel and the right-hand reel is considered the takeup reel. Once you flip the cassette over to play (or record) the other side or track, the reels have exchanged positions. The tape, again, unwinds from the left reel and is taken up by the right.

Okay, with that in mind, move on to Frame 21.

**12** Wrong. There are no plastic drive wheels involved with the head-assembly plate. You'd best read the paragraphs of Frame 28 again.

**13** That's right. You're moving along well now. Keep going and you'll be able to handle any kind of cassette repair that comes along. The next frame to read is Frame 24.

**14** You got that right. You understand the drive operation of cassette machines. Now for the fast-speed drives. They're pretty simple.

The flywheel in this machine has a rubber drive rim. It spins the white drive pulley you see beside the pencil in photo *a* of Fig. 6. The pulley drives the belt (held up by the pencil) which turns a fast-speed drive spindle. That spindle, as you can see if you look closely in photo *a*, is on a movable lever arm.

Now take a look at photo *b*. There are two wheels in the space between the takeup and rewind spindles. The metal one (to the left) is on the same shaft as the fast-speed drive spindle you saw below-decks in photo *a*.

When the FAST FORWARD button is held down, this above-deck fast-speed drive wheel is pulled over against the rubber rim of the takeup spindle (photo *c*). If the motor is on, the wheel drives the takeup spindle at high speed. The tape is pulled through very rapidly and wound up on the takeup reel in the cassette. (The brakes are moved back by the same action of the FAST FORWARD



button. The head-assembly stays in its STOP position.)

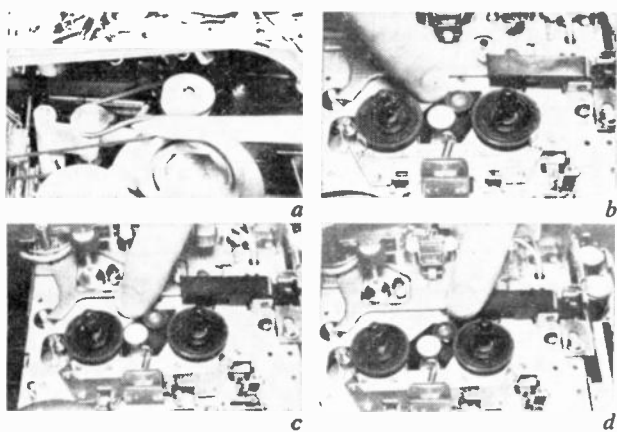

**FIG. 6—FAST-SPEED DRIVE SYSTEM. (a) RUNS OFF OF FLYWHEEL, by friction, and drives a wheel through a belt. (b) METAL WHEEL is on same shaft as belt-driven wheel in A. (c) DRIVE WHEEL against takeup spindle. (d) REVERSING WHEEL against rewind spindle.**

When the REWIND button is held down, the fast-speed drive wheel is pulled over against a fast-speed idler (photo *d*). That, in turn, is pressed against the supply spindle rim. The idler changes the direction of rotation. The tape is pulled through backward, very rapidly, and wound up on the supply reel in the cartridge. (Again, the brakes are pulled back, but the heads stay in their resting position.)

**Question:** How is motion of the fast-speed drive wheel reversed for driving the rewind spindle?

- By an extra idler between the fast-drive wheel and the rewind spindle. **Skip to Frame 17.**
- By a drive belt below-deck. **Turn to Frame 5.**
- By a drive belt above-deck. **Move to Frame 27.**

**Nope.** There's nothing even remotely resembling a drive belt operating the cartridge liftout device. All you really have to do is closely inspect the photo in Frame 9 and you can see the coupling mechanism. Do that, and if you have to, reread the explanation.

**That's awfully wrong,** and kinda mixed up as well. If you picked this answer out of anything but curiosity, start over reading Frame 6. The answer is somewhere in that frame.

**Yes.** The fast-speed drive wheel is pushed against a reversing idler wheel which presses against the supply spindle. To get fast forward, the fast-speed drive wheel itself is pushed against the takeup spindle.

You may be wondering about the pushbuttons that get all these different mechanical operations going. You've got glimpses of the buttons in other photos. The mechanism by which they transmit their motion when you push them is pictured in Fig. 7.

The buttons push metal slides that move back and operate the mechanisms. In photo *a*, the pencil is pointing to the PLAY slide. It moves back only when the PLAY button is pushed. To the right of it, you can see the RECORD slide. It and the PLAY slide go back together for recording. You can also see the holder on the RECORD slide which moves the Record/Play function switch; it's about halfway back along the slide (the switch handle fits into the holder).

In photo *b*, the pencil is pointing to the REWIND slide. To the left of it is the FAST FORWARD slide. The little

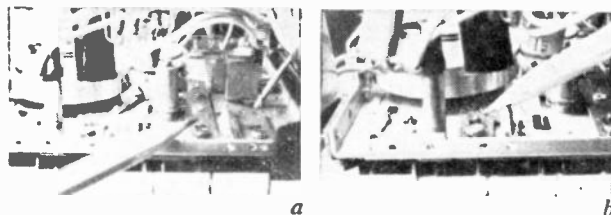

**FIG. 7—THESE SLIDES CONVERT PUSHBUTTON motion into mechanical changes that produce each operation.**

tab to the right is the STOP release: when the STOP button is punched, the tab releases all the slides.

**Question:** How are the amplifier, heads, etc., switched from playback to record?

- By a switch mounted on the side of the machine and operated by a drive belt. **Read Frame 7.**
- By a switch mounted on the circuit board, the handle of which is moved by a holder on the RECORD slide. **Check Frame 13.**
- By a slide that runs from the RECORD button to the PLAY button. **Proceed to Frame 25.**

**No, that's not the one.** Take another look at the pictures and read the text of Frame 24. It's important for you to know what to expect from which cartridge.

**That's right.** You're reading carefully, and getting the explanations. Hurry right along backward to Frame 6 for some more.

**No. Too bad . . . missing the first question.** But you can figure it out if you stop to think about whether the tape must be erased before or after it passes over the recording head. That's a clue that should let you go back and pick the right answer in Frame 1.

You'd probably figure it out, but I'll show you how the cassette fits into a machine. If it's not inserted right, the machine won't play (or record). The photos in Fig. 2 show how and where and why.

The back edge of the cassette goes into the machine first. It has to push against a spring at the rear of the cassette-well. You can see the spring in photo *b*. It holds

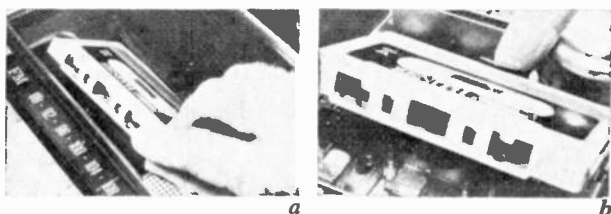

**FIG. 2—CASSETTE FITS INTO WELL back-edge-first, pushing against tension spring that holds it firmly forward after the front is pushed down.**

the cassette forward firmly against the guide pins. The spring also keeps the cassette firm when the heads are brought forward against the tape.

To insert the cassette, just put the back edge down into the well and slide it back toward the spring. Then, when the front edge clears, push it downward until the reel sprockets are engaged by the rewind and takeup spindles of the machine. The positioning pins guide the cassette into the right position. It snaps into place.

- Question:** Which part of the cassette goes into the cassette-well first?
- 21  The front edge. Go back to Frame 2.  
 The right end. Move along to Frame 29.  
 The rear edge. Read Frame 9.

- 22 **Are you sure you read the question right? If so, better go back and read the whole of Frame 9 again.** That answer is nowhere close to right. In fact, it's nonsense.

- 23 **No, it doesn't.** The capstan, which is an extension of the shaft of the flywheel, is fixed in position. Its position can't be changed. It only rotates, with the pressure roller against it. That white idler has some other purpose. And you can find it if you read Frame 6 again.

Prerecorded tapes are too expensive to take a chance on erasing. Cassettes have a built-in lockout that prevents this happening. Photo *a* in Fig. 8 shows this feature.

The bottom cartridge is a prerecorded cassette. Notice the square holes along the rear edge. These are lockout holes (sometimes called "anti-record notches"). The blank cartridge on top has plastic over these holes.

Photo *b* shows what these holes are for. When a blank cassette is in position, the little lever is pushed back. With the hole open, as it is on prerecorded cassettes, nothing pushes the lever back; it fits into the open hole and the lockout mechanism stays down.

Photo *c* shows the whole lockout lever. When it fits into the hole at the back of a cassette, the lower part of the lever goes down and blocks the RECORD slide. The RECORD button cannot be pushed in. So, you can't accidentally record on a prerecorded tape.

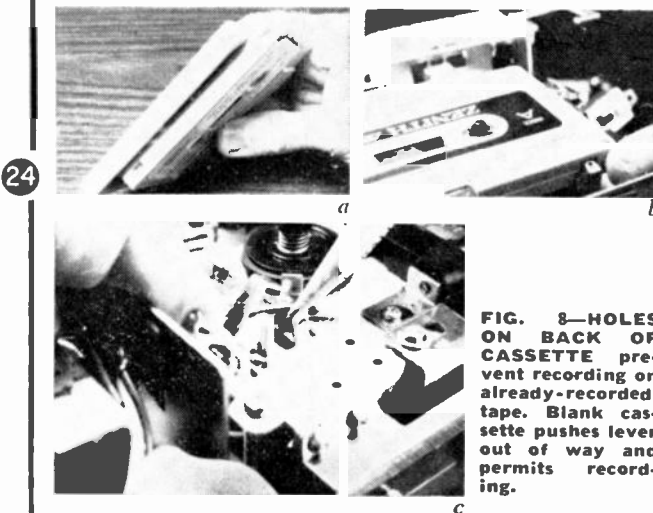

**FIG. 8—HOLES ON BACK OF CASSETTE prevent recording on already-recorded tape. Blank cassette pushes lever out of way and permits recording.**

24

The covered-over back of a blank cassette pushes the lever back, unblocking the RECORD slide. Once you've recorded on a blank, and want to keep it, you can knock out the hole coverings; then it'll block the RECORD slide just like any prerecorded tape. Or, if you decide you want to erase or record on a cartridge that has the holes open, just put plastic tape over the holes.

In a few machines, RECORD lockout is done with a switch interlock. Pushing in a blank cartridge, with the holes covered or still intact, opens a switch that prevents power being applied to the unit.

- Question:** Which kind of cassette can you record on?
- One with the holes still covered. See Frame 18.  
 One with one hole out and one in. Go to Frame 8.  
 One with the holes knocked out. Look at Frame 10.

- 25 **You didn't guess right.** The answer is plainly stated in Frame 17. You should go back and read it.

- 26 **That's not right at all. Better go back and read Frame 1 again.** The answer isn't there in black and white, but plenty of information is there to keep you from making this mistake on your next answer.

- 27 **No.** There's no above-deck drive belt for any purpose. Both drive belts are below-deck, and neither one does the rotation-reversing for the rewind operation. Have another look at Frame 14 and pick the right answer.

The tape heads are mounted on an assembly plate. They're kept back out of the way while the STOP button is down. Otherwise, the cassette couldn't be pushed down into place.

The photos in Fig. 4 show the tape heads and the assembly plate, with the machine cover removed for clear viewing. The (a) photo is taken with the STOP button depressed. The plate is in its resting position.

When the PLAY button is pushed down, a mechanical slide linkage moves the whole plate about 1/4 inch forward. Photo (b) shows the plate in this position. The heads are now up where they would push against the tape in a cassette.



- 28 **FIG. 4—ERASE AND RECORD/PLAYBACK HEADS are mounted on movable plate that slides them back out of the way when machine is stopped.**

The PLAY button is always pressed *along with* the RECORD button for recording. So, the heads move into their same position. The slide that operates the head-assembly plate is spring-loaded, so it pulls the assembly back when the STOP button releases it.

If you look closely, you can see details of the tape heads, too. The erase head is nearest you. The metal tab on one side is a guide which keeps the tape at the right height on the head. That's important, because you don't want the head to erase the other track while you're recording on or erasing one.

The record/playback head is beyond the erase head in the photos, over near the pressure roller and capstan. It, too, has a tape guide, but you can hardly see it.

**Question:** How is the motion of the PLAY button transferred to the head-assembly plate, to move it forward?

- By a metal slide linkage. Read on in Frame 19.  
 By a plastic drive wheel. Study Frame 12.  
 By the index finger of the left hand. See Frame 4.

- 29 **That's a bad guess.** You really must go back and read Frame 21 again. There's plenty of information there to give you the right answer.

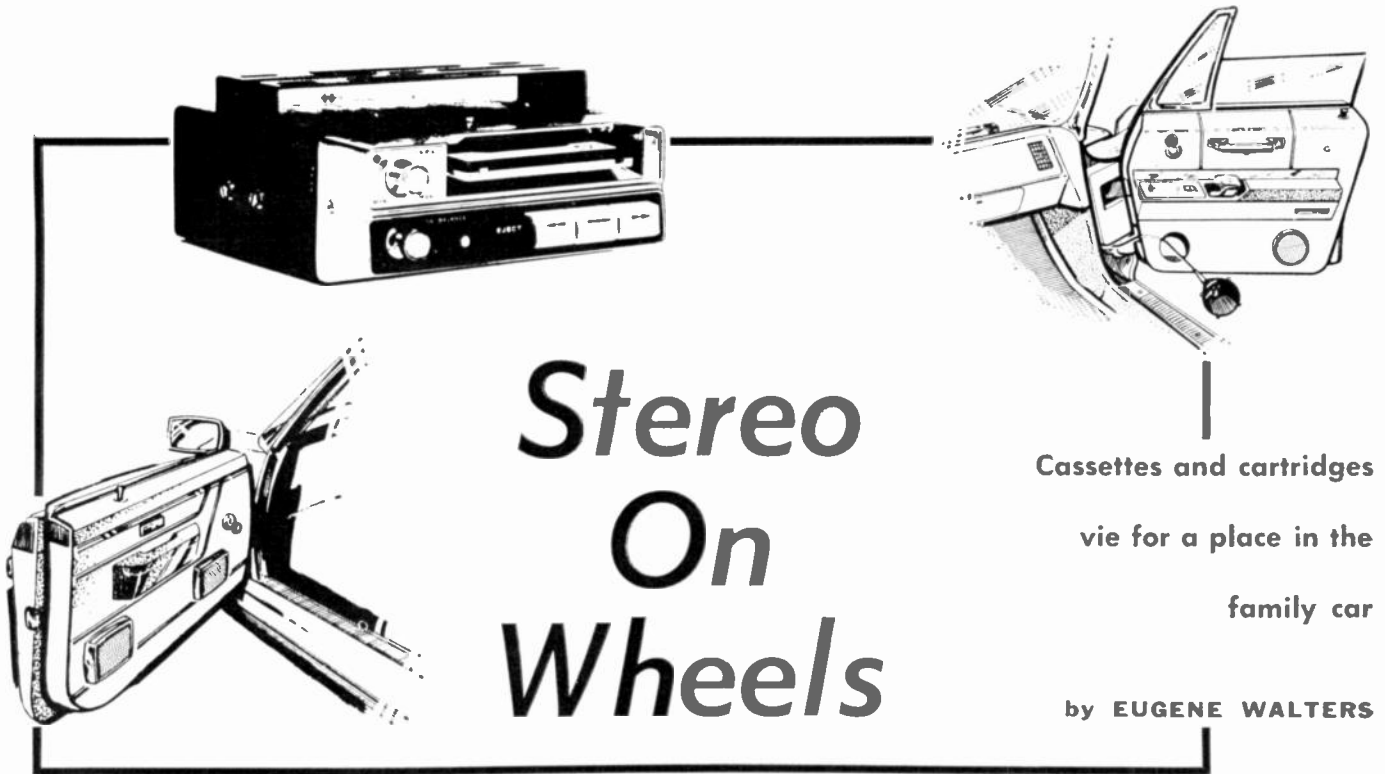

# Stereo On Wheels

Cassettes and cartridges

vie for a place in the  
family car

by EUGENE WALTERS

THERE WAS ONCE A TIME WHEN HIGHWAY MUSIC LISTENING was limited to a few fade-prone and static-filled AM stations on the family chariot's radio. Often, this was sufficient, and it still is for a large part of the motoring public. But Americans are not only highly mobile, they're also conspicuous consumers, and various methods of letting them play their favorite music while on the go have been tried over the years.

Remember the mini 45-rpm record player that mounted under the dash? And its many copies? Or the record player with a slot—just slip the record in and hope that you didn't get too many greasy paw prints on its precious grooves? Then a few hardy private individuals moved the tape recorder into the car with varying degrees of success. There were some who brought along a quality stereo rig that gulped amperes—running from an inverter power supply—and sometimes had to buy a station wagon just to hold all that gear. And there were smaller, battery portable machines of questionable fidelity that were small enough to repose on the front seat.

Then along came "Madman" Earl Muntz with a new idea—a 4-track continuous-loop tape cartridge player that mounted handily on the bottom of the dashboard. The idea caught on quickly—in Muntz's native California—where fads come and go with the changing phases of the moon. But this one held on and spread quietly to the East Coast, where it soon joined in combat with another upstart cartridge called 8-track. The 8-track format appealed to Detroit, and some manufacturers started to offer this Lear-Jet type player as standard equipment. The rest is recent history. The cartridge has caught on well, if not spectacularly, fighting for its place in the scheme of music listening while still another upstart—the compact cassette does battle for first place in the hearts of the motoring public.

The cassette has had to fight an uphill battle against the already well entrenched cartridge's "traditional" market. Two major selling points have been working well for the cassette: its compact size and the ease of recording on cassettes. This latter factor may be losing some of its importance now, since machines for recording stereo cartridges are no longer as scarce as they once were. At last

count, at least 15 manufacturers were offering cartridge record/playback machines for home use. That's still rather slim pickings, since about 90% of all cassette equipment sold today has recording capability.

A year ago, it was generally felt that the cartridge was beginning to lose ground to the cassette. The trend has reversed itself, at least temporarily. Cartridge sales have been hyped by the introduction of quadrasonic playback machines for both home and auto. RCA and Motorola introduced the concept last year (see *RADIO-ELECTRONICS*, October 1970, pp. 33-35). Since this cartridge was the first viable four-channel consumer product to hit the market, the 8-track cartridge suddenly had a new lease on life.

There's no comparable quadrasonic format established for cassettes so far—mainly because Philips insists on one particular format that many manufacturers are finding hard to swallow. The Philips format would continue the cassette's compatibility to the *n*th degree—making the new four-channel releases completely compatible with all other cassette machines. Signal-to-noise ratio with the very narrow track widths needed for this format can only be imagined at this point.

Cartridge advocates will point out that the 8-track cartridge, with its 33 $\frac{1}{3}$  ips speed has inherently better frequency response and signal-to-noise ratio than cassettes. That may have been true at one time, but cassettes have emerged this year as a superb high-fidelity music source, when played on appropriate equipment. This has been made possible by new tape formulations, particularly chromium dioxide and the equally new super-high-density ferric oxide coatings. The introduction of the Dolby noise reduction system has also been a big help, along with better (and more expensive) engineering in the playback equipment. Top-notch sound from a cassette is still an expensive living-room-only proposition, but it's happening right now.

In the meantime, some automotive manufacturers aren't all that sure about the cassette yet.

Some of the living-room's conveniences are beginning to creep into the highway music end of the business. The Qatron cartridge changer is now being offered for car installation. The changer's carousel holds 12 cartridges and is

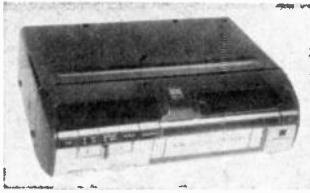

**CAR STEREO CASSETTE** with built-in FM stereo receiver is model CQ-909 by Panasonic.



**8-TRACK CARTRIDGE stereo** player has eject feature. It's a model CX-830 by Panasonic.



**COMPATIBLE CARTRIDGE** deck handles 4-channel and 2-channel stereo tapes. It's Toyo Qadio model CS-721.

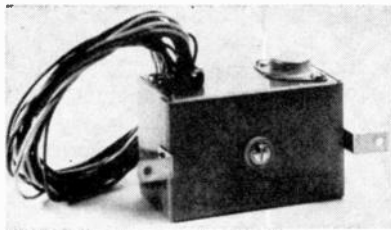

**SWITCH-O-MATIC** lets user play car radio through tape system. Switches automatically. Model 30-3160 by GC Electronics.



**CARTRIDGE TUNERS** plug into cartridge tape players and convert them into FM or AM/FM radios. GC's 30-3075 shown.

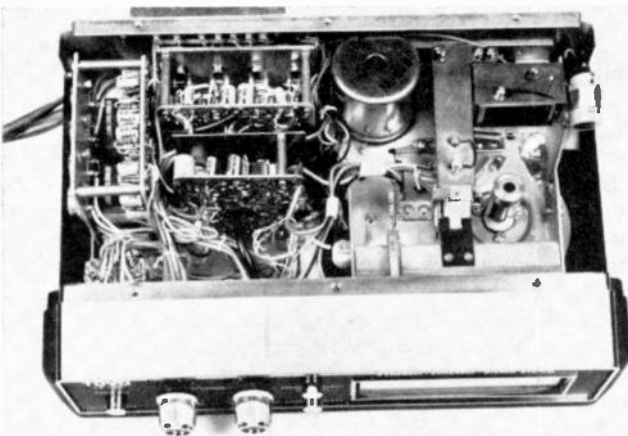

**INTERIOR VIEW OF 4-CHANNEL TAPE PLAYER.** It plays cartridge tapes and can handle both the new 4-channel tapes and the conventional 8-track tapes. Made by Toyo, it is one of the first of this new breed of car tape players.

a bit bulky for under-the-dash mounting, so the changer goes into the trunk with a control head on the dashboard. This not only gets the bulky unit out of the way, it helps theftproof it as well.

We can't help but wonder about environmental effects on the changer mechanism, especially in cold weather. Tape recorders carried in the trunk in sub-zero weather often have to be warmed up at room temperature for 30 minutes or so before they'll operate properly.

Most car cassette stereo machines fall into two categories—those that play back only, and those that also have a mono record function. Some refinements are beginning to appear on these machines, such as the automatic reversing player from Bell & Howell. Extra features like this generally mean a higher selling price. It can also mean a headache for the service technician who has to contend with such an extensive variety of different mechanisms with all kinds of variations on the basic design.

There are numerous accessories for both cartridge and cassette units. Probably the best known such item is the plug-in cartridge tuner that instantly converts the tape player to an FM radio. These tuners vary in design, and often are recommended only for use with a specific tape unit. Some of these tuners obtain their power from special power contacts in the tape machine that they mate with. Some of the "universal" types contain a 9-volt transistor radio battery and pass their signal to the tape system by magnetic induction with the playback head. All of these tuners require an external antenna and there are a couple of ways of attaching it.

One method, which is used with the specific mating units, calls for a splice in the car's existing antenna, with a tapoff running to a jack on the back of the cartridge machine. So if you see a tape player with an antenna jack on it, don't be too surprised. Another method, generally used with the "universal" type of cartridge tuner, requires that the antenna lead be brought out front where it can be plugged into the tuner cartridge itself each time it's installed in the tape slot. This can be a bit inconvenient since in its simplest form, this would require replugging into the existing car radio when you're all through. Two new tuners get around this very nicely by including an antenna "Y" connector in the package. Sold by GC Electronics in the Audiotex "Auto Stereo" line, the look-alike tuners are an AM/FM unit and an FM stereo tuner. The "Y" connector's a grand idea, and leaves the existing radio permanently connected to the car's antenna.

Maintenance accessories are easier to come by today than they were a couple of years ago. A head degausser for cartridge machines that plugs into the car's cigarette lighter is fairly common now, but virtually all of these are packaged in a cylindrical wand. Since you can't see the head you're demagnetizing, some groping and hoping is needed. We'd like to see someone package that head degausser in a cartridge shape; that way, the head would be located instantly, and the pole pieces would always be kept the proper distance from the head, avoiding any possible damage.

Head cleaning is really touch and go. It's impossible to see the heads, so conventional cotton swabs and alcohol are out. There are two possibilities: pressurized aerosol cleaner such as GC's "Blastoff," which directs its energy through a thin plastic tube (like tuner cleaner spray does), and head-cleaning cartridges that contain specially treated cleaning tape. While the latter method is far easier to use, remember that cleaning tapes need periodic replacement, since they get filled up with all that oxide gunk.

Too many car stereo tape owners neglect these simple maintenance procedures; service calls for "poor frequency response" or "excessive hiss" may be simply due to such lack of everyday (at least every week) care. The average

car stereo buff may have never owned a tape recorder before, so may be unaware of the need for these procedures. Whether you're selling a unit or servicing one, you've got another job to do—educating the customer.

The four-channel cartridge player may not be a major force in the automotive market right now, but the car is certainly the ideal listening room for "surround sound." There are only a few firms making quadrasonic 8-track cartridge players for the car right now—Motorola, Automatic Radio and Toyo—but others will be getting into the act soon. If the quadrasonic player is a replacement for an existing player, the installation might just be a piece of cake—especially if there are already four speakers in the car. The rear pair simply needs a bit of rewiring at the playback unit.

The cassette has been undergoing immense improvements in the past couple of years, but these changes won't be heard in car stereos for some time to come. The improvements have been in frequency response and background noise level—both relatively unimportant ingredients when listening on the highway, since road noise tends to mask the most objectionable characteristics. It's unlikely that any car cassette players will have built-in Dolby noise reduction circuits in the near future, but that won't prevent anyone from listening to pre-stretched (Dolbyized) cassettes in the car; all that's needed is to back off on the treble control a little.

The march of gadgets never ends. Newest in electronic accessories is a solid-state circuit that hides neatly behind the dashboard. Called "Switch-O-Matic," the device lets the highway listener play his conventional, mono car radio through the stereo tape player's speakers, presumably for superior sound reproduction. The device matches impedances properly and provides its own driving power for the speakers while connecting them automatically to the radio's output. When the radio is turned off, the speakers are automatically switched back to the tape unit. It's made by GC Electronics.

Auto stereo burglaries continue to be the most vexing single problem in such installations. Many would-be highway listeners are turned off by the very probable loss of this equipment soon after its installation. The in-dash units installed in Detroit are less susceptible to loss, but the majority of car tape units are still being purchased after the car leaves the showroom.

Not so new, but very important, is the family of anti-theft devices. There are various types of lockable mounts for stereo tape units and CB rigs. None of them will foil a really determined thief, but in most cases, such burglars will pass up a protected unit in favor of one that's easier to remove. These boys have to work fast, and anti-theft mounts slow them down. Besides the lockable brackets, there are various types of burglar alarms—some that protect the car as a whole, while others protect that very tempting hunk of electronic gear hanging from the dashboard. Some alarms ring bells; some make sirens wail; some blow the horn. We'd like to see one that would zap the thief with a death ray, or at least douse him with some indelible dye marker. R-E

**CASSETTES NOW USE TAPE FORMATS BELOW.** At far left is track arrangement for monaural cassette. Center diagram shows stereo (2 channel) arrangement. At the far right is the 4-channel setup proposed by Norelco.

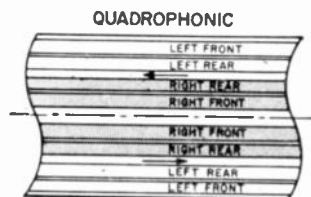
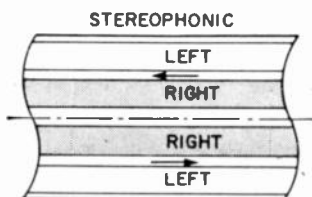
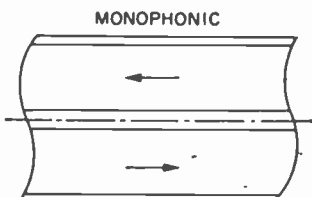

**TAPE FORMAT**

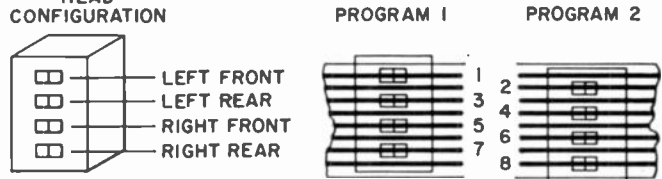

**FOUR CHANNEL TRACK ASSIGNMENTS**

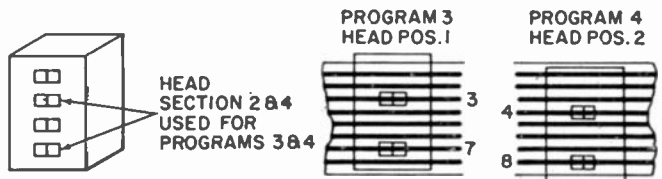
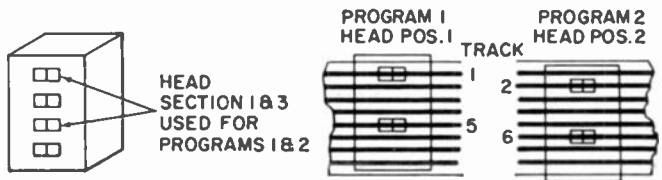

**TWO CHANNEL TRACK ASSIGNMENTS**

**CARTRIDGE TAPE FORMATS.** At the top of this page is the basic arrangement of tracks on a cartridge tape. Below that we show the arrangement of a 4-channel stereo cartridge tape. Directly above you can see how the conventional stereo cartridge format is set up. Note that the 4-channel and 2-channel arrangements are compatible.

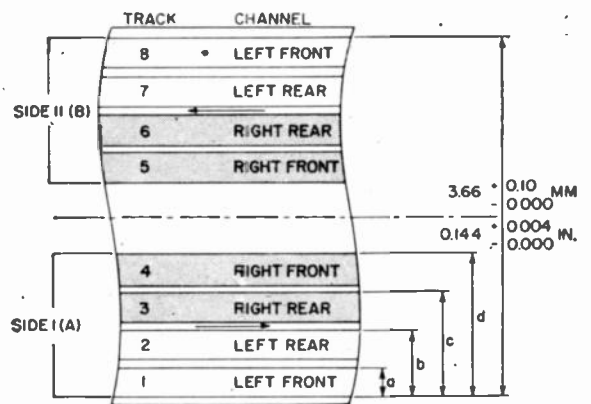

**ENLARGED VIEW OF 4-CHANNEL CASSETTE TAPE FORMAT.** Critics of this system say that track width is too small to deliver a good signal-to-noise ratio and that tape hiss may be a severe problem.



# 2 SAFETY AID PROJECTS for your CAR

by R. M. MARSTON

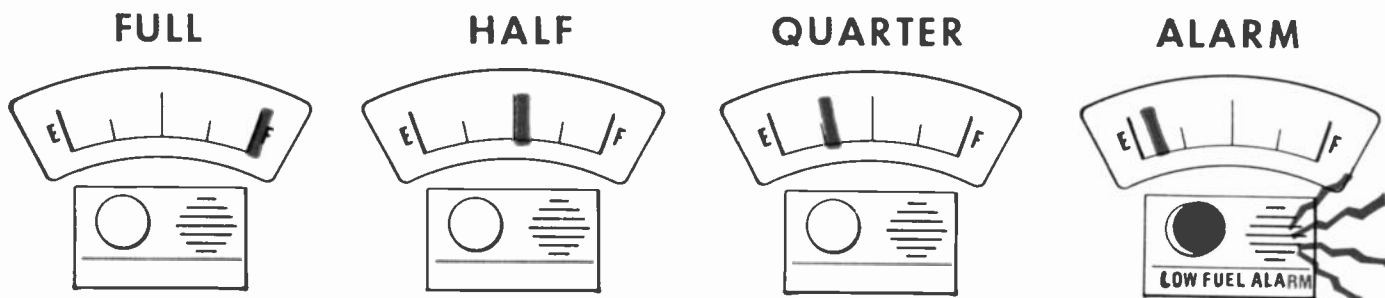

## 1. Low-fuel-level alarm

*Add this 3-transistor circuit to your car and you'll always know when you're running low on fuel*

THIS DEVICE IS ACTIVATED BY THE car's fuel-level gauge, and triggers a small warning light when fuel level falls below a preset value.

Alternatively, the unit can be made to operate a panel light if the engine's water temperature exceeds a preset value, if the vehicle has an electrically operated water-temperature gauge.

The device is, in fact, a voltage-operated electronic switch which turns

on whenever its input voltage falls below a preset value.

### How it works

The negative-ground version of the unit is in Fig. 1. The circuit is simple. It is made up of a voltage-sensing differential amplifier (Q1 and Q2) and a regenerative switch (Q2 and Q3).

In the differential section Q1 and Q2 are wired as emitter followers, but

share a common-emitter resistor, R2. An external voltage (derived from the car's fuel or water-temperature gauge) is applied to Q1's base via D1 and R1, and the base voltage of Q2 is determined by R4.

The emitter-follower action of Q1 and Q2 makes the voltage at the top of R2 close to the value of the larger of the two base voltages. Now, if the base voltages differ by more than a few tens of millivolts, the transistor with the higher base voltage is driven on and causes the base-emitter junction of the other transistor to be reverse-biased, so that transistor is cut off.

On the other hand, when the two voltages are equal, both transistors are biased on. Thus, Q2 goes on only when Q1's base voltage is equal to or less than that of Q2. D1-R1 and C1 form a simple smoothing network, so Q1's base voltage corresponds to mean, rather than instantaneous, input voltages.

Looking again at Fig. 1, Q2's collector current is fed into Q3's base, and Q3 drives a lamp or relay load in its collector circuit. Part of the Q2 collector voltage is also fed back to

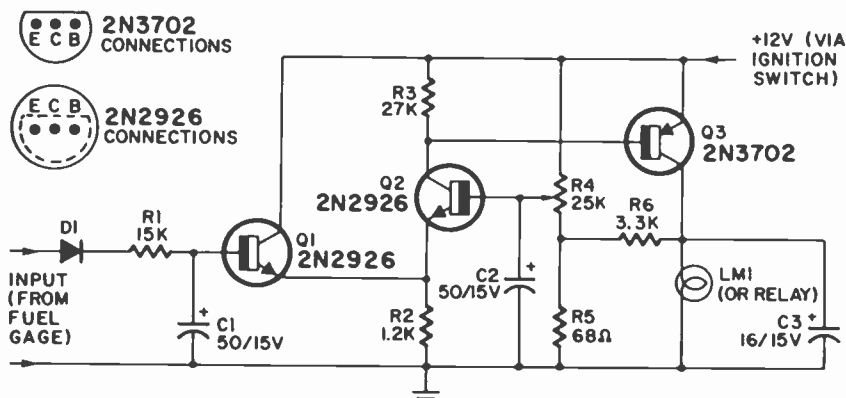

FIG. 1—CIRCUIT OF THE LOW-FUEL-LEVEL ALARM. Three transistors form the active portion of this simple device. A printed-circuit board makes it easy to assemble. The first time it works for you it pays for itself many times over.

the R4-R5 junction via R6. Thus, when Q1's base voltage is above that of Q2; Q2 and Q3 and the lamp (or relay) are off.

On the other hand, when both voltages are nearly equal, Q2 conducts and starts to drive Q3 on. As Q3 starts to go on, its collector moves toward the positive line potential, and a fraction of this rising voltage is fed back to the R4-R5 junction via R6, causing Q2's base voltage to increase. This increased base voltage turns Q2 and Q3 on even harder. A regenerative action thus takes place, and Q3 is driven rapidly to saturation and the lamp (or relay), goes on.

The feedback voltage obtained via R6 is just enough to maintain regeneration during the switching stage, so the circuit has little trigger-voltage backlash.

The lamp (or relay) is normally off, but switches sharply on as soon as the input voltage falls below the preset mean value determined by R4. Capacitor C2 insures that the circuit is not triggered by fairly rapid changes in battery voltage (due to sudden variations of engine speed), and C3 insures that the circuit is not triggered erratically by supply-line transients.

Most cars are fitted with the type of fuel gauge shown in Fig. 2. Here, a

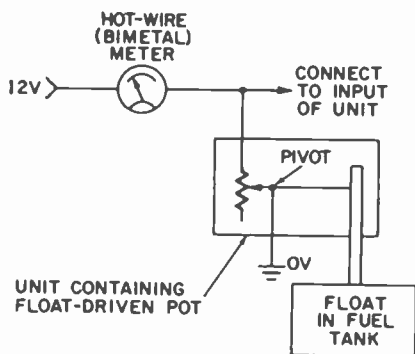

FIG. 2—MOST CAR FUEL GAUGES are wired like the one shown here. It is the type that can be used with the alarm.

float-driven potentiometer is wired in series with a hot-wire meter, and the potentiometer voltage is proportional to the fuel level (it decreases as fuel level falls).

Many cars also have electrically operated water-temperature gauges (see Fig. 3). An engine-mounted thermistor is wired in series with a hot-wire meter, and the thermistor voltage is inversely proportional to the water temperature (voltage falls as temperature rises).

Connecting one or other of these voltages to the input of the circuit in Fig. 1 enables the unit to operate the lamp (or relay) when either the fuel level falls below the preset value or the water temperature exceeds the preset

value.

The positive-ground version of the unit is shown in Fig. 4, and operates in a manner similar to that described above.

#### Build and use it

Before starting on your unit, make sure your car has the right type of gauge to operate the unit. If it is to be used as a low-fuel-level indicator, check to see that the voltage across the float-driven pot (Fig. 2) falls with fuel level, and is above 1.5 volts at the required operating value.

If it is to be used as an indicator of excessively high water temperature, check that the voltage across the thermistor (Fig. 3) falls as temperature rises, and is above 1.5 volts at the re-

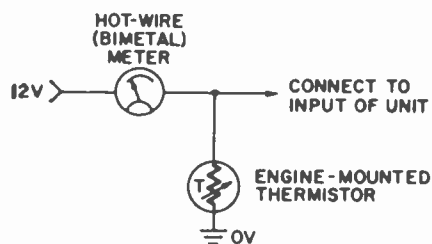

FIG. 3—UNIT BECOMES HOT-WATER ALARM if your car has this system for measuring engine water temperature.

quired operating level.

The circuit, less the lamp (or relay), is wired up on a 2½ x 1½-inch piece of perforated Veroboard with 0.15-inch hole spacing or on a P-C board. Fig. 4 shows details of a positive-ground version of the unit. The negative-ground version is similar, except that the polarities of D1, C1, C2, C3 and the supply leads are reversed.

When construction is complete, wire the unit to the car battery via the ignition switch, connect LM1 (or the relay), and test and adjust the unit as follows:

Reduce the fuel level in the gas tank to the required trip value. If the unit is to be used as for water-temperature indication, raise the thermistor temperature to the required level. Connect the unit's input to the gauge as shown in Fig. 2 or Fig. 3 and turn on the ignition. Now very slowly adjust R4 so that LM1 (or the relay) just goes on. Next, slightly increase the fuel level (or reduce the thermistor temperature) and check that LM1 goes off. Finally, recheck the adjustment. When setting is satisfactory, the unit is complete and ready for use.

FIG. 4—FOR POSITIVE-GROUND cars use this circuit instead of the one in Fig. 1. Note changes in transistors and polarities.

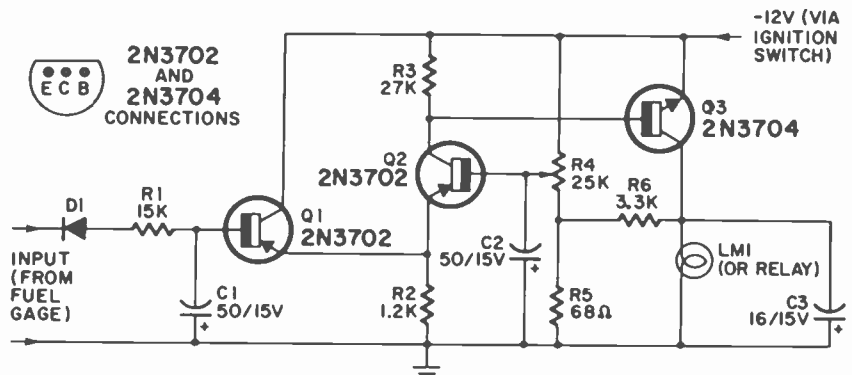

PARTS LAYOUT on the circuit board. Polarities are not shown as they depend upon the electrical system of the car. So check against Fig. 1 or Fig. 4, depending upon the one you use.

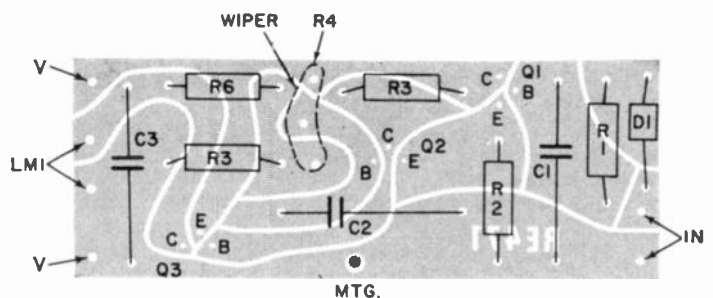

FULL-SIZE CIRCUIT BOARD pattern for the low-fuel alarm. Follow it exactly.

When the unit is used as a low-fuel-level indicator, the indicator in practice first starts to operate (for limited periods) when the instantaneous fuel level is slightly above the preset mean value. This occasional operation usually occurs under conditions of sharp acceleration or cornering, and is caused by sustained gravitational changes in fuel level (operation is not affected by normal fuel splashing). This phenomenon occurs only when the mean fuel level is close to the preset value and is advantageous, since it gives the driver an advance indication that fuel is running low. The phenomenon can be eliminated, if required, by increasing the value of R5, by trial and error, to increase circuit backlash.

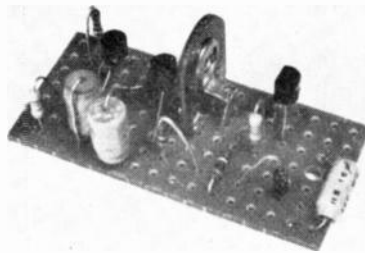

**ORIGINAL ALARM** was built on perf board. This photo shows how it looked.

The actual trip voltage levels of the unit are exceptionally stable. Thanks to the differential nature of the voltage comparator section, they are unaffected by variations in battery voltage and ambient temperature. R-E

#### PARTS FOR LOW-FUEL ALARM

**NOTE:** No parts list is shown as the exact parts you require vary according to whether you build a negative ground or positive ground system.

A circuit board for this project is available. It is made of G-10, tinned and drilled. The price for the board is \$2.25. Order No. 471-B for negative ground. Order No. 471-KP for positive ground.

A complete kit of all parts and circuit board is also available. The price is \$6. For positive ground order No. 471-K. For negative ground order No. 471.

Boards and kits available from Photolume Corp., 118 E. 28 St., New York, N. Y. 10016.

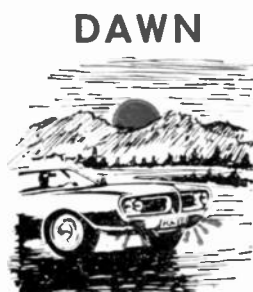
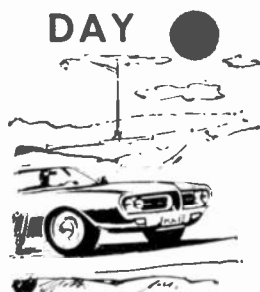

## 2. Automatic parking light operator

*Turns your lights on when it gets dark and then turns them off again when the sun comes up. You'll never get caught with your lights off again.*

THIS SIMPLE LITTLE UNIT TURNS CAR parking or side lights on automatically when it gets dark in the evening, and turns them off again when it gets light in the morning. (In some countries, cars parked on the streets during hours of darkness must have their parking lights on.)

The light triggering levels can be preset to suit individual requirements, and are independent of actual battery voltage. The circuit responds to *mean* light levels only, and is unaffected by sudden changes in light level—lightening flashes, passing headlights, etc.

Most of the circuit is wired up on a 2½ x 1½-inch piece of Veroboard panel. The entire unit can be built and installed in your car in a single evening. The device will work in any car fitted

with a 12-volt (positive or negative ground) lighting system.

#### How it works

The automatic parking-light circuit is shown in Fig. 1. Circuit operation is very simple. Resistor R1 and Zener diode D1 act as a simple voltage stabilizer and apply a fixed potential of 6 volts to the top of R2, regardless of actual battery voltage. Photoresistor R5 acts as a low resistance under bright conditions and as a high resistance under dark conditions; R2 and the R5 act together as a simple potential divider network, so the voltage at the R2-R5 junction varies in proportion to the light level on the face of R5. This voltage is smoothed by R3 and C1 and is passed on, via R4, as base bias to Q1. Transistors Q1 and Q2 are

wired as a super-alpha pair, and act like a single transistor with a very high current gain. This "transistor" is wired in the common-emitter mode, with relay RY1 as its collector load, and is driven on only when Q1's base bias exceeds 1.2 volts.

Thus, under bright conditions only a very low voltage appears at the R2-R5 junction, so negligible voltage is fed to Q1's base; Q1-Q2 and the relay are therefore off. Under dark conditions, on the other hand, a large voltage is developed at the R2-R5 junction, so heavy base bias is applied to Q1, and Q1-Q2 and the relay are driven on. The car's parking or side lights are activated by the relay switching contacts, and are off when the relay is off, and are turned on when the relay is on.

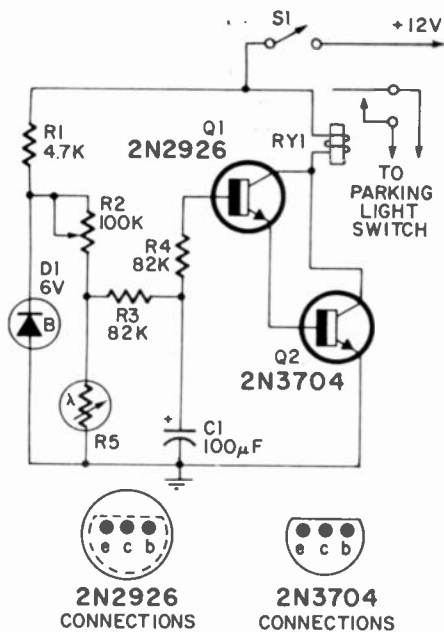

- PARTS LIST**  
 C1—100- $\mu$ F, 6V electrolytic capacitor  
 R1—4,700-ohm,  $\frac{1}{4}$ W resistor  
 R2—100,000-ohm trimmer potentiometer (vertical mount)  
 R3, R4—82,000-ohm,  $\frac{1}{4}$ W resistor  
 R5—cadmium sulfide photoresistor ( $\frac{1}{4}$ – $\frac{1}{2}$ -inch face diameter, 2,000–5,000-ohm resistance at 100 lux)  
 D1—6-volt, 300-mW Zener diode  
 Q1—2N2926 transistor (G.E.)  
 Q2—2N3704 (T.I.)  
 RY1—12-volt relay, 120-ohms or more coil resistance, 1 N.O. contact  
 S1—spsst switch  
 MISC—Veroboard, hookup wire, etc.

Since the voltage at the top of the R2–R5 divider network is stabilized at 6 volts, the voltage at the R2–R5 junction is dictated only by the R2 and R5 values; it is unaffected by variations in battery voltage. The light trigger levels of the circuit can thus be preset with R2, and are unaffected by battery voltage variations. The smoothing action of the R3–C1 network assures that Q1's base bias voltage corresponds to mean values of R2–R5 junction voltage, determined over a period of several seconds. The circuit's switching action is thus unaffected by sudden variations in light level. Capacitor C1 must be temporarily disconnected from the circuit when pre-setting trigger levels.

### Construction and use

The major part of the circuit, less the relay and photocell, can be wired on a Veroboard with 0.15-inch hole spacing. Fig. 2 shows details of this panel. When the panel is complete it can be mounted, together with the relay, in a suitable case. If a metal case is used, bond small rubber grommets to the underside of the panel, one below each mounting hole, to act as spacer/insulators to prevent the copper strips from shorting to the case.

The relay can be any 12-volt type with a coil resistance greater than 120 ohms, and one or more normally open contacts with current ratings suitable for

operating the car lights. A 700-ohm relay with 5-amp contacts is used on the prototype unit.

The photocell must be mounted in a small "head" and connected to the circuit with flexible leads. The head itself must be bonded (with impact adhesive or sticky tape) to a suitable surface inside the car, with the photocell face pointed toward the car interior. This mounting method enables the photocell to see mean light levels, but to be almost blind to localized external lighting such as headlamps and street lights, etc. Suitable mounting positions are the lower face of the windshield, the front of the dash panel or the head of the steering-column support bracket.

The photocell head is made by connecting a pair of flexible leads to R5 and sinking the assembly into a block of plastic so that only the photocell face is exposed. Fig. 3 shows how the prototype head was made.

Bond the photocell head in position in the vehicle, and connect it to the main circuit through its flexible leads; temporarily disconnect one side of C1. Connect the unit's +12 volt lead to the positive terminal of the battery, and the ground lead to the negative terminal. Wire the relay contacts across the vehicle's parking-light switch.

Now close S1, reduce the effective ambient light level to the required value (by shading R5's face or waiting for

FIG. 1—(above left) CIRCUIT OF SIMPLE 2-TRANSISTOR DEVICE. FIG. 2—(below left) VERO BOARD LAYOUT for the automatic light operator. Parts placement is also shown. FIG. 3—(below right) DETAILS OF PHOTOCELL MOUNTING. PHOTO (below right) shows what the completed unit looks like.

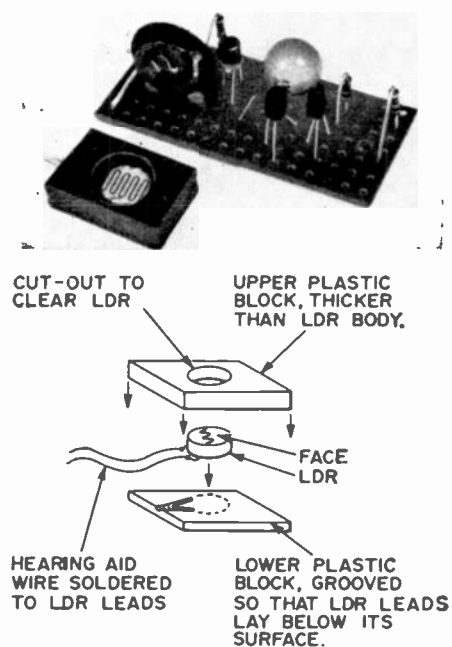
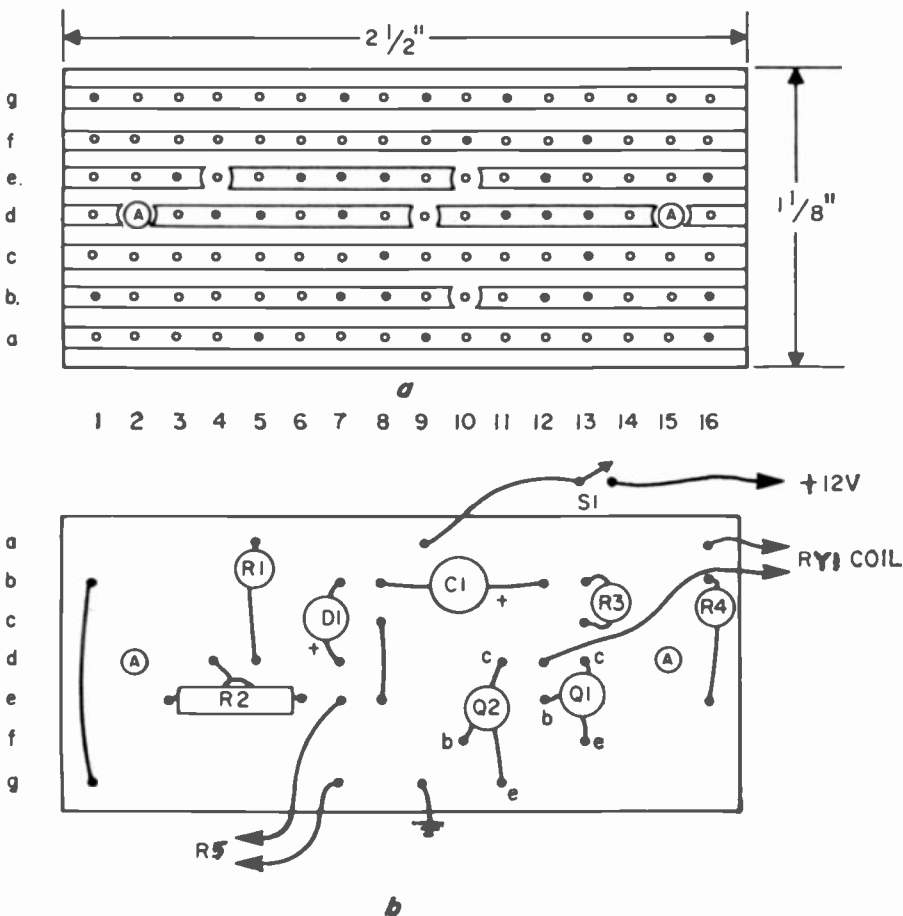

dusk), and adjust R2 so that the parking lights come on; now increase the light level, and check that the lamps go off again. Reconnect C1, and check that the parking lights still operate, after a period of several seconds, at the required lighting levels, but are unaffected by sudden variations in light level. If satisfactory, the unit is now complete and ready for use.

R-E

# 9 EXPERIMENTS

## with multipurpose semiconductors

by PAUL FRANSON

The best-known members of the solid-state revolution that is changing our lives so greatly are transistors and integrated circuits. These devices are now used in almost every type of electronic equipment, from inexpensive transistor radios to sophisticated missile computers that fly to the moon and beyond. However, other solid-state devices that are not so well publicized are also very important, and will become much more prominent in the future.

This article describes 9 simple, low-cost projects that give the experimenter a chance to work with three of the most interesting of these exotic semiconductor devices—the phototransistor, the unijunction transistor (UJT) and the silicon controlled rectifier (SCR). These simple projects, which are designed for safe, low-voltage operation from batteries, illustrate the basic principles that make the semiconductors so valuable in many applications. These three semiconductors plus a conventional npn silicon transistor, which is used in many of the projects, are readily available.

### Construction and components

Here are some suggestions for selecting and mounting the components used in the projects:

The leads on the semiconductors are really designed to be bent and soldered only once. If you want to build more than one project, as you surely will, mount each device on a small terminal strip or circuit board. Then the device itself will not have to be mounted more than once.

Solder connections to semiconductor devices rapidly, using good solder and a hot clean iron. Though these parts are relatively rugged, ex-

cessive heat can damage them as well as other components.

Most of the components used are not very critical. Wattage ratings of resistors and voltage ratings of capacitors are minimum values, and components with higher ratings can be used.

The relay called for in many projects should have a resistance of 200 to 2000 ohms and be fairly sensitive (20 mA pull-in current, for example). A suitable relay is the Callectro D1-966. A No. 47 pilot lamp can be substituted for the relay in many of the circuits, showing the operation visually. Do not exceed the contact ratings of the relay and be careful if you use it to handle 117 volts ac. A capacitor is shown across the relay coil in most projects. It protects the transistor against high transient voltages generated when the relay coil is turned off. A diode can also be used for protection. It should be connected across the coil with its cathode to the positive supply.

### The silicon controlled rectifier

The SCR is the best-known and most widely used of a whole family of semiconductors called thyristors or four-layer devices. The SCR is a semiconductor switch or relay with many interesting properties that have made it very useful in control circuits in industry and in consumer appliances.

The symbol for the SCR is shown in Fig. 1. As you can see, it is the



Fig. 1

symbol for a conventional diode or rectifier with a *gate* terminal added. It is this gate that makes the SCR so versatile. When the SCR is connected as

shown in Fig. 2, the SCR is "off." It will not conduct and the lamp stays off. However, if the gate is touched to

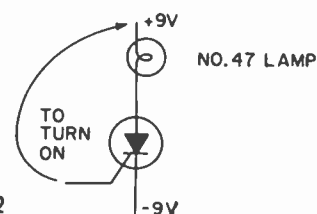

Fig. 2

the positive terminal, even momentarily, the SCR turns "on" and the lamp will light and stay on. A resistor in series with the gate lead should be used to prevent excessive voltage on the gate at high voltages. A low-voltage battery can also be used to trigger on the SCR by connecting a positive voltage between gate and cathode.

When the SCR is on, it has a voltage drop of about 1 to 2 volts across it.

The only way to turn off the SCR (and hence the light) is to break the current (or drop it below the "holding current"). This can be done by disconnecting the battery or by shorting the anode and cathode terminals for an instant.

When power is reconnected, or the short removed, the SCR will be off and will remain that way until triggered on again.

The maximum voltage that should be connected across the SCR in this way is called the blocking voltage.

When the SCR is operated from alternating current, rather than direct current, the operation of this circuit is different. In the first place, half the time the polarity across the SCR is reversed and it will not conduct (unless the reverse voltage,  $V_{RM}$ , is exceeded and this will probably destroy the device). However, the other half of the time, the SCR can be triggered "on" with a positive voltage. The battery



# 1 Garage Door Switch

With this light-operated switch, the light from a car headlight can turn on a motor that opens an electric garage door. Sensitivity is adjustable to prevent false triggering. The circuit latches on and should be turned off with a limit switch when the door is wide open. The switch draws negligible standby current. The potentiometer must be adjusted for reliable operation from bright headlights. It may be necessary to mount phototransistor at the end of a hollow tube to prevent unwanted operation from sunlight.

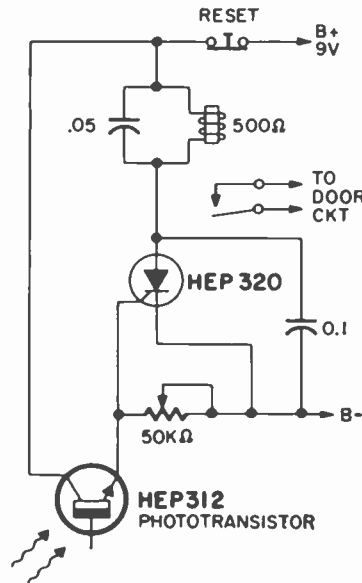

### PARTS LIST

- 1 HEP 312 or MRD450 phototransistor
- 1 HEP 320 or 2N5060 silicon controlled rectifier
- 1 50,000-ohm potentiometer
- 1 500-ohm relay (contacts must be suitable

- for current handled)
- 1 0.05- $\mu$ F, 25-volt capacitor
- 1 0.1- $\mu$ F, 25-volt capacitor
- 1 spst switch (reset)
- 6 1.5-volt batteries

# 2 Burglar Alarm

This low-cost burglar alarm will sound an alarm or turn on a silent warning light if a window or door is opened. It draws negligible current when not activated and can be operated from a battery. Switches S1, S2, etc., can be thin pieces of wire that will break if a door or window is opened, or they can be normally closed Micro-switches. If the circuit is broken, the SCR will turn on, pulling in the relay and activating the alarm until power is disconnected.

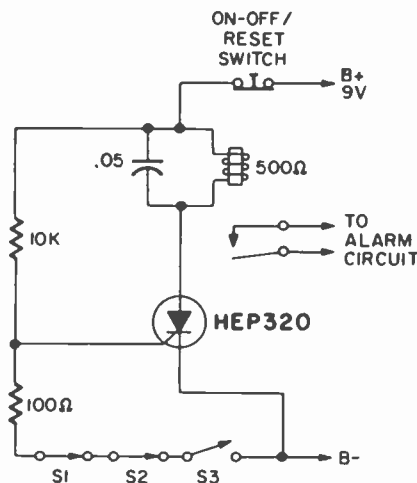

### PARTS LIST

- 1 HEP 320 or 2N5060 silicon controlled rectifier (SCR)
- 1 100 ohms, 1/2 watt, 10% resistor
- 1 10,000 ohms, 1/2 watt, 10% resistor

- 1 0.05- $\mu$ F, 25-volt capacitor
- 6 1.5-volt "D" cells (9 volts)
- 1 500 ohm dc relay
- 1 spst push switch (reset, optional)

# 3 Light-Sensitive Tone Generator

The output tone of this simple circuit varies with the amount of light hitting the phototransistor. It can be used as a simple musical toy. It can be modified to turn off completely in the dark or for multiple-octave range.

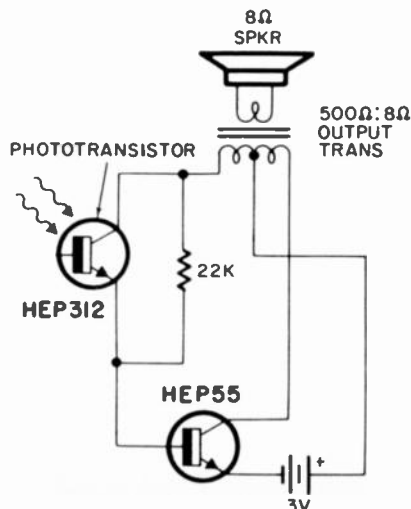

### PARTS LIST

- 1 HEP 312 or MRD450 phototransistor
- 1 HEP 55 or 2N3903 silicon NPN transistor
- 1 500-ohm to 8-ohm transistor output transformer (center tapped)
- 1 22,000 ohms, 1/2 watt, 10% resistor (omit for turn off in dark)
- 1 8-ohm speaker
- 2 1.5-volt batteries

**The SCR**  
A semiconductor switch or relay useful in control circuits

must remain connected since each time the anode current drops to zero (and during the half cycle when no current flows), the SCR turns "off."

By triggering the SCR "on" at different points in the positive half cycle, the average amount of current that flows can be varied. This is the principle behind SCR's used in lamp dimmers and motor speed controls.

Unfortunately, since an SCR conducts on only half the ac cycle, it cannot be used for full-wave (complete) control without relatively complicated circuitry. A triac, or ac silicon controlled rectifier, is usually used in these simple applications.

The 2N5060 or HEP 320 SCR used in these projects is a low-voltage (30 V) SCR with a maximum anode current rating of 800 mA (0.8 ampere). It is very sensitive, permitting it to be triggered directly by a phototransistor or finger touch. It is molded in plastic for low cost.

Other SCR's can handle higher currents and voltages, and are often used directly from the ac line.

### The unijunction transistor

The UJT is a unique semiconductor with properties completely unlike conventional transistors. The

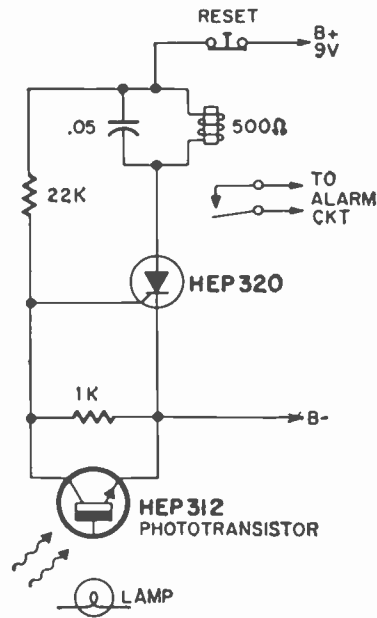

Fig. 3

UJT contains only one junction between n-type and p-type silicon, while conventional transistors have two junctions. The symbol is shown in Fig. 3. The most important characteristic of the UJT is its property of "firing", or conducting suddenly, when the voltage between the emitter and base-1 rises to a certain fraction of

# 4 Light-Operated Burglar Alarm

This sensitive burglar alarm is triggered by any object breaking a light beam. This turns on a silent alarm (1 amp) or bell, which stays on until the circuit is broken. A No. 47 lamp can replace the relay for a visual alarm.



### PARTS LIST

- 1 HEP 312 or MRD450 phototransistor
- 1 HEP 320 or 2N5060 silicon controlled rectifier
- 1 22,000 ohms, 1/2 watt, 10% resistor
- 1 1000 ohms, 1/2 watt, 10% resistor
- 1 500-ohm relay
- 1 0.5-μF, 25-volt capacitor
- 1 spst reset switch
- 6 1.5-volt batteries

# 5 Dusk Minder

The dusk minder turns a light on at sunset and off again at sunrise. It uses little current and offers completely automatic operation, making it ideal for vacation trips. The relay contact ratings must not be exceeded and the phototransistor must receive direct light from the sun.

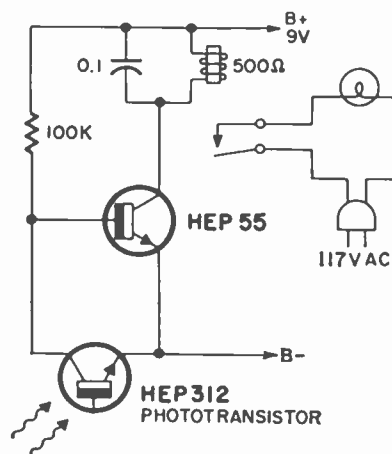

### PARTS LIST

- 1 HEP 312 or MRD450 phototransistor
- 1 HEP 55 or 2N3903 NPN transistor
- 1 500-ohm relay
- 1 100,000 ohms, 1/2 watt, 10% resistor
- 1 0.01-μF, 25-volt capacitor
- 6 1.5-volt batteries (9 volts)

# 6 Electronic Organ

A toy organ is fun for children. This organ can be played through an amplifier. It is easy to tune and has a pleasant output tone. The organ can be expanded to cover sharps and flats or many octaves by adding potentiometers. The potentiometers can be tuned with a piano or other musical instrument by comparing tones.

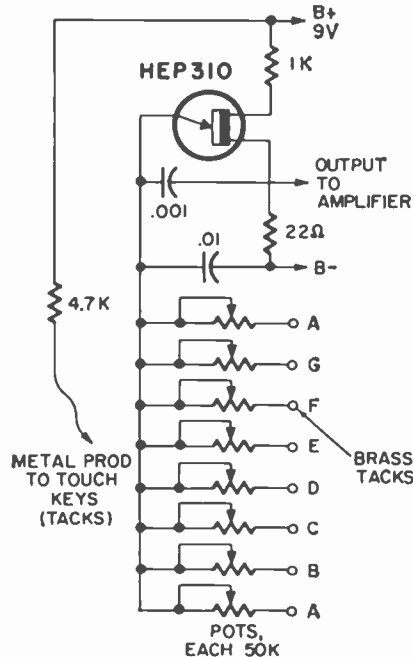

### PARTS LIST

- 1 HEP 310 or 2N4871 unijunction transistor
- 1 4700 ohms, 1/2 watt, 10% resistor
- 1 1000 ohms, 1/2 watt, 10% resistor
- 1 22 ohms, 1/2 watt, 10% resistor
- 8 50,000-ohm potentiometers
- 1 0.1-μF, 25-volt capacitor
- 1 0.001-μF, 25-volt capacitor
- 1 9-volt battery

The Unijunction Single-junction device that can conduct "suddenly", like a switch

the voltage between bases 1 and 2. This fraction is called the intrinsic standoff ratio,  $\eta$ . The firing generates a positive pulse at base-1 and a negative pulse at base-2.

If a resistor and capacitor are connected in the emitter circuit as shown in Fig. 4, and a voltage is ap-

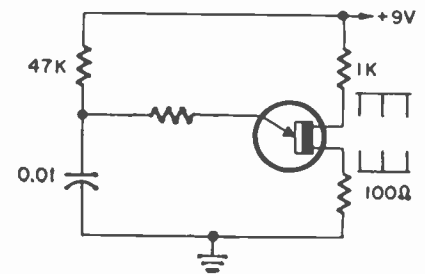

Fig. 4

plied, the voltage on the emitter will rise slowly until the device fires, discharging the capacitor. The cycle then repeats, producing a sawtooth emitter waveform. The resistor and capacitor can be varied to give long periods between pulses or very rapid pulses. The UJT is widely used in timing and pulse-generating circuits.

The HEP 310 or 2N4871 is a modern annular UJT with very stable characteristics. It is molded in plastic in a case like that used for many transistors and other devices.

### The phototransistor

A transistor chip (the silicon material inside a package) is very sensitive to light, which will cause current through the device to increase greatly. A phototransistor is a transistor specifically designed for maximum sensitivity to light, and supplied in a package that permits light to strike the chip. The symbol for a phototransistor is shown in Fig. 5. The wavy lines indicate light.

Until recently, phototransistors

# 7

## Commercial Killer

This simple gadget can turn off TV commercials with a light beam. The speaker stays silent while a flashlight beam strikes the phototransistor and sound is restored when the light is removed. The phototransistor must be shielded from stray light; a small paper tube is satisfactory.

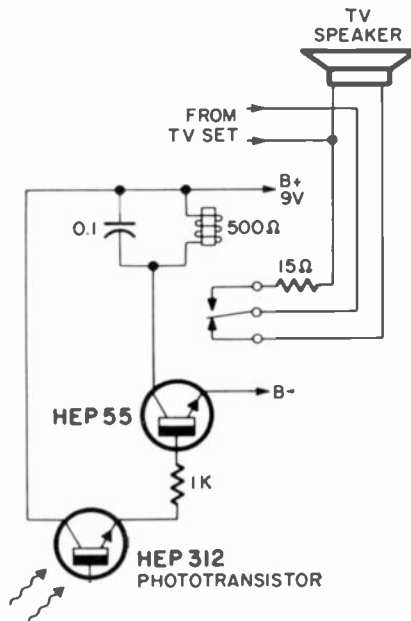

### PARTS LIST

- 1 HEP 312 or MRD450 phototransistor
- 1 HEP 55 or 2N3903 NPN transistor
- 1 1000 ohms, 1/2 watt, 10% resistor
- 1 500 ohms, relay
- 1 15 ohms, 5 watt wirewound resistor
- 1 0.1-μF, 25-volt capacitor
- 6 1.5-volt batteries (9 volts)

The Phototransistor  
Light reaching the base  
of this transistor  
causes current-flow increase

were relatively expensive, but now they are manufactured in low-cost molded packages that include integral

# 8

## Light Meter

A photographer needs a light meter to check light levels for proper exposures. A light meter can also be used to find levels for reading, close work, etc. This versatile meter has a wide range—it can be used for bright sunlight and inside without switching. Adjust the potentiometer for full scale in brightest light. Calibrate meter scale with a known-accurate light meter.

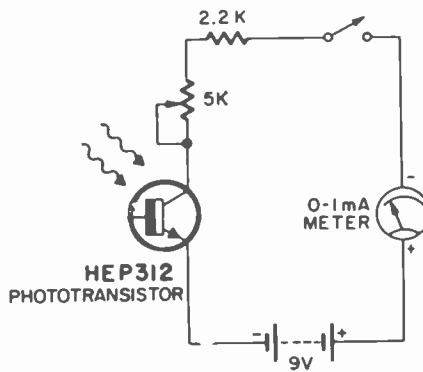

### PARTS LIST

- 1 HEP 312 or MRD450 phototransistor
- 1 2200 ohms, 1/2 watt, 10% resistor
- 1 5000 ohm potentiometer

- 1 spst switch
- 1 0-1 mA meter
- 1 9-volt transistor battery

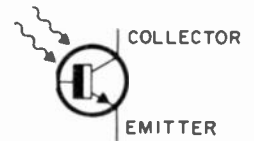

### BOTTOM VIEWS



HEP320  
2N5060  
SCR



HEP310  
2N4871  
UNIUNCTION  
TRANSISTOR



HEP55  
2N3903  
NPN TRANSISTOR



HEP312  
MRD450  
PHOTOTRANSISTOR

Fig. 5

lenses. Phototransistors are expected to find wide use "reading" computer cards and tape, recognizing letters in automatic reading equipment, counting and detecting objects, and in many other places.

The HEP 312 or MRD450 phototransistor is very sensitive. Its forward resistance falls from millions of ohms to a few hundred ohms as the light on it varies from dark to bright sunlight. Its highly directional lens must be aimed carefully for best results in many applications and in some uses, a tubular shield is necessary to prevent stray light from affecting circuit operation. The base lead of the HEP 312 is not brought out of the package as it is rarely needed.

Now dig into the projects and enjoy yourself. They are easy to build, fun to use, and really work. **R-E**

# 9

## Electronic Doorbell

Another similar unijunction circuit makes a doorbell that provides different tones when the front and back doorbell switches are pushed. This simple circuit can be adapted to more than two tones for signaling, etc. A higher voltage (to 25 volts) can be used for increased volume.

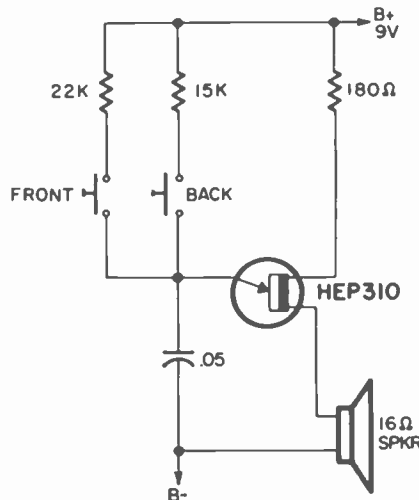

### PARTS LIST

- 1 HEP 310 or 2N4871 unijunction transistor
- 1 180 ohms, 1/2 watt, 10% resistor
- 1 22,000 ohms, 1/2 watt, 10% resistor
- 1 18,000 ohms, 1/2 watt, 10% resistor
- 1 0.05-μF, 25-volt capacitor
- 1 16 ohms speaker
- 1 9-volt battery

# Design for STEREO

by MANNIE HOROWITZ\*

## how to design your own solid-state audio amplifier

### Part V: Changes in temperature, leakage current and other factors can affect transistor bias. Here's how to stabilize it.

IN THE LAST ARTICLE, VARIOUS CIRCUITS for biasing transistors were discussed. It is important that the required bias point, once established, is maintained at or near the prescribed value. The different bias circuits aid in this function in varying degrees.

There are two primary factors which lead to instability in transistor bias circuits. These are 1. *Parameter variations with collector current*, and 2. *Parameter variations with temperature*.

#### Parameter variations with $I_c$

Since emitter and collector currents are about equal, any increase in collector current,  $I_c$ , is followed by a similar increase in emitter current,  $I_e$ . Alpha and beta do not necessarily vary with collector current, except that they normally increase rapidly as  $I_c$  becomes very large. Consequently, base current  $I_b$ , which is equal to the collector current divided by a relatively constant beta, also increases at moderate values of  $I_c$ .

The ac emitter resistance,  $r_e$ , since it is equal to  $26/I_e$ , obviously decreases as emitter and collector currents rise.

There is an ac resistance,  $r_c$ , between the collector and base of transistors arranged in common-base circuits. Dynamic resistance  $r_c$  is large when the input impedance is low, as in the common-base arrangement. It can assume values up to 1 megohm.

The common-emitter and common-collector circuits are characterized by high impedances in the input base circuit. Collector-to-emitter ac resistance is thus low compared to  $r_c$ . It is assigned the symbol  $r_d$ , which is approximately equal to  $r_c$  divided by beta. Factor  $r_c$ , and consequently  $r_d$ , decrease with any increase in  $I_c$ .

Here is an important voltage to watch— $V_{BE}$ . This is the base to emitter voltage of the forward-biased transistor junction. It is a primary factor in stability considerations. The base-emitter voltage has, in previous articles, been approximated at 0.2 volt for germanium transistors and 0.6 volt for silicon devices. It was inferred that these values are constants regardless of the current

\*Chief Project Engineer, EICO Electronic Instrument Co. Inc.

flowing through this junction. Well—this is almost so. Actually the voltage does increase with base and collector current.

#### Variations with temperature

$V_{BE}$  also varies with temperature. For a good general approximation, it is assumed to decrease at 2.5 mV (0.0025 volt) for every degree Celsius temperature rise. This is significant, for as  $V_{BE}$  decreases, the voltage bucking the power supply for the base circuit is reduced. Should the base supply voltage remain constant, the reduced base-emitter voltage results in an increase of the base current and consequently produces an increase in collector current as well.

Under most circumstances, alpha and beta will also increase with temperature.

The third important factor which increases with temperature is leakage current,  $I_{CBO}$ . This leakage current is significant when germanium transistors are involved, but it loses its primary importance when considering silicon devices. Just what this leakage is will be discussed next month. At the moment, simply remember that for germanium transistors,  $I_{CBO}$  doubles at about every 10°C rise in temperature, and for silicon devices it doubles for about every 6°C temperature increase. Due to  $I_{CBO}$ , the collector current rises rapidly with an increase of temperature.

#### Leakage current

The transistor has been described as consisting of two junction diodes arranged as in Fig. 1. In the normal mode

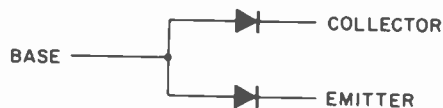

FIG. 1—JUNCTION DIODES compose the equivalent circuit of a bipolar transistor. The npn version is shown.

of operation for audio amplification purposes, the base-emitter junction is forward biased. For the npn transistor, the base is made positive with respect to the emitter. At the same time, the base-collector diode is reverse biased: the collector is positive with respect to the base. Theoretically, or more precisely,

ideally, the base-collector diode does not conduct any current.

As with all diodes, there is a leakage current in the reverse-biased base-collector junction. Current flows through the diode even though the cathode end is positive with respect to the anode. To be sure, this leakage current is much smaller than any forward current that would flow had the diode been biased in the opposite direction. The leakage current, assigned the symbol  $I_{CBO}$ , is frequently large enough to be significant in affecting the transistor collector idling current, or bias.  $I_{CBO}$  is defined as the leakage or reverse current flowing through the collector-base junction while the emitter lead remains open.

Now, what does the leakage current do if the emitter lead is connected to the negative terminal of a voltage source while the base lead remains open? The base-collector diode is reverse biased while the base-emitter diode is biased in the forward direction. Obviously, all the  $I_{CBO}$  leakage current flows into the base and through the base-emitter diode. As this leakage current flows into the base, the current flowing through the collector due to  $I_{CBO}$  would be this base current multiplied by the amplification factor of the transistor, or  $\beta_{ac}I_{CBO}$ . It is assigned the symbol  $I_{CEO}$ —the collector-emitter current that flows when the base lead is open.

In the bias equations stated in the previous article for the common-emitter circuit, dc collector current has been noted roughly as  $\beta_{ac}I_b$ —dc amplification factor multiplied by the base current. To determine the total collector current flowing, the leakage current must be added to the desirable current fed to the base, so that the entire collector current is now

$$I_c = \beta I_b + \beta I_{CBO} = \beta(I_b + I_{CBO}) \quad \text{Eq. 1}$$

As for the common-base circuit, the collector current is no longer merely  $\alpha_{ac}I_e$ , the direct current amplification factor multiplied by the desirable current fed to the emitter, but it is

$$I_c = \alpha I_e + I_{CBO} \quad \text{Eq. 2}$$

The emitter-follower suffers least from the effects of leakage current. The emitter current is approximately equal to the collector current modified by a small leakage factor.

$$I_B = I_C - I_{CBO} \quad \text{Eq. 3}$$

### Major stability factors

Whatever the established bias current is, and regardless of the circuit used, it is important that that bias point be maintained. Of the various factors discussed that can cause a transistor to drift away from the preset bias condition, the most important ones are:

**Leakage current:** The leakage current is a primary factor in establishing the idling current. This current varies, as noted above, with temperature. For germanium transistors, leakage current just about doubles for every 10°C rise in temperature while for silicon devices, it doubles for about every 6°C rise in temperature. However, it is usually a less significant factor where silicon transistors are used, as in these devices the leakage current at 25°C is near non-existent.

**Base supply voltage:** Obviously, a variation in the supply voltage which establishes the quiescent base current, drastically affects the bias current. In theoretical drawings, this supply voltage is drawn as a battery. But when practical circuits are used, the voltage is evolved from the variable power supply generators at the electric company's plants. Furthermore, the bias supply voltage can and does vary with amplified signals, temperature, and the portion of the cycle in which the applied signal exists. This supply voltage also has a significant influence on  $V_{BE}$ , the voltage across the forward biased base-emitter junction.

**Beta:** This factor varies with temperature as well as with collector current. Beta is frequently at a peak at one specific elevated temperature. It may also increase with collector current.

Although variations in beta due to temperature and collector current affect the bias current, it is outshined by beta variations within device categories. Thus, for any transistor type, beta is specified as being somewhere within a range of values. Transistor circuits should be designed to accommodate devices with any beta values specified for a particular type of transistor.

### Stability criteria

The three primary factors determining the stability of a transistor in a particular bias circuit arrangement, should be stated mathematically if the merits of the circuit are to be evaluated. In each case, it is desirable to determine the change in collector current,  $\Delta I_C$ , due to each of the three factors. Once the effect of each individual factor on  $I_C$  is established, the total effect can be determined by simply summing the individual  $\Delta I_C$ 's.

One stability factor,  $S$ , relates the change in collector current to the change in leakage current,  $\Delta I_{CBO}$ . Stated mathematically, it is

$$S = \Delta I_C / \Delta I_{CBO} \quad \text{Eq. 4}$$

In a similar manner, stability factors can be established to determine the change of collector current due to the change in base supply voltage,  $\Delta E_{BB}$ , and the change in collector current due to change in beta,  $\Delta \beta$ . These stability factors are assigned symbols  $S_K$  and  $S_\beta$ ,

respectively. Stated mathematically, they are

$$S_K = \Delta I_C / \Delta E_{BB} \quad \text{Eq. 5}$$

$$S_\beta = \Delta I_C / \Delta \beta \quad \text{Eq. 6}$$

As an example in the use of the stability factors, assume that for a particular bias circuit,  $S = 5$ . If  $I_{CBO}$  increases from 1 mA at 25°C to 5 mA at an elevated temperature, or it increases a total of 4 mA, the collector current increases 4 mA  $\times$  5 or 20 mA due to the rise in temperature. This is based on numbers being plugged into Equation 1, where  $\Delta I_C = S(\Delta I_{CBO}) = 5(4 \text{ mA}) = 20 \text{ mA}$ .

Similar solutions can be derived if the stability factors  $S_K$  and  $S_\beta$  are known for a circuit and  $\Delta E_{BB}$  and  $\Delta \beta$  have been determined.

In any problem or circuit, it is desirable to maintain a stability factor as close to its minimum value of "1" as is possible and practical.

The variation of collector current is of immense significance in the design of audio circuits. To explore this fact, assume a common-emitter circuit with a 667-ohm load resistor in the collector. Plot the load lines as in Fig. 2-a and -b.

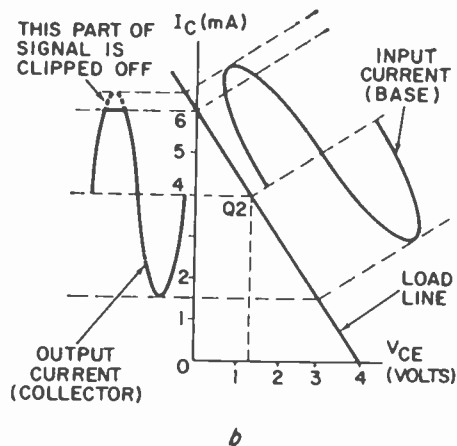
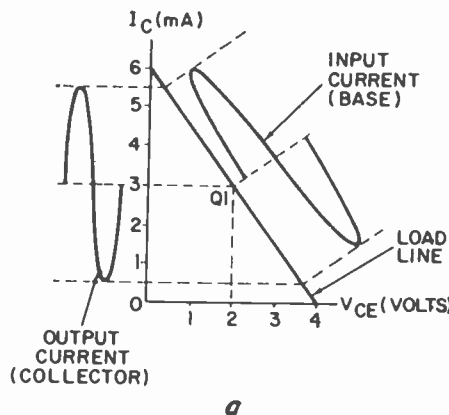

FIG. 2—NOTE EFFECT OF BIAS CURRENT shift on the output collector current and the flattened output signal. Transistor characteristic curves are omitted for clarity. All signal currents must travel along the load line.

Now, suppose that at 25°C, the transistor were biased at Q1 and that a fixed input signal would swing the collector current from 0.5 to 5.5 mA. The output current swing is drawn alongside

the collector current axis in Fig. 2-a. The quiescent collector current of a perfect sine wave is midway in the swing of the output curve—at 3 mA here.

Next suppose that the temperature rises and  $I_{CBO}$  increases, or some other factors cause  $\beta$  and  $E_{BB}$  to increase, or different transistors of the same type are used where  $\beta$  and  $V_{BE}$  differ from the average device, or any one of a number of other factors causes the quiescent point to shift. All significant factors cause the quiescent collector current to increase. Assume it increases from 3 mA to 4 mA, up to the quiescent point Q2. This condition is now drawn in Fig. 2-b.

The quiescent current is now at Q2. The negative portion of the input signal can still cause the negative portion of the collector current to swing the full 2.5 mA to a low of 1.5 mA. The positive portion of the input signal can only swing the collector current to its maximum value of 6 mA. When the input signal tries to force 1, beyond the 6 mA, only 6 mA is delivered at the collector. The output current curve has a flat top during the period of time when the 6 mA collector current should be exceeded.

The designer should be able to determine just how much leeway his circuit must give the input signals so that a full sine wave can be reproduced at the output at all times. As indicated, this shift may be due to other factors besides current and temperature variations in any one transistor. As is the case with all components, transistors of identical types have some tolerance in their characteristics. In some types, beta can vary by as much as 5 to 1, although it is frequently held to a 2 to 1 ratio.  $V_{BE}$ , a significant factor in determining collector current, is usually specified with a maximum rating, while a 0.5-volt spread between different transistors of the same type, is not unusual.

### Stability factors and bias

Three stability factors,  $S$ ,  $S_K$  and  $S_\beta$ , were just defined. Each of these factors can be calculated from the bias circuits and the components used in the particular circuit. Then the calculated values of  $S$ ,  $S_K$  and  $S_\beta$  can be substituted into equations 4, 5 and 6 respectively. The changes in collector current,  $\Delta I_C$ , for each factor can be calculated by multiplying the specific stability factor by the change involved.

Once  $S$  has been determined from the equations to be stated in the figures below, it should be multiplied by the change in leakage current,  $\Delta I_{CBO}$ , to determine the change in collector current due to this item. In a similar manner, determine  $S_K$  from the equations and multiply it by the change in base supply voltage  $\Delta E_{BB}$ , to establish the change in collector current to  $\Delta E_{BB}$ . Likewise, the product of  $S_\beta$  (as determined from the equations in the figures below) and the change of beta,  $\Delta \beta$ , will provide the data required to find the collector current change due to this variation.

One of the bias circuits which was  
(continued on page 58)



# Mr. Technician, You Can Move Ahead by Taking These

**Grantham School of Engineering** RE-4-71  
 1505 N. Western Ave., Hollywood, Calif. 90027  
 Gentlemen:  
 Please mail me your free Bulletin which explains how the Grantham home-study educational program can prepare me for my Associate in Science Degree in Electronics Engineering.

Name \_\_\_\_\_ Age \_\_\_\_\_  
 Address \_\_\_\_\_  
 City \_\_\_\_\_ State \_\_\_\_\_ Zip \_\_\_\_\_  
 I have been in electronics for \_\_\_\_\_ years.

## 1 Three Big Steps to Success... in ELECTRONICS ENGINEERING

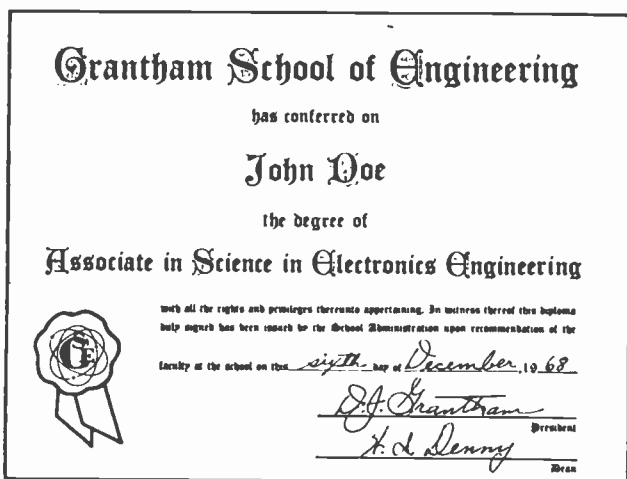
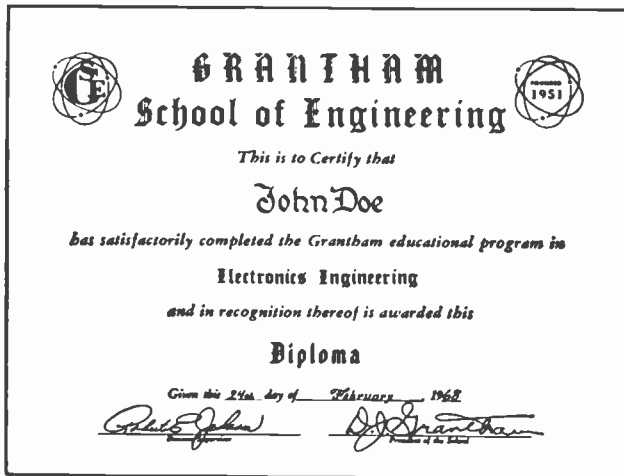

There they are — three big steps that lead electronics technicians to *greater success* — three deliberate steps to *greater recognition* and *more income*. Your future is shaped by the moves you make — by the steps you take. Begin now with Step #1.

**STEP #1** is a simple request for complete information on the Grantham Electronics Degree Program, offered to electronics technicians mostly *by correspondence*. You take the first step by mailing the coupon or postcard to the School. Then, we *mail* our catalog to you.

**STEP #2** is completing our college-level correspondence program and earning the valuable *Diploma in Electronics Engineering*. This diploma is awarded when you complete the four 100-lesson courses that make up the full correspondence program. However, each course as you complete it can greatly increase your knowledge and earning power in electronics.

**STEP #3** is attending the 2-week ASEE-Degree Seminar held at the School and earning your *Degree of Associate in Science in Electronics Engineering*. During this seminar you meet your correspondence instructors in person, participate in a general review, take a final examination, and at the close of the seminar are awarded the ASEE Degree.

### Accreditation, and G.I. Bill Approval

Grantham School of Engineering is *accredited* by the Accrediting Commission of the National Home Study Council, is *approved* under the G.I. Bill, and is *authorized* under the laws of the State of California to grant academic degrees.

### The Home-Study Method

Grantham School of Engineering is a *specialized*, college-level, educational institution—established in 1951—which teaches engineering by the so-called “new approach.” This is the method (often referred to by names such as “independent study”) that has recently created great interest among college educators. Actually, this “new approach” is not new at all. Grantham and many other good schools have been using it for years, under such names as “home study” and “correspondence instruction.”

As a technician, you already know the “hardware” side of electronics, and you can upgrade from technician to engineer while you continue your employment as a technician. Get complete details. Mail the coupon for our free bulletin.

**GRANTHAM SCHOOL OF ENGINEERING**  
 “the college that comes to you”

1505 N. Western Av, Hollywood, CA 90027

*Grantham is an Accredited Member of the National Home Study Council.*

# If You Were the BOSS and Had to CUT BACK, **WOULD YOU FIRE YOU?**

If you were the boss, how would you choose who to let go?

1. You'd probably fire the man who never completed his electronics education. This man may have a solid foundation, but he *quit learning* before he went far enough.
2. You'd probably fire the man who is only a "tinkerer" because his electronics education went *far enough* but *not deep* enough. A specialist must really understand before he can really perform.
3. You'd probably fire the man who has been in electronics for many years but has *not kept up to date* in this rapidly changing industry. Nothing becomes obsolete so quickly as the man who does not study.

***Who Will YOUR Boss Fire When He Has To Cut Back?  
DON'T BE THE MAN TO GET THE AXE!***

Investigate *now* the Grantham college-level program in electronics engineering, offered (by correspondence) to working technicians while they remain on their jobs. Grantham lessons place heavy stress on fundamental concepts of logic and mathematics (taught so you can understand them), and build from there in a systematic manner, covering physics, circuits, and systems. The lessons are easy to understand because they are carefully written, with step-by-step explanations and consistent review and regrouping of ideas.

*Now is the time*, not only to protect yourself from unemployment, but also *to prepare yourself for the greater demand in engineering* which is sure to come. You can't become an engineer in a few short weeks; it takes many months. You can be upgrading yourself in your present job while the economy is "slow", and then *be ready to move into engineering* when the national economy gets going again. Yes, now is the time to prepare, so that *you* will be ready to take advantage of opportunity when it presents itself.

Upgrading in your career begins when you begin studying the very first lessons of the Grantham ASEE Degree program in Electronics Engineering. You may very well move up *from* electronics technician *to* electronics *engineering* technician upon completion of the first 100 lessons (out of a total of 400 in the entire program). Upon completion of the program and receiving your ASEE Degree, you are then ready to work as an *electronics engineer*.

## Accreditation and G.I. Bill Approval

Grantham School of Engineering is *accredited* by the Accrediting Commission of the National Home Study, is *approved* under the G.I. Bill, and is *authorized* under the laws of the State of California to grant academic degrees.

## Not For Beginners

The Grantham educational program in electronics engineering is *not for beginners*. Every point is explained just as carefully as if you were a beginner, but this program is designed, written, and taught *for* and *to* experienced technicians; beginners are not accepted for enrollment. As a technician, you already know the "hardware" side of electronics, and you can upgrade from technician to engineering technician, and then to engineer, while you continue your employment in electronics.

## Grantham School of Engineering

• Established in 1951 •

1505 N. Western Ave.  
Hollywood, Calif. 90027

Telephone:  
(213) 469-7878



Get complete details. Fill out and mail the post card, or the coupon printed on the previous page.

discussed in the previous article is shown in Fig. 3. The collector current flowing through  $R_C$ , as well as the stability factors, can be approximated from the equations in the drawing.

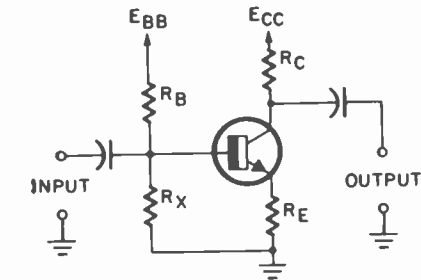

$$I_C = \frac{E_{BB} R_X + (R_E R_B + R_E R_X + R_B R_X) I_{CBO}}{R_E (R_B + R_X) + R_B R_X / \beta}$$

$$S = \frac{R_E R_B + R_E R_X + R_B R_X}{R_E (R_B + R_X) + R_B R_X / \beta}$$

$$S_E = \frac{R_X}{R_E (R_B + R_X) + R_B R_X / \beta}$$

$$S_\beta = \frac{(E_{BB} R_X + I_{CBO} R_B R_X) (R_E R_B + R_E R_X + R_B R_X)}{[\beta R_E (R_B + R_X) + R_B R_X]^2}$$

FIG. 3—BIAS CIRCUIT using resistors  $R_X$  and  $R_B$  to establish good stability factor approximating "1".

(Note that the equations are not to be memorized, but are used for simply substituting numbers found in the circuits. They may appear complex, but step-by-step substitution of circuit component values, will indicate just how easily they can be utilized.)

As can be seen in Fig. 4, the equa-

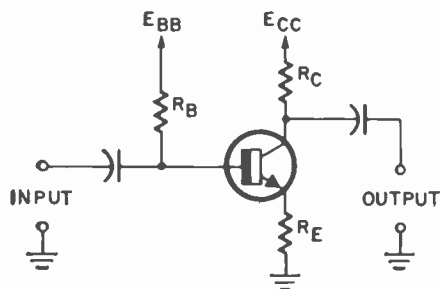

$$I_C = \frac{E_{BB} + (R_E + R_B) I_{CBO}}{R_E + R_B / \beta}$$

$$S = \frac{R_E + R_B}{R_E + R_B / \beta} \quad S_E = \frac{1}{R_E + R_B / \beta}$$

$$S_\beta = \frac{E_{BB} (R_E + R_B) + I_{CBO} R_B (R_E + R_B)}{(\beta R_E + R_B)^2}$$

FIG. 4—THE BIAS CIRCUIT OF FIG. 3, but  $R_X$  has been omitted.

tions for this circuit are simpler than those applying to the single battery bias circuit in Fig. 3. This is due to the absence of  $R_X$ . The two sets of equations are identical, but in the latter figure,  $R_X$  was made infinite in value.

Should the circuit be further simplified to that in Fig. 5, where  $R_X$  is omitted, the equations in the figure are used. The stability here is at its worst

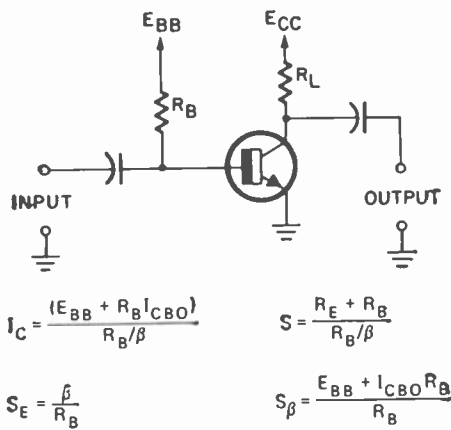

$$I_C = \frac{(E_{BB} + R_B I_{CBO})}{R_B / \beta}$$

$$S = \frac{R_E + R_B}{R_B / \beta}$$

$$S_E = \frac{\beta}{R_B}$$

$$S_\beta = \frac{E_{BB} + I_{CBO} R_B}{R_B}$$

FIG. 5—FURTHER SIMPLIFICATION of the circuit of Fig. 3 omits both  $R_X$  and  $R_E$ . Stability is at its worst here.

for no external circuitry is used to compensate for variations.

The bias circuit in Fig. 6 is similar to the one in Fig. 3, but with the addition of dc feedback. This arrangement provides the best stability of all when using simple resistor circuits for com-

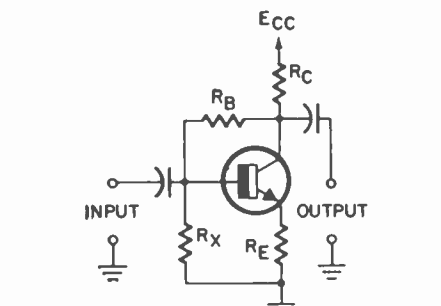

$$I_C = \frac{E_{CC} R_X + [(R_C + R_E + R_B) R_X + (R_C + R_B) R_E] I_{CBO}}{(R_C + R_B + R_X) R_E + R_X R_C + R_B R_X / \beta}$$

$$S = \frac{(R_C + R_E + R_B) R_X + (R_C + R_B) R_E}{(R_C + R_B + R_X) R_E + R_X R_C + R_B R_X / \beta}$$

$$S_E = \frac{R_X}{(R_C + R_B + R_X) R_E + R_X R_C + R_B R_X / \beta}$$

$$S_\beta = \frac{[(R_C + R_B + R_X) R_E + (R_C + R_B) R_X] [E_{CC} R_X + R_B R_X I_{CBO}]}{[(R_C + R_B + R_X) R_E + R_X R_C] \beta + R_B R_X)^2}$$

FIG. 6—VERY STABLE BIAS CIRCUIT using dc feedback from the collector to the base.

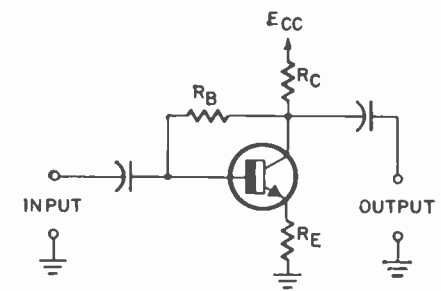

$$I_C = \frac{E_{CC} + (R_C + R_E + R_B) I_{CBO}}{R_C + R_E + R_B / \beta}$$

$$S = \frac{R_C + R_E + R_B}{R_C + R_E + R_B / \beta} \quad S_E = \frac{1}{R_C + R_E + R_B / \beta}$$

$$S_\beta = \frac{(R_C + R_E + R_B) (E_{CC} + I_{CBO} R_B)}{[\beta (R_C + R_E) + R_B]^2}$$

FIG. 7—CIRCUIT OF FIG. 6 with  $R_X$  removed. Stability suffers to some degree.

pensation. Once again, the equations are stated in the figure.

The circuit in Fig. 6 still has good stability characteristics if  $R_X$  is omitted, as in Fig. 7. The equations here are identical to those stated in Fig. 6, if  $R_X$  in that figure is considered infinite.

The collector current and stability equations for the emitter bias circuit are shown in Fig. 8. Note the similarity to

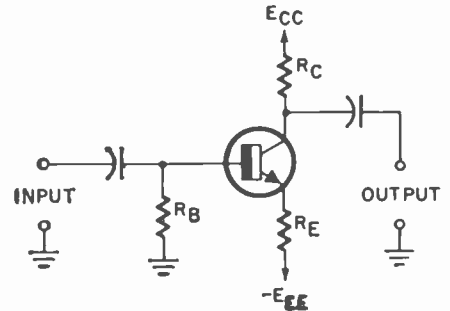

FIG. 8—EMITTER BIAS CIRCUIT uses the same equations as in Fig. 4. Only  $E_{EE}$  is substituted for  $E_{BB}$ .

the equations for the fixed bias circuit in Fig. 4.

One last bias circuit, discussed in the interest of stability, is shown in Fig. 9. This configuration looks very similar

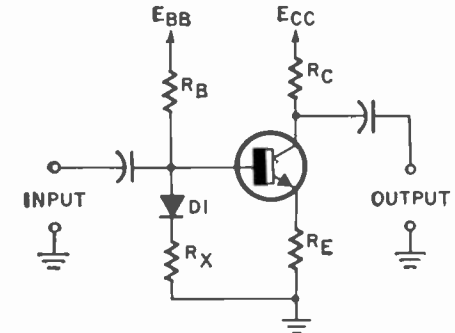

FIG. 9—BIAS CIRCUIT USES DIODE D1 to compensate for forward biased base-emitter junction voltage variation with temperature.

to the one drawn in Fig. 3, but with the addition of a forward biased diode. The voltage across the diode D1 is identical to that across the forward biased diode junction composing the base-emitter of the device. The voltage across this diode D varies with temperature identically as does the voltage across the base-emitter junction. The stability equations in Fig. 3 can be used for this circuit, but the actual stability S, is much better than indicated from the calculations.

### Design procedures

The stability equations are great for checking the circuits after they have been designed. But how should we proceed to execute a good stable design?

A few general rules can be deduced from the equations. In all bias circuits, make  $R_X$  as small as practical and  $R_E$  as large as possible.

Now, if germanium transistors are used, where  $I_{CBO}$  is usually a very important factor affecting stability, S is reasonably small if  $R_C$  is large and  $R_B$  is minimized.

$V_{BE}$  and beta vary considerably with temperature regardless of the transistor type. Furthermore, beta can have any one of a large range of values within any specific transistor category. The stability factors concerning these items are best limited if  $R_B$  and  $R_C$  are large resistors.

Using these basic rules, we can proceed with a design example to illustrate procedures. Suppose we want to design an audio preamplifier using a 12-volt battery supply. The low-noise 2N3391-A silicon transistor is to be used. The beta range is 250 to 500, with a mean average of 375, and the leakage current at 25°C is 0.1  $\mu$ A ( $10^{-7}$  or 0.0000001 amperes). The transistor is to be used in an ambient temperature ranging from 25°C to 55°C. The common-emitter circuit is to have a minimum ac voltage gain of 10 and a maximum output impedance of 6000 ohms. The maximum input signal it should accommodate is 0.8 volts peak-to-peak so that the output voltage must be able to swing a minimum of  $0.8 \times 10 = 8$  volts.

Start the design of the circuit by establishing the output load resistor value. The maximum output impedance is stated as 6000 ohms. To assure this, put a load resistor of less than 6000 ohms in the collector circuit. Using the next lower EIA standard value, let  $R_C = 5,600$  ohms.

The maximum ac gain of the circuit has been specified at 10. It has been mentioned in a previous article, and will be discussed further in subsequent articles, that ac voltage gain is approximately equal to the ratio of the resistor in the collector circuit to the resistor in the emitter circuit, or  $A_V = R_C/R_E$  for high beta transistors. So for a minimum gain of 10,  $R_E$  must be less than 560 ohms. To compensate for losses and ac emitter resistance ( $26/I_E$ ) discussed in a previous article, we will make  $R_E$  equal to 470 ohms. The approximate gain should then be about  $(5,600 \text{ ohms})/(470 \text{ ohms}) = 12$ .

Now plot the load line. It is to represent the sum of  $R_C$  and  $R_E$  or 5,600 ohms + 470 ohms = 6,070 ohms. A plot of a 6000-ohm load line is enough. Using a 12-volt supply, note the plot drawn in Fig. 10-a. The actual transistor characteristic curves, unnecessary for this discussion, have been omitted from the drawing in the interest of clarity.

It has been stated earlier that an 8-volt peak-to-peak output voltage swing is required to accommodate the 0.8-volt peak-to-peak maximum input signal. The peak-to-peak collector current swing is then  $8/6000$  ohms or 1.33 mA. The bias must be arranged so that the collector current can swing this 1.33 mA. Should the bias be set at a minimum extreme position while accommodating the swing, the current varies from 0 mA to 1.33 mA. At the opposite extreme position, the collector current accommodates this swing if it varies from 2 mA - 1.33 mA = 0.67 mA to 2 mA. These two borderline conditions are shown in Figs. 10-b and 10-c, respectively. Obviously, the idling bias currents are at the middle of each curve, or  $(1.33 -$

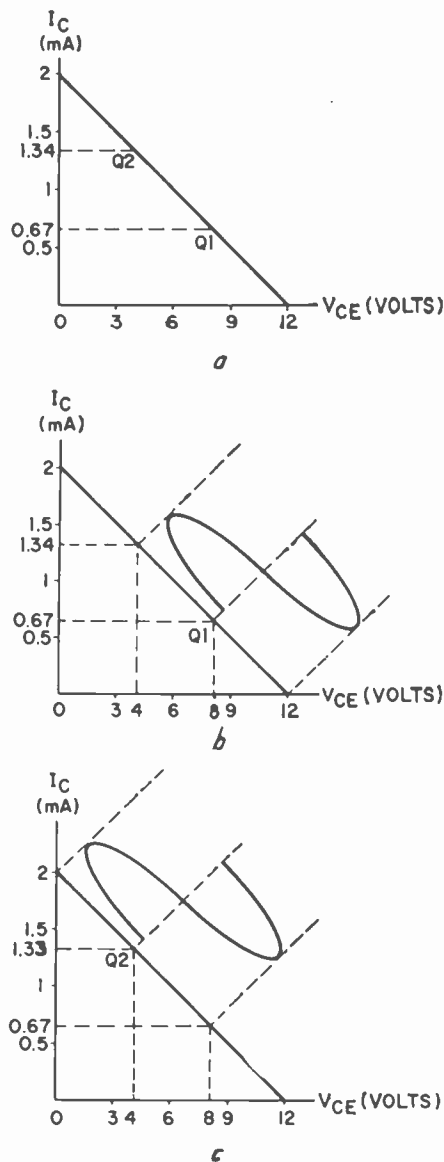

FIG. 10—**a)** PLOT OF LOAD LINE for the problem discussed in the text. **b)** QUIESCIENT POINT at one possible extreme position is shown. **c)** SECOND POSSIBLE extreme position quiescent point.

$0)/2 = 0.67$  mA in one case and  $(2 - 0.67)/2 + 0.67 = 1.34$  mA for the second case.

Fig. 10-b may be considered the condition at one extreme when the transistor is operating in a 25°C ambient temperature, and beta is at the minimum end of its specification range. In this case,  $I_{CBO}$  is at its minimum specified value.  $V_{BE}$ , the forward biased base-emitter voltage is at the maximum of about 0.2 volt for germanium devices and 0.6 volt for silicon transistors.

Fig. 10-c the other possible extreme, assumes the transistor is operating at the maximum temperature while beta is at the maximum of its range on the 2N3391-A specification sheet. It also assumes that  $V_{BE}$  has dropped at about 2.5 mV (.0025 volt) for each degree the transistor ambient temperature has risen above 25°C, while  $I_{CBO}$  has increased to its maximum value under the stated temperature limit. (Recall that to a good approximation,  $I_{CBO}$  doubles for every

10°C rise in the temperature of germanium transistors and for every 6°C rise in the temperature of silicon devices.)

From this analysis, we can then determine that the idling collector current change must be limited to  $1.34 - 0.67 = 0.67$  mA (the difference between the two idling currents), as the transistor temperature rises from 25°C to 55°C. We also determined that at 25°C, the idling current must be adjusted to 0.67 mA (calculated above from Fig. 10-b). The adjustment at 25°C assumes the minimum beta and  $I_{CBO}$  and the maximum  $V_{BE}$ .

The remainder of the design procedure begins by surveying the various bias circuits that can be used. Initially, select the simplest logical one, design it using procedures outlined in the previous article, and substitute the component values in the appropriate stability equations. Note the effect of the initially designed circuit on changes of  $I_C$ , considering each stability factor individually. Find the total change of  $I_C$  by summing the individual effects. Then check if the resulting idling current (the initial quiescent current plus the sum of the  $\Delta I_C$ 's) is compatible with the plot in Fig. 10-c. Thus,  $\Delta I_C$  from all causes should not exceed  $1.34 \text{ mA} - 0.67 \text{ mA}$  if the circuit is to operate under all desired conditions.

Should the change in  $I_C$  exceed the required value (0.67 mA in this case) compute the components needed for the next bias circuit in the complexity sequence. Once again calculate the stability factors and determine the ultimate effect on  $I_C$ . Add circuit complexities until you find a circuit which will provide the desired results.

An alternate and somewhat more sophisticated design method uses extreme points in the engineering procedure. It starts by assuming the simple bias circuit in Fig. 11. Two equations

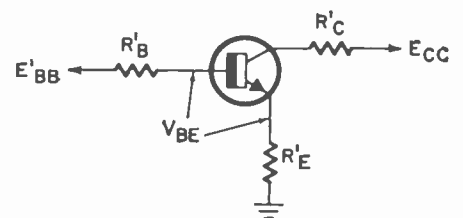

FIG. 11—**BASIC CIRCUIT** used in extreme point method of engineering stability into a design.

are established for the base circuit. The first assumes one extreme of collector current, the minimum value, where  $I_C = I_C(\text{min})$  and the transistor operates under its minimum temperature condition. Here,  $I_{CBO}$  is at its minimum value,  $V_{BE}(\text{min})$  is at its maximum,  $V_{BE}(\text{max})$ , and beta is at its minimum,  $\beta(\text{min})$ . Assume  $I_C = I_E$ . The base supply voltage is then equal to

$$E'_{BB} = I_C(\text{min}) \left( R'_E + \frac{R'_B}{\beta(\text{min})} \right) + I_{CBO}(\text{min}) R'_B + V_{BE}(\text{max}) \quad \text{Eq. 7}$$

A second equation assumes the maximum collector current, temperature and beta. The base-emitter voltage is at

(continued on page 92)



# 6 easy projects for beginners

by **MATTHEW MANDL**  
CONTRIBUTING EDITOR

*One- and two-transistor projects that work.  
Experiment with them on a circuit board*

THERE ARE MANY SIMPLE CIRCUITS which the newcomer in electronics can build to learn assembly methods, become familiar with fundamental theory, and at the same time end up with some useful devices. The six projects discussed here were selected because they all relate to amplifier-oscillator circuitry and illustrate how different items can be designed from similar electronic foundations.

These circuits are reliable and virtually fool-proof in operation. Parts are easy to get. Just enough experimenting is needed to give you a feel of electronic design in getting the end results you want.

## 1. Code-practice oscillator

A code-practice oscillator suitable for use with either a loudspeaker or ear-phones is shown in Fig. 1. Only a single transistor is needed, plus a capacitor, a variable resistor and a transformer. It will work with almost any low-cost audio-type transistor, either pnp or npn types. If an npn transistor is used, the battery polarities would have to be reversed. A 2N404 pnp transistor was used initially, and several others were tried and found to operate satisfactorily. Similarly, npn types such as 2N338, 2N498, and 2N560 were ok.

The transformer is a tube-type audio output, with the primary attached to the collector of the transistor and the battery as shown. The frequency of the signals produced by this oscillator can be changed by varying the 500,000-ohm pot. The value of the capacitor also has some effect on frequency, as does the particular design of the transformer and the transistor.

The whole unit can be built into a small plastic box, with the transformer dictating the space required. It is preferable to use a transistor socket to avoid possible damage to the transistor during soldering and to permit easy changing of the transistor for experimental purposes.

If you must solder the transistor into the circuit, hold the leads from the unit with a thin-nose pliers to absorb heat or attach an alligator clip to the lead during the soldering process. If the circuit fails to oscillate, recheck wiring carefully and make sure connections are tight. You may have to reverse the connections of *either* the primary or the secondary of the transformer (but not both) to get the proper phasing for oscillations. For instance, remove the ground from the secondary and wire it to the top of the winding and take the feed-back lead from the top and wire it to the bottom.

The oscillator of Fig. 1 generates a signal because the conduction of the transistor is periodically blocked and released. Hence, this device is called a *blocking oscillator*.

When the telegraph key is closed it applies the negative battery terminal to the base and collector circuits. Thus it supplies forward bias between base and emitter (negative and positive) and reverse bias between collector and emitter. Under these conditions the transistor will conduct. The rising collector current

flowing through the transformer primary induces a voltage in the secondary, since a *changing* signal amplitude causes induction. The signal across the secondary charges the capacitor so it is negative to the transformer side and positive toward the base. This is a form of reverse bias between the base and emitter and hence stops transistor conduction.

Now the capacitor discharges through the resistance until forward bias again prevails between base and emitter. At this time conduction occurs again

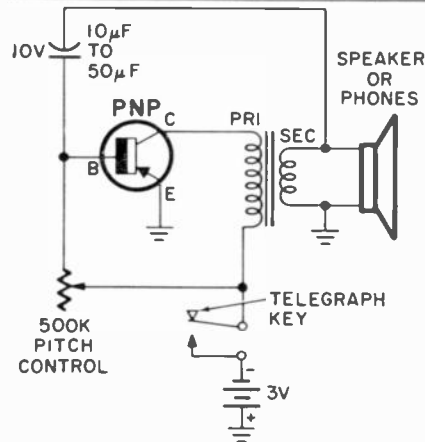

**FIG. 1—CODE PRACTICE OSCILLATOR** (above) is built on circuit board as shown below.

**FIG. 2—ELECTRONIC PITCH PIPE** (right) is built on the same board. Select a capacitor value that gives you the desired tone.

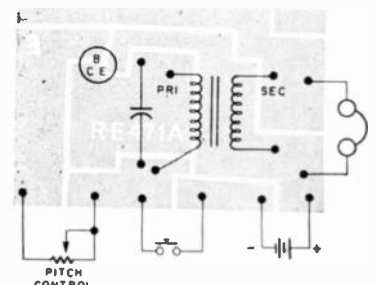
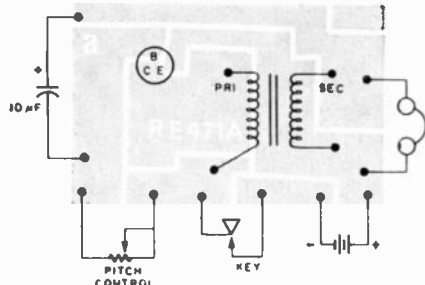
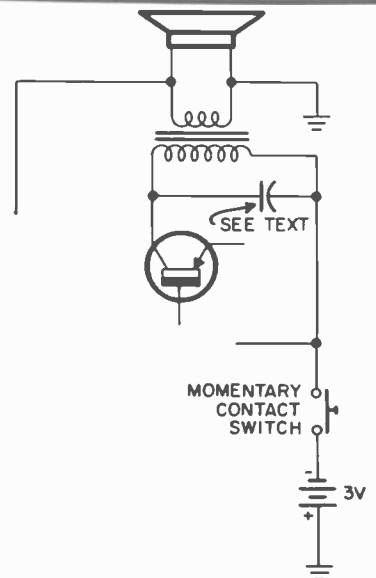

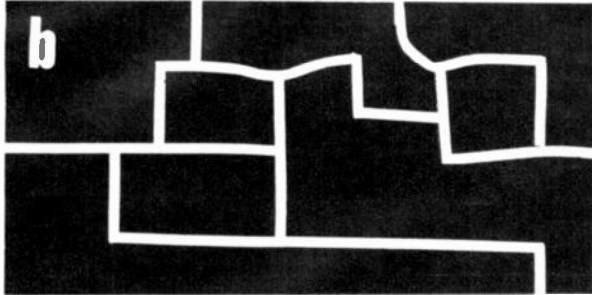
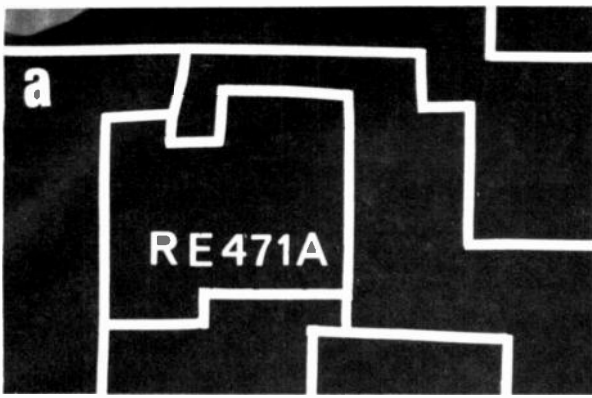

**FULL SIZE CIRCUIT BOARD PATTERNS.** One set of these boards is all you need to try the six circuits presented in this article. Solder component leads directly to the foil side of the board.

and the entire cycle is repeated. The time of discharge depends on the R-C constant. A larger capacitor or higher resistance slows down the discharge rate and decreases the frequency of oscillations.

## 2. Electronic pitch pipe

The oscillator of Fig. 1 can be used as an electronic pitch pipe to produce any tone needed to tune a guitar, saxophone, or other musical instrument. Instead of the telegraph key, an on-off

switch is substituted. A push-button momentary-contact type switch such as used on doorbells might be preferable since it would be easier to obtain the tone with one hand during tune up.

The variable resistor in Fig. 1 provides a limited frequency range and to extend the tone obtained to that needed for tuning purposes, you may have to shunt the transformer primary with a capacitor as shown in Fig. 2. Try various values from 0.001 to 0.05 $\mu$ F in conjunction with changes in the variable re-

**PARTS FOR THIS ARTICLE**

Parts needed to build the projects described in this article are specified in the text and the individual schematics.

An etched and tinned G-10 undrilled circuit board is available as part no. 471A-B for \$2.25.

A kit of the following parts plus the circuit board is also available. Parts include:

- Telegraph key
- 3 Transistors
- 5 Capacitors (.05, .02, 0.1, 8, and 10  $\mu$ F)
- Transformer
- 2 Resistors
- 3 Pots (20K, 250K, 500K)
- 2 1/2" PM speaker

Switches, probe, earphone, plug, jack and battery are not included.

This kit, order no. 471AK is \$8.85. Order from Photolume Corp., 118 East 28 Street, New York, N. Y. 10016

sistor until the desired frequency output is obtained.

Use a pitch pipe or tuning fork as a reference standard. Make sure batteries are fresh, since a drop in potential will alter frequency output. Any small speaker will suffice, including the subminiature types. With a 3-volt source, adequate volume will be obtained.

## 3. Signal injector

By arranging the output circuit of the oscillator as shown in Fig. 3, a convenient and compact audio-signal generator is formed for signal-tracing purposes in audio circuits. The 0.03- $\mu$ F capacitor blocks dc between the generator and the audio circuits under test, while permitting the ac signal to be applied. An alligator clip joins the ground system of the signal generator to that of the audio system under test while the metal-pointed probe permits manual signal injection at any point desired.

A typical signal-tracing setup is shown in Fig. 4. The signal is injected into one audio stage and if no output is obtained, the defective circuit has been isolated. The presence or absence of a signal can be checked with earphones, using a series capacitor to block dc from the phones. Another method is to start with the last stage and check for an output from the speaker instead of phones. If an output is obtained, move the audio oscillator probes to the input of the preceding audio stage, again listening for the output signal from the speaker. Once the defective stage is found, voltage, resistor, and transistor checks will isolate the defective component.

The audio signal generator is also useful to check for defective video-amplifier stages in TV sets, since these are basically audio amplifiers with extended frequency ranges to accommodate the detected picture signal. The injected audio signal will produce horizontal bars on the screen if the video stage is not defective and passes the signal through.

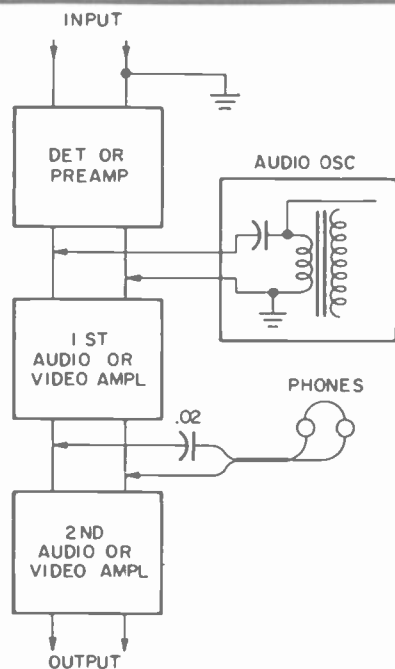
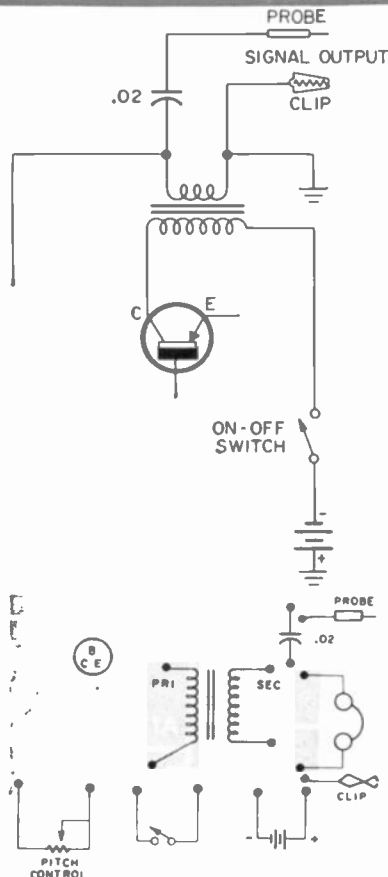

**FIG. 3—SIGNAL INJECTOR** is really another variation of the code oscillator.

**FIG. 4—(right) USING THE SIGNAL injector** is easy, as you can see here.



FIG. 5—(above) HORIZONTAL BARS are produced when using signal injector on video amplifier stage.

FIG. 6—(right) AUDIO OSCILLATOR has variable frequency output.

FIG. 7—(far right) AUDIO AMPLIFIER feeds headphones or small speaker. Bottom end of R2 goes to plus instead of minus side of battery.

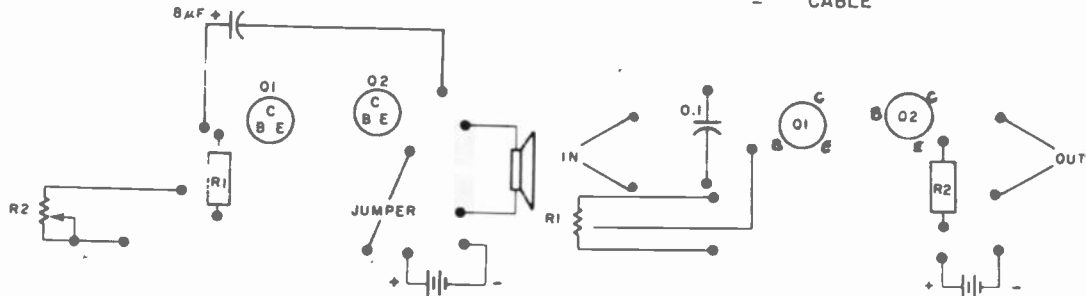
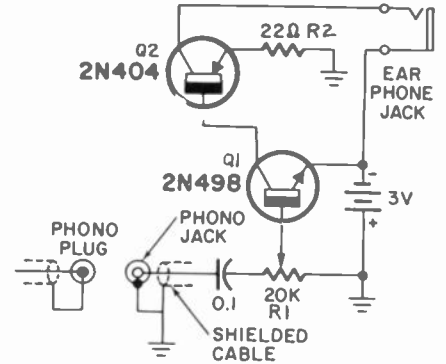
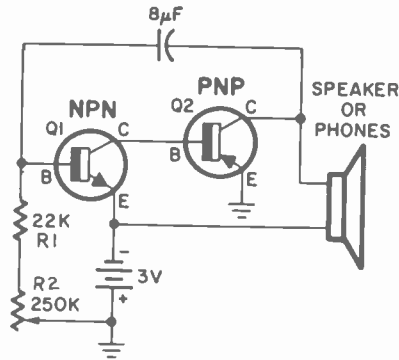

The bars, as shown in Fig. 5, will be evenly spaced and will have similar thicknesses if linearity is good. Thus, height and linearity can also be checked with this procedure. The number of bars visible depends on the frequency of the injected signal.

## 4. Metronome

If you play a musical instrument and like to make tape recordings of yourself or your group, you've probably noticed the tendency to speed up or slow down the tempo in certain passages. A conventional metronome can't be used because the tick-tock would be recorded with the music. Hence, what you need is an electronic metronome with earphone output. If sufficient power were also available to drive a speaker it would be convenient during group rehearsals when no recording is being made.

A circuit which meets these requirements is shown in Fig. 6. Two transistors provide for adequate signal level outputs and the operation is virtually foolproof. Note then the first stage uses an npn transistor which feeds a pnp. The output from the second transistor not only is applied to the speaker or phones, but is also coupled back to the base input of the first transistor. The result is an intermittent blocking of the conduction at a rate again depending on the R-C constants involved. Proper phasing is automatic since the phase of the output signal from Q2 is the same as that at the base of Q1.

The type of transistor is not too important and virtually any audio type will function. Satisfactory results were obtained by using any of the following npn types which were on hand: 2N293, 2N338, 2N498, and 2N560. For the pnp transistor, each of the following performed well: 2N329A, 2N404; 2N465, and 2N1413.

You can even interchange the two, using a pnp for Q1 and an npn for Q2. If you do this, however, you must reverse the battery polarity, placing the

negative potential at ground.

The value of the feedback capacitor determines the range of frequencies over which the variable resistor will tune. For a slower ticking rate the size of the capacitor is increased. If you make the capacitor too small you will get a steady oscillation just as with the blocking oscillator. For speaker operation you can increase the battery potential to 4.5 volts. For earphone operation 3 volts or less will provide sufficient volume.

If you lean toward classical music you can calibrate the frequency range and use a pointer knob on the variable resistor and a dial, showing frequency. The following shows the approximate frequencies for the various tempo designations:

	Beats Per Minute
Largo	44 to 72
Larghetto	72 to 100
Adagio	100 to 126
Andante	126 to 154
Allegro	154 to 184
Presto	184 to 208

In calibrating, however, you must remember that a change of speaker or phones (with a different impedance) will affect the frequency rate. Similarly, a change of resistance may alter the rate, as will low battery voltages (or voltages other than that used during calibration).

The output from the transistors is low-impedance and works best into a low-impedance unit such as the voice coil of a speaker or 4- to 16-ohm earphones. Generally, the older-type 2000-ohm earphones will give poor results.

## 5. Signaling device

The rapid "put-put" sound which can be obtained from the oscillator of Fig. 6 makes a good signalling device because it is an attention getter. A push button can be substituted for the switch and used as a doorbell or a call signal to a workshop, etc. Because of the low voltage involved, regular bell wire can

be used between the switch and the oscillator.

On occasion, slow-rate oscillators of this type have been used as an "annoyance box" for practical joke purposes. When the rate is adjusted for a beat only every 5 or 10 seconds, prolonged listening can irritate some people, particularly if the device is hidden in the room and the sound source is unidentified. For such a slow repetition rate the capacitor value must be from about 50-µF to 100 µF, depending on resistance and part values.

## 6. Audio amplifier

Without the feedback capacitor in Fig. 6 a conventional audio amplifier is formed. For satisfactory operation, however, some circuit changes should be made. For audio amplification transistor circuitry, component values are more critical because of input and output impedance factors and their effect on efficiency. Hence, for the circuit shown in Fig. 7 the values only hold for the 2N498 input transistor and the 2N404 output transistor. For other transistors you will have to try different values for the volume-control input resistor, as well as for the stabilizing resistor in the emitter of the output transistor.

Other precautions call for shielded input cable and short (or shielded) connections between the input plug and the base of the transistor. The circuit shown in Fig. 7 develops about 50 mW (depending on the value of the drive signal and the type transistor used in the output stage). Thus, loudspeaker operation is possible, though the volume is not too loud. This 2-transistor audio amplifier is most suitable for low-impedance earphone listening, with a fairly good input signal such as from a crystal phonograph pickup, a tape deck, or the AM output from a diode detector. Since no transformer or other bulky parts are present, the unit can be built on a miniature chassis just large enough to accommodate the input plus, output terminals, and components. R-E

# Kwik-Fix™ picture and waveform charts

by Forest H. Belt & Associates\*

SCREEN SYMPTOMS AS GUIDES

WHERE TO CHECK FIRST

SYMPTOM PIC	DESCRIPTION	VOLTAGE	WAVEFORM	PART
	Picture dark; not enough brightness	all Q1 voltages	not much help	R2, R3, R5, R6, R8, R10, C3
	Picture too bright and out of focus; brightness control has little effect	Q2 emitter	WF3	R2, R7, R15, R16, R17, R18, D1, Q2
	Picture goes out of focus and dark as brightness is turned up	Q2 emitter Q2 collector	WF5	R4
	Screen black	Q1 collector	WF3 WF5	R4, R6, R7, R14, R18, L1, Q1
	Contrast too high; brightness control can make picture out-of-focus	no help	WF2 through WF6	C3
	Picture too bright; focus okay; brightness control has little or no effect	all Q1 voltages	not much help	R5, R7, R8, R9, R10
	Picture streaky; arcing audible in chassis	no help	no help	R15 arcing
	No picture; raster brightness can't be turned down	Q1 base Q2 emitter	WF3 WF5	R18

\*an Easy Read™ feature by FOREST H. BELT & Associates © 1971

**NOTES:**

Use this guide to help you find which key voltage or waveform to check first.  
Study the screen and the action of the three controls.  
The most helpful clues for each symptom are found at the key test points listed for it.

Make voltage or waveform checks as suggested.  
Use the Voltages Guide or Waveforms Guide to analyze the results of those tests.  
For a quick check, test or substitute the parts listed as the most likely cause of the symptom.

(continued on page 68)

# One of our students wrote this ad!

Harry Remmert decided he needed more electronics training to get ahead. He carefully "shopped around" for the best training he could find. His detailed report on why he chose CIE and how it worked out makes a better "ad" than anything we could tell you. Here's his story, as he wrote it to us in his own words.

## By Harry Remmert

**A**FTER SEVEN YEARS in my present position, I was made painfully aware of the fact that I had gotten just about all the on-the-job training available. When I asked my supervisor for an increase in pay, he said, "In what way are you a more valuable employee now than when you received your last raise?" Fortunately, I did receive the raise that time, but I realized that my pay was approaching the maximum for a person with my limited training.

Education was the obvious answer, but I had enrolled in three different night school courses over the years and had not completed any of them. I'd be tired, or want to do something else on class night, and would miss so many classes that I'd fall behind, lose interest, and drop out.

### The Advantages of Home Study

Therefore, it was easy to decide that home study was the answer for someone like me, who doesn't want to be tied down. With home study there is no schedule. I am the boss, and I set the pace. There is no cramming for exams because I decide when I am ready, and only then do I take the exam. I never miss a point in the lecture because



Harry Remmert on the job. An Electronics Technician with a promising future, he tells his own story on these pages.

it is right there in print for as many re-readings as I find necessary. If I feel tired, stay late at work, or just feel lazy, I can skip school for a night or two and never fall behind. The total absence of all pressure helps me to learn more than I'd be able to grasp if I were just cramming it in to meet an exam deadline schedule. For me, these points give home study courses an overwhelming advantage over scheduled classroom instruction.

Having decided on home study, why did I choose CIE? I had catalogs from six different schools offering home study courses. The CIE catalog arrived in less than one week (four days before I received any of the other catalogs). This indicated (correctly) that from CIE I could expect fast service on grades, questions, etc. I eliminated those schools which were slow in sending catalogs.

### FCC License Warranty Important

The First Class FCC Warranty\* was also an attractive point. I had seen "Q" and "A" manuals for the FCC exams,

\*CIE backs its FCC License-preparation courses with this famous Warranty: graduates must be able to pass the applicable FCC License exam or their tuition will be refunded in full.



and the material had always seemed just a little beyond my grasp. Score another point for CIE.

Another thing is that CIE offered a complete package: FCC License and technical school diploma. Completion time was reasonably short, and I could attain something definite without dragging it out over an interminable number of years. Here I eliminated those schools which gave college credits instead of graduation diplomas. I work in the R and D department of a large company and it's been my observation that technical school graduates generally hold better positions than men with a few college credits. A college degree is one thing, but I'm 32 years old, and 10 or 15 years of part-time college just isn't for me. No, I wanted to *graduate* in a year or two, not just *start*.

If a school offers both resident and correspondence training, it's my feeling that the correspondence men are sort of on the outside of things. Because I wanted to be a full-fledged student instead of just a tagalong, CIE's exclusively home study program naturally attracted me.

Then, too, it's the men who know their theory who are moving ahead where I work. They can read schematics and understand circuit operation. I want to be a good theory man.

From the foregoing, you can see I did not select CIE in any haphazard fashion. I knew what I was looking for, and only CIE had all the things I wanted.

#### Two Pay Raises in Less Than a Year

Only eleven months after I enrolled with CIE, I passed the FCC exams for First Class Radiotelephone License with Radar Endorsement. I had a pay increase even before I got my license and *another* only ten months later. I'm getting to be known as a theory man around work, instead of one of the screwdriver mechanics.

These are the tangible results. But just as important are the things I've learned. I am smarter now than I had ever thought I would be. It feels good to know that I know what I know now. Schematics that used to confuse me completely are now easy for me to read and interpret. Yes, it is nice to be smarter, and that's probably the most satisfying result of my CIE experience.

#### Praise for Student Service

In closing, I'd like to get in a compliment for Mr. Chet Martin, who has faithfully seen to it that my supervisor knows I'm studying. I think Mr. Martin's monthly reports to my supervisor and generally flattering commentary have been in large part responsible for my pay increases. Mr. Martin has given me much more student service than "the contract calls for," and I certainly owe him a sincere debt of gratitude.

And finally, there is Mr. Tom Duffy, my instructor. I don't believe I've ever had the individual attention in any classroom that I've received from Mr. Duffy. He is clear, authoritative, and spared no time or effort to answer my every question. In Mr. Duffy, I've received everything I could have expected from a full-time private tutor.

I'm very, very satisfied with the whole CIE experience.

#### ENROLL UNDER NEW G.I. BILL

All CIE courses are available under the new G.I. Bill. If you served on active duty since January 31, 1955, or are in service now, check box on reply card or coupon for G.I. Bill information.

Every penny I spent for my course was returned many times over, both in increased wages and in personal satisfaction.

Perhaps you too, like Harry Remmert, have realized that to get ahead in Electronics today, you need to know much more than the "screwdriver mechanics." They're limited to "thinking with their hands"...learning by taking things apart and putting them back together...soldering connections, testing circuits, and replacing components. Understandably, their pay is limited—and their future, too.

But for men like Harry Remmert, who have gotten the training they need in the fundamentals of Electronics, there are no such limitations. As "theory men," they think with their heads, not their hands. For trained technicians like this, the future is bright. Thousands of men are urgently needed in virtually every field of Electronics, from two-way mobile radio to computer testing and troubleshooting. And with this demand, salaries have skyrocketed. Many technicians earn \$8,000, \$10,000, \$12,000 or more a year.

#### Send for Complete Information—FREE

Many men who are advancing their Electronics career started by reading our famous book, "How To Succeed In Electronics." It tells of the many electronics careers open to men with the proper training. And it tells which courses of study best prepare you for the work you want.

If you're "shopping around" for the training you need to move up in Electronics, this 44-page book may have the answers you want. We'll send it to you FREE. With it, we'll also include our other helpful book, "How To Get A Commercial FCC License."

To get both FREE books, just fill out and mail the bound-in postpaid card. If the card is missing, send the coupon below.

## CIE Cleveland Institute of Electronics

1776 East 17th Street, Cleveland, Ohio 44114

Accredited Member National Home Study Council • A Leader in Electronics Training... Since 1934



### NEW COLLEGE- LEVEL COURSE IN ELECTRONICS ENGINEERING

for men with prior experience in Electronics. Covers steady-state and transient network theory, solid state physics and circuitry pulse techniques, computer logic and mathematics through calculus. A college-level course for men already working in Electronics.

Cleveland Institute of Electronics  
1776 East 17th Street, Cleveland, Ohio 44114

Please send me without cost or obligation:

1. Your 44-page book "How To Succeed In Electronics" describing the job opportunities in Electronics today, and how your courses can prepare me for them.
2. Your book on "How To Get A Commercial FCC License."

I am especially interested in:

- |  |  |
|--|--|
| <input type="checkbox"/> Electronics Technology  | <input type="checkbox"/> Electronic Communications             |
| <input type="checkbox"/> Broadcast Engineering   | <input type="checkbox"/> Industrial Electronics and Automation |
| <input type="checkbox"/> First-Class FCC License | <input type="checkbox"/> Electronics Engineering               |

Name \_\_\_\_\_  
(PLEASE PRINT)

Address \_\_\_\_\_

City \_\_\_\_\_

State \_\_\_\_\_ Zip \_\_\_\_\_ Age \_\_\_\_\_

Check here for G.I. Bill information. RE-89

Circle 16 on reader service card

**DC VOLTAGES AS GUIDES**

Voltage change	to zero	very low	low	slightly low	slightly high	high
<b>Q1-base</b> Normal 7 V 5.5 at max brt	R7 shorted	R5 open R7 low R14 open, high	R3 open <sup>2</sup> R7 low R8 open R9 open R18 open, high Q1 faulty	R2 open, high R6 open R8 high	R7 open R18 low	
<b>Q1-emitter</b> Normal 6.5 V 5 V at max brt	R7 shorted	R7 low	R3 open <sup>2</sup> R7 low R8 open R9 open Q1 faulty	R2 open, high R5 open R6 open R8 high R14 open, high R18 open, high	L1 open	R7 open R8 low
<b>Q1-collector</b> Normal 15 V 18 V at max brt		R15 shorted <sup>2</sup> R16 open, high <sup>2</sup> D1 shorted <sup>2</sup> Q1 faulty Q2 faulty <sup>2</sup>	R4 open, high R18 low			R2 open, high R3 open R5 open R6 open R7 open R8 low R14 open, high R18 open, high L1 open Q1 faulty
<b>Q2-base</b> Normal 0.01 V	R2 very low <sup>1</sup> R14 open, high <sup>2</sup>					
<b>Q2-emitter</b> Normal 0. V	R2 very low <sup>1</sup> R4 open, high <sup>1</sup> R7 low <sup>1</sup> R14 open, high <sup>1</sup> R17 open <sup>1</sup> R18 low <sup>1</sup>					
<b>Q2-collector</b> Normal 7 V	R4 open C3 shorted	R4 high R5 low R7 low R14 open, high	R5 low R7 low R8 open R9 open R18 open, high C3 leaky	R2 v. low, open R3 open R8 high Q1 faulty	R7 open	
	<sup>1</sup> Goes positive <sup>2</sup> Volts low because of Brightness setting					

**NOTES:**

Use this guide and the Waveforms Guide to help you pinpoint the faulty part.  
Measure each of the six key voltages with a vtvm.  
For each, move across to the column that describes whatever change you find in that voltage.

Notice which parts might cause that change.  
Finally, notice which parts are repeated in the combination of changes you find.  
Test those parts individually for the fault described.



## WAVEFORMS AS GUIDES

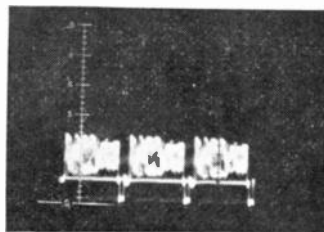

**WF1 Normal 2.5 V p-p**

This is the input waveform, coming from the emitter of the first video amplifier stage. Polarity is the same as the signal right out of the video detector, with sync pulses pointing negative. This waveform is displayed at the horizontal rate, because the vertical-rate waveform here doesn't show much information of value.

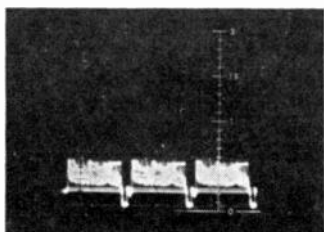

**WF2 Normal 0.7 V p-p**

Taken at the base of Q1, this waveform is the signal from the slider of R3, the contrast control. The amplitude listed here is about normal to produce a picture with good gray scale, if all the stages from here to the picture tube are working properly. Control R3 is set about two-thirds clockwise. The scope locks this waveform best in the negative sync mode.

V p-p low

V p-p high

V p-p zero

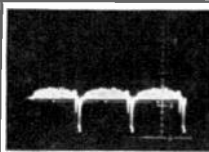

8 V p-p  
C3 open

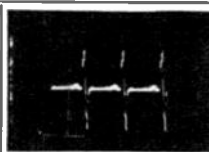

5 V p-p  
R6 high

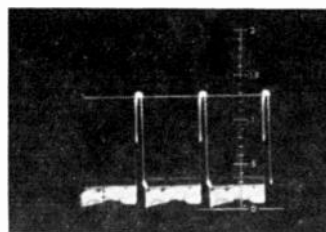

**WF3 Normal 13 V p-p**

Taken at the collector of Q1, with the scope set to show horizontal pulses. The horizontal blanking pulse dominates this waveform, leaving only a small part—about 3 volts peak to peak—of the overall amplitude taken up by the video. The scope locks this waveform best in the positive sync mode.

V p-p low  
R2 open  
R7 open  
R10 low

V p-p high

V p-p zero  
R5 low  
R14 open, high  
R18 open, high  
C3 leaky  
L1 open  
Q1 faulty

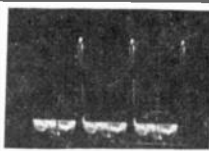

13 V p-p  
R2 open

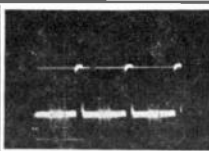

4 V p-p  
R3 open

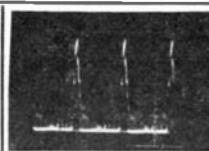

13 V p-p  
R4 open

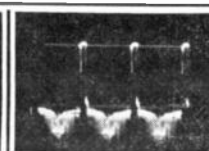

15 V p-p  
C3 open

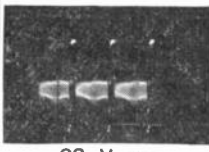

20 V p-p  
R6 high



10 V p-p  
R6 open

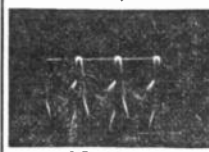

13 V p-p  
R7 low

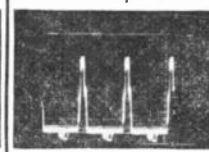

13 V p-p  
R18 low

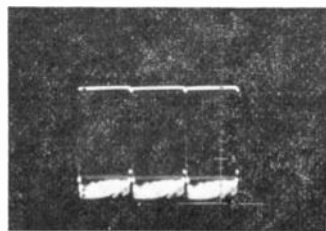

**WF4 Normal 13 V p-p**

This waveform also is taken at the collector of Q1, but with the scope set for vertical frames. Again, the dominant feature is the blanking pulses—vertical blanking in this case. If you look closely, you can see vertical sync pulses between each frame of video. The scope locks this waveform best on positive sync.

V p-p low  
R2 open  
R6 open  
R7 open  
R10 low

V p-p high

V p-p zero  
R6 open  
R14 open, high  
R18 open, high  
L1 open  
Q1 faulty

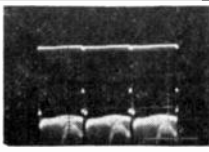

13 V p-p  
C3 open

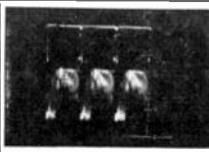

20 V p-p  
R7 low

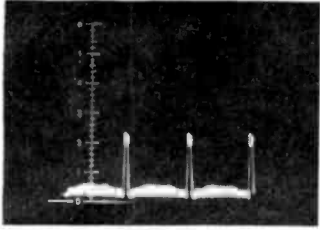

### WF5 Normal 2.5 V p-p

Taken in the emitter circuit of Q1, with the scope set to show horizontal pulses. Video is almost not noticeable, being overshadowed by the horizontal blanking pulses. Blanking is positive-going here, the same as in the collector circuit; being applied at the emitter, the blanking signal isn't inverted by the amplifier (the video is inverted, being applied at the base).

V p-p low R7 low	V p-p high	V p-p zero R2 low				
			4 V p-p R2 open	4 V p-p R3 open	1.5 V p-p R4 high	4 V p-p C3 open
			4.2 V p-p C3 leaky R5 low	6 V p-p R6 open	4 V p-p L1 open	6 V p-p R7 open
			3 V p-p R8 low	3.5 V p-p Q1 faulty	4 V p-p R14 open, high R18 open, high	1 V p-p R18 low

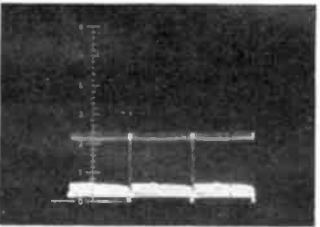

### WF6 Normal 5 V p-p

Also taken in the emitter circuit of Q1, but with the scope set for vertical frames. The blanking pulses dominate. You can see the vertical sync, and notice that it's the same polarity as the sync pulses in WF1 and WF2—negative-going. There's no inversion from base to emitter in this kind of amplifier. The display locks best with scope sync positive.

V p-p low R2 low R7 low	V p-p high R2 open	V p-p zero				
			4 V p-p R3 open	5 V p-p R4 high	7 V p-p C3 open	6 V p-p C3 leaky R5 low
			6 V p-p R6 open	6 V p-p R7 open, high	4 V p-p R8 low	4 V p-p R18 low

**NOTES:**

Use this guide and the Voltages Guide to help you pin down fault possibilities.

Use the direct probe of the scope. For WF1, WF2, WF3, and WF5, set the scope sweep at about 5 kHz; for WF4 and WF6, use about 20 Hz. These display three cycles.

Check the six waveforms at the four key test points. Note amplitude. If it's low or high, check the parts listed under those columns.

Note waveshape. If there's a change that matches one shown, check the parts indicated.



# Color-Killer Adjustments

Use new set-up procedures with RCA's improved chroma circuitry.

The color-killer circuitry in the CTC 38, CTC 39, CTC 41, CTC 42 and CTC 43 chassis is similar so the explanation and set-up procedure given here applies to all of them. In most areas, the conventional method of adjusting the killer threshold is adequate. Simply position the tuner to a vacant channel, adjust the control from the clockwise extreme until colored snow is visible, and readjust it until the color disappears. While this technique is completely satisfactory under most conditions, refinement of the threshold adjustment may be necessary in those instances when broadcast stations inadvertently allow a small amount of burst signal to be transmitted with a monochrome signal. The killer system in this series of receiver chassis was designed with high burst sensitivity to enhance fringe-area color reception, and because of this, "leaking" burst may open the chroma channel, even though this burst is attenuated as

much as 20 dB (1/10 of normal). This results in intermittent colored snow during monochrome reception. The adjustment to be described normally will make it possible to maintain color killing during monochrome reception when residual burst is present and also allow normal color reception.

In all these chassis, the color-killer stage is a transistor switch. When this switch is "off" (transistor not conducting) negative voltage obtained from the blanker grid circuit biases off the difference-amplifier stages. When conducting, the killer transistor enables the difference-amplifier tubes to conduct by removing the negative grid bias and supplying a ground return for the grid resistors (see diagram of simplified acc/color killer circuit).

The conduction point of the killer transistor depends on both 3.58-MHz oscillator grid bias and the COLOR KILLER control setting. Conduction is

controlled by combining a positive potential from B+ (through the killer control) with a negative potential from the 3.58-MHz oscillator grid. The resultant voltage is applied to the base of the killer transistor. With no color signal input, the oscillator grid voltage is low (approximately -3.5 volts); and the positive voltage from the killer control balances that obtained from the oscillator grid. Under these conditions the base bias is zero and the transistor switch is cut off. During color reception the oscillator grid voltage increases to approximately -8 volts. This increased negative bias is sufficient to override the positive potential from the killer control, thereby biasing the killer switch on and turning on the color-difference amplifiers.

In those areas where a transmitter is known to leak burst, the best policy is to refrain from changing the original setting of the color killer. If this control has been adjusted, it may be returned to the optimum setting using the factory set-up procedure:

Step 1. Connect a color-bar generator to the chassis to supply a constant-level color signal.

Step 2. Defeat the burst amplifier stage by connecting the cathode of the burst amplifier tube to approximately 270 volts B+ through a 39,000-ohm, 1-watt resistor. The burst amplifier cathode is TP 701 in the CTC 38 and CTC 39 chassis; TP 704 in the CTC 41, CTC 42 and CTC 43 chassis. The necessary B+ potential is available at terminal PW700-S in all chassis. This step makes the oscillator grid independent of incoming color signal amplitude.

Step 3. Connect negative 4.5 volts bias to the 3.58-MHz oscillator grid (pin 2) through a 470- $\mu$ H choke (Stock No. 124271). It is necessary to isolate the grid with a choke to prevent loading, since the oscillator must be running during the setup procedure to produce color on the screen. This step establishes the optimum oscillator grid bias for killer adjustment.

Step 4. Adjust the killer control to kill the color bars on the picture tube screen.

An alternate setup procedure which requires less equipment but which requires somewhat more skill may be used in lieu of the factory adjustment. Step 1. Tune receiver to a color broadcast.

Step 2. Connect a vtm through a 470,000-ohm resistor to the grid of the 3.58-MHz oscillator.

Step 3. Adjust receiver fine tuning (away from sound) until the vtm indicates -4.5 volts.

Step 4. Adjust the killer control until color is just killed.

R-E

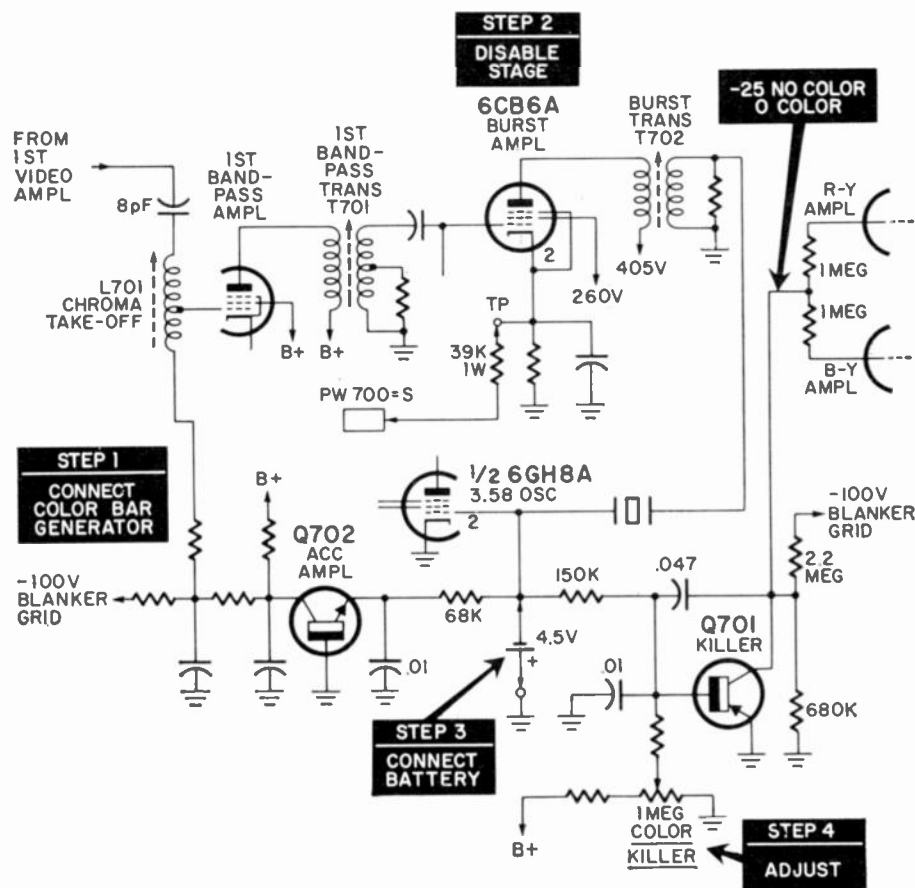

# NEW PRODUCTS

More information on new products is available from the manufacturers of items identified by a Reader Service number. Use the Reader Service Card on page 93 and circle the numbers of the new products on which you would like further information. Detach and mail the postage-paid card.

**AM & FM CASSETTE TUNER PACKS, model BF-11.** Converts cassette players or recorders to an FM or AM radio. Station selection is controlled by the slip-in tuner; sound components and volume

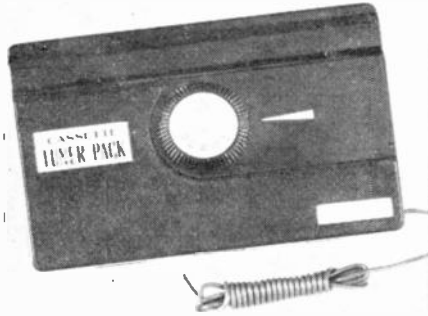

controls of player or recorder amplify radio signal. FM \$12.75, AM \$6.75—M&B Enterprises, 22 W. Madison, Suite 900, Chicago, Ill. 60602.

Circle 31 on reader service card

**SWITCHING DEVICE, Switch-O-Matic 30-3160.** Electronic solid-state device permits car radio to be played through tape system stereo speakers by automatically

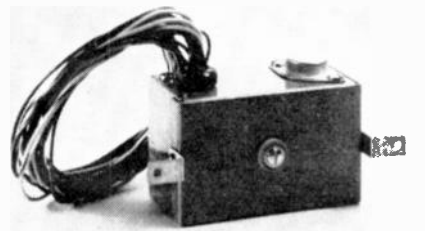

switching them in. When tape unit is being used, Switch-O-Matic automatically cuts itself out of the circuit. Mounts behind dashboard. \$17.95.—GC Electronics, 400 S. Wyman St., Rockford, Ill. 61101

Circle 32 on reader service card

**STEREO RECEIVER, model 8.** 200-watt direct-coupled amplifier (IHF music power), driven by both positive and negative power supplies, uses negative feedback down to dc for steady damping. Continuous power at 4 ohms is 160 watts. Response is 5 to 50,000 Hz  $\pm 1$  dB. Less than 0.3% total harmonic distortion and less than 0.4% intermodulation distortion. Has separate, stabilized power-supply circuits for different sections of the receiver. Pre-amplifier has two tape-monitor circuits

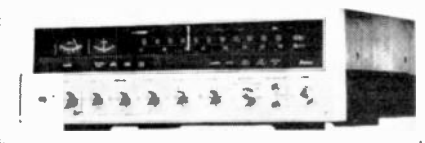

and permits direct deck-to-deck copying. Model 8 is complete with finished walnut cabinet. \$499.95.—Sansui Electronics Corp., 32-17-61 St., Woodside, N.Y. 11377.

Circle 33 on reader service card

**D.I.P. BOARDS,** for mounting and interconnecting 14, 16, 24 or 36 pin dual-in-line packages of IC sockets. Available pre-punched on either paper base phenolic or epoxy glass, the 1 oz. copper layout pattern permits mounting of packages having any number of terminations, pro-

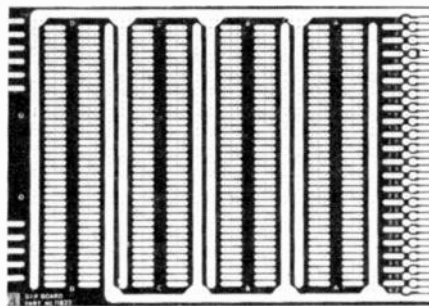

vided they are on 0.1" centers. D.I.P. boards allot room for mounting test points at front end of card. Sizes run from 4.5" wide x 6.5" long to 6.5" wide x 8.0" long.—Vero Electronics, Inc., 171 Bridge Rd., Hauppauge, N.Y. 11787.

Circle 34 on reader service card

**SOLID-STATE WIDE BAND OSCILLOSCOPE, model LBO-32B.** This 3" scope has bandwidth of dc to 7MHz and special input circuitry which stabilizes the dc level so

power line fluctuations have no effect on the position of the CRT display. Input sensitivity is 10 mV/cm. Horizontal and vertical amplifiers are balanced so the instrument adapts itself to use as a vector scope. Line sweep position makes a frequency comparator using the Lissajous technique. Calibration voltage is set at 0.03V p-p at line frequency and the sweep circuit has a frequency range of 1 Hz to 200 kHz in 6 steps, and automatically locks to the horizontal video pattern of the TV signal. \$189.50.—Leader Instruments, 37-27 27th St., Long Island City, N.Y. 11101.

Circle 35 on reader service card

**GAS TORCH,** Designed for home or industrial use. Torch kit includes industrial capacity oxygen and LP tanks,

valve regulators and accessories, useful for miniature welding, brazing and soldering operations. Oxygen capacity is 75 liters; LP gas capacity is 26.7 fluid ounces. Complete hose set and carrying handle bracket also included. Optional oxygen gauge, oxygen adapter fitting,



brazing rod kit available to meet the needs of jewelry repair shops, electrical/electronic applications, and educational institutions—Microflame, Inc., 3724 Oregon Ave. S., Minneapolis, Minn. 55426

Circle 36 on reader service card

**ELECTRONIC OVEN KIT, model GD-29,** cooks with invisible microwaves that instantly penetrate food and agitate the molecular structure, cutting cooking time as much as 70%. Featuring fail-safe operation, door design prevents leakage of microwaves from the oven cavity. The dual door interlock system instantly shuts

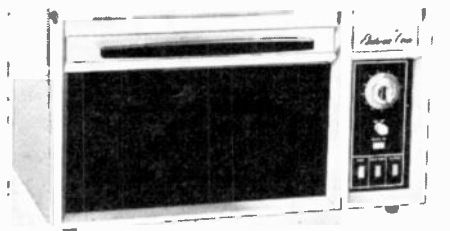

off the oven when the door is opened, and is tamperproof and foolproof. Meets all FCC regulations for radio frequency interference. 120-volt operation, cookbook included. Kit, \$399.95.—Heath Co., Benton Harbor, Mich. 49022.

Circle 37 on reader service card

**TRANSPARENT CRYSTALLIZING PAINT, Set "A" #P-71,246 and Set "B" #P71,247.** Create psychedelic slides and decor with paint which crystallizes as it dries in splintered patterns and intricate

**DON'T SETTLE FOR  
A HIT AND MISS  
IGNITION SYSTEM**



**Install a  
JUDSON  
ELECTRONIC MAGNETO**

It offers the combined advantages of both the standard transistorized and capacitive discharge systems in one simplified patented circuit. Provides better performance, a smoother running engine and keeps your car in tune. Installed in twenty minutes.

Write Today for Literature

**JUDSON**   
RESEARCH & MFG. CO.  
CONSHOCKEN, PA. 19428

Circle 61 on reader service card

designs. Apply with eye dropper or stick, instructions included. Set "A" has red,



green, blue, yellow, clear and fluorescent pink colors; Set "B" comes in orange, tropic green, turquoise, violet, black and brown. Each set \$5.00.—Edmund Scientific Co., 380 Edscorp Bldg., Barrington, N.J. 08007.

Circle 38 on reader service card

**DISTORTION MEASURING SET, Radford model D.M.S. Series 2.** Direct read-



ing instrument measures total harmonic content of a complex waveform in r.m.s. values expressed as a percentage of the total. Measures total distortion lower than 0.005% of input waveform. Completely portable, uses silicon semi-conductors powered by an internal battery. Frequency range is 20 Hz to 20 kHz in 6 bands. \$425.00—Audionics, Inc., 8600 N.E. Sandy Blvd., Portland, Ore. 97220.

Circle 39 on reader service card

**PAGING SPEAKERS, models 18/1, 18/4T, 18/5 and 18/8T.** The 18/1 is an 8" round speaker, 10 watts, 8 ohms; the 18/4T has a built-in line transformer and rotary type impedance selector for 8 to 4000 ohms, 70 V. Six line taps cover 10

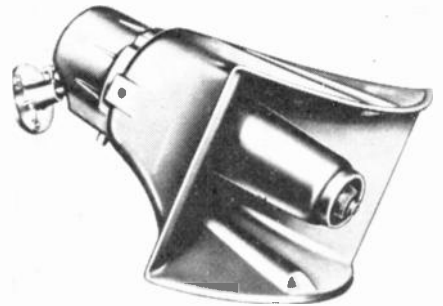

to 1.25 watts. The 18/5 and 18/8T both are 30 watts, 16 ohms. All nylon, rectangular construction, self-aligning diaphragm.—American Celoso Electronics, Inc., 251 Park Ave. So., New York, N.Y. 10010.

Circle 40 on reader service card

**CB ACCESSORY SPEAKER,** is a professional style mobile speaker similar to those used by police and fire departments, for CB operators. Audio response increases clarity and intelligibility by de-



emphasizing noise frequencies while boosting speech frequencies. 5 watts, permitting higher volume without distortion. Complete with mounting plug. \$13.00.—E. F. Johnson Co., Waseca, Minn. 56093.

Circle 41 on reader service card

**SOUND AMPLIFIER, models "S" and "ST".** Public address sound amplifiers. "S" (vacuum tube) line offers 2 mic - 2 aux master, treble and bass controls. Outputs from 10 watts to 100 watts. "ST" (transistor) line has 4 channel inputs for either microphone or auxiliary

# QUAD®

For 20 years and throughout the world the trade mark QUAD has identified the high quality audio equipment made by this Company.

Because others are now seeking to use the name in other ways we have to make it clear that by itself or combined with other words or numerals, QUAD identifies only audio equipment, components and related goods of our manufacture or sponsorship.

All other use of QUAD in connection with such goods is either a misuse, abuse or infringement which must and will be prosecuted.

**ACOUSTICAL MANUFACTURING CO. LTD.,  
Huntingdon, England**



inputs (4 inputs) master, treble and bass controls with same output as "S" —Precision Electronics, Inc., 9101 King St., Franklin Park, Ill. 60131.

Circle 42 on reader service card



**LAVALIER MICROPHONE, model RE85.** Two separate cases inside each other and insulated with rubber, minimize effects of shock and vibration. 30 feet of smooth-coated, 2-conductor shielded cable for noise reduction.

Weights 8 oz., is 2 3/4" long, less than 1" diameter, belt clip supplied. Omnidirectional microphone has frequency response of 90–10,000 Hz. \$133.00.—Electro-Voice, Inc., Buchanan, Mich. 49107.

Circle 43 on reader service card

**FM RECEIVER, model PF-200,** solid-state dual-band vhf communications receiver with crystal control or tuneable frequency selection. FM coverage of 30–50 MHz and 144–174 MHz bands used by police, fire, amateur, public ser-

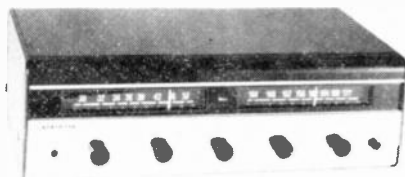

vice utilities, and U.S. Weather Bureau reports. Selectivity  $\pm 325$  kHz, 60 dB; sensitivity 1  $\mu$ V; six-position selector switch; variable squelch. \$99.95.—Lafayette Radio Electronics, 111 Jericho Turnpike, Syosset, N.Y. 11791.

Circle 44 on reader service card

**OSCILLOSCOPES, models 536A, 556A.**

The miniature 3-inch oscilloscope 536A is designed for training, inspection and monitoring application, the 5-inch 556A for use on production lines. On both models the vertical amplifier is ac/dc coupled and fully compensated with a sensitivity of 20 mV/cm over dc to a 1.5-MHz bandwidth, sweep frequency range from 10 Hz to 100 kHz in 4 ranges continuously variable. Model 536A, \$167.00, 556A, \$239.00, both come complete. Full specification catalogs available.—Kikusui Electronics Corp., c/o Marubeni-Iida (America) Inc., 200 Park Ave., New York, N.Y. 10017.

Circle 45 on reader service card

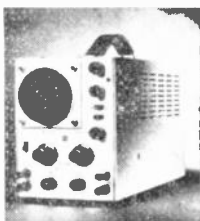

**MOBILE COMMUNICATION UNIT, Mobilink,** low-power AM transmitter used with a pocket receiver as accessory for mobile communications, base stations, paging, intercom extensions. All calls audible up to 1/2-mile. Convenient for com-

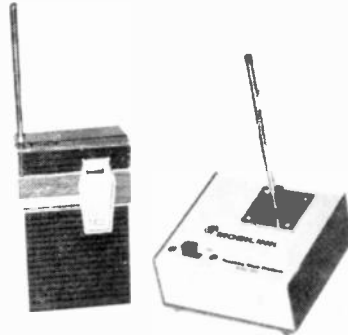

mmercial 2-way radio users—doctors, policemen, firemen, CB, amateurs. Mobilink transmitter is \$44.95; receiver, \$24.95.—Herbert Salch & Co., Woodsboro, Tex. 78393.

Circle 46 on reader service card

**BACKGROUND MUSIC RECEIVER AND TUNER, models RM300 and**



TP160. The RM300 receiver is 30-watt solid state, AM and FM, with FET circuitry, ceramic filters, IC's, and interstation muting. Unit has inputs for

**NOW A ONE STOP SHOPPING CENTER FOR YOUR AUTO RADIO AND 8 TRACK STEREO PARTS. AT FACTORY DISCOUNTS**

**WE ARE AUTHORIZED PARTS DISTRIBUTORS FOR:**

DELCO  
BENDIX  
MOTOROLA  
LEAR JET  
TENNA  
RANGER  
METRA  
AUTOMATIC  
ON GUARD  
CRAIG  
PANASONIC  
PHILIPS  
BELLE WOOD  
WARD  
QUICKMOUNT  
DEWEKO  
AC SPEEDO  
STERO LOCK MOUNTS  
SPARKOMATIC

**SEND YOUR ORDERS WITH PART NUMBERS TO**

**Laran Electronics, Inc.**

3768 Boston Road  
Dept. 200 Bronx, N.Y. 10469  
OR SEND MODEL, MAKE AND DESCRIPTION OF PART WANTED

Circle 62 on reader service card

**Build this pipelike Schober Recital Organ for only \$1850!\***

You couldn't touch an organ like this in a store for less than \$4,000—and there never has been an electronic instrument with this vast variety of genuine pipe-organ voices that you can add to and change any time you like! All four families of formal pipe tones are present in variety to delight players of classic and religious music. Yet you can change the entire organ for popular and theatrical sounds, or plug in special voices for baroque, romantic, or modern repertoires. If you've dreamed of the sound of a large pipe organ in your own home, if you're looking for an organ for your church, you'll be more thrilled and happy with a Schober Recital Organ than you could possibly imagine—kit or no kit.

You can learn to play it—and a full-size, full-facility instrument is easier to learn on than any cut-down "home" model. And you can build it, from Schober Kits, world famous for ease of assembly without the slightest knowledge of electronics or music, for design and parts quality from the ground up, and—above all—for the highest praise from musicians everywhere.

Send right now for the full-color Schober catalog, containing specifications of all five Schober Organ models, beginning at \$499.50. No charge, no obligation. If you like music, you owe yourself a Schober Organ!



\* Includes finished walnut console. (Only \$1446 if you build your own console.) Amplifier, speaker system, optional accessories extra.

Circle 63 on reader service card

The Schober Organ Corp., Dept. E-E9  
43 West 61st Street, New York, N.Y. 10023

Please send me Schober Organ Catalog and free 7-inch "sample" record.

Enclosed please find \$1.00 for 12-inch L.P. record of Schober Organ music.

NAME \_\_\_\_\_

ADDRESS \_\_\_\_\_

CITY \_\_\_\_\_ STATE \_\_\_\_\_ ZIP \_\_\_\_\_

**IMPOSSIBLE? . . . BARGAINS IN SURPLUS ELECTRONICS (AND OPTICS)**

- TACHOMETER/DWELL METER KIT** \$6.50  
 Obviously the only way we can provide an astounding value like this is by utilizing surplus parts. The 270 meter movement, surplus of an auto manufacturer, is worth several times our kit price alone. But we also include all the components required to build a fine auto Tach/Dwell Meter. Including transistors, zener diode, switch, printed circuit board and full instructions.
  - LOWEST COST DIGITAL COUNTER KIT** \$6.50  
 Here is another astounding surplus bargain kit. To the best of our knowledge this is the lowest cost decade counter complete with readout anyone has offered yet! We supply two M.S.I. integrated circuits, a 7490 decade counter, and a 7441 count of 10 decoder, 10 light bulbs that operate directly from the 5 volt supply, a printed circuit board, and full instructions for building a decade counter. Of course several of these counters can be cascaded for as many decades as you wish.
  - A DIGITAL COUNTER KIT** \$7.50  
 Same as above but with 74130 bidirectional counter for counting forwards or backwards. Used in preset counting, encoders, etc.
  - NIXIE READOUT DECADE COUNTER** \$11.75  
 Same as above but nixie readout instead of lamps. Includes B5750 nixie, which solders directly on P.C. board. Add \$1.00 for up/down option.
  - IEE PROJECTION DISPLAYS** \$7.50  
 This decimal readout device projects numbers onto a plastic screen. Can easily be viewed from many feet away. Original cost \$25.60. Used in perfect condition.
  - PRINTED CIRCUIT BOARD KIT** \$5.50  
 With 7490 decade counter, 7441 decoder and transistors to provide decade counter and driver for IEE readout above.
  - B5750 NIXIE, NEW, ORIGINAL, PKG.** \$6.00
  - 4.5 VOLT 100 MA MINIATURE WIRE LEAD BULB** 10 for \$2.00
  - GIANT 80 PAGE ILLUSTRATED CATALOG** .25  
 Free with any order or send .25 cents
- Charges Welcome \$10.00 Min.  
 BankAmericard - Mastercharge  
**ALL ITEMS POSTAGE PAID IN THE U.S.A.**  
**B. & F. ENTERPRISES**  
 Phone 617 532-2323  
 P.O. Box 44, Hathorne, Massachusetts 01937



Circle 64 on reader service card

record player, tape deck, microphone and paging phones. The *TP160* is the front end, without public address system, available separately.—Bogen Div., P.O. Box 500, Paramus, N.J. 07652.

Circle 47 on reader service card

**PAGING PROJECTORS, models PA12 and PA12F**, each 12 watts, feature computer-calculated horn flare; Alnico V magnet structure; 8-ohm voice coil impedance. Frequency response of *PA12* is 325 to 14,000 Hz; *PA12F* is 500 to 14,-



000 Hz. The housing is high-pressure injection molded. TR12 transformer available for line-voltage installations. *PA12*, \$27.00 *PA12F*, \$33.00.—Electro-Voice, Inc., Buchanan, Mich. 49107.

Circle 48 on reader service card

**LOW HEAT SOLDERING PENCIL, models D11-1 and D11-2**, provide continuous low heat for light and medium sol-

dering jobs, and fast high heat by depressing a button switch on the handle. The *D11-1* has 15- and 47-watt elements

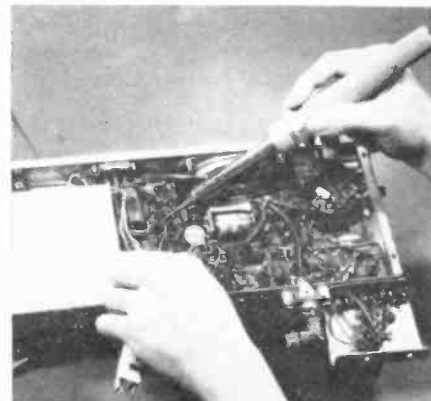

with 520°F continuous low temperature and 920°F high heat. The *D11-2's* elements are 20 and 53 watts, 630°F and 975°F. Tips are changeable, nickel-coated copper tips are included.—Wall Manufacturing Co., P.O. Box 3349, Kinston, N.C. 28501.

Circle 49 on reader service card

**TRIGGERED SWEEP OSCILLOSCOPE, B&K model 1460**. Fully automatic triggered sweep permits viewing entire TV color signal, including VITS, with the color-burst information. Two sweep selector positions. TVH and TVV. 5" screen. Vertical amplifier goes out



to 10 MHz, horizontal bandwidth is dc-800 kHz (3 dB). All solid-state. \$389.95.—Dynascan Corp., 1801 W. Belle Plaine Ave., Chicago, Ill. 60613.

Circle 50 on reader service card

Write direct to the manufacturers for information on the following item.

**CAR STEREO, models RCA 12R100, 12R200, 12R300, 12R400**. Cassette player/recorder, speakers, designed for convenient underdash mounting in cars, boats and planes. Solid-state circuitry operates on 12-volt dc (negative ground), with a peak power of 18 watts. Tapes are front



loaded, controls recessed in front frame. Stereo 8 player (12R300) \$78.50; cassette player (12R100) \$99.50; cassette player/recorder (12R200) \$119.50; stereo speaker kit (12R400) \$13.75.—RCA/Parts & Accessories, Deptford, N.J. 08096.

**NEW** from the "NO NOISE" originators

You've tried others, now try the best!

**3 years of constant research and testing have put us way ahead!**

NO NOISE has been an innovative force in the development and production of cleaners and lubricants for 25 years. Our technical people, who made us No. 1, were turned loose to create a new line that would out-perform anything on the market. Three years of experimentation and testing developed these 2 new products. Approved by leading service organizations.

**SUPER-LUBE**

A miracle concentrated formulation for heavy duty jobs. Its clinging action foams away corrosion, dirt and oxidation—and polishes all tuners continuously without drift or detuning. SUPER-LUBE's built-in lubricating quality makes channel selecting smooth and easy. For color and black & white.



8 oz. \$2.35

**Introductory Offer**

**BUY 4 CANS OF SUPER-LUBE AND GET 2 EXTRA CANS FREE FROM YOUR JOBBERS! MONEY BACK GUARANTEE!**

**SUPER SPRAY BATH** dissolves and flushes away grease, dirt, oil and oxidation. Simply spray tuners, its penetrative action cleans and restores tuners inside and out.

All NO NOISE products are non-toxic - non-flammable - no carbon tet - safe for all plastics.



24 oz. \$3.25



Often imitated but never duplicated

813 Communipaw Avenue  
 Jersey City, N. J. 07304

**ELECTRONIC CHEMICAL CORP.**

Circle 65 on reader service card



## NEW LITERATURE

All booklets, catalogs, charts, data sheets and other literature listed here with a Reader's Service number are free for the asking. Turn to the Reader Service Card on page 93 and circle the numbers of the items you want. Then detach and mail the card. No postage required!

**TOOLS CATALOG, No. SD-170**, is a 36-page color reference guide for tool buying. Listings include, hex drivers, various types of drivers, wrenches, electrical testers, crimping tools, kits, magnetic screw drivers, pliers, rivet tools, shelves, measuring tapes, terminals, wire stripper, and many others.—Vaco Products Co., 510 North Dearborn St., Chicago, Ill. 60610

Circle 51 on reader service card

**LOUDSPEAKER BROCHURE**, describes model EC-10 double re-entrant type speaker for use in sound systems or with mobile and Citizen band receivers. Photograph and specifications.—Atlas Sound, 10 Pomeroy Road, Parsippany, N.J. 07054.

Circle 52 on reader service card

**LOUDSPEAKER BROCHURE**. Detailed description and price information on new Futura line of high-fidelity loudspeaker systems for stereo. Includes a full-range acoustical air-suspension model and a three-way 12" sound system.—CTS of Paducah, Inc., 1565 N. 8th St., Paducah, Ky. 42001.

Circle 53 on reader service card

**TEST INSTRUMENT CATALOG, 1971**, contains photographs, condensed specifications, and prices for Hickok tube testers, transistor testers, oscilloscopes and signal generators used in industrial, communications, laboratory and service technicians' applications. Both bench top and portable models are shown.—Hickok Electrical Instrument Co., 10514 Dupont Ave., Cleveland, Ohio 44108.

Circle 54 on reader service card

**MONITOR RADIO CATALOG, CRX**, is a four-page listing of the complete line of AM and FM radios in the Portamon series. Listener can hear police communications, fire departments, aircraft take-offs, weather reports and other radio services. Specifications included for all models. Hallcrafters Co. Dept. PR, 600 Hicks Road, Rolling Meadows, Ill. 60008

Circle 55 on reader service card

**TV REPLACEMENT GUIDE**, gives part-to-part cross reference for transformer and deflection components. This commercial TV/Radio guide lists Admiral, Airline, Coronado Dumont, General Electric, RCA, Sylvania, Zenith and many others. Also lists flybacks, deflection yokes, and a conversion chart. 108 pages.—Stancor Inc. Div of Essex International, Inc., 3501 W. Addison St., Chicago, Ill. 60618.

Circle 56 on reader service card

**COMPONENT SELECTOR CATALOG, No. 300B**, lists various types of resistors, rheostats, potentiometers, trimmers, tap switches, variable transformers, relays, solid-state power controls, rf chokes, design aids. Includes specifications.—Ohmite Mfg. Co., 3660 Howard St. Skokie, Ill. 60076

Circle 57 on reader service card

**STEREOPHONES**. Entire headset line including accessories detailed with photographs and description of technical properties.—Koss Electronics, 2227 N. 31st St., Milwaukee, Wisc. 53208.

Circle 58 on reader service card

**TOOLS CATALOG, 1971**, offers hundreds of tools rarely sold by industrial distributors and useful to electronic technicians. Includes glass pliers, carbide saber saw blades, hand vises, magnetic work lamps, woodbits and special rotary wire brushes. Lists glass drills, step blocks, wire cutters, jewelers' screwdrivers, many other versatile hand tools and small power tools. Fully illustrated. 32 pages.—Brookstone Co., 1613R Brookstone Bldg., Peterborough, N.H. 03458.

Circle 59 on reader service card

(Write direct to the manufacturer for information on the following items.)

**PHONO NEEDLE CATALOG, 1971, #71N**. Comprehensive 120-page phonograph needle list-

ing, fully illustrated with special section on accessories including stereo headphones, cassette microphones and spindle adaptors. 15,000 needle numbers are cross-referenced.—E-V/Game, Inc., 80 Commercial St., Box 711, Freeport, N.Y. 11520.

**AUTOMOTIVE PERFORMANCE CATALOG, 1970**, source for high performance ignition system, engine over speed control and time measurement system needs. Fully illustrated catalog compares ignition systems on performance and cost basis. Lists capacitive discharge ignition, solid-state ignition devices, electronic ignition, racing timers. 50¢—ARE, P.O. Box 9562, San Jose, Calif. 95117.

**INDUSTRIAL ELECTRONIC COMPONENTS CATALOG, 1971, No. FR-71-1**. Listing of diverse hardware items as connectors, adaptors, alignment tools, cable clamps, clips, a broad selection of chemicals, and such items as nylon and metal mounting hardware and printed circuit materials.—GC Electronics, Rockford, Ill. 61101.

GIVE TO  
UNITED  
CEREBRAL  
PALSY



## NEW MONITOR RECEIVER goes anywhere!



- MOBILE with built-in DC supply
- BASE with AC supply in convenient desk-top stand
- PORTABLE with rechargeable power pack complete with handle and antenna

VHF FM models cover 148-174 MHz with 5 channels. Professional features include crystal filter and true noise-operated squelch.



You're going to hear more from...



**JOHNSON**

Waseca, Minnesota 56093

Circle 66 on reader service card

# Clever Kleps

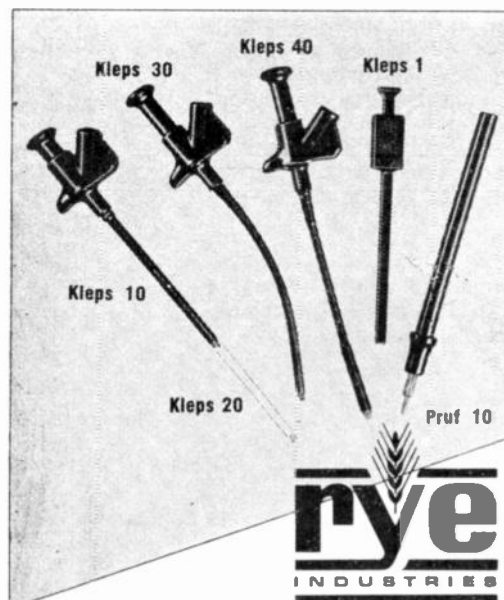

Test probes designed by your needs—Push to seize, push to release (all Kleps spring loaded).

**Kleps 10**. Boathook type clamp grips wires, lugs, terminals. Accepts banana plug or bare wire lead. 4 3/4" long. \$1.19

**Kleps 20**. Same, but 7" long. \$1.39

**Kleps 30**. Completely flexible. Forked-tongue gripper. Accepts banana plug or bare lead. 6" long. \$1.47

**Kleps 40**. Completely flexible. 3-segment automatic collet firmly grips wire ends, PC-board terminals, connector pins. Accepts banana plug or plain wire. 6 1/4" long. \$2.39

**Kleps 1**. Economy Kleps for light line work (not lab quality). Meshing claws. 4 1/2" long. \$ .99

**Prof 10**. Versatile test prod. Solder connection. Molded phenolic. Doubles as scribing tool. "Bunch" pin fits banana jack. Phone tip. 5 1/2" long. \$ .79

All in red or black — specify.

For additional information, write for our complete catalog of — test probes, plugs, sockets, connectors, earphones, headsets, and miniature components.

Available through your local distributor, or write to:  
**RYE INDUSTRIES, INC.**  
123 Spencer Place, Mamaroneck, N.Y. 10543

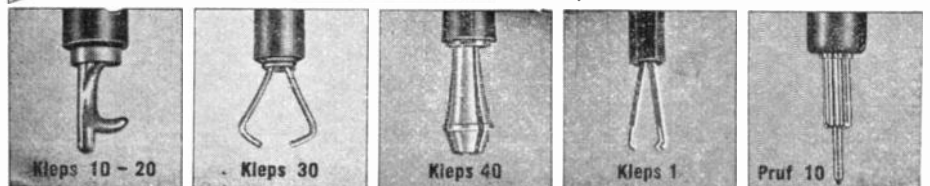

Circle 67 on reader service card



## ...the new Heathkit® 25" ultra-rectangular TV color picture is that perfect.

"Picture postcard perfect"...an apt description for the quality of color reproduction in the new Heathkit GR-371MX 25" ultra-rectangular solid-state color TV. And the reasons are as clear as the expanded 315 sq. in. view:

**New Heath MTX-5 ultra-rectangular matrix picture tube.** Developed in conjunction with leading domestic tube manufacturers to produce a sharper picture, purer colors, more natural flesh tones. Specially formulated etched face plate cuts out unwanted glare, increases contrast without sacrificing brightness. Matrix screen around phosphor dots eliminates reflected light, allows use of higher transmission glass for greater light output. New square-corner rectangular design opens up the largest picture in the industry...25" diagonal measurement, a full 315 sq. in. of viewing enjoyment. New shape allows complete transmitted image to be seen for the first time. Pictures don't wrap around sides of tube as before. And 25,000 volt high voltage assembly assures optimum picture quality.

**Unique solid-state design:** 45 transistors, 55 diodes, 2 silicon controlled rectifiers; 4 advanced ICs containing another 46 transistors and 21 diodes; and just 2 tubes (picture and high voltage rectifier) combine to deliver performance and reliability unobtainable in conventional tube sets.

**Other plus-performance features include:** High resolution circuitry for improved picture clarity, plus new adjustable video peaking that lets you select the degree of sharpness and resolution you desire; an exclusive solid-state VHF tuner with MOS Field Effect Transistor for superior reception even under marginal conditions; Memory Fine Tuning; 3-stage solid-state IF, factory-assembled and aligned; Automatic Fine Tuning; VHF power tuning; "Instant-On"; Automatic Chroma Control; adjustable noise limiting and gated AGC; adjustable tone control; hi-fi sound output to your stereo or hi-fi system.

**Exclusive owner-service capability...**only Heath offers you this money-saving advantage: built-in dot generator and tilt-out convergence panel let you do periodic dynamic convergence adjustments required of all color TVs. Modular plug-in glass-epoxy circuit boards with transistor sockets permit fast, easy service

and adjustment. Volt-Ohm meter supplied for detailed troubleshooting right down to the smallest part.

Available in choice of factory-assembled, pre-finished cabinets: Mediterranean, Early American, Contemporary...or without cabinet for custom installation.

Kit GR-371MX, 125 lbs., (less cabinet) .....579.95\*

*Choose from the complete line of Heathkit solid-state Color TVs... for every size and budget requirement:*



14" portable solid-state color TV

Kit GR-169, 69 lbs., including cabinet .....349.95\*

20" solid-state color TV

Kit GR-270, 109 lbs., less cabinet .....489.95\*

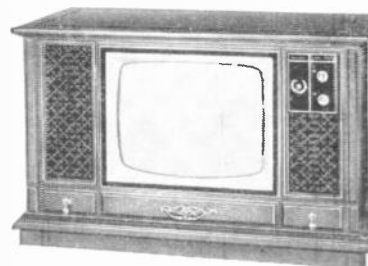
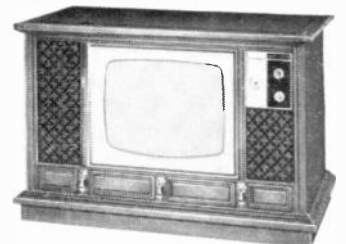

23" solid-state color TV

Kit GR-370, 124 lbs., less cabinet .....539.95\*



(A)

New 25-pedal  
"Legato"  
1,495\*

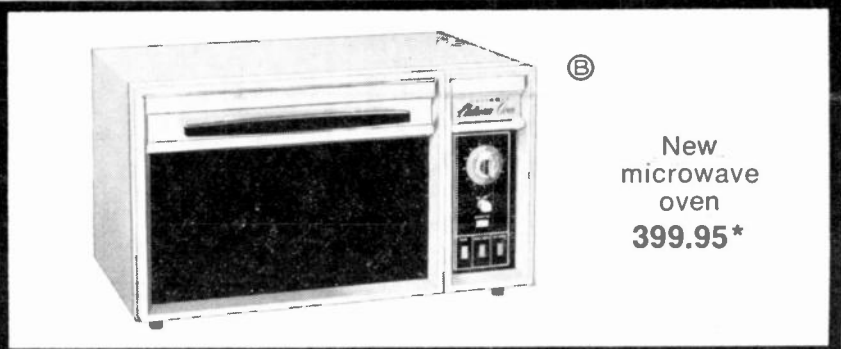

(B)

New  
microwave  
oven  
399.95\*



(C)

New solid-state  
amateur receiver  
319.95\*



(D)

New 15 MHz  
frequency counter  
199.95\*

## And while you're at it, picture these Heathkit newsmakers in your den, kitchen, ham shack or shop.

### (A) New Heathkit solid-state "Legato" 25-pedal Theater Organ

One of the world's most versatile musical instruments...now in money-saving kit form. Designed exclusively for Heath by Thomas Organ craftsmen. All solid-state. Features 15 manual voices, 4 pedal voices...any or all at the flip of a tab. 25-note heel & toe pedal board, range 16' & 8' C0 to C3. Color-Glo® key lights and comprehensive organ course supplied have you playing like a pro in minutes. Two 44-note keyboards; accompaniment range 8'...F1 to C5. Solo manual 16', 8', 4', 2'...F1 to C7. 200 watts peak power from two solid-state amplifiers...one for the 2-speed rotating Leslie speaker and one for the two 12" speakers. Tape record/playback jack on amplifier. Band Box & Playmate accessories available.

Kit TO-101, 299 lbs. ....1,495\*

### (B) New Heathkit microwave oven

The cooking revolution of tomorrow, here today in easy-to-build kit form...saving you hundreds of dollars over comparable electronic ovens. Exclusive patent-pending Heath double door interlock system provides absolute safety...oven cannot be turned on if door is open. Prepares meals in minutes, not hours. Cooks on china, glass, even paper plates in spacious, roast-size oven cavity.

ity. Low-profile, countertop design fits unobtrusively into kitchen decor. Portable convenience, too...can be used on patio, at poolside, etc...wherever a 120 VAC grounded outlet is provided. Give your wife a break from kitchen drudgery...with this new miracle of microwave cooking.

Kit GD-29, 97 lbs. ....399.95\*

### (C) New Heathkit solid-state 80-10 meter amateur receiver

All the quality you'd expect in a new Heathkit receiver...and solid-state to boot. Tunes USB, LSB, AM, CW & RTTY, 80-10M. 15 MHz WWV coverage. 100 & 25 kHz calibration. Dual gate MOSFET front end for greater dynamic range. Solid-state factory-assembled & aligned linear master oscillator for rock-solid tuning with 1 kHz readout. 1/4 µV sensitivity for 10 dB S+N/N. 2.1 kHz selectivity with built-in SSB crystal filter...optional AM & CW crystal filters available.

Kit SB-303, 21 lbs. ....319.95\*

### (D) New Heathkit solid-state 15 MHz frequency counter

Another Heathkit first...highly accurate frequency measurement at a price you can afford to pay. Delivers stable, accurate counting from 1 Hz to over 15 MHz. All integrated circuitry for top performance, high reliability. Automatic trigger level for wide range input without adjustment. Five digit cold-cathode readout with Hz/kHz ranges and overrange indicators give 8-digit capability. Input Z 1 megohm shunted by less than 20 pF for low circuit loading.

Kit IB-101, 7 lbs. ....199.95\*

### See these and 300 other Heathkit suggestions at one of the following Heathkit Electronic Centers:

CALIFORNIA: Anaheim, 92805, 330 E. Ball Road; El Cerrito, 94530, 6000 Potrero Avenue; La Mesa, 92041, 8363 Center Drive; Los Angeles, 90007, 2309 S. Flower St.; Redwood City, 94063, 2001 Middlefield Rd.; Woodland Hills, 91364, 22504 Ventura Blvd.; COLORADO: Denver, 80212, 5940 W. 35th Ave.; GEORGIA: Atlanta, 30305, 5285 Roswell Road; ILLINOIS: Chicago, 60645, 3462-66 W. Devon Ave.; Downers Grove, 60515, 224 Ogden Ave.; MARYLAND: Rockville, 20852, 5542 Nicholson Lane; MASSACHUSETTS: Wellesley, 02181, 165 Worcester St.; MICHIGAN: Detroit, 48219, 18645 W. Eight Mile Rd.; MINNESOTA: Hopkins, 55343, 101 Shady Oak Rd.; MISSOURI: St. Louis, 63123, 9296 Gravois Ave.; NEW JERSEY: Fair Lawn, 07410, 35-07 Broadway (Rte. 4); NEW YORK: Jericho, L.I., 11753, 15 Jericho Turnpike; New York, 10036, 35 W. 45th Street; OHIO: Cleveland, 44129, 5444 Pearl Rd.; Woodlawn, 45215, 10133 Springfield Pike; PENNSYLVANIA: Philadelphia, 19149, 6318 Roosevelt Blvd.; Pittsburgh, 15235, 3482 William Penn Hwy.; TEXAS: Dallas, 75201, 2715 Ross Avenue; Houston, 77027, 3705 Westheimer; WASHINGTON: Seattle, 98121, 2221 Third Ave.; WISCONSIN: Milwaukee, 53216, 5215 W. Fond du Lac

Retail Heathkit Electronic Center prices slightly higher to cover shipping, local stock, consultation and demonstration facilities. Local service also available whether you purchase locally or by factory mail order.

HEATH COMPANY, Dept. 20 4 Benton Harbor, Michigan 49022		 a Schlumberger Company	
<input type="checkbox"/> Enclosed is \$ _____, plus shipping.			
Please send model (s) _____			
<input type="checkbox"/> Please send FREE Heathkit Catalog. <input type="checkbox"/> Please send Credit Application.			
Name _____			
Address _____			
City _____ State _____ Zip _____			
*Mail order prices; F.O.B. factory. Prices & specifications subject to change without notice. CL-403			

Circle 68 on reader service card

# EDI

**THOUSANDS OF BARGAINS—TOP VALUES IN Electronic Parts**

Transistors, Modules, Speakers, Stereo, HI-FI, Photo Cells and thousands of other Electronic Parts. Send for **FREE** Catalog

**ELECTRONIC DISTRIBUTORS INC.**  
Dept. TA-2, 4900 Elston  
Chicago, Ill. 60630

RUSH CATALOG

Name \_\_\_\_\_  
Address \_\_\_\_\_  
City \_\_\_\_\_ State \_\_\_\_\_ Zip Code \_\_\_\_\_

Circle 69 on reader service card

## TTL INTEGRATED CIRCUITS

### TEXAS INSTRUMENTS DUAL IN LINES

Brand new current factory stock

Type	Function	Stock No.	Price
SN7404N	Hex inverter	M3040	1.00
SN7470N	J-K Flip Flop	M3041	1.00
SN7441N	BCD to decimal decoder/driver	M3042	3.95
SN7442N	BCD to decimal decoder	M3043	3.25
SN7490N	Decade counter	M3044	2.95
SN7492N	Divide by twelve counter	M3044	3.50
SN7493N	4 Bit Binary counter	M3045	3.50
SN7494N	4 bit shift register	M3046	3.50

## FAIRCHILD-NATIONAL-ITT

TTL dual in line, factory fresh stock

Type	Function	Stock No.	Price
9003	Triple gate	M3047	1.75
9016	Hex inverter	M3048	1.95
9022	Dual J-K Flip flop	M3049	2.95
9300	4 Bit Universal Register	M3050	3.95
9301	One of ten Decoder	M3051	2.95

## COMPUTER GRADE CAPACITORS

M2040 Sangamo or Pyramid 4 1/4" x 1 3/4"  
4000 MFD 50V ..... \$6.65 ea. 5 \$3.00

M2049 3500 Mfd. 55 volt 4 1/4" x 1 3/4"  
..... \$6.65 ea. 5 \$3.00

M2062 40,000 Mfd. 10 volt 3" x 4 1/4" Brand new  
..... \$1.25 ea. 6 \$7.00

Honeywell Boards 5 1/2" x 6". Loaded with late no. transistors, diodes, resistors and capacitors.  
M9127 ..... \$1.50 ea. 4/\$5.00

M4128 TRIAC's 400 volt, 6 Amp.  
Mounted on heat sink ..... \$1.50 ea. 5/\$7.00

**\$1.00 FREE WITH \$10.00 ORDER**  
**MINIMUM ORDER \$3.00**

Lots of other items—send for free flier; all merchandise fully guaranteed. Please include postage; excess will be refunded.

## DELTA ELECTRONICS CO.

BOX 1, LYNN, MASSACHUSETTS 01903

Circle 70 on reader service card

# In the Shop . . . With Jack

By **JACK DARR**  
SERVICE EDITOR

## BUSY BACKGROUND?

ONE FAIRLY MINOR PROBLEM, BUT ONE which customers often complain about, is "busy background." Translated, this means a sort of rippling, shimmering or "working" in large smooth areas of the picture. It's noticeable in monochrome pictures and can produce funny effects in color pictures.

The basic cause is pretty simple. This is due to *mixer noise* in the tuner! All mixers, being non-linear things, generate a certain amount of unavoidable noise. The only way to get rid of it is to override it with a lot of rf signal. Improve the signal-to-noise ratio, in other words. This is true of tube tuners and can happen in transistor tuners too. In fact, in many hybrid or solid-state TV sets, with transistor i.f. stages, you'll get a very similar effect at some position of the agc control!

The basic cure is even simpler. If the rf amplifier stage doesn't have enough gain, the signal-to-noise ratio will suffer. Outside of the normal reasons for this, such as weak tubes, bad resistors, etc., one often unsuspected

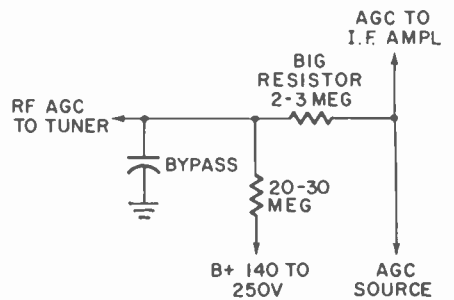

FIG. 1

cause of trouble is the rf agc voltage. Many sets use rf agc *delay* circuits.

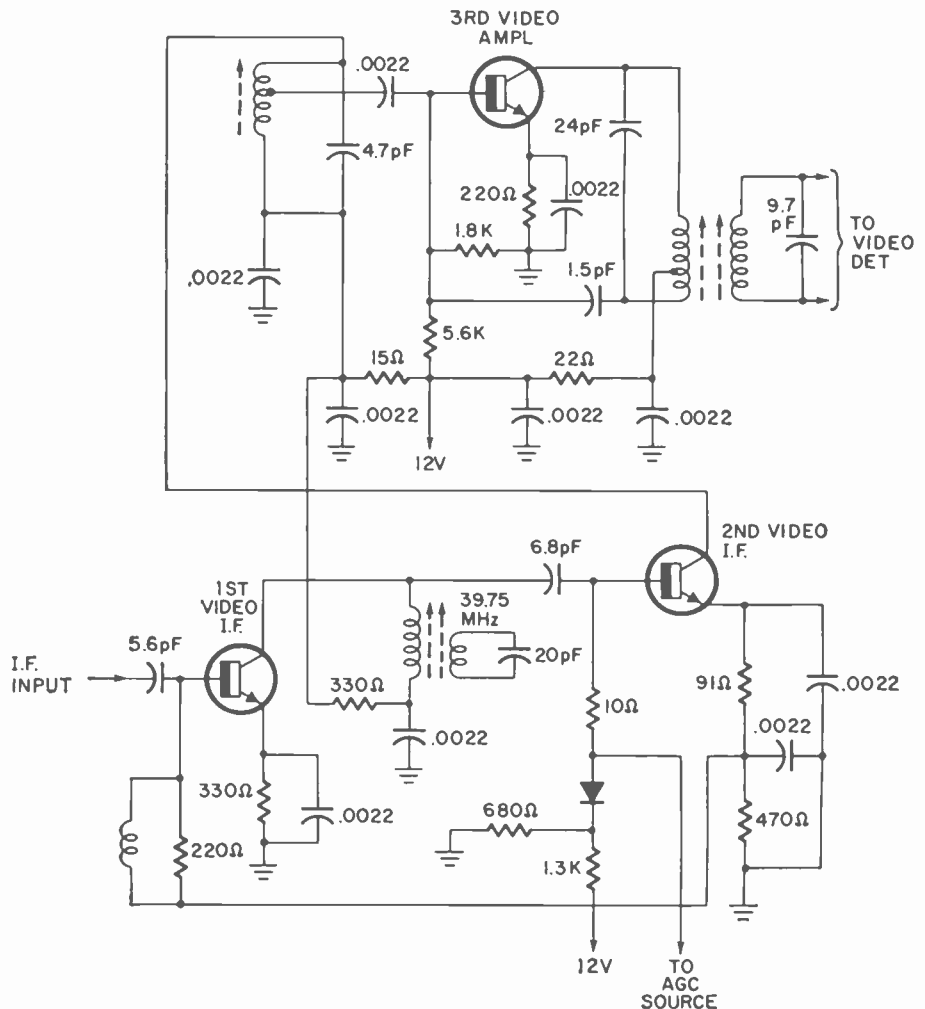

FIG. 2

The idea of these is to hold the rf amplifier at its *maximum* gain until we have used up all of the "control action" we can in the i.f. agc. At some point, we'll find that we simply can't reduce the gain of the i.f. stages any further by applying more reverse bias (bias which will reduce the gain—either polarity in solid-state, negative in tubes). If we try, we get clipping and a few other unpleasant things.

So, when this point is reached, the rf agc delay should let go and allow agc voltage to be applied to the rf amplifier, to reduce its gain. There are several ways of doing this. Some transistor agc circuits may have a special rf agc transistor, for delay purposes only. Of course, when this happens, the input rf signal is pretty strong.

This kind of "big signal" is normally found only in primary areas, close to the TV transmitter. However, in CATV and MATV systems, you'll often find signal levels as high as 1,000- $\mu$ V per channel. If the rf agc delay circuitry isn't working properly away we go again.

After checking the common problems, such as weak tubes, if the trouble still shows up, check the agc circuit. One common and often unsuspected cause of agc problems is the big delay resistor (Fig. 1). This is used in many sets, and has been for a long time. Its purpose is to feed a small positive dc voltage to the agc bus, so the agc voltage has to go higher than a preset level before it can affect rf amplifier gain.

You'll find 20 megohms, 30 meg-

ohms, etc. used here. Despite their large resistance value, these things are *critical!* They seem to have a tendency to drift and it takes only a very small percentage of drift to cause trouble. Because of the numerous shunt paths, you can't get a reliable check on them in-circuit. Lift one end and check them closely. For replacements, use 5% resistors, just for luck.

In transistor agc circuitry, a leaky gate or keyer transistor can upset things for three feet in all directions. (In one classic case, a leaky agc keyer transistor, reading about 12- $\mu$ A leakage, managed to upset not only the agc, but the vertical oscillator! It was fed from the same regulated 12-volt source.)

Regardless of where the keying pulse is applied—base, emitter or collector—a very minute leakage in the transistor will upset the bias, and of course, the agc. You'll find silicon transistors used in most of these because of their "practically zero" leakage characteristics.

Incidentally, you *can* clamp or override agc in transistor TV sets, just as easily as you can in tube circuitry. Fig. 2 shows the simplified i.f. agc circuitry of a typical solid-state chassis, Magnavox 908. To override the agc, just connect your bias box to the i.f. agc source. Set the bias-box at the *no-signal* agc voltage and polarity. In this case about +3.0 volts.

The no-signal voltage here is the agc voltage present when the controlled stages are in "maximum gain" condition. Clamp it at that level and that's all you

need. The main purpose of this test is to see whether the i.f. can be made to pass a picture signal. Once you get this, you can vary the agc voltage a little to see how it works.

Finally, if you have checked "everything" and it still doesn't work, look for an open agc bypass, especially on the rf agc line. In some solid-state sets these are low-voltage electrolytics. If they open or leak, they can cause some real howlers! **R-E**

This column is for your service problems—TV, radio, audio or general and industrial electronics. We answer all questions individually by mail, free of charge, and the more interesting ones will be printed here.

If you're really stuck, write us. We'll do our best to help you. Don't forget to enclose a stamped, self-addressed envelope. Write: Service Editor, Radio-Electronics, 200 Park Ave. South, New York 10003.

#### HORIZONTAL DRIFT

*I'm working on a Panasonic AN-32 portable TV. It works fine for a while, then the picture starts slipping horizontally after warmup. I suspected the sync tube, although I had an awful time trying to find one. Didn't help anyhow! What could cause this?—R. S., Endicott, N.Y.*

Lots of things. Try a new set of afc diodes first. Sync tubes seldom

## TECHNOTES

### CTC 10, INTERMITTENT BRIGHTNESS

This RCA color chassis was brought into the shop with intermittent brightness. The horizontal output tube did not heat up and appeared to be working normally, although a new one was installed in its place.

Looking into the high-voltage cage, I saw blue-green glow in the 3A3 high-voltage rectifier. Replacing the rectifier did not solve the brightness problem. Tapping the high-voltage cage caused the raster to disappear.

The 6BK4 voltage regulator tube was pulled and seemed to have something loose inside it. Taking a closer look, the piece from the plate section was loose and sometimes would lay on or accidentally touch the cathode. Installing a new 6BK4 restored raster and brightness.—*Homer L. Davidson*

### ZENITH 16Z7C19 TV CHASSIS

A Zenith TV Chassis 16Z7C19 with poor vertical linearity, along with a slow vertical roll is usually caused by a defective X5 diode in the cathode circuit of the 6BA11 vertical oscillator —*B. J. Brown*

### ROBERTS 720, 770, 770A, 770X TAPE RECORDERS

Motorboating often sets in when the function switch is in the play position and the volume controls are set nearly fully clockwise. Sometimes the rate is so low as to be almost inaudible but the VU meters will show a reading, usually as high as 0 dB.

To cure this problem, remove the back cover(s) to expose the amplifiers, and replace all four (2 in each channel) 20  $\mu$ F/300-volt electrolytic capacitors with 40  $\mu$ F/300-volt units. Incidentally, these capacitors are in the B+ line going to the preamp tubes.—*Sandor Mentler* **R-E**

CAN YOU QUALIFY  
*income*  
FOR MORE RESPONSIBILITY  
AS A CIRCUIT DESIGNER?

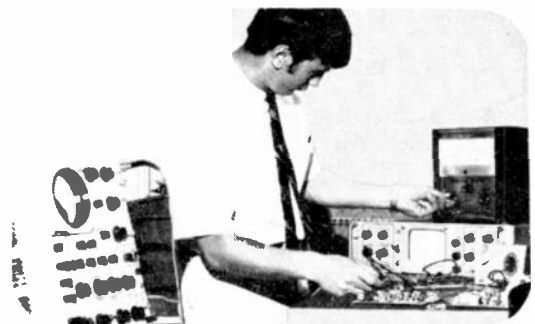

If you have a degree in engineering or formal training in electronics and work in the electronics industry, the Center for Technical Development's DIGITAL DESIGN PROGRAM (DDP-1) can make you more valuable as a trained circuit designer. DDP-1 is a new concept in practical home study courses designed to give you useable know-how fast. YOU CAN'T AFFORD TO WAIT ANOTHER DAY . . . WRITE FOR FULL DETAILS NOW!

We'll also send you information on our IC Logic and Power Supply courses.

870-8

Write Director, Dept. RE-041

0051H

THE CENTER FOR TECHNICAL DEVELOPMENT, INC.

517 East Main Street • Louisville, Ohio 44641

Circle 71 on reader service card





**Unsolder it  
with the  
Endeco  
300**

**Pencil  
Desoldering  
Iron**

**MODEL  
300**

**Removes miniature soldered components in seconds—without damage**

Hollow tip fits over connection; vacuums all solder for easy removal of component. Leaves terminals and mounting holes clean. Then, with 360° contact, it resolders faster, better than regular irons. Handles miniature and standard components in PC boards and conventional wiring. Self-cleaning. All parts replaceable. 40 watts, 120-v. Standard tip supplied, 5 other tip sizes available. Pays for itself. \$11.95 net East of the Rockies.

Larger model available. See your distributor or write:

**ENTERPRISE DEVELOPMENT CORPORATION**  
5127 E. 65th St. • Indianapolis, Ind. 46220

Circle 72 on reader service card

cause horizontal sync problems, unless they're completely dead. (Horizontal sync works on phase, vertical sync on amplitude. So any trouble in sync tube usually shows up as loss of vertical sync first.)

One more: in this circuit there is a 5.6-megohm resistor from the horizontal oscillator grid to B+120 volts. This is a "stabilizer" or hold-down resistor, intended to keep the grid from being driven too far negative. If this changes value, it will change the oscillator frequency. Check it for heat-sensitivity by touching it with a hot soldering iron.

**ZENITH COLOR:  
VERTICAL SHADING**

*I've a problem with a Zenith 20X1C38 chassis. There's a vertical shading on the raster, see diagram. It gets more pronounced as contrast is turned up. Color is fine. What is this?—B. M., New*



SHADING ON RASTER

Haven, West Virginia.

Probably something in the horizontal-blanking diode. Early production of this chassis has two diodes, later runs had three (one of them is a clamp). Check: the blanking is applied in the video amplifiers, through

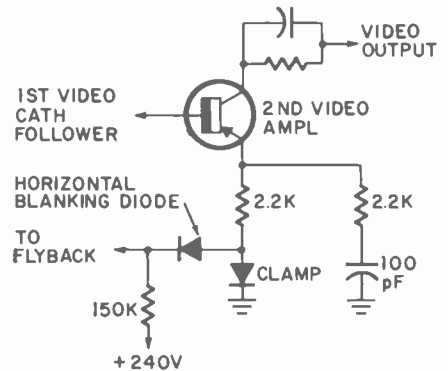

the diodes to the emitter of the 2nd video amplifier, a transistor. Turning the color off should have no effect, but as you said, turning the contrast down makes it "weaker".

A scope will show you this shading, as a "slant" of the video signal, at a horizontal-scan rate. However, it's just as easy to pull the horizontal blanking diode and check it for leakage, with a transistor tester. Or, replace it. Leakage in the video amplifier transistor can cause this, in some cases.

R-E

**BEST VALUES FOR SHOPS AND LABS**

**FREE \$1 BUY WITH EVERY 10 YOU ORDER**

Only applies to "\$1" Buys

**FREE GIFT WITH EVERY ORDER**

<p><b>KNOB SPECIAL</b></p> <ul style="list-style-type: none"> <li><input type="checkbox"/> 100 — ASSORTED RADIO KNOBS All standard types \$1</li> <li><input type="checkbox"/> 50 — TV KNOBS — POPULAR TYPES For most sets \$1</li> <li><input type="checkbox"/> 25 — VERTICAL LINEARITY KNOBS Long shank Front mount miniature assortment \$1</li> <li><input type="checkbox"/> 30 — VERTICAL LINEARITY KNOBS Side mount Standard sizes \$1</li> <li><input type="checkbox"/> 25—KNURLED RADIO KNOBS Hard to get Best selection \$1</li> <li><input type="checkbox"/> 40 — DELUXE RADIO KNOBS Choice assortment Popular types \$1</li> </ul> <p><b>ANY 6 KITS FOR \$5</b></p>	<ul style="list-style-type: none"> <li><input type="checkbox"/> TRANSISTOR RADIO <i>asst type</i> good, bad, broken, as-is, potluck \$1.50</li> <li><input type="checkbox"/> TAPE RECORDER—assorted types good, bad, broken, as-is, potluck \$4</li> <li><input type="checkbox"/> 300 — ASST. 1/2 W RESISTORS Top Brand, Short Leads, Excellent Selection \$1</li> <li><input type="checkbox"/> 100—ASST 1/4 WATT RESISTORS stand, choice ohmages, some in 5% \$1</li> <li><input type="checkbox"/> 100—ASST 1/2 WATT RESISTORS stand, choice ohmages, some in 5% \$1</li> <li><input type="checkbox"/> 70 — ASST 1 WATT RESISTORS stand, choice ohmages, some in 5% \$1</li> <li><input type="checkbox"/> 35 — ASST 2 WATT RESISTORS stand, choice ohmages, some in 5% \$1</li> <li><input type="checkbox"/> 50 — PRECISION RESISTORS asst. list-price \$50 less 98% \$1</li> <li><input type="checkbox"/> 20 — ASSORTED WIREWOUND RESISTORS, 5, 10, 20 watt \$1</li> <li><input type="checkbox"/> 4 — TOGGLE SWITCHES SPST, SPDT, DPST, DPDT \$1</li> <li><input type="checkbox"/> 10—ASSORTED SLIDE SWITCHES SPST, SPDT, DPDT, etc. \$1</li> <li><input type="checkbox"/> COLOR POWER TRANSFORMER — Good for most sets 260/150 List Price—\$10.75 \$6.95</li> <li><input type="checkbox"/> 6 — TRANSISTOR RADIO EARPIECES wires complete with plug \$1</li> <li><input type="checkbox"/> 100' — FINEST NYLON DIAL CORD best size, .028 gauge \$1</li> <li><input type="checkbox"/> 10 — SETS PHONO PLUGS &amp; PIN JACKS RCA type \$1</li> <li><input type="checkbox"/> 3—PRINTED CIRCUIT IF TRANSFORMERS 4-lug, 150 kC \$1</li> <li><input type="checkbox"/> 20 — DIPPED MYLAR CAPACITORS .01—600V \$1</li> <li><input type="checkbox"/> 20 — DIPPED MYLAR CAPACITORS .033—600V \$1</li> </ul>	<p><b>SARKES TARZIAN TUNER</b> 41mc</p> <p>Latest Compact Model good for all 41 mc TV's. BRAND NEW—</p>  <p>Best TUNER "SARKES TARZIAN" ever made—Just word for stability, definition &amp; smoothness of operation. An opportunity to improve and bring your TV Receiver up-to-date. \$7.95 COMPLETE with Tubes</p> <ul style="list-style-type: none"> <li><input type="checkbox"/> TV TUNER — asst. all new standard makes. Less tubes \$1</li> <li><input type="checkbox"/> WESTINGHOUSE STANDARD TUNER Series Type \$4</li> <li><input type="checkbox"/> MATCHED PAIRS TRANSISTORS NPN &amp; PNP (2N4232-2N2904) (2N2222-2N2107) Each set \$1</li> <li><input type="checkbox"/> UHF TUNER — TRANSISTOR TYPE Used in all TV sets \$3.95</li> <li><input type="checkbox"/> 50 — ASSORTED PRINTED CIRCUIT SOCKETS best types \$1</li> <li><input type="checkbox"/> ASTATIC #13T STEREO CARTRIDGE plug in, power point \$3.78</li> <li><input type="checkbox"/> RONETTE STEREO CARTRIDGE latest dual sapphire flipover type \$2</li> </ul>	<ul style="list-style-type: none"> <li><input type="checkbox"/> 12—MINIATURE ELECTROLYTIC CONDENSERS For Transistor &amp; miniature work \$1</li> <li><input type="checkbox"/> 10 — MINIATURE 456KC IF TRANSFORMERS Exceptional value \$1 —PC—1/2" x 1/2"</li> <li><input type="checkbox"/> HEAVY DUTY COLOR FOCUS RECTIFIER 14,000 PIV @ 1 ma \$1</li> <li><input type="checkbox"/> 50 — OIL IMPREGNATED TUBULAR CAPACITORS Percelean, Axial Leads—Most popular values \$3.95</li> <li><input type="checkbox"/> COLOR-TV RECTIFIER — Used in most color sets—6500 kv \$1.95</li> <li><input type="checkbox"/> 15 — ASST. ROTARY SWITCHES all popular types \$20 value \$1</li> <li><input type="checkbox"/> 15 — G.E. #NE-2 TUBES Neon Glow Lamp for 101 uses \$1</li> <li><input type="checkbox"/> 150' — BUSS WIRE #20 tinned for hookups, special circuits, etc. \$1</li> <li><input type="checkbox"/> 50 — .0033 DISC CERAMIC CAPACITORS C.R.L. \$1</li> <li><input type="checkbox"/> 3—ELECTROLYTIC CONDENSERS most popular number 50/30—150V \$1</li> <li><input type="checkbox"/> 7 — TV ELECTROLYTIC CONDENSERS desirable types \$1</li> <li><input type="checkbox"/> 5 — 6' LINE CORDS #18 Stranded Copper Wire \$1</li> <li><input type="checkbox"/> 2 — BELFUSE #450-1 and 3-1 RCA Replacement 945392-4 and 945392-3 \$1</li> <li><input type="checkbox"/> 25 — #130 WESTINGHOUSE PILOT BULBS 5000 Hours... Same as #47 \$1</li> <li><input type="checkbox"/> UHF OR VHF MATCHING TRANSFORMER Simple Fool-proof installation \$1</li> <li><input type="checkbox"/> 3—ELECTROLYTIC CONDENSERS C.D. 500 mfd—200 volts \$1</li> </ul>
--	--	---	--

**IMMEDIATE DELIVERY** . . . Scientific light packing for safe delivery at minimum cost.  
**HANDY WAY TO ORDER:** Pencil mark or write amounts wanted in each box, place letter F in box for Free \$1 BUY. Enclose with check or money order, add extra for shipping. Tear sheets will be returned as packing slips in your order, plus lists of new offers.  
**Minimum Order \$3.00**

Name .....

Address .....

Cost of goods .....  
Shipping .....  
estimated .....  
**TOTAL** .....

Please specify refund on shipping overpayment desired:  CHECK  POSTAGE STAMPS  MERCHANDISE (our choice) with advantage to customer

**BROOKS RADIO & TV CORP., 487 Columbus Ave., New York, N. Y. 10024** 212-874 5600 TELEPHONE

# TRY THIS ONE

## SHOCKPROOFED TOOLS

Automotive-type plastic fuel lines cut to size and slipped over the handles of pliers, cutters, screwdrivers, etc., not only provide a better grip but protect against shock when working on high-voltage components. In many cases these plastic fuel lines have dielectric strengths ranging upwards of 1000 volts per mil.—*Stanley Clark*

## MAGNET WIRE TO REPLACE HOOK-UP WIRE

When doing a lot of interconnecting wiring on a circuit board, try using magnet wire instead of hook-up wire. The thin-wall insulation allows the wire to lie flatter and give a

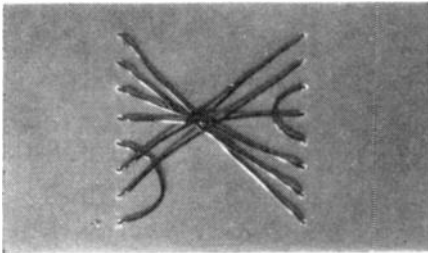

neater appearance. It's ideal for integrated circuit strapping. Use the

smallest magnet wire consistent with circuit current requirements. You can speed up your wiring by using the heat-stripping type (Sodereze) wire.—*A. E. Plavean*

## INCREASING VISUAL RESOLUTION

A method of increasing visual resolution when reading small movements on meters can be obtained with the use of a jeweler's eye loupe. It would be handy to use when a more sensitive meter is not readily available. It could be used for indicating a true value or as a relative indication of voltage, current or resistance. To illustrate: suppose a meter is placed in a circuit and you want to determine whether a particular action would increase or decrease a reading (small value). If you use it for true and small change values, read the proper scale (volts for voltage, etc.). If you use the meter for relative readings, choose the scale that had the most minor divisions, in order to detect any change more readily, as well as to count divisions as a numerical change (2 divisions, 4 divisions, etc.). Use the loupe in your eye or wide-side-down on the meter face.—*Alex Billas R-E*



## MISSILE BATTERY

The Only Lifetime Battery

Surplus—Ni-Cad plastic sintered-plate battery cells at approx. 10% of government cost

Connect these 1.2 V. cells in series to make batteries of any voltage. (Example: 10 cells = 12 V. Batt.), eyes, boats, radio, etc. All the good characteristics not possessed by lead-acid and other alkaline batteries such as: Lifetime service, lighter wgt., constant voltage, high discharge rate (approx. 10 times AH cap.), operate at 100% cap. In temp. range —75° to +165°F., not harmed by storage, discharge, overcharge, or freezing. May be charged thousands of times with the only maintenance of adding distilled water and keeping clean. Select cell sizes to fit your application below.

Type	New AMP Hr	Dimensions inches			Wgt. Oz.	Cost
		High	Width	Deep		
AH4	4	6	2	1/2	6	1.49
AH4	4	6	2	1/2	6	*2.95
AH6	6	4	2-1/8	15/16	8	1.79
AH6	6	4-5/8	2-5/8	3/4	8	1.79
AH6R	6	4-1/2	2-5/8	11/16	8	*2.95
AH10	10	4-3/4	2-3/4	1-3/16	16	2.29
AH10	10	4-3/4	2-3/4	1-3/16	16	*4.95
AH12	12	5-3/4	2-5/16	1-1/16	18	2.79
AH34	34	9-1/4	3-1/8	1-3/8	52	4.95
AH60	60	11-1/4	5	1-3/8	104	5.95

### SPECIAL CLOSE OUT!

Metal based Ni-Cad cells, ideal for motor starting.  
30AHM-30AH, 8 7/8x5x1-1/4, Wgt. 3-1/2 lbs. \$2.00  
52AHM-52AH, 9x5x1-5/8, Wgt. 11 1/2 lbs. \$3.50

Send for complete list including made up batteries. All cells guaranteed for satisfaction or money back. All cells not marked new are used but serviceable. Include postage on parcel post shipments.

## ESSE RADIO COMPANY

Dept. RE-4  
368 S. Meridian St.  
Indianapolis, Ind. 46225

Circle 73 on reader service card

## SHANNON MYLAR RECORDING TAPE

2 1/2" — 225' .. \$ .17	7" — 2400' .....	\$1.79
3" — 225' .. .19	7" — 3600' .....	2.95
3" — 300' .. .27	CASSETTE 60 minutes ..	.89
3 1/4" — 600' .. .58	CASSETTE 9-11 minutes ..	1.54
5" — 600' .. .62	CASSETTE 12-15 minutes ..	1.97
5" — 900' .. .80	2 1/2" TAPE REEL .....	.04
5" — 1200' .. .97	3" TAPE REEL .....	.05
5" — 1800' .. 1.49	3 1/4" TAPE REEL .....	.06
7" — 1200' .. .77	5" TAPE REEL .....	.12
7" — 1800' .. 1.12	7" TAPE REEL .....	.14

CANADIANS: Ordering is easy — we do the paperwork — try a small order

## WESTINGHOUSE ALL TRANSISTOR HOME/OFFICE MESSAGE CENTER

Leaves messages for other for replay . . . Built in speaker/microphone for talk-into convenience . . . Records up to 3 minutes of messages . . . Illuminated signal shows when a message is waiting. Control adjusts playback volume without affecting recording volume. Capstan Drive.  
BRAND NEW SOLD AS IS \$7.95

**IBM COMPUTER SECTIONS**

8 assorted Units we sell for \$1 are loaded with over 150 valuable parts.

Incl. — Transistors, Condensers, Resistors, Heat Sinks, Diodes, Etc.

**8 for \$1**  
**100 for \$10**

- WESTINGHOUSE FM TUNER (12DTS Tube) \$2.99
- WESTINGHOUSE FM TUNER #476-V-015D01 Transistor \$3.99
- 300 — ASSORTED HEX NUTS 2/56, 4/40, 5/40, 6/32, 8/32 \$1
- 250 — ASST. SOLDERING LUGS best types and sizes \$1
- 250 — ASST. WOOD SCREWS finest popular selection \$1
- 250 — ASST. SELF TAPPING SCREWS #6, #8, etc. \$1
- 150 — ASST. 6/32 SCREWS and 150 6/32 HEX NUTS \$1
- 150 — ASST. 8/32 SCREWS and 150-8/32 HEX NUTS \$1
- 150 — ASST. 2/56 SCREWS and 150-2/56 HEX NUTS \$1
- 150 — ASST. 4/40 SCREWS and 150-4/40 HEX NUTS \$1
- 150 — ASST. 5/40 SCREWS and 150-5/40 HEX NUTS \$1
- 500 — ASSORTED RIVETS most useful selected sizes \$1
- 500 — ASSORTED WASHERS most useful selected sizes \$1
- 100 — ASST. RUBBER BUMPERS for cabinet bottoms & other uses \$1
- 100—ASSORTED RUBBER GROMMETS best sizes \$1

## RCA 110° FLYBACK TRANSFORMER

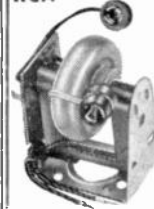

We scooped the Market Latest type — standard for all 110° TV's  
RCA's design of large Coil produces 18KV — assuring adequate width Incl. Schematic Diagram application for any TV  
List price \$13.00

Your price .. \$3  
10% off in lots of 3

## 110° TV DEFLECTION YOKE for all types TV's Incl schematic \$3

## "COMBINATION SPECIAL" RCA 110° FLYBACK plus 110° DEFLECTION YOKE \$5

## 90° FLYBACK TRANSFORMER for all type TV's Incl schematic \$2

## 90° TV DEFLECTION YOKE for all type TV's Incl schematic \$2

## 70° FLYBACK TRANSFORMER for all type TV's Incl schematic \$2

## 70° TV DEFLECTION YOKE for all type TV's Incl schematic \$2

## 2 — TV CIRCUIT BREAKERS Rated 4.2 TO 5.0 AMPS etc. \$1.19

## 70° COLOR YOKE For all round color CRT's \$12.95

## 90° COLOR YOKE For all Rectangular 19 to 25" Color CRT's \$10.95

- CO-AX CABLE RG59U grey or black 250'—\$9.100'—\$3.69 50'—\$1.49
- 4 — TV ALIGNMENT TOOLS most useful assortment #1 \$1
- 4 — TV ALIGNMENT TOOLS For Color TV #2 \$1.49
- 6 — TV COLOR ALIGNMENT TOOLS Most popular type \$2.79
- 5 — PNP TRANSISTOR general purpose, TO-5 case \$1
- 5 — NPN TRANSISTORS general purpose, TO-5 case \$1
- UNIVERSAL TV ANTENNA Back of set Mounting 5 section rods \$1.98
- 50 — ASSORTED TRANSISTORS big factory scoop—sold as is \$1
- 0 TO 200 MICRO AMP MINIATURE METER 1 1/2" x 1 1/2" Wt. 3 Oz Excellent S meter \$1
- 10 — STANDARD TRANSISTORS NPN & PNP 2N104, 2N114, etc. \$1
- 10—ASSORTED DIODE CRYSTALS 1N31, 1N48, 1N60, 1N61, etc. \$1
- 3 — TOP BRAND SILICON RECTIFIERS 1 amp 1000 PIV \$1
- 20 — ASST. PILOT LIGHTS #14 46, 17 51, etc. \$1
- 50 — ASSORTED #3AG FUSES popular ampere ratings \$1
- 4-50' HANKS HOOK-UP WIRE assorted colors \$1
- 100'—SPOOL SPEAKER WIRE 2 cond. mini zip, clear, 101 uses \$1.50
- 10 — ASST. RADIO & TV TUBES Every Tube a good number \$1
- 5 — I.F. COIL TRANSFORMERS 450-kc for Transistor Radios \$1
- 5 — AUDIO OUTPUT TRANSFORM Sub-min for Trans Radios \$1

## MARKET SCOOP COLUMN

- STANDARD TUNER — TRANSISTOR (GUIDED GRID) 4 Channel closed circuit \$1
- 12" UNIVERSAL SPEAKER, Top Quality \$4
- 10" PHILCO SPEAKER Top Quality Large Magnet \$2.69
- 8" UNIVERSAL SPEAKER Large Magnet—Special Buy \$2.49
- UTAH 8"—HEAVY DUTY 10 OZ. SPEAKER Ceramic Type—8 Ohm \$3.69
- 6"—ECONOMY SPEAKER Top quality 3.15 Mag. \$2.94
- 1 1/2" UNIVERSAL TWEETER 1.5" Magnet \$1.29
- UNIVERSAL 4" PM SPEAKER With 500.6 Output Transformer \$1
- 2 1/2" x 4" SPEAKER Special Buy \$69¢
- 3 1/2" — ROUND SPEAKER Special Buy \$59¢
- 4" x 6" "QUAM" 16 OHM SPEAKER Large magnet \$1.79 Special Buy
- 25 — 3900-OHM-7w RESISTOR 10% Coming glass \$1
- 20 — 47-600V CONDENSERS White Ceramic C.D. Americn \$1
- TV TWIN LEAD-IN 300 ohm 500' — \$7.100'—\$1.50 50' — \$1
- 5—ASST. GLOBAL VARISTORS Popular Types for most color TV \$1
- CRYSTAL LAPEL MICROPHONE High Imped. 200-6000 cps — 10 for \$5 \$59¢ ea.
- 4—ELECTROLYTIC CONDENSERS 75/30mf—150v \$1

Circle 74 on reader service card



# Earn Your Degree

## ELECTRONICS ENGINEERING

### through HOME STUDY

#### HIGHLY EFFECTIVE

#### HOME STUDY COURSES IN:

- Electronics Engineering Technology
- Electronics Engineering Mathematics

Earn your Associate in Science Degree in Electronics Engineering and upgrade your status and pay to the engineering level. Complete college level courses in Electronics Engineering. We're a forward looking school. Outstanding lesson material—thorough and easy to understand. Engineering taught on the basis of application and understanding rather than on the basis of memorization. Up to date in every respect. Acquire the knowledge and ability that means the difference between a low paying technician job and a high paying engineering position. Low tuition cost with low monthly payments. Free engineering placement service for our graduates. Write for free descriptive literature. Ask for bulletin R, no salesman will call on you.



### COOK'S INSTITUTE

of Electronics Engineering

Forest Hill Road  
P. O. Box 10634  
Jackson, Miss. 39209

Established 1945  
Formerly Cook's School of Electronics

Circle 75 on reader service card

### OUR STORE AT YOUR DOOR

# Olson ELECTRONICS

# FREE Catalog

Fill in coupon for a FREE One Year Subscription to OLSON ELECTRONICS Fantastic Value Packed Catalog—Unheard of LOW, LOW PRICES on Brand Name Speakers, Changers, Tubes, Tools, Stereo Amps, Tuners, CB, Hi-Fi's, and thousands of other Electronic Values. Credit plan available.

NAME \_\_\_\_\_  
ADDRESS \_\_\_\_\_  
CITY \_\_\_\_\_ STATE \_\_\_\_\_  
GIVE ZIP CODE \_\_\_\_\_

If you have a friend interested in electronics send his name and address for a FREE subscription also.

### OLSON ELECTRONICS

Dept. LP 260 S. Forge Street  
Akron, Ohio 44308

Circle 76 on reader service card

# NEW BOOKS

**ELECTRONIC INSTRUMENTATION AND MEASUREMENT TECHNIQUES**, by William David Cooper. Prentice-Hall, Inc., Englewood Cliffs, N.J. 07632. 495 pages, 6½ x 9½ in. Hardcover, \$12.95.

This textbook requires a knowledge of calculus for some sections. Covers measurement in general, dc/ac indicating instruments and bridges, the scope, waveform generators, frequency counters, transducers and analog/digital data systems.

**NETWORK THEORY** by Joseph B. Murdoch. McGraw-Hill Book Co., 330 W. 42nd St., New York, N.Y. 10036. 6 x 9½ in. 525 pages. Hardcover, \$16.00.

About half of this book examines steady-state analysis of linear networks while the other half considers the free and forced behavior of linear networks. Both theoretical concepts and applications are covered. In addition to traditional material, several modern topics including special matrices, gyrators, the negative impedance converter, n-port theory, and sensitivity are also included.

**SIMPLE TRANSISTOR PROJECTS FOR HOBBYISTS AND STUDENTS**, by Larry Steckler. Tab Books, Blue Ridge Summit, Pa. 17214. 5½ x 8½", 192 pp. Hardcover, \$7.95, softcover, \$4.95.

A collection of circuits, gadgets and projects for home and car to be built from diodes, SCR's, transistors, Trigacs, and integrated circuits. Emphasis on how and why the circuits work, along with schematics and parts lists, and a rundown on basic semiconductor construction techniques. Variety of projects, ranging from quite simple to complex, for the avid hobbyist or student.—ML

**SINGLE SIDEBAND FOR THE RADIO AMATEUR**, compiled by the Headquarters Staff of The ARRL. Published by The American Radio Relay

League, Newington, Conn. 06111. 6½ x 9½ in., 256 pp. Softcover, \$3.00 in U.S. and possessions, \$3.50 Canada and elsewhere.

This, the fifth edition of "the sidebander's bible" has been revised to include more than 60% new material with great emphasis on state-of-the-art theory and the application of solid-state devices. Its nine chapters, ranging from "Principles" and "Transceivers" to "Receivers" and "Vhf Techniques" are compilations of the most pertinent articles on SSB from the pages of QST. A must for the active sidebander and the Novice who is awaiting his more advanced license so he, too, may realize the advantages of SSB operation with its linears, transceivers, excitors, etc.—RFS

**SOLID STATE HOBBY CIRCUITS MANUAL, HM-91**, by RCA Distributor Products, Harrison, N.J. 07029. 5¼ x 8", 368 pp. Softcover, \$1.95.

Presents more than 60 solid-state circuits which can be built by electronics hobbyists ranging from beginners to experts. Detailed photographs, schematic diagrams, parts lists, and construction layouts are given. Also includes brief description of theory and operation of solid-state devices, construction tips, information on tools required, soldering techniques, testing, trouble-shooting.—ML

**SYNTHESIS OF TRANSISTOR AMPLIFIERS**, by Michael Kahn and John M. Doyle. Holt, Rinehart and Winston, Inc., 383 Madison Ave., New York, N.Y. 10017. 6½ x 9¾", 400 pp. Hardcover, \$10.95.

Intended primarily for use in technical programs in junior colleges and technical institutes, this text-book examines the principles of amplification and the transistor. Covers concepts of bias, gain, distortion, as well as the emitter-follower circuit, and amplifier design. Includes graphs and formulae. R-E

# NOW... YOU CAN ZIP-ORDER

## Amateur, Monitor and CB

## CRYSTALS

Your dealer has a new, fast, direct-factory ZIP Crystal Purchase Certificate that enables you to get the Amateur Controlled Quality Crystals you want mailed direct to you promptly. Ask about it.



# CRYTEK

formerly Texas Crystals

DIVISION OF  
WHITEHALL  
ELECTRONICS  
CORPORATION

1000 Crystal Drive

Fort Myers, Florida 33901

4117 W. Jefferson Blvd.

Los Angeles, California 90016

Circle 77 on reader service card

RADIO-ELECTRONICS

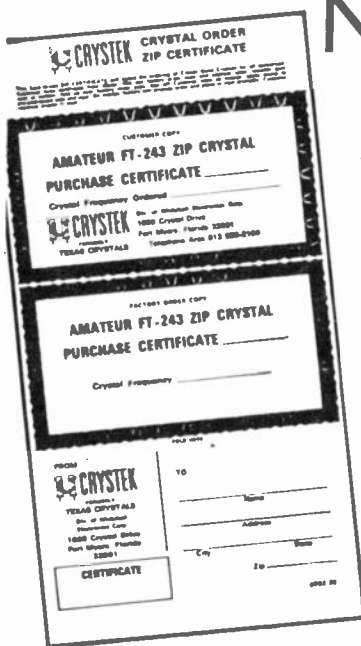

# COMING NEXT MONTH MAY 1971

## ■ PA System Selection Guide

An expert details a method for determining how you should select a PA system. Follow carefully to avoid buying too much or too little.

## ■ Speakers for PA

One of the most vital parts of a PA system are the speakers. What are the advantages of horns, columns, etc.? Where do they work best? How should they be positioned?

## ■ You And CATV

A look at CATV systems today. Examines the parts you see as well as the parts you don't. You'll find answers to such questions as, Why do they switch the channels around? What about FM reception? And many more.

## ■ Build A Densitometer

Make perfect prints every time. This unit makes it easy to determine the exact density of all of your negatives.

## ■ Replacing Color Picture Tubes

Here's the easy way to get this job done. A multitude of photos illustrate the procedure.

PLUS . . .

Home Appliance Electronics  
Technical Topics  
Kwik-Fix Troubleshooting Charts

# CB Troubleshooter's Casebook

Compiled by  
Andrew J. Mueller\*

**Case:** Radio blows fuses as soon as it is hooked up to power.

**Common to:** Squires-Sanders "Skipper"

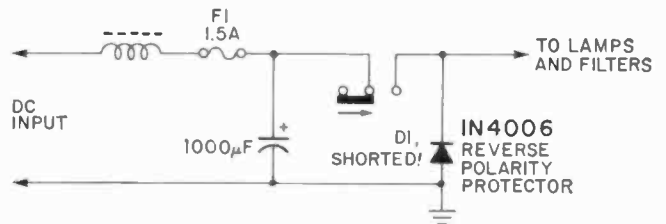

**Remedy:** Replace D1, the polarity protector.

**Reasoning:** The unit was accidentally connected to the power source backwards. D1 protected the unit by conducting heavily and blowing F1. However, before F1 blew, the excessive current shorted the diode. Replace D1 to restore normal operation. R-E

\*Service Manager, Tel-Air Communications, Inc., Pewaukee, Wis.

# EIGHT INSTRUMENTS IN ONE

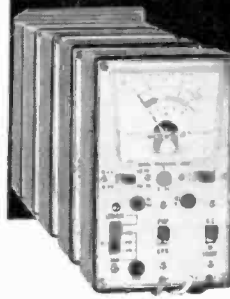

- Out-of-Circuit Transistor Analyzer
- Dynamic In-Circuit Transistor & Radio Tester
- Signal Generator
- Signal Tracer • Voltmeter
- Milliammeter
- Battery Tester
- Diode Checker

## Transistor Analyzer Model 212

Factory Wired & Tested — \$21.50  
Easy-to-Assemble Kit — \$14.50

YOU DON'T NEED A BENCH FULL OF EQUIPMENT TO TEST TRANSISTOR RADIOS! All the facilities you need to check the transistors themselves — and the radios or other circuits in which they are used — have been ingeniously engineered into the compact, 6-inch high case of the Model 212. It's the transistor radio troubleshooter with all the features found only in more expensive units. Find defective transistors and circuit troubles speedily with a single, streamlined instrument instead of an elaborate hook-up.

### Features:

Checks all transistor types — high or low power. Checks DC current gain (beta) to 200 in 3 ranges. Checks leakage. Universal test socket accepts different base configurations. Identifies unknown transistors as NPN or PNP.

Dynamic test for all transistors as signal amplifiers (oscillator check), in or out of circuit. Develops test signal for AF, IF, or RF circuits. Signal traces all circuits. Checks condition of diodes. Measures battery or other transistor-circuit power-supply voltages on 12-volt scale. No external power source needed. Measures circuit drain or other DC currents to 80 milliamperes. Supplied with three external leads for in-circuit testing and a pair of test leads for measuring voltage and current. Comes complete with instruction manual and transistor listing.

EMC, 625 Broadway, New York 12, N. Y.

Send me **FREE** catalog of the complete value-packed EMC line, and name of local distributor.

NAME \_\_\_\_\_ RE-4

ADDRESS \_\_\_\_\_

CITY \_\_\_\_\_ ZONE \_\_\_\_\_ STATE \_\_\_\_\_

# EMC

ELECTRONIC MEASUREMENTS CORP.  
625 Broadway, New York 12, New York  
Export: Pan-Mar Corp., 1270 B'way, N. Y. 1

# MARKET CENTER

## ELECTRONICS

PRINTED Circuit Boards, solder plated, for magazine projects. Send magazine page or drawing of circuit pattern. 20¢ square inch. Min. \$1.75 per board. Send remittance: **GENERAL PRINTED CIRCUITS**, Box 4013, Downey, Calif. 90241

"HOW TO INCREASE TRANSISTOR RADIO REPAIR PROFIT" Write: X T R. Box 1556, Las Vegas, Nev. 89101.

COLOR Organ Kits \$7.50. IC's \$.75. Catalog. **MURPHY**, 204 Roslyn Avenue, Carle Place 11514

RECEIVING & Industrial Tubes, Transistors. All Brands—Biggest Discounts. Technicians, Hobbyists, Experimenters—Request **FREE** Giant Catalog and **SAVE!** **ZALYTRON**, 469 Jericho Turnpike, Mineola, N.Y. 11501

JAPANESE NEW PRODUCTS MONTHLY! \$1.00 Refundable. **DEFRE**, P.O. Box 9308, No. Hollywood, Calif. 91609

B & K, Sencor test equipment, discount prices, Free catalog and price sheet. **FORDHAM RADIO**, 265 East 149th Street, Bronx, NY 10451

DISCHARGE Ignition, Photoflash. Free catalog parts, kits. **TRANSPARK**, Carlisle, Mass. 01741

CONVERT any television to sensitive big-screen oscilloscope. Only minor changes required. No electronic experience necessary. Illustrated plans \$2.00. **RELCO-A25**, Box 10563, Houston, Texas 77018

CONVERT your scope for dual trace sweep, described in July '70 R.E. Also high speed triggersweep. Semiconductor and PC board kits. **HAMLIN TECHNICAL PRODUCTS**, P.O. Box 901, Cupertino, Calif. 95014

TUBES—Lowest prices. Foreign-American. Obsolete, receiving, special purpose, transmitting tubes. Send for tube, parts catalog. **UNITED RADIO COMPANY**, 56-R Ferry St., Newark, N.J. 07105

TELEVISION—Instant starting! Convert receivers for pleasure-profit! Schematics, complete instructions. Guaranteed \$3.95. **DLW COMPANY**, 1304 Magnolia Drive, Richardson, Texas 75080.

RADIO and TV Tubes 36¢ each. One year guaranteed. Plus many unusual electronic bargains. Free Catalog. **CORNELL** 4217-E University, San Diego, California 92105

COLOR CONVERTER FOR B&W TELEVISION. Electronic Patented system. Write for free Brochure. **BELE ELECTRONICS CORP.** 111 Northeast Second Avenue, Miami, Florida, 33132

CAPACITORS 500µf. Eight for \$3.10. P.O. Box 203, New Hartford, New York 13413

### NEW RATES

CLASSIFIED COMMERCIAL RATE (for firms or individuals offering commercial products or services). 90¢ per word . . . minimum 10 words.

NON-COMMERCIAL RATE (for individuals who want to buy or sell personal items) 60¢ per word . . . no minimum.

FIRST WORD and NAME set in bold caps at no extra charge. Additional bold face at 10¢ per word. Payment must accompany all ads except those placed by accredited advertising agencies. 10% discount on 12 consecutive insertions, if paid in advance. Misleading or objectionable ads not accepted. Copy for June issue must reach us before April 5.

## CLASSIFIED ADVERTISING ORDER FORM

1	2	3	4	5
6	7	8	9	10
11	12	13	14	15
16	17	18	19	20
21	22	23	24	25
26	27	28	29	30
31	32	33	34	35

No. of Words { @ .60 Non-Commercial Rates } = \$ \_\_\_\_\_  
 { @ .90 Commercial Rate } = \$ \_\_\_\_\_  
 No. of Words in bold caps @ .10 = \$ \_\_\_\_\_

Total Enclosed \$ \_\_\_\_\_

Insert \_\_\_\_\_ time(s)

Starting with \_\_\_\_\_ issue

Payment must accompany order unless placed through accredited advertising agency 28

NAME \_\_\_\_\_

ADDRESS \_\_\_\_\_

CITY \_\_\_\_\_ STATE \_\_\_\_\_ ZIP \_\_\_\_\_

SIGNATURE \_\_\_\_\_

MAIL TO: RADIO-ELECTRONICS, CLASSIFIED AD DEPT., 200 PARK AVE. SOUTH, NEW YORK, N.Y. 10003

## ADVERTISING INDEX

RADIO-ELECTRONICS does not assume responsibility for any errors which may appear in the index below.

READER SERVICE CARD NO.	PAGE
Acoustical Mfg. Co., Ltd. ....	74
64 B.F. Enterprises .....	76
10 B&K (Division of Dynascan Corp.) ...	22
74 Brooks Radio & TV Corp. ....	84-85
71 Center for Technical Development, Inc. ....	83
4 Channel Master .....	13
8 Chemtronics .....	16
16 Cleveland Institute of Electronics ...	64-67
75 Cook's Institute of Electronics Engineering .....	86
C'REL Home Study Division of McGraw-Hill Book Co. ....	29-30
77 Crystek, Division of Whitehall Electronics .....	86
70 Delta Electronics Co. ....	82
12 Delta Products Inc. ....	24, 28
78 Edmund Scientific Co. ....	92
65 Electronic Chemical Corp. ....	76
69 Electronic Distributors, Inc. ....	82
3 EICO, Electronic Instrument Co., Inc. ...	12
72 EMC, Electronic Measurement Corp. ...	87
73 Enterprise Development Corp. ....	84
Esse Radio Co. ....	85
Grantham School of Engineering ...	54-57
68 Heath Co. ....	78-81
80 International Crystal Mfg. Co. ...	Cover IV
66 F. F. Johnson Co. ....	77
61 Judson Research & Mfg. Co. ....	74
62 Laran Electronics Corp. ....	75
7 Leader Instrument Corp. ....	15
5 Lectrotech, Inc. ....	14
79 Mallory Distributor Products Co. Cover III	
National Radio Institute .....	8-11
National Technical Schools .....	25
76 Olson Electronics Inc. ....	86
RCA Electronic Components Semiconductor Division .....	31
14 Test Equipment .....	27
RCA Institutes .....	18-21
RCA Parts & Accessories .....	5
67 Rye Industries, Inc. ....	77
9 Sams & Co., Howard W. ....	17
11 Sansui Electronics Corp. ....	23
63 Schober Organ Co. ....	75
2 Sencore, Inc. ....	7
6 Sonar Radio Corp. ....	14
Sylvania Electronic Components Group, GTE .....	Cover II, 1
13 Triad Division, Litton Industries ....	26
15 Ungar, Division of Eldon Industries, Inc. ...	32
MARKET CENTER .....	88-91
Fair Radio Sales	
Lakeside Industries	
Music Associated	
83 Park Electronic Products	
81 Polypaks	
82 Solid State Sales	
Surplus Center	
Sydmar Electronics	
SCHOOL DIRECTORY .....	89
Valparaiso Technical Institute	



waveform wouldn't be exactly half chopped off, but we're close.)

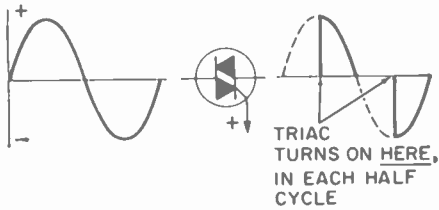

Fig. 5

Fig. 6 shows a complete control circuit of the basic type you'll find in a lot of appliances. The variable 100,000-ohm resistor applies the voltage to the resistor-capacitor network. During each half-cycle, the voltage on the .05- $\mu$ F capacitor builds up as the input voltage rises. When it reaches a value of approximately 28 volts ( $\pm$  4 volts) the "bilateral trigger diode" conducts, and gates the Triac on.

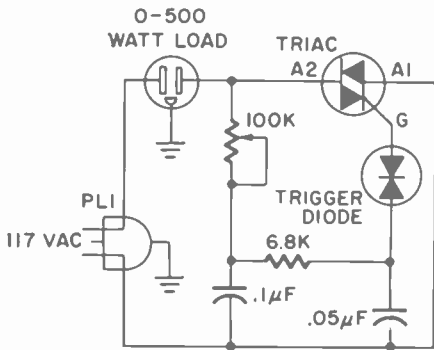

Fig. 6

The charging time of a capacitor in such a circuit depends on the amount of series resistance in the charging circuit. So, the setting of the 100,000-ohm pot determines the time needed for the capacitor to reach the firing voltage. The trigger diode, like the Triac, is also an "ac device", which will work just the same with either polarity.

In a different version of this circuit, a small neon lamp is used in place of the trigger diode. These lamps will "fire" (glow) whenever the applied voltage reaches approximately 68 volts. The values of resistors and capacitors are a little different, but the action is the same. The neon lamp is an open circuit until it fires. This allows a pulse of voltage to pass and reach the Triac gate. The lamp will fire once during each half-cycle, so once again we get full-wave control action.

You'll find these things used in multiple-speed blenders; variable-speed electric drills; multi-speed electric mixers, and so on. In a lot of cases, they'll be sealed up in real "Black Boxes" but if you have some idea what they're supposed to do, you can check them. They won't be too easy to check with an ohmmeter, for example, but you can almost always "jumper" a speed-control device. If the motor runs or the device operates, but it won't with the speed control device in circuit, that's it; replace it.

R-E

**DECODERS! COUNTERS! LATCHES! MEMORIES! IC's**

• GUARANTEED " BRAND NEW • SPEC SHEETS • LOWEST PRICES Any 3 — 10% Discount!

TYPE	DESCRIPTION	SALE	TYPE	DESCRIPTION	SALE
<input type="checkbox"/> SN7400N	Quad 2-input NAND gate	\$.88	<input type="checkbox"/> SN7474N	Dual D-type edge triggered flip flop	1.19
<input type="checkbox"/> SN7401N	Same as 7400 but with open collector output	.88	<input type="checkbox"/> SN7475N	Quad bistable latch	2.95
<input type="checkbox"/> SN7402N	Quad 2-input NOR gate	.88	<input type="checkbox"/> SN7476N	Dual J-K flip flop	1.49
<input type="checkbox"/> SN7404N	Hex inverter	.99	<input type="checkbox"/> SN7480N	Gated full adder	1.49
<input type="checkbox"/> SN7410N	Triple 3-input NAND gate	.88	<input type="checkbox"/> SN7481N	16-bit MEMORY	4.50
<input type="checkbox"/> SN7420N	Dual 4-input NAND gate	.88	<input type="checkbox"/> SN7482N	2-bit binary full adder	4.95
<input type="checkbox"/> SN7430N	8-input NAND gate	.88	<input type="checkbox"/> SN7483N	4-bit binary full adder	5.50
<input type="checkbox"/> SN7440N	Dual 4-input NAND buffer	.88	<input type="checkbox"/> SN7490N	Decade counter	3.95
<input type="checkbox"/> SN7441N	BCD-to-Nixie tube driver	3.95	<input type="checkbox"/> SN7491N	8-bit shift register	4.95
<input type="checkbox"/> SN7442N	BCD-to-decimal-decoder	3.95	<input type="checkbox"/> SN7492N	Divide-by-twelve counter	3.95
<input type="checkbox"/> SN7447N	BCD-to-7 seg decoder-driver	3.95	<input type="checkbox"/> SN7493N	4-bit binary counter	3.95
<input type="checkbox"/> SN7472N	J-K Master slave flip flop	.99	<input type="checkbox"/> SN7494N	4-bit shift register	3.95
<input type="checkbox"/> SN7473N	Dual J-K master slave flip flop	1.19	<input type="checkbox"/> SN7495N	4-bit right-shift left-shift register	3.95

**COUNTING SYSTEM**

3 PC. KIT **\$8.50**  
Includes SN7140 decade counter, SN7141 BCD decoder-driver, SN7175 quad latch with hookups instructions

**NIXIE\* TUBE \$5.95** (0-9), wide angle \* Similar to Burroughs

**SILICON EPOXY RECTIFIERS**

PIV	1Amp*	2Amp	3Amp
50	\$.05	\$.05	\$.08
100	.06	.06	.12
200	.07	.07	.15
400	.09	.09	.22
600	.12	.12	.28
800	.16	.16	.39
1000	.22	.22	.59

\*microminiature

**6 AMP FULL**

PIV	SALE
50	\$0.88
100	.99
200	1.25
400	1.50
600	1.75
800	1.95
1000	2.25

**WAVE BRIDGE RECTS**

**FAIRCHILD IC "AMP"**

Any 3 10% Discount!

Type	Description	Each
<input type="checkbox"/> 702	Wide Band DC	1.19
<input type="checkbox"/> 703	RF-IF Amp	1.19
<input type="checkbox"/> 709	Operational	1.19
<input type="checkbox"/> 710	Hi-Speed Diff.	1.19
<input type="checkbox"/> 2809	Dual 709's	1.98
<input type="checkbox"/> 2747	Dual 741's	2.98
<input type="checkbox"/> 741	Freq. Comp. 709	1.59

**4,000 BIT MEMORY \$8.50**

From IBM Computers, Guaranteed W/Spec Sheets

**SPRAGUE- IC's**

Your Choice 3 for \$1 **RTL**

<input type="checkbox"/> 908	Full Adder
<input type="checkbox"/> 909	Buffer
<input type="checkbox"/> 912	Half Adder
<input type="checkbox"/> 913	Shift Register
<input type="checkbox"/> 921-914	Dual 2 In. Gate
<input type="checkbox"/> 940-923	JK Flip Flop
<input type="checkbox"/> 960	Dual Buffer

10¢ Catalog on Fiber Optics, IC's, Semis, Parts

Terms: add postage. Rated: net 30, col's 25%. Phone Orders: Wakefield, Mass. (617) 245-3829. Retail: 211 Allison, St., Wakefield, Mass.

**POLY PAKS**

P.O. BOX 942 R LYNNFIELD, MASS 01940

Circle 81 on reader service card

**NOW build your own Capacitor Discharge Ignition System for as little as \$11.45!** Circuit diagram included with special ignition transformer.

TR-200 transformer 6 or 12 volts 11.45

Complete COMPAC KIT 6 or 12 volts 25.95 (as described in POPULAR ELECTRONICS—Nov 1966)

FREE LITERATURE on all SYDMUR "CD" Systems.

SYDMUR—P.O. Box 25, Midwood Station, Brooklyn, N.Y. 11230

ENJOY THE "MUSIC ONLY" FM PROGRAMS

**M. A. D.**

MUSIC ASSOCIATED'S DETECTOR for continuous, commercial-free music with ANY FM tuner or receiver

Kit \$49.50 Wired \$75.00 Cover \$4.95 List of FM stations with SCA authorization \$1.00. Excellent F.M. Monaural Tuner with M.P.X. Jack \$50.00

MUSIC ASSOCIATED  
65 Glenwood Rd., Upper Montclair, N.J. D7043 phone 201-744-3387

**SCHOOL DIRECTORY**

GET INTO **ELECTRONICS**

V.T.I. training leads to success as technicians, field engineers, specialists in communications, guided missiles, computers, radar and automation, Basic & advanced courses in theory & laboratory. Electronic Engineering Technology & Electronic Technology curricula both available. Associate degree in 29 mos. B.S. also obtainable. G.I. approved. Graduates in all branches of electronics with major companies. Start Sept. Feb. Dorms, campus. High school graduate or equivalent. Catalog.

VALPARAISO TECHNICAL INSTITUTE  
Dept. C, Valparaiso, Indiana 46383

**FREE Catalog** Of The WORLD'S FINEST GOV'T SURPLUS ELECTRONIC BARGAINS

Now **BIGGER** and **BETTER** Than Ever!

—MAIL THIS COUPON NOW—

NAME: \_\_\_\_\_

ADDRESS: \_\_\_\_\_

CITY: \_\_\_\_\_ STATE: \_\_\_\_\_ ZIP: \_\_\_\_\_

For your **FREE** copy, fill out coupon and mail. Dept. RE

**FAIR RADIO SALES**  
1016 E. EUREKA • Box 1105 • LIMA, OHIO • 45802

# MARKET CENTER

ARMY surplus electronics catalog, 10¢. RUSSELL, 9410 Walhampton, Louisville, Ky. 40222

## WANTED

QUICK CASH . . . for Electronic EQUIPMENT, COMPONENTS, unused TUBES. Send list now! BARRY, 512 Broadway, New York, N.Y. 10012, 212 WALKER 5-7000

## AUDIO - HI-FI

TRADE stereo cartridges. BAKER, Box 189, North Hollywood, Cal. 91603

BACKGROUND MUSIC, continuous, commercial, free. Solid-state MUSICON SCA ADAPTER plugs into any FM Tuner, Receiver. Line powered. 5 year guarantee! Only \$39 postpaid. K-LAB, Box 572R, South Norwalk, Conn. 06856

RENT 4-track open reel tapes—all major labels—3,000 different—free brochure. STEREO-PARTI, 55 St. James Drive, Santa Rosa, Calif. 95401

OLD TIME RADIO SHOWS on tape. Catalog Free. Box 724, Redmond, Washington 98052

## EDUCATION/ INSTRUCTION

MEMORIZE, Study: 1971 Test-Answers" for FCC First and Second Class License.—plus—"Self-Study Ability Test." Proven. \$9.95. COM-MAND, Box 26348-E, San Francisco, Calif. 94126

PSYCHEDELIC LIGHTING MANUAL. Make strobes, kaleidoscopes, organs, etc. Send \$2.95. LIGHTRAYS, 1315-C Weaver, Philadelphia, Pa. 19150

TV TUNER REPAIRS—Complete Course Details, 12 Repair Tricks, Many Plans, Two Lessons, all for \$1. Refundable. FRANK BOCEK, Box 3236 (Enterprise), Redding, Calif. 96001

CB'ERS Build your own 250 Watt Linear. Instructions \$2.00. Catalog 25¢. ROBERTS, Box 403, Whiting, Ind. 46394.

## INVENTIONS & PATENTS

INVENTIONS Wanted. Patented; Unpatented. GLOBAL MARKETING, 2420-AE 77th Ave., Oakland, Calif. 94605

## GOVERNMENT SURPLUS

JEEPS Typically from \$53.90 . . . Trucks from \$78.40 . . . Airplanes, Typewriters, Boats, Clothing, Camping, Sporting, Photographic, Electronics Equipment. Wide Variety, Condition. 100,000 Bid Bargains Direct from Government Nationwide. Complete Sales Directory and Surplus Categories Catalog. \$1.00 (Deductible First \$10.00 Order From Our Separate Included Catalog.) SURPLUS SERVICE, Box 820-REL, Holland, Mich. 49423



FOR 25 YEARS THE WORLD'S MOST NEEDED GIFT

Give to help people: CARE-New York, N.Y. 10016 or your nearest office

### Rebuild Your Own Picture Tubes?

With Lakeside Industries precision equipment, you can rebuild any picture tube!

For complete details, send name, address, zip code to:

LAKE-SIDE INDUSTRIES  
5234 N. Clark St.  
Chicago, Ill. 60640  
Phone: 312-271-3399

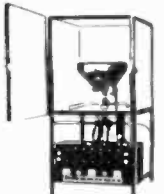

## INTEGRATED CIRCUITS / RECTIFIERS SEMICONDUCTORS / TRIACS

BCD Counter Kit consisting of:

- 1—PC Board 12707
- 2—7476 IC's
- 2—Silicon diodes
- 1—Set of instructions

When assembled by enclosed instructions, this kit will count pulses from 0-9 in BCD. These boards can be connected in series to count as high as desired. Example, two will count to 99, three to 999. \$6.95

ER900 TRIGGER DIODES. These bidirectional trigger diodes are one of the best and cheapest methods to trigger SCR's and triacs. 4/\$1.00

LIGHT EMITTING DIODES (LED's)  
Infra red . . . . . \$1.50  
Visible . . . . . \$1.50  
Photo detectors for each . . \$1.00

### TRIACS

PRV	1A	10A	15A
100	.40	.70	1.00
200	.70	1.10	1.40
300	.90	1.35	1.80
400	1.10	1.60	2.20
500	1.50	2.00	2.60

### UNIUNCTIONS!

TIS 43 General purpose Uniunions \$ .50

2N3819 General purpose N-Channel FET'S \$ .45

### TTL IC SERIES

- 7441 BCD DECIMAL DECODER . . . . . \$2.50
- 7474 DUAL FLIP FLOP . . . \$1.25
- 7475 QUAD BISTABLE LATCH . . . . . \$2.00
- 7476 DUAL JK MASTER-SLAVE JK FLIP FLOP \$1.50
- 7490 DECADE COUNTER . . \$2.50
- 7492 DIVIDE BY TWELVE \$2.50
- 7493 4 BIT BINARY COUNTER . . . \$2.50

### Silicon Power Rectifiers

PRV	3A	12A	30A
100	.09	.24	.40
200	.12	.28	.60
400	.16	.35	.90
600	.20	.50	1.10
800	.28	.70	1.40
1000	.35	.90	

Terms: FOB Cambridge, Mass. Send check or Money Order. Include Postage. Average Wt. per package 1/2 lb. No. C.O.D.'s. Minimum Order \$3.00

### FIBRE OPTICS

1/32" 2.5 mil. fibers in PVC packet. \$ .33/ft.

### COMPLETE LIGHT GUIDE BUNDLE

consisting of an 11" length of 1/10" dia. fiber optics with bound ends. \$4.00 ea.

Controlled Avalanche or Epoxy Rectifiers 1 AMP.

PRV	.06	PRV	.11
100	.06	600	.11
200	.07	800	.15
400	.09	1000	.20

### LINEAR CIRCUITS

709C operational Amp . . \$1.00

SE 501 Vldoe Amp . . . \$1.00

### Silicon Control Rectifiers

PRV	3A	7A	20A	70A
50	.25	.28	.60	
100	.30	.38	.85	3.50
200	.50	.60	1.10	6.50
300	.60	.68	1.30	
400	.70	.75	1.50	9.50
500	.80	.85	1.70	
600	.90	1.20	1.90	11.00

14 pin dual in line sockets 4/\$1.00

Send for our latest catalog featuring Transistors and Rectifiers; 325 Elm St., Cambridge, Mass.

**OLID**

Post Office Box 74D

**TATE**

Somerville, Mass. 02143

**ALES**

Tel. (617) 547-4005

Circle 82 on reader service card

## PEP'S Dollar Sale \$1 Money Back guarantee \$1

1 Amp Silicon Rectifier choice of package  
Bullet—Miniature Glass-Metal

- 5-800V units \$1.00
- 4-1000V units \$1.00
- 3-1200V units \$1.00

3 AMP Epoxy Package  
 10-100V units \$1.00  
 5-400V units \$1.00  
 2-1000V units \$1.00

Gen Purpose PNP Germ Transistor Similar to 2N404  
 8 For \$1.00

2 AMP BULLET RECTIFIERS

- 10-200V—\$1.00
- 8-100V—\$1.00
- 6-500V—\$1.00
- OP AMP 709C 1—\$1.00

15 AMP TRIACS PRESSFIT

- 5-50V 7—\$1.00
- 7 AMP SCR 5-100V 10—\$1.00

1 AMP GLASS RECTIFIERS

- 50-1000V 20—\$1.00

### SILICON CONTROL RECTIFIERS

PRV	1 Amp	3 Amp	7 Amp
50	.20	.25	.30
100	.25	.30	.35
200	.40	.45	.50
300	.60	.70	.80
400	.75	.85	.95
500	—	—	1.00
600	—	—	1.30

### TRIACS

PRV	1Amp	3Amp	6Amp	10Amp	15Amp
100	.40	.50	.75	1.00	1.20
200	.65	.75	1.00	1.40	1.80
300	1.00	1.10	1.25	1.90	2.20
400	1.30	1.40	1.80	2.30	2.60
500	1.60	1.80	2.10	2.75	3.10

### FULL WAVE BRIDGES

PRV	2Amp	3Amp	5Amp	10Amp
50V	1.25	1.35	1.50	1.70
100V	1.50	1.60	1.75	1.95
200V	1.75	1.85	2.00	2.20
400V	2.00	2.10	2.25	2.45
600V	2.50	2.60	2.75	2.95
800V	3.00	3.10	3.25	3.45

## PARK ELECTRONIC PRODUCTS

P. O. Box 78 N. Salem, N. H. 03073  
Tel. (603) 893-0276

NO SALES TAX WE PAY POSTAGE

Circle 83 on reader service card

RADIO-ELECTRONICS



**KEEP PACE WITH SPACE AGE! SEE MOON SHOTS—LANDINGS, SPACE FLIGHTS, CLOSE-UP!**  
**AMAZING SCIENCE BUYS**  
**for FUN, STUDY or PROFIT**

**FREE GIANT CATALOG!**

**3-CHANNEL COLOR ORGAN BARGAIN!**  
 Create tremendous variety of unusual & beautiful lighting effects with this low-cost top-quality 1500-Watt unit (500 W. per channel), compare with others selling for twice the price. Has pilot light, plus individual sensitivity controls and channel indicator lights (can operate ten 150 W. "spots" or 200 "Christmas lights, 15cs reg. house current—attaches to audio source w/ RCA-type phono plug, 5 1/2" x 6 7/8" x 2 1/2", 2 1/2 lbs. Thermal setting plastic case, 6 ft. cord, including complete instructions.  
 Stock No. 71.223EH .....\$44.50 Ppd.

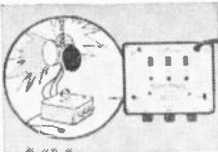

**PSYCHEDELIC LIGHTING HANDBOOK**  
 Two information packed pages! Fully explains latest in psychedelic lighting equipment, techniques, developments. Covers all facets of psychedelic light-show production including strobes, black lights, projectors, crystals, organic slides, mirrors, color organs, polarized color, light boxes, Music-Vision, etc. 8 1/2" x 11" looseleaf paper for 3 ring binder.  
 Stock No. 9100EH .....\$3.00 Ppd.

**LONG-WAVE BLACK LIGHT FIXTURE**  
 Extremely versatile, compactly designed, long wave (3200-1000 angstroms) black light (ultraviolet) fixture—eliminates harmful shorter wave ultraviolet rays. Use to identify minerals, fungi, bacteria check for surface flaws, oil and gas leakage—perfect for displays with fluorescent paper, paints, chalk, crayons, trace powder. Incl. adjustable aluminum reflector, push-pull switch, connecting plug. Mount vert., horiz., or on corner. 10 1/2" x 11 1/2" x 1 1/2".  
 Stock No. 70.364EH .....\$12.50 Ppd.  
 No. 60.124EH...REPLACEMENT BULB...\$4.75 Ppd.

**1st LOW-COST VACUUM PUMP!**  
 Nothing like it! Top-quality hand-held pump produces & maintains 27" of vacuum. Has instant release tab, 1 1/2" diam. stainless gauge (0-30"), 100's of uses—siphon noxious fluids, evacuate bell jars and castings, clean, retrieve, lift sterile objects demonstrate Magdeburg hemi-spheres, bleed fuel lines, check leaks, etc. Lifts 40 lbs. with included "T" nut—much more w/larger cup.  
 Stock No. 71.301EH .....\$12.00 Ppd.  
 No. 71.300EH (without gauge/lifter) .....5.50 Ppd.

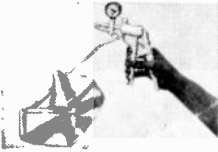

**BLACK-LIGHT MIGHTY MITES**  
 Relatively small (12") fixtures give surprisingly bright blacklight. Mirror-finished reflector makes instantly startling 8-watt, high-intensity bulb look like 40-watter. Up to 5,000 hours of safe, long-wave (3660A) black-light to really turn-on parties, light & theatrical shows, psychedelic discs, holiday decorations.  
 Shockproof end-caps remove for safe, easy replacement of bulb and starter. Stands upright or horizontal. Alum. case.  
 Stock No. 71.274EH .....\$14.95 Ppd.  
**DELUXE OUTDOOR/INDOOR MODEL**  
 Stock No. 71.299EH .....\$19.95 Ppd.

**25X to 900X LABORATORY MICROSCOPE**  
 Sturdy, monocular type, 3 coated achromatic parafocal objectives—5X (0.10 NA), 10X (0.25 NA), 60X (0.85 NA); triple revolving nose-piece. Automatic focusing stop prevents damage to objectives and slides. 15-cm. 160mm tube. Rack & pinion coarse focusing & fine micrometer type slide adjustments. 3 Huygenian eyepieces: 5X, 10X, 15X. Bakelite stage 4-1/2" x 4 5/16", 2 stage plus accept Edmund graduated mesh, stage No. 30,060—Substage equipment: Fixed-condenser lens, iris-diaphragm, 1-7/8" diam. plano-convex mirror.  
 Stock No. 85.049H... (11 1/4" H., 11 lbs. W.)...\$99.75 FOB

**MAIL COUPON FOR GIANT FREE CATALOG**  
 148 PAGES—1000's OF BARGAINS  
 Completely new 1971 edition. New items, categories, illustrations. Dozens of electrical and electromagnetics parts, accessories. Enormous selection of Astronomical Telescopes, Unique Lighting Items, Microscopes, Binoculars, Magnifiers, Magnets, Lenses, Prisms. Many war surplus items. Mail coupon for catalog "EII".  
**EDMUND SCIENTIFIC CO.**  
 300 EDSCORP BUILDING  
 BARRINGTON, N.J. 08007  
 NAME \_\_\_\_\_  
 ADDRESS \_\_\_\_\_  
 CITY \_\_\_\_\_ STATE \_\_\_\_\_ ZIP \_\_\_\_\_



**SPECIAL VISUAL EFFECTS PROJECTOR SET**  
 Fantastic variety. Incredibly beautiful. Create floating, exploding, fiery bursts of color like "Symphony of Spheres", "Chromatic Starbursts", "Crystal Starbursts". Features 25mm 500 W fan cooled projector—produces big image at short distance. Accepts two 9" diam. wheels (Dry Kaleidoscope & Hexaloscope), 2 cylindrical accessories (6" Colored Cloud & 7" Hexaloscope w/6x internal mirrored wall). Complete instructions.  
 Stock No. 71.212EH .....\$79.50 Ppd.  
**DELUXE MODEL**  
 No. 71.295H...w/kaleidoscopic lens...\$99.50 Ppd.

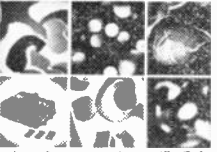

**3" ASTRONOMICAL TELESCOPE**  
 See moon shots, orbits-stars, phases of Venus, planets close up, 60 to 180 power. Aluminized and overcoated 3" diameter f/10 primary mirror, ventilated cell. Equatorial mount with locks on both axes. Equipped with 60X eyepiece and mounted Barlow lens, 3X finder telescope, hardwood tripod.  
**FREE "STAR CHART" & "HANDBOOK OF HEAVENS" HOW TO USE YOUR TELESCOPE!**  
 Stock No. 85.050EH .....\$29.95 Ppd.  
 Stock No. 85.105EH .....\$94.50 FOB  
 Stock No. 85.086EH .....\$239.50 FOB



**ROTATING MULTI-COLORED LIGHT**  
 Dazzling colors stream endlessly from constantly rotating light. Faceted transparent globe has hinged drum inside with red, green, blue & yellow stars. Bulb heat rotates drum which projects flickering star points on walls, ceilings, etc. While individual globe facets present constantly changing array of brilliant colors 93" star—approx. 12" high on bell-shaped base. Surprisingly light. Easily placed on table, TV, fireplace, or Xmas tree top.  
 Stock No. 71.000EH .....\$7.00 Ppd.

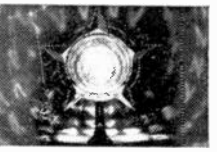

**1st LOW-COST XENON STROBE!**  
 Price breakthrough in bright, reliable electronic strobes. 50W Second Xenon tube. Variable flash rate—0 to 500 per minute. Long life more than 1,000,000 flashes. Printed circuit board design. Safe, durable Bakelite case. Externally mounted bulb, plastic shield. 6 1/2" x 3 1/2" x 1 1/2". Perfect for psychic deli, stop action lighting effects for home light shows, parties, displays.  
 Stock No. 71.342EH .....\$24.95 Ppd.  
**BUILD-IT-YOURSELF STROBE KIT**  
 Stock No. 71.343EH .....\$19.95 Ppd.

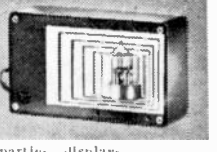

**UNIMAT "MINIATURE MACHINE SHOP"**  
 Compact, power tool for metal, plastics, wood with full capabilities of precision machine shop. Works as lathe or vertical drill press. Complete with motor, loaded with extras. 1 of a kind for industrial miniaturization. Home workshop, model shops, labs, etc. Use lock nut to turn, face, bore, recess, polish. Converts in 1 minute to vertical machine to mill, drill, jig bore, surface grind. Quickly mastered to produce professional quality work. 40-p. Instr. booklet. Shpg. wt. 2 1/2 lbs.  
 Stock No. 85.175EH .....\$149.50 F.O.B.

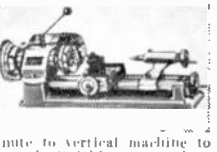

**ASTRONOMICAL TELESCOPE KITS**  
 Grind your own mirror for powerful telescopes. Kits contain fine annealed pyrex mirror blank, tool, abrasives, diagonal mirror, and eyepiece lenses. Instruments you build range in value from \$75 to hundreds of dollars.  
 4 1/4" DIAMETER—3 1/4" Thick  
 Stock No. 70.003EH .....\$10.75 Ppd.  
 6" DIAMETER—1 1/2" Thick  
 Stock No. 70.004EH .....\$13.95 Ppd.  
 8" DIAMETER—1 3/4" Thick  
 Stock No. 70.005EH .....\$21.50 Ppd.  
 10" DIAMETER—1 3/4" Thick  
 Stock No. 70.006EH .....\$52.50 FOB



**LOW-COST DOUBLE-BARRELED TUMBLER**  
 Rugged 12-lb. tumbler has TWO big 6-lb. (1 1/2-pt.) capacity rubber barrels, each with ten internal ribs—twice tumbling action of more expensive models. Quiet, resilient, dependable, safe operation. Features fan cooled, continuous-duty 1500 rpm motor; V-belt drive w/ nylon bearings; covered safety belt & pulleys. Real money saver for small shops, experimenters—great for rock hounds (10 1/2" x 11 1/2" x 12 1/2").  
 Stock No. 80.132EH... (18 lbs.)...\$39.95 Ppd.



**DESIGN FOR STEREO**  
 (continued from page 59)  
 its minimum. The base supply voltage at this extreme condition becomes

$$E'_{NB} = I_c (\max) \left( R'_E + \frac{R'_B}{\beta (\max)} \right) - I_{CBO} (\max) R'_B + V_{BE} (\min) \quad \text{Eq. 8}$$

The two equations are subtracted from each other. The various values of maximum and minimum collector current, beta, leakage current, and base-emitter voltage are then substituted into the resulting formula to establish a relationship between  $R'_E$  and  $R'_B$ . All the values can be determined from the data derived above. In some instances, such as for base-emitter voltage, actual data may not be supplied by the manufacturer of the transistor. But actual data might not actually be required, for as Equation 4 was subtracted from Equation 5, the remaining terms in the final equation will contain the difference of two values (such as  $V_{BE}(\max) - V_{BE}(\min)$ ) rather than the absolute numbers. The difference of the two values of  $V_{BE}$ , for example, can easily be calculated from the temperature difference under consideration, as  $V_{BE}(\max) - V_{BE}(\min)$  is approximately equal to 2.5 millivolts multiplied by this temperature difference.

From the actual value of either  $R'_B$  or  $R'_E$ , it is simple arithmetic to determine the remaining component from the final difference equation. One or the other factor may be limited by considerations such as gain, input impedance, distortion, etc. Calculate  $E'_{NB}$  from Equation 7 or 8. Once these resistors and  $E'_{NB}$  have been determined the circuit in Fig. 11 can be assumed to be but an equivalent circuit for any of the bias arrangements discussed here and in the previous article. Simple conversions can be made to any of the circuits by applying Thevenin's theorem, but in a reverse manner.

Identical equations using this method of analysis, can be written for the circuits in Fig. 3 and 6, if  $E_{NB}$  in Fig. 3 is connected to  $E_{CC}$ . They are

$$R_X = \frac{E_{CC} E'_{NB} R'_B}{E_{CC} - E'_{NB}} \quad \text{Eq. 9}$$

$$R_B = \frac{E_{CC} R'_B / E'_{NB}}{R'_E} \quad \text{Eq. 10}$$

However, for Figure 6,  $E_{NB} R'_B / E_{CC}$  must be subtracted from  $R'_E$  to determine the value of  $R'_E$ .

Once the final circuit has been established, its performance should be double-checked using the stability equations.

A fairly detailed design procedure was presented here. All this information is required to establish a truly stable design. As for the FET bias, less complexity is involved for the input and output circuits are relatively independent. The requirements and design procedures will be discussed next. **R-E**

A novice technician named Peter checked a set with his new multi-meter. Needle wrapped round the pin and he cried in chagrin  
 "Next time I'll not use the Ohm-Meter!"  
 Jack Darr

**EDMUND SCIENTIFIC CO. 300 EDSCORP BLDG. BARRINGTON, NEW JERSEY 08007**  
 ORDER BY STOCK NUMBER - SEND CHECK OR MONEY ORDER - MONEY-BACK GUARANTEE



# The moving sound of moving sound.

The kind you get from Mallory's new light-weight, go everywhere cassette tape recorders.

They're pushbutton simple. And built to fit in with the excitement of living.

We have three solid-state models in three price ranges . . . something for everybody. And

they come with a whisper-sensitive dynamic microphone, automatic recording level circuit, power-packed Duracell® batteries and a full-fidelity Duratape® cassette.

Mallory portable cassette tape recorders . . . when you're going places.

**MALLORY**

**MALLORY DISTRIBUTOR PRODUCTS COMPANY**

a division of P. H. MALLORY & CO. INC.  
Box 1556, Indianapolis, Indiana 46206; Telephone: 317-636-5353

**MCR 1232**

Total go-anywhere entertainment. Recorder and superb AM/FM radio. AFC, pop-up cassette ejector, built-in antenna. In a slim, tough case. The music-maker.



**MCR 1204**

Slim, neat, light. Battery operated. 3½" dynamic speaker and dynamic mike. For kids, teenagers . . . even Mr. Businessman.



**MCR 1209**

Great everywhere. Batteries or AC plug-in. Pushbutton operation. Slim, easy to carry, pack. Dynamic speaker and mike. The perfect gift.



Batteries • Capacitors • Controls • CRIME ALERT® • DURATAPE® Recorders • Resistors • Semiconductors • SONALERT® • Switches • Timers

Circle 79 on reader service card



# cash in on a GROWING NEW business...



INTERNATIONAL  
CRYSTAL MFG. CO., INC.  
10 NO. LEE • OKLA. CITY, OKLA. 73102

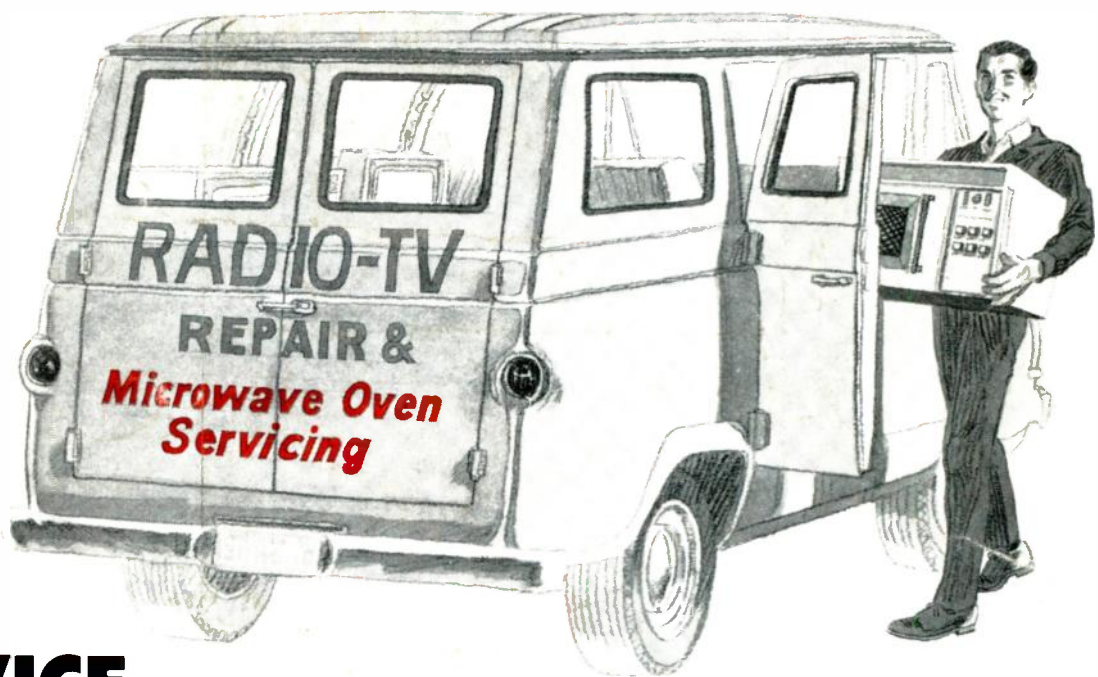

## SERVICE MICROWAVE OVENS

Thousands of new microwave ovens are sold each year for commercial or home use. As oven sales continue to climb a brand new opportunity opens for those presently engaged in radio and television servicing. It's an opportunity to supplement your present income . . . or start an entirely new servicing business.

A majority of the franchised "fast food" eating establishments are using microwave ovens. Hundreds of restaurants are discovering the oven that will bake a potato in five minutes, heat precooked frozen food in minutes. Homeowners everywhere are becoming aware of the electronic oven which cuts cooking time from hours to minutes . . . even seconds. Prepare yourself now for this new servicing and maintenance business.

International Crystal Mfg. Co., a pioneer manufacturer of microwave ovens, has information regarding this space-age opportunity for skilled technicians. Write today for complete details.

ADDRESS INQUIRIES TO:  
**SERVICING INTERNATIONAL CRYSTAL MFG. CO., INC.** 10 North Lee Oklahoma City, Okla. 73102

Circle 80 on reader service card