

# Radio-Electronics

60c ■ OCT. 1969

A  
GERNSBACK  
PUBLICATION

## SPECIAL ISSUE Stereo 1970

BUILD R-E's  
**Stereo  
Color organ**

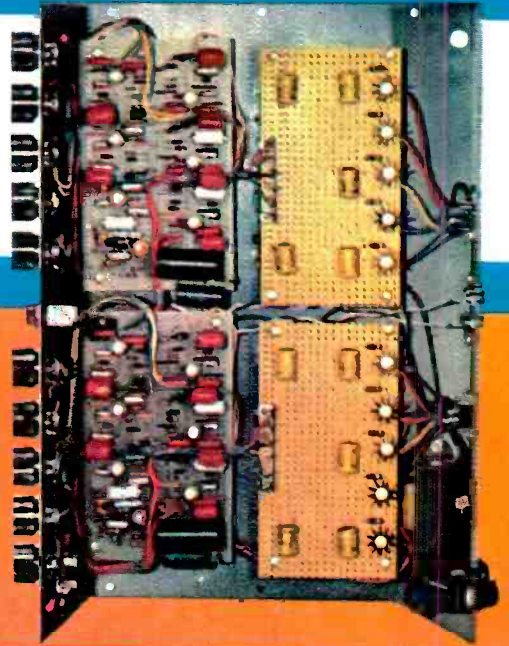

**NEW!** All IC  
**200-  
watt  
stereo  
ampl**

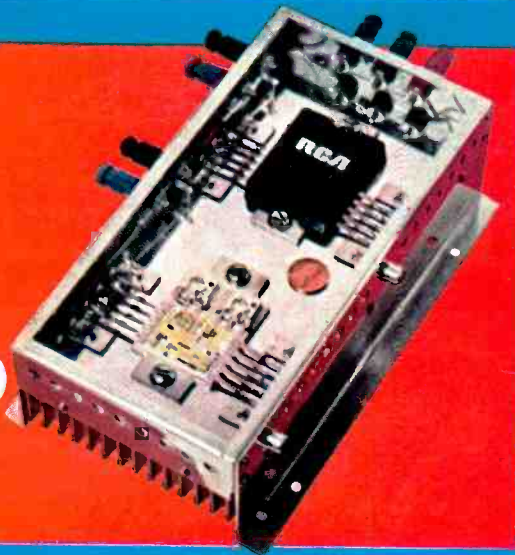

## R-E's

**STEREO RECEIVER  
ROUNDUP**

**STEREO HEADPHONE  
TEST REPORT**

## Electronic crossover

**EASY-READ  
DIAGRAM**

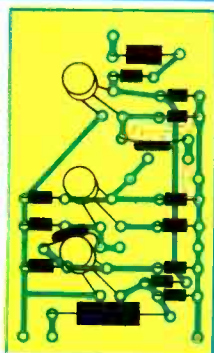

## ALL ABOUT TOOLS Tear-out book

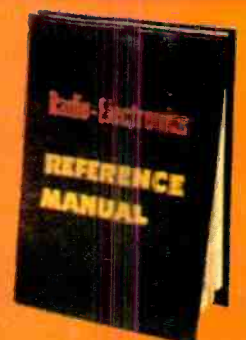

**Perfect speed synchronous motor**  
**Ultra low-mass tonearm floating within a gyroscopically gimballed mounting**  
**Viscous damped cueing and pause control**  
**Viscous damped tonearm descent during single and automatic play**  
**Adjustable sliding weight anti-skating control**  
**Safe, gentle two-point record support.**  
**You will not find all of these important features on**  
**automatic turntables selling for almost twice as much.**  
**You will find them all – and more – on**  
**Garrard's new SL72B for only \$89.50.**

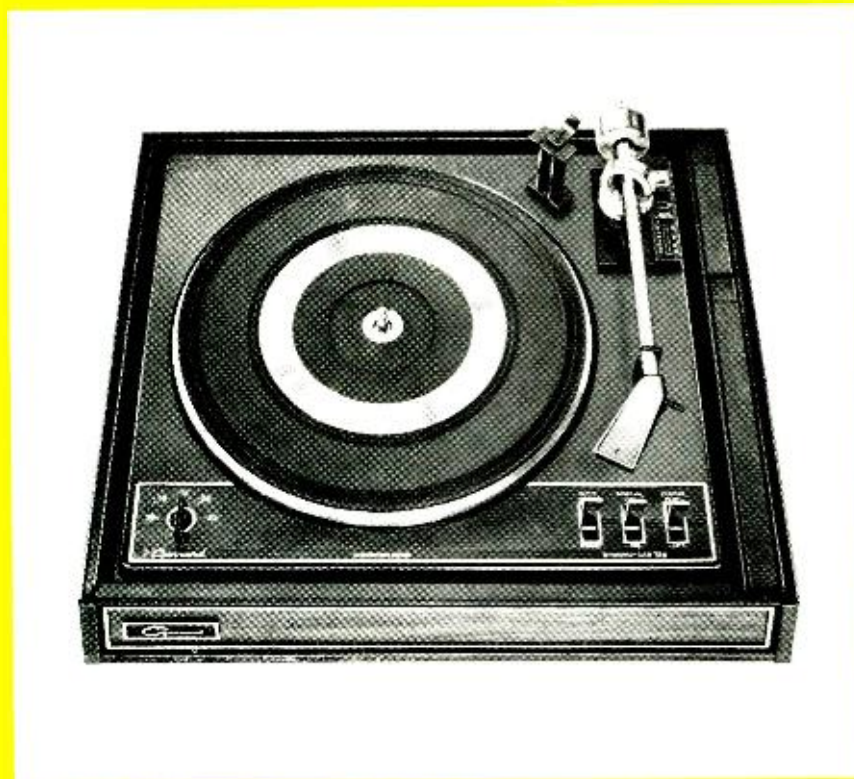

**Garrard**<sup>®</sup>  
*World's Finest*

There are now twelve new models in the Garrard line, just introduced.  
They are priced from \$37.50 to \$129.50 and include four ready to plug in modules.  
Write for complementary, full-color Comparator Guide to:  
Garrard, Dept. A149R, Westbury, N.Y. 11590





# "I REMEMBER RADIO..."

...do you?"

**Now laugh your way down memory lane... with wonderful old-time radio!**

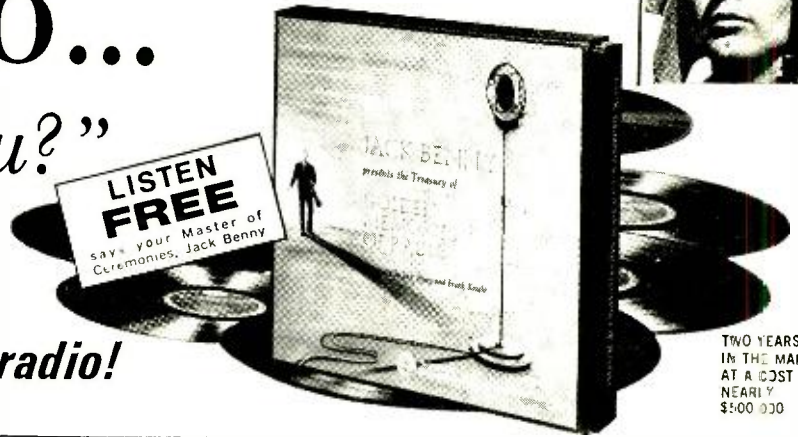

TWO YEARS IN THE MAKING AT A COST OF NEARLY \$300,000

**COMEDY! • DRAMA! • SPORTS! • HISTORY!**



**WHAT A GRAND AND GLORIOUS TIME YOU'LL HAVE** as these great, golden memories thrill you again and again! Actual broadcasts just as you heard them.

Do you remember Senator Claghorn, Titus Moody and all the uproarious goings-on in Allen's Alley? Do you remember how you split your sides laughing when Amos 'n Andy got on the telephone? Remember Fibber McGee and that famous overflowing closet? Remember how Baby Snooks (Fanny Brice) drove her Daddy wild? Vas you dere, Charlie? as Baron Munchausen (Jack Pearl) would say—and he's here too! All the magnificent humor,



the breath-taking adventures, the nostalgic music of the old-time radio years... wrapped up for the first and only time in this historic Treasury.

**IF YOU MISSED THE WORLD'S GREATEST NEWS BROADCASTS—HEAR THEM NOW!**

With all the magic of time turning back... this great Treasury brings you the Duke of Windsor renouncing his throne for the "woman I love"... the famous emotion-packed account of the Hindenburg disaster... Neville Chamberlain declaring war on Germany... Arthur Godfrey's long-remembered account of FDR's funeral... Harry Truman giving the first news of the atomic bomb on that fatal day in 1945.



← Circle 8 on reader's service card

**ALL YOURS** for family fun!—this amazing parade of old-time radio favorites, caught at their best!

The Easy Aces • Bing Crosby • Fred Allen • Allen's Alley • Bob Hope • Jack Benny and Mary Livingston • Baby Snooks • Jack Armstrong, All American Boy • The Lone Ranger • Sgt. Preston and His Dog King • Terry and The Pirates • Mary Noble, Back Stage Wife • The Romance of Helen Trent • Lorenzo Jones • Just Plain Bill • Mary Margaret McBride with guest, Alben Barkley • PLUS the most exciting and significant sports and news broadcasts in radio history! The Dempsey-Tunney Long Count, with announcer Graham

McNamee • Whirlaway wins The Kentucky Derby, with announcer Clem McCarthy  
The First Election returns broadcast by radio • President Calvin Coolidge presents Charles Lindbergh to Congress • Billy Sunday fights against the repeal of prohibition • Old-time commercials  
Special: A full-length ARCH OBOLER terror-tale produced in the old-time manner especially for this exclusive Longines Symphonette release!

You're at the ringside with the famous "long count" at the Dempsey-Tunney fight! You're in the stands screaming as Whirlaway wins the most famous and exciting Kentucky Derby! You're crouched over your crystal set as radio's first variety show goes on the air! You ride a landing craft on D-Day!

But we hardly can begin to describe the entire big 6-record Treasury with its magnificent feast of Golden Memories... great music, great singers, great dramatic shows, great moments that never will happen again... 30 or more years of the world's greatest entertainment... yours FREE for 10 days!

YOU RISK NOTHING when you send the coupon and receive by return mail this great Treasury! More than 80 priceless excerpts—over three hours of nostalgia and delight! And you can return the Treasury, owe nothing, and KEEP the great Bonus Album we also send you!

**FREE! RECORD ALBUM**

People call it: "The record that proves a parent knows more than his child!" Here are 20 of RADIO'S FAMOUS THEME SONGS you'll greet with delighted recognition! Call in your friends for a grand guessing game—but they'll have to be older than the TV generation!

TAKE THIS FREE RECORD ALBUM JUST FOR VISITING THE GOLDEN YEARS OF RADIO! Keep it—even if you return the Six-record Treasury!

6 purest vinyl records worth up to \$29.70 in fine stores

ONLY **\$5** A MONTH

OR JUST \$14.98 Stereo Edition Electronically rechanneled to simulate stereo listening just \$1.80 extra!

**MAIL COUPON TODAY!**

THE LONGINES SYMPHONETTE SOCIETY  
Symphonette Square, Larchmont, New York 10538

Yes, send my FREE BONUS RECORD ALBUM along with the six-record Treasury, GOLDEN MEMORIES OF RADIO. I may return the Treasury within 10 days and owe nothing, or send just \$5 a month until \$14.98 (plus modest postage and handling) is paid. I keep my FREE bonus record album, Radio's Famous Theme Songs, no matter what I decide.

CHECK ONE:  High Fidelity  
 Stereo (Electronically rechanneled to simulate stereo listening.) (just \$1.80 more).

Mr. \_\_\_\_\_  
 Mrs. \_\_\_\_\_  
 Miss \_\_\_\_\_  
Address \_\_\_\_\_

City \_\_\_\_\_ State \_\_\_\_\_ Zip \_\_\_\_\_

Circle 9 on reader service card

## PRISM PIPES LASER BEAM INTO CRYSTAL FILM

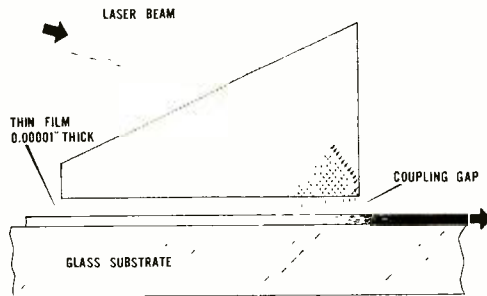
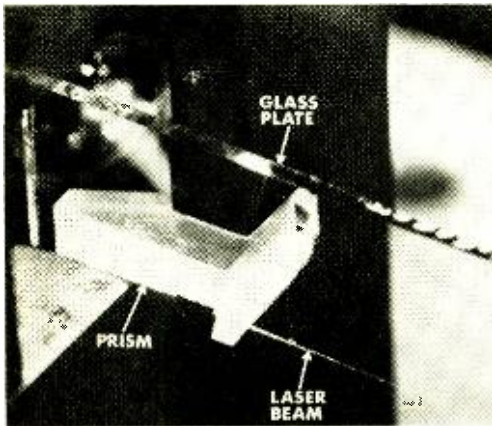

Laser beam-prism combination lets part of the light "tunnel" from the prism to the thin-film deposit in the form of electric and magnetic fields. In the film the polarized waves travel like electromagnetic waves in waveguides.

An efficient means of feeding laser beams into thin semiconducting film can lead to new laser amplifiers, light modulators, harmonic generators and parametric amplifiers according to Bell Labs, who developed the technique. The photo shows the streak of light from a laser beam traveling in a thin crystal film on a glass plate.

The drawing shows how the beam is fed into the thin film. (The beams flow in the crystal layers just as electrical current flows in copper wire.) A glass prism is used to reflect the laser beam into the film. Not all of the light beam is reflected from the base of the prism. Part of the light "tunnels" through the gap between prism and film, generating electric and magnetic fields.

Theoretically, an 80% energy transfer is possible. By changing the entry angle of the beam into the prism, the speed of the light waves travelling in the film can be varied.

### IN THIS ISSUE

Another R-E "last-word" audio project starts on page 33. Build a 10-channel IC stereo color organ that outperforms any similar projects you've seen. A MOSFET age circuit, IC op-amp filters and triacs mean spectacular color organ performance.

## LOOKING AHEAD

by DAVID LACHENBRUCH  
CONTRIBUTING EDITOR

### Digital TV tuning

A unique electronic TV tuning system has been suggested by two engineers from Fairchild Semiconductor as one of several possible tuning methods of the future. Under the plan, each station would use a 7-bit identifying code during the vertical blanking interval between picture transmissions. A digital tuning control—possibly of the type used in touch-tone phone dialing systems—would be used at the set or as a wireless remote-control tuning device. Varactor diodes in the set's tuner would respond to the pushbutton command, immediately locating the proper channel by means of the transmitted tuning code. Both uhf and vhf stations could be tuned immediately by this method, without the necessity of tuning through other channels in sequence.

The engineers said this system, using the station-transmitted tuning code, would have an estimated receiver circuitry cost of about \$20.

They also had an unusual proposal for a channel-number indicator. Since the picture tube itself is an indicator device, they reasoned, why not use it? A character generator could superimpose the channel identification on the screen for a period of five to 10 seconds after it's tuned in—then it would disappear, but would reappear on the screen for a short interval whenever a special 'display' button on the tuning device was activated, or when the channel was changed again.

### Anything you can do . . .

Although originally devised for different purposes, endless-loop tape cartridges and tiny two-reel tape cassettes show signs of taking on each others' characteristics.

The cassette was supposed to be a portable voice-recording system. The 8-track endless-loop cartridge was supposed to be a music-playback substitute for the LP record. So what's happening? First, take the cassette. Evolutionary refinements have resulted in much higher fidelity—to the

continued on page 12

### READINGS INDICATE GRAVITY PHENOMENA

Simultaneous readings on instruments 600 miles apart suggest a new phenomena—gravity waves—have been detected. Recordings were made near Chicago and College Park, Md. by Dr. Joseph Weber, a physicist, and his colleagues. The detectors for gravity waves are aluminum cylinders 5 feet long encircled with quartz piezoelectric crystals that generate electric pulses when the cylinders oscillate. The cylinders are cushioned against tremors originating in the earth.

According to relativity theory, the cylinders should oscillate as the gravity waves pass through the space-time continuum. The oscillation frequency is about 1660 Hz. in this experiment.

Further observations and confirmation of the discovery may help to resolve conflicting theories on the origin of the universe and the distribution of matter.

### WILLIAM DUBILIER, 81, RADIO PIONEER

William Dubilier, a pioneer in electronics and radio and holder of 600 patents, died in West Palm Beach, Fla., July 25. He was 81.

Founder of the Cornell-Dubilier Electric Corp., Mr. Dubilier invented the mica capacitor, an electronic flash tube, several radio broadcast systems, and such diverse items as nylon window screens to one of his last developments, in 1966, a sinus-congestion mask.

### NEXT MONTH

What's a MOSFET? How does it work? How can electronic experimenters and hobbyists put them to work in circuits? In November we'll start a two-part series that will answer these questions. Tom Haskett gives you the details.



# Radio-Electronics

October 1969 • Over 60 Years of Electronics Publishing

## BUILD ONE OF THESE

- Stereo Color Organ** . . . . . **33** . . . . . Brian Hollins  
*10 triac channels, IC filters and MOSFET age*
- Electronic 3-Way Crossover** . . . . . **42** Norman H. Crowhurst  
*12-dB/octave filters for your speakers*
- 200-Watt IC Stereo Amplifier** . . . . . **71** . . . . . F. S. Kamp &  
*Use two hybrids that deliver* J. C. Sondermeyer

## TELEVISION

- Service Clinic** . . . . . **74** . . . . . Jack Darr
- Kwik-Fix™ Troubleshooting Charts** . . . . . **45** . . . . . Forest Belt  
*The color burst amplifier*

## AUDIO—HI-FI—STEREO

- New For You** . . . . . **14** . . . . . John R. Free  
*Dynaco A-25 loudspeaker*
- In The Shop** . . . . . **16** . . . . . Jack Darr  
*How to fix hi-fi amplifiers*
- Report on Stereo Headphones** . . . . . **38** . . . . . Radio-Electronics  
*Results of R-E's listening tests* Editorial Staff
- Stereo Receivers: 1969-70 Roundup** . . . . . **50** . . . . . Joe Alderham  
*Hi-fi is better than ever*
- The Dolby System—How It Works** . . . . . **52** . . . . . Walter Salm  
*Taking the hiss from hi-fi tape recording*

## GENERAL ELECTRONICS

- Looking Ahead** . . . . . **2** . . . . . David Lachenbruch  
*Current happenings with future overtones*
- Tools for Electronics** . . . . . **59** Thomas R. Haskett  
*How to select and use them*
- Technical Topics** . . . . . **63** . . . . . Robert F. Scott

## DEPARTMENTS

- |  |                                    |                                    |
|--|------------------------------------|------------------------------------|
| CB Troubleshooter's Casebook . . . . . <b>82</b> | New Literature . . . . . <b>93</b> | Reader Service . . . . . <b>85</b> |
| Correspondence . . . . . <b>26</b>               | New Products . . . . . <b>87</b>   | Technotes . . . . . <b>84</b>      |
| New & Timely . . . . . <b>2</b>                  |                                    | Try This One . . . . . <b>54</b>   |

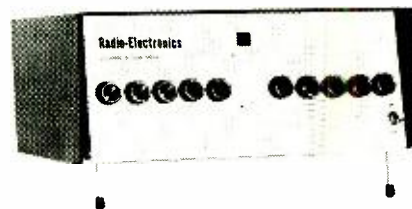

Build a 10-channel stereo color organ. Top performance with IC filters age and high-power triacs. [see page 33](#)

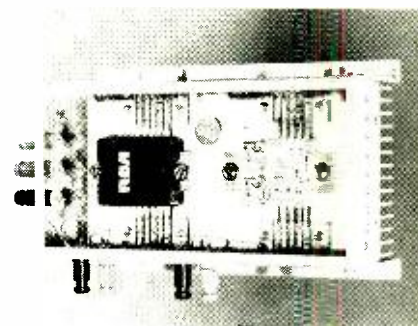

New hybrid IC powerhouse is matchbox size, but can deliver up to 100 watts. Use two for stereo. [see page 71](#)

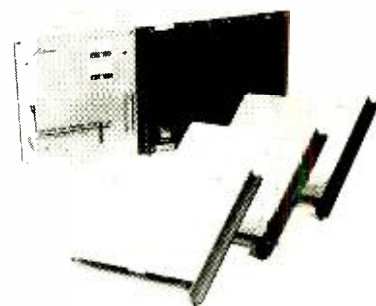

This electronic package spells trouble for tape hiss. Learn how the Dolby system is cleaning up recordings. [see page 52](#)

RADIO-ELECTRONICS, OCTOBER 1969, Vol. 40, No. 10  
Published monthly by Gernsback Publications, Inc., at Ferry St., Concord, N. H. 03302  
Editorial, Advertising, and Executive offices: 200 Park Ave. S., New York, N.Y. 10003. **Subscription Service: Boulder, Colo. 80302.**  
Second-class postage paid at Concord, N. H. Printed in U.S.A. One-year subscription rate: U.S. and possessions, Canada, \$6.  
Pan-American countries, \$7. Other countries, \$7.50. Single copies, 60¢. ©1969, by Gernsback Publications, Inc. All rights reserved.  
**POSTMASTER: Notices of undelivered copies (Form 3579) to Boulder, Colo. 80302.**



Radio-Electronics is indexed in *Applied Science & Technology Index* (formerly *Industrial Arts Index*)

## DIODE TV TUNER

Digital logic circuits are being used in RCA's top-line 1970 TV sets for vhf channel selection. The electronic channel-switching system uses a wireless remote control unit with computer PIN diode switching techniques to eliminate the mechanical tuning motor. Channel selection is instantaneous.

## IC FM TRANSCEIVERS TO GO UNDERGROUND

NEW YORK—According to G-E, this new hand-held FM two-way radio has more IC's than any previously available two-way gear.



The company is supplying some 1100 specialized two-way radios to New York City to improve safety and efficiency in the subway system. About 980 radios will be installed in train cabs, while 100 hand-held units will be used by Transit police and other subway personnel. Communication is through wire-cable antennas being installed in all subways.

### IN THIS ISSUE

Audio expert Norman Crowhurst shows you how to build a 3-way, 12-dB/octave electronic crossover network for loudspeakers on page 42.

Then try a 200-watt stereo amplifier to drive your speakers. All it takes is two of RCA's new power IC's and a good power supply. See page 71.

## ERASABLE HOLOGRAMS DEVELOPED

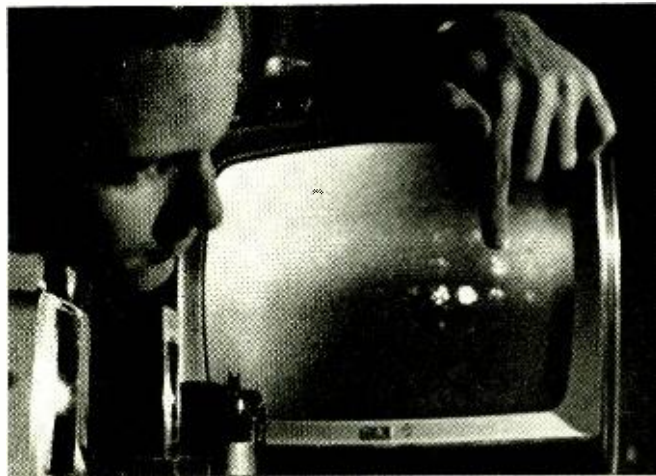

PRINCETON, N.J.—A technique for magnetically erasing holograms may soon lead to an optical computer memory able to store 100 million bits in a one-inch square film. According to RCA, write time with the technique is 10 nsecs and erase time 20  $\mu$ secs.

Manganese bismuth, a magnetic material, is deposited in a single-crystal layer on a mica base and magnetized to align its magnetic atoms. A pulsed laser beam is then split, one beam directed on the magnetic film, the other to the information bit pattern to be recorded and then to the film.

When the two beams interfere constructively, the magnetic material is warmed enough to realign the polarity of magnetic atoms. When

the beams cancel each other, no magnetization takes place. Since the resulting magnetic pattern matches the interference pattern of the converging light beams, a magnetic hologram is generated.

The magnetic hologram is read out by transmitting a laser beam through it, or reflecting the beam from it. To erase the hologram film, a strong magnetic field is used to realign magnetic atoms.

The speed, erasing feature and 2000-line/mm resolution make the process very attractive for an optical computer memory according to RCA.

The photo shows a TV display of a bit array as a laser beam strikes a hologram and the "bits" are picked up by the TV camera (lower left).

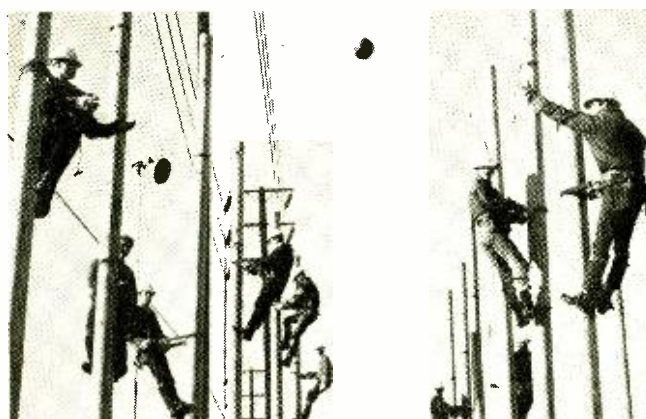

Basketball in the sky is part of the "curriculum" for a five-day school run by General Telephone Co. of California. Anchored 25 feet in the air, students at a pole-climbing school gain confidence in working at heights and agility to "walk the stick" without getting hurt. Anyone passing poorly or missing climbs down to retrieve the basketball.

## 2-CHANNEL TV AUDIO IS TESTED IN JAPAN

OSAKA, JAPAN—Experimental broadcasts in English and Japanese over two TV sound channels with FM-FM modulation were studied for the Osaka 1970 World's Fair in July. Plans call for continued broadcasts over main network channels for stereo concerts, simultaneous dubbing of foreign films and commentaries on other broadcasts.

If tests show there is no interference with the main sound channel and crosstalk is not serious, regular transmissions will begin this winter. Uhf-type adapters costing \$30 and up will be made by several major Japanese electronics companies.

## 'SORRY, 555-2368 DOES NOT ANSWER'

MURRAY HILL, N.J.—A new recorded "voice-with-a-smile" system is shown being checked at Bell Labs. The automatic intercept device tells callers what number they dialed and why a number cannot be completed. Pre-recorded phrases, words, and digits on a 96-track magnetic drum are connected in



a programmed sequence when a telephone number is not working. Part of a message might be: "The number you have reached, 555-2368, is not in service in the 311 area."

Plans call for installing 40 systems in 25 major cities to free operators for other duties. Time, weather and even baseball scores can also be recorded.

RADIO-ELECTRONICS



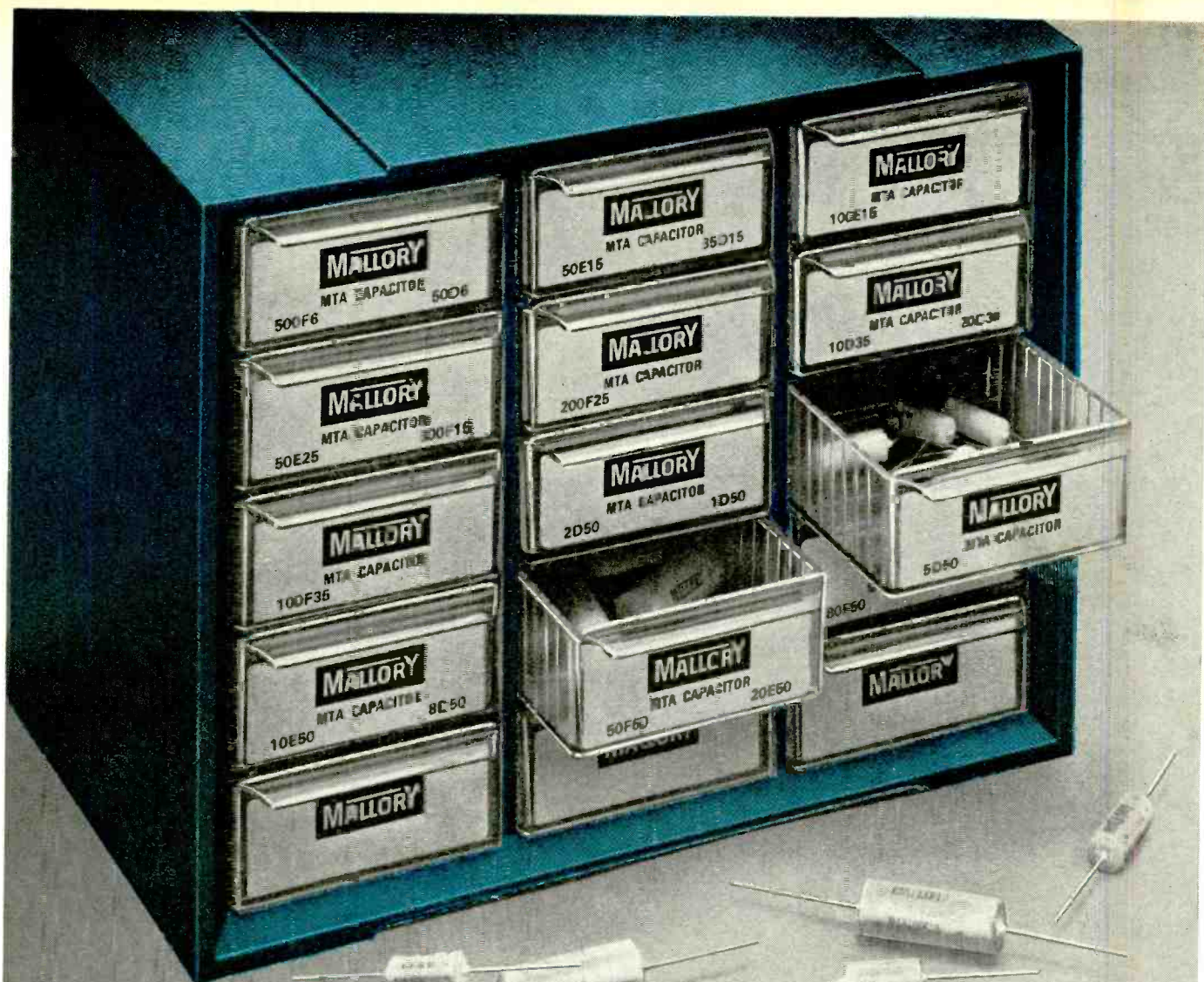

# The Benchtop Organizer.

Mallobin<sup>®</sup>. The smartest way to buy components . . . in this sturdy, stackable plastic case with partitioned drawers that keep parts where they belong. Indexed for instant access. Instant inventory.

The Mallobin you see here contains a popular assortment of our quality MTA capacitors. But that's just the beginning. We have others. There's one containing an assortment of 2-watt MOL resistors with ranges from 33 ohms to 56K ohms. Another contains MTV molded aluminum electrolytic capacitors with values from 750 mfd at 6

WVDC to 100 mfd at 50 WVDC. And there are many other cases which contain either GP, PVC, TT or TC capacitors. There are Mallobins for carbon and wirewound controls, too. Each with a wide range of popular values. The choice is yours.

But whichever you choose, you will find your Mallobin has a popular assortment of values that should satisfy all your component needs.

Remember the name Mallobin next time you're thinking of buying components. They're available from your local Mallory dealer.



**MALLORY DISTRIBUTOR PRODUCTS COMPANY**

a division of P. R. MALLORY & CO. INC.  
Box 1658, Indianapolis, Indiana 46206; Telephone: 317-636-5353

Batteries • Capacitors • Controls • Resistors • Semiconductors • Switches • Sonalert<sup>®</sup> • Timers • Vibrators • ICs • Cassette Tapes

Circle 10 on reader service card



## MAGNETIC 'BUBBLES' MOVE IN RARE EARTHS

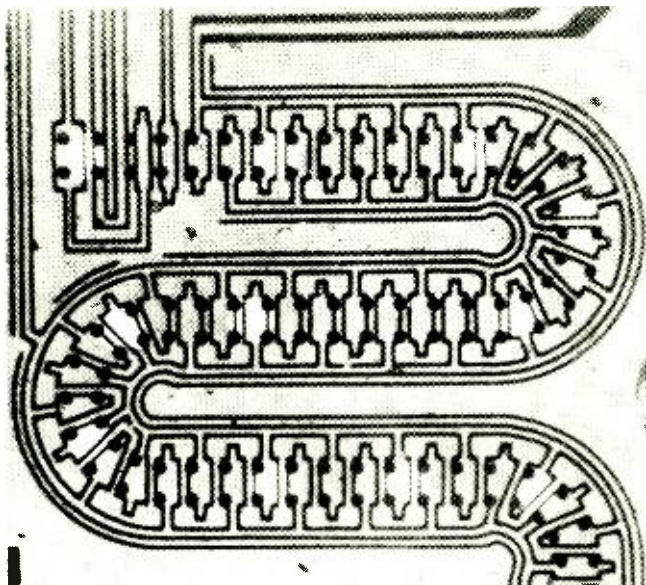

MURRAY HILL, N.J.—A new technology involving magnetic "bubble" movement in crystalline materials is being studied at Bell Labs for use in logic, memory, switching and counting functions.

The magnetic bubbles, seen as light dots in the photo, are about 0.004 inch in diameter, and move through the magnetic material in which they are formed. The circuit pattern in the photo is etched on the surface of a thulium orthoferrite sheet, a rare-earth iron oxide, and signals applied to the circuit

magnetically control the paths of the bubbles. The bubbles can also be directed with external magnetic fields.

Much smaller bubbles, the size of a few wavelengths of light, can also be manipulated, and may lead to memory densities of 1 million bits per square inch. In applications such as shift registers, data rates of 3 million bits per second have been demonstrated.

The presence or absence of the bubbles can be detected, they respond to each other's proximity (attracting or repelling) and can be com-

bined or separated with no change in their size. Bell, who was granted a patent for the discovery, suggests "a computer on a slice" may become practical after more work is done with the technique.

## PHONE FOR DEAF

MURRAY HILL, N.J.—A new telephone is under development by Bell Labs for deaf persons. Connected to a conventional phone, the Code-Com set allows a deaf person to "see" phone message in coded flashes of light or "feel" them in the vibration of a finger pad.



Light flashes come from a recess (black rectangle) in the center of the raised portion of the set. The circular vibrating pad is on the left. The sending key, used like a telegraph key, is on the right. The telephone "ring" may be indicated when the control unit switches on a light or other appliance.

## ATS 5 SATELLITE MISSES ITS ORBIT



CAPE KENNEDY, FLA.—Applications Technology Satellite 5, shown here undergoing final tests at the Hughes Aircraft plant in California, went into a tumbling orbit on the wrong side of the earth after launch on August 12.

The satellite's main rocket was fired earlier than planned to save fuel in smaller control rockets. Officials hope to shift ATS 5, jammed with 13 experiments, from an orbit over India to a stationary orbit west of South America. **R-E**

## Radio-Electronics

**HUGO GERNSBACK (1884-1967)**  
founder

**M. HARVEY GERNSBACK,**  
editor and publisher

**LARRY STECKLER,** managing editor

**Robert F. Scott, W2PWG**  
senior technical editor

**John R. Free,** associate editor

**Jack Darr,** service editor

**I. Queen,** editorial associate

**Matthew Mandl,** contributing editor

**David Lachenbruch,** contributing editor

**Vincent P. Cicenia,** production manager

**Elizabeth Shincel,** production assistant

**H. Matysko,** circulation

Cover by Harry Schlack

RADIO-ELECTRONICS is published by Gernsback Publications, Inc.  
200 Park Ave. South  
New York, N.Y. 10003  
(212) 777-6400

President: M. Harvey Gernsback  
Secretary: Bertina Baer

### ADVERTISING REPRESENTATIVES

**EAST**  
John J. Lamson, Eastern Sales Mgr.

**MIDWEST/N.&S. Car., Ga., Tenn.**  
Robert Pattis, the Bill Pattis Co.,  
4761 West Touhy Ave.,  
Lincolnwood, Ill. 60646  
(312) 679-1100

**W. COAST/Texas/Arkansas/Oklahoma**  
J. E. Publishers Representative Co.,  
8380 Melrose Ave., Los Angeles,  
Calif. 90069, (213) 653-5841;  
420 Market St. San Francisco, Calif.  
94111, (415) 981-4527

**SOUTHEAST**  
E. Lucian Nef Associates  
25 Castle Harbor Isle  
Fort Lauderdale, Florida 33308  
(305) 566-5656

**SUBSCRIPTION SERVICE:** Send all subscription orders and correspondence to RADIO-ELECTRONICS, Subscription Department, Boulder, Colo. 80302.

**MOVING?** For change of address, allow six weeks, furnishing both the old and new addresses and if possible attaching label from a recent issue below. Otherwise please print clearly your name and address exactly as it appears on your label.



name \_\_\_\_\_ (please print)  
address \_\_\_\_\_  
city \_\_\_\_\_ state \_\_\_\_\_ zip code \_\_\_\_\_

Mail to: RADIO-ELECTRONICS  
SUBSCRIPTION DEPT., BOULDER, COLO. 80302

RADIO-ELECTRONICS



# Here's a new, complete ICS course in TV Servicing that costs less than \$100.

**With the first two texts, you can repair 70 percent of all TV troubles.**

You need no previous experience to take this complete, practical course in TV Repairing.

You don't even have to know a vacuum tube from a resistor. Yet in a matter of months, you can be doing troubleshooting on color sets!

Course consists of 6 texts to bring you along quickly and easily. 936 pages of concise, easy-to-follow instruction, plus 329 detailed illustrations. You also receive a dictionary of TV terms geared directly to course material so you'll understand even the most technical terms. The dictionary will come in handy even after you've finished your course.

Instruction is simple, very easy to grasp. Photos show you what a TV screen looks like when everything is normal, and what it looks like when trouble fouls it up. The texts tell you how to remedy the problem, and why that remedy is best.

Quizzes are spotted throughout the texts so you

can check your progress. At the end of the course, you take a final examination. Then you get the coveted ICS® diploma, plus membership in the ICS TV Repairman Association.

By the time you've finished the course, you should be able to handle tough, multiple TV problems, on color sets as well as black and white.

This new TV Servicing and Repair Course has been approved by National Electronic Associations for use in their Apprenticeship program. Because of its completeness, practicality and price, it is the talk of the industry. The cost is less than \$100—just slightly over ½ the price of any comparable course on the market today. Remember, the sooner you get started on your course, the sooner you'll be turning your spare time

into real money. Fill out the coupon today. And we will rush to you all information, no obligation.

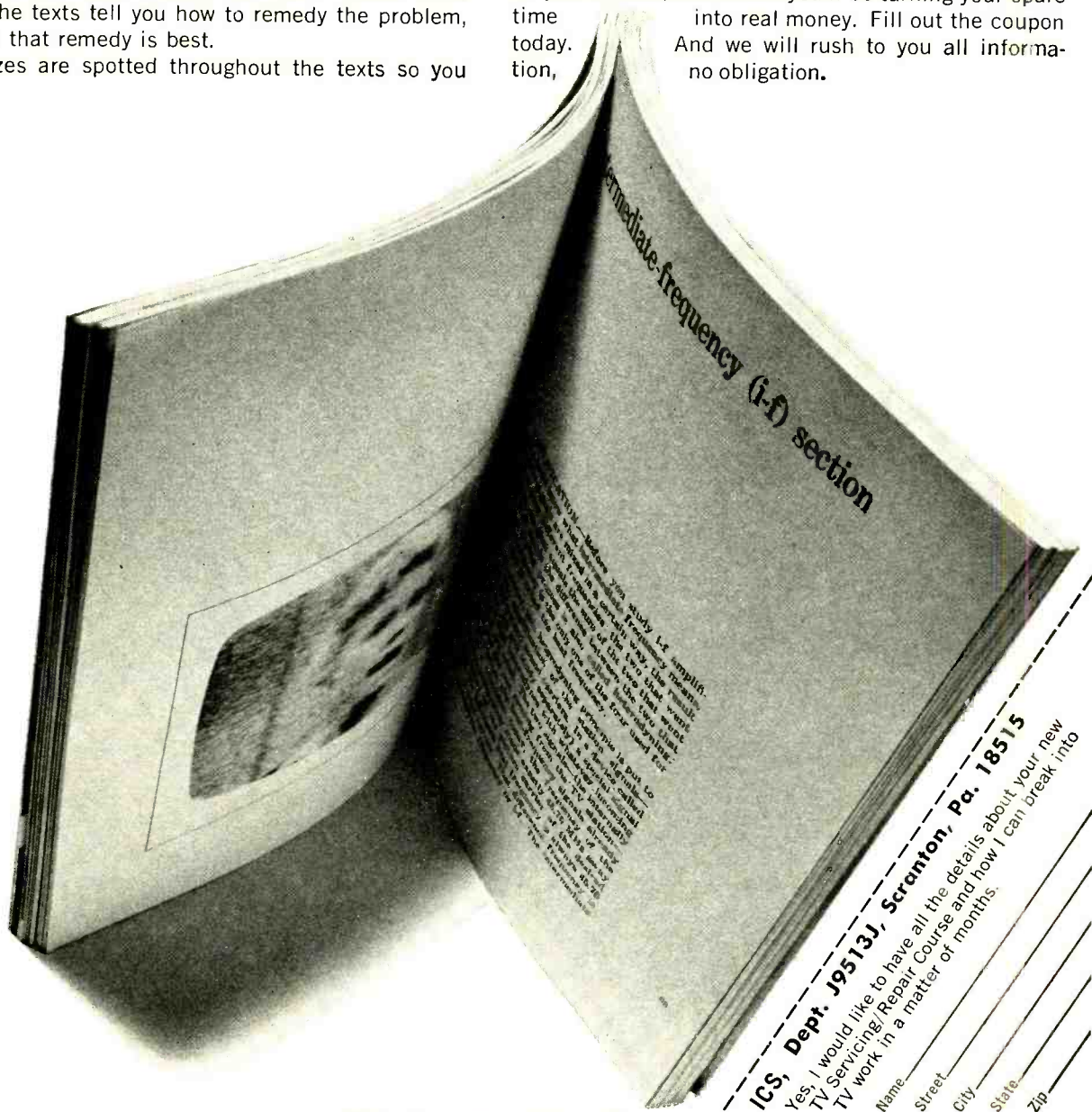

**ICS, Dept. J9513J, Scranton, Pa. 18515**  
Yes, I would like to have all the details about your new TV Servicing/Repair Course and how I can break into TV work in a matter of months.  
Name \_\_\_\_\_  
Street \_\_\_\_\_  
City \_\_\_\_\_  
State \_\_\_\_\_  
Zip \_\_\_\_\_

# You get more for your money from NRI-

## America's oldest and largest Electronic, Radio-TV home-study school

Compare if you like. You'll find—as have so many thousands of others—that NRI training can't be beat. From the delivery of your first lessons in the remarkable, new Achievement Kit we send you, to "bite size," easily-read texts and carefully designed training equipment . . . NRI gives you more value.

Shown below is a dramatic, pictorial example of all of the training materials included in just one NRI Course. *Everything* you see pictured below is included in low-cost NRI training. Other major NRI courses are equally complete. Text for text, kit for kit, dollar for dollar—your best home-study buy is NRI.

All this is yours—from Achievement Kit to the only Color TV specifically designed for training—when you enroll for NRI's TV-Radio Servicing course. Other courses are equally complete. But NRI training is more than kits and "bite-size" texts. It's also personal services which have made NRI a 50-year leader in the home-study field. Mail the postage-free card today.

### Approved under GI BILL

If you served since January 31, 1955, or are in service, check GI line in postage-free card.





## GET A FASTER START WITH NRI'S NEW EXCLUSIVE ACHIEVEMENT KIT

The day we receive your enrollment application we mail out your Achievement Kit. It contains everything you need to make an easy, fast start in the Electronics training of your choice. This attractive, new starter kit is an outstanding, logical way to introduce you to home-study as NRI teaches it . . . an unparalleled example of the value of NRI training . . . training that is backed up by a dedicated staff and the personal attention you should expect of a home-study school. It is your first of a number of special training aids carefully developed by the NRI laboratories to make your adventure into Electronics absorbing, meaningful. What's in the Achievement Kit? Your first group of lesson texts; a rich vinyl desk folder to hold your study material; the industry's most complete Radio-TV Electronics Dictionary; valuable reference texts; lesson answer sheets; pre-addressed envelopes; pencils; pen; engineer's ruler—even postage. No other school has anything like the NRI Achievement Kit.

## LEARNING BECOMES AN ABSORBING ADVENTURE WITH NRI TRAINING KITS

Electronics comes alive with NRI training kits. What better way to learn than by doing it? That's why NRI pioneered and perfected the "home lab" technique of learning at home in your spare time. You get your hands on actual parts and use them to build, experiment, explore, discover. NRI invites comparison with training equipment offered by any other school. Begin NOW this exciting program of practical learning. It's the best way to understand the skills of the finest technicians—and make their techniques your own. Whatever your reason for wanting to increase your knowledge of Electronics . . . whatever your field of interest . . . whatever your education . . . there's an NRI instruction plan to fit your needs, at low tuition rates to fit your budget. Get all the facts about NRI training plans, NRI training equipment. Fill in and mail the attached postage-free card today. No salesman will call. NATIONAL RADIO INSTITUTE, Washington, D.C. 20016.

OVER 50 YEARS OF LEADERSHIP



IN ELECTRONICS TRAINING

Accredited by the Accrediting Commission of the National Home Study Council

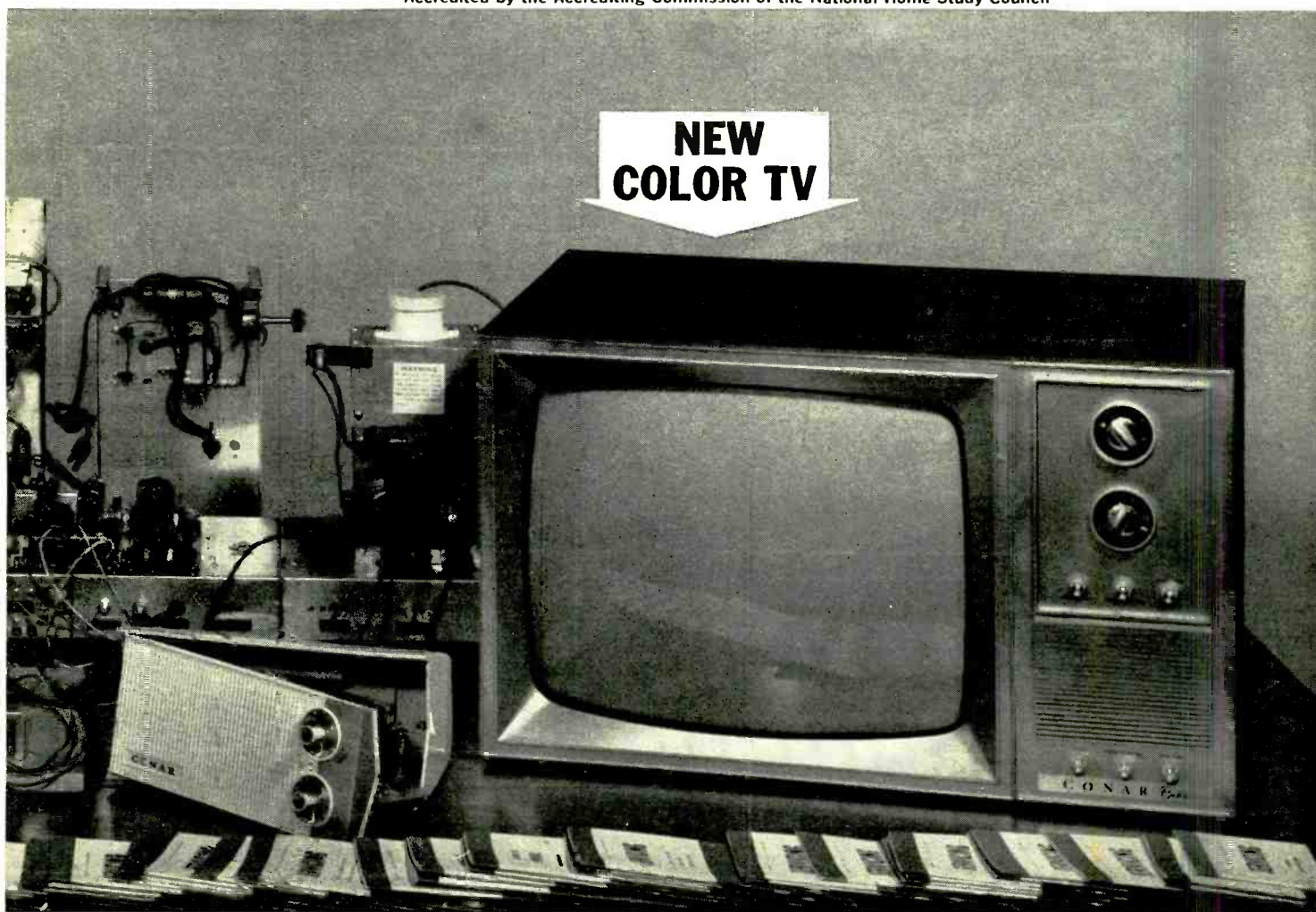



# Weller® simplifies soldering



## New TEMPMATIC® Temperature Controlled Soldering Tool

Combines all the advantages of a pencil iron, a fast heating soldering gun, and tip temperature control. Exclusive removable Powerhead contains Weller's temperature control system. Protects components even in the most delicate work situations. Tool weighs 7 oz. Use it for light or heavy duty soldering. Model GT-7A has 700°F.  $\frac{3}{16}$ " chisel point Powerhead. Model GT-6B has 600°F.  $\frac{1}{8}$ " conical point Powerhead.



## The original Dual Heat Guns

Fast heating. Long-life tips. Exclusive trigger-controlled dual heat. High soldering efficiency. Spotlight. 3 models from 100/140 watts to 240/325 watts.



## Dependable MARKSMAN Irons

They outperform other irons of their size and weight. Long-reach stainless steel barrels. Replaceable tips. 5 models from 25 watts to 175 watts.



## Weller 25-watt Iron for intricate work

Industrial rated. Weighs 1 $\frac{3}{4}$  oz. Delivers tip temperatures to 860°F. Cool, impact-resistant handle. Model W-PS with  $\frac{1}{16}$ " tip.

Weller®

WELLER ELECTRIC CORP., Easton, Pa.  
WORLD LEADER IN SOLDERING TOOLS

Circle 13 on reader service card

# LOOKING AHEAD

(continued from page 2)

point where major hi-fi component manufacturers are offering combination cassette recorders and receivers.

Record companies, which ignored the cassette for some time, are now issuing music releases in cassette form—and that includes majors RCA and Columbia. Several equipment makers have introduced cassette recorder players which are slot-loaded, just like the cartridge players. Portable and automobile play-only cassette machines are now available. Automatic-reverse cassette recorders and players will be forthcoming soon. And Sony and TDK of Japan have both announced new endless-loop cassettes.

If cassettes are beginning to act like cartridges, cartridges are beginning to act like cassettes. First came rather expensive cartridge recorders from Roberts and others. Now, lower-priced cartridge machines with record capability are expected to be available soon in automobile versions from Motorola and Lear Jet, and in portable format from others.

To solve the problem of selection of a particular part of the tape, fast-forward cartridge players became available. The next step, due soon from Lear Jet, will be an 8-track cartridge with fast rewind. (Lear isn't saying just how this will be accomplished in an endless-loop cartridge.) But a cartridge still is bigger than a cassette—or is it? Lear now promises a cassette-sized mini-cartridge designed to play through any 8-track-cartridge player.

## One less TV maker

A victim of the increasingly stiff competition from the giants—both domestic and foreign—is the Setchell Carlson brand name, which is disappearing from the consumer television market after 20 years, during which it pioneered the "Unitized" TV chassis. Setchell Carlson's assets have been sold by its parent company, Marquette Corp., to Audio-ronics Corp., a specialist in educational audio-visual equipment.

The Setchell Carlson name will be kept alive by Audio-ronics in the field of monitors and educational receivers, an area in which the TV manufacturer has increasingly specialized in recent years. Setchell Carlson is the second American firm to drop TV set manufacture within the last year, the other being Westinghouse.

## Renewal color tubes

The color TV tube replacement market is growing swiftly, a survey by Electronic Industries Association indicates. The poll of tube manufacturers found that approximately 1,130,000 color tubes will be replaced this year—renewals accounting for more than 16% of the total 1969 color tube market. In 1970, the figure should rise to 1,433,000, or 19% of the tube market. By 1972, the manufacturers believe, some 2,134,000 replacement tubes will be required, constituting 23.8% of all color tubes built that year. In 1974, the number may be 2,652,000, or 28.4% of color tube production.

## How long a warranty?

Almost all renewal color tubes carry factory-guaranteed replacement policies running one year from date of installation, although occasionally some distributors add their own warranties to bring the term up to 18 months or two years. The Admiral Corporation recently conducted a market test of a 3-year warranty on its first-line all-new color renewal tubes, and currently is evaluating the results.

Admiral quite frankly is trying to get deeper penetration of the independent service technician market, and it is weighing whether a 3-year warranty will help significantly. Other tube manufacturers will be watching closely. R-E



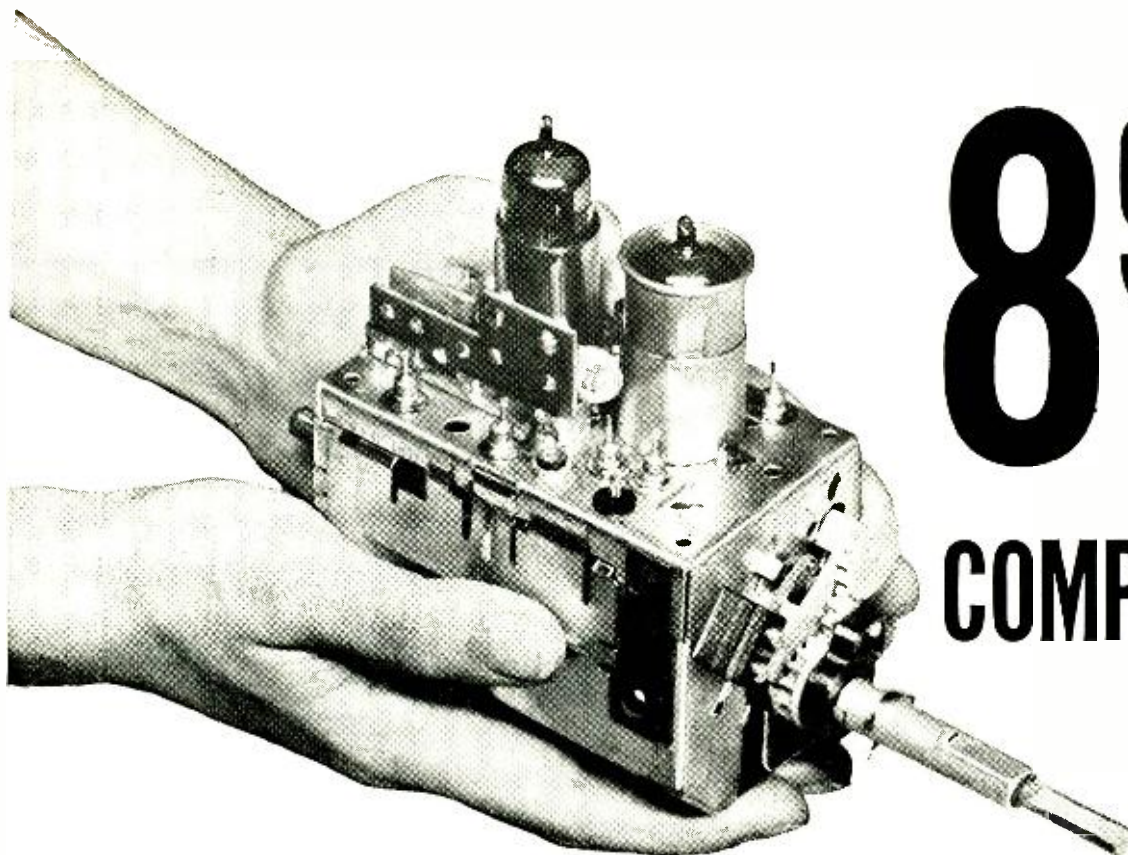

# 895 COMPLETE

Castle, the pioneer of television tuner overhauling, offers the following services to solve ALL your television tuner problems.

● **OVERHAUL SERVICE** — All makes and models.

- VHF or UHF tuner \$9.95
- UHF-VHF combination (one piece chassis) \$9.95
- TRANSISTOR tuner \$9.95
- COLOR tuner \$9.95  
(Guaranteed color alignment . . . no additional charge)

Overhaul includes parts, except tubes and transistors.

Simply send us the defective tuner complete; include tubes, shield cover and any damaged parts with model number and complaint. Your tuner will be expertly overhauled and returned promptly, performance restored, aligned to original standards and warranted for 90 days.

UV combination tuner must be single chassis type; dismantle tandem UHF and VHF tuners and send in the defective unit only.

And remember—for over a decade Castle has been the leader in this specialized field . . . your assurance of the best in TV tuner overhauling.

● **CUSTOM REPLACEMENTS**

Exact replacements are available for tuners that our inspection reveals are unfit for overhaul. As low as \$12.95 exchange. (Replacements are new or rebuilt.)

● **UNIVERSAL REPLACEMENTS**

Prefer to do it yourself?

Castle universal replacement tuners are available with the following specifications.

STOCK No.	HEATERS	SHAFT		I.F. OUTPUT		PRICE
		Min.*	Max.*	Snd.	Pic.	
CR6P	Parallel 6.3v	1¾"	3"	41.25	45.75	8.95
CR7S	Series 600mA	1¾"	3"	41.25	45.75	9.50
CR9S	Series 450mA	1¾"	3"	41.25	45.75	9.50
CR6XL	Parallel 6.3v	2½"	12"	41.25	45.75	10.45
CR7XL	Series 600mA	2½"	12"	41.25	45.75	11.00
CR9XL	Series 450mA	2½"	12"	41.25	45.75	11.00

\*Selector shaft length measured from tuner front apron to extreme tip of shaft.

These Castle replacement tuners are all equipped with memory fine tuning, UHF position with plug input for UHF tuner, rear shaft extension and switch for remote control motor drive . . . they come complete with hardware and component kit to adapt for use in thousands of popular TV receivers.

Order universal replacements out of Main Plant (Chicago) only.



## CASTLE TV TUNER SERVICE, INC.

MAIN PLANT: 5715 N. Western Ave., Chicago, Illinois 60645

EAST: 41-96 Vernon Blvd., Long Island City, N.Y. 11101

Circle 14 on reader service card

# We defy competition

to top Oxford quality, variety, delivery, and prices!

Here are the speakers with the quality features demanded for today's critical sound requirements. Extra heavy ceramic magnets for wider range, with Oxford's exclusive "Floating Suspension Surround" the permanently flexible edge that extends the low frequency spectrum without undesirable hangover, assuring smoother mid-range, brilliant high frequency response.



Paging and Talk Back Speakers



Public Address Speakers



"TEMPO" Hi-Fi Speaker



All Weather Speakers



Replacement Speakers



Professional Musical Instrument Speaker

Match your needs from a full range of speakers for new highs in high fidelity performance. Best of all, they're available now from -

**OXFORD.**  
of course.

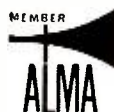

Write for complete information today!

**OXFORD TRANSDUCER COMPANY**

A Division of Oxford Electric Corporation

659 W. Washington Blvd., Chicago, Ill. 60606

Circle 15 on reader service card

# NEW FOR YOU

For manufacturer's literature,  
circle No. 23 on Reader Service Card.

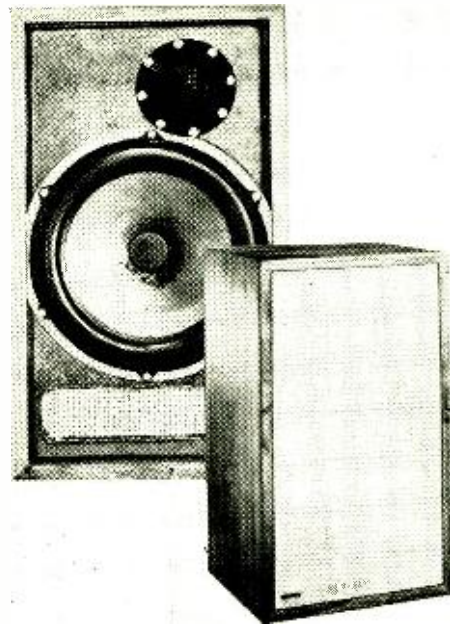

## Dynaco A-25 Loudspeaker System

Dynaco's entry into the speaker market with their A-25 is an unusual approach to speaker system design. Manufactured in Holland, the A-25 is a two-way bookshelf speaker system utilizing a 10-inch extended excursion woofer. Crossover to a soft-dome hemispherical tweeter occurs at 1500 Hz through a noninductive dual-section filter. A five-position switch alters treble output 3 dB (at 10 kHz) in each position. Nominal impedance is 8 ohms. Dynaco recommends 15 to 60-watt (continuous) amplifiers.

Listening test with the A-25 revealed it has a very wide, smooth and clean response. According to Dynaco, this is due largely to the non-resonant or "aperiodic" design of the system. Although the cabinet is ported, there is virtually no acoustic output from the slot. Instead, it is heavily damped to adjust each A-25 for flattest impedance curve.

To compare the A-25 with an acoustic-suspension system with excellent response in the bass range, the two speakers were hooked to a 50-watt/channel amplifier, and an A-B comparison was made using sweep tones from an audio test record. Except for the lowest record range the two speakers "tracked" perfectly, presenting an equal audible output. For the 20-40 Hz sweep tone, it was necessary to slightly increase the output to the A-25 to maintain an equal audible output. (This could have been a phase characteristic of the listening situation.)

The smoothness and range of the A-25 in response to test tones was also evident in music passages. More important, there was no coloration to musical instruments—or voice. High frequencies were very clear, and widely dispersed on either side of the center axis.

An outstanding characteristic of the A-25 is its ability to reproduce low-frequency elements without the "heaviness" often introduced by speaker systems. During orchestral crescendos, for example, individual bass instruments can be clearly identified. The excellent damping of the woofer has obviously contributed to the system's definition.

According to the manufacturer, the A-25 has less than 1% total harmonic distortion throughout the music range of most instruments, and is below 3% above 50 Hz (considerably lower above 1000 Hz) with a constant 25-watt input signal. Also, says Dynaco, the A-25's 3rd order harmonic distortion is less than 0.1% above 1000 Hz.—John R. Free

Circle 16 on reader service card ➤



Voltage supply in your city can vary as much as 10%. And even a 2% variation causes a significant tape speed change in tape decks with induction motors and a difference in reproduced sound that is intolerable.

The Concord Mark II stereo tape deck completely ignores fluctuations in line voltage. It is driven by a hysteresis synchronous motor which locks onto the 60 cycle power line frequency and maintains constant speed (within 0.5%) regardless of voltage variation from 75 to 130 volts. So if you're about to buy a tape deck that doesn't have a hysteresis synchronous drive motor, you're liable to negate any other fine feature it might have.

Don't get the idea the hysteresis motor is all the Concord Mark II has to offer. It also has just about every other professional feature. Three high-quality heads: ferrite erase head; wide gap Hi-Mu laminated recording head for optimum recorded signal and signal-to-noise ratio, narrow gap Hi-Mu laminated playback

head for optimum reproduced frequency response. No compromise combination heads. The three heads and four preamplifiers also make possible tape monitoring while recording.

The tape transport mechanism assures a fast startup—you don't miss a note. Supply and takeup tape tension arms eliminate startup burble. A special flutter filter eliminates flutter due to tape scrape or cogging action. A cue control provides instantaneous stop and start operation. Other important conveniences: the flip-up head cover permits you to see the head gap position markings for professional editing; 3 speeds; automatic sound-on-sound with adjustable level controls; variable echo control for reverb recording; calibrated VU meters with individual record indicator lights; stereo headphone jack; electronically controlled dynamic muting for automatic suppression of tape hiss without affecting high frequency response. All this, for under \$230.

The hysteresis drive Concord Mark III has

all of the features of the Mark II plus pressure-sintered ferrite heads for extended frequency response and virtually no head wear. It sells for under \$260.

The hysteresis drive Mark IV, the top-of-the-line Concord deck offers all of the performance and conveniences of the Mark II and III including wide gap record, narrow gap playback heads, tape source monitoring, sound-on-sound, echo recording. Plus, a dual capstan tape transport mechanism with electronic automatic reverse, no metal foil or signal required on the tape. Superior recording performance plus the convenience of automatic reverse and continuous play. A superb instrument with the finest performance money can buy, and it's under \$330. Audition the new Concord Mark series, the tape decks with the hysteresis synchronous drive motor. For "all the facts" brochure, write: Concord Electronics Corp., 1935 Armacost Ave., Los Angeles, Calif. 90025. (Subsidiary, Ehrenreich Photo-Optical Industries, Inc.)

For copy of Concord Mark III Instruction book, mail 25¢ in coin



**NEITHER AIR CONDITIONERS, TV SETS, WASHERS NOR ANY OTHER ELECTRICAL APPLIANCE CAN KEEP THE HYSTERESIS-DRIVE CONCORD MARK II FROM ITS PRECISELY APPOINTED SPEED.**







68  
673

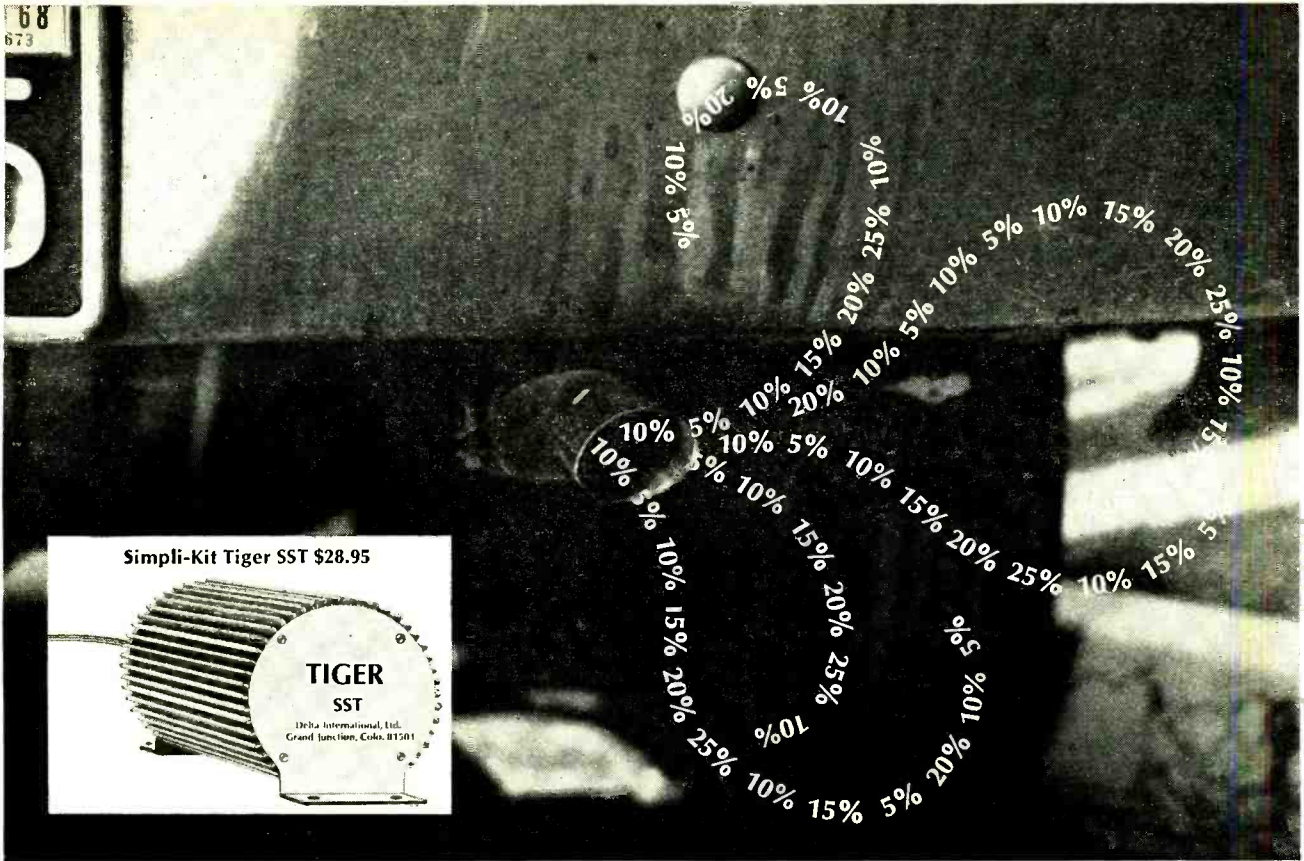

# Capture that top 10% (at least) engine performance you're now blowing out the exhaust!

## Announcing a new generation C. D. Ignition System—the Tiger SST.

Here, in a compact new unit, are all of the advantages of previous capacitive discharge systems that have been chalking up such impressive performance records the past several years—plus a good deal more. The dramatic results:

- gas mileage is increased up to 25%
- points and spark plugs last up to 5 times longer
- you go up to 5 times longer between tune-ups

The added performance your engine delivers with the Tiger SST is the fun part. You'll enjoy sharper acceleration to higher speeds—a smoother running engine at all speeds. And your engine will last longer.

Our new Tiger C. D. System is compatible with all domestic and foreign cars and trucks with 12 volt, negative ground systems. In Simpli-Kit form, the unit is easy to assemble and install in less than 60 minutes—no special skills or tools required. The unit is moisture proof and is not affected by underhood temperatures.

Order your Tiger SST today. It's the latest, most advanced C. D. System available. And, if you do an average amount

of driving, it should pay for itself in less than two months. You'll be satisfied. Guaranteed. Money back.

Dealer/Distributor inquiries invited.

### Special free offer!

Order now and receive a convenient to have, ruggedly built rechargeable flashlight **free**. It's a \$4.95 value that can put an end to the annoyance of dead batteries. Your order must be received within 30 days from date of this publication.

### Delta International, Ltd.

Box 1946C, Grand Junction, Colo. 81501

Enclosed is my check (or money order) for \$ \_\_\_\_\_  
Please send prepaid:

- Simpli-Kit Tiger SST @ \$28.95
- Assembled Tiger SST unit @ \$39.95

Make of car: \_\_\_\_\_ Year: \_\_\_\_\_

Name: \_\_\_\_\_

Address: \_\_\_\_\_

City/State: \_\_\_\_\_ Zip: \_\_\_\_\_

**Someone  
should develop  
an easy way  
to learn  
electronics at  
home**

**RCA Institutes  
did!**

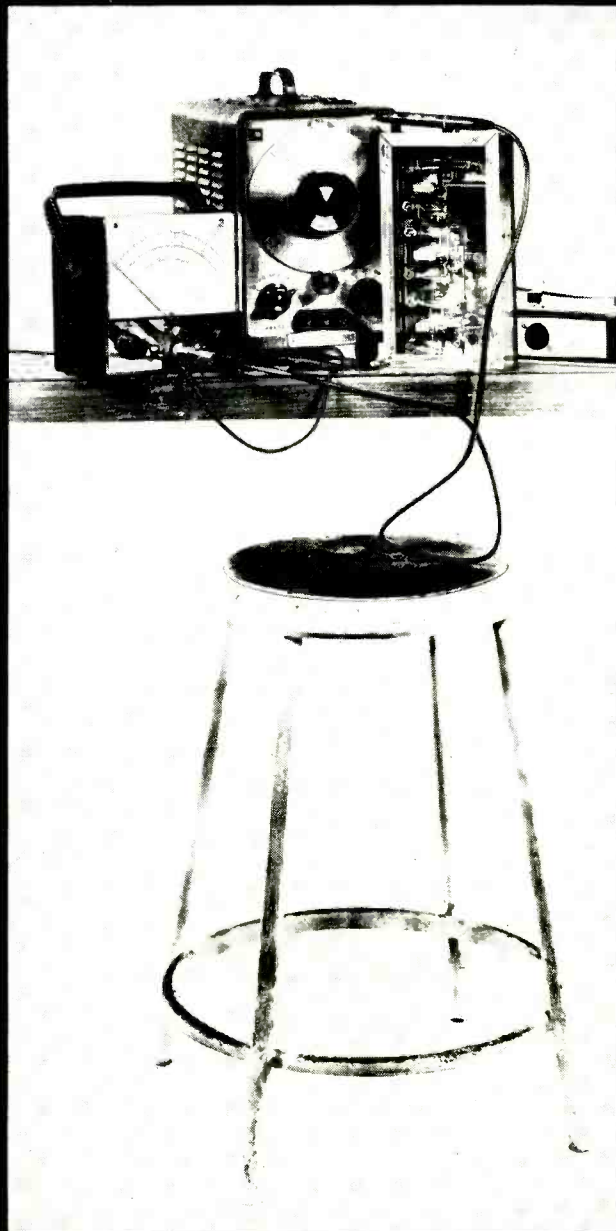

Here is a modern approach to learning electronics at home! RCA Institutes, one of the nation's largest schools devoted to electronics, has developed a faster, easier way for you to gain the skills and the knowledge you need for the career of your choice. Here for the first time is a student-proved, scientifically designed way to learn. If you have had any doubts in the past about home training in electronics—if you have hesitated because you thought you might not be able to keep up—or that electronics was too complicated to learn—here is your answer! Read how RCA Institutes has revolutionized its home training ideas!

**NEW courses  
in Solid State Technology  
and Communications  
Electronics.**

**Mail card today  
for full information.**



Find out  
about the  
easier,  
faster way  
to learn  
electronics  
at home

Send for new FREE full  
color career catalog

Accredited Member  
National Home Study Council

**RCA** Institutes

Please rush me FREE illustrated Career Catalog  
and information on courses checked below.

HOME STUDY

- |   |  |
|---|--|
| <input type="checkbox"/> Electronics Fundamentals   | <input type="checkbox"/> Digital Electronics     |
| <input type="checkbox"/> Television Servicing<br>(including color TV and<br>CATV lessons) | <input type="checkbox"/> Solid State Electronics |
| <input type="checkbox"/> Communications Electronics<br>(including CATV lessons)           | <input type="checkbox"/> Automation Electronics  |
| <input type="checkbox"/> FCC License Preparation  | <input type="checkbox"/> Industrial Electronics  |
| <input type="checkbox"/> Semiconductor Electronics  | <input type="checkbox"/> Nuclear Instrumentation |
|   | <input type="checkbox"/> Electronics Drafting    |
|   | <input type="checkbox"/> Computer Programming    |
|   | <input type="checkbox"/> Electronics in Spanish  |

CLASSROOM TRAINING

- Day     Evening     Electronics in Spanish.

Dept. RE-09

Name \_\_\_\_\_ (please print)    Age \_\_\_\_\_

Address \_\_\_\_\_

City \_\_\_\_\_ State \_\_\_\_\_

FILL IN ZIP CODE FOR FAST SERVICE ►

Veterans: Check Here

Canadians: These courses available in Canada. No postage. No customs. No delay. Inquiries will be referred to our school in Canada.

# RCA

Take advantage of this opportunity to train  
with a leader—RCA Institutes.

Home Training or Classroom Training.

**SEND THIS POSTAGE-FREE CARD  
TODAY FOR FREE CAREER BOOK**

**BUSINESS REPLY MAIL**  
No Postage Stamp Necessary if Mailed in U.S.A.

Postage will be paid by —

**RCA INSTITUTES, INC., Dept. RE-09**

320 West 31st Street

New York, N. Y. 10001

FIRST CLASS  
PERMIT NO.  
10662  
NEW YORK, N. Y.





**ALL CAREER PROGRAMS  
BEGIN WITH "AUTOTEXT"  
INSTRUCTION METHOD!**

**Prepare for the field of your  
choice immediately!  
No previous training or  
experience in electronics  
needed!**

With this new revolutionized method of home training you pick the career of your choice—and RCA Institutes trains you for it. RCA's Career Programs assure you that everything you learn will help you go directly to the field that you have chosen! No wasted time learning things you'll never use on the job! The Career Program you choose is especially designed to get you into that career in the fastest, easiest possible way!

And each Career Program starts with the amazing "AUTOTEXT" Programmed Instruction Method—the new, faster way to learn that's almost automatic! "AUTOTEXT" helps even those who have had trouble with conventional home training methods in the past. This is the "Space Age" way to learn everything you need to know with the least amount of time and effort.

**CHOOSE A CAREER PROGRAM NOW**

**Your next stop may be the job of your choice.** Each one of these RCA Institutes Career Programs is a complete unit. It contains the know-how you need to step into a profitable career. Here are the names of the programs and the kinds of jobs they train you for. Which one is for you?

**Television Servicing.** Prepares you for a career as a TV Technician/Serviceman; Master Antenna Systems Technician; TV Laboratory Technician; Educational TV Technician; CATV Technician.

Available with or without a TV Receiver Kit. Kit complete except for picture tube... an optional extra.

**FCC License Preparation.** For those who want to become TV Station Engineers, Communications Laboratory Technicians, or Field Engineers.

**Automation Electronics.** Gets you ready to be an Automation Electronics Technician; Manufacturer's Representative; Industrial Electronics Technician.

**Automatic Controls.** Prepares you to be an Automatic Controls Electronics Technician; Industrial Laboratory

Technician; Maintenance Technician; Field Engineer.

**Digital Techniques.** For a career as a Digital Techniques Electronics Technician; Industrial Electronics Technician; Industrial Laboratory Technician.

**Telecommunications.** For a job as TV Station Engineer, Mobile Communications Technician, Marine Radio Technician.

**Industrial Electronics.** For jobs as Industrial Electronics Technicians; Field Engineers; Maintenance Technicians; Industrial Laboratory Technicians.

**Nuclear Instrumentation.** For those who want careers as Nuclear Instrumentation Electronics Technicians; Industrial Laboratory Technicians; Industrial Electronics Technicians.

**Solid State Electronics.** Become a specialist in the Semiconductor Field.

**Electronics Drafting.** Junior Draftsman, Junior Technical Illustrator; Parts Inspector; Design Draftsman Trainee Chartist.

**SEPARATE COURSES**

In addition, in order to meet specific needs, RCA Institutes offers a wide variety of separate courses which may be taken independently of the Career Programs, on all subjects from Electronics Fundamentals to Computer Programming. Complete information will be sent with your other materials.

**CONVENIENT PAYMENT PLANS**

RCA Institutes offers liberal monthly payment plans to suit your budget. Be sure to check out all the RCA extras included at no additional cost.

**VALUABLE EQUIPMENT**

You receive valuable equipment to keep and use on the job—and you never have to take apart one piece to build another.

**Programmed Electronics Breadboard.** You now will receive a scientifically programmed electronic breadboard with your study material. This breadboard provides limitless experimentation with basic electrical and electronic circuits involving vacuum tubes and transistors and includes the construction of a working signal generator and superheterodyne AM Receiver.

**Bonus From RCA—Multimeter and Oscilloscope Kits.** At no additional cost, you will receive with almost every RCA Institutes Career Program the instruments and kit material you need to build a multimeter and oscilloscope. The inclusion of both these kits is an RCA extra.

**CLASSROOM TRAINING  
ALSO AVAILABLE**

RCA Institutes maintains one of the largest schools of its kind in New York City where classroom and laboratory training is available in day or evening sessions. You may be admitted without any previous technical training; preparatory courses are available if you haven't completed high school. Coeducational classes start four times a year.

**JOB PLACEMENT SERVICE, TOO!**

Companies like IBM, Bell Telephone Labs, GE, RCA, Xerox, Honeywell, Grumman, Westinghouse, and major Radio and TV Networks have regularly employed graduates through RCA Institutes' own placement service.

**SEND ATTACHED POSTAGE PAID CARD  
FOR COMPLETE INFORMATION. NO OB-  
LIGATION.**

All RCA Institutes courses and programs are approved for veterans under the new G.I. Bill.

Accredited Member  
National Home Study Council

IF REPLY CARD IS DETACHED—SEND THIS COUPON TODAY

RCA INSTITUTES, Inc., Dept. RE-09  
320 West 31st Street, N.Y., N.Y. 10001

Please rush me FREE illustrated catalog. I understand that I am under no obligation.

Name \_\_\_\_\_ Age \_\_\_\_\_  
(please print)

Address \_\_\_\_\_

City \_\_\_\_\_

State \_\_\_\_\_ Zip \_\_\_\_\_



# NOW— CHECK ALL TRANSISTORS IN OR OUT OF CIRCUIT...

Flick function switch to left to check all regular transistors.

Flick function switch to right to check any FET.

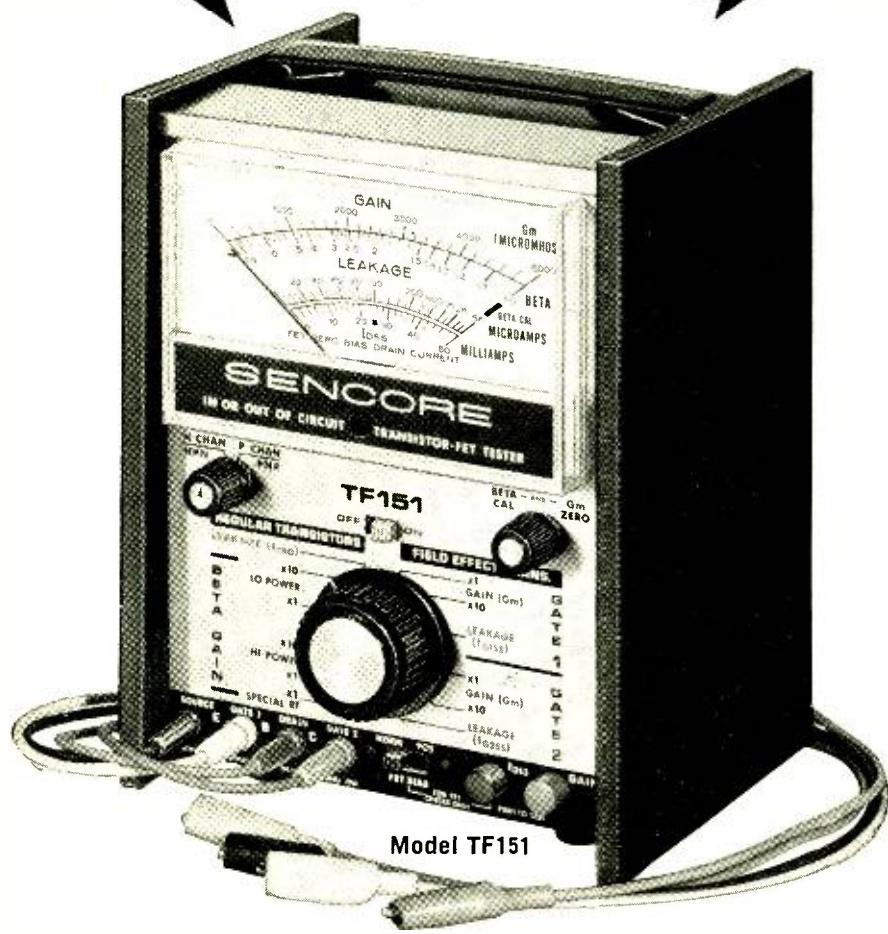

all regular transistors *plus* the new field effect transistors.

You won't be stopped when you run into the new FETs that are wired into the latest hi-fi, newest TV receivers and nearly every other new device coming on the market. For the very first time, you can check them all, in or out of circuit. The TF151 works every time using tried and proven signal injection techniques. New, improved tests on special RF transistors and the latest high power transistors, mean that the TF151 is the only up-to-date transistor tester on the market. A new, exclusive setup book in rear compartment guides you to every test for over 12,000 transistors and FETs. The book is not needed for general service troubleshooting. Regular transistors are checked for beta gain and  $I_{cbo}$  leakage. FETs are checked for transconductance and  $I_{gss}$  leakage. **only \$129<sup>50</sup>**

Your distributor just got this new tester in stock.  
See him, it obsoletes all others.



**SENCORE**  
NO. 1 MANUFACTURER OF ELECTRONIC MAINTENANCE EQUIPMENT  
426 SOUTH WESTGATE DRIVE, ADDISON, ILLINOIS 60101  
Circle 20 on reader service card

IN THE SHOP  
(continued from page 16)

voltage on the base to cut Q6 off, and there's no place for it to come from in this circuit! The chances are that Q6's collector-emitter junction is open.

The actual voltage ratio between top collector, center junction, etc. will vary with different makes. Some will split it evenly, others will have an unequal division, as here. In any case, it should be pretty close to the ratio given on the schematic.

The G-E model T20E (Fig 2.)

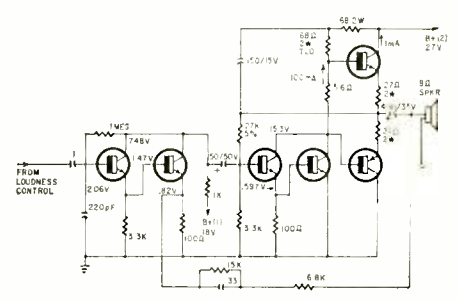

Fig. 2—G-E T20E phonograph channel.

has a more powerful amplifier circuit, with more elaborate interconnections. in these. or in any circuit where one transistor is connected "across" another, you'll have to *break the circuit* before you can get a reliable test. Even the best in-circuit transistor testers won't read a transistor correctly like this. To get a handle on this type of circuit, take out the *middle* transistor. This leaves both of the end ones ready for tests. (Then, you usually find that the one you just took out and laid on the bench was the bad one.)

If the complaint is distortion in one or both channels, there's only one really quick way to find the cause. Feed in a good clean audio signal, anywhere around 500-1000 Hz. Then follow this with a scope. You will be able to see any problems.

Be sure you aren't overloading the input. You can make up a home-made voltage divider with a couple of resistors to be sure that the input signal isn't too high. Rule of thumb: not more than 1 volt p-p.

Check the signal at the input, then at the output of the first stage. If you show peak clipping of the sine wave here, cut down the input signal.

Once you find the point where the signal either stops or distorts, you can take dc voltage readings, test transistors and check resistors.

Small leakages in transistors can cause large distortions. (They upset the bias.) **R-E**



# from Technician to ENGINEER

Advance beyond the technician level

## Become an electronics engineer

In the Grantham electronics engineering program, you can earn the Degree of *Associate in Science in Electronics Engineering* (the ASEEE) mostly by home study — and can continue in resident classes to earn your BSEE. In this program you can acquire an extensive knowledge of engineering, for greater prestige and better pay.

In America's race to the moon and outer space, *more and more* engineers are needed. By becoming an electronics engineer, you can move into the forefront of technology and engineering, and be an important part of this exciting age. You can help make things happen and be properly rewarded for doing so.

The demand for engineers continues to increase; electronics engineers are needed in the space program and in many other military and domestic projects. In a recent survey conducted by the Engineering Manpower Commission of the Engineers Joint Council, it was found that engineering employment in the electrical and electronics industries is expected to increase by 40% in ten years. The need for engineers is increasing faster than the population as a whole. The survey report indicates that in the next decade, employers expect to need almost *twice as many* new engineering graduates as are likely to be available.

If you have the desire to be an engineer, the determination to stick to your objective, and a reasonably good aptitude for mathematics and technology, the Grantham educational program can produce the wanted results for you. But make no mistake about it, to become an electronics engineer requires work. You must be willing to do that work; otherwise you can never reach your objective, regardless of what course of instruction you may choose.

## Grantham School of Engineering

*Specializing in Electronics since 1951*



1505 N. Western Ave.  
Hollywood, Calif. 90027

Telephone:  
(213) 469-7878

Circle 21 on reader service card

## Grantham School of Engineering

has conferred on

**John Doe**

the degree of

**Associate in Science in Electronics Engineering**



with all the rights and privileges thereunto appertaining. In witness whereof this Diploma  
has been issued by the School Administration upon recommendation of the

Faculty of the school on this sixth day of December, 1968

*D. J. Grantham*  
*F. D. Denny*

The Grantham *home study* program in electronics engineering consists of five "correspondence semesters" made up of a total of 370 lessons, followed by a two-week period of review and examination at the School. The prerequisite for enrollment in this program is high school graduation (or equivalent) and at least one year of experience as an electronics technician.

This *accredited* ASEE Degree program covers a review of basic electronic circuits and systems, applied engineering mathematics (including algebra, trigonometry, and calculus), classical and modern physics, technical writing, computer systems, electrical networks, and semiconductor circuit analysis and design. The ASEE Degree is awarded upon satisfactory completion of the 370 correspondence lessons and the final two-week residency at the School.

The Grantham educational program in electronics places heavy stress on fundamental concepts of logic and mathematics rather than on superficial manipulative skills. Since these fundamental ideas are largely unfamiliar to many electronics technicians, it is necessary to develop them in a systematic manner.

## Accreditation and G.I. Bill Approval

Grantham School of Engineering is *accredited* by the Accrediting Commission of the National Home Study Council, *is approved* under the G.I. Bill, and *is authorized* under the laws of the State of California to grant academic degrees.

### Grantham School of Engineering RE-10 '69

1505 N. Western Ave., Hollywood, Calif. 90027

Please mail your free Bulletin, which explains how the Grantham educational program can prepare me for my Associate in Science Degree in Electronics Engineering.

Name \_\_\_\_\_ Age \_\_\_\_\_

Address \_\_\_\_\_

City \_\_\_\_\_ State \_\_\_\_\_ Zip \_\_\_\_\_

# \$2001



## a Sony Sound Odyssey

If you are prepared to regard sound reproduction as an experience, and if this experience could possibly be worth \$2000 plus to you, read on.

This is the story about an epic sound system. An all-stops-out, damn-the-expense sound system. Extravagantly priced and extravagant in performance.

Three Sony TA-3120 solid-state stereo amplifiers deliver more than 300 watts of audio power with distortion low enough to be virtually immeasurable.

The control center: the professional Sony TA-2000 preamplifier. Typical of its credentials: IM distortion well under 0.1% at any

input; dynamic range of 80dB, more than enough to reproduce the full loudest-to-softest sound range of a symphony orchestra. Controls and conveniences? A brace of VU meters; tone controls with 11 discreet switch positions; tone-control cancel switch; level set controls at each input; stereo outputs that can be adjusted to suit the needs of different power amplifiers, etc.

The Sony TA-4300 solid-state electronic crossover is the heart of the ideal multi-channel system. Operating between the pre-amp and the 6 power amplifier sections, it feeds each speaker only the range it has been designed to reproduce.

The program sources: The ST-5000 FET stereo tuner with the Sony solid-state i.f. filter that never needs realigning brings in stations that never seemed to exist before. The TTS-3000 servo-controlled turntable, rated by High Fidelity Magazine as having "the lowest rumble figure yet measured (-77dB)" and the PUA-286 transcription arm track records flawlessly.

Enjoy an epic experience. Audition the \$2001 system. Sony Corporation of America, 47-47 Van Dam St., Long Island City, N.Y. 11101 (3) TA-3120 amplifiers, \$249.50 each; TA-2000 pre-amplifier, \$329.50; TA-4300 3-way electronic crossover, \$199.50; 5000FW FM stereo tuner, \$449.50; TTS-3000 turntable, \$149.50; PUA-286 arm, \$99.50; cabinet for 5000FW, \$24.50.

**SONY®**

Circle 22 on reader service card

[www.americanradiohistory.com](http://www.americanradiohistory.com)



# We're starting to show our muscle.

## The new E-V FOUR•A.

It's been a long time since anyone seriously challenged the status quo in speaker systems. But that is exactly what we have in mind.

Because if sound is the criterion, the E-V FOUR•A is destined to become the all-time best seller in a crowded and competitive field.

Skeptical? Good. Challenge us to a listening contest. Your personal "standard" against the E-V FOUR•A in your own listening room. Winner takes all.

We're confident we can win, hands down. And when you add our refreshing new look, plus our honest value it's almost no contest.

Of course we have a secret weapon: every critical step in the design of the E-V FOUR•A was tested, proved, and improved with the aid of our powerful scientific computer. It gave our engineers more significant data than has ever before been available to solve the complex problems of speaker design.

But what counts is the sound...pure and simple. So all we ask is that you listen to the E-V FOUR•A. And if what you hear upsets your notion of the status quo in high fidelity...that's progress.

ELECTRO-VOICE, INC., Dept. 1094E  
613 Cecil Street, Buchanan, Michigan 49107

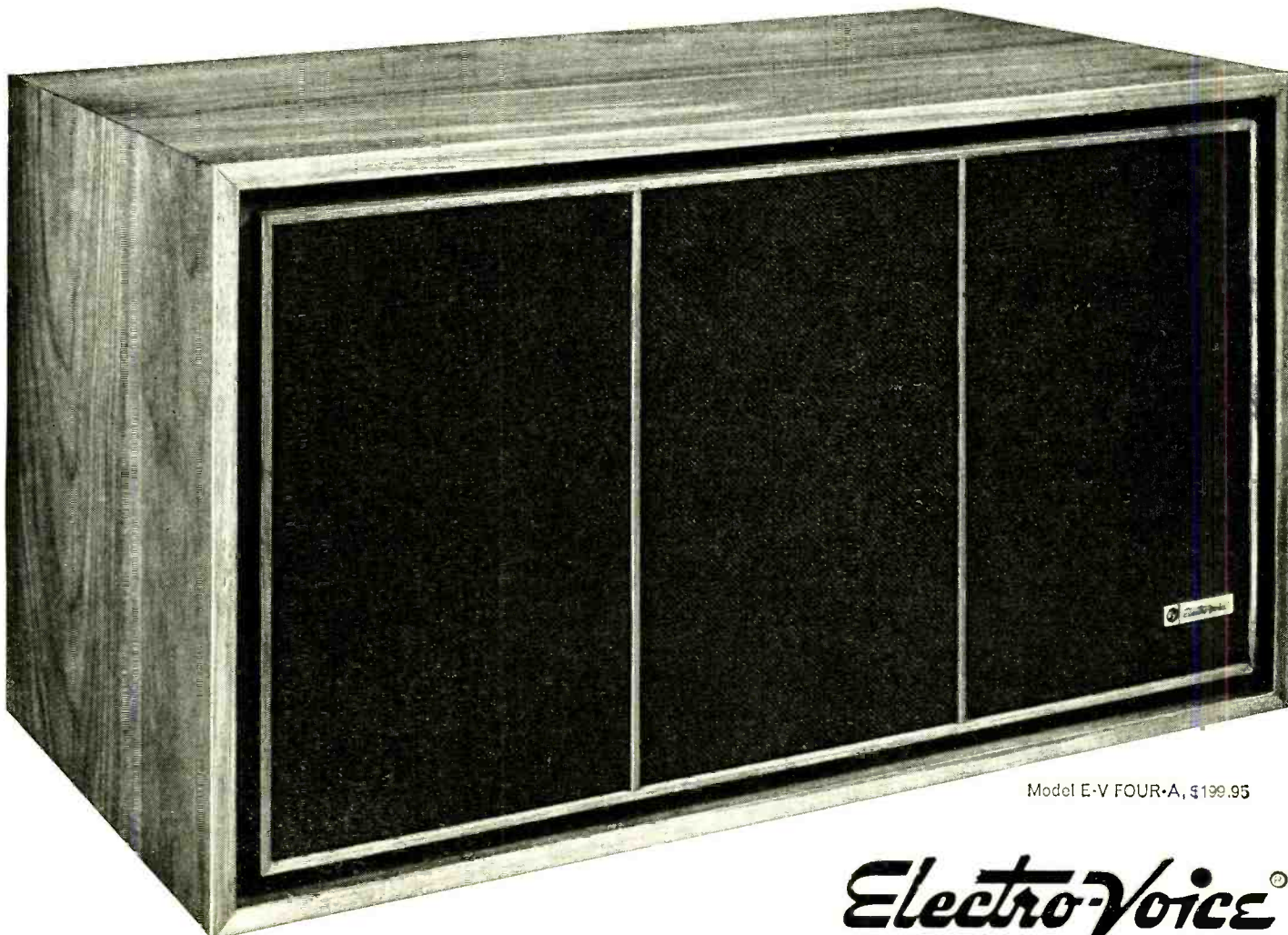

Model E-V FOUR•A, \$199.95

# Electro-Voice®

A SUBSIDIARY OF GULTON INDUSTRIES, INC.

Circle 23 on reader service card

[www.americanradiohistory.com](http://www.americanradiohistory.com)

# COMMUNICATE is the word with SONAR products

**ELECTRO-MEG** Model SI-1910  
Voice with Siren  
Model WH-1911  
Voice with Whistle



**\$79<sup>95</sup>**  
complete  
with  
batteries

Ideal for Police & Fire Depts., Ship to Ship Talk & Industrial, School & Camp Use. Absolute clarity and crowd control is assured with this powerful 10 watt solid state ELECTRO-MEG. Self powered loud speaker. Adjustable volume control. Press a button and utilize either a piercing continuous whistle or continuous siren depending on the model that can be heard for long distances. Horn is 8" in diameter, 13 1/2" in length.



Model FR-104/105

**VHF-FM MONITOR RECEIVERS**  
Perfect for Police, Fire, Tow Trucks. Fits the smallest auto yet powerful enough to deliver a clear signal. Solid State, operates on 6 crystal-controlled frequencies, dual conversion, dual limiter, Quadrupled tuned RF stage for greater image rejection. Noise Free Squelch, PLUG IN crystals for instant frequency change. Operates on 117VAC and 12VDC. Neg. or Pos. Ground.

Complete with AC and DC power cables, Mounting Bracket, less crystals. Crystals \$5.00 ea.  
FR-104 (25-50 MHz) **\$140<sup>00</sup>**  
FR-105 (150-175 MHz)



**VHF-FM TRANSCEIVER**  
(132-174 MHz) for all Business, Industrial, Police & Fire Communications. FCC Type Accepted and DOT Accepted.  
Provides instant voice contact with base stations, mobile units and other portable transceivers • use with all VHF narrow band systems • sensitive, noise immune squelch • 1.6 watt output.

Model 2301 — Single Channel, 1 Pair Crystals and AA Batteries. **\$375<sup>00</sup>**  
Model 2301A — Dual Channel, 1 Pair Crystals and AA Batteries. **\$475<sup>00</sup>**



**SONAR SENTRY VHF MONITOR (NARROW BAND) RECEIVERS WITH ADJUSTABLE SQUELCH.**  
Compact, fits a shirt pocket, yet powerful to deliver a clear clean signal. Operates on two crystal controlled VHF Channels plus broadcast band. Solid State. Battery test meter. Built-in Antenna. Perfect for Police, Fire, Aircraft & Weather reports.

with Battery, Earphone, and less Crystals Crystals \$5.00 ea.  
FR-103S (150-175 MHz) **\$49<sup>95</sup>**  
FR-106S (30-50 MHz)  
FR-103/FR-106 without Adjustable squelch \$39.95

**SONAR RADIO CORPORATION**  
73 Wortman Ave., Bklyn, N.Y. 11207 Dept. 401  
Please send me information on

ELECTRO-MEG  Model 2301/2301A  
 Model 104/105  Model FR-103S/106/S

Name \_\_\_\_\_  
Address \_\_\_\_\_  
City \_\_\_\_\_ State \_\_\_\_\_ Zip \_\_\_\_\_

Circle 24 on reader service card

# C orrespondence

## DIFFICULT? IMPRACTICAL?

Mr. John A. Walker's negative attitude toward certification of all electronic technicians in the July 1969 Correspondence Column reveals a common weakness, so often expressed by the majority of humans when faced with a difficult task—"it is too difficult", "it is impractical", "it can't be done". With such an attitude, our forefathers would have been unable to invent the lightbulb, telephone, telegraph, radio, etc., neither would putting a man on the moon have been accomplished.

Quoting from Mr. Walker's letter—"It is impractical to cover all specialties". With such a hopeless attitude, the certification of electronic technicians is doomed before it starts.

I would like to bring to Mr. Walker's attention one such example where the profession is more specialized and diversified than the electronics technology, and where national certification has been established. All one has to look at is physicians and surgeons. One finds the following specialists:

Allergists, Anaesthetists, Dermatologists, Ear, Nose & Throat specialists, Internal Medicine Specialists, Neurologists, Neurosurgeons, Obstetricians & Gynaecologists, Ophthalmologists, Orthopaedic Surgeons, Osteopathic Surgeons, Paediatricians, Pathologists, Plastic Surgeons, Psychiatrists, Radiologists, Thoracic Surgeons and Urologists.

The only practical organization for the electronics technician is a mandatory union.

If a medical graduate wishes to practice medicine, he must join the College of Physicians and Surgeons; if a lawyer wants to practice law, he must become a Member of the Bar; if a teacher wants to teach, he must join the Teachers' Association. If an electrician or plumber wishes to work in his trade, he is forced to join the union, and similarly, if the technician wants to earn a livelihood in electronics, he should be forced to join The Electronics Technician Society, Association, Union, or what ever you wish to call it.

R-E

ED KRENTZ  
Edmonton, Alberta, Canada

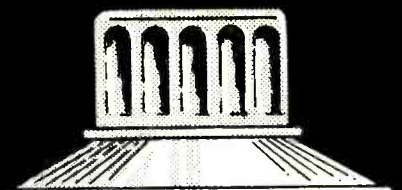

More and More Technicians Say:  
"We've tried cheaper  
substitutes . . . now  
**WE'RE BACK TO  
DEPENDABLE, RELIABLE**

# "NO NOISE"

World's No. 1 TRUSTED NAME BRAND

- VOLUME CONTROL & CONTACT RESTORER
- TUNER-TONIC with PERMA-FILM
- EC-44 FOR ELECTRICAL CONTACTS
- TAPE-RECO HEAD CLEANER
- FRIGID-AIR CIRCUIT COOLER

All Guaranteed Non-Flammable, No Carbon Tet, Non-Toxic, Non-Drift Tuner Cleaner And Guaranteed Not To Affect Plastics.

The Only Brand Perfect For  
Color TV and Black & White

FREE extender assembly for pinpoint application supplied with ALL NO-NOISE PRODUCTS.

## Electronic Chemical Corp.

813 Communipaw Ave. / Jersey City, N. J. 07304

Circle 25 on reader service card

# Olson

## ELECTRONICS

# FREE

## Catalog

Fill in coupon for a FREE One Year Subscription to OLSON ELECTRONICS Fantastic Value Packed Catalog — Unheard of LOW, LOW PRICES on Brand Name Speakers, Changers, Tubes, Tools, Stereo Amps, Tuners, CB, Hi-Fi's, and thousands of other Electronic Values. Credit plan available.

NAME \_\_\_\_\_  
ADDRESS \_\_\_\_\_  
CITY \_\_\_\_\_ STATE \_\_\_\_\_  
GIVE ZIP CODE \_\_\_\_\_

If you have a friend interested in electronics send his name and address for a FREE subscription also.

## OLSON ELECTRONICS

489 Forge Street, Akron, Ohio 44308

Circle 26 on reader service card



*It took more than skill  
to design the world's  
smallest complete mobile  
5-watt CB  
transceiver*



## **Johnson Messenger 125**

**\$99<sup>95</sup>**

Only the famous Johnson "talk-power" is big as ever on Johnson's radically new Messenger 125! Virtually every vehicle on the road, including the 1969 and 1970 models, can easily accommodate this versatile new radio. Its far-ahead features make operation extremely simple and enjoyable. Best of all, we sliced the most out of the price!

### **Features**

- 5 push button channels—no knobs ■ slide-lever vol. and squelch
- World's smallest panel configuration—1 $\frac{1}{16}$ " by 4 $\frac{1}{2}$ ", just 7" deep
- 4 watts output at 13.8 VDC ■ Accessories for portable use

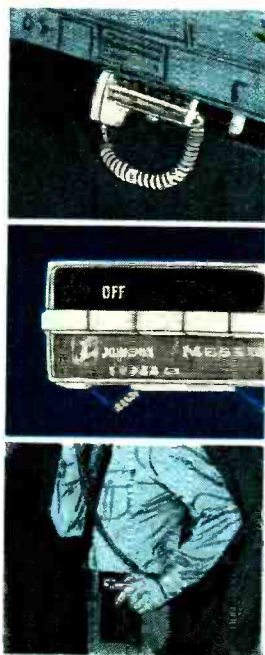

**E. F. JOHNSON CO.**  
WASECA, MINNESOTA 56093

Circle 27 on reader service card



**Hunting for a better job?**

**Here's the  
license  
you need  
to go after  
the big ones**

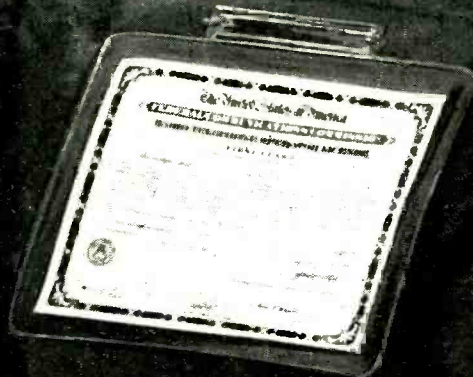



**A Government FCC License can help you bring home up to \$10,000, \$12,000, and more a year. Read how you can prepare for the license exam at home in your spare time—with a passing grade assured or your money back.**

**I**F YOU'RE OUT TO BAG A BETTER JOB in Electronics, you'd better have a Government FCC License. For you'll need it to track down the choicest, best-paying jobs that this booming field has to offer.

Right now there are 80,000 new openings every year for electronics specialists—jobs paying up to \$5, \$6, even \$7 an hour... \$200, \$225, \$250, a week... \$10,000, \$12,000, and up a year! You don't need a college education to make this kind of money in Electronics, or even a high school diploma.

But you *do* need knowledge, knowledge of electronics fundamentals. And there is only one nationally accepted method of measuring this knowledge... the licensing program of the FCC (Federal Communications Commission).

**Why a license is important**

An FCC License is a legal requirement if you want to become a Broadcast Engineer, or get into servicing any other kind of transmitting equipment—two-way mobile radios, microwave relay links, radar, etc. And even when it's not legally required, a license proves to the world that you understand the principles involved in *any* electronic device. Thus, an FCC "ticket" can open the doors to thousands of exciting, high-paying jobs in communications, radio and broadcasting, the aerospace program, industrial automation, and many other areas.

So why doesn't everyone who wants a good job in Electronics get an FCC License and start cleaning up?

The answer: it's not that simple. The government's licensing exam is tough. In fact, an average of two out of every three men who take the FCC exam fail.

There is one way, however, of being pretty certain that you will pass the FCC exam. And that is to take one of the FCC home study courses offered by Cleveland Institute of Electronics.

CIE courses are so effective that better than 9 out of 10 CIE graduates who take the exam pass it. That's why we can back our courses with this iron-clad Warranty: Upon completing one of our FCC courses, you must be able to pass the FCC exam and get your license—or you'll get your money back!

**They got their licenses and went on to better jobs**

The value of CIE training has been demonstrated time and again by the achievements of our thousands of successful students and graduates.

**2 NEW CIE CAREER COURSES**

**1. BROADCAST (Radio and TV) ENGINEERING**... now includes Video Systems, Monitors, FM Stereo Multiplex, Color Transmitter Operation and CATV.

**2. ELECTRONICS ENGINEERING**... covers steady-state and transient network theory, solid state physics and circuitry, pulse techniques, computer logic and mathematics through calculus. A college-level course for men already working in Electronics.

Ed Dulaney, Scottsbluff, Nebraska, for example, passed his 1st Class FCC License exam soon after completing his CIE training...and today is the proud owner of his own mobile radio sales and service business. "Now I manufacture my own two-way equipment," he writes, "with dealers who sell it in seven different states, and have seven full-time employees on my payroll."

Daniel J. Smithwick started his CIE training while in the service, and passed his 2nd Class exam soon after his discharge. Four months later, he reports, "I was promoted to manager of Bell Telephone at La Moure, N.D. This was a very fast promotion and a great deal of the credit goes to CIE."

Eugene Frost, Columbus, Ohio, was stuck in low-paying TV repair work before enrolling with CIE and earning his FCC License. Today, he's an inspector of major electronics systems for North American Aviation. "I'm working 8 hours a week less," says Mr. Frost, "and earning \$228 a month more."

**Send for FREE book**

If you'd like to succeed like these men, send for our FREE 24-page book "How To Get A Commercial FCC License." It tells you all about the FCC License...requirements for getting one...types of licenses available...how the exams are organized and what kinds of questions are asked...where and when the exams are held, and more.

With it you will also receive a second FREE book, "How To Succeed In Electronics." To get both books without cost or obligation, just mail the attached postpaid card. Or, if the card is missing, just mail the coupon below.

**ENROLL UNDER NEW G.I. BILL.** All CIE courses are available under the new G.I. Bill. If you served on active duty since Jan. 31, 1955, or are in service now, check box on reply card for complete details.

**CIE Cleveland Institute of Electronics**

1776 E.17th St., Cleveland, Ohio 44114

Accredited Member National Home Study Council  
A Leader in Electronics Training... Since 1934



**Cleveland Institute of Electronics**

1776 East 17th Street, Cleveland, Ohio 44114

Please send me without cost or obligation:

Your 44-page book "How to Succeed In Electronics" describing job opportunities in Electronics today, and how your courses can prepare me for them.

Your book on "How To Get A Commercial FCC License."

I am especially interested in:

- Electronics Technology       Electronic Communications
- Broadcast Engineering       Industrial Electronics
- First Class FCC License       Electronics Engineering

Name \_\_\_\_\_

(PLEASE PRINT)

Address \_\_\_\_\_

City \_\_\_\_\_

State \_\_\_\_\_ Zip \_\_\_\_\_ Age \_\_\_\_\_

Check here for G.I. Bill information

**RE-65**

Circle 28 on reader service card

## LATEST BEST SELLER (for you)

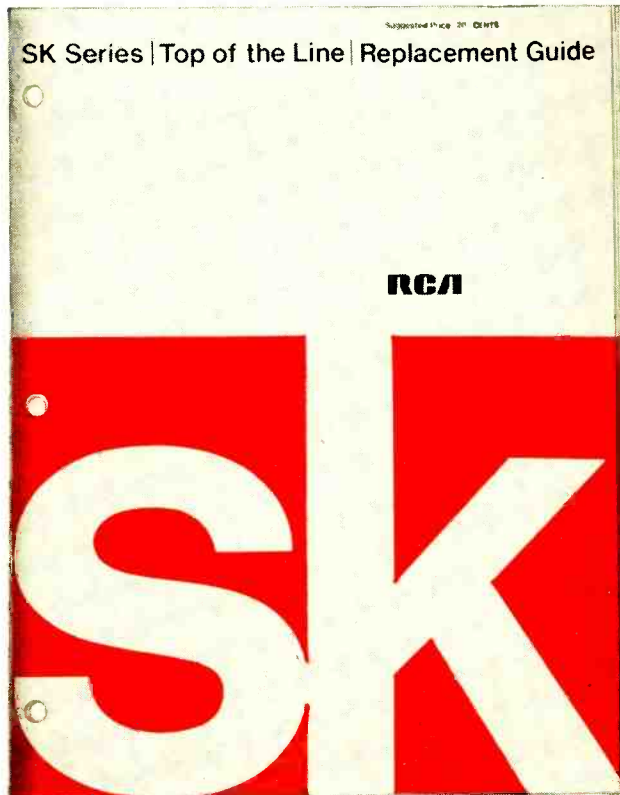

Here it is, strictly non-fiction—in fact, all fact—the indispensable RCA solid-state replacement guide. It works for you by charting the replacements of some 12,200 semiconductors—domestic and foreign. The 39 SK "Top-of-the-Line" transistors, integrated circuits, and rectifiers are designed and manufactured specifically for your kind of servicing problems. All top quality, too—no cast-offs, no factory seconds, no unbranded culls. All with electrical characteristics comparable or superior to originally designed-in devices.

As for range—from small-signal operations to the newest 100-watt audio outputs!

The comprehensive RCA SK Series—and the thousands of types they can replace—are *clearly* cross-referenced in the RCA SK Series Top-of-the-Line Replacement Guide.

Pick up your copy from your local RCA Distributor today.

RCA/Electronic Components/Harrison, N. J. 07029.

*Circle 29 on reader service card*

# RCA



# BUILD R-E's Stereo Color organ

*Spectacular performance with IC op-amp filters and MOSFET automatic gain control. Up to 300 watts/channel with triac-switched lamps*

by **BRIAN HOLLINS\***

**NATIONAL SEMICONDUCTOR**

WANT TO SPICE UP YOUR BEATLES OR Bach? A color organ can add a spectacular visual dimension to your hi-fi system—even to an ordinary table-model radio. The colored lamps will blink and glow in response to music intensity and frequencies.

The 10-channel stereo color organ described can be built for about \$160. If this figure tops your budget, a five-channel version can be assembled for about half that price. (Costs can easily be cut further by shopping for "bargain" packages of components.) The five-channel version will work with a stereo hi-fi or any audio

\*formerly with Fairchild Semiconductor

system with 3-16-ohm speakers. If you decide to build the smaller color organ, five additional channels can easily be added to the same chassis later by originally planning chassis layout carefully.

This color organ has two very important advantages over earlier circuit designs for color organs.

- First, its agc circuit accepts a wide input voltage range! This means the lights will respond evenly from the faintest violin whisper to the loudest drum roll. Without agc, any change in volume—even going from one record band to another—could cause the lights to saturate or go out entirely. Units with brightness controls for each channel must be "tweaked" constantly to maintain an even dis-

play. With this design, once you set the 10 (or 5) brightness controls to your preference, they rarely need touching again.

- Second, IC operational amplifiers are used in each channel as active filters. This design provides razor-sharp filter characteristics (Fig. 1) that insure good channel separation. Overlapping filter characteristics spoil the visual display of color organs since several channels often flash together.

What about lamp wattages? The triacs used to drive the lamps in the 10-channel version are limited to 150-watt loads. This light level is more than adequate for most listening rooms. But if you want higher wattages for auxiliary or commercial displays, 300-watt triacs can be sub-

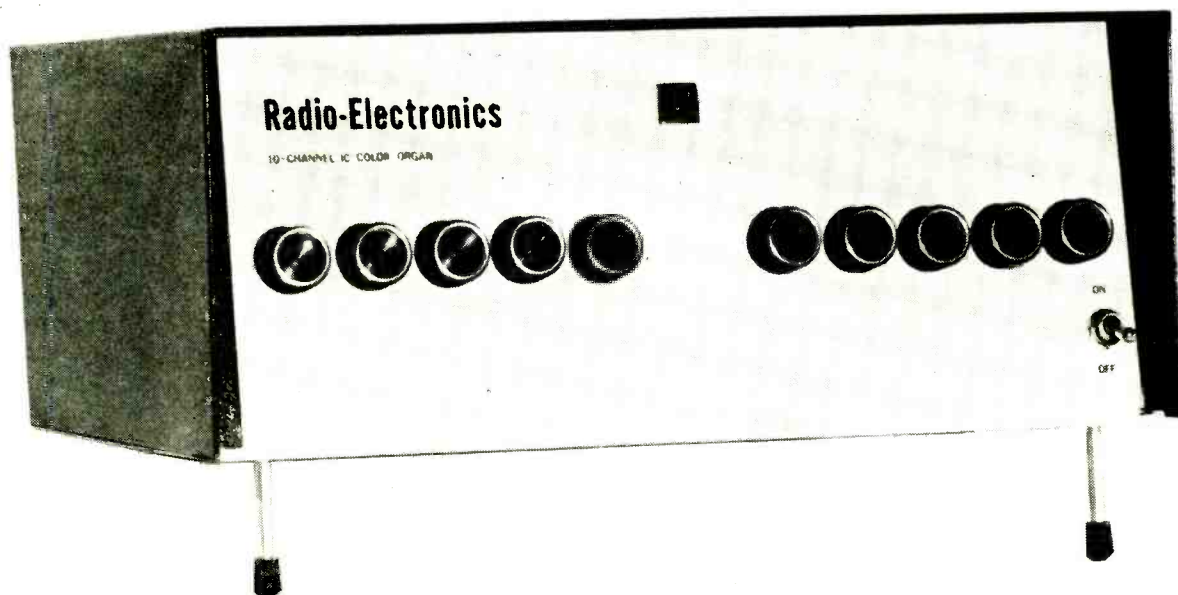



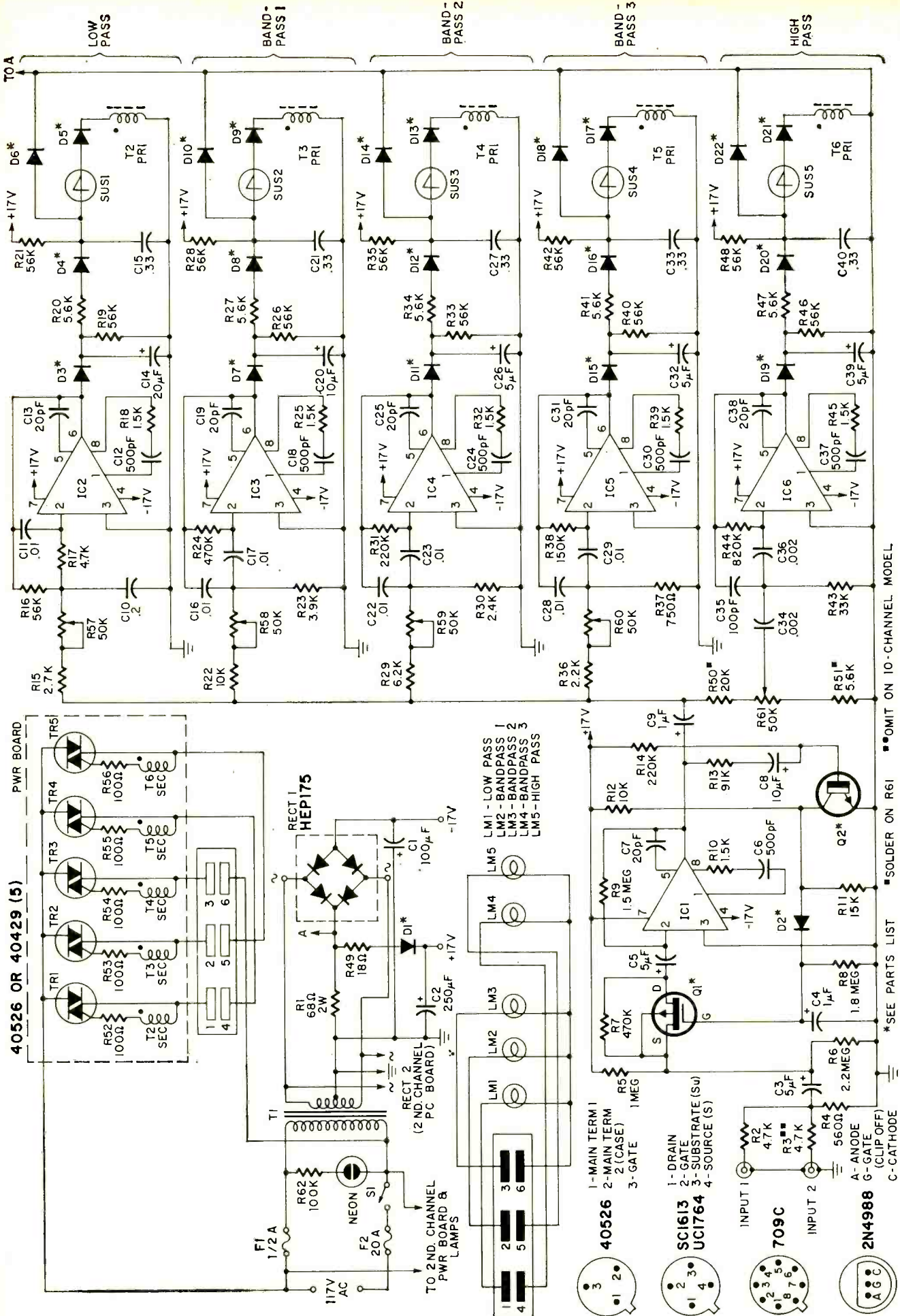

Fig. 2—Agc input stage (lower left) feeds the 5 IC band-pass filters (right) through C9. Pulse transformer primaries (far right) gate on the triacs through the secondary windings (upper left). PC board carries the power supply.



stituted for the lower-wattage devices.

### Circuit operation in brief

Operation of the input agc stage can be seen in the color organ circuit (Fig. 2) and a simplified representation of the agc circuit in Fig. 3. The inverting amplifier in Fig. 3 has a voltage gain of  $R_f/R_s$  due to the very high gain of IC1, a 709 operational amplifier. The gain of this stage can be changed by varying  $R_s$ .

This is accomplished in the agc stage by using a metal oxide silicon (MOS) transistor in place of  $R_s$ . The drain-source resistance  $R_{ds}$  of transistor Q1 is changed by applying a gate-source bias dependent on the peak output voltage of the stage. With no input to the stage, Q2 is saturated; consequently maximum gate-source bias is applied to Q1. This sets the amplifier to its maximum gain state.

An input to the stage provides an output that pulses Q2's collector toward its off state. The peak de-

tected bias applied to Q1's gate is then reduced and the  $R_{ds}$  of Q1 increases. This in turn reduces the overall gain and holds the output of the stage constant. The agc range of the stage is approximately 40 dB.

To provide the five frequencies for the colored lamps, commercial-grade 709 operational amplifiers employing multiple feedback are used. There are two advantages to this IC design: a useful voltage gain is possible and sharp amplitude attenuation beyond the cutoff frequency is obtained. The typical frequency response shown in Fig. 1 clearly demonstrates the desirable absence of overlapping adjacent characteristics. The dotted line shows the low-frequency attenuation introduced by coupling capacitor C9. This cutoff is needed to eliminate very-low-frequency components such as turntable rumble.

Frequency characteristics of the low-pass filter should be about 150 Hz (3 dB down), while the center

frequencies of bandpasses 1, 2 and 3 should be 350 Hz, 650 Hz and 1300 Hz. The high-pass filter should be 2500 Hz (3 dB down). Minor variations in these figures due to component tolerances will not be detectable, but an optional calibration procedure is included if you wish to adjust your color organ exactly to these frequencies.

A simplified version of a driver stage is shown in Fig. 4. Capacitor C1 charges toward the supply voltage ( $V_{cc}$ ) with timing constant  $R1C1$ . When the voltage across C1 exceeds about 7 volts, trigger diode SUS1, a silicon unilateral switch, switches on and discharges C1 through the pulse transformer primary. The pulse is coupled into the triac gate, which turns on and switches ac power to lamp LM.

This operation is phased to the line signal by D2, which discharges C1 to ground potential each time the line ac reverses polarity. Diode D2 then turns off and the cycle repeats. When a dc voltage E1 exists, C1 starts charging from E1 instead of ground and D1 switches on earlier in the cycle. This switches more power per cycle to the lamp. Voltage E1 is derived by peak detecting the filter stage output, so each lamp is illuminated when an output appears at its correspond-

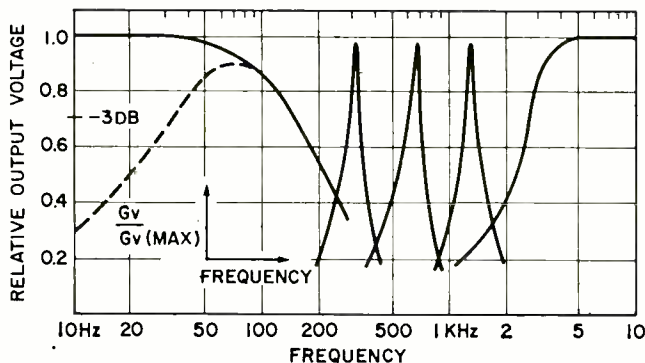
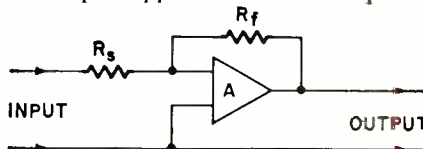

Fig. 1—Sharp frequency response of IC filters insures good channel separation. Dotted line is frequency cutoff to filter turntable rumble.

Fig. 3—Simplified agc circuit.  $R_f/R_s$  voltage gain is varied by using a MOSFET for  $R_s$  and varying its drain-source resistance.



### PARTS LIST

The following components are for a five-channel color organ. An identical set of parts is needed for the 10-channel version, except for fuses, T1, S1 and R62. Numbers in parenthesis are the stock and page numbers for most parts from the 1969 Allied Industrial Electronics Catalog (100 N. Western Ave., Chicago, Ill. 60680). If substitutions are used, consider space requirements on the PC board.

- C1—100- $\mu$ F electrolytic. Sprague TE1211 (43F6641, p180)
  - C2—250- $\mu$ F electrolytic. Cornell-Dubilier 250-25 (43F9270, p191)
  - C3, C5, C26, C32, C39—5- $\mu$ F electrolytic. Sprague TE1202 (43F6046, p180)
  - C4—1- $\mu$ F electrolytic. Sprague TE1200 (43F1779, p180)
  - C6, C12, C18, C24, C30, C37—500-pF ceramic disc. Centralab CE501 (43F0877, p198)
  - C7, C13, C19, C25, C31, C38—20-pF. Mallory SX (43F0400C, p187)
  - C8, C20—10- $\mu$ F electrolytic. Mallory MTA10D35 (43F0459, p188)
  - C9—1- $\mu$ F electrolytic. Sprague TE1200 (43F1779, p180)
  - C10—0.22  $\mu$ F. Sprague 2249R75 (43F3571, p183)
  - C11, C16, C17, C22, C23, C28, C29—0.01  $\mu$ F. Sprague 96P.10391 (43F3582, p185)
  - C14—20- $\mu$ F electrolytic. Mallory MTA20D30 (43F0456, p188)
  - C15, C21, C27, C33, C40—0.33  $\mu$ F. Sprague 3349R75 (43F3572, p183)
  - C34—0.002- $\mu$ F. Centralab CF-202 (43F1459, p198)
  - C35—100 pF. Mallory SX (43F0400C, p187)
  - C36—0.002  $\mu$ F. Mallory SX (43F0402C, p187)
- All capacitors 25V or more

- R1—68 ohms, 2W
  - R2, R3, R17—4700 ohms (omit R3 for 10-channel version)
  - R4—560 ohms
  - R5—1 megohm
  - R6—2.2 megohms
  - R7, R24—470,000 ohms
  - R8—1.8 megohm
  - R9—1.5 megohm
  - R10, R18, R25, R32, R39, R45—1500 ohms
  - R11—15,000 ohms
  - R12, R22—10,000 ohms
  - R13—91,000 ohms
  - R14, R31—220,000 ohms
  - R15—2700 ohms
  - R16, R19, R21, R26, R28, R33, R35, R40, R42, R46, R48—56,000 ohms
  - R20, R27, R34, R41, R47, R51—5600 ohms
  - R23—3900 ohms
  - R29—6200 ohms
  - R30—2400 ohms
  - R36—2200 ohms
  - R37—750 ohms
  - R38—150,000 ohms
  - R43—33,000 ohms
  - R44—820,000 ohms
  - R49—18 ohms
  - R50—20,000 ohms
  - R52—R56—100 ohms
  - R57—R61—50,000-ohm linear potentiometer
  - R62—100,000 ohms (optional)
- Unless noted, resistors are 1/4W, 10% or 5% (45F7150C, 45F7155C, p134)
- IC1—IC6—709C operational amplifier. Fairchild  $\mu$ A7709C, National LM709C. (See advertisements in RADIO-ELECTRONICS)
- Q1—p-channel MOSFET transistor. Philco-Ford SC1613, Union Carbide UC1764, Motorola 2N4352 (Allied p71)
- Q2—any npn transistor with  $h_{FE}$  over 40,  $V_{CE(sat)}$  over 15V. Motorola 2N708, 2N697, 2N718.

- D1—any 1-amp, 25V or more diode. HEP 156
  - D2—D22—any 25V or more diode. 1N4E4A, 1N98, Fairchild FD100
  - SUS1—SUS5—2N4988 silicon unilateral switch. G.E. (Allied p85)
  - TR1—TR5—40526 triac. RCA (Allied p39), 40429 for 300W/channel.
  - RECT1—bridge rectifier, HEP 175 (Motorola)
- Other parts**
- T1—1-amp, 24V CT transformer. Triac F45X (54F3661, p361)
  - T2—T6—1:1 pulse transformer. Sprague 11Z12 (54F0300, p363) or equal
  - S1—spst switch, 20A for 10 channels (56F4714, p208). 10A for 5 channels
  - Plug & Socket—Cinch-Jones P-306-CCT, S-306-AB (47F0806, 47F0883, p297)
  - Fuses—F1, 1/2 A. F2, 10A for 5 channels, 20A for 10 channels
  - MISC—Cabinet (Bud TV-2156), knobs, fuse holders, spacers, neon lamp, perforated board, 6-terminal strip(s), display sockets and lamps, input jacks (RCA type), Wakefield NF205 heat sinks (60F6529, p107), Grayhill 22-16-4 transistor sockets (47F-5289, p326), Cinch-Jones 8-ICS sockets (47F0155, p326)
- Etched, drilled and pretinned epoxy PC board available for \$8.50 each postpaid from Safford Electronics, 427 Benhow Rd., Greensboro, N.C. 27401. Also, kit of semiconductor, T1 and PC board(s): \$62 (five channels), \$130 (10 channels).
- \*Philco-Ford SC1613 (\$2.70 each) available from Milgray Electronics 160 Varick St., New York, N.Y. 10013 or write Philco-Ford Microelectronics Division, 609 Saw Mill River Road, Ardsley, N.Y. 10502 for other distributors. The Union Carbide UC1764 (\$4.90 each) is available from Eastern Radio Corp., 312 Clifton Ave., Clifton, N.J. 07011.

ing filter. Potential E1, therefore, varies as the filter stage output, and controls lamp brightness.

Use of pulse transformers to drive the triacs isolates the control circuits from the ac line, easing testing of the control circuitry.

### Assembly and calibration

All components fit on two PC boards except the power transformer, pulse transformers and triacs, resistors R52-R56, R50, R51 and the pots. You can prepare your own PC boards from the pattern provided, or order predrilled, solder-dipped boards.

Mount the triacs and pulse transformers on separate boards as shown in the photos. Wire and/or install the pulse transformers *identically* on both channels (use same wire for ground on each primary). If a band-pass lamp lights but does not respond to music, try reversing the wires on the primary. The triacs require clip-on heat sinks to prevent excess dissipation, and the cabinet should be drilled

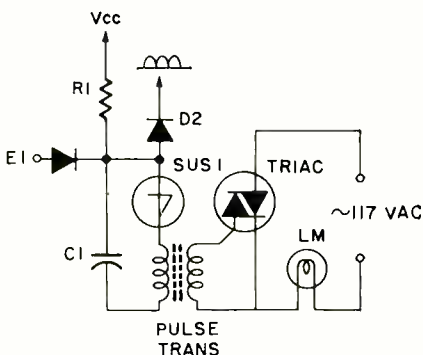

Fig. 4—Simplified driver stage. Space pulse transformers 1 inch to prevent interaction. Extend R1 above other components (long leads). Mount PC boards with insulative-type washers.

or cut below and above the mounting boards for ventilation. If 300-watt triacs are used, mount them on an aluminum heat sink with at least 36 square inches surface area. Since the cases of the *larger* triacs carry the full 117-volt ac input, the triacs or the heat sink itself must be electrically isolated from all other parts of the circuit, including the chassis.

Commercial pulse transformers can be used, but a considerable saving is possible by winding your own. Cut 3/8-inch diameter ferrite rod (used for AM radio antennas) into 1-inch lengths. Each core is wound with 50 turns of No. 30 gauge insulated copper wire to form the primary. This layer is then insulated with a cover of electrical insulating tape and a second 50-turn winding (secondary) put on. The secondary should also be covered with a layer of insulating tape.

The color organ will work with the component values shown, but the following calibration procedure can be followed for optimum performance. A sine-wave audio generator and oscilloscope are needed.

Connect the signal generator between one of the inputs and ground. Set the generator output to 0.5 volt p-p at 1 kHz. An undistorted sine wave will be seen at pin 6 of IC1. Alter the value of R13 until this waveform measures 9 volts p-p. This setting optimizes the amplitude response of the color organ.

Check the age action by increasing and lowering the input voltage; the output of IC1 should not change. Depending on the characteristics of Q1, this output should be constant over a 50-mV—5-volt input range.

When the optimum value of R13 is known, install a fixed resistor.

To calibrate the frequency response of the bandpass stages, temporarily connect a 25K potentiometer across R13 and adjust its value for a 1-volt p-p output of IC1 (pin 6) with a 0.5-volt p-p, 1-kHz signal at one of the color organ inputs. Turn all channel intensity controls to minimum resistance. Connect the oscilloscope to IC3 (pin 6) and adjust the signal generator frequency until the sine wave peaks. Ideally this should occur at about 350 Hz. The peak frequency can be altered to the desired value by changing the value of R23. The maximum p-p output voltage of this stage at the bandpass frequency should be about 15 volts. If not, it can be adjusted by changing R22.

Now check the output of IC4 (pin 6) and adjust the frequency giving peak output to approximately 650 Hz by changing resistor R30. Adjust the p-p voltage to about 15 volts by changing R29.

Repeat the procedure with the output of IC5 (pin 6), altering R37 to obtain a peak at approximately 1300 Hz. Alter R36 to obtain about 15 volts p-p output at the center frequency.

The low-pass (IC2) and high-pass (IC6) stages do not require frequency optimization, but may need adjusting for 15 volts output. For IC2, use a 100-Hz signal for this and alter R15 if necessary. For IC6 use 5 kHz and alter R50 if required.

### Hookup and displays

Inputs to the color organ are taken across the loudspeaker terminals. For the 10-channel color organ shown, the "live" terminal of each speaker is connected to each input and the ground terminal of each speaker to the ground input.

To connect a five-channel version to a stereo system, wire the live speaker terminals to the two inputs of the PC board (R2 and R3 must be installed) and the ground terminal of one speaker to the ground input. (*Make sure the stereo channels have a common ground in the hi-fi amplifier.*) The color organ sums the two inputs and sees them as a mono signal without affecting the stereo sound. For 8-ohm speakers, the crosstalk introduced is 78 dB down.

For any mono system with a 3-16-ohm speaker, connect the live loudspeaker terminal to one of the inputs and the ground terminal to the ground input.

Choice of a display arrangement is limited only by your imagination. One logical arrangement is to use flood or spot lamps of five different colors:

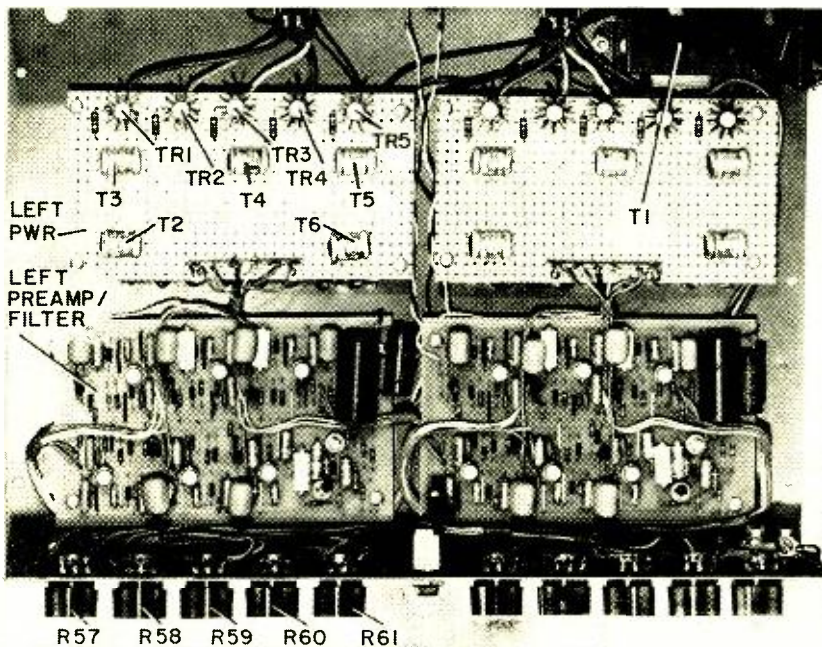



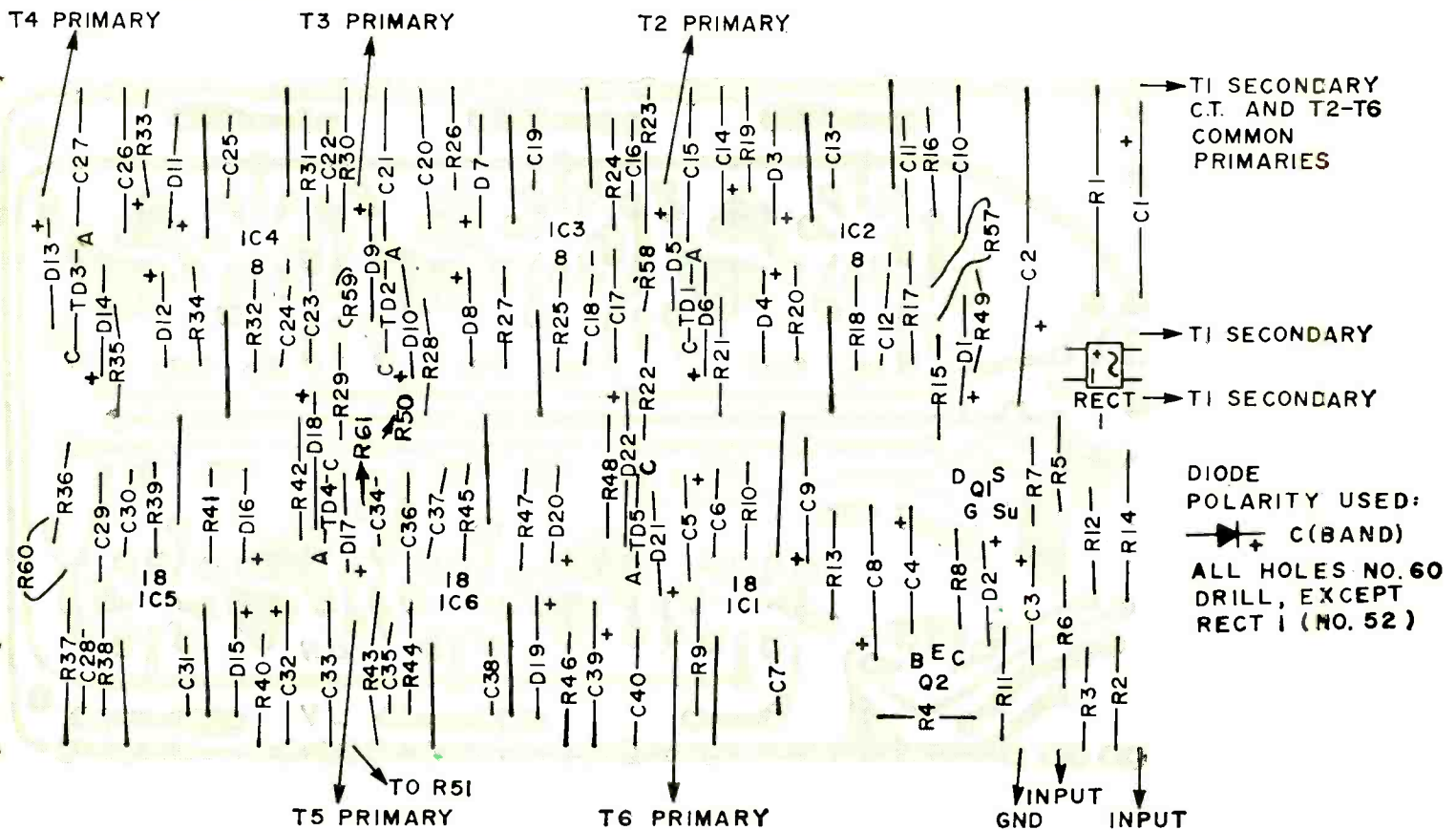
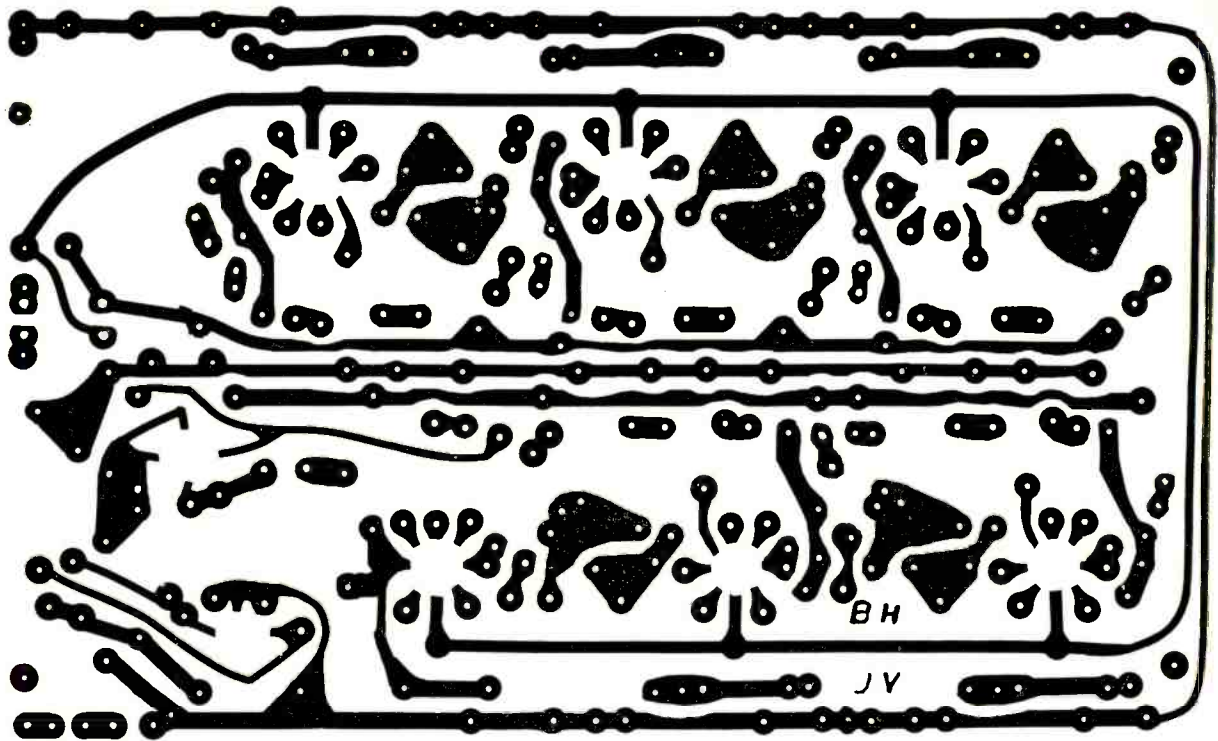

Actual-size copper-side PC pattern is on top with components side above. Board size can be 4 x 6 9/16". Codes TD1-TD5 above are SUS1-SUS5 on Fig. 2 and the parts list. For sockets, drill 9/32" holes for each

IC and transistor and solder them in. Otherwise, drill No. 60 holes at the end of each connection "finger" and solder devices in directly. Note: wrap a bare fine wire around MOSFET leads until they are installed.

red for the low-pass (bass) channel, amber, yellow and green for the band-pass 1, 2 and 3 channels, and blue for the high-pass (treble) channel.

Although some may prefer the effect, higher-wattage lamps may produce a delay between the sound you hear and peak lamp illumination. The G.E. 150-watt PAR 38 Dichro-Color lamps provide "rich" colors due to

built-in coatings.

The lamp-peaking delay can be shortened by biasing the lamps just below their illumination point. This can be done by lowering the values of resistors, R21, R28, R35, R42 and R48. (This might necessitate lowering IC1's output with R13.)

Lower wattage lamps such as Sylvania's stained-glass, 75-watt PAR

reduce this delay between sound and light. Low-wattage lamps can be wired in parallel for direct-view displays. For their transparent colored sign lamps, G.E. recommends 40-watt blue, 25-watt red and green, 15-watt orange and 11 watt yellow. This combination prevents the "cool" colors from being overpowered by the yellows and oranges.

R-E



## R-E STAFF REPORT

# Hi-Fi Stereo

STEREO HEADPHONES ARE IN! BECAUSE THEY REALLY do the job they have become one of the more desirable ways to listen to stereo sound.

Several things account for this change. First, and perhaps the most obvious, is that most of us like our music with oomph. To get it that way, we've got to turn up the watts and feed real power into our speaker systems. But while this is fine for us, the rest of the family, and our neighbors, might not like those hi-fi sounds.

Another solid reason for using phones is that they put you right in the middle of the music (and at the same time the middle of that stereo effect). When you get up to walk across the room, that perfect stereo position goes with you. And what the rest of the family is doing doesn't have any effect on your listening pleasure. With the phones on, level up, and thick padded ear seals you'll find yourself rather insulated from the rest of the world.

The great growing current interest in stereo phones led us to prepare this article. Because headphone users listen to them or at least through them, we decided to do an in-depth very subjective test of how they sound. The results of these tests appear on the next two pages of this article. But before you flip the page to those listings you might like to know how they were compiled.

First we decided that we would do a subjective report. Each of three editors on the staff of **Radio-Electronics** would use and listen to the phones and then report on their findings. Each of us used somewhat different testing techniques. Here's how it went.

### Editor I—Music only!

Our first editor decided to just listen to his favorite music. He reported "I merely took each pair of phones, one by one, plugged it into my stereo system and listened to several selections from a few favorite records. I included a band of theatre organ to cover the low end and another band of lively percussion to check out the highs. The rest was widely assorted so I could observe the reproduction of transient sounds

as well as overall quality.

"Comfort was also a simple test. If by the end of the listening period (about 45 minutes) the phones were not bothering me (too heavy, too tight) they were comfortable. If they did bother me, the degree of discomfort was subtracted from that perfect figure of ten.

"Ear seal effectiveness was also a practical test. The figure in that column merely depends on how much extraneous noise got through to my ears during the testing procedure."

### Editor II—Test record results!

Our second reviewer did it up brown. Here's his report on how he conducted his tests. "To check out the low-frequency response of the phones I tested, I measured the ability of the left and right earpieces to reproduce the lower three sweep bands (80 to 115 Hz, 40 to 80 Hz, and 20 to 40 Hz) of the Stereo Review Test Record, model 211. In addition to listening for the audible level of these sweep tones, a comparison with the record's reference warble tones was made. The ability of the phones to reproduce the final organ note in Sinfonia to Bach's Cantata No. 29 (Music of Jubilee, Columbia MS6615) was tested.

"To test high-frequency response I judged the ability of the stereo headphones to reproduce the high-frequency sweep tones on the test record (up to 20 kHz), and a judgment of their response to high frequency passages in the Bach Cantata.

"When it came time to determine overall response I based my judgment on a combination of high and low-frequency response and clarity of sound. Also, a check for any obvious drop in response to middle frequencies on the test record and in the Bach Cantata.

"Clarity of sound was an easy one to check out. It is based on obvious distortion introduced into the musical selection used and the ability





*1970 may be the year you buy your first set of stereo phones. This guide can make selecting a pair painless.*



# Headphones

of the stereo phones to handle moderately high levels without distorting sound.

"Effectiveness of the ear seal was determined by how snugly the phones fit over my ears to provide good low-frequency response.

• "Comfort was determined by judging the pressure applied by the headband as well as pressure on and around the ears caused by wearing the headphones. This was judged after using each pair of phones over the entire test period."

## Editor III—At home with phones!

Still another technique was used by this editor. He reports: "Testing all those headphones covered in this report in a house with four kids appeared, at first, to be an almost impossible task. With each child doing his or her own thing with a radio, record player, or TV; and my wife threatening to leave if I didn't get that pile of headphone cartons and boxes out of her livingroom. I was ready to quit before I even got started.

"Finally, to retain calm and keep everyone busy I enlisted the aid of my wife and nieces—13 and 19 years old. Test sessions were limited to one hour and not more than six headsets were tested in any one sitting. This was intended to prevent listening fatigue and also to allow enough listening time to evaluate such factors as comfort and effectiveness of the ear seal.

"All the phones were tested in pairs and were connected to a Bogen stereo receiver through a Lafayette stereo headphone adapter box. (We ran a quick

test to select pairs with about equal efficiency first, so their audio output levels would be about equal.) Then we listened to the program material which consisted mainly of orchestral selections from the Audio-Fidelity FCS-50,000, Vanguard VSD-100 and High Fidelity Stereo Review 211 test records. Sweep and spot-

frequency bands were used when we couldn't decide which of the two pairs of phones being used had the best high- or low-frequency response.

"Two listeners would make their tentative ratings and then turn the stereo phones over to the second pair of judges—usually my wife and I. The four of us would then decide which set of phones we liked best and then pair this one with a yet untested set.

"Throughout the tests, someone would ask for a previously tested set of phones to compare with another set he liked. It didn't take long to discover that the Koss ESP-6 had about the best and smoothest frequency response. So this set was then used as our standard for all tests that followed.

"Comfort was based on a combination of weight, balance, pressure on the ears, the tendency of the pads to cause perspiration and the length and flexibility of the cord. (My wife and my nieces were also influenced by how the headband fit without mussing their hair.)

"Effectiveness of the ear seal was easy to judge with eight- and nine-year old boys romping and blasting a TV and radio in adjoining rooms. If you couldn't hear them, the ear seal was rated tops."

## Other important considerations

When purchasing phones you might keep in mind that you will have to hook them up to the amplifier. It's easy if you have a new unit, just plug in the jack. But if your amplifier is one of the older models without a jack, you'll have to get an adapter control box.

The cord that connects the phones to the amplifier is also important. Coil cords seem best, but watch out for stiff, uncomfortable ones. Most of all make sure the phone you buy has a cord that is long enough.

You may discover that some current headphones are not listed in the table. We tested all phones we could obtain. Some units did not arrive in time to be included and therefore, are not listed. For a complete listing of the stereo phones we did check, and their specifications turn the page. We hope you will find this listing a useful guide.

—R-E

(TURN PAGE FOR CHART)



EDITOR III

EDITOR II

EDITOR I

HIGH-FREQUENCY RESPONSE  
LOW-FREQUENCY RESPONSE  
OVERALL RESPONSE  
COMFORT OF SOUND  
CLARITY OF SOUND  
EAR SEAL EFFECTIVENESS

HIGH-FREQUENCY RESPONSE  
LOW-FREQUENCY RESPONSE  
OVERALL RESPONSE  
COMFORT OF SOUND  
CLARITY OF SOUND  
EAR SEAL EFFECTIVENESS

HIGH-FREQUENCY RESPONSE  
LOW-FREQUENCY RESPONSE  
OVERALL RESPONSE  
COMFORT OF SOUND  
CLARITY OF SOUND  
EAR SEAL EFFECTIVENESS

MANUFACTURER	MODEL	PRICE
David Clark Co. Inc. 250 Park Ave. Worcester, Mass.	100	\$45.00
	200	\$26.95
	250	\$32.00
	300	\$19.00

Jensen Manufacturing Div.  
5655 W. 73 Street  
Chicago, Ill.

Koss Electronics Inc. 2227 N. 31 Street Milwaukee, Wisc.	ESP-6	\$95.00
	K-6	\$26.50
	KO-727	\$34.95
	PRO 4-A	\$50.00
	SP-3XC	\$24.95

Olsen Electronics  
260 S. Forge Street  
Akron, Ohio

4 6 5 7 5 5  
3 7 5 5 5 3  
7 5 5 6 8 4  
7 7 7 6 8 7

3 4 4 5 5 6  
7 9 8 5 9 6  
5 6 6 5 4 6  
6 6 6 5 5 6

4 6 4 5 6 6  
6 9 7 6 8 7  
6 5 6 6 7 5  
7 6 6 6 7 6

7 7 7 6 7 4

9 7 8 7 7 3

8 7 7 6 8 4

10 10 10 6 10 8  
5 4 5 5 5 7  
6 6 7 7 7 7  
7 7 7 8 10 9  
5 6 5 7 6 7

10 10 10 10 10  
6 6 6 7 8 8  
7 7 7 7 9 8  
8 7 7 8 7 9  
6 7 7 7 7 7

10 10 10 6 10 10  
6 5 6 7 7 7  
8 7 7 7 8 7  
8 8 8 8 8 9  
6 6 6 7 7 7

3 5 4 7 5 2  
5 6 5 7 4 8

3 6 5 6 5 3  
8 7 6 5 5 6

4 6 5 6 6 3  
7 7 7 5 5 7



PermaFlux Corp. 4111 San Fernando Rd. Glendale, Calif.	BHM-16 BDHS-28	\$35.00 \$45.00	4 5 5 7 6 6 5 5 6 7 6 7	3 4 4 5 5 6 3 4 4 7 5 7	4 5 4 7 5 6 4 5 4 6 6 7
Pioneer Electronics Inc. 140 Smith Street Farmingdale, N.Y.	SE-20 SE-30 SE-50	\$19.95 \$29.95 \$49.95	7 6 6 6 7 8 6 7 7 7 8 8 8 7 8 8 8 8	6 7 7 6 6 8 7 7 6 7 7 8 8 8 8 8 8 8	6 6 5 6 6 8 6 7 6 7 7 8 8 8 7 8 8 8
Sansui Electronic Corp. 34-43 56th Street Woodside, N.Y.	SS-2	\$12.95	6 6 6 7 6 7	8 7 7 6 5 4	6 5 5 8 6 6
Sennheiser Electronic Corp. 500 Fifth Ave. New York, N.Y.	HD-110S HD-414	\$72.00 \$29.95	4 5 6 7 6 6 8 9 9 8 8 6	4 6 6 6 6 6 7 8 8 7 8 6	4 3 4 6 5 6 8 9 9 9 9 6
Superex Electronics 1 Radford Place Yonkers, N.Y.	ST-C ST-M ST-PRO	\$19.95 \$29.95 \$50.00	7 6 6 7 7 6 7 8 7 6 8 7 8 7 7 7 7 7	7 6 6 7 7 7 7 5 5 7 5 7 7 8 7 6 7 6	5 5 5 6 7 8 8 7 7 6 8 8 7 8 7 5 7 8
E. J. Sharpe Instruments Inc. Amhurst Industrial Park Tonawanda, N.Y.	HA-9 HA-660 PRO HA-10A HA-10 MARK II	\$25.95 \$60.00 \$43.50 \$45.00	5 5 5 8 7 9 6 7 7 9 8 8 7 7 6 9 9 10 6 7 6 9 9 9	5 5 5 9 8 9 5 6 5 10 9 9 6 6 7 10 10 10 6 6 6 10 9 9	4 7 5 4 4 9 7 7 7 8 9 9 6 6 8 9 9 10 5 8 6 9 9 10
Telex Acoustics 9600 Aldrich Ave. S. Minneapolis, Minn.	Combo Adjustatone Serenata 1	\$19.95 \$15.95 \$59.95	5 5 5 7 5 6 5 4 5 5 5 6 4 5 5 8 6 6	3 7 7 5 7 5 3 6 3 4 3 5 2 6 5 9 6 9	4 4 7 9 8 9 3 5 5 7 8 9 3 6 4 7 4 6
Telefunken	TH-28	\$24.95	6 7 6 8 7 8	NOT TESTED	NOT TESTED

# Build a 3-way electronic crossover

*How to design a 12-dB/octave filter*

by **NORMAN H. CROWHURST**

IN A PREVIOUS ARTICLE I PUT THE matter of electronic vs electrical crossovers in some perspective, and commented that to date the only way to get a correctly designed 12-dB/octave (or sharper) electronic crossover is to design and build one yourself (March 1969, R-E).

The basic amplifier circuit around which a 12-dB/octave filter can be built is in Fig. 1. It consists of a central voltage-gain stage and two emitter followers, to provide impedance isolation so performance is not affected by external circuits and their impedances.

The output emitter follower makes the output signal voltage developed by the voltage-gain stage available with a low source impedance, and the base circuit of the input emitter

follower is fed by a 2:1 voltage divider. There is an additional 2:1 gain loss due to the 6 dB feedback used to sharpen the response to its correct shape.

So the voltage gain of the middle stage should be precisely 4 (12 dB). This will make the output signal voltage the same as the input, from each channel, within that channel's range.

Using a 12-volt supply and transistors with a current gain of about 100 (this is not critical in the circuit chosen) we calculate values. For the output emitter follower, we want the emitter dc voltage to be 6 volts. This allows maximum swing with the 12-volt supply.

Picking 510 ohms as the emitter resistor (assuming a 500-ohm load as minimum external output termination), the dc load at the base will be about 100 times this, or 51K. Using a bias potentiometer of 5.1K and 5.6K will bring the emitter voltage very close to 6-volts on a 12-volt supply.

Now to calculate the base input resistance of the output emitter follower: This consists of 5.1K and 5.6K, along with the reflected impedance of about 51K (with no external load connected) all in parallel. This combination figures to 2.5K. An external load of 500 ohms would reduce the reflected part to about 25K, reducing

the combined input impedance to 2.25K, which is not a serious change.

To achieve an in-range gain of 4:1, we assume a collector resistor of 1K and calculate the collector load, which is this 1K paralleled for signal purposes with 2.5K, to make 720 ohms. With this collector load, an emitter resistor of 180 ohms will control the stage voltage gain to 4:1.

To get 6-volts on the collector of this stage, its current must be 6 mA, so the emitter voltage will be 1.08-volts. The 180 ohms will reflect to the base circuit as 18K.

The next step was based on using identical capacitors for controlling turnover in each stage of coupling. For the high-pass filter, the reactance of the coupling capacitor between collector and output emitter follower needs to be 3.5K (2.5K plus 1K) at root-2 times turnover frequency.

The input emitter follower will provide negligible source impedance, so the base input impedance of the voltage-gain stage should be 3.5K also. Trial and error led to the choice of 5.1K and 43K, along with the 18K reflected through the stage from the 180-ohm emitter resistor, which comes very close to the 3.5K desired.

This combination of resistors also controls the emitter voltage to 1.08 volts, and thus collector current to 6 mA and the collector voltage to 6 volts.

The input emitter follower also uses a 510-ohm emitter resistor. Its bias will normally be taken through the feedback resistor. Its input impedance, reflected from the emitter resistor, will be about 51K. Using two 3.6K resistors across the input signal voltage will divide the input voltage in half (before feedback is considered).

Feedback will reduce this signal voltage to one-fourth input and the 4:1 gain will bring the output voltage up to equal the original input signal voltage, as well as reversing its phase.

The source resistance for the input signal voltage of  $\frac{1}{2}$ , at the base, is

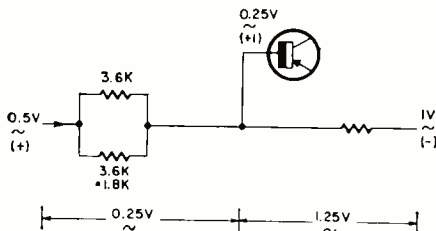
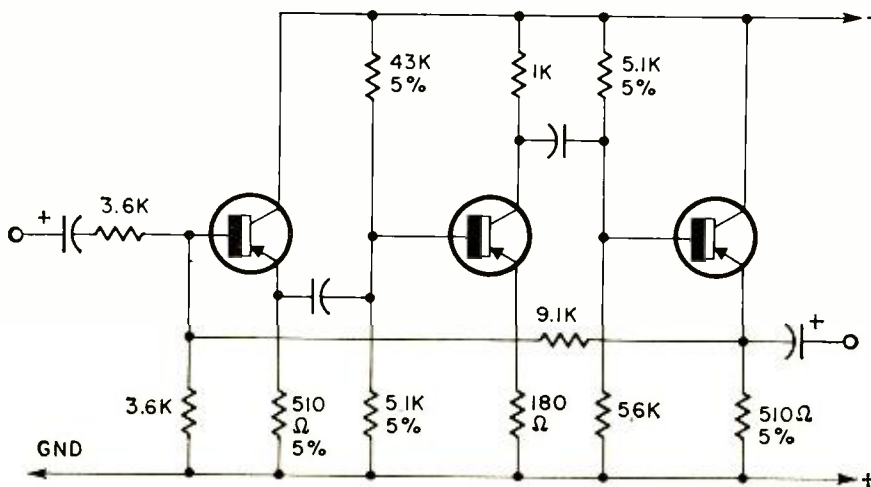

Fig. 1—Basic 12-dB/octave filter (below) uses two emitter followers. Fig. 2 (above)—Voltage relationships that determine feedback resistor value.





the parallel combination of two 3.6K resistors, or 1.8K. The signal voltage will be dropped, when feedback is applied, to 1/4, while the feedback resistor will connect back to a signal voltage of 1, reversed phase. (Fig. 2).

So the feedback resistor will have 1.25 times the original input voltage across it, thus needing to be 5 times the impedance that "drops" the 0.25 part. Five times 1.8K is 9K, for which a 9.1K resistor will serve.

Using a blocking capacitor to keep dc out of the input circuit, the bias of the input emitter follower is taken from a 6-volt point (the output emitter) through 9.1K and 3.6K, yielding a working voltage of about 1.7 volts. As the signal level at this point is 1/4 the input and output signal level, this voltage provides adequate margin for handling the signal.

The impedance reflected through the input emitter follower will be 1.8K divided by 100, or 18 ohms. And through the output emitter follower, 720 ohms divided by 100, or 7.2 ohms. Thus output loading can have little effect on operation.

#### Low-pass design

That about sets the picture for the high-pass configuration. For low-pass, we have the collector-circuit parallel impedance calculated at 720 ohms. This is the impedance the shunt capacitor works with. If we use a series resistor in the base circuit to make that also 720 ohms, the same value of shunt capacitor will serve. With the 3.5K in the base circuit, a 910-ohm resistor will bring the shunt combination at the base to 720 ohms. This resistor needs dc blocking, unless the section is bandpass, so the capacitor is needed for the high-pass function.

Thus the completed two-way crossover looks like Fig. 3. To make calculating the capacitors for turnover easier, we will figure them at whatever crossover frequency is chosen.

For high pass, they should be figured at root-2 times crossover, so their reactance will be root-2 times the series-circuit impedance at crossover, or 5K.

For low pass, they should be figured at crossover divided by root-2, so their reactance will be the parallel circuit impedance divided by root-2 at crossover, or 500 ohms,

This makes the figuring very convenient. We have tabulated some values of capacitors for selected crossover frequencies. If you want to make your crossover three-way or more, it is simple to combine the two functions into one circuit for any bandpass channels you use (Fig. 4).

If you plan on making several of these, in varying combinations, it may

be worth planning an etched circuit (Fig. 5) that can be wired for low pass, high pass or bandpass. Fig. 6 shows a completed circuit for a three-way crossover, using these circuit boards.

Finally, you may need to know how to check the performance. The first step is to open the feedback loop. This can most simply be done by lifting the 9.1K resistor from the output emitter and connecting a 12K resistor in series with it to the negative supply. Now the unit should show precisely 2:1 gain, and 90° phase shift with zero gain at frequencies that are root-2 times crossover for high pass, and crossover divided by root-2 for low pass.

This 90° phase shift pattern should look like a circle on the scope

when horizontal is connected to input and vertical to output with both inputs set to the same sensitivity. This can be set by paralleling them on the input and adjusting to give a 45° straight line. Check this at the appropriate root-2 frequencies. If the result is incorrect, find out where it goes wrong.

To find an error in a high-pass filter, or the high-pass function of a bandpass, use an electrolytic capacitor to bypass one of the turnover capacitors in turn; first one, then the other. Each of these should yield the 45° trace at root-2 times crossover frequency (Fig. 7).

If one of them doesn't, the capacitor has the wrong value and should be corrected. Finally, reconnecting the feedback should give the elliptical

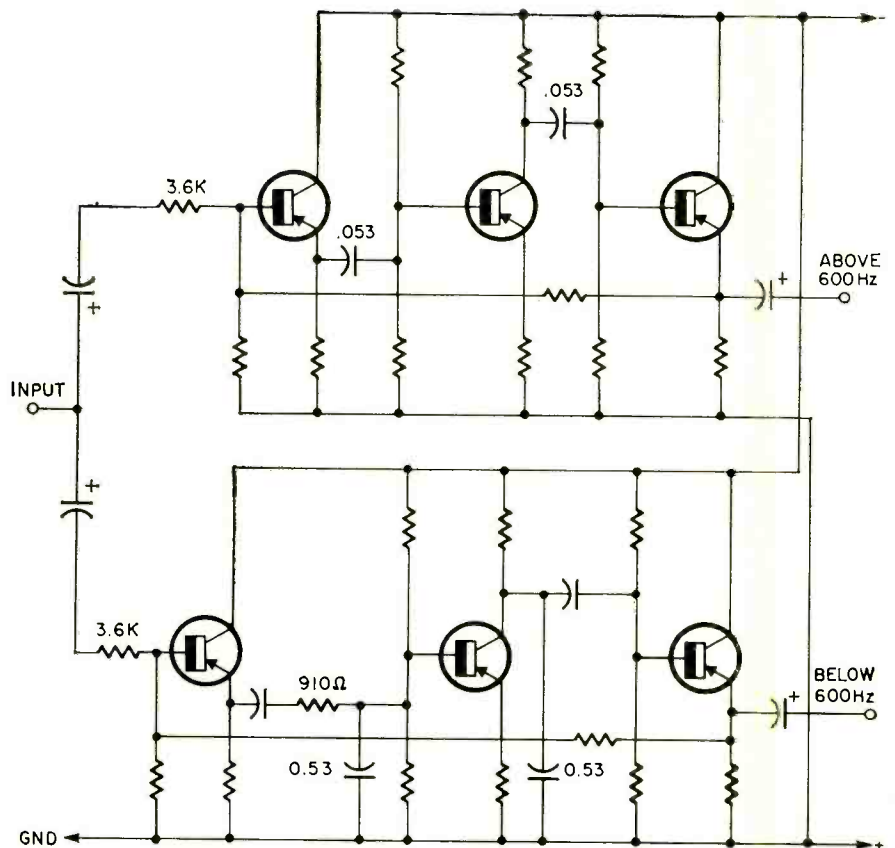
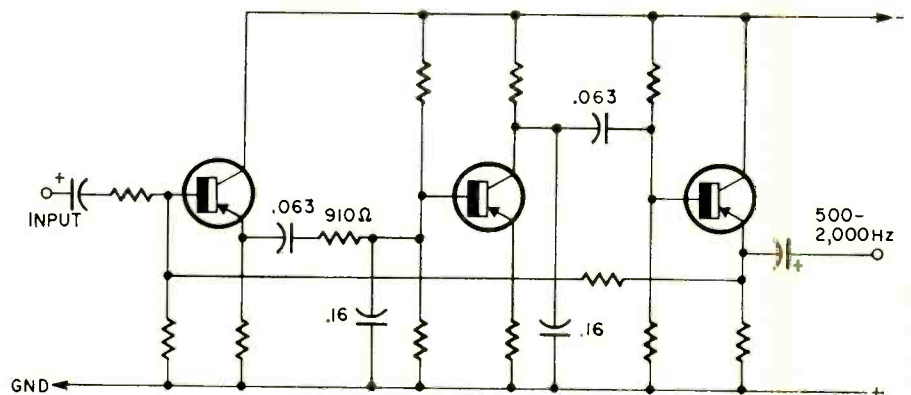

Fig. 3—High- and low-pass circuits alone make a useful 2-way crossover. Fig. 4—Band pass circuit added for a 3-way crossover. See table for values.











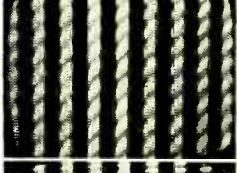
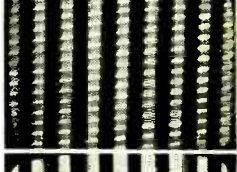

# Kwik-Fix™ picture and waveform charts

by Forest H. Belt & Associates\*

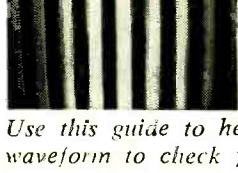
SCREEN SYMPTOMS AS GUIDES		WHERE TO CHECK FIRST		
SYMPTOM PIC	DESCRIPTION	VOLTAGE	WAVEFORM	PART
	NORMAL. Color bars show up as different shades of gray in these black-and-white photographs. Red is to the left, blue is in the middle, and green is at the right. As you can see in the photos that follow, color-sync symptoms can be shown this way just as successfully as with color photographs. Just read the descriptions of the symptoms that accompany the screen photographs.			
	Color slightly off sync; bars of color may float.	Screen-pin-6	not much help	C3 leaky
	Color out of sync; tint control narrow in range.	Cathode-pin-2	WF2 WF4	R3 open C2 open
	Color out of sync; tint control has no effect.	not much help	WF3 WF4	C8 open C6 short
	Color far out of sync.	Key-point-A	WF5	T1 faulty
	No color at all, just gray bars.	Grid-pin-1	WF4	R2 low/short C1 leaky/short
	Colors float lazily sideways.	not much help	WF2	C1 open
	Color weak and out of sync.	Grid-pin-1	WF3	C1 slt leaky
	Colors in sync, but wrong colors; tint control has no effect.	not much help	not much help	R6 open/short C6 open

\*an Easy-Read™ feature by FOREST H. BELT & Associates © 1969

Use this guide to help you find which key voltage or waveform to check first.

Study the screen and the action of the Tint control. Most-helpful clues to the fault are found at the key test points indicated.

Make voltage or waveform checks as indicated for screen symptoms.

Use the Voltage Guide and Waveform Guide to analyze results.

For a quick check, test or substitute the parts listed as the most likely cause of the symptoms.

## The Circuit

THIS BURST AMPLIFIER IS DECEPTIVELY SIMPLE. IT'S MERELY a keyed amplifier. The tube is biased past cutoff and blocks video. But keying lets the burst of color-sync signal be amplified. The keying pulse comes from the same flyback winding that keys the agc stage. The input connection is preceded in most receivers by one stage of bandpass amplification. Other versions can be reduced to this basic stage.

### Signal Behavior

A complete chroma signal (part of WF2), including color-sync burst, is fed from the first bandpass amplifier to the grid of the burst-amp stage by C1. The signal develops across grid load R1. Positive-going keying pulse WF1 is also fed to the grid of the burst amp. High-value cathode resistor R3 keeps the tube cut off most of the time, so no video or chroma information is amplified. The keying pulse lets the tube amplify, and the color-sync burst appears in the output (WF3).

Transformer T1 is called the *burst transformer*. It's tuned to 3.58 MHz to pass the color-sync burst efficiently. Its tapped secondary couples the burst signal through capacitors C7 and C8 to the phase detector that controls the 3.58-MHz Cw oscillator. Similar capacitors (not shown) couple the same signals to a phase detector for the automatic color control (acc) and color killer stages.

Exact phase of the sync signal applied to the phase detector is controlled by a capacitor-resistor shift network (C6 and R6) across half the secondary winding. The resistor is a potentiometer—the Tint control which lets a viewer adjust hue of the color picture for best flesh tones.

Bypass capacitors in the stage are C2 for the cathode resistor, C5 to bypass R5 and decouple the lower end of the transformer primary, and C3 and C4 for decoupling the screen supply circuit.

### DC Distribution

Cutoff bias for the tube is developed by comparatively large-value resistor R3 in the cathode circuit. Plate-supply path is through R5 and T1 from the 375-volt supply line. The screen, fed by well-decoupled R4, is supplied from 260 volts dc.

Dc drops across R4 and R5 are slight, indicating there's not much average current flow. However, there's enough to develop bias across R3 to keep the tube in cutoff except during the keying pulse. Grid return is through R1 to ground.

### Signal and Control Effects

With or without station signal, there is little change in dc voltages in the stage. The waveforms change, though. Without a signal, WF2 lacks the chroma and video information that is mixed with the keying pulse there. More noticeable is the missing color sync in all the other waveforms (waveforms without signal are included in the Waveform Guide).

Changing the Tint control position produces amplitude changes that are particularly noticeable in WF4 and WF5, and to a lesser degree in WF3. The Tint control has no effect on dc voltages.

### Quick Troubleshooting

The stage must receive both chroma and keying signals. Scoping WF2 (see Waveform Guide) shows if both are there. If so, your best bet is to try adjusting T1, with a low-capacitance scope probe at WF5. The transformer slug should make a noticeable difference in waveform amplitude (you can't see phase change on the scope). If T1 tunes okay, but color sync is still poor, check cathode dc voltage; it's the most revealing.

Hardest trouble to spot here is an open bypass capacitor. They show very nebulous symptoms. Best test is jumpering a good .01- $\mu$ F capacitor across each one. An open C5 keeps T1 from tuning properly.

An open R3 may confuse you. It doesn't cut the tube off as you might think. The killer control (not shown) completes the cathode return circuit. However, the change in cathode voltage is significant (see Voltage Guide).

Some parts are critical. Replace C1 only with that exact value; otherwise there'll be a drastic change in WF2. C6 must be a silvered mica or other NPO type (not temperature-sensitive). The 330-pF capacitors and the 1-meg resistors should be carefully matched, or they'll unbalance the output circuit. **R-E**

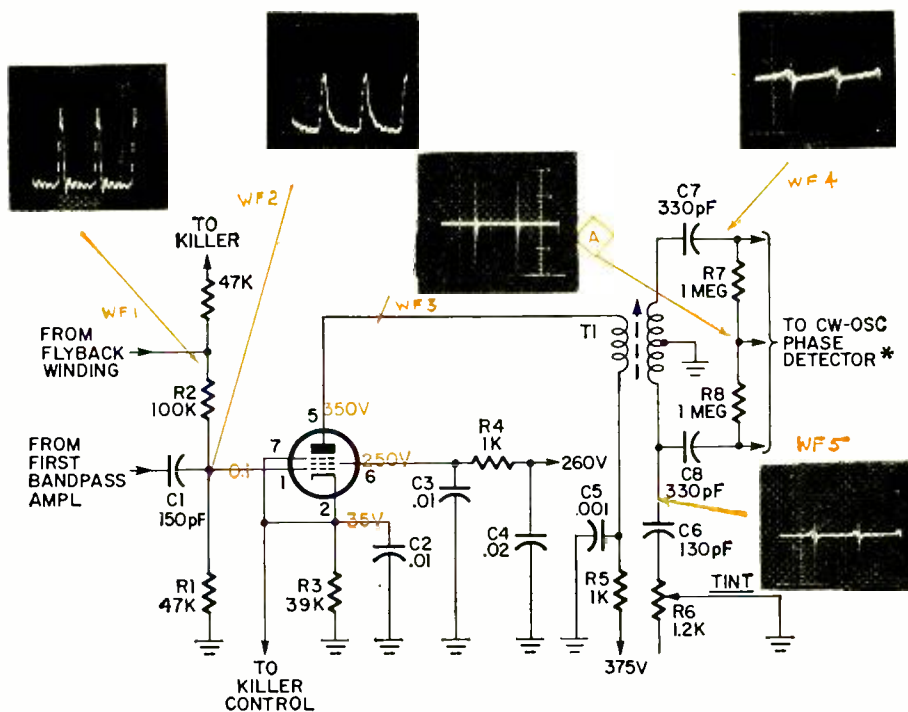

VOLTAGES AND WAVEFORMS TAKEN WITH KEYED-RAINBOW INPUT TO SET.

\*SIMILAR CONNECTIONS (CAPACITORS AND RESISTORS) GO FROM OUTPUT OF BURST TRANSFORMER TO ACC/KILLER PHASE DETECTOR



## DC VOLTAGES AS GUIDES

Voltage change	to zero	very low	low	slightly low	slightly high	high
<b>Grid-pin-1</b> Normal 0.2 V	R1 short C1 open R4 open* R5 open* T1 pri open* *or negative	R1 low	R1 low			C1 1k $\Omega$ short
*Varies slightly with Color control						
<b>Cathode-pin-2</b> Normal 35 V	C2 short	R1 short/lo C2 open R4 open	R1 slt low	C2 leaky R3 low R4 v high R5 v high T1 pri open	R3 open	R1 open
<b>Plate-pin-5</b> Normal 350 V	R5 open T1 pri open		R5 high	R4 open C5 leaky		
<b>Screen-pin-6</b> Normal 250 V			C3 leaky	C4 leaky		

	Slightly negative	Far Negative	Slightly positive	Far positive
<b>Key-point-A</b> Normal Zero to 0.3V	R7 low	T1 sec bot open	R7 open C6 open T1 sec top open	R8 open

Use this guide to help you pinpoint the faulty part. Measure each of the five key voltages with a vvm.  
For each, move across to the column that describes the change you find.  
Notice which parts might cause that change.  
Finally, notice which parts are repeated in the combina-

tion of changes you find.  
Test those parts individually for the fault described.  
**NOTE:** For more guides to narrow down the faulty part further, see Waveform Guide.  
**NOTE:** Dc voltages at other points in this stage are misleading for diagnosis, so are not a part of this guide.

## WAVEFORMS AS GUIDES

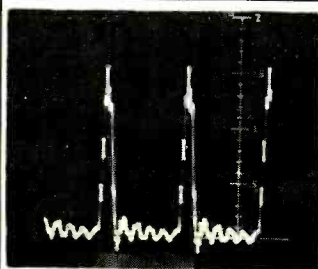

**WF1** Normal 160V p-p

Keying pulses from the flyback transformer. Nothing within the burst-amp stage affects the shape or amplitude of this waveform. If the pulse is missing, of course you can tell by scoping this input point. However, you can also tell quite easily from WF2, below. Waveform WF1 is included merely for reference. If it is low in amplitude, the trouble is outside the burst amplifier stage—probably in the flyback transformer.

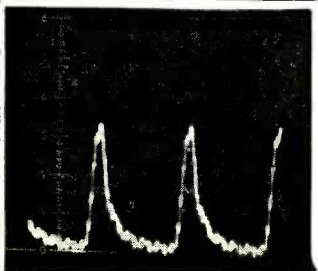



**WF2** Normal 30V p-p

Taken at grid-pin-1 of the burst amplifier tube. The shape comes from mixing the keying signal (WF1) with the video and chroma signals coupled into the stage by C1. If the video/chroma signals are missing, the trouble might be in the stage that precedes C1—usually the first bandpass amplifier. The amplitude of the video (color bars) along the lower part of the waveform varies in height with the strength of the chroma signal, and with the setting of the Color (Color Intensity) control.

V p-p low	V p-p high	V p-p zero				
R1 low R4 open C1 leaky C2 v leaky						
			11V p-p R2 open	100V p-p R2 low	45V p-p C1 open	13V p-p C1 leaky
						4V p-p C1 short

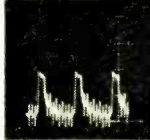
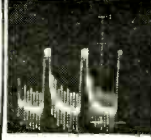

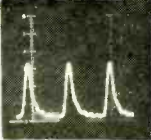

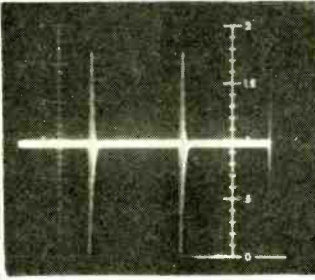

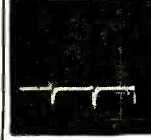

### WAVEFORMS AS GUIDES

			 10V p-p C2 short	 15V p-p R4 open	 160V p-p R2 short	 3V p-p Flyback pulse missing	 30V p-p Station signal missing
--	--	--	--	---	--	--	--

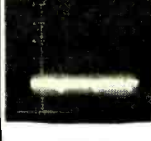
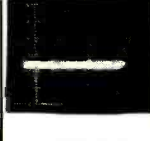
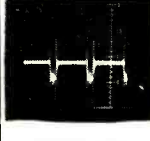

**WF3 Normal 180V p-p**

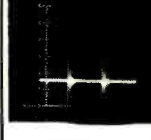
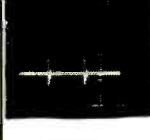

Output signal from keyed burst amplifier, taken at plate-pin-5. Video has been removed from between pulses. Each pulse contains several cycles of 3.58-MHz color-sync signal, extracted from station (or generator) color signal. The only way to "see" the burst signal spread out is with a triggered-sweep oscilloscope, which few shops own. Amplitude of this signal is affected to some degree by the Tint control setting, due to the loading effect reflected back through the windings of T1.

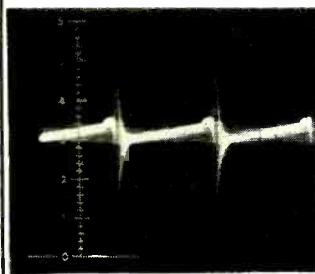
<b>V p-p low</b> R1 high R1 slt low R5 high R6 short C3 leaky C5 open	<b>V p-p high</b> R6 open	<b>V p-p zero</b> R1 low/short R3 open R4 open R5 open C2 open C6 short	 20V p-p R2 open	 70V p-p R2 low	 35V p-p R2 short	 25V p-p C1 open	
			 30V p-p C1 leaky	 15V p-p C1 short	 45V p-p R3 open	 150V p-p C2 short	
			 90V p-p C5 open	 300V p-p T1 sec top open	 150V p-p C6 short C7 open	 70V p-p Station signal missing	





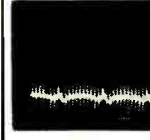
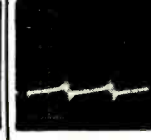





**WF4 Normal 55V p-p**

Taken past the output of burst transformer T1, after the coupling capacitor that feeds that portion of the signal to the phase detector (which controls the 3.58-MHz cw oscillator). Notice the upward slope of the baseline in the waveform. At the opposite end of the balanced resistor pair, the waveform is a flipped-over duplicate of this one, with downward-slanting baseline. The grounded transformer center-tap makes a phantom ground for the junction between the two balanced resistors. The values of C7 and C8 are critical here, and they must be matched.

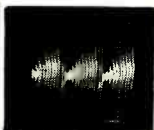
<b>V p-p low</b> R5 high R7 low	<b>V p-p high</b>	<b>V p-p zero</b> R4 open R5 open C6 short C7 open T1 sec top open T1 pri open	 7V p-p R2 open	 30V p-p R2 low	 15V p-p R2 short	 3V p-p C1 open	
---------------------------------------	-------------------	--	--	--	---	--	--

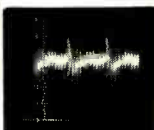
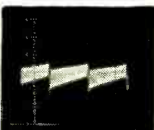



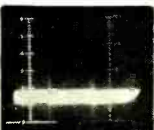

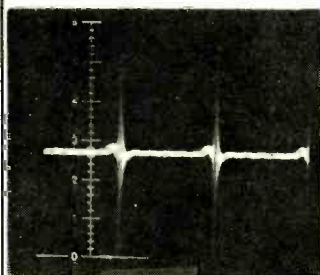





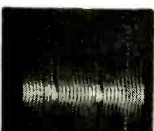

## WAVEFORMS AS GUIDES

			 18V p-p C1 leaky	 18V p-p C1 short	 20V p-p C1 v leaky	 15V p-p R3 open
			 50V p-p C2 short	 6V p-p C2 open	 70V p-p T1 sec gnd open	 25V p-p T1 sec bot open
			 12V p-p T1 sec top open	 45V p-p C6 short	 30V p-p C8 open R8 open R7 open	 30V p-p Station signal missing

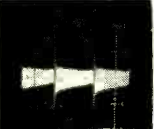

**WF5 Normal 55V p-p**

Taken directly from the bottom end of the burst-transformer secondary. The baseline is straight, not slanted as in WF4. Capacitor C7 is shaping the baseline of WF4; C8 has no effect on WF5. Tint control R6 affects the amplitude of WF5, the same as it does WF4 (and, to a small degree, WF3). Actually, most of the symptoms that show up in WF5 also show up in WF4. The chief departures from that rule concern faulty parts right around the secondary of burst transformer T1.

<b>V p-p low</b> R5 high R7 low	<b>V p-p high</b>	<b>V p-p zero</b> R4 open R5 open C6 short T1 pri open T1 sec bot open	 15V p-p R2 open	 45V p-p R2 low	 13V p-p R2 short	 3V p-p C1 open
			 17V p-p C1 leaky	 18V p-p C1 v leaky	 15V p-p R3 open	 60V p-p C2 short
			 25V p-p T1 sec gnd open	 60V p-p T1 sec to open C8 open R8 open R7 open	 17V p-p C1 short	 30V p-p Station signal missing

Use this guide and the Voltages Guide to help you pin down fault possibilities. With the low-capacitance probe of the scope, check the five key waveforms. The scope should be set at H or about 5 kHz, to show three cycles of waveform. Note amplitude. If it's low or high, check parts under those descriptions.

Note waveshape. If there's a change, check the parts indicated. NOTE: Only waveforms that help most with diagnosis are included in this guide (with the exception of WF1). NOTE: All waveforms in this guide are taken with a keyed-rainbow color-generator signal fed into the receiver at the front end.

# ... 1970 STEREO

## AMPLIFIER SECTION

MANUFACTURER	MODEL	OUTPUT PER CHANNEL IHF WATTS @ 8Ω	HARMONIC (IHF) %	DISTORTION INTER-MODULATION (IHF) %	SIGNAL-TO-NOISE LOW-LEVEL INPUT (dB down)	SENSITIVITY MAG. PHONO (mv in)
AUDIO DYNAMICS CORP.	ADC-1000	50	*	0.8	75	2
ALLIED RADIO CORP.	Allied 339	16	1	0.22	65	4
	Allied 369	30	1	2	70	3
	Allied 395	80	1	0.07	79	2.5
	Knight-Kit KG-988	40	1	0.28	40	2.5
BENJAMIN ELECTRONIC SOUND CORP.	1025A	16	0.8	*	80	(internally connected)
	1035	22.5	0.8	*	80	(internally connected)
	1045	30	0.8	*	80	(internally connected)
	1050A	50	0.8	*	85	(internally connected)
BOGEN COMMUNICATIONS DIV. LEAR SIEGLER, INC.	BR 320	25**	0.5	0.7	80	2.5
	BR 340	40**	0.5	0.7	83	3
	BR 360	50**	0.5	0.7	83	3
	DB 240	22.5**	0.5	0.8	80	2.5; 7
EICO	Cortina 3570	35**	0.8	2†	60	4.2
ELECTRO-VOICE, INC. DIV. GULTON INDUSTRIES	EV 1182	42	0.8†	*	-70; -65††	3
	EV 1282	92	0.8†	*	-70; -65††	3
	EV 1382	70	0.3†	*	-80; -65††	2
FISHER	250-T	40	0.5	1†	90	2.5, 7.5
HARMON-KARDON, INC. SUB. JERVIS CORP.	Nocturne 330	70	0.8	0.8	90	*
	Nocturne 820	110	0.5	0.5	90	*
HEATH CO.	AR-14	15	1	1 (60-6000 hz)	60 (phono)	4.5
	AR-15	75	0.5 at 50W	0.5 at 50W	60 (phono)	2.2
	AR-17	7	1	2 (60-6000 hz)	(45 phono)	5
	AR-27	7	1	2	(45 phono)	4
JVC NIVICO	5003 M	70		1†	70	1.5
KENWOOD	KR-77	28	<0.5	<0.5†	60	2
KLH RESEARCH & DEVELOPMENT	27	45	0.5	0.5	3μV	3.5 hi; 1.2 low
LAFAYETTE	LR-1000T	43	<1†	0.4†	*	2.2
McINTOSH	MAC-1700	40	<0.25†	<0.2†	75	2.4
MARANTZ CO., INC.	18	60	0.2 max.†	0.2 max.	74	1
	22	60	0.3†	0.3†	65	2
	25	45	0.3†	0.3†	52	2
	26	21	1†	1†	50	2
OLSON ELECTRONICS	RA 22	55	0.8†	*	57	3
	RA 90	15	<2	1	50	3
	RA 999	75	<1	1	55	3
PIONEER	SX-1500T	85	<1	0.5	65	2.5
RADIO SHACK DIV. TANDY CORP.	STA-35B	18	1	1	60	3
	STA-65B	36	1	1	60	4
	STA-120	70	0.5	0.5	65	2; 5 at 65 s/n
SANSUI ELECTRONICS CORP.	350	23	1	1	*	2.2
	2000	48	0.8	0.8	*	2.2
	4000	60	0.8	0.8	*	2.5
	5000	70	0.8	0.8	80	2.5
SCOTT, H. H.	342C	45**	<0.8	<0.3	65	3, 6
	386	67.5**	<0.8	<0.3	65	3, 6
	LR-88	40	<0.6	<0.3	65	4, 7
SHERWOOD ELECTRONIC LABORATORIES, INC.	SEL 200	140	0.2	0.3	90	1.5
	S7600a & S8600a	80	0.15	0.2	80	1.4
	S7800a & S8800a	120	0.35	0.6	65	1.6
SONY CORP. OF AMERICA	STR-6060	55	—	0.2†	100	2.3

\* = Not specified by mfr.; or not available. \*\* = At 4Ω. † = At or below rated power. †† = Auxiliary input. ‡ = Steep quiting slope.



# RECEIVER ROUNDUP

## FM TUNER SECTION

CHANNEL SEPARATION (dB)	BASS & TREBLE CONTROLS	LOUDNESS CONTROL	PAIRS OF INPUTS	SENSITIVITY (IHF) ( $\mu$ V)	SELECTIVITY (IHF) (dB)	SEPARATION (dB)	CAPTURE RATIO (dB)	SIGNAL-TO-NOISE RATIO (dB)	PRICE
35	ganged	*	*	2.0	*	35	3	*	\$289.50
25	ganged	control	4	2.5	20	25 at 1 KHz	7	56	149.95
35 at 10 KHz	separate	switch	5	2	35		2	56	189.95
45	separate	switch	7	1.6	*		2	69	299.95
45	separate	switch	5	3	28		3.5	45	179.95
*	separate	separate switch	1	3	*	27	*	65	299.50
*	separate	separate switch	*	3	*	28	*	65	349.50
*	separate	separate switch	1	3	*	28	*	65	449.50
*	separate	separate switch	2	2.7	*	30	*	70	599.50
40	ganged	switch	3	2.7	60	35	1.9	70 at 30 $\mu$ V	249.95
40	ganged	switch	3	2.7	60	35	1.9	70 at 30 $\mu$ V	279.95
40	ganged	switch	3	2.7	60	35	1.9	70 at 30 $\mu$ V	339.95
40	ganged	switch	1	2.5	55	35	2.5	65	*
50	ganged	switch	4	2.4	45	40	4.5	60	259.95
40	ganged	"built in"	3	2.5	*	35	2	*	222
40	ganged	switch	3	2	*	35	2	*	266
60	separate	switch	5	2.5	*	30	*	*	*
*	ganged	switch	*	2	45	38	2.8	65	299.95
*	ganged	switch	6	2.7	*	30	2	*	199.95
*	ganged	switch	8	1.8	*	32	1.5	*	299.95
45	ganged	(none)	2	5	*	30	3	50	114.95K
45	ganged	switch	5	1.8	70	40 at mid freq.	1.5	65	339.95K
40	ganged	(none)	2	5	*	30 at 1 KHz	3	50	69.95K
*	*	(none)	2	5	*	*	3	50	39.95K
*	ganged(a)	switch	4	1.8	*	35 at 1 KHz	2	60	349.95
	separate	switch	4	1.9	45	35 at 1 KHz	2.5	60	239.95
*	ganged	switch	3 (+ tape)	1.9	3.5	35 at 1 KHz	3	55	319.95
*	separate	switch	8	1.6	*	45 at mid. freq.	1.5	71	239.95
*	separate	switch	5	<2.5(b)		>30	>2	>65	599
50	separate	(none)	6	‡	50	45 at 1 KHz	2.5	70 at 50 $\mu$ V	695.00
47	separate	switch	7	2.4‡	80	40	2.5	65	425.00
42	ganged	switch	4	2.8	40	35	3	52	329.00
35	ganged	switch	4	3	*	30	3	57	199.00
50	ganged	switch	6	1.5	*	>30	2.8	55	200.00
42	ganged	"compensated"	2	3	*	>28	4.5	48	100.00
50	ganged	switch	4	1.5	*	>30	2	65	*
*	ganged	separate	*	1.7	*	37	1	65	360
*	ganged	(none)	2	3	35	25 at 1 KHz	8.5	45	119.95
*	ganged	switch	3	2.5	35	30	4	65	189.95
*	ganged	switch	3	2	50	35	1.5	65	269.95
40	ganged	switch	6	3	45	30	3	50	199.95
<50	separate	switch	10	1.8	50	35	2.5	65	299.95
<50	ganged	switch	12	1.8	40	35	1	60	379.95
<50	ganged	switch	11	1.8	50	35	1.5	65	449.95
50	ganged	switch	4	1.9	40	40	2.5	65	269.95
50	ganged	switch	4	1.9	40	40	2.5	65	349.95
50	ganged	switch	4	1.9	46	40	2.2	65	299.95
55	ganged	control	4	1.5	70	45	1.7	70	599
40	ganged	switch	2	1.8	55	40 at 1 KHz	2	70	359,319
55	ganged	switch	3	1.8	55	40	2	70	439,399
*	ganged	—	—	1.8	—	40	1.5	—	399.50

a = 5-band freq. control. b = 100% mod.

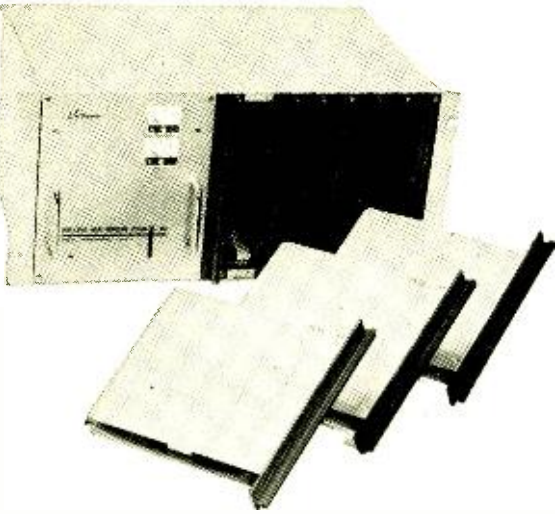

Rack-mounted A301 uses 4 plug-in PC cards for bands in identical stereo channels.

# THE DOLBY

## Taking the hiss from

*Rapidly gaining acceptance by major recording companies, through 10 dB. Although you need a 'black box' to hear a*

by **WALTER G. SALM**

THERE'S AN EVER-PRESENT ANNOYANCE with tape recordings. It's called tape noise. It takes various forms, with hiss being the most readily apparent to the listener. The other noises are tape recorder rumble and scrape, and that ever-present gremlin, print-through.

These noises occur at the tape recorder as the recording is being made—or in the case of print-through, after the tape is made. The noise isn't present in the signal coming to the tape equipment from the mixing console; up to that point, the signal's nice and clean.

Various methods have been tried to eliminate noise, hiss in particular—exotic filtering systems, compression or expansion amplifiers, and a variety of related devices. Manufacturers frequently announce a "totally new" noise-reduction system. Most of these systems work up to a point, but many inject "swishing" noises into the recording because of the compressor amplifier's relatively slow attack time. It can't react fast enough to the rapidly changing audio dynamics of the input.

### Low-passage noise

Where are these tape noises most noticeable? You don't need a cram course in audio to know—it's always in the low-level music passages. In the loud sections of a recording, there are plenty of desirable decibels to mask any intruding noise, but hit that *pianissimo* section and suddenly the hiss comes storming through, along

with print, scrape and rumble. If the intrusive noise could be drastically reduced in these low passages, so the reasoning goes, then the overall noise level would be reduced.

Working on this premise, Dr. Ray Dolby developed his A301 noise-reduction system, and started manufacturing it in England a couple of years ago. This system is inserted in the signal path between the console and the tape equipment during the taping session. During playback, the tape's signal must pass through the A301 again on its way to the amplifier. A Dolbyized tape cannot be played back without the benefit of reprocessing by the A301.

The A301 itself is actually a dual unit—two systems for two-channel stereo. The same stereo unit that's used for recording can be used for playback, simply by changing the connectors and flipping switches. The basic A301 is tagged at \$1495, so it's not a toy that the casual home recording enthusiast can buy for his amusement. Tape-to-tape dubs do not require further Dolbyized (as long as tape-to-tape equalization remains the same).

The overall effect is to reduce hiss and other noise factors by 10 to 15 dB! A listening test demonstrates its effectiveness graphically. A-B comparison with and without the A301 in the system makes one thing immediately apparent—with the Dolby, there's absolutely no discernible hiss, not one little bit of it.

As a starting point, the Dolby system divides the audio spectrum

into four frequency bands: 0–80 Hz, 80–3000 Hz, 3–9 kHz and 9 kHz to the upper limit of the audio spectrum. Crossover transitions between these bands are exceptionally smooth, with no measurable discontinuities or attenuation.

In the process of making a recording, low-level signals are boosted before reaching the tape recorder and compressed by an identical amount in playback. The expansion/compression moves the low-level signal up at least 10 dB. This 10-dB edge over intrusive noise is maintained during expansion. The net result is that noise level is at least 10 dB lower than without the Dolby process.

In his description to the Audio Engineering Society in 1967, Dolby characterized the basic elements of his black box as shown in Fig. 1.  $G_1$  and  $G_2$  are identical signal multipliers controlled by the signal's amplitude, frequency and dynamic properties. During recording, network  $G_1$  passes low-level signals to the adder, which adds a component (signal expansion) to the signal on its way to the recorder. During playback,  $G_2$  passes low-level components to the subtractor, which partially cancels these noise elements in the signal.  $G_2$  also partially cancels low-level (desirable) signal components, thus offsetting (compressing) the signal that had been partially expanded through  $G_1$ 's action.

Mathematically, Dolby explains that if the input to the recording processor is  $x$  (some function of time), the signal in the channel is  $y$ , and



# SYSTEM— How It Works

## hi-fi tape recording

*the Dolby system cuts tape hiss 10–15 dB and reduces print-Dolbyized tape, prerecorded tapes are sounding better than ever.*



A tape deck using one Dolby frequency band to cut tape hiss is manufactured by KLH.

the output signal from the reproducing processor is  $z$ , the condition is described as:

$$y = [1 + G_1(x)]x \quad (1)$$

and

$$z = y - zG_2(z) \text{ or}$$

$$z = \{ 1/[1 + G_2(z)] \} y \quad (2)$$

Combining equations (1) and (2):

$$z = \{ [1 + G_1(x)]/[1 + G_2(z)] \} x. \quad (3)$$

Solving these equations,  $G_1 = G_2$  and  $z = x$ . These solutions show that the output signal will equal the input signal if  $G_1$  and  $G_2$  are the same, provided  $G(z)$  does not become  $-1$  (no oscillation) and the functions in (1) and (2) are continuous and single-valued—in other words, no tracking ambiguity.

It looks fine on paper, and the proof of the math is in the listening: it works. In fact, it works so well that, in A-B tests, the listener can't help but wonder if someone hasn't jacked up the hiss level in the unprocessed tape—the difference is that marked and apparent. But no, there's been no monkeying with the tape—just the normal amount of dubbing and processing.

### Recording companies Dolbyize

First to recognize the value of this new system have been the major recording companies. Since every recording—tape and disc—must first go through several generations of tape dubs, eliminating the noise that creeps into these transfers and mixes makes

the final, non-Dolbyized product that much cleaner.

True, the prerecorded tape purchased by the consumer has its own hiss and other noises, but *all the preceding noise* in the production chain has been eliminated. Thus, instead of a noise level as high as 10 to 14 dB, the finished product may have a noise level of only 3 dB—a more-than-tolerable level. Tapes commercially produced this way sound so good, in fact, that duplicators such as Ampex have started touting their remarkably noise-free quality. Although discs have had very low noise levels for some years, those pressed from Dolbyized master tapes sound notably quieter and cleaner.

But it's no simple matter for a recording company to Dolbyize. First, there's the very limited production of A301's. Ray Dolby has a baker's dozen technicians in his London shop lovingly hand-crafting his A301's with a Rolls-Royce kind of zeal and perfectionism. Total production capacity now is about 25 units per month, and a large recording company may require at least that many units to handle its manifold operations.

Dolby won't be hurried. He's a perfectionist, and he sees this perfectionism as part of his stock in trade. A brilliant designer, he was largely responsible for the development of the electronic circuitry for the original Ampex video tape recorders while he was still a teenage undergraduate at Stanford University. He received a PhD in physics from Cambridge in 1961.

### Dolby at popular prices

The price picture isn't all that gloomy. There's one way the home recording enthusiast can get his feet wet with the Dolby system. It's called the KLH recorder. This is KLH's first entry in the tape field, and it's a lulu. In addition to a host of professional-caliber specs, the deck has a built-in Dolby system—and all for \$600. [A recently introduced KLH Dolby tape deck sells for less than half this price.]

Actually, it's not a full-blown Dolby. The machine just uses the third frequency band since this is where most hiss occurs. The KLH Dolby produces tapes recorded at  $3\frac{3}{4}$  ips with no higher noise level than

(continued on page 58)

Fig. 1—System's feed-back loops provide necessary expansion and compression to override background noise.

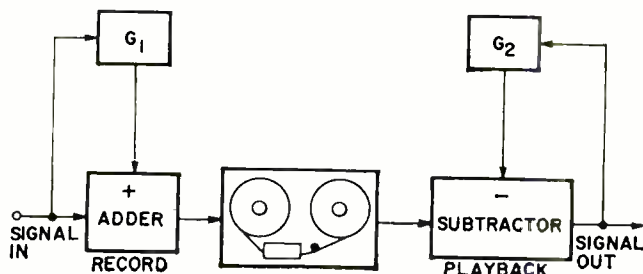

**“He’s a good worker.  
I’d promote him  
right now if he had  
more education  
in electronics.”**



## **Could they be talking about you?**

You'll miss a lot of opportunities if you try to get along in the electronics industry without an advanced education. Many doors will be closed to you, and no amount of hard work will open them.

But you can build a rewarding career if you supplement your experience with specialized knowledge of one of the key areas of electronics. As a specialist, you will enjoy security, excellent pay, and the kind of future you want for yourself and your family.

Going back to school isn't easy for a man with a

full-time job and family obligations. But CREI Home Study Programs make it possible for you to get the additional education you need without attending classes. You study at home, at your own pace, on your own schedule. You study with the assurance that what you learn can be applied to the job immediately.

CREI Programs cover all important areas of electronics including communications, radar and sonar, even missile and spacecraft guidance. You're sure to find a program that fits your career objectives.





**NEW!**  
 Expanded coverage of solid state electronics including integrated circuits!

You're eligible for a CREI Program if you work in electronics and have a high school education. Our FREE book gives complete information. Mail postpaid card for your copy. If card is detached, use coupon at right or write: CREI, Dept.1410-H, 3224 16th St., N.W., Washington, D.C. 20010.



**CREI, Home Study Division  
 McGraw-Hill Book Company  
 Dept.1410H, 3224 Sixteenth Street, N.W.  
 Washington, D.C. 20010**

Please send me FREE book describing CREI Programs. I am employed in electronics and have a high school education

NAME \_\_\_\_\_ AGE \_\_\_\_\_

ADDRESS \_\_\_\_\_

CITY \_\_\_\_\_ STATE \_\_\_\_\_ ZIP CODE \_\_\_\_\_

EMPLOYED BY \_\_\_\_\_

TYPE OF PRESENT WORK \_\_\_\_\_  G.I. BILL

- I am interested in
- Electronic Engineering Technology  Computers
  - Space Electronics  Nuclear Engineering Technology
  - NEW!** Digital Communications
  - NEW!** Industrial Automation

**APPROVED FOR TRAINING UNDER NEW G.I. BILL**

tapes recorded at 15 ips without Dolby treatment.

The KLH Dolby does a dandy job of killing hiss, and could be a very worthwhile investment for the serious recording hobbyist who wants to maintain the best possible quality in his home recordings. But what happens when he wants to dub and maintain noise free tapes? Buy two KLH recorders? This might be what the Cambridge whiz-kids had in mind, especially since they have an exclusive license to use the Dolby circuit for manufacturing in the US.

#### The system's noncompatibility

The Dolby system isn't a panacea. It can't clean up already recorded tapes. Its function is to process the sound going onto the tape, and then to reprocess it as it leaves the tape. It just won't clean up noise already indelibly etched in those oxide particles.

Another problem: in today's ever-expanding tape channel capabilities, the A301's price and relative unavailability makes it impossible to use with the 8- and 16-channel audio mastering that is becoming more and more popular. This might involve having as many as 16 units in a single re-

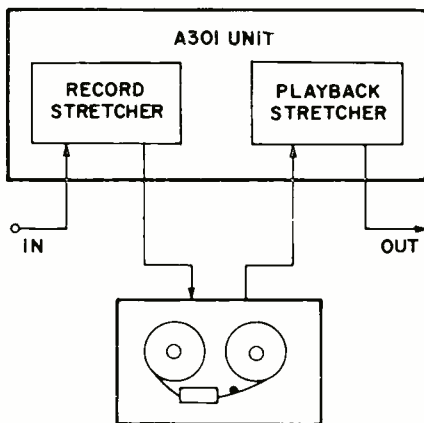

Identical A301 halves can serve for stereo or a record-playback monitor.

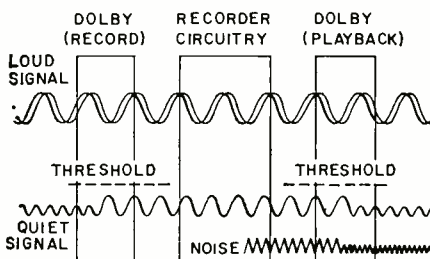

A301 boosts low-level audio before recording, compressing it in playback.

recording studio control room for making just one master tape. Fortunately,

such multitrack originals are mostly used for "Acid" rock and other popular sounds which don't make very critical demands so far as recorded noise levels are concerned. It's in the realm of the serious recording—which is usually taped in old-fashioned, two-channel stereo—that the Dolby system can really come into its own.

Another problematical restriction: Dolbyized tapes simply can't be played back on an ordinary tape system. The A301 must be in there to expand in the right places. Without it, the dynamics and recorded sound in general will come out sounding pretty weird. But in this era of electronic music and all of its strangeness to our more conventional ears, this may well open the door to a new avenue of experimentation with electronically generated musical effects. The engineer (or musician?) may play with a console that controls the amount of Dolby expansion to be imposed on a Dolbyized tape master.

And what about that A301? It's just a black box with some connectors on it. No knobs to twiddle; no meters to watch; no circuit failures to keep the service techs out of mischief. It's downright maddening! No knobs; really, Dr. Dolby! **R-E**

## HIGH-VOLTAGE PROTECTION FOR TRANSISTORS

When operating a transistor with a high-value collector load resistor, a power supply of 100 volts or more may be needed. This is OK as long as sufficient collector current flows to keep the collector-to-emitter voltage below the maximum rating.

The schematic shows a method of preventing this catastrophe. The bleeder current through R1 and R2 should be about ten times the normal collector current through the load resistor, R<sub>L</sub>. The voltage between point "B" and the positive terminal of the power supply must be below the tran-

sistor's maximum collector-voltage rating. The transistor's base bias may

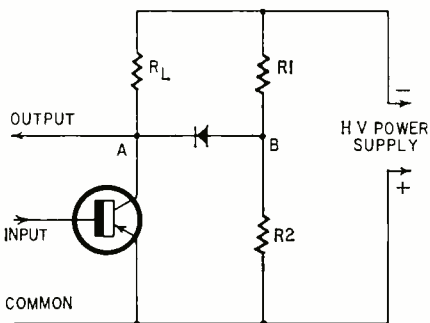

then be set to make the collector-to-emitter voltage about one-half this value. Under this condition, the diode is back-biased, and its resistance is so high as to have little effect on circuit operation. Should the transistor's base current go too far positive, the collector voltage rises until voltage at point "A" is equal to the voltage at point "B" (plus the diode's forward voltage drop). The diode conducts, the voltage at point "A" goes no higher. The transistor is protected. Reverse diode and power supply polarities for rpn transistors.—Frank H. Tooker **R-E**

## TOOLS FOR ELECTRONICS

This issue, starting on the facing page, is the second part of our new series of articles on tools for electronics. It winds up our description of pliers and cutters. Next month we will continue the series with the first part of an article on screwdrivers and how to use them. We believe you will find all of this material a handy, practical addition to your R-E Reference Manual.

If you wish you can purchase a special hardcover binder to keep your Reference Manual pages together. It has a dark blue fabric cover and is gold stamped Radio-Electronics Reference Manual. The cost is \$1.00, postpaid. Order from N. Estrada, 17 Slate Lane, South Hauppauge, N. Y.



## Specialized pliers

Surgeons use **hemostats** to clamp veins and arteries during an operation. Someone recognized the usefulness of such a tool, and developed the electronic version called **clamping pliers**, shown in Fig. 15.



Fig. 15—Hemostats can and are used outside of the operating room. Try these clamping pliers as a handy third hand. The Jonard model M-100-S is shown.

They have finger loops at the handle ends and very small, thin, serrated, needle-nose jaws. Their chief feature is a locking ratchet between the handles, which locks the jaws closed. To operate them, you simply grasp the work in the jaws, squeeze the handles until they lock, and let go. The jaws are then locked on the work. To unlock them, you squeeze and pull the handles slightly sideways. One of the most useful tasks for clamping pliers is as a heat sink when soldering semiconductor diodes, transistors, and small resistors. You can lock the pliers in place on the component lead, freeing both hands for the soldering gun (or iron) and solder. Clamping pliers are usually made in 5" or 6" sizes. Some models are available with bent jaws, for angle work. These pliers have almost no compressive or bending strength, and should be used only for picking up, holding, or clamping the work.

A somewhat similar device is shown in Fig. 16. This unit is actually an aluminum clamping pliers with a coiled spring between the handles

Fig. 16—Channellock's Heatsorb Clamp is another approach. This aluminum unit is ideal for heat-sinking transistor leads while soldering them into a circuit.



which provides the clamping action.

There are a number of very specialized pliers which are nearly unique, having been developed for specific jobs. One is shown here; a



Fig. 17—Bent-nose duckbill pliers is especially suited for relay adjustments. It can also be used on other industrial and communications gear. Jonard PLS-9 is shown.

Another specialized plier is illustrated in Fig. 20. It is very



Fig. 20—The Lock-Griplier by X-Acto is very useful for picking up and holding small parts. As it can be locked to clamp a part in place it too acts as that extra "third hand" when you need one most.

useful for picking up and positioning small parts, and it can be locked to clamp the work and free both hands. Notches in the jaws permit wire stripping.

Of course, there are still other specialized plier features. You can get extra-long handles, tapered jaws, and various combinations of features. What we've covered here are the most common features used in servicing and hobby electronics.

## Cutting pliers

Much like ordinary pliers, **cutting pliers** have handles, a joint, and jaws. They differ in that the jaws are shaped to sharp edges, and are used solely for cutting. The most common type is called **diagonal cutters**, or **dikes**, as the cutting edges form a diagonal from the plane of the handles (Fig. 21). As mentioned before, side cutters are straight



Fig. 21—Diagonal cutters are probably the most common type of cutting pliers and should be used only as cutters. At the left is the Vigor PL-506. At the right is the Allied Radio 26F-2906, which has insulated handles.

with respect to the handles, and are an accessory to standard pliers. Both types are different from scissors or shears, as the cutting edges meet and stop, instead of passing one another. Also, it is not necessary for the edges to be as sharp as those of scissors, as the cutting is accomplished more by sheer pressure than by fine edges.

Job application has a great deal to do with cutter size. Three general sizes are available to cope with various jobs: A small pair (4" long)

bent-nose duckbill plier, which is useful when adjusting relays, stepping switches, and other industrial and communications equipment (Fig. 17).

Installing and replacing flat-pack IC's can be troublesome—unless you have the right tool. Special pliers for pulling IC's are the only right tool (Fig. 18). Teeth extend from its blunt-nose jaws, slip in between the



*Fig. 18—Getting IC's in and out of sockets can be difficult. But if you use the right tool it's no trouble at all. Techni-Tools' IC Flat-Pack Plier is specially designed to pull IC's without damaging their sensitive pins or placing undue strain on the IC itself.*

leads of the IC and grasp the body securely.

A useful, multipurpose tool is the unusual wrench in Fig. 19.

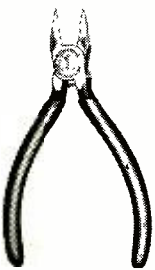

*Fig. 19—Plierench is a combination of a pliers and wrench in a convenient hand-held unit. A group of interchangeable jaws complete this Vaco tool.*

The jaws remain parallel in all positions, so you can use the tool on nuts and bolt heads. There's a half-round indent in each jaw, enabling you to grip round or hex objects. The jaws are smooth and won't mark the work. Compression is multiplied at the fulcrum and the jaws have great gripping power. Accessory jaws are available which extend this tool's usefulness—a medium-sized pipe-wrench jaw, a large pipe-wrench jaw, and an internal-external jaw which can grip the inside or outside of a pipe or metal tube.

is useful for printed-circuit and transistor work, where you find fine wire and tight quarters. Most technicians have medium-sized dikes (5" or 6" long); these are general-purpose types, and obviously the most useful for most standard-size chassis work. Large cutters (7" or 8" long) are also made; they can handle heavy bus bar, or even be used to cut a piece of a thin metal chassis. Of course, the smaller models are most useful in small work, and their strength is limited; the larger tools have strength for large jobs, but can't be used in restricted spaces. It's poor workmanship to cut work too large for the cutters, as you'll nick or dull the cutter edges. You cannot file or dress the cutting edges very much, as they'll be worn to the point of handle contact, which is the limiting factor.

Small and medium cutters should only be used for snipping soft copper wire, up to and including about No. 18. For heavier wire, such as No. 14 and No. 12 power lines and antenna wire, use large cutters or side-cutting lineman's pliers. For hard steel or nickel wire, use high-hardness cutters (Fig. 22). These types have carbide cutting edges.



*Fig. 22—High-hardness cutters are a must for trimming wire made of hard steel or nickel. Standard cutter edges cannot handle these materials. The Klein model 230D shown here has special carbide cutting edges to take care of this job.*

There are several variations on the cutters described so far. Dikes and side cutters are parallel cutters—the edges cut all the way up and down the jaw at the same time. A variation is called **tip or nose cutters**,



*Fig. 23—Tip or nose cutters have cutting edges only at the top end of the tip. You'll find them most useful where you want to clip a wire located deep down in a cluttered chassis. The unit shown is a Boker Model 539-6. The insulation on the handles gives the user a firmer as well as a safer grip.*



which bite only near the jaw tips (Fig. 23). These pliers are useful for snipping wire in crowded spaces.

Cutter edges are made in many styles. Regular edges are bevelled, and are used for most jobs, including hard wire. They leave a point on the wire end. **Semi-flush edges** leave a small point. **Full-flush edges** may be used only on soft wire; they leave no points on the wire, clipping instead straight across.

There are also variations in the shape of cutter jaws. Standard diagonals have rounded jaws, as you've seen so far. For fine work in confined spaces, the shape shown in Fig. 24 is used; it's called variously



*Fig. 24—Diagonal cutters come with a variety of jaw shapes. Standard units have rounded jaws, but needlepoint, thin-nose and tapered-nose tips for special applications are also available. Three kinds of pliers with various jaw types are available. At the left is the Xcelite 74CG a needle nose type. The Klein D257-4 in the middle has semi-flush cutter jaws as does the Hunter 97-B at the right.*

**needle point, pointed nose, thin nose, and tapered nose.**

If you use a conventional pair of dikes to snip off a wire end, it can flip into your eye or face, or fall into a chassis. To overcome this disadvantage, two methods of wire retention have been developed.

Some cutting pliers have **plastic inserts** in the jaws (Fig. 25).



*Fig. 25—Plastic inserts for the plier jaws grip the end of the wire you just cut, preventing the loose ends from shooting off and possibly injuring some other persons nearby. The inserts release the wire when the jaws are opened.*

When you clip off the end of a wire, the plastic grips the end. Other cutters have steel springs between the jaws, which do the same job



*Fig. 29—Heavy-duty end nippers have wide blunt jaws and are set up so the cutting edges are near the joint to provide great cutting power. At the left is the Klein model 232-8. The Jonard 992-8 is on the right.*

are near the joint, which provides for great cutting strength. Some of these cutters have angled cutting edges.

Another useful variation found on some cutters is the wire-stripping

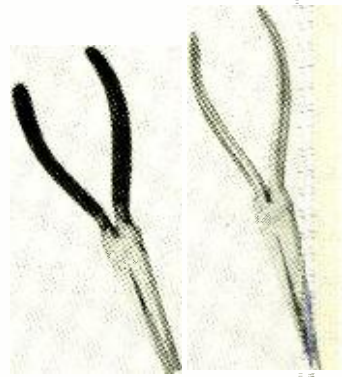

*Fig. 30—Wire-stripping cutters can be identified by the notch in their cutting blades. Two units are shown here. The Klein D240-6 (left) and Crescent 932-6 (right).*

hole (or notch) shown in Fig. 30. With the hole, you can strip insulation; with the rest of the jaw edges, you can cut wire.

### General notes on pliers

**Plastic handle grips** (Fig. 31) are available on nearly all pliers and cutters; some manufacturers furnish the grips installed, while others have them available as accessories. Grips are advantageous for two reasons: First, they make the tool more comfortable and easier to use, which reduces fatigue and increases efficiency. It is possible to get a more secure grip on plastic than on steel, thus minimizing the danger



*Fig. 31—Plastic grips are a plus in almost all cases. However, don't assume that the handles are insulated merely because you see plastic grips. Not all grips provide the same level of electrical protection. Most reliable manufacturers use grips that are excellent electrical insulators. But check to make sure before you poke around in voltage carrying circuits.*

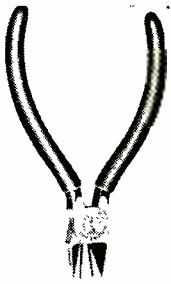

*Fig. 26—Steel springs between the jaws of the cutting pliers can also hold the loose end of a wire being cut. When you release the handle the springs let the wire go. Tool shown is the Klein model D2229.*

(Fig. 26). In each case, when you open the handles, the wire end is released.

Ordinary cutting pliers produce a slight shock when the cutting edges meet. This shock can damage certain miniature diodes, transistors, and IC's. To prevent such shock, **shear-type cutters** have been



*Fig. 27—Shear type cutters, like the Klein model D-207-SC, shown here, are specially built to reduce the cutting shock that can damage supersensitive miniature diodes, transistor and integrated circuits.*

developed. As shown in Fig. 27, the cutting edges pass one another, like scissors.

The cutters you've seen so far work in the plane of the handles, or slightly offset from it. **Transverse cutters** work at right angles to the handle plane. There are two types: **Long-nose end nippers** are simply long-nose pliers with transverse cutter edges at the tips (Fig. 28). Such



*Fig. 28—Transverse cutters have their cutting edges at the tips of the tool. While excellent for getting into tight corners such cutters have little cutting strength. The unit shown here is a Utica model 15165. Its handles are not insulated.*

a tool is practically indispensable for printed-circuit work, as it can be maneuvered down into a cluster of parts to nip a component lead coming straight out of the board. These nippers don't have much cutting strength since the cutting edges are at the jaw ends.

Where more cutting strength is required, **heavy-duty end nippers** are used (Fig. 29). The jaws are wide and blunt, and the cutting edges

of slipping and injuring your hand. Second, the grips are insulators, and this lets you work on hot circuits. It's usually better to purchase pliers with the grips factory installed, since the accessory types never seem to stay on the handles as securely. One point to watch out for. Plastic-covered handles don't automatically mean electrical insulation. Check first, and make sure they are really insulated before you use them in hot circuits.

Before you buy pliers, try to get your hands on them. Pick up the pliers by one handle; the other should fall freely. If it doesn't, the bolt may be binding. Work the handles back and forth a few times and see if the joint loosens up. If the joint binds, you'll waste time and effort using the pliers, since you'll have to force the handles open.

Good pliers and cutters are made of high-quality tool steel (or similar alloys) and they are usually drop forged. Since they are used to contact metal, they must maintain their shape and edges, not to mention temper. Steel tools rust, of course, and to prevent this you should go over your pliers with an oily rag now and then. If you find any rust, work it off with sandpaper, emery cloth, or a wire brush. Keep any serrations or milled surfaces free of debris by wire brushing them.

You can buy many pliers with chrome or nickel plating, which does not rust.

#### **A few other tips**

Don't destroy jaw alignment or ruin cutting edges by hammering with a plier. It is safer and cheaper to use a hammer. Never use a plier to cut a hot wire; the resultant hole in the cutting edge can't be removed. Use the right size gripping plier; if you can't grip the material and keep the plier jaws parallel, then the plier is too small for the job.

Don't use a needle-nose plier to grip objects of larger diameter than the point of one of the jaws. Don't use pliers to do a pipe-wrench job. And don't rock a diagonal cutter sideways to do a tough job; you may break the jaws. Use a large cutter. (to be continued)



# TECH TOPICS

by **ROBERT F. SCOTT**  
SENIOR TECHNICAL EDITOR

An active filter, transistor Vackar, unusual detector and a different wind direction indicator

It looks like *Technical Topics* got off to a good start in June. We told you that your comments and criticism would be welcome. Well, we got some feedback from John M. Mealing, Jr. on the heterodyne filter (Fig. 3, page 47). He writes, "I fear there was a slight drafting error. The output shown will not produce a bandpass characteristic. A corrected copy of the drawing is included. Also included are several Twin-T bandpass filters and their characteristics."

Mr. Mealing's "corrected" diagram showed the output taken from the plate (left) end of the Twin-T. A check of the original reference material showed the circuit in Fig. 3 to be correct so photocopies of the original report were forwarded to Mr. Mealing.

Being rushed to get out material for this issue, I didn't attempt a circuit analysis. However, at a glance, I see the right-hand half of the 12AU7, not as a feedback amplifier, but as a Q multiplier to increase the Q of the Twin-T to sharpen its response curve so there is a minimum attenuation of frequencies closely adjacent to the whistle frequency.

Note that Mr. Mealing says that the output connection shown will not produce a *bandpass* characteristic. Well, the circuit is not supposed to have a bandpass characteristic. I probably misled him with the statement "An audio filter can be used . . . if it is tunable with a very narrow *passband* and high attenuation at the interference frequency."

In casual conversation, I, and many others, often use *bandpass* and *passband* synonymously. However, when I write *passband*, I am referring to the response of a circuit to a band of frequencies in which the attenuation (or gain) is less than (or greater than) a specified value. On the other hand, a *bandpass* circuit or filter is one that passes a single band of frequencies. The lowest frequency is above zero and the highest is below infinity.

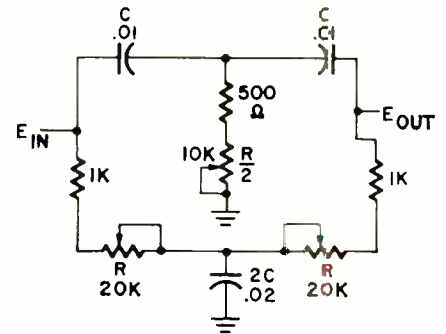

Fig. 1—Twin-T notch filter connected into a feedback loop becomes a pass-band. Filter reduces amount of feedback.

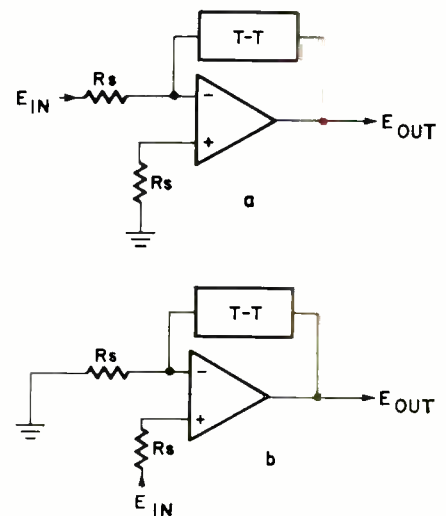

Fig. 2—Operational amplifier configurations with a bandwidth of about 100 Hz. CW transmissions require 400 Hz.

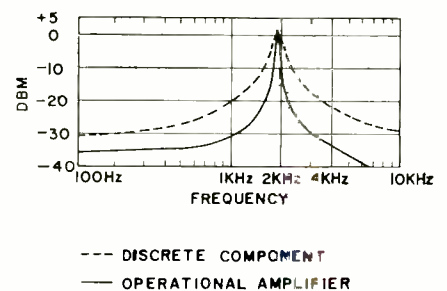

Fig. 4—Comparison of filter responses for discrete and operational amplifier circuits. Note sharp op-amp falloff.

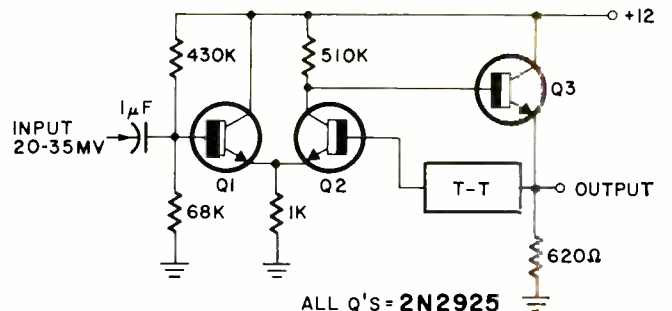
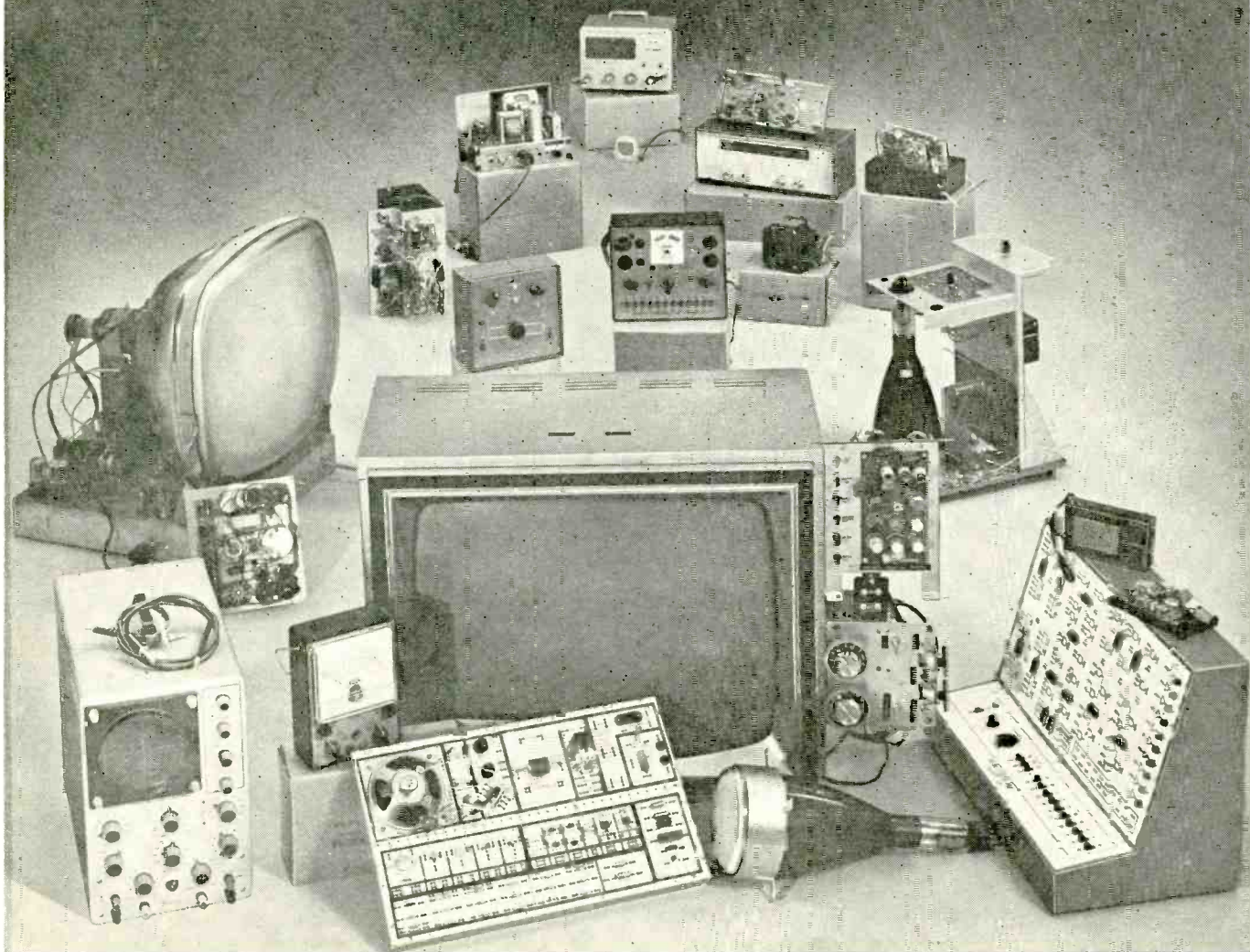

Fig. 3—Active filter with 30 dB power gain. Q3 serves as an impedance-matching emitter follower on the coupled pair.

**We pack your electronics course with kits to make your training fast. You'll enjoy every minute of it.**



## **Your NTS success package**

Choose a career in electronics: Computers. Color TV Servicing. Automation. Communications. Whatever the field, NTS has a complete home-study package to get you to the top *faster*. 10 thorough training courses. Each includes *everything* to give you the *working* knowledge required of successful technicians.

NTS Project-Method Training is the practical way to learn elec-

tronics. It's a proven combination of lessons and the best professional kit equipment available. NTS provides the *biggest selection of kits ever offered in home-study . . . all at no extra cost*. You'll construct these exciting kits to fully understand electronic circuits, components, and concepts. Our Project-Method lets you build skills by putting theory into practice . . . by working with your hands, as well as your head.

The NTS "learn and practice" approach makes training at home really easy. All it takes is a few hours a week . . . whether you're starting from scratch or in advanced courses. This is the all-inclusive success package that put thousands of men into the best paying jobs . . . or into their own business. If "just a living" isn't good enough for you, now is the time to get something better going for you!



## NTS COMPUTER ELECTRONICS

This is the future. And it's happening now. The number of computers will *increase many times* in the next few years.

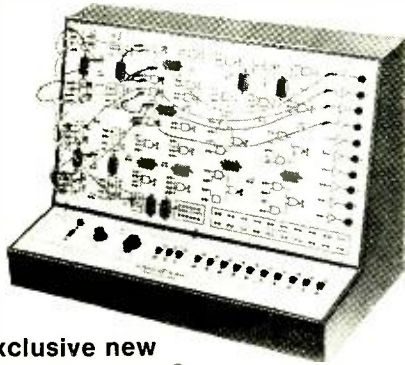

### Exclusive new Compu-Trainer®

NTS offers a solid grounding in computer operation, wiring, data processing and programming. One of the 10 important kits included is our exclusive Compu-Trainer®. It's a fully operational computer logic trainer — loaded with integrated circuits — the first ever offered in home study. It introduces you quickly to how, what, when and why of computers . . . from theory to practical servicing techniques. This unit is capable of performing 50,000 operations per second. And it's sent at no extra cost.

## NTS COLOR TV SERVICING

This is a broad, easily understood

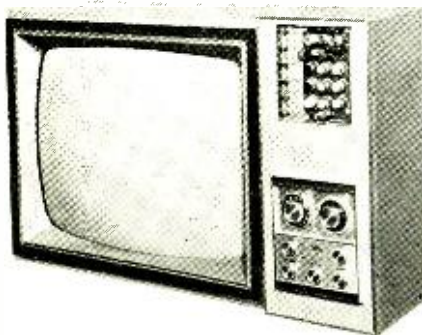

### COLOR TV 295 SQ. IN. PICTURE

program designed to make you a complete home-entertainment service technician. Included, at no extra cost, is a color TV that has more features than any

set on the market. You also learn all about stereo, hi-fi, multiplex systems, and become a specialist in Color TV Servicing. Kits also include AM-SW radio, solid-state radio, field-effect transistor volt-ohmmeter, electronic tube tester.

## NTS AUTOMATION/ INDUSTRIAL ELECTRONICS

You're trained in the "push-button" electronics that keep industry going and growing . . . from relay type controls to highly advanced systems essential to production. You receive 16 kits including a 5" wide band oscilloscope, and the new NTS electronics lab: a fascinating NTS exclusive experimental laboratory. A complete workshop which makes you familiar with solid-state, miniature, and integrated circuits.

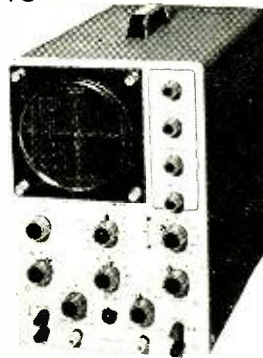

5"  
Oscilloscope

## NTS ELECTRONIC COMMUNICATIONS

The use of 2-way radio systems in private and commercial applications is skyrocketing. NTS prepares you for the big-money opportunities in the field of transmitting and receiving equipment. *Your tuition will be refunded in full if you cannot pass the FCC exam for a 1st Class Commercial Radio-Telephone License within*

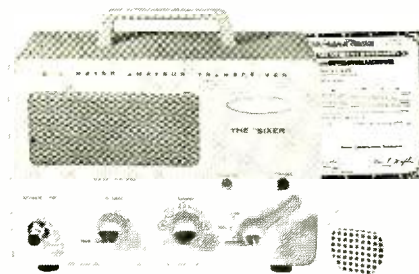

5 Watt AM Transmitter & Receiver

*six months after successfully completing this course. You build valuable kits including Amateur-Phone 6 Meter VHF Transceiver, solid-state Radio, and a field-effect transistor volt-ohmmeter.*

## CLASSROOM TRAINING AT LOS ANGELES

You can take classroom training at Los Angeles in sunny Southern California. NTS occupies a city block with over a million collars in facilities devoted exclusively to technical training. Check box in coupon.

## NATIONAL TECHNICAL SCHOOLS

World-Wide Training Since 1905

4000 South Figueroa Street  
Los Angeles, Calif. 90037, U.S.A.

## APPROVED FOR VETERANS

Accredited Member: National Association of Trade and Technical Schools, National Home Study Council.

**TODAY, MAIL  
COUPON  
FOR FREE  
COLOR  
CATALOG  
AND SAMPLE  
LESSON.**

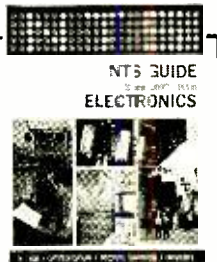

NATIONAL TECHNICAL SCHOOLS  
4000 S. Figueroa St., Los Angeles, Calif. 90037

Please rush Free Color Catalog and Sample Lesson, plus information on field checked below. No obligation. No salesman will call.

- MASTER COURSE IN COLOR TV SERVICING
- COLOR TV SERVICING
- MASTER COURSE IN TV & RADIO SERVICING
- PRACTICAL TV & RADIO SERVICING
- MASTER COURSE IN ELECTRONIC COMMUNICATIONS
- FCC LICENSE COURSE
- MASTER COURSE IN ELECTRONICS TECHNOLOGY
- INDUSTRIAL AND AUTOMATION ELECTRONICS
- COMPUTER ELECTRONICS
- BASIC ELECTRONICS

Name \_\_\_\_\_ Age \_\_\_\_\_

Address \_\_\_\_\_

City \_\_\_\_\_ State \_\_\_\_\_ Zip \_\_\_\_\_

- Check if interested in Veteran Training under new G.I. Bill.
- Check if interested ONLY in Classroom Training at Los Angeles. Dept. 206-109

With this question squared away (I hope), let's take a look at Mr. Mealing's contribution to *Technical Topics*.

### An active bandpass filter

The filter shown in Fig. 1 is a Twin-T notch filter. However, when it is connected into a feedback loop, the notch becomes the passband. This happens because the filter reduces the amount of feedback as resonance is approached. Thus, the output has a bandpass characteristic. The width of the passband divided by the center frequency is the Q of the circuit. Ideally, this is equal to 1/4 of the gain of the amplifier. Practically, this value is seldom achieved.

Two configurations using an operational amplifier are in Fig. 2. These filters have a bandwidth of approximately 100 Hz. This is fine if you want to listen to a whistle; but even CW transmissions require a 400-Hz bandwidth.

A discrete-component filter using

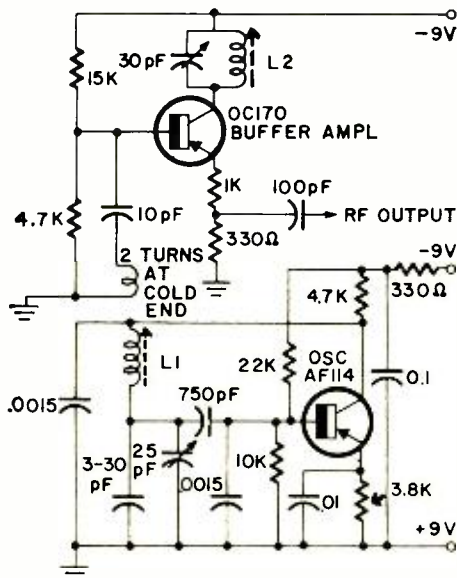

Fig. 5—Vackar oscillator operates at 21 MHz and shifts frequency from human body heat when person stands 2 feet away.

three transistors is in Fig. 3. Q1 and Q2 form an emitter-coupled pair. Q2 has a high-value collector resistor for high gain. Unfortunately, this also yields a high output impedance. Therefore, Q3 has been added as an impedance-matching emitter follower. It is also a low-impedance source for the filter. Fig. 4 compares the responses of the circuits in Figs. 2 and 3.

The values in Fig. 1 will tune the filter over a range of approximately 800-20,000 Hz. The center frequency  $f_0$  equals  $1/6.28RC$ , and Q is nearly constant over the entire frequency range.

Note: The active filter in Fig. 3 has about 30 dB of power gain. An input signal much more than 30 millivolts with drive Q2 to saturation. This will degrade the filter characteristics.

### A transistor Vackar

In June, we discussed a vacuum-tube Vackar oscillator used by a number of British hams. Figure 5 is a transistor Vackar oscillator used by G5BB for 21-MHz described in *RSGB Journal* (Now *Radio Communications*). Oscillator tank coil L1 and the buffer tank coil L2 consist of 19 and 23 turns, respectively, of No. 22 enameled wire on 1/4-inch slug-tuned forms. The oscillator is coupled to an OC170 buffer amplifier by a 2-turn coil wound around the cold end of L1. The OC170 and AF114 are pnp junction germanium transistors similar to the 2N1177.

G5BB reported that the oscillator tank is extremely temperature sensitive. Heat from a human body 2 feet away causes a gradual frequency shift. Interesting design factors developed in the article are:

Enclose the oscillator and tank circuit in a heavy metal box to protect it against drafts and sudden changes in ambient temperature.

For maximum stability, select a transistor with a cutoff frequency at least ten times the operating frequency and operate it in Class A.

Use inductive coupling to the

following circuit. Capacitive coupling appears to have an adverse effect on frequency stability.

### Unusual superregenerative detector

The superregenerative detector is characterized by high sensitivity and poor selectivity. Once the heart of the basic vhf/uhf communications receiver, its use is now confined almost entirely to model-control receivers where simplicity, light weight, small size and low power drain outweigh the disadvantages of broad tuning and reradiation. (If you don't know what a superregenerative detector is or how it works, a brief rundown follows this item.) The superregenerator in Fig. 6 features ultra-sharp tuning and very low power consumption. It was developed by Ted Hart, of Collins Radio and described in *Electronic Design* and *American Modeler* magazines. Disregarding the crystal between Q2's collector and emitter and the tuned circuit in the collector lead, we have a conventional multivibrator operating at 20-30 kHz. Now, look at the circuit as though Q1, C1, C2 and R1 were omitted. We have Q2 connected as a vhf crystal-controlled oscillator. Replacing the crystal with a 5-10-pF capacitor and we have a tuned-collector oscillator. Combining the multivibrator and crystal-controlled oscillator functions, Ted Hart has come up with a crystal-controlled superregenerator using a multivibrator-type quench circuit. Detected audio is developed across R4. A Twin-T or similar filter removes the quench frequency before amplification.

### Multivibrator frequency adjustment

The crystal and tuned circuit are selected for the desired receive frequency. The multi-vibrator frequency may be left as is or adjusted to a frequency no higher than one hundredth of the operating frequency.

[Superregenerative detector: Imagine an ordinary diode detector using the grid and cathode of a vacuum tube or the base-emitter junction of a transistor. The signal in the plate or collector circuit is an amplified replica of the signal on the grid or base. Take some of the detector's rf output voltage and feed it back to the input in proper phase so it adds to the input voltage and thus increases circuit amplification. This process is *regeneration*. If we feed back enough signal to overcome the losses in the input circuit, oscillation occurs.

A superregenerative detector is a regenerative detector designed so it quenches (goes in and out of oscillation) at a low rf rate—usually 20-100

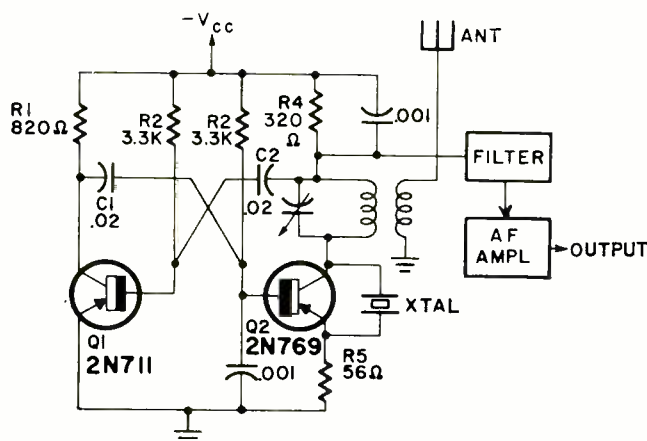

Fig. 6—Ultra-sharp tuning superregenerative detector uses Q2 as a vhf crystal-controlled oscillator for precision.



Hz). This additional regeneration makes the circuit extremely sensitive. Some superregenerators use a separate oscillator to supply the quench frequency but the simplest types produce the interruption frequency so a separate oscillator is not needed.]

### Wind-direction indicator

A number of methods have been developed for remote-indicating wind vanes. Among them are selsyns with the repeater driving a pointer around a compass rose; bridge circuits in which the resistance of one leg varies with vane position so wind direction is shown on a meter which indicates bridge unbalance; and vane-driven ro-

tary switches with one position for each desired indication. The switch contacts are connected to lamps marked N, E, S, W, etc. In many instances, it is difficult to protect the switch, pot or other pickup against ravages of the weather so these systems required frequent maintenance.

This solid-state wind indicator, described in *Le Haut-Parleur*, uses a small vane-driven bar magnet and reed switches as pickups (Fig. 7). The switches are normally open types connected between  $V_{cc}$  and the base of a 2N525 transistor (Fig. 8). The indicator is a 2-volt lamp in the collector circuit. The diagram of a 4-point indicator is shown in Fig. 9. The reed switches are hermetically sealed and are not affected by weather or corrosive elements in the air. Leads from the switches are run through a cable to the transistors and lamps at the remote point. **R-E**

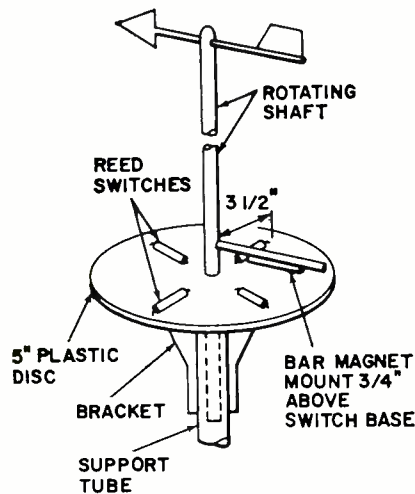

Fig. 7—Solid-state wind indicator uses reed switches as pickups and a vane-driven bar magnet. Reeds are open normally.

### CORRECTION

There is an error in the circuit of the Turn and Backup Indicator on page 95 of the April issue. Mr. J. M. Borde of Bombay, India noticed that the right-turn lamps are in series with the buzzer and will not function if both are rated at 12 volts. Actually Mr. Ives, the designer, connected the right-turn lamps between the flasher and ground as in the left-turn circuit. Our thanks to M. Borde for calling the drafting error to our attention.

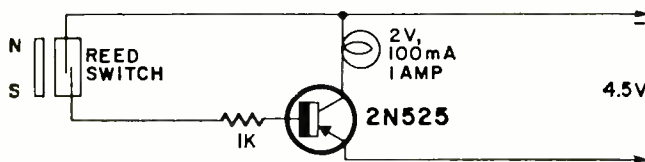

Fig. 8—Reed switches are connected between base and  $V_{cc}$  of 2N525's.

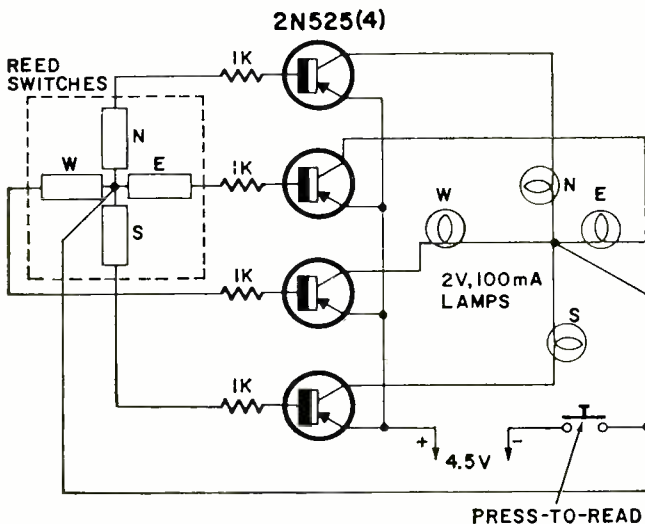

Fig. 9—Overall diagram of wind indicator. Indicator lamps indicate what position the vane is in.

## QUICK TEST HORIZONTAL OSCILLATORS

For those odd occasions when you want to know if the horizontal oscillator is on-frequency, but don't have a scope with you, try this. You'll need a standard "ringing-coil" of the type used in horizontal multivibrators, the correct size capacitor to make it resonate at 15,750 Hz, and a diode.

Connect the diode in series with one of the VOM leads and then connect the meter across the coil terminals (see diagram). Now, if you hold the coil near the set's horizontal oscillator coil, the horizontal output tube plate lead, the flyback, or any other point where there is a high 15.750-Hz energy field you'll get a good-sized reading on the meter.

This can be read on the 0-1 or 0-2.5 dc volts scale, if the meter is at least a 20,000 ohms per volt type. A more sensitive range is the 0-50 microampere scale.

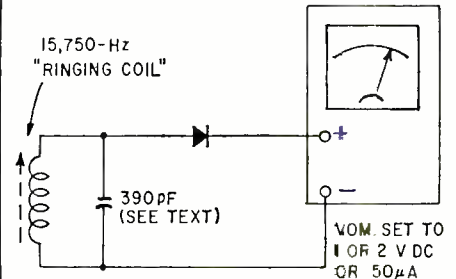

If you want to do a bit of gadgeteering, mount the coil on the end of a small metal or plastic box. Inside the box, mount a small variable capacitor, say about 0-100 pF., and then add enough fixed capacitance to bring the coil back to resonance with the variable capacitor set at about half-range or 50 pF. for the standard horizontal oscillator coil, this would be about another 220 pF for a total around 390 pF. (This varies with different coils; check the one you use to make sure.)

You can make a small dial-scale on the box, and use a pointer knob. This should be set at zero when the frequency is exactly 15,750 Hz, and then go + or - in either direction.

You can use this as a sort of rough 'output indicator', since it will indicate the presence or absence of a strong energy field on the plate cap of the horizontal output tube, the plate lead to the high-voltage rectifier, the damper tube or the flyback.

The 'frequency' calibration may be a bit wide, if you get a low-Q coil, but the output indication will be OK. You'll get readings like 1-1.5 volts dc with the pickup coil held against the set's oscillator coil.—*Jack Darr*

## PICK OF THE RECEIVER CROP

When you pick from the KENWOOD Tree you are sure to pick the finest. And KENWOOD's new stereo receivers certainly prove the point! Whichever one you choose, you will be getting top performance, top quality, and top value. That is because KENWOOD brings you the most carefully engineered hand-crafted stereo components on

the market today, with "extras" that set each model apart from the competition and give even the least expensive unit a mark of luxury. Throughout the world the KENWOOD Tree stands as a symbol of quality, dependability and fine stereo performance... so take your pick—and pick the finest!



TK-140X . . . FET, IC, Solid State, FM/AM, 200-Watt . . . \$349.95

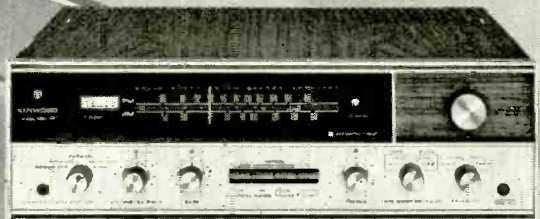

KR-77 . . . FET, IC, Solid State, FM/AM, 75-Watt . . . \$239.95

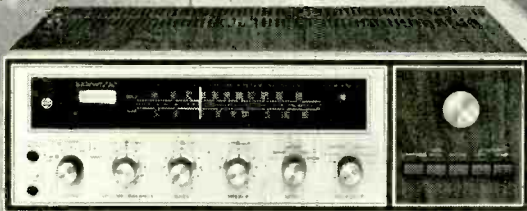

KR-100 . . . FET, IC, Solid State, FM/AM, 140-Watt . . . \$299.95



KR-70 . . . . . FET, IC, Solid State, FM, 75-Watt . . . . . \$199.95

*the sound approach to quality*



**KENWOOD**



3700 S. Broadway Pl., Los Angeles, Calif. 90007 • 69-41 Calamus Ave., Woodside, N. Y. 11377 • Exclusive Canadian Distr. — Perfect Mfg. & Supplies Corp. Ltd.

Circle 31 on reader service card



# NEW! All IC

# 200-watt stereo amp

A new thick-film hybrid IC that can deliver all the audio power you need. Features damage-proof protective circuits

by F.S. KAMP and  
J.C. SONDERMEYER\*

ADVANCES IN HIGH-POWER THICK-film technology combined with a unique circuit have resulted in a hybrid IC power amplifier with universal applicability. The amplifier was designed for the industrial and commercial market where a high-power, audio-range, reliable and compact linear

TABLE I

Data taken with split supply at  $\pm 37.5$  volts, 4-ohm load, 1-kHz signal frequency and feedback resistor = 820 ohms.

Zero signal dissipation = 1.725 watts\*

Input voltage = 1.00 @ 100 watts output

THD = 0.38% @ 100 watts output

Input voltage = 0.62 @ 35 watts output

THD = 0.14% @ 35 watts output

\* Of this, 585 mW is dissipation in resistors  $R_2$ ,  $R_3$  and  $R_4$ , leaving a device dissipation of 1.14 watts.

\*RCA Electronic Components, Somerville, N. J.

amplifier was needed.

Although not fabricated specifically for high-fidelity applications, the performance characteristics of the TA7625 hybrid power module (see Table I and Graphs I-III) suggest it is quite adequate for this purpose. The photo above showing an encapsulated and unencapsulated module mounted on a heat-sink type chassis indicates the extreme compactness possible for a 200-watt stereo amplifier. The power supply for the modules is mounted on a separate chassis, although single-chassis construction is possible if preferred. The power modules are available for \$80 each.

The protective circuitry of the modules insures they cannot be internally damaged by a sustained short at the output or faulty power-supply voltages. The design permits use of the module with capacitive loads (electrostatic speakers).

#### Structure & circuits

The internal structure of the hybrid amplifier is shown in Fig. 1. It has a rugged steel base plate on which

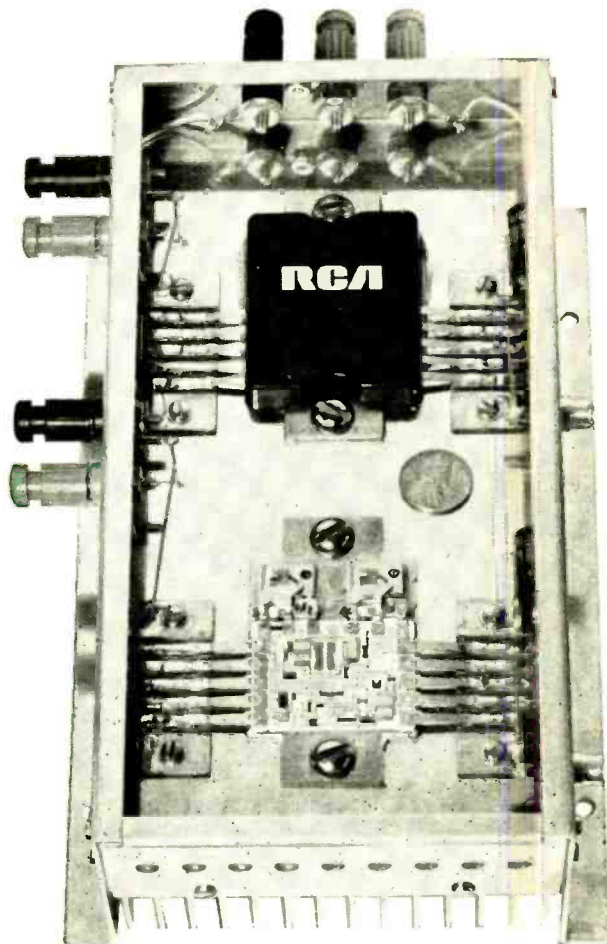

both the thick-film circuit and the output assembly are mounted. This output-transistor assembly is an all lead-solder mount system with a lead frame for easy fabrication. A ceramic substrate is used under each pellet to isolate it from the base plate. The pellet is mounted on a heat spreader which reduces the heat flux density by the time it gets to the ceramic.

The schematic for the circuit of the hybrid power amplifier is shown in Fig. 2. A differential bridge (Q1-Q2) is employed at the input of the amplifier to provide good control on the quiescent operating point zero-output voltage. Imbalances of the bridge circuit with supply variations are solved by using constant-current source Q3 in the emitter circuit. This approach is almost universally used in integrated circuits to function over a wide range of supply voltages.

The voltage at pin 8 dictates the output voltage at pin 3. A pair of matched resistors ( $R_2$  and  $R_3$ ) control the output voltage to half the supply voltage. Pin 8 is grounded directly for the split supply case (Fig. 3-a) and ac-grounded with a 100- $\mu$ F

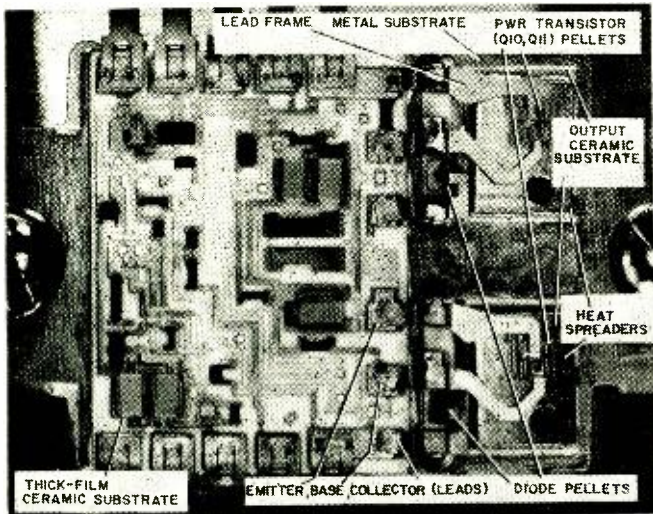
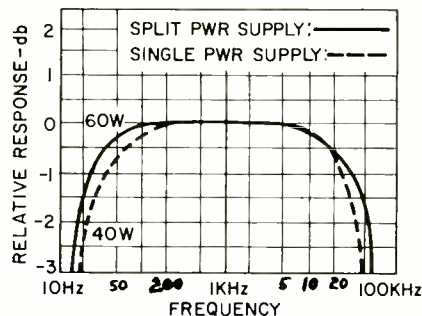
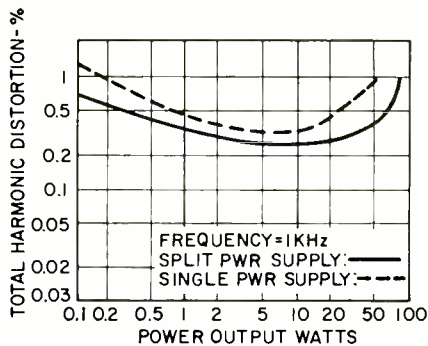
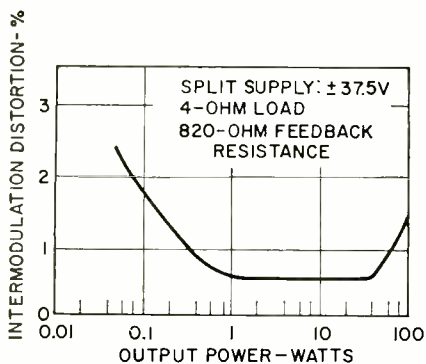

Graphs I-III above show performance curves for the IC. The Fig. 1 photo (left) shows the interior of the hybrid module and Fig. 2 below is the TA7625 schematic.

capacitor for the single supply case (Fig. 3-b). The constant-current sources (Q3 and Q4) allow the amplifier to be biased properly from a total supply voltage of much less than 30 volts to the 75-volt maximum.

The true class-B quasi-complementary output/driver stage is driven by the bidirectional current source. The output devices (Q10 and Q11) are chips from the 2N3055 family and the pnp/npn drivers are from the 2N5322/2N5320 families. The bidirectional current source npn/pnp's are from the 2N2101/2N4036 families.

A technique for eliminating crossover distortion in class-B output stages is to operate them from a high-imped-

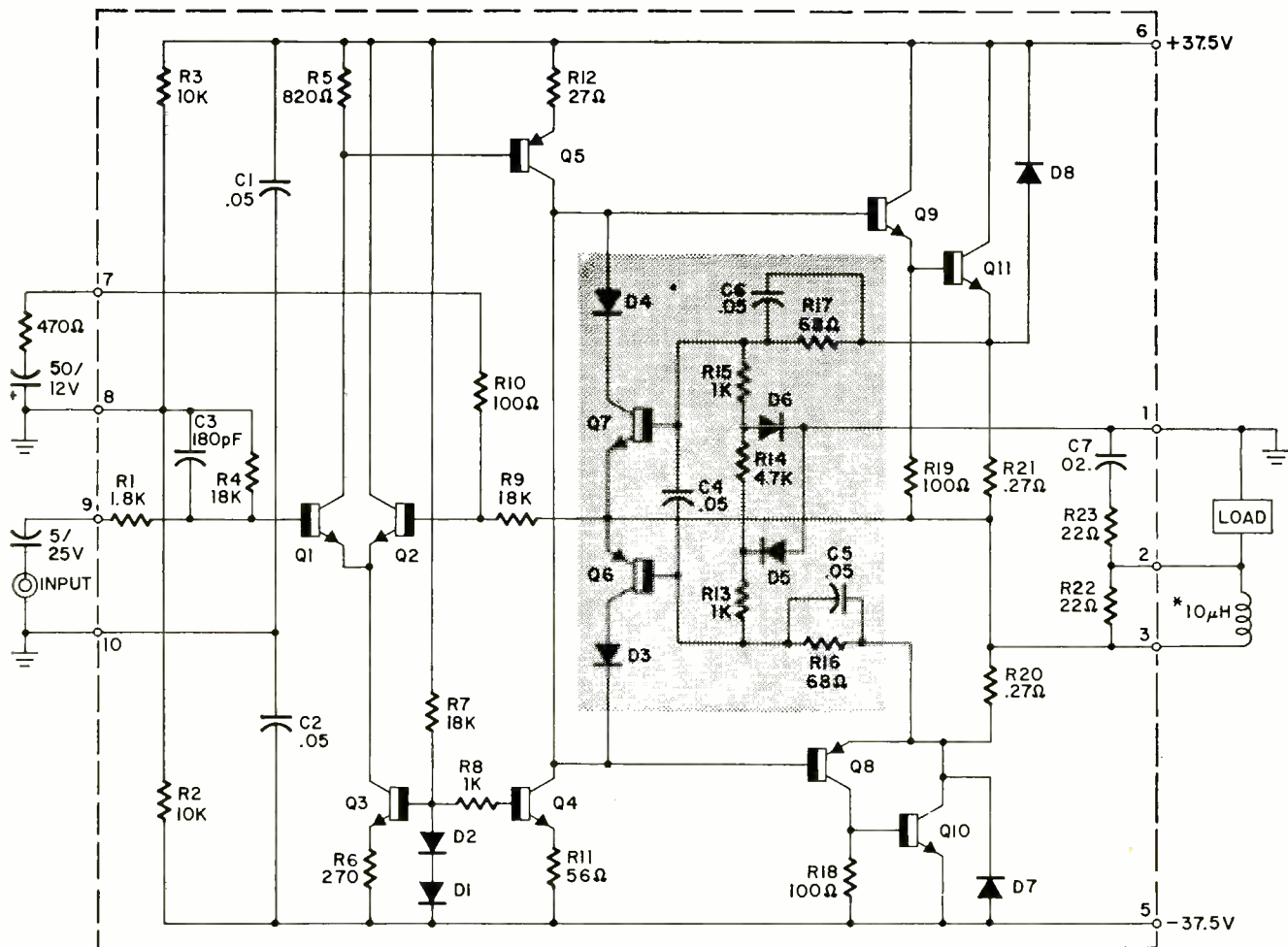

\*Miller No. 5220 or 40 turns of No. 20 copper wire (3 layers) over a 2W carbon resistor (100K+)



ance source (a current source). The current transfer characteristics of a typical output stage do not exhibit the offset steps as do the transconductance characteristics. The high-impedance source consists of a second current source, Q4, direct-coupled to the class-A predriver, Q5. In this case, the class-A stage is a pnp device since the bridge devices are now npn type. This arrangement also allows the current source to be an npn type as well and can share the same reference diodes, D1 and D2.

This approach is a simple collector-to-collector connection of complementary devices providing an inherently high collector impedance source; together with the differential bridge, the system performs as a "con-

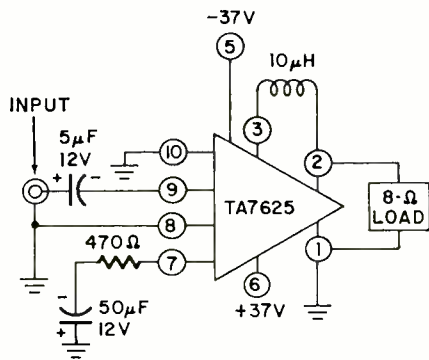

Fig. 3-a—This power supply configuration is a split supply (pin 8 grounded).

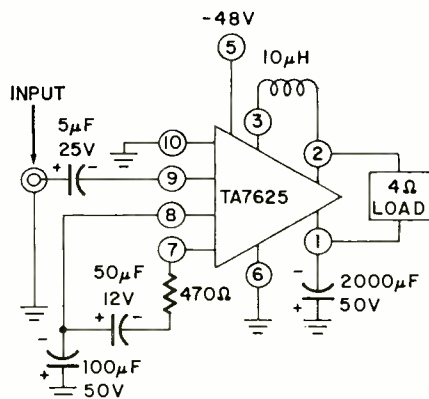
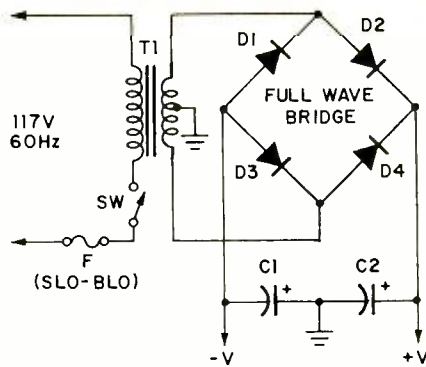

Fig. 3-b—The single supply arrangement with pin 8 ac grounded through 100 µF.

trolled bidirectional current source." Its operation is completely independent of supply voltage variations.

Versatility was achieved by bringing the feedback terminal out (pin 7). Maximum gain is limited by the 100-ohm internal resistor, R10.

The load-line limiting circuit (shaded area) protects the amplifier from a sustained short at the output. This unique limiting circuit places restrictions on the allowable operating area of the drivers and outputs. It functions as a voltage and current sampling circuit to provide operating



Power supply circuit for stereo ampl.

#### TA-7625 Power Supplies

$P_{out}$	C1-C2	D1-D4	F
120 watts (60W/chan.)	5000 µF 50V	1N1202A	7A
40 watts (20W/chan.)	3500 µF 50V	1N1614	2A

limitations on the output devices. The limits chosen do not inhibit normal operation, but any overload condition including a short circuit will remain within the safe area of operation of the device. Diodes D7 and D8 and the load-line limiting circuit protect against a faulty output transformer secondary that may reflect voltages to the amplifier output termination, exceeding the power supply voltages. The diodes clamp this reflected voltage to the power supply, while the load-line limiting circuit limits the drive.

Controlling the gain bandwidth product of the output stage in relation to the preceding stages and adding the 10-µH inductor and R23-C7 for capacitive loads are other design factors for added versatility.

R-E

#### RCA KC5144-E TV CHASSIS

There is a common defect in this set's tuner that is likely to cause trouble as the set ages. The symptoms usually show up first as flashing in the picture accompanied by a loss of vertical sync. Later, the circuit breaker will open intermittently. When the circuit breaker is reset, the set plays normally for quite a while.

If the trouble is not corrected at this point, the 4700-ohm, 1-watt and 470-ohm, ½-watt resistors (R13 and R91, respectively) in the tuner will burn up. If the tuner is run through the uhf channels, R55 and R56 (2200 and 1500 ohms, respectively) will also burn up.

This trouble has been traced to a terminal lug that carries B-plus voltage to C26. This lug is so close to ground that if a small particle of dust or other foreign matter lodges at this point, it will develop a carbon path to ground. Then the fun begins.—Sid Elliot

# TRY THIS ONE

#### HOMEMADE RUBBER FEET

You can make feet or pads for your home-brew gear out of a silicone rubber caulking compound such as G-E's Bathtub Seal. You can get it at most hardware stores.

Squirt the rubber cement at the de-

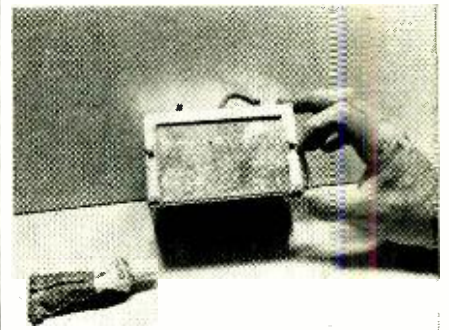

sired spot and smooth the edges with a knife. Level the feet as well as possible. Let the cement set over night. The next day grind off the rough edges so the feet are even and the case is level. (Be sure the surface is clean before applying the rubber cement).—Homer L. Davidson

#### CLOCK SHAFT REPAIR

A clock radio in our shop had a knob that turned the hands and also set the alarm, but the knob was slipping on its shaft. The threads on the small shaft from the clock body were stripped, and the aluminum extension shaft would turn around it. Since aluminum is not easily soldered, we made a replacement from a brass ballpoint-pen cartridge.

Cut off the ballpoint and solder that end of the tube to the threaded brass shaft on the clock. Measure the length of the original shaft and at that point solder a large washer with a small hole, as a knob. Snip off the remaining brass. Enlarge the hole in the Masonite back to pass the large washer.—H. L. Davidson

#### WANTED: TECHNOTES

If you are continuously fighting "tough-dog" service jobs, keep your eyes on *Technotes*. The chances are good that a fellow technician has passed on the dope that will help you tame the next "dog" that lards on your bench.

If you tame a dog, let us know all about it. We'll pass the word along and pay you at our regular rates. Schematics and photo bring an extra bonus.

# Service Clinic

By JACK DARR  
SERVICE EDITOR

## Yoke cracked

In a Magnavox U90413-15, with the 23" rectangular color tube, I have

poor convergence, bad pincushioning (mainly at the top) and poor horizontal linearity. The horizontal efficiency coil affects the edges of the raster, but doesn't help the center.

The two halves of the yoke's ferrite core seem to be split. The crack is about 2 mm wide. I checked others, and they do not show this wide a crack. Could this have any effect?—  
J. E., San Francisco, Calif.

Very likely! The two halves of this core should be cemented together, with about 0.001" "gap". This

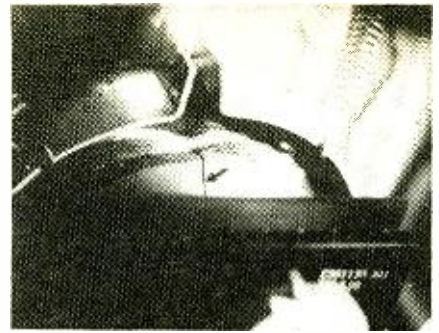

(continued on page 78)

JUST SAY  
WEN
wen  
makes  
soldering simple



**Model 199K,**  
5 pc. kit

130 watt "instant heat" soldering gun for wiring, appliance repair, radio, T.V., etc. Kit includes: solder gun with long nosed tip, 1 tip for cutting plastic and removing putty, 1 flat iron tip for removing dents from wood and heat sealing, 5 ft. solder, attractive heavy gauge metal case.

\$9.95

Mfg. Sugg. List



**Model 450K4 3 in 1**  
All-Purpose soldering kit

WEN exclusive single post design gives long reach & clear view of work. Automatic heat control for all soldering jobs. 3 interchangeable tips—3 separate heat ranges, 25-100 watts, 100-200 watts, 200-450 watts. Handsome molded plastic carrying case.

\$15.95

Mfg. Sugg. List

<p><b>Model 250.</b> 250 watt soldering gun. Heats in 3 seconds. Mfg. Sugg. List <span style="float: right;">\$12.95</span></p>			<p><b>Model 75.</b> For fast light work. Produces up to 100 watt heat. Mfg. Sugg. List <span style="float: right;">\$5.95</span></p>
<p><b>Model 100K Kit</b> 100 watts in 2½ seconds Mfg. Sugg. List <span style="float: right;">\$7.95</span></p>			<p><b>Model 222K5.</b> Soldering kit, 2 tips, 2 heat ranges—25-200 watts. Mfg. Sugg. List <span style="float: right;">\$11.95</span></p>

WEN PRODUCTS, INC.

5808 NORTHWEST HIGHWAY, CHICAGO, ILLINOIS 60631 312/763/6060

INDUSTRIALLY LISTED FOR CONTINUOUS DUTY. 100% AMERICAN MADE

Circle 32 on reader service card



not all  
cardioid microphones  
are alike ...



the

# SHURE UNISPHERE® I

TRUE CARDIOID UNIDIRECTIONAL DYNAMIC  
MICROPHONE SOLVES ALL THESE  
COMMON MICROPHONE PROBLEMS!

## PROBLEMS CAUSED BY INEFFICIENT REJECTION OF UNWANTED SOUNDS BY THE MICROPHONE

SITUATION	PROBLEM	CAUSES	SOLUTION
<p>REFLECTIONS</p>	<p>Feedback occurs where a so-called "cardioid" microphone is used and the speakers are placed to the rear of the microphone. A common occurrence in churches, auditoriums, and meeting rooms.</p>	<p>Sound bounces off hard surfaces on the walls, floor and ceiling, in and around the audience area and the microphone used is not effective in rejecting these sounds at all frequencies, and in all planes about its axis.</p>	<p>The Unisphere rejects sound at the rear with uniformity at all frequencies. Sounds bouncing off floors or other surfaces are uniformly rejected.</p>
<p>COLUMN LOUSPEAKERS</p>	<p>Unexplained feedback. Column loudspeakers are used to distribute sound more evenly to the audience in churches and auditoriums.</p>	<p>Feedback occurs when rear and side sound lobes of column speakers coincide with rear and side lobes of so-called "cardioid" microphones.</p>	<p>The Unisphere solves the problem because it has no rear or side lobes. Thus it rejects the side and rear lobes of the sound column speakers.</p>
<p>REVERBERANT BOOM!</p>	<p>A disturbing, echoing effect of low frequency sound often found in churches, large auditoriums, and arenas.</p>	<p>Low frequency reverberation and boominess occurring when microphone fails to retain unidirectional characteristics at low frequencies.</p>	<p>The Unisphere maintains a uniform pattern of sound rejection at all frequencies, even as low as 70 Hz. The response has a controlled roll-off of the low end—low frequency reverberation diminishes effect of boomy hall.</p>

## PROBLEMS CAUSED BY THE MICROPHONE'S INEFFECTIVENESS IN PICKING UP THE DESIRED SOUND

<p>GROUP COVERAGE WITH ONE MICROPHONE</p>	<p>A single microphone does not provide uniform coverage of a group. This is commonly experienced with choral groups, quartettes, instrumental combos, and speaker panels.</p>	<p>The particular "cardioid" microphone used lacks a uniform pickup pattern, so that persons in different positions within the general pickup area of the microphone are heard with varying tonal quality and volume.</p>	<p>The Unisphere affords uniform pickup of the group with a resulting consistency in volume and sound quality among the members of the group.</p>
<p>USING MULTIPLE MICROPHONES</p>	<p>Variation in the pickup level and tonal quality exists throughout the broad area to be covered. This may occur in stage pickup of musical and dramatic productions, panels and audience participation events.</p>	<p>The pickup pattern of the microphones used is too narrow, causing "holes" and "hot spots." The off-axis frequency response of the microphones also varies.</p>	<p>The Unisphere permits smoothness in pickup as true cardioid pattern gives broad coverage with uniformity throughout coverage area. Eliminates "holes," "hot spots," and variations in sound quality, simplifies blending many microphones.</p>
<p>DISTANT PICKUP</p>	<p>Too much background noise or feedback results when working with microphone at desired distance from sound source.</p>	<p>Long-range microphones are less directional with lower frequencies. Lobes or hot spots allow background noise or feedback.</p>	<p>Use the Unisphere to gain relatively long range with effective rejection of sound at all frequencies at the rear of the microphone.</p>

SHURE BROTHERS, INC., 222 HARTREY AVE., EVANSTON, ILL. 60204

Circle 33 on reader service card

**SERVICE CLINIC**

(continued from page 74)

problem occurs in other makes, and causes, at the very least, bad convergence. In this case, with a 2-mm gap, it could be causing all your troubles. Tighten it up until you can't see the crack.

**Needs a bias box**

How about a diagram for a TV bias supply, ac-powered?—I. W., Middleboro, Mass.

Here it is. It's just a small filament transformer, silicon rectifier, filter capacitor and a variable resistor.

The transformer determines the

voltage. To be safe, get a 24-volt one if you can. The silicon rectifier can be any kind. The filter capacitor should be about 500  $\mu$ F at 50 volts, and the variable resistor something like a 2-

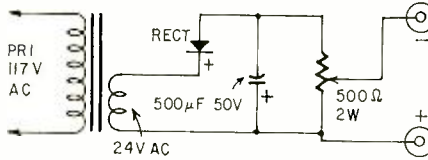

watt wirewound at about 500 ohms. This will give you a peak dc of about 30 volts. You can calibrate the variable-resistor knob, or measure it with a dc voltmeter.

**Testing 1500 speakers**

I take care of a 1500-unit drive-in theater. This requires a lot of speaker testing. How about some kind of test unit that would let me check individual speakers without having to go to the booth to turn on the amplifier?—P. R., South Plainfield, N. J.

Easy. All you'll need is a small audio signal generator with about 4-6 volts output. Each of your speakers will have a matching transformer. Lift one side of the primary and couple the test signal to the transformer. If anything is wrong, you won't hear the sound.

Several small noise- or buzzer-type signal generators are available. With one of these and a good vom, you should be able to make any necessary tests. **R-E**

**FREE!**



**BRAND NEW EDITION  
1970 Catalog 700**

Featuring Everything in Electronics for  
**• HOME • INDUSTRY • LABORATORY**  
 from the "World's Hi-Fi & Electronics Center"

Serving The Public  
Since 1920



**496 Pages**

- Electronic Parts...Tubes... Tools
- Citizens Band Equipment
- PA Equipment
- Test Instruments
- Closed Circuit TV
- Stereo Hi-Fi Systems & Components
- Tape Recorders
- Amateur Radio Equipment
- Radio & TV Sets & Accessories
- Cameras & Supplies
- Books

**LAFAYETTE RADIO ELECTRONICS**

Dept. 17109

**SYOSSET, L.I., N.Y. 11791**

**Send For FREE  
1970 Catalog  
TODAY**

.....  
 Send **FREE** 1970 CATALOG 700 17109  
 Name.....  
 Address.....  
 City..... State..... Zip.....

Circle 34 on reader service card

This column is for your service problems—TV, radio, audio or general and industrial electronics. We answer all questions individually by mail, free of charge, and the more interesting ones will be printed here.

If you're really stuck, write us. We'll do our best to help you. Don't forget to enclose a stamped, self-addressed envelope. Write: Service Editor, Radio-Electronics, 200 Park Ave. South, New York 10003.

1969



**AMAZING OFFER  
RADIO & TV SERVICE DATA**

Your best, complete source for all needed RADIO and TV diagrams and helpful servicing data. Most amazing values. Only \$2.50, \$3, \$4, per giant volume. Cover all important makes, models of all periods. Use this entire ad as your *no-risk* order form.

**NO-RISK ORDER COUPON**

**TELEVISION SERVICE MANUALS**

Supreme TV manuals are best for faster, easier TV repairs. Lowest priced. Factory data on practically all sets. Complete circuits, all needed alignments facts, wiring board views, waveforms, voltages, production changes, and double-page schematics. Only \$3 and \$4 per large annual manual. Check volumes wanted, send entire advertisement as your order form.

- 1969 TV, \$4.
- 1968 TV, \$4.
- 1967 TV, \$4.
- 1966 TV, \$3.
- Additional 1965 TV, \$3.
- 1965 TV, \$3.
- 1964 TV, \$3.
- 1963 TV, \$3.
- Additional 1962 TV, \$3
- Early 1962 TV, \$3.
- 1961 TV Manual, \$3.
- 1960 TV Manual, \$3.
- Additional 1959 TV, \$3.
- Early 1959 TV, \$3.
- 1958 TV Manual, \$3.
- Additional 1957 TV, \$3.
- 1955 TV, \$3.
- 1954 TV, \$3.
- 1951 TV, \$3.
- Master Index to all TV & Radio Manuals, 25¢

**RADIO DIAGRAM MANUALS**

Here are low-priced radio manuals that simplify repairing. Cover everything you need from recent radios to pre-war old-timers: home radios, stereo, combinations, transistor portables, FM, and auto sets. Large schematics, all needed alignment facts, printed boards, voltage data, dial stringing, films. Volumes are big, 8-1/2x11", about 100 pages, each.

**\$2.50**

- 1966.
- 1965.
- 1964.
- 1963.
- 1962.
- 1961.
- 1960.
- 1959.
- 1958.
- 1956.
- 1955.
- 1954.
- 1953.
- 1952.
- 1951.
- 1950.
- 1948.
- 1946.
- 1942.
- 1941.
- 1940.
- 1926-38. EACH, \$2.50

**SUPREME PUBLICATIONS**

1760 Balsam Road, Highland Park, ILL., 60035

Rush today **TV** and **Radio** manuals, checked in no-risk order form of this ad. Send post-paid, I am enclosing full price. You guarantee my complete satisfaction or my money back.

Name: \_\_\_\_\_  
 Address: \_\_\_\_\_  
 City: \_\_\_\_\_ State: \_\_\_\_\_

Circle 35 on reader service card

**RADIO-ELECTRONICS**





**DELTA** will tell you *everything!* — Complete Specs including schematics!



# MARK TEN<sup>®</sup> SCR

## CAPACITIVE DISCHARGE IGNITION SYSTEM

Now discover for yourself the dramatic improvement in performance of your car, camper, jeep, truck, boat — any vehicle! Delta's remarkable electronic achievement saves on gas, promotes better acceleration, gives your car that zip you've always wanted. Find out why even Detroit has finally come around. In five years of proven reliability, Delta's Mark Ten has set new records of ignition benefits. No re-wiring! Works on literally any type of gasoline engine.

- ▲ Dramatic Increase in Performance and in Fast Acceleration
- ▲ Points and Plugs Last 3 to 10 Times Longer
- ▲ Promotes More Complete Combustion
- ▲ Up to 20% Mileage Increase (saves gas)

KIT FORM **\$2995**  
12V ONLY

ASSEMBLED **\$4495**  
ONLY ppd.

## MODEL 3000 FET VOM

Delta now offers a compact, versatile, and extremely sensitive VOM which combines FETs and ICs for extreme accuracy. Compact (6½" W x 8" H x 3½" D), portable. Wt. 3¾ lbs.

**IN KIT FORM:** Feedback network with pre-selected components to eliminate all final calibration. Ready to use when assembled!

### NEW DELTA FEATURES:

- ▲ Mirror scale 200 A D'Arsonval meter
- ▲ Integrated circuit (IC) operational amplifier for extreme accuracy
- ▲ FET input stage with current regulator
- ▲ Two stage transistor current regulator and Zener diode on OHMS for absolute stability and accuracy
- ▲ Voltage clippers for protection of input stage

- ▲ Fully temperature compensated for low low zero drift
- ▲ Ten turns ZERO and OHMS adjust potentiometers
- ▲ Epoxy glass circuit boards and metal case
- ▲ Enclosed switches
- ▲ Uses readily available type AA cells
- ▲ Uses standard test leads for maximum flexibility and ease of measurement
- ▲ 10 Megohms input impedance

ONLY **\$7495**  
ppd.

Only **\$5995**  
ppd.

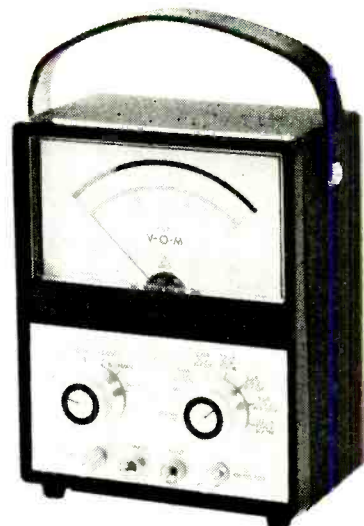

## COMPUTACH<sup>®</sup>

Delta, pioneers in CD ignition who produced the fabulous MARK TEN<sup>®</sup>, now offer a precise computer-tachometer which obsoletes any type tachometer on the market today! You achieve unbelievable accuracy in RPM readings due to the advanced, solid-state electronic matched components used in the computer, coupled with the finest precision meter in the world. Works on all 2, 3, 4, and 6 cylinder 2 cycle and with 4-6-8 cylinder—4 cycle 12 volt engines.

- ▲ 0-8000 RPM range
- ▲ Perfect linearity — zero paralax
- ▲ Adjustable set pointer
- ▲ Wide angle needle sweep
- ▲ Translucent illuminated dial
- ▲ Chrome plated die-cast housing
- ▲ All-angle ball & socket mounting
- ▲ Use it with ANY ignition system
- ▲ Meter: 3½" dia. X 3¾" deep
- ▲ Calibration kit included, no test eqpt. needed.

\*An exclusive computer-tachometer for precise RPM measurement in easy-to-build Kit form! **\$2995**  
ppd.

**KIT FORM ONLY**

EP 3-B

DELTA: Please send me literature immediately. I am enclosing \$\_\_\_\_\_ for items checked.

- Mark Ten SCR  Kit  Assembled  
 Model 3000 FET VOM  Kit  Assembled  
 Computach (Kit only)

Please ship immediately.

Name \_\_\_\_\_

Address \_\_\_\_\_

City \_\_\_\_\_

State \_\_\_\_\_

Zip \_\_\_\_\_

\*My car is (Model) \_\_\_\_\_

(Year) \_\_\_\_\_

Write today for complete literature packet



# DELTA PRODUCTS, INC.

P.O. BOX 1147 • GRAND JUNCTION, COLORADO 81501

Circle 36 on reader service card



## SINCLAIR AUDIONICS IC-10

# the world's most advanced HIGH-FIDELITY AMPLIFIER

### Specifications

Power output: 10 watts peak, 5 watts RMS continuous  
 Frequency Response: 5Hz to 100KHz plus or minus one decibel  
 Total Harmonic Distortion: Less than 1% at full output  
 Load Impedance: 3 to 16 ohms  
 Power Gain: 110 db  
 Supply voltage: 8 to 18 volts DC  
 Size: 1 x .4 x .2 inches  
 Sensitivity: 5 mv  
 Input impedance: Adjustable externally up to 2.5 ohms for above sensitivity.

### Circuit Description

The first three transistors are used in the preamp and the remaining 10 in the power amplifier. The output stage operates in class AB with closely controlled quiescent current which is independent of temperature. A high level of overall feedback is used throughout both sections and the amplifier is completely free from crossover distortion at all supply voltages. Battery operation is eminently satisfactory.

### Construction

The monolithic IC chip is bonded onto a gold plated area on the heat sink bar which runs through the package. Wires are then welded between the IC and the tops of the pins which are also gold plated in this region. Finally the complete assembly is encapsulated in solid plastic which completely protects the circuit. The final device is so rugged that it can be dropped thirty feet on to concrete without any effect on performance. The circuit also functions perfectly at all temperature extremes from well below zero to above the boiling point of water.

### Applications

Each IC-10 is sold with a very comprehensive manual giving circuit and wiring diagrams for a large number of applications in addition to high fidelity uses. These include public address, use in cars, intercom systems, stabilized power supplies, electronic organs, oscillators, volt meters, tape recorders, solar cell amplifier, radio receivers. The transistors in the IC-10 have cut off frequencies higher than 500MHz so the preamp section can be used as an RF or IF amplifier making it possible to build complete radio receivers without any additional transistors.

## SINCLAIR IC-10 \$12.00

Check or money order. Allow 2 wks. delivery. Send for complete literature describing the complete line of Sinclair-Audionics products.

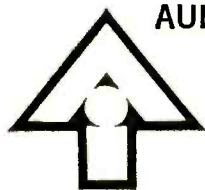

### AUDIONICS INC.

9701 S.E. Mill  
 Portland, Ore.  
 97216

Circle 37 on reader service card

MAIL EARLY  
 IN THE DAY!



ZIP CODE NUMBERS  
 BELONG  
 IN ALL ADDRESSES



YOUR POSTMASTER

# DEALERS! HOBBYISTS!



# NEW AND FREE FROM WINEGARD

Our giant catalog of TV and FM antennas, mounts, wire, couplers, amplifiers, wall plates and antenna systems equipment!

Now, for the first time ever, you can have Winegard's sensational 52-page Catalog illustrating and describing the world's most complete line of high quality antennas and MATV equipment for homes and commercial buildings. That's right! Even if you're not in the electronics business, you can use this Catalog to select Winegard products. Send for your FREE copy today, plus the name of your nearest Winegard distributor.



WINEGARD COMPANY, 3013-6 Kirkwood Street  
 Burlington, Iowa 52601

Gentlemen: Please send me your FREE Catalog.  
 Electronics is my business.  Electronics is my hobby.

NAME \_\_\_\_\_ (please print)  
 ADDRESS \_\_\_\_\_  
 CITY \_\_\_\_\_  
 STATE \_\_\_\_\_ ZIP \_\_\_\_\_

## U.S. GOV'T ELECTRONIC SURPLUS

Nationally Known-World Famous SURPLUS CENTER offers finest, most expensive, Government Surplus electronic units and components at a fraction of their original acquisition cost.

ORDER DIRECT FROM AD or WRITE FOR CATALOGS

### COMPUTER TRANSISTORS ON HEAT SINKS

IBM Computer Quality Units

(#22-928) -- Unit consists of one 150-watt power transistor on heavy, ribbed, aluminum heat sink. Many experimental uses. (1 lb.) **\$1.99**  
 Cost Gov't Over \$10.00



(#22-915) -- Unit consists of two 150-watt power transistors, 3 pots, several diodes, capacitors, resistors, etc. on heavy, ribbed aluminum heat-sinks. Ideal for use as motor speed control. (4 lbs.) **\$4.91**  
 Cost Gov't Over \$13.00

### RUNNING TIME METER

(#DX-104) -- Use to record number of operating hours of electric lights and electrical devices such as refrigerators, furnaces, etc. Records total hours, tenths and hundredths up to 9,999.91 hours. For 115-volt, 60-cycle. Size 4 1/2" x 3" x 2 1/2". Shipping weight 2 lbs. **\$5.69** Cost Over \$29.00



### 12 and 24-VOLT TRANSFORMER

(#15-920) -- General Electric 115-volt, 60-cycle to 12 and 24-volts @ 750-watts. Capacity 42-amps. @ 24-volts, 14-amps. at 12-volts. Useful for battery chargers, running DC motors, etc. 7" x 5" x 3". (18 lbs.) Cost Gov't Over \$33.00 **\$16.72**

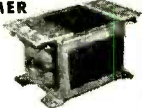

### EXPANDED SCALE 0 - 15 DCVM

(#21-900) -- Brand new, expensive voltmeter reads 0.5 to 16-volts DC and 5 to 8-volts. Very useful for automotive and aircraft battery charge indicator, etc. 360-degree movement, black phenolic case. 7" x 5" x 2 1/2". (3 lbs.) **\$12.95**  
 List \$32.50



### SURPLUS TELETYPEWRITERS



Orig. Cost Over \$1500.00  
**\$249.50**  
 SPECIAL  
 (ITEM #22-936) -- Used but excellent teletypewriters, Model 15 complete with A.C. (C. Data-Com). Permits using teletypewriter over regular long distance connection. Complete with 30' power supply, control telephone, etc. Wt. 300 lbs. Size 22" x 22" x 42".  
 Also have limited number Model 19 Teletypewriters with perforator, Data-Com, etc. Write for Sale price.



SEND 25¢ COIN OR STAMPS FOR CATALOGS  
 All Items FOB Money Back Guarantee

**SURPLUS CENTER**  
 DEPT. RE 109 LINCOLN, NEBR. 68501

## NEW FROM INJECTORALL



# HERE'S PROOF!

PROOF that "SUPER 100" tuner cleaner is BETTER!

Tested by a leading independent laboratory against competitive products!

	SUPER 100	A	B	C
CLEANING	Excellent	Good	Fair	Fair
LUBRICATION	Good	Fair	Fair	Poor
PLASTIC ATTACK	None	None	None	None
FLAMMABILITY	None	None	None	None
CONDUCTIVITY	None	None	Slight	Slight
ANTI-STATIC PROTECTION	Excellent	Fair	Poor	Poor
DRIFT	None	Slight	Yes	Yes

SUPER 100 TUNER CLEANER . . . for COLOR and Black and White TV tuners 6 oz. spray can with INJECTORALL steel needle CAT. NO. 100-6 net \$2.10 Buy it at your Electronic Dealer. For free catalog on the complete line, write to:

**INJECTORALL ELECTRONICS CORP.**

Great Neck, New York 11024

Circle 39 on reader service card



# Don't sell a color picture tube unless its been on a test ride.

Down at the bottom of the page, you have a major advance in space-age homeliness.

And a major advance in color tube testing as well.

That machine squatting down there is our beloved Iron Horse, the fully-automated, revolving carousel we use to test our color bright 85<sup>®</sup> tubes for emission, gas leakage, shorts, arcing and screen uniformity prior to shipment.

Now we don't intend to go into a song and dance on how total automation reduces testing error.

But we will tell you one thing.

Our Iron Horse test ride, combined with our life testing and 100% set testing, makes it almost impossible for you to get a defective color tube from us.

Which in turn makes it almost impossible for you to get chewed out by a customer.

Next time you need a color replacement tube, remember the great thing about the color bright 85. We don't send it to you till it's been around.

**SYLVANIA**  
GENERAL TELEPHONE & ELECTRONICS

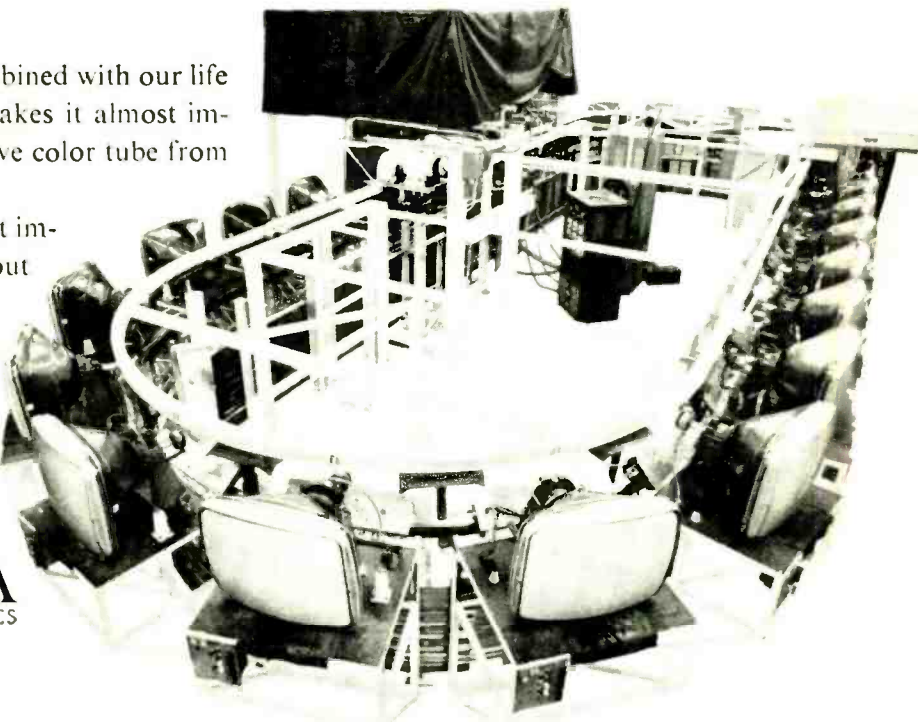

*Circle 40 on reader service card*

# there's no end to what Master flameless heat guns can do

fast adjustable heat to 1,000° F.

- Shrinks tubing, molds or welds plastics, dries finishes, etc.
- Adjustable orifice allows precise temperature regulation.
- Switches from hot to cool air instantly.
- Takes a variety of air flow adapters to match any job.

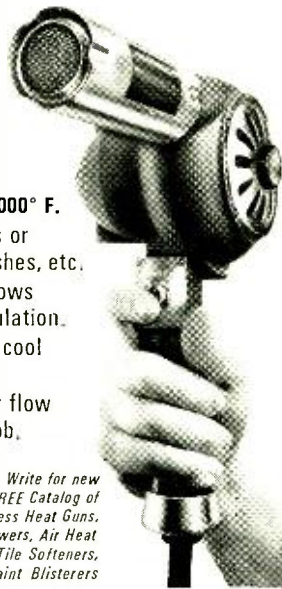

Write for new FREE Catalog of Flameless Heat Guns, Blowers, Air Heat Torches, Tile Softeners, Paint Blasters

**Master**  
appliance corporation

Racine, Wisconsin 53403

Circle 41 on reader service card

## Accuracy like a VTVM... Convenience like a VOM...

### NEW BATTERY-OPERATED FET SOLID-STATE VOLT-OHMMETER #116

Easy-to-build KIT

**\$29<sup>95</sup>** = 116K

Factory-Wired & Tested

**\$39<sup>95</sup>** = 116W



Now you can get all the benefits of a VTVM (laboratory accuracy, stability and wide range) but with its drawbacks gone; no plugging into an AC outlet, no waiting for warm-up, no bulkiness. New Field Effect Transistor (FET) design makes possible low loading, instant-on battery operation and small size. Excellent for both bench and field work.

**Compare these valuable features:**

- High impedance low loading: 11 megohms input on DC, 1 megohm on AC
- 500-times more sensitive than a standard 20,000 ohms-per-volt VOM
- Wide-range versatility: 4 P-P AC voltage ranges: 0-3.3, 33, 330, 1200V; 4 RMS AC voltage ranges: 0-1.2, 12, 120, 1200V; 4 DC voltage ranges: 0-1.2, 12, 120, 1200V; 4 Resistance ranges: 0-1K, 0-100K, 0-10 meg., 0-1000 meg.; 4DB ranges: -24 to +56DB.

Sensitive easy-to-read 4 1/2" 200 micro-amp meter. Zero center position available. Comprises FET transistor, 4 silicon transistors, 2 diodes. Meter and transistors protected against burnout. Etched panel for durability. High-impact bakelite case with handle useable as instrument stand. Kit has simplified step-by-step assembly instructions. Both kit and factory-wired versions shipped complete with batteries and test leads. 5 1/4" H x 6 3/4" W x 2 7/8" D. 3 lbs.

Send FREE catalog of complete EMC line and name of nearest distributor. RE-10

Name \_\_\_\_\_  
Address \_\_\_\_\_  
City \_\_\_\_\_  
State \_\_\_\_\_ Zip \_\_\_\_\_

**EMC**

ELECTRONIC MEASUREMENTS CORP.  
625 Broadway, New York, N.Y. 10012  
Export: Pan-Mar Corp. 1270 B way, N.Y., N.Y. 10001

# CB Troubleshooter's Casebook

Compiled by  
Andrew J. Mueller\*

**Case 1:** Distorted modulation and frequent modulator tube replacement.

**Common to:** ECI Fleet Courier.

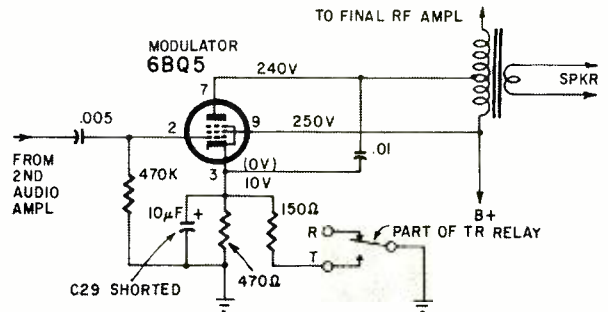

**Remedy:** Replace C29.

**Reasoning:** When C29 shorts, it removes bias from the 6BQ5. The tube now draws excessive plate current, causing premature tube failure. Modulation is distorted since the operating point shifts when bias is removed. The effect of this no-bias condition is that the output signal is not symmetrical with the input signal, hence the distortion. **R-E**

## VERTICAL POSITIONING TROUBLE IN SCOPE

I just built a kit scope. Now, I can't position the trace vertically, more than about 1 1/2 inches from the top or the bottom of the CRT. All of the voltages in the circuit check, except for the pin-2 grid of the 12BH7. Book says 8.5 volts to ground, and I've got 28 volts. The company service department gave me no encouragement, but they insist that I should have 8.5 volts at this point, as the book says. What's going on?—A. W., Albany, Ga.

Believe them. After all, they made the thing! Seriously, you can see that this much difference in voltage between these two tubes would cause a "difference" in the steady-state dc plate voltages, and a shift of the spot position. Looking at this circuit, I'd say that by taking out all tubes, you could measure voltages across that voltage divider (which is all that resistor string is) and tell where your trouble is really located. I'd tend to suspect a slight leakage (say about 20 volts worth) through that 0.1-µf coupling capacitor from the 6BQ7 plate. **R-E**

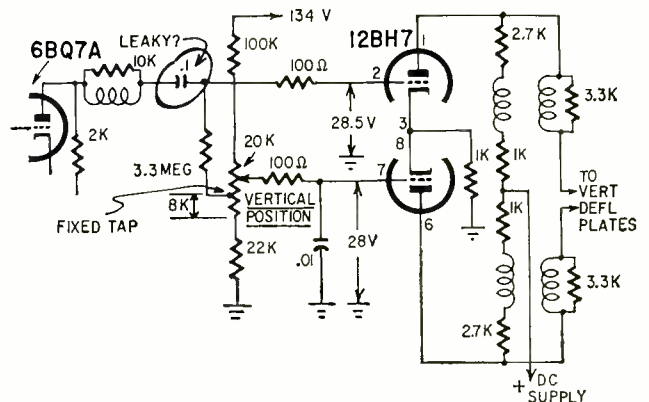



# Go on a quality kick

## You can afford it with these Outperformers

You give up nothing — except a high price — when you buy these quality performance Pioneer hi-fi units. Designed for the discriminating budget-minded buyer, they contain advanced engineering features and looks that put them in the class of much more expensive stereo components.

**SA-500 INTEGRATED STEREO AMPLIFIER** — The perfect starter unit for a stereo system, the all solid state SA-500 produces 44 watts of music power. Even at the highest crescendo, distortion is less than 0.5%. Two sets of inputs plus outputs for speakers, tape recording, loudness contour and a headset jack make it tops in versatility. \$99.95

**TX-500 AM-FM TUNER** — All solid state, its multiplex circuitry provides wide channel separation with excellent frequency response. An FET front end, combined with years-ahead design, assures high sensitivity and superb image

rejection. Containing advanced features that place it on a par with more expensive units, it is priced at \$99.95.

**SR-202 REVERBERATION AMPLIFIER** — The most dramatic new component in years! No matter what your system is, the SR-202 adds dimension and greater realism to your stereo sound than you can realize. The SR-202 increases the natural quality of your recordings and tapes. Reverberation can be added to an audio amplifier using one or two tape recorders, a record player, or a tuner. In fact, a total of 15 equipment combinations are possible. \$95.00

These three Pioneer Outperformers are each housed in a handsome cabinet with brushed chrome facing and Brazilian rosewood end pieces. Hear them in action at your local Pioneer dealer.



 **PIONEER**<sup>®</sup>

**PIONEER ELECTRONICS U.S.A. CORPORATION, 140 Smith Street, Farmingdale, N.Y. 11735 • (516) 694-7720**  
West Coast: 1335 W. 134th St., Gardena, Calif. 90249 (213) 323-2374 & 321-1076 • Canada: S. H. Parker Co., Prov. Ontario



Circle 44 on reader service card

# COLOR ORGAN

## ONE KILOWATT-FOUR CHANNELS

### ULTRA - COMPACT - LOW COST



Build Dancing Colored Lighting Displays That Leap And Sparkle In Ever Changing Color Combinations Of Red, Blue, Green And Yellow. Displays Which Dance In Rhythm And Intensity According To The Frequency Content Of The Musical Input Taken From The Loudspeaker Terminals Of Any Audio Amplifier.

#### YEAR ROUND ENJOYMENT

Hi-Fi Enhancement — Lawn Parties — Musical Groups — Display Advertising — Spectacular Christmas Displays.

Features: Tunable Active R-C Filters For Frequency Separation  
 • All Silicon Solid State Design  
 • Walnut Wood Grain Panel — Compact Bakelite Case That Measures Only 7 $\frac{3}{4}$ " x 4 $\frac{1}{2}$ " x 2 $\frac{1}{2}$ " Deep.

Easy to Assemble Printed Circuit Board Kit — \$49.95  
 Factory Assembled — \$65.00

Add \$2.00 For Handling And Shipping Costs  
 N. J. Residents Add 3% Sales Tax  
 (Payment Must Accompany Order)

**EDISON INSTRUMENTS, INC.**

54 West Cherry Street • Rahway, N. J. 07065  
 (201) 381-0140

Circle 45 on reader service card

# It's yours free

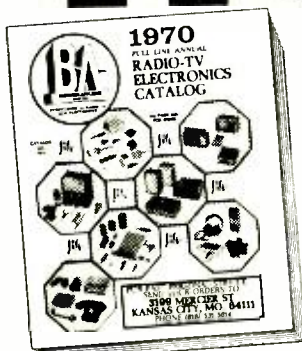

for the asking!

**GIANT 274 PAGE  
1970  
RADIO-TV  
ELECTRONICS  
CATALOG**

#### YOUR BUYING GUIDE FOR . . .

TV's, Radios, Recorders, Phonos, Amateur and CB equipment, electronic parts, tubes and test equipment . . . featuring B-A's famous big bargain packed section!

Write to:

**BURSTEIN-APPLEBEE CO.,**  
 DEPT. RE-J 3199 MERCIER ST.,  
 KANSAS CITY, MO. 64111

Name \_\_\_\_\_

Address \_\_\_\_\_

City \_\_\_\_\_

State \_\_\_\_\_

Zip Code \_\_\_\_\_



Circle 43 on reader service card

# TECHNOTES

## INTERFERENCE IN CHANNEL-8 PIX

In moderate to weak signal areas, Emerson color sets may exhibit interference in a channel-8 picture. It is due to the radiation of the 4th harmonic of the video i.f. from the leads connecting the aft IC on the PC board to the aft circuits in the tuner.

Take the following steps, in order, to eliminate or minimize the interference:

1. Check to see that the set is operating from a properly installed balanced 300-ohm antenna. If you are not certain as to whether or not the antenna system is properly balanced, use the resistive pad shown in the diagram between antenna lead-in and tuner input. It will show an improvement on an unbalanced antenna system.

2. Reduce the signal into the tuner using additional resistor pads. Dress the four leads connected between the aft IC and the tuner down and away from the 300-ohm shielded lead (going to the tuner input terminals) to reduce picture interference.

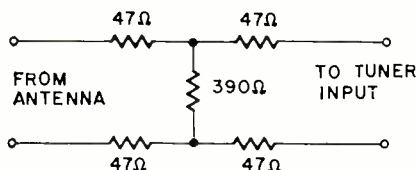

3. Disconnect the lead between pin 9 of the IC and the aft switch on the front panel.

4. Connect a fixed rf choke (Emerson part No. 705049 in series with each of the three remaining aft leads between the IC and the tuner. These chokes (3) should be connected in series with the leads at the PC board.

5. When interference persists, connect a small tunable trap (Emerson part No. 708542) between pin 2 of the IC and the PC board. Keep the leads as short as possible.

In most cases, it is only necessary to redress the aft leads between the IC and tuner. Signal strength is an important factor and picture interference can be eliminated or minimized by improving the pickup efficiency of the outdoor antenna. If the signal is too weak, the pad cannot be used to improve antenna balance, because it further attenuates the incoming signal.

If interference remains after the above steps have been taken, retune the secondary of the aft transformer very slightly (about  $\frac{1}{3}$  turn or less) to shift the tuning point away from the point of picture interference to an interference-free point.—Emerson Field Service Bulletin

## DISTORTION IN G-E TV PORTABLE

If the audio is initially good and becomes distorted in a few hours or if it is poor when the set is first turned on and gradually gets better, the trouble may be traced to the quadrature-coil tuning capacitor. This capacitor (C308 in S-2, P-2 and V-2 chassis and C307 in H-2 and G-1 chassis) has a negative temperature coefficient to compensate for temperature-produced drift in associated components. Distortion occurs when this capacitor does not track properly with temperature changes.

Replacement capacitors must have the proper temperature coefficient for distortion-free performance. In the chassis lister above, the capacitor should be 18 pF, 10% N470 (G-E catalog No. ET18X399).

After replacing the capacitor, realign the quad coil and then check the audio quality at two temperature extremes; when the set is cold and when it has reached normal operating temperature.—G-E Portafax

R-E



# NEW PRODUCTS

More information on new products is available from the manufacturers of items identified by a Reader Service number. Use the Reader Service Card at the left and circle the numbers of the new products on which you would like further information. Detach and mail the postage-paid card.

**AUTOMATIC TURNTABLES** Three models. *Model Minichanger* is designed for compact equipment installations, especially for shelf component systems. *Model 5500T* comes complete with base,



cartridge and diamond stylus. *Model 4700*, \$29.95, is ideal for replacement purposes.—**BSR (USA) Ltd.**, Blauvelt, N. Y.

Circle 46 on reader service card

**LAPEL MICROPHONE**, small and easily handheld, this crystal unit is ideal to be worn readily on a lapel or pocket. It



has an impedance rating of 85 K ohms and a sensitivity of -65 dB. \$1.25.—**Calectro, CC Electronics**, Rockford, Ill.

Circle 47 on reader service card

**STEREO RECEIVER SYSTEM, Model KRS-44**, solid state includes *Model KR-44*, receiver and two speakers. Receiver delivers 48 watts music power at 8 ohms. FM/AM tuner section features 2 FET's,

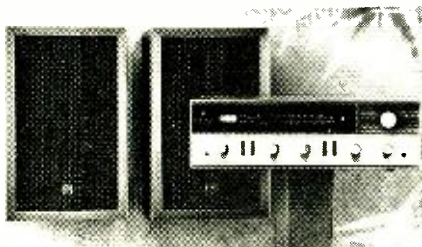

3-gang tuning capacitor and 2 IC i.f. circuits and offers either 75 or 300 ohms antenna input. The 6½" woofers and 3" cone-type tweeters provide a frequency response of 50-20,000 Hz, with an

impedance of 8 ohms. \$239.95.—**Kenwood Electronics Inc.**, Los Angeles, Calif.

Circle 48 on reader service card

**VU METER LINE** consisting of 9 models measures amplitude of studio signals in broadcast and recording applications. Units conform to all specs of ASA Stan-

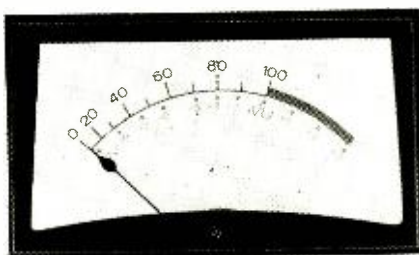

dard C16.5-1954. Attractive recessed-mounting meters available. Price range \$29.50-\$33.00.—**API Instruments Co.**, Chesterland, Ohio

Circle 49 on reader service card

**INSULATION STRIPPER, Model 40**, removes outer insulation of multiconductor cable within 0.060" to 0.250" without damaging inner shielding or conduc-

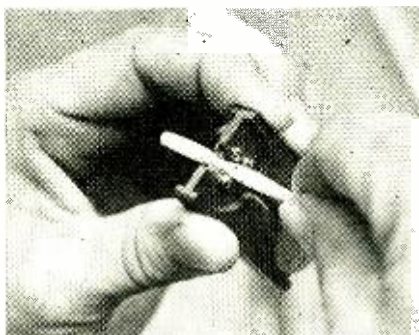

tor. Ideal for MIL 80144, Kynar, Tedlar and other high-temperature insulation except Teflon. \$19.80.—**MacDonald & Co.**, Glendale, Calif. 91204

Circle 50 on reader service card

**AUTO STEREO TAPE PLAYERS**, the *Untouchables* series, include a built-in



alarm system which triggers a loud alarm to frighten off would-be thieves in case

of an attempted burglary. Come in 12 models; 4- and 8-track tape players with/without FM radio, 8-track tape cartridge with FM radio, 4- and 8-track stereo players and compact 8-track players. Price range \$59.95-\$179.95.—**Tenna Corp.**, 19201 Cranwood Parkway, Cleveland, Ohio 44128

Circle 51 on reader service card

**RADIO CONTROL, Model Genie AC-24**, solid-state, 24-volt, can be used as garage-door opener system. Signal- from palm-sized transmitter are picked up by



receiver which activates door opener. Pushbutton on the transmitter controls garage door and light within a range of 100'.—**Alliance Mfg. Co.**, Dept. M1, Alliance, Ohio

Circle 52 on reader service card

**SOLDERING-IRON STAND** designed to hold instrument irons safely. Its sturdy spiral rack holds the iron at the proper grasping angle. Replaceable sponge with a cavity for holding excess dross, is kept



moist by a simple water-injection system. Translucent plastic water reservoir permits users to see when refilling is needed. Extra cavity opposite the reservoir holds spare tips.—**Hexacon Electric Co.**, Roselle Park, N.J.

Circle 53 on reader service card

**AM/FM CASSEIVER SYSTEM, Model 2560**, combines an AM/FM stereo receiver, cassette recorder and pair of speakers. Receiver section features FET circuitry, minimizing cross-modulation and drift. IC's are utilized both in the i.f. section and in the preamplifier. Cassette is powered by a precision synchronous ac motor, which cuts out annoying

# now... a better way to drive and adjust hex socket screws

## ...IN PRECISION WORK

With the tools in this new, compact convertible screwdriver set, you can turn all types of hex socket screws . . . in all types of locations . . . faster, easier than with conventional keys.

Handy midgets are ideal for such delicate, precision work as assembly and servicing of instruments and controls. Remarkable "piggyback" torque amplifier handle adds grip, reach, and power needed for other applications, lets you do more jobs with fewer tools.

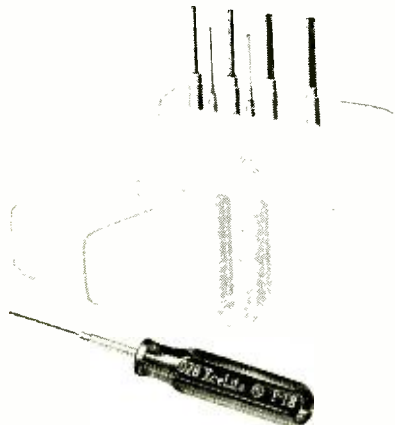

### PS-89 SET

8 midgets (hex size .028" thru 1/8") plus hollow, "piggyback" handle. Slim, trim, see-thru plastic case fits pocket or tool box, doubles as bench stand.



### REQUEST COMPLETE HAND TOOL CATALOG

which includes information on other Xcelite Compact Sets, too — slot tip/ Phillips/Scrulox® screwdrivers, nutdrivers, and combinations.



Nationwide availability through local distributor

XCELITE, INC., 10 Bank St., Orchard Park, N. Y. 14127  
In Canada contact Charles W. Pointon, Ltd.

Circle 106 on reader service card

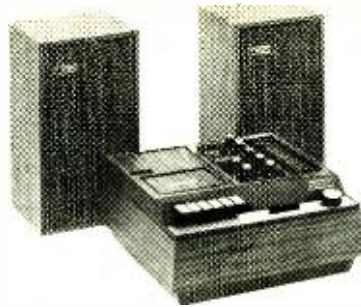

flutter and wow. \$399.95—H. H. Scott Inc., Maynard, Mass. 01754

Circle 54 on reader service card

Write direct to the manufacturers for information on items listed below:

**POWER AMPLIFIER, Model Stereo 80,** is rated at 40 watts continuous rms power

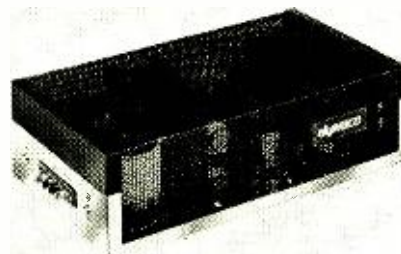

per channel across the entire audio spectrum with both channels driven simul-

taneously into 8 ohms. Harmonic distortion 0.5% and IM under 0.1% at rated output. \$159.95 factory-assembled. \$119.95 kit form.—Dynaco Div., Philadelphia, Pa.

**COMMUNICATIONS RECEIVERS, The Mark 6,** solid state, and crystal controlled are available in one-, two- and six-frequency models. Model *Scan-O-Matic*, six-channelled, automatically scans frequencies installed every half

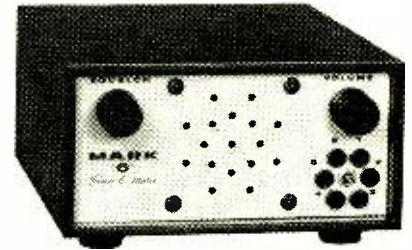

second and locks on to the active frequency until carrier is released. Sensitivity, 0.8  $\mu$ V for 20 dB quieting. Selectivity, 6 dB  $\pm$ 12 kHz. Power requirements, 117 Vac or 12 Vdc.—Sonic Industries Inc., Indianapolis, Ind.

**HIFI CABINET Model 303,** crafted from genuine hardwood and finished in oiled walnut, features two adjustable component shelves (17 3/4" x 15"), a changer/turntable shelf (17 3/4" x 15") that glides out on ball-bearing slides and a speaker compartment (25 3/4" x 16 3/4" x 14"). Overall dimension, 32 3/4" x

## ELECTRONICS DATA GUIDE

<b>Conversion Factors and Constants</b>	<b>Equal Resistors in Parallel</b>
1 mil = .001	$R_{total} = R/n$ where n is the number of resistors
1 meter = 1000 millimeters	<b>Resistors in Parallel, General Formula</b>
1 inch = 2.54 centimeters	$R_{total} = \frac{1}{\frac{1}{R_1} + \frac{1}{R_2} + \dots}$
1 hour = 60 minutes	<b>Resistors in Series</b>
1 day = 24 hours	$R_{total} = R_1 + R_2 + \dots$
1 year = 365 days	<b>Resistors in Series-Parallel</b>
	$R_{total} = R_1 + \frac{R_2 \times R_3}{R_2 + R_3} + \dots$
	<b>Resistors in Parallel-Series</b>
	$R_{total} = \frac{R_1 \times R_2}{R_1 + R_2} + R_3 + \dots$
	<b>Resistors in Series-Parallel-Series</b>
	$R_{total} = R_1 + \frac{R_2 \times R_3}{R_2 + R_3} + R_4 + \dots$
	<b>Resistors in Parallel-Series-Parallel</b>
	$R_{total} = \frac{R_1 \times R_2}{R_1 + R_2} + R_3 + \frac{R_4 \times R_5}{R_4 + R_5} + \dots$
	<b>Resistors in Parallel-Series-Parallel-Series</b>
	$R_{total} = \frac{R_1 \times R_2}{R_1 + R_2} + R_3 + \frac{R_4 \times R_5}{R_4 + R_5} + R_6 + \dots$
	<b>Resistors in Parallel-Series-Parallel-Series-Parallel</b>
	$R_{total} = \frac{R_1 \times R_2}{R_1 + R_2} + R_3 + \frac{R_4 \times R_5}{R_4 + R_5} + R_6 + \frac{R_7 \times R_8}{R_7 + R_8} + \dots$
	<b>Resistors in Parallel-Series-Parallel-Series-Parallel-Series</b>
	$R_{total} = \frac{R_1 \times R_2}{R_1 + R_2} + R_3 + \frac{R_4 \times R_5}{R_4 + R_5} + R_6 + \frac{R_7 \times R_8}{R_7 + R_8} + R_9 + \dots$
	<b>Resistors in Parallel-Series-Parallel-Series-Parallel-Series-Parallel</b>
	$R_{total} = \frac{R_1 \times R_2}{R_1 + R_2} + R_3 + \frac{R_4 \times R_5}{R_4 + R_5} + R_6 + \frac{R_7 \times R_8}{R_7 + R_8} + R_9 + \frac{R_{10} \times R_{11}}{R_{10} + R_{11}} + \dots$
	<b>Resistors in Parallel-Series-Parallel-Series-Parallel-Series-Parallel-Series</b>
	$R_{total} = \frac{R_1 \times R_2}{R_1 + R_2} + R_3 + \frac{R_4 \times R_5}{R_4 + R_5} + R_6 + \frac{R_7 \times R_8}{R_7 + R_8} + R_9 + \frac{R_{10} \times R_{11}}{R_{10} + R_{11}} + R_{12} + \dots$
	<b>Resistors in Parallel-Series-Parallel-Series-Parallel-Series-Parallel-Series-Parallel</b>
	$R_{total} = \frac{R_1 \times R_2}{R_1 + R_2} + R_3 + \frac{R_4 \times R_5}{R_4 + R_5} + R_6 + \frac{R_7 \times R_8}{R_7 + R_8} + R_9 + \frac{R_{10} \times R_{11}}{R_{10} + R_{11}} + R_{12} + \frac{R_{13} \times R_{14}}{R_{13} + R_{14}} + \dots$
	<b>Resistors in Parallel-Series-Parallel-Series-Parallel-Series-Parallel-Series-Parallel-Series</b>
	$R_{total} = \frac{R_1 \times R_2}{R_1 + R_2} + R_3 + \frac{R_4 \times R_5}{R_4 + R_5} + R_6 + \frac{R_7 \times R_8}{R_7 + R_8} + R_9 + \frac{R_{10} \times R_{11}}{R_{10} + R_{11}} + R_{12} + \frac{R_{13} \times R_{14}}{R_{13} + R_{14}} + R_{15} + \dots$
	<b>Resistors in Parallel-Series-Parallel-Series-Parallel-Series-Parallel-Series-Parallel-Series-Parallel</b>
	$R_{total} = \frac{R_1 \times R_2}{R_1 + R_2} + R_3 + \frac{R_4 \times R_5}{R_4 + R_5} + R_6 + \frac{R_7 \times R_8}{R_7 + R_8} + R_9 + \frac{R_{10} \times R_{11}}{R_{10} + R_{11}} + R_{12} + \frac{R_{13} \times R_{14}}{R_{13} + R_{14}} + R_{15} + \frac{R_{16} \times R_{17}}{R_{16} + R_{17}} + \dots$
	<b>Resistors in Parallel-Series-Parallel-Series-Parallel-Series-Parallel-Series-Parallel-Series-Parallel-Series</b>
	$R_{total} = \frac{R_1 \times R_2}{R_1 + R_2} + R_3 + \frac{R_4 \times R_5}{R_4 + R_5} + R_6 + \frac{R_7 \times R_8}{R_7 + R_8} + R_9 + \frac{R_{10} \times R_{11}}{R_{10} + R_{11}} + R_{12} + \frac{R_{13} \times R_{14}}{R_{13} + R_{14}} + R_{15} + \frac{R_{16} \times R_{17}}{R_{16} + R_{17}} + R_{18} + \dots$
	<b>Resistors in Parallel-Series-Parallel-Series-Parallel-Series-Parallel-Series-Parallel-Series-Parallel-Series-Parallel</b>
	$R_{total} = \frac{R_1 \times R_2}{R_1 + R_2} + R_3 + \frac{R_4 \times R_5}{R_4 + R_5} + R_6 + \frac{R_7 \times R_8}{R_7 + R_8} + R_9 + \frac{R_{10} \times R_{11}}{R_{10} + R_{11}} + R_{12} + \frac{R_{13} \times R_{14}}{R_{13} + R_{14}} + R_{15} + \frac{R_{16} \times R_{17}}{R_{16} + R_{17}} + R_{18} + \frac{R_{19} \times R_{20}}{R_{19} + R_{20}} + \dots$
	<b>Resistors in Parallel-Series-Parallel-Series-Parallel-Series-Parallel-Series-Parallel-Series-Parallel-Series-Parallel-Series</b>
	$R_{total} = \frac{R_1 \times R_2}{R_1 + R_2} + R_3 + \frac{R_4 \times R_5}{R_4 + R_5} + R_6 + \frac{R_7 \times R_8}{R_7 + R_8} + R_9 + \frac{R_{10} \times R_{11}}{R_{10} + R_{11}} + R_{12} + \frac{R_{13} \times R_{14}}{R_{13} + R_{14}} + R_{15} + \frac{R_{16} \times R_{17}}{R_{16} + R_{17}} + R_{18} + \frac{R_{19} \times R_{20}}{R_{19} + R_{20}} + R_{21} + \dots$
	<b>Resistors in Parallel-Series-Parallel-Series-Parallel-Series-Parallel-Series-Parallel-Series-Parallel-Series-Parallel-Series-Parallel</b>
	$R_{total} = \frac{R_1 \times R_2}{R_1 + R_2} + R_3 + \frac{R_4 \times R_5}{R_4 + R_5} + R_6 + \frac{R_7 \times R_8}{R_7 + R_8} + R_9 + \frac{R_{10} \times R_{11}}{R_{10} + R_{11}} + R_{12} + \frac{R_{13} \times R_{14}}{R_{13} + R_{14}} + R_{15} + \frac{R_{16} \times R_{17}}{R_{16} + R_{17}} + R_{18} + \frac{R_{19} \times R_{20}}{R_{19} + R_{20}} + R_{21} + \frac{R_{22} \times R_{23}}{R_{22} + R_{23}} + \dots$
	<b>Resistors in Parallel-Series-Parallel-Series-Parallel-Series-Parallel-Series-Parallel-Series-Parallel-Series-Parallel-Series-Parallel-Series</b>
	$R_{total} = \frac{R_1 \times R_2}{R_1 + R_2} + R_3 + \frac{R_4 \times R_5}{R_4 + R_5} + R_6 + \frac{R_7 \times R_8}{R_7 + R_8} + R_9 + \frac{R_{10} \times R_{11}}{R_{10} + R_{11}} + R_{12} + \frac{R_{13} \times R_{14}}{R_{13} + R_{14}} + R_{15} + \frac{R_{16} \times R_{17}}{R_{16} + R_{17}} + R_{18} + \frac{R_{19} \times R_{20}}{R_{19} + R_{20}} + R_{21} + \frac{R_{22} \times R_{23}}{R_{22} + R_{23}} + R_{24} + \dots$
	<b>Resistors in Parallel-Series-Parallel-Series-Parallel-Series-Parallel-Series-Parallel-Series-Parallel-Series-Parallel-Series-Parallel-Series-Parallel</b>
	$R_{total} = \frac{R_1 \times R_2}{R_1 + R_2} + R_3 + \frac{R_4 \times R_5}{R_4 + R_5} + R_6 + \frac{R_7 \times R_8}{R_7 + R_8} + R_9 + \frac{R_{10} \times R_{11}}{R_{10} + R_{11}} + R_{12} + \frac{R_{13} \times R_{14}}{R_{13} + R_{14}} + R_{15} + \frac{R_{16} \times R_{17}}{R_{16} + R_{17}} + R_{18} + \frac{R_{19} \times R_{20}}{R_{19} + R_{20}} + R_{21} + \frac{R_{22} \times R_{23}}{R_{22} + R_{23}} + R_{24} + \frac{R_{25} \times R_{26}}{R_{25} + R_{26}} + \dots$
	<b>Resistors in Parallel-Series-Parallel-Series-Parallel-Series-Parallel-Series-Parallel-Series-Parallel-Series-Parallel-Series-Parallel-Series-Parallel-Series</b>
	$R_{total} = \frac{R_1 \times R_2}{R_1 + R_2} + R_3 + \frac{R_4 \times R_5}{R_4 + R_5} + R_6 + \frac{R_7 \times R_8}{R_7 + R_8} + R_9 + \frac{R_{10} \times R_{11}}{R_{10} + R_{11}} + R_{12} + \frac{R_{13} \times R_{14}}{R_{13} + R_{14}} + R_{15} + \frac{R_{16} \times R_{17}}{R_{16} + R_{17}} + R_{18} + \frac{R_{19} \times R_{20}}{R_{19} + R_{20}} + R_{21} + \frac{R_{22} \times R_{23}}{R_{22} + R_{23}} + R_{24} + \frac{R_{25} \times R_{26}}{R_{25} + R_{26}} + R_{27} + \dots$
	<b>Resistors in Parallel-Series-Parallel-Series-Parallel-Series-Parallel-Series-Parallel-Series-Parallel-Series-Parallel-Series-Parallel-Series-Parallel-Series-Parallel</b>
	$R_{total} = \frac{R_1 \times R_2}{R_1 + R_2} + R_3 + \frac{R_4 \times R_5}{R_4 + R_5} + R_6 + \frac{R_7 \times R_8}{R_7 + R_8} + R_9 + \frac{R_{10} \times R_{11}}{R_{10} + R_{11}} + R_{12} + \frac{R_{13} \times R_{14}}{R_{13} + R_{14}} + R_{15} + \frac{R_{16} \times R_{17}}{R_{16} + R_{17}} + R_{18} + \frac{R_{19} \times R_{20}}{R_{19} + R_{20}} + R_{21} + \frac{R_{22} \times R_{23}}{R_{22} + R_{23}} + R_{24} + \frac{R_{25} \times R_{26}}{R_{25} + R_{26}} + R_{27} + \frac{R_{28} \times R_{29}}{R_{28} + R_{29}} + \dots$
	<b>Resistors in Parallel-Series-Parallel-Series-Parallel-Series-Parallel-Series-Parallel-Series-Parallel-Series-Parallel-Series-Parallel-Series-Parallel-Series-Parallel-Series</b>
	$R_{total} = \frac{R_1 \times R_2}{R_1 + R_2} + R_3 + \frac{R_4 \times R_5}{R_4 + R_5} + R_6 + \frac{R_7 \times R_8}{R_7 + R_8} + R_9 + \frac{R_{10} \times R_{11}}{R_{10} + R_{11}} + R_{12} + \frac{R_{13} \times R_{14}}{R_{13} + R_{14}} + R_{15} + \frac{R_{16} \times R_{17}}{R_{16} + R_{17}} + R_{18} + \frac{R_{19} \times R_{20}}{R_{19} + R_{20}} + R_{21} + \frac{R_{22} \times R_{23}}{R_{22} + R_{23}} + R_{24} + \frac{R_{25} \times R_{26}}{R_{25} + R_{26}} + R_{27} + \frac{R_{28} \times R_{29}}{R_{28} + R_{29}} + R_{30} + \dots$
	<b>Resistors in Parallel-Series-Parallel-Series-Parallel-Series-Parallel-Series-Parallel-Series-Parallel-Series-Parallel-Series-Parallel-Series-Parallel-Series-Parallel-Series-Parallel</b>
	$R_{total} = \frac{R_1 \times R_2}{R_1 + R_2} + R_3 + \frac{R_4 \times R_5}{R_4 + R_5} + R_6 + \frac{R_7 \times R_8}{R_7 + R_8} + R_9 + \frac{R_{10} \times R_{11}}{R_{10} + R_{11}} + R_{12} + \frac{R_{13} \times R_{14}}{R_{13} + R_{14}} + R_{15} + \frac{R_{16} \times R_{17}}{R_{16} + R_{17}} + R_{18} + \frac{R_{19} \times R_{20}}{R_{19} + R_{20}} + R_{21} + \frac{R_{22} \times R_{23}}{R_{22} + R_{23}} + R_{24} + \frac{R_{25} \times R_{26}}{R_{25} + R_{26}} + R_{27} + \frac{R_{28} \times R_{29}}{R_{28} + R_{29}} + R_{30} + \frac{R_{31} \times R_{32}}{R_{31} + R_{32}} + \dots$
	<b>Resistors in Parallel-Series-Parallel-Series-Parallel-Series-Parallel-Series-Parallel-Series-Parallel-Series-Parallel-Series-Parallel-Series-Parallel-Series-Parallel-Series-Parallel-Series</b>
	$R_{total} = \frac{R_1 \times R_2}{R_1 + R_2} + R_3 + \frac{R_4 \times R_5}{R_4 + R_5} + R_6 + \frac{R_7 \times R_8}{R_7 + R_8} + R_9 + \frac{R_{10} \times R_{11}}{R_{10} + R_{11}} + R_{12} + \frac{R_{13} \times R_{14}}{R_{13} + R_{14}} + R_{15} + \frac{R_{16} \times R_{17}}{R_{16} + R_{17}} + R_{18} + \frac{R_{19} \times R_{20}}{R_{19} + R_{20}} + R_{21} + \frac{R_{22} \times R_{23}}{R_{22} + R_{23}} + R_{24} + \frac{R_{25} \times R_{26}}{R_{25} + R_{26}} + R_{27} + \frac{R_{28} \times R_{29}}{R_{28} + R_{29}} + R_{30} + \frac{R_{31} \times R_{32}}{R_{31} + R_{32}} + R_{32} + \dots$
	<b>Resistors in Parallel-Series-Parallel-Series-Parallel-Series-Parallel-Series-Parallel-Series-Parallel-Series-Parallel-Series-Parallel-Series-Parallel-Series-Parallel-Series-Parallel-Series-Parallel</b>
	$R_{total} = \frac{R_1 \times R_2}{R_1 + R_2} + R_3 + \frac{R_4 \times R_5}{R_4 + R_5} + R_6 + \frac{R_7 \times R_8}{R_7 + R_8} + R_9 + \frac{R_{10} \times R_{11}}{R_{10} + R_{11}} + R_{12} + \frac{R_{13} \times R_{14}}{R_{13} + R_{14}} + R_{15} + \frac{R_{16} \times R_{17}}{R_{16} + R_{17}} + R_{18} + \frac{R_{19} \times R_{20}}{R_{19} + R_{20}} + R_{21} + \frac{R_{22} \times R_{23}}{R_{22} + R_{23}} + R_{24} + \frac{R_{25} \times R_{26}}{R_{25} + R_{26}} + R_{27} + \frac{R_{28} \times R_{29}}{R_{28} + R_{29}} + R_{30} + \frac{R_{31} \times R_{32}}{R_{31} + R_{32}} + R_{32} + \frac{R_{33} \times R_{34}}{R_{33} + R_{34}} + \dots$
	<b>Resistors in Parallel-Series-Parallel-Series-Parallel-Series-Parallel-Series-Parallel-Series-Parallel-Series-Parallel-Series-Parallel-Series-Parallel-Series-Parallel-Series-Parallel-Series-Parallel-Series</b>
	$R_{total} = \frac{R_1 \times R_2}{R_1 + R_2} + R_3 + \frac{R_4 \times R_5}{R_4 + R_5} + R_6 + \frac{R_7 \times R_8}{R_7 + R_8} + R_9 + \frac{R_{10} \times R_{11}}{R_{10} + R_{11}} + R_{12} + \frac{R_{13} \times R_{14}}{R_{13} + R_{14}} + R_{15} + \frac{R_{16} \times R_{17}}{R_{16} + R_{17}} + R_{18} + \frac{R_{19} \times R_{20}}{R_{19} + R_{20}} + R_{21} + \frac{R_{22} \times R_{23}}{R_{22} + R_{23}} + R_{24} + \frac{R_{25} \times R_{26}}{R_{25} + R_{26}} + R_{27} + \frac{R_{28} \times R_{29}}{R_{28} + R_{29}} + R_{30} + \frac{R_{31} \times R_{32}}{R_{31} + R_{32}} + R_{32} + \frac{R_{33} \times R_{34}}{R_{33} + R_{34}} + R_{34} + \dots$
	<b>Resistors in Parallel-Series-Parallel-Series-Parallel-Series-Parallel-Series-Parallel-Series-Parallel-Series-Parallel-Series-Parallel-Series-Parallel-Series-Parallel-Series-Parallel-Series-Parallel-Series-Parallel</b>
	$R_{total} = \frac{R_1 \times R_2}{R_1 + R_2} + R_3 + \frac{R_4 \times R_5}{R_4 + R_5} + R_6 + \frac{R_7 \times R_8}{R_7 + R_8} + R_9 + \frac{R_{10} \times R_{11}}{R_{10} + R_{11}} + R_{12} + \frac{R_{13} \times R_{14}}{R_{13} + R_{14}} + R_{15} + \frac{R_{16} \times R_{17}}{R_{16} + R_{17}} + R_{18} + \frac{R_{19} \times R_{20}}{R_{19} + R_{20}} + R_{21} + \frac{R_{22} \times R_{23}}{R_{22} + R_{23}} + R_{24} + \frac{R_{25} \times R_{26}}{R_{25} + R_{26}} + R_{27} + \frac{R_{28} \times R_{29}}{R_{28} + R_{29}} + R_{30} + \frac{R_{31} \times R_{32}}{R_{31} + R_{32}} + R_{32} + \frac{R_{33} \times R_{34}}{R_{33} + R_{34}} + R_{34} + \frac{R_{35} \times R_{36}}{R_{35} + R_{36}} + \dots$
	<b>Resistors in Parallel-Series-Parallel-Series-Parallel-Series-Parallel-Series-Parallel-Series-Parallel-Series-Parallel-Series-Parallel-Series-Parallel-Series-Parallel-Series-Parallel-Series-Parallel-Series-Parallel-Series</b>
	$R_{total} = \frac{R_1 \times R_2}{R_1 + R_2} + R_3 + \frac{R_4 \times R_5}{R_4 + R_5} + R_6 + \frac{R_7 \times R_8}{R_7 + R_8} + R_9 + \frac{R_{10} \times R_{11}}{R_{10} + R_{11}} + R_{12} + \frac{R_{13} \times R_{14}}{R_{13} + R_{14}} + R_{15} + \frac{R_{16} \times R_{17}}{R_{16} + R_{17}} + R_{18} + \frac{R_{19} \times R_{20}}{R_{19} + R_{20}} + R_{21} + \frac{R_{22} \times R_{23}}{R_{22} + R_{23}} + R_{24} + \frac{R_{25} \times R_{26}}{R_{25} + R_{26}} + R_{27} + \frac{R_{28} \times R_{29}}{R_{28} + R_{29}} + R_{30} + \frac{R_{31} \times R_{32}}{R_{31} + R_{32}} + R_{32} + \frac{R_{33} \times R_{34}}{R_{33} + R_{34}} + R_{34} + \frac{R_{35} \times R_{36}}{R_{35} + R_{36}} + R_{36} + \dots$
	<b>Resistors in Parallel-Series-Parallel-Series-Parallel-Series-Parallel-Series-Parallel-Series-Parallel-Series-Parallel-Series-Parallel-Series-Parallel-Series-Parallel-Series-Parallel-Series-Parallel-Series-Parallel-Series-Parallel</b>
	$R_{total} = \frac{R_1 \times R_2}{R_1 + R_2} + R_3 + \frac{R_4 \times R_5}{R_4 + R_5} + R_6 + \frac{R_7 \times R_8}{R_7 + R_8} + R_9 + \frac{R_{10} \times R_{11}}{R_{10} + R_{11}} + R_{12} + \frac{R_{13} \times R_{14}}{R_{13} + R_{14}} + R_{15} + \frac{R_{16} \times R_{17}}{R_{16} + R_{17}} + R_{18} + \frac{R_{19} \times R_{20}}{R_{19} + R_{20}} + R_{21} + \frac{R_{22} \times R_{23}}{R_{22} + R_{23}} + R_{24} + \frac{R_{25} \times R_{26}}{R_{25} + R_{26}} + R_{27} + \frac{R_{28} \times R_{29}}{R_{28} + R_{29}} + R_{30} + \frac{R_{31} \times R_{32}}{R_{31} + R_{32}} + R_{32} + \frac{R_{33} \times R_{34}}{R_{33} + R_{34}} + R_{34} + \frac{R_{35} \times R_{36}}{R_{35} + R_{36}} + R_{36} + \frac{R_{37} \times R_{38}}{R_{37} + R_{38}} + \dots$
	<b>Resistors in Parallel-Series-Parallel-Series-Parallel-Series-Parallel-Series-Parallel-Series-Parallel-Series-Parallel-Series-Parallel-Series-Parallel-Series-Parallel-Series-Parallel-Series-Parallel-Series-Parallel-Series-Parallel-Series</b>
	$R_{total} = \frac{R_1 \times R_2}{R_1 + R_2} + R_3 + \frac{R_4 \times R_5}{R_4 + R_5} + R_6 + \frac{R_7 \times R_8}{R_7 + R_8} + R_9 + \frac{R_{10} \times R_{11}}{R_{10} + R_{11}} + R_{12} + \frac{R_{13} \times R_{14}}{R_{13} + R_{14}} + R_{15} + \frac{R_{16} \times R_{17}}{R_{16} + R_{17}} + R_{18} + \frac{R_{19} \times R_{20}}{R_{19} + R_{20}} + R_{21} + \frac{R_{22} \times R_{23}}{R_{22} + R_{23}} + R_{24} + \frac{R_{25} \times R_{26}}{R_{25} + R_{26}} + R_{27} + \frac{R_{28} \times R_{29}}{R_{28} + R_{29}} + R_{30} + \frac{R_{31} \times R_{32}}{R_{31} + R_{32}} + R_{32} + \frac{R_{33} \times R_{34}}{R_{33} + R_{34}} + R_{34} + \frac{R_{35} \times R_{36}}{R_{35} + R_{36}} + R_{36} + \frac{R_{37} \times R_{38}}{R_{37} + R_{38}} + R_{38} + \dots$
	<b>Resistors in Parallel-Series-Parallel-Series-Parallel-Series-Parallel-Series-Parallel-Series-Parallel-Series-Parallel-Series-Parallel-Series-Parallel-Series-Parallel-Series-Parallel-Series-Parallel-Series-Parallel-Series-Parallel-Series-Parallel</b>
	$R_{total} = \frac{R_1 \times R_2}{R_1 + R_2} + R_3 + \frac{R_4 \times R_5}{R_4 + R_5} + R_6 + \frac{R_7 \times R_8}{R_7 + R_8} + R_9 + \frac{R_{10} \times R_{11}}{R_{10} + R_{11}} + R_{12} + \frac{R_{13} \times R_{14}}{R_{13} + R_{14}} + R_{15} + \frac{R_{16} \times R_{17}}{R_{16} + R_{17}} + R_{18} + \frac{R_{19} \times R_{20}}{R_{19} + R_{20}} + R_{21} + \frac{R_{22} \times R_{23}}{R_{22} + R_{23}} + R_{24} + \frac{R_{25} \times R_{26}}{R_{25} + R_{26}} + R_{27} + \frac{R_{28} \times R_{29}}{R_{28} + R_{29}} + R_{30} + \frac{R_{31} \times R_{32}}{R_{31} + R_{32}} + R_{32} + \frac{R_{33} \times R_{34}}{R_{33} + R_{34}} + R_{34} + \frac{R_{35} \times R_{36}}{R_{35} + R_{36}} + R_{36} + \frac{R_{37} \times R_{38}}{R_{37} + R_{38}} + R_{38} + \frac{R_{39} \times R_{40}}{R_{39} + R_{40}} + \dots$
	<b>Resistors in Parallel-Series-Parallel-Series-Parallel-Series-Parallel-Series-Parallel-Series-Parallel-Series-Parallel-Series-Parallel-Series-Parallel-Series-Parallel-Series-Parallel-Series-Parallel-Series-Parallel-Series-Parallel-Series-Parallel-Series</b>
	$R_{total} = \frac{R_1 \times R_2}{R_1 + R_2} + R_3 + \frac{R_4 \times R_5}{R_4 + R_5} + R_6 + \frac{R_7 \times R_8}{R_7 + R_8} + R_9 + \frac{R_{10} \times R_{11}}{R_{10} + R_{11}} + R_{12} + \frac{R_{13} \times R_{14}}{R_{13} + R_{14}} + R_{15} + \frac{R_{16} \times R_{17}}{R_{16} + R_{17}} + R_{18} + \frac{R_{19} \times R_{20}}{R_{19} + R_{20}} + R_{21} + \frac{R_{22} \times R_{23}}{R_{22} + R_{23}} + R_{24} + \frac{R_{25} \times R_{26}}{R_{25} + R_{26}} + R_{27} + \frac{R_{28} \times R_{29}}{R_{28} + R_{29}} + R_{30} + \frac{R_{31} \times R_{32}}{R_{31} + R_{32}} + R_{32} + \frac{R_{33} \times R_{34}}{R_{33} + R_{34}} + R_{34} + \frac{R_{35} \times R_{36}}{R_{35} + R_{36}} + R_{36} + \frac{R_{37} \times R_{38}}{R_{37} + R_{38}} + R_{38} + \frac{R_{39} \times R_{40}}{R_{39} + R_{40}} + R_{40} + \dots$
	<b>Resistors in Parallel-Series-Parallel-Series-Parallel-Series-Parallel-Series-Parallel-Series-Parallel-Series-Parallel-Series-Parallel-Series-Parallel-Series-Parallel-Series-Parallel-Series-Parallel-Series-Parallel-Series-Parallel-Series-Parallel-Series-Parallel</b>
	$R_{total} = \frac{R_1 \times R_2}{R_1 + R_2} + R_3 + \frac{R_4 \times R_5}{R_4 + R_5} + R_6 + \frac{R_7 \times R_8}{R_7 + R_8} + R_9 + \frac{R_{10} \times R_{11}}{R_{10} + R_{11}} + R_{12} + \frac{R_{13} \times R_{14}}{R_{13} + R_{14}} + R_{15} + \frac{R_{16} \times R_{17}}{R_{16} + R_{17}} + R_{18} + \frac{R_{19} \times R_{20}}{R_{19} + R_{20}} + R_{21} + \frac{R_{22} \times R_{23}}{R_{22} + R_{23}} + R_{24} + \frac{R_{25} \times R_{26}}{R_{25} + R_{26}} + R_{27} + \frac{R_{28} \times R_{29}}{R_{28} + R_{29}} + R_{30} + \frac{R_{31} \times R_{32}}{R_{31} + R_{32}} + R_{32} + \frac{R_{33} \times R_{34}}{R_{33} + R_{34}} + R_{34} + \frac{R_{35} \times R_{36}}{R_{35} + R_{36}} + R_{36} + \frac{R_{37} \times R_{38}}{R_{37} + R_{38}} + R_{38} + \frac{R_{39} \times R_{40}}{R_{39} + R_{40}} + R_{40} + \frac{R_{41} \times R_{42}}{R_{41$



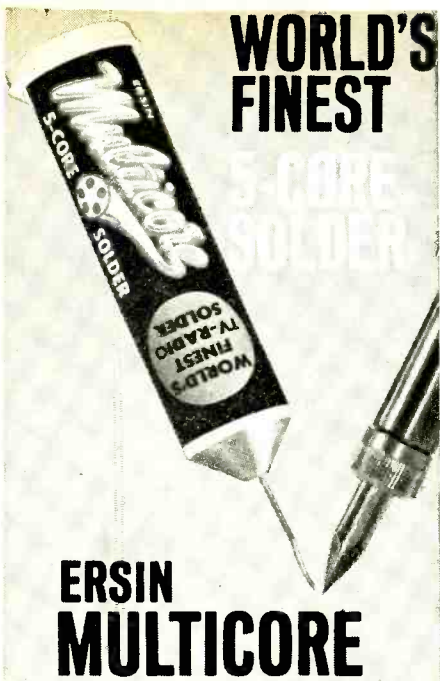

**WORLD'S FINEST**

**ERSIN MULTICORE**

**ONLY 69¢**

BUY IT AT RADIO-TV PARTS STORES  
 MULTICORE SALES CORP. WESTBURY, N.Y. 11590  
 Circle 128 on reader service card

# the new SANSUI AU555

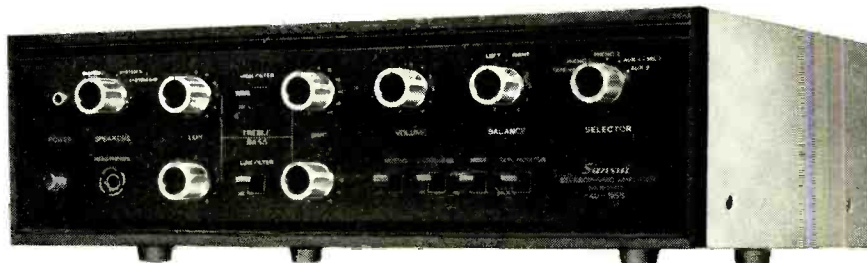

The AU555 by Sansui is an outstanding, professional control amplifier. 60 watts (IHF) of music power, bandwidth from 20 to 30,000 Hz and a distortion factor of less than 0.5% assure you of clean sound reproduction. The Sansui AU555 offers almost unlimited versatility with its pre- and main amplifier sections designed for independent usage, 2-adjustable speaker damping factors, 4-position speaker selector switch, 4-outputs and 7-inputs, and much, much more . . . At your franchised Sansui dealer. \$159.95.

**Sansui®**

SANSUI ELECTRONICS CORP. Woodside, New York. 11377 • Los Angeles, California. 90007  
 SANSUI Electric Co., Ltd., Tokyo, Japan • European Office Frankfurt a.M., West Germany  
 Circle 110 on reader service card

**EDI**

**THOUSANDS OF BARGAINS—TOP VALUES IN Electronic Parts**

Transistors, Modules, Speakers, Stereo, Hi-Fi, Photo Cells and thousands of other Electronic Parts. Send for **FREE** Catalog

**ELECTRONIC DISTRIBUTORS INC.**  
 Dept. TA-2, 4900 Elston  
 Chicago, Ill. 60630

RUSH CATALOG

Name \_\_\_\_\_  
 Address \_\_\_\_\_  
 City \_\_\_\_\_ State \_\_\_\_\_ Zip Code \_\_\_\_\_

Circle 109 on reader service card

**MODEL 4000**

**Mercury FIELD EFFECT METER**  
 COMBINES THE FINEST FEATURES OF THE VTVM & VOLT-OHMS MILLIAMMETER

- .300 V. FULL SCALE DC
- LARGE 6" METER
- AC and BATTERY OPERATED
- HIGH IMPEDANCE (11 MEGS DC)
- 5 DC CURRENT RANGES

Solid State — so there's NO WARM UP! • NO DRIFT!  
 • NO INTERNAL HEAT TO UPSET STABILITY!  
 • ISOLATION FROM AC LINE!

**ONLY 79<sup>95</sup>**  
 WIRED

Includes: AC-OHMS/DC Probe  
 Power Requirements: 115 V 50/60 Hz, 3W  
 7½ x 6½ x 4 — 3 lbs.

All Mercury Test Equipment Guaranteed For One Full Year!  
 Write for complete catalog of Mercury Test and Repair instruments, and name of your nearest dealer.

**MERCURY ELECTRONICS CORPORATION**  
 315 Roslyn Road • Mineola, N.Y. 11501 • (516) 742-5400  
 CANADA: William Cohen Corp. • 8900 Park Avenue • Montreal-11

Circle 111 on reader service card

# America's Top-Rated Stereo Kits Now a Best Buy!\*



- \*LT-112B-1  
FM Stereo Monitor Tuner Kit:  
Now \$149.95
- LK-60B  
160-Watt Stereo Amplifier Kit:  
Now \$149.95
- LR-88  
135-Watt AM/FM Stereo Receiver Kit:  
Now \$299.95

**SCOTT**

Write for new Scott Kit Catalog.  
H. H. Scott, Inc., 111 Powdermill Road,  
Maynard, Mass. 01754. © 1969, H. H. Scott, Inc.

**POPULAR SCIENCE SAYS:**  
". . . How does it perform? In a word, flawlessly; stereo performance is superb, and the set's sensitivity will cope with the deepest fringe-area reception conditions . . . I rate the LT-112B as one of the finest FM tuners available — in or out of kit form."

**STEREO REVIEW SAYS:**  
"We measured the IHF sensitivity of the Scott LT-112B tuner as 1.4 microvolts, which certainly makes it one of the most sensitive tuners we have encountered."

**AMERICAN RECORD GUIDE SAYS:**  
"Scott LT-112B tuner must be placed in the very top echelon of today's components."

**AUDIO SAYS:**  
"Here's a stereo FM/AM receiver kit with a real hot front end, fairly high power output, low distortion, and excellent operating flexibility . . . The Scott LR-88 offers a most competent design at a price well below that for an equivalent factory-assembled unit."

**ELECTRONICS ILLUSTRATED SAYS:**  
"One of the finest examples of solid-state integrated-amplifier kit design, packaging and performance we have seen in the Scott LK-60."

**HIGH FIDELITY SAYS:**  
". . . an unprecedented high sensitivity, one which surprised even us . . . This is certainly a tuner for use in the most difficult of reception areas; stations seem to pop in all across the tuner dial."

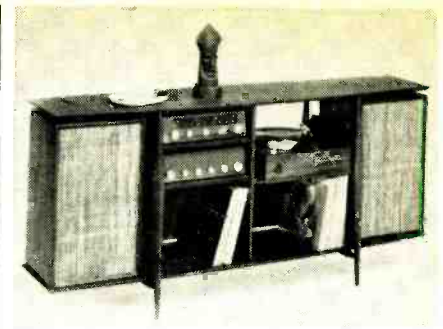

72½" x 16". Also provides plenty of space for records. \$142.50.—Audio Originals, Indianapolis, Ind.

**HEARING PROTECTOR, Ear-Valv**, has a sound-actuated mechanism which acts as an auxiliary to the human ear's own

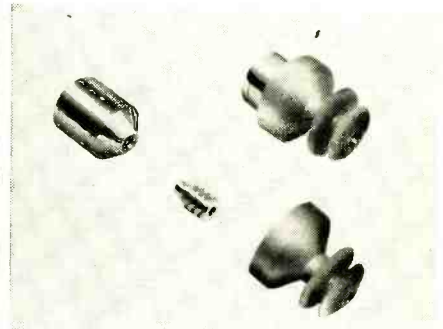

protective mechanism. Damaging noises are filtered out while harmless level

Circle 10 on reader service card

## AT A PRICE YOU CAN AFFORD

Our TREMENDOUS BUYING POWER & PURCHASING EXPERIENCE make it possible. We invest Thousands of Dollars (in just a single item) to create a good DOLLAR BUY, resulting in the AMAZING & EXCITING OFFERS that follow:

**FREE \$1 BUY WITH EVERY 10 YOU ORDER** Only applies to "\$1" Buys **FREE GIFT WITH EVERY ORDER**

- |  |  |  |  |
|--|--|--|--|
| <ul style="list-style-type: none"> <li><input type="checkbox"/> 300 — ASST. ½ W RESISTORS<br/>Top Brand, Short Leads, Excellent Selection . . . . . \$1</li> <li><input type="checkbox"/> 100—ASST ¼ WATT RESISTORS<br/>stand. choice ohmages, some in 5% . . . . . \$1</li> <li><input type="checkbox"/> 100—ASST ½ WATT RESISTORS<br/>stand. choice ohmages, some in 5% . . . . . \$1</li> <li><input type="checkbox"/> 70 — ASST 1 WATT RESISTORS<br/>stand. choice ohmages, some in 5% . . . . . \$1</li> <li><input type="checkbox"/> 35 — ASST 2 WATT RESISTORS<br/>stand. choice ohmages, some in 5% . . . . . \$1</li> <li><input type="checkbox"/> 50 — PRECISION RESISTORS<br/>asst. list-price \$50 less 98% . . . . . \$1</li> <li><input type="checkbox"/> 20 — ASSORTED WIREWOUND<br/>RESISTORS, 5, 10, 20 watt . . . . . \$1</li> <li><input type="checkbox"/> 4 — TOGGLE SWITCHES<br/>SPST, SPDT, DPST, DPDT . . . . . \$1</li> <li><input type="checkbox"/> 10—ASSORTED SLIDE SWITCHES<br/>SPST, SPDT, DPST, etc. . . . . \$1</li> <li><input type="checkbox"/> TV TUNER — asst. all new<br/>standard makes. Less tubes . . . . . \$1</li> <li><input type="checkbox"/> TV TUNERS asst. all new standard<br/>makes, including Tubes . . . . . \$3</li> <li><input type="checkbox"/> WESTINGHOUSE STANDARD<br/>TUNER #470V120H01 — (3GK5<br/>— 6CG8 Tubes) . . . . . \$4</li> <li><input type="checkbox"/> UHF TUNER — TRANSISTOR<br/>TYPE Used in all TV Sets . . . . . \$3.95</li> <li><input type="checkbox"/> 50 — #3AG FUSES 10 AMP.<br/>popular type with pigtailed . . . . . \$1</li> </ul> | <ul style="list-style-type: none"> <li><input type="checkbox"/> 4 — 50' HANKS HOOK-UP WIRE<br/>assorted colors . . . . . \$1</li> <li><input type="checkbox"/> 100' — SPOOL SPEAKER WIRE<br/>2 cond, mini zip, clear, 101 uses . . . . . \$1</li> <li><input type="checkbox"/> 100' — TV TWIN LEAD-IN WIRE<br/>300 ohm, deluxe heavy duty, clear . . . . . \$2</li> <li><input type="checkbox"/> UNIVERSAL TV ANTENNA<br/>Back of set mounting . . . . . \$1.98</li> <li><input type="checkbox"/> 3 WAY UHF—VHF—FM SPLIT-<br/>TER Two Sets of terminals<br/>make hookup a cinch . . . . . \$1.98</li> <li><input type="checkbox"/> 5 — 6' LINE CORDS<br/>#18 Stranded Copper Wire . . . . . \$1</li> <li><input type="checkbox"/> MOTOROLA PWR TRANSFORM<br/>110v, CT 150/150v, 6.3v . . . . . \$1</li> <li><input type="checkbox"/> 10 — TRANSFORMERS assorted<br/>Audio Outputs, Choices, I. F. 's, etc. . . . . \$1</li> <li><input type="checkbox"/> 8 — ASST LUCITE CABINETS<br/>hinge cover, handy for parts . . . . . \$1</li> <li><input type="checkbox"/> 20—PENLITE BATTERIES 1½v . . . . . \$1</li> <li><input type="checkbox"/> 15—BATTERIES C-cell similar 935 . . . . . \$1</li> <li><input type="checkbox"/> 10—BATTERIES D-cell similar 950 . . . . . \$1</li> <li><input type="checkbox"/> 5—BATTERIES (Transistor) similar 216 \$1</li> <li><input type="checkbox"/> 100' — FINEST NYLON DIAL<br/>CORD best size, .028 gauge . . . . . \$1</li> <li><input type="checkbox"/> RONETTE SAPPHIRE CARTRIDGE<br/>dual flipover type—value \$5 . . . . . \$1</li> <li><input type="checkbox"/> RONETTE STEREO CARTRIDGE<br/>latest dual sapphire flipover type . . . . . \$2</li> <li><input type="checkbox"/> COLOR-TV RECTIFIER —<br/>Used in most color sets—6500<br/>PRV (Volts) . . . . . 3 for \$1.95</li> </ul> | <ul style="list-style-type: none"> <li><input type="checkbox"/> TRANSISTOR RADIO asst type<br/>good, bad, broken, as-is, potluck . . . . . \$1.50</li> <li><input type="checkbox"/> TAPE RECORDER — assorted types<br/>good, bad, broken, as-is, potluck . . . . . \$4</li> <li><input type="checkbox"/> 32' — TEST PROD WIRE<br/>deluxe quality, red or black . . . . . \$1</li> <li><input type="checkbox"/> HEARING AID AMPLIFIER<br/>incl. 3 Tubes, Mike, etc. (as is) . . . . . \$1</li> <li><input type="checkbox"/> COLOR POWER TRANS-<br/>FORMER — Good for most<br/>sets . . . . . \$6.95</li> <li><input type="checkbox"/> 6—TRANSISTOR RADIO EAR-<br/>PIECES wired complete with plug<br/>1—SQ. YARD GRILLE CLOTH<br/>most popular brown &amp; gold design . . . . . \$2</li> <li><input type="checkbox"/> S20—SHURE M-7D DIAMOND<br/>NEEDLE exact replacement . . . . . \$3</li> <li><input type="checkbox"/> \$15.00 TELEVISION PARTS<br/>"JACKPOT" best buy ever . . . . . \$1</li> <li><input type="checkbox"/> 10 — SETS PHONO PLUGS &amp;<br/>PIN JACKS RCA type . . . . . \$1</li> <li><input type="checkbox"/> 10 — SURE-GRIP ALLIGATOR<br/>CLIPS 2" plated . . . . . \$1</li> <li><input type="checkbox"/> 50 — ASSORTED PRINTED CIR-<br/>CUIT SOCKETS best types . . . . . \$1</li> <li><input type="checkbox"/> 10 SETS — DELUXE PLUGS &amp;<br/>JACKS asst. for many purposes . . . . . \$1</li> <li><input type="checkbox"/> 70—BRASS FANSTOCK CLIPS<br/>popular type &amp; size . . . . . \$1</li> <li><input type="checkbox"/> 20 — ASST. PILOT LIGHTS<br/>#14, 46, 47, 51, etc. . . . . \$1</li> <li><input type="checkbox"/> 50 —ASSORTED #3AG FUSES<br/>popular ampere ratings . . . . . \$1</li> </ul> | <p><b>MARKET SCOOP COLUMN</b></p> <ul style="list-style-type: none"> <li><input type="checkbox"/> 12" OXFORD SPEAKER. Top \$4<br/>Quality . . . Large Magnet . . . . . \$4</li> <li><input type="checkbox"/> 10" PHILCO SPEAKER \$2.69<br/>Top Quality . . . Large Magnet . . . . . \$2.69</li> <li><input type="checkbox"/> 6"—ECONOMY SPEAKER Top \$1.69<br/>quality 2 15 Mag. . . . . \$1.69</li> <li><input type="checkbox"/> 5" UNIVERSAL TWEETER \$1.29<br/>1 Oz. . . Magnet . . . . . \$1.29</li> <li><input type="checkbox"/> UNIVERSAL 5½" PM SPEAKER \$1<br/>Alnico 5 magnet, quality tone . . . . . \$1</li> <li><input type="checkbox"/> UNIVERSAL 4" PM SPEAKER 79¢<br/>Alnico 5 magnet, quality tone . . . . . 79¢</li> <li><input type="checkbox"/> 2" x 6" SPEAKER \$1<br/>Alnico 5 magnet, quality tone . . . . . \$1</li> <li><input type="checkbox"/> 2½" x 4" SPEAKER 69¢<br/>Special Buy . . . . . 69¢</li> <li><input type="checkbox"/> 3½" — ROUND SPEAKER 59¢<br/>Special Buy . . . . . 59¢</li> <li><input type="checkbox"/> 25 — 3900-OHM-7w RESISTOR \$1<br/>10% Corning glass . . . . . \$1</li> <li><input type="checkbox"/> 20 — .47-600V CONDENSERS \$1<br/>White Ceramic C.D.-American . . . . . \$1</li> <li><input type="checkbox"/> SPECIAL TUBE BUY 3CB6, 3DT6,<br/>4CS8, 12AU7, 12BH7, etc. . . . . 49¢</li> <li><input type="checkbox"/> 10 — ASST. RADIO &amp; TV TUBES \$1<br/>Every Tube a good number . . . . . \$1</li> <li><input type="checkbox"/> 2—PRINTED CIRCUIT IF TRANS-<br/>FORMERS 4-Lug, 450 KC . . . . . \$1</li> </ul> |
|--|--|--|--|

IMMEDIATE DELIVERY . . . Scientific light packing for safe delivery at minimum cost.  
HANDY WAY TO ORDER: Pencil mark or write amounts wanted in each box, place letter  
F in box for Free \$1 BUY. Enclose with check or money order, add extra for shipping.  
Tearsheets will be returned as packing slips in your order, plus lists of new offers.

Minimum Order \$3.00

Please specify refund on shipping overpayment desired:  CHECK  POSTAGE STAMPS  MERCHANDISE (our choice) with advantage to customer

**BROOKS RADIO & TV CORP., 487 Columbus Ave., New York, N. Y. 10024** 212-874 5600  
TELEPHONE



sounds are permitted to pass through unaltered. Replaceable insert cushion is made of formula silicone rubber. Device consists of 18 precision watchlike parts. \$3.95 a pair—Sigma Engineering Co., North Hollywood, Calif. 91601

**THIRD HAND**, *Solder Jockey*, firmly secures a supply of solder to the pliers or other tool to which it is attached due to its magnetic base. Both objects to be soldered can then be held at the same

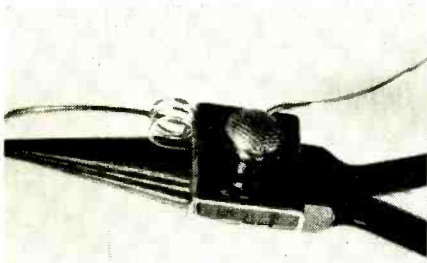

time. Unit is useful while soldering connections together. \$1.00.—*Solder Jockey*, P.O. Box 1427, Long Island City, NY, 11101 R-E

**COMING NEXT MONTH**

Two special projects for hobbyists are slated for November. A UJT circuit, tantalum capacitor and SCR are the heart of an automatically resetting darkroom timer. For model railroaders, there's a solid-state electronic throttle that can't be beat.

# The brand for all reasons



BSR McDONALD 600

Every BSR McDonald automatic turntable is precision made in Great Britain to the most exacting specifications. Upon their arrival in the U.S., every model is unpacked and re-tested under actual playing conditions. That's why BSR service calls are the lowest in the industry—and perhaps that also explains why BSR sells more turntables than anyone else in the world.



**McDONALD**

BSR (USA) LTD.  
BLAUVELT, N.Y. 10913

Please send FREE detailed literature on all BSR McDonald automatic turntables.

Name \_\_\_\_\_

Address \_\_\_\_\_

City \_\_\_\_\_

State \_\_\_\_\_

Zip \_\_\_\_\_

Circle 112 on reader service card

**CANADIANS: Ordering is easy — we do the paperwork — try a small order**

## WESTINGHOUSE ALL TRANSISTOR HOME/OFFICE MESSAGE CENTER

Leaves messages for other for replay... Built in speaker/microphone for talk-into convenience... Records up to 3 minutes of messages... Illuminated signal shows when a message is waiting. Control adjusts playback volume without affecting recording volume... Capstan Drive; BRAND NEW \$10 SOLD AS IS

**IBM COMPUTER SECTIONS**  
8 assorted Units we sell for \$1 are loaded with over 150 valuable parts.  
Incl. — Transistors, Condensers, Resistors, Heat Sinks, Diodes, Etc.  
**8 for \$1**  
**100 for \$10**

## SHANNON MYLAR RECORDING TAPE

2 1/2" — 225' .. \$ .17	7" — 2400' .. \$ 1.79
3" — 225' .. .19	7" — 3600' .. 2.95
3" — 300' .. .27	CASSETTE 60 minutes .89
3 1/4" — 600' .. .58	CASSETTE 90 minutes 1.54
5" — 600' .. .62	CASSETTE 120 minutes 1.97
5" — 900' .. .80	
5" — 1200' .. .97	2 1/2" TAPE REEL .... .04
5" — 1800' .. 1.49	3" TAPE REEL .... .05
7" — 1200' .. .77	3 1/4" TAPE REEL .... .06
7" — 1800' .. 1.12	5" TAPE REEL .... .12
	7" TAPE REEL .... .14

## RCA 110° FLYBACK TRANSFORMER

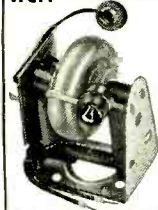

We scooped the Market Latest type — standard for all 110° TV's RCA's design of large Coil produces 18kV—assuring adequate with Incl Schematic Diagram application for any TV List price \$13.90 Your price .. \$3 10% off in lots of 3

- 110° TV DEFLECTION YOKE for all types TV's incl schematic .. \$3
- "COMBINATION SPECIAL" RCA 110° FLYBACK plus 110° DEFLECTION YOKE .. \$5
- 90° FLYBACK TRANSFORMER for all type TV's incl schematic .. \$2
- 90° TV DEFLECTION YOKE for all type TV's incl schematic .. \$2
- 70° FLYBACK TRANSFORMER for all type TV's incl schematic .. \$2
- 70° TV DEFLECTION YOKE for all type TV's incl schematic .. \$2
- 2 — TV CIRCUIT BREAKERS Rated 4.2 TO 5.0 AMP'S, etc. .. \$1.19
- 70° COLOR YOKE For all round color CRT's .. \$10.95
- 90° COLOR YOKE For all Rectangular 19 to 25" Color CRT's .. \$10.95
- BONANZA "JACKPOT" not gold, not oil, but a wealth of Electronic Items—Money-Back-guarantee .. \$5
- 300 — ASSORTED HEX NUTS 2/56, 4/40, 5/40, 6/32, 8/32 .. \$1
- 250 — ASST. SOLDERING LUGS best types and sizes .. \$1
- 250 — ASST. WOOD SCREWS finest popular selection .. \$1
- 250 — ASST. SELF TAPPING SCREWS #6, #8, etc. .... \$1
- 150 — ASST. 6/32 SCREWS and 150 6/32 HEX NUTS .. \$1
- 150 — ASST. 8/32 SCREWS and 150—8/32 HEX NUTS .. \$1
- 150 — ASST. 2/56 SCREWS and 150—2/56 HEX NUTS .. \$1
- 150 — ASST. 4/40 SCREWS and 150—4/40 HEX NUTS .. \$1
- 150 — ASST. 5/40 SCREWS and 150—5/40 HEX NUTS .. \$1
- 500 — ASSORTED RIVETS most useful selected sizes .. \$1
- 500 — ASSORTED WASHERS most useful selected sizes .. \$1
- 100 — ASST. RUBBER BUMPERS for cabinet bottoms & other uses .. \$1
- 100—ASSORTED RUBBER GROMMETS best sizes .. \$1
- MOTOROLA HEP KIT—INTEGRATED CIRCUITS INCLUDES —One 3-K Rip-Op, One Dual Buffer, One 4-input Gate, Two Dual 2-Input Gates, All Five 2—MOTOROLA HEP-170 RECTIFIER 2 1/2 AMP'S and 1000VPIV Covers all 600MA to 2500MA Units Voltage ranging from 50PIV to 1000 PIV .. \$1
- 3 — TOP BRAND SILICON RECTIFIERS 1 amp, 1000 PIV .. \$1
- 5 — I.F. COIL TRANSFORMERS 456-ke for Transistor Radios .. \$1
- 5 — AUDIO OUTPUT TRANSFORM Sub-min for Trans Radios .. \$1
- 5 — PNP TRANSISTORS general purpose, TO-5 case .. \$1
- 5 — NPN TRANSISTORS general purpose, TO-5 case .. \$1
- 50 — ASSORTED TRANSISTORS big factory sweep-sold basis .. \$1
- METER SENTRY—SOLID STATE Protects meter movements up to 25 amp's surge .. 99¢
- 10 — STANDARD TRANSISTORS NPN & PNP 2N404, 2N413, etc. .. \$1
- 10—ASSORTED DIODE CRYSTALS 1N31, 1N48, 1N60, 1N64, etc. .. \$1
- 4 — TV ALIGNMENT TOOLS most useful assortment #1 .. \$1
- 4 — TV ALIGNMENT TOOLS For Color TV #2 .. \$1.49
- AMPLIFIER 110v AC-DC, 5 Watt Wired — Phono, Comb, Intercom, etc. needs 3-12AX7, 2-501G, as is .. \$3
- UNIVERSAL MICROPHONE Regular/remote/Single & Dual plug .. \$2
- CRYSTAL LAPEL MICROPHONE High Impedance, 200-6000 eps .. \$9.95
- STEREO HEADPHONES Hi-Fi Quality .. Complete with Stereo plug .. \$5.95
- 50 — TUBE CARTONS (colored) assorted sizes for Popular Tubes .. \$1
- 4 — 36" Hi-Fi CABLES RCA Molded Phone plug at one end stripped and tinned leads on other end .. \$1
- 3—JUMPER CABLES — 36" Length Mule RCA Type pin Plug on Both Ends .. \$1.19
- 50 — ASST. TERMINAL STRIPS all types, 1-Jug to 6-Jug .. \$1
- 25 — INSTRUMENT POINTER KNOBS selected popular types .. \$1
- 1 — LB SPOOL ROSIN-CORE SOLDER 40-60 top quality .. \$1
- 2—ELECTROLYTIC CONDENSERS C.D. 500 mfd—200 volts .. \$1
- 2—ELECTROLYTIC CONDENSERS C.D.—250 mfd—350 Volts .. \$1
- 3—ELECTROLYTIC CONDENSERS most popular number 50/35—130v .. \$1
- 7 — TV ELECTROLYTIC CONDENSERS desirable types .. \$1
- 2—G.E. PIECES OF EQUIPMENT stacked with over 200 useful parts .. \$1
- 50 — ASSORTED MYLAR CONDENSERS popular selected types .. \$1
- ALL AMERICAN TUBE KIT 12BA6, 12BE6, 12AV6, 50C5, 35W4—total list \$9.70 .. \$2

Circle 113 on reader service card



# Clever Kleps

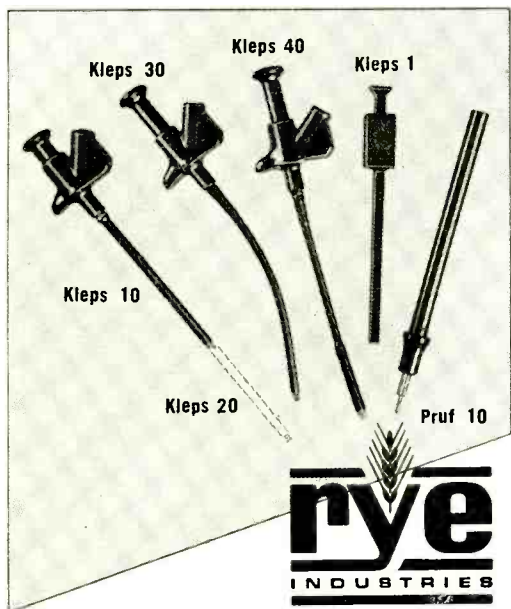

Test probes designed by your needs—  
Push to seize, push to release (all Kleps spring loaded).

**Kleps 10.** Boathook type clamp grips wires, lugs, terminals. Accepts banana plug or bare wire lead. 4¾" long. **\$1.19**

**Kleps 20.** Same, but 7" long. **\$1.39**

**Kleps 30.** Completely flexible. Forked-tongue gripper. Accepts banana plug or bare lead. 6" long. **\$1.47**

**Kleps 40.** Completely flexible. 3-segment automatic collet firmly grips wire ends, PC-board terminals, connector pins. Accepts banana plug or plain wire. 6¾" long. **\$2.39**

**Kleps 1.** Economy Kleps for light line work (not lab quality). Meshing claws. 4½" long. **\$.99**

**Pruf 10.** Versatile test prod. Solder connection. Molded phenolic. Doubles as scribing tool. "Bunch" pin fits banana jack. Phone tip. 5½" long. **\$.79**

All in red or black — specify.

For additional information, write for our complete catalog of — test probes, plugs, sockets, connectors, earphones, headsets, and miniature components.

Available through your local distributor, or write to:  
**RYE INDUSTRIES, INC.**  
129 Spencer Place, Mamaroneck, N.Y. 10543

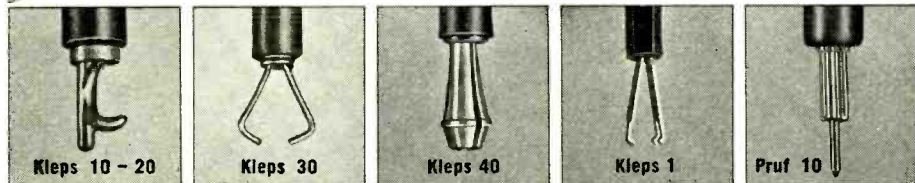

Circle 114 on reader service card

## Build this magnificent Schober Theatre Organ for only \$1550!\*



\*Includes finished walnut console. Amplifier, speaker system, optional accessories extra. Only \$1150.50 if you build your own console.

The Schober Organ Corp., Dept. RE-71  
43 West 61st Street, New York, N.Y. 10023

- Please send me Schober Organ Catalog and free 7-inch "sample" record.
- Enclosed please find \$1.00 for 12-inch L.P. record of Schober Organ music.

NAME \_\_\_\_\_  
ADDRESS \_\_\_\_\_  
CITY \_\_\_\_\_ STATE \_\_\_\_\_ ZIP \_\_\_\_\_

You couldn't touch an organ like this in a store for less than \$3500—and there hasn't been a musical instrument with this vast variety of genuine Theatre Organ voices since the days of the silent movies! Haunting tibias, biting strings, blaring reeds—the whole A to Z gamut of real pipe sounds that make the simplest playing a thrilling experience and give the professional organist everything he needs. If you've dreamed of the grandeur of authentic big-organ sound in your own home, you won't find a more satisfying instrument anywhere—kit or no kit.

You can learn to play it. And you can build it, from Schober Kits, world famous for ease of assembly without the slightest knowledge of electronics or music, for design and parts quality from the ground up, and—above all—for the highest praise from musicians everywhere.

Send right now for your copy of the full-color Schober catalog, containing specifications of the five Schober Organ models, beginning at \$599.50. No charge, no obligation—but lots of food for a healthy musical appetite!

Circle 115 on reader service card

## NORTRONICS REPLACEMENT TAPE HEADS IMPROVE THE PERFORMANCE OF ANY TAPE RECORDER!

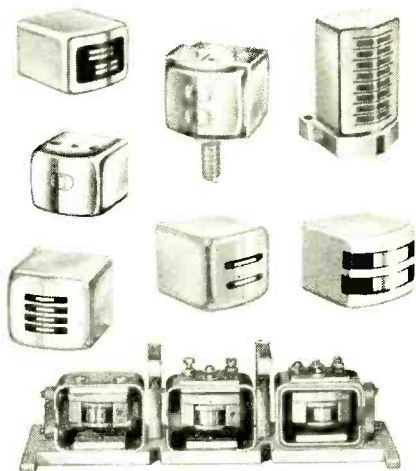

### WORLD'S LARGEST HEAD SELECTION FOR PROFESSIONAL EQUIPMENT

AMPEX • MAGNECORD • SCULLY  
CONCERTONE • RCA • CROWN

AS WELL AS 1800  
POPULAR PRICED RECORDERS  
DOMESTIC AND IMPORTED



MONO OR STEREO  
REEL-TO-REEL OR  
CASSETTE AND CARTRIDGE  
TYPES

ANY TRACK STYLE  
Full, Half, Quarter, or Eighth

ANY FUNCTION  
Record, Playback, Erase, R/P, and R/P/E

Replace worn tape heads with the brand most often chosen by tape recorder manufacturers for use in original equipment. (Over 80% use Nortronics!) It's a quicker and easy way to better response, cleaner sound, optimum performance.

NORTRONICS Bulletin 7230A describes the complete line of Nortronics replacement heads, conversion and mounting kits, and accessories. Write for your free copy.



8101 Tenth Avenue North  
Minneapolis, Minnesota 55427  
Phone: (612) 545-0401

Circle 116 on reader service card

RADIO-ELECTRONICS



## NEW LITERATURE

All booklets, catalogs, charts, data sheets and other literature listed here with a Reader's Service number are free for the asking. Turn to the Reader's Service Card facing page 87 and circle the numbers of the items you want. Then detach and mail the card. No postage required!

**TEST EQUIPMENT.** solid-state, including vectorscopes, color-bar generators capable of producing 10 color bars with each bar spaced 30 electrical degrees apart, picture-tube analyzer, transistor analyzer, sweep-circuit analyzer and Citizen's-band analyzer plus power supplies are detailed with specs and prices in an 8-page catalog.—**Lectrotech Inc.**, Chicago, Ill. 60625

Circle 61 on reader service card

**CABINETS** consisting of six panels and twelve vise-grip slides as well as some typical applications to which they are put are illustrated in a 4-page bulletin, "New do-it-yourself FLEX-CAB". Sizes, descriptions and prices also given.—**Bell Educational Lab, Div. Belltronix Systems, Inc.** Hauppauge, N.Y.

Circle 62 on reader service card

**AEROSOL PRODUCTS** for cleaning and lubricating transistor circuitry, TV tuners and all electronic, electrical and mechanical relays and contacts are described in a 4-color aerosol chemical brochure.—**GC Electronics**, Rockford, Ill.

Circle 63 on reader service card

**TV & RADIO TUBES** is the title of a 32-page catalog covering over 100 different types of tubes plus many hand tools, electronic lubricants and electrical equipments. Photos and illustrations are also included. Item prices are listed.—**Cornell Electronics Co.**, San Diego, Calif. R-E

Circle 64 on reader service card

## MOST ADVANCED IGNITION SYSTEM ON THE MARKET

### JUDSON'S ELECTRONIC MAGNETO

Provides Better Performance. Reduces Fuel Consumption. Increases Plug and Point Life. Prevents High Speed Miss and Plug Fouling. You'll feel the difference right from the start.

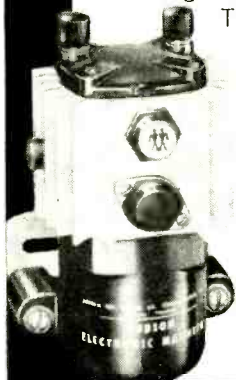

The accepted standard in electronic ignition.

COSTS ONLY

**\$49.50**

EASILY INSTALLED

Write Today For Free Literature

**JUDSON** RESEARCH & MFG. CO. CONSHOHOCKEN, PA. 19428

Circle 117 on reader service card

Now... available by mail

## thermy<sup>®</sup> ELECTRONIC THERMOMETER

measures the temperature of anything you can touch!



- ... works on contact—in seconds
- ... ranges from  $-60^{\circ}$  to  $+400^{\circ}$  F and  $-50^{\circ}$  to  $-200^{\circ}$  C
- ... uses any quality VTVM or multimeter
- ... 42-inch leads reach into hidden corners
- ... just \$14.95, including handsome carrying case

You've never made temperature tests so fast and accurately as with THERMY. Only an electronic thermistor enables you to take accurate temperature of solid objects! Check for heat build-up in electronic circuits. Measure the heat/cold flow of refrigerants. It's the perfect tool for all repairmen and engineers.

THERMY works with any multimeter. Simply take a reading off the meter and get the temperature from THERMY's conversion scale. It's that easy... and that fast. Your money refunded if THERMY isn't all you expect—and more!

If you don't have your own, order either of these multimeters

**Precision Model NH-65** • 20,000 ohm/volt DC • mirrored scale • diode overload protection • compact, rugged design • 44 microamp D'Arsonval movement •  $4\frac{1}{2} \times 3\frac{3}{8} \times 1\frac{1}{2}$ " • only \$14.95 ppd, including batteries and test leads.



**Deluxe Grand Master Model 80M** • 20,000 ohm/volt DC • 26 ranges on 2-color, mirrored scale • diode overload protection • DC volts: 2.5V, 10V, 50V, 250V, 1000V, 5000V • AC volts: 2.5V, 10V, 50V, 250V, 1000V, 5000V (8000 ohms/volt) • DC amps: 50ua, 2.5mA, 25mA, 250mA, 10 amps • Ohms: 0 to 10K, Rx1, Rx10, Rx100, Rx1000 (10 megohm maximum) • Dimensions:  $7 \times 5\frac{1}{4} \times 2\frac{1}{2}$ " • Only \$29.95, ppd, including batteries and heavy-duty test leads.



## "THE ST-PRO-B PASSED \*CBS LABS' TESTS BETTER THAN ANY STEREO HEADSET PREVIOUSLY ENCOUNTERED"

As appearing in HIGH FIDELITY MAGAZINE EQUIPMENT REPORTS, October 1968 issue.



\*Test data and measurements are obtained by CBS Laboratories, a division of Columbia Broadcasting System, Inc.

Convince yourself — listen to the ST-PRO-B and the complete line of Superex stereo phones.

You'll be delighted with the breathtaking realism, matchless quality, and comfort — possible only with our exclusive woofer/tweeter design. Prices start at \$19.95; ST-PRO-B approx. \$50

Write for your copy of test report.

**SUPEREX ELECTRONICS CORP.**  
151 Ludlow St., Yonkers, N.Y. 10705

Circle 118 on reader service card

Hi Tone, Inc. 110 East 59th Street, 20th floor, New York, N.Y. 10022. Dept. RE-10

Please send the following:

Qty.	Item	Unit Price	Total Price
_____	Thermymy	\$14.95 ppd	_____
_____	Model NH-65 Multimeter	14.95 ppd	_____
_____	Carrying pouch for NH-65	1.00 ppd	_____
_____	Model 80M Multimeter	29.95 ppd	_____
_____	Fitted Texon case for 80M	7.95 ppd	_____
		Total	\$ _____
		(N.Y.C. and N.Y.S. residents add tax)	\$ _____
		Total Enclose J	\$ _____

NAME \_\_\_\_\_  
(PRINT)  
ADDRESS \_\_\_\_\_  
CITY \_\_\_\_\_ STATE \_\_\_\_\_ ZIP \_\_\_\_\_

Circle 119 on reader service card

# 8 Exciting New Kits



**NEW**  
Kit IG-28 \$79.95\*

Standard 9 x 9 Display **OR** Exclusive Heath "3 x 3" Display

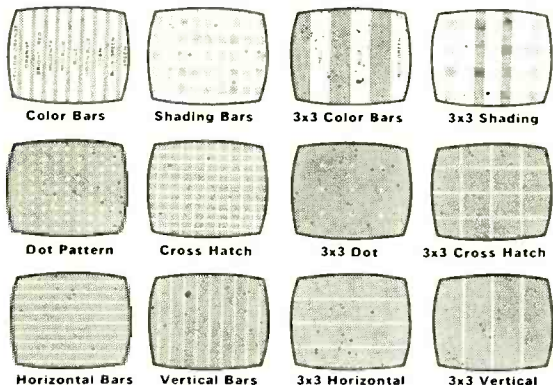

Color Bars    Shading Bars    3x3 Color Bars    3x3 Shading  
Dot Pattern    Cross Hatch    3x3 Dot    3x3 Cross Hatch  
Horizontal Bars    Vertical Bars    3x3 Horizontal    3x3 Vertical

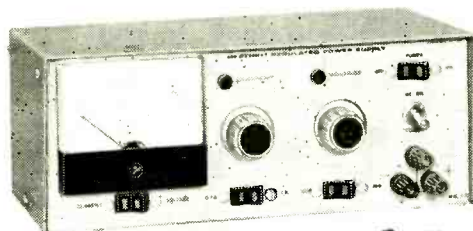

**NEW**  
Kit IP-28  
\$47.50\*

**NEW**  
Kit ID-29  
\$29.95\*

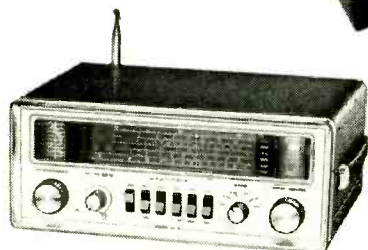

**NEW**  
Kit GR-78  
\$129.95\*



**NEW**  
Kit GD-209A  
\$149.95\*

## NEW Heathkit Color Bar-Dot Generator... Advanced Integrated Circuitry Produces 12 Patterns Plus Clear Raster, Eliminates Divider Chain Instability Forever

The new IG-28 is the signal source for all color and B&W TV servicing. No other instrument at any price will give as much stable, versatile TV servicing capability. Its solid-state circuitry produces dots, cross hatch, vertical and horizontal bars, color bars, and shading bars in the familiar 9x9 display... plus exclusive Heath 3x3 display of all these patterns... plus a clear raster that lets you adjust purity without upsetting AGC adjustment. Fifteen J-K Flip-Flops and associated gates count down from a crystal controlled oscillator, eliminating divider chain instability and adjustments. And for time-saving convenience the IG-28 has variable front panel tuning for channels 2 through 6. Plus & minus going video signals at the turn of a front panel control... for sync, in-circuit video or chroma problems, use the front panel sync output. Two front panel AC outlets for test gear, TV set, etc. Built-in gun shorting circuits and grid jacks too. Add any service-type scope with horizontal input and you have vectorscope display capability as well. Fast, enjoyable circuit board-wiring harness construction. You can't beat the Heathkit IG-28 for versatility or value... put it on your bench now. 8 lbs.

## NEW Heathkit 1-30 VDC Solid-State Regulated Power Supply

The new modestly priced IP-28 is an excellent power supply for anyone working with transistors. Compact Heathkit instrument styling with large, easy-to-read meter... two voltage ranges — 10 V., 30 V.... two current ranges — 100 mA, 1 A. External sensing permits regulation of load voltage rather than terminal voltage. Adjustable current limiting prevents supply overloads and excessive load current. Convenient standby switch. Fast, easy assembly with one circuit board and wiring harness. Order yours today! 9 lbs.

## NEW Heathkit Solid-State Auto Tune-Up Meter... Measures Dwell, RPM And DC Voltage

The new Heathkit ID-29 is most versatile... really three automotive test instruments in one. Measures Dwell on all 4-cycle, 3, 4, 6, or 8 cylinder engines... measures RPM in two ranges, 0-1500 and 0-4500... measures DC voltage from 0 to 15 volts. And no batteries are needed... running engine provides both signal and power. Easy to use... on both 6 and 12 volt system without changing leads. Lightweight and easy to carry... its black polypropylene case has a built-in lead storage compartment and is resistant to virtually everything. Fast, simple assembly... only about 5 hours. The perfect accessory for the handyman, emergency road service personnel or shop mechanics... order your ID-29 now. 4 lbs.

## NEW Heathkit GR-78 Solid-State General Coverage Receiver... Tunes 190 kHz To 30 MHz In Six Bands

The new GR-78 combines wide coverage, superior performance and portability with sharp styling to provide a remarkable value in general coverage receivers. Tunes AM, CW & SSB signals from 190 kHz to 30 MHz in six switch-selected bands. The all solid-state circuit employs modern FET's in the RF section and 4 ceramic filters in the IF to deliver maximum sensitivity and sharp selectivity. Bandsread Tuning is built-in, and can be calibrated for either Shortwave Broadcast or Amateur Bands. Completely portable... comes with a nickel-cadmium rechargeable battery pack and built-in charger that operates from 120 or 240 VAC and 12 VDC. Many built-in features... 500 kHz crystal calibrator... switchable Automatic Noise Limiter... switchable Automatic Volume Control... Receiver Muting... Headphone Jack and many more. Order yours today. 14 lbs.

## NEW Heathkit Deluxe Radio-Controlled Screw-Drive Garage Door Opener Semi-Kit

The next best thing to a personal doorman. The "wireless" factory assembled transmitter operates up to 150 feet away. Just push the button and your garage door opens and the light turns on... and stays on until you're safely inside your home. The giant 7 ft. screw mechanism coupled with the 1/4 HP motor mean real power and reliability and the adjustable spring-tension clutch automatically reverses the door when it meets any obstruction... extra safety for kids, pets, bikes, even car tops. Assembles completely without soldering in just one evening. Easy, fast installation on any 7' overhead track (and jamb & pivot doors with accessory adapter). Order yours now. 66 lbs.

Adapter arm for jamb & pivot doors, Model GDA-209-2, \$7.95\*



# From The Leader



## NEW Heathkit Ultra-Deluxe "681" Color TV With AFT . . . Power Channel Selection & Opt. RCA Hi-Lite Matrix Tube

The new Heathkit GR-681 is the world's most advanced Color TV with more built-in features than any other set on the market. Automatic Fine Tuning on all 83 channels . . . power push button VHF channel selection, built-in cable-type remote control . . . or you can add the optional GRA-681-6 Wireless Remote Control any time . . . plus the built-in self-servicing aids that are standard on all Heathkit color TV's. Other features include high & low AC taps to insure that the picture transmitted exactly fits the "681" screen, automatic degaussing, 2-speed transistor UHF tuner, hi-fi sound output, two VHF antenna inputs, top quality American brand color tube with 2-year warranty. With optional new RCA Matrix picture tube that doubles the brightness, Model GR-681MX only \$535.00.

**GRA-295-4**, Mediterranean Cabinet shown . . . . . **\$124.95\***

### Heathkit "295" Color TV

With Optional RCA Matrix Tube . . . with the same high performance features and built-in servicing facilities as GR-681 above . . . less AFT, VHF power tuning and built-in cable-type remote control. You can add the optional GRA-295-6 Wireless Remote Control at any time. New optional RCA Matrix tube doubles the brightness, Model GR-295MX, \$485.00.

**GRA-295-1**, Contemporary Walnut Cabinet shown . . . . . **\$64.95\***

Both the GR-681 and GR-295 fit into the same Heath factory assembled cabinets; not shown Early American style at \$109.95\*

### NEW Deluxe Heathkit "581" Color TV With AFT

The new Heathkit GR-581 will add a new dimension to your TV viewing. Brings you color pictures so beautiful, so natural, so real . . . puts professional motion picture quality right into your living room. Has the same high performance features and exclusive self-servicing facilities as the GR-681, except with 227 sq. inch viewing area, and without power VHF tuning or built-in cable-type remote control. The optional GRA-227-6 Wireless Remote Control can be added any time you wish. And like all Heathkit Color TV's you have a choice of different installations . . . mount it in a wall, your own custom cabinet, your favorite B&W TV cabinet, or any one of the Heath factory assembled cabinets.

**GRA-227-2**, Mediterranean Oak Cabinet shown . . . . . **\$109.95\***

### Heathkit "227" Color TV

Same as the GR-581 above, but without Automatic Fine Tuning . . . same superlative performance, same remarkable color picture quality, same built-in servicing aids. Like all Heathkit Color TV's you can add optional Wireless Remote Control at any time (GRA-227-6). And the new Table Model TV Cabinet and roll around Cart is an economical way to house your "227" . . . just roll it anywhere, its rich appearance will enhance any room decor.

**GRS-227-5**, New Cart and Cabinet combo shown . . . . . **\$54.95\***

Both the GR-581 and GR-227 fit into the same Heath factory assembled cabinets; not shown, Contemporary cabinet \$64.95\*

### NEW Heathkit Deluxe "481" Color TV With AFT

The new Heathkit GR-481 has all the same high performance features and exclusive self-servicing aids as the new GR-581, but with a smaller tube size . . . 180 sq. inches. And like all Heathkit Color TV's it's easy to assemble . . . no experience needed. The famous Heathkit Color TV Manual guides you every step of the way with simple to understand instructions, giant fold-out pictorials . . . even lets you do your own servicing for savings of over \$200 throughout the life of your set. If you want a deluxe color TV at a budget price the new Heathkit GR-481 is for you.

**GRA-180-1**, Contemporary Walnut Cabinet shown . . . . . **\$49.95\***

### Heathkit "180" Color TV

Feature for feature the Heathkit "180" is your best buy in color TV viewing . . . has all the superlative performance characteristics of the GR-481, but less Automatic Fine Tuning. For extra savings, extra beauty and convenience, add the table model cabinet and mobile cart. Get the value-packed GR-180 today.

**GRS-180-5**, Table Model Cabinet & Cart combo . . . . . **\$42.50\***

Both the GR-481 and GR-180 fit the same Heath factory assembled cabinets; GRA-180-2, Early American Cabinet \$94.95\*

Add the Comfort And Convenience Of Full Color Wireless Remote Control To Any Rectangular Tube Heathkit Color TV . . . New Or Old!

**Kit GRA-681-6**, for Heathkit GR-681 Color TV's . . . . . **\$64.95\***

**Kit GRA-295-6**, for Heathkit GR-295 & GR-25 TV's . . . . . **\$69.95\***

**Kit GRA-227-6**, for Heathkit GR-581; GR-481 & GR-180 Color TV's . . . . . **\$69.95\***

## Now There Are 6 Heathkit® Color TV's To Choose From

### 2 Models In 295 Sq. Inch Size

**NEW**  
Kit GR-681  
With AFT  
**\$499.95\***

(less cab net)



Kit GR-295

**\$449.95\***

(less cabinet)

### 2 Models In 227 Sq. Inch Size

**NEW**  
Kit GR-581  
with AFT  
**\$419.95\***

(less cabinet)



Kit GR-227

**NOW ONLY**

**\$379.95\***

(less cabinet & cart)

### 2 Models In 180 Sq. Inch Size

**NEW**  
Kit GR-481  
with AFT  
**\$359.95\***

(less cabinet)



Kit GR-180

**NOW ONLY**

**\$329.95\***

(less cabinet & cart)

Reception Is Simulated  
On All Sets Shown



a Schlumberger subsidiary



## NEW

### FREE 1970 CATALOG!

Now with more kits, more color. Fully describes these along with over 300 kits for stereo/hi-fi, color TV, electronic organs, electric guitar & amplifier, amateur radio, marine, educational, CB, home & hobby. Mail coupon or write Heath Company, Benton Harbor, Michigan 49022.

HEATH COMPANY, Dept. 20-67  
Benton Harbor, Michigan 49022

Enclosed is \$ \_\_\_\_\_, plus shipping.

Please send model (s)

Please send FREE Heathkit Catalog.

Please send Credit Application.

Name \_\_\_\_\_

Address \_\_\_\_\_

City \_\_\_\_\_

State \_\_\_\_\_

Zip \_\_\_\_\_

\*Mail order prices; F.O.B. factory. Prices & specifications subject to change without notice.

CL-365R

Circle 120 on reader service card



# MARKET CENTER

## ELECTRONICS

Ultra-sensitive and powerful METAL DETECTORS join the many who are finding buried coins, minerals, relics and artifacts. Don't buy till you see our free catalog of new models. Write JETCO—Box 132-RE, Huntsville, Texas 77340

TUBES—LOWEST PRICES in the world. Hard to get British, German, foreign and American obsolete and present day special purpose transmitting tubes. Send for giant tube and parts catalog. UNITED RADIO CO., Dept. R-56, Ferry St., Newark, N.J. 07105

CONVERT any television to sensitive Big-Screen Oscilloscope. Only minor changes required. No electronic experience necessary. Illustrated plans \$2.00. RELCO-A25, Box 10563, Houston, Texas 77018

RECEIVING & INDUSTRIAL TUBES, TRANSISTORS, All Brands—Biggest Discounts. Technicians, Hobbyists, Experimenters—Request FREE Giant Catalog and SAVE! ZALYTRON, 469 Jericho Turnpike, Mineola, N.Y. 11501.

Discharge IGNITION, PHOTOFLASH. Free catalog parts, kits. TRANSPARK, Carlisle, Mass. 01741

SPECIAL CLOSE-OUT SALE. Rectifiers, Transistors, and many other Electronic Parts. Lowest prices. Free catalogue. ELECTRONIC COMPONENTS COMPANY, P.O. Box 2902R, Baton Rouge, La.

INTEGRATED CIRCUIT KITS: computer, audio, others. New catalog free. KAY ENGINEERING, Box 3932-D, Long Beach, California 90803.



33¢  
100 TUBES OR MORE  
30¢ PER TUBE

### TUBES

1 YR. GUARANTEED

Mutual Conductance Laboratories, Inc. (formerly Bostel, Brandeis and Cline) Distributors of all types of tube and tube materials.

- Don't confuse our 1st quality tubes with seconds & factory rejects.
- If not shipped in 24 hrs. your order free!
- Free! New catalog write today!



DEPT. RE-10  
4217 University Ave.  
San Diego, Calif. 92105

# ONE DOLLAR

It's the RE-USABLE Blis-Dor paks. only miniature parts WAREHOUSE. It eliminates buying expensive parts cabinets, so that all hobbyists, schools, colleges, can JUST REACH OUT FOR YOUR BLIS-DOR PAK FUN, to open, HANG EM! STACK EM! STORAGE EM! READ EM! SAVE EM!

- |   |  |
|---|--|
| <input type="checkbox"/> \$25 SURPRISE PAK: transistors, rect, diodes, etc. ...<br><input type="checkbox"/> 50 GERMANIUM GLASS DIODES, 1N34, 1N48 no test<br><input type="checkbox"/> 40 TOP HAT SILICON RECTIFIERS, no test-as values<br><input type="checkbox"/> 40 EPOXY RECTIFIERS, silicon asst, no test<br><input type="checkbox"/> 40 PRECISION RESISTORS, 1/2-2W, 1% asst values ...<br><input type="checkbox"/> 30 TRANSISTORS, rf, if, audio, osc, no test<br><input type="checkbox"/> 60 TUBULAR CONDENSERS, to .5mf to 1KV, asst ...<br><input type="checkbox"/> 50 DISC CONDENSERS, to .05mf npo, temp coef, asst<br><input type="checkbox"/> 30 POWER RESISTORS, to 25 watts, to 24K ohms ...<br><input type="checkbox"/> 10 VOLUME CONTROLS, to 1 meg, switch too!<br><input type="checkbox"/> 10 ELECTROLYTICS, to 100mf, tubular too, asst ...<br><input type="checkbox"/> 40 RADIO & TV KNOBS, asst colors & styles<br><input type="checkbox"/> 10 TRANSISTOR ELECTROLYTICS to 100mf, asst values<br><input type="checkbox"/> 50 COILS AND CHOKES, if, rf, ant, osc, peaking, etc<br><input type="checkbox"/> 65 HALF WATTERS, to 1 meg, 5% popular values too<br><input type="checkbox"/> 2 MAGNETIC REED SWITCHES, glass sealed<br><input type="checkbox"/> 10 PANEL SWITCHES, toggle, slide, micro, rotary ... | <input type="checkbox"/> write for our<br><b>"BLIS-DOR" BARGAINS</b><br><b>YOUR CHOICE \$1 EACH</b><br><input type="checkbox"/> 5 "IBM" COMPUTER BOARDS, many trans, diodes.<br><input type="checkbox"/> 40 "MICRO" CONDENSERS, for transistor circuitry<br><input type="checkbox"/> 50 TERMINAL STRIPS, 1 to 8 lug types<br><input type="checkbox"/> 4 PHOTO ELECTRIC CELLS, hi, iml., schematic<br><input type="checkbox"/> 40 "TINY" RESISTORS, 1/10W, 5% too! to 1 meg |
|---|--|

NEW! Trap Door PAK



Buy 5 PAKS & CHOOSE 1 FREE

RE-USABLE PAK 6 for \$5

## 1400-PC. GLASS FIBER OPTIC KIT

It's FUN!



\$4.88

It's Educational!

- ★ Make light "pipes"
- ★ Dazzling displays
- ★ Triggers photo & infra-red cells

It's Gifty!



709 AMP

OPTICAL SCIENTIFIC BREAKTHRU! Allows "hair thin" glass fibers (2-ft. long) to transmit & receive cold light energy of any color, by internal reflection. Bundled, packaged, it guides, pumps, pipes light around corners, walls, even in circles, triggering such devices as light sensitive transistors, diodes, etc. 11 CUTS. IRKINDS. ACTS like wire. Only one's imagination controls its 1000's of uses. FREE. 12pc. accessory kit, with "how-to-do" booklet.

Terms: add postage. Rated: net 30. coil's 25%  
 Phone Orders: Wakefield, Mass. (617) 245-3829  
 Retail: 211 Albion, St., Wakefield, Mass.

**POLY PAKS** P.O. BOX 942 R  
 LYNNFIELD, MASS 01940

GIANT "XMAS" CATALOG ON: Parts, Rectifiers,  
 Transistors, SCRs, I.C.'s, Equipment, 10¢

## LOWEST PRICES ON LINEAR AMPLIFIERS

Guaranteed! With Spec. Sheets!

**\$2.22** 3 for \$6

"BLISTER" PACKED

Type	Use
<input type="checkbox"/> 702	D.C. Amplifier
<input type="checkbox"/> 709	Operational Amp
<input type="checkbox"/> 710	Differential Comparator
<input type="checkbox"/> 711	Sense Amplifier

## SILICON RECTIFIERS

PIV	EPOXY METAL EPOXY			PIV	SALE
	1.5A	2A	3 AMPS		
50	.06	.06	.15	2000*	1.00
100	.07	.07	.19	3000	1.35
200	.09	.09	.22	4000	1.65
400	.12	.12	.31	5000	2.25
600	.16	.16	.43	6000	2.96
800	.21	.21	.49	8000	3.50
1000	.32	.32	.79	10000	3.95

# ADVERTISING INDEX

RADIO-ELECTRONICS does not assume responsibility for any errors which may appear in the index below.

READER SERVICE CARD NO.	PAGE
37	Allied Radio Corp. 75-76 Audionics, Inc. 90-91
149	B & K (Division of Dynascan Corp.) Cover III
113	Brooks Radio and TV Corp. 90-91
112	BSR USA Ltd. 91
43	Burstein-Applebee Co. 84
14	Castle TV Tuner Service 13
28	Cleveland Institute of Electronics 28-31
107	(Slide Rule) 88
16	Concord Electronics Corp. 15
	CREI, Home Study Division of McGraw-Hill Book Co. 54-57
18	Delta International Ltd. 17
36	Delta Products, Inc. 79
45	Edison Instruments, Inc. 84
125	Eddie Electronics Inc. 99
23	Electro-Voice, Inc. 25
109	Electronic Distributors, Inc. 89
25	Electronic Chemical Corp. 26
108	EMC Electronic Measurement Corp. 82
	Enterprise Development Corp. 88
8	Garrard (British Industries Corp.) Cover II
21	Grantham School of Electronics 23
127	Heald Engineering College 99
120	Heath Co. 94-97
119	Hi-Tone, Inc. 93
39	Injectoral Electronics Corp. 80
11	International Correspondence Schools 7
148	International Crystal Mfg. Co. 104
27	Johnson Co., E. F. 27
117	Judson Research and Mfg. Co. 93
31	Kenwood 70
34	Lafayette Radio Electronics 78
9	Longines Symphonette Society 1
10	Mallory Distributor Products Co. 5
41	Master Appliances Corp. 82
111	Mercury Electronics Corp. 89
126	Microfleet, Inc. 99
128	Multicores Sales Corp. 89
	National Radio Institute 8-11
	National Technical Schools 64-67
116	Nortronics 92
26	Olson Electronics, Inc. 26
15	Oxford Transducer Corp. 14
124	Pennwood Numechron Co. 99
44	Pioneer Electronics 83
17	Raytheon Co. 16
	RCA Electronic Components Semiconductors Cover 1V
29	RCA Institutes 18-21
114	Rye Industries, Inc. 92
122	S & A Electronics 98
110	Sansui Electronics Corp. 89
123	SCA Services Co. 99
115	Schober Organ 92
100	Scott, Inc., H. H. 90
20	Senore 22
33	Shure Bros. 77
24	Sonar Radio Corp. 26
22	Sony Corp. of America 24
118	Suprex Electronics Corp. 93
35	Supreme Publications 78
	Surplus Center 80
40	Sylvania (Subsidiary of General Telephone & Electronics) 81
13	Weller Electric Co. 12
32	Wen Products, Inc. 74
	Winegard Co. 80
106	Xcelite, Inc. 88
121	Yeats Appliance Dolly Sales 98
	<b>MARKET CENTER</b> 100-103
139	Arcturus Electronics Corp.
	Cornell Electronics Co.
138	Edmund Scientific Co.
	Fair Radio Sales
	Kenzac Co.
	McGee Radio Company
	Music Associated
140	Park Electronic Products
136	Poly Paks
	Prestige
	Relco
137	Solid State Sales
	Technical Materials Co.



**HIGH-AMPERAGE** low voltage 750VA transformer 24/12 volts 36/60 amps from 115/230 \$10.00. Nickelcad batteries 4AH \$1.95, 8AH 2.50. Free catalog with order. **ARROW SALES**, 2534 S. Michigan, Chicago, Ill. 60616

**RADIO & TV TUBES** 33¢ each. One year guaranteed. Plus many unusual electronic bargains. Free catalog. **CORNELL** 4217-E University, San Diego, California 92105

**OSCILLOSCOPE IMPROVEMENT KITS.** High speed Triggersweep eliminates sync problems. Dual trace FET switch displays two waveforms together. **SOLID-STATE SERVICES**, P.O. Box 901, Cupertino, California 95014.

**LASER KITS**, Scientific Equipment, Giant Catalog, 50¢. **MAYFIELD**, 446 Yarnell, Arizona 85362

## WANTED

**QUICK CASH . . .** for Electronic EQUIPMENT, COMPONENTS, unused TUBES. Send list now! **BARRY**, 512 Broadway, New York, N. Y. 10012, 212 WALKER 5-7000.

## INVENTIONS & PATENTS

**FREE "Directory of 500 Corporations Seeking New Products."** For information regarding developments, sale, licensing of your patented/unpatented invention. Write: **RAYMOND LEE ORGANIZATION**, 230-U Park Avenue, New York City 10017.

**INVENTORS:** protect your ideas! Free "recommended procedure". **WASHINGTON INVENTORS SERVICE**, 422X Washington Building, Washington, D.C. 20005

**INVENTIONS WANTED.** Patented; Unpatented. **GLOBAL MARKETING**, 2420-AE 77th Ave., Oakland, Calif. 94605

## AUDIO - HI-FI

Tapemates makes available to you ALL 4-TRACK STEREO TAPES. All labels—postpaid to your door—at tremendous savings. For free brochure write: **TAPEMATES CLUB**, 5280 RE West Pico Blvd., Los Angeles, Calif. 90019.

**TAPE RECORDER SALE.** Brand new nationally advertised brands, \$10.00 above cost. Amazing discounts on stereo components. **ARKAY ELECTRONICS**, 1028-E Commonwealth Avenue, Boston, Mass. 02215

**WRITE** for highest discounts on components, recorders, tapes, from franchised distributors. Send for **FREE** monthly specials. **CARSTON**, RFD #3, Route 7, Brookfield, Conn. 06804

**AUDIO YOUR HOBBY?** Details on advanced plans, projects free. **SONLAB**, 307 Dickinson, Swarthmore, Pa. 19081.

**RENT STEREO TAPES \$1.00** week postpaid, free catalogue. **TAPE LIBRARY**, P.O. Box 8126, Washington, D.C. 20024.

## EDUCATION/ INSTRUCTION

**ELECTRONICS ENGINEERING.** Day or evening classes. Bachelor of Science Program evenings. Associate in Science Program day or night. If you are married or if you must work for a living while obtaining your education, this is the college for you. Approved for Veterans. **WESTERN STATES COLLEGE OF ENGINEERING**, 970 West Manchester Avenue, Inglewood, California 90301.

**FCC First Class License** in six weeks—nation's highest success rate—approved for Veterans Training. Write **ELKINS INSTITUTE**, 2603E Inwood Road, Dallas, Texas 75235

**FREE TV TUNER REPAIR** tricks. Plans, details, complete courses. **FRANK BOCEK**, Box 3236R, Redding, Calif. 96001

OCTOBER 1969

# INTEGRATED CIRCUITS / RECTIFIERS SEMICONDUCTORS / TRIACS

## TRIACS

PVR	5 AMP	10A
100	.90	1.20
200	1.40	1.75
300	1.75	2.25
400	2.25	2.75
500	2.60	3.25

**ER900 TRIGGER DIODES.** These bidirectional trigger diodes are one of the best and cheapest methods to trigger SCR's and triacs .....3/\$1.00

## UNIUNCTIONS!

Similar to 2N2419. RBB of 5-7 stand off ratio of .6 and Ip of 12 with data sheet **SPECIAL \$1.00**

**ZENERS** 750 milliwatt 7-68V \$4.00  
10 Watt 7-1800 \$7.50

## MOUNTING HARDWARE KITS.

These kits are used to mount our SCR's Zeners and Rectifiers etc.  
6x32 stud (3, 12 amp rectifiers, 7A SCR's) 6 sets/\$1.00  
¼x28 stud (30 amp. rectifiers, 20 amps SCR's.) 4 sets/\$1.00

Send for our latest catalog featuring Transistors and Rectifiers; 325 Elm St., Cambridge, Mass.

**2N1163 a TO-3 PNP GERMANIUM TRANSISTOR** rated at 35v and a gain of 50 at 25 amps. \$1.75

**N-CHANNEL FET'S TO-18** plastic units, low noise, low leakage, 25 volts source to gate, 50 ma gate current Gain to 9000 µmho's. \$ .80

**NEON LIGHT OR NIXIE TUBE DRIVERS.** An NPN, TO-18, SI Transistor. With a VCBO of 120 3/\$1.00

## Silicon Power Rectifiers

PRV	3A	12A	30A
100	.09	.30	.50
200	.16	.50	.80
400	.20	.70	1.20
600	.30	1.00	1.50
800	.40	1.25	1.80
1000	.50	1.50	2.20

Terms: FOB Cambridge, Mass.

Send check or Money Order. Include Postage, Average Wt. per package ½ lb. No C.O.D.'s. Minimum Order \$3.00

9300 8 BIT MEMORIES ...\$3.95

## LINEAR CIRCUITS

**CA 3011 FM-IF AMPLIFIER** \$5.90  
**702C WIDE BAND DC AMPL.** \$1.95 ea.  
**709C OPERATIONAL AMPL.** \$1.95 ea.  
**710C HI SPEED DIFF. AMP.** \$1.95 ea.  
**711C DUAL COMPARATOR** \$1.95 ea.

## DIGITAL RTL CIRCUITS

**2-914 QUAD 2 input gates** \$1.25  
**900 Buffer** \$ .75  
**925 Dual 2 input gate expander** \$ .75  
**923 JK flip flop** \$1.00  
**2-923 Dual JK flip flops** \$1.50

## Controlled Avalanche or Epoxy Rectifiers 1 AMP.

PRV	PRV
100	.07 600 .18
200	.09 800 .22
400	.12 1000 .35

## Silicon Control Rectifiers

PRV	3A	7A	20A	70A
50	.35	.45	.70	
100	.50	.65	1.00	4.00
200	.70	.95	1.30	8.00
300	.90	1.25	1.70	
400	1.20	1.60	2.10	12.00
500	1.50	2.00	2.50	
600	1.80	2.40	3.00	16.00
700	2.20	2.80		
1000			5.00	24.00

# SOLID

Post Office Box 74D

# TATE

Somerville, Mass. 02143

# SALES

Tel. (617) 547-4005

Circle 137 on reader service card

# SHOPPING MART

A selection of products available by mail for readers of Radio Electronics. All merchandise sold on money-back guarantee. Order by No. Send check or M.O.

UNUSUAL BARGAINS BY MAIL

GIANT FREE CATALOG 144 PAGES



**BRIGHT IDEAS' in UNIQUE LIGHTING** Big, new 100-page handbook packed with facts, loaded with illustrations. All latest developments, applications, equipment. Covers strobes, sources, black light, projectors, crystal and organic dyes, color organs, mirrors, polarized color, screens, light boxes, MusicVision etc. Rare find for business, home, hobby. Ideal for display houses, combos, experimenters, hobbyists. 8 1/2" x 11" loose-leaf paper punched to fit 3 ring binder. . . . add new developments as they happen. Stock No. 9100EH . . . \$3.00 Ppd.

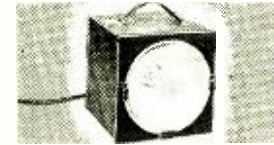

**CATCH THAT STROBE ACTION!** It's wild. Spectacular stop-action lighting effects will make a party, create a light show, turn the "swingers" into psychedelic performers. Top quality, low-cost, solid state electronic strobe. Adjustable flash rate from 2 to 16 flashes per second. Clear lucite lens protects long life Xenon lamp-up to 10,000,000 flashes. 60" high lustre reflector covers 2,000 sq. ft. area—even in dark of night club. Rugged but compact (6" sq.) & lightweight (3 1/2 lb.). Wrinkle-finished metal case. 110-120 V. AC, UL approved. Stock No. 71,174EH . . . \$89.95 Ppd.

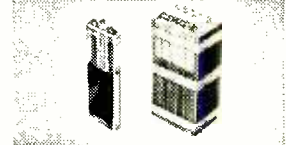

**Ni-Cd BATTERY BARGAIN** Terrific value—slightly use, govt surplus. Lightweight 5 cell 5 volt, 4 Amp-hour battery with almost unlimited life. Extremely high current output. Recharges in 1 hour with Edmond kit. Won't deteriorate when left discharged. Minimum maintenance—few drops of water per year. Rugged, shock-resistant vibration resistant nylon case. Fully recharged, filled with electrolyte. 3 1/2" x 2" x 6" 2 Ppd. Stock No. 70,942EH \$15.00 Ppd. **CHARGER KIT** Stock No. 70,807EH \$ 8.00 Ppd. Stock No. 41,109EH. CELL \$3.95



**ROTATING MULTI-COLORED LIGHT** Dazzling colors stream endlessly from constantly rotating light. Faceted, transparent globe has lowered drum inside with red, green, blue & yellow stars. Bulb heat rotates drum which projects flickering star points on walls, ceilings, etc. while individual globe facets present constantly changing array of brilliant colors. 9 1/2" star-approx. 12" high on bell-shaped base. Place on table, TV, fireplace—top of Christmas tree or display. Stock No. 71,000EH . . . \$6.00 Ppd.



**LONG-WAVE BLK. LIGHT FIXTURE** Extremely versatile, compactly designed, long wave (3200 luov angstroms) black light (ultraviolet) fixture. Has 6-W, 110-V lamp with built-in filter. Use to identify minerals, fungi, bacteria—check for surface flaws, oil and gas leakage—perfect for displays with fluorescent paper, paints, chalk, crayons, trace powder. Incl. adjustable aluminum reflector, push-pull switch, connecting plug. Mount vert., horz., or on corner. 10" H., 1 1/2" W., 1 1/2" D. Stock No. 70,364EH . . . \$12.50 Ppd. No. 60,124EH . . . (Bulb) \$4.50 Ppd.

## GIANT FREE CATALOG

Edmond, 300 Edscorp Building, Barrington, New Jersey 08007

**148 PAGES — 1000'S OF BARGAINS** Completely new 1970 edition. 202 pages of electrical and electronic parts, accessories. Enormous selection of Astronomical Telescopes, Microscopes, Binoculars, Magnifiers, Magnets, Lenses, Prisms, Many war surplus items for hobbyists, experimenters, workshops, factory. Mail coupon for FREE catalog "EH".

NAME.....  
ADDRESS.....  
CITY.....  
STATE.....ZIP.....

ORDER BY STOCK NUMBER • SEND CHECK OR MONEY ORDER • MONEY-BACK GUARANTEE

# EDMUND SCIENTIFIC CO. 300 EDS CORP BUILDING BARRINGTON, NEW JERSEY 08007

Circle 138 on reader service card



**FREE Catalog** Of The WORLD'S  
FINEST GOV'T  
SURPLUS ELECTRONIC BARGAINS

Now **BIGGER** and  
**BETTER** Than Ever!

---MAIL THIS COUPON NOW---

NAME: \_\_\_\_\_

ADDRESS: \_\_\_\_\_

CITY: \_\_\_\_\_ STATE: \_\_\_\_\_ ZIP: \_\_\_\_\_

For your FREE copy, fill out coupon and mail. Dept. RE  
**FAIR RADIO SALES**  
1016 E. EUREKA • Box 1105 • LIMA, OHIO • 45802

ENJOY THE "MUSIC ONLY" FM PROGRAMS

## M. A. D.

MUSIC ASSOCIATED'S DETECTOR  
for continuous, commercial-free music  
with ANY FM tuner or receiver.



Kit \$49.50 Wired \$75.00 Cover \$4.95 List of FM  
stations with SCA authorization \$1.00. For com-  
plete information write or call:

**MUSIC ASSOCIATED**  
65 Glenwood Rd.,  
Upper Montclair, N.J. 07043  
phone 201-744-3387

## MR. SCA OPERATOR

NEED A RELIABLE SOURCE FOR  
HIGH QUALITY, LOW COST SCA  
RECEIVERS, OR SCA DEMODULATOR  
UNITS?

A new and proven sub-carrier demodula-  
tion scheme using old established principles  
is now practical due to recent component  
developments and mass production. The  
resultant reduction in cost is passed on to  
you.



MODEL SCA-6137 SINGLE FREQUENCY FM  
RECEIVER. Size: 12" x 5 1/2" x 4 1/2". Price:  
\$69.95 (Quantity 1-9)

SCA-6137 FM Receiver Features:

- Range: 88 to 108 MHz • Frequency Field Adjustable • All Solid State Devices • RF Stage
- 3 IF Stages • Automatic Frequency Control
- Two 67 KHz Amplifier Stages • 67 KHz Ratio Detector • Adjustable Muting • Main/Sub-Carrier Switch • One Watt Audio Output • 4" Monitor Speaker • Provision for External Speaker • 117 Volt AC Operated.

Also available: SCA-3 sub-carrier demodulator  
PC Card with muting control. Size: 2 1/2" x 3" x  
5/8". Operates on 6 to 12 Volts DC at 6 ma. Avail-  
able from stock. Price: \$39.95 (Quantity 1-9)

Quantity discounts and detailed specifications are  
available to SCA operators.

Send orders and inquiries to:

JanZac Company; P.O. Box 177;  
Stamford Conn. 06904

KenZac Company; P.O. Box 66251;  
Houston, Texas 77006

# MARKET CENTER

NO TUITION, RENT. Memorize, study—Com-  
mand's "1969 Test-Answers" for FCC first class  
license. Plus Command's "Self-Study Ability  
Test." Proven. \$5.00. **COMMAND PRODUCTION**,  
Box 26348-E, San Francisco, Calif. 94126

AUCTION: Test equipment, tools, tubes, transis-  
tors, etc. Send 50¢ for list. (no stamps)  
**JOHN B. MELCHER**, 28120 G FH, APO SF 96334.

JAPANESE NEW PRODUCTS MONTHLY! \$1.00.  
Refundable. **DEERE**, 10639 Riverside, North  
Hollywood, Calif.

CUSTOMIZED KEY TAGS: Choice of resistor em-  
bedded in transparent, shock-resistant plastic.  
Distinctive! Smart! Chain included. \$1.00.  
**PLASTECH**, 2258 Portal Way, San Jose, Calif.  
95122

## GENERAL

TREASURE HUNTERS! PROSPECTORS! Relco's  
new instruments detect buried gold, silver,  
coins. Kits, assembled models. Transistorized.  
Weights 3 pounds. \$19.95 up. Free catalog. **REL-  
CO-A25**, Box 10839, Houston, Texas 77018

## HEARING AIDS

2/3 OFF DEALER  
PRICES

LARGEST SELECTION of tiny,  
all-in-the-ear, behind the ear,  
eyeglass and pocket models.  
FREE HOME TRIAL. No obliga-  
tion. Money back guaran-  
tee. No down payment. Easy  
terms. No salesman or deal-  
ers. Order direct and save 65%. Write for free catalog.  
**PRESTIGE**, Dept. D-149, Box 10947, Houston, Tex. 77018.



## GOVERNMENT SURPLUS

JEEPS Typically From \$53.90 . . . Trucks From  
\$78.40 . . . Boats. Typewriters. Airplanes,  
Multimeters, Oscilloscopes, Transceivers, Elec-  
tronics Equipment, Used. 100,000 Bid Bargains  
Direct From Government Nationwide. Complete  
Sales Directory and Surplus Catalog \$1.00 (De-  
ductible First \$10.00 Order). **SURPLUS SERVICE**,  
Box 820-REL, Holland, Michigan 49423

## NEXT MONTH

In November we'll show you how im-  
portant it is to breadboard your cir-  
cuit ideas before assembling the  
finished product. Included are some  
valuable tips on breadboard tech-  
niques.

WRITE NOW FOR FREE 1970 CATALOG

McGEE RADIO COMPANY

1001 BARGAINS IN SPEAKERS—PARTS

TUBES—HIGH FIDELITY COMPONENTS

RECORD CHANGERS—TAPE RECORDERS—KITS

EVERYTHING IN ELECTRONICS

1901 McGee St., Kansas City RE, Missouri 64108

## TREASURE

Find buried gold, silver,  
coins, treasures.

5 Powerful models.

Write for free catalog

**RELCO** DEPT. D-149  
BOX 10839, HOUSTON, TEX. 77018

**\$19.95 UP**

## RECHARGEABLE EVEREADY NI-CAD BATTERIES

9V (8.75V) 1/2 amp. hr. cap., size 2 3/4" long x 1 3/8"  
diam. Made of 7-N38 or BH 500 button cells. Suita-  
ble to power cameras, elect. flash, phonos, radios,  
exp. power supplies, many other uses. Retail value  
\$12.00 ea. A fortunate purchase permits selling  
these life time batteries on a money back guarantee  
basis at a fraction of cost. Pospaid at \$2.95 ea.  
(6 for \$15.00)

Miniature Swiss, permanent magnet precision motor,  
reversible, (escap) 1-6 volts D C with reduction gear  
50 rpm. High torque \$1.95 ea.

**TECHNICAL MATERIALS COMPANY**  
769 Inwood Road — Union, N.J. 07083  
Phone 201-687-9172 — 201-687-5171

## LATEST ARCTURUS SPECIALS

- Color focus rectifiers, 14,  
000 P.I.V. at 1 MA, 99¢ each.  
6.5 KV—79¢

- Color TV yokes 70° & 90°  
types. Fit almost all sets  
\$10.95.

- 1700 Transistor types—39¢

- DS-501, 2N278 power tran-  
sistor types. Cat. #349, 69¢

- HEP170, Motorola HV/Current  
epoxy silicon rectifiers,  
2.5 amps at 1,000 PIV, 49¢

- Fully transistorized UHF  
tuners. Fit most sets. Cat.  
#UHF567, \$4.95 each.

- UHF tuners, 1 tube type.  
Fit most sets. Cat. #UHF3,  
\$3.95 each.

Complete listings of electronic  
items at similar bargain prices  
are available. Write for our  
latest catalog. Minimum order  
\$5.00, plus postage.

## ARCTURUS ELECTRONICS CORP.

502-22nd St., Union City, N.J. 07087

Dept. MRE

Phone: 201-864-5568

Circle 139 on reader service card

RADIO-ELECTRONICS



## Unusually Long Interval Times

Electronic timers based on R-C time constants are simple and quite reliable for recycling periods up to 60-90 seconds. Generally, the circuits become much more complex and reliability is degraded when a recycling time of several minutes is required.

Here is a circuit that uses a Schmitt trigger to drive a heating element (H) wound over the case of transistor Q3. The leakage current through Q3's base-collector junction increases with temperature until it is high enough to trip the Schmitt trigger and turn off the heater. When the junction cools down, the Schmitt trigger flops back and the heating cycle

begins its cycle all over again.

Note that one of the collector load resistors for the Schmitt trigger (Q1-Q2) is very much larger than the other. This is done so that when Q2 conducts, the voltage across the common emitter resistor (R1) is large enough to keep Q4 in conduction. However, when Q1 is conducting and Q2 is off, the voltage across R1 is much smaller and Q4 is cut off completely. Using a 200-ohm heater and the circuit constants shown in the diagram, the timer takes about 5 minutes to recycle.—G. Varadarajan

(The author did not include details on the heater. However, you can probably use resistance wire salvaged from a wire-wound resistor or potentiometer.—Editor) **R-E**

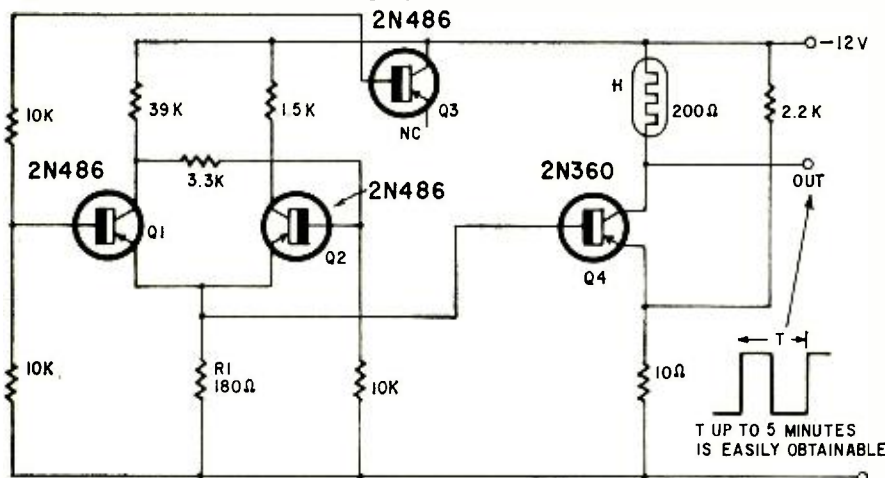

**CLASSIFIED COMMERCIAL RATE** (for firms or individuals offering commercial products or services). 70¢ per word . . . minimum 10 words.  
**NON-COMMERCIAL RATE** (for individuals who want to buy or sell personal items) 30¢ per word . . . no minimum.  
 Payment must accompany all ads except those placed by accredited advertising agencies. 10% discount on 12 consecutive insertions, if paid in advance. Misleading or objectionable ads not accepted. Copy for January issue must reach us before October 10.

## CLASSIFIED ADVERTISING ORDER FORM

1	2	3	4	5
6	7	8	9	10
11	12	13	14	15
16	17	18	19	20
21	22	23	24	25
26	27	28	29	30
31	32	33	34	35

\_\_\_\_\_ { @ .30 Non-Commercial Rates } = \$ \_\_\_\_\_  
 No. of Words { @ .70 Commercial Rate }  
 Total Enclosed \$ \_\_\_\_\_  
 Insert \_\_\_\_\_ time(s)  
 Starting with \_\_\_\_\_ issue  
 Payment must accompany order unless placed through accredited advertising agency 28

NAME \_\_\_\_\_  
 ADDRESS \_\_\_\_\_  
 CITY \_\_\_\_\_ STATE \_\_\_\_\_ ZIP \_\_\_\_\_  
 SIGNATURE \_\_\_\_\_  
 MAIL TO: RADIO-ELECTRONICS, CLASSIFIED AD DEPT.,  
 200 PARK AVE. SOUTH, NEW YORK, N.Y. 10003

# SCHOOL DIRECTORY

## GET INTO ELECTRONICS

V.T.I. training leads to success as technicians, field engineers, specialists in communications, guided missiles, computers, radar and automation. Basic & advanced courses in theory & laboratory. Electronic Engineering Technology & Electronic Technology curricula both available. Associate degree in 29 mos. B.S. also obtainable. G.I. approved. Graduates in all branches of electronics with major companies. Start Sept., Feb. Dorms, campus. High school graduate or equivalent. Catalog.

**VALPARAISO TECHNICAL INSTITUTE**  
 Dept. C, Valparaiso, Indiana 46383



## distinguished graduates

hold important engineering and business administration posts throughout U.S. Professionally-oriented college with outstanding placement record. Four-quarter year permits degree in three years. Fine faculty. Modern labs. Small classes. 300-acre campus. Accredited. Approved for vets. Moderate costs. Enter Jan., March, June, Sept. For Catalog, write Adm. Director.



**TRI-STATE COLLEGE**  
 24109 College Avenue, Angola, Indiana 46703

## PEP'S Dollar Sale

### \$1 Money Back guarantee \$1

- 1 Amp Silicon Rectifier** choice of package
  - 5-800V units \$1.00
  - 4-1000V units \$1.00
  - 3-1200V units \$1.00
- 3 AMP Epoxy Package**
  - 10-100V units \$1.00
  - 5-400V units \$1.00
  - 2-1000V units \$1.00
- 5 AMP Epoxy Package**
  - 8-100V units \$1.00
  - 6-200V units \$1.00
  - 3-800V units \$1.00
- SILICON STUD MOUNT 12 AMP**
  - 5-100V units \$1.00
  - 2-800V units \$1.00
  - 1-1000V units \$1.00
- SILICON STUD MOUNT 20 AMP**
  - 3-100V units \$1.00
  - 1-1000V unit \$1.00
- SILICON STUD MOUNT 40 AMP**
  - 3-50V units \$1.00
  - 2-100V units \$1.00
- SILICON STUD MOUNT 60 AMP**
  - 2-50V units \$1.00
  - 1-1000V unit \$1.00
- SILICON GLASS DIODES DO-7**
  - 10-100V units \$1.00
- SPECIAL INTEGRATED CIRCUITS**
  - Dual 4 Input Nand Gate Digital . . . \$1.50
  - Quad 2 Input Nand Gate Digital . . . \$1.50
  - J-K Flip Master Slave Digital . . . \$1.75
  - Linear I.C. Operational Amp 709C Type . . . \$1.75
- POWER TRANSISTOR**
  - 85 Watt Similar to 2N-212-1724-1208
  - 1 Unit . . . \$1.00
- SCR Silicon Controlled Rectifier TO-5 Package**
  - 5-40V units \$1.00
  - 4-100V units \$1.00
  - 3-200V units \$1.00
  - 2-400V units \$1.00
- 7 AMP SCR**
  - 4-50V units \$1.00
  - 3-100V units \$1.00
  - 2-200V units \$1.00
  - 1-800V units \$1.00
- 20 AMP SCR**
  - 2-50V units \$1.00
  - 1-300V unit \$1.00
- Gen Purpose PNP Germ Transistor Similar to 2N404**
  - 8 For \$1.00
- ZENER DIODES 3 Watt**
  - 10 Volts
    - 3 units \$1.00
  - ZENER DIODES 1 Watt**
    - 1 EA 4V-6V-8V-10V
    - 4 units \$1.00
  - GERM GLASS DIODES DO7 GEN PURPOSE**
    - 20 Units \$1.00
    - Replaces 1N-34 1N-60 1N-64 1N-295
  - Zener Diodes 250 to 400 Milliwatt**
    - 1 EA 2V-4V-6V-8V-10V
    - 5 units \$1.00
- Power Transistors**
  - 2N-155
    - 3 units \$1.00
  - 2N-176
    - 2 units \$1.00
- RADIATION FREE TUBE FOR COLOR TV**
  - 50,000 Volts Replaces RCA 3A-3A or Equivalent. Guaranteed for life of set or 5 years. Eliminates heat to prolong life of other tubes. \$8.99 each
- NO SALES TAX WE PAY POSTAGE**

## PARK ELECTRONIC PRODUCTS

P. O. Box 78 N. Salem, N. H. 03073  
 Tel. (603) 893-0276

Circle 140 on reader service card

*NOW With Solid State Circuitry & Rechargeable Batteries*

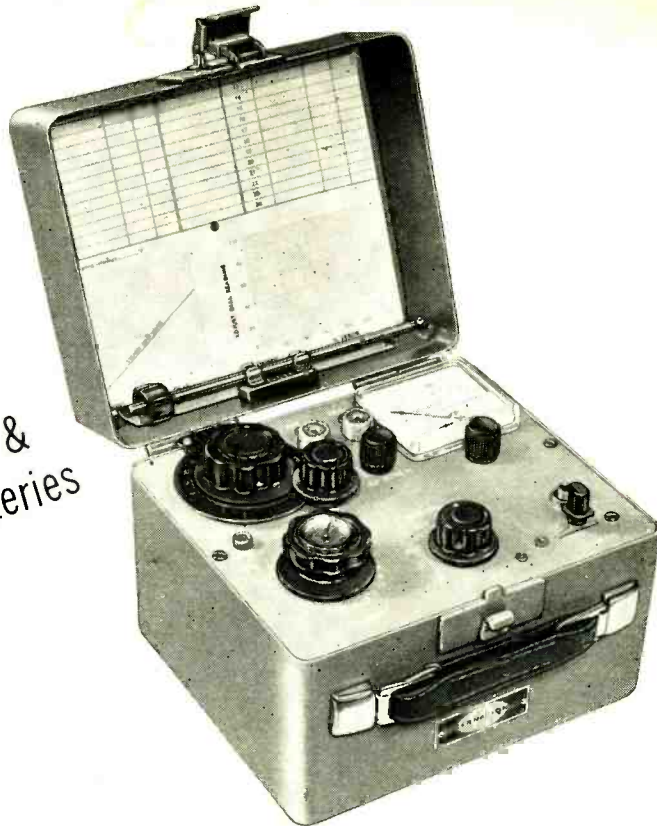

**ICM** FM-2400C

# *frequency meter...*

- Completely Portable
- Tests Predetermined Frequencies  
25 MHz - 500 MHz

The **FM-2400C** provides an accurate standard frequency signal for testing and adjustment of mobile transmitters and receivers at predetermined frequencies between 25 and 500 MHz. Up to 24 crystals may be inserted into the meter. The frequencies can be those of the radio frequency channels of operation, and/or of the intermediate frequencies of the receivers between 5 MHz and 40 MHz. Frequency stability (standard)  $\pm .001\%$  from  $\pm 32^\circ$  to  $\pm 122^\circ$ F. Frequency stability with built-in thermometer, calibrated crystals and temperature corrected charts,  $.00025\%$  from

$\pm 25^\circ$ F to  $\pm 125^\circ$ F. (.000125% special 450 MHz crystals available)

FM 2400C (Meter Only)..... **\$445.00**

RF Crystals

Hi Band..... **\$24.00 ea.**

Lo Band..... **15.00 ea.**

IF Crystals..... **8.00 ea.**

*Write for free catalog.*



**CRYSTAL MFG. CO., INC.**  
10 NO. LEE • OKLA. CITY, OKLA. 73102



# Pacesetter

## New "Silent Partner" Model 1077 Television Analyst

The fast pace of technology today demands change and originality in all areas of electronics. Diagnostic equipment is no exception; and new instrument designs will continue to appear as new service needs arise. *The service technician who can keep up with these changes today will enjoy more profit tomorrow!*

To help you keep pace with solid-state circuitry and UHF broadcasting developments, B&K announces a new advance: the Model 1077 Television Analyst. *It handles all the new solid-state TV receivers and analyzes both UHF and VHF! It's the Silent Partner that helps set the pace towards more business for you.*

The 1077 analyzes every stage in color and black-and-white TV receivers without external scopes or wave-form interpretation. Handles any solid-state circuit, foreign or domestic. Handles eight VHF plus all UHF RF channels. The 1077 includes 20-48 MHz IF, audio, video, sync, three color adjustment patterns (white dot, color bar, and cross hatch), bias voltage, and AGC keying pulse. The RF, UHF, and IF generators are modulated with the output of a built-in *Flying Spot Scanner* which uses slides of standard test patterns (supplied).

So, if you're looking for a "Silent Partner" to add dollars to your bank account, don't miss the 1077 Television Analyst. Because when it comes to creating new business, the 1077 Television Analyst is a profit natural!

For detailed information, see your distributor or write for the latest B&K catalog.

**B&K Model 1077  
Television Analyst.  
Net: \$379.95.**



**B&K puts an end to test equipment.  
We've developed Silent Partners.**

**B&K** Product of DYNASCAN CORPORATION 1801 W. Belle Plaine, Chicago, Illinois 60613

Circle 149 on reader service card

# Why do you protect your service reputation each time you install an RCA color picture tube?

PAID PX



Whether it's in the customer's living room, or at the bench in the shop, it helps to be able to replace a color picture tube with confidence.

If it's an RCA tube that's being installed, the tube itself can contribute to that confidence.

Here is a product made with know-how...from the most experienced manufacturer in the business. A tube unstintingly manufactured to the highest quality standards... RCA standards. A color picture tube whose built-in technology helps protect your time and talent.

Why not specify RCA picture tubes for your requirements? They'll help protect your service reputation. Just as they're designed to protect the biggest reputation in the COLOR TV industry.

RCA Electronic Components, Harrison, N.J.

# RCA