

POPULAR COMMUNICATIONS

Uncensored Two-Way Radios!

Also in this issue:

- **Radio in Eritrea**
- **Monitoring the Hurricane Hunters**
- **Coaxial Cable: More Than a Wire**
- **Low-Power FM'casters Battle the FCC**

U.S. \$3.50 Canada \$4.50



0 74851 08635 3

**Plus: CB, Nostalgia, Satellites,
Pirate Radio, & More!**

AOR[®] THE NEW CLASSIC



**FREE VHF Converter
or Collins CW filter!!!**
Limited time offer

AOR AR3030 GENERAL COVERAGE RECEIVER

- State-of-the-art DDS synthesizer with superfine 5Hz tuning resolution.
- All-mode reception including USB/LSB/CW with true carrier reinsertion, FM/AM with synchronous detection and even FAX.
- Fully adjustable VFO on SSB/CW.
- Excellent sensitivity and unmatched selectivity with COLLINS 8-resonator mechanical filters, 6kHz AMW.
- Direct keyboard frequency entry or smooth main tuning knob.
- Dual VFO's as standard.
- 100 full-featured memory channels.
- Unique frequency entry as "meter bands".
- Excellent audio with large speaker and powerful 3-watt audio amplifier.
- Full AGC control with AGC-off position and rear panel AUX connector.
- RS-232C port standard for full computer control capability.
- Rear panel IF output as standard.
- Built-in COR (Carrier Operated Relay) circuit for automatic stop/start of tape recorder or other connected device.
- Large, easy-to-read backlit LCD display.
- Accurate, attractive analog S-meter.
- Optional VHF converters and computer-control software.
- Optional 500Hz CW and 2.5kHz SSB Collins mechanical filters.

Superior performance & unsurpassed value. With the COLLINS mechanical filter inside.

The 15 month dream of the renown AOR R & D team is now a reality. . . . The new AR3030 HF receiver is here! AOR's ambitious effort has produced a full-featured, full-coverage, all-mode shortwave receiver that has become an overnight sensation. This new receiver combines the classy look of a custom extruded aluminum case and an attractive, well-planned front panel with the very latest in state-of-the-art engineering, including a low noise direct digital synthesizer (DDS) with full 20kHz to 30MHz coverage and the superb IF filtering characteristics offered by the legendary COLLINS mechanical filters! With the 6kHz COLLINS AM filter included as standard, the long awaited AR3030 HF receiver is, the "New Classic" from AOR!

**CALL YOUR FAVORITE
DEALER FOR
DETAILS TODAY!!!**

AOR Manufactured by
AOR, Ltd. Japan



Distributed by:
Electronic Dist. Inc.
1 • 800 • 344 • 0397

EEB

NATIONS LARGEST RECEIVER OUTLET

SUMMER SUPER SALE!!!

Bearcat Scanners

BC3000XLT 25-550/760-1300MHz⁽¹⁾

- Scan 100ch/sec, search 300ch/sec, 400 memory channels. 20 x 20 banks.

LIST \$499.95 **EEB \$369.95**



BC9000XLT 25-550/760-1300MHz⁽¹⁾

- Alpha numeric LCD on all 500 memory ch. Scan 100 ch/sec, search 300 ch/sec, data skip, attenuator 15dB, Cor recorder control.

LIST \$769.95 **EEB \$389.95**



BCT-7 All Band 26-956MHz⁽¹⁾

- A must for the frequent highway travelers. 7135 pre-programmed chs., search by state & service. Police, HP, DOT, Fire, News, WX, CB, plus 100 User memories, scan 100 ch/sec.

LIST \$319.95 **EEB \$169.95**



Other BEARCAT Scanners...

BC120XLT	\$129.95	BC760XLT ⁽¹⁻²⁾	\$199.95
SC150Y/B ⁽¹⁾	\$169.95	BC860XLT ⁽¹⁾	\$169.95
BC148XLT-1 ⁽¹⁾	\$99.95	BC890XLT ⁽¹⁻²⁾	\$229.95
BC220XLT ⁽¹⁾	\$224.95		

AOR

AR2700 (A-1-3) NEW, .1-1300MHz \$399.95

AR3000A (1-3) .1 - 2036MHz \$1029

SDU5000 AOR \$995 ICOM \$1095

AR8000 (1-3) .1 - 1900MHz \$649.95

OPTO ELECTRONICS & AOR...A New Exciting Scanner System

- The SCOUT 40 will capture a signal, store and reaction-tune your AOR AR2700/AR8000 Scanner. SCOUT 40 works on near field high level signals.
- Imagine listening to all the action on your scanner without ever Programming. Great for air shows, car races, Air Fields, Marinas, Emergency scenes, Las Vegas Casinos. Any time you want to listen in on what's happening in you local area.

"A MUST FOR NEWS GATHERING SERVICES!"

- **EEB is offering a package system including:**

 1. Modification to AOR scanner, (we are a factory authorized AOR service)
 2. Interconnect cable.
 3. SCOUT 40 (Version 3.1) and AR2700 for \$849.00 or the AR8000 for \$1095. System is 100% Checked Out & warranted by EEB. SCOUT 40 (3.0) requires ARCX Cable...\$49.00



SCOUT 40 \$399.95

SONY ICFSW7600G

Special Buy!!!

EEB's Hottest Seller. SONY's best valued SWL Receiver in years. All Mode, .15 - 30MHz, 76 - 108MHz. FM, 22 station memory, Synchro-detector, Dual Conversion, it's got it all!



AC adaptor ACE60M \$24.95, AN-1 Active antenna, \$84.95 Extended 1 yr warranty \$18.95

Other SONY's at Special Summer Prices

ICFSW55	\$339.95	• ICFSW100	\$344.95
ICFSW77	\$459.95	• ICFSW30	\$104.95
ICF2010	\$344.95	• ICFSW33	\$159.95

\$169.95

Ask for a FREE Stereo Headset and Radio Stand with your SONY order.

Best OF...GRUNDIG

YB400 Portable \$179.95

SAT700 Base \$388.00

LOWE SPECIAL

HF150 Reg \$599 NOW \$569.00

HF225 Reg \$749 NOW \$699.00

HF150 Options 10% OFF!!!

LOWE HF250 NEW Exciting HF Receiver From LOWE

- 30kHz - 30MHz in 100Hz steps • 255 Memory channels
- Filters 10, 7, 4, 2.2, .2kHz • RS232 Computer Control
- IR Remote • Opt. Synchro. Detect. • Built like a Battleship
- Great Audio "LOWE has done it again!"

Suggested Retail \$1259 CALL for Quote.



Best Of...REALISTIC

PRO 62 (1) Portable \$249.95

PRO2035 (1) Base \$359.95

Best Of...SANGEAN

ATS606P Great portable \$169.95

ATS818 .1 - 30/88 - 108MHz \$149.95

ATS818CS Cassette \$219.95

- (A) Pending FCC certification
- (1) Cellular Block (not restorable)
- (2) Cellular Block, but can be restored
- (3) Un-Blocked O.K. to qualified buyers (Govt., Export, etc.)

Check out EEB's NEW BBS!!!

Dial us up. Check us out!

Tech Info, Used-Demo Specials, MORE!

1 - 703 - 938 - 3781

DRAKE R8A

Improved and upgraded version of the world famous R8.

- Improved Ergonomics • Dynamic range (+100dB)
- 3rd OIP +20dB • Increase memory to 440 ch.
- Scan 40 ch/sec. It's time to trade-in your R8, call for Quote.

SW8 - Great SWL & Portable \$679.95



\$1085.00

WJ HF1000 World's

Ultimate Receiver

\$3799

Opt. Preselector
HF1000D \$649.00



GE SUPERADIO II

Everyone needs a good AM/FM DX radio. Great audio, large ferrite antenna, 4 I.F. stages.

\$59.95



Opto Electronics

- SCOUT 40 (3.1) runs AOR & ICOM list \$449 **EEB \$399.95**
- DC440 Decoder CTSS, DCS, DTMF list \$259 **EEB \$229.95**
- R10/R20 Interceptors Self tuning, nearfield receiver

R10 FM save \$40, Now \$319.95
R20 AM Now \$109.95

95 Catalog...FREE
96 Pages, SWL, Scanners, Antennas, Books, Lots more.



FREE in the U.S., 3rd class (4 weeks). \$2 1st class (1 week). \$2 Can/Mex. \$5 elsewhere.

ELECTRONIC EQUIPMENT BANK

323 MILL Street NE
Vienna, VA 22180

*We accept VISA/MasterCard/American Express/Discover

ORDERS: 800-368-3270

Local Tech: 703-938-3350

FAX: 703-938-6911

*We ship via UPS, Federal Express and Mail

- Sorry, no COD's
- Free Catalog in USA
- Prices Subject to change
- Prices do not include freight
- Returns subject to restock fee up to 20%

EEB

POPULAR COMMUNICATIONS

JULY 1995

VOLUME 13, NUMBER 11

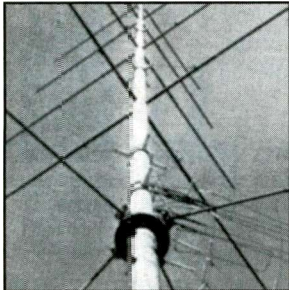

19



28



52



8

FEATURES

Two-Way Radio Uncensored 8

Learn first-hand why the public loves those handheld radios

By Tom Kneitel, K2AES, Editor

Eye of the Storm 10

With the hurricane season upon us, let's monitor the "hurricane hunters."

By Don Schimmel

Radio: The Old Days 19

Meet the radio broadcasters who followed their dreams.

By Alice Brannigan

Books You'll Like 24

Guerrilla Broadcasters, Free Space!, The Whole Spy Catalog, and more.

By R.L. Slattery

Radio In Eritrea 26

The radio station based in Africa's newest country.

By James Renn

COLUMNS

Satellite View.....	28
New Products.....	31
Listening Post.....	32
How I Got Started.....	37
Scanning VHF/UHF.....	38
Pirates Den.....	41
You Should Know.....	42
Clandestine Communique.....	47
The Ham Column.....	48
CB Scene.....	52
Washington Pulse.....	54
Antennas 'n' Things.....	58
Communications Confidential.....	60
Broadcast DXing.....	74

DEPARTMENTS

Beaming In.....	5
Mailbag.....	6
World Band Tuning Tips.....	44
Communications Shop.....	83

This month's cover: Two-way radio at work—security guard Albert Schickner stands by on call at the Raritan Bay Medical Center, in Perth Amboy, NJ. Photo by Larry Mulvehill, WB2ZPI.

EDITORIAL STAFF

Tom Kneitel, K2AES/KNY2AB, Editor
Deena Marie Amato, Associate Editor

CONTRIBUTING EDITORS

Gerry L. Dexter, Shortwave Broadcast
Gordon West, WB6NOA, Emergency
Don Schimmel, Utility Communications
Edward Teach, Alternative Radio
Harold A. Ort, Jr., SWL Conf. Coord.
Chuck Gysi, N2DUP, Scanners
Tim Kridel, AM/FM Broadcasts
Capt. William Mauldin, WG4R, Thoughts & Ideas
Donald E. Dickerson, N9CUE, Satellites
Brian Battles, WS10, Amateur Radio
Joe Carr, K4IPV, Antennas
Ted Lisle, KD4EXK, Handi-Chat Editor
Jack Elliott, SSB-734, CB Communications

BUSINESS STAFF

Richard A. Ross, K2MGA, Publisher
Donald R. Allen, N9ALK, Advertising Mgr.
Emily Kreutz, Sales Assistant
John Dorr, K1AR General Manager
Frank V. Fuzia, Controller
Simon Schatzmann, Circulation Director
Catherine Ross, Circulation Manager
Melissa Nitschke, Operations Manager
Carol Licata, Data Processing
Denise Pyne, Customer Service

PRODUCTION STAFF

Elizabeth Ryan, Art Director
Barbara Terzo, Associate Art Director
Susan Oliveri, Assistant Art Director
Edmond Pesonen, Electronic Comp. Mgr.
Dorothy Kehrwieler, Production Manager
Emily Kreutz, Assistant Production Manager
Pat Le Blanc, Phototypographer
Hal Keith, Technical Illustrator
Larry Mulvehill, WB2ZPI, Photographer



CQ Communications, Inc.
76 North Broadway
Hicksville, NY 11801-2953 USA

A publication of

Offices: 76 North Broadway, Hicksville, NY 11801. Telephone (516) 681-2922. FAX (516) 681-2926. Popular Communications (ISSN-073-3315) is published monthly by CQ Communications, Inc. Second class postage paid at Hicksville, NY and additional offices. Subscription prices (payable in U.S. dollars): Domestic—one year \$22.95, two years \$41.00, three years \$60.00. Canada/Mexico—one year \$32.95, two years \$61.00, three years \$96.00. Foreign—one year \$34.95, two years \$65.00, three years \$96.00. Foreign Air Mail—one year \$82.95, two years \$262.00, three years \$240.00.

U.S. Government Agencies: Subscriptions to Popular Communications are available to agencies of the United States government, including military services, only on a cash with order basis. Requests for quotations, bids, contracts, etc. will be refused and will not be returned or processed.

Entire contents copyright © 1995 by CQ Communications, Inc. Popular Communications assumes no responsibility for unsolicited manuscripts, photographs, or drawings. Allow six weeks for change of address or delivery of first issue.

Printed in the United States of America.

Postmaster: Please send change of address to Popular Communications, 76 North Broadway, Hicksville, NY 11801.

QUALITY COMMUNICATIONS EQUIPMENT SINCE 1942

AMATEUR RADIO EQUIPMENT

KENWOOD YAESU ICOM JRC

SR STANDARD



Universal has been selling the finest in new and used amateur radio equipment since 1942 and is an authorized sales and service center for all major lines.

COMMUNICATIONS RECEIVERS

YAESU KENWOOD JRC

DRAKE



ICOM



Universal Radio carries an excellent selection of new and used communications receivers. JRC NRD-535D shown.

RTTY AND FAX DECODERS

◆ Universal M-8000 Decoder



The professional-grade M-8000 was designed primarily for the military, commercial and diplomatic user, but can be used by the hobbyist who requires maximum intercept capability. The color VGA output includes a spectral display and simulated tuning scope. Modes currently include: CW, Baudot, FAX, SITOR, ARQ-M2 & M4, ARQ-E/E3, ARQ6-90, ARQ-S, SWED-ARQ, FEC-A, FEC-S, ASCII, Packet, Pactor, Piccolo, VFT, ACARS, POCSAG and GOLAY. Too many features to list here. Monitor and printer optional. \$1349.00 (+\$10)

◆ Universal M-400 Reader



The self-contained Universal M-400 is a sophisticated decoder and tone reader offering exceptional capabilities. The SWL can decode: Baudot, SITOR A and B, FEC-A, ASCII and SWED-ARQ. Weather FAX can also be decoded to the printer port. The VHF-UHF listener can copy the ACARS VHF aviation teletype

mode plus GOLAY, POCSAG and SUPER POCSAG digital pager modes. Even off-the-air decoding of DTMF, CTCSS and DCS. Big two-line, 20 character LCD and parallel printer port. The M-400 runs from 12 VDC or with the supplied AC adapter. No computer or monitor is required. Made in the U.S.A. \$399.95 (+\$6)

◆ Universal M-1200 Decoder Card

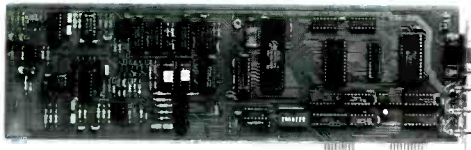

Turn your PC into a powerful intercept device! Reception modes include: CW, Baudot RTTY, SITOR, FEC-A, ARQ-M2, ARQ-E/E3, FAX and ARQ6-90 plus ASCII and Packet. VHF

enthusiasts can copy PL, DCS, the ACARS aviation mode, POCSAG and GOLAY. Operation is easy through on-screen menus, status indicators and help windows. Requires PC with VGA monitor. Made in the U.S.A. \$399.95 (+\$5)

★ FREE 100 PAGE SWL - HAM CATALOG ★

Universal offers an informative catalog covering everything for the shortwave, amateur and scanner enthusiasts. With prices, photos and full descriptions. This comprehensive publication is FREE by bookrate, or for \$2 by first class mail. Request it today!

COMMERCIAL RECEIVERS



The Watkins-Johnson HF-1000 is the ultimate receiver! Advanced D.S.P. technology, 58 bandwidths, 1 Hz display. Under \$4000. Please contact us to receive a spec. sheet.

PORTABLE RECEIVERS

ICOM

SONY

GRUNDIG

SANGEAN

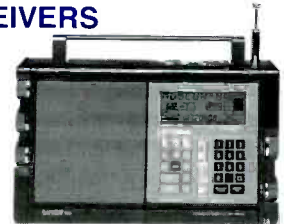

Universal offers over 40 portable receivers from \$50 to over \$500. Our free catalog fully describes & prices all models.

COMMUNICATIONS BOOKS

- **Passport To Worldband Radio 1995** By L. Magne
Graphic presentation of all shortwave broadcast stations. Equipment reviews, too. A must have book. \$17.95 (+\$2)
 - **World Radio TV Handbook 1995**
All shortwave broadcast stations organized by country with schedules, addresses, power, etc. \$24.95 (+\$2)
 - **Worldwide Aeronautical Frequency Dir.** By R. Evans
The definitive guide to commercial and military, HF and VHF/UHF aero communications including ACARS. Brand new Second Edition. 260 pages. \$19.95 (+\$2)
 - **Shortwave Receivers Past & Present** By F. Osterman
Your guide to over 200 receivers with new and used values, specifications and features. Photos for most. \$8.95 (+\$2)
 - **Comprehensive Guide to Military Mon.** By Douglass
Covers equipment, SW and VHF/UHF frequencies, identifiers, playbook, bases and black projects. \$19.95 (+\$2)
 - **Discover DXing!** By J. Zondlo
An introduction to DXing AM, FM and TV. \$4.95 (+\$2)
 - **The World Below 500 KiloHertz** By P. Carron
An introduction to the world of longwave DX. \$4.95 (+\$2)
- Be sure to include \$2 per title for shipping.

Prices and specifications are subject to change. Returns are subject to a 15% restocking fee.

Universal Radio, Inc.
6830 Americana Pkwy.
Reynoldsburg, Ohio
43068-4113 U.S.A.

☎ 800 431-3939 Orders & Prices
☎ 614 866-4267 Information
➔ 614 866-2339 Facsimile

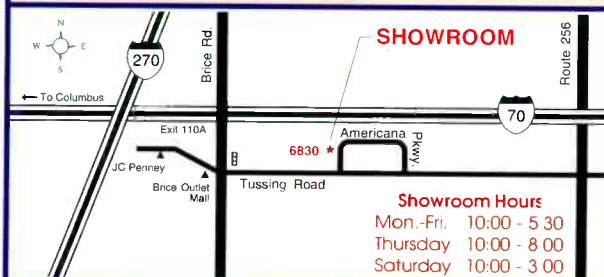

Showroom Hours
Mon.-Fri. 10:00 - 5:30
Thursday 10:00 - 8:00
Saturday 10:00 - 3:00

universal radio inc.

You Won't

Miss a Thing

With

SCOUT™

Reaction Tune



The SCOUT™ Has Taken Tuning Your Receiver To a New Dimension

Featuring Automatic Tuning of your AR8000 and AR2700 with the Optoelectronics Exclusive, Reaction Tune (Pat.Pend.). Any frequency captured by the Scout will instantly tune the receiver. Imagine the possibilities! End the frustration of seeing two-way communications without being able to pick up the frequency on your portable scanner. Attach the Scout and AR8000/2700 to your belt and capture up to 400 frequencies and 255 hits per frequency. Or mount the Scout and AR8000/2700 in your car and cruise your way into the future of scanning. A simple interface cable will connect you to a whole new dimension of scanning.

The Scout's unique Memory Tune (Pat.Pend.) feature allows you to capture frequencies, log into memory and tune your AR8000/2700 at a later time. A distinctive double beep will inform you when the Scout has captured a new frequency, while a single beep indicates a frequency that has already been recorded. For discreet monitoring, a pager style vibrator will inform you of any hits the Scout captures.

The Scout will also Reaction Tune and Memory Tune Icom CI-V receivers: (R7000, R7100, and R9000) and (Pro 2005/6 equipped with OS456, Pro 2035 equipped with OS535). Download the Scout frequencies to a PC with the Scout Utility Disk and CX-12AR (optional), then compare them to the Spectrum CD-ROM/PerCon FCC Database (optional).

**Act Now!! Let the Scout Reaction Tune
you into The World of Scanning**

SCOUT™ \$449



*Scanner not included

Features

- Automatically tunes these receivers with Reaction Tune (Pat.Pend.) CI-V receivers (ICOM's R7000, R7100, and R9000), (Pro 2005/2006 equipped with OS456, Pro 2035 equipped with OS535) or AOR models (AR2700 and AR8000).
- Records and saves 400 unique frequencies
- Records 255 hits on each frequency in memory
- Digital Filter and AutoCapture (Pat.Pend.)
- 10MHz-1.4GHz single frequency range
- View frequencies in RECALL mode
- 10 digit LCD with EL Backlight
- 16 Segment RF signal strength bargraph
- CX-12AR Computer Interface (optional)
- PC Utility Disk for downloading memory to PC
- Rapid charge NiCads with 10 hour discharge time
- Scout Spectrum CD-ROM/PerCon FCC database (optional)
- AC Adaptor/Charger
- DB 32 VHF/UHF mini-antenna shown with Scout (optional)
- Distinctive Beeper/Vibrator indicate frequency hits

At right: Scout shown with CLIPMATE™. A handy windshield mount for Scout, for quick access and visibility.

CLIPMATE™ \$25.00

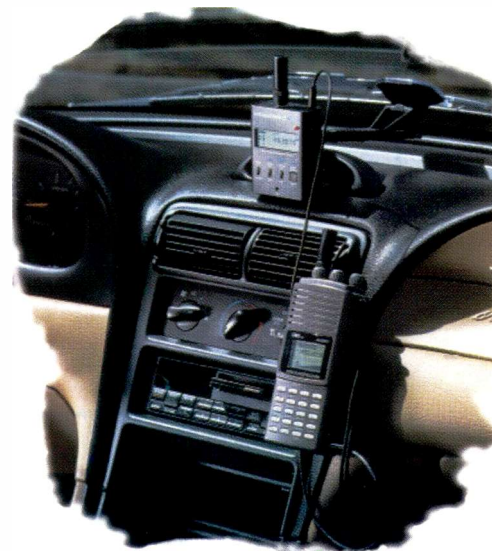

OPTOELECTRONICS®

5821 NE 14th Avenue • Ft. Lauderdale, FL 33334

Contact Factory for shipping prices. Visa, Master Card, & C.O.D.(cash or money order only)

All prices and specifications are subject to change without notice or obligation

MADE IN THE U.S.A.

ORDER LINE
800-327-5912
Tel:305/ 771-2050
Fax:305/ 771-2052

Free Speech & Free Radio vs. The FCC

Sometimes people have felt that, for whatever reason, they wanted to transmit programming into their local community. Towards this end they have established micropower FM broadcast stations, these being operated without FCC authorization and licenses. Such stations aren't necessarily "underground" activities. Most operate quite openly, and publicize their programs.

It is not that the operators refuse to obtain licenses, instead it's that the FCC staunchly refuses to license micropower stations. Not only that, the sporadic appearance of these stations has never failed to get the FCC all het up about yanking them off the air, one by one.

The FCC won't license low-power FM (LPFM) broadcasters. The agency requires a minimum power of 100 watts. LPFM stations use from 1 watt to 40 watts. Micropower operators point out that a full-power license costs thousands of dollars in FCC fees, plus about \$100,000 in engineering surveys and other start-up expenses, plus the equipment. Micropower stations can be set up for as little as \$500 to \$600, they argue. Most importantly, their proponents say, these stations are altruistic in nature, and non-commercial. Mostly, they seek to serve only a localized community area, seeking to provide specialized entertainment or information, and in-depth neighborhood coverage ignored by other local media.

I recall when microcaster WRFI, *Radio Free Ithaca*, in N.Y., on 88.5 MHz, was raided by the FCC back in 1981. The 10-watt station had an audience of about 1,500 listeners. A feature was the nightly broadcast of BBC news. Its passing was lamented in the local press.

The FCC claimed that a cable TV system had verbally complained to the agency about interference to their video, consisting of small horizontal lines.

In 1990, WQNR, an FM microcaster in Selden, N.Y., was located in the same county where I live. I remember when it was raided and shut down by the FCC. WQNR had started out in 1986 as an AM station using carrier current, but the FCC had shut that operation down. As an FM microcaster, WQNR was run one night each week by a 39-year-old operator. WQNR had reached an audience estimated at 20,000.

The FCC claimed that it had received a complaint that WQNR interfered with cable TV reception.

In 1993, the FCC gave enormous static to KAFR, *Arizona's Free Radio*, 92.7 MHz, in Phoenix. Listener supported KAFR operated 6 to 10 p.m., Monday through Fri-

day, easily heard from the Phoenix Mountain Preserve, north beyond the Deer Valley Airport; and from 59th Avenue, eastward to Scottsdale Road.

These are only a few representative examples that quickly came to mind. I don't want to go too far down Memory Lane, just far enough to show the micropower pot's been simmering for a long time. Now it's starting to boil over.

Here's the thing, these stations just won't stop popping up. They're appearing more often, and from coast to coast. Except now they're doing it with more and more regularity. Furthermore, the operators are no longer quite so willing to pay the fines and then slink off quietly into oblivion. Now they're angry. It's become a "Free Speech" movement. There are attorneys involved, and the operators are fighting back—questioning the legality of FCC's denying them rights to have low-power broadcasting access to the airways.

Looks like this grass-roots movement got a full head of steam in 1994 when the San Francisco Bay Area spawned several FM microcasters, notably *Radio Libre*, and *Free Radio Berkeley*.

More than mere platter spinners, these stations were socially conscious activists, free-speech oriented rebels. The stations were openly confrontational regarding the FCC's attitudes towards microcasters.

The FCC swooped down *Free Radio Berkeley* like a falcon on a mouse. The agency tried to obtain a temporary injunction to shut down FRB while they figured out how to administratively pursue silencing it on a permanent basis. This time, the mouse bit back!

FRB showed up and argued that by completely prohibiting low power broadcasting, the Commission is depriving prospective broadcasters and their listeners of access to the airwaves in violation of the First Amendment. They claimed that when First Amendment free speech rights are impacted by government regulation, the government must establish that the contested regulations are the least restrictive means available to further a compelling state interest.

Traditionally, FCC regulation of the airwaves has been justified because the agency claims the spectrum can't accommodate an unlimited number of users. FRB argued that the regulations prohibiting low power broadcasting, and the FCC justification for them, are based on outdated assumptions about technical capabilities. Contrary to the FCC's assertions to support its ban on LPFM, FRB argued that microcasting can

be permitted without risk of signal interference to high-power broadcasters.

FRB cited that Canada has licensed LPFM stations in rural areas since 1989, and urban areas since 1993. They noted an FCC report which cited the Canadian law, in support of this contention, and how the FCC's position banning LPFM is based upon a study they did back in 1978.

FRB continued by stating that by prohibiting LPFM, the FCC effectively eliminates opportunities for low-cost broadcasting on community issues as an alternative to mainstream perspectives. This, they said, violated the agency's mandate to regulate in the interests of the whole public, not just the economically powerful.

The Commission responded by reaffirming its traditional authority to license stations based on the validity of the scarcity doctrine.

FRB challenged the constitutionality of the present regulations which don't allow for the licensing of stations using less than 100 watts. This was a point also raised two years earlier by KAFR in its own defense. The FCC did not, as matter of law, establish that the regulations were constitutional. Furthermore, the fact that a statute is constitutional doesn't compel the conclusion that regulations created under it are also constitutional.

The FCC also argued that the FCC met its statutory mandate with its 1978 extensive feasibility study of LPFM before deciding to prohibit these stations. FRB said that technology has changed since then, and along with it the feasibility of LPFM. Supporting its argument, the FCC attempted to establish irreparable harm by asserting that FRB's broadcasting may interfere with legitimate licensed broadcasting. The agency pointed out that FRB's equipment wasn't FCC approved, and there were two documented instances of interference. They mentioned the possibilities of spurious signal emissions causing interference to air navigation and communications operations. These were the same allegations made in the KAFR case, even though KAFR used FCC type-approved equipment!

After listening to the FCC's presentations, and FRB's defense of its operations, Judge Claudia Wilken, United States District Court For the Northern District of California handed down a decision (C-94-03542-CW). The FCC's motion for a preliminary injunction was denied! The action was stayed, "in order to allow the FCC to address the Constitutional issues in the

(Continued on page 81)

GILFER KNOWS GRUNDIG!

GRUNDIG Yacht Boy 400



- 40 Memory Channels
- 1.6—30 MHz, plus LW, MW & FM Stereo (w/phones)
- Wide & Narrow Bandwidths
- SSB Capable
- Clock, Timer & Alarm Functions
- Carrying Case, External Antenna & Batteries Standard
- Optional AC Power Supply Available

GRUNDIG Satellit 700



- 512 Memory Channels (expandable to 2048!) with Alpha-numeric ID Display
- Synchronous AM Detection with Selectable Sideband
- 1.6—30 MHz, plus LW, MW & FM
- SSB Capable
- Clock, Timer & Alarm Functions
- AC Power Supply
- Audio Output: 3W

Send \$1 for complete catalog of shortwave products!

GILFER
SHORTWAVE

52 Park Avenue
Park Ridge, NJ 07656

ORDERS: (800) GILFER-1
NJ & Technical: (201) 391-7887
Fax: (201) 391-7433

MAILBAG

LETTERS TO THE EDITOR

Each month we select representative reader letters for our Mailbag column. We reserve the right to condense lengthy letters for space reasons. All letters submitted must be signed and show a return address. Upon request, we will withhold sender's name should the letter be used in Mailbag. Address letters to Tom Kneitel, Editor, Popular Communications Magazine, 76 N. Broadway, Hicksville NY 11801.

Adventures at Station WTTT

I have read and re-read the January *Beaming In* editorial about Tom's experiences as a young intern many years ago at station WTTT. This was more than enjoyable, and I found it to be rather special. It gave me a chance to glimpse at a side of POP'COMM's Editor not seen very often, and one that I appreciate and understand. This type of editorial with personal experiences conveys a special message and feeling that I think should be done more often. I do realize that there is much to be said, and the editorial page is the place to do it. But, once in a while, why not let readers see more of the "hidden" Tom Kneitel that had shone through in the words of the January editorial?

Rickey Stein, RCMA NJ-001,
North Brunswick, N.J.

Pay no attention to that man behind the curtain.—Editor.

VOA Comment

This concerns Gerry Dexter's *Voice of America* mention in the February *Listening Post* column. What bothers me the most is that there are no broadcasts in English by U.S.-based stations directed towards American citizens who are living, working, stationed, or traveling abroad. I appreciate that because the VOA was created to educate the rest of the world about the USA and democracy, a mandate existed preventing it from broadcasting directly to American citizens.

Speaking from the viewpoint of an occasional overseas traveler, I confirm that every hour one can tune in foreign-based stations for international news in English. Yet, there lacks a certain intimacy that one has when tuned to "locals," such as all-news, or NPR stations.

Once, while in Israel, I was able to pick up the VOA station on the island of Rhodes (1260 kHz). I could also receive the FM signal from Cyprus of the British Forces Broadcasting Service station. The BFBS

station reminded me of the AFRTV that our government once used to bring a touch of home to members of our armed forces stationed overseas. Too bad it isn't around on shortwave any longer. The Christian Science Monitor broadcasts were good for news, but are also being cut back.

With the advent of satellite-TV, many hotels carry CNN. I remember the last time I traveled, the CNN news wasn't updated very frequently. Also, reception was poor (possibly the hotel's equipment wasn't working properly). This is why I like radio, and would enjoy hearing (non-religious, non-political) news and other programming directed towards overseas Americans.

Martin M. Wishnewitz,
Jackson Heights, N.Y.

Cordless Phone Comment

I include cordless phones in my scanning. Some calls are funny. What's not funny is what people say when the call sounds fuzzy, or when they hear any sounds in the handset other than the person they're speaking to.

When hearing interference or static, I've heard them say, "That's not my phone. There are people listening in with scanners and that's why the phone is so noisy." Can people be that stupid? By their reasoning, if their own TV's or AM/FM radios were operating while they were gabbing, their cordless phone calls would be messed up.

Someone ought to tell cordless phone owners to try this. Next time you have a call, find any fluorescent light in your home or office. Walk up to it with the phone. Better yet, invite someone with another cordless phone using the same channel as your phone to come over. Then attempt to make a call while they are using their phone. You may find that the sounds seem identical to the ones you have been blaming on people with scanners!

M.C.F.,
Greycliff, WY

A recent CBS-TV "48 Hours" program showed how uninformed average people can be about the most basic consumer electronics products. One of the many quick buck "discount" stores in New York's Times Square was secretly taped telling a shopper that the standard cordless phone they were selling worked off a satellite and had a range of several hundred miles. This was their standard sales pitch for the unit. We have helped to spread your message, M.C.F., but it may not make much difference.—Editor.

(Continued on page 82)



The Latest From AOR Products

Available at a Dealer Near You!



"The New Star" AR 2700...Out of this world Wideband Scanner

The new AR 2700 from AOR is another break-through for general coverage scanners at an affordable price. It combines wide freq. coverage with many advanced features & options, including computer interface and voice recorder. With this small marvel, you will never miss important calls and conversations through the use of the optional digital voice recorder.

• FEATURES •

Wide frequency range: 500kHz to 1,300MHz with various step size, 5, 6.25, 9, 10, 12.5, 20, 25, 30, 50, & 100kHz (wide FM only).

Auto Mode tuning: Comprehensive band plan has been pre-programmed to simplify the operation. The AR 2700 will automatically select the appropriate mode and channel step.

Great flexibility in programming, for Scan and Search mode. Delay, Pause and Priority intervals can be set to a specific value. Program search, Manual search, Bank link, Delay, Pause, Pass, Scan, Bank delete, Priority are provided.

High Capacity: 500 channels into 1- banks and 1- search banks.

Optional Digital Voice Recording: 20 seconds of digitized recorded conversation and playback through the use of the RU-2700 option.

Computer control port may be connected via an optional adaptor to a computer for remote control of the AR 2700.

AR8000 shocks the market. AOR made every effort to incorporate the latest technology in to this new scanner.

• SPECIFICATIONS •

- Range: .5 - 1900MHz usable to 100kHz
 - Modes: AM/NFM/WFM/USB/LSB/CW
 - Stepsize: 50Mz to 999.995kHz
 - Sensitivity(μ V): 30 to 1000MHz
SSB .2 AM 1.0 NFM .35 WFM 1.0
 - Filters: (kHz) SSB 4 AM/NFM 12 WFM 180
 - Memories: 50 ch. x 20 banks=1000 total
 - Size/Wt.: 6.1 x 2.8 x 1.6 inch. 20 oz. batt. incl.
- * Cell blocked for all, but Approved agencies.



- Covers .5-1900MHz*
- Ferrite Rod antenna below 2MHz
- Only portable scanner on U.S. market to have true SSB, both LSB & USB. Others attempt SSB using a BFO, but are difficult to tune and produce poor SSB audio.
- 4 level alpha numeric LCD read out frequency, mode, signal strength, band scope spectral display, battery low, remote and more
- Computer control up/down load data, will add a new dimension to the world of scanning.
- Clone your memory banks with a friend, load 1000 memory channels in seconds

.1 - 1900MHz*



WINDOWS Control of the AOR AR8000 Receiver

The Remote Computer Scanning System

Enhance the AR8000 receiver capabilities by providing automated Personal Computer control over the receiver scanning, logging and memory functions.



- △ Scan with user specified Tuning Step from 10Hz to 100MHz
- △ Scan by Mode, Class of Service, or Type of Unit
- △ Maximum Scan Rate possible. User adjustable if desired.
- △ Unattended frequency monitoring by time and date.
- △ Advanced computer control unlimited by the radio's memory capacity or predefined operations.
- △ Rearrange all your frequencies in any combination you desire by click and drag as well as direct entry.

Computer Interface for the AR8000



Unlike some of the European devices sold today, this unit is smaller, lighter, and makes no power demands on your receiver. With the extra shielding and smaller size there is less chance of additional interference leaking into your radio. The AR8000INF is also the only interface that is upgradeable for use with the optional Tape recorder controller due first quarter '95.

- △ Low Power, powered by your serial port
- △ No Drain on the batteries in the radio
- △ Light weight, perfect for Laptop use
- △ Hi-Tech Surface mount design for reliability
- △ 100% Shielded cable to receiver for reduced interference
- △ PC Software included for Windows and DOS
- △ Detailed Programers documentation available
- △ Designed and Manufactured in the USA

Other AOR Products available: SDU5000. AR3000. TSC100, WX2000



Electronic Distributors Co.
325 Mill Street, N.E.
Vienna, VA. 22180

Phone: 703 938 8105 FAX: 703 938 4525

Exclusive North and South American Distributors.



Two-Way Radio: Uncensored

Scanning Those Handheld Radios the Public Loves

BY TOM KNEITEL, K2AES, EDITOR

No doubt about it. The public is sold on two-way radio. Two-way has been popularized by cellars, CB, scanners, and continuing media attention. To serve the public's needs, there are now many low-power short-range two-way FM radios available. They're versatile, relatively inexpensive, and plentiful.

Seems you see these on sale in every outdoors and sports supply shop, and even in auto accessory stores. Police and security suppliers sell them, so do companies catering to construction, agricultural, ranching, and general business customers. The units are also displayed in the catalogs of major electronics suppliers.

Hikers, campers, and sports teams use these VHF and UHF radios. So do private guard services, hotel security officials, investigators, and armored car crews. They're useful during biking, hunting, fishing, snowmobiling, and motorcycling activities. They're used at construction sites, and in building complexes. There are farmers, flea markets, warehouse, factory, and supermarket workers, fast-food eateries, circuses, carnivals, shopping mall personnel, and so many other applications for these radios that they stagger the imagination. Think of a need for instant short-range communications and keeping abreast of minute-to-minute changes, and you've got a reason to be on the air!

In case you were wondering, yes, there's been no shortage of sleazeballs and highly suspicious activities reported by those who have spent some time monitoring low-power FM two-way comms frequencies.

For most scanner owners, channels popularly used by low-powered FM handhelds offer a potential for monitoring that hasn't yet been fully explored. These simplex channels are sprinkled across the VHF/UHF spectrum. There's often good listening there, especially when you consider that stations you hear are in your own community. Obviously, the limited transmitting range of the equipment is a factor that makes the radios particularly attractive to at least some of those who show up on these channels.

The equipment commercially offered for use in the 49 MHz band runs 100 mw., (that is, one-tenth of 1 watt), and is often designed for multi-channel operation. These are usually "hands-free" units with headsets and small mics attached to a portable handheld radio that may be attached to a belt by means of a clip. These

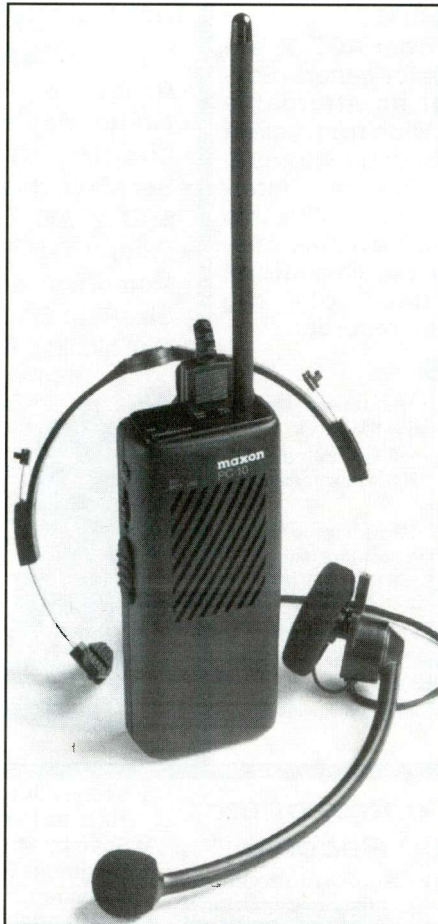

The no-license 49 MHz band has 100 mw. transceivers you can monitor on any scanner. This one comes from Maxon Systems, Inc.



Some low power FM handhelds can operate on two channels, like this one from Fanon Courier, of Tustin, Calif.

units don't need a license in the U.S. Although they are authorized for operation on any frequency in the 49.82 to 49.90 MHz band, invariably they are produced to operate on any of six specific channels within this band (see chart). These channels are shared with cordless phone handsets, and all but one are also used by wireless room (baby) monitors.

All low-power two-way FM radios, except those on 49 MHz, require FCC licenses. That means licenses must be applied for (accompanied by a fee) and obtained in order for *legal* use in the U.S. Manufacturers pack the license application forms in with the equipment. Got the picture?

With regard to licenses, I think the public views these radios as if they were CB

sets which don't need FCC licenses. You never hear call signs used on low-power FM channels. With millions in use, my guess is that only a tiny percentage of the low-power FM radios are FCC licensed. The rest are being operated without the required FCC licenses.

Does it really make any difference, except to the FCC? Given the power levels and limited range of the equipment, these radios don't have the potential to cause very much interference. There is no practical way for the FCC to detect and nab most unlicensed low-power handheld radio users. You don't hear of many getting hassled. Policing them must surely be a low priority activity at the FCC.

This is the FCC's problem, and not

something for scanner owners to anguish over. The radios are handy, useful, and still increasing in popularity. The public loves them. If you have a scanner, why not listen in? Good things to hear.

Frequencies

The VHF/UHF frequencies used by these radios come from diverse communications services. Several of the channels have become unofficially known by color-coded and/or numerical identifications. These codes may have been arbitrarily designated by some manufacturer(s). Maybe it was done with an eye towards sparing technophobe consumers from being intimidated by having to deal with actual frequency information.

What's the range of low-power FM radios? Different frequencies allow various power levels, but most of the commonly used handhelds run only a couple of watts. One company states its 1-watt 150 MHz band radio will communicate over "several miles," while another has a 2-watt handheld claimed to provide comms for two miles. These distances reflect those generally encountered in the performance specs of manufacturers.

The 462 MHz GMRS handheld radios are permitted the use of 5 watts, and have been rated with a simplex range of up to seven miles. With all VHF/UHF low-power handheld portable radios, there are important variables that could possibly reduce potential range. These include the

quality of the equipment used, as well as using equipment in need of service, experiencing low battery power, interference, having a poor station location, or obstructions in the line-of-sight signal path between the units communicating.

Channel Chatter

One of the leading manufacturers of 49 MHz two-way gear is Maxon Systems, Inc., of Kansas City, Mo. Their single-channel equipment operates on 49.86 MHz, though the company also offers five-channel sets. Their literature mentions an average communications range of 1/4-mile.

Frequencies 151.625, 154.57, and 154.60 MHz are easily the most popular low-power VHF handheld channels. Many radios offer one or more of these three frequencies, so be sure to give these channels special attention. The popular Radio Shack BTX-120 handheld comes ready for operation on 154.60 MHz.

Radio Shack is a large national marketer of GMRS handhelds. Its units come equipped with 462.6375 and 462.7125 MHz, very active low-power designated simplex frequencies in the GMRS band. Popular GMRS handhelds are also produced by Maxon and Motorola.

Some Maxon GMRS handhelds are supplied ready to access base station repeaters operating on 462.675 MHz. This channel is used nationwide as the GMRS emergency channel. Other Maxon 1-watt GMRS handhelds appear to come ready for oper-

Main Low Power Handheld Frequencies

Frequency	Channel
49.83	6
49.845	2
49.86	3
49.875	5
49.89	7
151.625	Red
151.955	Purple
154.57	Blue
154.60	Green
462.5625	(GMRS)
462.5875	(GMRS)
462.6125	(GMRS)
462.6375	(GMRS)
462.6625	(GMRS)
462.6875	(GMRS)
462.7125	(GMRS)
464.50	Brown
464.55	Yellow
467.7625	Channel J
467.8125	Channel K
467.85	Silver Star
467.875	Gold Star
467.90	Red Star
467.925	Blue Star
469.50	
469.55	



(Left) Radio Shack's BTX-120 is a 1-watt handheld transceiver that comes ready to operate on 154.60 MHz. (Middle) The Radio Shack PRS-100 offers up to seven mile range with 5 watts with two channels in the 462 MHz GMRS band. (Right) Motorola's "Personal 2-Way Radio" operates in the 462 MHz GMRS band.

ation on 462.575 and 462.625 MHz. These frequencies are among a group allowed to be used for simplex, but are most popularly used for duplex by GMRS base station repeater outputs (467 MHz inputs). Other similar GMRS frequencies available for low-power simplex, but primarily used for duplex by means of base station repeaters are 462.55, 462.60, 462.65, 462.70, and 462.725 MHz.

Note that business radio frequencies 467.85 through 467.925 MHz have been noted being offered in UHF handhelds for sale to the general public. It's not really cricket to use these channels, except in certain special applications. Those are low-power channels the FCC designated for large ship dockside cargo-loading use. Don't bet on that use being taken too seriously by some equipment suppliers.

Several popular low-power handheld frequencies noted in use are "itinerant" channels which permit licensed stations to use a maximum of 110 watts.

Check out our chart for a listing of the currently popular low-power two-way comms channels reported in use by our correspondents. Our chart indicates their known numbers or nicknames, and other comments. Here's a chance to zero in on all sorts of uncensored chatter that can vary widely from the fare found on other scanner channels. ■

Eye of the Storm!

Listening to the Hurricane Hunters

BY DON SCHIMMEL

Many POP'COMM readers are avid followers of the hurricane tracking efforts by the National Oceanic and Atmospheric Administration (NOAA) and U.S. Air Force "Hurricane Hunters."

This is an appropriate time of the year to review this subject since these storms take place roughly during the July through November period.

The National Weather Service defines a hurricane as a severe cyclone originating over tropical ocean waters, and having winds 74 miles an hour or higher. (In the western Pacific, these storms are called typhoons.) The area of strong winds takes the form of a circle or an oval, sometimes as much as 500 miles in diameter. In the lower latitudes hurricanes usually move toward the west or northwest at 10 to 15 mph. When the center or eye approaches 25° to 30° north latitude, direction of motion often changes to northeast with increased forward speed.

For over 50 years, aircraft have been used to track tropical storms and make meteorological measurements of wind velocities and directions, eye location and size, pressure readings, and humidity in the storm area.

With yet another hurricane season upon us, it would be interesting to look at some pictures and details of communications of past hurricanes.

While there are several different formats for reporting weather and storm observations, one of the most valuable is the coded VORTEX report used for voice messages for data obtained by the hurricane vortex penetration by the reconnaissance aircraft. Your attention is invited to the VORTEX report monitored during the NOAA tracking of Hurricane Emily.

NOAA has two WP-3D aircraft which are a variation of the U.S. Navy Orion (P-3). Orion was based on the commercial Lockheed Electra and incorporated various design modifications including a longer body. The two aircraft are designated NOAA-42 and NOAA-43 respectively.

The U.S. Air Force Reserve also participates in hurricane hunting tasks. According to an Air Force Reserve News Service, the 53rd Weather Reconnaissance Squadron (WRS) designation was activated and assigned to the Air Force Reserve's 403rd Airlift Wing, Keesler AFB, Mississippi effective Nov. 1, 1993.

When the 53rd was activated, their old

VORTEX Voice Message Codes	
Vortex fix	Location of surface and/or flight level center of a tropical or subtropical cyclone obtained by reconnaissance aircraft penetration
A	hrs Z, date and time
B	deg N/S, latitude of vortex fix; deg E/W, longitude of vortex fix
C	mb/m, millibars/meters, minimum height at standard level
D	knots, estimate of maximum surface wind observed
E	deg/nm, bearing/range from center of maximum surface wind
F	deg/kt, maximum flight level wind near center
G	deg/nm, bearing and range from center of maximum surface wind
H	mb, minimum sea level pressure computer from dropsonde or extrapolated from within 1500 feet of sea surface
I	C/m, maximum flight level temperature/pressure alt outside eye
J	C/m, maximum flight level temperature/pressure alt inside eye
K	C/c, dew point temperature/sea surface temperature inside eye
L	eye character: closed wall, poorly defined, open SW, etc.
M	Eye shape/orientation/diameter: Code eye shapes as: C is circular; CO is concentric; E is elliptical. Transmit orientation of major axis in tens of degrees, i.e., 01 is 010 to 190; 17 is 170 to 350. Transmit diameter in nautical miles. Examples: C8 is circular eye 8 miles in diameter. E09/15/5 is elliptical eye, major axis 090-270, length of major axis 15 nm, length of minor axis 5 nm. CO8-14 is concentric eye, diameter inner eye 8 nm, outer eye 14 nm
N	deg N/S, confirmation of fix: coordinates & time; deg E/W; time Z
O	fix determined by/fix level: fix determined by: 1 penetration; 2 radar; 3 wind; 4 pressure; 5 temp. Fix level (indicate surface center if visible; indicate both surface & flight level centers only when same): 0 is surface; 1 is 1500 ft.; 8 is 850 mb; 7 is 700 mb; 5 is 500 mb; 4 is 400 mb; 3 is 300 mb; 2 is 200 mb; 9 is other.
P	nm, navigation fix accuracy /meteorological accuracy
Q	remarks

Here is the key for decoding VORTEX format messages.



Hurricane Andrew as it hit New Orleans 8/25/92. Picture transmitted by NAM, USN Norfolk, VA. Contributed by August A. Stellwag, NY.

unit designation, the 815th Weather Squadron, was inactivated.

The reservists track hurricanes and tropical storms over the Atlantic and Pacific Oceans. During Hurricane Emily, they flew

more than 230 hours in support of gathering hurricane data for the National Hurricane Center in Coral Gables, Fla.

The 53rd Squadron traces its roots back to August, 1944 when it was activated as

HF 150 IBS★★★★

**REAL RADIO, RUGGED,
RELIABLE**

Simplicity makes the HF150 easy to operate, and the synchronous detection produces superb audio which enhances the outstanding performance!

- Frequency: 30kHz - 30MHz
- Multimode: AM, AMN, LSB, USB
- 60 Memories (FREQ. & MODE)
- Tuning Step: 8Hz
- Bandwidth 7kHz & 2.5kHz
- 3 Ant. inputs, 600 Ohm BAL, 50 Ohm Coax and high impedance whip
- Built In Speaker, Ext. Jack & Record OUT
- Power 10-15VDC .15A (.3A max)
- Includes FREE AC adaptor
- Size: 7.3"W x 3.2"H x 6.3"D; 2.9 lbs.

*New for the
LOWE HF150
Display Back-
Light kit for
LCD readout.*

*The BL150 is easily
installed, instructions
included.*



LOWE



SP150

**New....Just Released!
The Ultimate
Lowe Accessory!**

The latest from Lowe is a combination audio filter, amplifier and speaker. Works well with any SW receiver or transceiver, but designed to compliment the HF150 and PR150.

Features:

- 10W Audio amplifier
- Variable notch filter
- High pass filter
- Low pass filter
- Built-in loudspeaker
- External speaker output
- Headphone output



*The SP150, PR150 and the HF150 shown
pictured on the three tier rack system.*

PR150 Pre - Selector w/Pre-Amplifier

While a perfect match to the HF150, this excellent unit is very effective with other SW receivers. Lowe's recently revamped model obtains wide coverage of 100KHz to 30MHz through the use of seven tunable bandpass filters. Multiple antenna inputs, pre-amp attenuator and much more. Hear what you've been missing by eliminating intermod & image interference.

Antenna input: 50ohm unbalanced, 600ohm balanced • **Power:** 10 - 15VDC
Size: 7.3"w x 3.2"H x 6.3"D



ACARS FROM LOWE....The Air Master!

The Lowe Air Master is a super combination of hardware and software for the receiving and decoding of ACARS (Aircraft Communications Addressing and Reporting System). This is a new teletype message format used to transmit data between commercial aircraft and airport ground stations. ACARS was developed and implemented to reduce the work load of flight crews by using computers to handle routine communications. This information is transferred via VHF to the ACARS ground station. Generally speaking, if your customer is able to receive VHF voice transmission, then ACARS traffic should be no problem from the same source. When using the Air Master software with your PC and an air-band receiver, you'll be able to view the ACARS messages as they are received. The package includes the MS-DOS software for use with a 386 or higher PC, the computer interface and manual. The interest level in this market is growing rapidly. Be sure to get a demo or evaluation unit for your store. Look for upcoming product reviews and new product releases.

WRTVH RECEIVER OF THE YEAR!

HF 225 IBS★★★★

Rated 4 stars by Passport's Larry Magne.

- Multimode, AM, SSB, CW
- 30 Memory Channels
- Optional AM Synchro & FM
- Filter for all Modes: 2.2, 4.7, 10kHz 200Hz audio CW filter
- Built-In Speaker, Ext. Speaker, Rec. Jacks
- 10-15VDC .15A (.3A MAX) AC/Nicads Opt.
- Size 10"W x 4.2"H x 8"D; 4.18 lbs.



HF 225E EUROPA

A "Turbocharged" HF225 for the dedicated DXer! Same high performance features of the HF225 plus these additional features:

- 7, 4.5 & 3.5kHz replacement filters for excellent selectivity
- Reduced residual noise thru shielded coils and switching diodes
- Synchronous detector (D225) & KPAD1 standard on Europa version

CALL, FAX OR WRITE FOR DETAILED FLYER!

HF 235 THE PROFESSIONAL CHOICE

Top of the line rack version of the HF225, with similar specs. A professional communications receiver for the discriminating user, with high stability OSC & opt. computer RS232.

Two or three tier rack mounts, along with a variety of accessories are also available from EDCO. Keypads for the HF150 and HF225, Carrying Cases, Mounting Brackets, and a Computer Control Interface are just a few of the extras which can give you optimum performance of your LOWE product. Contact EDCO for full details.



**Electronic Distributors Co.
P.O. Box 1936 • Vienna • VA 22180
Ph 703 • 938 • 8105 FAX 703 • 938 • 4525
Contact your favorite Dealer today!**



Talkin's No Fun Without A Jo Gunn!

4 + 4 STAR

UPS SHIPPABLE



Other Models & Sizes Available in 10 or 11 Meters



Call or send \$2.00 for Complete Catalog and Pricing of Antennas.



Route 1 - Box 32C, Hwy. 82
Ethelsville, AL 35461
(205) 658-2229
FAX: (205) 658-2259
Hours: 9 am - 5 pm (CST)
Monday - Friday

DEALER INQUIRIES, PLEASE CALL

1995 WRTH Equipment Buyer's Guide

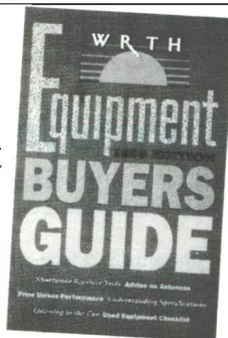

Your #1 source for advice on what to buy in equipment and accessories for SWL'ing. Objective reviews and equipment evaluations make this new volume a must for all SWL's. WRTHBG95 ©1995 **\$24.95**
Shipping \$4 USmail \$7 Foreign

Free 24 page catalog jam-packed with books for SWL's CB'ers, scanner buffs and Radio Amateurs. Send for your free copy today!

Radio Bookstore



PO Box 209
Rindge, NH 03461



(800) 457-7373

CIRCLE 51 ON READER SERVICE CARD

Hurricane Emily

NOAA-42 to Miami Monitor Via Phone Patch With MacDill AFB

A	28/1920Z
B	28° 05' N 67° 45'W
C	805 millibars.....meters
D	260° 65 knots
F	325° 75 knots
G	265° 14 nautical miles
H	NA
I	17° C/1545 meters
J	23° C/1710 meters
K	16° C/NA
L	open, E, S
M	C15
N	28° 05' N 67° 45' W 1920Z
P	2/6 nautical miles

Remarks:

Fix made from 5000 foot radar alt.....97 millibars.....most rain bands and turbulence in North and West quadrants.

Note:

..... indicates small portion missed during copying.

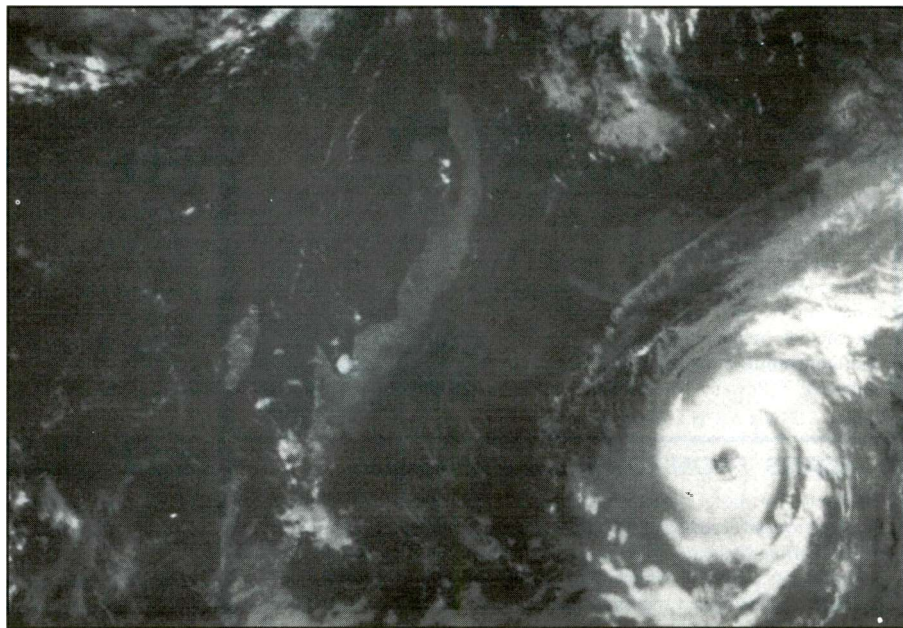

This satellite picture which appeared in U.S. Air Force publication shows Hurricane Hugo just before it came ashore in South Carolina on September 22, 1989. Hugo caused damage in excess of one billion dollars.

the third WRS at Presque Isle Army Airfield, Maine. From there it transferred several times, including tours in Bermuda, England, and Puerto Rico, before landing at Keesler in July, 1973. The former active-duty unit was inactivated June 30, 1991, when the Air Force's entire WC-130 weather reconnaissance mission was transferred to the Reserve.

The aircraft flown for the WRS missions are modified C-130 air frames designated as versions WC-130E and WC-130H.

The NOAA reconnaissance planes work KJY74, Miami Monitor, on 3407, 5562-Secondary, 6673 (Delta), 8876 (Echo),

10015 (Foxtrot), 11398, 13267 (Golf)-Daytime Primary, and 21937 kHz. All are USB.

The Air Force Reserve WRS planes using TEAL and GULL as the flight designator have been observed on 4701 kHz.

USAFR WRS and NOAA units may both work KJY74 through MacDill AFB as relay. The following frequencies have been noted: 4746, 6750, 8993, 11246, 13244, and 18019 kHz. All are USB.

The USAFR WRS VHF and UHF frequencies in use include: 38.50, 349.4, 349.9 and 385.9 MHz.

When a hurricane hits the U.S., the Fed-

OUT OF THIN AIR AND INTO THE THICK OF THINGS.



THE DRAKE R8A

The Drake R8A World Band Communications Receiver. Turn it on, tune it in, and as easy as that, you're hearing world events as they happen... uncensored and complete. And with the R8A's astounding clarity, it's almost as if you're there. In fact, no other communications receiver puts you closer to the action in even the most distant parts of the world.

If you're a hobbyist, you'll marvel at the R8A's simplicity of operation. If you're an expert, you'll admire the high-powered features. The Drake R8A offers superior performance in a complete package that includes built-in filters and other unique features that have made Drake the foremost name in world band communications. The R8A from Drake...you've got to hear it to believe it.

DRAKE, FOR A WORLD OF DIFFERENCE.

Order Now Risk-Free!

15-DAY MONEY BACK TRIAL

We are so confident you'll be impressed with the R8A's performance, we'll give you a full refund on your factory direct order, less shipping charges, if the R8A doesn't meet or exceed your expectations. Call for complete details.

Order Today, Factory Direct or call for the dealer nearest you **1-800-937-2538**



DRAKE

R.L. Drake Company, P.O. Box 3006, Miamisburg, Ohio 45343, U.S.A. ■ Sales Office: 513.866.2421 ■ Fax: 513.866.0806 ■ Service and Parts: 513.746.6990 ■ In Canada: 705.742.3122
© 1995 The R.L. Drake Company

DRAKE is a registered trademark of The R.L. Drake Company.

eral Emergency Management System enters the picture. FEMA has as part of its responsibilities:

- Coordinating federal aid for presidentially declared disasters and emergencies.
- Supporting state and local governments in a wide range of disaster planning, preparedness, mitigation, response, and recovery efforts.

The FEMA daytime primary is 10493 kHz and the night primary is 5211 kHz. Both are USB mode. Depending on the track of the storm, if it makes its way up the eastern region of the U.S., FEMA stations you may hear in connection with a hurricane might be WGY946, Baton Rouge, LA; WGY974, Tallahassee, FL; WGY964, Jackson, MS; WGY954, Montgomery, AL; WGY944, Atlantic, GA; WGY934, Columbia, SC; WGY904, Thomasville, GA; WGY953, Delaware City, DE; WGY902, New York City, NY; and FEMA Headquarters, WGY983 in Washington, DC.

An appropriate map is very helpful tool to have for plotting storm positions, and to determine its apparent path. Now all that remains is to turn on the receiver and check the given frequencies for hurricane reports.

Additional Weather Related Frequencies (National)

Atlantic Small Vessel Net: 6224 & 12353 kHz (evenings)

VFR Enroute Aircraft Weather Comms: 122.0 MHz

Enroute Military Aircraft Comms: 239.8, 342.5, 344.6 MHz, 375.2 MHz

FAA Centers Weather Comms:

Atlanta ARTCC 135.725; Boston ARTCC 133.925; Chicago ARTCC 134.875; Cleveland ARTCC 135.425; Denver ARTCC 124.675; Fort Worth ARTCC 133.775; Houston ARTCC 126.625; Indianapolis ARTCC 134.825; Jacksonville ARTCC 134.175; Kansas City ARTCC 128.475; Los Angeles ARTCC 135.9; Memphis ARTCC 133.675; Miami ARTCC 132.725; Minneapolis ARTCC 135.675; New York ARTCC 134.725; Oakland ARTCC 135.7; Salt Lake City ARTCC 133.025; Seattle ARTCC 135.925; Washington, DC ARTCC 134.525 MHz

USCG Weather Bulletins: 2670, 4426, 6501, 8764, 13089, 17314 kHz; 157.10 MHz

VHF-FM Weather Broadcasts: 162.40, 162.425, 162.45, 162.475, 162.50, 162.525, 162.55 MHz; Canada 161.65, 161.775 MHz

WWV, Ft. Collins, CO: 2500, 5000, 10000, 15000, 20000 kHz: during severe weather, North Atlantic Ocean weather information may be sent at eight and nine minutes past the hour; Pacific Ocean weather information at 48, 49, 50, and 51 minutes past the hour.

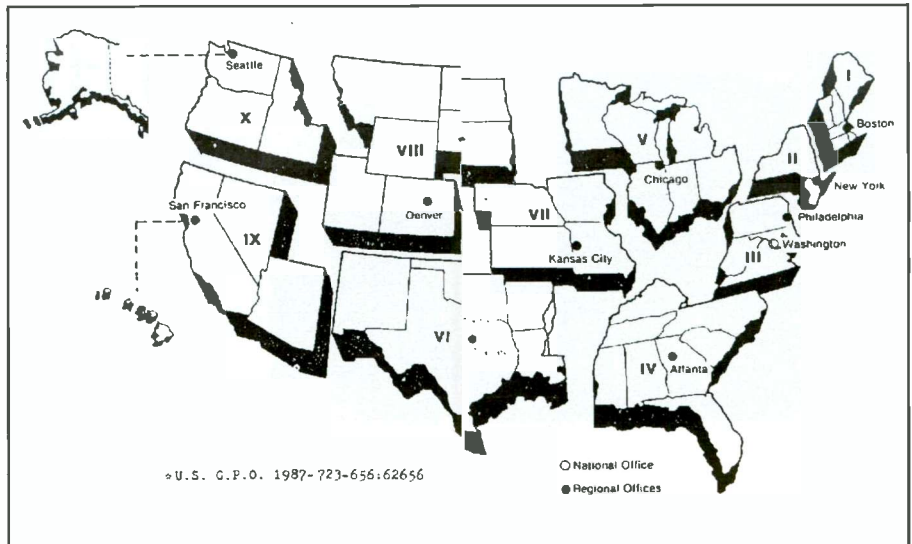

Federal Emergency Management (FEMA) Regions.

CHEEK

The Ultimate Scanner!

The King of Scanners takes this step-by-step, richly illustrated, bench manual beyond everything ever published on scanner mods. Bill is a perfectionist who will help you convert your scanner into precisely what you've always wanted!

260 pgs, large format, lay-flat binding, **FINALLY AVAILABLE!**

\$24.95 until 6/30/95, then \$29.95.

EMERGENCY RADIO!

Scanning News As It Happens

"Excellent..." Barry Gokhwater

"Rates a 10!" Dispatch Magazine

Norm Schrein

214 pages, \$14.95

"A winner..." 911 Magazine

"Irresistible" Bill Cheek

SCANNERS & Secret Frequencies

"Must reading..." Electronics Now

"A giant undertaking...authoritative" Monitoring Times

"Absolutely the best..." Norm Schrein

Henry Eisenson

320 pages, \$19.95

"Useful, knowledgeable..." PopComm

"You can't miss!" ASG

"A high point!" RCMA

Underground Database

Everything that's sort of legal.

100 pages, large

format, \$23.75

Television GRAY Market

Cable & satellite chips, descramblers, etc.

"Explores this shadowy fringe area in depth... good info." PopComm

Henry Eisenson

160 pages, \$23.75

INDEX Publishing Group, Inc.

3368 Governor Drive, Suite 273P

San Diego, CA 92122

619-281-2957 (editorial)

First book \$4 sh, \$2 ea add'l

CA add 7.75% tax

MO/check via mail.

Order Line 800-546-6707



This NOAA photograph shows one of the two Lockheed WP-3D Orion weather reconnaissance aircraft. The WP-3D Orions have eight-man crews: two pilots, one flight engineer, one navigator, one chief scientist, one camera operator, one flight director, and one mission scientist; passenger scientists can be embarked in these aircraft.

CIRCLE 64 ON READER SERVICE CARD

SCANBLASTER™

BLAST your way through the Frequency Spectrum

Featuring the SCOUT and the OPTOSCAN456

981		
9200 MHz	Local Railway	12:57:58
9250 MHz	Sheriff's Office	12:56:02
4875 MHz	Marina	12:55:32
	University	12:50:35
	Airport	12:50:14
	Local Government	12:49:58
	Fire Rescue	12:49:57
	Hwy Patrol	12:49:55
	Local Police	12:49:53
	Hardware Store	12:49:52
	Hardware Store	12:49:48

	State Trans De
	Airlines
	Comm'l Fishing
	Marina
	Fire Rescue
	Playland
	Emergency Svcs
	County Zoo
	Police
	Cruise Line
	Charter Airlin
	Power Company
	Power Company
	Wholesale Club
	Hardware Store
	Hardware Store
	Local Police
	Sheriff's Offi

STOP	LOCKOUT	EDIT	RESET
LOG	TMP L/O	OPTIONS	HELP
STORE		BAND	
CLOSE	NEW		



- Each **SCANBLASTER™** series includes in the accessory set:
- CX12A Computer Interface
 - N100 FM Notch Filter
 - BLP-70 Low Pass Filter
 - BHP-300 High Pass Filter
 - DB32 UHF/VHF Mini Antenna
 - RD27 27 MHz Antenna
 - RD440 440 MHz Antenna
 - RD800 800 MHz Antenna
 - Spectrum CD-ROM FCC Database
 - Utility Disk SCOUT Download Program
 - AC100 Rapid Charge Adaptor
 - Cable/Adaptor SCOUT Reaction Tune Pat. Pend.
 - CC30 Carry Case for SCOUT
- 3 YEAR EXTENDED WARRANTY**

SCANBLASTER™ I

Includes:
SCOUT Pat. Pend.
OPTOSCAN456
Accessory Set

\$999 (Save \$328)

SCANBLASTER™ II

Includes:
SCOUT Pat. Pend.
Accessory Set

\$849 (Save \$179)

SCANBLASTER™ III

Includes:
OPTOSCAN456
Accessory Set

\$699 (Save \$179)

SCANBLASTER™ UPGRADE

Accessory Set Only

\$459 (Save \$120)

OPTOELECTRONICS®

ORDER LINE
800-327-5912
TEL: 305-771-2050
FAX: 305-771-2052

5821 NE 14th Avenue • Ft. Lauderdale, FL 33334 • Contact Factory for shipping prices. Visa, Master Card, & C.O.D. (cash or money order only)
• OPTOSCAN456 software featured, SCANSTAR COMML™ Software also available from: PROBE, SCANCAT, SCANNERWEAR™ and RADIO MGR
All prices and specifications are subject to change without notice or obligation.

TUCKER ELECTRONICS BRINGS YOU . . . THE NEW OPTO SCOUT 40

**Automatically Tunes Your New
AOR 8000 or Icom Scanner!**

New! OptoElectronics Scout 40.....Only \$439

Not only does the new OptoElectronics Scout 40 serve as a great frequency counter between 10 MHz and 1.4 GHz, it will now automatically REACTION TUNE (Pat. Pend) your receiver to any frequency it captures! All you need is an AOR 8000/2700 or Icom R7000/7100/9000 and a computer interface such as the OptoElectronics CX12AR. You can also recall any previously stored frequencies from the Scout's 400 memories and automatically tune your receiver from those as well. The Scout features a custom 10 digit LCD display as well as an EL Backlight for night operation. A 16-segment bargraph is built-in to the LCD display which provides an indication of RF signal strength. A distinctive double beep informs you that a new frequency has been recorded, and a single beep indicates an already stored frequency has been hit again. The Scout even has a pager-style vibrator to inform you when a frequency has been recorded! The Scout is great for taking with you on trips, for sporting events, or anywhere else where you need your scanner tuned FAST! Get a new Scout 40 from Tucker today!

New! OptoElectronics CX12AR...Computer Interface for AOR 8000/2700, Icom R7100/7000/9000 only \$99 with demo software!

OPTOELECTRONICS

WE WILL HAVE THE NEW AOR 2700! CALL FOR DETAILS



Sony ICF-SW100S
World Band Receiver.....**\$349**



- Ultimate Travel Radio...smallest radio available that features synchronous detection
- Outstanding Performance...covers 150 kHz to 30 MHz continuously as well as AM broadcast and FM stereo

The Peak Performer . . . Entirely Unrivaled In The Hand-Held Scanner World

AOR AR8000 All Mode Wide-Band Radio Receiver.....\$649



Entirely unrivaled in the hand-held scanner world. Covers 500 kHz-1900 MHz tuning (870-890 MHz cellular blocked) in 50 Hz steps. ALL MODE reception supports AM, USB, LSB, CW, NFM, and WFM modes. The NEW multi-line alphanumeric display allows you to enter descriptive information along with the frequency, and store it all in the 1000 memory channels provided. If you're new to scanning, this scanner can be set to New User Mode, easier-to-use than ever, while Expert Mode can be used when you're ready for it. A computer-control option (OPTO CX12AR) is available for those interested in computer controlled scanner operation. If you want the hottest hand-held scanner around, this is the one for you!
OPTO CX12AR Computer Interface...\$99

FedEx Federal Express Economy Service available on most orders only \$6.95

Tucker SW-500
Portable Shortwave Active Antenna/Tuner...**\$79.95**



If you want to expand your range or just want to get better reception from the stations you currently listen to, we have developed the new TUCKER SW-500 Active Antenna.

This portable (only 1.75" x 5.5" x 4.6") antenna is perfect for indoor use by itself, in conjunction with an outside antenna or both!

Call, Write or Fax For Our FREE Catalogs!



Call Now: 800-527-4642



1801 Reserve Street, Garland, TX 75042 • P.O. Box 551419, Dallas, TX 75355-1419 • In Dallas: 214-348-8800 • Fax 24 hs. in English, Español, Français, und auf Deutsch: 214-348-0367



CIRCLE 160 ON READER SERVICE CARD

Radio: The Old Days

Broadcasters That Followed Their Dreams

BY ALICE BRANNIGAN

Beginning in 1897, the University of Arkansas, Fayetteville, operated an experimental wireless telegraphy station. By 1916, voice transmissions had been added, and the station was operating under the Special Land Station call letters 5YM. Ray Poindexter's book, *Arkansas Airwaves* (published by its author, N. Little Rock, Ark., 1974) states that a federal order closed down civilian stations during much of World War I. That meant 5YM was dismantled between 1917 and 1919, but it returned after that. The popularity of the transmissions from 5YM led the University to apply for a non-commercial broadcast license.

As a result of the application, on December 4, 1923, a license was issued with the call letters KFMQ. The station was authorized to operate on 1140 kHz with 100 watts. KFMQ was constructed by the Dept. of Electrical Engineering, and situated in a small structure south of the Engineering Hall. The antenna, a 100-foot long inverted "L" with its fan-type counterpoise located 35 feet below, was erected 100 feet above the Engineering Hall. KFMQ, *The Voice of The Ozarks*, began operation on January 4, 1924.

By December of 1924, KFMQ had shifted to 1090 kHz and upped its power to 500 watts. Its new operating location was in the UOA's Administration Building. By February, 1925, KFMQ was moved to 1000 kHz.

The year 1926 saw more adjustments.

In February, KFMQ changed its call letters to KUOA. During KUOA's normal summer vacation shut-down period, a new 750-watt transmitter was installed because a higher power had been approved. KUOA resumed in September with its new power, but in April of 1927, the Federal Radio Commission moved KUOA to 1010 kHz and chopped back its power again to 500 watts.

In March of 1928, KUOA was allowed to increase its power to 1 kW, and told to move to 1390 kHz. There was a catch. KUOA would no longer have its own full-time frequency, but would have to share air time on 1390 kHz with Little Rock's KRLA. By summer of 1929, the Federal Radio Commission had whittled KUOA's air time down some days of the week to a mere four and a half hours. KUOA didn't operate Sundays, and it was normally dark during school summer vacation time. It was barely on the air at all!

KUOA's sparse air-time situation wasn't unusual during that era. It was described in George H. Douglas' book, *The Early Days of Radio Broadcasting* (McFarland & Co., Jefferson, N.C., 1987). Douglas wrote, "Nearly all stations owned by educational institutions felt themselves very ill-used by the Commission. Many got what they considered bad frequencies, and worse, the majority had to accept daytime-only licenses. For instance, the University of Arkansas station was forced to share time with a local commercial station—with the commercial station getting three quarters of

the time, including all the nighttime hours...The same thing happened to many educational stations throughout the late 1920s. In the years before the Radio Act of 1927, dozens of educational stations entered the field every year.

"Starting around 1928, they began dropping off like flies: 23 stations gave up in 1928 alone. Many educational stations had begun operation with the idea of offering nighttime adult education courses, but, cheated out of this time slot, saw no purpose in continuing."

KUOA had plenty of Ozark grit. Determined to continue its dream of broadcasting, the station took a new approach. In July, 1931, KUOA was leased to the Southwestern Hotel Co., owners of the Goldman Hotel, Fort Smith, Ark. Cleverly, KUOA had become a commercial station! The studios and transmitter remained at the UOA campus until February of 1933 when there was a fire at the studio.

As a commercial venture, KUOA was so successful that, in early 1933, the UOA sold it to the hotel company and the Publisher of *The Fayetteville Daily Democrat* newspaper. They moved it to downtown Fayetteville. By April of 1933, KUOA had been granted the right to shift to 1260 kHz where it could operate daytime as a commercial station without having to share hours! The station's 1 kW transmitter was relocated to Mt. Sequoyah, northeast of Fayetteville.

In June of 1935, the station was sold to



KUOA

UNIVERSITY OF ARKANSAS
FAYETTEVILLE

1390 Kilocycles—215.7 Meters—1000 Watts

SCHEDULE

Mon.	12:30 p. m., Luncheon program
	1:15 p. m., Women's program
	5:00 p. m., Student program
	7:00 p. m., Farmer's program
Tues.	12:30 p. m., Luncheon program
	5:00 p. m., Student program
Wed.	12:30 p. m., Luncheon program
	1:15 p. m., Women's program
	5:00 p. m., Student program
	7:00 p. m., Extension lectures
	7:30 p. m., Music program
Thu.	12:30 p. m., Luncheon program
	5:00 p. m., Student program
	7:00 p. m., Horrock Ramblings
Fri.	12:30 p. m., Luncheon program
	1:15 p. m., Women's program
	5:00 p. m., Student program
Sat.	12:30 p. m., Luncheon program

Write us for information about University Courses by mail

KUOA

The Voice of The Ozarks

This 1932 QSL from KUOA shows how its schedule had been whittled down due to having to sharing a frequency with a commercial station.

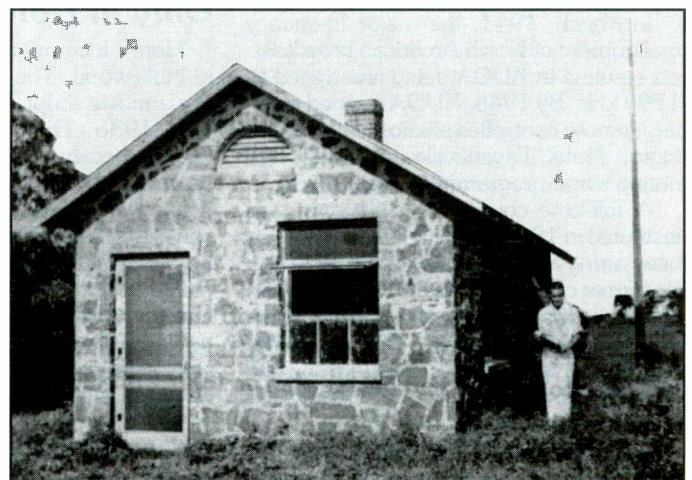

The KUOA transmitter building atop Mt. Sequoyah in 1933.

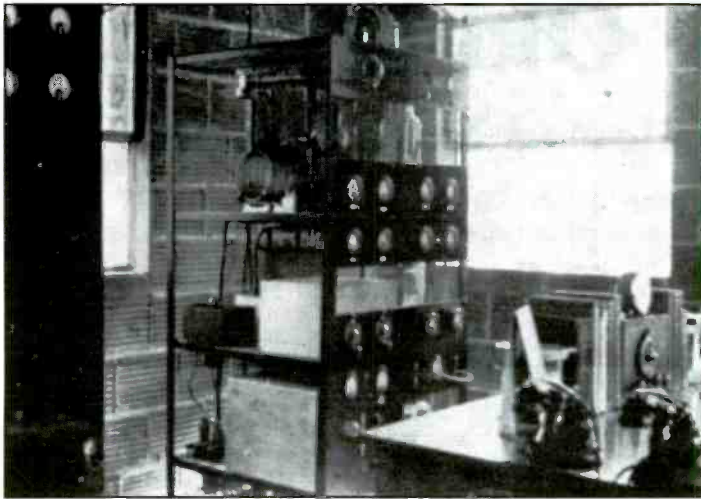

The KUOA 1 kW transmitter, as used in 1933.



KUOA's transmitter building, Siloam Springs, Ark., as it looked in 1967. It was constructed in 1936. (Photo by Jan D. Lowry, Calif.)

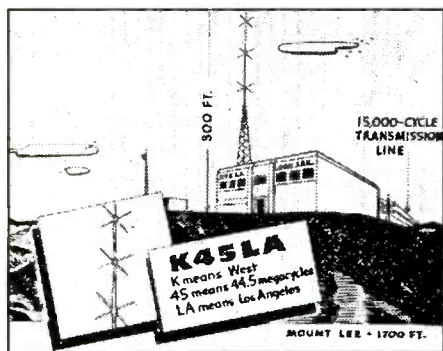

An artist's conception of the K45LA appeared on the station's 1941 QSL card.

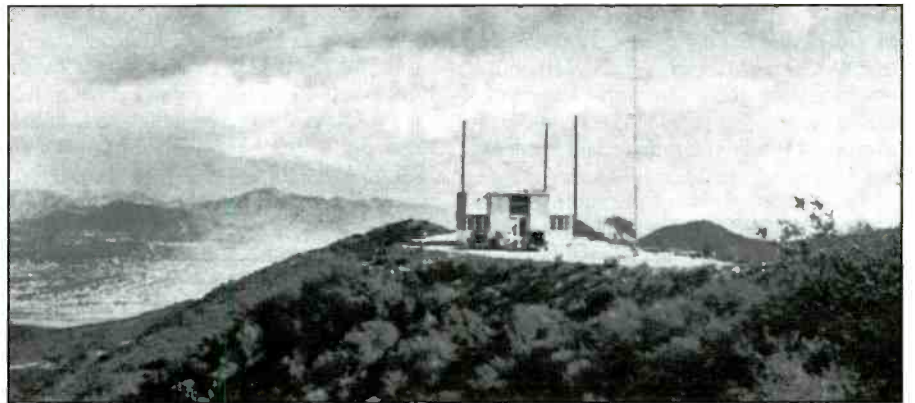

Don Lee Company's K45LA atop Mt. Lee in Hollywood, as it appeared in 1941.

John Brown University of Siloam Springs, Ark. Late that year, the new owners sought permission to change KUOA into a 50 kW station known as KPSN, *The People's Station of the Nation*. The concept was later abandoned, but in 1936 KUOA did increase its power to 2.5 kW when the station's facilities were relocated to Siloam Springs. In September of 1937, the power was upped to 5 kW.

In March, 1941, the major frequency realignment of North American broadcasters resulted in KUOA being reassigned to 1290 kHz. By 1946, KUOA opened auxiliary remote controlled studios at the Washington Hotel, Fayetteville, and was originating some programming from there.

A full-time country music format was instituted in 1974. Since 1993, KUOA has been airing a satellite-delivered county music format obtained from the Jones Satellite Network. KUOA operates daylight hours on 1290 kHz with 5 kW. The transmitter is in Siloam Springs, Ark. KUOA is the oldest continuously licensed AM broadcaster in Arkansas!

Special thanks to Broadcast Pro-File, P.O. Box 982, Hollywood, CA 90078-0982. We excerpted most of the information about KUOA from their lengthy ref-

erence report on the station. Broadcast Pro-File can furnish, at reasonable cost, detailed, accurate, historical reports about any American AM, FM, or TV broadcast station, past or present. Many broadcasters use their services. A catalog is available from Broadcast Pro-File for \$1.00.

The Don Lee Story: Only in Hollywood!

Here's a company that could exist only in Hollywood. The events make it sound like a movie script. Yet it's all true.

In 1936, The Don Lee Broadcasting System became fascinated with the concept of FM'casting, as described by Maj. Edwin Armstrong. The company's dream was to place an FM station on the air in Los Angeles. Given the simple fact that the public owned no FM receivers, and therefore there was no audience for such a station, the Don Lee folks were longer on wonderful dreams than on hard logic. That never stood in their way. This was business as usual.

Following the publication of Armstrong's article in the *Proceedings*, they asked their FM Engineer, Frank M. Kennedy, to design an FM broadcast transmit-

ter in accordance with Armstrong's published circuits and data. The unit wasn't built for lack of a suitable site to locate the transmitter.

The Lee Co. decided it had to create a site. When space to accommodate the proposed FM station on 1,700 ft. Mt. Lee, in the Hollywood Hills, was completed, they applied for an FM broadcast license. The FCC authorized operation on 44.50 MHz, and issued the call letters K45LA.

Mt. Lee had been selected because it had become the site of the Don Lee pioneer TV station, W6XAO. At this point we need to backtrack our narrative a bit.

In December, 1931, when there were but four TV receivers in Los Angeles, Don Lee spent an extravagant \$500,000 to open his TV experimental station, W6XS on 2.1 to 2.2 MHz, from Gardena, Calif. W6XS transmitted an 80-line low-definition electron beam picture. This was the first television station in the American west; it maintained a modest daily schedule.

In 1933, Lee wanted to upgrade the W6XS transmission definition to 300-lines, 24-frames. In order to accomplish this, a wider bandwidth was required. Therefore, the station's frequency was shifted to 45.00 MHz for video, and 49.75 MHz for audio.

Too Good to be True?



ICOM R7100-2

ICOM's Best VHF/UHF Communications Receiver

With the most popular features of the legendary R7000, plus a few features that listeners wanted, the R7100 is ICOM's best compact receiver.

The R7100 offers 25-800 and 900-2000 MHz frequency coverage on a brilliant LCD readout, selectable tuning steps, USB/LSB/AM/FM modes with wide and narrow selectivity switching.

900 scannable memory locations store frequency, channel number, mode and search steps; ten search banks with memory channel lockout, 5 or 12 channel-per-second scan speed and scan-resume delay are also found on this model.

Grove is slashing prices on a limited number of **ICOM R7100-2** and **R-1** scanners. If you have been waiting for a miracle, wait no longer — these are prices that we never believed we could offer! Hurry and take advantage of these rock bottom prices!

Retail Price: ~~\$1942.50~~
Last Grove Price: ~~\$1499.95~~

Special Limited-Time Offer:
\$1299.95*

High sensitivity and stable SSB reception are additional perks, as are sensitive, all-mode squelch and easy pushbutton function selection. Prices subject to change due to yen fluctuations.

Order SCN15-C

\$16 UPS
\$31 UPS 2nd Day Air
\$36 US Priority Mail
\$27.50 Canadian UPS;
\$43.50 Canadian APP

NOTE: Cellular-capable, full-frequency-coverage model R7100-1 available only to federal, state, county, city and local government agencies and cellular service providers who submit an official purchase order.

SCN15-G R7100-1: \$1539⁹⁵
(plus shipping)

*For an additional \$55, receive the **GRE Super Converter (CVR3)** and get full 25-2000 MHz coverage—a \$94 value from the factory!

ACCESSORIES:

ACC 36	UT36 Voice Synthesizer	\$55.95
ACC 72	TVR7100 Video Adaptor	\$274.95
ACC 74	CT17 computer interface	\$122.95
BRK 5	MB23 carrying handle	\$11.95
BRK 8	MB5 mounting bracket	\$42.95
ANT 8N	46" extendable whip antenna	\$23.95
CVR 6	Shortwave Scanverter	\$99.95
Installation of one or more accessories		\$20.00
MAN 4	Service Manual	\$50.00
SFT 2	Scanat Pro comp. software	\$79.95
<i>(Requires CT-17 Interface kit, ACC 74, above)</i>		
SPK 3	SP20 speaker	\$224.95
SPK 13	Grove Sound Enhancer	\$249.95
SPL 2	SCPC Splitter	\$64.95

ICOM R1 Pocket Scanner



Retail Price: ~~\$599.00~~
Last Grove Price: ~~\$499.95~~

\$7.50 UPS
\$11 UPS 2nd Day Air
\$12 US Priority Mail
\$13 Canadian UPS
\$12.50 Canadian APP

Special Limited-Time Offer:
\$419.95*

Imagine, a shortwave and VHF/UHF scanner with 100 kHz-800MHz and 900-1300 MHz frequency coverage that fits in your shirt pocket! You select the mode—AM, FM wide or narrow—and install up to 100 of your favorite shortwave and scanner frequencies into memory. An edge-lit LCD shows frequency, memory channel, and other settings as well.

Less than 2" wide, the R1 scans, searches and autoloads, has knob tuning, a signal strength indicator, and even a 24-hour clock timer! This high-sensitivity scanner comes with flex whip, rechargeable battery, BP-82 battery pack, AC wall charger/adaptor and belt clip. Requires 6 AA batteries. Prices subject to change due to yen fluctuations.

*Free BP-82 battery pack with every order—a \$65 value!

ACCESSORIES:

ANT 8	Range extending telescoping whip	\$16.95
BAT 1	AA Alkaline batteries	\$ 7.9
BAT 11	BP-90 Replaceable AA battery case	\$23.95
BAT 12	BP-84 Triple-life battery pack	\$79.95
BAT 13	AA rechargeable nicad batteries	\$ 2.75
CAS 3	R1 Carrying case (no battery pack)	\$21.95
CAS 4	BP-90 Carrying case	\$33.95
CAS 5	BP-84 Carrying case	\$23.95
DCC 5	CP-12 Cigarette power cord	\$29.95
HDP 1	Headphones	\$19.95
MAN 3	Service Manual	\$36.50
MAN 5	Owner's Manual	\$21.95
PWR 14	BC-72A Desk Charger	\$119.95
PWR 17	BA12 Battery Charter Adaptor	\$21.00

Order SCN 13

GROVE ENTERPRISES

P.O. BOX 98, 300 S. HYW. 64 W.
BRASSTOWN, NC 28902-0098
1-800-438-8155 (US & CANADA)
OR 704-837-9200;
FAX 704-837-2216



VERY LIMITED STOCK!

DON'T MISS THIS INCREDIBLE OPPORTUNITY TO OWN THESE FINE ICOM PRODUCTS!

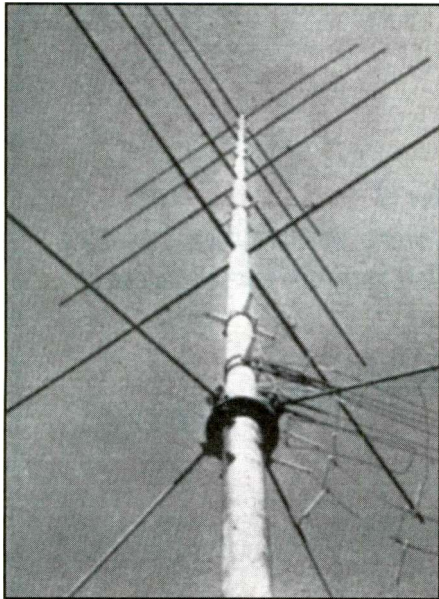

Looking skyward at the K45LA antenna from its base. It was assembled on wooden horses and later raised, complete.

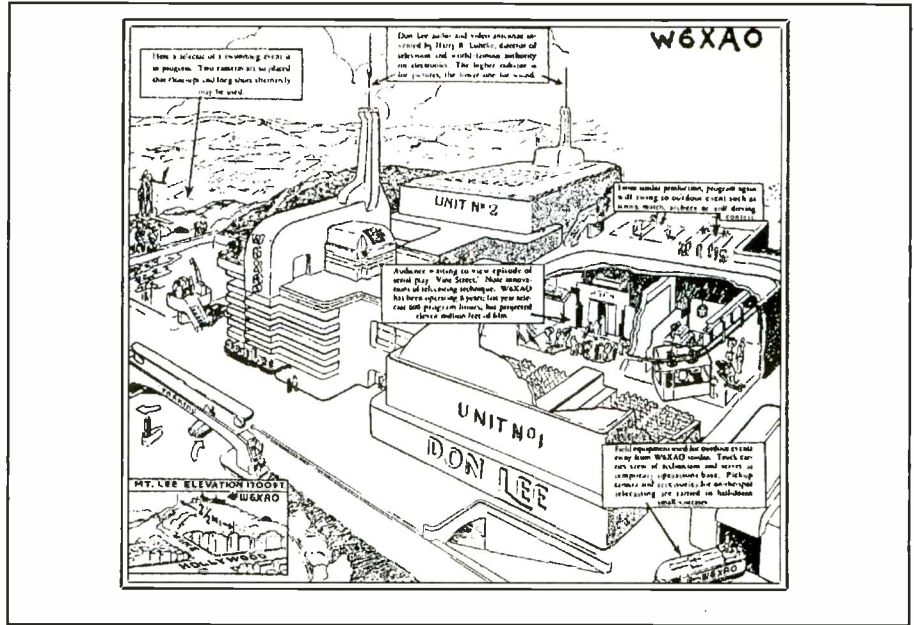

By 1939, W6XAO issued this artist's idealized conception of the new TV facilities on Mt. Lee.

The change caused a new license to be issued bearing the call letters W6XAO, replacing W6XS. The daily broadcast schedule was continued. Soon enough, W6XAO's future changed when, unfortunately, in August of 1934, Don Lee died.

Don Lee had been a wealthy and flamboyant Cadillac dealer who had gotten into radio when he purchased station KHJ in 1927. KHJ had been a profitable venture for him. Upon Don Lee's death, his GM dealerships were cancelled. His broadcasting interests were continued, though not with the participation of his son and heir, Thomas Lee. His son had no interest in the business and didn't want to assume the responsibility. The courts judged him incompetent, and the Don Lee Broadcasting officers took over operation of the company, under the direction of Willet Brown.

Thomas Lee retired to the elegant castle Don Lee had once imported brick by brick from Ireland, and then reconstructed at Lancaster, Calif. On its grounds were an auto race track and an airfield. Thomas Lee had his own race cars, his plane with a pilot, and a nurse. He took no part in running the company.

Willet Brown, on behalf of the company, purchased 20 acres of Mack Sennett's failed "Hollywoodland" real estate venture at the eastern boundary of Griffith Park. This was atop the 1,700-foot hill that then had the *Hollywoodland* sign spelled out in huge letters.

The sign achieved world notoriety in 1932 because of 24-year-old British starlet Peg Entwistle. After securing only a bit part in David Selznick's 1932 film *Thirteen Women*, she felt Hollywood had rejected her talents. Thereupon, Entwistle stripped off her clothing and leapt to her death from

OFFICE OF

The Times-Mirror Company

PUBLISHERS OF

Los Angeles Times

FOUNDED BY HARRISON GRAY OTIS, DECEMBER 8, 1881
LOS ANGELES, CAL.

TIMES BUILDING
BROADWAY AT FIRST

OFFICERS AND DIRECTORS

HARRY CHANDLER
PRESIDENT AND GENERAL MANAGER

MARIAN OTIS-CHANDLER
VICE-PRES. AND SECRETARY

F. X. PFAFFINGER
TREASURER

HARRY E. ANDREWS
ASSISTANT GENERAL MANAGER AND
MANAGING EDITOR

MRS. MABEL OTIS-BOOTH

K H J

We hereby confirm your reception of KHJ on April 13, -1934

Radio Department

This 1924 QSL from pre-Don Lee KHJ shows (upper left) the L.A. Times Building, with the antennas on the roof. (Courtesy of POP'COMM's Cathy Ross. The QSL was earned by her dad, Paul Hofer, Jr.)

the top of the thirteenth letter of the sign. Peg was only the first of several failed starlets to use the sign for this tragic purpose. Today the sign is a tourist attraction, but reads only "Hollywood."

Brown renamed his purchase Mt. Lee, and in 1939 he had TV Engineer Harry Lubcke design and build luxurious new W6XAO television facilities there. W6XAO's transmission quality was upgraded to 525-lines at 30-frames, and began from Mt. Lee in December of 1940.

K45LA construction began soon after the W6XAO Mt. Lee facilities started. Mt. Lee had also become the location of the 5 kW transmitting facility used by KHJ, Don Lee Broadcasting's AM station on 930 kHz. KHJ had first gone on the air in 1922 as C.R. Kieruff's front-room 5 watt station. KHJ was soon purchased and improved by the *Los Angeles Times*. In 1927 the *Times* sold the 500-watt station to Don Lee. Leg-

end says Lee paid the staggering price (for those days) of \$500,000.

The Don Lee KHJ studios were seven miles away, and fed to the AM transmitter by regular landline. FM programming was planned to originate from the AM studios, but be delivered to the FM transmitter over a special 15 kHz high fidelity landline.

Engineer Frank Kennedy decided to use an omni-directional FM turnstile antenna on a tower mounted atop the FM transmitter building. A 50 kW Western Electric transmitter couldn't be obtained immediately, but was placed on order. Arrangements were made to secure the immediate delivery of a 1 kW Western Electric FM transmitter.

That 1 kW K45LA transmitter on Mt. Lee reached out and covered a total of 6,944 square miles.

Kennedy's FM installation plans had to take into consideration how and if the three broadcast facilities could be operated suc-

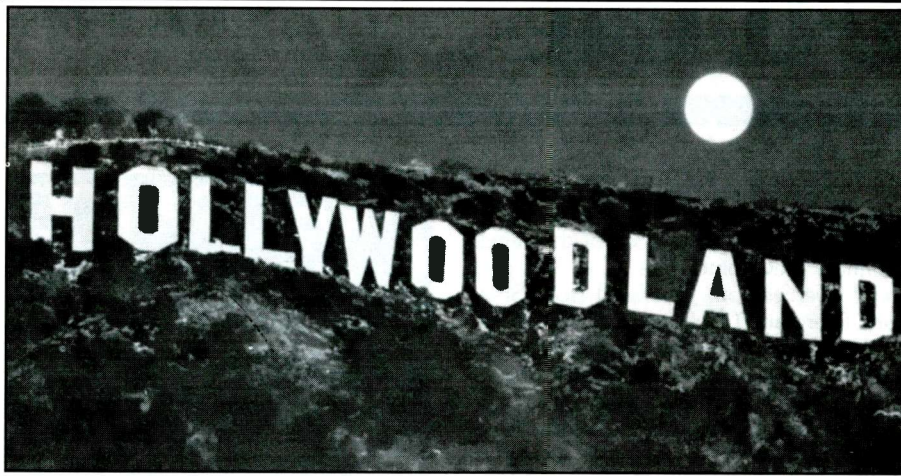

The jinxed "Hollywoodland" sign atop what later became Mt. Lee, site of the Don Lee broadcast facilities.

cessfully in relatively close proximity. He was wondering what interference the 50 kW FM signal might cause to the TV cameras, landline studio/transmitter links, or telephone communications.

With respect to this, Kennedy decided to locate the FM building about 450 feet away from the TV facilities. All telephone and power lines were buried within 150 feet of either building, and all lines were below the top of Mt. Lee.

K45LA commenced operation on August 11, 1941. It was the first FM broadcast station in the far west. With its noon to midnight daily schedule, K45LA managed to carve a niche for itself, even in a market where there were no FM receivers. Within the first month of K45LA's operation, at least 2,000 FM receivers were sold! Some of KHJ's AM programs were simulcast, but the FM station originated many of its own programs.

By 1946, K45LA had become renamed KHJ-FM, and the station had migrated to the FCC's newly created FM band, situated between 88 and 108 MHz. At first, KHJ-FM used 99.7 MHz, then later was shifted over to 101.1 MHz.

In May of 1948, Lee Broadcasting got approval to operate W6XAO as commercial TV station KTSL on Channel 2. By November, 1949 plans were being made to move the KTSL transmitter to Don Lee Broadcasting property on Mt. Wilson, and the studios to the new Don Lee building at 1313 N. Vine Street. Lamentably, in January, 1950, during the move, Thomas Lee committed suicide by leaping from the seventh floor of the Wilshire Building. This tragedy meant that Don Lee Broadcasting had to be liquidated to satisfy the heirs.

The KTSL move was completed, but KTSL station was sold to CBS. General Tire and Rubber purchased the AM and FM stations. A General Tire subsidiary, General Teleradio, was formed to operate the AM and FM stations, and that company later purchased Los Angeles TV station KFI-

TV, Channel 9, then changed its call letters to KHJ-TV. The Walt Disney Co., now owns this station, calling it KCAL.

The present heir to K45LA/KHJ-FM's legacy is KRTH. This station still operates

on 101.1 MHz, but is no longer located on Mt. Lee. KRTH has its antenna at 3,130 feet, and operates with more than 50 kW. Since 1989, the station has been owned by the Beasley Broadcasting Group. The station runs an oldies format.

The current incarnation of KHJ, Don Lee's original AM station, is Spanish language station KKHJ, 930 kHz. New owners here, too.

The Mt. Lee site is now primarily used for communications facilities of the CHP and Los Angeles County Sheriff Dept.

Special thanks to Warren Wells, Los Angeles, Calif., whose monograph on the history of TV Channel 9 in Los Angeles was a rich source of information about the TV activities of Don Lee Broadcasting.

We always appreciate reader input in the form of old time radio and wireless photos, old QSL's, station listings, picture postcards relating to radio, memories, news clippings, ideas, and questions. It's what we use to put this column together.

Next month I'll be on vacation, but there will be a fascinating article here by Ronald R. Thomas that I know you'll enjoy. ■

Timestep

The Weather Satellite System

Images available as often as every 4 minutes.

Full screen color animation of up to 1000 frames.

Direct temperature readout.

Latitude / Longitude and political boundaries.

Easy to use mouse operation.

3D Cloud images.

Automatic operation.



HRPT Image of southern Hudson Bay

If you want to see the world's weather right now from anywhere in the world, including the Americas, Europe, the Middle East, Japan and Australia, then we have a system for you. Watch local weather systems or track hurricanes and tropical storms. We can supply simple systems for beginners or advanced HRPT systems for enthusiasts. All component parts are available separately. Systems and satellites available include HRPT, WEFAX, APT, NOAA, Meteor, Okean, GOES, Meteosat and GMS. Color brochures available.

**Spectrum International Inc. PO Box 1084 Concord Mass. 01742 USA
Tel. (508) 263-2145 Fax. (508) 263-7008**

Manufactured by: Timestep PO Box 2001 Newmarket CB8 8XB England
Tel. 01440 820040 Fax. 01440 820281

Guerrilla Broadcaster's Story

In 1979, a military coup overthrew El Salvador's elected President. However, the ruling military-civilian junta wasn't able to put down a rebellion by leftist insurgents, who were armed by Cuba and Nicaragua. Extreme right-wing death squads organized to do away with suspected leftists were blamed for thousands of deaths during the 1980's. The USA strongly supported the government with military aid.

Beginning in 1979, and every day for 12 years, El Salvador's Radio Venceremos operated as an underground radio station. From bunkers under aerial bombardment, on the run from government troops, foiling high-tech jamming efforts, the station fought for its space on the airwaves, just as the guerrilla insurgents battled for space in the nation's political system. Always on the run from endless army offensives, Radio Venceremos became the main voice of the leftist opposition in the middle of a rebellion, challenging the government.

The rebels were never defeated. The 12-year civil war, in which 75,000 lives were lost, ended in 1992. That's when government and leftist rebels signed a peace accord, and when Radio Venceremos left its mountain hide-out to begin broadcasting from San Salvador, the capital city.

The story of Radio Venceremos has now been documented in considerable detail, in Jose Ignacio Vigil's new book, *Rebel Radio*. It's presented as "a tribute to the courage, inventiveness, vitality, and audacity of the Salvadoran people." That's to say, the book is based upon interviews with of the

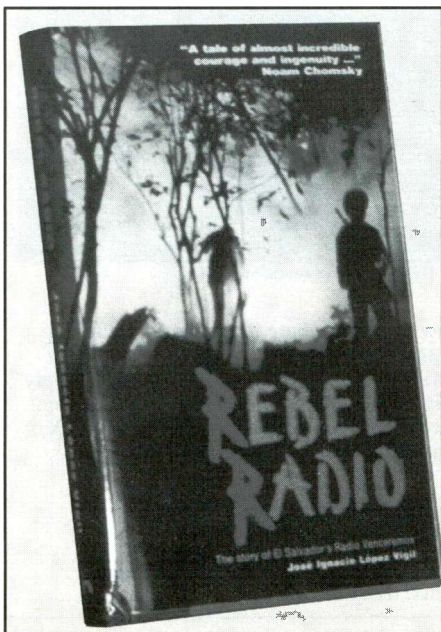

12 former Radio Venceremos rebels who operated the station during its underground days. Expect a strong dose of the rebels' political viewpoint. This is a 308-page hardcover edition, translated from Spanish. There are 11 photos, plus two maps.

Vigil interweaves the details of the rebel station's operation with insights into guerrilla activities, doctrine, and the reminiscences of the everyday life of the insurgents. This was a bold station that snapped its fingers in the face of adversity. What we found most interesting, was seeing how the feisty little clandestine broadcaster eventually became the nationally recognized voice of a political movement, and an important player in a long rebellion. The amazing power of radio!

You might find it an interesting story. We did. The gutsy underground station that had to keep running for its life every day for more than a decade was definitely a piece of work.

Rebel Radio is \$19.95 from Curbstone Press, 321 Jackson Street, Willimantic, CT 06226. Phone: (203) 423-5110.

Getting Out

The next round in the space race won't be run by NASA. This time, it will be private companies building space stations, shooting payloads to the planets. These companies will employ the engineers, technicians, and other personnel that must develop and provide aerospace and communications technologies.

Science fiction, you say? Take another guess. Right now, Congress is grumbling about the public funds allocated to NASA, and suggesting how much better it would be for the private sector to run the Space Program.

B. Alexander Howerton's 160-page illustrated book *Free Space! Real Alternatives for Reaching Outer Space*, tells about ten companies that are gearing up for space travel. Run by NASA/aerospace alumni, they have the savvy and the big-bucks backing to make it happen.

Howerton's book, for example, tells about International Space Enterprises. This is a private U.S./Russian venture with plans to launch a lunar lander in 1997. Another chapter discusses OUSPADEV, which is building a complete space station to operate as a high-flying hotel, complete with zero-gravity honeymoon suites!

Mars Direct, we learn, is a company that plans to convert the Martian atmosphere into fuel to run an outpost there. The Artemis Project proposes to send Hollywood camera crews into outer space.

There is much more in *Free Space!*, including companies that are actively prepar-

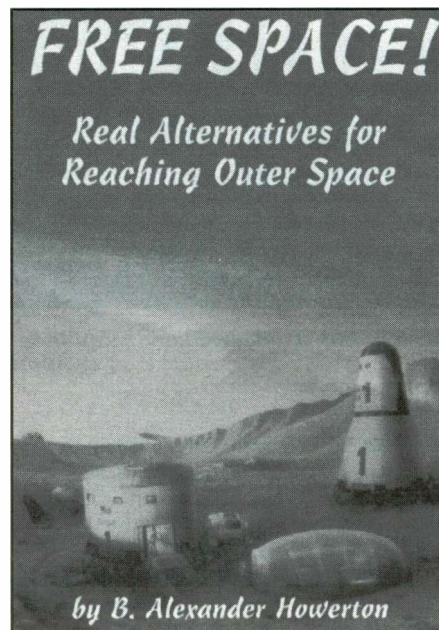

ing to construct dwellings for the Moon, Mars, and outer space. It's well written, and tells a most interesting story. Some of the book's illustrations are in color.

Here's a book recommended for anyone curious about the future direction of space exploration and communications. If you're planning on entering or remaining in the aerospace technologies, Howerton's book will provide the scoop on ten companies worth keeping in mind as potential employers.

Free Space! is \$14.95, plus \$4.00 shipping and handling, from Loompanics Unlimited, P.O. Box 1197, Port Townsend, WA 98368. Credit card orders can call: 1-800-380-2230. (Wash. State residents please add 7.9 percent tax.)

Investigation/Surveillance Information Galore

Surveillance writer Lee Lapin took a full two years to travel in order to interview spies, detectives, information locators, and electronic surveillance experts. When he put his findings down on paper, they emerged as a gigantic 440-page illustrated book weighing nearly 3 lbs. Newly published, this is *The Whole Spy Catalog*.

This is a no-nonsense, hands-on encyclopedia brimming over with professional secrets, tricks of the trade, "inside" phone numbers, source names and addresses, ordering information, and cutting edge techniques to trace, track, surveil, and investigate, anyone or anything.

A sampling of the text and sources covers the latest and greatest audio bugs, phone taps, room monitors, and listening post

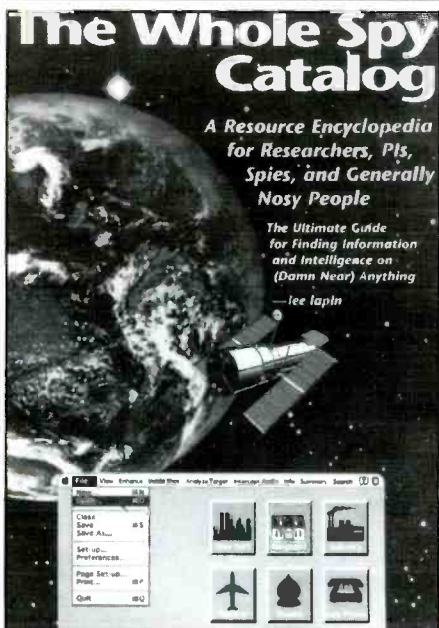

equipment. He has a source where you can buy actual KGB surveillance equipment.

Lots of information is provided relating to phone taps and cellular phone intercept, including the software that turns a PC into a cellular reader.

How to locate and research anyone info allows readers to check things out. There are tear-out FAX forms for your immediate use in doing so. Lapin says a \$5 phone call can locate 90 percent of the population if you know the right technique. Shows you how to get a tally of their assets, too.

There are countermeasures here, too. Shows how to protect yourself from and/or find any electronic bug in the world, or tap. More so, Lapin's book explains effective scrambling techniques for phones, cellular, FAX, and modem communications, including a software driven scrambler he says the FBI doesn't want you to know about.

More too, such as how to use online sources, or get high resolution satellite photos of any location in the world. How to subscribe to all sorts of unusual publications, for instance an in-house FBI newsletter. Far too much in this massive book to cover in total here, but this should give you the general idea. It's wall-to-wall with illustrations, too.

The Whole Spy Catalog is \$44.95, plus \$5.00 shipping and handling (\$6 to Canada) from CRB Research Books, Inc., P.O. Box 56, Commack, NY 11725. VISA/MC welcome. Toll-free order line: 1-800-656-0056; Canada/AK/HI orders: (516) 543-9169. (NY State residents please include \$4.00 tax.)

In addition...

We received an interesting 64-page book called *Scanner Busters*, by D.C. Poole. The book, published in Scotland, discusses the use of scanners with respect to coping with communications technologies that make listening difficult. These

technologies include trunked systems, digital short range radios, digital cordless phones, spread spectrum radios, the clipper chip, and GSM (U.K.) cellphones.

The book was written primarily for European scanner owners, so it is mostly keyed towards their systems. Nevertheless the information is generally relevant to systems used here in North America, and is well presented.

This book is priced (only) in Pounds Sterling at 4.95, and is available from Interproducts, 8 Abbot Street, Perth, Scotland PH2 0EB. VISA/MC are accepted. Phone or FAX orders: 011-44-1738-441199. If you don't have a credit card, and you wish to purchase this book, ask at a commercial bank about how to obtain a money order in Pounds Sterling at the current exchange rate.

NEW!! SCANCAT GOLD **IMPROVED!**

Since 1989, The Recognized Leader in Computer Control

Once you use SCANCAT with YOUR radio, you'll NEVER use your radio again WITHOUT SCANCAT!

SCANCAT supports most radios by:
AOR, DRAKE, KENWOOD, ICOM, YAESU and JRC (NRD)
Plus PRO-2005,6 & 2035/OS456, Lowe HF-150, and Watkins-Johnson HF-1000

SCANCAT 6.0 FEATURES

- Search between any 2 frequencies.
- Log found frequencies to files while scanning.
- Search by ANY increment.
- Scan Disk Files Frequencies.
- Create Disk files.
- Spectrum Analysis to Screen OR Printer.
- Import from most text formats to a working SCANCAT file.

SCANCAT - GOLD FEATURES

We simply don't have the space to tell you ALL the new GOLD features
SCANCAT-GOLD includes ALL ABOVE 6.0 FEATURES PLUS

- Link up to 15 frequency disk files.
- Link up to 15 search banks.
- D-BASE IMPORT w/DUPLICATE filters.
- IMPORT virtually any database.
- Scan HF & VHF Icom's simultaneously.
- Search by CTCSS & DCS TONES with PRO2005,6/2035 (& ICOM/DC440).
- PRINT to ANY printer, or Disk File.
- MULTIPLE search filters.
- Automatic BIRDIE LOCKOUT.

PLUS - POWERFUL COMMERCIAL FEATURES SUCH AS:

- Demographic search for frequency co-ordination and 2-way Usage Analysis.
- Detailed logging to ASCII type files with DATE, TIME, Sig Str, Air Time
- UNLIMITED file sizes with our exclusive SCANCAT filing method.
- Exclusive "MACRO" control by frequency of Dwell, Hang, Resume, Sig. Threshold and even 6 separate programmable, audible alarms.
- Command line options for TIMED ON/OFF (Unattended) logging/searches.

****SCANCAT IS NOT COPY PROTECTED —USE ON AS MANY COMPUTERS AS YOU NEED ****
SCANCAT will run on virtually ANY 640K computer, EVEN HP-100XLT PALMTOP!

SCANCAT comes ready to run ALL supports radios within only ONE program. SCANCAT makes your listening hobby a breeze! Plus, the included SCANPORT allows you to convert your favorite BBS, D Base or Text Files to a running SCANCAT file: 100+ Page manual included. Requires a 640K MS-DOS computer w/RS-232C serial port - hard disk recommended. Manufacturer's Interface not included.

CALL or WRITE for FREE information or our \$5.00 FULLY OPERATIONAL DEMO DISK (includes shipping/handling). ORDER NOW & RECEIVE as a BONUS, FOUR SCANCAT FREQUENCY FILES!

SCANCAT GOLD	\$94.95	UPGRADE	\$24.95
SCANCAT 6.0	\$69.95	from any version	
SQUELCH DETECT CABLES	\$24.95	<small>PLUS \$5.00 SHIPPING & HANDLING \$7.50 FOREIGN</small>	
OPTOScan456 kit	\$299 (\$10 s/h)		

Order OS456 board & SCANCAT-GOLD combined and receive our \$15 frequency disk. **FREE!**

Order direct or contact your favorite dealer

COMPUTER AIDED TECHNOLOGIES

P.O. Box 18285 Shreveport, LA 71138

Orders Only (318) 636-1234 - FAX (318) 686-0449 (24 hrs)

Live Tech Support - (318) 687-2555 (9 a.m. - 1 p.m. Central M-F)

Nitetime BBS (SCANCAT File Area) (318) 631-3082 (7 p.m. - 6 a.m. Central)

Online support available in GENIE's Radio & Electronics RoundTable. Call 800-638-9636 to subscribe to GENIE!
(See our ad on page 37, 63 & 70)

FREE DEMO ON BBS

Radio In Eritrea

Africa's Longest War

BY JAMES RENN

A little over four years ago, in May of 1991, fighters of the Eritrean People's Liberation Front (EPLF) marched into the Eritrean capital city of Asmara, bringing an end to contemporary Africa's longest war. Two years later, in April of 1993, the Provisional government held a referendum on Eritrea's future. In an election monitored by a United Nations observer mission, over 99 percent of the population voted for independence from Ethiopia. Africa's newest country was born.

At the Eritrean National Museum in Asmara a separate building is devoted to the EPLF's 30 year war for independence against Ethiopia. Among the vast array of automatic weapons, artillery pieces, maps, and medical supplies is an olive drab tent, a reel-to-reel tape player, and a couple of shortwave transmitters. It is the original equipment of "Dimtsi Hafash Eritrea," or "The Voice of the Broad Masses of Eritrea."

The station was first set up in 1979, when a massive Soviet military intervention on behalf of the Ethiopian government forced the EPLF to withdraw in a "strategic retreat" to the countryside. "At that time, the EPLF decided it needed a radio station to mobilize our people, organize our army, and inform the world of our situation," says Mahmoud Omar Chirum, Head of Eritrean radio. "It was decided that the only means of expression of our rights and our struggle was through a radio station."

Operating under the EPLF's Department of Information, the Voice of the Broad Masses of Eritrea began broadcasting from the field, in the northern part of Eritrea known as the Sahel. The station broadcast four hours a day on one shortwave band using 10 kilowatts. Programs were initially in the two principle languages of the area, Tigrinya and Arabic, but Amharic and Tigre were soon added so broadcasts could be directed to Ethiopian forces. The station quickly expanded, broadcasting on five medium wave and three shortwave bands in five languages.

Mahmoud, a former EPLF fighter who joined the station in 1986, says the most difficult problem encountered while sending EPLF's message was the jamming efforts of the Ethiopian government. They got around that problem, he says, by switching to differing frequencies during the day.



"The Voice of the Broad Masses of Eritrea" in Asmara.



Mahmoud Omar Chirum, head of Eritrean Radio.

The station staff also had to contend with bombing runs targeted at silencing the broadcasts. "We had to move the station from place to place to avoid the bombing... but," Mahmoud emphasized, "we never stopped broadcasting."

In May, 1991, the Marxist regime of Mengistu Haile Mariam in Ethiopia was overthrown and EPLF forces fought their way into Asmara, occupying the capital

and bringing an end to Ethiopian control over Eritrea.

The EPLF took control of the medium wave station operated by the Ethiopians in Asmara. During this transition there was a period of about three months where The Voice of the Broad Masses of Eritrea was broadcast simultaneously from Asmara and the Sahel, while the radio staff worked to consolidate operations. Eventually all



Original equipment of *The Voice of the Broad Masses of Eritrea* on display in the Eritrean National Museum, Asmara.

broadcasting, both medium and shortwave, originated in the newly-liberated capital city.

Today, the station broadcasts in six languages on four shortwave and two medium wave frequencies (see table below). It is a rare catch for DXer's in North America, while less so in Europe. Mahmoud keeps a stack of letters on his desk from shortwave listeners in other countries who have heard his station. A majority of the reports come from Europe and a few from Asia.

In these times of cut-backs in governmental support for international radio broadcasts, it is nice to know that Eritrea will become a stronger voice on the short-

wave bands. A new building for the Ministry of Information is being built in Asmara and is scheduled to be ready mid-1996. Expanded operations of the station are being planned with higher-powered transmitters and more programs. And, perhaps of greatest interest to DXer's, an overseas service is in the works, initially with programming in Italian, French, and English.

It will be at least a couple of years before Eritrea becomes an easier catch on shortwave bands. If you are lucky enough to hear it, send Mahmoud a reception report at *The Voice of the Broad Masses of Eritrea*, P.O. Box 872, Asmara, Eritrea. ■

Broadcasting Schedule for "The Voice of the Broad Masses of Eritrea"

Shortwave (kHz): 3940 & 7380 broadcast at 10 kW
5000 & 7020 broadcast at 2 kW

Medium wave (kHz): 1089 broadcasts at 10 kW
945 broadcasts at 50 kW

Schedule (UTC)

On 945/5000/7020 kHz: 0330-1030, 1200-1400, 1430-1700
Languages: Afar, Tigre, Tigrina

On 1089/3940/7380 kHz: 0330-0600, 1200-1400, 1430-1700
Languages: Arabic, Amharic, Kunama

It's time you found out...

What over 185,000 people already know.

NOW YOU'RE TALKING!

was written with you, the reader, in mind.

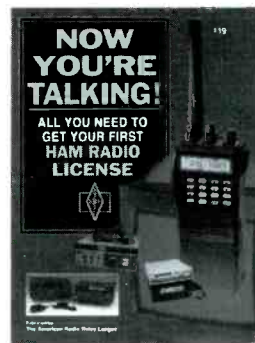

There's never been a more exciting time to get your Ham license. You can use Amateur Radio as a fun, friendly method of local communication, an invaluable tool in emergencies, or even experience the thrill of talking to Astronauts and Cosmonauts in orbit.

Whether you want to enter Amateur Radio as a Technician and choose to skip the code, or as a Novice licensee, *Now You're Talking* will provide you with the information you need in bite-size, easy-to-understand diagrams, photos and sketches, you'll be familiar with all the questions used to make up the FCC test...and you'll be ready for it.

In addition to study material that won't let you down, you'll find invaluable operating hints and tips you'll use once you pass your test. *Now You're Talking: All You Need to Get Your First Ham License* is the book you'll use even after you've passed your exam.

You can shop around for bargains, or you can join the thousands of licensed amateurs who have used *Now You're Talking* to pass their exam. Order your copy today:

Enclosed is \$19 plus \$4 for shipping (a total of \$23) or charge \$23 to my
() VISA () Mastercard
() Discover () American Express

For more information Call
1-800-326-3942

Signature _____

Acct. No. _____

Expiration Date _____

Name _____

Address _____

City _____ State _____ Zip _____

PC

THE AMERICAN RADIO RELAY LEAGUE
225 MAIN STREET
NEWINGTON, CT 06111

CIRCLE 52 ON READER SERVICE CARD

July 1995 / POPULAR COMMUNICATIONS / 27

INSIDE THE WORLD OF SATELLITE COMMUNICATIONS

Your Turn



Meet Arthur Schwarz—TVRO hobbyist extraordinaire!

Tom Harrington's book is a much requested item these days. One request comes from Harry Ditmore, of Idaho who wants to know where to get a copy of *Satellite Radio*. The publisher is Universal Electronics Inc., 4555 Groves Road, Suite 12, Columbus, OH 43232 ; phone (614) 866-4605, FAX (614) 866-1201. It's the best book you'll find on receiving radio signals off your TVRO system; including shortwave as well as domestic stations. The book also explains how to pull a wide variety of data and other specialized digital and voice signals off your system with plenty of easy to read instructions and diagrams. Check it out Harry, and thanks for writing.

Our next letter is from Trevor Fletcher, of Alberta, Canada. He sends an interesting article from the *Canadian Press*. According to the article, U.S. company Power DirecTV wants permission to operate in Canada. They propose using the programming supplied by both American and Canadian communication satellites. Currently only Canadian companies are allowed to operate in the North Country, but the Ca-

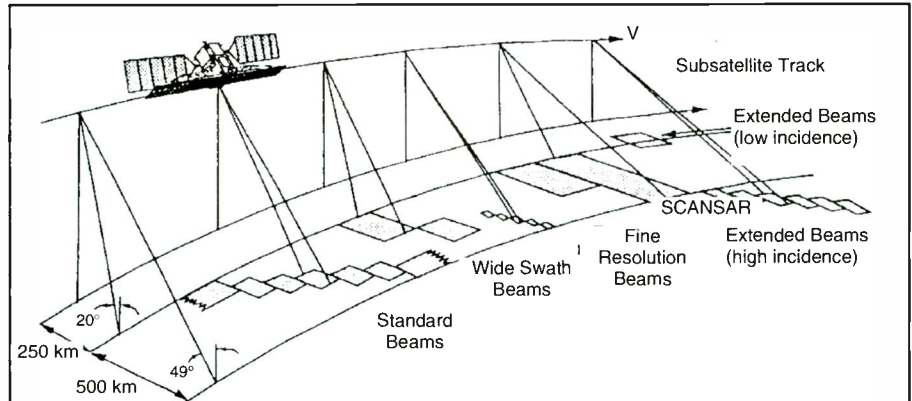

Imaging modes

Mode	Resolution (R ¹ × A, m)	Looks ²	Width (km)	Incidence (degrees)
Standard	25 × 28	4	100	20-49
Wide (1)	40-30 × 28	4	165	20-31
Wide (2)	32-25 × 28	4	150	31-39
Fine resolution	11-9 × 9	1	45	37-48
ScanSAR (N)	50 × 50	2-4	305	20-40
ScanSAR (W)	100 × 100	4-8	510	20-49
Extended (H)	22-19 × 28	4	75	50-60
Extended (L)	63-28 × 28	4	170	10-23

¹ Nominal; ground range resolution varies with range.

² Nominal; range and processor dependent.

Orbit Parameters

Altitude (local)	793-821 km
Inclination	98.6°
Ascending node	1800 hours
Period	101 min.
Repeat cycle	24 days
Sub-cycles	7 & 17 days
Re-observation	3 + days

nadian government will decide if cost savings proposed by this U.S. interest will help Canadian consumers.

Trevor sent along a second article as well. Shelley Page of the *Ottawa Citizen* reports the Canadian Space Agency is in the final testing of its newest Earth observation satellite—RADARSAT. This \$500-million spacecraft underwent vibration and thermal testing in preparation for its late summer launch. The spacecraft will use radar to see through clouds and monitor forest fires, floods, and track icebergs, oil spills, and drug runners, according to gov-

ernment officials. The satellite will maintain an orbit of 300 km above the Earth's surface. Its synthetic aperture radar will make images in daylight or in total darkness, and it can view a 500 km wide swath of the Earth.

Finally, Trevor sends along a photo of his friend Arthur Schwarz, a good neighbor who enjoys watching Deutsche Welle TV on his TVRO system. Good to hear from both of you.

Next we hear from Juan Fierro, of Nevada. Juan says he enjoyed the series on weather satellites and has sent along some

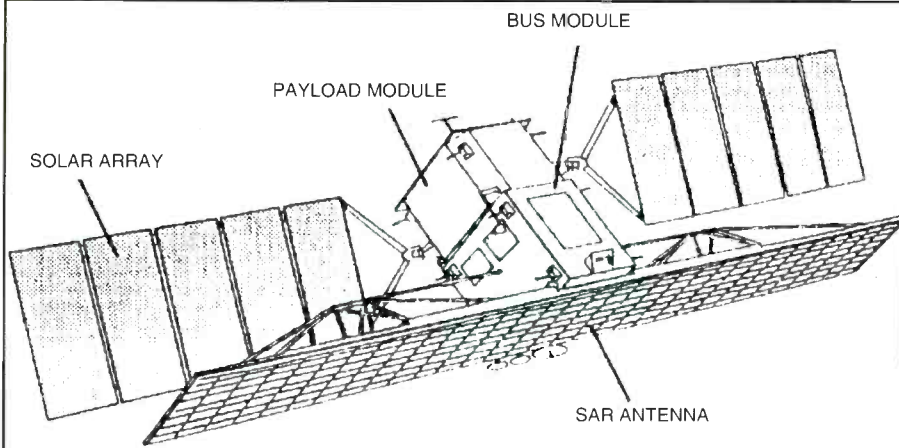

RADARSAT in Imaging Configuration

Radar System Parameters

Frequency	5.3 GHz
Wavelength	5.6 cm
Polarization	Horizontal
Pulse bandwidths	11.6, 17.3, or 30.0 MHz
Pulse length	42.0 μ s
PRF	1,270 - 1,390 Hz (2 Hz steps)
Peak power	5 kW
Average power	300 W (nominal)
Max. on time	28 min per orbit
Antenna size	15m \times 1.5m
Pointing	$\leq 0.2^\circ$
Beams in RAM	20
Spacecraft mass	2,750 kg
Spacecraft power	2,500 W
Altitude control	$\sim 0.05^\circ$
Solar array	3.4 kW

Both figures are courtesy of Canadian Space Agency.

weather maps he has pulled off HF and landline BBS. This can be an economical alternative to direct weather satellite reception. Juan states he built a wefax demodulator from Radio Shack parts for approximately \$5, and uses it with an IBM compatible computer. Juan uses the HFFAX.EXE program that he downloaded from his public domain BBS. He says you can print the photos or line art images on any printer you have available. Some programs however, require the VGA graphics. Almost forgot to mention that Juan is also a licensed Ham — N7RCM. I'm sure others besides myself are interested in your \$5 demodulator plans, Juan. Send them along next time you write.

We again cross the seas for our next let-

ter. It comes from Trace Ward (ZL2BS) of New Plymouth, New Zealand. Trace points out that the Russian amateur satellites RS10/11 and 12/13 (and RS-15 I might add) are easy to use. Trace reports you only need a good quality 10 meter receiver and a 2 meter CW or SSB transmitter to start. After adding a dipole antenna for receive and a 2 meter vertical for uplink, you only need to add a set of headphones to this station arrangement. This will keep you from having problems with feedback loop if you use SSB. Remember the 29.350 to 29.500 MHz is used for SSB and CW satellite downlinks in the Amateur radio service.

Our final letter comes from Wes Leathrock who wants more info on the JVFAX program. He says he's had some difficulty

Save on **ALL** **Radio Shack** Scanners & Radios WITH MANUFACTURERS WARRANTY IN U.S. (copy available on req.)

3 WAYS TO SAVE

1^o FREE
SHIPPING & HANDLING
48 STATES

2^o BIG
PRICE REDUCTION

3^o NO TAX
COLLECTED
49 STATES

NEW PRO-62
\$300

Triple-conversion, 200 ch.
Hyperscan, 800 MHz,
VHF (Hi & Lo), UHF, AIR,
AM/FM, keylock,
backlight.



\$259 with NI-CAD batteries **\$259**

CALL 1-800-433-SAVE 9-5 Central Mon.-Fri.
FREE: Since 1981

The Difference Is The Price

USRADIO[®]

USRadio 377 Plaza, Granbury, Tx. 76048

SURVEILLANCE

FM TRANSMITTERS MINI (KITS)

- 3-VOLT FM XMTR, up to 300 ft. indoors, 1500 ft. outdoors
- PHONE XMTR, range to 500 ft., uses phone-line power
- Sound-Activated XMTR, range to 500 ft.
- 2-STAGE XMTR, 9-Volt, very powerful

All above require simple soldering at 2 to 4 places.

\$29.95 ea.**

TELE FM WIRELESS MONITORING SYSTEM. (Kit) **\$99.00***

TELE CALL FORWARDER. Transfers incoming calls. **\$99.00***

CALLER ID. Registers incoming number. **\$99.00***

TEL REGISTER WITH PRINTER. Records dialed number, duration, and prints record. **\$139.00***

12-HOUR LONG-PLAY RECORDER. Modified Panasonic. Records 6 hrs. on each side of 120 tape (supplied). Compatible with VOX and Tel Rec Adapter. **\$119.00***

VOX VOICE-ACTIVATED SWITCH. Makes recorder self-activating with voices or other sounds. **\$28.50****

TELE RECORDING ADAPTER. Records incoming and outgoing calls. **\$28.50****

TELEPHONE SCRAMBLERS. Over 4,000 separate codes. **\$199.00***

VOICE CHANGER. Changes man's voice to lady's and vice versa. **\$49.00***

For Shipping & Handling add \$5.00 and **\$2.00 per item. Colo. residents add sales tax. Mail Order, VISA, M/C, COD's o.k. Inquire for dealer prices. Free catalog.

MUCH, MUCH MORE — OUR 25TH YEAR!

TOLL FREE 1-800-926-2488

A.M.C. SALES, INC.

193 Vaquero Dr., Boulder, CO 80303
Tel: (303) 499-5405, Fax: (303) 494-4924
Mon.-Fri. 8 a.m.-5 p.m. Mtn. Time

CIRCLE 75 ON READER SERVICE CARD

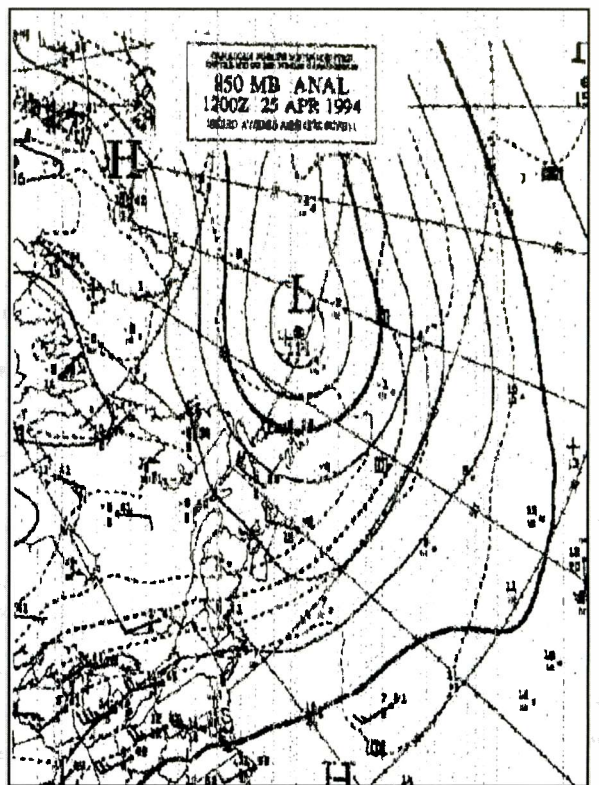
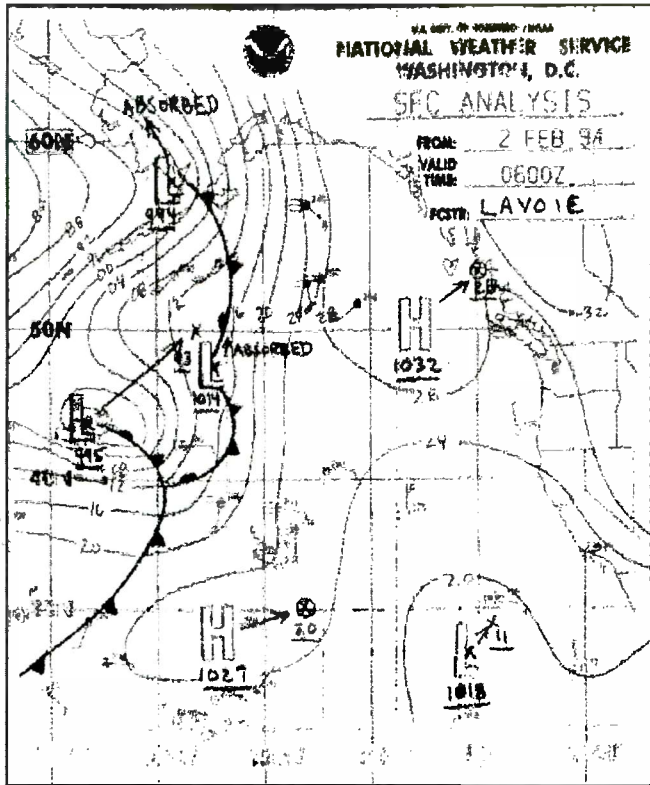
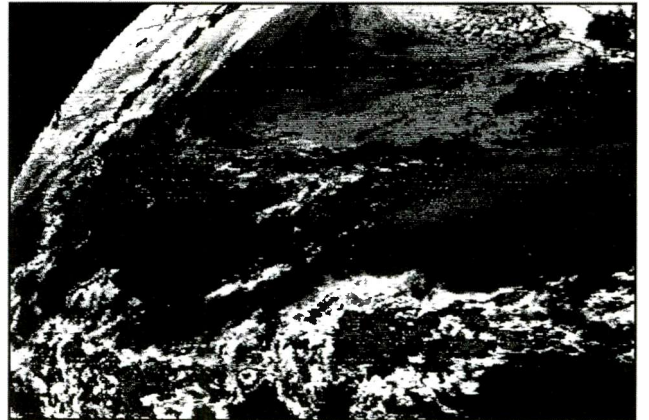
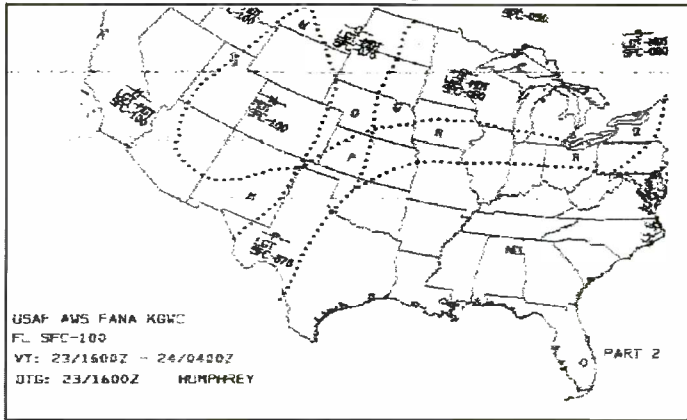

These weather maps are courtesy of Juan Fierro.

PROFESSIONAL 10 HOUR RECORDER. Built like a **BATTLESHIP**



- * Special Pop'Comm price \$149
- * Heavy Duty commercial recorder (NOT "improvised" from a consumer model)
- * Full one year warranty * Dimensions 11.5 x 7 x 2.75"
- * BUILT-IN voice activation: add \$25
- * Also available: 12, 14 and 16 hour models
- * Recorders come with full applications info for scanners, etc.

FREE
32 Page
Special Equipment
Catalog



VIKING INTERNATIONAL *SINCE 1971*
150 EXECUTIVE PARK BLVD. #4600
SAN FRANCISCO, CA 94134
PHONE: (415) 468-2066 FAX: (415) 468-2067

No shipping charges on prepaid orders. COD's OK. Cal. residents add tax.
Sorry, no credit cards (all they "do" is increase prices...)

CIRCLE 82 ON READER SERVICE CARD

getting on the BBS to access the program. This information, you may remember, was sent along from old salt satellite sleuth Ron Burke, of Indiana. Wes, a quick call to Ron may explain why you were having problems. It seems that you were having trouble with the program name. It is listed in the BBS as follows: JVFX70.ZIP. This public domain software for displaying weather maps and photos directly off satellites is an IBM or IBM compatible program. Try a different BBS Wes, like the Dallas Imaging Group at (214) 394-7438; look into directory 22—it should top the list. Also try the original BBS carrying this information at (703) 362-8673.

That just about does it for this edition. Don't forget to drop us a line with your questions, photos, and satellite info. See you next month. ■

NEW PRODUCTS

REVIEW OF NEW AND INTERESTING PRODUCTS



AEA's KK-1 Keyboard Keyer

AEA puts the world at your fingertips, literally, with the new KK-1 Keyboard Keyer. The KK-1 turns any standard PC-compatible 101-key keyboard into an easy-to-use, feature-packed Morse machine. Using the provided cable, the KK-1 shares a keyboard with your computer. A simple key combination switches the keyboard between the keyer and your computer.

The KK-1's extensive features take full advantage of the keyboard's layout. For example, the separate numeric and cursor control keypads are used for accessing the majority of functions. The function keys let you select the 12 nestable message buffers with a single keystroke.

Unique features, such as short-term memory and message repeat, make the KK-1 versatile and easy to use. Home your skills with an extensive code practice mode that allows you to choose between commonly heard words and random character groups. A built-in iambic keyer allows you to choose paddles for a change of pace.

Other unique features include:

- A four-digit LED display with mode indicators.
- Adjust character formation speed and average sending speed together or independently.
- Nineteen weight settings to compensate for transmitter keying characteristics, or to give yourself a distinctive flat.

With more usable features for your money than any other Morse keyboard, the KK-1 continues AEA's tradition of top-notch keyers.

Suggested retail price for the KK-1 is \$199. The KK-1 is available from your favorite amateur radio dealer.

For more information contact Advanced Electronic Applications, Inc., P.O. Box C2160, Lynwood, WA 98036. Phone (206) 774-5554, FAX: (206) 775-2340, or circle 101 on our Readers Service.

New GMRS Radio

Maxon Systems introduced a new General Mobile Radio Service GMRS radio.



The GMRS-210+3 provides 2 watts of power, up to 5 watts when operated with the supplied vehicular power supply cord. Ten-channel operation (seven general purpose, one safety/emergency, and two dealer programmable simplex or repeater channels) provides increased flexibility.

An eight-button keypad is used to select channels, radio programming features and initiate the various scan modes. User programmable options include scan delay time, power save, channel lockout, and transmit time-out timer. CTCSS independently programmed transmit/receive frequencies assure private communication between similarly programmed radios.

The radio's high/low power switch (used to conserve battery capacity) and control knobs are top-mounted for convenient operation. Channel, frequency, and radio status information are displayed on the radio's illuminated LCD.

A variety of optional accessories are available: an external magnetic mount mobile antenna, 3-watt alkaline battery case, 4-watt rechargeable Ni-Cad battery pack, durable speaker/microphone, voice-operated mini-VOX headset, desktop charger, and a durable nylon case.

Included is a 2-watt rechargeable Ni-Cad battery pack, a "Rubber Duck" antenna, an AC/DC charger, a vehicular power supply cord and plug, a belt clip, and hand strap. The handheld radio weighs only 18 oz., and is compact enough to fit into a back pack or glove box.

For more information contact Maxon Systems Sales Department, 10828 NW Air World Drive, Kansas City, MO 64153. Phone: (816) 891-1093.

Noise Reduction Unit

JPS Communications, Inc., announces



the new ANC-4 Antenna Noise Canceller, an RF device designed to remove locally-generated noise from signals received by a primary antenna. The unit is installed right at the antenna connector of the receiver/transceiver to cancel locally-generated noises, such as "power line" noise, computer/TV noise, electrical noise from local machinery or equipment, etc., before they get into the receiver and affect the receiver's AGC circuits. This allows reception of signals well below the noise level induced by the local interference.

To cancel local noise, the interference signal must be detected and its phase and magnitude adjusted so that it matches the offending interference, but is 180 degrees out of the phase, effectively cancelling its interference. Controls are provided on the front panel to allow adjustment of both the phase and magnitude of the local interference, providing extremely deep cancellation of the offending interference.

This unit may be used with any receiver or transceiver with RF power output of 150 watts PEP or less. An RF detector built into the unit automatically bypasses the network whenever transmit RF is detected. The unit is not designed to be used at the output of a high power linear power amplifier, but must be installed at the lower RF level of the transceiver, if transmitting is anticipated.

The unit connects between the main station antenna and the receiver antenna connector. A short wire antenna and a short collapsible whip are supplied with each unit to act as the noise pickup antenna.

If no "main" antenna is available, the ANC-4 may be used as an active antenna by plugging the noise antenna (or a longer wire antenna) into the noise antenna jack and using the "noise gain" control to increase the antenna output.

The unit requires 12VDC@300mA. Adapters are available from JPS.

For more information, contact JPS Communications, Inc., P.O. Box 97757 Raleigh, NC 27624-7757, or circle 102 on our Readers' Service.

WHAT'S HAPPENING: INTERNATIONAL SHORTWAVE BROADCASTING BANDS

One of shortwave's oldest broadcasters seems to have discontinued its high frequency operations. Radio Luxembourg can trace its shortwave activity to pre-WWII days, having begun transmissions with a 6 kW transmitter in the 49 meter band back in July, 1938. It was used as a propaganda station by the Nazi's during the war, even carrying broadcasts of William Joyce, the notorious Lord Haw Haw. After the Germans were pushed out in 1944, the station came under the control of SHAEF—Supreme Headquarters Allied Expeditionary Force, then resumed broadcasting as Radio Luxembourg in the fall of 1945.

The station had dropped its English programming about a year ago, and, a few months ago, discontinued use of 6090—one of its two long used frequencies. Now the other—15350 is also off the air.

We haven't seen any official explanations so perhaps we can cling to some small hope that the situation isn't permanent.

Kol Israel has cut back its English language schedule, although there's some chance this may be reversed. At this writing, however, English from Israel is aired only at 0500-0515 on 7465, 9435 and 17545; 1100-1130 on 15640, 15650 and 17575 and 2000-2010 on 7405, 7465, 9435, 11603 and 17575—less than an hour a day, all told.

Italy's RAI has been one of the most unchanging of broadcasters over a period of decades. You may remember that last year it began relays via the BBC's Ascension Island station. It's now added the BBC's Singapore station as well! The broadcast is in Italian, on 11850 between 1000-1100.

Speaking of the BBC, there's now a North American edition of the BBC's magazine—*BBC Worldwide*, which contains "comprehensive details" of all BBC broadcasts and frequencies, program features, and previews. It amounts to about 100 pages each month. For more info you can write to BBC Worldwide, Panorama House, 2 the Drive, Hove, East Sussex BN3 288, England.

The Voice of Vietnam is now being relayed by transmitters in Russia. These are aired at 0400-0600 on 5940 (English), and 0600-0700 in Spanish on 7400, beamed to the Americas from a transmitter located north of Amavir. Another VOV/Russia broadcast is believed to air in Vietnamese on 7270 from 0700-0800, though not from the same site.

Ethiopia has a new government station, Radio Fana, scheduled from 0330 to 0800 and 1530 to 1730 on 6210 and 9335, all in Amharic and local languages.

Another new station which may be on the air by now is Radio Alpha and Omega,

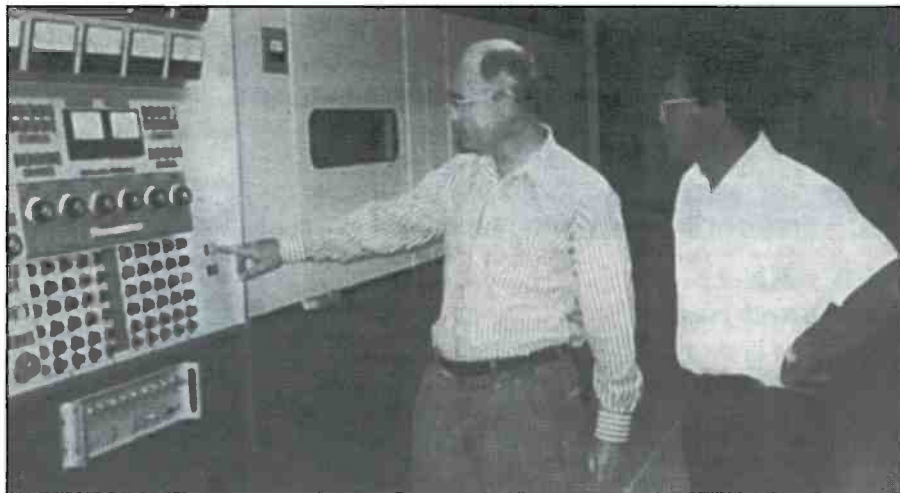

AWR Asia put its third transmitter on the air at its station on Guam.



This neat shack belongs to Alain Lorange, St. Leonard, Quebec, and features Sangean 803A and AX-190 shortwave receivers, plus scanners and accessories.

which is supposed to come on the air via the transmitters of the Icelandic National Broadcasting Service. Supposedly the station will eventually have its own transmitters operating from Iceland.

Colombia's government station, Radio Nacional de Colombia is now active on 4955. It has been inconsistently active on 31 and 25 meters in recent years.

Radiotelevision Ivoirienne is reported to have reactivated its 11920 frequency, running to sign off at 2000 and including some English. The Ivory Coast government sta-

tion is one of the most difficult stations to QSL in all of Africa—even though they have a QSL card which even includes the term "SWL!" If you are trying to verify this station it might be worth trying to hear and report this new channel.

Islamic Republic of Iran Broadcasting has a new address: P.O. Box 15875/1575, Tehran, Iran.

KNLS, Alaska says it is now offering seasonal QSL cards, the first one in effect until September 24. The new cards are individually numbered and limited to 200 each.

Weather Stations/Scanners/CB

COMMUNICATIONS ELECTRONICS INC.
Emergency Operations Center

New Scanner Products Available
Now readers of *Popular Communications* may purchase communications and weather forecasting equipment directly from Communications Electronics Inc. Order today from CEI and save.

Bearcat Scanners

Bearcat 9000XLT-R base/mobile	\$374.95
Bearcat 3000XLT-R handheld	\$344.95
Bearcat 890XLT-R base/mobile/WX	\$228.95
Bearcat 860XLT-R base	\$154.95
Bearcat 760XLT-R base/mobile	\$189.95
Bearcat 700A-R info mobile	\$148.95
Bearcat 560XLA-R base/mobile	\$76.95
Bearcat 220XLT-R handheld/SPECIAL	\$208.95
Bearcat 178XLT-R base/WX alert	\$128.95
Sportcat 150-R handheld w/800 MHz	\$159.95
Bearcat 148XLT-R base/WX alert	\$83.95
Bearcat 120XLT-R handheld	\$124.95
Bearcat 80XLT-R handheld	\$159.95
Bearcat BCT7-R info mobile	\$168.95

Weather Stations

Now you can be your own weather reporter with the Davis Weather Monitor II. Our top-of-the-line weather station combines the most advanced weather monitoring technologies available into one incredible package. Glance at the display, and see wind direction and wind speed on the compass rose. Check the barometric trend arrow to see if the pressure is rising or falling. Push a button, and read indoor and outdoor temperature, wind chill, humidity and barometric pressure. Our package deal includes the new ultra high resolution 1/100 inch rain collector part #7852-R, and the external temperature/humidity sensor, part #7859-R. The package deal is order #DAV1-R for \$479.95 plus \$15.00 shipping. If you have a personal computer, when you order the optional Weatherlink computer software for \$139.95, you'll have a powerful computerized weather station at an incredible price. For the IBM PC or equivalent order part #7862-R. Apple Mac Plus or higher including PowerBook, order part number 7866-R.

The Weather Monitor II (7440) comes complete with an anemometer with 40 feet of cable, external temperature sensor with 25 feet of cable, junction box with 8 feet of cable, AC power adapter, detailed instruction booklet and one year limited factory warranty.



Davis Weather Monitor II 7440-R	\$334.95
Davis Weather Wizard III 7425-R	\$154.95
Davis Remote Display Unit 7815-R	\$84.95
Davis Rain Collector II 001* 7852-R	\$59.95
Davis Rain Collector II 0.2 mm 7852METRIC-R	\$59.95
External Temperature/Humidity Sensor 7859-R	\$99.95
Davis Anemometer Mast Mount 7890-R	\$15.95
Weatherlink Software for IBM PC/Version 3.0 7862-R	\$139.95
Weatherlink Software for Apple/Version 3.0 7866-R	\$139.95
4-Conductor 40' (12.2 m) extension cable 7876-R	\$17.95
6-Conductor 40' (12.2 m) extension cable 7878-R	\$21.95
8-Conductor 25' (7.6 m) junction box cable 7880-R	\$14.95
8-Conductor 50' (15.2 m) junction box cable 7881-R	\$24.95
8-Conductor 100' (30.5 m) junction box cable 7882-R	\$44.95
Modem Adaptor 25-Rin for communications port 7870-R	\$9.95
Car/Boat/RV Lighter Cord 7873-R	\$9.95
2400 baud modem for Weatherlink MEXT-R	\$39.95
Talking weather card - Call 313-994-9000 for demo IT1-R	\$474.95
Weatherlink language disks: Francaise, Deutsche, Italiana, Espanola 7865-R	\$24.95
Barometer, Indoor Hygrometer & Thermometer, Clock/Calendar BA888-R	\$79.95
Indoor-Outdoor Thermometer/Barometer & Hygrometer by OSI BA213-R	\$79.95
Thermometer with transparent calendar & clock display by OSI TC188-R	\$19.95
Thermometer with AM/FM clock radio by Oregon Scientific CR388-R	\$39.95
Indoor/Outdoor Thermometer with Jumbo Display by OSI JB880EX-R	\$24.95

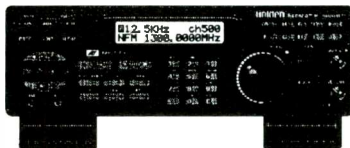

Bearcat® 9000XLT-R Radio Scanner
Mfg. suggested list price \$769.95/CE Special \$374.95
500 Channels · 20 banks · Alpha numeric display
Turbo Scan · VFO Control · 10 Priority channels
Auto Store · Auto Recording · Reception counter
Frequency step resolution 5, 12.5 & 25 KHz.
Size: 10-1/2" Wide x 7-1/2" Deep x 3-3/8" High

Frequency Coverage:
25.000-549.995 MHz., 760.000-823.995 MHz.,
849.0125-868.995 MHz., 894.0125-1,300.000 MHz.
The new Bearcat 9000XLT gives you pure scanning satisfaction with amazing features like TurboSearch™ to search VHF channels at 300 steps per second. This base and mobile scanner is ideal for surveillance professionals because it has a selectable attenuator to help eliminate annoying intermodulation from adjacent frequencies in highly populated areas and selectable AM, Wide FM and Narrow FM modes that allow you to change the default receiving mode of the BC9000XLT. Other features include **Auto Store** - Automatically stores all active frequencies within the specified bank(s). **Auto Recording** - This feature lets you record channel activity from the scanner onto a tape recorder. **Hi-Cut** filter to help eliminate unwanted static noise. You can even get an optional **CTCSS Tone Board** (Continuous Tone Control Squelch System) which allows the squelch to be broken during scanning only when a correct CTCSS tone is received. For maximum scanning enjoyment, order the following optional accessories: PS001 Cigarette lighter power cord for temporary operation from your vehicle's cigarette lighter \$14.95; PS002 DC power cord - enables permanent operation from your vehicle's fuse box \$14.95; MB001 Mobile mounting bracket \$14.95; BC005 CTCSS Tone Board \$54.95; EX711 External speaker with mounting bracket & 10 feet of cable with plug attached \$19.95. The BC9000XLT comes with AC adapter, telescopic antenna, owner's manual and one year limited warranty from Uniden.

CB/GMRS Radios



The new Maxon GMRS 210+3 transceiver is a PLL synthesized 10 channel radio on General Mobile Radio Service frequencies. Two repeater channels are programmable and one channel (462.675 MHz) is set aside for emergency and safety communications. The seven remaining

interstitial frequencies 462.5625, 462.5875, 462.6125, 462.6375, 462.6625, 462.6875 & 462.7125 MHz are all-Rurpose GMRS radio channels. 2 watts of RF power for exceptional transmitting range. Up to 5 watts when used with the supplied 12 volt vehicular DC power cord. CTCSS built-in. Includes 450mAh Ni-cad rechargeable battery pack, AC/DC wall battery charger, owner's manual, FCC license application, belt clip, antenna. Order today.

Maxon GMRS210+3-R GMRS transceiver \$199.95	
Cobra 148FGTL-R CB with freq. counter \$209.95	
Cobra 29LTDWX-R CB/Weather Alert	\$114.95
Cobra HH40-R CB 40 ch. Handheld	\$99.95
Ranger RCI2950-R 25 watt 10 meter	\$239.95
Uniden GMR100-R GMRS Handheld	\$144.95
Uniden WASHINGTON-R SSB CB Base	\$199.95
Uniden GRANTXL-R SSB CB Mobile	\$139.95
Uniden PRO538W-R CB & Weather	\$59.95



Digital Barometer



The Oregon Scientific BA888-R forecasting barometer displays rising, falling and constant barometric trends. Other features include 6-line advanced liquid crystal display, weather forecast shows sunny, cloudy, slightly cloudy or rainy, °C or °F selectable, indoor relative humidity, indoor temperature, barometric pressure bar graph shows trend for past 24 hours, clock/calendar/alarm.

Special \$99.95

VHF Transceiver

RELM® WHS150-R Transceiver/SPECIAL
Mfg. suggested list price \$481.67/CE price \$299.95

Severe weather spotters depend on the RELM WHS150 transceiver for direct two-way communications with their police or fire department, civil defense agency or ham radio repeater. The WHS150 is our most popular programmable five watt, 16 channel handheld transceiver that has built-in CTCSS, which may be programmed for any 39 standard EIA tones. Frequency range 148.000 to 174.000 MHz. Will also work 144.000-148.000 with slightly reduced performance. The full function, DTMF compatible keypad also allows for DTMF Encode/Decode and programmable ANI. Weighing only 15.5 oz., it features dealer programmable synthesized frequencies either simplex or half duplex in both 5.0 and 6.25 KHz increments. Other features include scan list, priority channel, selectable scan delay, selectable 5 watt/1 watt power levels, liquid crystal display, time-out timer and much more. When you order the WHS150 from Communications Electronics Inc., you'll get a complete package deal including antenna, battery, belt clip and user operating instructions. Other accessories are available. A weather reporting case with survival bell hook, part #LCHWHIS is \$49.95; rapid charge battery charger, part #BCWHIS is \$69.95; speaker/microphone, part #SMWHIS is \$54.95; extra nicad battery pack, part #BP007 is \$59.95. The radio technician maintaining your radio system must order programming instructions part #P1150 for \$18.00 to activate this radio. FCC license required for United States operation.

Other neat stuff

Soundtronic AC101-R digital portable shortwave receiver - 20 memory	\$39.95
Grundig Satellit700-R digital portable shortwave receiver with 512 memory	\$459.95
Grundig Yacht Boy 400-R digital portable shortwave receiver - 40 memory presets	\$179.95
Grundig Yacht Boy 230-R digital portable shortwave receiver	\$109.95
Sangean AT5800-R portable 30 memory shortwave receiver	\$69.95
Sangean AT5803A-R portable shortwave w/AC adapter - 9 memory presets	\$129.95
Sangean AT5808-R portable 45 memory shortwave receiver	\$149.95
Uniden EXP9200-R 900 MHz, 1 or 2 line spread spectrum cordless telephone	\$289.95
Uniden EXP9100-R 900 MHz, 1 line cordless spread spectrum telephone	\$229.95
Bogen FR3110-R Digital Fax Friday Fax-on-Demand system & answering machine	\$399.95
Bogen FR3020-R memory expansion module for Fax Friday/up to 36 minutes	\$99.95
Bogen FR2000-R Digital two-line advanced voice mail system & answering machine	\$279.95
Bogen FR0018-R memory expansion module, doubles recording time to 36 minutes	\$79.95
FANS P161P-R 60 name/number caller ID, unwanted call blocker, automatic paging	\$149.95
SNI ID200-R Bouncer name/number caller ID, call reject, forward to machine	\$89.95
ICOM GP 22-R handheld global positioning system (GPS)	\$494.95
WX70-R weather radio with National Weather Service storm alert	\$399.95
RELM WHS150-R VHF handheld 5 watt, 16 channel transceiver	\$339.95
RELM RH256NB-R VHF 25 watt, 16 channel synthesized transceiver	\$289.95
Ranger RCI2950-R 25 watt 10 meter ham radio transceiver	\$239.95
Cobra RDL7125W-R Safety Alert receiver & Super Wideband laser/radar receiver	\$159.95
Uniden LKD99005W-R Super Wideband Laser/Radar Detector - V62 undetectable	\$139.95
ANTE-R VHF scanner/VHF transmitting antenna PL259 connector	\$29.95
ANTMBDC-R magnet mount scanner antenna w/ BNC connector	\$29.95
ANTMBC-R magnet mount scan antenna w/Motorola plug	\$29.95
ANTMPLR-R magnet mount scan antenna with PL259 connector	\$29.95
ANTSGBNC-R glass mount scanner antenna with BNC connector	\$29.95
ANTSGMOT-R glass mount scanner antenna with Motorola jack	\$29.95

Buy with confidence

It's easy to order from us. **Mail orders to:** Communications Electronics Inc., P.O. Box 1045, Ann Arbor, Michigan 48106 U.S.A. Add \$15.00 per radio or telephone product for U.S. ground shipping and handling in the continental U.S.A. unless otherwise stated. Add \$10.00 shipping for all accessories and publications. Add \$10.00 shipping per antenna. For Canada, Puerto Rico, Hawaii, Alaska, P.O. Box, or APO/FPO delivery, shipping charges are two times continental U.S. rates. Michigan residents add state sales tax. No COD's. Satisfaction guaranteed or return item in 31 days for refund, less shipping. 10% surcharge for net 10 billing to qualified accounts. All sales are subject to availability, acceptance and verification. Prices, terms and specifications are subject to change without notice. We welcome your Discover, Visa, American Express or MasterCard. Call 1-800-USA-SCAN to order toll-free. Call 313-996-8888 if outside the U.S.A. FAX anytime, dial 313-663-8888. For technical assistance to solve your communications problem, call the **Communications Electronics technical support hotline for \$2.00 per minute at 1-900-555-SCAN.** Scanner Distribution Center and CEI logos are trademarks of Communications Electronics Inc. Sale dates 6/20/95-9/30/95. ID 056195WX. Copyright © 1995 Communications Electronics Inc.

For credit card orders call 1-800-USA-SCAN
Communications Electronics Inc.
Emergency Operations Center

P.O. Box 1045, Ann Arbor, Michigan 48106-1045 U.S.A.
For information call 313-996-8888 or FAX 313-663-8888

Radio Korea International (RKI)

Time/Freq. Schedule of English Broadcast SHORTWAVE SERVICE (Effective Nov. 1, 1994)

Region	Time(UTC)	Frequency(MHz)
Europe	08:00	7.550, 13,670
	*19:30	7.250(30 min.)
	21:00	6.480, 15.575
North America	01:00	15.575
	06:00	11.945
	**11:30	9.650(30 min.)
South America	01:00	7.550
Middle East & Africa	16:00	9.515, 9.870
Southeast Asia	12:30	9.570(30 min.)
		13.670(30 min.)
General Service	12:00	7.180
	12:30	11.740(30 min.)
	14:00	5.975, 7.275
		11.740
	16:00	5.975
	19:00	5.975

*BBC Skelton relay

**RCI Sackville relay

SATELLITE SERVICE (WRN Network I)

Astra 1-B (Europe)	09:00 -10:00 UTC (Sponsored by Lucky-GoldStar)	11.538 GHz VH-1, TR22 Vertical audio subcarrier 7.38 MHz
Galaxy 5 (North America)	04:00-05:00 EST 21:30-22:30 EST	3.820 GHz WTBS, TR 06 Vertical audio subcarrier 6.80 MHz

English-language Service : Tel:- (82) - (2) 781-3728, 3729, 3735
RKI Fax Number : - (82) - (2) 781-3799
Address: English-language Service, Radio Korea International,
KBS, Seoul, Korea 150-790

Radio Korea International's time/frequency schedule. Thanks to Stan Schmidt, Evansville, Indiana.

Correct reports received too late for the current limited edition card will be verified with one of the two standard style cards—the station building or world map card. Reports must contain the UTC date and time heard, frequency, as many program details as possible, and a complete return address. The station will also accept recordings. The address is P.O. Box 473, Anchor Point, AK 99556. You can also fax your report to (615) 371-8791.

WRNO, New Orleans says it QSL's 100 percent. Send the usual report info—date, time, frequency, and program details heard to WRNO Worldwide, P.O. Box 100, New Orleans, LA 70181. Include a self-addressed, stamped envelope or two International Reply Coupons. WRNO offers many limited edition QSL cards.

Odd doings with signals from the Voice of Turkey, reports Steve Pellicciari, of Norwalk, CT. Steve says the station's car-

rier is always on, even when there's no programming. And there's always an "annoying high pitch whistle" present. Anyone else notice this? (Nice to hear from you again, Steve!)

Your loggings are always welcome. Just remember to list them by country, double space them (at a minimum) and add your last name and state abbreviation to each. We're also in need of shack photos, spare QSLs and such for use as illustrations. Station schedules, shortwave news and observations, QSL information (station addresses, reporting requirements, etc.) background information, and so on are also very much welcome.

Loggings

Here are this month's logs. Remember that all times are UTC, which is five hours ahead of EST, making 0000 the equivalent

Abbreviations Used in Listening Post

AA	Arabic
BC	Broadcasting
CC	Chinese
EE	English
FF	French
GG	German
ID	Identification
IS	Interval Signal
JJ	Japanese
mx	Music
NA	North America
nx	News
OM	Male
pgm	Program
PP	Portuguese
RR	Russian
rx	Religion/ious
SA	South America/n
SS	Spanish
UTC	Coordinated Universal Time (ex-GMT)
v	Frequency varies
w/	With
WX	Weather
YL	Female
//	Parallel Frequencies

of 7 p.m. EST, 6 p.m. CST, etc. Language broadcast is assumed to be English unless otherwise indicated (AA=Arabic, GG=German, FF=French, etc.).

ALBANIA—Radio Tirana, on 9580//11840 at 0230 with news. (Pellicciari, CT)

ANTIGUA—BBC relay, 5975 at 0445. (Pellicciari, CT)

ARGENTINA—Radio Nacional, 6060 at 0835 in SS with ID. (Martin, IL) 11710 at 0933 in SS. (Pappas, SD)

ARMENIA—Radio Yerevan, 9480 at 2302 with news read by woman. (Dybka, TN)

ASCENSION ISLAND—BBC World Service for Africa on 9600 at 0300 with "Network Africa." (Jeffery, NY)

AUSTRALIA—Radio Australia, 5995 at 1320 with economic news. (Larison, NE) 6020//9580//9860 at 0730 with Pacific Service. (Pellicciari, CT) 9660 via Darwin at 2315. (Dybka, TN) 9710 at 1041. (Fox, NC) 17860 at 0203. (Martin, IL)

AUSTRIA—Radio Austria Int'l, 6015 (via Canada) at 0550. (Fox, NC)

BENIN—Radiodiffusion du Benin (at Parakou, editor), at 0621, in FF, with music on 5025. (Martin, IL)

BOLIVIA—Radio Tropico, 4549.4 at 0414-0443 close, with vocals, yipping, folk music with ID. Flutes and accordions. (Paszkiwicz, WI)

BRAZIL—Radio Cancao Nova, 9675 at 2307 with ID in PP, mention of Sao Paulo. (Dybka, TN)

Radio Cultura (Araraquara) on 3365 in PP at 0027 with music. (Jeffery, NY)

Radio Nova Visao, 11705.1 at 2359-0030 in PP with music, announcements, ID, mentions of Brazil, religious talk with applause. (Paszkiwicz, WI)

Radio Sao Gabriel, Cachoeira, 3375 in PP at 2305. (Martin, IL)

BULGARIA—Radio Bulgaria, 9700 at 2130, 2205, 0010. (Larison, NE)

BURKINA FASO—Radio Burkina, 4815 at 0651 in FF. (Martin, IL)

CANADA—Canadian Forces Network, via RCI, 5920//9755 at 0309 with sports, messages to military personnel from loved ones. (Dybka, TN) CFCX, 6005, at 1800. (Pellicciari, CT)

CBC Northern Service, 9625 at 1715 with science program. (Pellicciari, CT)

Radio Canada Int'l, 11845 at 2330 and 11940 in FF at 2335. (Vaage, CA) 11855 and 17820 at 1355. (Larison, NE)

CHAD—Radiodiffusion Nationale, 4904 at 0603 in FF with music and talk. (Martin, IL)

CHINA—China Radio International, 9690 (via Spain) at 0300 with report on US-China trade. (Pellicciari, CT)

Gansu People's Broadcasting System, 9710 in CC

at 2305; 0427. (Klingman, NY; Jeffery, NY) Listed as low power and irregular operation. Editor.

CPBS, 4905 at 2305 in CC. (Martin, IL)

COLOMBIA—La Voz del Rio Aruca, 4895 at 0309-0340 with jingles, mentions of Bogota, "buenos noches." ID. "Colombiano." phone talk, commercial, RCN ID. (Paszkievich, WI)

Radio Super, Bogota. 6065 in SS at 0635. (Martin, IN)

Caracol Bogota, 5075//6150 at 0504 in SS with IDs, news, music. (Martin, IL) 0645 with music, ID 0700. (Pellicciari, CT) 6150 at 0532. (Pappas, SD)

CONGO—RTV Congolaise, 4765 at 0510 in FF with music, talk, drums. (Martin, IL)

COSTA RICA—Adventist World Radio, 5030 in SS at 1018. (Pappas, SD) 9725 at 0022 with ID and address of PO Box 1177, Alajuela, Costa Rica, and program "The Quiet Moment." (Zamora, NM) 9725 at 2304 with "Heartsongs." ID and "It is Written." (Jeffery, NY)

TIFC, 5054.6 at 1111 in SS. (Pappas, SD)

Radio For Peace Int'l., 7385.3 at 0939. (Pappas, SD) 15050 at 0532 with ID and ad for RFPI shirts. (Jeffery, NY) Gives address as P.O. Box 88, Santa Ana, Costa Rica and USA phone of (503) 345-3326. (Fletcher, BC)

Radio Reloj, 4831.7 at 0406 with music, news, clock ticking, tones, talk. (Martin, IL) 0842 in SS with music, IDs. (Pappas, SD)

CROATIA—Croatian Radio, 5895 at 2314 with talks and classical music. (Martin, IL)

CUBA—Radio Havana Cuba, 6000//9820//9830 at 0200 with news, "DXers Unlimited." (Pellicciari, CT) 9505 at 2350 in SS. (Vaage, CA) 9820 at 0335. (Wilden, IN) 9830USB at 0610. (Fox, NC) 11720 at 1538 in EE. (Martin, IL)

Radio Rebelde, 5025 in SS at 1421:0015. (Dybka, TN; Martin, IL)

CZECH REPUBLIC—Radio Prague, 7345 at 0000 with news and features. (Larison, NE)

DENMARK—Radio Denmark, via Norway, 5965



RCI's blue on white plastic pennant.

at 0610 in Danish. (Pellicciari, CT) 11850 in DD at 1530 with ID. (Pappas, SD)

DOMINICAN REPUBLIC—Radio Barahona, 4930 at 0204 with news in SS. (Klingman, NY)

ECUADOR—Radio Jesus del Gran Poder, 5049.8 at 1131 in SS. (Pappas, SD)

Radio Escuelas Radiofonicas, 5010.3 at 1117 in SS with talk and music. (Pappas, SD)

La Voz del Napo, 3280 at 1100 in SS with ID. (Pappas, SD) 1101 with music, ID. (Dybka, TN) 0202 in SS with music. (Martin, IL)

Radio Quito, 4920 at 0601 with SS and rap. (Dybka, TN)

HCJB on 3220 with Andean flute music at 1104. (Dybka, TN)

9420 at 0743 to 0830 sign off. "Saludos Amigos" broadcast to Europe. (Pappas, SD) 9745 at 0200

(Fox, NC) 12005 at 0200 with time check, announcement and "On Line" program. (Wilden, IN)

ENGLAND—BBC on 11750 at 2317. (Vaage, CA) 12097 at 1703. (Wilden, IN)

EQUATORIAL GUINEA—Radio Nacional, 4925 at 0553 in unidentified language with music and drums. (Martin, IL)

FINLAND—Radio Finland Int'l, 17740 at 1440. (Larison, NE)

FRANCE—Radio France Int'l, via Gabon, 4890 at 0445 in FF with pops. (Martin, IL) 12015 (via Gabon, editor)//15530 at 1600. (Larison, NE)

FRENCH GUIANA—RFO Guyane, 5055 at 0520 in FF with pops and talk. (Martin, IL)

GERMANY—Radio Liberty on 7245 at 0500 in RR with "Radio Svoboda" ID. (Dybka, TN)

Radio Deutsche Welle, 6100 at 0505 in GG

Pager Decoder Pager Decoder Pager Decoder

Message Tracker 2.0

Effective July 1, 1995 selling only 2.0 Version.

Call for Information on our new Plus and Pro Versions.

2.0 Additional Capabilities:

- Larger Buffer
- Larger Cap Code List
- Multiple Cap Code Lists
- Plus Additional Improvements

\$139⁹⁵

S & H within U.S.

Decode digital pager messages using your PC and scanner. Adaptor connects to your RS-232 port and audio output jack on scanner. The Message Tracker software program allows you to select various options and features.

(Additional Charges for outside U.S.)
Tx Residents add 8.25% Sales Tax

We currently accept checks and money orders only. Call for latest product and ordering information.

Mail Your Order Today !!!

Advanced Features Include:

- Decodes both ASK and FSK Signals
- POCSAG - ASK (512 1200 2400 baud)
- POCSAG - FSK (512 1200 baud)
- GOLAY (600 baud)
- Auto Baud Rate Detection
- Handles GOLAY and multi-speed POCSAG modes on same frequency
- Option to monitor all messages on channel
- Option to monitor messages only from your capcode address list
- Output to File with Time Stamp
- Displays both Alpha and Numeric Messages

Name: _____
 Addr: _____
 City: _____
 State: _____ Zip: _____
 Phone: _____
 E-mail: _____
 Message Tracker 2.0 : \$ 139.95
 S & H: \$ _____
 Tx Residents:(8.25%): \$ _____
 Total Purchase: \$ _____

K & L Technology
 P.O. Box 460838
 Garland, Tx 75046-0838

Phone/Fax: 214-414-7198
 E-mail: KLTsupport@aol.com

Min. Recommended System : 386

Pager Decoder Pager Decoder Pager Decoder

AR3030 HF Receiver



IBSx***

AOR offers leading edge technology in receiver design with the introduction of the AR3030! Unbelievable design & price tag...nothing has been spared! Compare AR3030 features with other receivers costing over \$1000...The AR3030 is the winner!

SPECIFICATIONS

Frequency: 30-kHz-30MHz plus optional internal VHF converter 108-174MHz • Memories: 100 programmable w/ scan • Modes: AM, LSB, USB, CW, FAX, FMN • Tuning Accuracy: 10Hz • Image & Spurious rejection: >70dB • Dynamic Range: >100dB @ 25kHz spacing
 Antenna inputs: (1) Coax 50Ω unbal. (2) 450Ω bal. (3) Hi-Z for whip
 Audio output: External speaker, FAX, Record • IF Output: 455kHz
 Computer: RS-232C • Power: 12VDC -800mA (max. audio); 8AA Nicad or Alk (not incl.) • Size: 10"W x 3.5"H x 9.5"D; 4.8 lbs.

Superior Performance & Unsurpassed Value!



Electronic Distributors Corp.
 325 Mill St. Vienna, VA. 22180

Phone: (703)-938-8105 • FAX: (703)-938-4525

Available at your favorite dealer.



CIRCLE 58 ON READER SERVICE CARD



**Radio Broadcasting Service
RADIO NEPAL**

P. O. Box 634, KATHMANDU / NEPA

QSL-VERIFICATION-CARD

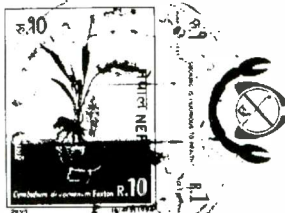

Dear Ed Rausch,

We are very pleased to confirm your reception report of our transmission, which is in accordance with our schedule.

Date: 20th Nov. 1994

Frequency (kHz) 5005

Time (UTC): 11:50 - 12:15

We thank you for your report, we will be pleased to hear from you again. With best wishes from Nepal.

Broadcast Hours: 00:15-17:15 HRS (UTC)

FREQUENCIES: 5005, 7165/3230, 1143, 810, 792, 684, 648, 576 (kHz)

R. Karki
Signature

Ed Rausch
17 vanderberg place
Cedar Grove
New Jersey 07009 -
1039 USA

Ed Rausch of New Jersey is very proud of this nice QSL from Radio Nepal.

(Martin, IL) 9615 with news at 2120 (Larison, NE) 9670 at 0112. (Fox, NC)

GHANA—Ghana Broadcasting Corp., 3366 at 0042 with pop, news and ID. (Martin, IL)

GREECE—Voice of Greece, 6260 at 0430 with news. (Pellicciari, CT) Here and parallel 7450 at 0000 with sign on, ID in EE, news in Greek. (Daniels, NJ)

GUATEMALA—La Voz de Nahuala, 3362 at 0014 in SS with music, talk, ID. (Martin, IL)

Radio Tezulutlan, 4835 at 0154 in SS with music, ID. (Martin, IL)

Radio Cultural, 3300 in SS at 0018 with religious program. (Martin, IL) 0410. (Klingman, NY)

Radio Maya de Barillas, 3324.8 at 1204 in SS with IDs at 1219 and 1228. (Pappas, SD)

HAWAII—KWHR, 9830 at 1030. (Fox, NC)

HONDURAS—Radio Internacional, 4930 in SS at 2330 with music and IDs. (Martin, IL) 0241 with sports. (Dybka, TN)

Radio Copan International, 15675 at 2101 with ID, address. (Martin, IL)

Radio Luz y Vida, 3250 at 0020 in SS with talk and music. (Martin, IL) 0144 with SS love songs. (Klingman, NY)

La Voz Evangelica, 4820 at 1230 with religious programs in SS. (Pappas, SD) 0221. (Martin, IL)

ISRAEL—Kol Israel on 9435 at 1800. (Fox, NC)

Resuth Hasidur, 9390 at 0130 with interview program in Hebrew. (Klingman, NY)

JAPAN—Radio Japan, via Canada, 5960 at 0300 with ID, news and magazine program. (Zamora, NM) 6025 via Canada at 0500. (Jeffery, NY) 0559. (Wilden, IN) 9535 at 1510 with news, ID, "This Week." Off at 1600. (Zamora, NM) 1900. (Larison, NE) 12015 at 0306. (Dybka, TN)

JORDAN—Radio Jordan, 9560 at 1405. (Larison, NE) 1610. (Jeffery, NY) 9830 at 1800 in AA. (Pellicciari, CT)

KENYA—Kenya Broadcasting Corp., 4995 at 0215 in EE with woman dj. (Martin, IL)

KUWAIT—Radio Kuwait, in AA at 1800 1801. (Jeffery, NY; Pellicciari, CT) 11990 at 1800. (Fox, NC)

LESOTHO—Radio Lesotho, 4800 at 0345 in unidentified language, cow mooing, birds singing, talks. (Martin, IL)

LIBERIA—ELWA, 4760 at 2152 with religious programs in EE. (Martin, IL)

MALI—China Radio Internationale via Mali, 15110 at 2014 with music, report on China's agriculture. (Martin, IL)

MALTA—Voice of the Mediterranean, 11925 at 1359 with IS and music. (Jeffery, NY)

MAURITANIA—Radio Mauritanie, 4845 in AA at 0643 with music. (Martin, IL)

MEXICO—Radio Mil, 6010 at 0717 with SS music and talk. (Martin, IL) 0800. (Pellicciari, CT)

Radio Educacion, 6185 in SS at 0422 with music and IDs in SS/EE. (Martin, IL) 0830 in EE/SS. (Pellicciari, CT)

MOLDOVA—Radio Dnester Int'l, 9620 with music, news in EE, address and sign off at 2159. (Dybka, TN)

MOROCCO—VOA relay, 17895 at 1700 with VOA Africa. (Dybka, TN)

NAMIBIA—Namibian Broadcasting Corp, 3270 at 0400 with news and African pops. (Klingman, NY) 3290 at 0103 with music. (Martin, IL)

NETHERLANDS—Radio Netherlands, 6015 at 0334 with weather. (Fletcher, BC) 6020 at 2358. (Martin, IL) 0400. (Fox, NC)

NETHERLANDS ANTILLES—Radio Netherlands Bonaire relay, 6165 at 0005. (Larison, NE) 15315 at 2215 in Dutch. (Zamora, NM) 17605 at 1900. (Larison, NE)

NEW ZEALAND—Radio New Zealand, 9700 at 0710. (Martin, IL) 15115 at 2308 with news and music. (Jeffery, NY)

NIGER—La Voix du Sahel, 5020 in FF at 0603. (Martin, IL)

NIGERIA—Radio Nigeria, Lagos, 3326 at 2302 with unison voices singing. (Martin, IL) 4770 from Kaduna at 0604 with instrumentals and new age. (Wilden, IN)

NORTH KOREA—Radio Pyongyang, 13760 at 0000 and 15130 at 0005. (Larison, NE) 11334.8//13760//15130 at 0008 with IDs. (Pappas, SD)

NORWAY—Radio Norway Int'l, 11850 at 1500 in NN with ID. (Pappas, SD)

PARAGUAY—Radio Nacional, 9735 at 0110; 0130 in SS with music. (Martin, IL; Pellicciari, CT)

PERU—Radio San Martin, 4810 at 0325; 0410 with music and SS. (Pellicciari, CT; Klingman, NY)

Radio Sensacion, 6895.2 at 2342-0015 with religious talk, organ bridge, mention of Huancabamba. (Paszkievicz, WI)

Radio Norandina, 4460.8 at 0330 with vocals and flutes, ID, announcements, vocals, mention of "onda corta." (Paszkievicz, WI)

Radio Soledad, 4633, presumed, 0353-0410 fade, with vocals, announcement, ID, drama. (Paszkievicz, WI)

Radio Frecuencia San Ignacio, 5700 at 0215-0240. Vocals with flutes, announcements, ID, huaynos. (Paszkievicz, WI)

Radio Andina, 4995 at 0625 with music. (Martin, IL)

Radio Eco, 5097 at 0459 in SS. (Martin, IL)

Radio Cora, 4914 at 0401 in SS. (Martin, IL)

POLAND—Polish Radio, 6000 at 2047 with interview. (Jeffery, NY)

PORTUGAL—RFE/RL on 15370 at 1640 in RR. News item about Chechnya. (Pappas, SD)

Radio Portugal, 9570 at 0230 with stamp corner. (Pellicciari, CT)

RUSSIA—Voice of Russia, 7105 at 0220 with Commonwealth update. (Pellicciari, CT) 7150 at 2100 with ID, news. (Dybka, TN) 2200 with world service. (Fox, NC) 13640 at 2320. (Larison, NE)

Golos Rossi, 15290 at 0928 in RR. (Pappas, NY)

SAUDI ARABIA—BSKSA, 9870 in AA at 1800. (Pellicciari, CT)

SOUTH AFRICA—Channel Africa, 11725 at 0508 in FF with IDs and music. (Martin, IL)

SABC, 4810 at 0200 w/music, news. (Martin, IL)

Radio Oranje, 7270 at 0511 with cigarette and tire commercials. (Dybka, TN) (May have gone off the air by now, editor)

SPAIN—Radio Exterior, 6055 in SS and 9540 in EE. (Pellicciari, CT) 9540 at 0035 with sports news, ID. "Cultural Encounters." (Zamora, NM) 0522. (Martin, IL)

SWEDEN—Radio Sweden, 6195 at 0230 with news. (Pellicciari, CT) 11650 at 1435 with "In Touch with Stockholm." Off at 1500. (Zamora, NM)

SWITZERLAND—Swiss Radio Int'l, 6135 at 0100. (Fox, NC) 9885 at 0105. (Larison, NE) 9905 at 0030 with IS, ID with frequencies for Central America, time check and into GG. (Zamora, NM)

TAHITI—Radio Tahiti, 15169 at 0759 in FF. (Martin, IL)

TAIWAN—Voice of Free China, via WYFR at 0302 on 5950, news followed by Chinese classical music. (Wilden, IN)

THAILAND—Radio Thailand, 7145 at 1300 sign on with IS and IS "This is HSK9, Radio Thailand World Service broadcasting from Bangkok.." and into JJ program, then into Mandarin at 1315. (Zamora, NM)

TOGO—Radio Kara, 3222 at 2245 in FF. (Martin, IL)

Rdf. Togolaise, Lome, 5047 at 0622 in FF. (Martin, IL)

TURKEY—Voice of Turkey, 9445 at 2300. (Larison, NE)

UGANDA—Radio Uganda, 4976 at 0410 with news, commercials, music. (Martin, IL)

UKRAINE—Radio Ukraine Int'l, 9810 at 0102 with news, ID, music program. (Dybka, TN)

VATICAN—Vatican Radio, 7305 at 0310 with IS and sign off. (Wilden, IN)

VENEZUELA—Ecos del Torbes, 4980, at 1048 in SS with IDs at 1050, 1052. (Pappas, SD) 0140; 0340. (Pellicciari, CT; Martin, IL)

VIETNAM—Voice of Vietnam, 9840 at 2220. (Larison, NE)

YUGOSLAVIA—Radio Yugoslavia, 6190 at 0211 in EE. (Dybka, TN)

ZAMBIA—Christian Voice, 4965 at 0423-0450 with test, ID, Christian contemporary music, address, jingle, contest and program previews. Also announced 6065 and 7250. (Paszkievicz, WI)

And that does it! Raise your glass, tip your hat, click your heels in appreciation to the following who came through for you this month:

Jill Dybka, Nashville, TN; Bjorn F. Vaage, Granada Hills, CA; Dave Jeffery, Niagara Falls, NY; Steve Larison, Holdrege, NE; Tim Daniels, Jackson, NJ; Marina Pappas, Huron, SD; Richard Klingman, Mt. Upton, NY; Trevor Fletcher, Vancouver, BC; Clifford Fox, Hiddenite, NC; Steve Pellicciari, Norwalk, CT; Sheryl Paszkiewicz, Manitowoc, WI; Larry R. Zamora, Alamogordo, NM; Sue Wilden, Columbus, IN; Lisa Martin, Zeigler, IL.

Thanks to each of you!

Until next month—good listening!

SCANNING VHF/UHF

BY CHUCK GYSI, N2DUP

MONITORING THE 30 TO 900 MHz "ACTION" BANDS

We're right in the thick of the hot scanning season. The summer is the best time for scanning action. Nothing compares to listening to urban police departments on a hot summer night as officers hop from one call to another.

Not only the routine police channels become active, but also those frequencies associated with summertime activities. For instance, if you live near an amusement park, you can hear all the action as park patrons crowd through the admission gates during nice summer days. Likewise, park rangers in city, county, state, and federal park areas become busy controlling crowds and troublemakers on hot summer days.

Use the search function on your scanner and explore those active channels that may be in use only during the "outside" months of June, July and August. If you like listening to business or special emergency frequencies, here's a tip: School buses aren't using these channels during the summer months. Remember, you may find new users on these frequencies if you don't have to monitor school buses!

Windy City Monitoring

An anonymous reader from the Chicago area says he's been a *POP'COMM* subscriber for many years and enjoys the magazine because it always provides him with useful data and scanning perspectives.

He says he has used a special technique for scanning Chicago police and he's been keeping a bank programmed in this method ever since he learned of it. Here is how he takes into consideration of programming the scanner and why he does it as such:

The city of Chicago is divided into 25 police districts. Primary dispatch frequencies are shared by two police districts that usually are adjacent. The exception to this is District 3, which has a dispatch frequency all to itself. Each primary dispatch frequency is called a radio "zone" and is numbered one through 13. The first two numbers of a given unit designator tell which district the unit is in. For example, Unit 2514 would be a unit of District 25.

There also are frequencies that virtually all police units have the capability to monitor. These are "citywide" channels and, as the name implies, make the listener aware that the forthcoming radio traffic is intended for all units to hear, no matter where they happen to be.

One scanning and programming method that some listeners believe might simplify matters a bit and avoid the scanner from stopping on an active frequency that contains routine radio traffic (and preventing hearing something of interest that may be



During the hot summer months, the VHF marine frequencies often come alive in many areas of the nation. Scan the 156.200 to 157.200 MHz region for most boating action.



Wherever families congregate, you are bound to find someone using UHF handheld radios on GMRS frequencies.

happening on another frequency) is as follows: If your scanner contains at least 20 channels, program channels 1 through 13 with the corresponding radio zone numbers. Channel 1 would be programmed with the frequency of Zone 1, Channel 2 with Zone 2, etc. Channels 14 through 20 would be programmed with the citywide frequencies.

Then, lockout channels 1 through 13. By doing this, you are only checking and stopping on active citywide frequencies while scanning. On the citywide channels, you may hear something like: "Units on

citywide, report of shots fired, man down, at (address or intersection), this is the Fifth District, Zone 9 radio." If you wish to hear the radio traffic of the responding units, you would only have to manually go directly to channel 9 and just listen there until you've heard what you want to know.

One could, of course, modify this to suit personal preferences. If you want to keep track of all activity constantly, within a particular district or districts, you might want to "unlock" the channel containing the zone number for the district of interest. If

your scanner has a priority function, you could still leave the channel "locked out" and just make the channel number of importance a "priority" channel, then engage the priority function.

Here's a list of Chicago Police Department primary frequencies:

1. 460.475 Zone 1 (Districts 16 and 17)
2. 460.050 Zone 2 (Districts 19 and 23)
3. 460.225 Zone 3 (Districts 13 and 14)
4. 460.150 Zone 4 (Districts 1 and 18)
5. 460.500 Zone 5 (Districts 2 and 21)
6. 460.400 Zone 6 (Districts 7 and 8)
7. 460.075 Zone 7 (District 3 alone)
8. 460.200 Zone 8 (Districts 4 and 6)
9. 460.025 Zone 9 (Districts 5 and 22)
10. 460.100 Zone 10 (Districts 10 and 11)
11. 460.375 Zone 11 (Districts 20 and 24)
12. 460.425 Zone 12 (Districts 15 and 25)
13. 460.450 Zone 13 (Districts 9 and 12)
14. 460.125 Citywide 1 (traffic, gangs)
15. 460.175 Citywide 2 (detectives, tactical)
16. 460.275 Citywide 3 (emergency messages)
17. 460.325 Citywide 4 (youth, evidence technicians)
18. 460.350 Citywide 5 (special events)
19. 460.250 Citywide 6
20. 460.300 Citywide 7 (command, phone patch)

The Chicago Police Department also utilizes additional frequencies including: 154.650, 154.740, 154.800, 154.830, 155.850, 155.970, 156.000, 158.730, 158.850, 158.880, 159.030, 856.9375,

857.9375, 858.9375, 859.9375, 860.9375.

(Note: The 800 frequencies are trunked.)

The anonymous reader who sent in this great listening tip thought that perhaps this method of monitoring Chicago police might be beneficial to listeners in the Chicago area. This trick will work in any metro area that has frequencies set up in a similar fashion. It's a great method to monitor all the hot action without having to listen to activities that aren't too exciting (like car stops, etc.).

Restoring Cellular

One of the questions I receive the most for this column is how to restore deleted cellular frequencies from a scanner. Regardless of what the law says about eavesdropping on cellular, many still want to be able to access the 869-894 MHz band on their mobile or handheld scanners.

On some scanners, the operation is simple to carry out. However, I caution those who have never held a soldering iron before that the time to learn is not when the guts of your radio are sprawled out across a desk. You'd be better off learning how to solder on an old transistor radio and leave the scanner job to someone more experienced or a neighborhood ham who would be willing to oblige.

Each scanner that can be modified for cellular reception (and that means that some *cannot* be modified) has a method

Seeker 800

800mHz Handheld Gain!

Finally there's a Duck with real gain for the 800 mHz band! Even 1/4 wave tuned antennas can't come close to matching Seeker 800's performance. The secret is Seeker 800's patented, 1/2 wave, ground independent, commercial quality design. Significantly improves signal reception on handheld scanners, counters, & cell phones! Only 11.75 inches long! Connects to a standard BNC antenna mount.



only \$37.99

plus \$5.49 S&H

1-800-950-WARE

Write for a FREE catalog (no calls please)

RADIOWARE
PO Box 1478 Westford MA 01886
(508) 452-5555

CIRCLE 86 ON READER SERVICE CARD

1995

Bearcat

RADIO CLUB & National Scanning

CONVENTION

THREE DAYS OF SCANNING EXCITEMENT

JULY 14, 15 & 16

LANCASTER HOST RESORT

Registration ONLY \$10 in Advance

\$15 at the Door

Demonstrations

Seminars

Startek Frequency
Counters



Exhibitors

Speakers

Radio Shack
Much More!

Call Now for Show Reservations

1-800-423-1331

Use your Visa, Mastercard or Discover

Or mail your check or money order for \$10 to:

National Scanning, Box 360, Wagontown, PA 19376

For room reservations call the Lancaster Host Resort

1-800-233-0121

AR8000 Interface

Computer Interface for the AR8000

- ▲ Low Power, powered by your serial port
- ▲ No Drain on the batteries in the radio
- ▲ Light weight, perfect for Laptop use
- ▲ As small as a DB-25 Connector
- ▲ Hi-Tech Surface mount design for reliability
- ▲ 100% Shielded cable to receiver for reduced interference
- ▲ PC Software included for Windows and DOS
- ▲ Manual included
- ▲ Detailed Programmers documentation available
- ▲ Designed and Manufactured in the USA
- ▲ Optional 100% shield computer cable from AR8000INF to computer for reduced interference

Unlike some of the European devices sold today, this unit is smaller, lighter, and makes no power demands on your receiver. With the extra shielding and smaller size there is less chance of additional interference leaking into your radio. The AR8000INF is also the only interface that is upgradeable for use with the optional Tape recorder controller due first quarter '95.



Electronic Distributors Corp.

325 Mill St. Vienna, VA. 22180

Phone: (703)-938-8105 • FAX: (703)-938-4525

Available at your favorite dealer.



NEW
PORTABLE
SATELLITE ANTENNA



Complete
2' KU Band System

Introductory Offer \$389.95
plus shipping & handling

For **FREE** information package and pricing of other products

• **Call 219-236-5776** •



Prices & specifications subject to change without notice.

R.C. Distributing Company
PO Box 552 • South Bend, IN 46624

CIRCLE 72 ON READER SERVICE CARD

that generally works only for that scanner. So, if I were to tell you how to modify a Uniden Bearcat 200XLT scanner, that doesn't mean that the same procedure would work for a Uniden Bearcat 2500-XLT, for instance.

If you are sincerely interested in restoring the cellular bands to a new scanner, you should ask about the procedure from the business you purchased your scanner from. They may be willing to mail you instructions to help you accomplish the task.

If you can't get your hands on a hot sheet to tell you how to make the mod, you should consider one of the several modification books that have been published and are available from several of the advertisers in *POP'COMM*. These books will give you the information needed to make the change to your scanner.

It should be noted, too, that while the procedure may work on a particular model, there may be changes to the cellular modification depending on the model's serial number. These modification books generally offer this information.

In addition, if you are wired, many computer bulletin boards and online services, as well as Internet FTP sites such as oak.oakland.edu, offer modification files for download.

Scanning Around the Falls

Mike Iszak, VE3XLS, writes from Port

Colborne, Ontario, which is near Niagara Falls and Buffalo, New York. He passes along some frequencies of interest for his area, which should prove interesting to monitor if you find yourself near the falls: 142.230, Port Colborne and Welland police; 142.410, St. Catharine's police; 153.800, Niagara Region Fire Department F1; 153.770, Niagara Region Fire Department F2; 169.080, Port Colborne Works Department; 170.280, Augustine School Bus lines; 147.300, VE3WCR ham repeater; 460.425 and 460.075, Buffalo police; 155.130, Niagara Regional Ambulance dispatch; 152.135, Niagara Regional Paramedics (ambulance to hospital); 141.690, Ontario Provincial Police (CTCSS tone decoder required because of constant transmissions); 160.935, CN Rail dispatch; 161.415, CN Rail end-to-end.

Mike uses a Realistic Pro-42 portable, a Pro-2032 base and a Pro-2025 mobile, and monitors the 147.300 VE3WCR repeater.

Send 'Em In

What are your favorite frequencies? Do you have any scanner-related questions? Do you have any listening tips worth passing along to your fellow readers? How about sending in a photo of your listening post or antenna farm? Write to: Chuck Gysi, N2DUP, Scanning VHF/UHF, Popular Communications, 76 N. Broadway, Hicksville, N.Y. 11801-2909, or e-mail to POPCOMM@aol.com via the Internet. ■

SPECTRUM by PerCon
Frequency Database CDROM
For DOS / WIN / MAC

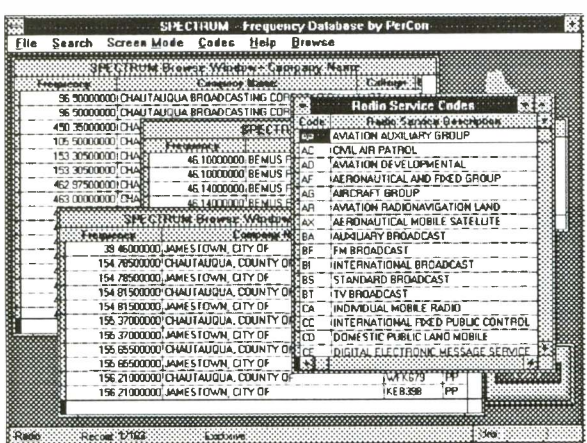

SPECTRUM is a frequency database with over 3 million FCC licenses. Search, Browse, Export and Print by Callsign, Frequency, Name, City, RS Code and County. Easy! Easy! New! Ham Callsign with Open Repeater CDROM - \$19.95

\$29.95

For More Information
CALL NOW!

PerCon Corporation
4906 Maple Springs / Ellery Rd.
Bemus Point, NY 14712
(716) 386-6015 (716) 386-6013 FAX

Shipping for UPS
Blue is \$7.50

CIRCLE 68 ON READER SERVICE CARD

ICOM™ IC-R9000
Slave Receiver(s) Frequency Hand-Off

The DELTACOMM™ I-9000 (1-2000 MHz) communication manager and your MS-DOS computer gives you a custom interface integrated with optimized software that will not just control but will maximize the potential of your R9000. Here are a few (there are many more) examples of the advanced features DELTACOMM™ I-9000 has to offer.

- ★ Multiple slave receiver frequency hand-off. ★
- Database switching control for up to eight (8) antennas.
- CYBERSCAN™ for systems employing frequency hopping techniques.
- Spectrum log at speeds in excess of 2100* channels/minute.
- Characterize receiver with birdie log function. ★
- ★ Load a 100 channel memory bank in 14 seconds. ★
- Custom dual squelch detection interface for optimized speed.
- Priority channel sampled every 2.5 seconds. ★
- ★ Selective control of tape recording by channel number. ★

Programmable signal strength threshold limits allow selective monitoring.

DELTA COMM™ I-9000 communication manager comes complete with Delta Research custom (CI-V) communication interface, UL listed power supply, manual and receiver interface cable for \$499.00 + \$10.00 (U.S.) or \$30.00 (foreign) S&H. For additional information on DELTACOMM™ communication managers for ICOM™ R7000, R7100, R71A, R72 and IC735, contact us. *Performance is proportional to video card, type of computer (286 or faster) and receiver squelch detection method.

Master Card **Delta Research** **AMERICAN EXPRESS**
Box 13677 | Wauwatosa, WI 53213 | FAX/Phone (414) 353-4567

CIRCLE 57 ON READER SERVICE CARD

PIRATES DEN

BY EDWARD TEACH

FOCUS ON FREE RADIO BROADCASTING

The word I'm getting is that activity on the pirate radio frequencies has dropped off in recent months, possibly due to current FCC activity. Several operators have been cited by the Feds of late, so it's not hard to figure that would create a little timidity. Or it could simply be one of those occasional "natural" downturns in activity, but I tend to doubt it. Anyway, let's see what's in the file this month.

George Roberts, of Pennsylvania caught Black Rider Radio on 6955 lower sideband at 0200, with a wide mix of music—everything from jazz to hillbilly. This apparently new station didn't announce any kind of QSL mail drop, at least George didn't note anything up to their sign off at 0230. Anyone have an address for this?

Solid Rock Radio was heard by Don Sebesky, of North Carolina at 0130 on 7415 upper sideband airing some kind of radio drama, but signals were poor and Don says he couldn't make out much of the story.

Don also had Radio USA at 0320 on 6955 with host Mr. Blue Sky and heavy rock, an ad for 3-K Laboratories, plugs for t-shirts, mentions of several frequencies often used by pirate stations.

Radio Is Not Radio—Jack Sheldon, in Michigan snagged this one on 6955 upper sideband at 0255 with computer-voiced ID "The Real Radio is Not Radio does not QSL" and "Radio USA is not Radio USA." Also a list of people who were "not" other people. "You could get a headache trying to figure this out," says Jack. Indeed. (By the way, George Roberts is not Jack Sheldon and did not report this station and both did not report this station!)

Rock of North America—RKNA—was heard by Sebesky at 2341 on 6956 upper sideband, hosted by "The Old Western Fella" who played several rock numbers, mentioned one or two other pirate radio stations and gave the Wellsville mail drop address. Also mentioned something about a laser powered power supply.

Up Against the Wall Radio was another Roberts logging. This was heard on 6957 at 0205, carrying rock tunes and talking about the end of the world "as we know it." Good level in Pennsylvania, but very little talk content.

WLIS—We Love Interval Signals is still going strong. It was heard by Roberts on 7415 to 0400 sign off but being QRM'd by The Real Radio USA. Radio Animal was the host, as usual. He announced the Blue Ridge Summit address for QSL reports.

Voice of the Unknown Monkey Spanker was found on 6996 upper sideband at 0632 with hosts "Uncle Spanky" and "Harry Palms." Included a song called

NORTH AMERICAN PIRATE RELAY SERVICE

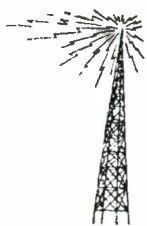

TO: Duane Vandenburg

QSL# 34 PROGRAM: TEST

TIME: 0135 UTC DATE: 23 Jan 93

FREQ: 7415 kHz POWER: 100 watts

OUR MOTTO: "Excellence in Free Radio Programming".

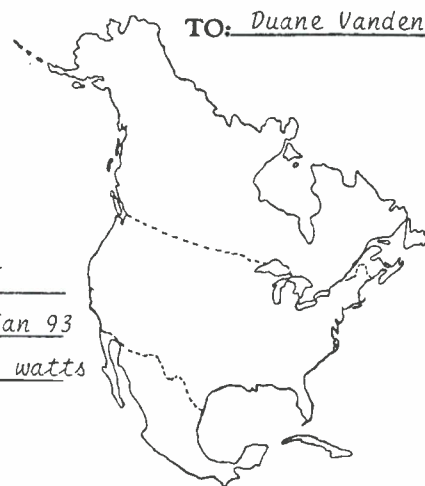

Duane Vandenburg, of Wisconsin got this early QSL from the North American Pirate Relay Service.

"Spanking the Monkey for Free Radio" and dedicated the program to "famous monkey spankers," including yours truly! Hey, I've never even met a monkey—and didn't care for the group very much, either!

Voice of Laryngitis on 6955 upper sideband was noted at 0131 by Bud McPowell in Georgia. They featured "Cowboy Stan Huxley" and a number of songs and comments not in very good taste. Off at 0209.

Radio Free Massachusetts was logged by Sebesky on 9655 upper sideband at 0545. Various pop/rock numbers and host H.V. Short saying it was a test transmission. Also IDs in French, as well as English.

I get two or three letters each month from listeners who are new to the pirate chasing scene and who invariably ask the same basic questions—where and when do you look for them, "why haven't I been able to hear one yet?," and how to QSL them once they have been heard. Obviously I don't have the space to cover the answers to such questions. The answers, however, can be found in the annual *Pirate Radio Directory*, by Andrew Yoder and George Zeller (\$12.95 plus \$2 s/h from Tiare Publications). Zeller's excellent introduction to pirate radio answers all your questions, and covers all the bases.

Michael Forinash, of South Dakota wonders about something called "Full Disclosure," which he heard apparently being relayed by WWCR. This is a commercial shortwave program, Michael, paid for by the program sponsor or producer. Some of these program names do sound like a

tag belonging to a real pirate station. Not so is the case, though.

Once again, a reminder that I welcome your logging reports and other pirate information whenever you have material you can send. Join the of the pirates and contribute as often as you can! Thanks. I also need copies of QSLs for use as illustrations. Your help is very much appreciated!

Before closing this month, apologies to Duane Vandenburg, of Wisconsin, whom I renamed "Dave" in the March issue. Sorry, Duane!

I'll be back next month with more pirate radio logs and information. ■



GPS and Radio Location

Most of you have heard about the satellite navigation system that is now in place. This constellation of satellites is known as GPS, which stands for Global Positioning System. GPS first came to the attention of the public in a big way during Operation Desert Storm. Troops in the flat desert used small portable GPS units to determine their exact location. Since the war, GPS has taken the country by storm.

GPS satellites orbit the earth twice every day, transmitting exact time and position information. This information relates to latitude, longitude, and altitude. With a portable GPS receiver, the exact position anywhere on earth can be determined by the user. This information, which gave the troops their position in the desert, cannot be used by civilians in many different ways.

When fully operational, the GPS satellite system will consist of 21 working satellites and three orbiting spare satellites. Operating 11,000 miles above the earth, these satellites will send signals to users below giving them two dimensional and a three dimensional positioning information. Although the Department of Defense has densensed the system slightly for obvious reasons, the current GPS satellites can still give you, the civilian user, your exact position in longitude and latitude within just a few feet. It is very accurate, even in this densensed operating condition.

The basis of Global Positioning System technology is precise time and position information. By using atomic clocks, which are accurate to within one second every 70,000 years, for time information and location data which is programmed into the satellite, the satellite sends out a continuous signal, which consists specifically of this time and position information. On the ground, the GPS unit receives these signals, and by calculating the distance between the user and each satellite, it determines the exact position on the earth's surface. It takes a minimum of three satellites to get a position fix. Four satellite signals are desired for optimum accuracy. And, reception of more than three make the position fix even more exact. By using the calculations of at least three satellites, an algorithm computation takes place within the GPS unit, and a position fix can be determined.

Initially, positions were displayed in longitude and latitude only on the face of most GPS units. With the improvement of GPS units, they include much more than just

longitude and latitude displays. Map interfaces now show LED mapping information, most tailored for marine and aviation use. The FAA has recently approved instrument approaches to airports during instrument flying weather using published GPS approach charts. The use of GPS information is certainly not limited to aviation and marine users.

GPS units depend on at least three satellite signals to give a two dimensional fix or display. Four satellite signals are required for the much more desired three dimensional position fix. The FAA GPS instrument approach requirements depend on four signals for the equipment to operate properly.

Each satellite in the 21-satellite system broadcasts two different signals. One is known as the Standard Positioning Service or SPS. This system is for civilian use worldwide. The other system is known as the Precise Positioning Service or PPS. The PPS system is the very exact military system. The SPS system gives the worldwide user an accuracy of up to 25 meters. A meter is 39.37 inches, so 25 meters equals about 85 feet. Because the Department of Defense doesn't feel civilian users need much more accuracy than that, the SPS signals are subjected to SA, Selective Availability interference. When engaged, SA enters random errors into the data stream transmitted by the satellites. When SA is engaged, SPS signal accuracy can be reduced to an error of 100 meters or 328 feet. This is desired in the event there is a military action in progress somewhere in the world, and unfriendly forces are trying to use the GPS system to their advantage.

By using a technique called Differential Global Position System or DGPS, the user can overcome the effects of SA induced interference and increase the accuracy of the GPS unit. Briefly, here is a description of what happens when a GPS user induces DGPS. One GPS receiver is placed at a known location. The position information from this exact known location is used to calculate corrections which are applied to the position data transmitted by the satellites. This corrected information is then sent to other GPS units operating in the area. The resulting accuracy is then improved, through calculations to 10 to 15 meters, or about 40 feet.

Most GPS units on the market today sell for somewhere between \$400 and \$1600,

depending on the features, size, and mapping overlays available. These GPS systems are normally portable, and give the user positioning information, velocity, and navigation information. My GPS unit does not have a map overlay, however, it does provide me with position information and track and cross track information when navigating between two known points. Like most GPS units, my handheld has a bank of preprogrammed positions, mostly airports and navigation aids. There are also memory locations provided for me to enter a present location, destination location, and several waypoints along the way.

The use of GPS units is, of course, being utilized in commercial, private, and military aircraft and marine vessels. Others are joining the ranks of GPS users rapidly. Hams are using GPS units to display position information during mobile packet operations. Bus and cab companies are using interfaces with mobile radio to show bus and cab positions within a city. Avis is adding GPS mapping computers to some of their rental cars in a test program. Police are using small GPS units as tracking systems, and "tailing" a car is no longer necessary as GPS constantly sends out the criminals location. Some testing is being done at an even higher level. One example is a small transmitter which is disguised as a belt buckle, and given to an agent who is working on a drug undercover case. Eventually, GPS "bugs" will allow the tracking of just about anything, anywhere, as the technology gets better and sizes are reduced.

The opportunity to use GPS in military operations, civilian logistics support, law enforcement tracking, and in industry is endless. This is one of the most rapidly expanding fields of electronics today. Units are offering more and more features, and technology is offering improved mapping and smaller units. Car manufacturers will soon be offering a GPS mapping display on new cars. You can just follow the cursor to your desired location, as the map will move as your car reads the GPS signals and displays your location and that of your programmed destination.

To show you just how extensive this program is, the National Park Service is testing GPS units in the California desert to track and map the movement of tortoises. Airborne testing packs are being sent into the higher altitudes to allow for high altitude tracking of weather balloons. Ocean

Tap into secret Shortwave Signals

Turn mysterious signals into exciting text messages with this new MFJ MultiReader™

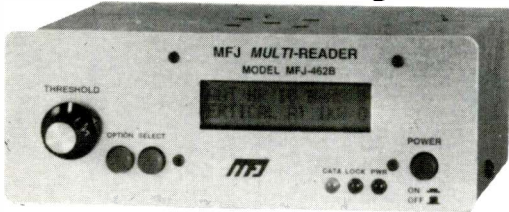

MFJ-462B Plug this self-contained MFJ MultiReader™ into your shortwave receiver's earphone jack.

Then watch mysterious chirps, whistles and buzzing sounds of RTTY, ASCII, CW and AMTOR turn into exciting text messages as they scroll across your easy-to-read LCD display.

You'll read interesting commercial, military, diplomatic, weather, aeronautical, maritime and amateur traffic... traffic your friends can't read -- unless they have a decoder.

Eavesdrop on the World

Eavesdrop on the world's press agencies transmitting *unedited* late breaking news in English -- China News in Taiwan, Tanjung Press in Serbia, Iraqi News in Iraq -- all on RTTY.

Super Active Antenna

"World Radio TV Handbook" says MFJ-1024 is a "first rate easy-to-operate active antenna... quiet... excellent dynamic range... good gain... low noise... broad frequency coverage."

Mount it outdoors away from electrical noise for maximum signal, minimum noise. Covers 50 KHz to 30 MHz.

Receives strong, clear signals from all over the world. 20dB attenuator, gain control, ON LED. Switch two receivers and aux. or active antenna. 6x3x5 in. remote has 54 inch whip, 50 ft. coax.

3x2x4 in. 12 VDC or 110 VAC with

\$129⁹⁵ MFJ-1024 MFJ-1312, \$12.95.

Indoor Active Antenna

MFJ-1020A **\$79⁹⁵**

Rival

outside long wires with this *tuned* indoor active antenna. "World Radio TV Handbook" says MFJ-1020 is a "fine value... fair price... best offering to date... performs very well indeed."

Tuned circuitry minimizes intermod, improves selectivity, reduces noise outside tuned band. Use as preselector with external antenna. Covers 0.3-30 MHz. Has Tune, Band, Gain, On/Off/Bypass Controls. Detachable telescoping whip, 5x2x6 in. Use 9 volt battery, 9-18 VDC or 110 VAC with MFJ-1312, \$12.95.

Compact Active Antenna

MFJ-1022

\$39⁹⁵

Plug this new compact MFJ all band active antenna into your general coverage receiver and you'll hear strong clear signals from all over the world from 300 KHz to 200 MHz -- including low, medium, shortwave and VHF bands.

Also improves scanner radio reception on VHF high and low bands.

Detachable 20 in. telescoping antenna. 9 volt battery or 110 VAC with MFJ-1312B, \$12.95. 3/16x1/4x4 in.

Copy RTTY weather stations from Antarctica, Mali, Congo and many others. Listen to military RTTY passing traffic from Panama, Cyprus, Peru, Capetown, London and others. Listen to hams, diplomatic, research, commercial and maritime RTTY.

Listen to maritime users, diplomats and amateurs send and receive error free messages using various forms of TOR (Telex-Over-Radio).

Monitor Morse code from hams, military, commercial, aeronautical, diplomatic, maritime -- from all over the world -- Australia, Russia, Hong Kong, Japan, Egypt, Norway, Israel, Africa.

Printer Monitors 24 Hours a Day

MFJ's exclusive *TelePrinterPort™* lets you monitor any station 24 hours a day by printing their transmissions your Epson compatible printer.

Printer cable, MFJ-5412, \$9.95.

MFJ MessageSaver™

You can save several pages of text in 8K of memory for re-reading or later review.

High Performance Modem

MFJ's high performance *phaseslock loop* modem consistently gives you solid copy -- even with weak signals buried in noise. New threshold control minimizes noise interference -- greatly

improves copy on CW and other modes.

Easy to use, tune and read

It's easy to use -- just push a button to select modes and features from a menu.

It's easy to tune -- a precision tuning indicator makes tuning your receiver easy for best copy.

It's easy to read -- the 2 line 16 character LCD display with contrast adjustment is mounted on a sloped front panel for easy reading.

Copies most standard shifts and speeds. Has MFJ AutoTrak™ Morse code speed tracking.

Use 12 VDC or use 110 VAC with MFJ-1312B AC adapter, \$12.95. 5/16x2/16x5/16 inches.

No Matter What Guarantee

You get MFJ's famous one year *No Matter What™* unconditional guarantee. That means we will repair or replace your MFJ MultiReader™ (at our option) no matter what for a full year.

Try it for 30 Days

Order an MFJ-462B MultiReader™ from MFJ and try it in your own setup -- compare it to any other product on the market regardless of price.

Then if you're not completely satisfied, simply return it within 30 days for a prompt and courteous refund (less shipping).

Order today and try it -- you'll be glad you did.

Receive Color News Photos, MFJ 12/24 Hour LCD Clocks, Weather Maps, RTTY, ASCII, Morse Code

MFJ-1214PC

\$149⁹⁵

Use your

computer and radio to receive and display *brilliant full color* FAX news photos and incredible WeFAX weather maps with all 16 gray levels. Also RTTY, ASCII and Morse code.

Animate weather maps. Display 10 global pictures simultaneously. Zoom any part of picture or map. Frequency manager lists over 900 FAX stations. Automatic picture capture and save.

Includes interface, easy-to-use menu driven software, cables, power supply, comprehensive manual and Jump-Start™ guide. Requires 286 or better computer with VGA monitor.

Super Hi-Q Loop™ Antenna

The Super Hi-Q MFJ-1782

Loop™ is a **\$269⁹⁵**

professional quality

remotely tuned 10-30

MHz high-Q antenna.

It's very quiet and has a very narrow

bandwidth that reduces receiver over-

loading and out-of-band interference.

High-Q Passive Preselector

MFJ-956

\$39⁹⁵

The

MFJ-956 is a

high-Q passive LC preselector that

lets you boost your favorite stations

while rejecting images, intermod and

other phantom signals. Covers 1.5-30

MHz. Has preselector bypass and

receiver grounded position. 2x3x4 in.

Mobile Scanner Ant.

Cellular MFJ-1824BB/BM

look-a-like. Covers **\$19⁹⁵**

25-1300 MHz. High

-est gain on 406-512 and

108-174 MHz, 19 in.

Magnet mount. MFJ-

1824BB has BNC/UHF

plug; MFJ-1824BM has

Motorola plug.

MFJ Antenna Matcher

MFJ-959B

\$89⁹⁵

Matches your antenna to your receiver so you get maximum signal and minimum loss.

Preamp with gain control boosts weak stations 10 times. 20 dB attenuator prevents overload.

Pushbuttons let you select 2 antennas and 2 receivers. Cover 1.6-30 MHz. 9x2x6 inches. Use 9-18 VDC or 110 VAC with MFJ-1312, \$12.95.

High-Gain Preselector

MFJ-1045C

\$69⁹⁵

High-gain, high-Q receiver preselector covers 1.8-54 MHz. Boost weak signals 10 times with low noise dual gate MOSFET. Reject out-of-band signals and images with high-Q tuned circuits. Pushbuttons let you select 2 antennas and 2 receivers. Dual coax and phono connectors. Use 9-18VDC or 110 VAC with MFJ-1312, \$12.95.

Dual Tunable Audio Filter

MFJ-752C Two separately tun-

able filters let you peak

desired signals and notch

out interference at the same time. You

can peak, notch, low or high pass

signals to eliminate heterodynes and

interference. Plugs between radio

and speaker or phones. 10x2x6 in.

Easy Up Antennas Book

How to build MFJ-38

and put up **\$16⁹⁵**

inexpensive, fully

tested wire antennas

using readily available

parts that'll bring

signals in like you've

never heard before.

Covers receiving antennas from

100 KHz to almost 1000 KHz.

Includes antennas for long, medium

and shortwave, utility, marine and

VHF/UHF services.



MFJ-107B **\$9⁹⁵**



MFJ-108B **\$19⁹⁵**

MFJ-105B **\$19⁹⁵**



MFJ-108B **\$19⁹⁵**

MFJ-105B **\$19⁹⁵**

MFJ-108B, dual clock displays

24 UTC and 12 hour local time

simultaneously. MFJ-107B, single

clock shows you 24 hour UTC time.

3 star rated by *Passport to World*

Band Radio!

MFJ-105B, accurate 24 hour

UTC quartz wall clock with large 10

inch face.

MFJ Antenna Switches

MFJ-1704

\$59⁹⁵



MFJ-1702B **\$21⁹⁵**

MFJ-1704 heavy duty antenna switch lets you select 4 antennas or ground them for static and lightning protection. Unused antennas automatically grounded. Replaceable lightning surge protection device. Good to 500 MHz. 60 dB isolation at 30 MHz.

MFJ-1702B for 2 antennas.

World Band Radio Kit

MFJ-8100K

\$59⁹⁵ kit

MFJ-8100W

\$79⁹⁵ wired

Build this *regenerative* shortwave

receiver kit and listen to shortwave

signals from all over the world with just

a 10 foot wire antenna.

Has RF stage, vernier reduction

drive, smooth regeneration, five bands.

Free MFJ Catalog

Write or Call toll free... 800-647-1800

Nearest Dealer/Orders: 800-647-1800

Technical Help: 800-647-TECH(8324)

• 1 year unconditional guarantee • 30 day money back

guarantee (less s/h) on orders from MFJ • FREE catalog

MFJ ENTERPRISES, INC.

Box 494, Miss. State, MS 39762

(601) 323-5869; 8-4:30 CST, Mon.-Fri.

FAX: (601) 323-6551; Add s/h

MFJ... making quality affordable

Prices and specifications subject to change © MFJ Enterprises, Inc.

POP'COMM's World Band Tuning Tips

July—1995

Freq.	Country/Station	UTC	Notes	Freq.	Country/Station	UTC	Notes
2460	R. Alvorada, Brazil	0000	PP	6040	R. Thailand	1130	
3220	HCJB, Ecuador	0430		6055	R. Rwandaise, Rwanda	0430	
3240	TWR, Swaziland	0300		6070	CFRX/CFRB, Canada	1200	
3250	R. Luz y Vida, Honduras	0100	SS	6082	R. San Gabriel, Bolivia	1000	SS
3260	Estereo Carrizal, Ecuador	0100	SS	6090	R. Bandeirantes, Brazil	0800	
3290	Namibia Broadcasting Svc	0345		6095	Vatican Radio	0250	
3300	R. Cultural, Guatemala	0300		6130	Lao National Radio, Laos	1200	
3310	Channel Africa, S. Africa	0357		6140	R. Nationale du Burundi	0300	FF
3325	R. Maya, Guatemala	1100	SS	6150	Caracol Colombia	0330	SS
3360	La Voz de Nahuala, Guatemala	0300	SS	6155	R. Austria Int'l	0700	
3366	GBC, Ghana	0600		6165	R. Netherlands, Bonaire relay	0100	
3375	R. Clube Dourados, Brazil	0100	PP	6165	Swiss Radio Int'l	0530	
3380	R. Chortis, Guatemala	0130	SS	6180	R. Nacional Amazonas, Brazil	0900	PP
3396	ZBC, Zimbabwe	0256	s/on	6200	R. Metropolis, Czech Rep.	2300	
3925	R. Tampa, Japan	1200	JJ	6250	R. Nacional Malabo, Eq. Guinea	0500	SS
4505	R. Horizonte, Peru	1030	SS	6260	V of Greece	0130	GG/EE
4633	R. Soledad, Peru	0330	SS	6570	Defense Forces Bcsting Svc, Myanmar	1130	Burmese
4753	RRI Ujung Pandang, Indonesia	1200	II	6627	LV de San Antonio, Peru	0300	SS
4760	ELWA, Liberia	0600		6870	R. Mogadishu, Somalia	0330	
4765	R. Rural, Brazil	0230	PP	7020	V of Broad Masses of Eritrea	0330	vern
4770	Centinela del Sur, Ecuador	0200	SS	7100	VOIRI, Iran	0030	
4775	R. Tarma, Peru	0100	SS	7125	RTV Guineenne, Guinea	0530	FF
4779v	R. Cultural Coatan, Guatemala	0030	vern	7150	Trans World R., Swaziland	0400	vern
4779v	R. Coatan, Guatemala	0030	SS	7150	R. Vilnius, Lithuania	0000	LL/EE
4785	R. Super de Ibaque, Colombia	0200	SS	7170	ORTS, Senegal	0700	FF
4810	R. 2000, S. Africa	0230	EE/Afk	7185	Channel Africa, S. Africa	0430	FF
4815	RTV Burkina, Burkina Faso	0700	FF	7210	Qatar Broadcasting Service	0245	AA
4820	R. Ukraine	0130	Ukrain	7305	Vatican Radio	0250	
4830	R. Tachira, Venezuela	0200	SS	7345	R. Prague, Czech Rep.	0700	
4840	R. Valera, Venezuela	0300	SS	7400	V of Vietnam, via Russia	0600	SS
4845	ORTM, Mauritania	0630	FF	7405	R. Ukraine	0000	
4865	La Voz del Cinaruco, Colombia	0600	SS	7475	RTT, Tunisia	0400	AA
4870	ORTB, Benin	0530	FF	8300	New Star Broadcasting Stn (cland)	1600	CC, irr.
4885	R. Clube do Para, Brazil	0000	PP	8473	Defense Forces Radio, Australia	1500	
4885	Ondas del Meta, Colombia	1000	SS	9200	R. Omdurman, Sudan	1800	
4890	NBC, Papua New Guinea	1100	EE	9420	Voice of Greece	0130	GG/EE
4915	GBC-Radio One, Ghana	0400		9435	Kol Israel	0500	
4920	R. Quito, Ecuador	0200	SS	9445	Voice of Turkey	2330	TT
4955	R. Nacional, Colombia	0300	SS	9475	R. Cairo, Egypt	0200	
4965	R. Alvorada, Brazil	0900	PP	9480	R. Voice of the Martyrs, Germany	1800	via Armenia
4980	Ecos del Torbes, Venezuela	0300	SS	9525	R. Marti, USA	0000	SS
4985	R. Brazil Central	0130	PP	9530	R. Singapore Int'l	1300	
5020	LV du Sahel, Niger	0500	FF	9535	R. Japan	1400	
5030	AWR, Costa Rica	0330	SS	9535	Swiss R. Int'l	1000	
5035	R. Centafricaine, Cent. Af. Rep.	0430	FF	9540	R. Espana Exterior, Spain	0100	
5047	RTV Togolaise, Togo	0500	FF	9560	R. Jordan	1600	
5055	TIFC, Costa Rica	0400		9570	R. Portugal	0230	
5055	RFO, French Guiana	0400	FF	9570	R. Romania Int'l	0230	
5075	Caracol Colombia	0300	SS	9575	Radio Medi Un, Morocco	0030	FF
5454	R. Alianza, Ecuador	1045 ^v	ss	9580	R. Tirana, Albania	0230	
5910	R. Denmark, via Norway	0230	DD	9580	Africa No. One, Gabon	2200	FF
5940	V of Vietnam, via Russia	0400		9585	Channel Africa	0254	s/on
5960	R. Japan via Canada	0100		9600	HCJB, Ecuador	0730	
5975	BBC via Antigua	0100		9605	UAE Radio, Abu Dhabi	2300	
6000	R. Havana Cuba	0130		9605	Vatican Radio	0330	SS
6005	R. Reloj, Costa Rica	0200	SS	9610	BBC relay, S. Africa	0230	
6015	R. Austria Int'l, via Canada	0530		9620	R. Dniester Int'l, Moldova	2130	
6020	R. Netherlands	0100	DD	9645	R. Bandeirantes, Brazil	0500	PP

Freq.	Country/Station	UTC	Notes	Freq.	Country/Station	UTC	Notes
9650	R. Korea, S. Korea, via Canada	1130		13590	R. Pakistan	1600	
9655	R. New Zealand Int'l	1300		13605	R. Australia	1100	
9670	Deutsche Welle via Portugal	0100		13635	Swiss R. Int'l, via Fr. Guiana	0030	
9690	R. Nacional, Argentina	2300		13670	R. Vlanderen Int'l, Belgium	1400	
9690	China Radio Int'l, via Spain	0300		13675	UAE Radio, Dubai	1630	
9700	R. Bulgaria	0000		13680v	R. Iraq Int'l	1200	AA,irr
9700	R. New Zealand Int'l	0800		13730v	R. Korea Int'l	1400	
9705	R. Portugal	0230		13750	AWR, Costa Rica	1200	s/on
9710	China Radio Int'l	0000		13770	Monitor Radio	2000	
9725	RAI, Italy	0100		13785	R. Tashkent, Uzbekistan	1200	
9735	R. Nacional, Paraguay	0100	SS	13830	Croatian Radio	1600	Croat
9745	HCJB, Ecuador	0730		13860	INBS, Iceland	2300	Icelandic
9755	Radio Canada Int'l	0000		15009	V of Vietnam	1330	
9765	Voice of the Mediterranean, Malta	0600		15050	RFPI, Costa Rica	1600	
9770	V of UAE, Abu Dhabi	2300		15084	VOIRI, Iran	2200	Farsi
9780	Yemini Republic Radio	0300		15095	R. Damascus, Syria	2030	
9810	FEBA, Seychelles	1530		15105	R. Moscow, Russia	1500	
9815	Radio Havana Cuba	0200	USB	15140	R. Veritas, Philippines	1530	
9825	R. Kiribati	0600		15168	R. Tahiti	0300	FF/TT
9830	KHBN, Oalau	1200		15175	BSKSA, Saudi Arabia	1200	AA
9840	V of Vietnam	1330		15180	R. Ukraine	0130	
9860	Swiss R. Int'l, via Fr. Guiana	0400		15220	Golos Rossii	1200	RR
9860	R. Sweden	1100	Swed	15235	V of Great Homeland, Libya	2000	AA
9870	R. Austria Int'l	0130		15240	Channel Africa, S. Africa	1600	
9900	R. Cairo, Egypt	2230		15240	R. Sweden	1330	
9960	Wings of Hope, Lebanon	1530		15270	Deutsche Welle via Rwanda	2055	s/on
9977	R. Pyongyang, N. Korea	1100		15270	HCJB, Ecuador	1930	
10058	V of Vietnam	0000	VV	15315	R. Moldova Int'l	1430	
11550	Family Radio, via Taiwan	1300		15325	R. Canada Int'l	2100	
11560	R. Cairo, Egypt	1400	AA	15345	RTV Marocaine, Morocco	1800	AA
11580	Trans World Radio, Guam	1500		15345	RAE, Argentina	0200	SS
11610	Ntl R of Saharan Arab Dem. Rep (clan)	2230	AA	15395	UAE Radio, Dubai	1330	
11620	All India Radio	1100		15400	R. Finland Int'l	1330	
11630	Croatian Radio	1600	Croat	15430	Radio Japan	2300	
11650	R. Sweden	1330		15435	V of the Great Homeland, Libya	1645	s/on
11650	KFBS, Saipan, No. Marianas	1300	RR	15445	Radiobras, Brazil	1200	
11670	R. France Int'l, via Fr. Guiana	0130	SS	15475	R. Atlantika, Russia	1300	RR, Tu-Fr
11690	FEBC, Philippines	1200	VV	15475	Africa Number One, Gabon	2100	FF
11705	R. Nova Visao, Brazil	0000	PP	15490	HCJB, Ecuador	1700	
11710	RAE, Argentina	0200		15530	R. Australia	2200	II
11715	China R. Int'l, via Mali	0300		15555	R. Pakistan	1600	
11715	R. Korea, S. Korea, via Canada	1030		15565	R. Australia	1200	
11720	R. Bulgaria	2100		15570	All India Radio	1200	
11740	All India Radio	1530	s/on	15575	R. Korea, S. Korea	0030	
11750	Qatar Broadcasting Service	1330	AA	15590	Vatican Radio	1345	
11765	RAI, Italy, via Ascension Is.	0200	II	15615	Reshet Bet, Israel	2300	HH
11775	R. Espana Exterior, Spain	1900		15650	V of Greece	1400	GG/EE
11775	Central Broadcasting System, Taiwan	2300	CC	15675	R. Pakistan	1430	Urdu
11790	VOIRI, Iran	0030		15675	R. Copan Int'l, Honduras	2300	SS
11800	R. Australia	1300		15770	All India Radio	1200	vern
11805	VOA relay, Thailand	1230		17490	HCJB, Ecuador	1000	USB
11810	R. Jordan	0530	AA	17500	RTT, Tunisia	1330	AA
11825	R. Tirana, Albania	2200		17520	V of Greece	1430	GG/EE
11830	Vatican Radio	2250		17575	Kol Israel	1100	
11830	R. Romania Int'l	0400		17605	R. Netherlands via Bonaire	1830	
11845	R. Canada Int'l	2200		17620	R. France Int'l	1600	
11850	R. Norway Int'l	1200	Sun	17630	Africa No. One, Gabon	1430	FF
11870	FEBA, Seychelles	1500		17655	R. Netherlands via Bonaire	1830	
11885	UAE Radio, Abu Dhabi	2300		17670	Swiss Radio Int'l	1500	
11890	R. Oman	1430	AA	17740	R. Finland Int'l	1430	
11905	R. Thailand	0030		17745	R. Algiers, Algeria	1930	
11920	RTV Ivoirienne, Cote d'Ivoire	2000		17745	R. Tashkent, Uzbekistan	1200	
11925	HCJB, Ecuador	0600		17755	R. Espana Exterior, Spain	1630	SS
11955	R. Nacional, Angola	2200	PP	17775	R. Romania Int'l	1300	
11960	VOA via Greece	1800	AA	17810	R. Japan	2300	
11970	R. Havana Cuba	0030	SS	17820	R. Canada Int'l	1300	
11990	R. Kuwait	1800		17870	R. Sweden	1500	
11995	FEBA, Philippines	1300		17870	RAI, Italy	1730	II
12050	R. Cairo, Egypt	2100	AA	17895	Qatar Broadcasting Service	1400	AA
12085	R. Damascus, Syria	2030		17900	R. Portugal	2000	PP
12095	BBC, England	1300		17905	RFPI, Costa Rica	1900	USB
13460	Croatian (Hrvatska) Radio	1230		21455	HCJB, Ecuador	1330	

Popular Communications Goes "Online"

If you have access to Internet e-mail, then you can contact Popular Communications online! Plus, if you are a member of certain commercial online services, you may access some of our specific contact areas. For instance, you can submit contributions to our columns, ask a column author a question, or even submit a letter to "Mailbag." Be sure to specify the name of the column or author so we can quickly direct your message to the proper person. Also please include your complete street mailing address for our files. Here's how to find us:

America Online—Go to the Ham Radio Club (keyword: Ham Radio), click on "Message Center," and look for the Popular Communications area under the category, "Manufacturers, Dealers, & Vendors." E-mail to SCAN911 (POP'COMM Online representative).

CompuServe—E-mail only at this time; direct to Rich Moseson, 72127,745 (POP'COMM Online Coordinator) or John Dorr, 71301,424 (POP'COMM Marketing Director).

Genie—Move to page 345 (the Radio & Electronics Roundtable/Radio & Electronics Bulletin Board), then find Category 16 (Commercial Vendors—Books, Magazines, Videos, etc.) and Topic 3 (Popular Communications). E-mail to CQ.

Internet—E-mail only at this time; address to SCAN911@aol.com or CQ@genie.geis.com

buoy tracking is testing GPS to track ocean currents under adverse conditions. To improve GPS use for tracking purposes, Elk in Montana are being equipped with small GPS collars, replacing the small battery radio beeping units used in the past.

Global Positioning System units are being introduced to the nationwide trucking industry. Interstate trucks are being equipped with GPS units and small satellite transmitters. A system in the truck tracks the position, and sends a position report through a satellite link to the dispatch center. When a pickup order comes in, the dispatcher can quickly check the GPS mapping display, find the closest truck, and have the order picked up in a minimum of time.

There will soon be a GPS unit in your future. And, just think, with this system operating, you'll always know where you are, and how to get to your destination. The old saying of "you are never lost if you know where you came from and where you are going" will be out of date, as you will always know where you are—exactly.

(Permission granted to publish the attached photographs granted by Jim White, Public Relations Manager, Magellan Systems Corporation Inc., phone 909-394-5507)

Feel The Comfort Of Extended Operations With The IC-T21A!



Expand your coverage with a **FREE!** SMA/BNC Connector with every radio purchased (See your dealer for details on this limited time offer)

Backlit Keypad! with 4 selectable levels of control!

Maximum Comfort

Elastomer Construction — This special material provides a comfortable, positive grip. The compact design fits the natural curve of your fingers and hand—especially welcome during long operating times.

Backlit Keypad — Ample spacing between keys for positive, error free operation.

Large Display — Indicates 17 different functions, battery capacity and subband frequency.

Full Crossband Duplex Operation

Dual Band Receive Capability — Permits reception of another band (i.e.: 440 MHz on the IC-T21A).

Full Crossband Duplex Operation — Possible with the unique "whisper mode" microphone (standard) for telephone type QSO's

6 Hours Operating Time*

Low Power Consumption — Consumes only 8 mA while standing by.

Auto Power Control — Conserves the battery by monitoring the repeater signal strength and selecting the best matching output power from 5 levels (down to 15 mW).

Auto Low Power Function — Automatically selects 15 mW just before battery exhaustion so you can complete your QSO.

* 5.5 to 6 hours with 1:1.8 duty cycle (Tx high: RX:Standby)
Battery Capacity Indicator — Shows battery capacity.

New Scanning Standards

Ultra High Speed Scan — 3 to 4 times faster than most other handhelds (33 channels/sec., 12.5 memory ch./sec.)

Bonus Band — Can be scanned while the main band is being scanned (e.g.: 70 cm for the IC-T21A).

6 Priority Watch Modes — Check for other signals while operating on a VFO frequency.

Ultra-Convenient Repeater Operations

Subaudible Tone Scan — Detects, displays and programs the tone frequency into the VFO. Permits access to a repeater when you don't know the tone frequency.

Auto Repeater Function — Automatically activates repeater settings (duplex ON/OFF, duplex direction, tone encoder ON/OFF) when the operating frequency falls in the repeater output range.

Repeater Memory — Quickly recall settings of your last worked repeater (RPT-M key).

5 DTMF Memories — Automatically dial your favorite telephone numbers.

Selectable DTMF Transmission Speed — Adjust the IC-T21A/T41A to the capabilities of the repeater (5 cps, 2.5cps, 1.6 cps, 1 cps).

Powerful 6 W Output Power*

Our newly designed SC-1257 power module provides all the power necessary to reach fringe areas. Accepts 4-16 input.

*with a 13.5 VDC power source.

Innovative Memory Functions

114 Memory Channels — Store all repeater information.

Memory Select Channels — For quick access, up to 30 can be designated Memory Select Channels.

Memory Transfer — Quickly transfers a memory channel's contents to VFO. Useful for searching for signals near a memory channel.

EEPROM — Memory information is retained virtually forever.

And More!

* Includes Flexible Antenna, Belt Clip, handstrap, Rechargeable Ni-Cd Battery Pack and Charger

* Built-In Pager, Code Squelch, Pocket Beep & Tone Squelch

ICOM America, Inc. Corporate Headquarters

2380-116th Ave. N.E., Bellevue, WA 98004

©1994 ICOM America, Inc. The ICOM logo is a registered trademark of ICOM, Inc. All stated specifications are subject to change without notice or obligation. All ICOM radios significantly exceed FCC regulations limiting spurious emissions.

ICOM
Experience the Quality

Call our Brochure Hotline for FREE Literature on ICOM Radios: (206) 450-6088

CLANDESTINE COMMUNIQUE

WHAT'S NEW WITH THE CLANDESTINES

Activity has been noted again from The National Radio of the Saharan Democratic Republic, the station of the Polisario Front. The station is currently using 11610, with a broadcast in Arabic at 1800. Although the full schedule isn't known, the 1800 transmission should be relatively easy to pick up in much of North America. The Polisario Front wants independence for the Western Sahara (with Polisario governing, of course).

In a related development it seems that the Polisario Front's program, Voice of Free Sahara, is again being aired over Radio Algiers. It is back on at its former time of 2200 to 2300 on 9640, airing programming in Arabic and Spanish. Another Radio Algiers frequencies 15215 and 17745 have also been used for this program in the past, but neither is shown on the current schedule. That's unfortunate for us as the two higher frequencies offer more consistent reception.

The Voice of Free Tajikistan schedule includes daily broadcasts at 0300, 0600, 0900, and 1100 using frequencies 6875, 6890, and 7080, although it is possible that only the latter channel sees any activity. Each broadcast runs about 40 minutes, but the on-the-hour starting time reportedly varies by a considerable degree.

The Voice of Kashmir Freedom airs programs at 0230 to 0330 and 1430 to 1530 using 5300 upper sideband, 5750 AM mode and 6300 upper sideband. The station seeks the removal of Indian control over Kashmir and is thought to operate from inside Pakistan (this is hardly a very chancy guess!).

According to a writing found in clandestine broadcasting expert George Zeller's A*C*E column, a station known as La Voz de Guatemala Mayan is about to come on the air, based in northwest Guatemala, northeastern or north central Chiapas state, in Mexico. At the moment it isn't known if this will be on shortwave, medium wave, or both, although the impression is left that this is to be a real rubber band and paper clip affair, at least at the outset. Oddly, the operators of the station are aware of DXing and QSLs and will even try to present some DX programs. The operational hours are to be somewhere between 1200 and 1300, although perhaps not covering the complete hour. The station will speak on behalf of Frente Segundo.

A second station is also said to be in the offing—La Voz de Chiapas. In a later report George says his contact now reports that both of these stations have been active on shortwave (in the 7400 to 7500 range), operating from mobile transmitters in various parts of Mexico, Guatemala, and even Honduras. The broadcasts are supposed to be



The Polisario Front has resumed broadcasting on shortwave, over both its own facilities and with its program carried on Radio Algiers.

in both Mayan and English, and are the outgrowth of a growing trend toward "pan-Mayan" unity in the region. Well, we'll see! It all sounds plausible, but wouldn't we be overwhelmed with surprise if it all turn out to be a hoax!

In a (sort of) answer to a recent question—no, we don't know of any clandestine broadcasting activity associated with the recent mini-war between Ecuador and Peru. Has anyone seen any radio-related material regarding this conflict?

The Voice of Human Rights and Freedom for Iran current schedule is from 0230 to 0425 on 9380, 1630 to 1825 on 9270 and 11470, 0600 to 0645 on 15150, and from 1545 to 1625 on 9255. Reception reports can be sent to Manouchehr Ganji, 18 bis, rue Violet, 75017 Paris, France.

The Free Voice of Ethiopian Unity via Russian radio, has been noted from 1600 sign on, on 11945 with broadcasts in Amharic, with Voice of Russia programming before and after the hour-long broadcast. The schedule is Wednesday and Sunday only, not daily.

Colombian clandestine Radio Patria Libre continues to operate regularly. Your best shot at this one is probably at 1200 on or near 6260. The station tends to jump around from time to time, so if you don't hear it on 6260 check for a considerable distance above and below the frequency. Still no clues as to an address for this station. How many years has it been, now?

Cuba continues to jam some or all of the anti-Castro broadcasters. La Voz del CID, for one—noted on 6306 after 0600.

That'll do it for this month. Remember that your notes, loggings, comments, and other news and observations are very much welcome. Incidentally, it helps greatly if you keep your loggings entirely separate from "Listening Post" items as we approach these two columns in an entirely different and separate manner. We also need copies of any clandestine QSLs you may receive so we can let readers see what they look like. We do hope you'll check in with us now and then.

Until next month, good hunting! ■

GETTING STARTED AS A RADIO AMATEUR

AA: Amateurs Anonymous?

“Call Rick Palm at ARRL HQ. The League handles amateur rule violations. Have a nice day.”—FCC Field Office

This is what hams hear when they call FCC field offices to complain about other operators' poor on-the-air behavior—some of which is illegal, some not. When they telephone League HQ as suggested by the FCC, some are irritated to learn that there's an all-volunteer program, the Amateur Auxiliary to the FCC (AA), comprised of amateurs organized on several levels who must try to resolve the problem on a friendly, no-fault basis through negotiation and peer pressure before the FCC can be brought into the picture. Callers want criminals paraded before the community and summarily executed by firing squad to warn that “we don't tolerate this sort of thing in the pristine Amateur Radio service.”

So who's doing what about the problem? And what is “the problem?”

Let's go to the expert: ARRL Field Services Manager Rick Palm, K1CE, explains how the AA works, what it is, and what it isn't:

Enabled by legislation in 1982 and created by an ARRL/FCC agreement in 1984, the AA was designed to bring about better rules compliance by amateurs through voluntary means. The program was felt to be a natural extension of the long-standing tradition of self-determination in the amateur community (the popular term “self-policing” is a misnomer: Amateurs and AA members aren't policemen) and based on the Official Observer (OO) segment of the League's Field Organization. OOs had a long history of helping fellow amateurs with mostly technical problems involving signal quality.

The new program added the following dimension: Certified AA volunteers could, after exhausting all other reasonable means of resolving an on-the-air problem, participate in the evidence-gathering process that could lead to an FCC enforcement action. This would enable the FCC's Field Operations Bureau to effectively employ its shrinking resources in extreme cases worthy of prosecution.

Although the program shows measured success, it's been perceived a failure by many vocal amateurs who point to continuing problems on the bands. The AA program isn't perfect, but it's not fair to pin the blame on the shoulders of capable volunteers.

There are myths surrounding the AA

and the FCC, which have led to misperceptions among hams. Let's separate myth from reality:

Myth: *If the FCC signed an agreement with the ARRL allowing volunteer amateurs to enforce the rules, why aren't they doing it?*

Reality: The FCC never turned over any enforcement power to amateurs, nor would it be permitted to do so. The AA provides an unbiased forum for technical and operational advice to amateurs who are receptive. The task isn't to find fault, but to identify cause-and-effect, much of which isn't based on technical, but behavioral or social issues, and to find ways to solve problems on a voluntary basis. The mission isn't direct enforcement. AA volunteers are limited by statute to “the detection of improper Amateur Radio transmissions,” communication of such to the FCC, and issuing Advisory Notices.

Under carefully controlled conditions, AA volunteers may gather evidence and provide it to the FCC, which can be used in an enforcement action. But enforcement is a function reserved by the FCC.

Myth: *The FCC devotes a great deal of time to monitoring the Amateur Radio bands to enforce the rules in Part 97.*

Reality: Amateur Radio is a low priority at the FCC. It's not considered a “safety of life” service (the ARRL disagrees with this assessment) and the Commission's limited resources are devoted to what it considers more important services, such as public safety and air navigation/communication. The FCC has indicated that hams are largely on their own in keeping the spectrum in shape.

Myth: *The bands are a mess and Amateur Radio is going down the tubes. Idiot operators are communicating ethnic slurs, expletives, and all sorts of inappropriate and illegal language. They must be served with Notices of Violation and fines, and have their licenses revoked.*

Reality: First, most of the celebrated problems are generally confined to a couple of specific frequencies and a small handful of poor operators. The amount of discussion about this rare and unusual behavior makes it seem like this must be an enormous problem, but it's not really as bad as it sometimes seems. To most amateurs with more than a dozen years of experience, the bands are actually “cleaner” now than they were, say, in the 1970s.

Surprise! Most inappropriate communication is just that—inappropriate, but not illegal. It can be rude, crude, and offensive, but not actionable—it's constitutionally protected, free speech. You don't have to be a lawyer to understand that the First Amendment cuts for us in the liberty to express ourselves freely as members of polite society, and against us by protecting the same rights for those who express themselves outside of cultural norms and mores. And some argue that most of the language in question has become part of the fabric of our society, anyway.

Myth: *So obscenity and indecency are legal, or at least the FCC looks the other way, and apparently, so should we.*

Reality: Obscenity and indecency are complicated issues, and the judicial system has further muddied the waters. The courts have recently called into question the FCC's authority to enforce some of its rules concerning indecent language on a 24-hour basis. The FCC is reluctant to expend its limited resources in developing further cases in such an unsettled judicial/regulatory climate.

It boils down to this: What's truly actionable and what isn't? The League, the amateur community and perhaps even the FCC, don't have the answer to this question—yet. ARRL officials have met with the FCC to pin this down, and obtained a commitment to pursue the worst cases.

The League believes it's within the capability of the AA to document cases so egregious as to be deserving of aggressive enforcement, even in this uncertain climate. This is a major objective. (For a discussion of these issues, refer to the ARRL's *FCC Rule Book*).

Myth: *There is nothing we can do personally.*

Reality: Behavior that's inappropriate, but not illegal, or isn't so serious that anyone can reasonably expect the FCC to devote resources to its correction, must be addressed by amateurs themselves. The first step is that hams must not let the bad behavior drive out the good: Everyone who cares about Amateur Radio must maintain the highest possible standards when operating, even in the face of provocation. Second, hams must let other amateurs know, as politely as possible, that they expect them to observe the same standards. Third, amateurs must be realistic: Interference is a fact of life and most interference between hams is of the “no-fault” kind that's better

resolved by being flexible than by confrontation. Finally, amateurs must place greater emphasis on recognizing good operating, of which there are countless examples to be heard every day.

Behavior that's clearly illegal and repetitive, and deserving of FCC attention, should be referred to the local Official Observer Coordinator (OOC) for action. Contact your ARRL Section Manager or HQ for the name and address of your OOC.

Myth: Being an OO is a thankless job.

Reality: OOs observe operating practices that fill them with frustration. It's unavoidable in a program like this. But OOs experience a sense of satisfaction when they're able to call an undesirable situation to the attention of someone who honestly wasn't aware of it and is genuinely appreciative of the assistance.

If the OO truly understands his role—that he's an advisor/helper, not a policeman—he'll gain rewards. ARRL President George Wilson III, W4OYI, commended AA members for their competency, effectiveness and dedication, saying, "Each of us is aware of instances where the program has directly resulted in better operating conditions for all."

Myth: The AA deals with RFI and non-amateur intruders into our bands.

Reality: The program is restricted to deal only with on-the-air amateur interference and improper operation by amateurs in the amateur bands.

Myth: AA members are involved in gray areas of the rules.

Reality: OOs are advised to avoid hair-splitting and to deal only with clearly defined, black-and-white rule violations. They are further advised to steer clear of zealotry, even paranoia, about some regulations.

The AA must avoid giving the impression that it can cure the ills of the air. It's difficult for some amateurs to understand how to deal with advocates of "free thinking" noncompliance with gentlemen's agreements, and so forth. Nonconformists enjoy bringing the general amateur population to loggerheads. They feed on the ignorance of others; baiting, then harassing anyone they can. This leads to some of the messes occasionally heard on the bands. To expect the AA to solve such general problems isn't realistic.

Myth: Malicious interference occurs when someone transmits on top of someone else.

Reality: Malicious interference—the illegal type—exists only when the following conditions are met:

- 1) Two stations are in communication on a frequency.
- 2) Another station is transmitting on the same or an adjacent frequency.

3) The two original stations, noting that they can't maintain communication through the third station's transmissions, decide to move to another frequency.

4) When they move, the third station follows and commences interfering transmissions once again.

These conditions are critical to a determination that willful or malicious interference is present. Additionally, it must exist on a regular, repeated basis: No one can reasonably expect the FCC to act on a one-time, isolated event. Otherwise, as mentioned earlier, unintentional interference is

a fact of life on the amateur bands. No one can expect interference-free operation on today's congested bands.

Myth: OOs issue citations. Recipients are obligated to respond. They are the ham radio police.

Reality: OOs issue friendly, Advisory Notices to alert amateurs to possible equipment factors or operating practices that might have contributed to an apparent departure from a rule or the good amateur-practice standard. No reply is necessary.



World's Most Powerful CB and Amateur Mobile Antenna*

Lockheed Corp. Test Shows
Wilson 1000 CB Antenna Has
**58% More Gain Than The
K40 Antenna (on channel 40).**

In tests conducted by Lockheed Corporation, one of the world's largest Aerospace Companies, at their Rye Canyon Laboratory and Antenna Test Range, the Wilson 1000 was found to have 58% more power gain than the K40 Electronics Company, K40 CB Antenna. This means that the Wilson 1000 gives you 58% more gain on both transmit and receive. Now you can instantly increase your operating range by using a Wilson 1000.

**Guaranteed To Transmit and Receive
Farther Than Any Other Mobile
CB Antenna or Your Money Back**
New Design**

The Wilson 1000 higher gain performance is a result of new design developments that bring you the most powerful CB base loaded antenna available.

Why Wilson 1000 Performs Better

Many CB antennas lose more than 50% of the power put into them. The power is wasted as heat loss in the plastic inside the coil form and not radiated as radio waves.

We have designed a new coil form which suspends the coil in air and still retains the rigidity needed for support. This new design eliminates 95% of the dielectric losses. We feel that this new design is so unique that we have filed a patent application on it.

In addition, we use 10 Ga. silver plated wire to reduce resistive losses to a minimum.

In order to handle higher power for amateur use, we used the more efficient direct coupling method of matching, rather than the lossy capacitor coupling. With this method the Wilson 1000 will handle 3000 watts of power.

The Best You Can Buy

So far you have read about why the Wilson 1000 performs better, but it is also one of the most rugged antennas you can buy. It is made from high impact thermoplastics with ultraviolet protection. The threaded body mount and coil threads are stainless steel; the whip is tapered 17-7 ph. stainless steel. All of these reasons are why it is the best CB antenna on the market today, and we guarantee to you that it will outperform any CB antenna (K40, Formula 1, you name it) or your money back!

*Inductively base loaded antennas
**Call for details.

Lockheed - California Company

A Division of Lockheed Corporation
Burbank, California 91520

Aug. 21, 1987

Wilson Antenna Company Inc.
3 Sunset Way, Unit A-10
Green Valley Commerce Center
Henderson, Nevada 89015

Subject: Comparative Gain Testing of Citizen's Band Antennas
Ref: Rye Canyon Antenna Lab File #870529

We have completed relative gain measurements of your model 1000 antenna using the K-40 antenna as the reference. The test was conducted with the antennas mounted on a 16' ground plane with a separation of greater than 300' between the transmit and test antennas. The antennas were tuned by the standard VSWR method. The results of the test are tabulated below:

FREQUENCY (MHZ)	RELATIVE GAIN (dB)	RELATIVE POWER GAIN (%)
26.965	1.30	35
27.015	1.30	35
27.065	1.45	40
27.115	1.50	45
27.165	1.50	41
27.215	1.60	45
27.265	1.75	50
27.315	1.95	57
27.365	2.00	58
27.405	2.00	58

**58%
MORE
POWER GAIN
THAN THE
K40**

Individual test results may vary upon actual use.

CALL TODAY
TOLL FREE: 1-800-541-6116
FOR YOUR NEAREST DEALER
Wilson 1000

DEALERS Exclusive dealer areas still open

Roof Top Mount.....**59⁹⁵**
Trunk Lip Mount.....**69⁹⁵**
Magnetic Mount.....**79⁹⁵**
Little Wil.....**29⁹⁵**
Wilson 2000 Trucker.....**59⁹⁵**

Wilson
ANTENNA INC.
1181 GRIER DR., STE. A
LAS VEGAS, NV 89119

1991 Summary of Official Observer Activity

Category	Reports	% of total
Portions of signal out of band	472	27
Miscellaneous	214	12
Good guy	194	11
Chirp	161	9
Improper ID	148	8
Broad signal	127	7
Causing interference	104	6
Hum	99	5
Language	95	5
Key clicks	58	3
Distorted audio	41	2
Frequency instability	32	2
Spurious	16	1
Carrier	4	0.2
Overdeviation	2	0.1
Harmonic	1	0.06
Total	1768	100%

means: peer pressure, no-fault emphasis, negotiation and so forth. Only after all other voluntary means of resolving a problem are exhausted and it's been determined through extensive review that the case is of a most serious nature, is the FCC asked for action. In these cases, the FCC should then commit to make every reasonable effort to prosecute them diligently. The ARRL is working toward this end.

Myth: Reasonable ham radio license fees will give the FCC more money to devote to enforcement.

Reality: Money from licensing fees goes to the government's general fund and aren't earmarked for specific agency use.

To get more information about the ARRL Amateur Auxiliary to the FCC or about the League's Official Observer program, contact ARRL headquarters at 225 Main Street, Newington, CT 06111; phone (203) 666-1541; e-mail rpalm@arrl.org.

Write or call me personally at the same mailing address and telephone number; my e-mail address is bbattles@arrl.org.

The notice is simply for the benefit of the individual ham and for the Amateur Radio service as a whole. OOs are friendly helpers, not police officers/enforcers. The mission is to assist those who are receptive to

being assisted. Table 1 (above) is the 1991 summary report of OO activity. It gives you a picture of what an OO is all about.

Recalcitrant cases are handled at high-levels in the program, through voluntary

Daiwa's PS50TM Power Supply...



More Power, Features and Quality...For Less!

Daiwa's very compact "Powerhouse" • Their smallest adjustable voltage and voltage & current metered regulated DC supply! Binding posts & cigarette lighter socket outputs. Perfect for handheld and mobile scanners, HamBand H.T.'s and CB's.

DAIWA

Available at your favorite dealer.

Electronic Distributors Corp.

325 Mill St. Vienna, VA. 22180

Phone: (703)-938-8105 • FAX: (703)-938-4525

Exclusive North and South American Distributors

YOU AIN'T HEARD NOTHIN' ... YET

Since 1967, CRB Research has been the world's leading publisher and supplier of unique hobby and professional books and information including:

- Scanner Frequency Guides
- Shortwave Frequency Guides
- Military/Federal Communications
- Broadcast Station Registries
- Undercover Communications
- Survival Communications
- Covert Operations
- Electronic Espionage
- Surveillance
- & Other Related Topics!

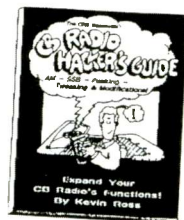

ASK FOR BIG FREE CATALOG

New titles are constantly being added to our exciting catalog. If it's interesting and unusual, we've got it. You'll see. Ask for our latest FREE catalog.

CRB RESEARCH

P.O. Box 56, Commack, NY 11725

Phone: (516) 543-9169

FAX: (516) 543-7486

THE ULTIMATE NOISE/INTERFERENCE REDUCTION AND FILTER UNIT



At long last, the most advanced noise reduction/filter unit is now available from JPS. DUAL DSP chips are used in the NIR-12 to provide simultaneous bandwidth filter, noise reduction (2 types) and tone removal. Both Spectral Subtraction (NIR[®]) and Dynamic Peaking noise reduction methods are included to provide reduction of IMPULSE noises as well as atmospheric white noise. An AUTOMATIC NIR[®] mode is included to set the noise reduction at the optimum point, based upon the measured Signal-To-Noise ratio of the received signal. A spectral notch filter provides cancellation of multiple heterodynes from tune-ups, adjacent channel carriers, CW, RTTY, or similar signals without interfering with voice signals. The notch filter operates in 5 milliseconds or less. The super-selective FIR filters are continuously variable in both bandwidth and center frequency. Bandwidth is adjustable between 50 Hz and 3200 Hz. The user-friendly front panel gets you operating on the air in the shortest possible time. An internal access to the dual DSPs is provided via RS-232 for experimenters.

Other fine JPS Amateur Radio products include: NIR-10 Noise & Interference Reducer; NRF-7 General Purpose Noise Reducer & Filter Unit; NTR-1 Wideband Noise and Tone Remover; SSTV-1 DSP Filter for SSTV; NF-60 DSP Spectral Notch Filter. 115VAC/12VDC adapter available

If you want the best, get JPS.

JPS Communications, Inc.

"First and Finest in DSP Noise Reduction"

Features

- ♦ Superior Audio Noise Reduction
 - Atmospheric White Noise
 - Automobile Ignition Noise
 - Power Line Noise
 - Static
 - Computer/TV Interference
 - Digs Out Weak Difficult-to-read Signals
 - Greatly Reduces Listener Fatigue
- ♦ Both Spectral Subtraction and Dynamic Peaking Noise Reduction
- ♦ Manual and AUTOMATIC NIR[®] Noise Reduction Control
- ♦ Operates on Audio From Any Radio
- ♦ Dual DSP Accessible Via RS-232
- ♦ All Modes Usable Simultaneously
- ♦ Notch Filter Removes All Tones from Voice and Operates in <5 msec
- ♦ Super FIR Filters provide:
 - Fully Adjustable Bandwidth, Center Frequency
 - "Real Time" Operation
 - Very Steep Skirt Selectivity
 - Greater than 60dB Ultimate Rejection
 - Linear Phase; Minimum Passband Ripple
 - Usable as Bandpass, Highpass or Lowpass

TOLL FREE ORDER LINE: 800-533-3819

We accept MC, VISA, Money Order, or Check (\$US)
P.O. Box 97757, Raleigh, NC 27624
FAX: (919)790-1456 Technical Info: (919)790-1048
Compuserve: 71673.1254 Internet: jps@nando.net

Contact us for a dealer near you.

27 MHz COMMUNICATIONS ACTIVITIES

Would you like to nearly double the effective range of your CB and still run legal power? Then try operating single sideband!

Single sideband (SSB) is simply another mode of operating on the 40 legal CB channels. Most CBs units are set up to operate only in AM mode, and are limited to 4 watts legal power. However, CBs equipped for sideband mode can legally put out as much as 12 watts peak power when operating SSB. The result is that, under identical conditions, sidebanders running legal power can communicate almost twice as far as AM operators who are also running the legal limit.

One of the reasons that sideband is more effective is that it puts more energy into a narrower signal. Here's what I mean: think of an AM signal as an Oreo cookie—it consists of a center carrier (like the white stuff in the middle an Oreo) and two sidebands (like the chocolate cookies on either side of the white stuff). Now, the carrier exists solely to give the CB receiver at the other end of the communication something to lock onto. The carrier does *not* contain any of the transmitted audio of the operator's voice. That's why it is possible to key the microphone, not say a word, and yet "throw" a carrier.

The actual information in an AM signal (the sound of your voice, for example) is contained in the two sidebands (the upper sideband and the lower sideband), and they carry *exactly the same information*. In fact, when you press the transmit button in AM mode, 50 percent of the power goes into the carrier (which means it is essentially wasted), and the remaining 50 percent is split between the two sidebands! If you could find a way to get rid of the carrier and transmit only one sideband, you would concentrate a lot more power into a much narrower signal, and the result would be longer-range communications.



The Cobra 148F GTL—a professional quality mobile sideband rig.

That's *exactly* what a sideband CB rig does. Switch it to upper sideband (USB) or lower sideband (LSB) and key the mike, and nothing happens *until* you say something. That's because there's no carrier, just the signal of your voice being transmitted—with full power—on the sideband of your choice as you speak. Because there is no carrier for a receiver to lock onto, a sideband transceiver includes another control, a clarifier, which used to adjust the receiver so that it is exactly on the same frequency as the transmitted signal. Otherwise, the voice may sound unnaturally high, like Donald Duck, or unnaturally low, a bit like the Jolly Green Giant.

It takes a little practice to get used to adjusting the clarifier, but it's well worth the effort. Not only do you get additional range, but the entire culture of sideband CB is generally more civilized than AM CB. Maybe it's because you can't "chuck" a carrier, but most sideband operators more closely re-

semble ham radio operators in their on-the-air behavior and operating habits. Sidebanders, for example, generally identify themselves using a number assigned by one sideband network or another, and they use their own first names on the air instead of handles. I make no bones about it. While there are many AM operators who I admire and respect, sideband is my favorite operating mode.

For the most part, you'll find sidebanders operating on the lower sideband of channels 35-40 and sometimes on Ch. 16. There are, however, exceptions—recently I heard of a group near Catskill, New York, operating on the upper side of Ch. 40. It's important that you get on the right sideband, because no matter how hard you try, you will *never* be able to clarify a signal if it is an upper sideband signal and you are listening on lower sideband. If you can't clarify a signal, try switching sidebands, it just might work.

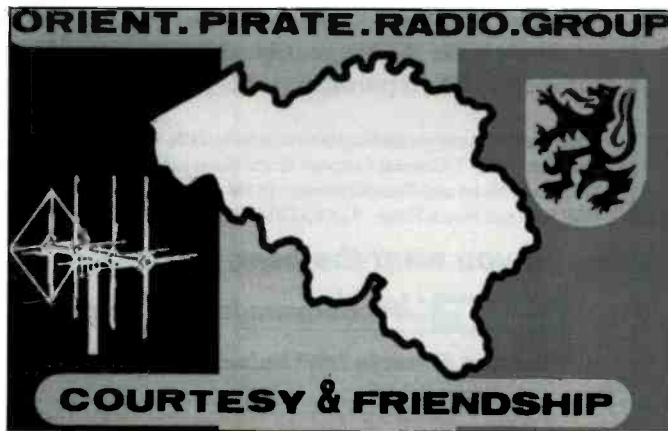
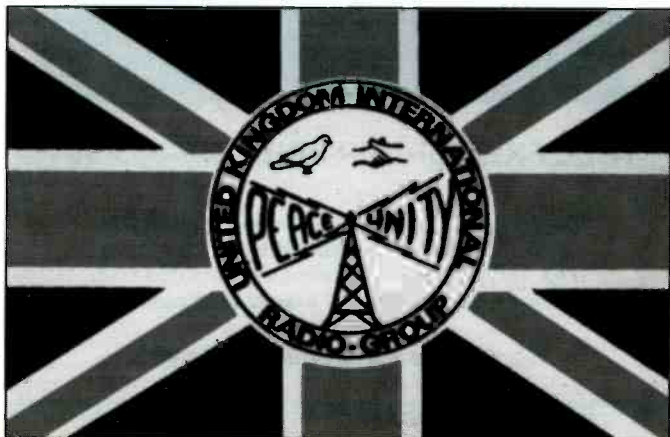

Neyens Roger sent in these really neat looking stickers, from Luxembourg.

There's another good reason to operate sideband: SSB operation is far less likely to cause adjacent channel interference because the signal is narrower. Let me give you a real-life example—the other night I was participating in a network on 37 LSB when we could hear “hash” breaking in from another channel. We traced it to an AM operator running heavy power on Ch. 32—five channels away!

The next day, I checked on another sideband network that operates every morning. Some of the operators are running powerful ham rigs, yet I couldn't hear them at all just one channel away!

A New Sideband Rig from Cobra

If you'd like to try operating sideband, you're going to need a sideband-equipped radio. Recently I checked out a dandy, the new Cobra 148F GTL. This is a 40-channel AM/SSB mobile that includes a five-digit frequency counter, an S/RF/SWR meter, automatic noise limiter, and even a noise blanker.

The 148F has a true frequency counter—the circuitry measures and displays the actual frequency being synthesized by the radio. By contrast, some of the 10-meter ham radio mobile rigs that are finding their way onto the CB channels don't have a real frequency counter. Instead, they have only a digital readout—which displays a number created by the microprocessor that controls the radio. With a digital readout, there can be a difference between the frequency that is shown and the actual frequency that the radio is really operating on. An easy way to spot the difference is to move the clarifier; if the frequency doesn't change, that's a good clue that the radio doesn't have a real frequency counter. Fortunately, you don't have to worry about that problem with the 148F—it's got the real thing.

At the heart of this new radio is the same main circuit board you'll find in Cobra's new top-of-the-line base station, the 2010, so the 148F GTL comes from an impressive technical heritage. And it shows—hooked to a 20-amp power supply and my base antenna, the 148F actually produced a somewhat louder signal than my beloved Cobra 2000 GTL base station, both in AM and SSB modes. My test partner reported “very clear” audio produced by the 148F from my base station and from my Jeep.

My sources inside Cobra tell me that the reason for the apparently louder signal is that Cobra is holding much higher tolerances for modulation and so forth during the final check-out of its transceivers in the manufacturing process. The result is the same as if you took the radio to a CB technician and had a full “legal-limit” tune-up.

I found the 148F easy to operate on the road, and, typical of Cobra transceivers, the noise limiter and noise blanker do a superb job of knocking out any ignition noise. In addition, there's lots of clear audio com-

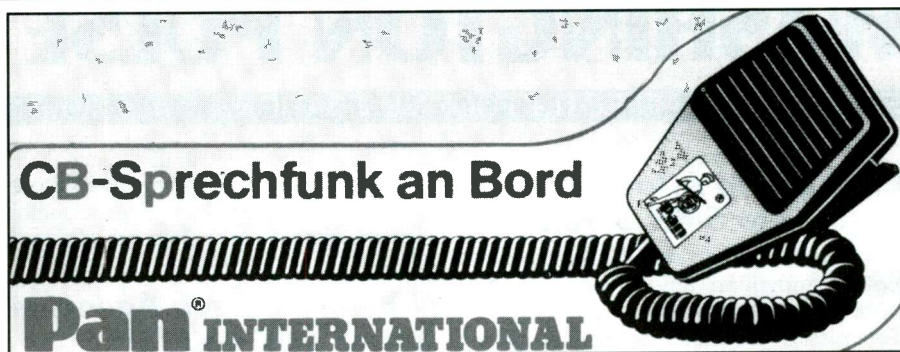

(Courtesy of Neyens Roger.)

ing out of the bottom-mounted speaker. A pushbutton tone control makes it possible to knock out some of the high frequency audio for a more mellow sound when listening at a base station, but I preferred the somewhat sharper “full-strength” audio in the noisier environment of a vehicle.

This is a sophisticated transceiver that will serve well either as a base station (when hooked to a power supply) or as a mobile unit. Cobra's press release says the average selling price of the 148F GTL is \$369.95, but it should be available for less from discounters. For the name of your local dealer or for more information, call 1-800-262-7222, and tell 'em you read about it in POP'COMM.

If you want to go sidebanding, you're also going to need an identification number. Often you can get one by checking into one of the sideband networks that operate in your local area, but if you want a number that will be recognized worldwide, contact the SSB Network, P.O. Box 908, Smithtown, NY 11787. Send the network coordinators a self-addressed, stamped legal-size envelope, and they will send you back the details on how to get a number from a network that has more than 125,000 affiliated members in the U.S., Canada, and around the world.

A Call to Action

A friend publishes a two-page newsletter for Ch. 9 monitors in upstate New York. A recent issue featured the following, which is reprinted with permission:

Citizens Arise—Reclaim the Band

Across the nation there is a growing movement for real CB operators to reclaim their fair share of operating space. Our first task is to reclaim the name. Not all that is called CB these days really is. So to help ease the confusion and set the record straight, this is who we are and here is what we do.

Citizens Band. Regular CB, Channels 1 to 40, stock radios. Short range (two to five miles dependable), two-way radio for everybody. No license required. Preferred mode of transmission is SSB on channels 16 and 36-40, AM on all others.

Free Band. Illegal, but popular hybrid of amateur and CB. Uses about 60 channels worth of frequencies both above CB channel 40 and

below CB channel 1. Range of hundreds to thousands of miles under the right conditions. Preferred mode of transmission is SSB but you will find some AM and FM. Usually high powered amateur gear or modified CBs with power amplifiers.

Bully Band. These are the overpowered, echo-chambered, roger beeping, foul mouthed, S.O.B.s you hear making life miserable for the legal operators on channels 1 to 40. They usually have the equipment to be Free Banders, but lack the courage and the perverse sense of humor needed.

To which I say, “Amen.”

Thanks for the cards and letters—next time we'll dip into the Mailbag. Please write to me here at *Popular Communications*.

NEW! ScanStar™ Commercial Edition

From Signal Intelligence
The Leader in Computer Scanning

The Commercial Edition has all Professional features plus:

- o Multi-radio scanning, search/slave & peer strategies.
- o Spectacular graphical scan window has “all in view” status. Quickly lock/unlock channels with mouse.
- o Two independent scan windows. Scan up to 4 radios at the same time. Hot switch display.

Professional Edition Features:

- o Spectrum analysis on R7100, R9000, AR3000, OS456, NRDS35. Great graphics - support for most printers.
- o Scan by tone with OS456 or DC440 + other radio.
- o Scan multiple groups, banks and search ranges all at the same time! Alarms for priority channels.
- o Unlimited channels and banks. Select all features on a per-channel basis. No frequency restrictions.
- o Comprehensive report printing & data logging.
- o Import & export data, read & write radio memory.
- o Terminal window for TNC, decoder or modem.
- o Monitoring Assistant, background scan & more!

Equipment Supported:
OS456, R7100, R7000, R9000, FRG9600, DC440, AR3000, NRDS35, NRDS25, RB, MR8100.

System Requirements:
IBM PC 386/486/586 with 4 MEG ram, hard disk, VGA, mouse, serial ports. DOS 5/6 with DOS=HIGH, or OS/2 2.1 or 3.0. Cables and interfaces not supplied.

Commercial Edition \$129⁹⁷
Professional Edition \$79⁹⁷
Plus shipping, handling and state sales taxes. To order call:
1-408-926-5630

Signal Intelligence PO BOX 640891 San Jose CA 95164 408-926-5630 VOICE & FAX	FREE DEMO Download from Scan*Star BBS, 2400-9600 N61, login as “guest” 1-408-258-6462
--	--

CIRCLE 78 ON READER SERVICE CARD

WASHINGTON PULSE

FCC ACTIONS AFFECTING COMMUNICATIONS

Changes to Allow Telco Entry into SMR Service

In keeping with its commitment to promote competition among providers of mobile telecommunications services, the Commission amended its rules to allow wireline telephone companies to hold licenses in the Specialized Mobile Radio (SMR) service and in the subscriber-based 220-222 MHz land mobile (commercial 220 MHz) services. The Commission also eliminated the prohibition on the provision of dispatch service by common carriers.

When the Commission established the SMR service in 1974, it prohibited telephone companies from becoming licensees; this was considered necessary to promote competition in the fledgling SMR industry. The Commission adopted an analogous wireline restriction for the commercial 220 MHz when it established the service in 1991. The Commission indicated that rationale for excluding wirelines from SMR licensing also applied to the commercial 220 MHz service.

The Omnibus Budget Reconciliation Act of 1993 (Budget Act) prescribed comprehensive regulatory changes for the mobile services marketplace. The legislative history of the Budget Act identified the ban against wirelines holding SMR licenses as a regulation that should be viewed by the Commission. Congress also granted the Commission authority to repeal the common carrier dispatch ban, which has been in effect since 1982. In a Notice of Proposed Rule Making, released August 11, 1994, the Commission proposed to eliminate these restrictions.

The Commission stated that eliminating the wireline prohibition will infuse new capital and expertise into the mobile services marketplace, and will yield a broader range of services at a lower cost to consumers. Repealing the wireline prohibition will also stimulate competition and promote opportunities for additional entry of small entrepreneurs, such as rural telephone companies, into the SMR and commercial 220 MHz services. The Commission also notes that statutory and regulatory safeguards are available to prevent wireline carriers from engaging in discriminatory interconnection policies that would adversely affect non-affiliated SMRs and 220 MHz licensees.

The Commission said eliminating the dispatch prohibition will enhance competition by permitting all CMRS providers to offer dispatch services. The introduction of new competitors may lower costs to subscribers and provide more choices. It is consistent with the Commission's efforts to achieve regulatory symmetry among com-

parable services. The Commission permitted CMRS licensees to provide dispatch upon the effective date of the rule changes.

N.Y. Metro Area Agencies to Use 482-488 MHz

The Commission waived Parts 2 and 90 of its Rules to permit the assignment of frequencies in the 482-488 MHz band (television channel 16) for the public safety radio services in New York City Metropolitan area. This Waiver was granted for a period of at least five years or until the Commission assigns Channel 16 in New York City for advanced television service (ATV) and a broadcast licensee is authorized and ready to commence ATV operations.

TV Channel 16 is currently allocated to the broadcasting service, but there is no Channel 16 allotment in New York City. The FCC believes that circumstances warrant a waiver of the Commission's Rules to permit public safety use of Channel 16. Use of this channel for public safety operations will provide needed spectrum relief to help alleviate congestion of public safety radio frequencies in the New York City area and to help meet the needs of the public safety community for interoperability of communications for responding to emergency situations.

Low Power Television Licensees Eligibility for Four-Letter Call Signs

Pursuant to the First Report and Order in MM Docket No. 93-114, 9 FCC Rcd 2555 (1994), low power television stations (LPTV) are eligible to apply for four-letter call signs, thereby modifying their initially assigned five-character alpha-numeric call signs. In that Order, the Commission stated that such modifications may be competitively beneficial to the low power television industry by promoting viewer recognition of LPTV stations and by enabling LPTV operators to more effectively market their stations.

In the Order, the Commission stated that a phased implementation of the new call sign policy would be necessary to expeditiously handle the potentially large number of requests for modified call signs, and that a schedule would be established by public notice whereby licensees and permittees could apply at the appropriate time, with the oldest stations having the first opportunity.

Accordingly, the eligibility schedule will be extended such that a modified call sign in the form of a four-letter call sign may be requested for any low power television sta-

tion, which has been granted a license by the Commission in 1989 or earlier, irrespective of the station licensee at that time. No other low power television station licensees are eligible to apply at this time, and no call signs may be reserved. Subsequent public notices are now issued setting dates for later-authorized stations. Thereafter, the Commission will announce when call sign requests from low power television station permittees can be filed. Television translator stations are not eligible for four-letter call signs.

Call sign requests will be processed in accordance with the procedures set forth in section 73.3550 of the Commission's Rules. Requests for four-letter call signs must be made by letter to the Secretary, Federal Communications Commission, 1919 M Street, N.W., Washington D.C., 20554. An original and one copy of the letter must be submitted. A filing fee is presently not required for LPTV call sign modifications. As many as five call sign choices, listed in descending order of preference, may be included in a single request. Requesters must also submit the drug certification statement required by Section 1.2002 of the Commission's Rules. Incomplete or otherwise defective filing will be returned by the FCC.

Call signs are assigned on a "first-come-first-served" basis. Receipt by the FCC of a request for an available call sign blocks the acceptance of subsequent requests until the first received request is processed to completion. In the case of requests by low power television operators for the same call sign being received on the same date, the assignment will be made to the station having the longest continuous record of broadcast operation under substantially unchanged ownership and control. If a low power television operator and an AM, FM, or full power TV operator apply on the same date at the FCC, the AM, FM, or full power TV operator will prevail. It should be noted that a low power television station operator may not request call sign used by another broadcast station unless the stations are commonly owned or unless the LPTV operator has the other station's written consent. Two or more LPTV stations may not have the same call sign. All four-letter call signs assigned to low power television station will include a suffix of "-LP."

Requests about the availability of particular call signs may be made to the FCC Reference Center, phone (202) 418-0270.

Amateur Station Vanity Call Sign System

On December 23, 1994, the Federal Communications Commission adopted

rules to implement a vanity call sign system in the amateur radio service. The vanity call sign system is being implemented by means of four starting gates. A public notice will announce the opening of each gate, along with the date when FCC Form 610-V will become available. The starting gates are:

GATE 1. Any class operator who is applying for:

A. The call sign that was previously shown in his/her primary station license, or

B. The call sign that was previously shown in the primary station license of a deceased spouse, child, grandchild, stepchild, parent, grandparent, stepparent, brother, sister, stepbrother, stepsister, aunt, uncle, niece, nephew, or in-law, or

C. The call sign that was previously shown on the club station license for which the applicant is currently the license trustee.

GATE 2. Any Amateur Extra Class operator who is applying for a call sign for his/her primary station or for the club station for which he/she is currently the license trustee.

GATE 3. Any Advanced Class operator license who is applying for a call sign for his/her primary station or for the club station for which he/she is currently the license trustee.

GATE 4. Any class operator who is applying for a call sign for his/her primary station or for the club station for which he/she is currently the license trustee. Also, a class operator who is applying for a call sign that was previously shown on the primary station license of a deceased person and who is acting with the written consent of the deceased person's spouse, child, grandchild, stepchild, parent, grandparent, stepparent, brother, stepsister, aunt, uncle, niece, nephew, or in-law, for the club station for which he/she is currently the license trustee.

You may request a vanity call sign only when you hold an unexpired amateur operator/primary license document, and where applicable, a club station license document (FCC Form 660). Military recreation and RACES stations are not eligible for vanity call signs. If you have recently filed an FCC Form 610 or 610-B for any purpose, you are not eligible for a vanity call sign until you receive your license document.

Except for GATE 1 and the written consent portion of GATE 4, you may list on Form 610-V one to 25 specific call signs in order of your preference. Each call sign must be from the group designated under the sequential call sign system for your, or a lower, operator license class. The geographic region designator used in the sequential call sign system is an option left to the applicant. A summary of the sequential call sign groups follows. If you hold an Amateur Extra Class operator license document, for example, you can choose from Groups A, B, C, or D.

Your current call sign will be vacated from your license. Upon confirming that you are eligible for the first call sign on your list, the license data base as it then exists will be searched. If the call sign is assignable to your station, your license will be modified to show that call sign. Otherwise, the search will be repeated using the other call signs in your order of preference until a call sign is selected. Should no call sign on your list be assignable to your station, the call sign that you vacated will again be shown on your license.

Choose your list of call signs very carefully. List only call signs from the groups for which your operator class is eligible and

which you believe are unassigned. Give the exact prefix, numeral, and suffix for each call sign. Do not request call signs in general terms. A request such as, "Any call sign with my initials," cannot be accommodated. Do not request that a call sign should be reserved for future assignment. The FCC cannot provide current call sign status data. The license data base is available from the National Technical Information Service, 5285 Port Royal Road, Springfield, VA 22161, (703) 487-4600 or 1-800-553-NTIS. It is also available from private publishers. However, since vanity call sign requests will be continually accepted and processed, there is no guarantee that

Imagine . . .

A shortwave antenna so good you won't need or want any other type of antenna system!

With the ALPHA DELTA Model DX-ULTRA Full Spectrum Dipole you don't have to imagine anymore! We designed it for "knock-your-socks-off" performance with an absolutely no-compromise attitude — with full frequency access from AM Broadcast through 30MHz!

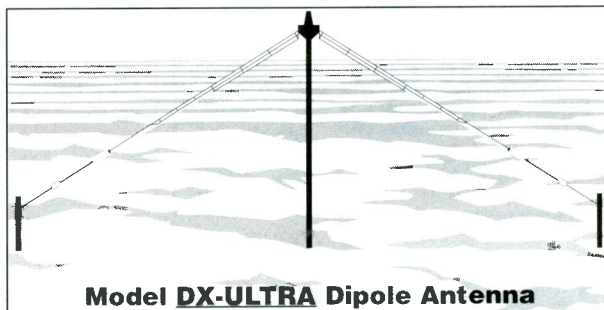

Model DX-ULTRA Dipole Antenna

- Absolutely remarkable performance for Medium Wave, Tropical, International Shortwave, Government, Military, Embassy, Maritime, Aircraft, Commercial and all other Utility communication frequency ranges.
- The DX-ULTRA design provides extremely low-noise performance for maximum sensitivity to weak DX signals.
- The wire elements' "Tapered Wing" design allows broadband operation on 1/2 wavelength and 3/4 wavelength multiples of various frequency ranges.
- The DX-ULTRA is designed with a pair of ISO-RES inductors and parallel wire elements for maximum broadband, efficient performance - no lossy narrowband traps. The difference on your S-meter can be phenomenal!
- Our exclusive Model DELTA-C Center Insulator with the built-in Model SEP ARC-PLUG® Static Electricity Protector provides effective protection for your sensitive receiver components. Connectors accept either coax or balanced line.
- Overall length of the DX-ULTRA is only 80 feet with dipole, inverted-vee, or full sloper configurations possible!
- Fully assembled - no cutting or soldering required. All components are rated for 2kW of power with all stainless-steel hardware. Can be used with a wide-range antenna tuner for commercial, military, or embassy operation.
- The DX-ULTRA is designed specifically for full spectrum shortwave performance, not just for the narrower amateur or international shortwave bands.

Alpha Delta Model DX-ULTRA, 80 ft. in length . . . \$119.95

If your space does not permit the full 80 ft. length of the DX-ULTRA, we suggest our Model DX-SWL 1/4 wave sloper (60 ft.) or our DX-SWL-S 1/4 wave sloper (40 ft.). These antennas have similar design philosophies.

At your Alpha Delta dealer or add \$5.00 for shipping and handling in the continental United States. Export orders - please call for quote.

ALPHA DELTA COMMUNICATIONS, INC. 

P.O. Box 620, Manchester, KY 40962 • 606-598-2029 • FAX 606-598-4413
current solutions to current problems

WORLDS SMALLEST FM TRANSMITTERS

MICRO-MINIATURE FM TRANSMITTER!

In spite of its micro-miniature size, the XWB1000-EZ transmitter kit punches out a signal up to 1/2 mile away! Including the battery, this is absolutely the smallest FM transmitter available. Miniature battery and holder included on circuit board for minimum size. Amazing audio sensitivity. Picks up sounds at the level of a whisper. Use with any FM broadcast receiver from 88 to 108 MHz. XANDI's famous E-Z kit approach makes assembly a snap. Kit includes pre-assembled surface mount module, microphone, antenna wire, and battery.



● **XWB1000 E-Z \$49.95**

LONG RANGE CRYSTAL CONTROLLED FM TRANSMITTER!

With a range of up to 1/2 mile, the new XTL1000-EZ transmitter KIT is an outstanding performer. Miniature battery and holder included on circuit board. Amazing audio sensitivity. Picks up sounds at the level of a whisper. Works with any VHF scanner or surveillance receiver at 143 MHz. XANDI's famous E-Z kit approach makes assembly a snap. Kit includes pre-assembled and tested surface mount module, microphone, antenna wire, and battery.

● **XTL1000 E-Z \$69.95**

LONGER RANGE CRYSTAL CONTROLLED FM TRANSMITTER!

With a range of up to 1 mile, the new XTL3000-EZ transmitter E-Z KIT out performs any other unit available. Miniature battery and holder included on circuit board. Amazing audio sensitivity. Picks up sounds at the level of a whisper. Works with any VHF scanner or surveillance receiver at 143 MHz. XANDI's famous E-Z kit approach makes assembly a snap. Kit includes pre-assembled and tested surface mount module, microphone, antenna wire, and battery.

● **XTL3000 E-Z \$89.95**

1-800-336-7389

SATISFACTION GUARANTEED.

CHECK, VISA, MC, MO
or COD, S&H EXTRA

ASK FOR OUR
NEW CATALOG!



XANDI Serving The Public Since 1981
ELECTRONICS, INC.
1270 E. BROADWAY RD #113, TEMPE, AZ 85282

CIRCLE 83 ON READER SERVICE CARD

GMRS Radios & Accessories



Finally!! A radio has been made with the serious GMRS & React user in mind! Maxon has developed a 2 to 5 watt, 10 channel, repeater capable radio with CTCSS included at a reasonable price! This unit has features you would normally expect to find only in commercial radios:

- high/low power setting
- Scan function
- Programmable CTCSS tones
- 2 freq. programmable channels!

Plus many other features to numerous to mention here.

MAXON GMRS-210+3 10 ch. 2-5 watt.....\$198.95

Many accessories available:

WTA-13G VOX headset.....\$48.90
WTA-4GM 1/4 wave mobile antenna.....\$28.90
Maxrad 5/8 wave mobile antenna.....\$49.00
Miniature speaker mikes, throat mikes and ear mikes also available for added privacy and convenience.

MAXON GMRS-21A 1 watt H.T.....\$144.00
UNIDEN GMR-100 1 watt H.T.....\$159.00

Many models of ICOM & YAesu HT's & mobiles in stock. **We have the lowest shipping rates!**

Shipping info.: Orders shipped in 24 hours with cert. ck. or money order. COD's shipped via UPS in 24 hours. \$8.50 for pkgs. to 3lbs.

Sports-Communications Dist.

P.O. Box 36, Scotts Mills, OR 97375
(800) 573-2256 fax: (503) 873-2051

CIRCLE 80 ON READER SERVICE CARD

a call sign appearing to be available on the license database will be free when your request is processed.

SUMMARY OF THE SEQUENTIAL CALL SIGN SYSTEM GROUPS

GROUP A. For stations licensed to Amateur Extra Class operators.

One letter prefix K, N, or W, and two letter suffix;

Two letter prefix AA-AL, NA-NZ, KA-KZ, or WA-WZ, and one letter suffix;

Two letter prefix AA-AG, AI, AJ, or AK, and two letter suffix.

GROUP B. For station licensed to Amateur Extra and Advanced Class operators.

Two letter prefix with first letter K, N, or W, and two letter suffix;

Two letter prefix AL, AH, KP, and two letter suffix.

GROUP C. For stations licensed to Amateur Extra, Advanced, General, Technician, and Technician Plus Class operators.

One letter prefix K, N, or W, and three letter suffix;

Two letter prefix KH, KL, NH, NL, NP, WH, WP, or WL, and two letter suffix.

GROUP D. For stations licensed to Amateur Extra, Advanced, General, Technician, Technician Plus, and Novice Class operators and for club stations.

Two letter prefix with first letter K or W, and three letter suffix.

For further information, contact the FCC's consumer assistance branch, 1270 Fairfield Road, Gettysburg, PA 17325-7245, (800) 322-1117, or (717) 337-1212.

Experimental Licenses

The Commission granted the following experimental applications:

KA2XNO, Westinghouse Communications Services, Inc., experimental to operate in the 3100-3500 MHz range for fulfillment of U.S. Airforce contract. FX: Anne Arundel, MD.

KB2XCC, Dynaflo Company, experimental to operate on frequencies 216-220 MHz for development, testing, and demonstration of a monitoring device. MO: CONUS

KE2XNA, Orbital Sciences Corp., experimental to operate on frequency 2092.59 MHz to test earth station to ensure that it will function properly prior to commencing DSC missions. FX&MO: Fairmont, Marion, WV

KE2XNL, Orbital Sciences Corp., experimental to operate on 2092.59 MHz in support of NASA SEASTAR Satellite project. FX: Fairmont, Marion, WV

KE2XOL, Disaster Emergency Response Association, Inc., experimental to operate on frequencies 149.220, 149.195, and 149.245 MHz for use of mobile ground radio equipment to establish communication links through the NASA Satellite ATS-3, providing commu-

nication from disaster areas and search and rescue locations. MO: CONUS, U.S. Territories & Possessions, PR, & High Seas

KF2XEZ, Spectralink Corp., experimental to evaluate, in practical terms, the effect of reducing the number of hopping frequencies from 50-25 and the maximum authorized peak power to 500 mWatt, on interference with wideband multilateration systems. FX&MO: CONUS

KF2XFA, Cost-Effective Monitoring Systems, experimental to operate in 216.01-219.99 MHz to develop a radio telemetry seismic data acquisition system. MO: CONUS

Input/Output, Inc., experimental to operate on 216.01 and 219.99 MHz to develop a radio telemetry seismic data acquisition system. MO: CONNUS

KK2XGT, DSC Communications Corp., experimental to operate on 1895.150-1917.950 MHz to verify the operational aspects of a PCS network. FX&MO: Plano, Collin, TX

KM2XBF, Advanced Programming Concepts, experimental to operate on 1239 MHz for fulfillment of U.S. Marine Contract. FX: Austin, Travis, TX

KB2XR, University of Massachusetts-Lowell Research Foundation, experimental to operate on the 0.1-3.0 MHz band for fulfillment of NASA government contract. FX: Groton, Middlesex, MA

KE2XEX, U.S. West Communications, Inc., experimental to operate in the 2300-2310 MHz and 2390-2400 MHz band to use fixed wireless local loop technology to provide local exchange service for business and residential applications. FX&MO: Within stets of CO, MT, and NM

KG2XAD, Space Applications, Corp., experimental to operate on various frequencies for development and testing a computer program for remote control of HF Radio, Data Modem, and Automatic Link Establishment. FX: Linthicum, MD

KI2XBZ, Garmin International, Inc., experimental to operate on various frequencies for development of land mobile, maritime, and aviation equipment. FX&MO: Lenexa, KS

KI2XCU, Harley-Davidson, Inc., experimental to operate on various frequencies to test CB radios on motorcycles prior to export. MO: York, PA

KO2XGN, Nexus Telecommunication Systems, Ltd., experimental to operate in the 902-928 MHz band to test Part 15 devices. MO: Within Orlando, FL: Minneapolis, MN; and Chicago, IL.

Radio Broadcast License Renewal Booklet: New FCC Form to Be Used By All Radio & TV Applicants

As a result of the Commission proceeding in MM Docket No. 92-168 (Renewal Reporting Requirements for Full Power,

Commercial AM, FM, and TV Broadcast Stations), the FCC Form 305-S (Application for Renewal of License for Commercial and Noncommercial Education AM, FM, and TV Broadcast Stations) has been revised; FCC Form 348 (Application for Renewal of a Low Power TV, TV Translator Station License) has been eliminated.

The new FCC Form 303-S (application for Renewal of License for AM, FM, TV, Translator or LPTV Station) will be used to apply for renewal of license for a commercial or noncommercial AM, FM, TV, Translator, or LPTV broadcast station. It can also be used in seeking the joint renewal of licenses for an FM, or TV translator station and its co-owned primary FM, TV, or LPTV station. All changes were recently approved by the Office of Management and Budget.

The revised FCC Form 303-S has been printed and is now available for use. As of April 3, 1995, only the new FCC Form 303-S may be filed to renew any broadcast station (AM, FM, TV, Translator or LPTV). The old Form 303-S and Form 348 may not be used to renew the license for these stations after March 31, 1995.

The new FCC Form 303-S may be obtained either by writing to the Commission's Form Distribution Center, 2803 52nd Avenue, Hyattsville, MD 20781, or by calling 1-800-418-3676 and leaving a request on the answering machine provided for this purpose. A limited number of copies are also available in the Commission's Forms Self-Service Center, 1919 M St., N.W., Room L-17, Washington DC.

In order to assist licensees in filing for renewal and to simplify the renewal process for licensees to the extent possible, the Commission has produced a booklet that will be mailed to licensees approximately seven months prior to the expiration date of their station's license. This booklet contains all information and forms that are needed for license renewal: FCC 303-S; other renewal related forms (FCC Form 396—Broadcast EEO Program Report, FCC Forms 323/323-E—Ownership Reports, FCC Form 5072—Mailing Address Change and FCC Form 159—Fee Remittance Advice); instructional material (overview of renewal process and question by question instructions for FCC Form 303-S); and appendices (filing and expiration date charts, local public notice worksheets and environmental/RF compliance worksheets).

The renewal booklet has been printed and is now available. As with the new 303-S, the renewal booklet may be obtained by either writing to the Commission's Form Distribution Center at the address above or by calling 1-800-418-3676 and leaving a message. When requesting the renewal booklet using these options, please refer to the "license renewal booklet." A limited number of copies of the booklet are also available in the Commission's Forms Self-Service Center, 1919 M Street, N.W.,

Room L-17, Washington, D.C.

FAX-ON DEMAND: The new FCC 303-S and the renewal booklet are also available using the FCC Fax-On-Demand system. Copies may be ordered via fax 24 hours by calling (202) 418-0177 from the handset of any fax machine. Follow the system voice prompts and enter the document retrieval number when requested.

a. To order the FCC 303-S, use the document retrieval number 003031.

b. Because of its size, the renewal booklet has been made available in three separate files (instructional material, forms, and appendices). To receive the complete Renewal Booklet, you must request the following three files using the document

retrieval number indicated for each of the three sections:

1. instructional material—document retrieval number 000007;
2. forms only—document retrieval number 000008; and
3. appendices—document retrieval number 000009.

Due to the limited number of phone lines into the forms Fax-On Demand system, callers may wish to call during non-business hours. If you have difficulty with the transmission of your fax contact Dorothy Conway, at (202) 418 0217. For additional information contact Jackie Swank, at (202) 418-2610. ■

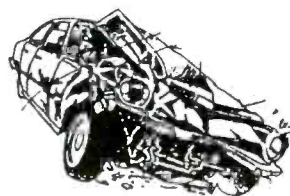

When seconds count, REACT® needs you...

...to summon help for an injured motorists, an elderly woman trapped in a fire, a trucker stranded in a blizzard, a drowning child!

As a REACT volunteer CB radio monitor you may be the only communications life-line for someone in serious trouble. You relay messages from those desperate for help to police or other emergency services.

Your REACT Team will also use CB and other radio services to provide safety communications for events like parades, marathons and even balloon races. The fellowship with other REACT members at Team meetings and annual conventions is an added bonus.

Volunteer. Join Today!

Add a New, Exciting Challenge to Your Life. Help Save Lives and Property!

REACT® International, Inc.

Tel (316) 263-2100

FAX (316) 263-2118

P.O. Box 998, Wichita, KS 67201



CIRCLE 74 ON READER SERVICE CARD

SIMPLE ANTENNAS AND ACCESSORIES FOR SIGNAL IMPROVEMENT

Coaxial Cable: More Than Just a Wire

Transmission lines are conduits for transporting RF signals between elements of a system. For most readers of this column, the "system" is your antenna and receiver, so the transmission line is what transports the signal from the antenna to the receiver's antenna input terminals.

Although often erroneously characterized as a "length of shielded wire," transmission lines are actually complex networks containing the equivalent of all the three basic electrical components: resistance (R), capacitance (C), and inductance (L). Because of this fact, engineers mathematically analyze transmission lines in terms of a complex RLC network. Fortunately, for our purposes a more descriptive approach is more than sufficient.

For most readers, the transmission line of choice is *coaxial cable*. Although there are a number of different types of coax, all forms consist of two cylindrical conductors sharing the same axis (hence "co-axial") and separated by a *dielectric* insulating material (see Fig. 1). For low frequencies (in flexible cables) the dielectric may be polyethylene or polyethylene foam, but at higher frequencies Teflon and other materials are often used. In some applications, dry air and dry nitrogen gas dielectrics are used (but unless you are a broadcast station engineer, you don't care much).

Several forms of coaxial line are available. Flexible coaxial cable is by far the most common form. The outer conductor (or "shield") in such cable is made of either copper braid or aluminum foil. The braid may appear silver, rather than copper, but except for a couple odd-ball types (and at least one too-cheapie import), the "silver" colored braids are actually *tinned* copper... which makes them corrode less and solder better.

Unusual Coaxial Cables

In general, coax with an aluminum foil outer shield is for television master antenna systems. Because the foil can't easily be soldered, it should not be used by most shortwave listeners, and only occasionally by VHF/UHF scanner users. The reason why some scanner people might use the line is that it tends to be optimized for low loss in the VHF/UHF regions.

Another form of flexible or semi-flexible coaxial line is *helical line*, in which the outer conductor is spiral wound. This type of line is often used in broadcast applications, and in VHF/UHF transmitters for communications. *Hardline* is coaxial cable that uses a thinwall pipe as the outer conduc-

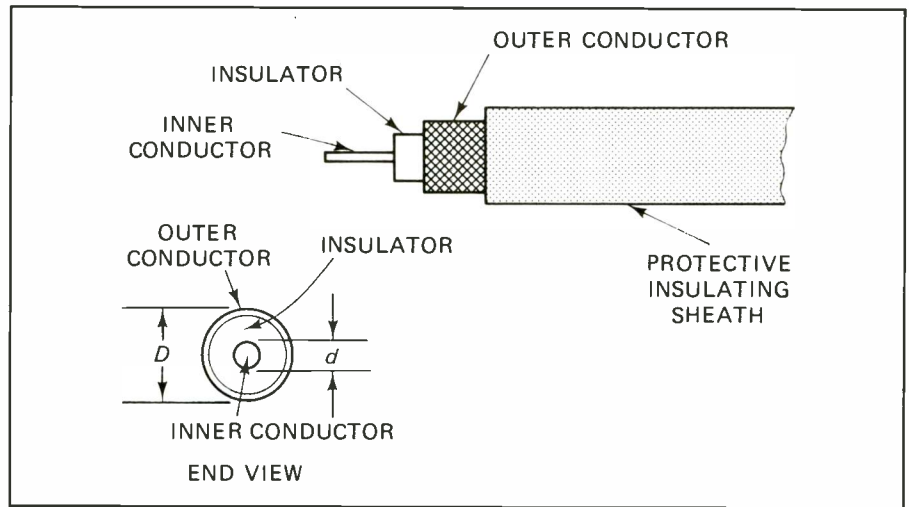

Fig. 1. Standard coaxial cable.

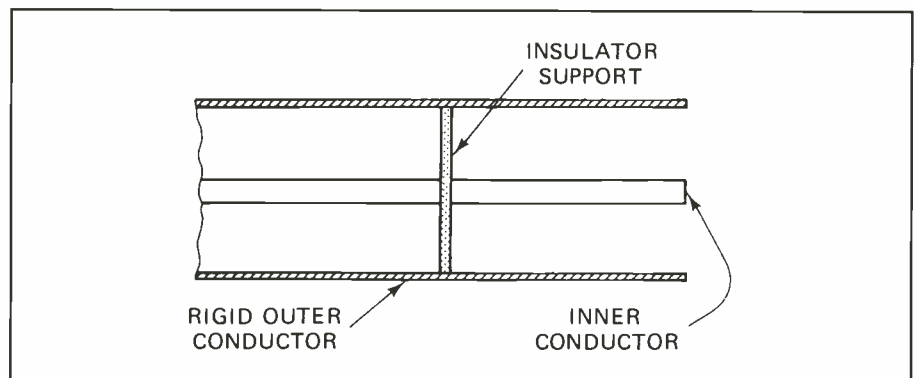

Fig. 2. Rigid gas-filled broadcast coaxial cable.

tor. Some hardline coax used at microwave frequencies uses a rigid outer conductor like small diameter copper plumbing pipe, and a solid dielectric. *Gas-filled coax line* is a special case of hardline which is hollow (Fig. 2), the center conductor being supported by a series of thin ceramic or Teflon insulators. The dielectric is either anhydrous (i.e. dry) nitrogen or some other inert gas. This type of line is normally restricted to broadcast stations, or other cases where high power transmitters are used.

Some flexible UHF/microwave coaxial cable uses a solid "air-articulated" dielectric (Fig. 3), in which the inner insulator is not continuous around the center conductor, but rather is ridged. Reduced dielectric losses increases the usefulness of the cable at higher frequencies. This cable is low loss at UHF and above, but also tends to be expensive and hard to obtain, so is less useful for hobbyist and amateur purposes.

Double shielded coaxial cable (Fig. 4) provides an extra measure of protection against transmitter radiation from the line, and electromagnetic interference (EMI) from outside sources from getting into the system. But again, the nature of the cable, the practical difficulty in working with the stuff, and its less-than-easy availability make it harder to deal with than regular coax (Fig. 1), so it is only rarely used.

Why Use Coax?

There are some compelling reasons to use coaxial cable. First, the antenna type might require it. Almost any practical type of resonant antenna will want to see coax as the transmission line. Second, coaxial cable makes it possible to use such accessories as *balun* transformers that enhance system performance. Third, the shielded nature of the coaxial cable makes the an-

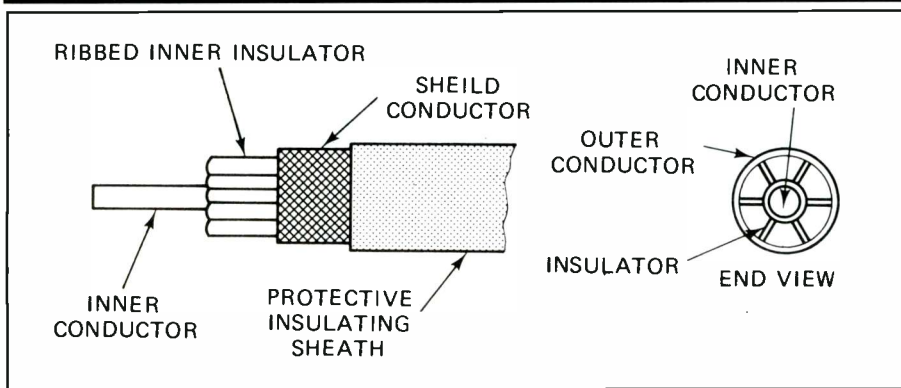

Fig. 3. Articulated dielectric microwave coax.

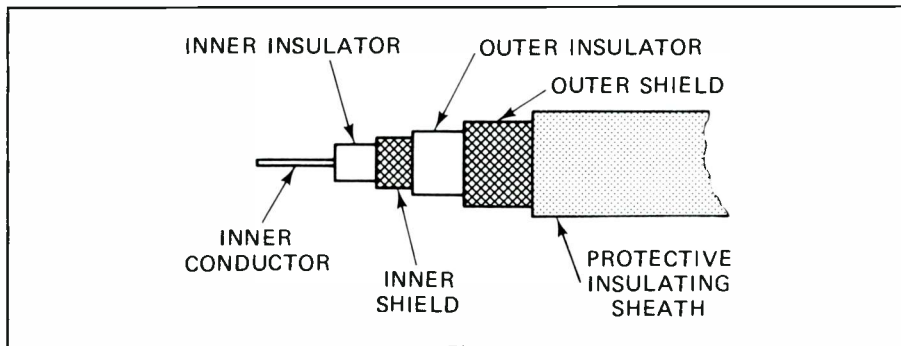

Fig. 4. Double-shielded coax.

Coaxial Cable Velocity Factors

TYPE OF DIELECTRIC	Z ₀ (ohms)	VEL.FACTOR (V)
Polyethylene Coaxial Cable	*	0.66
Polyethylene Foam Coaxial Cable	*	0.80
Air-Space Polyethylene Foam Coaxial Cable	*	0.86
Teflon	*	0.70

* Various impedances depending upon cable type.

Table 1.

tenna/receiver system less vulnerable to local EMI problems, including interference from local (but undesired) radio stations.

Coaxial Cable Attributes

There are two basic attributes of coaxial cable that are of importance to you. The first is the *characteristic impedance* (Z_0), also called *surge impedance*; the second is the *velocity factor* (V).

The characteristic impedance of the transmission line is defined technically in terms of the unit length capacitance and inductance, but for our purposes we can

note that it is impedance that will result in maximum signal power transfer. If the rated impedance of the line is 75 ohms, then connecting one end to a 75 ohm antenna input on the receiver, and the other end to a resonant antenna that has a 75 ohm feedpoint impedance, results in maximum signal power transfer from the antenna to the receiver.

Using a cable with a characteristic impedance different from either the receiver input impedance or the antenna feedpoint impedance, results in losses due to voltage standing wave ratio (VSWR). In a perfect system, the VSWR problem is avoided by

using a matched impedance system wide. But as a practical matter it is often impossible to achieve a perfect 1:1 VSWR except possibly at a single frequency.

For HF shortwave antennas, the mismatch caused by using a 75 ohm cable on a 50 ohm antenna (or vice versa) is basically not worth worrying about (1.44:1 VSWR). At VHF/UHF, when weak distant stations are sought, the loss might become a little more noticeable, but for most people it is hardly worth climbing up on the roof to fix. The one exception is where the antenna has some form of matching element (or circuit) built-in. For those antennas, the effects of mismatching the line might be worse than in the simple case most of us face.

One can tell the characteristic impedance from the type number of the cable. Anything marked "RG-58" or "RG-8" (or any of their many variants) are 52 ohm cables. The RG-58 is the small type, while the RG-8 is the larger cable. Similarly, "RG-59" cables are thin 75 ohm types, while "RG-11" are thicker 75 ohm types. There is little advantage to receiver operators for the thicker types (but hams with their transmitters need them), so use the RG-58 and RG-59 variants for convenience. The only exception is that some RG-8 and RG-11 types have lower losses at VHF/UHF. For long runs to antennas of those frequencies, the thicker cables might be the answer.

The velocity factor (V) of the cable is due to the fact that signals don't propagate at the speed of light (as they do in space), but rather at some fraction of the speed of light. If "c" is the speed of light (about 300,000,000 meters/sec), and "v" is the speed of the signal in the coaxial cable, then velocity factor V is v/c. Typical values for coaxial cable are in the 0.66 to 0.80 region (see Table 1).

The importance of the velocity factor is that it makes the electrical length of coaxial cable different from the physical length. If you build a coaxial cable *balun*, or a quarter wavelength impedance matching section, a half wavelength shorted stub for EMI elimination, or anything else where the electrical length of the line is critical, then velocity factor is very important to you.

For example, let's assume that you are building a 62 MHz collinear dipole, i.e., one in which half wavelength antenna sections are separated by quarter wavelength phase reversal sections, and want to cut cable for the phase reversal elements. The formula for $\lambda/4$ is $L_{\text{inches}} = 2952 / F_{\text{MHz}}$, so for 62 MHz, the *physical length* is $2952 / 62 = 47.6$ inches. That's the appropriate length for quarter wavelength antenna elements, but not for quarter wavelength coaxial sections. For that case, the formula is $L_{\text{inches}} = (2952 V) / F_{\text{MHz}}$, so if the selected cable has a velocity factor of 0.66, the correct coax length is $[(2952)(0.66)] / 62 = 31.4$ inches. Quite a difference! ■

COMMUNICATIONS CONFIDENTIAL

YOUR GUIDE TO SHORTWAVE "UTILITY" STATIONS

Queries have been received concerning SCORPION callsigns. Such callsigns were previously noted in communications during the Gulf War; a few were SCORPION TOWER, SCORPION RADIO, SCORPION GCA, and SCORPION 69. This latter callsign was assigned to the UH-1 (Bell helicopter) used to calibrate the GCA radar. It is not yet known if the present meaning is the same as that used in the past.

Rick Baker, OH, provides some U.S. Navy news. "The Los Angeles-class Nuclear Attack Submarine USS Omaha (SSN-692) was inactivated December 16, 1994."

Another item indicated that two Nimitz-class aircraft carriers currently authorized for construction are to be named the USS Harry Truman (CVN-75) and the USS Ronald Reagan (CVN-76). These carriers will be nuclear-powered.

On January 1, 1995, KFS World Communications, Half Moon Bay, CA, changed its name to Globe Wireless, the name of the KFS predecessor.

"The name Globe Wireless was used earlier in this century by a network of coastal radio stations owned by the Dollar Steamship Line. Several Globe Wireless stations, including the headquarters station in San Francisco, were subsequently purchased by IT&T, former owners of KFS Marine Radio.

"Globe Wireless currently HF radio service from coastal stations in California (KFS), Louisiana (WNU) and Newfoundland, Canada (VCT). Construction and equipment installation is underway at additional sites in the Hawaiian Islands, New Zealand, and Sweden."



Globe Wireless offers an entire range of data communication services including e-mail, facsimile, telex, telegrams, Inmarsat, and HF radio.

Andrews Air Force Base is the home of the 89th Airlift Wing of the USAF Air Mobility Command. Their only assignment is to fly the president, vice president, and top administration officials on an anywhere/anytime basis.

The 89th AW has a fleet of 21 UH-1N Bell helicopters, some Learjets, C-20B/C/F/H Gulf streams made by Grumman, Beech C-12A/F, and three Douglas C-9C's. For long-distance travel there are Boeing 707 variants (C-135B/C and C-137B/C), plus the two Boeing VC-25A Presidential transportation aircraft.

An article in the Martinsburg, West Virginia *Journal*, explained that the pilots of the 89th AW frequently engage in training missions at the Eastern Regional Airport located near Martinsburg or at one of the

To: David Sabo, Seoul, Republic of Korea

Q S L

This confirms your reception of
Nairobi Aeradio, Kenya
on 11300 kHz USB/voice at 2025 UTC on 22 January 1993.

Transmitter/Power: 2 K.W. (AERCOMM) SR 160 (Omni)
Antenna: BICONE
Location: 14 KM EAST OF NAIROBI CITY.

(Signature/Official Stamp)

FOR DIRECTOR OF CIVIL AVIATION
DIRECTORATE OF CIVIL AVIATION
P.O. Box 30163
NAIROBI.

Thank you for showing interest.

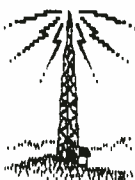

This computer generated PFC was sent in by David Sabo, S. Korea.

many other airports found in the North-eastern part of the U.S.

One exercise involves the aircraft making an approach to the airfield, touching down for a moment, and immediately taking off. Various problem simulations are part of the training so as to prepare pilots for any emergencies they might encounter on actual official flight assignments. A huge thanks to those readers who furnished details regarding Southbound II, and the weather reports given by Herb Hilgenberg.

Robert Pettengill, OK, forwarded an article from the October 1994 issue of *Cruising World*, which indicated Herb had discontinued his marine SSB weather advice in June 1994.

Due to cutbacks at his place of employment, Herb had to leave Bermuda—his sta-

tion was located near St. George's Harbor.

"As a Marine Reporting Station (MAREP) designated by the National Weather Service to supplement NOAA's broad network of weather stations, sophisticated ground radar and space satellites, Southbound II began playing a significant role in improving the accuracy of the world's weather forecasts.

"Solicited from as many as 60 ships checking in daily on SSB Channels 6-A and 12-A, starting at 2200 UTC, Herb's on-site confirmations of actual off shore weather and sea conditions were downloaded each night to a computerized data base to help formulate the morning NWS forecast. Plotting the boats on a long/lat grid overlaid on a satellite image so precise that the Gulf Stream's flow could be followed, Herb

Call Toll Free
1-800-666-0908

Pricing and Orders Only

YAESU FRG-100



Worldwide desktop communications receiver
 Covers 50kHz - 30MHz
 AM/SSB/CW
 (FM optional)

- 50 memory channels
- Built in selectable filters 2.4, 4, 6kHz
- WRTH "Best Communications Receiver" 1992
- Many, many more features

➤ **CALL FOR OUR LOW DISCOUNT PRICING** ◀

Yacht Boy 400



GRUNDIG
 World Receivers
 The Ultimate In
 Digital Technology

Satellit 700



AOR
 AR8000
 CALL FOR
 PRICE

SCANNERS

Bearcat
 SC150
 BC200XLT, BC220XLT
 BC3000XLT
 BC890XLT
 BC9000 XLT
 BC760XLT, etc

AOR

AR8000
 AR2700
 AR3000
TRIDENT
 TR-2400
 many others

SHORTWAVE

Drake R8, SW8,
 Sony, Sangean,
 Grundig,
 Panasonic, Lowe
 Conn Sales, Information
 Tech Help
(203) 666-6227



LENTINI COMMUNICATIONS, INC.

21 Garfield St. Newington, CT 06111

C.O.D.'s OK — SAME DAY SHIPPING

HOURS: M-F 10am - 6pm SAT 10am-4pm

CIRCLE 66 ON READER SERVICE CARD

Get A New Image

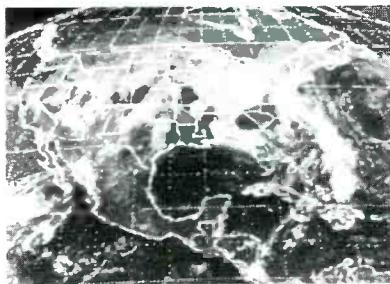

PC HF Facsimile \$99

PC HF Facsimile is a simple, yet comprehensive short-wave fax system for the IBM PC and compatibles. It includes an FSK demodulator, advanced signal processing software, tutorial audio cassette, and complete reference manual. Just plug the demodulator into a serial port, install the software and getting FAX is a snap.

PC SSTV \$149.95

PC Slow Scan Television is a complete system for sending and receiving full color amateur SSTV. The package includes an SSTV FSK modem, SSTV software, image capture utilities and reference manual. All popular formats are supported including Robot, Scottie, Martin and AVT. The system requires a 286, 386 or faster PC with VGA or super VGA display.



Have It All For Only \$199.95

For a limited time we are offering both software packages with a single FSK modem for under \$200. This combination offer will let you send and receive all the popular HF image transmission modes.

Call or write for our free catalog. Visa and Mastercard welcomed.

Software Systems Consulting
 615 S. El Camino Real, San Clemente, CA 92672
 Tel.(714) 498-5784 Fax.(714) 498-0568

CIRCLE 79 ON READER SERVICE CARD

THE MONITORING MAGAZINE

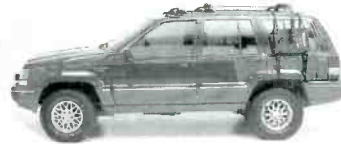

OWN THE WORLD'S BEST FOUR-WHEEL-DRIVE BASE STATION

Add a QMS Antenna Tuner System to your SSB.

\$895.00

The QMS is an SGC Smartuner® automatic antenna coupler, an SG-303 extended full-range antenna, and the special exterior—waterproof—mounting package, all in one.

The QMS is that large box strapped to the side. We admit, at first glance it looks a little unusual.

But once you use it, you'll find an almost unbelievable jump in reception and transmitting range (3-20 db). The QMS makes a typical HF-SSB perform like it's never performed before. Match it with a cutting edge SGC HF-SSB and it will blast holes through major mountain ranges and probably some laws of physics. Power and focus are everything in HF-SSB ham rigs. Buy this and own the best base station on—or off—the road.

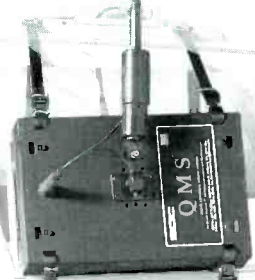

Mounting the tuner and antenna on the outside reduces engine noise and eliminates power-draining antenna wire runs between the antenna and tuner.

QMS. It's the look of focused power.

LEARN TO LOVE THE LOOK



**NO COMPROMISE
 COMMUNICATIONS**



1-800-259-7331

The SGC Building P.O. Box 3526 Bellevue, WA 98009 USA (206) 746-6310 Fax: (206) 746-6384

CIRCLE 76 ON READER SERVICE CARD

July 1995 / POPULAR COMMUNICATIONS / 61

SHORTWAVE SALE

Tremendous savings on Sangeans top of the line digital shortwave receivers.

**ATS
818CS**

PLL synthesized, dual conversion. AM-FM-SW digital receiver with programmable cassette recorder. 45 memory presets, and 150 - 29999 KHz continuous coverage w/BFO for SSB \$209.00

**ATS
818**

Same as ATS-818CS but w/o cassette recorder \$149.00

**ATS
808**

PLL synthesized, dual conversion. AM-FM-SW digital receiver 45 memory presets, 150 - 29999 KHz continuous coverage, 3 in. speaker, and local/DX selector \$135.00

**ATS
606P**

Ultra-compact. PLL synthesized, dual conversion. AM-FM-SW digital travel receiver 45 memory presets, 150 - 29999 KHz continuous coverage Comes w/pocket antenna \$145.00

All receivers come with AC adapter, full numeric keypad for direct frequency entry, auto-scan, dual local/UTC time display, sleep/timer alarm functions, and a full 1 yr. warranty. Models ATS-818/CS, ATS-808 have tricolor digital displays. Add \$5.00 for shipping. CA Residents please remit Sales Tax.

Toll Free 1-800-818-7780

At these great prices now is the time to buy a full featured Sangean digital shortwave receiver.



VISA

CHILTON PACIFIC LTD.
5632 Van Nuys Blvd., #222
Van Nuys, California 91401

GMRS

EMERGENCY Radios

- Hiking
- Skiing
- Traveling
- Fishing
- Camping
- Hunting

Communicate with others NOW using the most versatile radio available on the market today.

MAXON
GMRS-210+3
2-5 Watt portable
NOW Only \$ 210.00

(Comes with the nationwide emergency frequency, 462.675 MHz installed!)

Many other accessories are available: headsets, mobile antennas, speaker/mics and more. Mobile radios too!

GMRS RADIO SALES
P. O. Box 37825
Phoenix, AZ 85069
1-800-571-GMRS
Fax: (602) 878-6398

CIRCLE 87 ON READER SERVICE CARD

CALLSIGN STATION

BFV	Bulgarian Embassy Helsinki
BOK	Bulgarian Embassy Nicosia
CDH	Bulgarian Embassy El Djazair
COD	Bulgarian Embassy Beirut
CUJ	Bulgarian Embassy Lisbon
CWB	Bulgarian Embassy London
DMZ	Bulgarian Embassy Beirut
DTP	Bulgarian Embassy Stockholm
FIM	Bulgarian Embassy Madrid
FNZ	Bulgarian Embassy Baghdad
FOW	Bulgarian Embassy Bruxelles
GAT	Bulgarian Embassy Cairo
GIP	Bulgarian Embassy Luanda
GUB	Bulgarian Embassy Damascus
KIT	Bulgarian Embassy Kiev
LZO	Bulgarian Consulate Geneva
MIZ	Bulgarian Embassy Tripoli
OLG	Bulgarian Embassy Baghdad
ORB	Bulgarian Embassy Paris
PFR	Bulgarian Embassy Rome
PRO	Bulgarian Embassy Bonn
PZO	Bulgarian Embassy Warszawa
SDV	Bulgarian Embassy Berne
ZFO	Bulgarian Embassy Havana

DKI	UNID Bulg. Emb. (has been heard in QSO with ZFO)
GDO	UNID Bulg. Emb.
GPR	UNID Bulg. Emb. (has been heard in contact with BOK)
KSA	UNID Bulg. Emb.
I.ZF	UNID Bulg. Emb.
PMO	UNID Bulg. Emb. (probably EMB Washington D.C. or DIPL-mission New York)
VJZ	UNID Bulg. Emb.
ZLG	UNID Bulg. Emb.

These two lists (above, and the following page) of Bulgarian Diplomatic details were prepared by Leif Dehio, Germany, and forwarded via Ary Boender, Netherlands.

methodically addressed conditions affecting each vessel, offering advice for safe passage making, consolation when needed, and many favors that won't be forgotten."

Zel Eaton, MO, reported hearing Herb on 12359 kHz giving weather reports during February 1995.

JFF, IL, added some information, saying he also monitored Herb in November and December 1994 on 12359 kHz. JFF assumes Herb is in Canada, possibly the seaboard area, because it seems Herb was discussing snow and other local weather when talking with various Caribbean located vessels. His local weather matched the weather in eastern Canada.

Anthony J. Franz, FL, says his equipment includes a Realistic DX-390, and a 24-foot dipole that he constructed in his living room. In addition, he also uses PC Facsimile 6.0 and AEA FAXII for decoding CW, RTTY, and FAX.

We heard from W. Charles Alexander, OH, who said, "I am enclosing some of my UTE logs, mostly GHFS and USSTRAT-COM. I enjoy reading the column each month. I am 41 years old, and have been interested in shortwave radio for longer than I care to remember (my interest began between eight and ten years old)!"

Perry Crabill, Jr., VA, had a total of 1100 beacons logged as of the end of this past February. He stated, "Several morn-

ings I also heard European and African LW broadcast stations; the French station on 216 kHz shows up most often, with Luxembourg on 234 kHz, and Algeria on 198 kHz in there from time to time. I don't bother logging these because I consider them as interference."

Slawomir Stys, Japan, writes, "I am a fan of SW receiving, This past January I purchased POP'COMM where I found out that many people, like me, are monitoring the SW bands. Currently I am using the SONY ICF SW 55 receiver with a SONY wide-band antenna AN-1. In the near future, I plan to buy the AOR 3000A and a discone antenna to monitor 100 kHz-2036 MHz range."

Donald Tomkinson, CA, informed us, "I am using an Icom R71A with loop antennas made with coaxial cable and oriented N/S and E/W. These single turn loops also work well on most HF frequencies. I also use a 45-foot random wire; all of these antennas are located indoors as I live in an apartment. I have other SW radios and antennas, but the R71A and the loops work the best for beacons.

"The noise level here at my location in California has really been high. On some frequencies the blanking level has to be set at almost max. Normally it is set at about 1 o'clock. I modified the R71A with a product from Willco Electronics called the ICM-

MFA SOFIA

FREQUENCY	STATION	CALLSIGN	TIME UTC	RTTYMODE
8068,00	MFA Sofia	DOR	9,32	F1B-75
8088,00	MFA Sofia	DOR 2	8,37	F1B-150
10145,00	MFA Sofia	DOR	8,24	F1B-120
10154,00	MFA Sofia	DOR	14,48	F1B-75/ F1B-100/ F1B-120/ F1B-120 ASCII
10158,00	MFA Sofia	DOR	14,53	F1B-75
10240,00	MFA Sofia	DOR	13,20	F1B-75
11026,00	MFA Sofia	DOR	7,45	F1B-120
11164,00	MFA Sofia	DOR	20,05	F1B-100
11625,00	MFA Sofia	DOR	12,14	F1B-300 ASCII
12066,00	UNID BULG-DIPLO	DOR ???	12,18	F1B-210,23 ASCII
12072,00	MFA Sofia	DOR	14,45	F1B-75
			13,04	F1B-270.44 ASCII
12112,00	MFA Sofia	DOR	7,00	F1B-75
12124,00	MFA Sofia	DOR	10,26	F1B-75
12134,00	MFA Sofia	DOR	10,31	F1B-75
12138,00	MFA Sofia	DOR	11,39	F1B-75
12153,00	MFA Sofia	DOR	13,03	F1B-75/100/150
12161,00	MFA Sofia	DOR 2	11,10	F1B-300 ASCII
			8,33	F1B-120
12165,00	MFA Sofia	DOR	8,57	F1B-120
12178,00	MFA Sofia	DOR 2	8,45	F1B-150
12190,00	MFA Sofia	DOR 2	8,47	F1B-150
			12,50	F1B-600 ASCII
12223,00	MFA Sofia	DOR	20,45	F1B-75/ F1B-180 ASCII
12227,00	MFA Sofia	DOR	12,35	F1B-240 ASCII
			14,02	F1B-75
13413,00	MFA Sofia	DOR	10,21	F1B-75
13418,00	MFA Sofia	DOR	14,35	F1B-75
13938,00	MFA Sofia	DOR 2	8,55	F1B-120
14380,00	MFA Sofia	DOR	8,46	F1B-75
14387,00	MFA Sofia	DOR	10,00	F1B-75/120
14392,00	MFA Sofia	DOR	14,24	F1B-120
14426,00	MFA Sofia	DOR	16,00	F1B-120 ASCII/ F1B-75
				F1B-75
14433,00	MFA Sofia	DOR	14,30	F1B-75
14990,00	MFA Sofia	DOR	14,00	F1B-75
16015,00	MFA Sofia	DOR	12,17	F1B-75
16025,00	MFA Sofia	DOR	9,32	F1B-75
16036,00	MFA Sofia	DOR 2	8,30	F1B-120
16040,00	MFA Sofia	DOR	11,32	F1B-75
16048,00	MFA Sofia	DOR	13,42	F1B-75
16120,00	MFA Sofia	DOR	7,53	F1B-75
16336,00	MFA Sofia	DOR	15,14	F1B-75
16354,00	MFA Sofia	DOR	11,25	F1B-75
18035,00	MFA Sofia	DOR	10,05	F1B-75
18520,00	MFA Sofia	DOR	9,35	F1B-75
19160,00	MFA Sofia	DOR 2	9,27	F1B-150
			10,18	F1B-75
			8,53	F1B-75
20359,00	MFA Sofia	DOR		

1024. The receiver now has 32 banks of 32 channels, plus two VFO's for each bank, resulting in 1088 channels."

Here are some excerpts from a letter from Terry Weinhold, PA. "I am 39, and have been in the listening hobby about 20 years, a General-class ham 11 years, and I did some time as a Navy MARS operator.

"I was a SW broadcast listener for about eight years, joining NASWA back in 1976-77, but after I got my Ham ticket in 1984, I devoted most of my time to Hamming rather than SWLing. However, I recently got hooked in Utility stations, especially maritime coastal stations. In fact, I am now spending half of my radio time monitoring coastal stations."

In addition to his Russian Diplomatics loggings, Mark Chinsky, NY, said he had found some sort of official Russian voice net on 16222 kHz in the clear USB mode.

How about some of you Russian linguists checking this out? Mark did not indicate a specific time of operation for the activity.

Two well-known SWL clubs have passed from the scene. The Society to Preserve the Engrossing Enjoyment of DXing (SPEEDX) and the Association of DX Reporters (ADXR) have both disbanded.

The demise of these clubs seems to have been brought about by a combination of recent postage increases, a rise in printing costs, and a drop in membership renewals.

To remedy the situation, a "UTE only" electronic/hard copy club has gotten underway. The effort has been named, "The Worldwide UTE News Club." Richard Baker, OH, will be the editor of the electronic edition. Inquiries can be sent by e-mail to: ae411@yfn.yu.edu, while requests for the hard copy can be directed to Tim Braun, 15915 Smithey, Drive, Hay-

NEW! CAT-WHISKER NEW!

TIRED OF YOUR HANDHELD SCANNER ALWAYS FALLING OVER JUST TO KEEP THE ANTENNA "VERTICAL?"

Try our unique, swivel base, telescopic scanner antenna. Our new CAT-WHISKER lets you lay your handheld scanner on its back and still keep the antenna vertical!

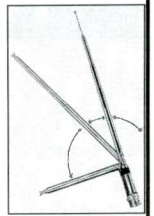

- Swivels to ANY angle
- Easily adjusts to any length AND frequency
- Fits ANY scanner with a BNC antenna connector
- Fits on BACK or TOP mount scanner antenna inputs

What other antenna will let you lay your handheld on a car seat and still receive?

CAT-WHISKER #1 (5 to 23 inches)\$19.95
CAT-WHISKER #2 (6 to 36 inches)\$24.95
(plus \$5.00 S & H)

COMPUTER AIDED TECHNOLOGIES

P.O. Box 18285, Shreveport, LA 71138
Orders (318) 636-1234
FAX (318) 686-0449 (24 hrs)
(See our ad on page 25, 37 & 70)



Get online with CQ on GENIE®



Look for us in the Radio & Electronics Roundtable

To join GENIE, use your computer & modem to call 1-800-638-8369.

At the U#= prompt, type JOINGENIE

And for a special introductory offer,

At the key/offer code prompt, type BWH528

CIRCLE 62 ON READER SERVICE CARD

FREE SHIPPING!

Portable Scanner Radio

Hurry, supply is limited on Uniden's 200-channel handheld scanner that features 12 band coverage (including 800 MHz, modifiable for cellular band) and 10 scanning banks! Includes a rechargeable battery pack, AC adaptor, carry case, antenna, earphone and FREE modification diagram. #BC200XLT



\$229

CB Radio w/ SSB

An industry leader, Cobra's SSB/AM radio features an RF gain control, noise blanker circuitry and an automatic noise limiter for superior reception! Includes SWR Cal control, Dynamike control, SWR/S-RF meter and much more! Factory Refurbished 148GTL with one-year warranty.

\$159

Quentent Communications

Ph: 408-998-2355
1000 S. Bascom Ave.
San Jose, CA 95128

VISA • AMERICAN EXPRESS • DISCOVER
MASTER CHARGE • MONEY ORDER

CIRCLE 71 ON READER SERVICE CARD

COMMODORE® USERS

SWL

SWL: A receive only cartridge for CW, RTTY (Baudot & ASCII) for use with Commodore 64/128. Operating program in ROM.....\$69.95
NOW \$49.95

ART-1: A complete interface system for send and receive on CW, RTTY (Baudot & ASCII) and AMTOR, for use with the Commodore 64/128 computer. Operating program on disk included...\$199.00
NOW \$169.95

ART-1

AIR-1

AIR-1: A complete interface system for send and receive on CW, RTTY (Baudot & ASCII) and AMTOR, for use with Commodore VIC-20. Operating program in ROM.....\$99.95

MORSE COACH: A complete teaching and testing program for learning the Morse code in a cartridge. For C64 or C128.....\$49.95
VEC SPECIAL.....\$39.95

MORSE COACH

G AND G ELECTRONICS
OF MARYLAND

8524 DAKOTA DRIVE
GAITHERSBURG, MD 20877
(301) 258-7373



CIRCLE 151 ON READER SERVICE CARD

YOU AIN'T HEARD NOTHIN' YET

Since 1967, CRB Research has been the world's leading publisher and supplier of unique hobby and professional books and information including:

- Scanner Frequency Guides
- Shortwave Frequency Guides
- Military/Federal Communications
- Undercover Communications
- Survival Communications
- & Other Related Topics!

New titles are constantly being added to our exciting catalog. If it's interesting and unusual, we've got it. You'll see. Ask for our latest FREE catalog.

**Ask For Big
Free Catalog**

CRB RESEARCH

P.O. Box 56, Commack, NY 11725
Phone: (516) 543-9169
FAX (516) 543-7486

CIRCLE 11 ON READER SERVICE CARD



Monitoring position of Kevin Tubbs, VT. Note the souvenir banners on the wall.

market, VA 22069 (please include a SASE with your request).

In the February column, an unidentified beacon was reported by Bjorn Vaage. CA, on 397 kHz. William R. Mayer (state not given) advises beacon LLJ is in Challis, ID. Now on to this month's UTE loggings!

UTE Loggings SSB/CW/RTTY/SITOR/etc. All Times in UTC.

- 50.000: OMA. Liblice. Czech time/signal station in CW at 1722. (AB)
- 71.138: DECCA station Hjorring. Denmark. Danish chain, purple freq. Hrd 1720 w/pulses.
- 73.250: Probably RAF Crimond w/75 bd RTTY crypto mssgs. Hrd at 1808. (AB)
- 77.500: DCF77, Mainflingen, Germany time/signal station in CW at 1726. (AB)
- 84.550: DECCA station Gilze-Rijen. Holland chain, master freq. Hrd at 1612 w/pulses. (AB)

Abbreviations Used For Intercepts

AM	Amplitude Modulation mode
BC	Broadcast
CW	Morse Code mode
EE	English
GG	German
ID	Identification/led/location
LSB	Lower Sideband mode
OM	Male operator
PP	Portuguese
SS	Spanish
tfc	Traffic
USB	Upper Sideband mode
w/	With
wx	Weather report/forecast
YL	Female operator
4F	4-figure coded groups (i.e. 5739)
5F	5-figure coded groups
5L	5-letter coded groups (i.e. IGRXJ)

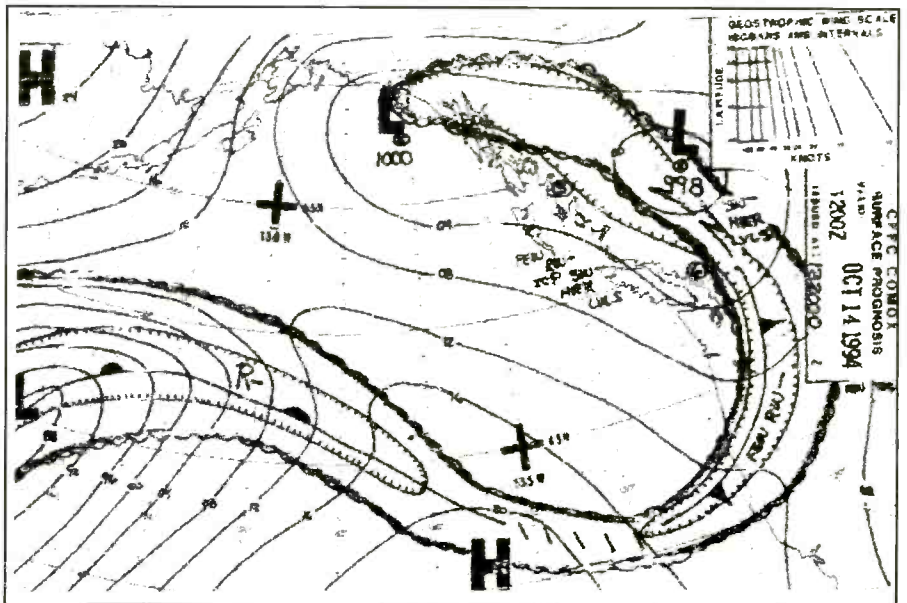

Floyd Hutson, CA, received this FAX on 12755 kHz, LSB, 120/576.



NATIONAL AERONAUTICS AND SPACE ADMINISTRATION AIRCRAFT

NASA 426

TO RADIO AAAJN - THIS CONFIRMS YOUR RECEPTION OF HF, USB RADIO TRANSMISSIONS AS INDICATED BELOW

DATE: 19 SEPT 94 TIME: 0227 Z FREQUENCY: 8861 KHZ
 A/C HOME BASE: Wallops Island, Virginia 23337-5099
 A/C TYPE: P-3B Orion TAIL #: N426NA
 APPROX. LOCATION: 15N 20W

REMARKS: NASA 426, a former Navy Orion now operated by NASA, was underflying the flight path of the Orbiter Atlantis (STS-64). The aircraft had departed from Ascension and was en route to Ponta Delgada, Azores.

George W. Postell, Chief Pilot

SIGNATURE/TITLE

Here is a PFC from the collection of Jim Navary, VA.

113.330: DECCA English chain, Shotishan, Red freq. Hrd 1719 at 1619 w/pulses. (AB)

128.580: DECCA station Heiloo. Frisian chain, Green freq. Hrd at 1619 w/pulses. (AB)

196: Beacon FRN, Fort Richardson, Anchorage, AK. (GB)

206: Beacon GLS, Galveston, TX at 0724. 1559 miles. (AH); Beacon QI, Yarmouth, NS, Canada. (RC)

211: Beacon K7, St. Ann des Montes, PQ Canada at 0559. 400 Hz. (PC)

212: Beacon BCC, Bear Creek (Tanana), AK. (GB)

214: Beacon GYN, Gallatin, TN, at 0105. (JB); Beacon CHX, Choix, Mexico at 0838. (SF)

223: Beacon YKA, Kamloops, BC, Canada at 0920. (SF)

227: Beacon SJY, San Jacinto/Hemet, CCA at 1820. (DT); Beacon LA, Lakeland, FL, at 0741. 1120 miles; Beacon LCE, La Ceiba, Honduras at 0945. 2011 miles. (AH)

236: Beacon GNI, Grand Isle, LA w/cw & voice. Announced "...regular broadcast will be resumed at 1100 Zulu (etc)." Hrd 0538. (JB)

240: Beacon LE, Lewiston, ME. (RC)

241: Beacon YGT, Igloolik, NWT, Canada at 0753. 1960 miles. (AH)

242: Beacon OZW, Howell, MI. (RC); Beacon GM, Milwaukee (Gen. Mitchell Flid—Teels), WI. Passes wx. (A)

244: Beacon BA, Barranquilla, Colombia at 0908.. 2135m. (AH)

245: Beacon FS, Sioux City, SD at 0746. DSB; Beacon LFB, Lafayette, TN at 0501. (PC)

248: Beacon HZP, Zionsville, IN at 1845. (RH)

257: Beacon CGE, Cambridge, MD at 0803. (JO)

260: Beacon YSQ, (DAID) Atlin, BC, Canada. (GB)

265: Beacon EDE, Edenton, NC at 0755. (JO)

272: Beacon UTO, Indian Mountain, AK. (GB)

277: Beacon YLC, Lake Harbour, NWT, Canada at 0715. 400 Hz. 1671 miles. (PC)

278: Beacon OS, Los Angeles Int'l (LAX), CA at 2259. (BV); Beacon ADG, Adrian, MI. (RC)

279: Beacon CEP, Ruidoso, NM at 0850. (SF)

282: Beacon GWF, Lancaster Fox Field, CA at 2300. (BV)

284: Beacon TEH, Bogota, Colombia at 0902. 2556m. (AH)

287: Beacon MKP, McKeesport, PA. (RC)

288: Beacon NCE, Portsmouth Harbor, NH at 0839. MCNT, new freq, ex-322 kHz. (PC)

290: Beacon AOP, Rocksprings, WY at 0900; Beacon YYF, Penticton BC, Canada at 1110; Beacon YYH, Spence Bay, NWT, Canada at 0620. (DT)

290: Beacon TVK, Centerville, IA. (RC)

292: Beacon DF, Dana Point, CA. Off the air! Was on 24 hours a day. (DT)

293: Beacon TOR, Torrington, WY at 0903. (SF)

294: Beacon ZIP, Zipaquira, Colombia at 0750. 2529m. (AH)

298: Beacon HL, Cape Henlopen, DE at 0750. (JO); Beacon MK, Milwaukee WI at 0610. MCNT. (PC)

300: Beacon ABL, Ambalema, Colombia at 0721. 2562m. (AH); Beacon C, Mobile Point LS, AL at 0324. (JO)

301: Beacon X, u/i at 2045. MCNT: FSK on carrier, peaks E/W. (PC)

302: Beacon L, Point Loma Light Station near San Diego, CA. Hrd at 2302. (BV)

304: Beacon BN, Nashville, TN at 0846. (JD)

307: Beacon LUX, Laurens, SC at 0307. (RH2)

312: Beacon FVM (DAID) Five Mile (Pipe Line Camp), AK. (GB)

314: Beacon VM, Ventura Marina, South Jetty Light No. 2, CA at 2305. (BV)

911 ACTION!

ACTION!



Don't miss all the action!!

Join the Bearcat Radio Club Today!!

The Bearcat Radio Club membership offers:

1. The *National Scanning Report*, America's #1 all-scanning magazine. A FREE year subscription to every member.
2. A FREE frequency list for your county.
3. FREE access to our computer bulletin board and national frequency database -- members only.
4. FREE Classified ads - Buy, Sell or Trade.

TWO GREAT LEVELS OF MEMBERSHIP

ASSOCIATE MEMBERSHIP - \$19.90

Includes all of the benefits listed above.

FULL MEMBERSHIP - \$29.90

Includes all of the benefits listed above PLUS a free copy of the *Betty Bearcat Frequency Directory* book (a \$14.95 Value)

Join TODAY!!

Call 1-800-423-1331

Bearcat Radio Club, P. O. Box 291918, Kettering, OH 45429

UNLOCK FULL 800 MHz

FREE CELLULAR FREQUENCY CHARTS

\$40

CLASSIC SCANNERS

PRO 34,37,39,43,46,2004,5,6

2022,26,27,30,32

BC 200,205,2500,700,760

855,890,950

Over 1500 Satisfied Customers

Same Day Service...

FREE Insured

UPS Return

FOR DETAILS CALL:

508-281-8892

SHIP TO:

**Cellular Security Group
 37 Causeway Street
 Gloucester, MA 01930**

Note: Certain modifications may be in violation of F.C.C. rules and regulations. Cellular Security Group assumes no further responsibilities beyond those stated in this ad.

Note: ONLY the "classic scanners" listed above can be unlocked and some are restricted by the date of manufacture.



SURVEILLANCE

& COUNTERSURVEILLANCE Electronic Devices

Hidden Video Cameras • Electronic Kits • Voice Changers
Bug and Phone Tap Detectors • Shotgun Mics • Micro Recorders
• Vehicle Tracking • Locksmithing • AND MORE!

Extra Long Play Telephone Recorders - Silently Tapes **\$125.00**
Incoming/Outgoing Phone calls automatically... and up

SPY FOR CATALOG SEND \$5.00 TO...P.O. Box 337,
OUTLET Buffalo, NY 14226 (716) 691-3476 - (716) 695-8660

C. CRANE COMPANY

COMMUNICATION

Shortwave • Scanners • Antennas
SANGEAN, GRUNDIG, DRAKE, UNIDEN, AOR

The most powerful loop antennas for
Shortwave/MW and much more!

International shipping

558-10TH ST. FORTUNA CA 95540

Free Catalog FAX 707-725-9060

800 - 522 - (TUNE) 8863

CIRCLE 56 ON READER SERVICE CARD

MONITOR WITH THE PRO'S

The World Scanner Report

published 10x/yr for casual hobbyists • follows the latest
technology of scanning the radio frequency spectrum from
DC-to-daylight • consumer & hobby electronics • do-it-
yourself scanner/receiver projects. • SASE or 2 IRC for info, or
US Funds: \$4/ea. \$25/yr. Canada*15%; foreign*25% surr/50% air; MCVISA ok

COM Electronics Engineering; PO Box 262478; San Diego, CA 92196

CIRCLE 55 ON READER SERVICE CARD

To Order Back Issues

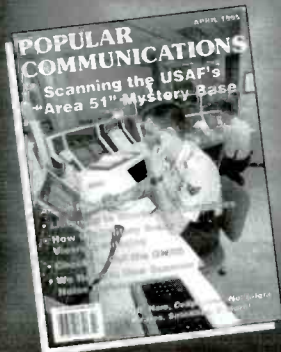

Only
\$3.50
Per
Issue

When ordering back issues include the following information: Name, address, city, state & zip. Please make a list of the issues you're requesting. When paying by credit card send the number along with the expiration date. Check, Money Order, Mastercard, VISA, Discover and AMEX accepted.

Complete your collection today.

1-800-853-9797

or Fax 1-516-681-2926

Popular Communications
76 North Broadway
Hicksville, NY 11801

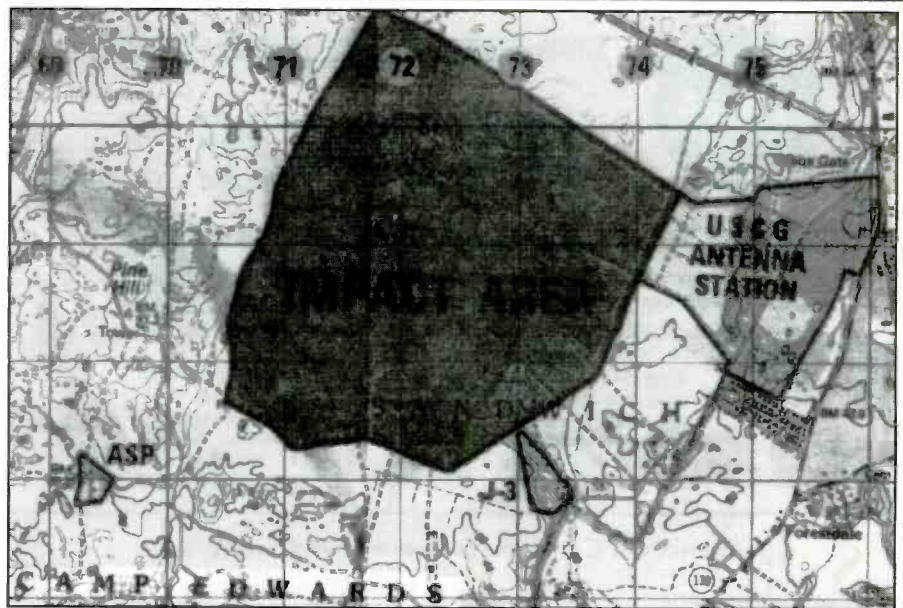

This map shows the location of the NMF antenna farm. Photos were taken by Kevin Tubbs, VT.

- 315:** Beacon BL, Salinopilos, Brazil at 0736. 3274m. (AH)
- 317:** Beacon CBE, Cumberland, MD at 0842. (JO)
- 320:** Beacon FLA, Florencia, Colombia at 0637. 2771m. (AH); Beacon HTN, Miles City, MT at 0936; Beacon YQF, Red Deer, Alberta, Canada at 0945. (SF)
- 323:** Beacon TAB, Crown Point, Tobago at 0800. 2193m. (AH)
- 326:** TWEB UMM, Summit, AK. (GB)
- 327:** Beacon FXC, Cayenne, French Guiana at 0754. 3793m. (AH)
- 329:** Beacon AAU, Ashland, OH at 1952; Beacon CH, Charleston, SC at 0156. (RH2); Beacon AAA, Lincoln, IL. (RC)
- 337:** Beacon NA, Santa Ana (John Wayne), CA at 2307. (BV); Beacon HM, Tokyo (International—Hameda), Japan at 1235. (SS)
- 338:** Beacon PBT, Red Bluff, CA at 1010. Aviation wx. (DT); TWEB CMQ, Anchorage, AK. (GB)
- 341:** Beacon AK, Oakland, CA at 0808. (SF)
- 344:** Beacon JA, Jacksonville, FL at 0920. (JD); Beacon FCH, Fresno Chandler Municipal, CA at 2309. (BV)
- 347:** Beacon CH, Chitose, Japan at 1400. (SS); Beacon LFA, Klamath Falls, OR at 0930. (SF)
- 353:** Beacon ZES, Vancouver Island, BC, Canada at 1025. (DT); Beacon LLD, Lanai, Hawaii at 0902. (SF)
- 357:** Beacon RB, Eda, Japan at 1237. (SS)
- 360:** Beacon VEL, Velasquez, Colombia at 0615. DSB? 2304m. (PC)
- 365:** Beacon PBC, Mt. Pleasant, TN at 0927. (JD)
- 367:** Beacon HA, Hao Atoll, French Polynesia at 0657.0 CW ID, DAID. 56574 miles. (PC)
- 368:** Beacon OH, Chicago, (O'Hare—Leana), IL. (A)
- 369:** Beacon SLOP, Shelby, NC, at 0436. (RH2); Beacon ZDX, St. John's, BWI at 0832. (JO)
- 370:** Beacon PAI, Pacoima (Barton Heliport), CA at 2311. (BV)
- 372:** Beacon ORH, u/i at 0506. 400 Hz? peaks N/S.
- 373:** FQ, u/i at 1241. (SS) Possibly PQ, Tateyama, Japan. (Ed.)
- 378:** Beacon CPM, Compton, CA at 2312. (BV)
- 380:** Beacon BBD, Brady, TX at 0911. (SF); Beacon COL, Barra del Colorado, Costa Rica at 1144. 2247m; Beacon BR, Egilsstadir (Breidavadi), Iceland at 1248. (SS); Beacon SJX, St. James, (Beaver Island), MI at 0358; Beacon VKS, Vicksburg, MS at 0212. (RH2)
- 383:** Beacon PI, Pocatello, ID at 0920. (SF)
- 385:** Beacon GAI, Gaithersburg, MD at 0712. (JO); Beacon BF, Bakersfield (Meadows Field), CA at 2314. (BV)
- 387:** Beacon PV, Turks and Caicos, BWI at 0638. 1366m. (AH)
- 388:** Beacon BOG, Bogata, Colombia at 0534. 1000 Hz. 2382m. (PC)
- 390:** Beacon HK, Kagoshima, Japan at 1407. (SS)
- 391:** Beacon SWZ, Smyrna, TN at 0936. (JD); Beacon EBY, Neah Bay, WA at 0841. (SF)
- 392:** Beacon CF, Chesterfield, VA at 1041. (JO)
- 394:** Beacon OR, Chicago (O'Hare—Roamy), IL. (A)
- 400:** Beacon UWI, Dalton, GA at 0627. Spurior sidebands. (PC); Beacon BGA, Bucaramanga, Colombia at 0858. 2397m. (AH); Beacon SJE, San Jose del

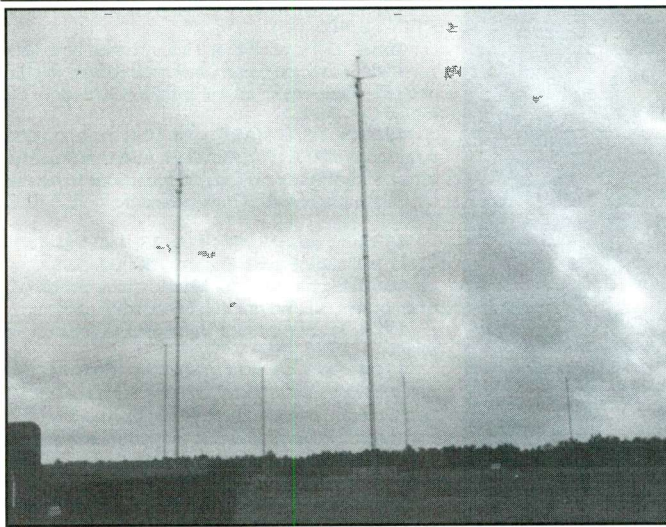

Portion of NMF antenna installation

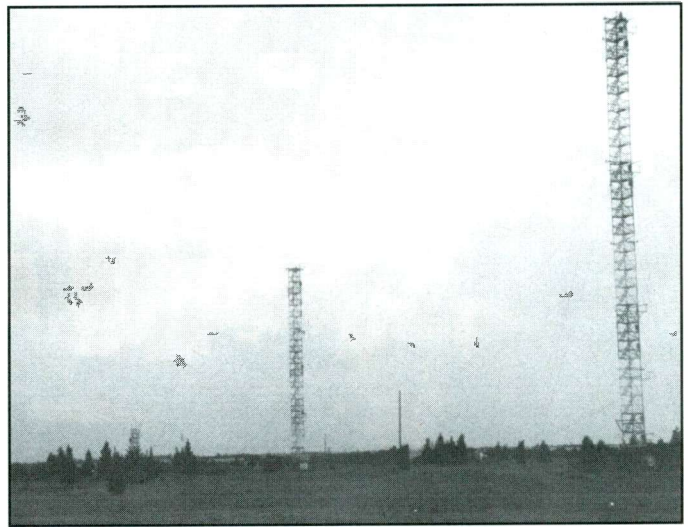

METEO station towers.

Guaviare, Colombia at 1015. 2694m. (AH)
401: Beacon DF, Zama, Japan at 1252. (SS)
403: Beacon R, Toronto, Ont., Canada at 0353. (RH2)
404: Beacon MOG, Yreka, CA at 1255. Aviation wx. Ex-382. (DT)
406: Beacon OK, Oklahoma City, OK at 0652. DSB. (PC)
407: Beacon RVB, Mobridge, SD at 0706. (PC); Beacon RZZ, Roanoke Rapids, NC at 0357. (JO)
410: Beacon NZJ, Santa Ana (El Toro MCAS), CA at 2315. (BV)
412: Beacon MTU, Mitu, Colombia at 0758. 2793m. (AH)
413: Beacon CBC, Anahuac, TX at 0952. (JD)
414: Beacon IA, Chicago (O'Hare—Taffs), IL. (A); Beacon CSS, Washington Court House, OH at 2111. (RH2)
415: Beacon HZE, Hazenden, ND at 0748. New freq; ex-205 kHz. (PC)
419: Beacon GB, Great Bend, KS at 0437. DSB. (PC)
425: Beacon PCA, Punta Cana, Dominican Republic at 0906. (AH)
426: Beacon IZS, Montezuma, GA at 0634. (JD)
427: Beacon BTS, Dillingham, AK. (GB)
429: Beacon JNM, Monroe, GA at 0406. (RH2)
518: Netherlands CG NAVTEX, Station PBK w/gale wrngs at 1904 & 2124, FEC 100 at 1904. (AB)
519: Beacon EAA, Eagle, AK. (GB)
524: Beacon HEH, Newark, OH at 0344. (JO)

529: TWEB FDV, Nome, AK. (GB)
530: TIS at LAX Airport, CA. On 24 hrs, wipes out local freeway TIS's! (DT)
2182: U/i USCG station in USB at 0439 issues Hurricane force warning. Opr was OM in EE & SS. (ML); VAU, Yarmouth CG Radio at 0140 in USB w/kg S/V Mirage for distress comms. Vessel taking on water, is several hundred miles off Florida coast and could not hr USCG stations. At 0230 Mirage reports may have to abandon ship. Later, CG rescue swimmer stranded in raft after cable broke but later rescued by SH-60 fm Navy cruiser. (RB)
2295.8: Believed be HFVBR, Landeskriminalamt or LKA (German State Police), Station HFVBR in ARQ-E 96/425 at 0700 idling in ARQ-E. These are supposed to be MOI stn runs by LKA. (RB)
2670: NMA21, St. Petersburg, FL at 0320 w/wx forecast. (AF)
2702: Two-tone channel mkr at 2312 in CW for UK Coastal control. (AB)
2863: Tokyo Meteo report for Tokyo, Fukuoka, Kansai, Seoul. EE & YL oprs. Hrd at 1310 & 1340. Also on 6679, 8828, 13282 kHz. All in USB. (SS)
2975.2: U/i CW net hrd at 0801 involving stns FRE, WUI, and MDK. Stns pass 5L grps. Preambles to mssgs are very distinctive: PBL NR 03 QSO NR 80793 QTR 03:05 BT RN 133 BT AAA LT LT VVV BT. (GH)
3039: Stn Bravo Foxtrot hrd in USB at 0752 wkg stns Foxtrot, Golf, India, Lima, November, and Mike (simplex comms). Advised that callsign for track 3333 would be Scout 705. Was asked if Scout 705 was com-

ing up to the Playground. Mention of Einstein and Red Crown. Possible Navy exercise. (GH)
3262: SLHFM "P" in CW started at exactly 2100 w/3 grps of 5 P's foll by RMP (Navy Kaliningrad) then into wx forecast for Baltic area. Also hrd another day at 1900 & 2300. Sent "P" for three mins then went silent on each sked. (AB)
3278: P7X in CW at 0152 sending 5FL grp mssgs. Same type preambles and 120 grp count mssgs prev noted on 5125 kHz w/callsign E9I. (TS)
3280: OLX, MOI Prague in CW at 0200 w/mssg for 246; at 1900 w/mssg for 168; at 2100 w/mssg for 244. Callup was VV DE OLX. Tfc in 5F grps. (AB)
3357: NAM, Norfolk, VA w/FAX chart at 0140. (AF)
3455: Aeroflot 356 in USB at 0538 w/kg New York w/position report over TROUT (off Florida's northern coast). (GH)
3485: At 0110 very slow CW w/NVLK NVLK NVLK HXVH HXVH HXVH w/NY Volmet in background. (SM)
3707: Scrambled speech in USB at 0757. (TS)
3757.1: CW pip every second. Hrd 1858. (AB)
3823: First Monday of month. YL/unknown rptng "SIM PITYORKA PITYORKA CHETA NUL NUL" (755/00) fm 2100-2105, then off. (SM)
4030: "Atencion Cuatro Dos Uno Cuatro Nueve; then into 5F grps at 0200. (AF)
4081.3: CW beep every four sec. Duration of beep two sec. Hrd at 1856. (AB)
4146: OM/EE discussing oil rig explosion: 38 killed, one missing. Sounded like Cajun accent. Hrd 0200-0210 in USB. (RK)
4174: WFKW, M/T Overseas New Orleans, U.S. flag, product tanker heard at 0522 in ARQ w/time log tix for Port Everglades to Mobile Oil Marine Dept. (RB)
4270: CFH, Halifax Naval, NS, Canada at 0351 in RTTY 75/850 w/meteo. (TS)
4357: WAH, St. Thomas Radio w/wx forecast. 0230 sked every night. (AF)
4463: OM/RR w/824 824 824 1 fm 2020-2025. then 2447 65 2447 65 and into 5F grps. At 2030 MOSSAD YL w/FTJ on top of RR 5F stn. (SM)
4468: YL/EE at 0136 in AM. (KW)
4469: CAP stn Red Star 4 wrking Red Star 424 in USB at 0333 discussing nbrs stn that interferes w/CAP net on this freq. Nbrs stn is the daily 0100 YL/EE sked on 4470 kHz. (TS)
4470: YL/EE w/1-0 count and 808 on FRI at 0100. After ten tones Count 186 and into 3/2F grps. (SM); YL/EE at 0100 w/3F x3 foll by ten count. Rpts sequence for ten mins. Then 3/2F grps. Sig so strong it can be hrd w/antenna disconnected. Some days there is earlier sked at 2300 on freq. Format is same. Copied above w/DX-392 and 200-foot vertical longwire held aloft by surplus wx balloon. I was in the middle of a cornfield 40 miles due west of Chicago. Cold and wet, but no QRM! (JFF)
4480: MOSSAD stn ULX2 on unusual freq at 2230. Usually 4880 kHz. (SM)



**NCOM:
USNS COMFORT
(T-AH-20)**

THIS WILL VERIFY RECEPTION OF:
HOSPITAL SHIP USNS COMFORT (T-AH-20)
ON: 12590.0 SITOR AT: 0158 Z DATE: 29 JUNE 1994

TRANSMITTER/POWER: 700w

ANTENNA: 35 FOOT WHIP 120' OFF THE WATER

LOCATION: JAMAICA

VERIFYING OFFICIAL: MASTER RICHARD BAKER, USNS COMFORT (T-AH 20) MILITARY SEALIFT COMMAND, ATLANTIC FPO, NEW YORK, NY 09566-4008

*C. J. Moore R/O
N620/645*

Richard Baker, OH, shares his PFC with readers.

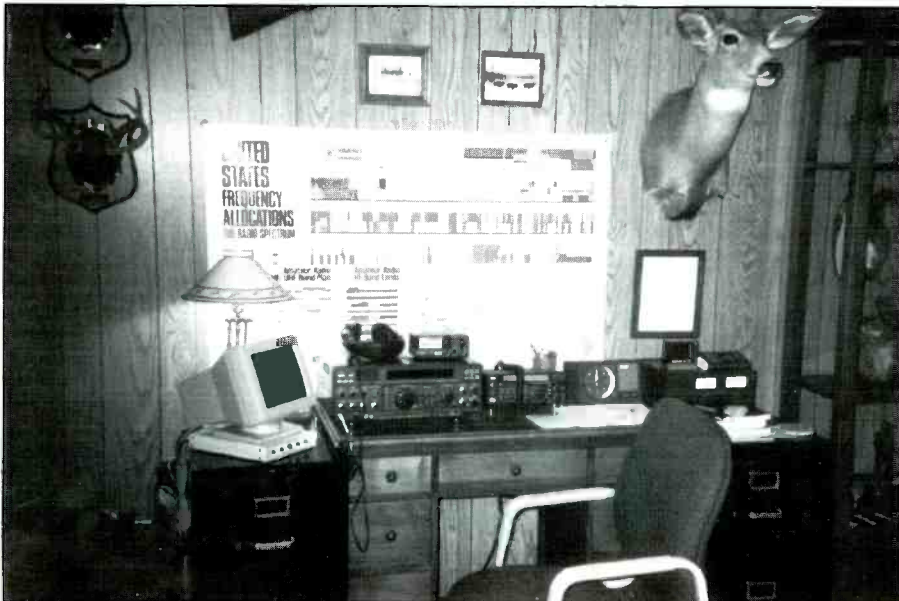

This photo shows the shack of Richard L. Sumner, IN.

CB RADIO OWNERS!

We specialize in a wide variety of technical information, parts and services for CB radios. 10-Meter and FM conversion kits, repair books, plans, high-performance accessories. Thousands of satisfied customers since 1976! Catalog \$3.

CBC INTERNATIONAL
P.O. BOX 31500PC, PHOENIX, AZ 85046

PAY TV AND SATELLITE DESCRAMBLING

all new info **VOLUME 6** all new info

Volume 6: Our entire collection of all current cable satellite and wireless turn-ons.

- Pay TV Volumes 1-5 (all different Vol. 1 basics)
- Wireless Cable Hacking
- Complete Wizard (VCL+)
- Satellite and DBS Handbook (includes Hacker info)
- Hacker Video
- Cellular Phone Hacking

\$15.95 each or 3/\$34.95 or 5/\$52.95
Newsletter \$29.95/12 issues. Catalog \$1.
All our info \$129.95 (includes sub)

SCRAMBLING NEWS
3494 DELAWARE AVENUE, BUFFALO, NY 14217-1230
Voice/FAX (716) 874-2088 BBS (716) 871-1915

CIRCLE 77 ON READER SERVICE CARD

WINDOWS™ Control for Scanners

ScannerWEAR™ SoftControl 1.3

NOW SUPPORTS:

- OptoScan 456/535
- AOR 3000/3000A
- ICOM R7000/7100

- Memory banks include 100 channels per bank with frequency, description and mode.
- Search ranges include frequency, step, mode and description.
- Data logging to the file includes date and time stamp, signal strength, tone and number of hits, location*.
- Spectra analysis in real time.
- CTCSS & DCS controlled scanning.
- OPTOSCAN 456/535 now in stock for \$289

ScannerWEAR™ SoftControl STD Windows control for all your basic scanning needs. **\$39.00** Plus tax & shipping

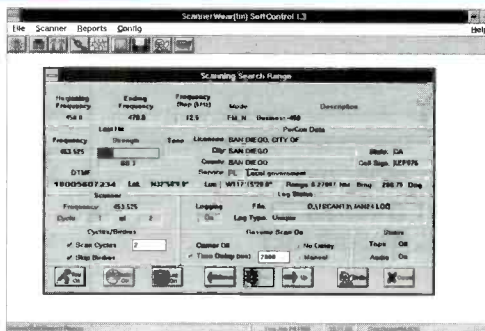

\$99.00 Plus tax & shipping

R·C·S·I
Radio Control Systems, Inc.

CALL (800) 560-7234

Tech Support (619) 560-7008; 10am-4:30pm PST
8125-G Ronson Road, San Diego, CA 92111
VISA, MasterCard, UPS COD

4489: GFL, Bracknell Meteo w/coded WX in RTTY 50/400. (TS)

4560: YHF2 in USB at 1830. Mossad bcst. (AB)

4585: Crescent 6 and Crescent 2 (USAF) in USB at 0121 discussing check-out flight in Charleston. SC for u/i Col. (ML)

4593.5: USAF MARS net in USB mode at 0033 w/net control AFA1FQ, AFA1UN, AFA1LM (Pennsylvania), and AFA1LE. 1FQ asked for anyone to take t/c for Pittsburgh. and AFA1UN passed t/c to AFA 1LE. (DS)

4594: At 2000 YL/GG rptng 736 foll by 804 804 71 71 and into 5F grps. Ended w/00000. (SM)

4663: Irkutsk meteo for Irkutsk, Chita, Ust-Ilimisk. Krasnoyarsk, YL/EE opr in USB at 1305. (SS)

4722: Royal Air Force Volmet w/wx forecast for aviation at 0225. (AF)

4724: Skier 48, a LC-130H fm 109th AG (NY ANG) at Niagra Falls. NY at 2323 in USB wkg Andrews GHFS (or pp, Albroom. These ski equipped a/c fly DEW Radar and OP DEEP FREEZE support missions. (RB)

4780: At 1815 YL rptng Kilo papa Alpha 13 Papa. (SM)

4931: B3Z (English) requesting W9Q (American) to receive Alligator. WOF and OME also involved at 2238. W9Q said "Grid 4304 is unable to release to Alligator." (SM)

5046: YL/EE announcing 102 102 102 then 1-0 count at 0102 and then 3/2F grps at 0117 in AM. (KW)

5197: Halifax Military wkg Nippigon w/pp concerning if Lt. Copeland will be taking Nippigon to sea for next deployment. Hrd at 0159. Answer was "Negative, he will be in the UK." (AF)

5266: Sweep jammer here at 0234. (TS)

5277: Panther. U.S. Customs facility, Bahamas at 2334 in USB wkg 76Y (a/c) for position report, 26 miles fm "XY." (RB)

5306: SLHFM "C" in CW at 2335. (AB)

5328: OM/RR at 2200 w/571 571 1. At 2205 2937 96 2937 96 and into 5F grps. Rpid at 2200 on 4642 kHz. (SM)

5420: Nbr stn in CW w/DDM AAT DPM DD AAT (cut nbs) then into 5F grps. Hrd at 0100. Ended w/AR at 0113. (AF)

5547: YL/EE in USB at 0227 advises NW 108 to tune to 8843 primary. 8874 secondary to contact Hawaii. (ML)

5696: C4Y wkg Rescue Leader One in USB. Pilot has spotted man floating on wreckage. Were trying to rescue. Later, USCGC Point Steele arrived on scene (Pt. Steele is SAR Cutter out of Cleveland) to assist as man too weak to grab life rope dropped from copter. Man brought aboard cutter and taken to hospital. Hrd fm 2200-2250. (RK); During attempted rescue on sailing vessel Mystic, rescue swimmer in water and injured. All hands rescue in progress w/Rescue a/c 1502, 1504, 1714. and 6019 plus injured swimmer's helo and rescue 6034. Also USN Cruiser Relentless and her helo Cutlass 462. Swimmer was lost for some time but relocated on his raft approx 6 mi. from location of Mystic. Swimmer had lost feeling in right leg and drifting in-out of consciousness. was seasick and had capsize several times. Swimmer picked up by Rescue 6034 at approx 0600 EST then transported to Relentless for medical evaluation. Cutlass 462 hoisted remaining POB Mystic to safety. Other stns hrd were COM-SALANT Chesapeake, Miami Ops (p/p) & Air Station Elizabeth City. (DC)

5697: Feedback-type sig, several tones rising in pitch one after the other. This was interspersed w/white noise xmsns. (TS)

5748.5: U/i CW stn X282 hrd at 0839 clg TQ2A. No joy. (GH)

5750: OM/EE at 0506 w/5F grps. Signs off w/0000. (TF)

5834: At 1800 YL w/Union Susan Peter then QRU and off. (SM)

6273: UUF, THRP Gruzuya, passenger ship. at 0553 in ARQ w/EE t/c to Black Sea Lines after sending Selcal XVSQ, for WCC. Chatham Radio. (RB)

6604: NY Radio in USB at 0206 w/wx forecast. (ML)

6628: A/c ?LGO?447 reports position & flight level 310 to NY Aeradio in USB at 0042. NY advised flight to contact Santa Maria on 5598 primary. 3016 secondary after reaching 40W. (DS)

6676: Singapore Meteo in USB w/wx for Singa-

Reception verification letter received by Steve McDonald,
BC, Canada.

Dear Mr. McDonald,

In response to your letter dated March 25, 1993, I can tell you the intercept you recorded is correct. I will give you as much of the information you requested as I can.

Call Sign: Even though NADY is our call sign, that call was not used on the circuit in question. International call signs are:

Voice - USS SHREVEPORT
CW/Teletype - NADY
Aviation Voice - MOHAWK

Frequency/Mode: 5698 Khz assigned frequency, USB, Voice

Date/Time/Location: The best I can tell you without becoming classified is that 17 Mar 93, USS SHREVEPORT was off the coast of Virginia involved in a real time Sea Air Rescue (SAR) mission. The mission lasted over one week.

Equipment: SHREVEPORT High Frequency transmission equipment is standard U.S. Navy issue/installation. Transmitter: AN/URT-23, tunable approximately 2-30 Mhz with a Peak Envelope Power (PEP) in CW mode of 1000 Watts. This transmitter feeds an Omnidirectional Broadband Discage Antenna (located on Forecastle as seen in photograph)

This is the second QSL request SHREVEPORT has received from that SAR operation. The last radio operator requesting QSL was from upstate New York. It is a pleasure to hear our transmitters work well enough to reach Vancouver B.C., it is also disturbing to find out my operators are increasing power more than what is required to reach the intended receiver. This is however, the problems with HF communications. I also think the HF propagation was exceptionally good that night. The United States Navy does not work in the High Frequency Band much anymore. Most transmissions are FM, VHF, UHF, AND SHP in both line of sight and satellite communications using voice and data transmission modes. HF like CW is becoming a dinosaur.

Sincerely,



S. P. HORVATH
CWO, W4 USN
COMMUNICATIONS OFFICER
USS SHREVEPORT (LFD-12)

Reception verification letter received by Steve McDonald, BC, Canada.

pore, Kuala Lumpur and other cities. OM/EE opr at 1322. (SS)

6683: Air Force One wkg Andrews w/signal ck. Hrd at 2118. (NP)

6730: Roll Call clg Nightwatch. Wanted know if stn could do a data circuit. USB at 0532. (WCA)

6738: Architect in USB at 2303 w/RAF airfield wx. (TS)

6753: Canadian Forces VOLMET fm St. Johns Military in USB mode fm 2240-2249. Was YL/EE, very strong sig. She had bad case of giggles for good part of bcst. Must have been having good time because I hrd assorted rowdiness in background. (DS)

6780: Every WED YL/EE w/1-0 count foll by 207 at 1700. After 10 tones Count 126 and into 5F grps. Also on 8085 kHz. (SM)

6826: YL/SS in AM mode at 0308 w/5F grps. Same opr noted concurrently w/similar ttc on 8136 kHz but not //. (DS)

6840: YL/SS at 0231 rptng 6050 9185 9042 9096 5950; YL/EE at 0101 rptng 416. (JD)

6981: Chatter between various CFARS stns in USB fm 0147-0206. Calls incl CIW2105 and CIW8102. One of stns apparently located in British Columbia, judging from ref's to BC TV. (DS)

7445: YL in USB at 0429 rpt MIW in phonetics til 0432. Then "Message message. Group 4-0, group 4-0, Text, text." Foll by 5L phonetic grps. (DS)

7452: SLHF "R" in CW at 1848. (AB)

7535: SESEF Norfolk: At 1721, the Paul Hamilton clg SEAGULL control, foll by Norfolk SESEF & into testing. Also ID'ed as Newport News Shipyard. At 1732, NNCD, USNS San Diego (T-AFS-6) former USS San Diego, (AFS-6) w/start of HF rdo tests. At 1751, NYKN, USS Yorktown (CG-48), w/HF tests. At 1802, PCU (Precommissioned Unit) Milius (DDG-69) w/tests

of seven "23E" HF radios. At 1809m NAHM, USS Guam (LPH-9) "tech Control" clg SESEF, no joy. Primary mode in USB. (RB)

7784: KAWN, Carswell auto wx stn, Texas at 0520 in RTTY 75/846 w/wx. (RH1)

7846: YL/SS in AM at 0713 w/5F grps. (PS)

7913: 9JZ, Lusaka Air at 0548 w/RTTY 50/479 w/RYS & ID. (RH1)

8066.3: U/i stn w/NRGTU TMTMR several times then ANW three times foll by 5L (cut nbr) grps. New grp started NRGTU ANG. (PS)

8110: RFQP, Jibuti, Djibouti at 0102 in ARQ-M2 200, Ch. AA. French Forces stn w/"Controle De Voie" circuit. Has also been hrd at 2032 on 8050 kHz. (PS)

8294: WBN7618, tug Explorer w/calls to WPE in USB at 0549. Tug made contact then passed position and status report. Shore stn was nil hrd. (DS)

8305: LOR, Puerto Belgrano, Argentinean Navy w/Navigational aid bcst in SS at 0130. RTTY 75/225. (PS)

8332.4: RFHII, Noumea, New Caledonia at 2137 in ARQ-E3 100/340. French Forces stn w/"Controle De Voie." (PS)

8357: Cyprior M/V Petra Wave hrd in CW at 0643 wkg Port Said Radio (SUP) w/ETA mssg. Vessel's CW callign P3BW6. (GH)

8367.1: FAGE, FS Germinal (F-735) French Navy Foreal-class frigate out of Brest at 0044 in CW wkg FUF, Fort de France with unclass (non-protége) mssg. (RB)

8395: SQFQ, HMS Carlskrona, Royal Swedish Navy minelayer/training ship at 2316 in ARQ w/tlx in Swedish. Sitor log-in abbrev is "HMSCKR" w/selcall 26503. (RB)

8412.5: YLCQ, TH Pure at 2331 in FEC w/several EE admin mssgs fm master, KM Padafet to Rina

Radio, then into crew TG's. (RB)

8448: A9M, Bahrain Radio w/CW mkr & freq listing. Hrd at 0154. (AF)

8474: HCG, Guayaquil Radio in CW at 2355 wkg unknown vessel. (WLL)

8500: RBSL, Indian Navy, Bombay at 1639 in RTTY 48/822 w/mkr & RY's. (RH1)

8571: UFN, Novorossiysk, Russia w/CW mkr at 0312. (AF)

8582.5: KLB, Seattle, Washington w/CW mkr & freq listing at 0230. (AF)

8843: Hawaiian-2 wkg Honolulu in USB at 0234; advised next position ESCRO at 0336. Honolulu advised contact San Francisco when reaching ESCRO on 5574 primary and 3413 secondary. (DS)

8903: Flying south over northern Cameroon KLM 597 hrd in USB wkg N'djamena Radio in Chad w/estimate for position TJR (Garoua). Advised that position TJN (N'Garoundere) was next. (GH)

8967: Roll Call w/75 char. EAM. Made two or three mistakes. Gave ID as Road Call then corrected it to Roll Call. Same mssg also by Roll Call at 0430 (8968 kHz) and 0452 (8468 kHz) by Brokov. (WCA)

8972: Blue Star wkg Ashley-07 re 07 completing some sort of task concerning ?Stocking?. Was USB fm 0316-0319. Have logged Blue Star as callign in this freq since at least 1989. (DS)

8992: King 81 wkg Minute Man. Departing to Columbus then to Elsworth & gave mission nbr. USB mode at 1700. (WCA)

9014: Shadow 01 inbound Birmingham, AL at 12110 wkg Andrews. (NP)

9017: Nightwatch wkg Calhoun A10W105 then Checkman wkg Owlhoot at 2038 in USB. (KW)

9070: Every WED YL/GG w/1-0 count foll by 718 at 1600. After 10 tones Gruppen 59 and into 5F grps. Also on 7473 kHz. (SM)

9215: Siren sounding signal at 0320. This has been hrd on various Mossad freqs. Also on 6840 kHz. Sig stopped at 0327. Then into unkn language comms by OM opr. (AF)

9325: YL rptng Charlie November fm 0330-0335 then into 5F GC grps. CN is very active between 0200-0400 on various days. (SM)

10184: White noise bursts at 1643. (TS)

10261: Warbling tone hrd here are 0116. Any ideas? (RK); One user of warbling jammers is Iraq. (Ed.)

10780: Air Evac 50224 at 0243 clg Cape Radio, no joy. At 1707 Aria 1, Advanced Range Instrumentation a/c wkg Cape Radio re comms problems w/units. USB mode. (RB)

11000: At 1300 YL rptng Baker Edward Charlie foll by Queen Robert Union rptd then off at 1307. This is new stn. (SM)

11175: Lobo, Albrook AFB & Cobra 20 w/ops re rescue attempts by u/i chopper which trying pick up men in raft. Divers couldn't go in due numerous sharks circling. Cobra 20 (C-130) asked Lobo via Albrook to call M/V Solar Flare on Ch. 16 (VHF) to aid in rescue. Hrd 1710-17630 in USB. (RK)

11217: King 81 wkg MacDill w/request for wx info. USB at 1825. (WCA)

11220: Possible NEACP or Looking Glass activity in USB at 2140. Stns incl WAR46 (Ft. Ritchie, MD & Nightwatch-01). Ref'd this freq as Sierra 301. (DS)

11226: SAM 203 w/Sec'y of State Christopher on board w/pp to State Sept official. Sec'y discussing Sen. Jesse Helms w/staff & party given by Mac McClardy of White House... & Strobe Talbot's health. Patch was via Andrews. (NP)

11232: Raleigh 70 w/pp thru Offutt GHFS re pickup of Special Forces unit at Ft. Lewis. Hrd at 1936. (NP)

11270: At 0836 OM/RR rptng 685 685 685 85470 til 0840 then 00000 and off. No 5F grps sent. (SM) The 00000 grp supposedly signifies QRU. (Ed.)

11396: American 1242 wkg NY, then American 1473 wkg San Juan at 1728 in USB. (KW)

11545: Lincolnshire Poacher stn in USB hrd fm 1800-1845, YL/EE opr. Very British-sounding. Fair-poor reception. Off at 1845. (RK)

11624: Homestead AFB at 2034 w/FAX 120/576. Wx pix of Africa & Middle East. (PS)

13089: USCG Master Station Pacific in USB w/marine-High Seas forecast. Computerized voice. Some QRM fm international phone svc on 13092 kHz USB. Hrd at 1815. (RK)

13211: Mystic Star activity w/aircraft 65 to An-

draws for pp's probably to SAM Command Post & Andrews Meteo. USB fm 1634-1651. (DS)

13242: MacDill wkg CK w/data send at 2048 in USB. (KW)

14000: At 1400 YL rptng Frank Young Peter foll by Queen Thomas Charlie and into 5L grps. Phonetics are from 1948 ARRL alphabet. Carrier stayed on til 1445 then Mossad YL rptd Charlie India Oscar 2 4 times then carrier off. I think it has given the game away!! (SM)

14432: ARIA Control, 4950th Test Wing, at 1708 in USB wkg ARIA 2 duplex in 14497 re test data set-up. (RB)

15016: MacDill OM Opr w/EAM. Out at 2142. USB mode. (KW)

15850: Alum 52 in USB clg Offutt AFB (Omaha, NE) at 1700 requesting wx at location Charlie Yankee Delta. (RK)

16261.8: RFTJD, Libreville, Gabon (French Forces) at 1310 in ARQ-E3 192/383 w/5L grps to RFFUEA, RFFUBF, RFFUBAJ. (RH1)

16318: MFA Cairo at 0831 in Sitor A w/tfc in AA. (RH1)

16500: Two OM, heavy accents, sometimes in EE, sometimes in SS. Many mentions of "Puerto Villarta" and "coca." Hrd at 2352 in USB. (RK)

16787.8: DSR. Rostock. Denmark at 1754 in Sitor-B 100 (FEC) w/tfc list & news in GG. (PS)

16800.1: URSU, Sovship Nikita Mitchenko w/Odessa at 1334. URJL, Sovship B. Gorbатов w/Odessa at 1358. Both RTTY 50/170. (RH1)

16816.1: ASC, Capetown, S. Africa at 1015 in Sitor B w/Nav 7 warning, man overboard E. of Madagascar!! (RH1)

16875: U/i stn at 1745 in RTTY 75/550 w/5L grps. Off w/QRU SK. (PS)

17430: YL rptng Hotel Kilo fm 1600-1605 w/electronic tones. Then 68 5F grps for 921. (SM)

17445.5: 5YE, Nairobi Meteo at 1210. FAX 120/576. Superb wx chart (on 17443.7 kHz USB). (RH1)

17485: YL/EE at 0139 in AM w/4F grps. Mssg completed 0139 & carrier dropped at 0141. (REB)

18042.1: Deplu Jakarta at 0825 in RTTY

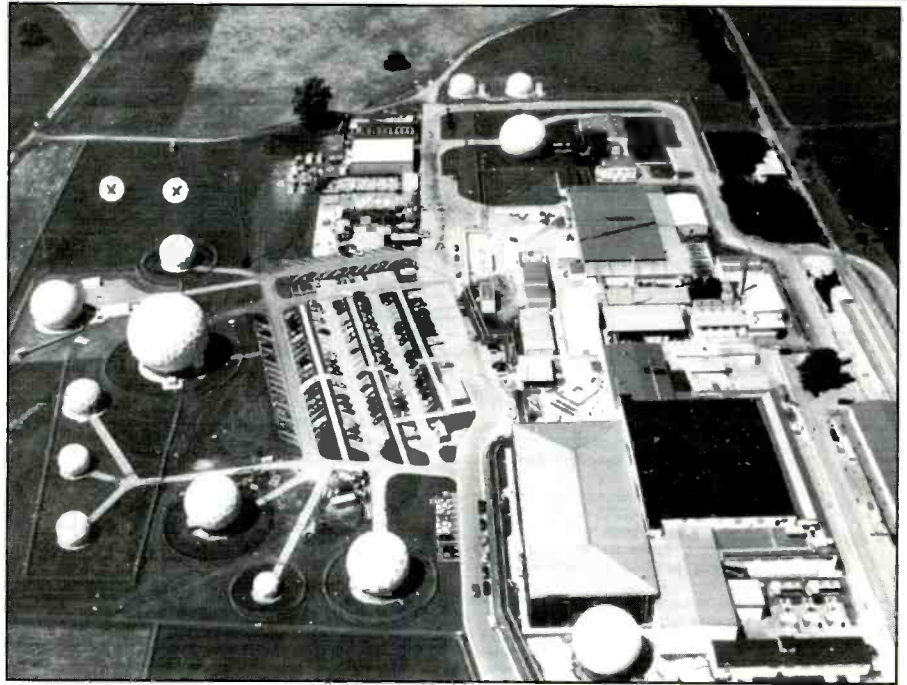

This photo of the Bad Aibling, Germany station was sent in by an anonymous contributor. The X's designate the approximate locations of two radomes added after the photo was taken.

50/369 w/tfc in 5L grps for all Embassies. (RH1)

18064.1: SNN299, MFA Warsaw at 1232 in RTTY 100/302, POL-ARQ. (RH1)

18219.8: CLP wkg u/i stn at 1739 in RTTY 50/500. (Ed.)

18380.4: RFFAAP, Guerre Dipermil Paris at 1135 in ARW-E3 100/386 w/tfc in FF for COMSUP Reunion. (RH1)

18966.2: RFLI, Fort de France, Martinique, French Military at 2221 in ARQ-E3 96/425 w/FF to RFHJCF. (JC)

19865.5: YZJ4, TANJUG Belgrade at 1619 in RTTY 48/151 w/nx in SS. (RH1)

20286.6: SOV288, PAP Warsaw at 1805 in Sitor B w/exchange rates & nx/Pol. (RH1)

21017: OTH radar at 2052. (TS)

21807.7: YOY28, ROMPRESS Bucharest at 0740 in RTTY 50/369 w/nx in EE. (RH1)

22808.1: DFZG, MFA BELGRADE at 1533 in RTTY 75/388 w/nx in EE. Strong sigs. (RH1)

This month's contributors: A—ANDY1W5A, IL; AB—Ary Boender, Netherlands; AF—Anthony Franz, FL; AH—Al Hemmalin, RI; BV—Bjorn Vaage, CA; DC—Don Chillari, ?; DS—David Sabo, MD; DT—Donald Tomkinson, CA; Ed.—Don Schimmel, WV; GB—Gerald Brookman, AK; GH—Garie Halstead, WV; JC—James Callaway, Jr., NV; JD—Jill Dybka, TN; JF—JJF, IL; JO—Jim Osborn, VA; KW—Kevin Wonders, IL; MC—Mark Chinsky, NY; ML—Michael Layden, PA; NP—Norm Pihale, MN; PC—Perry Crabill, Jr., VA; PS—Paul Scalzo, Quebec, Canada; RB—Richard Baker, OH; RC—Ralph Craig, OH; REB—Robert E. Bishop, S. Korea; RH1—Robert Hall, S. Africa; RH2—Russ Hill, MI; RK—Richard Klingman, NY; SF—Stan Forsman, CA; SM—Simon Mason, England; SS—Slawomir Stys, Japan; TF—Trevor Fletcher, Alb., Canada; TS—Tom Severt, KS; TW—Terry Weinhold, PA; WCA—W.C. Alexander, OH; WL—Wes Linscott, ME; WM—William Mayer, ?.

Our thanks to all!

YOU AIN'T HEARD NOTHIN' ... YET

Since 1967, CRB Research has been the world's leading publisher and supplier of unique hobby and professional books and information including:

- Scanner Frequency Guides
- Shortwave Frequency Guides
- Military/Federal Communications
- Broadcast Station Registries
- Undercover Communications
- Survival Communications
- Covert Operations
- & Other Related Topics!

New titles are constantly being added to our exciting catalog. If it's interesting and unusual, we've got it. You'll see. Ask for our latest FREE catalog.

CRB RESEARCH

P.O. Box 56, Commack, NY 11725

Phone: (516) 543-9169/FAX: (516) 543-7486

CIRCLE 11 ON READER SERVICE CARD



COPYCAT
The ONLY Commercially Available Computer Control Program
for the Universal M-7000 & M-8000
Also, supports AEA's PK-232 and the MFJ-1278

Features

- 32K Incoming Text Buffer
- Mouse Support (but not required)
- Runs on any 640K PC Compatible
- Pull Down Menus
- 20+ Programmable Macros
- On Line Help Screen

FINALLY, an IBM-compatible COMPUTER CONTROL PROGRAM for the M-7000 and M-8000. Let COPYCAT free you FOREVER from remembering all those buttons and keys. COPYCAT does it all! Simple "PULL-DOWN" menus control all functions. No more looking through complicated manuals or searching for buttons. ALL commands are in plain English. *PLUS* COPYCAT has a fully editable text buffer, with cut & paste. Save/load/edit/print files. PROGRAMMABLE macros and much more. COPYCAT supports ALL the above units within ONE program. Simply select your unit from COPYCAT's EASY-TO-USE menu and GO!

COPYCAT \$69.95 (DEMO DISK \$5.00 Refundable with purchase)

(Be sure and order our serial adapter if you do not have the specially wired cable for the M-7000/8000)

SERIAL CABLE ADAPTERS FOR M-7000 AND M-8000 \$24.95.

SHIPPING/HANDLING \$5.00 (\$7.50 Foreign)



COMPUTER AIDED TECHNOLOGIES

P.O. Box 18285 Shreveport, LA 71138

Orders Only (318) 636-1234 - FAX (318) 686-0449 (24 hrs)

Live Tech Support - (318) 687-2555 (9 a.m. - 1 p.m. Central M-F) Nitetime BBS (SCANCAT File Area) (318) 631-3082 (7 p.m. - 6 a.m. Central)

Online support available in Genie's Radio & Electronics RoundTable. Call 800-638-9636 to subscribe to Genie!

(See ad on page 25, 37 & 63)

Order direct or
contact your
favorite dealer

Now The Company That Takes You Around The World Lets You Take The World Around With You.



The Drake SW8 – Finally, Professional Desktop Performance In An Affordable, Portable World Band Shortwave.

The company that has been setting the standards in premium-quality world band shortwave performance now puts top-of-the-line features and technology at your fingertips with the SW8... wherever you want to take it. Designed for both desktop use and easy portability, the

Drake SW8 includes many of the same features that have made Drake a perennial favorite of experts – superb audio, versatility, and the unique combination of professional quality and functional simplicity. So tune in the world and get the best of all worlds – quality and affordability, desktop

technology and portability.

The Drake SW8.

To order your SW8 direct, for more information, or for the dealer nearest you call:

1-800-968-7426

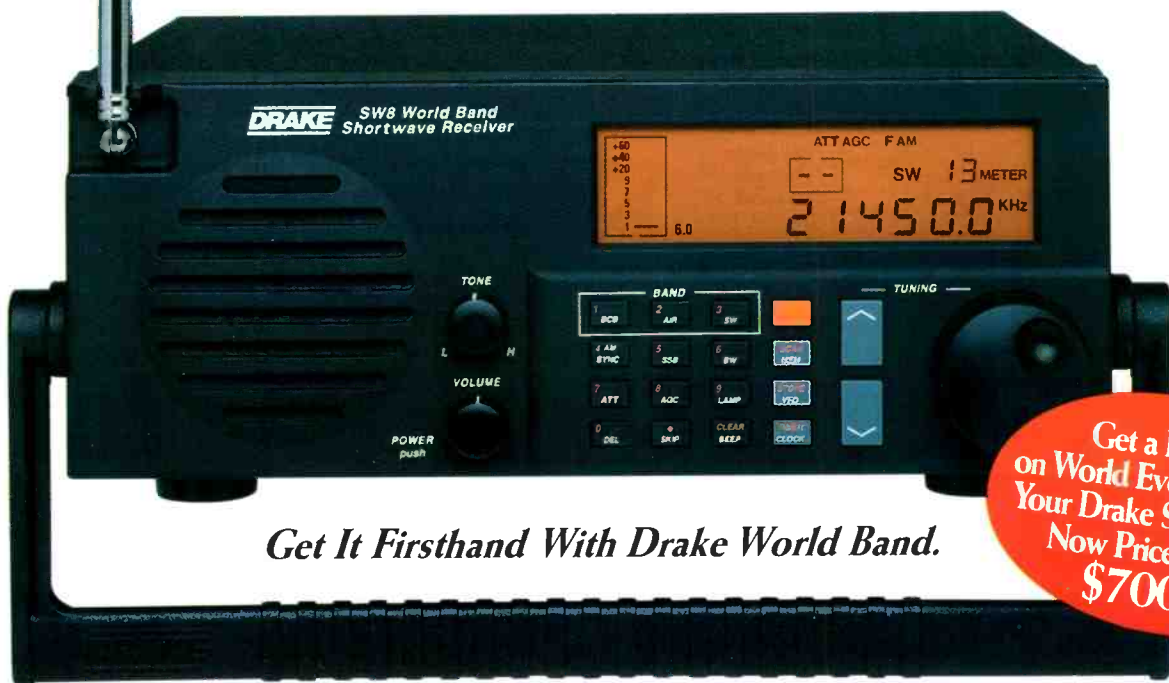

Get It Firsthand With Drake World Band.

**Get a Handle
on World Events... Order
Your Drake SW8 Today.
Now Priced under
\$700.00**

BROADCAST DX'ING

BY TIM KRIDEL

DX, NEWS AND VIEWS OF AM AND FM BROADCASTING

Strength in Numbers: In keeping with an industry trend toward consolidation, the FCC in mid-February approved the assignment of the license of San Francisco's KSFO-AM from First Broadcasting Co., to Bay-area rival KGO-AM Radio, Inc., a subsidiary of Capital Cities/ABC, Inc. Since Cap Cities also owns KGO-TV, the petition required a request for a waiver of Section 73.3555(b) of the FCC's rules prohibiting the common ownership of radio and television stations in a single market. In order to meet the standards for a waiver of the "one-to-a-market" rule, which seeks to promote multiplicity, competition, and diversity by avoiding undue concentrations of ownership, a proposed combination involving stations in a top-25 market must leave at least 30 separately owned, operated, and controlled licenses.



Cedar Rapids, Iowa, is home to "All-Hit" KQCR. The 100-kW station first took to the air on April 29, 1975. (Courtesy an anonymous Q103 staffer.)

Pending AM Call Letter Changes

Old	Pending	
WRIC	WGTH	Richlands, VA
WWMO	WPAI	Eden, NC

Changed AM Call Letters

New	Was	
KAPL	KDOV	Phoenix, AZ
KBRD	KLDY	Lacey, WA
KCAZ	KBEA	Mission, KS
KCDR	KMIX	Turlock, CA
KINF	KING	Seattle, WA
KIXW	KZXY	Apple Valley, CA
KKDD	KFMS	Las Vegas, NV
KLSQ	KOWA	Laughlin, NV
KQFN	KQWB	Fargo, ND
KRAM	WKBQ	St. Louis, MO
KRPM	KULL	Seattle, WA
KTOF	KHAK	Cedar Rapids, IA
KVRG	KSUR	Soledad, CA
KWFS	KLLF	Wichita Falls, TX
KZBN	KKSB	Santa Barbara, CA
WBPS	WBIV	Natick, MA
WCKN	WYAK	Surfside City, SC
WCKO	WZAM	Norfolk, VA
WCOO	WSFL	New Bern, NC
WGVL	WSSL	Greenville, SC
WISW	WOMG	Columbia, SC
WJPY	WECY	Seaford, DE
WKZB	WOHT	Cleveland, MS
WMIH	WRDZ	Cleveland, OH
WNCY	WPRC	Lincoln, IL
WNIO	WFNE	Niles, OH
WNRB	WSSH	Boston, MA
WODT	WQUE	New Orleans, LA
WPOL	WMQX	Winston-Salem, NC
WRTK	WHOT	Youngstown, OH
WTMN	WCQL	Portsmouth, NH
WVCY	WXOL	Oshkosh, WI
WXLN	WZCC	New Albany, IN
WZZW	WNST	Milton, WV

Changed FM Frequencies

KIRC	Seminole, OK	105.5 MHz	Moved to 105.9 MHz, 6 kW.
KSCQ	Silver City, NM	94.5 MHz	Moved to 92.9 MHz.

Requesting Changed FM Frequency

KYFM	Bartlesville, OK	100.1 MHz	Seeks move to 99.9 MHz.
------	------------------	-----------	-------------------------

Requesting Modified AM Facilities

KBIX	Muskogee, OK	1490 kHz	Seeks drop to 580 watts.
KGDP	Orcutt, CA	660 kHz	Seeks increase to 50/10 kW.
KIAM	Nenana, AK	630 kHz	Seeks increase to 10/3.1 kW.
WIMK	Middlesboro, KY	560 kHz	Seeks daytime increase to 5 kW.
WLMI	Montgomery, AL	740 kHz	Seeks daytime increase to 10 kW.
WXTL	Jacksonville Beach, FL	1010 kHz	Seeks increase to 50/19 kW.

Modified AM Facilities

KCCF	Cave Creek, AZ	1100 kHz	Increased daytime to 50 kW.
KSIR	Brush, CO	1010 kHz	Run 25 kW days, added 280 watt nights.
WJJQ	Tomahawk, WI	810 kHz	Reduced to 980 watts.
WMIN	Hudson, WI	740 kHz	Increased days to 850 watts.
WYSL	Avon, NY	1030 kHz	Changed to 1040 kHz; 2.5/500 watts.

Granted Permits to Construct New FM Stations

AL	Mountain Brook	102.5 MHz	99 watts (WOWC booster)
CA	Esparto	97.9 MHz	6 kW
LA	Amite	95.5 MHz	6 kW
OR	Ashland	88.3 MHz	230 watts
OR	Family Camp	107.1 MHz	(KSKD booster)
TN	Murfreesboro	91.7 MHz	1 kW
UT	Payson	103.9 MHz	300 watts (KYKN-FM booster)

Cancelled

KGMR	Clarksville, AR	91.7 MHz	383 watts
KPWV	Aspen, CO	107.1 MHz	470 watts
WLJI	Summerton, SC	99.5 MHz	6 kW

Changed Shortwave Call Letters

New	Was	
WVHA	WCSN	Scotts Corner, ME



NRD-535D

"Best Communications Receiver"

World Radio TV Handbook 1992



"Unsurpassed DX Performance"

Passport to World Band Radio 1992

Setting the industry standard once again for shortwave receivers, the NRD-535D is the most advanced HF communications receiver ever designed for the serious DXer and shortwave listener. Its unparalleled performance in all modes makes it the ultimate receiver for diversified monitoring applications.

Designed for DXers by DXers! The NRD-535D (shown above with optional NVA-319 speaker) strikes the perfect balance between form and function with its professional-grade design and critically acclaimed ergonomics. The NRD-535D is the recipient of the prestigious World Radio TV Handbook Industry Award for "Best Communications Receiver."



Japan Radio Co., Ltd.

Japan Radio Company, Ltd. New York Branch Office - 430 Park Avenue (2nd Floor), New York, NY 10022, USA Tel: (212) 355-180 / Fax: (212) 319-5227
Japan Radio Company, Ltd. - Akasaka Twin Tower (Main), 17-22, Akasaka 2-chome, Minato-ku, Tokyo 107, JAPAN Tel: (03) 3584-8836 / Fax: (03) 3584-8878

- Phase-lock ECSS system for selectable-sideband AM reception.
- Maximum IF bandwidth flexibility! The Variable Bandwidth Control (BWC) adjusts the wide and intermediate IF filter bandwidths from 5.5 to 2.0 kHz and 2.0 to 0.5 kHz—continuously.
- Stock fixed-width IF filters include a 5.5 kHz (wide), a 2.0 kHz (intermediate), and a 1.0 kHz (narrow). Optional JRC filters include 2.4 kHz, 300 Hz, and 500 Hz crystal type.
- All mode 100 kHz - 30 MHz coverage. Tuning accuracy to 1 Hz, using JRC's advanced Direct Digital Synthesis (DDS) PLL system and a high-precision magnetic rotary encoder. The tuning is so smooth you will swear it's analog! An optional high-stability crystal oscillator kit is also available for ± 0.5 ppm stability.
- A superior front-end variable double tuning circuit is continuously controlled by the CPU to vary with the receive frequency automatically. The result: Outstanding 106 dB Dynamic Range and +20 dBm Third-Order Intercept Point.
- Memory capacity of 200 channels, each storing frequency, mode, filter, AGC and ATT settings. Scan and sweep functions built in. All memory channels are tunable, making "MEM to VFO" switching unnecessary.
- A state-of-the-art RS-232C computer interface is built into every NRD-535D receiver.
- Fully modular design, featuring plug-in circuit boards and high-quality surface-mount components. No other manufacturer can offer such professional-quality design and construction at so affordable a price.

THE FREQUENCY ALMANAC®

THE MOST COMPREHENSIVE SET OF FREQUENCY DIRECTORIES EVER PUBLISHED!!

Simplified Frequency format listed by county.
Each county lists public safety by state, county and city agencies, including 800MHz, followed by business and *all other services*.

- Direct From FCC Data Files
- Covers All Land Mobile and Fixed Services Between 30MHz and 2GHz
- Books For Each Of The Fifty States
- From The Publishers of Frequency Directories for over 15 Years

\$19.95ea
AK*, AL, AR, AZ*, CO, CT, GA, ID, IN, IA, KS, KY, LA, MA, MD, MN, MO, MS, MT, NC, ND, NE, NJ, NM, NV, OH, OK*, OR, PA, SC, TN*, UT, VA, WA,

\$24.95ea
CA, FL, IL, MI*, NY, TX, WI*

\$9.95ea
DE, HI*, ME, NH, PR, RI, SD, VI, VT, WV, WY,

*Updated June, 1995

For 1st Book Add:

\$3.95 S&H For 4th Class or

\$5.95 S&H For Priority Mail 2-3 Days

(\$6.95 For CA, FL, IL, MI, NY, TX, WI)

For More Than 1 Book Add \$1.00 S&H Per Book

Compare The Page Counts To Other Directories

State	Pages	State	Pages
AK	96	MT	136
AL	208	NC	334
AR	184	ND	115
AZ	176	NH	206
CA	829	NJ	88
CO	224	NM	272
CT	100	NY	94
DC	See MD	NV	96
DE	48	OH	504
FL	472	OK	480
GA	336	OR	230
HI	56	PA	127
IA	272	PR/VI	116
ID	128	RI	56
IL	520	SC	164
IN	320	SD	121
KS	252	TN	261
KY	223	TX	840
LA	212	UT	104
MA	231	VA	270
MD	152	VT	72
ME	120	WA	172
MI	365	WI	288
MN	292	WV	136
MO	280	WY	128
MS	170		

U.S. Scanner News

Published By
U.S. Scanner Publications
The ONLY national monthly magazine devoted entirely to the hobby of VHF-UHF monitoring.
No Shortwave, No Broadcast!!

Each Month You Get:

- Outstanding feature articles
 - In-depth, unbiased reviews
 - Accurate frequency information
 - The latest FCC actions
 - Helpful scanning and technical hints
 - Plus regular monthly columns
- 1yr \$18.00; 2yr \$32.00; 3yr \$46.00**
Sample Copy \$3.00 1st Class

➤ California Book is 820 Pages

Dealer Inquiries Welcome



1-800-890-6999

US SCANNER PUBLICATIONS

PO BOX 14923

PORTLAND OR 97214-4923

FAX (503) 233-5176 (503) 230-6999



Along with being the birthplace of rocker John Mellencamp, Seymour, Indiana can also boast of being home to WZZB-AM and WQKC-FM. This photo of their facilities comes to us courtesy of R.C. Watts, Louisville, Kentucky.

Since the respective signals of KSFO and KGO-AM served virtually the same portion of the San Francisco market, Cap Cities had to demonstrate that the proposed merger would not result in a combined audience share of more than 25 percent. Cap Cities was able to satisfy the "top 25 market/30 voice standard" by submitting Arbitron surveys showing both that the combined audience share of KSFO and KGO-AM was 8.8 percent and that the fifth-ranked San-Francisco-Oakland-San Jose market would still be served by 58 radio and 21 TV stations, owned and operated by 53 different entities.

In granting such waivers the Commission has in the past taken into consideration the financial state of the stations involved, explaining that "efficiencies of operation as may be achieved through the use of common facilities and staff" were also in the public interest. Cap Cities argued that the proposed acquisition would be a win-win situation for KSFO and KGO-AM/TV, as well as the San Francisco community, because although the intention was to operate the stations separately, the combination would allow a streamlining of operations through both a pooling of resources and elimination of redundancies.

Included in the application were estimates that the affiliation of KSFO and KGO-AM would result in a total savings of approximately \$1.45 million per year, with \$750,000 alone coming from consolidation of personnel, and another \$45,000 through the joint purchasing of administrative and production supplies. The Commission appears to have been persuaded by these figures in light of the fact that KSFO-AM had operated at loss of over \$2 million in 1994, with projections calling for a similar loss in 1995 if a sale was not approved.

In its decision the FCC agreed with Cap Cities that the merger would "create efficiencies resulting in significant cost savings and the potential for enhanced programming and service benefits." According to a

New FM Call Letters

KHMG	Barriguda, GU
KSRG	Ashland, OR
KTLW	Lancaster, CA
WCNA	Potts Camp, MS
WDJU	Meridianville, AL
WDUC	Marathon, FL
WYYS	Streator, IL

FREE
SAMPLE
COPY!

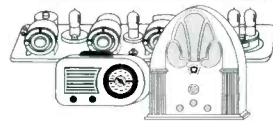

ANTIQUE RADIO CLASSIFIED

Antique Radio's Largest-Circulation
Monthly Magazine

Articles - Classifieds - Ads for Parts & Services

Also: Early TV, Ham Equip., Books,
Telegraph, 40's & 50's Radios & more...

Free 20-word ad each month. Don't miss out!

1-Year: \$29.95 (\$47.95 by 1st Class)

6-Month Trial - \$16.95. Foreign - Write.

A.R.C., P.O. Box 802-T9, Carlisle, MA 01741



Or Call: (508) 371-0512



SHOCKING MANUALS!

Survival Electronics, Computers, Phones, Security, Weaponry, Rocketry, Energy, Financial, Medical. 150+ offers also include Special Projects, Research Services and Hardware. By John Williams, former Senior Electronic Design Engineer (Lockheed), Professor of Computer Science (NMSU). As seen on CBS "60 Minutes", Forbes, etc. Since 1971. New Catalog \$4. Add \$5 total SH. VISA, MC OK. No CODs. PDs. Educational purposes only.

CELLULAR & CORDLESS PHREAKING: Describes how cellphones are reprogrammed and scanned, forcing ACK, Test Mode, control data formats, operating systems, computing encoded MINs, ESNs, SIDNs - much more! Keypad mods of 100+ cellphones detailed. Plus cordless hacking, scanner mods. \$69.

PBX HACKING: Average loss to PBX hacking is \$30,000! Step-by-step descriptions on how they are hacked; countermeasures. \$39.

PHONE COLOR BOXES: As designed by phone phreakers. Plans for 15 phone color boxes - Red, Blue, Black, Silver, Cheese - more! \$29.

BEYOND VAN ECK PHREAKING: Plans for surveillance systems used to eavesdrop on the emanations from computer monitors and TVs. \$29.

SECRET & SURVIVAL RADIO: Describes the optimum freqs, equipment, modes and circuits for secret, survival and security situations. Includes small transmitters and receivers, ultrasonic, infrared and fiberoptic commo, improvising and optimizing antennas. 70+ circuit diagrams. \$29.

COMPUTER PHREAKING: Describes both computer infections and how computers are penetrated. Includes 2 PC disks: [1] FLUSHOT+ protection system. [2] Disk loaded with hacker files. \$39.

Also, VOICE MAIL HACKING (\$29), STEALTH TECHNOLOGY (\$29), STOPPING POWER METERS (\$29), RADIONICS MANUAL (\$29), EM BRAINBLASTER (\$29), UNDER ATTACK! (\$29), HIGH VOLTAGE DEVICES (\$29), ATM (\$39), CONS & SCAMS (\$29), PHREAKING CALLER ID & ANI (\$29), HACKER FILES (\$59), ROBOFFONE (\$29) - more!

CONSUMER TRONICS: 2011 Crescent Dr., P.O. Drawer 537, Alamogordo, NM 88310. Voice: 505-434-0234, 505-434-1778 (8AM-8PM MST, Mon-Sat). FAX: 434-0234 (for orders only 24-hour, 7-days/week. If you get answering machine press *#* then *1* any time).

VIDEO SYNC GENERATOR



Restores Horizontal
and Vertical
Sync Lines from Distorted
Analogue Video Formats

For Free Information Package on Completed Units and Pricing



• Call 219-236-5776 •



R.C. Distributing • PO Box 552 • South Bend, IN 46624

CIRCLE 73 ON READER SERVICE CARD

51.092

ELECTRONIC COMPONENTS

Whether you order 1 part or
all 51,092...MOUSER stocks
and...ships same day!!

CALL... (800) 992-9943

For your FREE 316pg. Catalog

**MOUSER
ELECTRONICS**

958 North Main St. Mansfield, TX 76063

CIRCLE 67 ON READER SERVICE CARD

CQ Amateur Radio

If you enjoy Amateur Radio, you'll enjoy CQ.

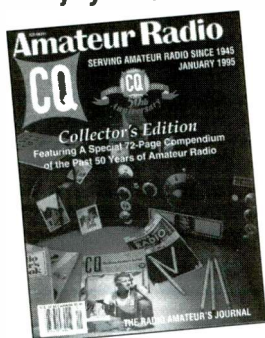

It's a different kind of ham magazine.

Fun to read, interesting from cover to cover, written so you can understand it. That's CQ. Read and enjoyed by over 90,000 people each month in 116 countries around the world.

It's more than just a magazine. It's an institution.

CQ also sponsors these thirteen world famous awards programs and contests: The CQ World Wide DX Phone and CW Contests, the CQ WAZ Award, the CQ World Wide WPX Phone and CW Contests, the CQ USA-CA Award, the CQ WPX Award, the CQ World Wide 160 Meter Phone and CW Contests, the CQ Five Band WAZ Award, the CQ DX Award, and the highly acclaimed CQ DX Hall of Fame. Accept the challenge. Join the fun. Read CQ.

Also available in the Spanish language edition. Write for rates and details

SUBSCRIBE TODAY!

CQ The Radio Amateur's Journal
76 North Broadway
Hicksville, New York 11801

Please start my CQ subscription with the next available issue.
Enclose payment or charge information with order. Term and rate (check one):

	USA	VE/XE	Foreign
1 Year	<input type="checkbox"/> 24.95	<input type="checkbox"/> 37.95	<input type="checkbox"/> 39.95
2 Years	<input type="checkbox"/> 44.95	<input type="checkbox"/> 70.95	<input type="checkbox"/> 74.95
3 Years	<input type="checkbox"/> 64.95	<input type="checkbox"/> 103.95	<input type="checkbox"/> 109.95

Name _____

Address _____

City _____

State _____ Zip _____

() Check () M/C () VISA () AMEX () Discover

Card No. _____

Expires _____

Signature _____

(Signature required on all charge orders)
Please allow 6-8 weeks for delivery of first issue.

Phone 516-681-2922; FAX 516-681-2926
1-800-853-9797

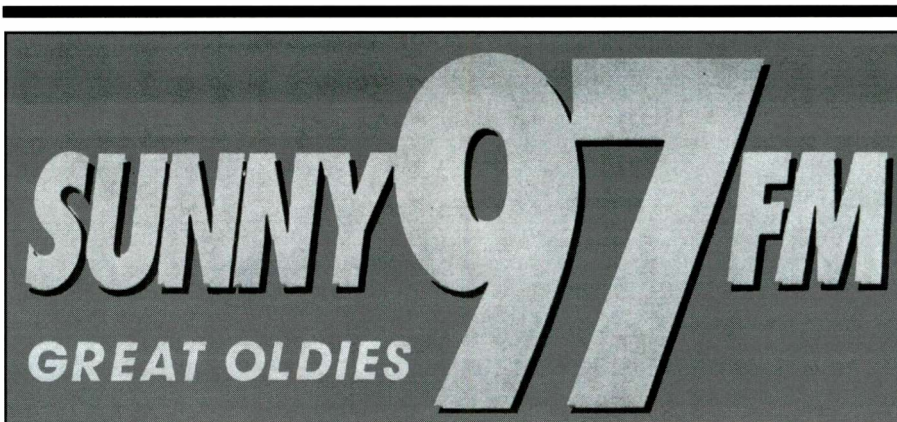

KPSN-FM rode off into the Arizona sunset in late November 1994. "Sunny 97 FM" was the favorite station of reader Paul Swietek, of Gilbert, AZ, who sent in this bumper sticker.



Not one to be outdone by cross-town rival CISN in the quest for Edmonton, Alberta's radio audience, CIRK-FM—"K97"—used billboards like this one to publicize its promotion that gave listeners chances to win cars and condos. (Courtesy Trevor Fletcher, Edmonton.)

Commission press release, under Cap Cities' ownership KSFO will adopt a talk format "complementing" that of KGO-AM, including public affairs programming "analogous to" that offered by KGO-AM.

The waiver is not the first that Cap Cities has received for its San Francisco holdings. In 1989, the FCC allowed the company to retain its ownership of KGO-AM and KGO-TV, and late last year the Commission upheld its 1989 waiver to allow Cap Cities to own the Los Angeles stations KABC-AM/TV and KLOS-FM.

Such pro-consolidation rulings by the FCC are riding a wave of *laissez faire* sentiment that appears to have crested with a draft bill introduced in February that would continue the trend toward deregulation and consolidation. The proposed legislation, sponsored by Senate Commerce Committee Chairman Larry Pressler (R-S.D.), seeks to repeal the current radio ownership limits of 20 AM and 20 FM stations. As Herb

McCord, president and CEO of Granum Communications told *Broadcasting & Cable*, "The radio business clearly benefits from the economies of scale that could be realized by putting stations together. The radio industry is healthier than ever."

A Labor of Love: After 45 years in radio, Elmer "Smokey Silver" Gunkel will at last have a station of his own. The Manteca, California man in early February was given the green light by the FCC to construct a 3,000-watt FM station licensed to Modesto. KEJC-FM is planned to go on the air sometime this summer. Gunkel, who first applied for the license in 1988, persisted over many other applicants in a competition made even more fierce after the FCC announced in 1985 that 93.9 MHz would be the last FM channel issued for the crowded Northern San Joaquin Valley radio dial.

Although a format has not yet been chosen, "Deciding what music to play will be the last decision we make," Gunkel said in

Pending FM Call Letter Changes

Old	Pending	
KZOC	KANS-FM	Osage City, KS
WMCI-FM	WRVC-FM	Catlettsburg, KY
WZLZ	WMOS	Quincy, IL

Changed FM Call Letters

New	Was	
KAMD-FM	KWEH	Camden, AR
KBAE	KLKM	Llano, TX
KBUE	KNAC	Long Beach, CA
KCRR	KGCI	Grundy Center, IA
KCXX	KABE	Lake Arrowhead, CA
KDAT	KTOF	Cedar Rapids, IA
KDNR	KZBP	Los Lunas, NM
KDOV	KCIA-FM	Medford, OR
KDVE-FM	KDSQ	Denison, TX
KGVA	KAEP	Ft. Belknap Agency, MT
KHAK	KHAK-FM	Cedar Rapids, IA
KHJA	KXKY	Holdenville, OK
KHTC	KCHT	Phoenix, AZ
KLSN	KAJJ	Marshalltown, IA
KLTO	KMPQ-FM	Rosenberg, TX
KLVO	KARS-FM	Belen, NM
KMGX	KRVD	Rio Del, CA
KMIX	KEXX	Tracy, CA
KORR	KOUU-FM	American Falls, ID
KRAZ	KRMR	Ketcum, ID
KSAC	KRAZ	Sutter Creek, CA
KTLN	KLNO	Thibodaux, LA
KUTC	KUJJ	Seattle, WA
KVRG-FM	KVRG	Seaside, CA
KWFS-FM	KEFS	Wichita Falls, TX
KWNN	KMIX-FM	Turlock, CA
KXBK	KAFK	Bryan, TX
KYBJ	KAEW	Lake Jackson, TX
KZYZ	KAJZ	Willits, CA
WALS	WZLC	Oglesby, IL
WBPS	WBIV	Natick, MA
WDGG	WRVC-FM	Ashland, KY
WELS-FM	WKGK	Kinston, NC
WFNQ	WBBO-FM	Forest City, NC
KFSJ-Fm	WSTF	St. Augustine, FL
WGLL	WIFF-FM	Auburn, IN
WJAD	WEGC	Leesburg, GA
WKQH	WMGU	Marathon, WI
WLBL-FM	WRMW	Wausau, WI
WHMX	WAZK	Trinity, AL
WNCY-FM	WAAU	Neenah-Menasha, WI
WOHT	WKZB	Drew, MS
WPGY	WRAK-FM	Williamsport, PA
WQEG	WTCO-FM	Russell Springs, KY
WSRQ	WWAZ	Queensbury, NY
WSUX	WECY-FM	Seaford, DE
WURN	WEYQ	Marietta, GA
WVCY-FM	WVCY	Milwaukee, WI
WVUC	WMMN-FM	Barrackville, WV
WWRD	WBYB	Brunswick, GA
WZBQ	WZBQ-FM	Carrollton, OH
WZZW-FM	WZZW	Milton, WV

Requesting Permits to Construct New FM Stations

AL	Trinity	88.1 MHz	12 kW
AZ	Nogalez	99.1 MHz	6 kW
CA	Livingston	89.1 MHz	230 watts
CA	McCloud	91.9 MHz	
CA	Point Arena	102.3 MHz	1.2 kW
CA	Templeton	100.5 MHz	
HI	Lahaina	101.1 MHz	984 watts (KHLI booster)
IA	Ottumwa-Borger	89.1 MHz	13.5 kW
ID	Shelley	107.9 MHz	100 kW
ID	Sun Valley	107.5 MHz	100 kW
IL	Mount Vernon	89.7 MHz	6.2 kW
IL	Neoga	98.9 MHz	6 kW
IL	Taylorville	94.3 MHz	
IL	Virginia	101.3 MHz	6 kW
IN	Anderson	89.5 MHz	400 watts
IN	Indianapolis	88.1 MHz	100 watts
KY	Clinton	102.1 MHz	
KY	Glasgow	94.1 MHz	2 kW
LA	Jackson	104.5 MHz	6 kW
LA	Lake Arthur	103.7 MHz	25 kW
MA	Nantucket	91.1 MHz	2 kW
ME	Islesboro	105.5 MHz	25 kW
ME	Winter Harbor	97.7 MHz	6 kW
MN	Hermantown	92.1 MHz	6 kW
MN	Nashwauk	102.9 MHz	25 kW
MN	Park Rapids	92.5 MHz	
MN	Walker	101.9 MHz	6 kW
MN	Walker	104.9 MHz	6 kW
MS	Pascagoula	88.9 MHz	30 kW
MT	Butte	91.3 MHz	880 watts
MT	Cascade	104.9 MHz	
MT	Hamilton	91.9 MHz	850 watts
NC	Atlantic Beach	91.5 MHz	26 kW
NC	Norlina	94.3 MHz	6 kW
NV	Moapa Valley	104.7 MHz	3 kW
NY	Alfred	101.9 MHz	1.3 kW
NY	Champlain	90.9 MHz	2.3 kW
NY	Jeffersonville	102.2 MHz	6 kW
NY	Minetto	106.5 MHz	5 kW
OH	Athens	95.9 MHz	6 kW
OH	Bryan	90.9 MHz	750 watts
OH	Defiance	91.9 MHz	6 kW
OH	Pleasant City	92.1 MHz	6 kW
OR	Bonanza	102.9 MHz	785 watts
OR	Grants Pass	91.1 MHz	250 watts
OR	Keno	98.5 MHz	
OR	Malin	100.3 MHz	750 watts
OR	Merrill	105.7 MHz	112 watts
PR	Mayaguez	88.3 MHz	2 kW
TN	Cookeville	91.7 MHz	500 watts
TX	San Saba	97.1 MHz	779 watts
WA	Quincy	102.9 MHz	2.5 kW
WI	Balsam Lake	104.9 MHz	
WV	Fisher	103.7 MHz	310 watts

a *Sacramento Bee* profile sent to us by POP'COMM reader George Saunders. But if he decides to follow his own tastes and go with country music, Gunkel certainly won't have to look to a satellite service for programming—his own musical library includes over 30,000 titles on everything from 45s to open-reels to compact discs.

Community Service: As Gunkel was gearing up his station, 2,900 miles to the east another veteran broadcaster was sell-

ing out. Bobbi Lewis, president of Rockland Communicators and West-Land Communicators, sold her two Rockland County, New York stations, WRKL-AM and WRGX-FM, for \$4.5 million. "I had accomplished what I wanted to accomplish," Lewis said in a *Rockland Journal-News* article supplied by POP'COMM reader Howard Miller. Eight years after she started as WRKL's receptionist, Lewis purchased the station in late 1985 for \$1.11

million, and acquired WRGX a little over three years later, for \$5 million. Although the new owner, Odyssey Communications, claims no changes are in store for what it calls WRKL's "rich local heritage" of serving the Rockland community, the sale is expected to allow the station to expand its broadcast day outside its current dawn-to-dusk schedule. As for WRGX, the new owners could hardly ask for a more successful format. Following an October 1993 switch

from soft rock to a mix of alternative-based album rock, "X-107" saw its weekly audience jump from 28,000 to 160,000.

Newer Oldies: If you're between the ages of 30 and 44 and you live in Phoenix, Arizona, you'll want to dig out your bell-bottoms and tune your radio to 96.9 MHz. Or so the management of KCHT hopes, anyway. Acting on its research suggesting that the rock hits of the '70s would attract a substantial chunk of the Valley's radio audience, KPSN this past November dropped music from earlier decades to go after what it views as the nostalgic—and lucrative—baby-boomer group. The new KCHT—"K-Hits"—hopes that the format change will raise the station from its Arbitron rankings of 14th place.

As part of establishing the new format, several personalities have been released. "They're associated with oldies," station manager Buz Powers told the *Arizona Republic*. "We have to make this a clean difference to the listener." But for fans of the former "Sunny 97 FM," the abrupt change in calls and format came as an unwelcome surprise. As *POP'COMM* reader and KPSN faithful Paul Swietek observes, "With no notice to its listeners [they] changed formats on the Monday immediately following Thanksgiving. How's that for a major letdown after a joyful holiday!" And while KCHT management is optimistic about their new niche, competitors scoff at the idea, pointing out that seven

area stations already program rock.

In the Know: Readers Falguni Lupi and Lavon Edwards check in to ask what references are available to AM and FM DXers? While standards like *White's Radio Log* and Vane Jones' *Station Guide* are long out of print, there isn't any shortage of material on the market, although choosing the best one depends on what sort of information you seek. The annual *World Radio TV Handbook* contains addresses, formats, and power for AM stations in the U. S. that run 10 kW and over, as well as Canadian stations running over 100 watts.

You might consider Bruce Elving's *FM Atlas*. The new 16th edition of the *FM Atlas* is just out. You can get a copy for \$16.95, plus \$5 shipping/handling (\$6 to Canada) from CRB Research, P.O. Box 56, Commack, NY 11725. Visa/MC orders: 1-800-656-0056. Canadian orders: 1-516-543-9169. N.Y.S. residents please add \$1.87 tax.

Clubs are another fine source for information, with some of their more prominent titles including the *IRCA AM-FM Almanac*, the *IRCA Mexican Log*, and the *NRC AM Radio Log*. Contact the IRCA Bookstore at 9705 Mary NW, Seattle, WA 98117, and NRC Publications, Box 164, Mannsville, NY 13661, or check with the *POP'COMM* advertisers. But no matter what reference one buys, it is only as good as its user's maintenance—diligently recording any call letter, format, and power

changes that are listed monthly in this column is absolutely necessary to keep your records up-to-date in the ever-changing world of radio.

In Brief: Proving there's life after politics, former presidential candidate and senator Gary Hart in early February debuted his a talk show on Denver's KOA-AM. "Heartland," which can be heard Sunday evenings, features as its guests public figures ranging from politicians to authors to athletes, reports *Broadcasting & Cable*. The industry magazine also disclosed that former New York governor Mario Cuomo is being wooed by several syndicators to host a similar talk show.

If football fans can no longer look to CBS for NFL games, they can still listen. The network's Radio Sports division has inked a four-year contract giving it exclusive broadcast rights for the 1995 through 1998 seasons. Under the agreement CBS, which has held the radio rights to the NFL for 15 of the last 17 seasons, will air a 53-game package of both regular and post-season events, including the Super Bowl.

Leonard Kahn, developer of the AM stereo system bearing his name, has made clear his unwillingness to accept defeat in the battle royal for a national AM stereo standard. Three separate legal actions are under way by Kahn, including a patent-infringement suit against General Motors and an antitrust suit against rival Motorola. A third seeks a reversal by a U.S. Court of Appeals of the FCC's 1993 choice of Motorola's C-Quam system as the national standard on the grounds that the Kahn system did receive a full and fair review by the Commission.

As we reported in the March issue, Edmonton, Alberta's CISN-FM was running a \$45,000 promotion where each time a listener hear a cow mooing on the air, he or she could call in and win \$100. Now, according to an article in the *Calgary Herald* supplied by Trevor Fletcher, the station's "Cash Cow"—actually a costumed station employee—was on two separate occasions fondled and choked by a 37-year-old woman. The woman, who has been charged with one count each of sexual assault and common assault, apparently had a crush on one of the country station's personalities. As a result of the attacks, station policy is that the cow now must be escorted at all public appearances. As CISN promotions director Cori Horton explained in the *Herald* article, the bulky costume makes the wearer vulnerable to attack, and anyway "you can't have the Cash Cow whaling back on someone."

Thanks: Do you have an eye-catching QSL or bumper sticker in your collection that you'd like to show off but don't want to part with? You can have your cake and eat it, too, by sending us a crisp black-and-white or color photocopy. And don't forget to pass along any news clippings and station and shack photos. Until then, 73s.

Motron 310 Garfield St Suite 4
ELECTRONICS Eugene, Oregon 97402
 PO Box 2748

New DTMF & ROTARY TEST DECODERS

TONE-MASTER™ TM-16A & TM-16A Plus



Decode and display DTMF from nearly any audio source; scanner, tape recorder, etc. And now decode and display either DTMF or Rotary digits from a telephone. TM-16a PLUS with RS-232 serial output includes Logger Software for optional automatic date/time/number logging using your IBM Compatible computer. Prices and specifications subject to change without notice.

TM-16a DTMF & Rotary Decoder \$179.00 **TM-16a Plus with RS-232 output \$249.00**

Shipping/Handling \$5 USA/Canada, \$15 Foreign. Premium shipping available for an additional charge.       

Orders: (800) 338-9058 Info: (503) 687-2118 Fax: (503) 687-2492

+30db

The Original **Select-A-Tenna** ★★★★★



- AM RADIO ANTENNA WORKS WITH THE BUILT-IN ANTENNA IN YOUR RADIO
- NO WIRES TO CONNECT
- NO BATTERIES
- HIGH-Q SUPER GAIN AND SELECTIVITY
- PROVEN WORLD-WIDE FOR OVER 22 YRS
- SATISFACTION GUARANTEED
- THIS ONE REALLY WORKS!

\$59.95 PLUS SHIPPING

INTENSITRONICS CORP. P.O. BOX 562 DEPT. Q HALES CORNERS, WISC. 53130	TOLL-FREE 1-800-382-4155 FAX 1-317-883-7555
---	--

MADE IN USA

CIRCLE 65 ON READER SERVICE CARD

Beaming In (from page 5)

appropriate forum."

Judge Wilken's decision contained a number of observations that get right to the heart of the matter. For instance, she pointed out that, "the FCC is arguably violating its statutory mandate as well as the First Amendment by refusing to revisit the issue of LPFM. In all circumstances, except those involving vessels in distress, all radio stations shall use the minimum amount of power necessary to carry out the communications desired."

She noted that, "at most, the government's *allegations* of brief interference present an issue for balancing of hardships. The Court finds that the harm to the First Amendment rights of FRB and the public at large which may result from enforcing the current regulations outweighs the slight showing of interference proffered by the government."

In her conclusion, Judge Wilken observed, "The government has so far failed to address the constitutional issues in the FCC actions against FRB and has inadequately addressed them in arguments before this court. This court defers to the FCC to provide guidance on the factual and technical issues related to the constitutionality of the regulatory scheme. That is, in the light of current technology, is a total ban on new licensing of LPFM the least restrictive means available to protect against chaos on the airwaves?"

Judge Wilken went on further to state, "On the present record, this Court does not find a probability that the Plaintiff will succeed on the merits, particularly in the absence of guidance from the FCC on FRB's constitutional challenge to the regulations at issue. While there may be a serious question as to the merits, on the present record the Court does not find that the balance of harm tips sharply in favor of the FCC."

For the micropower FM broadcasting, LPFM, *Free Radio*, or whatever you wish to call it, movement, this has been a sign of hope. We here at POP'COMM have many times spoken out in favor of the FCC's establishing an LPFM service to meet the public's need.

The FCC has, in the past, been proven successful with its standard menu of claims each time the agency has dragged a low-power FM community broadcaster into court. The FCC has honed its traditional arguments to a fine edge—lack of license, possible or vague interference to vital systems, etc. Courts have been willing to buy the FCC's neatly wrapped package. FRB has shown that low-power community FM stations could become a legal reality!

One more thing before we go this month. Every home-brew FM station isn't an altruistic community project. A few months ago, they shut down WEFX, 89.7

MHz, in Holbrook, N.Y., right in my home county. WEFX was built from \$20,000 worth of equipment, all of it apparently stolen from local radio stations. The operator didn't have to worry about the Free Speech issue. That's because he was arrested by the police on five counts of burglary and three counts of criminal possession of stolen property.

For the record, as FCC regulations presently stand, operating an unlicensed radio station can lead to civil or criminal prose-

cution. Criminal penalties can be up to a year in jail and a \$100,000 fine. Except in isolated cases, the FCC usually settles the matter by seizing the equipment and getting the operator to promise not to do it again.

My appreciation for the help with this month's "Beaming In" is extended to Bartholomew Lee, Esq., of San Francisco, Calif., Eric M. Nelson, WA0KVD, of San Diego, Calif., and *Arizona Free Radio*, Station KAFR, P.O. Box 47473, Phoenix, AZ 85068-7473. ■

The single most comprehensive source of information on HF propagation is now available from CQ!

The NEW Shortwave Propagation Handbook

Completely updated!

CQ has been a leader for nearly 50 years in providing timely and invaluable information on HF propagation. Thousands of radio amateurs were helped by our first propagation handbook. Now, you can take advantage of the information and techniques presented in this completely updated and revised volume. It's certain to be one of ham radio's classics.

Authors George Jacobs, W3ASK, Ted Cohen, N4XX, and Robert Rose, K6GKU, have spent years gathering information from individuals and organizations around the world. Collectively, they have devoted much of their professional and amateur radio careers to advancing ionospheric science. This knowledge and experience can now be at your fingertips in this truly unique reference source! Be sure to order yours today!

The NEW Shortwave Propagation Handbook

By George Jacobs, W3ASK
Theodore J. Cohen, N4XX
Robert B. Rose, K6GKU

Only \$19.95 + \$4 s/h

Here are just some of the highlights that make this book a must for your library:

- Principles of ionospheric propagation
- Solar cycle predictions
- "Do-it-yourself" propagation predictions/charts
- Ionospheric forecasting
- Analysis of HF propagation prediction software
- Unusual HF and VHF ionospheric propagation
- Expansive references and data sources
- Specific predictions for the upcoming Cycle 23
- How to access NOAA's geophysical databases
- Scores of charts, tables, and summary information
- Stunning photography including the largest ever observed solar flare in 1989
- Complete overview of WWV and WWVH propagation services

Order toll-free 1-800-853-9797

YES, Send me _____ copies of CQ's *The NEW Shortwave Propagation Handbook* at \$19.95 each plus \$4 s/h:

Name _____ Callsign _____

Address _____

City _____ State _____ Zip _____

Check M/O Visa Mastercard AMEX Discover

Card # _____ Expiration Date _____

Mail your order to:

CQ Communications, Inc., 76 North Broadway, Hicksville, NY 11801. FAX 516-681-2926

Also available through your local dealer!

Mailbag (from page 6)

The Bat That Won't Go Away

Trying to make up my mind as to what to do about getting a better antenna. Saved an article from page 60 from the January '93 issue of POP'COMM. In it, antenna columnist Joe Carr writes, "But no antenna ever worked as well as one invented by editor Tom Kneitel. If you get the chance, ask Tom to tell you about the infamous Vampire Bat antenna..." Thus this letter to you. What is the Vampire Bat, and why does Joe Carr praise it so highly?

Charles Horton,
Azle, Texas

In 1966, during my tenure as Editor of "S9 Magazine," I wrote an article for a CB antenna project. This was the Vampire Bat; portable and small enough to carry around in the pocket, it could be used either vertically or horizontally, could not possibly cause TV interference, and was virtually 100 percent effective. I said the FCC would be happy if all CB'ers used a Vampire Bat. It could be constructed in a few minutes, and consisted of two resistors and some coaxial cable mounted on a bat-shaped cardboard support form. The bat-shaped form is what the dry cleaner used to put in the collars of my shirts. The Vampire Bat was an antenna dummy load, so it had the minor drawback of not allowing a CB radio to send out any signals. Since this was an April Fool's issue story, I deliberately omitted mention of this one thing it didn't do. I simply extolled the many wonderful things it could do.

Over the years, the Vampire Bat has taken itself a life of its own. I'm proud to note that it remains in legend and myth as the prototype of the ultimate wonderful electronic gizmo which promises everything, yet does absolutely nothing.

—Editor.

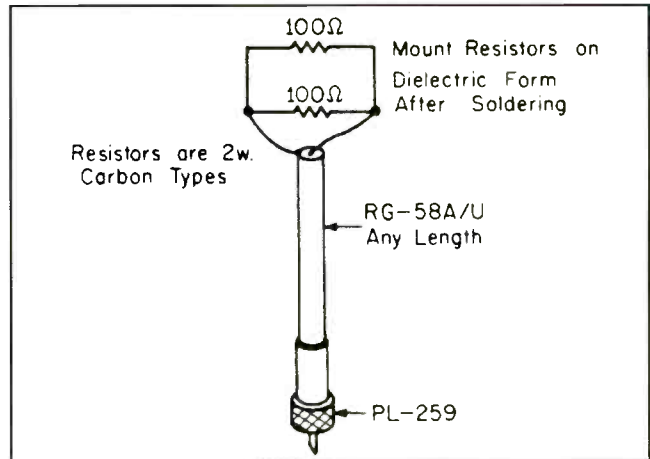

Schematic for the Vampire Bat, in case you want to build one.

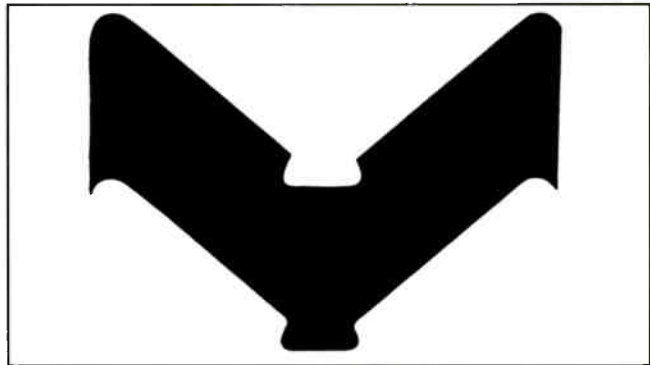

Mystical bat-shaped form used to mount the circuit on.

TUCKER ELECTRONICS

CARRIES THE COMPLETE ICOM RECEIVER LINEUP!

ICOM

Give us a call today for a complete catalog of these
and many other great products to complete your listening post.
TUCKER ELECTRONICS: YOUR COMPLETE SOURCE FOR ICOM RECEIVERS!



Icom IC-R7100A12



Icom IC-R100



Icom IC-R71A

Icom IC-R1-15



Call Now: 800-527-4642

TUCKER
E L E C T R O N I C S

1801 Reserve Street, Garland, TX 75042 • P.O. Box 551419, Dallas, TX 75355-1419 • In Dallas: 214-348-8800 • Fax 24 hrs. in English, Español, Français, und auf Deutsch: 214-348-0367

COMMUNICATIONS SHOP

Advertising Rates: Non-commercial ads are 30 cents per word, including abbreviations and addresses; minimum charge \$6.00 per issue. Ads from firms offering commercial products or services are \$1.00 per word; minimum charge \$20.00 per issue. Boldface words are \$1.20 each (specify which words). Leading key words set in all caps at no additional charge. All ads must be prepaid in full at time of insertion; a 5% discount is offered for prepaid 6 time insertions. All ads must be typewritten double spaced.

Approval: All ad copy is subject to Publisher's approval and may be modified to eliminate references to equipment and practices which are either illegal or otherwise not within the spirit or coverage scope of the magazine.

Closing Date: The 10th day in the third month preceding date of publication. Because the advertisers and equipment contained in Communications Shop have not been investigated, the Publisher of Popular Communications cannot vouch for the merchandise listed therein. Direct all correspondence and ad copy to: PC Communications Shop, 76 N. Broadway, Hicksville, NY 11801.

Please take note: As of May 1, 1995, we are no longer accepting free subscriber ads.

CB RADIO OWNERS AND DEALERS. A new line of accessory circuits is now available. Breaker Beeper, Receiver Pre-Amplifier, Roger Beeper, many more—some never before available! Send an S.A.S.E. for a free catalogue to 6810 7th Street, N.E., Tacoma, WA 98422.

TRADE OR SELL Realistic HTX-202 with optional speaker mike, \$200. Realistic PRO-37 200 channel scanner, \$200. Have manuals. Will trade both for ICOM R-1. Call Steve, (914) 774-8891.

TOMCAT'S BIG CB HANDBOOK, by Tom Kneitel. 221 large pages, fully illustrated. Complete guide to worldwide AM, SSB, Freeband, 27 MHz operations. Everything they never told you (legal & otherwise) from world's leading CB authority. Only \$15.95 plus \$5.00 s/h (Canada \$6.00) from CRB Research Books, Inc., PO Box 56, Commack, NY 11725. (NYS residents add \$1.78 sales tax).

WANTED: RADIO NEWS MAGAZINE, February 1944 (Special Signal Corps Issue). Pay \$25.00-\$50.00 depending on condition, & Military Radio Manuals (all years). **GENE, KD4YIZ**, 1-800-619-0900, MMI, Box 720024, Atlanta, GA 30358-2024.

FORMER INTELLIGENCE AGENT!!! Catalog of affordable security, surveillance, countermeasures, cellular intercept, night vision, special and unconventional weapons. Monitoring is our specialty. Send \$5 to Lowry, 3111 Arendell Street, Morehead City, NC 28557.

WORLD'S MOST UNUSUAL Communications Books! A large selection of outstanding titles covering scanners, "confidential" frequency registries, bugging, wire tapping, electronic surveillance, covert communications, computers, espionage, monitoring, and more! New titles being added constantly! Ask for our big FREE catalog. CRB Research, BOX 56-PC, Commack, NY 11725.

LOOKING FOR crystals for Drake 2B receiver. Also need information on restoring cellular capacity to Realistic Pro-46 scanner. Sue Wilden, 2204 6th Street, Columbus, IN 47201.

WANTED: USED OPTOELECTRONICS APS104 PRESELECTOR. FOR SALE: OPTOELECTRONICS CF800 8355 MHz Filter/Amp. Brent Gabrielsen, 1177 East Tonto, Apache Junction, AZ 85219. (612) 969-8663.

COMMODORE 64 HAM PROGRAMS—8 disk sides—over 200 Ham programs—\$16.95. 32¢ stamp gets unusual software catalog of Utilities, Games and British disks. Home-Spun Software, Box 1064-PC, Estero, FL 33928.

MINI SONY Surveillance TV System. Swedish/German light meters, temperature chart recorder, professional sound meter. Shack applications. Pictures/info; \$1/LSASE to: R. Summers, 6804 Rockforest Drive, Louisville, KY 40219.

WANTED: ICOM R1 or AOR AR 1000XLT in mint condition. NYC or Long Island. Ed, (718) 278-6567.

THE GE SUPERADIO III with up to four modifications is choice for many DX'ers. Low as \$85. MC, VISA, 800-944-0630.

TUNE In On Telephone Calls. Revised and Updated Edition! Tom Kneitel's controversial 160-page book. Everything you need to know to effectively use a scanner and communications receiver to eavesdrop on private telephone calls from homes, offices, cars, ships, aircraft, trains. Explanatory text, photos, extensive listings section covers USA/Canada on HF, VHF, UHF, and above; thousands of locations, frequency assignments. Explains equipment, best techniques, laws regarding monitoring cellular, cordless, ship/shore, high seas, Air Force 1, airliners. 1-way paging, more. Only \$14.95 plus \$5.00 s/h (Canada \$6.00) from CRB Research, PO Box 56, Commack, NY 11725. NY residents add \$1.70 sales tax. Dealer inquiries invited. Visa/MC OK. Tel: 1-800-656-0056.

WOW! UNDERSTANDING & REPAIRING CB RADIOS by Lou Franklin. Giant 380-page technical book picks up where THE "SCREWDRIVER EXPERTS" GUIDE leaves off. Includes circuit descriptions and troubleshooting guide for virtually all CB radios: 23 and 40-channel, crystal and PLL, solid-state and tube, AM, FM, SSB, CW, American, British and export models. Covers test equipment, transistor basics, synthesizers, receivers, transmitters, power supplies, T/R switching, antennas, interference, parts and accessory sources. Over 350 illustrations, plus huge subject index. Moneyback Guarantee! Only \$29.95, plus \$3.50 U.S. & Canadian Air Mail, VISA/MC accepted. Free catalog of unique CB books, plans, and modification kits with order. Catalog only \$3. **CBC INTERNATIONAL INC., BOX 31500PC, Phoenix, AZ 85046.** Thousands of satisfied customers since 1976.

WANTED HIGH PERFORMANCE? The "Great" CBs, necessary accessories, antennas of the "Golden Era." Special Schematics, Classic Tubes, Dynamite Xstrs. L.S.A.S.E. to: AC, PO Box 383, Buckner, NY 40010-0383.

WANTED: Circuit diagram and maintenance manual for EDDYSTONE receiver model S680/2A (England). LU3FS, C.C. 303, (2000), Rosario, S.F., Argentina.

INTERNATIONAL CLASSIFIED ADS. Buy sell or trade electronic "stuff." Biweekly publication. Free ads, send today! Trading CIRC-IT, 86 Victoria Street, South Kitchener Ontario Canada N2G 2A9. SASE for information. E-mail b.lyleven@genie.geis.com.

RADIO SHACK SCANNERS - Lowest prices all catalog items. 1000-channel PRO-2035, reg. \$449, our price, \$389. PRO-62 and PRO-51, Call! DX-390, reg. \$220, call! No tax out of Florida. Call 1-800-848-3004. Orders only. **COTRONICS INC., 2250 SE Federal Hwy., Stuart, FL 34994.**

BUILD THE ULTIMATE 11 meter vertical. For detailed plans send \$15 to Terrapin Sales, P.O. Box 12426, La Crescenta, CA 91224-5426.

800MHz coverage!
We have scanners with 800MHz coverage!
Brands available include:
ICOM, Kenwood,
Yupiteru, and AOR

ATLANTIC HAM RADIO LTD.
(416) 636-3636 368 Willson Ave
(416) 631-0747 (fax) Downsview, ON
All U.S. orders shipped UPS Air Canada M3H 1S9

As heard about on WHRI, WINB, WWCR, Radio Copan International
Reviewed by Larry Miller In April '93 "MT"
Introducing—The New "TINY TENNA" Indoor Active Antenna
The "TINY TENNA" works on LW, MW, SW, VHF & UHF. It runs on a 9 volt battery or AC adapter. (not included) Great for travelers, vacationers, apartment or condo dwellers, etc. No frills, nothing fancy...only pure performance and Made in the USA!
Complete and easy hook-up for ALL Receivers! Satisfaction Guaranteed!
Special for "POP COMM" Readers! Only \$19.95*

DWM Enterprises
1709 N. West Avenue, Jackson, MI 49202
*plus \$4 US shipping, \$5 Canada/Mexico, \$6 DX Check or MO only, please US Funds

FIRE AUDIO CASSETTE TAPES
Listen to the action as New York City F.D.N.Y. responds to working fires.
60 minute audio tapes.
Other metro area fire departments listed in brochure.

FREE BROCHURE
1-800-575-1075

MOUNTAIN SALES
Unit 257-PC, 163 E. Main St. Little Falls, NJ 07424

YOU AIN'T HEARD NOTHIN' YET

Since 1967, CRB Research has been the world's leading publisher and supplier of unique hobby and professional books and information including:

- Scanner Frequency Guides
- Shortwave Frequency Guides
- Military/Federal
- & Other Related Topics!

Ask For Big Free Catalog

CRB RESEARCH
P.O. Box 56, Commack, NY 11725
Phone: (516) 543-9169/FAX: (516) 543-7486

CIRCLE 11 ON READER SERVICE CARD

Quality Microwave TV Antennas

WIRELESS CABLE - IFTS - MMDS - Amateur TV
Ultra High Gain 50db(+) • Tuneable 1.9 to 2.7 Ghz.

- 55-Channel Dish System \$199.95
- 36-Channel Dish System \$149.95
- 20-Channel Dish System \$124.95
- Optional Commercial Grid Antenna (not shown) Add \$50.00
- Yagi Antennas, Components, Custom Tuning Available
- Call or write (SASE) for "FREE" Catalog

PHILLIPS-TECH ELECTRONICS
P.O. Box 8533 • Scottsdale, AZ 85252
(602) 947-7700 (\$3.00 Credit all phone orders)
MasterCard • Visa • American Express • C.O.D. • Quantity Pricing

CIRCLE 70 ON READER SERVICE CARD
July 1995 / POPULAR COMMUNICATIONS / 83

SCANNING RECEIVERS for monitoring police, fire, aircraft. Base, mobile, handheld. Antennas, CBs, and accessories. HPR Box 621136C, Littleton, CO 80162.

CW? NO PROBLEM. You can increase your speed, no matter how many times you've failed before. **Results guaranteed** when you follow the instructions. PASS Publishing's CW Mental-Block Buster program helps you **explode mental blocks** that hold you back. Based on 40 years of research, the **CW Mental-Block Buster** uses guided meditation, dynamic visualizations, and powerful affirmations to blast through mental blocks. You can do code! That means new bands, more contacts, more fun! (This is not a CW practice tape.) The CW Mental-Block Buster audio cassette and practice booklet are only \$29.95 ppd. in the US. GA residents add 6% sales tax. (Quantity discounts available for classes.) PASS Publishing, PO Box 768821, Roswell, GA 30076. 404-640-6295; FAX: 404-640-8780. MC/VISA, COD. Mail/fax orders include signature. Office hours after 4:30 Eastern.

SCANNER MODIFICATION HANDBOOK VOL. 1 by Bill Cheek. The famous original 160-page book. Performance improvement modifications. Simple step-by-step instructions, many photos. Primarily PRO-2004 & PRO-2005, some for PRO-34, BC-200/205XLT, BC-705XLT. BC-705XLT. Restore blocked-out bands, speed up scanning rate, disable "beep," increase number of channels, improve squelch action, add an S-meter, interface with shortwave receivers, etc. Make the PRO-2004 & 2005 into a 6,400 channel scanner; put 3,200 channels into the PRO-34! Plus, cellular frequency charts, antenna info & mods, inside info on frequency management, operating hints, emergency power supplies, scanners & the law, lots more! Only \$18.95, plus \$5.00 s/h (Canada \$6). Residents of NY State add \$2.36 tax. Big 220 page VOL. 2 with more mods for PRO-2004/5/6, PRO-34, PRO-2022, BC-760/950XL, BC200/205XL, also available. \$18.95 plus \$5.00 s/h (Canada \$6). NY State residents include \$2.36 tax. If both books are ordered at the same time, send only \$5 s/h. (NY State res. add \$3.65 tax if ordering both books.) Order from CRB Research Books, Inc., PO Box 56, Commack, NY 11725. Visa/MC welcome. Tel: 1-800-656-0056.

RADIO MONITORS NEWSLETTER OF MARYLAND FOR THE SERIOUS SHORTWAVE AND SCANNER LISTENERS. PO BOX 394, Hampstead, MD 21704. For a one year subscription: \$15.00. Sample copy: one dollar.

CW Lite is the **easiest** Morse Code training method in the world, bar none! And it is the fastest, too. Just closed your eyes and relax. This powerful **hypnosis cassette tape** does the rest. Subliminals speed you along! Only \$15.95 ppd in US (GA residents add 6% tax). Order today! **PASS Publishing**, Box 768821, Roswell, GA 30076. 404-640-6295; FAX: 404-640-8780. Office hours after 4:30 PM Eastern. MC/VISA, COD. Mail/fax orders include signature.

PRO 23, 34, 37, 39, 43, 46, 51, 2006, 2022, 2026, 2027, 2032, BC-855XLT, BC-2500XLT 800 MHz modifications. Well explained and illustrated steps. \$12 each, or \$20 if we do modification. Available to sell your products in Quebec and Canada: new brands and products welcome. 405 Grenfell, Labrador City, Newfoundland. A2V 1J3 Canada.

CB RADIO HACKER'S GUIDE! Big 151 page book: pictorials, diagrams, text. Complete guide to peaking, tweaking, & modifying 200+ CB radios for enhanced performance & more features. Which screws to turn, which wires to cut. AM & SSB radios: Cobra, Courier, GE, Midland, Radio Shack Realistic, SBE, Sears, Uniden/President. Get the most from your CB radio & operations. Only \$18.95, plus \$4.00 shipping (\$5.00 to Canada). NY State residents add \$1.95 tax. Order from CRB Research Books, Inc., PO Box 56, Commack, NY 11725. Visa/MC OK. Tel: (516) 543-9169.

SATELLITE RADIO BOOK AND GUIDE. Newbook covers all Audio Services, SCPC, Subcarriers, FM Squared, Facsimile, Press Services, Weather Services. Simple how-to-receive instructions. \$16.95, plus \$3 Priority Mail. UNIVERSAL ELECTRONICS, 4555 Groves Road, #12, Columbus, OH 43232, or call (614) 866-4605.

PAN-COM INT'L CATALOG. Over 350 Kits, Plans. Licensed/unlicensed AM/FM broadcasting. Ham/CB/SW/DX, 1750M transmitters, Surveillance devices, Computers/Software, Science Projects, MORE! \$1 refundable. Box 130-P08, Paradise, CA 95967.

COMPLETE LAW ENFORCEMENT CELLULAR phone monitoring guide. All methods of attack, frequencies, channels, base, spacing, increment search, cell search, **phone number target interception.** **FREE** equipment catalog with order. \$21. Operative Supply, PO BOX 2343, Atlantic Beach, NC 28512.

MEN OF ACTION AND ADVENTURE — Paladin Press has been described as "the most dangerous press in America." Millions of satisfied readers disagree. Outrageous and controversial books and videos on firearms, exotic weaponry, unconventional warfare, new identity, espionage and investigation, privacy, action careers and more! To order our 50-page catalog send \$1.00 to: Paladin Press, Box 1307-3BP, Boulder, CO 80306. (303) 443-7250.

SELECTED SHAREWARE (MSDOS): Choice programs. All good. Many unusual. No disappointments. \$1 each. Free catalog on disk. Restricted book listing included. **MENTOR PUBLICATIONS, Box 1549-P, Asbury Park, NJ 07712.**

MINIATURE TRANSMITTERS! All types! Send \$2 for information, refundable on first purchase. Parsec Electronics, P.O. Box 34594, Phoenix, AZ 85067-4594.

LOCATING, TRANSLATING SERVICE: Books, shop service manuals, journals. Will barter third world translation services, book forwarding. Waterproof pages optional. Specialties: Bio-medical, folk medicine, Celestial Navigation, \$200 package. Bater with bible translators, Peace Corps, others. R.V. Engineering, PO BOX 734, Ottertail, MN 56571. (218) 367-2636.

ANTENNAS FOR CB, SCANNER, CELLULAR, 2-WAY base, portable, mobile. High quality at discount prices. Price list, \$1. **Radio Communications Services**, 1007 Eastfield, Lansing, MI 48917.

GUIDE TO THE AR1000. We publish a complete, 90-page guide for the operation and use of all AOR-AR1000 and Fairmate HP-100/200 scanners. Comes with 10 scan bank templates and a handy, six-panel, folded Quick Reference Card. \$18.45 including S&H in the USA. Design EQ, PO Box 1245-PC, Menlo Park, CA 94025. 415-328-9181.

UHF MILITARY BAND (225 to 400 MHz) monitoring aids. High performance MAX-225 ground plane antenna designed especially for this band, fully assembled, \$29.95 plus shipping. GRE Super Amplifier 20 dB scanner preamp (100 to 1000 MHz), \$55.95 plus shipping. "Directory of North American Military Aviation Communications," your state or province, \$24.95 plus shipping. "Top Secret Registry," \$21.95 plus shipping. USA shipping is \$4 for first item, and \$1 for each additional item. Canadian shipping \$5 for first item, and \$2 for each additional. NY State residents add 8.5% sales tax to item price and shipping cost. MC/VISA welcome. CRB Research, P.O. Box 6, Commack, NY 11725. Phone orders: 1-800-656-0056, Canada/AK/HI phone orders: (516) 543-9169.

NTR-1 DSP NOISE/TONE REMOVER, new. I paid \$169.95; yours for only \$95. Send money order to Yassin Abdela, Two Riverside Street, Rochester, NY 14613. Call (716) 254-0940 before mailing check.

MILITARY RADIOS: Easily made battery adapters for military radios & other electronics. Get **POWER UP!** Big new 96-page manual of instructions, diagrams. Use readily available commercial batteries in PRC-6, -8, -9, -10, -25, -28, -47, -74, -77, TRC-77, AN/PRC-9, AN/PRT-4, RT-77, URC-68, more; also mine detectors, night scopes, radiacs, field telephones, etc. Only \$13.95, plus \$4 s/h (\$5 Canada). NYS residents add \$1.53 tax. CRB Research Books, Box 56-PC, Commack, NY 11725. VISA/MC accepted. Phone (516) 543-9169.

NEW AWARDS PROGRAM! For SWL's, DX'ers, Scanner Buifs! Self-addressed stamped envelope brings details! ISWAC, Box 66, Hanover, MI 49241.

RCI-2950/2970 MODIFICATION MANUAL. Power and modulation increase. Clarifier, receiver, noise blanker modifications, operating hints, and more. Parts included, \$20 ppd U.S. money order. \$25 COD (MO residents add \$1.15 tax). Scott, P.O. Box 510408, St. Louis, MO 63151-0408, (314) 846-0252.

HAM RADIO PROGRAMS (plus 100s of other applications). Low as \$1.00 per disk. Send \$2.00 for catalog and sample disk to: TRI-MI SOFTWARE, 517 Pine Brook Road, Eatontown, NJ 07724. (908) 389-1049.

THE AMERICAN INTERNATIONAL CLUB is the fastest growing 27 MHz LSB DX club in existence. For application send SASE: AIC, Box 701431, Queens, NY 11370.

SHORTWAVE LISTENER looking for RTTY, FAX, etc., enthusiasts in Miami, FL area. I have equipment, but can use more know-how. Maybe start a club? Call Dan. (305) 226-3987.

R-390A SALES-SERVICE PARTS. Info, SASE. Miltronix, PO BOX 3541, Toledo, Ohio 43608.

HALLICRAFTERS CONTINENTAL MODEL 5R33A manual wanted. Will pay postage and copying. Steve Batson, 4012 Staunton Ave., Charleston, WV 25304.

FOR SALE: Amplifier with four 4-1000A's, Dahl transformers, Jennings vacuum variables monoband 10-12 meters—\$5,000. Grady, POB 62, Cookeville, TN 38503. 615-432-5588.

"FORBIDDEN SECRETS OF THE LEGION OF DOOM HACKERS!" Big 224-page handbook. The infamous LOD's condemned programs and amazing techniques, from the LOD's now shut down in BBS. Hacking, phreaking, and more! Hard to locate information, now in this limited edition. For reference and informational purposes only. \$20.95, plus \$5 s/h (Canada \$6). NYS add \$2.21 tax. VISA/MC okay. CRB Research Books Inc., Commack, NY 11725. Phone orders: 1-800-656-0056.

NATIONAL SCANNING REPORT, America's #1 all-scanning magazine. Articles, frequencies, new products, more. One year subscription (\$19.90) includes custom frequency print-out for your county. Order toll-free 1-800-423-1331. Sample copies \$3.00 cash from Box 360, Wagontown, PA 19376.

FREE IMPORT/EXPORT CB CATALOG by **FAX-ON-DEMAND** 24 hours a day. **LOWEST PRICES.** Call **LORD/WYATT COMMUNICATIONS**, (718) 789-7329.

LAST CHANCE: We have a very limited supply of the modifiable cellular Bearcat scanners left, BC-200XLT, BC-2500XLT, BC-890XLT, etc. Once these are gone, they are gone forever. Call for close-out prices—we ship COD, and free U.P.S. shipping to 48 states. Galaxy, Box 1202, Akron, OH 44309, (216) 376-2402, 8:30-4:30 EST. Our 11th year!

RESTRICTED top secret Hacker information. Cellular/cable/surveillance/satellite/VideoCipher/books/videos and more. Catalog—\$3. **TELECODE**, P.O. Box 6426-PC, Yuma, AZ 85366-6426.

HOW TO BUY A USED SHORTWAVE RECEIVER—\$6 ppd. Complete catalog of Patriot/Right Wing books - \$1. Bohica Concepts, POB 546-PC, Randle, Washington 98377.

WANTED: Service manual for Realistic DX-300 S.W. receiver with schematics. Please write: Dwight Kornelsen, VE5 DXK, Box 1311, Watrous, Saskatchewan, SOK 4T0 Canada.

FM BROADCASTING: Transmit many miles, excellent sound, 80-108 MHz. Not a bug. Kit or assembled, full info call 24 hours. R. Scott Communications, (604) 642-2859.

TRADE: POP COMM 1982 to October 1990 complete, plus November 1990 to present (missing 8 issues) towards 800 MHz handheld or base scanner, or digital SW receiver, in good condition. Can ship from Maine in July. Harold Rosenberg, 5260 Rosedale Avenue, Montreal, Quebec, H4V 2H6, (514) 488-8594.



"The Largest Dealer of Scanners in the World"

SCANNER WORLD, USA®

10 New Scotland Ave., Albany, NY 12208 • 518-436-9606

MODEL: FB-911

FIRE BOX PHONE

\$45.99 (\$5.50 Shipping Each)



13 memory phone, 3 direct access emergency memories, auto redial, ringer on/off, top light flashes when telephone is ringing, tone/pulse switchable, desk/wall mount, front door closes for authentic fire box appearance, FCC approved. Size 16"H x 8 1/2"W x 7"D. We also have the PB104, dark blue POLICE PHONE BOX for only \$45.99 (\$5.50 Shipping).

GM-1™ GLASS MOUNT SCANNER ANTENNA

Frequency coverage 25-1200 MHz — only 22 inches tall. No holes to drill — includes contact glue pads for easy installation. Complete with 17 foot cable, Motorola connector, and mounting hardware. Swivels to vertical position — performance unaffected by moisture on the window.

Made in USA.

SPECIAL \$39.99

(\$4.00 Shipping Each)

GLASS MOUNT ANTENNAS FOR TRANSCEIVERS

Includes mounting kit and cable. Low band, High band and UHF band includes PL259 connectors. 800 cellular band antenna includes TNC connector.

GM-27 27 MHz Low Band for CB	\$39.99	(\$4.00)
GM-155 144-174 MHz High Band	\$39.88	(\$4.00)
GM-450 450-470 MHz UHF Band	\$39.99	(\$4.00)
GM-800 Cellular Telephone Band	\$34.99	(\$4.00)

CB Radios	In Stock
Two-Way Radio Batteries	In Stock
Scanner Antennas	In Stock
Power Supplies	In Stock

SCANNER ACCESSORIES

BCAD70	14.99	BP4	24.99
BCAD100	14.99	BP55	16.99
BCAD140	14.99	MA917	26.99
BCAD580	16.99	MA518	14.99
BC003	7.99	ESP25	16.99
BC002	59.99	GRE8002	79.99
PS001	12.99	GRE-HH	54.99
UA502A	12.99	GRE9001	89.99
BP205/200	34.99	GRE3001	62.99
BP70	16.99	FBE	5.99
VC001	12.99	FBSW	5.99

★ ALL MERCHANDISE NEW, IN FACTORY SEALED CARTONS ★

UNIDEN BEARCAT BC200XL

\$224.99 (\$8.00 Shipping)



Digital programmable 200 channel hand held scanner with raised button keyboard for easy programming of the following frequency ranges: 29-54 MHz, 118-174 MHz, 406-512 MHz, 809-956 MHz. * Features include: Scan delay, memory backup, key pad lock, sidelit liquid crystal display, channel lockout, 10 twenty channel banks, direct channel access, automatic search, one full year factory warranty, 10 priority channels, Ni-Cad battery pack, AC adapter/charger, flexible rubber antenna, carry case are all included. Size is 2-1/16"W x 1-3/8"D x 7-1/2" high. (* Excludes Cellular) #CC-008 Heavy Duty Leather Carry Case **\$27.99**

RADIO SCANNERS

BEARCAT BC60XL	\$109.99	(7.00)
BEARCAT BC70XL	114.99	(8.00)
BEARCAT BC80XL	219.99	(8.00)
BEARCAT BC100XL	159.99	(7.00)
BEARCAT BC120XL	169.99	(7.00)
BEARCAT BC142XL	83.99	(6.00)
BEARCAT BC144XL	89.99	(7.00)
BEARCAT BC147XL	99.99	(7.00)
BEARCAT BC148XL-1	104.99	(7.00)
SPORTCAT SC150B/Y	174.99	(8.00)
BEARCAT BC178XL	149.99	(7.00)
BEARCAT BC200XL	224.99	(8.00)
BEARCAT BC220XL	259.99	(8.00)
BEARCAT BC350A	129.99	(7.00)
BEARCAT BC400XL	93.99	(7.00)
BEARCAT BC560XL	109.99	(7.00)
BEARCAT BC580XL	194.99	(7.00)
BEARCAT BC700A	199.99	(7.00)
BEARCAT BC760XL	249.99	(7.00)
BEARCAT BC800XL	229.99	(8.00)
BEARCAT BC855XL	149.99	(8.00)
BEARCAT BC860XL	199.99	(8.00)
BEARCAT BC890XL	284.99	(8.00)
BEARCAT BC2500XL	369.99	(9.00)
BEARCAT BC8500XL	369.99	(9.00)
BEARTRACKER BCT2	149.99	(7.00)
BEARTRACKER BCT7	209.99	(7.00)
COBRA SR900	99.99	(7.00)
COBRA SR901	74.99	(6.00)

BOOKS

Scanner Master	29.95
Covert Intelligence	8.95
Air Scan Directory	14.99
Betty Bearcat	5.99
Top Secret (8th)	18.99
Covert Techniques	9.95
Tomcat's Big CB	13.95
World Radio	18.99
Survival Directory	6.95
Rail Scan	7.95
Monitor America	24.99
Police Call	9.29
Scanner Modification	17.99

Uniden®/Bearcat BC-142XL 10 Channel Base/Mobile Programmable Scanner

\$83.99



(\$6.00 Shipping)

Programmable, digital, AC or DC operation, weather backup, priority lockout button, squelch, memory backup, 2 digit LED display. Frequency coverage 29-54 MHz, 136-174 MHz, 406-512 MHz. Sizes 9"x6 1/2"x2 1/4". Includes AC adapter and telescopic antenna. Optional Cigarette Lighter Cord #142MPC \$4.99

RELM RH-256NB HIGH BAND TWO-WAY RADIO

SPECIAL PACKAGE DEAL \$339.99

(Plus \$9.00 Shipping Each)



16 channel digital readout two-way radio. Covers high band frequency range of 146-162 MHz without retuning. Perfect two-way radio for ambulance, police, fire, tow trucks, taxis, commercial companies who use this band. Features include CTCSS tones built-in, priority, 25 watts output, channel scanning, back-lighted keyboard, message light, time out timer, scan delay, external speaker jack. Size is 2 1/4"H x 6 1/2"W x 10 1/4"D.

SPECIAL PACKAGE DEAL includes RH-256NB, mobile microphone, 1/4 wave body mount antenna, mobile mounting bracket and mobile power cord, all for the low price of \$339.99.

We also have the hand-held version WHS-150 at only \$349.99.

UNIDEN BEARCAT BC-400XL

\$99.99

(\$7.00 Shipping)



Our best selling mobile scanner, 16 channel AC-DC programmable digital, AC-DC cords, telescopic antenna, mobile mounting bracket, weather search priority, 29-54 MHz, 136-174 MHz, 406-512 MHz, external speaker and antenna jacks.

BEARCAT BC-100XL

100 Channel Digital Programmable Hand-Held Scanner

\$159.99

(\$7.00 Shipping)



Our best price ever on a full featured complete package hand-held scanner. Manufactured by Uniden. Features include 11 bands of weather, aircraft, public service, trains, marine, plus more (29-54 MHz, 118-174 MHz, 406-512 MHz). 10 channel banks, 10 priority channels, lighted LCD display, earphone jack, channel lockout. AC/DC operation, scans 15 channels per second, track tuning. Special package deal includes the following accessories: AC adapter/charger, rechargeable Ni-Cad battery pack, flexible rubber antenna, carry case.

SPORTCAT SC-150

100 Channels - 12 Bands Including Public Service, Air And 800 MHz

ONLY \$174.99

(\$8.00 Shipping)



Programmable hand-held sport scanner with 100 channels and 12 bands with aircraft and 800 MHz. Features include: 10 one touch direct access channels with 10 corresponding channel identifiers, band search, data lockout, headphone jack, WX search, rechargeable Ni-Cad battery, illuminated LCD, lockout, auto delay, volume and squelch control. Available in yellow and black. (Specify color.) Dimensions 2 1/2" x 1 1/4" x 6". Coverage: 29-54, 118-174, 406-512, 806-956 MHz.

Cobra SR-901

AVAILABLE ONLY FROM SCANNER WORLD ONLY!

\$74.99

Each (Plus \$6.00 Shipping Each)



\$69.99 (2 or more)

Features include: 10 programmable channels, one touch memory channels, one touch memory programming, external speaker jack, 29-54 MHz, 136-174 MHz, 400-512 MHz, squelch, lockout, full frequency digital readout, AC or DC operation, retains memory up to 3 days without power, scan button. Includes AC adapter, telescopic antenna, and complete operating instructions. Size: 7 1/4"W x 2"H x 7 1/4"D. One year factory warranty.

Optional mobile cigarette lighter cord #901MPC \$4.99

UNIDEN BEARCAT BC 800XL

DIGITAL BASE SCANNER

\$229.99

(\$8.00 Shipping)



Receive police, fire, ambulance, cordless phones, marine, trains, weather, ham, stock cars, public service plus much more. Frequency coverage 29-54 MHz, 118-174 MHz, 406-512 MHz, 806-912 MHz (continuous), 40 channels, AC/DC operation, digital programmable, memory backup requires 2 AA batteries (not included), telescopic antenna included, AC power cord included, external speaker jack, external antenna jack. Dimensions: 9 1/4"D x 4 1/2"H x 12 1/2"W. Channel lockout, direct channel access, scan delay, priority, digital display, auto weather button, automatic search, track tuning.

UNIDEN BEARCAT BC-760XL

\$249.99

(\$7.00 Shipping)



Digital Programmable 100 Channel Scanner

BC760XL covers the following frequencies: 29-54 MHz, 118-174 MHz, 406-512 MHz, 806-954 MHz (excludes cellular). Features compact size of 6-15/16"W x 1-5/8"H x 7-3/8", scan delay, priority, memory backup, channel lockout, bank scanning, key lock, AC/DC power cords, telescopic antenna, mounting bracket supplied, one year factory warranty, search, direct channel access, track tuning, service search including preprogrammed frequencies by pushing a single button for police, fire emergency, aircraft, weather, and marine services plus exclusive optional features never available on any scanner before. First is an RF receive amplifier for boosting weak signals for only \$34.99 plus a CTCSS tone board is available for only \$59.99 to make this the number one scanner available in the USA. Optional cigarette lighter plug #760MPC \$4.99

— IF YOU CAN'T FIND WHAT YOU WANT IN THE ABOVE LISTING, GIVE US A CALL, WE MAY HAVE WHAT YOU WANT —

ORDERING INFORMATION: Call (518) 436-9606 to place orders or mail orders to Scanner World, USA®, 10 New Scotland Ave., Albany, N.Y. 12208. Orders will be shipped within 24 hours by United Parcel Service if order is accompanied by MasterCard, Visa, cashier's check, money order. COD (COD shipped by United Parcel Service will be cash or money order only). (If a COD package is refused, customer will be billed for shipping and COD charges.) Mail orders with personal or business checks enclosed will be held 4 weeks for bank clearance. Prices, specifications, and terms subject to change without prior notice. If items are out of stock we will back order and notify you of delivery date. All shipments are F.O.B. Scanner World® warehouse in Albany, N.Y. We are not responsible for typographical errors. All merchandise carries full manufacturer's warranty. Bid proposals and purchase orders accepted from government agencies only. Free full line catalog mailed 4 times per year. Merchandise delivered in New York State add your local sales tax. No returns accepted after 7 days of merchandise receipt. *Add (\$5) per item and \$4.00* for all accessories ordered at same time. COD orders will be charged an additional \$4.95 per package. Full insurance is included in shipping charges. All orders are shipped by United Parcel Service to street address only. (No P.O. Box). Shipping charges are for the 48 continental US States only. Alaska, Hawaii and all others ask for quote on shipping charge. FAX # 518-465-2945.

Scanner World, USA® • 10 New Scotland Ave., Albany, NY 12208 • 518-436-9606

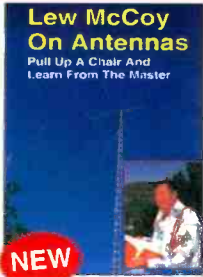

NEW

McCoy on Antennas

CQ magazine author and acclaimed authority on antenna theory and design, Lew McCoy, W1ICP, has written a truly unique antenna book that's a must for every amateur. Unlike many technical publications, Lew presents his invaluable information in a casual, non-intimidating way. **Lew McCoy on Antennas**—It's not just an antenna handbook, but a wealth of practical antenna advice for the ham!

Order No. MCCOY.....\$15.95

Building and Using Baluns and Ununs

Written by world-renowned expert Jerry Sevick, W2FMI, this volume is the definitive source for his latest practical information and designs on transmission line transformer theory. W2FMI has unraveled the technological mysteries with designs that are simple and work. Discover new applications for dipoles, yagis, log periodics, beverages, antenna tuners, and countless other examples. Order No. BALUN.....\$19.95

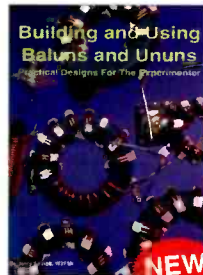

NEW

1995 Amateur Radio Almanac, 2nd Edition

If you're looking for information about ham radio, it's in the **1995 Amateur Radio Almanac**! Compiled by Doug Grant, K1DG, this volume is filled with over 500 pages of facts, figures and information. CQ's almanac is a resource you'll refer to over and over again. If it's ham radio, it's in The Source!

Order No. BALM95.....\$19.95

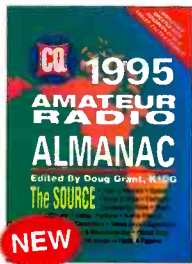

NEW



The Quad Antenna

Hams love antenna books. Written by noted author Bob Haviland, W4MB, **The Quad Antenna** is the authoritative technical book on the design, construction, characteristics and applications of quad antennas. Discover how to easily build a quad antenna for your station that will help you fill your logbook with rare DX that you've only dreamed about before.

Order No. QUAD..... \$15.95

The Packet Radio Operator's Manual



This book is written by CQ columnist and Amateur Radio Packet authority Buck Rogers, K4ABT. An excellent introduction and guide to packet operation, it is the perfect single source, whether you're an advanced user or just starting out. Learn about packet radio without all the technical jargon. This book is the definitive resource for the active packet user.

Order No. PROM..... \$15.95

CQ Buyer's Guides

Dealers • Manufacturers • Product Specs • Feature Articles • Equipment Prices



NEW

1995 Beginner's Guide to Amateur Radio

Whether you're a Novice, Technician or just beginning to think about getting your license, CQ's Beginner's Guide is the perfect addition to your shack. In addition to practical articles on HF, DXing, building your first station, QSLing, and more, you'll also find our famous dealer and manufacturer's listings!

Order No. 95BBG....\$5.95



1995 Equipment Buyer's Guide

Learn from the experts about packet radio, satellites, installing towers, SSTV, and DXing tips. Our 1995 Equipment Buyer's Guide is a package of solid information including the latest in amateur dealers and manufacturers. Discover why this year's edition is the best yet!

Order No. 95EBG....\$5.95

CQ's Buyer's Guides are the single source for information on what equipment is available, features and functions, and where to buy it!

Now Available Direct From CQ!

Title	Order No.	Price	Title	Order No.	Price
ARRL Antenna Book (17th Edition)	ARRLAB	\$30	ON4UN Antennas and Techniques for Low Band DXing	LOWDX	\$20
ARRL Handbook (New Edition)	ARRLHB	\$30	1995 NA Callbook	NACB	\$35
ARRL Operating Manual	ARRLOM	\$18	1995 Int'l Callbook	INTCB	\$35
ARRL Repeater Directory ('95-'96)	ARRLRD	\$7	1995 Callbook Pair	NAICB	\$65
ARRL Antenna Compendium Vol. 1	ARRANT1	\$10	Gordon West No-Code Technician Plus License Manual	GWTM	\$10
ARRL Antenna Compendium Vol. 2	ARRANT2	\$12	Gordon West General License Manual	GWGM	\$10
ARRL Antenna Compendium Vol. 3	ARRANT3	\$14	Gordon West Extra License Manual	GWEM	\$10
ARRL Antenna Compendium Vol. 4	ARRANT4	\$20	World Radio TV Handbook	WRTVH	\$24
ARRL Weather Satellite Handbook	ARSAT	\$20			
ARRL FCC Rule Book	ARFCC	\$9			
ARRL World Map	ARMAP	\$12			

VIDEO LIBRARY

Keys, Keys, Keys

Enjoy nostalgia with this visual celebration of amateur radio's favorite accessory written by CQ's Dave Ingram, K4TWJ.

Order No. KEYS.....\$9.95

The VHF "How-To" Book

This book is the perfect operating guide for the new and experienced VHF enthusiast as only Joe Lynch, N6CL, can describe.

Order No. BVHF.....\$15.95

Ham Radio Horizons: The Book

This is an excellent book for the beginner or for use in your club's licensing classes. HRH, by Peter O'Dell, WB2D, is full of information about all phases of ham radio and how to get started.

Order No. BHOR.....\$12.95

The Vertical Antenna Handbook

Take advantage of the 20 years of research and practical experience of naval communications engineer Capt. Paul H. Lee, USN(ret), N6PL. Learn basic theory, design, and practice of the vertical antenna. Discover easy construction projects such as a four-band DX vertical or a broadband array for 80 meters. Paul Lee can get you started today!

Order No. VAH..... \$9.95



All Videos Available In PAL format

Getting Started in Ham Radio

This is a fast-paced video introduction to the fascinating world of ham radio. CQ's experts show how to select equipment and antennas; which bands to use; how to use repeater stations for improved VHF coverage; the importance of grounding and the basics of soldering. Get the most out of your station, whether it's home-based, mobile or hand-held.

Order No. VHR\$19.95

Getting Started in Packet Radio

This video will help de-mystify the exciting but sometimes confusing world of packet radio. Learn how to get started using your computer on the radio. Included are step-by-step instructions on making packet contacts and using packet bulletin boards, networks and satellites.

Order No. VPAC.. \$19.95

Getting Started in Contesting

For the newcomer to contesting or an experienced veteran, this video is for you! You'll get advice and operating tips from some of contesting's most successful competitors, including Ken Wolff, K1EA, Dick Newell, AK1A, and CQ's own contest columnist, John Dorr, K1AR. Here's just a sample of what you'll see: what contesting's all about, explaining contest jargon, tips for beginners, how to compete from a small station, operating secrets from the "pros", live QSOs from world-class stations, and VHF/UHF contesting.

Order No. VCON\$19.95

Getting Started in Amateur Satellites

Learn with this video how veteran operators set up their satellite stations. Find out how to locate and track ham satellites with ease. Watch as operators access current satellites and contact far ranging countries around the world. This video is filled with easy to understand advice and tips that can't be found anywhere else.

Order No. VSAT..... \$19.95

Getting Started in DXing

Top DXers share their experience with equipment, antennas, operating skills, and QSLing. You'll see hams work rare DX around the world. If you're new to DXing, this video is for you! All this valuable information may well give you the competitive edge you need to master the world of DXing.

Order No. VDX..... \$19.95

Getting Started in VHF

This is the ideal introduction to VHF. See demonstrations of the latest radios. Also, learn about repeater usage as well as the more exotic VHF operating modes. Whether you are interested in packet radio, satellite operation, or simply using your local repeater, this is your video!

Order No. VVHF....\$19.95

Ham Radio Horizons: The Video

This introduction to Amateur Radio is an excellent complement to the Ham Radio Horizons book. Enjoy seeing all aspects of ham radio ranging from what it takes (and costs) to get started to how you can get your ham license. HRH is ideal for public events, presentations to community groups and as an opening to your club's licensing courses!

Order No. VHOR.....\$19.95

Order Toll-Free 1-800-853-9797

YES! I want to learn from the experts. Rush me my book(s), video(s), buyer's guide(s) right away!

Please add \$4 shipping & handling. **FREE shipping & handling for orders \$50 and over.**

Please make your check or money order payable to: CQ Communications, Inc.

Qty	Item #	Description	Price	Total Price
Shipping/Handling				
Total				

Name _____ Callsign _____

Address _____

City _____ State _____ Zip _____

MC/VISA/AMEX/Discover # _____ Expires _____

Form of payment: MC VISA AMEX Discover Check Money Order

Please mail your orders to:  **CQ Communications, Inc., 76 North Broadway, Hicksville, New York 11801-9962 FAX 516-681-2926**

MILITARY ELECTRONICS. URC-68 AM/FM handhelds w/NiCad's-\$225/pr. URC-773 FM manpack (uses D-cells), \$375. RC-292 field antenna, \$75. TRC-3 seismic intrusion det.sys. (uses 9v. bat.) \$250/set of four. 1-800-316-0701.

COMPLETE SOURCE CODE and all rights to CCC-ScanSys, the best scanner control program for Radio Shack PRO-2205/6/35. Includes documentation, disk files for printed manual, any assistance required. Contact Dan. (518) 456-0678.

SECRET CB BOOKS I-29, \$10 each. Sams books \$15 each. Modulation kits RCI 2950, HR 2510, Connex 3300, Cobra 148, Cobra 29, plus many more, \$17. Call 1-800-536-0109 for free catalog.

COLLECTOR seeks TV/radio news dept. mic. flags. Any condition. cash paid! Mark Jeannette, (408) 475-1197.

WANTED: All possible modifications for Realistic PRO-2026 mobile scanner. Send info Bob Madorin, 7815 Westgate, Lenexa, KS 66216.

KENWOOD R-5000 with YK-88A-1. YK-88SN. IF-232C. IC-10 and software \$750. PRO-2006, \$300. All like new, in box(es). Bob Randall (402) 483-2429.

SHACK CLEAN OUT! Equipment, books, magazines, club bulletins, tapes, station momentos, miscellany. Full list for an SASW w/two units of postage. G. Dexter, 213 Forest Street, Lake Geneva, WI 53147.

PROBE. Powerful! Easy! Fast! Ultimate software for Optoelectronic's **OptoScan 456.** Free details. **Data-File Inc.,** Box 20111, St. Louis, MO 63123.

PIRATE RADIO, TIS, or emergency MW antennas. Ten-foot fiberglass, \$184 plus shipping. HELIXING, 1302 McCameron, Lockport, IL 60441, (815) 836-0426.

CABLE DOCTOR—Stop the bullet and ID signaling cable lines. Send \$21 to RR Enterprises, Department PC, Box 3532, Easton, PA 18043.

BEARCAT SCANNERS, CB's, PROFESSIONAL RADIO and accessories at incredible prices. Catalog, \$3. Double refund on first order. V. MC. DISC. E.I.S., 917 State Rt. 42, Sparrowbush, NY 12780, (914) 856-8800.

DISCOVER ANSWERS to the 15 most asked questions about the inner workings of the **TELEPHONE INDUSTRY.** Call now 1-900-656-8818, \$2 per minute, adults over 18 only. For a list of the 15 questions call Clark's Creative Computing at 1-619-320-8793.

KENWOOD R-5000 shortwave receiver for sale, with HS-5 headphones, manual, all mint, \$650, plus shipping.

FREE Buy/Sell listing searches. FREE two month listing. Used/Surplus/Antique Equipment/Parts/Books. **Communications/Computer/Electronics Exchange BBS.** Modem: (201) 993-0811 (8/N/1/ANSI) or Suite 111, 103 Washington, Morristown, NJ 07960.

LOOKING for owner's manual for Panasonic model RF-4900. Scott Douglas, 513 North Franklin Street, Juneau, AL 99801.

FOR SALE: Galaxy Saturn base, Siltronix 1011D Comanche 10& 11 meter transceiver handheld, Palomar Elite 250 mobile linear. Call (501) 942-4453.

WORLD'S MOST UNUSUAL Communications Books! A large selection of outstanding titles covering scanners. "confidential" frequency registries, bugging, wire tapping, electronic surveillance, covert communications, computers, espionage, monitoring, and more! New titles being added constantly! Ask for our big FREE catalog. CRB Research, BOX 56-PC, Commack, NY 11725.

WANTED: "World Radio Handbook" circa 1955 or earlier. Also pre-1970 lists of U.S. radio stations such as White Radio Log including photocopies). Ralph Marson, 8070 Busch, Centerline, MI 48015.

DRAKE R8, like new in box with manual, plus unused balun antenna and many related books. (Total retail, \$1200+) Asking \$850. (401) 231-8225.

HOME AUTOMATION. Become a dealer in this fast-growing field. Free information. Send name, address, phone to ECS, Box 407, Fairbury, NE 68352, or call (800) 838-4051.

MacRadio. Macintosh tutorial program for New Pool Novice & Technician HAM License. \$29.00 + \$3.00 shipping (CA add \$2.40 tax). Lightning Industries, 1806 Milmont Dr., #125, Santa Clara, CA 95035 (408) 942-7998.

MILITARY MONITORING GUIDE. New book covers all phases of Military Monitoring. Military Frequencies all services: U.S. Military Bases, Military Black Projects, Major Air Force Installations, Monitoring Equipment and Systems, Navy/Coast Guard, and more, \$19.95. plus \$4 Priority Mail. UNIVERSAL ELECTRONICS, 4555 Groves Road, #12, Columbus, OH 43232. (614) 866-4605.

WANTED: Non-working, Regency HX-1000 scanner for parts. Preferably in good physical condition. Also, working drop-in charger for same. Les Wilson, 104 Rhoda Ave., North Babylon, NY 11703-3212.

COMPUTER \$\$\$! Start a home computer business or enhance any business with computer business needs. Startup/operation manuals, video tapes, business software, turn-key computer systems. FREE brochure. The Harsin Company, 8681-B West, New Bethel Road, Lexington, IN 47138. (812) 866-4076. (24-hours).

MORSE CODE Got You Down? Why let a mental block stand between you and upgrading? Use PASS Publishing's **CW Mental-Block Buster to blast through those barriers.** Just follow the instructions for 30 days—Results Guaranteed! Based on 40 years of research, the **CW Mental-Block Buster** uses guided meditation, dynamic visualizations, and powerful affirmations to blast through mental blocks. **You can do code!** That means new bands, more contacts, more fun! (This is not a CW practice tape.) The **CW Mental-Block Buster** audio cassette and practice booklet are only \$25.95 ppd. in the US (GA residents add 6% sales tax). (Quantity discounts available for classes.) PASS Publishing, PO Box 768821, Roswell, GA 30076. 404-640-6295; FAX: 404-640-8780. Office hours after 4:30 PM Eastern. MC/VISA, COD. Mail/fax orders include signature.

JRC NRD-535D Shortwave receiver & matching speaker NVA-319, like new, original everything, \$1,395. Kenwood R-5000 receiver (good condition) and computer interface, \$550. Plus shipping. Call now, (512) 447-9260.

YOU'RE SMART—save big. **Drake R-8,** \$749. Unblocked: **Realistic Pro-2005,** \$249. Unblocked: **Bearcat BC 890XLT,** \$169. AOR GaAS FET amplifier, \$49. MAX Cellular handheld antenna, \$24. Buyers call: (414) 297-9368. (24 hours)

ONLY ONE OF EACH LEFT—\$9 a piece: '94 Passport, '94 WRTM. Cheek's Scanner Modifications (Vol. 1 and 2), Beyond Police Call, Aeronautical Frequency Directory, Betty Bearcat (Great Lakes). Buy 'em all, \$59. To purchase: (414) 297-9368 (24 hours)

VHF AERO SCANNER GUIDE: Kneitel's Air-Scan, sixth edition. Great new edition of the new comprehensive and popular USA/Canada VHF aero band directory ever published: Civilian, Military, Private Airports, Heliports & Seaplane Bases, Control Towers, ARTCC, Weather, Approach/Departure, FSS, Ground Control, ATIS, Unicom, National & Air National Guard freqs., etc. Many listings for airport security, fire/rescue, airline ground services & more beyond the aero band. You ONE "must have" guide to tens of thousands of aero related monitor frequencies! Only \$18.95, plus \$5 s/h (\$6 to Canada) from CRB Research, P.O. Box 56, Commack, NY 11725. VISA/MC accepted. Phone orders 1-800-656-0056. Orders from Canada/HI/AK: (516) 543-9169. (NYS res. add \$2.04 tax.)

I'M INTERESTED in exchanging frequencies with scanner listeners in the Buffalo, Western New York area, and Toronto Southern Ontario area. Joe Galante, 34 Hampton Court, Williamsville, NY 14221-4301.

NEWS NETWORKS, sports, music, radio reading services are available on SCA sub-carriers. For catalog of SCA/SAP receivers and other items, send \$1 to AJL Enterprises, Box 5354, High Point, NC 27262.

Advertisers' Index

AMC Sales, Inc.	29
AOR, LTD.	Cov II
A.R.R.L.	27
Ace Communications.	Cov III
Alpha Delta Communications, Inc.	55
Antique Radio Classified.....	77
Atlantic Ham Radio	83
Bearcat Radio Club.....	39,65
C. Crane Company	66
CB City International, Inc.	68
CRB Research.....	50,64,70,83
CQ Books & Videos.....	86,87
CQ Magazine	78
CQ New Shortwave Propagation Handbook..	81
Cellular Security Group	65
Chilton Pacific Limited	62
COMMtronic Engineering	66
Communications Electronics, Inc.....	33
Computer Aided Technologies.....	25,37,63,70
Consumertronics	77
DWM Enterprises, Inc.	83
Delta Research	40
Drake, R.L. Company.....	13,73
EDCO	7,11,35,37,39,50
Electronic Equipment Bank.....	1
G & G Electronics	64
GMRS Radio Sales	62
Genie Radio & Electronics RoundTable	63
Gilfer Shortwave.....	6
Grove Enterprises, Inc.....	21
ICOM America, Inc.....	46,Cov IV
Index Publishing Group, Inc.....	14
Intensitronics Corp.	80
JPS Communications, Inc.	51
Japan Radio Co., Ltd.....	75
Jo Gunn Enterprises	12
K & L Technology.....	35
Lentini Communications, Inc.	61
MFJ Enterprises, Inc.	43
MoTron Electronics	80
Mountain Sales.....	83
Mouser Electronics.....	77
Optoelectronics, Inc.....	4,15
PerCon Corporation	40
Philips-Tech Electronics	83
Quement Communications	63
R.C. Distributing.....	40,77
REACT International	57
Radio Bookstore.....	12
Radio Control Systems, Inc.	68
Radioware	39
SGC, Inc.....	61
Scanner World USA	85
Scrambling News.....	68
Signal Intelligence	53
Software Systems Consulting	61
Spectrum International, Inc.	23
Sports Communications Dist.	56
Spy Outlet	66
Timestep	23
Tucker Electronics	16,82
U.S. Scanner Publications	76
USRadio.....	29
Universal Radio, Inc.	3
Viking International	30
Wilson Antenna, Inc.	49
Xandi Electronics.....	56

Reach this dynamic audience with your advertising message, contact Don Allen, N9ALK at 217-344-8653, FAX 217-344-8656



**Grundig
YE400
\$199**



**Sangean
ATS818
\$145**



**Bearcat BC890XL
29-958MHz
\$249**



**Bearcat
BC3000
25-
1300MHz
\$379**

**Bearcat
BC220
Twin
Turbo
\$229**

**Bearcat
BC80
with
800MHz
\$169**

Radioware A Receiver Inside Your Windows Computer

Radio Analyzers Data Bands Stations Configure Help

LSB USB Tx Frequency Tx Freq. 4,900,000

Frequency 8,800,000

Max Frequency

Min Frequency

Filter Mode

400 1800 2700 AMAX USB

200 16K AM LSB

50

Calibrate Calibrate 14,316,782

Configure RX Ant Power Mixer Gain Analog Gain Comp Level TX Ant Power Volume

A .45 to 30MHz Receiver with Digital Signal Processing & TX option, \$549.00



GW2 Pre amp \$79
1 to 2000 MHz, Variable Gain

GW3 Pre amp \$99
1 to 3000 MHz, Variable Gain
Two Notch Filters



**Trident
TR980
5-999MHz
AM/NFM &
WFM
\$299**



**Trident
TR2400
100kHz-
2860MHz
1kHz Steps
VFO,
BFO/USB, LSB,
Signal Strength
Meter
\$499**



**Trident
TR1200
.5-1300MHz
AM/NFM/WFM
1000 Channels
\$399**



**Trident Spectrum Analyzer
\$699**

1 800 445 7717

Is your *tail* free information superhighway for more information, more products, more tech support and the best deals. Call about these and a host of other radio receivers and accessories. You'll reach our order line, tech support line, fax line, or fax back information service; all by dialing our toll free number in the US, or Canada 24 hours a day, 7 days a week. For export products and information, dial 317 849 2570 or fax us at 317 849 8794 in Spanish, Francais, oder Deutsch. For computer users, our BBS offers free product and frequency information. Dial 317 579 2045, or e-mail: acescan@aol.com. So call us now, we'll give you the benefit of our over 20 years experience with radio receivers. Mastercard, Visa, AMEX, Discover, Government & Corporate P.O.'s, plus COD. Price/specs/availability subject to change. Free trial period on all units. All units carry full factory warranty. IN residents add Tax. Flat rate-ground shipping, \$6.95. Air Freight for as little as \$10.95 per unit for most locations. All trademarks property of their respective owners. Products are made or licensed under a variety of patents, write for details. Call to confirm price and delivery before ordering.

ACE Communications

10707 E. 106th St., Fishers, IN 46038

CIRCLE 15 ON READER SERVICE CARD



The New Leader In Satellite Communications!

and digital

**"ONLY THE
...IC-820H
showed both transmitter
and receiver performance that will
result in efficient packet operation
at 9600 baud." —QST, May 1995**



IC-820H FEATURES:

- Built-in Auto Satellite Functions
- All Modes in a Compact Case (9.5" W x 2.7" H x 10.0" D)
- "Plug and Play" 9600 bps Operations
- Built-in High Stability Crystal (± 3 ppm)
- Independent Controls with Sub Tuning
- New DDS for 1 Hz Resolution
- IF Shift (electronically shifts for effective interference reduction)
- Satellite Memory and Tracking Function (rev./normal tracking on main/subband)
- Doppler Compensation Function
- 10 designated Satellite Memories
- Data Jack for Packet Ops. (9600 bps)
- New Modulation Limiter Circuit
- 2 VFO's each for VHF and UHF Bands
- 50 Memory Channels
- Stereo Headphone Jacks
- 2 Antenna Connectors
- Noise Blanker
- RIT Function
- Memory Allocation Function
- Attenuator
- Programmed/Memory/Mode Select Scan
- CW Semi-Break In and Side Tone
- AF Speech Compressor (audio)
- Auto Repeater and One-Touch Functions
- Separate Main and CW Filters
- CW Narrow Filter (optional)
- Tone Scan (optional)
- 45 W (FM, CW), 35/6 W (SSB) VHF
- 40 W (FM, CW), 30/6 W (SSB) UHF
- Microphone Optional

IC-820H 2 M/440 MHz Dual Band All Mode Transceiver

The IC-820H isn't your typical base station transceiver. This all mode dual bander has compact and lightweight dimensions offering operating versatility other base stations just can't match. Mobile and field operations are ideal with this rig. But don't let its size fool you. This is a high performance transceiver with state-of-the-art construction, circuit design and cutting edge features.

ICOM's **Newly Designed I-loop DDS** (digital direct synthesizer) is employed in the PLL circuit of the IC-820H. Previous PLL circuits for 10 Hz resolution transceivers contained 2-loop circuits. The new I-loop has a single loop and **Generates a Signal with Superior 1 Hz Resolution**. ICOM's DDS PLL also contains a normal PLL as the main-loop and a DDS as the sub-loop.

Satellite operation with the IC-820H's **Built-In Satellite Functions** has never been this easy. These include **Normal and Reverse Tracking** for different modes of satellite communications; **Independent Uplink/Downlink Control** for Doppler shift compensation; **Separate Satellite VFO** and **10 Dedicated**

Satellite Memories provide quick switching from normal to satellite operation as well as easy recall of satellite and downlink frequencies.

With **Independent Controls and Indications for Both Bands**, this dual bander is as easy to operate as most single band transceivers – and exchanging the main and sub bands is just a switch away. **Separate 5-Meters** simultaneously indicate each band's respective signal strengths.

The **Sub Tuning Function** can be assigned to the **RIT** or **SHIFT** control and allows you to tune automatically at variable tuning speeds. This is especially useful when searching for signals over a wide frequency range – eliminating the need for excessive rotations of the main dial.

The IC-820H's **Compact Size** enables easy installation in a shack as well as a vehicle. Overall dimensions may be small, but important points such as LCD size and space between switches are more than adequate.

An important consideration in all mode transceivers is the interference reduction circuit. The IC-820H's

IF Shift Circuit electronically shifts the center frequency of the receiver passband to evade interfering signals.

The IC-820H's **Data Terminal** (in ACC socket) is connected to its modulator circuit directly. This **Data Jack supports Packet Operation** at up to **9600 bps**. A newly designed **Modulation Limiter Circuit** prevents you from exceeding the maximum deviation – even with large amounts of data.

For more information about the IC-820H, visit your local ICOM dealer, contact ICOM Technical Support in the Hamnet forum on CompuServe®@ 75540,525 (Internet: 75540.525 @ compuserve.com) or

**call ICOM's brochure hotline:
(206) 450-6088.**

View a video demonstration
of this product
▶ VHS ◀
at your participating
ICOM dealer today!

© 1995 ICOM America, Inc. 2380 116th Ave N.E., Bellevue, WA 98004. The ICOM logo is a registered trademark of ICOM, Inc. All stated specifications are subject to change without notice or obligation. All ICOM radios significantly exceed FCC regulations limiting spurious emissions. CompuServe is a registered trademark of CompuServe, Incorporated, an H&R Block Company. 820395Y

Experience the Quality™

ICOM®