

Electronics[®]

Designing ruby lasers: page 90

Transistors on paper substrates: page 100

Inspecting IC's visually: page 104

August 19, 1968

\$1.00

A McGraw-Hill Publication



Digital remote control captures the conventions

p. 74

MOSBY TAKE WA 9633
BOX 959
DASIC COMM ELEC
R NISLER
142 N55936 44880 02-71

Giant



Only .25" tall, UTC's new BIT-250 gives you the biggest performance in miniature audio transformers.

The unique BIT-250 audio transformer is UTC's newest technological breakthrough. Up to 80 mw power handling capability. Frequency response flat within ± 2 dB from 300 Hz to 250 kHz. Low .25" profile. BIT-250 outperforms units many times its size!

The BIT-250 leads in packaging flexibility, too. Gold-plated ribbon Kovar leads are solderable or weldable. Flat pack terminations may be adapted for PC board plug-in applications.

BIT-250 is metal-encased (Grade 4) and fully ruggedized. It is designed, man-

ufactured and successfully tested to all MIL-T-27B environmental specs.

Seventeen standard types covering a wide variety of applications are ready for off-the-shelf delivery. Custom designs available to your special requirements.

For all the facts on the BIT-250, the giant among miniature transformers, call your distributor and ask for Bulletin-250A. Or write United Transformer Company, Division of TRW INC., 150 **TRW** Varick St., New York, N.Y. 10013. UNITED TRANSFORMER COMPANY

Need distortion measurements in a hurry?

CUT YOUR TIME 70%!

hp Distortion Analyzers save time in the lab—and require a minimum of operator training on the production line. With automatic nulling on the 333A and 334A, you cut measurement time 70% by a simple, fast pre-null, and a flip of the MODE switch to AUTOMATIC. The instrument does the rest! It accurately completes the nulling, typically >80 dB rejection. It will also track drifting and unstable signals!

Use the all-solid-state hp 333A or 334A where you need fast measurement of total distortion of any signal between 5 Hz and 600 kHz; harmonics up to 3 MHz.

Extras—You can make voltage measurements up to 3 MHz. Use the HIGH PASS FILTER to get pure distortion measurements of signals greater than 1 kHz without 60 cycle and harmonics. On the 334A, measure distortion at carrier levels as low as 1 volt with the 550 kHz to 65 MHz RF Detector.

The 331A and 332A Distortion

Analyzers have all these features except automatic nulling and high-pass filters. H05-332A and H05-334A meet FCC requirements on broadcast distortion measurements.

Get full information on how hp Distortion Analyzers can cut your distortion measurement time. Contact your nearest hp field engineer, or write to Hewlett-Packard, Palo Alto, California 94304. Europe: 54 Route des Acacias, Geneva.

HEWLETT *hp* PACKARD

SIGNAL ANALYZERS

Circle 1 on reader service card

Model No.	Automatic Fundamental Nulling	Hi-Pass Filter	R.F. Detector	Gear Reduction Tuning	Price
331A				X	\$625
332A			X	X	\$655
333A	X	X			\$825
334A	X	X	X		\$855

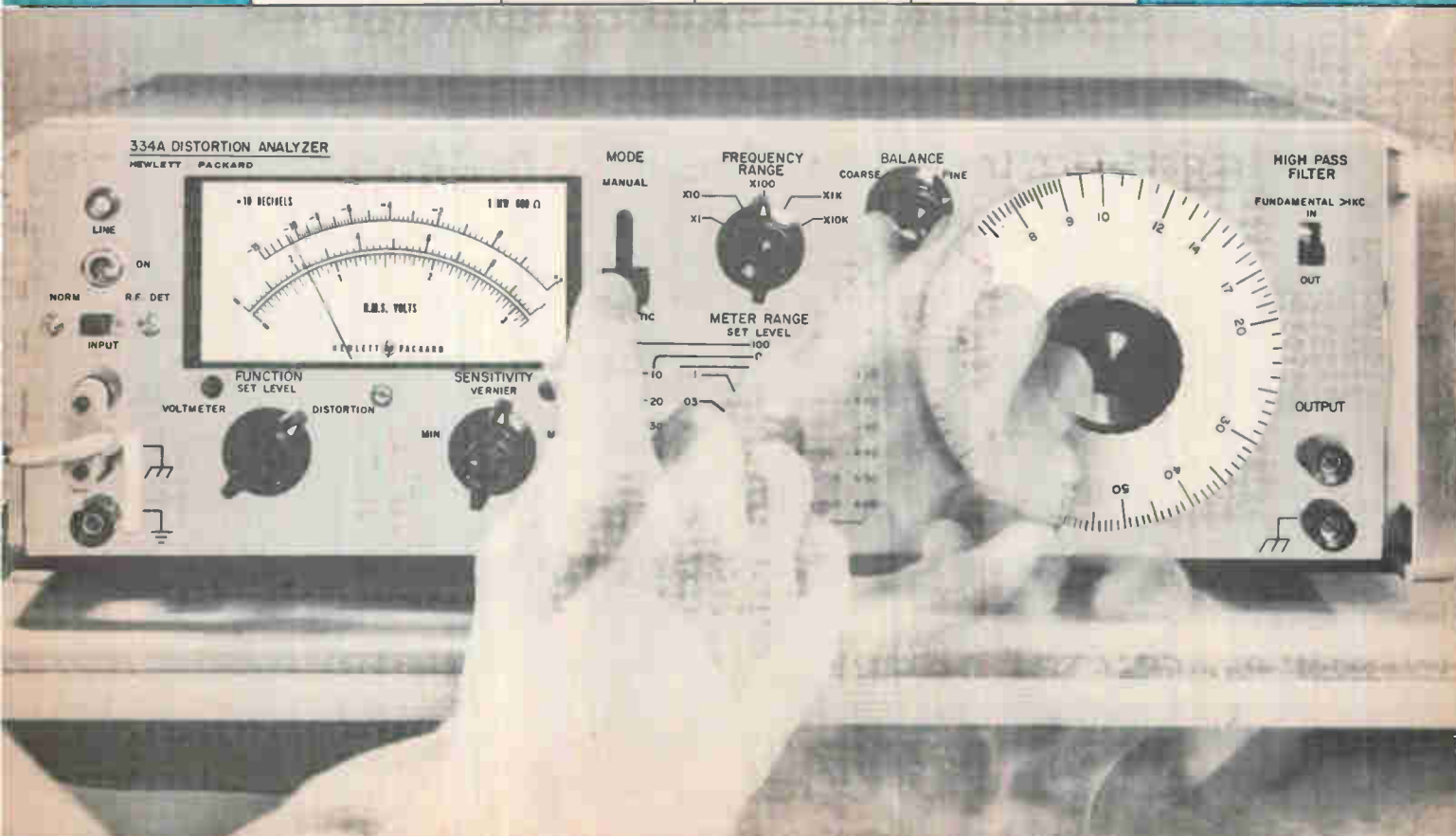

DEMAND PROOF

Hewlett-Packard's 3950 Series of Analog Tape Recorders gives you the best slot signal to noise ratio available in the industry. To prove it, we'll present you with

verified data for any tape speed from 3¾ to 120 ips. HP knows how important this information is in pinpointing signal to noise ratios for multiplexed subcarrier channels in your telemetry recording—so we invite you to demand proof of the 3950 Series' high performance.

But superior performance with up to 2 MHz capability isn't the whole story. To people with critical deadlines

and government contracts to meet, price and delivery are of the utmost importance. HP can deliver, and at a price that fits comfortably into your budget.

Here's an example of what we mean: a 3950 Recorder with cabinet, up to 15-inch reels, switch panel, 6-speed transport, 3-speed equalization, meters, 14-track direct record/reproduce—at 1.5 MHz. All for \$19,700.

You can't afford *not* to check further on these high-reliability, low-maintenance recorders. And while you're at it, don't forget—*demand proof*.

Call your local HP field engineer for specifications, or write Hewlett-Packard, Palo Alto, California 94304; Europe: 54 Route des Acacias, Geneva.



MAGNETIC RECORDERS



42803 A

News Features

Probing the News

- 119 **Electronics abroad: Automated subway: Hamburger special**
124 **Telephony: Sylvania to unveil tactical switching system, built on speculation for the military**

Electronics Review

- 45 **Companies: New man at Fairchild**
47 **Electro-optics: Space communications**
48 **Lasers: Sweeping the frequencies**
50 **Components: Photoconductive arrays**
52 **Manufacturing: Beam leads on the substrate**
54 **Consumer electronics: IC's in a blender**
56 **For the record**

Electronics Abroad

- 183 **Sweden: Computer plots instant patient data; Weather maps in a hurry**
184 **Latin America: Moving toward inter-american telecommunications; Brazil may drop PAL tv**
185 **France: Accurate, reliable low-level altimeter**
185 **Great Britain: Small company takes space cutback in stride; Radar to defend against locust swarms**

New Products

- 135 **High-capacitance busbar keeps noise off d-c lines**
141 **Instruments review**
141 **Capacitance bridge is fast, accurate**
143 **Synthesizer offers pure wave**
147 **Components review**
147 **Switch contacts fight contamination**
150 **Little relay turns to industry jobs**
153 **Semiconductor review**
153 **TTL gate protects itself from spikes**
154 **SCR delivers 550 amps**
157 **Microwave review**
157 **TWT amplifier is smaller by half**
158 **Lightweight devices test radar**
161 **Production equipment review**
161 **Solder flows at 212°F**
162 **Molten resins speed fastening**
165 **Subassemblies review**
165 **Read-only memory uses bipolar IC's**
168 **Loran receiver gets standards role**
173 **Charger feeds at constant rate**

Technical Articles

- Broadcasting 74** **CBS nominates a convention hopeful**
Lightweight, portable color tv camera sends NTSC signals to a base station where an operator can control as many as six cameras through a new digital command system
Marvin Kronenberg, Renville H. McMann Jr., Paul Berger, Howard W. Foodman, Clyde W. Smith, Joseph Petit, and Robert Moore, CBS Laboratories
- Circuit design 84** **Designer's casebook**
▪ FET and IC keep oscillator linear
▪ Flip-flop isolates pulse from switch bounce
▪ Schmitt trigger built from a logic IC
▪ SCR's monitor discharge rate
▪ Rule of thumb for ripple calculations
▪ Bridge and transistor form exclusive-OR gate
- Applied design 90** **Charting a simpler approach to lasers**
Instead of plowing through equations, engineers can now use plots of component parameters to build or modify normal-mode pulsed systems
S. Donald Sims and Lawrence Waszak
Biorad Inc.
- Instrumentation 96** **FDR: a new deal for faultfinders**
Frequency-domain reflectometry pinpoints defects in microwave systems at actual operating frequencies and tests waveguide links
James D. Thompson and Alden Hart
Alfred Electronics
- Advanced 100 technology** **Flexible thin-film transistors stretch performance, shrink cost**
Ability to deposit insulated-gate FET's on a variety of substrates promises continuous manufacturing process with high yields
Peter Brody and Derrick Page
Westinghouse Research Laboratories
- Reliability 104** **Visual inspection of IC's boosts reliability at little cost**
Vendors and users can agree on manufacturing specs and test criteria to weed out latent failures before fabrication is completed
William R. Rodrigues de Miranda
Raytheon Co.

Departments

- | | | | |
|----|--------------------------|------------------------|------------------------|
| 4 | Readers Comment | 33 | Electronics Newsletter |
| 8 | Who's who in this issue | 59 | Washington Newsletter |
| 14 | Who's who in electronics | 172 | New Books |
| 22 | Meetings | 176 | Technical Abstracts |
| 31 | Editorial Comment | 174 | New Literature |
| | 181 | Newsletter from Abroad | |

Electronics

Editor-in-Chief: Donald Christiansen

Associate managing editors

Technical: Stephen E. Scrupski
News: Robert Henkel
Copy: Sally Powell

Senior associate editors

Joseph Mittleman, Harry R. Karp

Department editors

Avionics & Space: Alfred Rosenblatt
Computers: Wallace B. Riley
Communications: William Bucci
Components: George Watson
Consumer electronics: John D. Drummond
Design theory: Joseph Mittleman
Industrial electronics: Harry R. Karp
Military electronics: Richard Gundlach

Domestic bureaus

Boston: James Brinton, manager
Chicago: Frederick Corey, manager
Los Angeles: Lawrence Curran, manager; Burton Bell
New York: Howard Wolff, manager
San Francisco: Walter Barney, manager; Peter Vogel
Washington: Robert Skole, manager; Paul Dickson, William F. Arnold

Foreign bureaus

Bonn: John Gosch
London: Michael Payne
Tokyo: Charles Cohen

Copy editors

James Chang, Larry Miller

Graphic design

Art director: Gerald Ferguson
Assistant art directors: Valerie Betz, Susan Hurlburt
Production editor: Arthur C. Miller

Editorial research: Kay Fontana

Editorial secretaries: Lorraine Longo, Claire Goodlin,
Patricia Gardner, Barbara Razulis, Stina Colombo

McGraw-Hill News Service

Director: Arthur L. Moore; Atlanta: Fran Ridgway; Chicago: Robert E. Lee
Cleveland: Arthur Zimmerman; Dallas: Marvin Reid
Detroit: James Wargo; Los Angeles: Michael Murphy
Pittsburgh: Louis Gomolak
San Francisco: Margaret Drossel
Seattle: Ray Bloomberg; Washington: Charles Gardner, Daniel B. Moskowitz,
Herbert W. Cheshire, Seth Payne, Warren Burkett, William Small, William D. Hickman
McGraw-Hill World News Service
Bonn: Robert Dorang; Brussels: James Smith; Hong Kong: Wes Perry;
London: John Shinn; Mexico City: Gerald Parkinson; Milan: Ronald Tagliasco, Jack Star;
Moscow: Jack Winkler; Paris: Robert E. Farrell, Peter Kilborn;
Rio de Janeiro: Leslie Warren; Tokyo: Marvin Petal

Reprints: Susan Nugent

Circulation: Isaaca Siegel

Publisher: Gordon Jones

Electronics: August 19, 1968, Vol. 41, No. 17

Published every other Monday by McGraw-Hill, Inc. Founder: James H. McGraw 1860-1948.

Publication office 99 North Broadway, Albany, N.Y. 12202; second class postage paid at Albany, N.Y.

Executive, editorial, circulation and advertising addresses: McGraw-Hill Building, 330 W. 42nd Street
New York, N.Y. 10036. Telephone (212) 971-3333. Teletype TWX N.Y. 710-581-4235. Cable address:
MCGRAWHILL N.Y.

Subscriptions solicited only from those professionally engaged in electronics technology. Subscription rates:
qualified subscribers in the United States and possessions and Canada, \$8.00 one year, \$12.00 two years,
\$16.00 three years; all other countries \$25.00 one year. Non-qualified subscribers in the U.S. and
possessions and Canada, \$25.00 one year; all other countries \$50.00. Air freight service to Japan \$50.00
one year. Single copies: United States and possessions and Canada, \$1.00; all other countries, \$1.75.

Officers of McGraw-Hill Publications: Joseph H. Allen, President; J. Elton Tuohig, Executive Vice President;
David J. McGrath, Senior Vice President-Operations; Vice Presidents: John R. Callahan, Editorial; Paul F. Cowie,
Circulation; John R. Emery, Administration; John M. Holden, Marketing; David G. Jensen, Manufacturing;
Jerome D. Luntz, Planning & Development; Robert M. Wilhelmy, Controller.

Officers of the Corporation: Shelton Fisher, President and Chief Executive Officer; John L. McGraw, Chairman;
Robert E. Slaughter, Executive Vice President; Daniel F. Crowley, Donald C. McGraw, Jr., Bayard E. Sawyer, Senior
Vice Presidents; John J. Cooke, Vice President & Secretary; Gordon W. McKinley, Vice President & Treasurer.

Title © registered in U.S. Patent Office; © Copyright 1968 by McGraw-Hill, Inc. All rights reserved. The contents
of this publication may not be reproduced either in whole or in part without the consent of copyright owner.

Subscribers: The publisher, upon written request to our New York office from any subscriber,
agrees to refund that part of the subscription price applying to copies not yet mailed.
Please send change of address notices or complaints to Fulfillment Manager; subscription
orders to Circulation Manager, Electronics at address below. Change of address notices
should provide old as well as new address, including postal zip code number. If possible,
attach address label from recent issue. Allow one month for change to become effective.

Postmaster: Please send form 3579 to Fulfillment Manager, Electronics,
P.O. Box 430, Hightstown, New Jersey 08520

Readers Comment

But is it art?

To the Editor:

The RCA Music Synthesizer may have been a scientific success, but its artistic standing is still in doubt at this late date. Unfortunately, credits earned in the scientific community are not transferable to the artistic community especially where the performing arts are involved, as Dr. Harry F. Olson has yet to discover, judging by his intemperate letter [July 8, p. 7]. When one ventures into the arts, he must recognize that he is delving into the subjective matter of taste. Here there is no academy that hands down accolades from above to protect him from criticism, but a rough democracy that votes with its dollars from below. Unlike engineering, however, where few objective standards exist for evaluating the practitioner, it instantly becomes clear when the musician places the horn to his lips whether he is adept or inept and no amount of formal schooling, including the Ph.D., will save him.

The disclaimer that "the reason we developed the synthesizer was to learn more about the sound that we reproduced" does not echo the statements made publicly before the Northern New Jersey Section of the IEEE (then the IRE) that the synthesizer was developed to eliminate costly fees paid the artist and otherwise remove his objectionable presence. It is this gratuitous maligning of the living musician that has made RCA especially vulnerable. Dr. Olson simply does not appreciate the creative role of the artist. Witness the naive statement that "this demonstration showed that the synthesizer was inherently capable of producing great music." The synthesizer is no more capable of inherently producing great music than a grand piano is inherently capable of producing great music. Great music is an invention of the composer and the performing artist. The demonstration merely showed that the synthesizer could imitate music once it was created, but hardly as efficiently as the familiar tape or disk recorder. We are still waiting to hear original great music

Here's a new digital IC from Sprague. The 54/74107A.

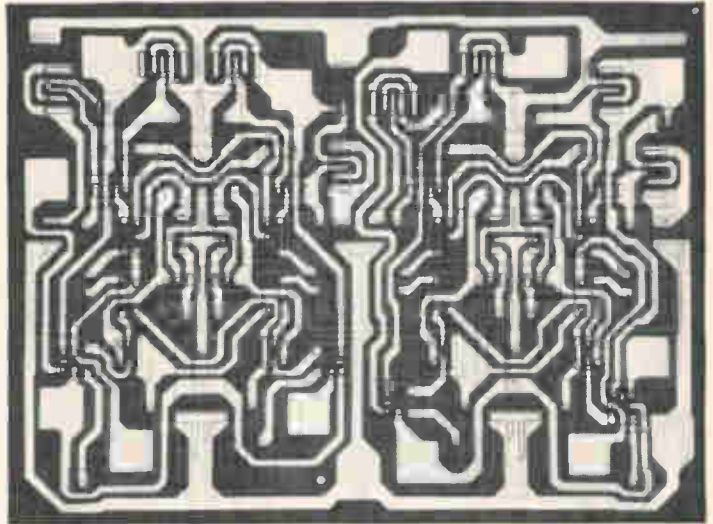

It's a single-chip replacement for the 5473/7473 dual JK m-s flip-flop.



In DIP it has pin 7 GND, just like the rest of the Series 54/74 family.



For existing designs, it's also offered in the "old" pinning in either DIP or flat pack.

Choose 0 to +70 or -55 to +125 C temperature range. Choose "old" or new compatible pinning.

Choose Sprague for all Series 54/74.

And coming soon: Complex-Function circuits.

To request samples, call your Sprague representative. For further information, write to Technical Literature Service, 35 Marshall St., North Adams, Mass. 01247.

SPECIFICATIONS

Dual JK m-s Flip-Flop

	DIP PIN 7 GND	DIP PIN 11 GND	TO-88 PIN 11 GND
0 to +70 C	USN-74107A	USN-7473A	USN-7473J
-55 to +125 C	USS-54107A	USS-5473A	USS-5473J
Clock freq.	15 MHz	15 MHz	15 MHz
P _{diss}	50 mW/ff	50 mW/ff	50 mW/ff
Fan Out	10	10	10

SPRAGUE WORCESTER . . . the world's finest microcircuit facility.



BREAKTHROUGH
10 μ V resolution

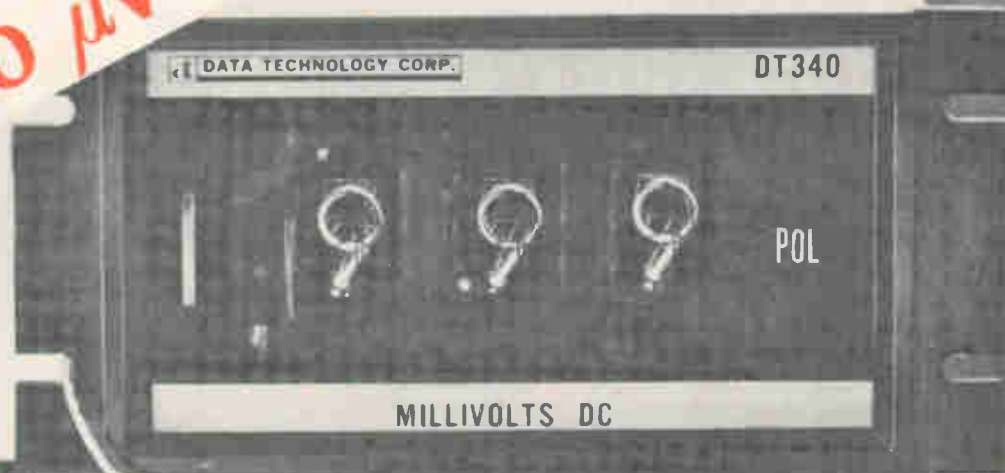

Interface directly with transducers in all areas of electronics

Applications: Medical electronics—pH, blood pressure, flow rate.
Consumer electronics—volts, ohms, current.
Military electronics—altitude, field strength, dBm.

Applications Contest

Data Technology is sponsoring a contest to determine the most unique application for the new high resolution DT-340 series panel meters. First prize will be a round trip ticket for two anywhere in the contiguous United States. Five other winners will receive monogrammed attache cases. Entries must be submitted before August 31, 1968. Decision of the judges is final. Send coupon for complete details.

Please enter me in the contest for the most unique application of the new high resolution DT-340 Panel Meter.

Name _____

Title _____

Address _____



Data Technology Corporation

2370 Charleston Road, Mountain View,
California 94040. Phone (415) 964-2600, TWX (910) 379-6476.

Readers Comment

from it.

Whether the RCA Music Synthesizer can measure up to its press releases will depend upon its wide availability to creative composers. Its size and cost will have to be reduced by many orders of magnitude before it replaces the ubiquitous piano as the composer's working tool. At present, it is conceivable that their synthesizer could turn out endless fake Iturbi's, but it would be amusing to see how many of these recordings RCA could sell.

Sam Levine

Reston,
Va.

Gamma radiation

To the Editor:

An article, entitled "Radiating worry," [April 15, pp. 56-59] stated that different brands of tv sets were emitting harmful amounts of gamma radiation. However, nowhere did the story indicate at what dis-

tance from the television sets this quantity of radiation was detected.

Was it at the surface, 1-inch, 1-foot, or 12 feet in front or back of the screen?

The distance, as I am sure you are aware, is of considerable importance (inverse square law states that at double the distance, the amount of radiation is decreased to one quarter the original dose rate, or at half distance increases four-fold).

Though the general public is probably not aware of this, I believe that most of your readers are technical personnel and, like myself, would be most interested in this information.

Arthur W. Hall

Bureau of Mines
Dept. of the Interior
Morgantown,
W. Va.

■ The distance was 5 centimeters from the set, and measurements were taken from top, front, bottom, and sides.



Calkins



Skingley



Schiff

Mistaken identity. These authors were incorrectly identified in the Aug. 5 issue. We regret the error.

SUBSCRIPTION SERVICE

Please include an Electronics Magazine address label to insure prompt service whenever you write us about your subscription.

Mail to: Fulfillment Manager
Electronics
P.O. Box 430
Hightstown, N.J. 08520

To subscribe mail this form with your payment and check new subscription renew my present subscription

Subscription rates: qualified subscribers in the U.S.: 1 year \$8; two years, \$12; three years, \$16. Non-qualified: 1 year \$25. Subscription rates for foreign countries available on request.

CHANGE OF ADDRESS

ATTACH LABEL HERE

If you are moving, please let us know five weeks before changing your address. Place magazine address label here, print your new address below.

name _____

address _____

city _____

state _____

zip code _____

Application For

FET SWITCHES

PROBLEM: Switch high level signals with minimum drive voltage.

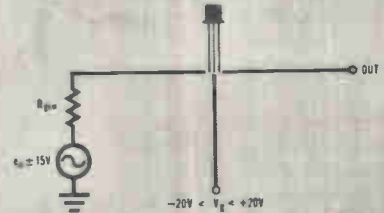

REQUIRED: Select FET to switch ± 15 V signals . . . maximum available drive voltage is ± 20 V. Use either a MOS or a junction type.

GIVEN: $e_{in} \dots \pm 20$ V
Available supply voltages . . . ± 20 V
Maximum $r_{ds(on)}$ allowed . . . 150 Ω

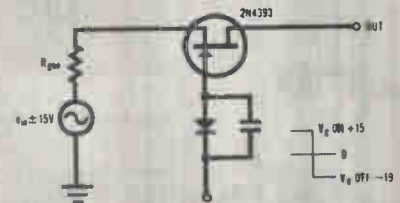

SOLUTION: Junction FETs are available in various ranges of V_P and $r_{ds(on)}$. This provides a trade-off between drive voltage and ON resistance. A good choice for this application is the 2N4393:

V_P max: -3 V

$r_{ds(on)}$ max: 100 Ω

The required drive voltages are:

$V_{G(OFF)} = -19$ V

$V_{G(ON)} = +15$ V

Pinched to pick a FET? Contact us for applications help . . . and our FET switch data packet.



Siliconix incorporated

1140 W Evelyn Ave • Sunnyvale, CA 94086
Phone (408) 245-1000 • TWX: 910-339-9216

Who's Who in this issue



McMann



Kronenberg

The job of coordinating efforts to produce the compact Minicam VI color tv camera featured in the article on page 74 fell to Marvin Kronenberg, manager of CBS Laboratories' television engineering department. The holder of five patents in the color tv field, Kronenberg has worked on crt displays, closed-circuit setups for medical research, transistorized cameras, and an educational tv system.

The new camera reflects the basic concepts of Renville H. Mc-

Mann Jr., vice president and director of engineering at CBS Laboratories. Also the holder of several patents, McMann designed much of the Minicam's circuitry.

Paul Berger contributed to the design of the key digital command system by which the camera is controlled from a base station. Another who helped develop this remote control system is Harold W. Foodman, a section chief in the television engineering department.

The Minicam's video processor

and power system were designed by Clyde W. Smith, who, before joining the labs in 1966, developed two portable color television cameras for use at low light levels. Joseph Petit, a project engineer and specialist in tv camera circuitry, helped design the camera-head deflection system and video preamplifier, while Robert Moore, a former GE engineer, worked on the r-f portion of the Minicam. He is a project engineer and has been with CBS for about three years.



Page

Brody

Enthusiastic about the potential of materials other than silicon, Peter Brody has devoted most of his working life to the study of thin-film phenomena and devices. After receiving his Ph.D. in physics at the University of London, he taught for several years, then came to the U.S. in 1959 and joined Westinghouse. Since 1962 he has headed a group of device physicists and engineers and, among other things, developed the thin-film transistor process described on page 100. Derrick Page, another Briton, received his Ph.D. in electrical engineering from the University of Birmingham. He came to the U.S. in 1963.

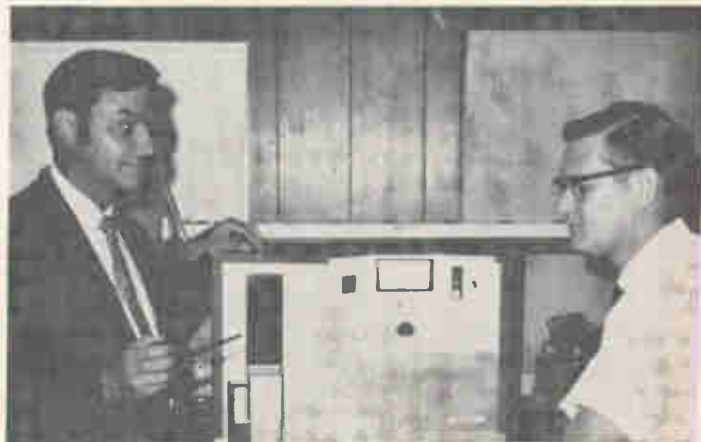

Sims

Waszak

To get long flash-lamp life and useful, reliable output energy from a laser, S. Donald Sims and Lawrence Waszak of Biorad, Inc. developed a short cut for designing ruby laser systems. They bypassed time-consuming equations and guesswork with a set of design charts (page 90). Before becoming the president of Biorad in 1966, Sims was director of solid state laser technology for the technical research group of the Control Data Corp. He received his Ph.D. from Purdue University. Larry Waszak worked at Kollsman Instrument, and at TRG where he helped develop new laser products. He is currently the manager of the electronics department at Biorad.

Do you have this new capacitor data?

Developing new applications for instruments, like the one described on page 96, is one of the side-jobs encountered by



Hart

Alden Hart, regional sales manager for Alfred Electronics. He worked on the project with James Thompson who is a sales engineer at Alfred. Hart's engineering degree is from Stanford University. He worked for Sylvania and Eimac before joining Alfred in 1965. Thompson's degree is from the University of California at Berkeley.



Thompson

When Raytheon decided to do something about the quality of purchased integrated circuits, it found that William R. Rodrigues de Miranda's work for the communications and data processing operation had already resulted in a set of visual criteria of reliability (p. 104). The equipment division adopted de Miranda's specification, and other divisions later contributed ideas and accepted the spec too. Now it's in the process of becoming a corporate Raytheon specification. Before he joined Raytheon, where he is in charge of reliability analysis, he worked for Honeywell's Areo-Florida facility, studying failure modes in IC's and interconnection techniques for high-density IC packaging. He is a native of the Netherlands and has a BSEE from Hogere Technische in Eindhoven.



de Miranda



DIPPED MICAS . . . for entertainment and commercial equipment

Single-film silvered-mica capacitors cost less than stacked mica or ceramic types. These capacitors are rated at 300 WVDC and have good stability and retrace characteristics over their operating temperature range of -55°C to $+85^{\circ}\text{C}$. Capacitance values from 10 to 360 pF, $\pm 5\%$ are available. Put this quality and performance into your next design. Ask for Engineering Bulletin 1010.

CIRCLE READER SERVICE NUMBER 220



SPARK GAPS . . . for TV tube protection

Sprague spark gaps suppress transient voltage surges and protect your expensive picture tube and allied circuitry. They are available in 1.5 kV and 2.5 kV ratings, and have a maximum capacitance of 0.75 pF, providing an economical means of safely bypassing transient overvoltages. All Sprague spark gaps are 100% tested to insure your circuitry. Use them to protect your picture tube warranty. Ask for Engineering Bulletin 6145A.

CIRCLE READER SERVICE NUMBER 221

DISC CERAMICS . . . for general, temperature-compensating, and low-voltage applications in industrial, commercial, and consumer equipment



Cera-mite[®] general application discs for bypass and coupling at low cost. Nine disc sizes from .300 to .875 inches have 100, 250, 500, and 1000 WVDC ratings, in standard or temperature-stable formulations. Dual-section discs have up to $.022\mu\text{F}$ @ 1000 V. Ask for Engineering Bulletin 6101D.

CIRCLE READER SERVICE NUMBER 222



Cera-mite temperature-compensating discs for controlled capacitance change with temperature in R-F oscillators, precision amplifiers, timing circuits, other critical applications. Select from ten linear temperature coefficients from NPO to N2200. Capacitance values from 1 to 2200 pF with 1000 WVDC ratings are available, plus popular values at 3000, 4000, and 5000 WVDC for TV yoke circuits. Mini-fied units in 250 WVDC ratings may be obtained with capacitance values ranging from 22 to 990 pF. Ask for Engineering Bulletin 6102B.

CIRCLE READER SERVICE NUMBER 223



Hypercon[®] ultra-high capacitance discs for low-voltage circuits. Replace electrolytics with non-polar Hypercon capacitors only a fraction as large. The $2.2\mu\text{F}$, 3 volt disc has a diameter of .875 inches; the $0.1\mu\text{F}$, 25 volt unit measures .750 inches. Ask for Engineering Bulletin 6141F.

CIRCLE READER SERVICE NUMBER 224

For bulletins in which you are interested, write Technical Literature Service, Sprague Electric Co., 35 Marshall St., North Adams, Mass. 01247

SPRAGUE COMPONENTS

CAPACITORS
TRANSISTORS
RESISTORS
INTEGRATED CIRCUITS
THIN-FILM MICROCIRCUITS
INTERFERENCE FILTERS

PACKAGED COMPONENT ASSEMBLIES
FUNCTIONAL DIGITAL CIRCUITS
MAGNETIC COMPONENTS
PULSE TRANSFORMERS
CERAMIC-BASE PRINTED NETWORKS
PULSE-FORMING NETWORKS



[®] Sprague and [®] are registered trademarks of the Sprague Electric Co.

What's new in counters?



GR's new 1191-Z Counter is a 500-MHz general-purpose counter that has full counter-timer functions, programmability, high-speed data access, eight-digit readout, and a high-precision time base . . . and it costs only \$2190!

It's a combination of the 1191 Counter that has become the first choice of many counter users and GR's new 100-to-1 scaler. In combination, they provide all the many features found in the 1191 alone (see opposite page) *plus* the added benefits of high-frequency operation.



The 1191-Z is also available in a 100 MHz model that uses a 10-to-1 scaler. In all other respects performance is similar to that of its 500-MHz counterpart. Price is \$2040.



Everything you want in a low-cost, general-purpose counter

This counter is celebrating its first anniversary, and it's had a busy year. The reason? It gives a lot of performance per dollar. For instance, with the 1191 you can:

- measure frequency (to 20 MHz), single period, multiple period, time interval, frequency ratio, and count events.
- program measurement functions, ranges, and most of the secondary controls.
- read your measurement to eight significant figures, and with automatic display of decimal point and units.
- have two high-sensitivity input channels with full controls for trigger level, slope, and polarity.
- have a choice of time base to match needs and budget; a room-temperature oscillator with better than $2 \times 10^{-7} / ^\circ\text{C}$ stability or a high-precision oscillator (optional) with better than $2 \times 10^{-10} / ^\circ\text{C}$.
- have included (optional) fully buffered 1-2-4-8 BCD output.
- spend as little as \$1340 for the basic counter or as much as \$1540 with both options.



Automatic-ranging counter that measures to 6 Hz in less than 0.2 second

We call this counter the counting man's thinker . . . and it's more the truth than it is a play on words. Once you turn the power on and connect the unknown signal to this counter's input terminals you can forget about it. You need give no thought to selecting range, units of measurement, or where to place the decimal point. All that thinking is done for you . . . by the counter! And that's not all. It will measure frequencies as low as 6 Hz (with 6-figure resolution) in less than 0.2 second and to 0.6 Hz in less than 2 seconds. How? By means of a built-in IC computer that converts a multiple-period measurement into a frequency readout.

The 20 MHz frequency range of the 1159 can be extended to 100 MHz or 500 MHz by use of one of two scalars, while retaining six-figure resolution.

Price of the 1159 Recipromatic Counter is \$2235 for either the bench or rack model.

For complete information on GR's exciting new line of IC counters, write to General Radio Company, W. Concord, Massachusetts 01781; telephone (617) 369-4400. In Europe: Postfach 124, CH 8034, Zurich 34, Switzerland. Prices apply only in the U.S.A.

GENERAL RADIO

New hp 1802A 3.5 ns, 100 MHz Plug-in

Now You Can Disregard Capacitive Effects When You Measure Nanosecond Rise-Times And High Frequencies With a Real Time Scope!

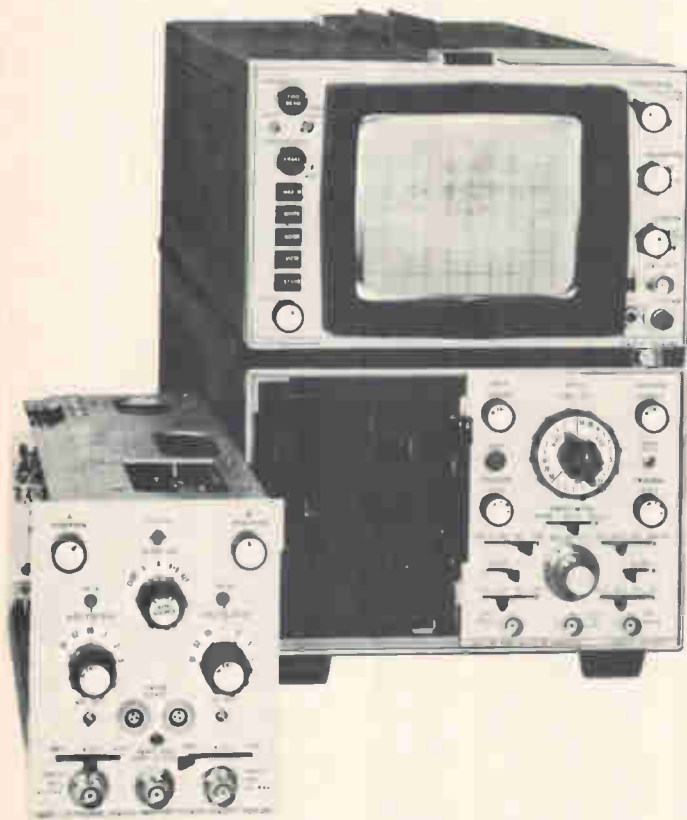

The new hp 1802A Dual-Channel Vertical Amplifier plug-in used with any of the mainframes in the hp 180 scope system is designed to *eliminate the effect of input capacitance*—and its associated problems of signal attenuation and circuit loading. In fact, the input capacitance of the 180/1802A system is too low to be measured, so Hewlett-Packard now specifies the system as having a low reflection (<0.13) and an extremely low SWR of 1.35:1 at 100 MHz, 10 mV/cm sensitivity (1.1:1 at all other deflection factors).

For the first time you can forget about the influence of capacitance—the big problem in making high frequency real time measurements. You can measure nanosecond rise times and high frequencies over a wide range of source impedances—with 10 mV/cm sensitivity. You can look at your signal—without capacitive distortion of your display—and without capacitive disturbance of your circuit under test!

You have a near-perfect termination for your 50 Ω systems—regardless of your signal frequencies—with the 50 Ω impedance of the 180/1802A system. Optional resistive dividers increase resistance 5, 10, 50 or 100X with only 0.7 pF capacitance. You can make more than 90% of your high frequency real time measurements with these dividers and the 180/1802A system.

You can get higher resistances with the new hp 1123A 100 k Ω Active Probe which adds only 3.5 pF capacitance to your measurement system. Combine the active probe and its set of X10 or X100 matched resistive dividers and you've increased resistance greatly and *reduced* capacitance to only 3 pF!

Use the new 1802A Plug-in with the hp 181A Variable Persistence and Storage mainframe when you want to capture and hold high frequency single shot phenomena—or look at low rep rate fast rise time pulses.

Get the full story on the new 1802A plug-in and your **free measurement error calculator** for calculating rise time accuracy of your measurement system from your nearest hp field engineer. Or write to Hewlett-Packard, Palo Alto, California 94304. Europe: 54 Route des Acacias, Geneva.

Price: hp 180 Scope System with 100 MHz capability, \$2500; with 100 MHz and variable persistence and storage, \$3150; hp 1802A amplifier plug-in alone, \$1200; hp 1123A Active Probe, \$325.

These are photographs of a 2 ns rise time signal—showing the effects of different probe capacitances.



50 Ω Source to 50 Ω Load



200 Ω Source Impedance, 0.7 pF capacitance

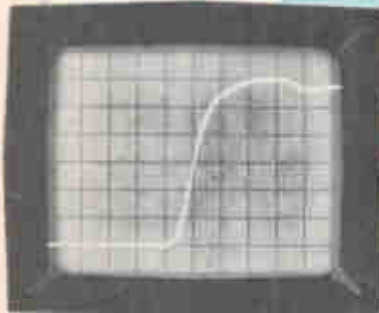

200 Ω Source Impedance, 10 pF capacitance



500 Ω Source Impedance, 20 pF capacitance



Capacitance and Fast Rise Time Measurements

Rise time displayed on an oscilloscope is basically the result of the relationship of source impedance—and the capacitance of the signal source, the capacitance of the probe, and the capacitance of the scope.

The formula for calculating rise time—if you want to do things the hard way—is t_r observed $\approx \sqrt{t_{rg}^2 + t_{rp}^2 + t_{rs}^2}$ where t_{rg} is rise time of the signal source; t_{rp} is rise time of the probe ($t_{rp} = 2.2 R_g C_i$); and t_{rs} is rise time of the scope.

To get an accurate rise time measurement of high frequency, fast rise time signals you need a measurement system with capacitance so low, it is essentially insensitive to a wide range of source impedances and frequencies. Otherwise you will have signal attenuation and capacitive loading of your circuit under test.

See for yourself what capacitance does to the rise time of your circuit under test. Use the t_r formula or calculate t_r using the new hp measurement error calculator—it's free on request!

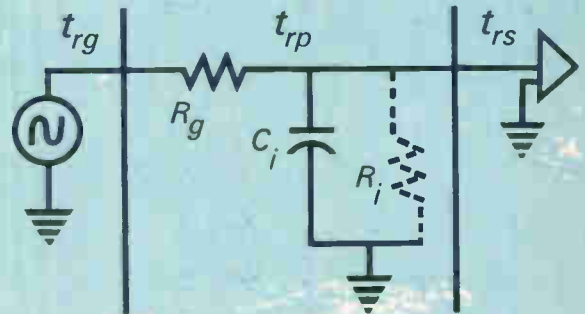
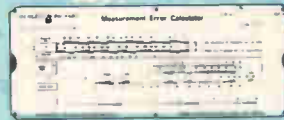

HEWLETT  PACKARD

OSCILLOSCOPE SYSTEMS

NEW

LOW COST

\$35*

HIGH PERFORMANCE

.05% Regulation

POWER SUPPLIES

Specifically Designed
for Op Amp use

(Integrated Circuit and Discrete)

Fully
Warranted
5 years

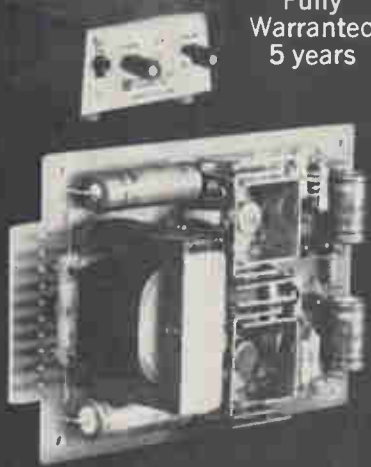

Modularized on Plug-in Cards

Model 2.15.50*

output current of 50 ma, each output.
(Priced at \$35.00, 1 to 9)

Model 2.15.100

output current of 100 ma, each output.
(Priced at \$48.00, 1 to 9)

Input, remote sense, and output are brought to the edge of the epoxy glass circuit board for mating with a 10 pin P.C. connector.

Dimensions: 4½ L x 3 W x 1½ H

Also available in bench style cases; other voltages and current ratings on request.

OFF-THE-SHELF SHIPMENT
(Within 24 Hours)

For complete data on these and other SCL power supplies, request Catalog 1167

**SEMICONDUCTOR
CIRCUITS, INC.**

163 Merrimac St. - Woburn, Mass. 01801
(617) 935-5200

Who's who in Electronics



Venner

Jack H. Venner is a navigator, and when he plots the course for the Electro-Optics division of the Kollsman Instrument Corp. he sees more than the vastness of space. For Venner, who has just added a corporate vice presidency to his job as divisional general manager, has watched the once-bright space market lose a good deal of its luster.

When his group burst into the light six years ago as Kollsman's Space division, it was totally dependent on NASA for its business. But, says Venner, that dependence turned out to be merely a prologue to disenchantment—"We found that we couldn't commingle aircraft-oriented people and hardware with what was needed for those space contracts."

Three baskets. The next step toward Kollsman's present setup occurred about two years ago. Space business was dwindling, and the company was forced to look for other markets. Attention was naturally drawn to Southeast Asia and what appeared to be a drawn-out Vietnam war, with its demands for specially designed materiel. With the old Space division as a base, personnel were drawn from throughout the 4,000-employee

company, and the Electro-Optics division was born.

While space business is still a factor—work is going on, for example, on the Orbiting Astronomical Observatory's optical subsystem—Venner places the division's future eggs in three baskets. They are:

- Optomechanical devices, such as the Army's night-vision project. "We missed out on the first generation of the Starlight scope, but we're in on the second—use of channel amplifiers to reduce the scope to 20% of its present size," says Venner.

- Advanced tracking systems. Venner believes that by "getting away from classic detectors (vidicons and the like) sensitivity can be increased and we can build smaller systems."

- Digioptics, with lenses capable of wide spectrometry. Digioptics is Kollsman's term for systems used to track stars, measure laser beam position and deflection, align antennas, and boresighting.

Venner summarizes his division's attitude this way: "We're optimistic because we're certain that new areas of business are going to continue to open regardless of changes in the economy."

IBM relies heavily on its centers—such as the Electronics Systems and the Federal Systems centers—to pave its way into new technologies and markets. Now the International Business Machines Corp. has decided to take elements

from several centers and unite them into the Communications and Engineering Sciences Center.

"The center will concentrate IBM's thrust into the area of communications," says Robert P. Crago, the center's new chief. "It

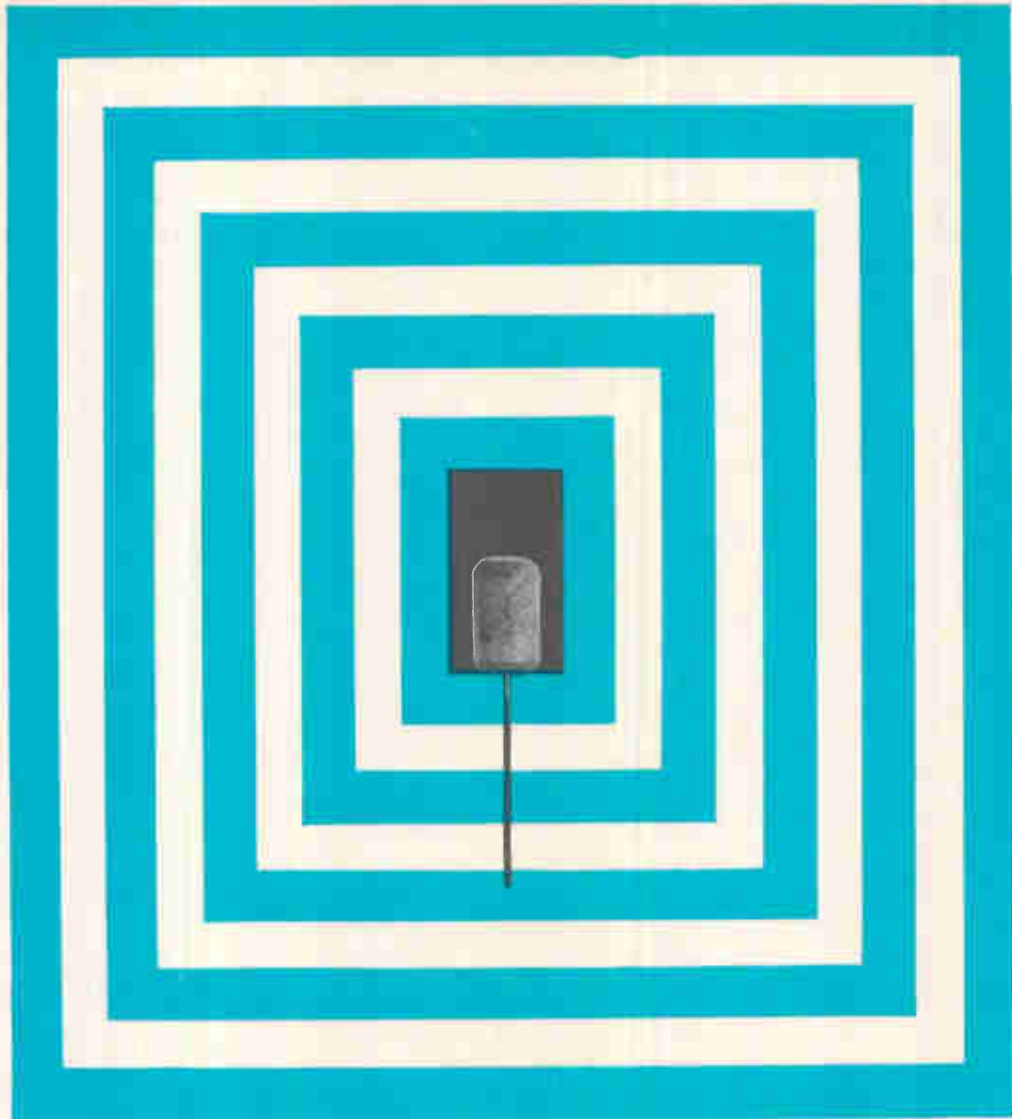

squeeze powder!

Fansteel's "FD" capacitor grade tantalum powder cuts anode size...capacitor cost. Yet improves electrical parameters.

How's that for putting on the squeeze! Compare standard with FD powder. You'll see how FD reduces material cost 35-45% per anode . . . how high purity achieves maximum capacitance without sacrificing electrical properties . . . how low density FD anodes reduce impregnation problems!

As a result of new powder making techniques, you can have smaller, more economical medium and high voltage capacitors. Fansteel FD powder is available in finished anodes or bulk powder form.

Your Fansteel Sales Engineer has detailed technical data. Ask him . . . or write us for your copy.

grade of Ta Powder	Standard	Fansteel FD
weight	4.4 gm	2.3 gm
density	10.5 gm per cc	8.5 max. gm per cc
CV rating	7000	7000



FANSTEEL INC.
NUMBER ONE TANTALUM PLACE
NORTH CHICAGO, ILLINOIS 60064

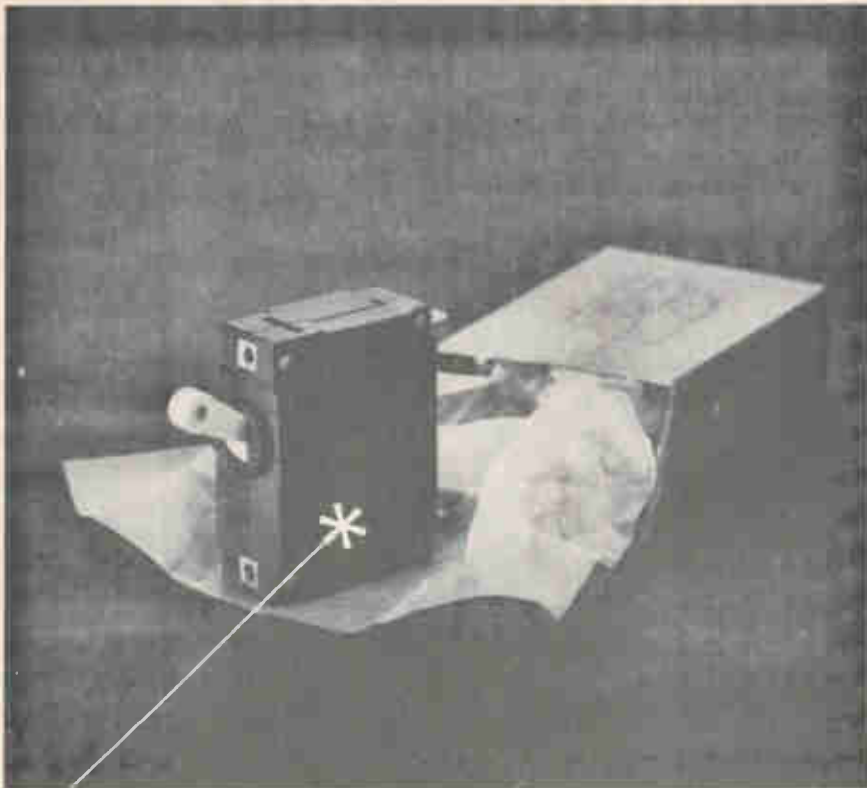

**You can order this circuit breaker
in a current rating of 0.020 amp.
Or 0.437 amp.
Or 6.84 amp.
Or 14.3 amp.**

The Heinemann Series JA breaker. We can wind *any* rating you'd like—up to 30 amp—into the overload-sensing coil.

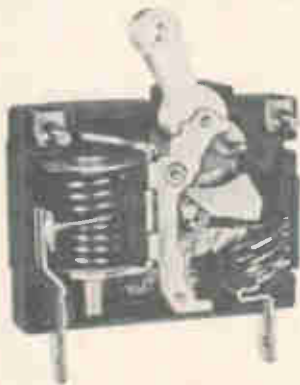

And you can be certain that every breaker will carry its full rated load without any nuisance tripping, no matter how high ambient temperature may climb. Overcurrent, and overcurrent alone, trips Heinemann hydraulic-magnetic breakers—though their time delay is

appropriately shortened or lengthened as temperatures rise and fall.

Understand, we make our breakers in conventional ratings too, and we're happy to sell you these if they're what you really need. But we needn't cajole you to accept a "standard" for lack of a more precise rating.

Equipment manufacturers who demand both good looks and performance in components are turning more and more to the JA breaker. It has a lot going for it—optional special internal circuitry, small size, easy-mounting round boss, white handle, a choice of nine color caps, and a range of time delays for fast or slow tripping. Bulletin 3350, newly revised, gives complete information on the JA line. Write Heinemann Electric Company, 2600 Brunswick Pike, Trenton, N.J. 08602.

4162



HEINEMANN

Who's who in electronics



Crago

will get us more deeply into an area in which IBM is already involved."

Crago, 41 years old, is an electronics engineer with a communications background. He most recently headed the civil programs department of the Federal Systems Center, and has now been appointed a vice president of the parent Federal Systems division. The union of several elements, he says, will give the new center instant experience in hardware development, advanced technology, and electronic systems.

Computer talk. If any one theme is to characterize the new center, it will be communication between computers. Explains Crago: "We'll be working on anything that will make it easier for one computer to talk with another." Other hardware will include high-speed modems, multiplexers, faster data correction devices and data displays, lasers, and sensors.

The new center will be organized into four departments: communications and exploratory studies, engineering, signal processing, and special processors. It will employ its own staff of marketing men and be treated from the outset as a complete center.

Crago has been with IBM since 1949, when he worked on the company's first large-scale commercial data processors, the 700 series. He has headed the IBM plant and laboratory in Kingston, N.Y., and has held various positions in the Federal Systems division.

Last year he was put in charge of bringing the defense-oriented Federal Systems Center into civil programs. This department is now well established, he says. This June, for example, it received five civil contracts.



Overplate for metallographic sectioning purposes

Gold layer

Copper alloy contact material

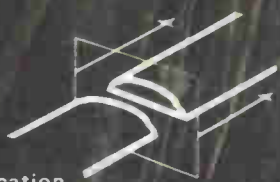

Illustration is 1400X magnification cross-section through selectively plated contact at point shown

CINCH PUTS THE GOLD ONLY WHERE YOU NEED IT

IN THE AMOUNT YOU WANT—With Cinch selective plating you benefit from reduced gold content and the absolute control of gold thickness at the contact area. The result is a better connector at lower cost . . . that also helps reduce the U.S. gold drain.

In conventional barrel plating, the amount of gold deposited at any point is a function of the geometry of the part and cannot be accurately controlled from part to part. To compensate, excessive gold deposits must be used, but there is still no guarantee that every part will receive the minimum gold plate specified, due to the random nature of the process.

Cinch continuous process selective plating deposits the same controlled amount of gold on every contact. Only the contact area is plated, reducing gold consumption as much as 60%.

A wide range of Cinch connectors is available with selectively plated contacts. For information on how selective plating can provide you with a better product at lower cost, write to Cinch Manufacturing Company, 1501 Morse Avenue, Elk Grove Village, Illinois 60007.

C-6814

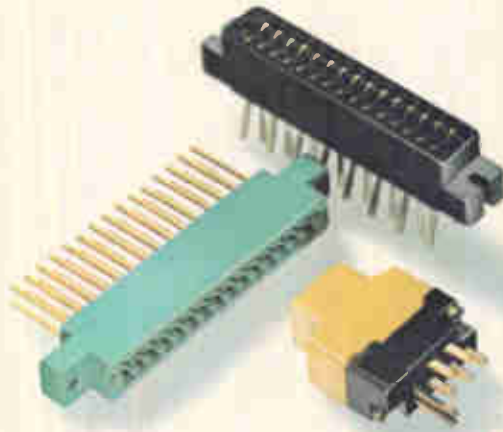

CINCH

DIVISION OF UNITED-CARR



CONSISTING OF CINCH MANUFACTURING COMPANY, CINCH-GRAPHIK, CINCH-MONADNOCK, CINCH-NULINE, UCINITE (ELECTRONICS) AND PLAXIAL CABLE DEPT

Circle 17 on reader service card

DANA SERIES 5700

The most accurate DVM there is—0.0025%. And the most stable—0.009% for a year. And the fastest—18 milliseconds for dc, 45 milliseconds for ac. It also has a 3-speed filter, and can be calibrated with just a single adjustment. The finest DVM in the world.

DANA SERIES 5500

Best DVM in the \$3000-\$4000 class. Accuracy is 0.005%. Six months stability is 0.006%. It has 5 dc ranges, 3 ac ranges, 5 ohm ranges, 3 ratio ranges, autoranging and 10% over range.

5700

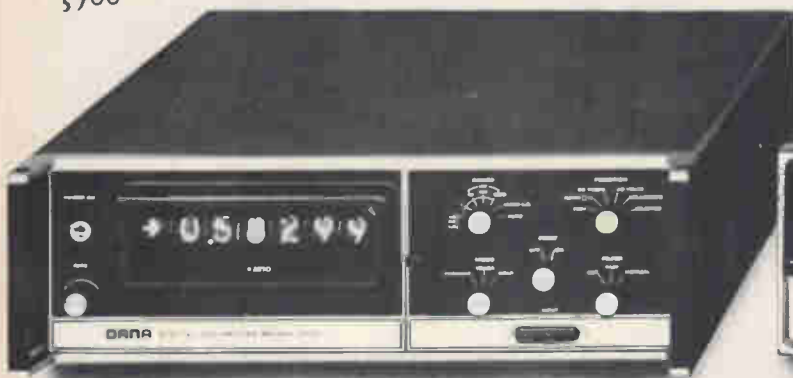

5500



Go to the head of

DANA SERIES 4400

Our newest DVM. It takes on all comers in the \$1000-\$2000 class. 90-day accuracy is 0.01%. There's a 1-volt range on ac and dc with 20% over ranging. There are plenty of integrated circuits to keep reliability honest. It even has the Dana 3-pole active filter for noise nuisance. You can choose between two rack-mount units and one portable unit. And anyone who can push buttons can operate it.

4400



DANA SERIES 5400

There's no better 4-digit instrument made. It's a multimeter. Measures ac/ac ratio. Has sample and hold, differential input, integrator and/or broadband filtering. It, too, has a 3-pole noise filter. With more than 1000 of them out in the field, it's almost a legend.

There're all in full detail in our handsome new brochure. So is the rest of the Dana line. The book is yours if you ask. Dana Laboratories, Inc., 2401 Campus Drive, Irvine, California 92664.

DANA

5400

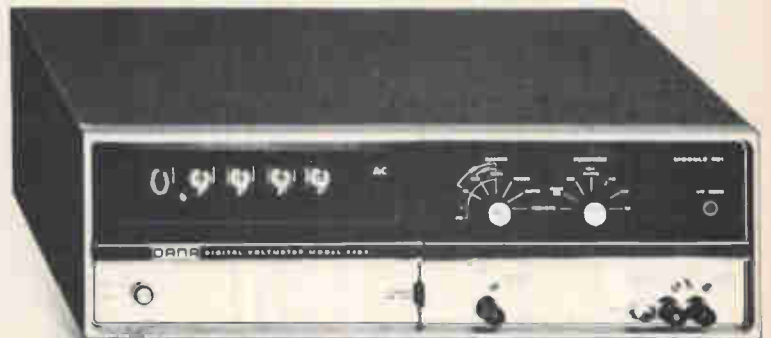

he class. Any class.

When will someone introduce a

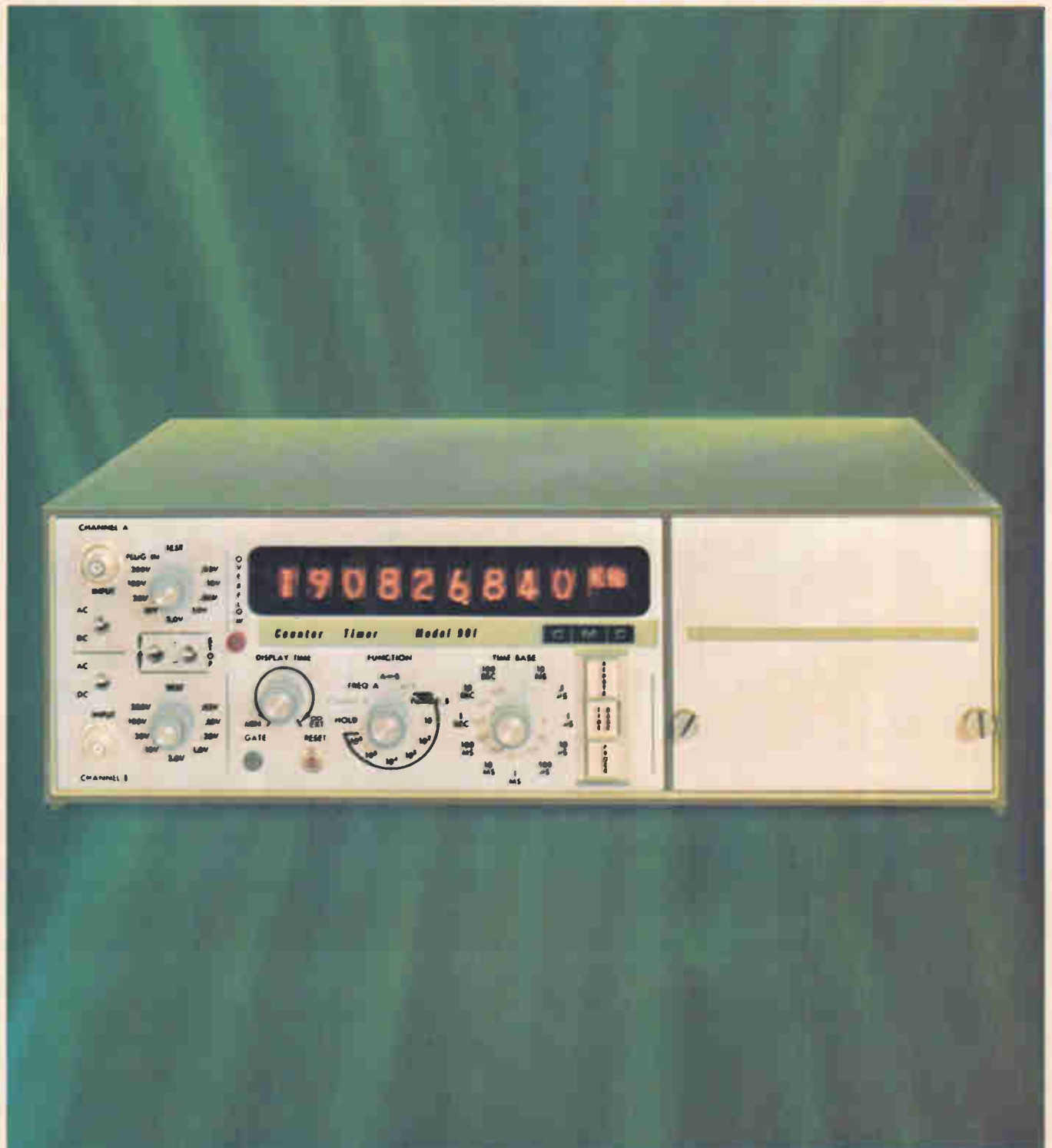

true 200-MHz counter-timer?

NOW!

And it's yours for less than \$2500 !

Imagine a universal counter-timer that offers 200-MHz direct counting instead of 100 or 125... that provides nine-decade readout instead of eight... that offers gate times from 1 microsecond to 100 seconds instead of to only 10 seconds... that provides time-interval resolution of 10 nanoseconds instead of 100... that has an input sensitivity of 10 mV instead of 100... and that can be operated completely by remote control, including attenuator and trigger levels.

Imagine all that in a new state-of-the-art IC counter-timer. Then decide how much more you would be willing to pay. Brace yourself: *This unique CMC Model 901 actually costs from \$250 to \$1000 less than the closest competitive models, which still fall far short of 901 performance!*

But that's not all. The CMC 901 achieves its 200-MHz range without prescaling, heterodyning, or requiring plug-ins. And it offers time-interval measurement as an integral function of the basic counter at no extra cost. Also, the unique CMC design and the use of advanced IC's throughout the main circuitry greatly enhances reliability and reduces heat dissipation and maintenance problems.

And here's more. Two optional heterodyne converters are also being introduced with the 901 — the Model 931 for a range to 1.2 GHz, and the Model 935 for 3.2-GHz operation.

For complete specs on this first, true, 200-MHz universal counter-timer — circle the reader service card.

See the Model 901 at WESCON Booth 1806-81



A Division of Pacific Industries

12970 Bradley/San Fernando, Calif. 91342/(213) 367-2161/TWX 910-496-1487

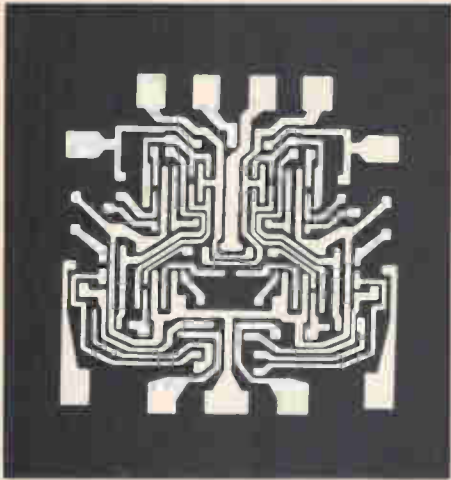

Precision plotting.

That's what our new Micro/Plotter coordinatograph offers you—precision plotting to $\pm .001$ inch.

Now you can produce highly accurate master layouts for printed circuits, optical resolution targets, maps, charts, graphs, and tool templates.

Micro/Plotter features rack and pinion motion, ultra-flat work surface, and abscissa rail pivots. And it's available with a special hardwood or backlighted translucent glass top—rectangular or rotary. An optical electronic digital display unit eliminates scale dials and tapes, increases operating speed and efficiency. And a new electrostatic top prevents movement of drafting films, minimizes air pockets, and improves accuracy.

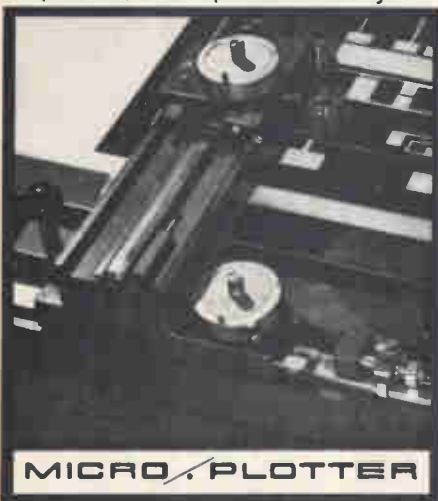

Write today for complete information.
Consul & Mutoh, Ltd., 519 Davis St.,
Evanston, Illinois 60201
Eastern Regional Office: 7601 Castor Ave.
Philadelphia, Pa. 19152

MUTOH
MICRO PLOTTER

Meetings

Satellites in spotlight at Eascon

Though it's almost impossible these days to find a person who can't detail what's wrong with air traffic control, it's not nearly as easy to find someone who's got an answer—even a partial one. A growing number of companies, however, are suggesting that special-purpose satellites could improve at least a portion of this rapidly deteriorating situation.

Several will detail their design ideas at the 1968 Electrical and Aerospace Systems Conference (Eascon) Sept. 9-11 in Washington.

RCA's Defense Electronics division proposes a Spot (speed, position, and track) system for transoceanic aircraft and ships that would generate data for both position fixes and ground surveillance. M.W. Mitchell and J.D. Barnla, RCA engineers, will describe in their paper the stationary satellite network that would work at L band. Ground stations would transmit a continuous-wave signal, modulated with two or more tones and a data link, to the satellite. Aircraft would derive their position from this signal using onboard data processors and then report their location via the satellite to ground stations.

A way of reducing the separation distance between planes making North Atlantic commercial flights and thereby increasing the amount of traffic that could be handled, will be offered by the Hughes Aircraft Co. It will suggest a modification of its design for a vhf aeronautical communications satellite. Roy J. Adams, Hughes space sciences division engineer, said the proposed stationary satellite, "without any significant increase in complexity," could reduce cross-track errors in aircraft doppler and inertial navigation systems. The satellite would provide aircraft with a single line-of-position nearly coincident with North Atlantic routes. Combining the accurate measure of aircraft cross track position with the other cockpit-derived position data could provide a "significant reduction" in cross track error, Adams will predict.

A study of economical ground/

aircraft satellite communications systems will be offered by Quintus C. Wilson of the Mitre Corp. He'll propose the use of higher frequencies to allow satellite phased-array steering, subsynchronous satellite orbits, and time division modulation.

Satellite systems design for transoceanic air traffic control will also be discussed in papers to be delivered by TRW Inc.'s Systems group, and General Electric Co.'s research and development center. In a related topic, infrared proximity-warning indicators for general aviation will be discussed by Dr. Charles Leigh, NASA's Electronics Research Center. The status of proximity-warning indicator projects will be detailed by John L. Brennan of the Federal Aviation Administration.

It's anticipated that the direction Comsat will take with some of the ground stations to be used by the upcoming Intelsat 4 satellite will be disclosed by William G. Schmidt of Comsat. He will discuss the design of a 32-access time-division multiple access system that could be used by emerging nations with modest channel demands. The system is designed to work with one of the Intelsat 4 transponders and a network of ground stations that have average traffic of 20 channels per station.

New ideas in radar processing will also be discussed at the three-day meeting. A General Electric Co. airborne radar design that would more accurately distinguish between low-flying aircraft and ground clutter will be offered by Charles P. Rasmussen of GE's Aerospace Electronics department. Better clutter rejection is obtained with a coded burst waveform in which two bursts of slightly different pulse spacing are used instead of one. A scaled-down nonflyable feasibility model of the burst-coded processor is currently being constructed and will be tested on simulated moving targets.

An Emerson Electric Co. doppler radar processor using digital modi-

(Continued on page 24)

New ITT C-7 COAX offers GREATER FLEX-LIFE



- At least 30% greater flex-life than other types
- Brute tensile strength of 100,000 PSI
- Minimum elongation of 10%

Improved C-7 is an exclusive 7 strand high strength conductor for our new miniature TFE coaxial cables. It combines the most desirable characteristics of hard and soft drawn conductor materials—tensile strength and flexibility. Conductor breakage during assembly and installation is sharply reduced—a real cost-saving feature!

New TFE coaxial cables with C-7 conductors are available now. They meet or exceed all MIL-C-17D specifications.

Set your nearest authorized ITT Electronic Wire and Cable distributor or contact ITT Wire and Cable, Division of International Telephone and Telegraph Corporation, Clinton, Massachusetts 01510.

IN CANADA: ITT WIRE AND CABLE, Cooksville, Ontario.

IN EUROPE: ITT WIRE AND CABLE, Lister Road, Basingstokes, Hants, England.



WIRE AND CABLE **ITT**

CIRCUIT BOARD MANUFACTURING

PROBLEM SOLVERS

The Hole



SOLID CARBIDE 1/8" SHANK CIRCUIT BOARD DRILLS Series 260 & 265

Precision drilling with every drill size. 58 drill sizes from No. 80 to 1/8". Maintain location and hole size tolerances to very close limits . . . at drill feeds up to 15 feet per minute. Ends delamination and bur problems. Use same collets and bushings for every drill size. Write for Catalog D67.

Unique four facet drill point for chip-clearing precision penetration.



The Edge

SOLID CARBIDE DIAMOND CUT ROUTERS



Diamond cut teeth, not flute edges, give faster, smoother routing of all materials. Hold closer tolerances, last longer than standard design routers. Cut stacked boards without board flutter. Write for Catalog E68.



AIR BEARING SPINDLES

Rotational center line runs true to less than 2 millionths of an inch! Speeds up to 150,000 RPM. Totally free of vibration . . . spindle shaft literally floats on air. Friction free with air turbine drive for cool operation constantly! Ideal for circuit board drilling and routing. Also supplied with electric high-frequency drive. Write for Catalog AB68.

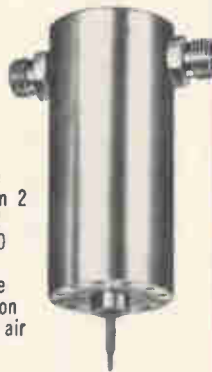

THE METAL REMOVAL COMPANY

1859 West Columbus Avenue / Chicago, Illinois 60626
Plants located in CHICAGO • LOS ANGELES • SAN JUAN

MASTER TOOL AND WHEEL MAKERS FOR THE WORLD
END MILLS / DRILLS / REAMERS / BURS / SPECIAL TOOLING

Meetings

(Continued from p. 22)

fied discrete Fourier transform techniques will be discussed. Using time-compression techniques and digital filter banks, the processor employs metal-oxide-semiconductor memory elements and medium scale integration.

By offering a technical session covering a wide range of subjects, and other inducements, Eascon hopes to lure back much of the military and Government audience it lost when it ceased being primarily a military show a few years ago. There's only a \$1 charge for advance registration and the convention will offer free bus transportation between major Government buildings, the Pentagon, and the meeting location, the Sheraton Park Hotel.

For more information, write Mrs. Harriett Manley, Page Communications, 3300 Whitehaven Northwest, Washington, D.C. 20007; or call 202-337-7600.

Calendar

Western Electronic Show and Symposium, IEEE; Biltmore Hotel and Sports Arena, Los Angeles, Aug. 20-23.

Electronics and Aerospace Systems Conference, IEEE; Sheraton Park Hotel, Washington, Sept. 9-11.

Meeting of the Union Radio Scientific International; Hotel Somerset, Boston, Sept. 9-12.

Group on Antennas & Propagation International Symposium, IEEE; Northeastern University, Boston, Sept. 9-12.

International Conference on Microwave and Optical Generation and Amplification, IEEE; and the University of Hamburg; University of Hamburg, West Germany, Sept. 16-20.

Cedar Rapids Conference on Communications, IEEE; Veteran's Memorial Coliseum, Cedar Rapids, Iowa, Sept. 19-21.

Aerodynamic Deceleration Systems Conference, American Institute of Aeronautics and Astronautics; El Centro, Calif., Sept. 23-25.

Conference on Electronics Design, Institution of Electrical Engineers, Institution of Electronics and Radio

(Continued on page 26)

first at the SUMMIT

Allen-Bradley hot-molded resistors are the *first* resistors to meet the requirements at the *S level* of the new MIL-R-39008A specification, which covers the general requirements for established reliability for Insulated Fixed Carbon Composition Resistors. ■ And Allen-Bradley provides this "peak" performance in *all three ratings*—the 1 watt, 1/2 watt, and 1/4 watt—and over the *complete resistance range* from 2.7 ohms to 22 megohms! ■ This conclusively demonstrates the superiority of Allen-Bradley's exclusive hot-molding technique. Completely automatic machines developed, built, and used only by Allen-Bradley produce such uniformity from

resistor to resistor—billion after billion—that long-term performance can be accurately predicted. And Allen-Bradley hot-molded resistors have no known incident of catastrophic failure. ■ For complete specifications on this quality line of resistors that afford tops in performance, please write to Henry G. Rosenkranz and request Technical Bulletin 5000.

Allen-Bradley Co., 1201 S. Second St., Milwaukee, Wis. 53204. Export Office: 630 Third Ave., New York, N.Y., U.S.A. 10017. In Canada: Allen-Bradley Canada Ltd.



ALLEN-BRADLEY
QUALITY ELECTRONIC COMPONENTS

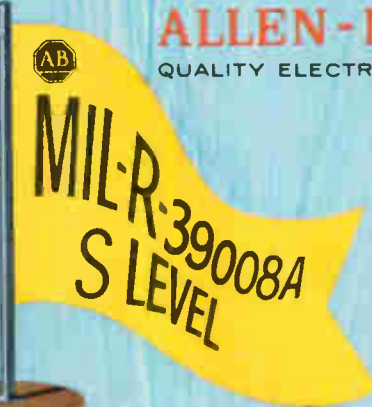

Type GB
1 WATT

Type CB
1/4 WATT

Type EB
1/2 WATT

PROBLEMS IN DESIGN?

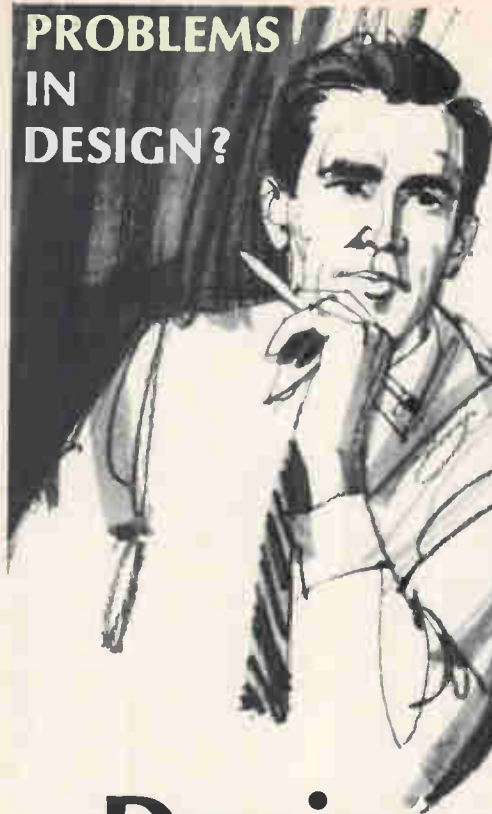

Transient Pulses
and Dips?

High Supply Voltage?

Load Power Factors?

Close Regulation?

Sine Wave?

Square Wave?

Design... with Sola CV Transformers in mind

Sola constant voltage transformers are available in designs with harmonic neutralized (CVS) and normal harmonic (CVN) wave shape outputs. Our CVS transformers contain less than 3% total rms harmonic content in the output and are recommended for all AC applications where harmonics can affect operation. Regulation is $\pm 1\%$ for an input range of $\pm 15\%$ of nominal voltage. CVS transformers are patented by Sola.

CVN transformers provide the same $\pm 1\%$ regulation and contain an average of 20% rms harmonic content. They're recommended for electrical loads not affected by harmonics, such as solenoids, relays and filaments, and where rectification to DC is required.

Sola CV transformers also are available in electronic-power component types providing a regulated source of plate and filament voltages (CVE and CVF).

Give your equipment design the best chance of operating at peak efficiency, without the damaging effects of voltage dips and surges. Contact Sola today for more information on how our transformers can fit your line. SOLA ELECTRIC, 1717 Busse Rd., Elk Grove Village, Illinois.

SUPPLIERS OF CONFIDENCE
TO THE INDUSTRIES
WE SERVE

SOLA ELECTRIC



DIVISION OF SOLA BASIC INDUSTRIES

IN CANADA: SOLA BASIC LTD., 377 EVANS AVENUE, TORONTO 18, ONTARIO
DIVISIONS: ANCHOR ELECTRIC • ENGINEERED CERAMICS • HEVI-DUTY ELECTRIC
LINOBERG HEVI-DUTY • NELSON ELECTRIC • SIERRA ELECTRIC • SOLA ELECTRIC

Meetings

(Continued from p. 24)

Engineers, IEEE; Cambridge University, England, Sept. 23-27.

Symposium on Physics & Nondestructive Testing, Gordon & Breach Science Publishers; O'Hare International Inn, Schiller Park, Ill., Sept. 24-26.

Instrumentation Fair, IEEE; Sheraton Park Hotel, Washington, Sept. 25-26.

Ultrasonics Symposium, IEEE; Statler Hilton Hotel, New York, Sept. 25-27.

Association for Computing Machinery Conference & Exposition; Las Vegas, Sept. 27-29.

International Fair for Electronics, Automation, and Instruments; Copenhagen, Sept. 27-Oct. 4.

Engineering Management Conference, IEEE; Marriott Motor Hotel, Philadelphia, Sept. 30-Oct. 1.

Government Microcircuit Application Conference, Department of the Army; Washington, Oct. 1-3.

Allerton Conference on Circuit and System Theory, IEEE; Allerton House, Monticello, Ill., Oct. 2-4.

Call for papers

Geoscience Electronics Symposium, IEEE; Marriott Twin Bridges Motor Hotel, Washington, April 16-18, 1969. Jan. 1 is deadline for submission of abstracts to M.E. Ringenbach, director, Equipment Development Lab, U.S. Weather Bureau, Room 201, Gramax Building, 8060 13th St., Silver Spring, Md. 20910.

International Microwave Symposium, IEEE; Dallas, May 5-8, 1969. Jan. 3 is deadline for submission of abstracts and summaries to J.B. Horton, chairman, technical program committee, Texas Instruments, MS-905, P.O. Box 5012, Dallas 75222.

Short courses

Design and application of measurement systems, Ohio State University, Columbus, Aug. 26-30; \$175 fee.

Display systems engineering, University of California, Los Angeles, Aug. 26-30; \$275 fee.

Digital process control systems, Purdue University's Schools of Engineering and Laboratory for Applied Industrial Control, Lafayette, Ind., Sept. 16-25; \$250 fee.

ERIE
TECHNOLOGICAL
PRODUCTS, INC.



LOOK FIRST TO ERIE FOR...

CUSTOM *Hybrid* INTEGRATED CIRCUITS

*When choosing your Custom HYBRID Circuit Source...
Check ERIE'S "Total Package" In-Plant Capability*

There are very specific reasons why ERIE is becoming a preferred source for Custom Hybrid Integrated Circuits. Our distinctly superior *resistor technology* is unique in the industry, as is our in-depth *capacitor technology*. We produce our own *precious metal formulations*, our own *substrates*, *semiconductors* and the best *protective encapsulant* available. Result? Economy, greater reliability, excellent quality control and delivery to meet your schedules. Prototypes available in about two-weeks with production quantities in about six weeks.

Look first to ERIE as *Your Custom Hybrid* source. Our total in-plant capability and *exPERIENCE* are unparalleled in the industry.

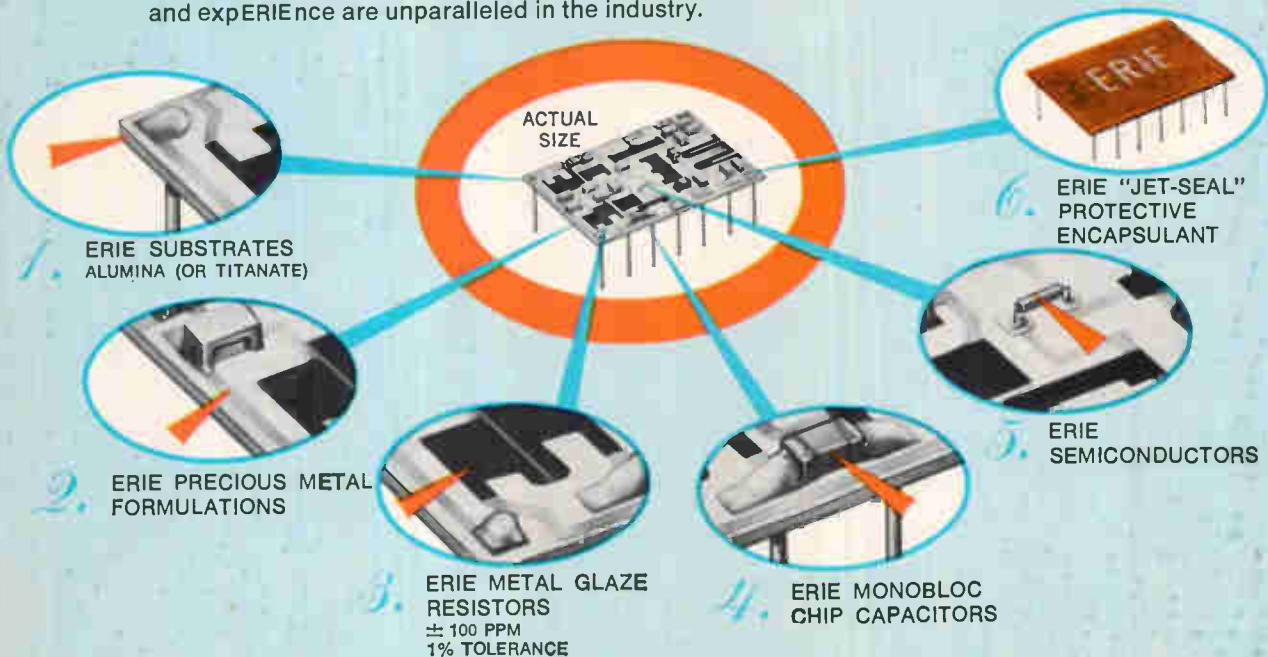

Write today for ERIE "Custom Hybrid I/C" Brochure...



ERIE TECHNOLOGICAL PRODUCTS, INC. • 644 West 12th St. • Erie, Pa. 16512 • Phone (814) 456-8592

The Electronic

For the modular man, the do-it-yourself AMPMODU* Interconnection System solves your interconnection problems for modular packaging. You start with a post and a receptacle—and you build from there. Two sizes: Standard which uses .031 x .062 posts and Miniature which uses .025 x .025 posts.



Standard or miniature—vertical receptacles
Stake posts in a mother board. Machine apply vertical female contacts randomly or in a row on the daughter board. Horizontally plug daughter board to mother board.

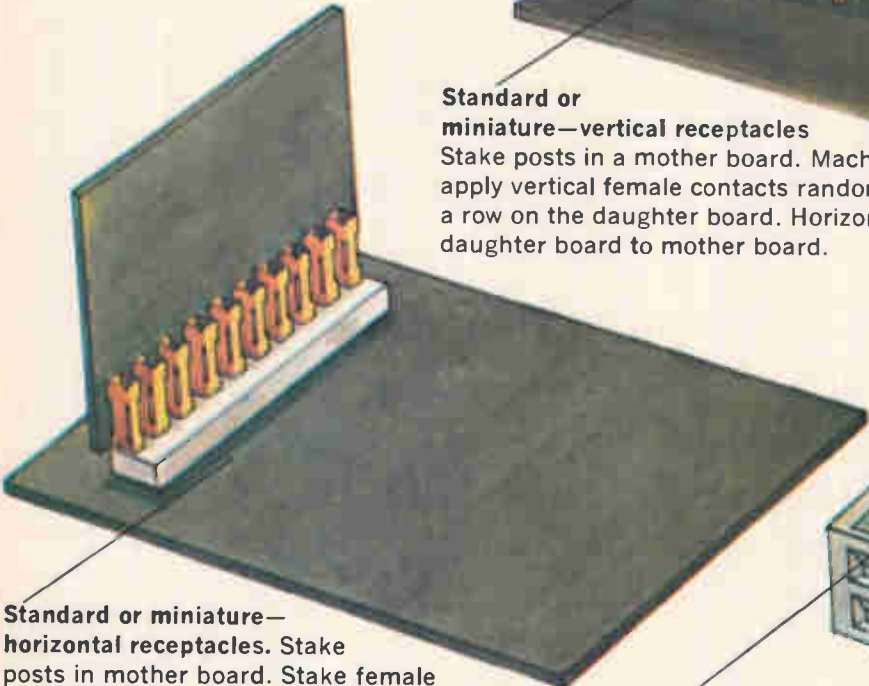

Standard or miniature—horizontal receptacles. Stake posts in mother board. Stake female contacts horizontally on edge of daughter board and plug daughter board vertically into mother board. Posts can be placed randomly or in even patterns in both horizontal or vertical approach.

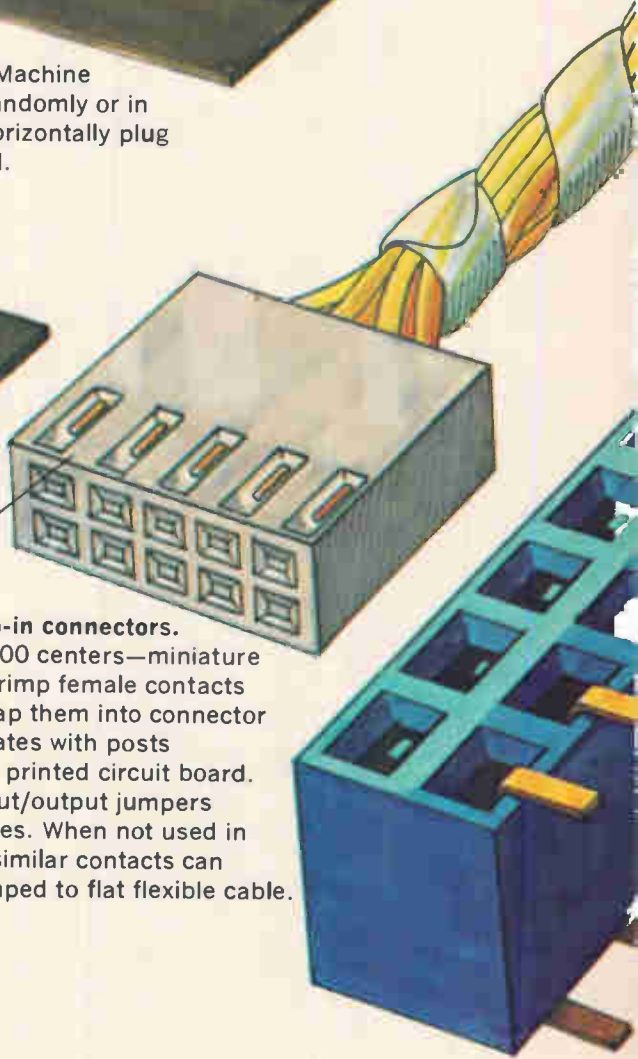

Crimp-snap-in connectors. .150 and .100 centers—miniature size only. Crimp female contacts on wire. Snap them into connector housing. Mates with posts installed on printed circuit board. Also for input/output jumpers for grid plates. When not used in a housing, similar contacts can also be crimped to flat flexible cable.

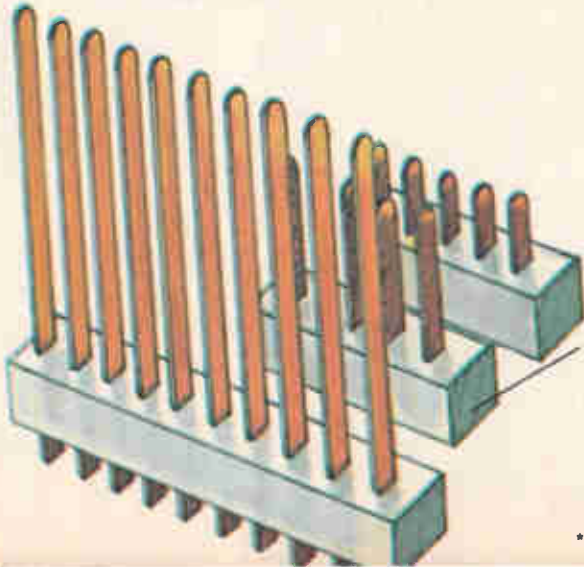

Incremental nylon connectors provide standard size posts in three different lengths. Permits one, two or three daughter boards to be stacked horizontally to mother boards. Where metallic chassis are required, posts are available in snap-in nylon blocks.

Connector Set

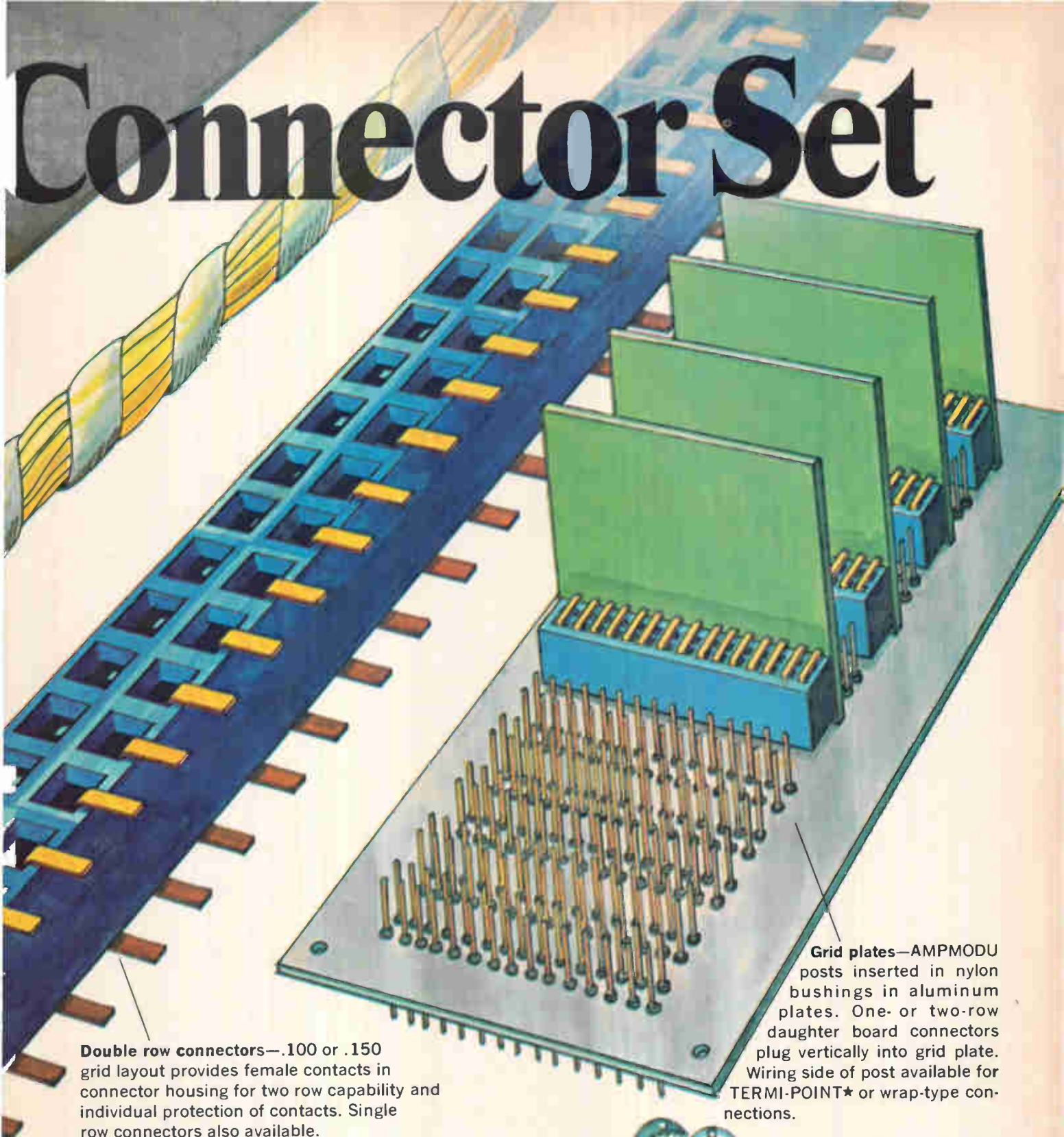

Double row connectors—.100 or .150 grid layout provides female contacts in connector housing for two row capability and individual protection of contacts. Single row connectors also available.

The AMPMODU Interconnection System is your electronic building block connector set providing you design flexibility and cost advantage unmatched by other systems. Complete details are available by writing AMP INCORPORATED, HARRISBURG, PA. 17105.

Grid plates—AMPMODU posts inserted in nylon bushings in aluminum plates. One- or two-row daughter board connectors plug vertically into grid plate. Wiring side of post available for TERMI-POINT★ or wrap-type connections.

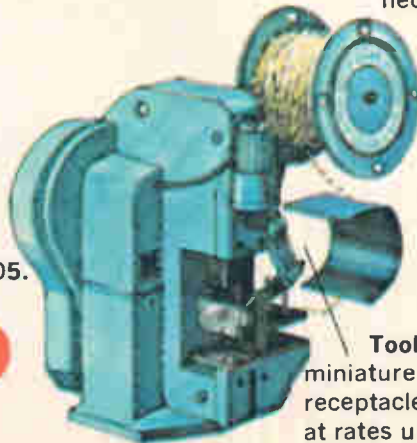

Tooling: The AMP-O-LECTRIC★ with miniature applicator inserts AMPMODU receptacles and posts into circuit boards at rates up to 2000 an hour.

AMP

INCORPORATED

Circle 29 on reader service card

RCA-2N5470 **"overlay" power transistor** **for UHF and Microwave**

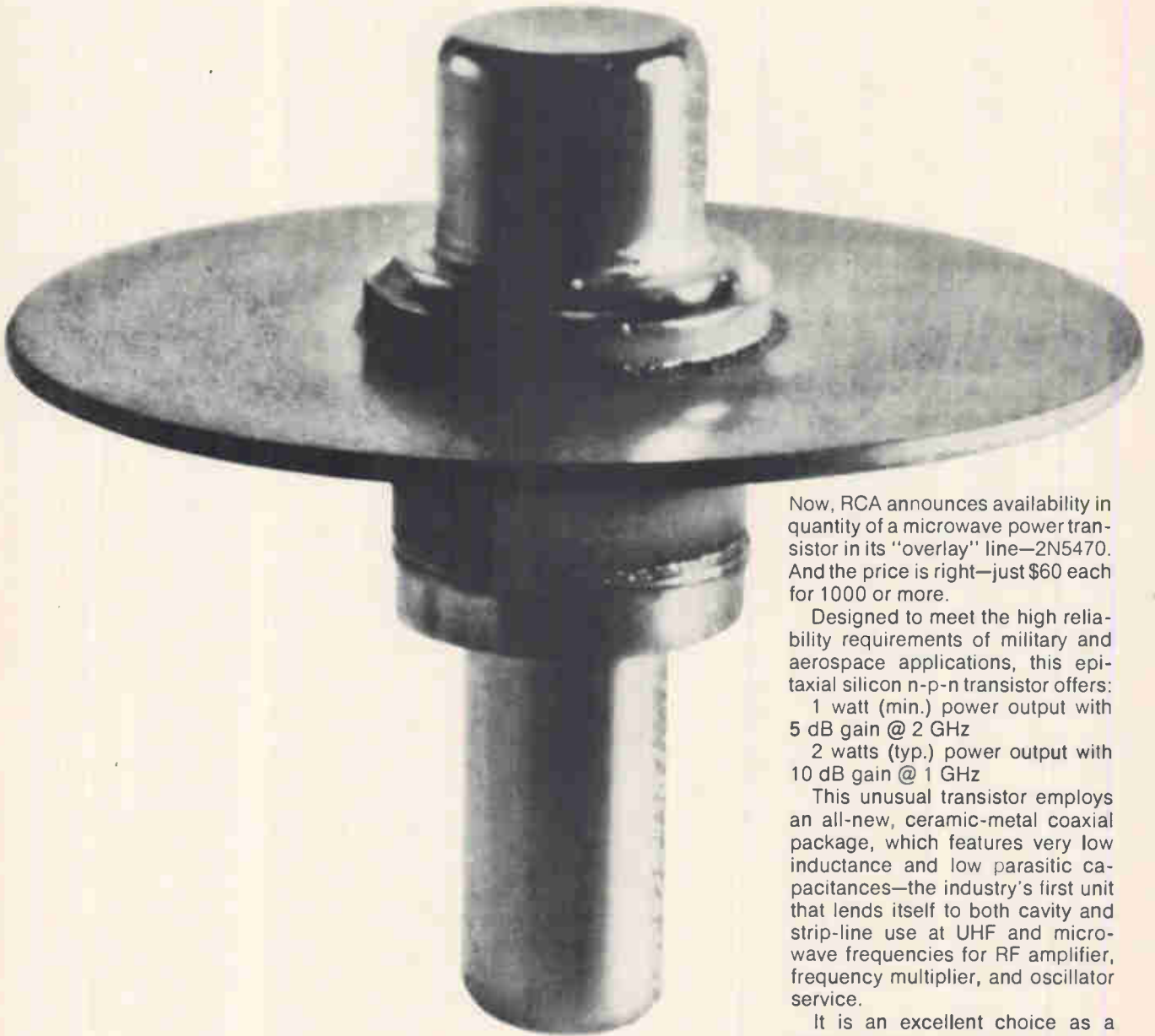

Now, RCA announces availability in quantity of a microwave power transistor in its "overlay" line—2N5470. And the price is right—just \$60 each for 1000 or more.

Designed to meet the high reliability requirements of military and aerospace applications, this epitaxial silicon n-p-n transistor offers:

1 watt (min.) power output with 5 dB gain @ 2 GHz

2 watts (typ.) power output with 10 dB gain @ 1 GHz

This unusual transistor employs an all-new, ceramic-metal coaxial package, which features very low inductance and low parasitic capacitances—the industry's first unit that lends itself to both cavity and strip-line use at UHF and microwave frequencies for RF amplifier, frequency multiplier, and oscillator service.

It is an excellent choice as a power source in L- and S-band, and can be used advantageously as a varactor driver for microwave power sources through X-band.

For more information on RCA-2N5470, see your RCA Representative. Ask him, too, about RCA developmental type TA7403 for your special microwave fundamental frequency power oscillator applications. For technical data, write: RCA Electronic Components, Commercial Engineering, Section P-M-8-2, Harrison, N.J. 07029.

RCA

Editorial comment

Down with the upkeep

When consumers start saying "It's not the initial cost, it's the upkeep," designers and manufacturers listen. Too many trips to the local repair shop and the buyer will do more than switch brands; he'll warn his friends and neighbors against buying the article. The threat of lost sales is an extremely effective weapon, and manufacturers respond by designing goods not only for low cost, but minimum maintenance.

Unfortunately, the Federal Government doesn't follow the consumer's lead. Once it has bought and installed an inefficient system, usually on the basis of a low bid, Congress is expected to vote the funds for its upkeep.

With the advent of cost effectiveness techniques, the picture is changing. Cost effectiveness is no longer just a buzzword; real cases have proved its worth. The Government promotes it in many ways—the Defense Department's directive on integrated logistics support (ILS) is a good example. It has as its goal high efficiency and cost effectiveness over the life span of a system. The cornerstones of ILS are planned maintenance, support personnel, and logistic technical data.

Assistant Secretary of Defense Thomas Morris put it well when he said that in addition to a plan for the operational performance of a new system there must be a companion plan for its logistic support. As development proceeds, both plans must be constantly revised if the system is to be most effective.

Nothing sells ILS like its successful application. For example, Hughes Aircraft redesigned the airborne computer for the fire control system of the F-106; the result was impressive—an annual savings in maintenance and support that is

estimated at over \$3.5 million.

Grumman applied ILS in an entirely different way. It examined the contracts it had for two carrier-based aircraft, the A6A and the E2A, and recognized that critical manpower limitations and limited carrier deck space were major problems. Grumman's solution was to design common support equipment for the two aircraft. Specifically, the autopilot, air data computer, and inertial navigation systems for the A6A and E2A are identical, and other parts of the avionics use common subassemblies. The common test equipment costs about \$6.5 million; if designed separately, the two sets of test equipment would have cost about \$5 million each.

Morris recently posed some interesting challenges to the electronics industry. Should we, he asked, be seeking "no maintenance" systems? For example, is a 4,000-hour "no overhaul" aircraft worth considering? The 4,000-hour figure is about double today's average. At this figure, it is conceivable that some classes of aircraft would outlive the time span of their primary mission. Would development and production costs for such a system be prohibitive or would they be reasonable when compared to the support resources saved and the complete elimination of downtime?

Determining whether goals such as Morris postulates can be reached requires careful analysis—perhaps by computer modeling of the whole complex system. Further, if ILS is to work, the engineer must design his support gear as an integral part of the system, not as an afterthought. Success in meeting the Assistant Secretary's challenge would approach the ultimate in integrated logistics support.



To solve some sticky ferrite problems, we're pressing tubes and rods up to 20 inches.

The old way of making large ferrite parts is simple: epoxy or glue small ferrites together. But the resulting problems aren't so simple. Magnetic characteristics suffer. Costs are high. And delivery schedules are excessive.

Now, new pressing and firing techniques let Indiana General make single piece large parts. Up to 35 lbs. And in giant sizes, like 10" sq. x 2" plates, 3" dia. x 20" rods, and 6" O.D. x 4" I.D. x 20" tubes.

Our large ferrite parts have opened

up new design opportunities in oceanography. VLF communications applications, in the 10 to 80 kc range, need large ferrite parts for higher power. And our new sizes, in Ferramic® O-5, deliver the massive "brute wave forces" to penetrate denser-than-air media with none of the problems of epoxied ferrite assemblies. O-5's high permeability results in higher sensitivity in antennas where signal strength dissipates rapidly.

So instead of looking high and low for high power, low frequency antenna ferrites, look to Indiana General. Where we keep magnetics problems from making you come unglued. For technical information on our new large ferrite parts capability, write Mr. K. S. Talbot, Manager of Sales, Indiana General Corporation, Electronics Division/Ferrites, Keasbey, New Jersey.



INDIANA GENERAL

Making Magnetics Work.

Electronics Newsletter

August 19, 1968

Six Motorola aides switch to Fairchild

The expected recruiting drive by C. Lester Hogan to strengthen Fairchild Semiconductor has started. In his first move since leaving Motorola Semiconductor to become president of Fairchild Camera & Instrument [See story on p. 45], Hogan hired Leo Dwork, Motorola's vice president in charge of the product and operations groups, and five key managers.

Already at Fairchild Semiconductor's Mountain View, Calif., headquarters with Dwork are Andrew Procassini, manager of reliability assurance; Wilfred Corrigan, director of three product groups—silicon-transistors, hybrid circuits, and germanium mesa transistors; Eugene Blanchette, director of integrated-circuit operations; George Scalise, manager of European operations, and William Lehner, manager of equipment and plant operations. Their Fairchild jobs haven't yet been assigned.

The big question: where does Dwork's arrival leave Fairchild Semiconductor's general manager, Tom Bay? A possible clue: Hogan is also wearing the hat of "acting general manager" at Fairchild Semiconductor, says one source, and Bay is "on Hogan's staff."

Integrated system for communication, navigation, IFF . . .

Big problems—money and political—slow what will be the most ambitious avionics program in Air Force history, but the proposed integrated communications, navigation, and identification system (I/CNI) will definitely be funded this year. About \$2 million will be spent, probably for competitive industry studies. A more ambitious effort had been planned, but the funding squeeze killed it.

An in-house Air Force Systems Command study group, aided by Mitre and industry, concluded last year that I/CNI is technologically feasible, but the program hasn't yet been approved. The Air Force is now putting together a more detailed plan in hopes of getting approval later this year. The program grew out of concern about the proliferation of black boxes aboard aircraft and the wasteful use of r-f spectrum.

An integrated system would offer all CNI functions in one secure radio link: low-duty-cycle navigation signals, providing precise navigation and timing, can be embedded in a communications signal. As the Air Force now sees it, the system would provide a global navigation accuracy to within 600 feet, local accuracy to within much less than 600 feet, global timing within less than 1 microsecond, global identification-friend-or-foe (IFF) capabilities, 2,400-bit-per-second communications, secure access for more than 100 simultaneous users, and a global propagation reliability exceeding 90%.

I/CNI would require 16 synchronous satellites in four constellations: 12 in inclined elliptical orbits and four in equatorial orbits.

The problems are formidable. The Air Force will have to decide who will run the program; Congress and the other services must be sold on the plan; companies will have to reorganize their operations to compete for this new business. The cost is in the billions of dollars.

. . . could be flying within 10 years . . .

An ambitious development schedule is proposed by the Air Force's Electronics Systems Division for the I/CNI. The goal: an operational system within five to 10 years. Running in parallel with systems studies

Electronics Newsletter

and tests is a big effort to push the state of the art in several areas. They include: airborne phased-array antennas, computer logic circuitry (using large-scale integration), high-power traveling wave tubes, electronically tuned preselectors, digital matched filters using LSI, and synthesizers.

The division has just proposed that the Air Force seek from industry preliminary design studies in fiscal 1971. During 1969 and 1970, it plans "very austere tests." These "single-thread" demonstrations would be conducted by two parallel industry teams in an operational environment such as airborne warning and control (AWACS).

The two biggest technical problems in going to I/CNI: avionics reliability and redundancy. The Air Force will have to completely rethink its position in these areas.

... but technical problems remain ...

The key to an I/CNI system is the development of a common multifunction waveform or modulation technique. The Air Force is moving fast on this—a request for proposals is due shortly from the Rome Air Development Center on a waveform study.

In-house studies show that the technology exists for a valid signal-coding structure. Spread-spectrum multiple access is a likely candidate: frequency hopping, pseudo noise or a composite of the two. Another possibility is gated pseudo noise, which uses overlapping pulses and a carrier turned off and on in a random manner. A digital matched-filter array would provide a flexible signal processor, but filter technology needs to be developed. With proper funding, LSI is the answer, Air Force researchers say.

Satisfying all the design requirements—on paper—for a common waveform is a gated pseudo noise approach with matched filters, says the Air Force.

... and FAA may use system eventually

I/CNI could provide the answer to the air traffic control problems of the FAA. The FAA has representatives on the Air Force I/CNI Committee and is monitoring the program carefully.

One Air Force official speculates that a dual I/CNI might be the best approach—a secure system for the military and another system for commercial traffic. But he estimates it could take as long as 20 years before such a dual system could become operational.

The I/CNI waveform, with an address unique to an airfield, could operate as a microwave instrument landing system. A low-data-rate signal could go over a I/CNI link for instrument approaches; data would be coupled to a cockpit display. Instead of using radar, the system would operate in a beacon-transponder mode with the I/CNI waveform. Each aircraft would have its own address, as well as a position address constantly being updated by the system. I/CNI central timing could also be the basis of a collision-avoidance system.

Police to test car teleprinters

Although metropolitan police departments say there is an acute need for them, and although more than a half-dozen companies say they're ready to produce them, teleprinters have not been installed in squad cars. What's been needed is a major operational testing of hardware. With this in mind, the Justice Department's office of law enforcement assistance has just given the Milwaukee police \$95,000 to test equipment from six or seven manufacturers.

IDEAS / CRT Information Displays

Display systems for military and aerospace equipment: rugged and reliable.

Tactical military operations and aerospace missions have become more and more dependent on CRTs for visual information display systems in mobile command and control equipment in land, sea, airborne or space environments.

Military and aerospace services demand a whole new breed of CRT information display systems. They have to be small and lightweight, extremely rugged and reliable, must operate at high speeds with improved deflection efficiencies and low power consumption. They frequently must offer simultaneous rear port projection and film recording capability, reduced depth-to-viewing-screen diameter ratio...and low cost. Some applications require high resolution multicolor visual displays. Add all these requirements together and this new class of information display system would appear to be impossible to achieve.

To meet these objectives, Sylvania formed a task team from our Electronic Systems and Electronic Components Divisions. It consists of specialists with outstanding technical strength in many areas.

This team has developed a number of new concepts which can now be applied to the information display requirements of industry in general as well as to military operations and aerospace missions. Here are a few of the problems that have been thrown at us, and how we solved them.

Problem—Eliminate the need for a complex shock and vibration isolation system for a high-resolution CRT display while reducing size and weight.

Sylvania's solution—Development of an integrated CRT mount and cathode ray tube providing a compact, lightweight, safe and rugged assembly. Installed in any equipment, it will withstand severe shock and vibration levels as applied through a simply defined bonded flange.

The CRT has high-voltage/low-beam-current with dynamic focusing, and incorporates a new rugged electron gun with improved-focus electrode design. A ruggedized low-power heater/cathode improves the reliability of the CRT.

Problem—Clearly visible data display in ambient daylight.

Sylvania's solution—Development of a unique contrast enhancement technique utilizing special phosphors and special filters and polarizers. Since the design does not require high brightness levels, reliability is increased significantly.

Problem—Rapid writing speeds and decreased retrace settling times, combined with improved deflection efficiencies.

Sylvania's solution—Unique high-speed deflection system design incorporating a special retrace settling time circuit which substantially reduces average power requirements.

Continued on next page

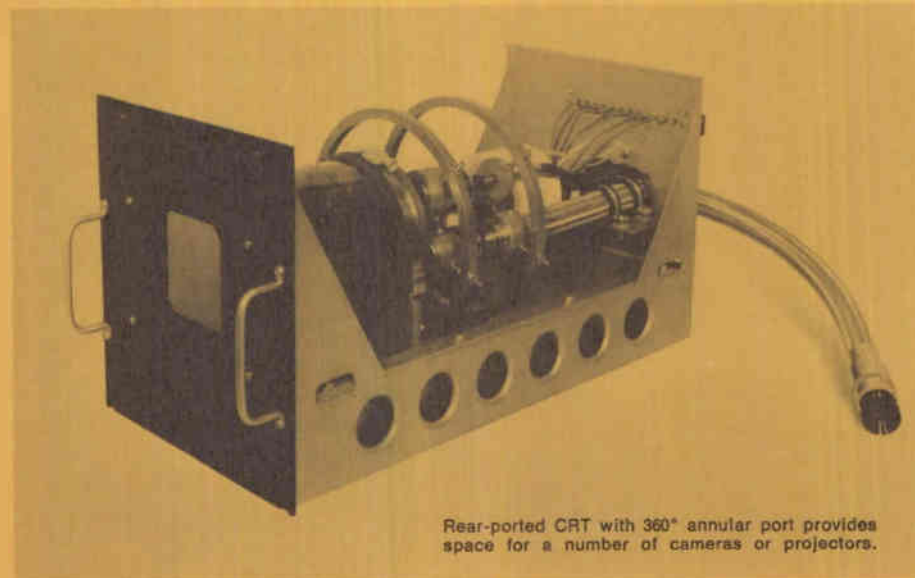

Rear-ported CRT with 360° annular port provides space for a number of cameras or projectors.

This issue in capsule

Microwave Diodes

Punch-through varactor specs assure repeatable performance.

Integrated Circuits

New functional arrays simplify memory designs.

Receiving Tubes

Unique fin structure cools off horizontal-amplifier operation.

Diodes

New voltage-variable capacitor diode family tunes FM and TV bands.

TV Tubes

New 15" picture tube brightens the picture for small-size color TV sets.

Manager's Corner

Progress and breakthroughs in readouts—are you missing something?

valuable tool for you in specifying varactors to assure repeatability in performance.

How PTV diodes work

The capacitive and resistive change in punch-through diode characteristics is dependent on the changes in the depletion layer formed in a p-n junction when a bias voltage is applied. The structure of a typical diode is shown in Fig. 3. It consists of a heavily doped n-type substrate on which has been grown a lightly doped epi-

taxial layer of thickness t . A p-type dopant is then diffused to a depth X into the surface of the n-type layer.

When a reverse bias is applied to the varactor, mobile electrons flow toward the n+ substrate "uncovering" the positively charged donor atoms, thus forming a region of width W within the epitaxial layer which is depleted of mobile carriers. The width of this depletion region varies with applied voltage as: $W = K_1(\phi - V)^\gamma$, where ϕ is the intrinsic voltage of the junction, (0.5 for silicon), K_1 is a constant and V is the reverse bias voltage. The value of γ varies from $1/3$ to $1/2$ depending on the doping gradient of the epitaxial layer.

The boundaries of the depletion region act as the plates of a parallel-plate capacitor with a capacitance equal to: $C_j = \epsilon A/W$ where ϵ is the dielectric permittivity of the depleted silicon and A is the junction area. Increasing the applied reverse bias, V , increases W and decreases C_j .

Depletion width, W , increases with applied voltage but cannot extend very far into the n+ substrate because of the very high density of charged donors there. When $W = t$, little capacitance change can occur. This point is defined as the punch-through point. When biased in the positive direction from the punch-through point toward the contact potential, ϕ , capacitance increases rapidly with the applied bias voltage.

The resistance of the PTV also varies with applied bias. As the depletion layer takes up more of the high-resistivity n-layer, the series resistance decreases rapidly until the punch-through voltage is reached. From this point on, the resistance of the n-layer is essentially zero, and the remaining diode resistance is that of the p-layer, substrate and ohmic contacts.

CIRCLE NUMBER 301

Table 1—Measured Diode Efficiencies

	β_1	β_2	Observed Efficiency
PTV #1.	4.3	1.35	50%
PTV #2.	5.65	1.32	72%
PTV #3.	6.22	1.28	78%
PTV #4.	8.19	1.21	80%

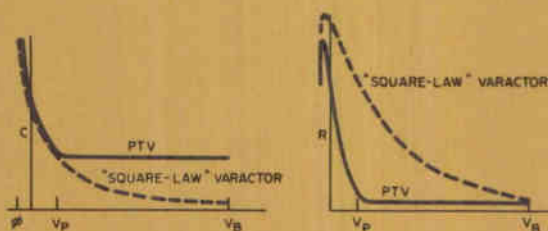

Fig. 1. Capacitance and resistance versus bias voltage for PTV diode and normal abrupt-junction varactor.

Table 2—Characteristics of Punch-through Varactors

	BV Volts Min.	C_{j-6} pf	T_2 ps typ.	$\frac{159}{RC}$ GHz min.	β_1 Ratio min.	β_2 Ratio max.	R_1 °C/W max.
D4330	30	0.2-0.5	150	200	5	1.5	75
D4331	30	0.5-1.0	150	200	5	1.5	70
D4332	30	1.0-2.0	150	200	5	1.5	65
D4339	45	0.2-0.5	250	200	5	1.5	75
D4340	45	0.5-1.0	250	175	5	1.5	60
D4341	45	1.0-1.5	250	175	5	1.5	55
D4342	45	1.5-2.5	250	175	5	1.5	50
D4348	60	0.4-0.8	300	175	5	1.5	55
D4349	60	0.8-1.5	300	150	5	1.5	45
D4360	80	0.5-1.0	300	150	5	1.5	55
D4361	80	1.0-1.5	400	150	5	1.5	50
D4362	80	1.5-2.5	700	125	5	1.5	40
D4370	100	0.5-1.0	1,000	125	5	1.5	50
D4371	100	1.0-2.5	2,000	125	5	1.5	40
D4440	45	0.5-1.0	200	175	5	1.5	45
D4441	45	1.0-1.5	200	175	5	1.5	40
D4449	60	0.5-1.0	400	150	5	1.5	50
D4450	60	1.0-2.5	400	150	5	1.5	35
D4451	60	2.5-4.0	400	150	5	1.5	30
D4458	80	0.5-1.0	300	150	5	1.5	50
D4459	80	1.0-1.5	400	125	5	1.5	40
D4460	80	1.5-2.5	700	125	5	1.5	30
D4461	80	2.5-4.0	1,000	125	5	1.5	25
D4469	100	1.0-2.0	2,000	125	5	1.5	35
D4470	120	4.0-5.0	3,000	90	5	1.5	20
D4471	120	5.0-10.0	3,000	90	5	1.5	15

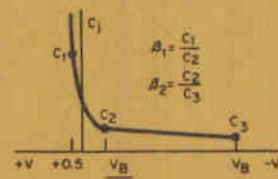

Fig. 2. PTV capacitance curve with measuring points for β_1 and β_2 defined.

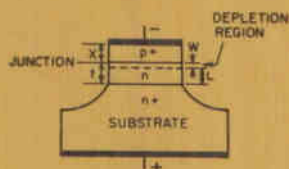

Fig. 3. Simplified cross-section of PTV varactor p-n junction.

Four-bit storage registers can simplify your memory design.

Functional arrays with more bits per package reduce can count. Parallel 4-bit read in/read out circuits cut down on circuit-board wiring.

Here is a 4-word, 8-bit memory circuit that uses two types of Sylvania digital function arrays to give you low power and high speed with a minimum of wiring. The arrays used are Sylvania's SM-60 and SM-70 four-bit storage registers. Two SM-70s are used as an input storage register while eight SM-60s make up the memory array.

Both arrays have input characteristics of Sylvania's popular SUHL line of integrated circuits and are com-

pletely SUHL compatible. Low power consumption and high operating speed are inherent in the design of the SM-60 and SM-70. Typical power requirements are 30mw/bit and operating speed is 20 ns/bit. Both devices can be used at clock rates up to 20 MHz.

The SM-60 and SM-70 (Fig. 1) are similar devices with the exception of their output configuration. Output from the SM-70 results directly from the clock pulse. It has an active SUHL pull-up network for driving high capacitance loads.

Each output of the SM-60 is normally in the logical "1" state regardless of the data clocked in and stored. Data is transferred out of the SM-60 only when an output enable pulse is applied. The readout is non-destructive. Since the SM-60 does not have an active pull-up network, groups of outputs can be bused together for transfer to a common bus. It is this wired-OR technique that is used in the memory circuit of Fig. 2.

In the arrangement shown, a 4-bit memory address is used to select the proper word for the read and write function. To write, the write line (pin 2 of the SM-60) is driven with a positive pulse which sets and latches

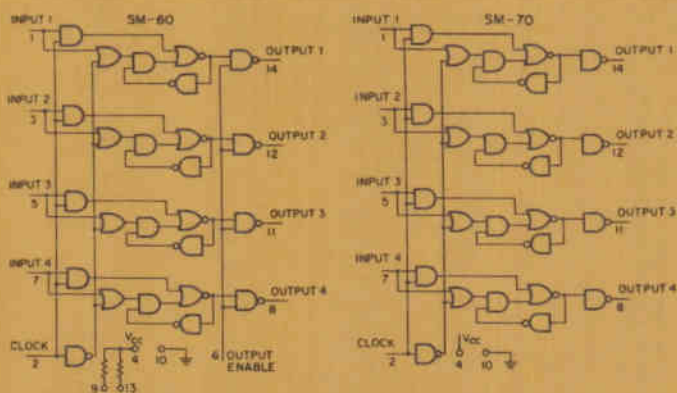

Fig. 1. Logic arrangement of SM-60 and SM-70 are similar except for output stage. The SM-70 reads out on clock pulse, while the SM-60 requires an "enable" pulse before giving an output.

Typical Performance Characteristics of SM-60, SM-70 Series

Output current	20 ma
Noise Immunity	±1 volt
Max. Frequency	20 MHz
Store "0"	25ns
Store "1"	20ns
Power Drain	30 mw/bit
Power Supply	5.0 volts
Logic Levels	"0" = 0.25 V, "1" = 3.3 V
Input loading	Data = 2.9 ma Clock = 4.4 ma Enable (SM-60) = 4.4 ma
Operating Temperature	-55°C to +125°C (SM-60, -61; SM-70, -71) 0°C to +75°C (SM-62, -63; SM-72, -73)

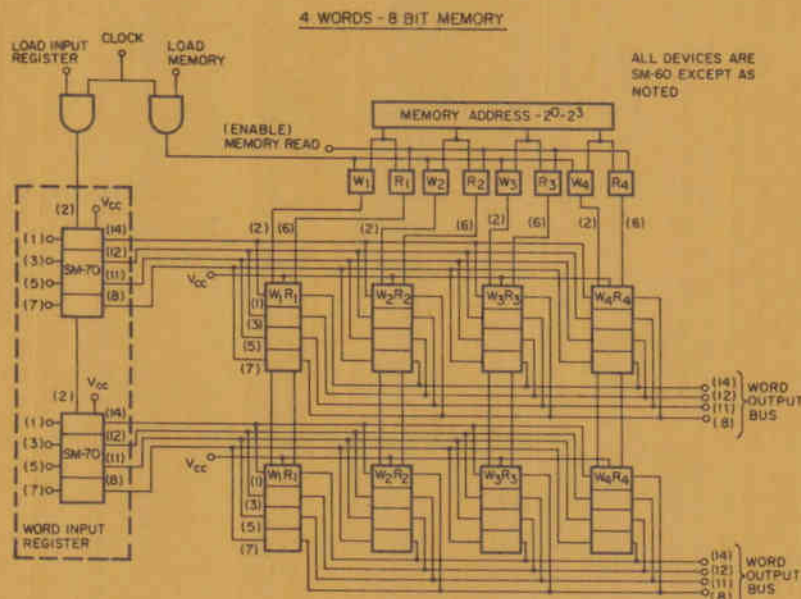

Fig. 2. Complete 4-word, 8-bit memory employs two SM-70s as the word input register and eight SM-60 four-bit storage registers as memory array.

the selected memory register. To read, a logical "1" is applied to the enable input (pin 6 of the SM-60). This transfers the contents of the selected memory elements onto the four word-output buses. The input register is loaded by ANDing a LOAD command and a CLOCK PULSE. Similarly, the memory is loaded by the ANDing of the LOAD MEMORY command and a CLOCK PULSE. The read and write amplifiers used will depend on the interfacing requirements of the logic used in the rest of the system.

The SM-60 and SM-70, like the rest of Sylvania's SUHL line, offer such advantages as a single 5-volt power supply, excellent noise immunity, high logic level swing and low power consumption. The SM-60 and SM-70 are both available in 14-lead dual in-line packages and TO-85 flat packs.

CIRCLE NUMBER 302

Fin-radiator cools off horizontal output tube for longer life, greater reliability.

The Sylvania-developed plate and fin structure in the new 6LR6 horizontal deflection amplifier provides high heat dissipation capability, with a plate-to-screen current ratio of 20 to 1.

Sylvania's new, patented 6LR6 represents a major design improvement in receiving tubes for horizontal-deflection-amplifier service in color TV sets.

It's a double-ended beam-power pentode, in a T12 envelope, with 12-pin base construction.

The tube's most significant feature is a newly-designed radiator fin assembly that dissipates heat uniformly to prevent "hot spots". This unique Sylvania design concept uses an increased thickness of high conductivity material to carry internal heat to integral radiators outside the anode structure. A total of 8 radiating surfaces dissipate the heat uniformly. As a result, the tube has superior cooling—distorted and buckled fins are a thing of the past and electrical characteristics remain stable over the longer life of the tube.

Effective ratio of peak plate current to peak screen current, $\frac{I_b}{I_{c2}}$, is about 20 to 1. When peak plate current is 700 mA, for example, peak screen-grid current is only about 32 mA, an excellent ratio.

Another significant feature of the 6LR6 is its combination of electrical and mechanical characteristics that aid in the suppression of Barkhausen oscillations. Cavitrap anode construction, a patented ripple-edge beam plate and the low knee voltage of the tube, all combine to provide snivet-free operation. If necessary, due to circuit design considerations, an even further safeguard against snivets can be obtained by applying a small positive voltage to the beam plate. The tube also has excellent low drive characteristics due to sharp cutoff under high pulse plate-voltage conditions.

It's really a color-set designer's dream at the present state of the art. Compared with existing tubes in the same service, it operates more reliably with better heat dissipation, lasts much longer, minimizes the chance of breakdown and premature failure, permits lower-cost associated circuitry, is more efficient and virtually eliminates internally generated Barkhausen oscillations. The tube's peak plate current capability also makes the 6LR6 a tube to be considered for low B+ voltage operation.

CIRCLE NUMBER 303

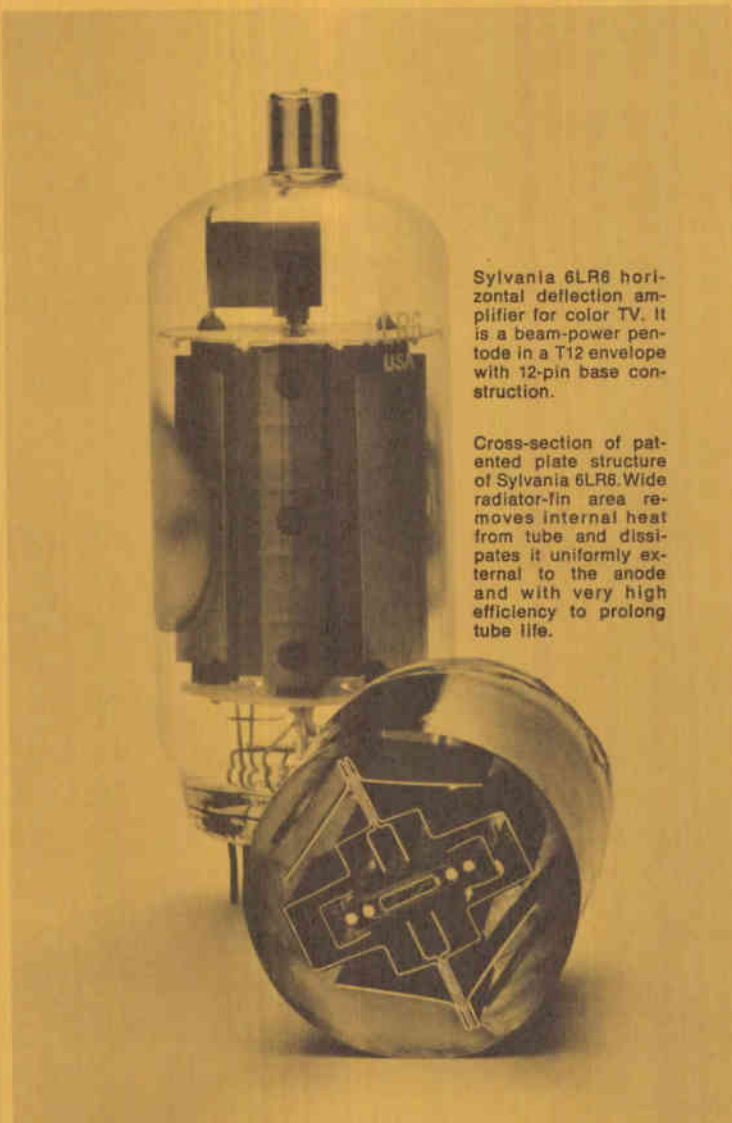

Sylvania 6LR6 horizontal deflection amplifier for color TV. It is a beam-power pentode in a T12 envelope with 12-pin base construction.

Cross-section of patented plate structure of Sylvania 6LR6. Wide radiator-fin area removes internal heat from tube and dissipates it uniformly external to the anode and with very high efficiency to prolong tube life.

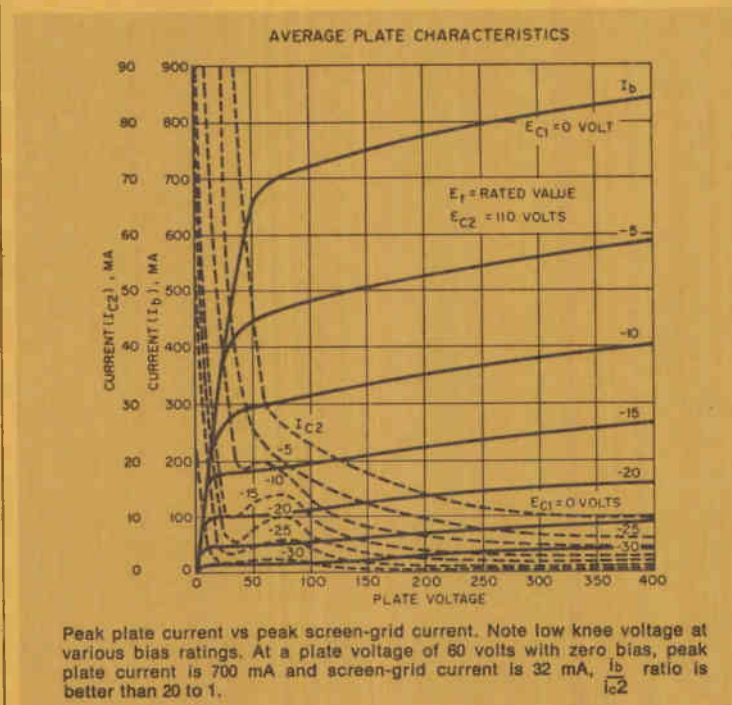

Progress and breakthroughs in readouts — are you missing something?

Dramatic breakthroughs always get attention. More often, developments every bit as important can accumulate over a period of time and tend to go unnoticed. The last major breakthrough in integrated-circuit technology, for example, was the planar process back in 1959. If we judge integrated-circuit technology in terms of breakthroughs, little has happened since then. Yet, since that time we have progressed from a point where it was difficult to make a simple gate function to a state of sophistication where hundreds of logic functions can be produced on a single chip. A similar sort of development pattern has happened in electroluminescent (EL) display devices, but many engineers are not aware of the changes that have taken place.

Sylvania has been aware of these changes because most of them have come from our own laboratories.

In pioneering electroluminescent developments, we recognized long ago that EL was potentially the ideal display device from the human engineering point of view. For example, the blue-green response of EL phosphors closely follows the response curve of the human eye. Also from a human engineering viewpoint, the flat single-surface presentation permits wide-angle viewing and eliminates the parallax problems associated with stacked-number display devices.

Because of this belief in the inherent advantages of EL, Sylvania has spent considerable time and energy in improving the original device. While few of these improvements could be classed as dramatic breakthroughs, nonetheless the EL device of today is quite different from the devices of only a few years ago.

Take brightness, for example. Five years ago, the nominal brightness of an EL display was about 12 foot-lamberts. Sylvania was aware of this limitation and went to work on it. Today, without a breakthrough, but through steady development of new materials and processes, brightness levels of 50 foot-lamberts are readily obtained.

In addition, development of techniques for contrast improvement has resulted in EL devices readable at ambient light levels as high as 3,000 foot-candles.

The development of hermetically sealed devices is another product improvement that Sylvania would hardly class as a dramatic breakthrough. But breakthrough or not, this development has made it possible to use EL displays in such stringent environments as outer space.

One development of the past few years that we feel might come under the heading of a breakthrough is the development of all-glass construction. This technique enables Sylvania engineers to decrease character size to as small as 1/4-inch and at the same time increase panel size. The all-glass construction gives us the ability to tackle new designs that were previously impractical. It can be used for small high-density displays that previously could not be hermetically sealed. In addition, it provides greater freedom in the application of legends and high-contrast layers.

As a final example of the progress that has been made in EL devices, consider the broad range of display devices now available. In addition to the well-known numeric and alpha-numeric displays, there are now bar-graph displays with resolutions of 50 lines per inch and random-access displays that can be used to provide both alpha-numeric and pictorial readouts.

In short, if you haven't looked at EL lately, you have been missing something. Sylvania engineers will be glad to bring you up to date.

A. J. Robinson
Engineer-in-charge
EL Department

This information in Sylvania Ideas is furnished without assuming any obligations.

SYLVANIA

A SUBSIDIARY OF
GENERAL TELEPHONE & ELECTRONICS

NEW CAPABILITIES IN: ELECTRONIC TUBES • SEMICONDUCTORS • MICROWAVE DEVICES • SPECIAL COMPONENTS • DISPLAY DEVICES

C6

NAME _____
TITLE _____
COMPANY _____
ADDRESS _____
CITY _____ STATE _____ ZIP _____

Circle Numbers Corresponding to Product Item

300 301 302 303 304 305

Please have a Sales Engineer call



HOT LINE INQUIRY SERVICE

Need information in a hurry? Clip the card and mail it. Be sure to fill in all information requested. We'll rush you full particulars on any item indicated.

You can also get information using the publication's card elsewhere in this issue. Use of the card shown here will simplify handling and save time.

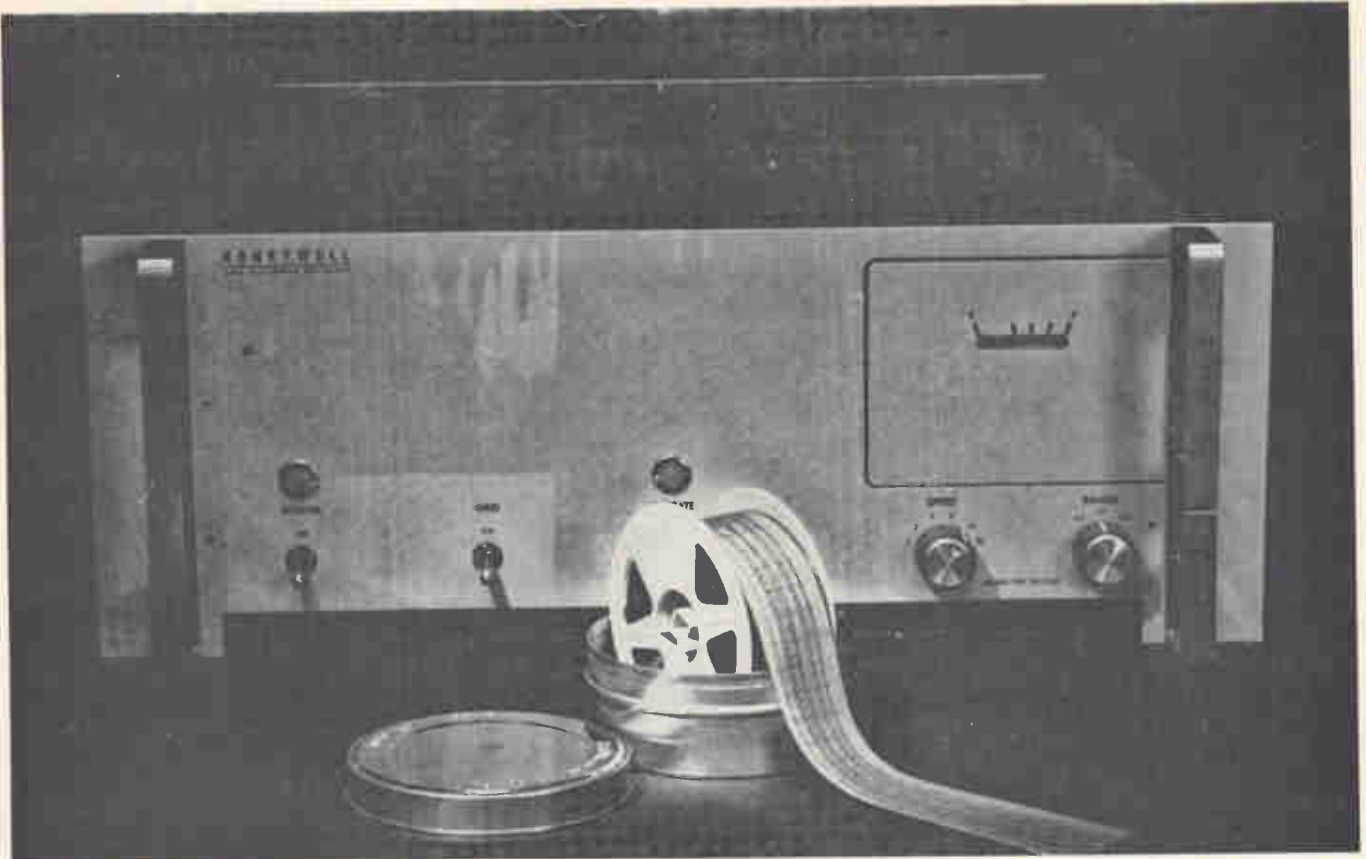

Easily installed, the new Microfilm Recorder Accessory makes high-quality archival records on inexpensive 35mm film.

Like to cut cost of oscillographic recording up to 95% with a simple microfilm attachment? Here's Honeywell's solution:



8 rolls (1500')
Standard recording paper
\$280.00



150' of film
(equivalent of 1500')
\$14.00

A rewarding investment, our new Model 2400 Microfilm Recorder Accessory lets you make permanent dynamic records at up to 1/20th of the cost of using direct-write paper. It will record data on film simultaneously with your Visicorder oscillograph's paper record, or can be operated so only a microfilm record is obtained.

You save money, and you save space because microfilm makes for convenient storage and easy access to data for analysis and reference. Viewing and reproduction can be handled by any of a large number of units currently available.

Better resolution, too! In addition to being economical, the Microfilm Accessory lets you record data at speeds not possible on direct-write oscillographs. When used with our Model 1508 Visicorder, for example, you could record data on the paper record at 120 ips, the instrument's fastest paper speed. At the same time, the Microfilm Accessory could record the identical data at an equivalent paper speed of 320 ips for greater resolution of the data.

For maximum recording versatility, you have three methods of recording when your Visicorder is equipped with the Microfilm Accessory: microfilm only, direct-write only, and combined microfilm and direct-write. Depending on the importance and/or dura-

tion of the data to be recorded, you can choose the proper method with a simple, three-position switch.

The Model 2400 is easily mounted above a rack-mounted Visicorder, and can be factory or field-installed. Film is contained in a plug-in magazine that can be removed and replaced in about 10 seconds; extra accessory magazines are available.

Fits these Famous Honeywell Visicorders:



Model 1612



Model 1912
(Shown with
Microfilm Accessory)



Model 1508

Available for immediate delivery, the Microfilm Recorder Accessory is another example of how Honeywell's broad line, backed by local sales and service, can provide the *precise* solution to your instrumentation problems. For full details, call Mr. Don Anderson (collect) at: (303) 771-4700, or write: Honeywell, Test Instruments Division, P.O. Box 5227
Denver, Colorado 80217.

Honeywell

Honeywell engineers sell solutions

Companies

Musical chairs

"Fairchild has an engine that needs tuning, and I think I know how to tune it," said C. Lester Hogan. And with that mild comment, he embarked upon one of the most significant moves in the semiconductor industry since eight young scientists founded Fairchild 11 years ago. Hogan's dramatic switch—from executive vice president and general manager of Motorola's Semiconductor Products division to president and chief executive officer of the Fairchild Camera & Instrument Corp.—is bound to have profound effects on both companies.

For Fairchild, it means that for the first time since the Semiconductor division began producing the greater part of corporate sales and profits, the entire company will be headed by a man well versed in the semiconductor business. Moreover, Hogan's strength in product engineering and manufacturing complements Fairchild Semiconductor's preoccupation with advanced technology.

For Motorola, which has probably never been in better shape, it means a period of uncertainty while waiting for the other shoe to drop, even though Hogan said he didn't intend to take any Motorola personnel with him. But Stephen L. Levy, named Hogan's successor after a brilliant four-year career at Motorola, realistically expects his former boss to do some recruiting in Phoenix after he finds out where Fairchild needs help.

Help on the way. Indeed, Levy said his first task would be to keep personnel losses at a minimum. How well he succeeds may determine how successful Hogan is in



Switches sides. C. Lester Hogan resigned as executive vice president and general manager of Motorola Semiconductor Products division to take over as president and chief officer of Fairchild Camera & Instrument. The naming of a semiconductor executive indicates that the Fairchild corporation is placing top priority on its semiconductor operations.

stopping a trend that he himself started: Motorola's gains in semiconductor sales at the expense of Fairchild. For although Hogan's departure doesn't exactly help Motorola, it doesn't leave it helpless, either. Levy has been running the division since last April, when he was named assistant general manager. And on Sept. 1 the division will get back some strength when John R. Welty returns to Motorola after a brief stint as general manager of Philco-Ford's Microelectronics division.

So the initial impact of the move is likely to be on Fairchild. The coming of Hogan formalizes the new supremacy of production over technology in the Semiconductor division and the importance of the division itself in the corporate structure. This importance will be

established even more solidly if—as expected—corporate headquarters are moved to Mountain View, Calif., (where the Semiconductor unit is situated) from Syosset, N.Y.

One top Motorola executive expressed it this way: "Fairchild, by the very nature of the way it was founded, seemed dedicated to technology for its own sake. This was not the flavor at Motorola; Les had the desire to maintain his technological position, but his main interests were product engineering and getting the product to the customer. We upgraded engineers working on products as opposed to engineers working in the lab; at Fairchild, it almost seemed that no engineer wanted to be in production."

Hogan came to Motorola 10 years ago from Harvard, where he was Gordon McKay professor of ap-

plied physics. An earthy, unprofessional type, he is generally credited with attracting the talent and directing the spectacular rise that put Motorola within reach of being No. 1 in semiconductor sales. Indeed, Levy says that by year's end Motorola will overtake Fairchild in integrated-circuit sales and will be tops in domestic semiconductor volume.

Juggling talent. In contrast to the Motorola rise, Fairchild Semiconductor has been hard-pressed for the past 18 months or so. It has been undercut by the departure of key executives and at the same time squeezed by the parent corporation's demands for profits to support other divisions. Efforts to stem the tide by juggling talent have resulted in an opéra-bouffe in which the corporation has had four presidents and gone through a six-week interregnum, with no president at all, since last fall. The climax was the resignation in June of group vice president Robert N. Noyce [Electronics, July 8, p. 52], who insiders thought was in the running for the top job.

Noyce and Gordon L. Moore, another Fairchild Semiconductor founder, are currently associated in a small semiconductor venture called the Intel Corp. Now far from the world of corporate finance, Noyce has joined in the semiconductor sport of raiding Fairchild; at least two of his former colleagues are joining him at Intel.

Even before Noyce's departure, board chairman Sherman N. Fairchild had been looking outside the corporation for a new president. At least two semiconductor executives reportedly got offers, and even a number of mergers were considered. Then, early in July, Walter Burke, a Fairchild financial adviser, got in touch with Hogan and made an offer.

The negotiations were the best-kept secret in the industry, although at some point Levy heard of them. Late in July, Fairchild suddenly became unreceptive to outside propositions, which may have been the tip-off that Hogan had accepted. At any rate, on Aug. 7, Hogan told Daniel E. Noble, Motorola vice chairman and chief technical offi-

cer, that he was leaving. The next day he offered his resignation to Robert W. Galvin, the chairman of the board.

Galvin, who had talked Hogan out of leaving to take the presidency of the General Instrument Corp. only last January, reacted swiftly and with anger: he accepted the resignation on the spot, named Levy to the job, and locked Hogan out of his office. "You don't expect them to kiss you," Hogan said later, without rancor. His personal belongings were delivered to his home, and Hogan took up duties at Fairchild the following Monday, Aug. 12.

Hogan's heroes. The reaction at Fairchild Semiconductor was almost delirious. Sales and marketing personnel, who were informed at the conclusion of a sales convention in Hawaii, dubbed themselves "Hogan's Heroes." "I couldn't be



Moves up. Stephen L. Levy succeeds Hogan as general manager of Motorola's semiconductor operations. Since April he worked as assistant general manager, reportedly to take some of the load off Hogan's back.

happier," said Jerry Sanders, marketing manager. "We already have the product planning, the technology, the R&D, the sales force, and the marketing strength. Now we have the balance of good manufacturing and top management direc-

tion, he added."

Sanders said he didn't believe that Hogan would change Fairchild's main marketing emphasis—on data processing sales—materially. But at Motorola, Hogan's basic strategy was to make a broad, inexpensive product line, and that kind of thinking is bound to affect Fairchild.

Head hunting? Hogan himself was reluctant to discuss change at Fairchild. "The company is equal to anyone in technology, and I'm not planning any shakeup," he said. "I want to find out what the problems are, and find ways to solve them." That innocuous statement may mean that the other shoe will indeed drop in Phoenix: the continued raids have left Fairchild weak in middle-management talent, so one of Hogan's first moves in his new job may be a head-hunting expedition.

As an outsider looking in, Hogan recently attributed some Fairchild misfortunes to its de-emphasis of conventional (discrete-device) product lines. Indeed, he pointed out that Motorola virtually "backed into" much of its present business in discretetes after these markets were abandoned by firms such as Fairchild. At the same time, he felt Fairchild was too hasty in setting up overseas operations before it had a chance to refine its process at home and get yields up to reasonable levels.

Levy's top team in Phoenix will consist of himself, operations director Leo Dwork, and Welty, whose new responsibilities haven't been defined yet, but who says he plans to go back to Motorola as scheduled. Those three were together years ago at Sylvania. Levy joined Motorola in 1964 as product marketing manager after eight years at Philco Microelectronics in Lansdale, Pa.; he became director of operations in 1966 and was named a vice president in July, 1967. When he was named Hogan's assistant last April, it was reportedly to take some of the work load off Hogan's back.

Levy says he has no plans to name a successor as assistant general manager.

The division faces its transition

period with big backlogs. It recently announced plans to add 175,000 square feet to its recently completed 300,000-square-foot plant in Mesa, Ariz. Hogan expects Motorola to continue to be successful; if it isn't, he says, "then I've been a lousy manager."

Electro-optics

Crystal clear

In 1965, when the Mariner spacecraft made close-up pictures of Mars, more than eight hours were required to transmit each picture back to earth. It transmitted a digital signal with a brute-force encoding scheme to transmit the low-power signals over the long distances.

Future missions may be able to transmit complex analog video signals over noisy channels back to earth almost in real time, if a technique being studied at the University of Illinois is perfected. Present deep-space missions can't use analog transmission because the received signal is too deeply buried in noise. W. J. Poppelbaum and Michael Faiman are developing a method that uses a paper-thin electro-optic crystal of a material such as potassium dihydrogen phosphate (KDP) with a transparent ground plane on one side.

Old stuff. An electron gun paints an image, in the form of a charge pattern, on the face of the crystal, which is enclosed in a vacuum chamber with windows at each end. The charge pattern produces an electric field across the crystal, between its face and the ground plane on the back; the field varies in accordance with the light and dark areas of the picture.

An electric field on the KDP crystal rotates the plane of polarized light shining on the crystal. With no field on the crystal and with an analyzer—a device whose transparency to polarized light depends on its orientation relative to the plane of polarization—behind the crystal at right angles to the

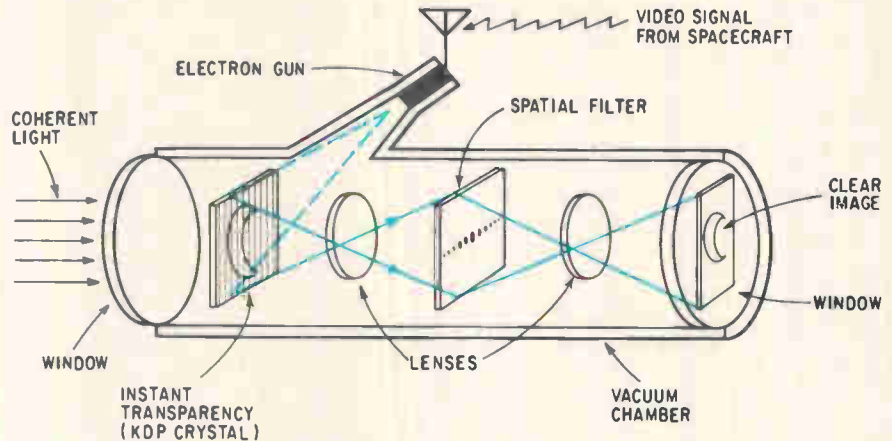

Optical filter. The signal (crescent) buried in the noise (vertical bars) is recovered by inserting a filter in the plane of the two-dimensional Fourier transform established by the first lens. The filter removes the noise transform; a second lens reconstructs the image from the signal transform.

plane of incident polarization, none of the light is able to get past the analyzer.

As the field on the KDP crystal increases, it rotates the plane of polarization more and more, so that more and more light gets through the analyzer. With a field on the KDP crystal corresponding to the video image, the analyzer recreates the image, forming what Poppelbaum and Faiman call an "instant transparency."

New stuff. This much of their idea is quite old. But they have added something new: a laser instead of an ordinary source of polarized light. With the coherent light, a lens system behind the KDP crystal in place of the analyzer produces a pattern that is mathematically described as a two-dimensional Fourier transform of the input video signal—corresponding to the variations of light and dark in the horizontal and vertical directions of the image. Another lens system behind that can reconstruct the image from the transform. Inserting a spatial filter in the transform plane can sort out any undesired parts of the image [Electronics, Sept. 6, 1965, p. 72], explains the developers.

The signal can be made up of alternate frames of picture-plus-noise and noise-only by closing the spacecraft camera shutter for alternate frames.

The spatial filter thus determines the frequency content of the noise

in both the x and y directions on the image; these frequencies can then be subtracted from the filtered picture-plus-noise in the next frame, and a cleaned-up picture reconstructed from the difference.

The new technique's main advantage in such an application would be its ability to form the Fourier transform of a two-dimensional video signal very quickly—as contrasted with some recent special-purpose Fourier-transform computers that work only with audio signals in one dimension [Electronics, April 15, p. 124; June 24, p. 92].

Better stuff. The Illinois investigators aren't now involved in spacecraft picture transmission. They're trying to improve the picture quality obtainable from the electro-optic crystal and to develop an adaptive spatial filter that can vary with time, following the variations in noise that usually occur in a channel.

Adaptive filters might be made from photochromic materials, which darken when exposed to light. The filter would require a material with a time constant of a small fraction of a second—about the frame repetition rate of the video signal. Present photochromic materials usually have time constants of seconds or minutes.

Or a color center filter, made from a material such as potassium bromide, might be used. These materials darken when exposed to

light of a particular wavelength, and bleach out under light of a different wavelength.

Or another electro-optic crystal might be used, together with a beam splitter and a vidicon tube. The vidicon would generate another image corresponding to the noise frequencies, and paint this on the second crystal, which would then filter out the undesired noise.

Poppelbaum and Faiman will discuss the technique this week at Wescon, along with some of their other experiments in unconventional electro-optic data processing.

Lasers

Done with mirrors

A Stanford University team headed by Stephen E. Harris demonstrated more than a year ago that a continuous-wave laser will generate a parametric fluorescence at two lower frequencies when passed through a nonlinear optical crystal [Electronics, Aug. 7, 1967, p. 44]. The two frequencies, one visible and one in the infrared range can be tuned by heating the lithium niobate crystal.

Now, by using all the power of a pumping laser and adding a system of lenses and mirrors, the Harris group has achieved c-w parametric oscillation that's po-

tentially tunable all the way from 5 microns to 0.6 micron—or from the middle infrared through the blue-green portion of the visible spectrum. The Stanford team isn't the first to demonstrate tunable parametric oscillation; that distinction belongs to a Bell Telephone Laboratories group [Electronics, April 15, p. 52]. But the Stanford team is the first to demonstrate such oscillation in the visible part of the spectrum. And the measured bandwidth of oscillation—line-widths—is on the order of one angstrom—10 times less than those previously reported—indicating that the technique has great potential for spectroscopic applications.

More power. The two frequencies generated in the LiNbO_3 crystal are known as the signal (visible) and idler (ir) frequencies, and their sum is equal to the pumping frequency. As the crystal is heated the signal wavelength decreases and the idler increases; the absolute limit is the wavelength of the pump, which explains why the generated visible frequency can be tuned only as far as the blue-green.

To achieve oscillation, Harris had to increase pumping power, which he did by finding a way to use all oscillating modes in the argon laser pump. The frequency of laser oscillation is given by the expression

$$F = \frac{nc}{2L}$$

where n is an integer, c is the speed of light in the cavity, and L is the length of the cavity; the laser will oscillate at every frequency corresponding to an integral number of half-wavelengths for which the gain from oscillation is greater than the losses from absorption, diffraction, and other factors in the cavity.

If the parametric oscillator cavity—the LiNbO_3 crystal—is short, only one of the laser modes will be used for pumping, and a great deal of the laser power will be wasted. Harris found that if the oscillator mirrors were arranged so that the $C/2L$ frequency of the idler modes were equal to the $C/2L$ frequency of the pumping laser, the comb of pump modes would interact with the comb of idler modes to drive a single signal mode. Thus the entire power of the laser is used, even though its modes of oscillation may be randomly phased and erratic in amplitude.

The present system delivers 1.5 milliwatts, c-w, over the entire tuning range. To allow for full use of the multimode pump, Harris had the oscillator constructed with a relatively long cavity; the crystal is 1.65 centimeters long. The barium sodium niobate, or "bananas," crystal used by Bell Labs is only 5 millimeters long. Harris says that the long crystal, operating at frequencies far from the "degenerate" state—where signal frequency equals idler frequency—contributed to the narrow oscillation bandwidths.

Why 'bananas'? The pump is a Spectra-Physics Corp. argon ion laser with a central frequency at 5,145 angstroms. Harris found that heating the crystal from 374° to 427°F tuned the signal frequency from 6,800 angstroms to 7,050 angstroms, with the idler in its corresponding range of from 2.11 microns to 1.90 microns. Harris has since reported tuning over a 400-angstrom range, and he says that complete tuning from the infrared through the visible depends only on constructing the proper broadband mirrors. The Bell group tuned over 800 angstroms but in the infrared range.

Even without such mirrors, he

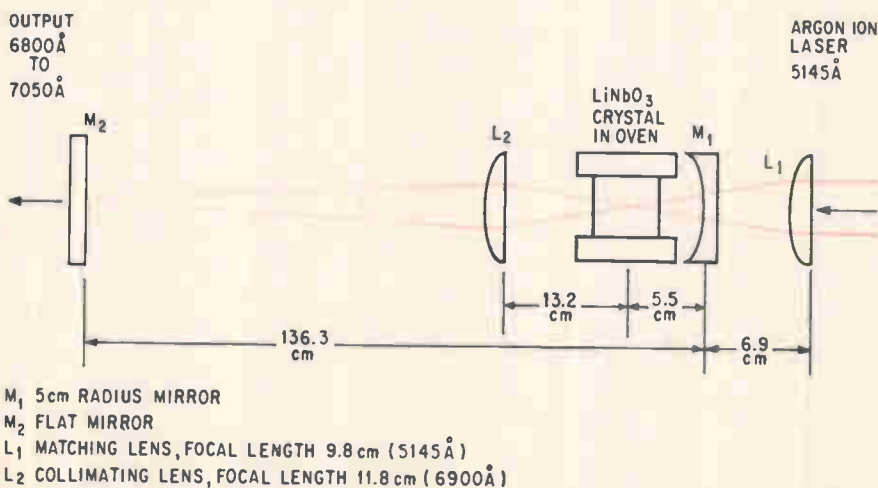

In sight. Stanford group has achieved continuous-wave parametric oscillation that's potentially tunable from the infrared to the blue-green.

"Ministac"™

A New High Voltage High Frequency SILICON RECTIFIER

"Ministac" is a fast-recovery, *silicon*, microminiature rectifier that can replace vacuum tubes and selenium sticks. Offering easier mounting and a smaller package, "Ministac" is competitively priced. Due to Semtech's high-volume production techniques, "Ministac" is being produced without sacrificing quality or reliability.

"Ministac" operates efficiently with all types of wave forms. Applications include:

- R. F. Power supplies
- Focus rectifiers
- High-voltage devices for —
 - CRT's
 - Image intensifier tubes
- Voltage multipliers for —
 - Data display systems
 - Multivision equipment
 - Television receivers

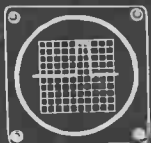

"Ministac" specifications:

Peak Inverse Voltage	3 kV to 7 kV
Average Rectified Current	10 mA
Leakage Current	100 nA
Junction Capacitance	1 pF max.
Recovery Time	100 ns

"Ministac" is small measuring only .400 x .120.



Enlargement of "Ministac" with solid internal construction using high temperature bond

"Ministac" junctions are metallurgically bonded at *high temperature* producing a high-strength multi-junction unitary stack. This process allows Semtech to use the Supratalaxial junction (liquid phase epitaxial) proven to be superior for high-voltage, fast-recovery devices.

For more information, contact Semtech or your nearest representative and get your copy of "Ministac — Design Freedom with New High Voltage-Low Current Rectifiers."

San Francisco — 941 E. Charleston, Suite 10, Palo Alto, California 94303
(415) 328-8025
Chicago — 140 N. La Grange Road, La Grange, Illinois 60525
(312) 352-3227 / TWX: 910-683-1896
Dallas — 402 Irving Bank Tower, Irving, Texas 75060 / (214) 253-7644
New York — 116-55 Queens Blvd., Forest Hills, New York 11375
(212) 263-3115 / TWX: 710-582-2959
Boston — P.O. Box 264, Woburn, Massachusetts 01801
(617) 935-5595
European Sales — Bourns A. G. Alpenstrasse 1, Zug, Switzerland
(042) 4 82 72/73



SEMTECH™
CORPORATION

652 Mitchell Road, Newbury Park, California 91320
(805) 498-2111, (213) 628-5392 / TWX: 910-336-1264

points out, narrowband mirrors could easily be made for any 300- or 400-angstrom segment of the spectrum.

Present equipment is materials-limited and very tricky to align; the Stanford group spent 18 months improving the crystal, and Harris says that a vital element in the success of the experiment was the unusually pure LiNbO_3 crystal grown by Robert S. Feigelson of the Stanford Center for Materials Research. The Bell Labs group turned to "bananas" when it was unable to obtain oscillation in lithium niobate.

Harris says that in four or five years, the parametric oscillation technique should have a strong impact on spectroscopy, where equipment is already complex and expensive. "There is always a use for a tunable light source," he notes.

Components

Light reading

During the last seven years Hewlett-Packard has designed experimental photoconductive arrays for in-house use in instruments whose input is visual binary signals and whose output is to a decimal indicating device, typically a Burroughs' Nixie tube. The technique is especially handy because it provides complete electrical and physical isolation between the instrument and the source being measured. Now H-P has decided to sell custom arrays to the industry. They can be designed to replace photodiode arrays, photomultiplier tubes and feeler potentiometer systems, the company says.

What's unique about the arrays is that they are produced on a single ceramic substrate, explains an applications engineer at Hewlett-Packard.

Adds applications engineer Rolf Murchison, "We've found no other company making multicell arrays on a single ceramic substrate." Clairex Electronics and Vactec both make discrete photoconductor

cells and tie them together on circuit boards, but, says Murchison, that doesn't provide the advantages of a single substrate or very high packing density. The industry, he continues, has stayed with packaged devices with resulting prices of 89 cents per cell, compared with H-P's projected price of 39 cents per cell. In addition, the cumbersome circuit boards can't approach the 200-cell density that H-P can group into each square inch of substrate. On H-P arrays, minimum cell size is 0.04 inch square; minimum conductor width and spacing is 0.015 inch.

Cluttered cells. H-P's photoconductor products group has developed two types of photoconductor arrays: parallel arrays, that operate much as parallel resistors with one common ground and one lead for each cell, will be designed for applications which require only a small number of cells. But as the substrate becomes cluttered with many cells, the problem of bringing a lead out from cells placed near

the center of the device becomes very difficult and the company has designed grid screen arrays which, so far, permit deposition of a 32-by-32 cell matrix on a 1.25-inch square substrate. On this particular device, each dot of photoconductive material is 25 mils square.

Parallel arrays, says Murchison, are good for functions that read simultaneously or continuously, but for complex logic patterns, screen grid arrays are most efficient. On a grid array, a signal entering any horizontal line can be made to emerge from any vertical line, depending on which junction is on; scanning the outputs is necessary to read these arrays.

The original use for which H-P designed the parallel arrays still remains the most important in H-P's marketing projections. A typical application, says Murchison, is conversion of a decade scaler's binary code into 10-line decimal code. Neon lamps, he explains, are turned on according to the 0 or 1 states of the binary circuits. The neon lamps

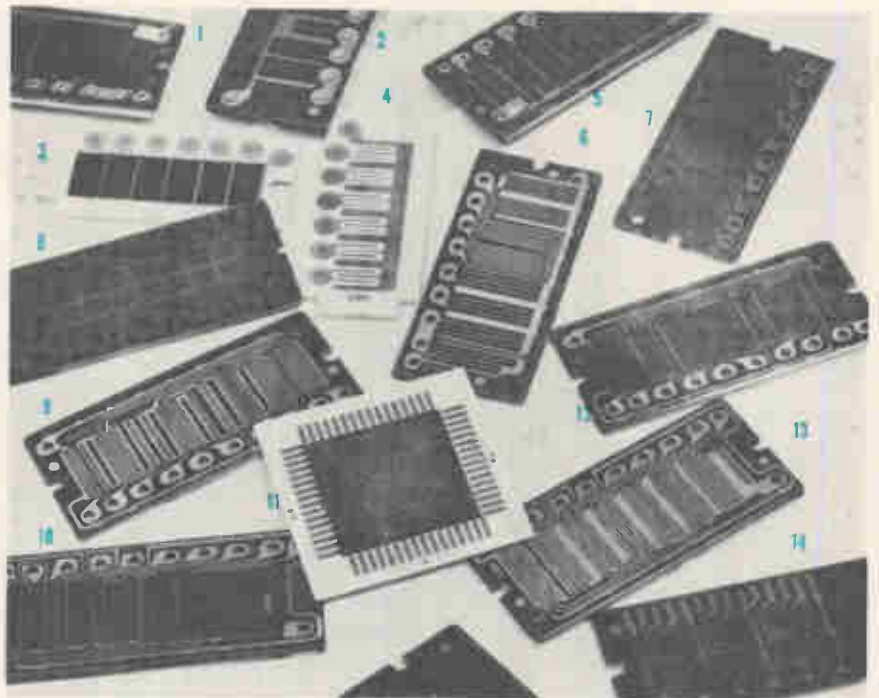

Array of arrays. Examples of photoconductive arrays produced by Hewlett-Packard on single substrates soon to be made available to industry on a custom basis: BCD decoder (1), with photoconductive film (7) (12) and without (6) (9); BCD 10-line decoder with photoconductive film (8), 32-by-32 cross grid array (11), and seven-element gold conductor with photoconductive film (10) and without (13); and special-purpose counting plate for autoranging and functional readout for H-P instruments (5).

Pulse Fidelity

This double-exposure photograph shows the same 12-ns-wide pulse displayed by the Tektronix Type 454 (upper trace) and by a 7-ns, 50-MHz oscilloscope (lower trace). Note the difference in detail of the pulse characteristics displayed by the Type 454 with its 2.4-ns risetime performance.

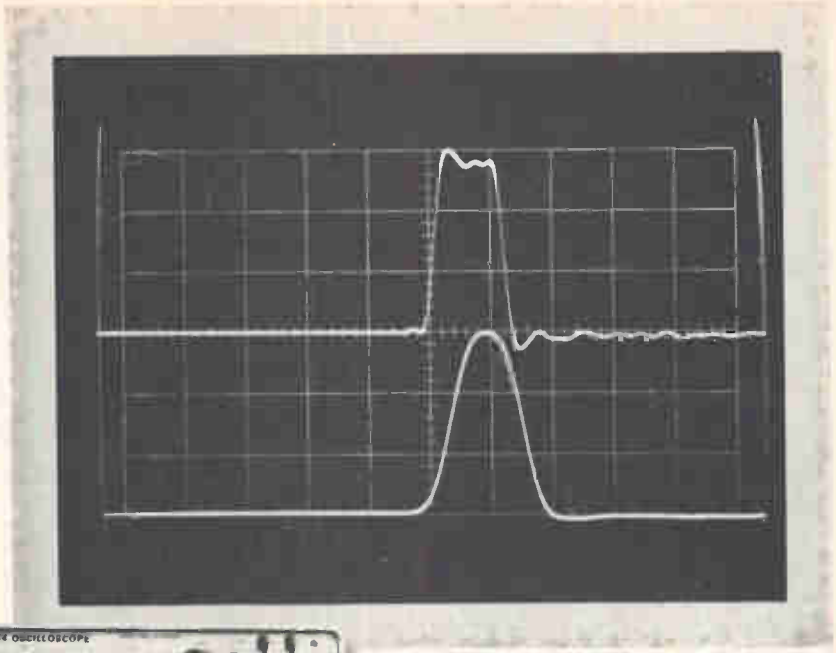

10 ns/div

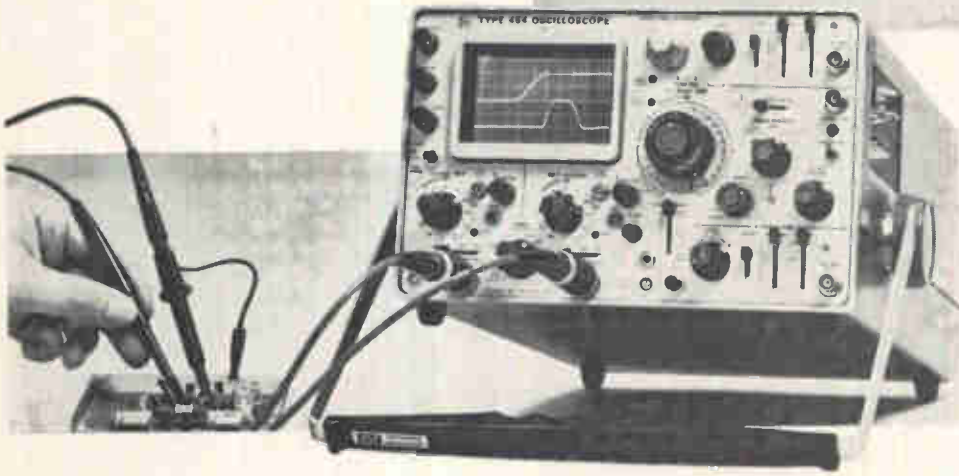

**150 MHz,
2.4 ns
with or
without
probes**

The Tektronix Type 454 is an advanced portable oscilloscope with DC-to-150 MHz bandwidth and 2.4-ns risetime performance where you use it—at the probe tip. It is designed to solve your measurement needs with a dual-trace vertical, high performance triggering, 5-ns/div delayed sweep and solid state design. You also can make 1 mV/div single-trace measurements and 5 mV/div X-Y measurements.

The vertical system provides the following dual-trace performance, either with or without the miniature P6047 10X Attenuator Probes:

Deflection Factor*	Risetime	Bandwidth
20 mV/div to 10V/div	2.4 ns	DC to 150 MHz
10 mV/div	3.5 ns	DC to 100 MHz
5 mV/div	5.9 ns	DC to 60 MHz

*Front panel reading. With P6047 deflection factor is 10X panel reading.

The Type 454 can trigger internally to above 150 MHz. Its calibrated sweep range is from 50 ns/div to 5 s/div, extending to 5 ns/div with the X10 magnifier on both the normal and delayed sweeps. The delayed sweep has a calibrated delay range from 1 μ s to 50 seconds.

Type 454 (complete with 2 P6047 and accessories).....	\$2600
Rackmount Type R454 (complete with 2 P6047 and accessories)	\$2685
Type 200-1 Scope-Mobile® Cart	\$ 75

U.S. Sales Prices FOB Beaverton, Oregon



*Coordinated research,
design and manufacturing*



*... part of the Tektronix commitment
to progress in the measurement sciences*

5 ns/div delayed sweep

The delayed sweep is used to measure individual pulses in digital pulse trains. The Type 454 with its 1 μ s-to-50 s calibrated delay time, 5-ns/div sweep speed and 2.4-ns risetime permits high resolution measurements to be made. Upper trace is 1 μ s/div; lower trace is 5 ns/div.



Double Exposure

X-Y

The upper display is a 150-MHz signal that is 50% modulated by a 2 kHz signal. The lower display is an X-Y trapezoidal modulation pattern showing the 150-MHz AM signal vertically (Y) and the 2 kHz modulation signal horizontally (X). Straight vertical line is the unmodulated carrier. Multiple exposure.

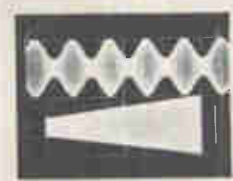

150 MHz AM

For a demonstration, contact your nearby Tektronix field engineer, or write: Tektronix, Inc., P. O. Box 500, Beaverton, Oregon 97005.

are grouped next to the photoconductive array so that a unique, low-resistance path through the array to one of the 10 output lines is determined by the combination of lamps lit by a particular count in the scaler.

Hewlett-Packard has been using these devices to derive control signals for driving digital display tubes in H-P counters making low-voltage measurements. Switching, coding, translating, reading, or position sensing are other applications that Murchison foresees for the arrays. Presently, two toy manufacturers, where stricter-than-military secrecy obtains, are evaluating arrays, as are several aerospace firms and an electric clock manufacturer.

Coated with glaze. Hewlett-Packard's custom arrays will rely heavily on thick films laid on a 90% alumina substrate which the company can supply in various sizes, for example, 1 by 1, 2 by 2, and ½ by 3 inches.

The manufacturing process starts with the substrate, over which a dark blue glaze is laid to make the substrate opaque to red neon light and, consequently, to eliminate cross-talk between the gold conductor patterns laid down on the glaze with a silk-screen technique. Cadmium sulphoselenide, the photoconductive material, is then laid on the gold pattern and coated with a protective varnish.

The photoconductive material, explains Murchison, has a very high resistivity in nonilluminated conditions, typically 10^{13} ohms. However, when exposed to illumination from a neon source, the material's resistivity can drop as low as 10^6 ohms, permitting current to flow through the gold conductor pattern to the output. The photoconductive material is roughly 50% cadmium sulfide and 50% cadmium selenide. The 50/50 mixture provides the best properties of each component.

Cadmium sulfide, explains Murchison, is stable with respect to aging and environmental conditions, but has a very slow response time to light. Cadmium selenide, on the other hand, has a very quick response time, but is very sensitive to temperature variations and is subject to age degradation. Cad-

mium sulfide peaks at 5,100 angstroms and pure cadmium selenide peaks at 7,200 angstroms; the combination of the two, says Murchison, matches the spectral output of small neon lamps with which the devices will be most often used. For specific functions, the array may be specified for peak spectral response in a range of 6,500 angstroms to 7,100 angstroms.

No moving parts. For switching applications, Murchison says, the photoconductor array is especially impressive because it has no moving parts and the delay time between changes in resistance is relatively slow. The photoconductor material can change from its "on" state to less than 1% conductivity in less than 4 milliseconds; from "off" state, the material reaches 90% conductivity in less than 2.5 milliseconds. The dynamic change is smooth, almost analog, says Murchison and results in very low noise. By varying the light intensity, he adds, it is possible to sweep the device's resistance. For other, more complex, applications photoconductive arrays can be made to produce a sine wave output or any other function that can be drawn in two planes by variable sweeping of the light sources over a simple or complex conductor pattern.

The photoconductor products department will be one of three in Hewlett-Packard Associates. Says Murchison, "The market is very difficult to assess because nobody out there really knows how many applications will be realized."

Manufacturing

Substrate windows

Hybrid circuit designers don't like packaged integrated circuits because they take up too much real estate. Face-down bonding of IC chips is much better, but the method still can't be depended on and the results can't be inspected. And though beam-lead IC's hold out the most promise, designers find them hard to come by.

With these problems in mind, a new technique developed at the MIT Lincoln Laboratory, Bedford, Mass., should stir a lot of interest. Realizing not only that beam-lead IC's take up little real estate, and can be electrically more reliable than wire or face-down bonds, but also that beam-lead IC's were almost impossible to buy, two scientists decided to use monolithic IC chips and supply the beam leads themselves on the substrate.

Naturally, Robert E. McMahon and Ronald A. Cohen call their idea "the beam-lead substrate." And they have already constructed such hybrids, using glass, silicon, or ceramic substrates.

Fenestrated. To build a hybrid using a ceramic substrate, McMahon and Cohen cut IC-sized windows in the material and fill them with an easy-to-etch material. Then they add a metalization layer and etch this to create interconnection patterns.

The holes in the ceramic are

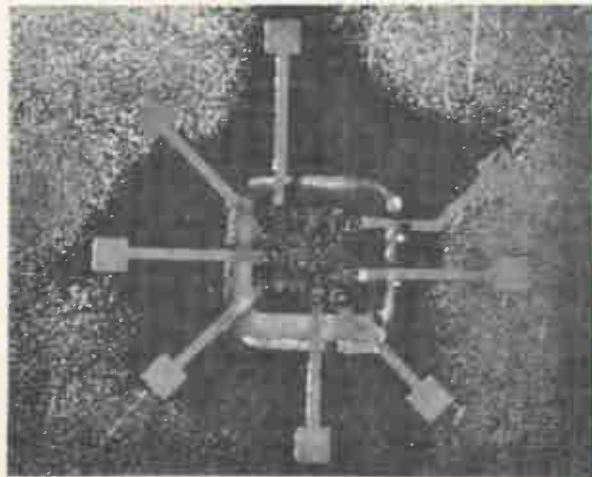

Model one, number one. An ordinary resistor-transistor-logic integrated circuit is bonded to a substrate using ribbon-like beam leads. The IC was slipped into the cavity in the substrate from the back.



Two bits says you've never seen a 1.5 amp bridge this small with

- 75 nanosecond recovery
- 25 amp surge rating
- PIV's to 600V
- Controlled avalanche
- Wired or board mounted
- Made entirely with individually fused-in-glass diodes
- Reasonably priced

Now that you *have* seen it, don't you want to know more? First of all, you can get our data sheet, just packed with all kinds of specs and charts too detailed to put in this ad. Just circle the reply card now.

Second . . . if you send us your circuit requirements, we'll see to it you get the right sample for the job.

And . . . if it's fast action you want, why not call Fred Swymer collect at (617) 926-0404.

580 Pleasant St., Watertown, Mass. 02172, (617) 926-0404

UNITRODE



STANDARD RECOVERY

PIV to 600V
Rating 1.5A
Surge 25A

FAST RECOVERY (500 nsec)

PIV to 600V
Rating 1.0A
Surge 20A

ULTRA-FAST RECOVERY (75 nsec)

PIV to 200V
Rating 1.0A
Surge 20A

HERE'S WHAT IT LOOKS LIKE INSIDE

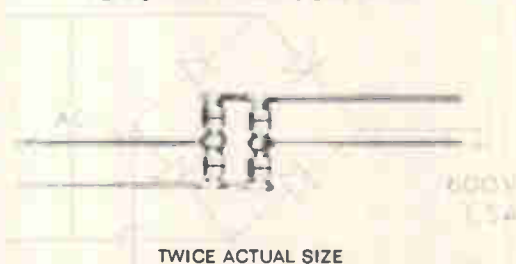

TWICE ACTUAL SIZE

AND HERE'S WHAT IT LOOKS LIKE INSIDE THE INSIDE



With the silicon die metallurgically bonded between terminal pins of the same thermal coefficient, the hard glass sleeve is fused to the entire outer silicon surface. Result — a voidless, monolithic structure.

TERMINAL PINS METALLURGICALLY BONDED DIRECTLY TO SILICON

See Us at WESCON — Hollywood Park

etched out also, and the IC's placed in them so that their bonding pads line up with the ribbon-like beam leads, which now overhang the windows. A slightly modified ball bonder is then used for electrical connections.

The game's nearly the same with a silicon substrate. An oxide layer is first grown over the substrate to underlie the metalization pattern. After the interconnections are etched on the top of the slice, the windows for the IC's are etched into the silicon from the back.

McMahon, assistant group leader of the component design and development group, points out that the technique not only uses easy-to-get monolithic IC's but also offers better heat sinking than most other hybrid approaches. The bottom of the monolithic chip, which is about the same thickness as the substrate, can be placed right on a heat-sink layer.

Thus, rather than having to dissipate its heat through electrical con-

tacts, as with face-down bonding, or through a layer of substrate material, as with beam-leaded or wire-bonded IC's, heat can flow straight through the chip, perhaps to a copper sheet backing up the whole hybrid assembly.

Glassivated. Also, McMahon says, with the beam-lead substrate it might become possible to eliminate the sort of bulky packaging now used for hybrids.

McMahon suggests glassivating the entire hybrid to make maximum use of space and volume in electronic systems. This could mean more function per package, and the glassivated package would be more efficiently filled with circuitry.

Even if glassivation proves difficult, McMahon thinks other semi-rigid coating materials—perhaps plastics—would give enough protection to the substrate and leads. Such a hybrid would be nearly flat on top and bottom, without IC chips or flatpacks to pop off.

So far, McMahon's group has

worked with arrays of resistor-transistor and transistor-transistor logic circuits, and it's pleased with the results. What bugs remain in the technique are of the production and cost variety and don't mean added research. Even now, the production-line personnel of most IC houses could probably deal with the system, and the cost of drilling or etching out holes could be reclaimed in money saved through automated bonding—or in not buying beam-lead IC's.

Consumer electronics

Recipes for IC's

American technology, having automated just about everything, now seems set on making things more automatic. As evidence of this trend, a newly developed line of food blenders eliminates even push

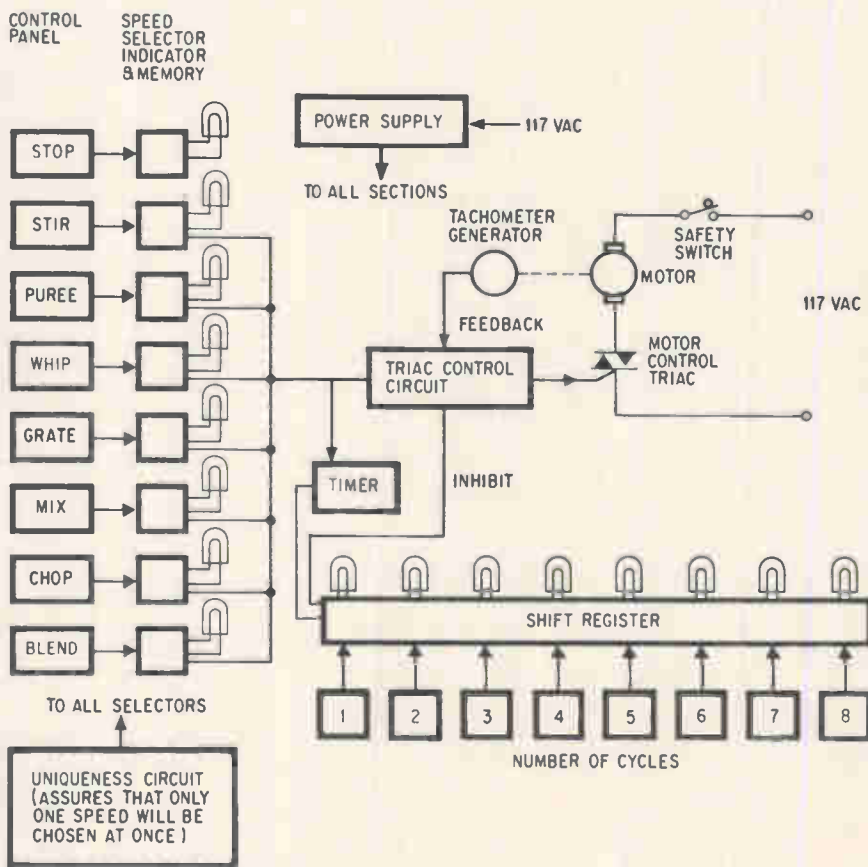

Kitchen aid. Food blender, designed with Motorola integrated circuits, will soon be made available by John Oster Manufacturing. The design eliminates push buttons and switches. Speed selection is made by touching insulated capacitance plates.

hp 3420B:

THE MOST ACCURATE DC VOLTMETER IN THE WORLD!

With the hp 3420B DC Differential Voltmeter/Ratiometer you get accuracy of 22 ppm, one-hour stability of <1 ppm, and resolution of 0.2 ppm — a combination of performance features that gives you the most accurate portable dc voltmeter in the world!

The 3420B is designed for convenient, logical and quick operation. In addition to pushbutton selectors, you get a rapid zero adjustment—without shorting the circuit under test, without disconnecting the input. Press the ZERO button and it

automatically opens the input and internally shorts the 3420B for precise zero adjustment. The 3420B operates from ac line power, or internal rechargeable batteries for those measurements where you want complete isolation from power line ground.

Circuit loading error is essentially eliminated with the $>10^{11}\Omega$ at null input resistance on the 1 V and 10 V ranges.



HEWLETT *hp* PACKARD

ANALOG VOLTMETERS

The 3420B gives you the convenience of four ratio ranges — the widest ratio range available on a dc differential voltmeter! Use the ratiometer for dc/dc voltage ratio measurements, resistive divider ratio measurements and dc voltage measurements normalized to engineering units.

Find out about the world's most accurate dc voltmeter. Check your Hewlett-Packard Instrumentation Catalog. Or, call your nearest hp field engineer or write to Hewlett-Packard, Palo Alto, California 94304. In Europe: 54 Route des Acacias, Geneva. Price: hp 3420B, \$1300; hp 3420A (ac line operation only), \$1175.

098/16

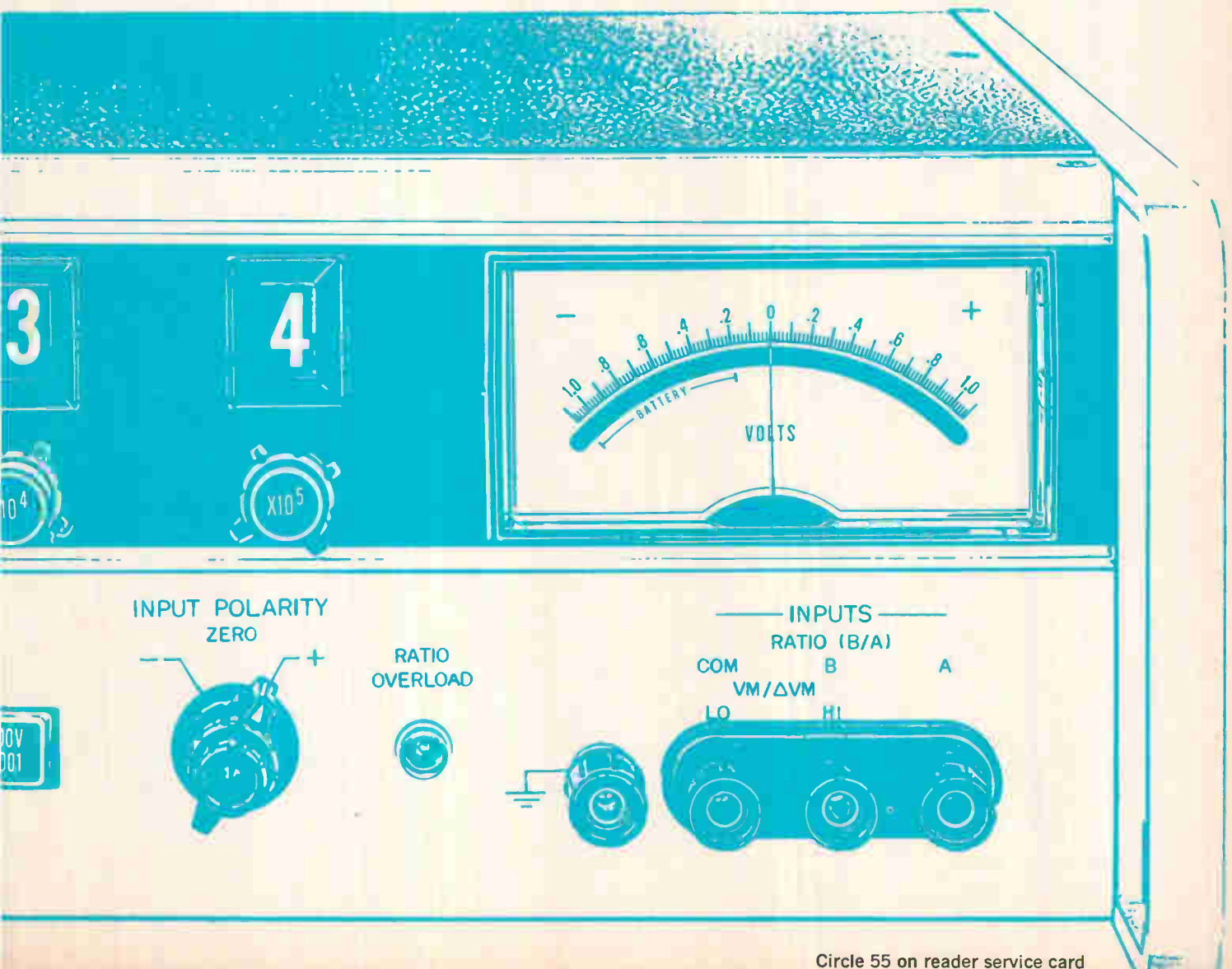

Circle 55 on reader service card



New Victoreen MOX Resistors

Now values to 2500 megohms in a compact package only 1/4 OD x 5" long

Now — by specifying new Victoreen metal oxide glaze resistors — you can buy resistance by the inch.

Based on our standard 1/4" OD size, Victoreen Series MOX resistors, per inch of lineal length, give up to 7.5 kv ratings . . . 500 megohms resistance . . . 2.5 watts power dissipation. Tolerances are $\pm 2\%$ or $\pm 5\%$ right across the board up to the 5" size . . . $\pm 1\%$ and $\pm 0.5\%$ in some sizes. Stability is exceptional, too — less than 1% full-load drift in 2000 hours . . . shelf life drift less than 0.1% per year.

Victoreen MOX Resistors are available right now in sizes and ratings that make them near-perfect — for HV probes with DVMs, meter multipliers, HV plate load resistors and similar circuits. And still more new sizes and ratings are on the way, too.

A-1962

VICTOREEN INSTRUMENT DIVISION
10101 WOODLAND AVENUE • CLEVELAND, OHIO 44104
IN EUROPE: GROVE HOUSE, LONDON RO., ISLEWORTH, MIDDLESEX, ENGLAND



Electronics Review

buttons, long the symbol of effortless living. Seeking new applications and markets for integrated circuits, Motorola's Semiconductor Products division has teamed with the John Oster Manufacturing Co. of Milwaukee to develop prototypes of food blenders using IC's.

The two prototypes—the "Cyclotron" and the "Humatic"—use low-cost, plastic-packaged high-threshold-logic (HTL) IC's developed by Motorola's applications engineering department. Three series of devices are used—the MC 662, 664, and 669.

The monolithic circuits are similar to the company's line of diode-transistor-logic devices and were chosen for their relative immunity to electrical noise. Toward this end, zener diodes are used in the IC's because of their high threshold level—about 5 volts.

Seven speeds. The IC's form a shift register that controls the blender's cycle functions. The Cyclotron has seven speeds that can be run continuously or automatically cycled on or off—one to eight times—for performing intermittent blending that redistributes the food in the blades for chopping, grating, or grinding.

For the record

Out of the dark. Itek Corp. will build a high-resolution stabilized night sight for use in helicopters, tanks, and ground weapons under a \$2.5 million Army contract. For direct viewing, the sight has a narrow bandwidth, pulsed laser for ranging and target illumination. It also has image motion stabilization.

Contract. The Sperry Gyroscope division of Sperry Rand is conducting a design study of an experimental phased array radar for the White Sands Missile Range. It is part of a program to develop a phased array tracking system that will provide an active or passive monostatic radar for acquiring and tracking multiple airborne high-performance targets.

Now get IC Op Amp power...

with high gain and high voltage

RCA has these two monolithic OP AMP units for you—ready to meet your design requirements for high input impedance, high gain and high power output. Only the price isn't high! Ask your RCA Distributor for his price and delivery. Write RCA Electronic Components, Commercial Engineering Section, ICN8-2 Harrison, New Jersey 07029 for Data Sheet.

All characteristics below are typical

Power output (8% THD)
Output swing voltage (P-P)
Input impedance
Open-loop Gain
Input Offset Voltage
Input Offset Current
Input Bias Current
Noise Figure
Slew Rate

RCA-CA3033
for $\pm 12V$ Supply

122 mW
21V
1.5 M Ω
90 dB
2.6 mV
5 nA
83 nA
—
1.2V/us

RCA-CA3033A
for $\pm 18V$ Supply

255 mW
32V
1 M Ω
96 dB
2.9 mV
9 nA
103 nA
16 dB
2.5V/us

\$3.95 (1000 units)

\$4.95 (1000 units)

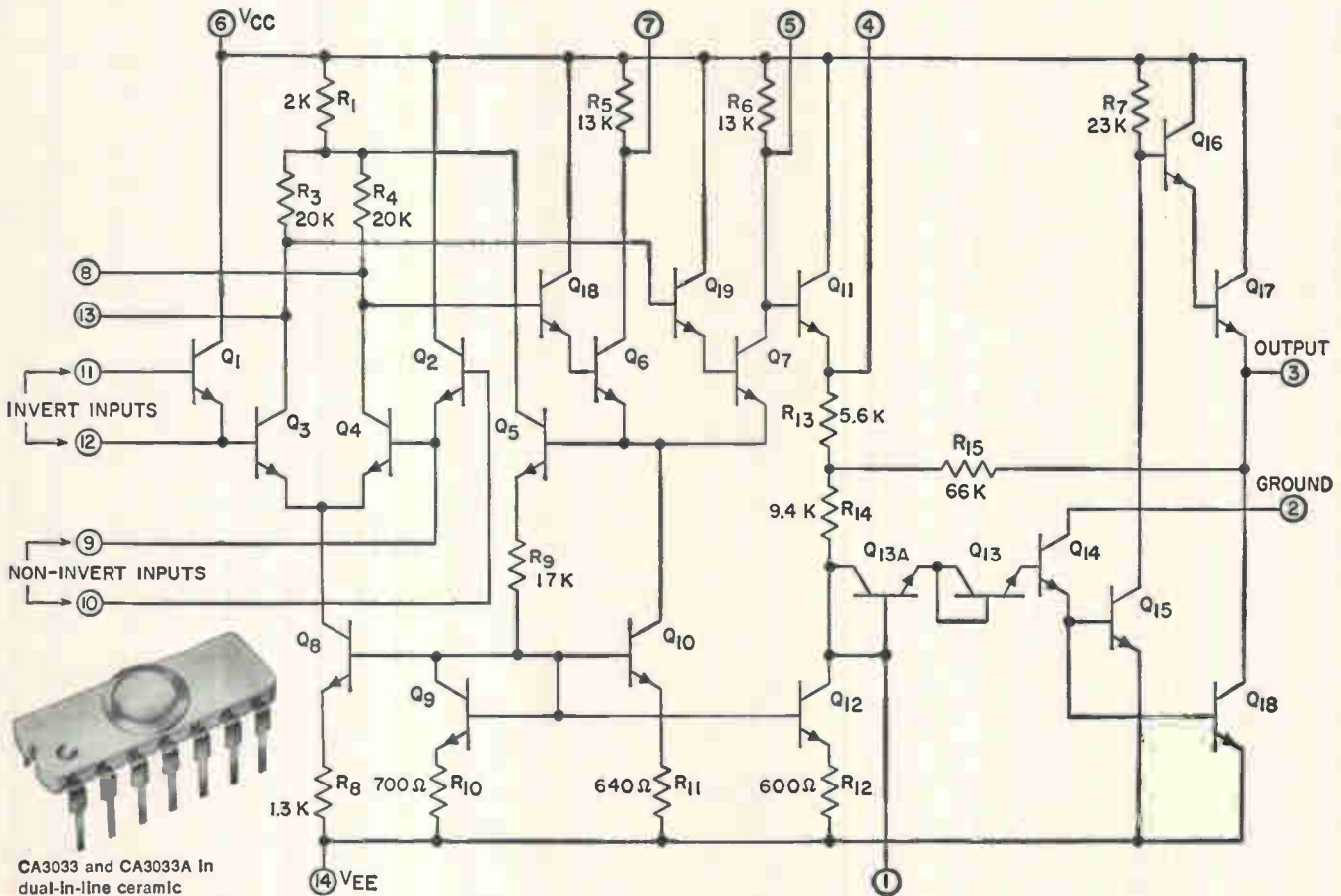

CA3033 and CA3033A In dual-in-line ceramic package (-55° to $+125^{\circ}C$ operating temperatures)

CA3033 now available in dual-in-line plastic as CA3047 at \$1.95 (1000 units)

RCA Integrated Circuits

Skillful substrate handling improves microstrip circuit performance for PACT program

Very early in Sperry's PACT (Progress in Advanced Component Technology) Program, scientists and engineers involved in the effort concluded that materials selection and fabrication for substrates would be critical to their success. As a result, much of the early PACT work concentrated on substrate technology. Today's operating microstrip devices attest to the success of that endeavor.

Considerable work has been done with various dielectric and ferrimagnetic materials, as well as with substrates combining both materials. Much of the PACT activity has been concentrated in the development and utilization of ferrimagnetic substrates.

PACT has benefited significantly from Sperry's extensive in-house production capability for ferrimagnetic materials. The availability of 400 different ferrite and 500 different garnet compositions freed development engineers from dependence on commercially available ferrites and enabled them to use optimum material characteristics rather than working inside restrictions imposed by the material.

As reported earlier (Progress Report #2) PACT personnel proved that a thicker substrate contributed materially to lower insertion losses. This led to the adoption of 55 mils as the PACT standard for ferrite substrates instead of the more familiar 25 mil configuration.

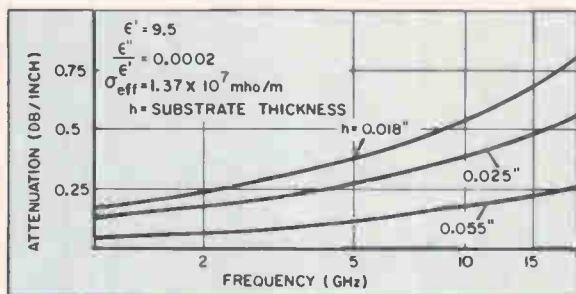

ATTENUATION VS FREQUENCY
FOR 50 OHM MICROSTRIP LINE
ON VARIOUS SUBSTRATE THICKNESSES

Similar progress has been made in the understanding and control of substrate microstructure, surface finishing, ground plane spacing, strip width, conductor dimensional tolerances and impedance matching for minimum losses in microstrip transmission lines.

In the area of ferrimagnetic substrate fabrication, PACT has explored two methods: dry pressing substrates to size and a highly automated wafering technique. In the latter process, acceptable surface finishes have been achieved with minimum labor, materials waste has been minimized, and excellent process controls have been developed.

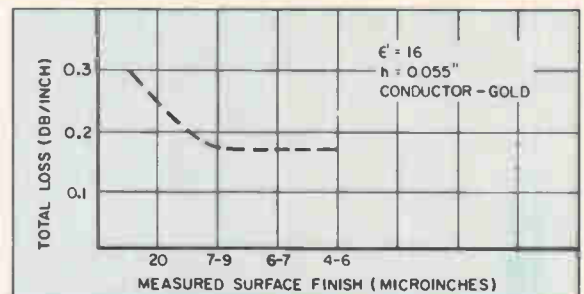

TOTAL LOSS — VS — SURFACE FINISH OF SUBSTRATE

In summary, Sperry efforts have been directed at placing substrates in their proper perspective. The objective is to let circuit requirements dictate substrate characteristics rather than letting substrate limitations force circuit compromises. These efforts included close attention to manufacturability, and they have resulted in products which offer the best practical combination of performance, availability and cost.

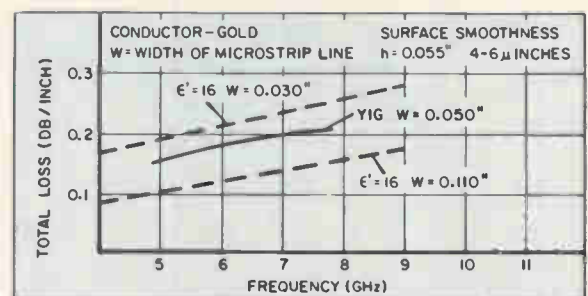

TOTAL LOSS — VS — FREQUENCY
FOR VARIOUS STRIP WIDTHS

If you would like more information about PACT progress in substrate technology and about microwave integrated circuits that use it, contact your Cain & Co. representative or write Sperry Microwave Electronics Division, Sperry Rand Corporation, Clearwater, Florida.

*For faster microwave progress,
make a PACT with people
who know microwaves.*

Washington Newsletter

August 19, 1968

**FAA lacks funds
for electronic
voice switching . . .**

The FAA is trying to determine if it can scrape together enough money to get started this year with the electronic voice switching portion of the semiautomatic National Airspace System. The agency has enough money to continue installing the NAS at the current pace, but it hasn't a cent of the \$75 million needed for the voice switching system. With part of its fiscal 1969 funds frozen, the FAA still doesn't know how much money it will get this year.

Inability of the FAA to start the switching system this year could mean an expensive retrofit later. The system is vital to NAS because present electromechanical switches aren't fast enough for NAS computers. The computers will control voice communications between aircraft and en route control centers.

By juggling operating funds, the FAA might be able to begin leasing equipment with an option to buy. Firms competing to build the equipment most likely would be Sylvania, Collins Radio, and North Electric. Delivery would start 12 to 18 months after the contract was signed. The FAA could also lease electronic switching from local telephone companies as a service, but the Bell System has been reluctant to do this.

**. . . so airspace plan
may lag even more**

The National Airspace System, already six months behind schedule, could slip back even more in the confusion over the electronic voice switching system. Two radars installed at Jacksonville, Fla., are now due to go into partial operation toward the end of this year, but without their common digitizers, which convert radar inputs into digital data. Chicago is the next en route center scheduled to go operational—sometime in 1970. NAS is currently slated for completion by 1973.

**Systems group
ready for action**

It was touch and go several times during the past few months but now the eight-company consortium being organized to apply systems analysis to major urban problems is in business to stay. "The problems of getting this thing in motion have been tremendous, but now we're going ahead," says one insider. The group—headed by Schriever Associates [Electronics, Feb. 5, p. 59]—calls itself Urban Systems Associates Inc. Within the next week or two it will name a president, settle on a corporate framework, and decide on financing.

Two projects being discussed with local government planners: a San Francisco urban renewal program, and a regional development project for water resources for Arizona. One of the difficulties that plagued the organizational efforts of the consortium, which includes five electronics and aerospace companies, was lack of experience in dealing with urban and regional development problems, in determining markets, and in making the distinction between technological and sociological problems.

**NASA plan foresees
further budget cuts**

The space agency, catching most of its project managers and other middle managers by surprise, has come up with an "interim operating plan," the first in its 10-year history. The plan is based on NASA's belief that it will be allowed to spend only \$3.85 billion during the current fiscal year. One official explains that it's "based on the reality of what NASA faces. It's

Washington Newsletter

far better for the agency to engineer the cuts now, than let Congress or the Bureau of the Budget do it later."

The austere budget contrasts with the \$4.37 billion originally requested by the White House and the \$4.03 billion that Congress agreed to but has not yet passed.

While it will take a while for the impact of the plan to be determined in detail, NASA has already sketched its effect on major projects. For one thing, it will mean the dropping of nearly 4,000 agency and contractor employees. Money budgeted for the Apollo Applications program will be reduced from the requested \$439 million to \$140 million. As a result, post-Apollo lunar exploration and an earth-orbiting Saturn 5 workshop will be kept alive only as studies.

New plans made for data bank

The Administration is trying to breathe new life into the national data bank, a program generally thought to be a dead issue because of the storm of Congressional criticism it generated. The data bank is back in the plans of the Bureau of the Budget, so there'll undoubtedly be a new round of squabbling between Congress and the Administration. The bureau, with the privacy issue in mind, is now drawing up specific new proposals to present to Congress.

Congress will continue to watch closely any efforts to move ahead with the bank, and will insist on such safeguards as giving individuals the right of access to their records. Opponents are now citing a recent General Accounting Office report stating that the Air Force's computerized personnel management system has an unacceptable error rate—5%.

Patent pact appears on way to adoption in rewritten form

A new treaty that would set up a worldwide patent system appears well on the way to adoption. The accord has been rewritten to skirt the biggest stumbling block to U.S. ratification, the question of whether the criterion for the granting of a patent should be "first to file" or "first to invent." The compromise proposal permits each nation to set its own criterion; each patent office would accept all other countries' patent searches.

The working draft of the pact required all signatories to go the first-to-file route; when proposed by the Administration last year, it ran into a wall of opposition from U. S. business interests and Congress [Electronics, June 12, 1967, p. 48]. And Sen. John McClellan (D., Ark.) recently introduced a compromise bill that would retain this nation's first-to-invent criterion. The measure will be taken up by Congress next year.

Ratification of the international treaty is expected by the early 1970's.

Addenda

Sen. William Proxmire (D., Wis.), increasingly agitated over what he calls "excessive profits and mismanagement" in defense procurement, will begin this fall a comprehensive investigation of Pentagon buying by his economy-in-Government subcommittee. . . . IBM's Federal Systems division is negotiating a contract for the programming of the Sentinel antiballistic missile system; the award will be announced shortly. . . . There's no telling how far it will go, but legislation to stiffen FCC licensing procedures and perhaps even to revamp the commission is on Congressional drawing boards. The House Commerce committee, irate over what it calls ineptitude in the handling of routine paper work, may suggest legal machinery to give Congress more authority over the FCC.

0-20Vdc @ 1000A

0-150Vdc @ 70A

0-150Vdc @ 35A

0-300Vdc @ 35A

0-300Vdc @ 18A

0-600Vdc @ 18A

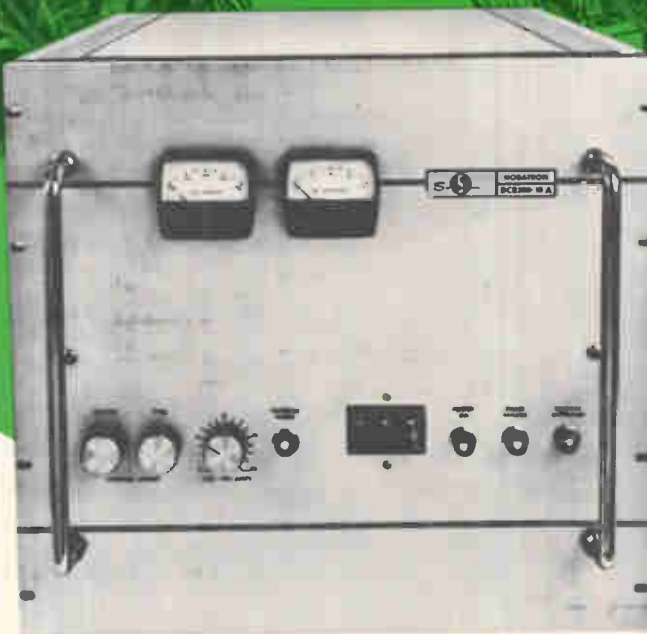

New Sorensen High Power DCR's:

The addition of 6 new models now brings the total number of Sorensen regulated, high power, high efficiency DCR's to 34—the widest product line from the industry's leader in both DC and AC power supply technology and production.

The DCR Series covers the voltage ranges of 0-20/0-40/0-60/0-80/0-150/0-300/0-600/ and even up to 6000 Vdc at power levels of 400, 800, 1500, 2400, 5000, 10,000 and 20,000 watts. And—Sorensen's 25 years experience in design and manufacture makes it possible to offer these power supplies from stock at prices as low as 19¢/watt.

The DCR Series offers all of the standard features found in state-of-the-art power supplies including Voltage/Current Regulation,

Low Ripple, Remote Programming, Remote Sensing, Operating Temperatures to 71°C and compliance with MIL-I-26600 and MIL-I-6181D.

FREE! An illustrated data package containing detailed electrical and mechanical specifications for each DCR power supply and a new CATALOG featuring 176 different Sorensen regulated DC and AC power supplies.

Contact your local Sorensen representative or Raytheon Company, Sorensen Operation, Richards Avenue, Norwalk, Connecticut 06856. TWX 710-468-2940

RAYTHEON

for more data on this versatile instrument . . . **Call Sorensen: 203-838-6571**

NEW hp 85 dB Wave Analyzer... with autoranging for faster wave analysis

Autoranging—With automatic amplitude ranging and human engineered controls, the new hp 3590A Wave Analyzer practically analyzes waveforms from 20 Hz to 620 kHz by itself! Once the input attenuator is adjusted, autoranging steps through the entire 85 dB dynamic range over 3 μ V to 30 V full scale.

Four Bandwidths—Pick a 10 Hz, 100 Hz, 1 kHz or 3.1 kHz bandwidth when you want to separate closely-spaced signal components, characterize noise or analyze a frequency spectrum. Flat passbands with steep skirts are provided by active filtering. Shape factor is 3.5:1 at the -60 dB and -3 dB bandwidth rejection points.

> 85 dB Dynamic Range—This dynamic range and electronic sweeping make the 3590A Wave Analyzer ideal for making permanent linear or logarithmic spectrum recordings. You can make Bode plots of a system down to a noise level of 0.3 μ V.

Spectrum Analysis—Spectrum recordings are easy to make. Simply connect a recorder, select one of the five sweep rates, tune to the starting frequency and start the sweep. The 3590A does the rest!

With autoranging and adjustable electronic sweeping, you get a complete, accurate picture of what the amplitude and frequency really are—you are not limited by the quasi-stationary effect of high Q devices because the sweep time can be as long as 10 minutes.

The 3590A mainframe is \$3200. The 3591A mainframe (\$3350) has selectable input impedances of 75, 135, 150 and 600 Ω . Three plug-ins are available: 3592A low cost slave and program unit when used in

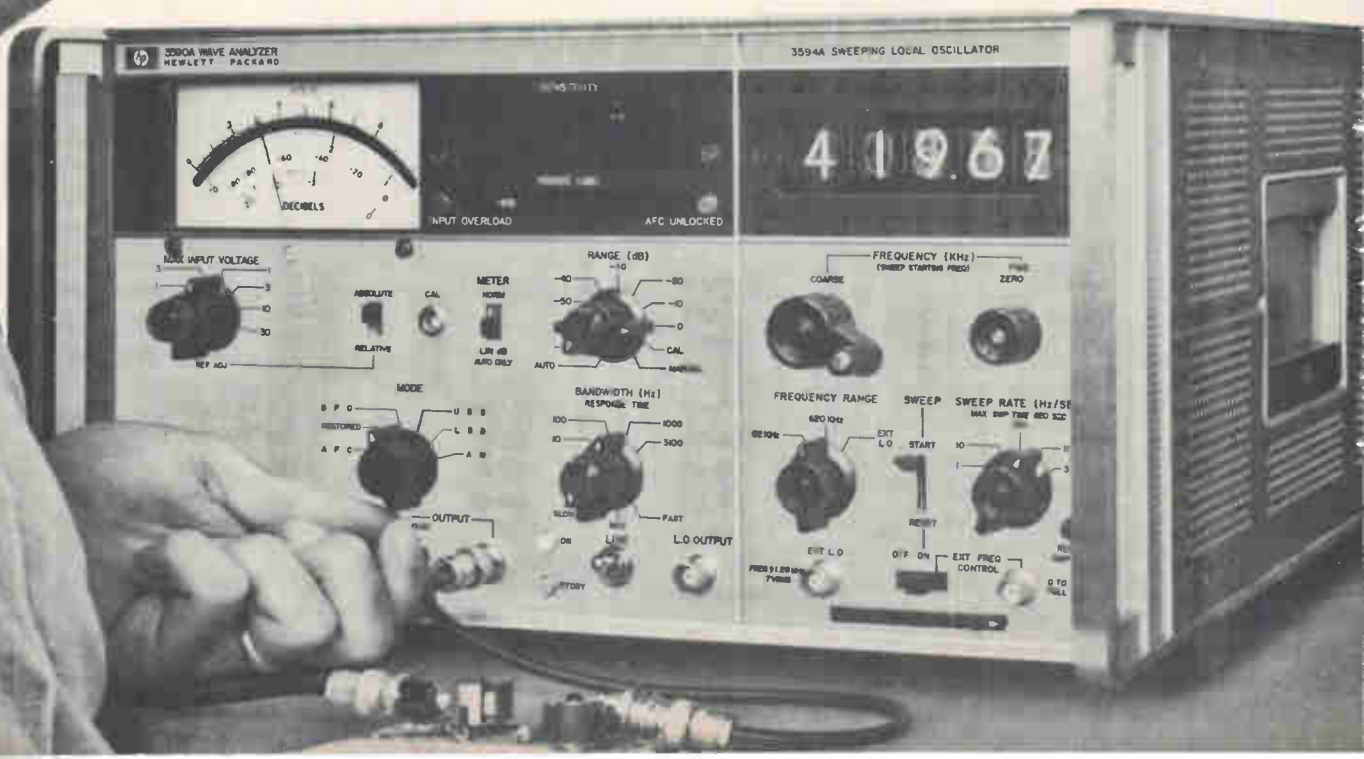

.....electronic sweeping for spectrum analysis

second 3590A, \$80; 3593A with 3-digit mechanical display, \$1100; 3594A with 5-digit electronic counter frequency display, \$1600. Use hp X-Y recorders 7004A or 7005A (11" x 17") or, 7030A or 7035A (8½" x 11") with either mainframe.

Get full information on the new hp 3590A Wave Analyzer from your hp field engineer. Or, write to Hewlett-Packard, Palo Alto, California 94304. Europe: 54 Route des Acacias, Geneva.

HEWLETT **hp** PACKARD

SIGNAL ANALYZERS

098/7

Bode Plot—30 kHz low pass elliptic filter response was recorded automatically while being stimulated by the BFO output. Linear dB and logarithmic frequency recorder outputs, 1 kHz BW, 1 kHz/sec sweep rate were used.

Harmonic Distortion—Plot of hp 204C Oscillator, (60 dB distortion specification) using 1 kHz BW, with a kHz/sec sweep rate.

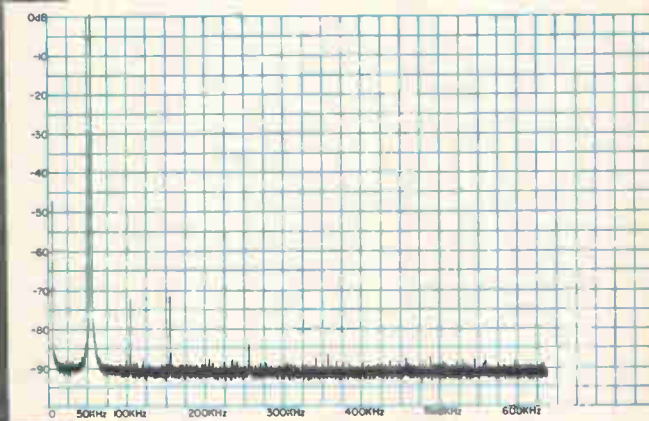
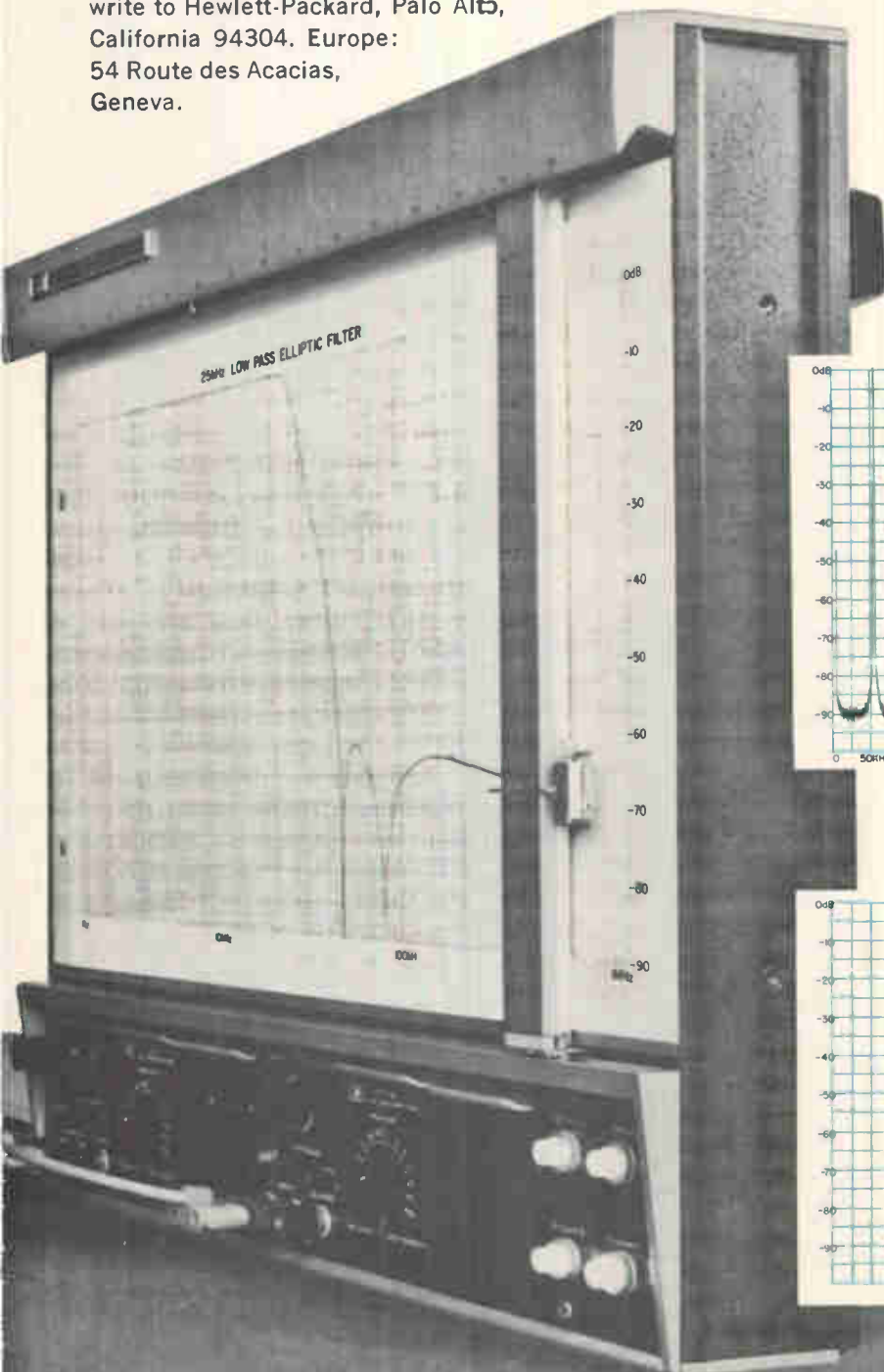

Signal with Line Frequency Related Sidebands—1 kHz signal with line-related spurious FM-ing of fundamental using 10 Hz BW, 1 Hz/sec sweep rate.

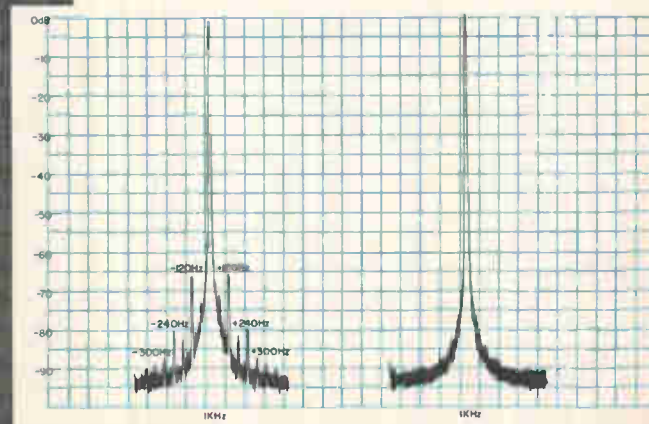

DESIGN IN JUST ONE OF THESE SILICON POWER TRANSISTORS, AND PAY AN AVERAGE 25% LESS FOR IT...

SWITCHES

Type	Polarity	I_C (Cont)-A	V_{CE0} (Sus)-V	New Price†	% Reduction
2N3719 2N3720	PNP	3	40 60	\$ 6.50 7.25	18% 21%
2N1724 2N1725				NPN	5

SWITCH/AMPLIFIER

2N3021 2N3022 2N3023 2N3024 2N3025 2N3026	PNP	3	30, 45 & 60	14.50 20.00 30.00 20.00 29.00 33.00	34% 33% 33% 33% 27% 34%									
2N3445 2N3446 2N3447 2N3448				NPN	7.5	60 & 80	6.00 9.00 9.60 12.00	25% 25% 26% 38%						
2N3789 2N3790 2N3791 2N3792							PNP	10	60 & 80	5.00 5.95 5.85 6.35	16% 16% 17% 15%			
2N3055										NPN	15	60	1.45	26%

†100-up

THE MORE YOU USE, THE MORE YOU'LL SAVE.

And we've made it as attractive as possible for you to do so — prices on all of these tried and true devices have just been reduced as much as 38% (2N3448, from \$19.50 to \$12) including the ever-popular 2N3055 which now lists at only \$1.25, 1,000-up!

Practically translated, you can now design highly-reliable, equipment-proven Motorola silicon power units into more industrial/military switching, series pass regulator, servo amplifier, hammer driver, CRT display, converter, inverter, series and shunt regulator driver and output stage designs (where you may have been using germanium) for less cost than ever.

But price reductions alone aren't the best reasons for specifying Motorola silicon power — you benefit from advantages like Annular* construction which minimizes leakage and increases reliability . . . completely specified and guaranteed parameters including safe operating areas . . . NPN and PNP capability . . . and a variety of voltages and packages to meet your power dissipation requirements.

Want the how-to-design-it, technical story on these price-reduced, quality silicon power transistors? Write Box 20912, Phoenix, Arizona 85036 for complete, return-mail data sheets on any or all of them.

The more we send, the more you'll use.

*Annular semiconductors patented by Motorola Inc.

-where the priceless ingredient is care!



MOTOROLA
Semiconductor Products Inc.

This time try EECOSWITCH®...



...on your front panel

Why settle for second best on your equipment when at no extra cost you can have EECOSWITCH.

With EECOSWITCH you get:

- 7 complete lines with dozens of coded outputs to choose from.
- Off-the-shelf delivery of standard models.
- Interchangeability with other makes of rotary thumbwheel switches without panel alterations.
- Answers for your application problems generated by EECO's 20 years of switch and digital system experience.
- Sample assemblies for new design prototypes.
- EECO's exclusive 2-year warranty.

The EECOSWITCH catalog describes our complete line and includes 15 pages of useful application data. Send for your copy today.



There's an EECOSWITCH
for almost any application



COMPONENTS DIVISION

ELECTRONIC ENGINEERING COMPANY OF CALIFORNIA

1441 EAST CHESTNUT AVENUE · SANTA ANA, CALIFORNIA 92701 · (714) 547-5651

"See the EECOSWITCH in Action at EECO WESCON Booths 1526-1529, Sports Arena."



**Needles are
for knitting—
right?
Right.**

**...and Digits are for
measuring—right?**

Ri-i-ight!

...using a moving-needle meter with:
• parallax errors! • range selection errors!
• interpolation errors • an unprotected
movement that burns out on wrong polar-
ity or high voltage!

Or are you using an NLS **X-3A**
Digital Multimeter with:

- 0.1% accuracy
- Fully protected on all ranges
- Floating input
- Automatic polarity indicator
- Overload indicator
- 2000 digits per range
- 0.05% resolution
- Unique HI-MED-LO range selector
- Scaled analog output (drives strip chart recorder)
- Wide measurement capability
- Measures:
- DC Volts—10 μ V to 1 KV in 6 ranges (to 30 KV with optional HV probe)
- AC Volts—0.5V to 300V in 3 ranges
- Ohms—10 m Ω to 2000 Meg Ω in 9 ranges
- Current—10 pico amps to 200 mA in 8 ranges (to 2 amps with optional shunt)

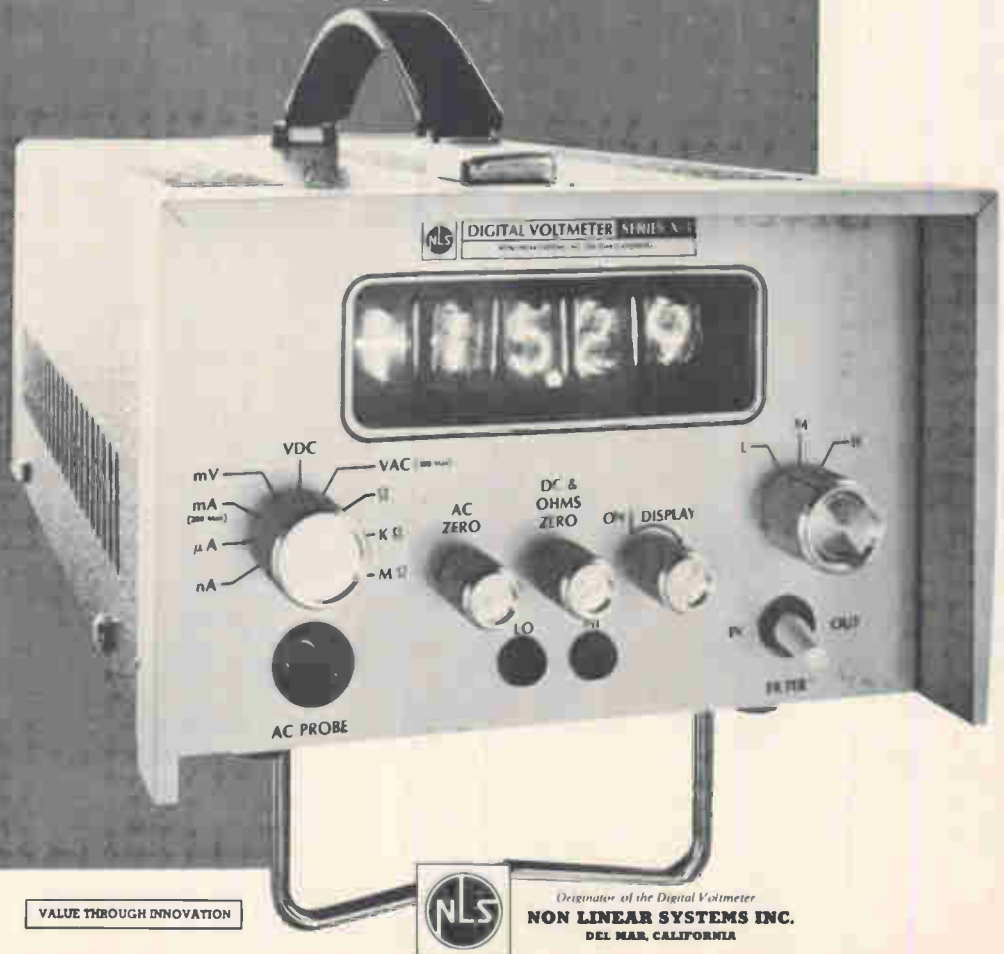

VALUE THROUGH INNOVATION



Originator of the Digital Voltmeter
NON LINEAR SYSTEMS INC.
DEL MAR, CALIFORNIA

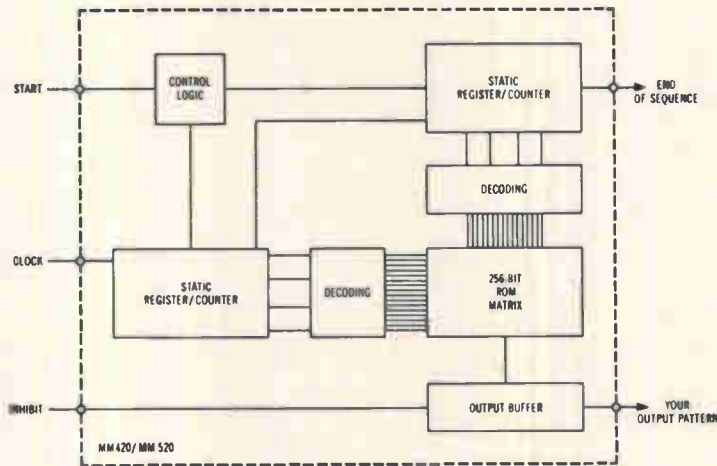

For a paltry \$38* each
 you can get a complete
 read-only memory
 system on a chip
 (made to your specs
 and delivered 4
 weeks from next Tues.)

*Buy a hundred of the MM520 commercial version at \$38 each.
 Or, better yet, buy more.

National Semiconductor

National Semiconductor, 2975 San Ysidro Way, Santa Clara, California 95051. (408) 245-4320.

Now playing at WESCON: the Astro/348 story.



Catch the full story on MIL-C-81511 Astro/348® at the Amphenol WESCON exhibit.

A working model shows how Amphenol's design simply and effectively meets subminiature, environmental requirements. And the Amphenol MIL-C-81511 family is growing. Additional contact sizes

and insert arrangements are now on the way. A complete display including accessories will be a part of the WESCON display.

We're also showing cable assemblies and connectors built by our Space and Missile Systems. See them at the Amphenol WESCON display.



AMPHENOL CONNECTOR DIVISION
THE BUNKER-RAMO CORPORATION

Specify Amphenol electronic components . . . produced in Canada, England, France, Japan, Mexico, United States, West Germany.

National Driver Test.

You pass with highest marks by ordering any or all of our new drivers. A request for further information gets a C— and a complete set of driver education pamphlets specially prepared for those who are power crazy.

Who's my local distributor

Have Salesman call

Send further info.

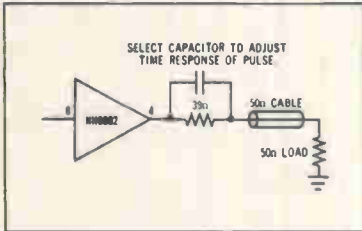

1. NH0002 current amplifier:

High input impedance; output $\pm 10V$ and $\pm 100mA$ continuous or $\pm 400mA$ pulsed. \$20.00 in 100 lots (\$11.60 for the industrial NH0002C).

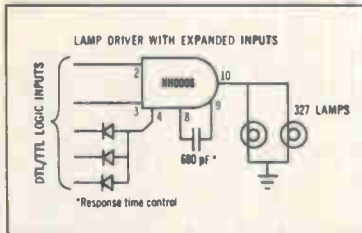

2. NH0006 relay/lamp driver:

Drives up to 300mA at 28V; inrush currents controllable. \$23.20 in 100 lots (\$12.00 for the industrial NH0006C).

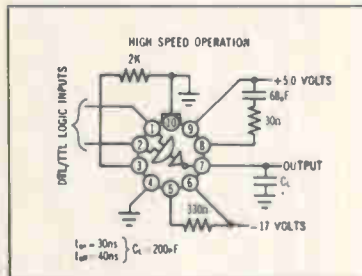

3. NH0007 MOS clock driver:

$\pm 500mA$ output compatible with all MOS devices; 5MHz top speed. \$24.00 in 100 lots (\$16.00 for the industrial NH0007C).

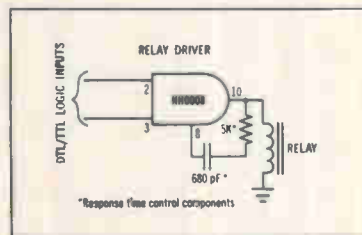

4. NH0008 high current driver:

Output 600mA steady-state or 3A pulsed: like the NH0006 only more so. \$36.00 in 100 lots (\$18.00 for the industrial NH0008C).

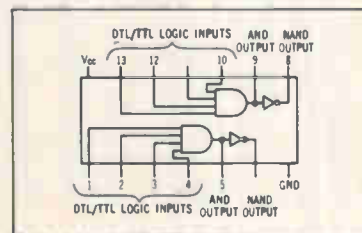

5. DM7830 differential line driver:

High speed pair for driving transmission lines; eliminates ground loop errors and ringing. \$16.00 in 100 lots (\$8.00 for the industrial DM8830).

National Semiconductor

2975 San Ysidro Way, Santa Clara, California 95051. (408) 245-4320.

What's behind the new cartridge type lighting bugs?

Bright ideas.

Like the new Tri-A-Lite that offers three colored feedback indications, all contained in one indicator light. The white translucent cap becomes illuminated red, green or amber when voltage is applied to the appropriate lamp circuit.

Then there's the Hide-A-Lite indicator that is white in the "off" position and colored

when energized. Perfect for use as warning lights or on system control panels where signal and indicator speed are critical.

Just circle the reader service number for complete information on these new indicator lites, or better yet, see us in Booth #125 at Wescon, Hollywood Park. You can win a new Volkswagen just by guessing the correct number of

miniature lamps and indicator lites in our Lighting Bug contest jar.

Chicago Miniature has also developed a new high brightness numeric readout that weighs only 1.5 grams and requires only 1/2" mounting space. It will be on display at Wescon.

You can count on it.

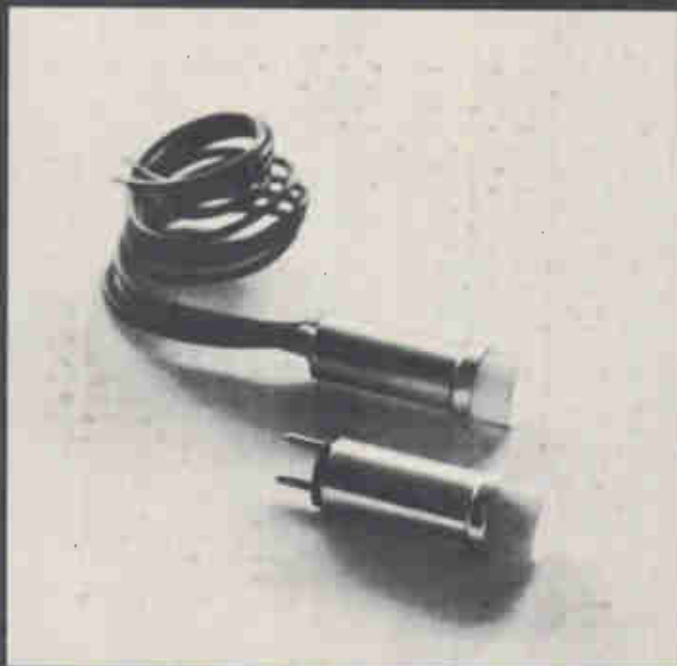

Chicago Miniature Lamp Works

4433 N. Ravenswood Ave., Chicago, Illinois 60640, (312) 784-1020



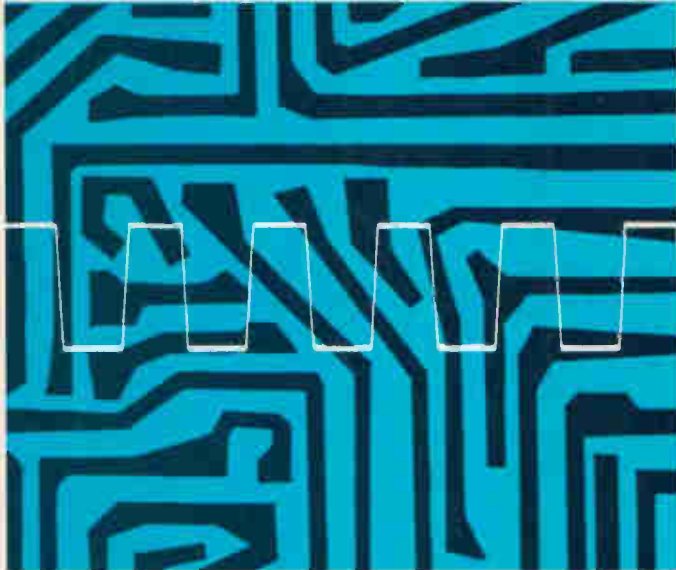

Better circuit testing requires better pulse generators.

Better check these out.

The Hewlett-Packard 8002A and the Model 8003A Pulse Generators offer you new and improved control over your input pulses for testing circuits under actual operating conditions. With clean, well-controlled and clear geometry pulses, you now have a versatile way to analyze circuit outputs without being restricted by the limitations of the pulse generator itself.

The 8002A Pulse Generator gives you excellent control of your

pulses, with rise and fall independently controllable by means of a vernier. Variable rise and fall times, 10 nsec to 2 sec, and rise/fall, fall/rise ratios up to 30:1. Repetition rate is 0.3 Hz to 10 MHz. 50 ohm source impedance, even during transitions; reflections are minimized. Price: \$700.

For the best pulses and greatest versatility for your money, the 8003A Programmable Pulse Generator is your best buy. Here you get simultaneous positive and negative outputs, 5 nsec rise time, pulse width of 30 nsec to 3 sec

and a 10 MHz repetition rate. Great for fast switching applications, wide frequency testing capability of the 8003A also makes it ideal for testing analog devices such as wideband amplifiers, filters and other linear circuits. Price: \$470.

If you've been searching for a better way to test circuits, a way to get better, more accurate results, get complete details on these two pulsers by calling your local HP field engineer. Or write Hewlett-Packard, Palo Alto, Calif. 94304; Europe: 54 Route des Acacias, Geneva.

HEWLETT  PACKARD

PULSE GENERATORS

18804

NEW

high-brightness NIXIE tubes. designed for tomorrow, delivered today.

TYPE B-5750

LOW COST:
\$3.95 each in 1000 quantities.

HIGH BRIGHTNESS:
time sharing up to 12 digits,
or for DC operation.

TUBE SIZE:
0.53" diameter; 1.5" height.

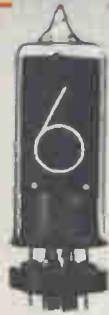

TYPE B-5855

LOW COST:
\$4.35 each in 1000 quantities.

ULTRA-HIGH BRIGHTNESS:
time sharing more than 12
digits, or for DC operation.

MINI TUBE SIZE:
0.51" diameter; 1.35" height.



TUBES SHOWN ACTUAL SIZE

TIME-SHARING OPERATION:

like numerals can be driven in parallel,
reducing driver costs, and without sacrifice
of brightness.

IC-COMPATIBLE PIN CONFIGURATION:
dual-inline layout designed for IC de-
coder/drivers.

OPTIONAL PIN CONFIGURATION:
conventional plug-in type for socket
mounting, or flying leads for direct
soldering.

COMBO PIN SPACER/LEAD STRAIGHTENER:
simplifies PC-board and/or socket in-
sertion.

DECIMAL POINTS:
positioned left and right, independently
operable.

CHARACTER HEIGHT: 0.5"

MINI-SIZE, LOW-COST SOCKETS:
for DC or time-sharing operation.

ULTRA-RELIABLE:
like all ultra-long-life NIXIE tubes.

LONGEST STATIC LIFE:
for demanding applications.

SPECIAL-CHARACTER TUBES:
+/- tubes available from stock. Alpha/
special-character tubes made to order.

MOST COMPLETE HARDWARE BACK-UP:
low-cost IC decoder/drivers available
off-shelf. Custom assemblies at pro-
duction costs through modular design.

MOST COMPLETE APPLICATIONS BACK-UP:
design and applications assistance of
the kind available only from Burroughs,
the originator of NIXIE tubes. For a
demonstration, application notes and
full information call or write
Burroughs Corporation,
Electronic Components Division,
Dept. N-17, P.O. Box 1226,
Plainfield, New Jersey 07061
TEL: (201) 757-5000.

Burroughs 

Technical Articles

**CBS's miniature
color tv camera
page 74**

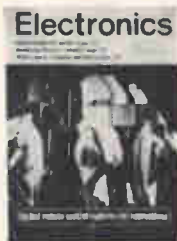

A digital remote control technique borrowed from spacecraft data-transmission technology makes possible a backpack color tv camera (cover) used by CBS to cover the political conventions. The command system permits the radio control of such functions as color registration and phasing from a base station as far as 10 miles away.

**Guide to laser
system design
page 90**

Choosing the essential elements for a pulsed ruby laser system has so far been more art than science. Little data is provided by manufacturers on the components needed, and application information is also scarce. Now a set of design charts that show how key component parameters affect system performance can help the engineer develop a system from scratch or modify an existing system.

**Frequency-domain
reflectometry pinpoints
microwave faults
page 96**

More meaningful checks of microwave systems are possible using frequency-domain reflectometry instead of the well-known time-domain reflectometry. With the new technique, analyses are made at the operating frequency of the microwave system. The method can be used to routinely locate faults in cable systems aboard ships, aircraft, and missiles, and to test antenna transmission lines, delay lines, and radio-frequency distribution systems. The distance along the transmission system to a fault is determined by viewing the signals on a crt.

**Transistors on film
or paper substrates
can be flexed
page 100**

Until now, comparatively rough substrates have been ruled out for insulated-gate field effect transistors. It's been customary to use brittle substrates such as glass or sapphire and to polish them before deposition. The promise of fabricating FET's on such substrates as paper, Mylar tapes, cellulose acetate film, and anodized metal foil suggests new applications—in toys, for instance. Transistors with gain bandwidth products of 60 Mhz and gm's of 6,000 micromhos have been made.

**Reliability of IC's
need not be costly
page 104**

Most electronic equipment doesn't demand the minuscule failure rates required for space missions. With most gear, costs are as important as reliability, and an all-out effort to reduce failures would be impractical. Users have tackled the problem in a variety of ways, but the Raytheon Co. has devised a unique approach involving fabrication specifications that the vendor can meet by making visual checks at little or no extra cost.

Coming

Diode displays

LSI circuit translates machine language to drive a solid state numerical display—all in the same small package.

CBS nominates a convention hopeful

It introduces the lightest portable color tv camera in existence, a unit that sends NTSC signals to its base station where an operator can control as many as six cameras through a new digital command system

By Marvin Kronenberg, Renville H. McMann Jr., Paul Berger, Howard W. Foodman, Clyde W. Smith, Joseph Petit, and Robert Moore
CBS Laboratories, Stamford, Conn.

The Republican convention has just ended and the Democratic convention is about to begin, but the most promising candidate so far is the new portable color tv camera CBS is using to cover these political conclaves.

Dubbed the Minicam VI by its developer, CBS Laboratories, this wireless unit and its attached backpack produce an NTSC (National Television Systems Committee) signal suitable for direct broadcasting without further processing. These transmissions, which go to a base station, are less susceptible to data-link noise and multipath effects

than are conventional raw video signals.

The key developments making all this possible are a new digital command system based on spacecraft data-transmission technology, and a new 1-inch, high-resolution, lead-oxide camera tube. The command system enables the radio control of all functions—color registration, iris, black level pedestal, gamma, gen-lock, vertical and horizontal phasing—from a base station located as far as 10 miles away, depending on the transmission path.

The numerous control functions involved make the use of motor-driven potentiometers for remoting

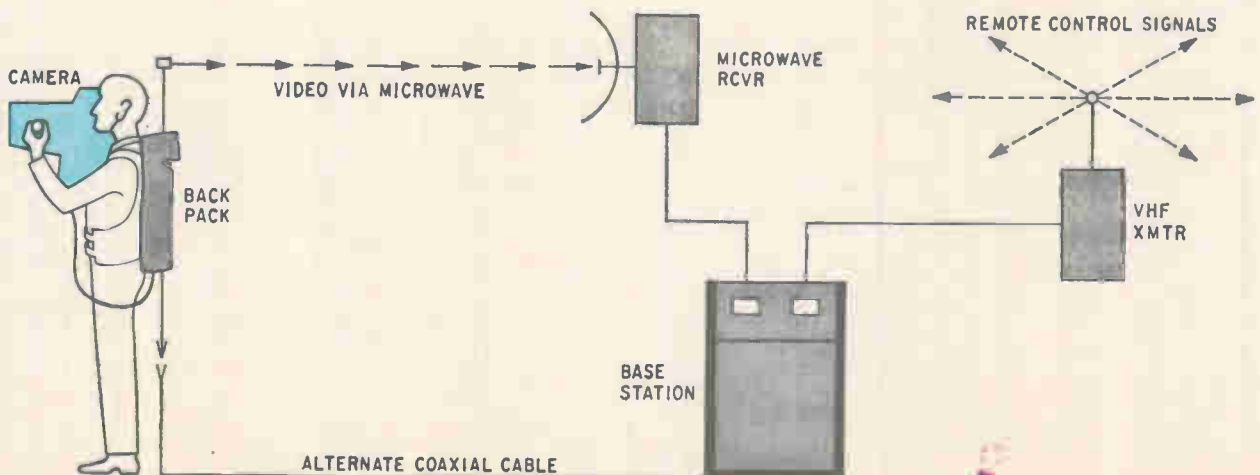



The Minicam. Essentially a low-power tv transmitter, the system sends an NTSC signal to remote base station.



On base. Station is functionally equivalent to a conventional studio control console.

Flying high. Besides being groundmobile, the Minicam proves handy aloft, as here in a helicopter.

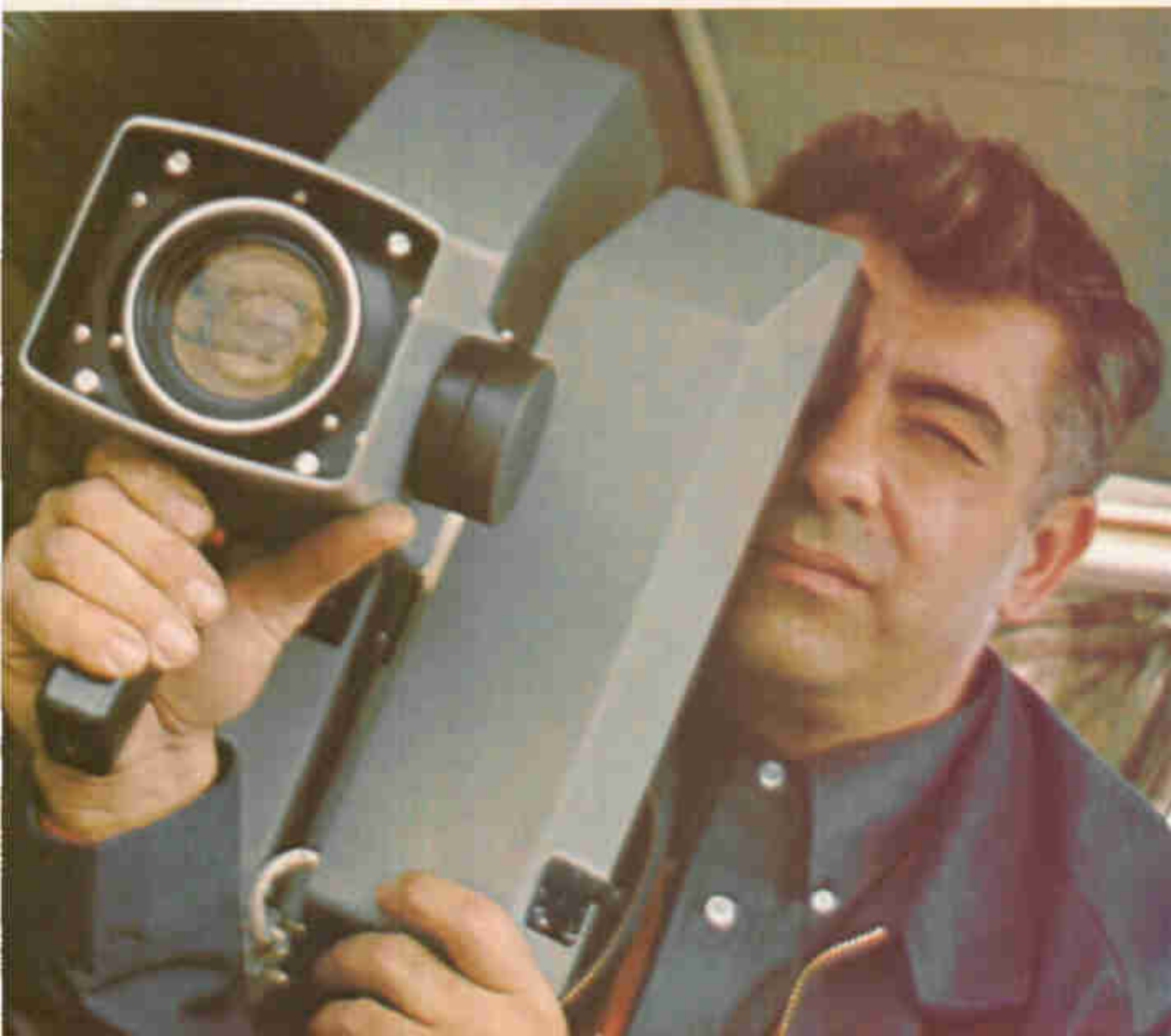

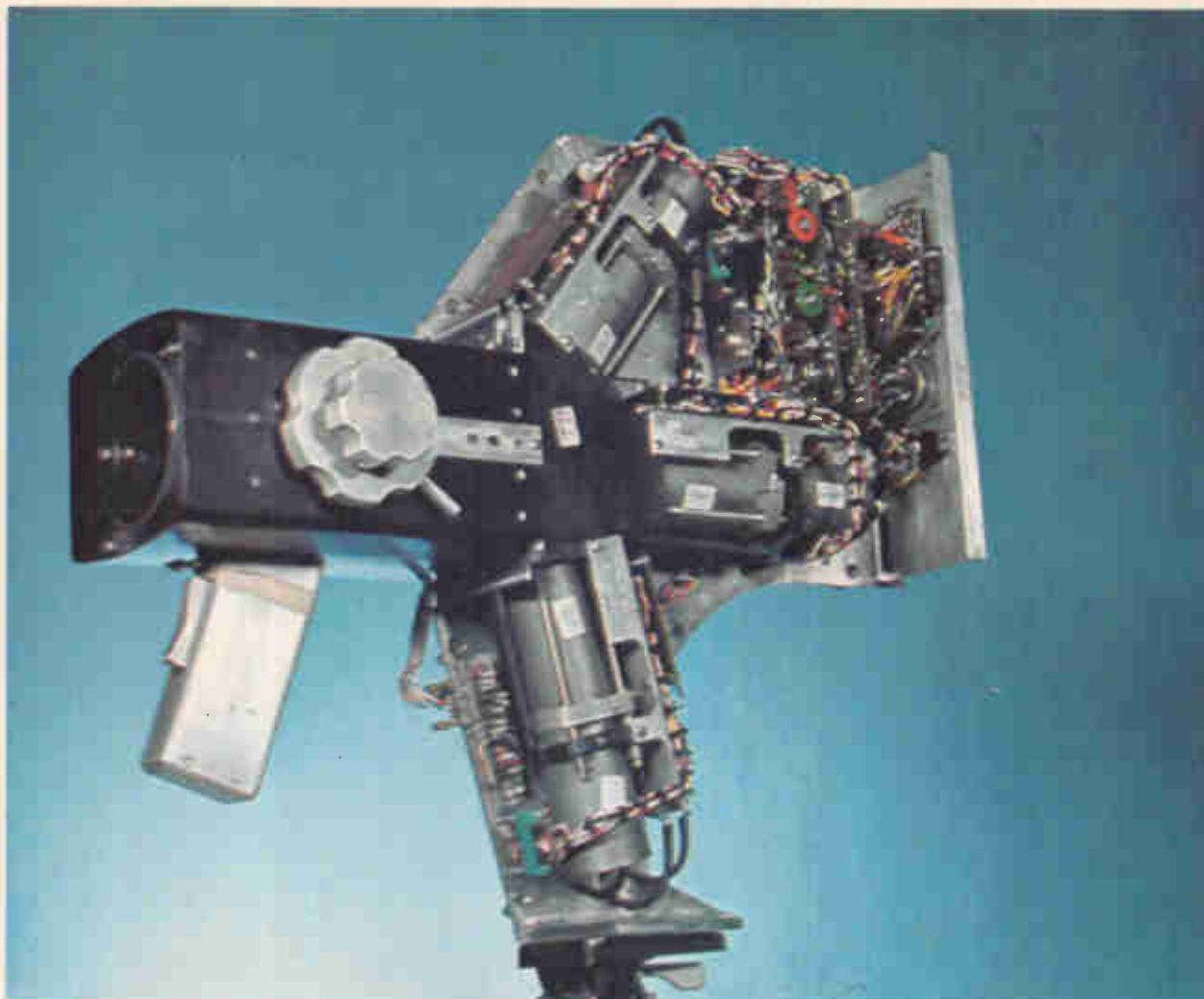

Up tight. Camera-head optics and electronics, above, have been squeezed into a small package. At left is the lead-oxide pickup tube with deflection yoke and preamplifier.

continuous controls impractical, and the new all-electronic control system had to be developed.

Strings attached

The camera can also be linked to its base station by a single-conductor coaxial cable if terrain features interfere with wireless communications. However, cable losses limit the hookup distance between camera and station to about a mile.

The camera head, including zoom lens and 3-inch viewfinder, weighs 18 pounds, and it can be used up to 100 feet away from the backpack, which weighs 32 pounds with battery and 12 pounds without.

Besides the supply battery, the backpack contains all the video processing circuitry, the control receiver for picking up the command signals, and a microwave transmitter to send the video information back to the base station. The control signals are transmitted by a 150-, 450-, or 950-megahertz carrier. The microwave video transmitter operates at 2, 7, or 13 gigahertz with different modules.

The use of omnidirectional antennas at the base station and camera locations permits the control of several cameras at different locations over a single channel. However, since each camera requires a separate microwave channel for picture transmissions, a directive microwave dish antenna is employed at the base station and an omnidirectional unit at each backpack. The base station operator tracks each camera individually with the dish.

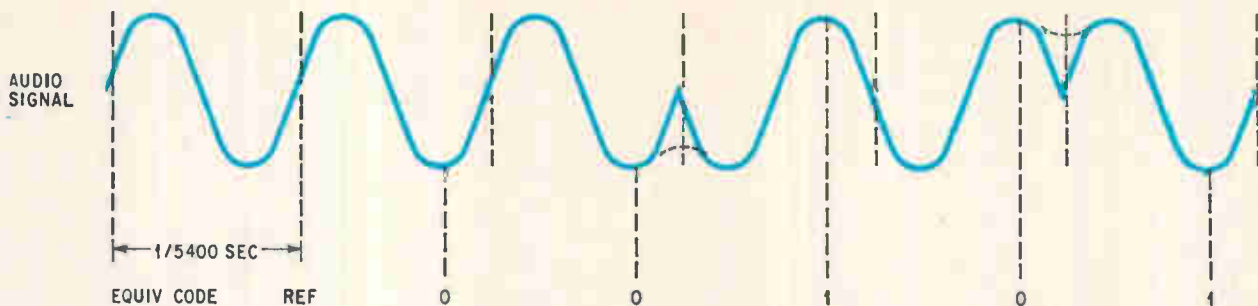

Encoding control signal. Information is encoded by phase shifting a 5.4 kilohertz subcarrier 180° to denote a binary 1. The absence of a phase shift on successive cycles denotes binary 0.

In cable operation, the several carriers are frequency multiplexed to achieve two-way transmission of the video and control signals over a single line. The video is sent down the cable modulated on a 35-Mhz carrier. In the reverse direction, the digital control signal, consisting of a modulated audio subcarrier, is transmitted on a 500-kilohertz carrier. Other carriers in the 500-khz range are used for two-way voice communications between the cameraman and the video operator at the base station.

The Minicam system is normally powered by batteries; when operating in the cable mode, though, the camera can be powered over the coax.

Unlike other portable color cameras, which send back separate red, blue, and green signals to their base stations for processing, the Minicam VI does all of the signal processing in the backpack. As noted before, this reduces the possibility of noise pickup and cuts down on the color errors that can be caused by multipath effects.

Another important advantage is that a tv program can be recorded right at the camera location with a portable video recorder. For on-the-spot recording, a local control box plugged into the backpack enables an operator to perform all the functions of the digital command system.

In the studio

Applications for the Minicam don't stop at the

political conventions. This camera system is due to make changes in the broadcast studio, too.

At a conventional studio, most of the adjustments to improve camera performance are made by video operators seated at control consoles—one operator per camera. The cameras and their associated equipment are heavy and bulky, as are the attached cables. The advent of the Minicam will lead to lighter and smaller studio cameras, cables, and gear, and—because the digital command system makes many of the necessary adjustments automatically—will enable a single console operator to control several cameras over a single very-high-frequency channel. The quality of the Minicam's pictures during remote broadcasts equals that of the pictures produced by the finest of present color studio cameras under the same conditions.

In designing more mobile tv equipment, engineers can't always take full advantage of the latest advances in electronic technology. Broadcasting procedures are pretty much standardized, and any new equipment must conform with established station practices and with the experience and capabilities of studio personnel. Cameramen, video operators, and program directors have their roles to play, and any camera design that places an undue burden on one of them will not be successful.

In the case of the Minicam, it was necessary to unburden the cameraman of any control functions,

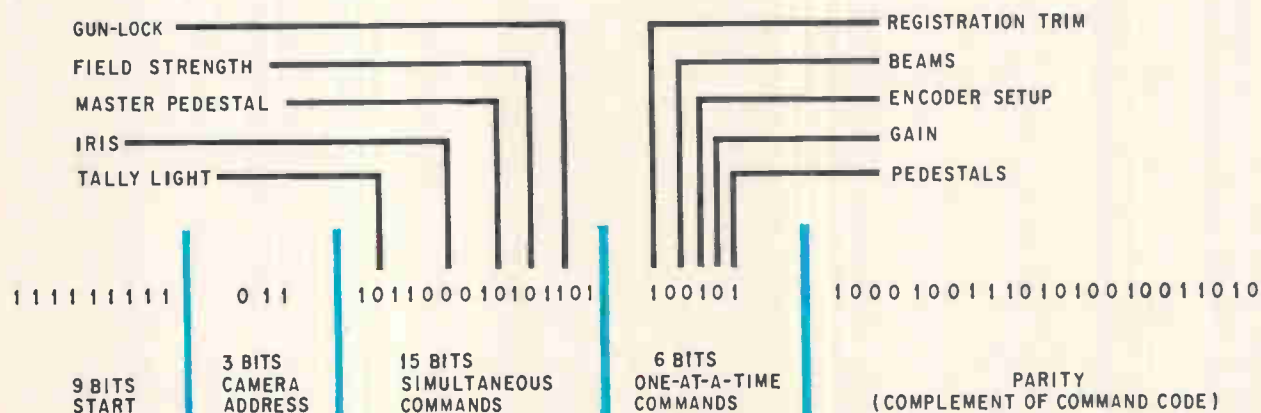

Command code organization. The basic command word, not including the nine-bit start signal, is made up of 24 bits. After each word is transmitted, it is repeated with 1's and 0's interchanged to detect any false information.

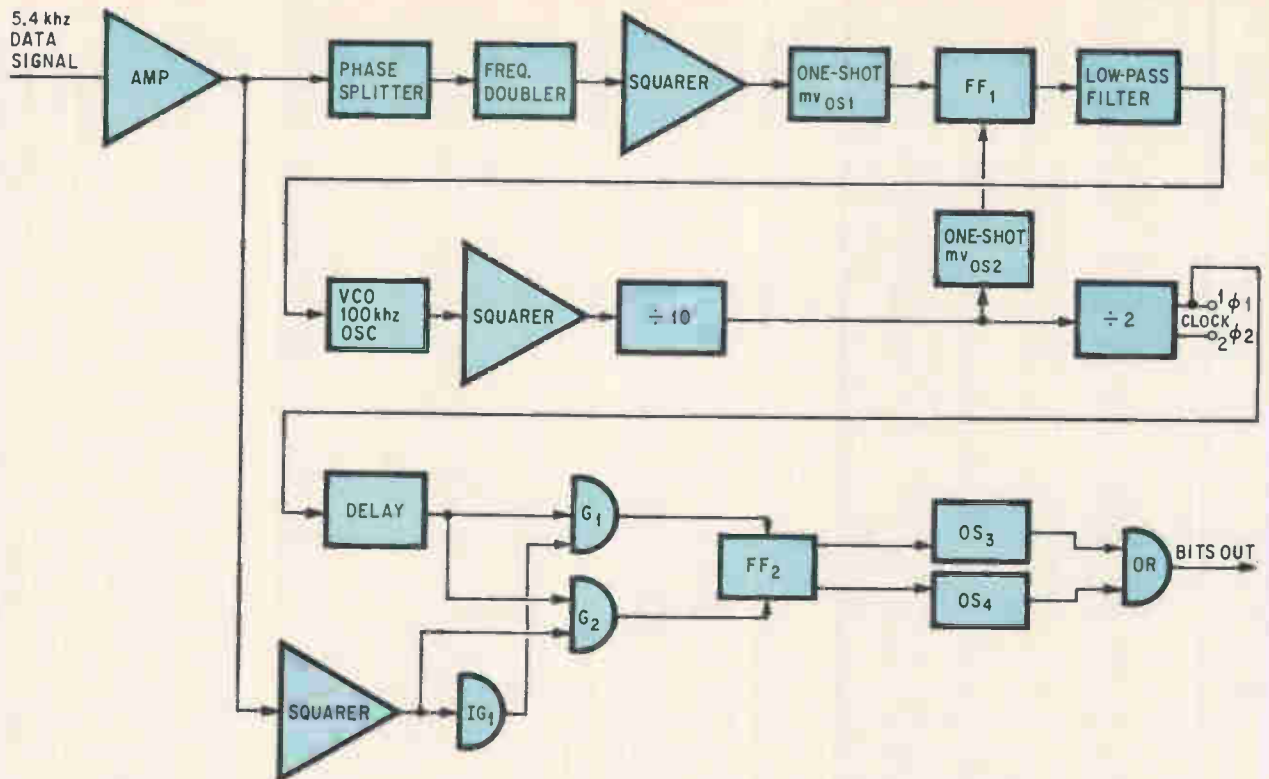

Bit decoder. The incoming coded signal from the base station is decoded by a series of operations, including frequency multiplication and division. The detected output bits are then used to switch circuits or vary controls.

leaving him free to "shoot" the scene. Hence, the digital command system.

A key aspect of this system is the gen-locking (synchronizing) of each camera with the local tv network master sync generator. Gen-locking of the vertical, horizontal, and color components of the synchronizing signal is handled automatically by a closed-loop arrangement in which the control system continuously sends out corrective commands to the backpack generator. These corrections are determined from information supplied by comparators at the base station. The commands are encoded in binary form on a 5,472-hertz subcarrier.

The method employed here is similar to a technique widely used to transmit data to and from spacecraft. Basically, the information is encoded by phase shifting the 5.4-khz subcarrier 180° (0° to 180° or 180° to 0°) to signify a binary 1. A 0 is indicated by the absence of a phase shift on two successive cycles, as shown on page 77.

The command signal consists of several separate instructions, each addressed to a specific camera, and it is repeated and updated continuously as controls are adjusted. The complete control cycle takes about 1/10 second to encode and transmit, enabling multiple camera control to be carried out on a single channel at a rate fast enough to be effectively simultaneous.

A sample of the command code is on page 77. The sequence of commands starts with a nine-bit segment of 1's to indicate to the cameras that a

message is on the way. The second word is a three-bit segment containing the address of the camera to be commanded. This is followed by 15 bits of simultaneous commands that can be transmitted without instructions from the station operator. These commands involve such things as field strength, tally light, and gen-lock. Registration and focus adjustment, which are handled only occasionally by the operator, are carried by a six-bit word used in combinations to indicate any one of 64 functions.

To eliminate false commands such as might be produced by pulse transients, the bits are transmitted a second time with all the 1's and 0's interchanged. If the complementary bits don't match the command bits, the message will be rejected.

Decoding

The phase-shifted 5,472-hz data signal goes from the system's vhf receiver to a gain-control amplifier at the input of the decoder. To recover the data clock, the amplifier feeds a phase splitter that drives a frequency doubler. The output of the doubler, a 10,994-hz sine wave, is squared and used to drive one-shot multivibrator OS₁. This repetitively sets a flip-flop, FF₁, that's wired for toggle operation.

FF₁'s clock input is driven by OS₂, another one-shot multivibrator that's fired by a divide-by-10 network counting down from a primary 100-khz voltage-controlled oscillator. The output at FF₁ is a pulse train with a positive duty cycle proportional to the phase difference between its two driving sig-

nals. The pulse signal is passed through a low-pass filter to obtain a d-c level for the voltage-controlled oscillator. The output of the divide-by-10 circuit is further counted down by two to derive the system's two-phase clock.

The phase-modulated sine-wave input is also passed through a squaring network and then inverted. Both the inverted and noninverted data is combined with one phase of the clock through gates G_1 and G_2 , whose outputs are used, respectively, to set and clear flip-flop FF_2 . The Q and \bar{Q} sides of FF_2 drive OS_3 and OS_4 , respectively, and the outputs of these two oscillators are OR's to provide data output.

Since the 1's in the coded data are represented by a phase shift and the 0's by the lack of one, FF_2 will change state only when a phase shift occurs, and this change will be on positive and negative edges of FF_2 's Q output. Thus, OS_3 and OS_4 are used to convert the 1's into positive-polarity data.

At the controls

The decoded command words fall into two categories—those used to perform switching functions and those for continuous functions. The switching of such gear as the lens iris motor and microwave transmitter is done by means of flip-flops or relays. But the remoting of continuous-control commands requires motor-driven potentiometers or an equivalent arrangement having the memory characteristic of a motor and the gain-varying capability of a potentiometer.

Motor-driven potentiometers were deemed impractical in this application because of the numerous functions to be controlled, plus the weight and size of these devices. Instead, the system uses a sample-and-hold circuit that offers the advantage of the high impedance of metal oxide semiconductor field effect transistors, the low leakage capability of a polycarbonate dielectric capacitor, and a d-c variable gain control circuit that provides the memory capability of a potentiometer. This circuit, shown below, is much lighter than a potentiometer, though, and requires far less space and power.

The decoded data signal applied to the input charges or discharges capacitor C to a level corresponding to the analog d-c level of the control signal at the base station. Because of the very high leakage resistance of the capacitor, the charge will hold until it's changed by the control operator.

The d-c level at the capacitor is buffered and amplified by a combination of integrated-circuit, differential MOS FET amplifier and operational amplifier that provides an input impedance greater than 10^{15} ohms whether power is on or off. The feedback loop of the op amp serves as a voltage follower to give an output signal that's proportional to the charge on the capacitor.

In the variable gain control circuit on page 80, the d-c level at the output of the sample-and-hold circuit is applied to the base of Q_2 . The video signal to be varied modulates constant-current generator Q_1 , and the resulting signal current is split between Q_2 and Q_3 , a balanced pair. The d-c

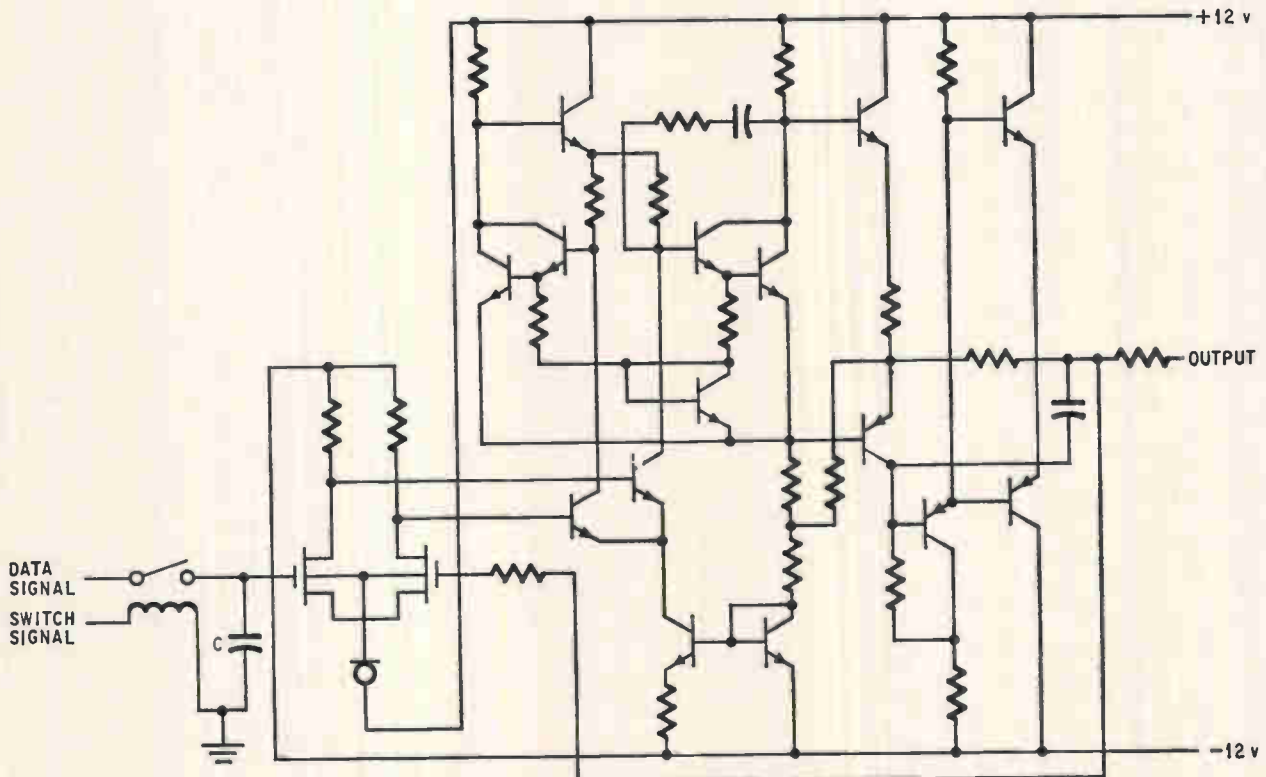

Sample hold circuit. Solid state equivalent of motor-driven potentiometer uses low-leakage polycarbonate dielectric capacitor with high-impedance MOS FET differential amplifier and IC op amp to achieve memory capability.

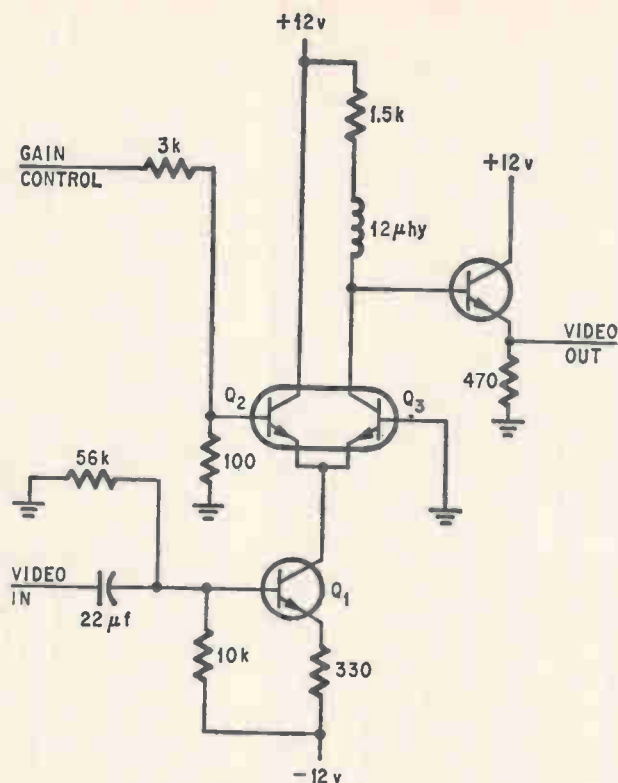

Video gain control. Gain is varied by the unbalancing of the Q_2 , Q_3 pair with a control signal at Q_2 's base.

control signal varies the ratio of the current flowing through Q_2 and Q_3 , and thus controls the amplitude of the output video.

The fact that good performance depends on achieving a balance between Q_2 and Q_3 suggests that the circuit might be integrated to take advantage of the matching performance of transistors in IC's. However, it was found in practice that parasitic capacitance in the IC's produced high-frequency-response variations when gain settings

were changed—a problem that doesn't arise when discrete transistors are employed. Q_2 and Q_3 have been put in the same TO-5 can to ensure maximum gain stability.

Other continuous control functions are handled in a similar manner.

Tiny tube

The advanced design of the electron gun and lead-oxide target of the new 1-inch hybrid pickup tube puts the tube's performance in a class approaching that of the standard 30-millimeter Plumbicon. Unlike the commonly used image orthicon, the new tube, type Z-7946, is uniquely suited for use in broadcast-quality portable tv cameras. The Minicam camera system uses three of the tubes, which were developed for the project by the General Electric Co.

The tube's lead-oxide photoconductive layer construction provides high sensitivity, low lag, and low dark current. And it uses electrostatic focusing and magnetic deflection to achieve light weight and low power consumption.

The camera head contains all the circuitry needed to produce raw video, plus the circuits to handle the scanning and focusing functions. Because the Minicam VI employs electrostatic focusing, image rotation during focus adjustment is eliminated.

The preamplifier for the pickup tube is the heart of the camera since its signal-to-noise ratio directly determines the signal-to-noise ratio for the system as a whole. Also, since most of the system's gain is concentrated in the preamplifier, its gain stability is a major factor in determining the over-all color stability of the camera.

Until the development of the latest generation of field effect transistors, transistor preamplifier designs had always had signal-to-noise ratios inferior to those of the best Nuistor circuits. Bipolar-transistor circuitry has good high-frequency signal-to-noise characteristics, for example, but generally poor low-frequency noise characteristics.

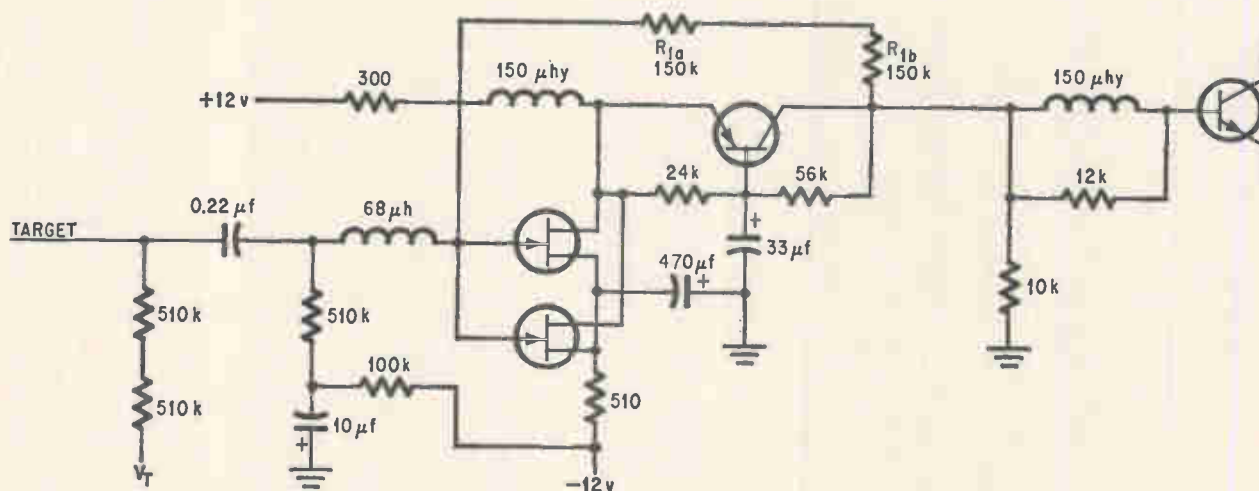

Camera-tube preamplifier. Featuring parallel field effect transistors, circuit stabilizes low-frequency gain with respect to temperature with a low-capacity, 40-decibel-gain feedback loop.

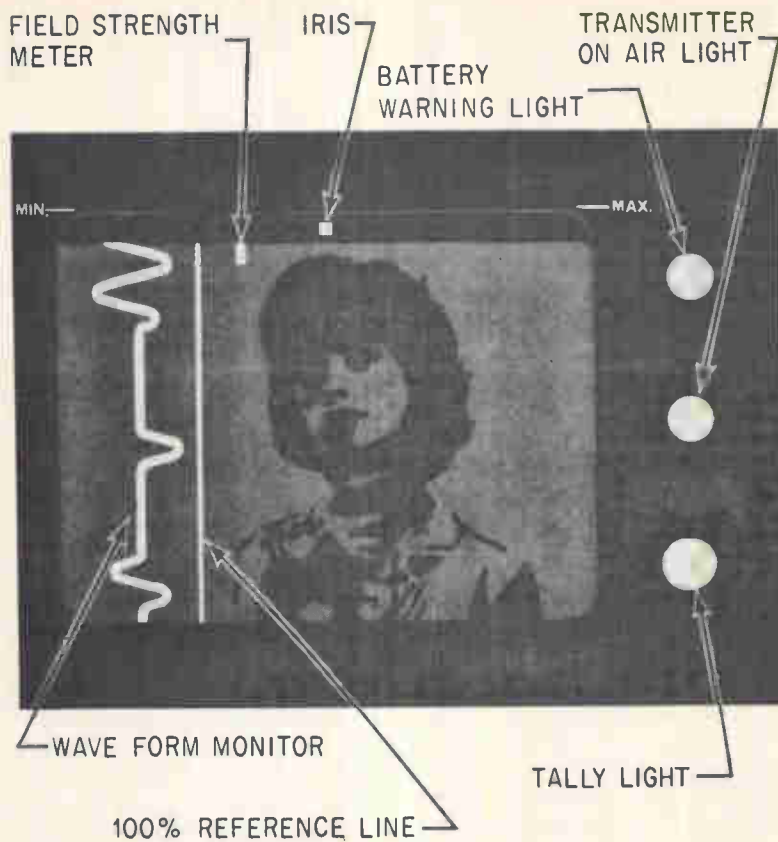

Viewfinder. Video level can be set and flesh tones adjusted by use of the waveform monitor.

Besides the usual low-noise requirement for a pickup tube preamplifier, the use of a lead-oxide target demands a still lower signal-to-noise ratio as these devices are linear with respect to light-input versus signal-output performance. It thus becomes necessary to include a black stretch gamma amplifier within the signal processing chain to match the output signal to the approximately square law characteristic of the system's display kinescope.

The color camera has two FET's paralleled, as shown on opposite page. This paralleling helps to minimize the C^2 figure of merit since a large portion of the preamplifier input is in the pickup tube's target assembly. Adding other FET's would further improve the figure of merit, but the law of diminishing returns applies here.

A folded cascode design is used to minimize FET drain capacity multiplication by Miller effect. The output of the cascode is fed back to the input through the low-capacity feedback resistance, R_{1a} , R_{1b} , and since the loop gain is approximately 40 decibels, the preamplifier appears as a 3,000-ohm load to the pickup tube at low video frequencies. This amount of feedback fully stabilizes low-frequency gain with respect to temperature.

High-frequency signal-to-noise performance is improved by a Percival coil input that's adjusted to resonate with the input capacity at about 7 Mhz. The coil increases the high-frequency signal

through the FET's but also puts a pronounced peak in the high-frequency response. This peak is later removed by a complementary network in the output amplifier; the result is an over-all flat response to 5 Mhz with good sine-squared pulse-transient performance. Typical signal-to-noise ratios for this design are between 46 to 50 db, measured on the basis of rms noise to a peak-to-peak signal of 300 nanoamperes. With carefully selected components and individual amplifier peaking, 52 db has been reached on occasion.

The three deflection yokes are in parallel and are driven by conventional sweep circuits. However, separate centering windings are used on each yoke to minimize drifts. The sweep circuit provides for switchable overscan and focus rock so that the three tubes can be rapidly aligned.

The viewfinder shown above uses a 3-inch tube. In the illustration, a pulse whose horizontal position indicates the iris setting of the camera has been inserted at the top of the unit. The field strength of the video microwave transmitter, as received back at the base station, is indicated by another pulse.

To give the cameraman an accurate means of setting video level, a waveform monitor is employed to sample the video in a line extending from the top to the bottom of the picture, and to display the samples as a pattern. This feature permits the cameraman to correctly set both iris and pedestal and to adjust for proper flesh tones.

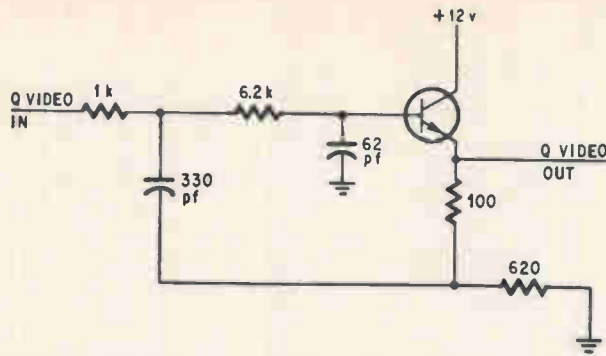

Active Q filter. A transitional filter in the encoder improves overshoot by minimizing attenuation.

The biggest problems facing designers of the encoder were the limited space available and the stringent stability requirements that had to be met because of the wide temperature changes that might be encountered as the camera is moved about. Since black balance couldn't be touched up while the cameraman was walking around, it was necessary to design a circuit that needed no adjustments.

A double-balanced-type ring modulator, shown below, was chosen because the diodes, which are the modulating elements, are easily matched. The circuit is matched for both carrier-black balance—and modulation frequencies—video balance—eliminating the need for the conventional video balance control.

The use of the complementary differential amplifier, Q_2 , Q_3 , yields high common-mode rejection

at all modulation frequencies because there's no emitter resistor or current source to raise the problem of stray capacitances. The circuit is equivalent to a balanced transformer except that it has much broader frequency response.

Curve fitting of the NTSC "Q" response shows the need for an attenuation of approximately 10 db per octave. This dictates the choice of a second order filter but since slightly less attenuation must be used to achieve sufficient gain, the overshoot, which is approximately 4%, was improved by using the transitional filter shown at left. Other networks can also be used, but the one selected yields the minimum time delay considering the constraints of cutoff frequency, attenuation, and overshoot.

Because the filter design lends itself to miniaturization, it was decided to make it an active filter. The result is that the complete NTSC encoder has been built on a 5-by-5-inch printed-circuit board mounted in the backpack.

The need to gen-lock the backpack sync generator to the station sync constituted another major challenge to the camera's designers. Fading between cameras, mixing, superimposing titles, and other special effects require that all cameras participating in a telecast be accurately phased with respect to each other. Therefore, the vertical, horizontal, and color components of the backpack sync generator have to be individually phased via the control system, and coherence with the base station sync must be maintained. As indicated in the diagram on the right, the frequency and phase control of the 3.58-Mhz subcarrier is accomplished by using a varicap to slightly pull the frequency of a

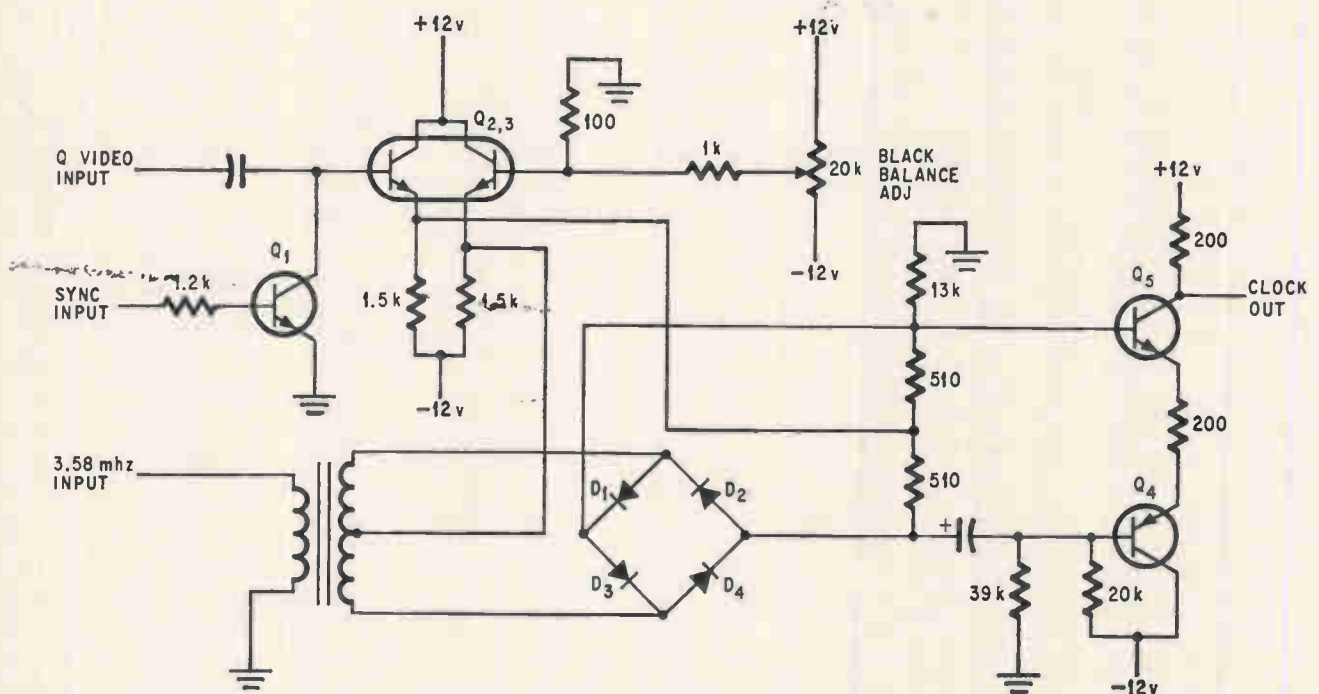

Balancing act. The stringent space and stability requirements for the encoder are met by using diode modulating elements in a double-balanced-type circuit that's balanced for carrier and modulation frequencies.

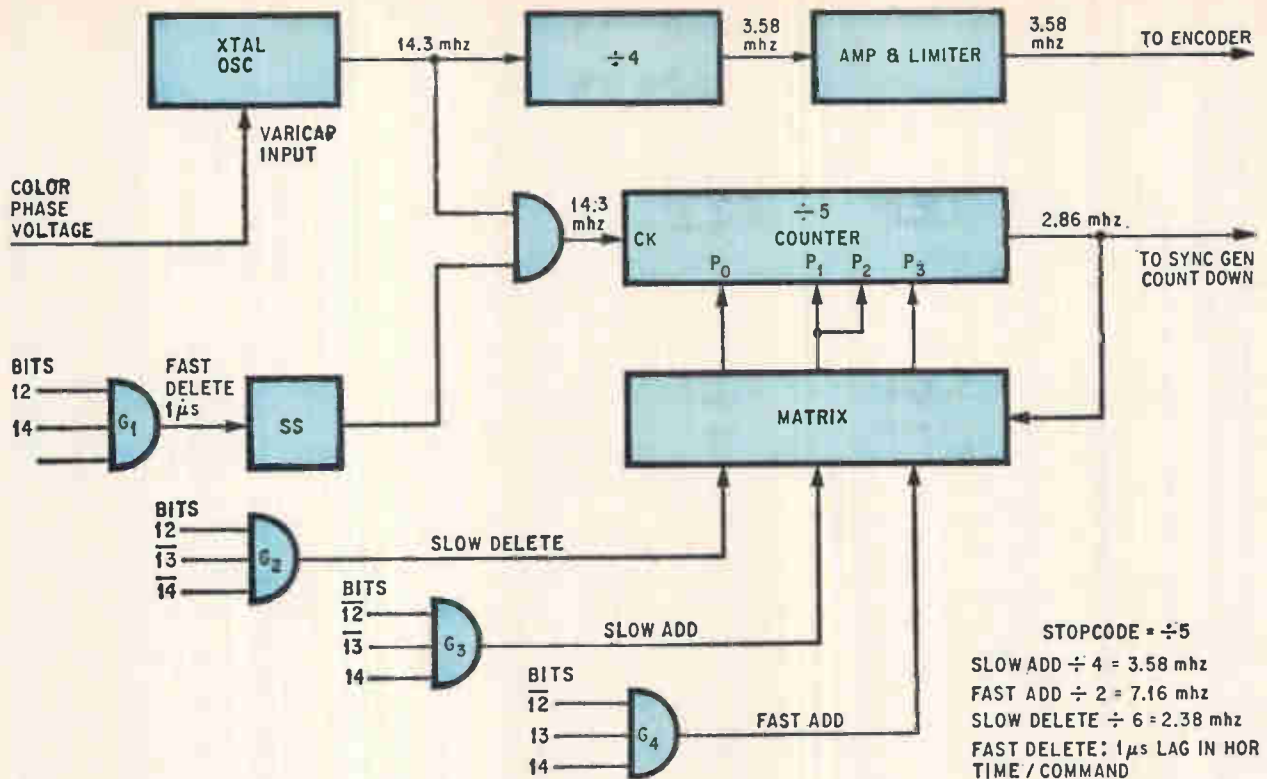

Horizontal sync and color phase. Sync is controlled by varying the division of the counter; the color subcarrier is varied in frequency and phase by using a varicap to pull the master clock oscillator.

14.3-Mhz oven-enclosed master oscillator for the backpack sync generator. The varicap's input voltage is derived from one of the memory sample-and-hold circuits and is tied in with the control system, which continuously adjusts the voltage in step with the error signals developed by the base station color-subcarrier comparators.

Horizontal phase control is effected in a different manner. Referring to the diagram, gates G_1 , G_2 , G_3 , and G_4 use coded information from the control system to provide several modes of phase correction by varying the division of a counter and inhibiting 14.3-Mhz pulses to the counter.

The pulse output of the counter is fed to the sync generator counters and ultimately provides the vertical and horizontal components of the composite sync signal. The repetition rate of the counter output depends upon the commands received by G_1 , G_2 , G_3 , and G_4 . A stop code will reset the counter and the output will be 2.86 Mhz—the nominal value when no phase correction is required.

Other commands to correct horizontal phase in one direction or the other are decoded by the gates and the matrix, which put the counter in its various states. Horizontal phase can be adjusted in steps as small as 70 nanoseconds or as large as one microsecond, depending on the error present.

Back at the base

The base station is functionally equivalent to the control console for any conventional studio color

camera, except that there are r-f transmitting and receiving equipment and digital encoding circuits in the Minicam system.

In addition to a digital sequencer that can handle up to six cameras, the station contains a separate gen-lock circuit for each camera in the loop. This circuit compares the local sync with the sync from the remote camera, and develops the necessary command signal to bring all the cameras into exact synchronization with each other. Other circuits include a modulator-demodulator that demodulates the incoming 30-Mhz video signal and the low-frequency interphone carrier, and that also generates the 450-khz subcarrier used to get the command signal to the camera.

The base station's equipment is housed in two field cases equipped with handles.

It should be noted that special credit for the success of this project is due Peter C. Goldmark, president and director of research of CBS Laboratories, Joseph Flaherty and Richard Streeter of the CBS television engineering and development department, and Herbert Hannam of GE.

References

- A.R. Kaye, "A Solid State Television Fader Mixer Amplifier," SMPTE 97th Technical Conference, March 29, 1965.
- R. Rainger, "A Camera Tube Head Amplifier," Royal Television Society Journal, Vol. 2, No. 10, 1967.
- Renville H. McMann Jr., "A Digitally Controlled Portable Color Camera for Studio, Field or Wireless Operation," CBS Laboratories, March 25, 1968.

Designer's casebook

FET and IC keep oscillator linear

By J. Mailen Kootsey

Loma Linda University, Loma Linda, Calif.

Operational amplifiers have been used as constant current sources in a variety of configurations. In this application, an operational amplifier combined with a field effect transistor supplies the charging current for a unijunction transistor relaxation oscillator. The resulting oscillator can be voltage

or current controlled, has good frequency control linearity, and uses a minimum of components.

Current through the input resistor R_1 flows through the field effect transistor Q_1 and charges the timing capacitor C_1 . The operational amplifier supplies the gate voltage for Q_1 and thus keeps the input—the point between R_1 and the op amp—at ground potential so that the charging current is in direct proportion to the input voltage. If the input voltage is constant, the voltage increases linearly with time until C_1 is discharged by the firing of the unijunction Q_2 . When the capacitor discharges, a negative output pulse is available across R_2 , a carbon temperature-compensating resistor. The instantaneous frequency of the output pulse is proportional to $V_1 / (R_1 C_1) - V_1$ is the input voltage—within limits set by leakage currents, the discharge rate of the capacitor, and I_{DSS} of Q_1 . With the component values shown, the output frequency varied from 0 to 1400 hertz with a differential linearity better than $\pm 0.1\%$.

In addition to frequency changes made by varying $R_1 C_1$, several modifications can be made. Additional input resistors can be tied to the input for the purpose of summing several voltages—the sum must always be positive. For voltage inputs of negative polarity, the input terminal can be grounded and the voltage applied instead to the non-inverting input of the operational amplifier. The circuit is basically a current feedback configuration, so the input resistor R_1 can be removed to make a current-controlled oscillator. If positive output pulses are desired, they can be obtained across a 27 ohm resistor inserted in a series with base one of Q_2 .

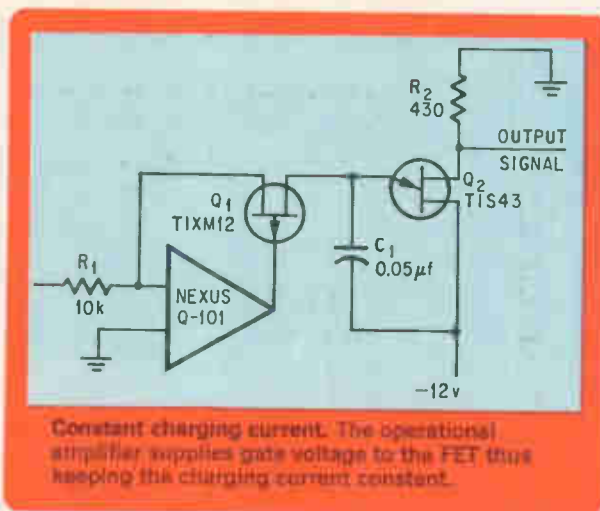

Flip-flop isolates pulse from switch bounce

By Larry V. Hendricks

Varian Data Machines, Newport Beach, Calif.

The narrow pulses that a digital designer injects into a newly assembled system are generated by the manual closing of a switch. Unfortunately, contact bounce in the switch causes voltages other than

the one desired. An integrated flip-flop and a transistor make up a pulse generator whose output is isolated from the spurious voltages.

When the switch, S_1 , is depressed, capacitor C_1 discharges and causes the point common to C_1 and R_1 to drop from +5 volts to ground. This negative swing is coupled through C_2 into the trigger input T of the flip-flop. The flip-flop connects point Q to the +5-volt supply and generates a negative voltage at point Q. From point Q this negative voltage is coupled through C_4 onto the base of Q_1 .

The transistor is biased into cutoff and its collector is moved from ground up to +5 volts. These

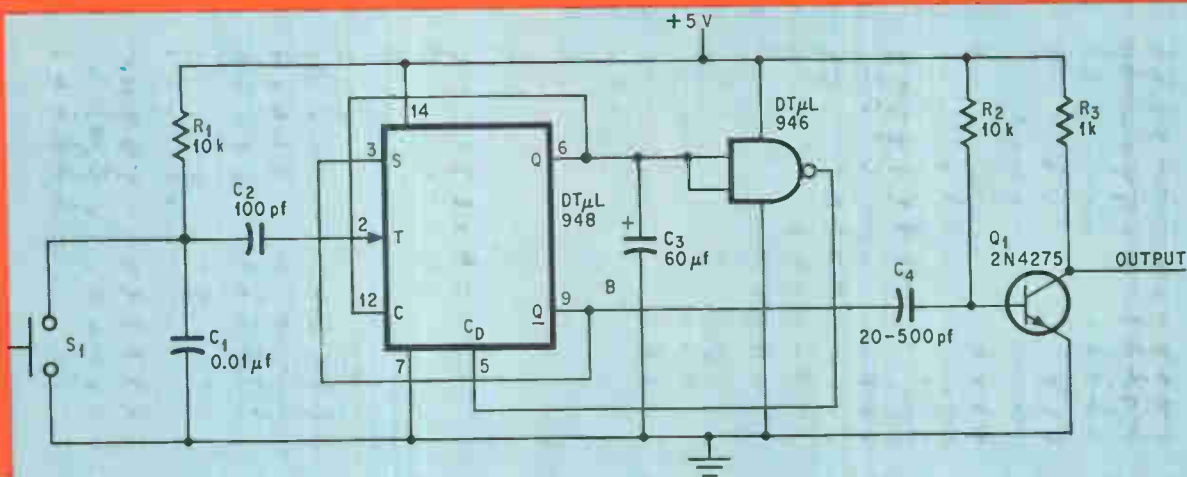

Timekeeper. The momentary negative voltage at the B terminal on the flip-flop produces a positive voltage pulse when the switch is depressed. This keeps bounce voltages at the switch from reaching the output. Gating of the NAND gate by C₃'s voltage generates a zero-voltage at the C₄ terminal.

processes form the leading edge of the output pulse. After 100 nanoseconds, C₄ will have discharged through R₂ to a voltage that allows Q₁ to return to saturation, and the falling edge of the pulse is formed.

Capacitor C₃, charging to the voltage at point Q, will after 30 milliseconds reach a voltage that turns on the NAND gate. This moves the output of the NAND gate to zero, returning the flip-flop to its original state.

Schmitt trigger built from a logic IC

By Aubrey Deene Ogden

Western Electric Corp., Eldridge, Md.

In digital systems where an inexpensive amplitude comparator or squaring circuit is required, a Schmitt trigger can be built easily with a single IC that contains two DTL NAND gates with expander nodes. The feature that enables the dual gate to be used as a Schmitt trigger is the expander nodes of the gates. These nodes are normally used to expand the number of input diodes (the fan-in) to the gate.

The advantages of this means to obtain the Schmitt trigger function are the availability and low cost of dual DTL gates. In systems where DTL gates are used, dual gates are used frequently and no additional part numbers will be required. In systems using other logic types, the cost of the dual gate will be less than that for achieving the Schmitt trigger function using either integrated operational amplifiers or a discrete component Schmitt trigger.

Of course, the integrated dual gate approach will also have size and reliability advantages over the discrete component trigger circuit.

The node of the first gate is used as the input of the trigger. A 1K input resistor limits the input current to the base of Q₁. When the input is below the input threshold, Q₁ is off and R₁ supplies base current to Q₂. With Q₂ on, the output is low. When the

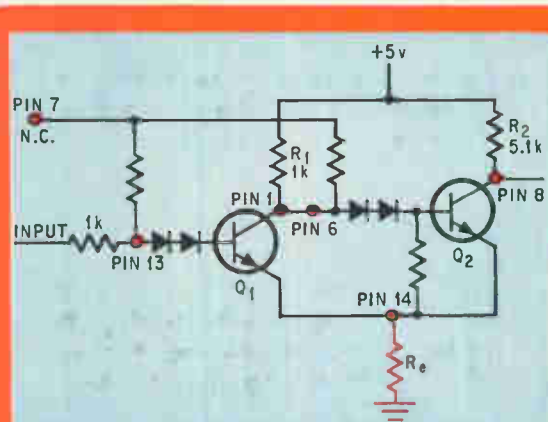

Discrete trigger. The Schmitt trigger as it is commonly represented is built from discrete transistor and resistor components.

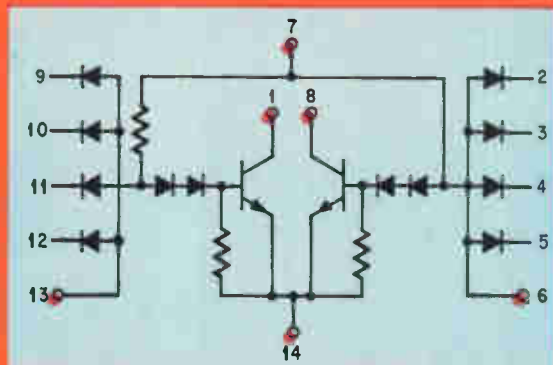

Available material. Two DTL NAND gates have external terminals which when properly connect will perform a triggering function.

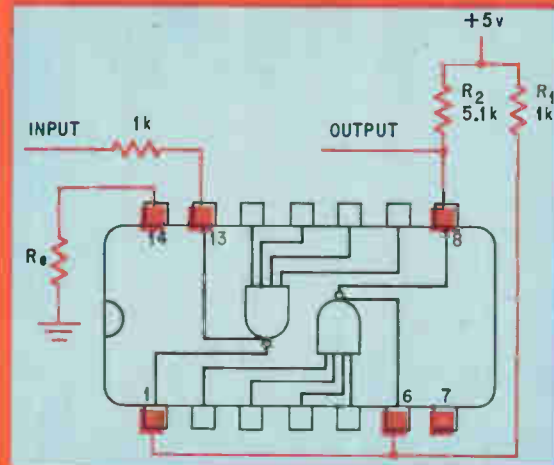

End product. The necessary external resistors connections when added to the IC gate make it a Schmitt trigger.

input signal increases to the input threshold, Q_1 turns on. The input threshold is determined by the two offset diodes, the base-emitter junction of Q_1 , and voltage drop across R_e due to the emitter current of Q_2 . With Q_1 on, Q_2 turns off and the output goes high. When the input signal drops to a level again determined by the diodes and the IR_e drop,

Q_1 turns off and Q_2 goes on. This threshold is slightly different from the threshold level as the input voltage increases due to different voltage drops across R_e for the on and off state of the trigger.

SCR's monitor discharge rate

By C.B. Avera

National Center for Urban and Industrial Health, Cincinnati

Manufacturers of nickel-cadmium and other rechargeable cells specify minimum voltages to which cells may be discharged if maximum cell life is to be realized. A solid-state switch, which opens automatically when battery voltage reaches a preset minimum, has been developed to protect batteries in portable equipment from overdischarge.

The switch is closed manually by pressing the momentary-contact "ON" switch, SW_2 , which triggers SCR_1 . Manual opening of the switch is accomplished by pressing the momentary-break "OFF" switch, SW_1 .

While SCR_1 conducts, C_1 remains charged to nearly the full voltage of the battery. When the

battery voltage drops to a minimum (determined by the setting of R_1), Q_1 conducts, discharging C_3 through the primary of T_1 and triggering SCR_2 . This parallels C_1 with SCR_1 , momentarily reversing the voltage across SCR_1 and causing it to turn off. The value of R_2 is chosen to limit the battery current through SCR_2 to some value less than its sustaining current so that SCR_2 will turn off immediately after the discharge of C_1 .

The value of R_3 is chosen for optimum temperature compensation of Q_1 , assuming a supply voltage, V_{min} , equal to the difference between the minimum allowable battery voltage and the drop across SCR_1 . Under these conditions, R_1 will be so adjusted that C_3 charges to a voltage equal to μV_{min} , where μ is the standoff ratio of Q_1 . Therefore, μV_{min} is the minimum allowable avalanche voltage of D_1 .

A suitable value for C_1 is easily determined experimentally. One or two microfarads has proven adequate for applications in which the load currents have been less than one ampere and the loads resistive or inductive. Capacitive loads require greater values of C_1 . If the load is noise-generating, it may be necessary to include C_2 to prevent triggering of Q_1 by noise pulses.

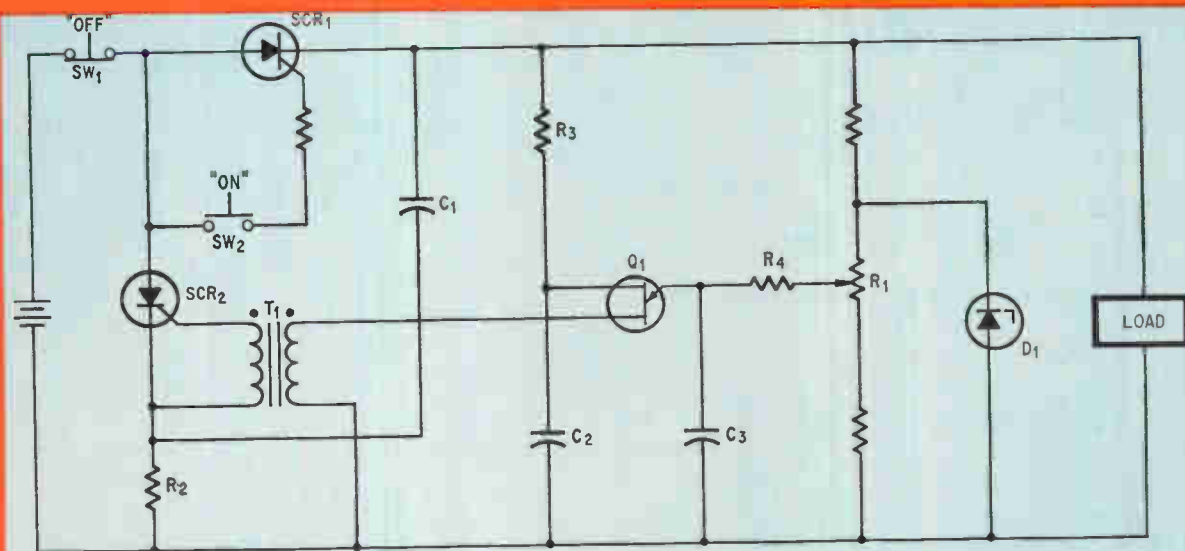

On and off. The actual switching function is performed by SCR₁. Automatic cutoff occurs when SCR₁ is triggered by the voltage-sensing UJT pulse generator, and the cutoff level is determined by R₁. The switches, SW₁ and SW₂, allow manual operation.

If visual indication of cutoff is desired and if a small continuing drain on the battery can be tolerated, R₁ can be replaced by a low-current incandes-

cent lamp, in which case SCR₂ must be chosen to have a sustaining current less than the lamp current.

Rule of thumb for ripple calculations

By Robert P. Owen

Berkleonics, Inc., Monrovia, Calif.

Power supplies operating from the available a-c line voltages usually depend on a large capacitor in the circuit for the reduction of ripple. By storing each half cycle of the supply—the half-wave rectifier will of course only store every other half cycle—the capacitor maintains a reservoir of current which the load can draw on. In most home appliances—televisions, radios and phonographs—the current requirements in the load are fairly constant, consequently the current drawn from the capacitor is limited to a narrow range. Ripple in the capacitor is dependent on the amount of current drawn from the capacitor by the load. It should be obvious that there would be no ripple if the load was disconnected and there was no current drawn

from the capacitor. On the other hand if the capacitor was completely emptied of charge every half cycle then the ripple voltage would be equal to the peak voltage on the transformer secondary.

Calculating the ripple in the output of a supply is a usually tiresome process that entails the use of one of the designers handbooks and the plotting of points in the graphs in the handbook. Peak-to-peak ripple voltage can however be easily calculated by a simple formula which was derived after a thorough examination of the power supply's operation.

In a full wave rectified supply operating from a 60 hertz line voltage the peak point of every half cycle occurs every 8.3 milliseconds—this number is attained when the number of half cycles, 120, is divided into one second. The charge current which appears as a spike when the power supply operation is being examined with an oscilloscope, is actually only 1.3 milliseconds wide. In the rest of the half cycle time, 7 milliseconds, the capacitor is being discharged into the load. As the discharge takes place, voltage on the supply capacitor, which is expressed by the familiar equation $E = Q/C$, is

dropping. The drop is expressed by the differential equation

$$dE/dt = CdQ/dt$$

where dE/dt = change in filter capacitor voltage.

$$dQ/dt = \text{change in capacitor charge due to load requirements}$$

$$C = \text{capacitance of filter capacitor}$$

Since C is a constant, the value of the supply's filter capacitor and the term dQ/dt can be expressed as current and the above equation is re-written as

$$dE/dt = I/C$$

If both sides of this equation are multiplied by dt the resultant equation

$$dE = Idt/C$$

shows the effect of current changes on the filter capacitor voltage. This fluctuation in the capacitor

voltage is the ripple voltage—the potentially interfering by-product. The time distance between the two limits in the capacitor voltage is 7 milliseconds; the previously mentioned discharge time of the capacitor. The peak-to-peak voltage on the capacitor is then related to load current by the equation

$$e_{p-p} = 7I/C$$

where e_{p-p} = peak to peak ripple voltage

$$I = \text{load current in milliamperes}$$

$$C = \text{value of filter capacitor in microfarads}$$

In a half wave rectifier the ripple voltage will be larger since the discharge time will be 14 milliseconds.

For power supplies operating from a 400 hertz supply the equation

$$e_{p-p} = I_{d-c}/C$$

expresses the relationship between ripple voltage and the load current.

Bridge and transistor are exclusive-or gate

By Robert C. Hoyler

Westinghouse Electric Co., Pittsburgh

Two gates and two inverters are usually necessary to build an exclusive-or gate, which satisfies the Boolean equation $Y = \overline{A}B + A\overline{B}$. The circuit output is 1 when either input A or input B is 1; there is no output when both are 1. By placing a diode bridge across a switching transistor's input, this gating can be realized by a simpler circuit.

If a logic bit having positive polarity appears at the A input when no information is presented to B, diodes D_1 and D_2 conduct. Current flows through the resistor R_1 and the base-emitter junction of Q_1 . This biases the transistor into saturation and makes its collector voltage fall from 4 volts to almost zero. The negative swing in the collector voltage is the output signal used to gate the following circuit. The diodes won't conduct if the input at B is the

same polarity and magnitude as that at A.

A positive input voltage at B will cause conduction in diodes D_3 and D_4 if no pulse is present at input A. Current flows through R_1 and the base-emitter junction of Q_1 as it did when D_1 and D_2 were conducting. Again, Q_1 is driven into saturation and a logic pulse is developed at the collector.

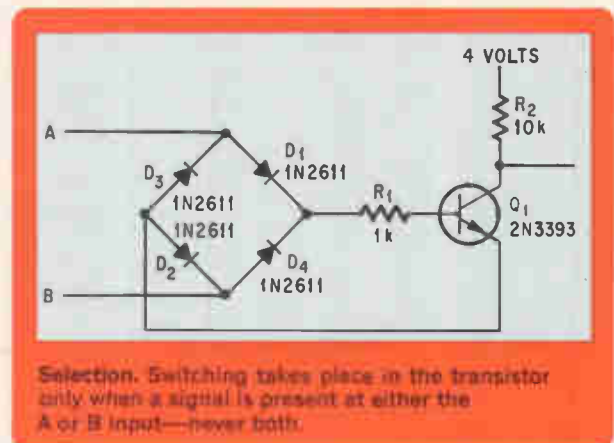

SYNCHRO-TO-DIGITAL

• 20,000°/second tracking • .01°/15 bit accuracy • binary or BCD

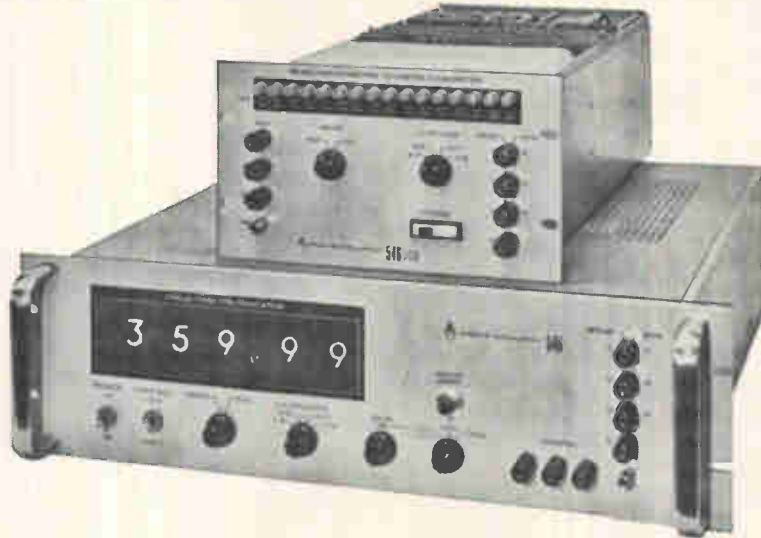

DIGITAL-TO-SYNCHRO

• 11 to 16 bits • accuracy to 30 arc seconds • 4 μ s data strobe

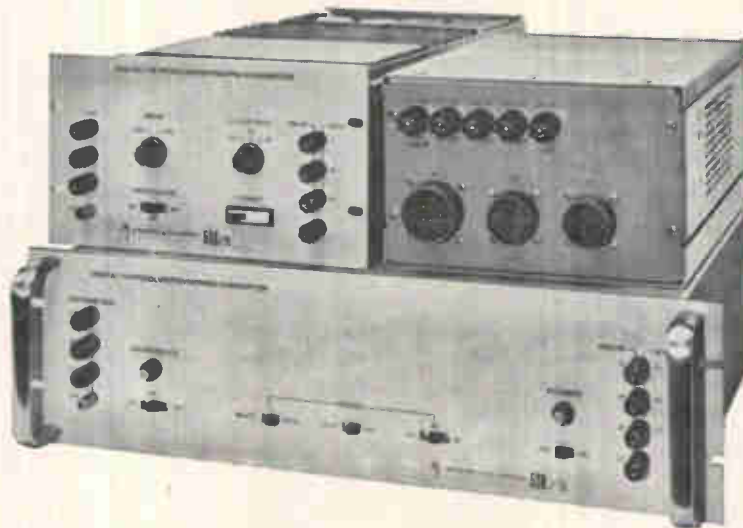

- low cost • all solid-state designs
- precision trigonometric transformers



NORTH ATLANTIC industries, inc. TERMINAL DRIVE, PLAINVIEW, NEW YORK • (516) 681-8600

Charting a simpler approach to lasers

Instead of plowing through equations, engineers can now use plots of component parameters to build or modify normal-mode pulsed systems

By S. Donald Sims and Lawrence Waszak

Biorad Inc., New Hyde Park, N.Y.

Choosing the essential elements for a pulsed ruby laser system has been something of a black art. Little data is provided by manufacturers on the components—crystal, lamp, reflectors—and application information is just about nonexistent.

Without guidelines, a designer can't build such a system or even modify one in a logical fashion.

Charts will be presented here that give the designer an insight into key component parameters and their effects on system performance.

These charts will enable him to easily design a ruby laser system for different pulse widths, and will permit him to calculate the necessary lamp power, ruby dimensions, and reflector requirements, plus predict laser output power and flash lamp life.

The normal-mode pulsed ruby laser is used primarily in systems requiring long pulse durations—0.1 to 20 msec—and relatively high peak power. It's used in such manufacturing operations as drilling, the welding of metals, and the machining of plastics and ceramics.

Also, since laser systems concentrate heat in small areas for short times, fine wires can be welded without destroying them.

The design of a normal-mode ruby laser depends on many interrelated parameters. The basic ingredients of the laser head system, on page 92, are a lamp that supplies enough energy to excite the atoms in a ruby crystal, a pulse-forming network to drive the lamp, a ruby crystal, and front and back reflectors that provide optical feedback. It's the mix of these ingredients—the juggling of limitations, compromises, and tradeoffs—that must be determined before the system's performance can be predicted and optimized.

First things first

Supplying energy to the ruby crystal in the proper pulse length is the designer's first consideration. This energy is generated by a single linear flash lamp in a focused enclosure. The use of multiple

lamps gains nothing—once the maximum loading is reached, the pumping solid angle of the lamps is reduced by the number of lamps used; the same loading per lamp must be maintained.

Xenon flash lamps have been found to be best in supplying this energy to the ruby crystal. Their efficiency in a 700-angstrom band centered about 5,600 Å—the pumping wavelengths used for ruby crystals—isn't strongly dependent on the lamp geometry, but does vary with power density.

The spectral efficiency of the lamps, η_s , ranges between 80 microwatts per angstrom output per watt input for small-diameter lamps with high power densities, and 120 microwatts per angstrom output per watt input for larger diameters that result in lower power densities. A typical design value for most commercial lamps is 100 microwatts per angstrom output per watt input.

The chart on page 92 plots the flash lamp's efficiency as a function of its diameter.

Radiance, a measure of the lamp's brightness, isn't greatly dependent on lamp geometry, either. It can be determined from the length of time the pump pulse is applied to the lamp and from the lamp loading factor, k .

The loading factor is the ratio of the operating lamp energy, W , to W_{max} , the maximum energy it can sustain before exploding. This upper limit depends on lamp dimensions and applied pulse width:

$$W_{max} = 1.2 \times 10^4 DL(T)^{1/2}$$

The relationship between lamp life and loading factor is as follows:

k	lamp life (hours)
1.0	0-10
0.7	10-100
0.5	100-1,000
0.4	1,000-10,000
0.3	10,000-100,000

Shedding some light

"Light amplification by stimulated emission of radiation" is a lot harder to say than "laser," but much more explicit. A laser system produces highly coherent light by using ordinary light to excite atoms and make them radiate at a certain wave-length.

A typical laser system is built around a rod of active material, such as ruby. Both ends of the rod are optically polished to produce a flat surface; one end is coated with a material that totally reflects light, the other with a substance that only partly reflects light. The light that is reflected at this end sustains the excitation; the light that isn't reflected forms the laser beam.

Pumping it up. The source of ordinary light, commonly called the pump, is usually a xenon flash tube. This light, which is directed onto the rod, raises the atoms in the ruby crystal from minimum-energy ground level to a band of higher energy. These energy levels depend on the characteristics of the active material.

The atoms then drop from this high energy level to an intermediate energy state. Then they return to the unexcited state and it is when they make this last transition that they emit light of a certain wavelength. The wavelength, like the high-energy level, depends upon the material used.

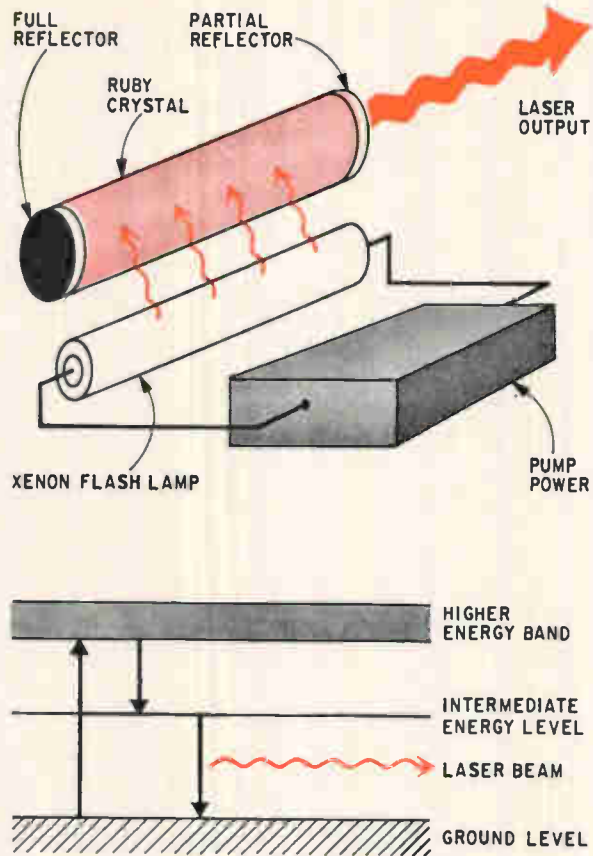

Lamp and pump

A linear flash lamp is similar to a mercury arc lamp; it has an electrode at each end of a xenon-filled cylindrical quartz tube with an inner bore diameter of D and length L . The spectral radiance, N , of such a lamp is given by:

$$N = \frac{\eta_1 W}{\pi^2 D L T}$$

Where W is the total input energy to the lamp in joules and $\pi^2 D L$ represents the light-emitting area in square centimeters of a lamp with a lambertian surface. T is the lamp pulse width in seconds, and η_1 is the spectral efficiency of the lamp.

The actual value of the radiance must take into account the loading factor, and can be written as:

$$N = 0.122 k(T)^{-1/2}$$

A lamp's light rays are reflected by the optically polished walls of its enclosure and are focused on the ruby. This light energy excites the atoms in the ruby and the process is called pumping. The pumping rate, P (atoms excited per second), is related to the flash lamp radiance by:

$$P = \frac{\sigma_p \Delta \lambda \Omega t R N}{h \nu_p}$$

where σ_p = interaction cross-sectional area for the

- pump process ($1.1 \times 10^{-19} \text{ cm}^2$)
- $\Delta \lambda$ = pump bandwidth (700 Å)
- Ω = light acceptance angle for an elemental volume of ruby (10 steradians)
- t = transmission into the ruby (0.93)
- R = pump reflector efficiency (0.8)
- $h \nu_p$ = pump photon energy (3.5×10^{-19} joules).

The factors, σ_p , $\Delta \lambda$, $h \nu_p$, and t depend on the ruby's characteristics, while Ω and R are properties of the pump enclosure. The values given are typical of cylindrical or elliptical focusing enclosures.

When these values are substituted into the previous equation, the pumping rate becomes:

$$P = 200k(T)^{-1/2}$$

The laser energy output in joules is given by:

$$E = p_o T_1 V$$

where T_1 (the laser pulse length) = $T - T_{th}$

T_{th} = time from the start of the pump pulse to the onset of laser radiation, and can be expressed as

$$T_{th} = \frac{1}{P + A} \ln \left(\frac{1}{\frac{P - A}{P + A} - \frac{\alpha_t}{\alpha_o}} \right)$$

T = lamp pulse width

V = ruby volume

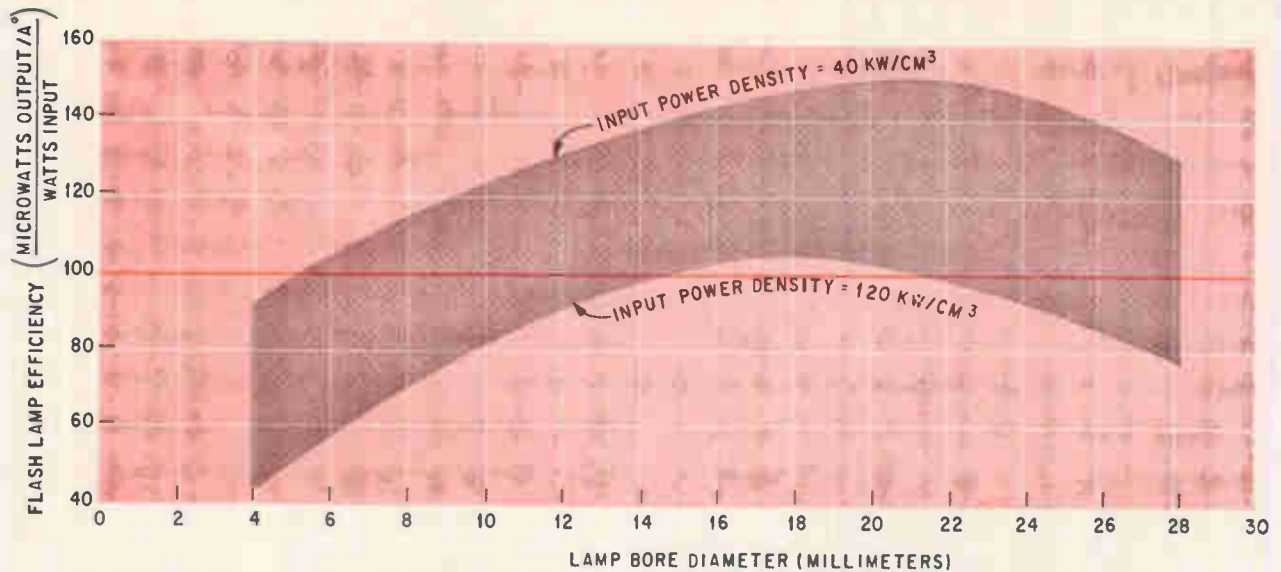

Spectral efficiency. Although the efficiency of xenon flash lamps depends somewhat on the bore diameter, the line shown in color represents a good design value for most commercially available lamps.

p_o = power output per unit volume of ruby.
 The power per cubic centimeter that can be extracted from a ruby operated in the normal mode is:

$$P_o = \frac{qh\nu}{2\sigma} \left[\frac{\alpha_t - \alpha_1}{\alpha_t} \right] \left[\alpha_o(P - A) - \alpha_t(P + A) \right]$$

where $h\nu$ = photon energy at the ruby wavelength

σ = interaction cross-section at the ruby wavelength

$h\nu/\sigma$ = 12 joules per square centimeter

A = Einstein A coefficient (350/second)

α_o = unpumped absorption coefficient (0.3 cm^{-1})

α_1 = scattering loss coefficient (0.01 cm^{-1})

α_t = gain coefficient for maximum output and is equal to

$$\alpha_t = \left[\frac{P - A}{P + A} \alpha_o \alpha_1 \right]^{1/2}$$

q = empirical factor used to match the predicted output to empirical results (0.8)

P = pumping rate.

Using the curves in the plot of the laser output energy-density, $p_o T_1$, for different pulse widths and loading factors on page 93, the energy density can be predicted for a given lamp pulse width and loading factor. The ruby's volume, the lamp, and the optimum output reflector are then selected.

To find the appropriate ruby volume, the desired output energy is divided by the output energy density determined from the design chart. For example, if 10 joules of energy were needed for 8-millisecond pulses, and the chart shows that a flash lamp operating at a loading factor of 0.4 will produce an output energy density of 3 joules/ cm^3 , then 3.33 cm^3 would be required for the output desired.

If a longer lamp life is desired, a smaller loading factor should be used. A loading factor of 0.3 would yield an output energy of 1.4 joules per cubic centimeter and necessitate a ruby volume of 7.2 cm^3 .

Finding a light

The lamp is chosen on the basis of surface area. In the focused pump enclosure, its image should have about the same surface area as the ruby.

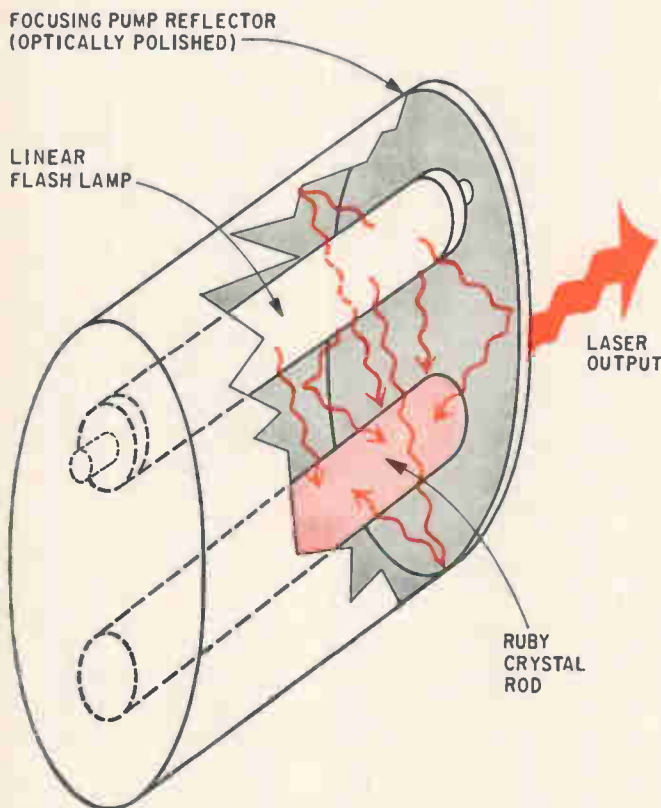

Head assembly. Locating the flash lamp and ruby crystal rod at the focuses of an elliptical reflecting cavity ensures that all the light rays emitted by the lamp will illuminate the rod.

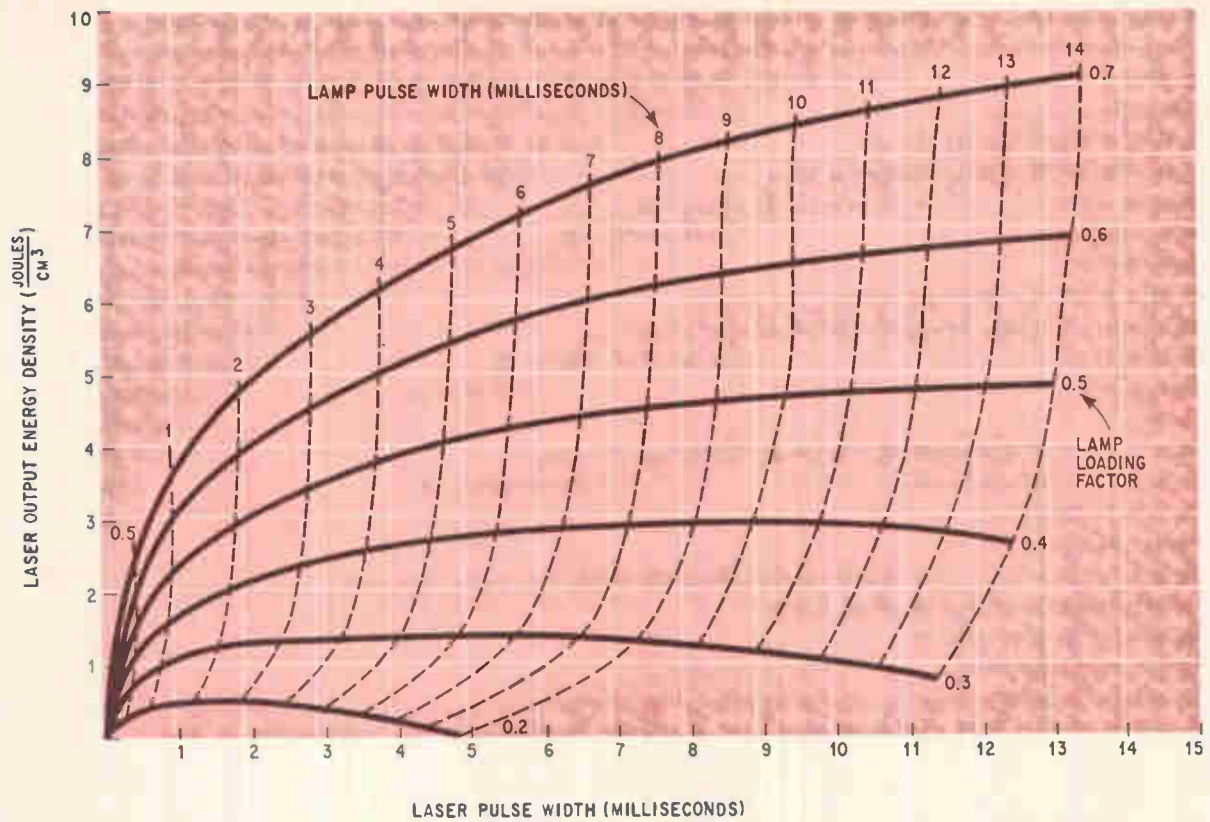

Output energy density. Lamp pulse width and loading factor yield laser output energy density and pulse width.

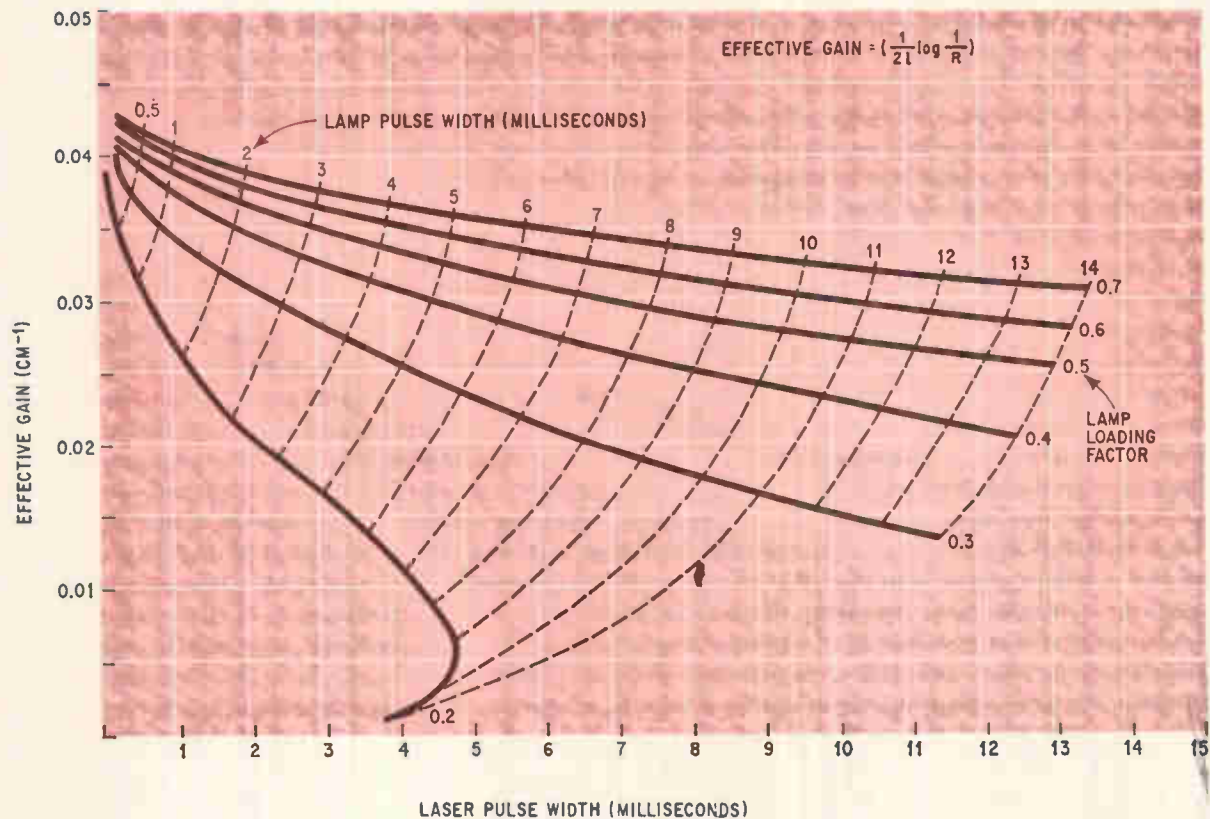

Reflectance. If the lamp loading factor and either the lamp's or laser's pulse width is known, this chart can be used to find the necessary effective gain. The length of the ruby rod is then substituted in the effective-gain equation to give the reflector requirements.

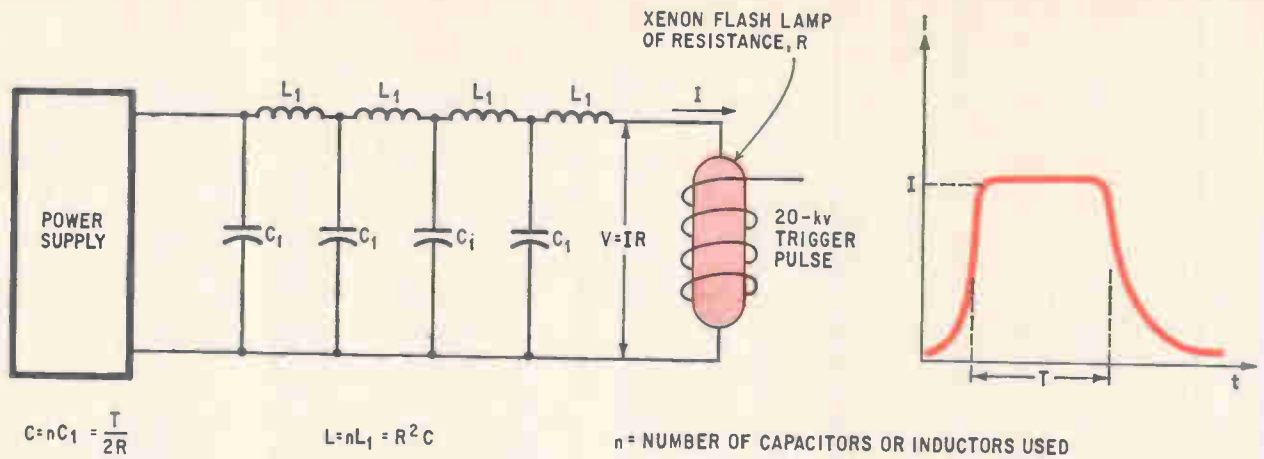

Pulse-forming network. This stores energy from the power supply and matches the lamp impedance to that supply. A trigger pulse ionizes the gas in the flash lamp and the stored energy discharges through the lamp.

If water surrounds the crystal, an emersion effect permits the use of a lamp that's 1.33 times larger in diameter (index of refraction of water = 1.33). The water surrounding the lamp has no net effect because the combined effects cancel each other out—the lamp image outside the water is 1.33 times as large, but its radiance is cut by that amount.

Cooling considerations dictate that the ruby crystal be of a relatively long length and small diameter. And flash lamps shaped this way offer the advantage of higher impedance. In practice, though, the lamps commercially available force a compromise.

Lamps of a small bore diameter may not reach the 10^{-4} design value of efficiency, while the large-diameter lamps usually perform above that level. To determine operating efficiency, the lamp's power density must be found by inserting the loading factor into the equation for W_{max} and dividing by the lamp arc volume, $\pi D^2 L / 4$. The power density, p_1 , of the lamp is then

$$p_1 = \frac{1.53 \times 10^4 k(T)^{-1/2}}{D}$$

Since the lamp's diameter, pulse width, and loading factor are known, the equation for the power density can be solved and the calculated value used with the design chart on page 92 to find the lamp's efficiency. For example, if a lamp with a 10-mm bore were operated at $k = 0.4$ and a power density of 40-kilowatt/cm³, the actual efficiency would be 1.25 times greater than the initial design value.

The system would thus be more efficient than originally predicted, and the designer would have the option of using this increased output or again going through the charts using the new information.

Reflections

When power is propagated through a ruby rod of length l , it's amplified by the factor $e^{(\alpha_t - \alpha_r)l}$. And if a sufficient amount of power is reflected through the ruby by the front and rear reflectors, R_1 and R_2 , oscillation will occur. The necessary condition for oscillation can be expressed as:

$$R_1 R_2 e^{2(\alpha_t - \alpha_r)l} = 1$$

The length here is expressed in centimeters. The rear reflector is unity in this design and the front reflector is adjusted for optimum output coupling.

For a given loading factor and pulse width, the effective gain required can be found from the design chart on page 93. The required reflectance, R_1 , is then determined by solving the effective gain equation for any given length of ruby rod. The value of R_1 is representative of the dielectric coating that's applied to the end of the ruby rod.

The remaining component is the energy-storing network that supplies the current pulse to the lamp. This network, shown above, consists of a number of series inductors and parallel capacitors arranged as a lumped constant equivalent of a transmission line with the characteristic impedance of $(L/C)^{1/2}$.

When the flash lamp is ignited by the trigger pulse, half the network voltage appears across the lamp and remains there for a time equal to $(LC)^{1/2}$.

The input energy, W , pulse width, T , and lamp dimensions completely specify the energy-storage network's capacitance and inductance, along with the lamp-burning voltage and current.

The resistivity, ρ , of the xenon flash lamp is related to the discharge current density, J .

$$\rho = 1.15(J)^{-1/2}$$

The resistivity is in ohm-centimeters and the current density in amperes per square centimeter. Current flowing through the lamp can be expressed in terms of the lamp's dimensions, pulse width and the input power by:

$$I = \left[\frac{0.77WD}{TL} \right]^{2/3}$$

The lamp resistance, R , is simply W/IT^2 , and the lamp-burning voltage, V , equals IR .

In a properly matched network, the capacitance is charged to twice the lamp voltage; the required capacitance is therefore $W/2V^2$ and the network inductance is R^2C .

JEDEC
Registered

PNP

SILICON POWER TRANSISTORS

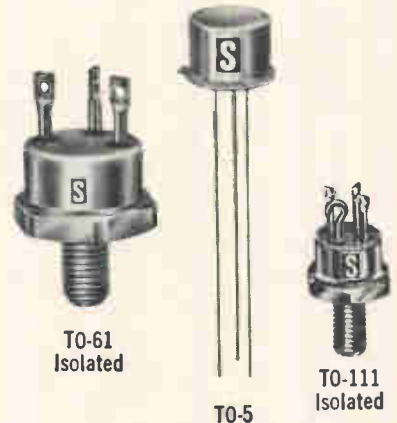

All devices have 100% Hi-Rel processing, including High Temperature Vacuum Bake, Temperature Cycle (-65°C to + 200°C), High Temperature aging (100 hours) and Fine and Gross Leakage Tests. JEDEC registered, these high reliability PNP transistors and their complements are immediately available from Solitron.

20 AMP Series

Type Number TO-61 Isolated	MAXIMUM RATINGS			PRIMARY ELECTRICAL CHARACTERISTICS (T _c = 25°C)					
	V _{CEX} Volts	V _{CEO} Volts	V _{EB0} Volts	h _{FE}		V _{CE(sat)} Volts	V _{BE(sat)} Volts	I _{CEX} μA	f _r MHz
				I _C = 20A V _{CE} = -5V	I _C = 10A V _{CE} = -5V	I _C = 10A I _B = 1.0A	I _C = 10A I _B = 1.0A	V _{CE} = Rated V _{CEX}	I _C = 1.0A V _{CE} = -10V
2N5312	-80	-80	-6	Min.	Range	Max.	Max.	Max.	Min.
2N5314	-100	-100	-6	5	30-90	-1.5	-1.5	10	30
				5	30-90	-1.5	-1.5	10	30

10 AMP Series

Type Number TO-61 Isolated	MAXIMUM RATINGS			PRIMARY ELECTRICAL CHARACTERISTICS (T _c = 25°C)					
	V _{CEX} Volts	V _{CEO} Volts	V _{EB0} Volts	h _{FE}		V _{CE(sat)} Volts	V _{BE(sat)} Volts	I _{CEX} μA	f _r MHz
				I _C = 10A V _{CE} = -5V	I _C = 5A V _{CE} = -5V	I _C = 5A I _B = 0.5A	I _C = 5A I _B = 0.5A	V _{CE} = Rated V _{CEX}	I _C = 1.0A V _{CE} = -10V
2N5316	-80	-80	-6	Min.	Range	Max.	Max.	Max.	Min.
2N5318	-100	-100	-6	10	30-90	-0.6	-1.2	10	30
				10	30-90	-0.6	-1.2	10	30

5 AMP Series

Type Number TO-5	Type Number TO-111 Isolated	MAXIMUM RATINGS			PRIMARY ELECTRICAL CHARACTERISTICS (T _c = 25°C)					
		V _{CEX} Volts	V _{CEO} Volts	V _{EB0} Volts	h _{FE}		V _{CE(sat)} Volts	V _{BE(sat)} Volts	I _{CEX} μA	f _r MHz
					I _C = 5.0A V _{CE} = -5V	I _C = 2.0A V _{CE} = -5V	I _C = 2.0A I _B = 0.2A	I _C = 2.0A I _B = 0.2A	V _{CE} = Rated V _{CEX}	I _C = 0.2A V _{CE} = -10V
2N5404	2N5408	-80	-80	-6	Min.	Range	Max.	Max.	Max.	Min.
2N5405	2N5409	-100	-100	-6	5	20-60	-0.6	-1.2	10	40
2N5406	2N5410	-80	-80	-6	5	20-60	-0.6	-1.2	10	40
2N5407	2N5411	-80	-80	-6	10	40-120	-0.6	-1.2	10	40
		-100	-100	-6	10	40-120	-0.6	-1.2	10	40

Dial 1-800-327-3243 for a "No Charge" telephone call and further information

Solitron DEVICES, INC.
1177 BLUE HERON BLVD. / RIVIERA BEACH, FLA / (305) 848-4311 / TWX: (510) 952-6676

FDR: a new deal for faultfinders

Frequency-domain reflectometry pinpoints defects in microwave systems at actual operating frequencies and can be used to test waveguide links

By James D. Thompson and Alden Hart

Alfred Electronics, Palo Alto, Calif.

Time-domain reflectometry, or TDR, is widely used to find defects in microwave transmission and antenna systems, but it suffers from two serious drawbacks. These are eliminated, though, in a new technique called frequency-domain reflectometry.

TDR can't perform its analyses at the actual operating frequencies of the microwave system. It uses pulses rather than sine waves, and the characteristics of the pulses—not the system under test—determine the frequency spectrum that must be used in the test. "Faults" turned up by TDR may not even be within the system's frequency range.

The older method's other drawback is that it requires a system that can pass a fundamental frequency on the order of a few megahertz, as well as its harmonics, which may reach well over 12 gigahertz. This wide frequency range makes it impossible to use TDR on waveguide systems and filter-equipped band-limited transmission systems.

Frequency-domain reflectometry, or FDR, on the other hand, pinpoints defects by sweeping a band of frequencies into the system and analyzing the reflected returns. The frequencies lie within the operating band of the system. FDR is based on the fact that microwave energy is partially reflected by a line defect or termination mismatch.

FDR has been developed as a new application for Alfred Electronics' 8000/7051 sweep network analyzer. Tied in with a sweep signal generator and microwave sampling equipment, the analyzer can find faults in cable systems aboard ships, aircraft, and missiles, and can test antenna transmission lines, delay lines, and radio-frequency distribution systems. The signals caused by reflections from the defect are displayed on a cathode-ray tube. FDR is being used at frequencies between 200 Mhz and 40 Ghz, and this range can be extended.

Testing a transmission system with FDR is a two-step process. First, a quick check is made to see whether the system does suffer from a fault

or mismatch. This is done by using the setup shown on page 97 to make swept-frequency measurements of either insertion loss at the output or return loss at the input. If an out-of-spec condition is found, the next step is to pinpoint its location.

For insertion-loss measurements with both the input and output connectors accessible, the network analyzer indicates the ratio of output power to incident power. If, however, either of the connectors isn't accessible—as on a mast antenna cable aboard a ship, or on a cable to a distant superstructure point in an airplane or missile—the return loss is measured and the network analyzer indicates the ratio of reflected power to incident power. In either case, the readout is direct and in decibels.

Taking a ratio of the output or reflected power and the incident power automatically compensates for any power variations of the sweep generator across its band, giving a true graph of performance in db versus frequency on the analyzer crt. The instrument provides a readout over a 60-db dynamic range, so that even long cable systems with high losses can be measured. Typical displays of insertion and return loss are shown on page 98.

Pinpointing troubles

To make the fault location measurements and measure the length of a cable, a waveguide or coaxial tee junction is added to the insertion-loss setup, as shown on page 97. The cable under test is connected through the tee.

At high frequencies, the source and the point of reflection are separated by many wavelengths. However, if the frequency is not fixed but swept by the sweep oscillator across a band, the number of wavelengths in the system changes. And, at a crystal detector connected through a tee to both the sweep oscillator and the transmission system or cable, out-of-phase and in-phase conditions for the direct and reflected signals will alternate continuously.

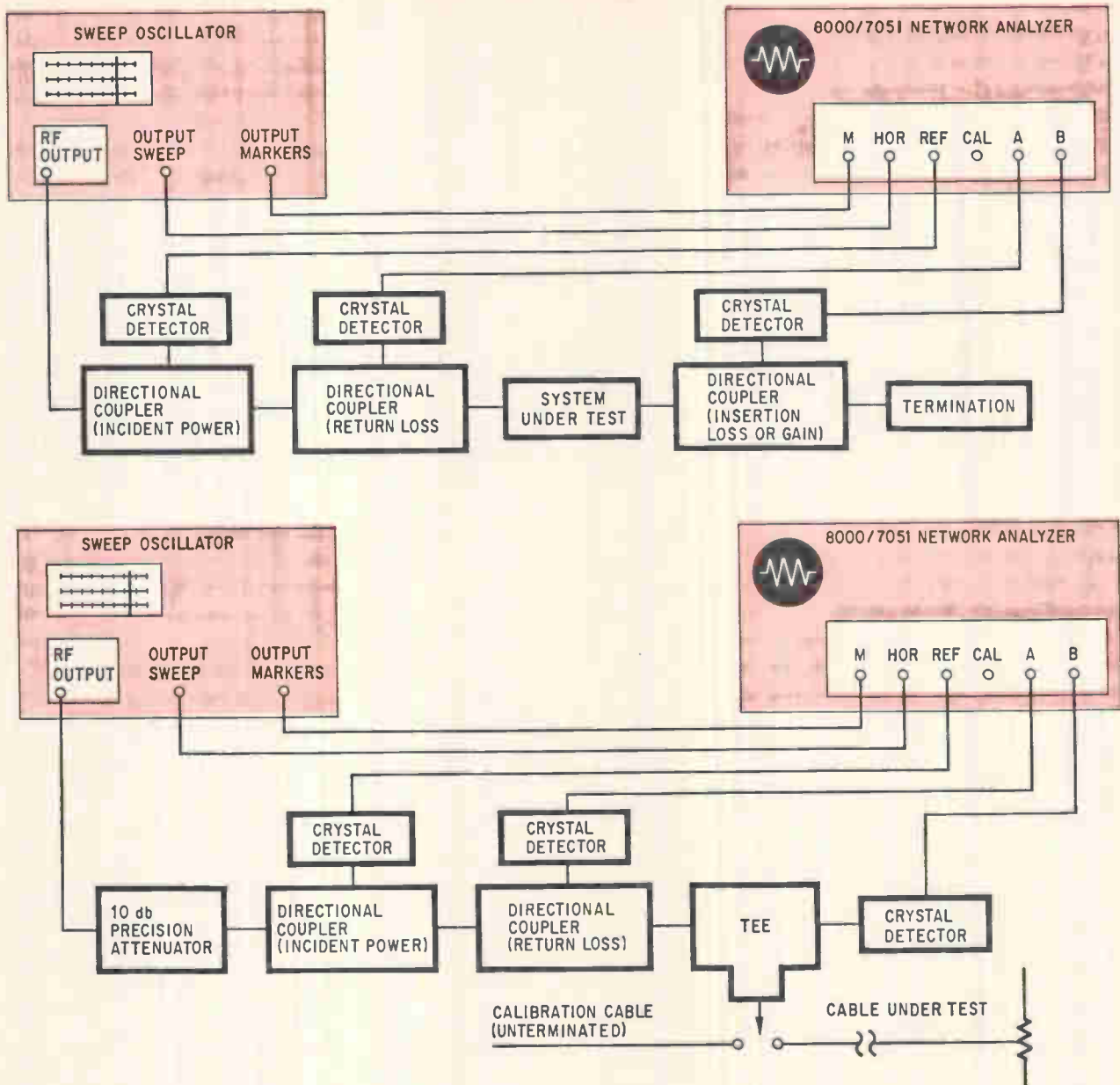

Test and retest. Standard return and insertion-loss measurements are made with Alfred 8000/7051 sweep network analyzer, top, to indicate whether faults exist. A measurement tee is then substituted so frequency-domain reflectometry tests can be made, bottom.

The reflected power combines with the incident signal at the detector with a phase relation that varies with both distance to the discontinuity and signal frequency.

As the frequency is swept, the number of wavelengths between the tee and the point of reflection varies. The display consists of amplitude "ripples" caused by the summing of the incident and reflected signals.

This display of the varying-magnitude signal is actually a logarithmic presentation of the standing-wave ratio. The ripple peaks are adjacent voltage standing-wave ratio maximums that occur at each frequency during the sweep at which the round-trip length of the reflected wave path has changed by one wavelength. The number of ripples appearing across the full width of the display

(which is inversely proportional to the frequency separation of adjacent ripples) indicates the distance from the fault to the crystal detector. The distance can be read directly from the crt when the sweep generator has a sweep width (ΔF) that calibrates the display in "ripples per foot."

Making measurements

With the FDR test setup, shown above, the only variable that must be adjusted is the sweep width, ΔF . The simplest way to set it is to use a calibration cable with the same propagation constant as the cable to be tested.

For example, if a 10-foot-long cable is used, and the sweep width is adjusted so that 10 complete ripples appear on the crt, the display is calibrated to 1 foot of cable per ripple. Similarly, a ΔF set-

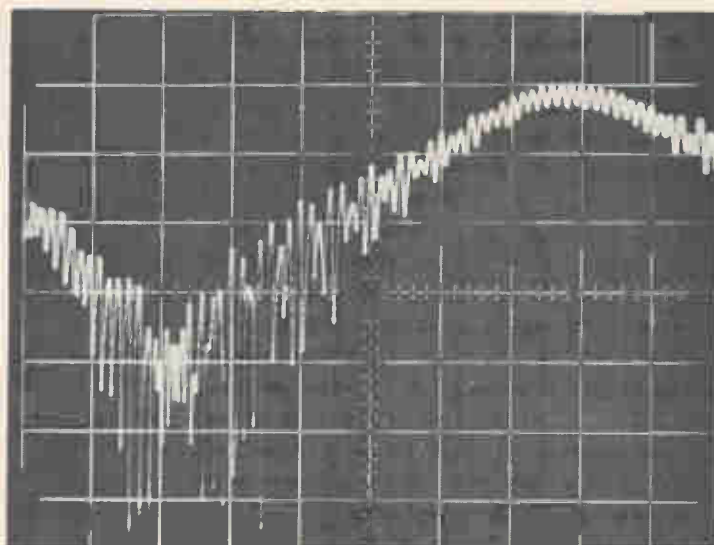
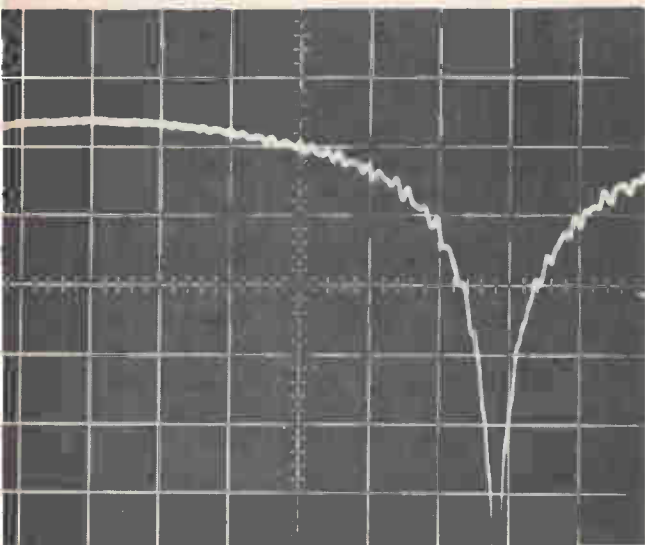

Losses. Insertion loss, left, is greater than 35 decibels at 3.56 Ghz, indicating a fault. Return loss, right, is 11 db.

ting with the same cable that produces 5 ripples on the display means the calibration is set at 2 feet per ripple, and 2 ripples on the display set's calibration at 5 feet per ripple.

The calibration cable is simply a convenient way to set ΔF without a cavity wavemeter. For example, ΔF settings of 324 Mhz, 162 Mhz, and 64.8 Mhz could be used for calibrations of 1, 2, and 5 feet per ripple, respectively. The cable's propagation constant, K , is 0.659.

With ΔF set, the instrumentation is ready. The cable to be tested is connected to the measurement tee in place of the calibration cable. If cables with different propagation constants are being tested, the ΔF adjustment doesn't have to be changed; the number of ripples need only be multiplied by the ratio of the new propagation constant to the constant of the calibration cable.

The form of the ripple displays varies with cable conditions. For example, unterminated RG-58/U coaxial cable in good condition has a display like that shown below, left. Putting a crimp in the cable produces a more complex display, as shown below, right. The crimp, barely discernible to the eye, becomes immediately apparent on the scope.

If the cable system is terminated in a match or near-match, very little power is reflected from the termination. Thus, the ripple pattern is due to discontinuities only. If a transmission system has a filter, measurements of return and insertion loss will indicate some sort of discontinuity, as shown on page 99. However, the display, using sweep frequencies centered well above the filter's cutoff frequency, pinpoints the discontinuity, as shown above. In other words, sweep frequencies can be selected to ignore the presence of path filters. In this

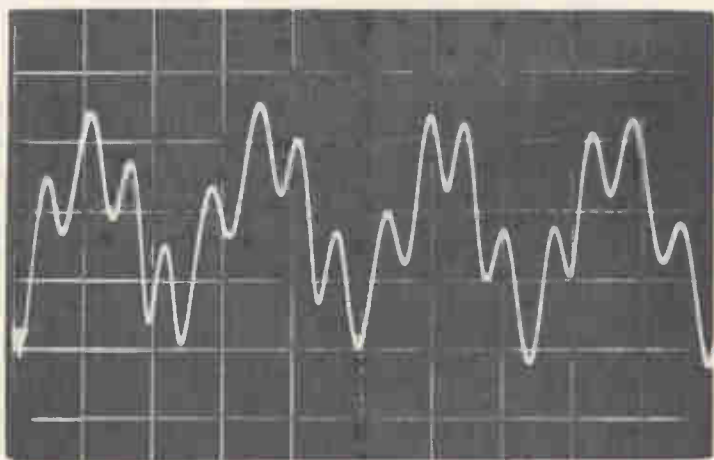
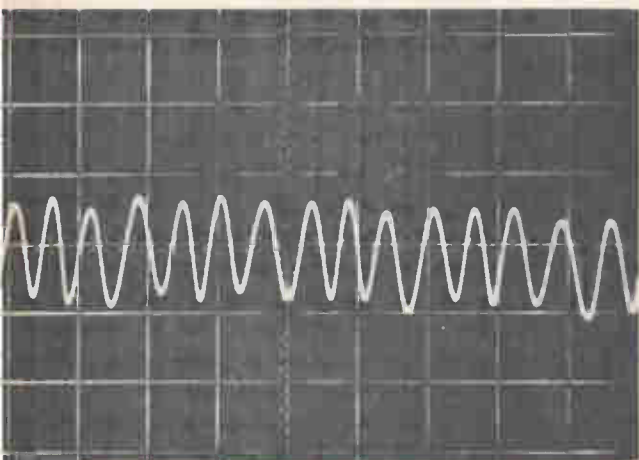

Good and bad. Display from 32-foot 4-inch length of open RG-58 U coaxial cable indicates, with 2-feet per ripple calibration, that cable is 32 feet 6 inches long, left. Accuracy is typically better than 5%. The display is affected if the cable is crimped 8 feet from the measurement end, right. The pattern has two parts: 16+ ripples superimposed on a four-ripple pattern caused by the crimp and indicating a fault at the 8-foot point.

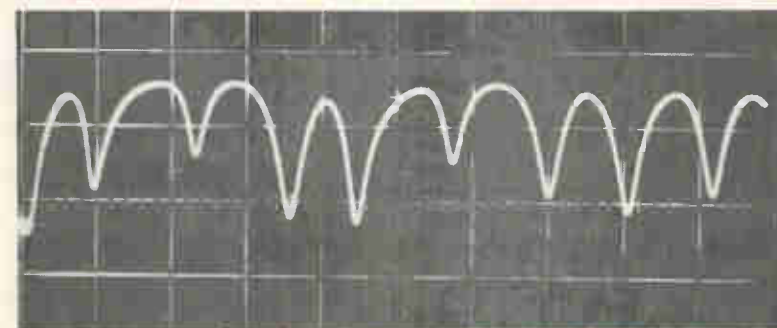
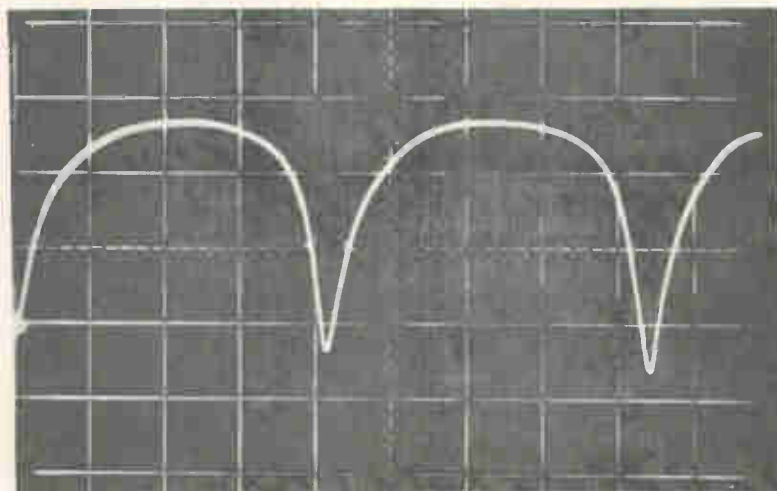
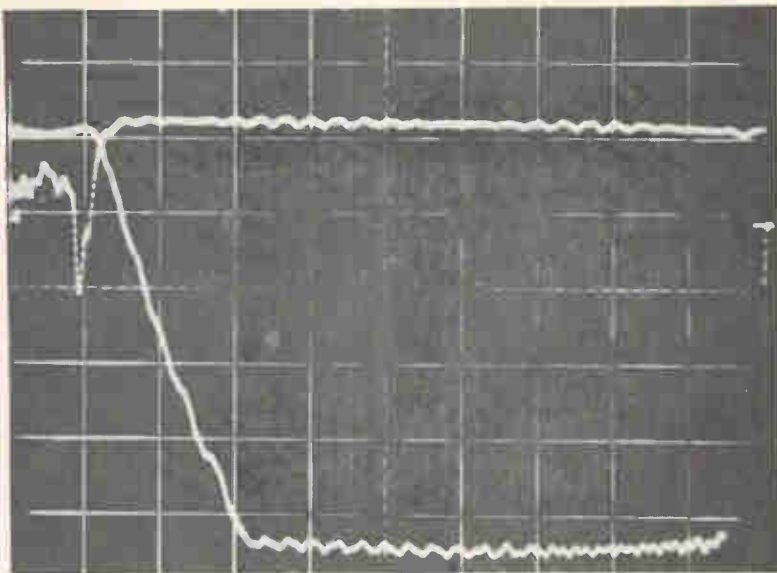

Pass filter. In upper photo, return loss (top) and insertion loss (bottom) indicates a 2.15-GHz pass filter in the cable, whose distant end is open. With the sweep centered at 2.6 GHz and calibration at 2 feet per ripple, $2\frac{1}{3}$ ripples indicate that the filter is $4\frac{2}{3}$ feet down the cable, center. With sweep at 2.1 GHz, display of $8\frac{2}{3}$ ripples indicates that open-end discontinuity is $17\frac{1}{3}$ feet distant, bottom. Short skirts on two of the ripples, coinciding with the two ripple peaks in the center photo, indicate a slight mismatch at the filter below the cutoff.

case, the cable has a 2.15-GHz low-pass filter. The part of the cable from the tee to the filter is checked with frequencies well above 2.15 GHz and the part to the antenna with frequencies below 2.15 GHz, as shown above.

The amplitude of the ripple can also indicate mismatch magnitude, if a constant-amplitude sample of incident and reflected power is fed through the tee to the crystal detector. If a leveled sweep oscillator or a ratiometric display is used to make the system lossless and free of incident power variations, the peak-to-peak ripple amplitude presented in db is the logarithmic standing wave ratio (swr).

The swr can be converted to numerical vswr by using the equation:

$$vswr = \text{antilog} \frac{swr \text{ (db)}}{20}$$

With the vswr known, the return loss is determined from the equation:

$$\text{Return loss} = -20 \log \frac{vswr - 1}{vswr + 1}$$

If the transmission system isn't lossless, the return loss calculated must be increased by the round-trip transmission loss in db.



Advanced technology

Flexible thin-film transistors stretch performance, shrink cost

Ability to deposit insulated-gate field effect transistors on a variety of substrates promises continuous manufacturing process with high yields, and new applications

By Peter Brody and Derrick Page

Westinghouse Research Laboratories, Pittsburgh, Pa.

Continuous batch processing, higher powers, and lower costs are in the offing for thin-film transistors. The secret's in that oft-neglected design variable—the substrate. Until now, comparatively rough substrates have been ruled out for insulated-gate field effect transistors. Instead, it's been customary to use brittle substrates—such as glass, sapphire, alumina, or quartz—and polish them before deposition. Those constraints may be eliminated by a Westinghouse Research Laboratories process that has been successfully used to fabricate thin-film transistors on a wide variety of flexible substrates, including Mylar tapes, cellulose acetate film, polyimides, anodized metal foils, and even rough-textured paper.

The primary advantage is the ability to prepare transistors by a quasi-continuous process in which a roll of substrate material winds through a vacuum-enclosed printer. Inside the vacuum chamber the

roll pauses for several minutes while the various transistor layers are deposited, then moves to the next "frame". To date, two types of masks have been used, one to deposit 100 transistors, the other to deposit 658, each on one-inch-square areas.

Since capacitors, resistors, and interconnections can readily be prepared by the same techniques, the Westinghouse development should permit the continuous fabrication of integrated circuits on flexible substrates as well as testing and "encapsulation" without breaking vacuum. Because atmosphere contaminants could be kept out and successive process steps held to a maximum of 8 and 10 depositions, expectations are of very high yields, perhaps approaching 100%.

By opening up a greater variety of substrates, the process makes it possible to use materials with better heat conducting properties. For example, a tellurium transistor fabricated on an anodized

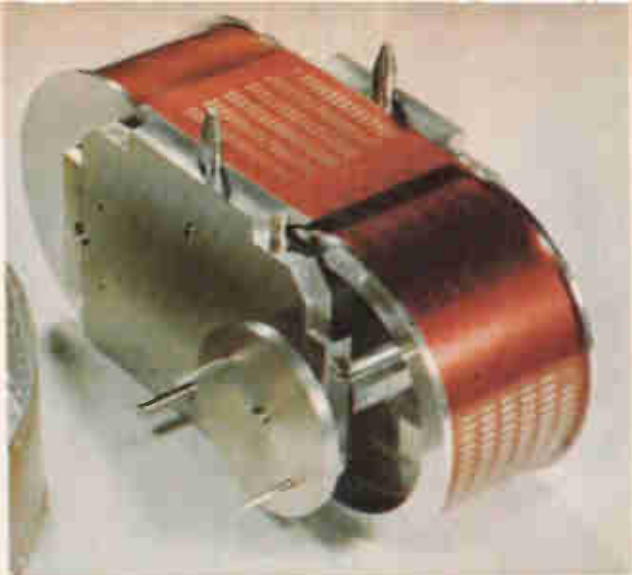

Results achieved with flexible transistors:

- $g_m = 6000 \mu\text{mhos}$ at 4 ma
- $\frac{g_m}{2\pi C_g} = 60 \text{ Mhz}$
- Source-drain voltage $> 200 \text{ v}$
- Over 1,000 hrs drift-free operation
- 1 watt dissipated in small device on aluminum foil
- Operation up to 150°C
- Transistors can be flexed and cut

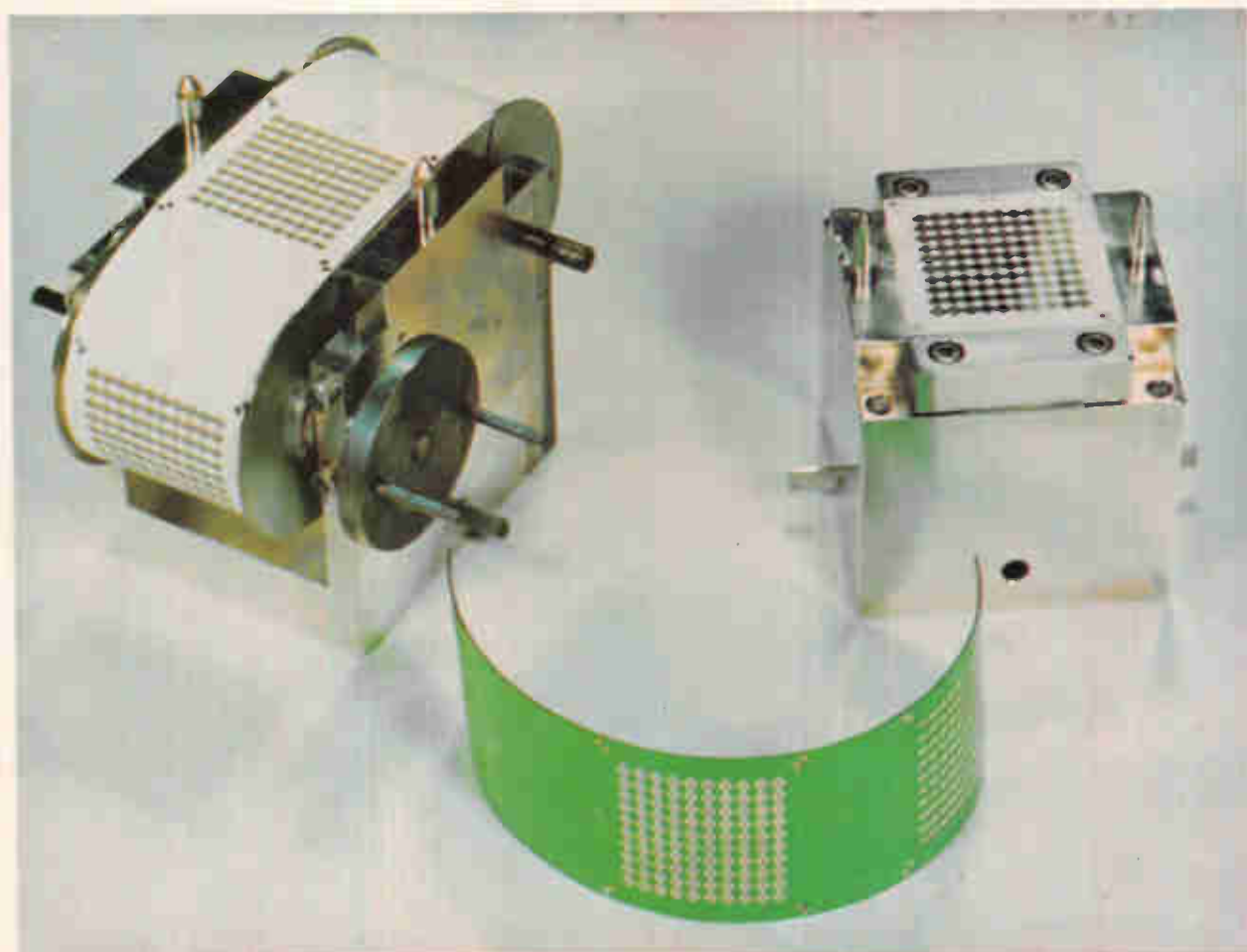

Colorful amplifiers. Red substrate contains array of 100 thin-film transistors; green substrate has 658. Both types of masks are positioned between pins of the supply spool, which is placed in a vacuum chamber.

aluminum substrate dissipated a watt of power. Since the device's channel dimensions were 0.5 by 30 mils it handled power densities greater than 60 kilowatts per square inch.

Another advantage is the ability to use inexpensive bases for transistors in many applications where cost is now prohibitive—in toys, novelties, hobby kits, and teaching aids, to name a few. Provided high powers, frequencies, and temperatures aren't called for, such devices could be deposited on paper.

Cut down to size

Success of the process stems from the fact that both smooth and rough substrates present surfaces comparable to thin films on an atomic scale. Surface irregularities which really matter are about 50 to 100 angstroms across, usually. The roughness of the new substrates, visible under a light microscope, appears to a thin film as a gentle undulation.

However, with very rough substrates, such as fibrous paper, it's advantageous to first deposit a



Continuous. Without breaking the vacuum, transistors can be made on a variety of substrates wound on spools.

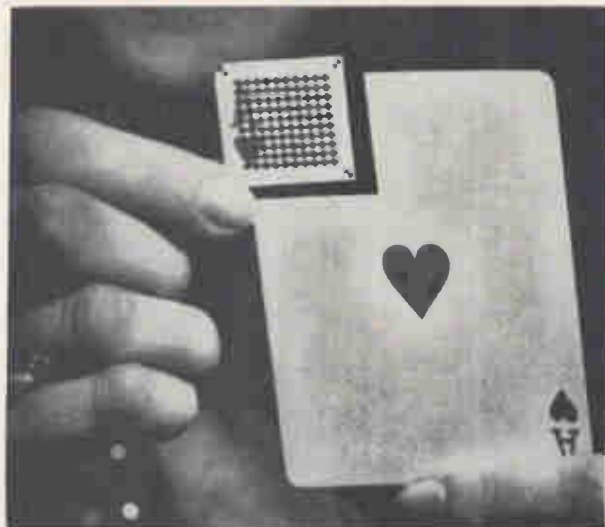

Ace card. Deposited on the surface are 100 transistors.

layer of glassy material about a fraction of a micron thick before fabricating the transistors.

Initial efforts were made with small squares of paper as substrates. Early transistors on these bases were placed in breadboard circuits to make an 8-Mhz oscillator. Researchers found that the thin-film transistors could be bent repeatedly into radii as small as 1/16 of an inch without changing operating characteristics. And they also discovered that the transistors could be cut in two so that each half still continued to function.

Like other thin-film transistors, the Westinghouse devices have low resistance contacts at the source and drain and a metal gate electrode separated from the semiconductor by an insulator. All but a few devices so far have been fabricated with tellurium, a p-type semiconductor. And most are operated in the enhancement mode so that when the

insulator gate is positively biased there is virtually no current flowing from source to drain. In fact, leakage currents for a typical 40-mil-wide tellurium transistor are a few microamps, and below a microamp for cadmium selenide transistors.

Many of these devices performed stably for over 1,000 hours and did not suffer from drift although the gate insulator was fabricated with silicon monoxide. This material has plagued thin-film transistor designers because it can trap electrons or positive ions, and produce changes in threshold voltage with time. Westinghouse is also investigating other types of gate insulators.

Gain bandwidth products as high as 60 megahertz have been achieved with these devices. This figure is arrived at by dividing transconductance by input capacitance. It's expected that the tellurium transistors will eventually have gain bandwidth products of 200 to 250 Mhz.

In the 100-transistor array there are 10 rows of 10 transistors whose channel widths are all the same, 40 mils, but whose lengths range from 10 mils to .4 mil, (10 microns).

The best transconductance obtained with a 10-micron-long transistor was 6,000 micromhos at 4 milliamps drain current. Other transistors have been built, which are capable of sustaining source-drain voltages of over 200 volts. The transistors will operate at up to 150°C ambient temperature. The gm's of comparable devices don't vary by more than 20%, an encouraging figure for these early experimental versions, considering that a gm spread by a factor of 2:1 is considered acceptable in a production run.

Cooling off

Like conventional thin film transistors, these flexible devices can't handle as much power nor operate at as high frequencies as large area bipolar transistors. The power handling is limited by the small cross-section available for current in field effect devices. This raises the impedance. For the best power-frequency capability, the transistor should operate at low impedance level.

However, fabricating these devices on substrates that dissipate heat better than the traditional glass substrates increases their power handling capability and may affect performance in other ways, for example, it may raise their cut-off frequency. It is likely that some of the instabilities associated with conventional thin-film transistors arise from the excessive heat developed in the active region. Hopes are to get about a watt and a half audio output by either paralleling the thin-film transistors or by fabricating a larger device. And eventually 10 to 15 watts at audio frequencies are expected.

Various circuits, including cascade amplifiers, down converters, and oscillators, have been built with paper-based transistors. These have been passivated with silicon monoxide and then operated satisfactorily without being encapsulated.

Work has begun on an integrated circuit audio amplifier and a simple I-C logic gate. Resolution

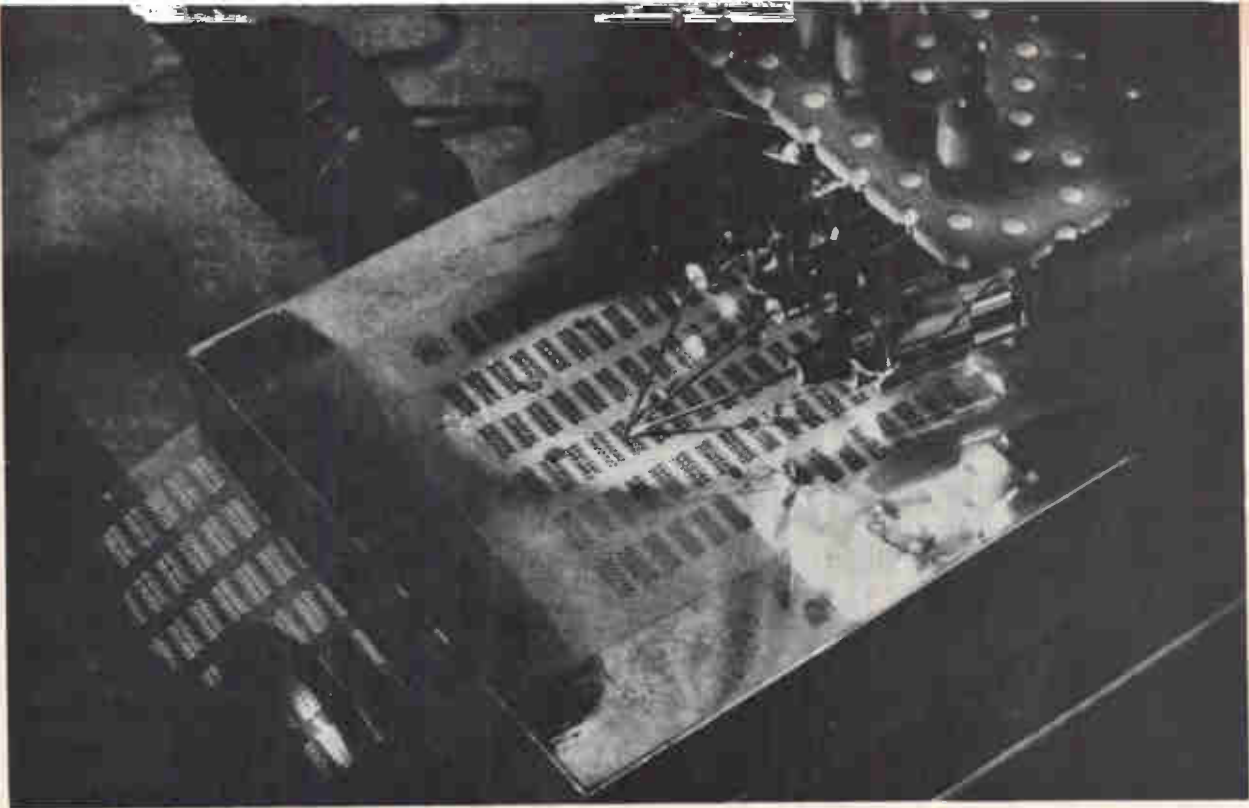

On-line testing. After a frame of 658 tellurium transistors is deposited on this Mylar substrate, test probes in the vacuum chamber contact the devices' three terminals as a check on fabrication.

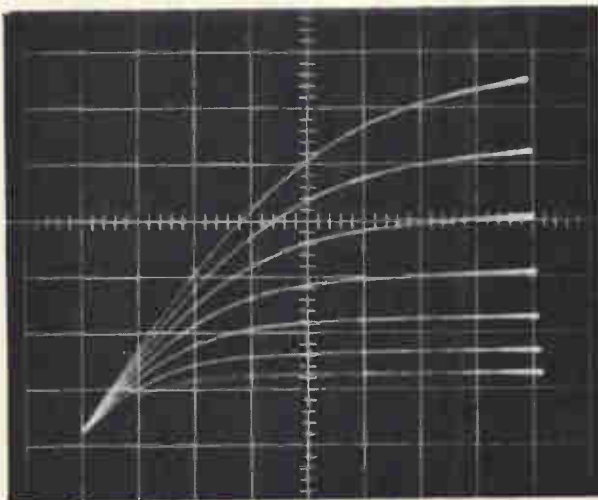

Source-drain characteristics. For a half-watt device, results are shown on a scale measured by 2 milliamps/division vertically and 5 volts/division horizontally.

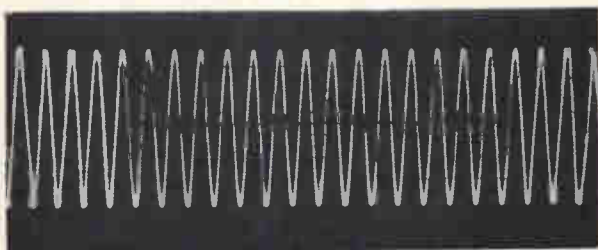

Waveform. The performance of 4-MHz oscillator circuit containing a paper transistor is shown with a peak-to-peak output of 1.4 volts.

limits of the Westinghouse process are similar to those of silicon technology. For example, engineers have consistently aligned a 10 micron gate region over a 10 micron source-drain gap with one micron accuracy. An accuracy of 2 microns is typical for commercial silicon devices.

Thus it is possible to pack thousands of thin-film transistors and passive components in a small area. However, this will probably be the exception rather than the rule with devices deposited on flexible substrates. The potential saving from inexpensive substrates and continuous fabrication will enable designers to use larger areas, thereby avoiding the expense of high density and high resolution masks. Typical channel lengths of the transistors will probably be 5 to 10 microns and widths will range up to several tens of mils.

Not ready to market

Although the "flexible" transistor looks very promising, it is still in the early stages of development and won't be available commercially for several years. For while the performance is generally comparable with silicon metal-oxide-semiconductor devices, leakage currents tend to be larger and turn-on voltages vary over a wider range than that achieved in silicon technology. Better gate insulators and improved control of the semiconductor-insulator interface properties are some of the improvements that must be made. It's likely that the Westinghouse thin-film transistors will eventually supplement silicon integrated-circuit technology by being fabricated on unusual substrates and in systems where flexibility or coverage of large areas are advantages.

Visual inspection of IC's boosts reliability at little cost

Vendors and users can agree on manufacturing specs and test criteria to weed out latent failures before fabrication is completed

By William R. Rodrigues de Miranda

Raytheon Co., Communications and Data Processing Operation, Norwood, Mass.

Between the minuscule failure rates of space electronics and the laissez-faire reliability of consumer electronics lies a vast region of medium reliability. For the equipment in this region, costs are as important as reliability; a no-holds-barred attack on failures would be as impractical as ignoring them. A maker of such equipment must let product cost determine the extent of his reliability effort.

Integrated circuits need special attention, not only because of their complexity but also because of the difficulty of finding potential faults through black-box testing. And as IC's become more prevalent in equipment, the product's reliability becomes more dependent on that of the IC.

Many equipment makers became acutely aware of the need for this special attention when they started to use IC's in large quantities. The quality of workmanship in the circuits they bought led to serious dissatisfaction. Users have attacked the problem in a variety of ways [Electronics, May 13, p. 88], but the Raytheon Co. recently devised a unique approach: it goes beyond performance specifications to fabrication specs that the vendor can meet through visual checks at little or no additional cost.

Every IC manufacturer, of course, has his own criteria for judging the acceptability of his product before it's shipped. The trouble is, these criteria were created by the manufacturer; with his concern about yield and cost, he can hardly be regarded as a disinterested party. The reliability record of manufacturer-tested IC's is impressive in many cases, but the maker is still most interested in getting the product through its electrical tests. And devices that pass these may have latent failure mechanisms that come into play later.

Here is where the user's task begins. He has recourse to two basic methods of weeding out

latent failures. One way is to produce an actual failure from the latent mechanism by accelerated testing—burn-in, temperature cycling, and thermal shock, for example. The other method is to pick out failure-prone IC's before fabrication is completed.

This second method is something new for IC buyers. It's effective because many failures are caused by manufacturing defects easily visible through a microscope. Defective units can therefore be identified by visual inspection of the IC's during the manufacturing process. IC manufacturers have done this for years, but visual inspection hasn't been performed to the customer's specification at low cost.

Part of contract

Raytheon has specified how the IC is to be constructed and what level of workmanship is acceptable. The document containing this information has become an important part of Raytheon's contract package.

The universal specification the company is now using opens with a statement of material and process requirements. It then gives "Detail requirements for acceptable construction." This section contains stipulations on the layout of the circuit and on its internal and external structural design. The last section, "Detail requirements for acceptable workmanship," is the part most often violated as a result of human error.

In its present form, the specification applies to digital monolithic circuits. However, it's being adapted for hybrid and monolithic linear circuits. The requirements will be slightly different. Hybrids will need criteria for conductive, resistive, and capacitive films. Linear IC's may need more stringent criteria for contamination, because parameter variations are more critical in these circuits.

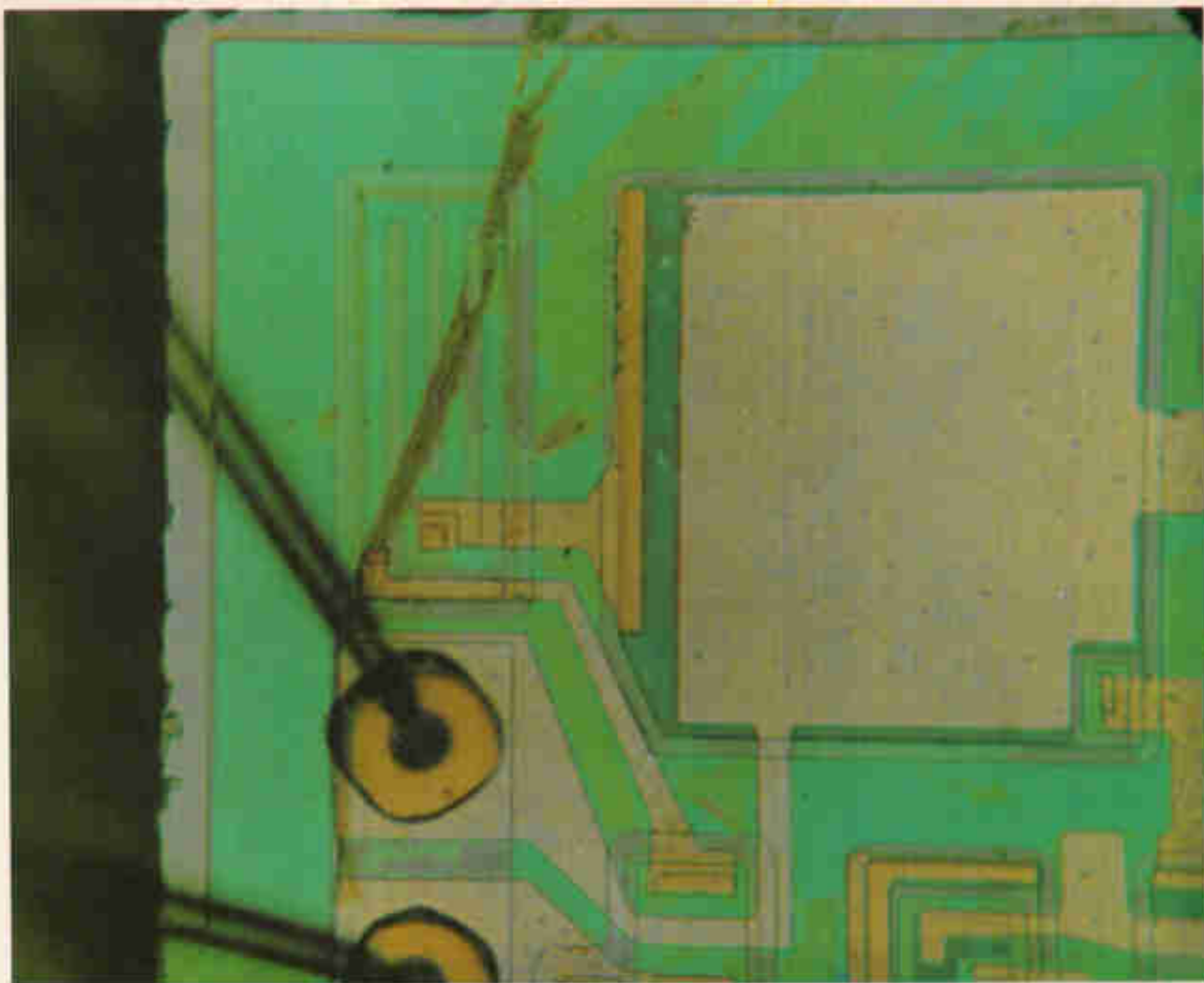

Two strikes. The variations in color from blue to green on the oxide surface indicate poor process control. A more critical cause for rejection in this IC is the gold smear across the top left of the chip. This smear became a conductive path and caused a diode elsewhere on the chip to burn out.

Stipulations for materials and processes are similar to those in most MIL specs—the parts must be new, unused, and undamaged, for example. And if the manufacturer discovers faulty or nonconforming materials, he must correct the defect and immediately report to the customer.

But Raytheon has established additional requirements, related directly to its goals as an equipment manufacturer. Corrosion resistance is an example. The metals used for leads, studs, and cases must be either inherently resistant to corrosion or plated or treated. Plating must not be removable by normal handling, or by the environmental extremes spelled out in the applicable specification control drawing.

A monometallic system of connections to the IC metalization is not required, although it's definitely preferred. The spec merely requires that the reliability and performance of the IC not be affected by intermetallic effects such as purple plague (which can cause bonds to weaken and ultimately fracture). If the manufacturer wants to use an intermetallic system—gold-aluminum wedge bonds, for instance—he must demonstrate in the form of data that these bonds are at least as reliable as conventional

ball bonds and that his bonding process is closely controlled.

Once the manufacturer has established his processes, and once it has been shown that the product is reliable, no changes can be made that could introduce uncertainty. Accordingly, certain parameters and processes are defined as critical. For example, the resistivity of the epitaxial layer may not be changed by more than 20%, and there may be no change in material or deposition method used for metalization.

If the vendor feels that a major change is warranted, he must notify both the customer and, to minimize complications, all those concerned in the vendor company.

Construction

The requirements for external construction are intended to ensure integrity of the seal and the electrical connections. To prevent short circuits, for example, the clearance between the case and a lead wire must be at least 0.001 inch at any point. When this isn't feasible, an isolation test must be performed. And to prevent porosity in the seal, the cover-to-case seal must not be made with tin-

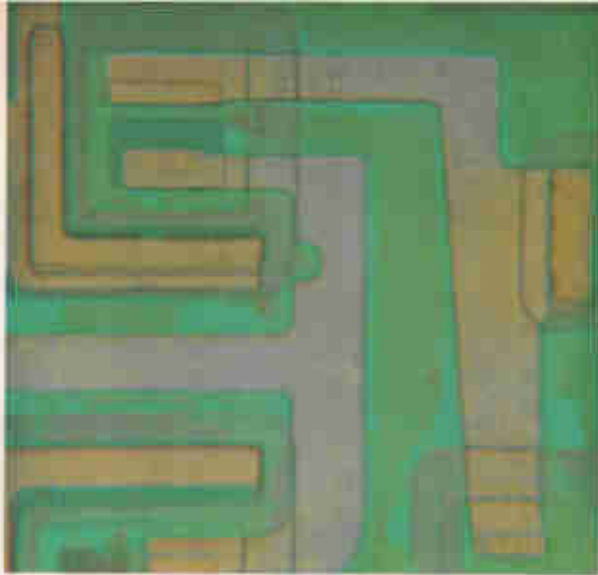

Notched. A defect in the metalization mask created this notch in the metalization. If it extended more than halfway across the metalized path, it would be cause for rejection.

lead or pure tin solder.

Inside the package, constraints are imposed on the semiconductor chip that forms the IC. These are intended to ensure that the chip is soundly attached. The fastening method must be compatible with the environmental tests and the chip must be parallel to the mounting surface (if it were at an angle, there might be voids under it). The chip must be oriented so that the lead wire paths are as short, and therefore as safe, as possible.

The bonding pads must be located in such a way that the lead wires don't cross each other or active parts of the chip. And to prevent shorting to the bare silicon on the edge of the chip, bonding pads and metalization paths must be placed far enough from the edge to be insulated from the chip.

Ball bonds on top of other (defective) ball bonds are allowed only if the manufacturer has previously established a procedure for making them and has demonstrated by testing that these double bonds are as strong and reliable as single bonds.

Workmanship

The package must be free of contaminants, residue dents, cracks, porosity, and any foreign substances discernible with the naked eye.

The chip itself, naturally, is the object of greatest interest. To make sure that the integrity of the active parts of the chip isn't jeopardized, the chip must not contain any cracks or scribelines that touch or cross a junction or metalization (unless it is part of an inactive circuit or at ground potential). Because they might propagate, cracks longer than 1 mil in active areas (that is, the area enclosed by an isolation diffusion) are forbidden, as are cracks longer than 1 mil that point toward an active region and end within 1 mil of it.

To prevent potential loose particles at the edges of the chip, semicircular cracks that delineate pieces of silicon, with the piece remaining in place, are not permitted.

The oxide layers and glass passivation layers must be of uniform thickness, as indicated by a uniform color. They must not contain localized discoloration or have a rainbow appearance within the active regions. Areas of simultaneous processing (base, emitter, or isolation areas) should have approximately the same colors at different places on the chip. There should be no areas of bare silicon exposing a junction or touching a metalization path. All these requirements are intended to ensure that there is a sufficiently thick insulation layer; the color of an oxide layer indicates its thickness, and differences in color indicate surface irregularities. And a variation in color indicates something probably even more important: an irregularity in the process. Even though it may not be possible to pinpoint a failure mode, the products of an out-of-control process are suspect and should be rejected.

To prevent eventual short circuits, there should be no serious mask misalignment, evidenced by one junction window touching another. And to prevent excessive current density, every contact window should have at least a third (or at least $\frac{1}{4}$ square mil) of its area covered by metalization.

Making the right connections

Metalization paths should not show stains (residue from the processing), scratches or voids that expose the underlying oxide over more than 50% of the width of the metalization (25% when a path less than $\frac{1}{2}$ -mil wide crosses a step in the oxide), or smears or irregularities that reduce the distance between adjacent metal paths to less than 25% of the original separation. The object here is to minimize the chances of a short being created between adjacent metalization by contamination or particles, and to keep the current density down to an acceptable level. The values are somewhat arbitrary, of course, but they are needed to provide specific criteria for the inspectors.

When the manufacturer uses ball bonds to attach lead wires to the IC, there is concern about the current density. So the spec requires that at least a part of the wire at the top of the ball be within the boundaries of the bonding pad and that it be completely within the ball as viewed from above. At least 50% of the compressed metal ball should be in contact with the pad. The diameter of the bond should be at least twice but no more than five times the thickness of the wire.

There is similar concern about wedge bonds and ultrasonic bonds, so two-thirds of the bond impression must be within the boundaries of the area allotted for bonding on the chip.

To prevent shorts caused by particles becoming wedged between bonds, the separation between bonds, or between a bond and an adjacent metalized path, should be at least $\frac{1}{4}$ mil. And to prevent a short from the bond to the chip, oxide must be visible between the bond and the edge of the chip.

The lead wires themselves must not be nicked or damaged to the extent that the effective diameter of the wire is reduced by more than a third.

Too much too near. These ball bonds are too large, and they are so close together that it would be easy for contamination to establish a conductive path between them.

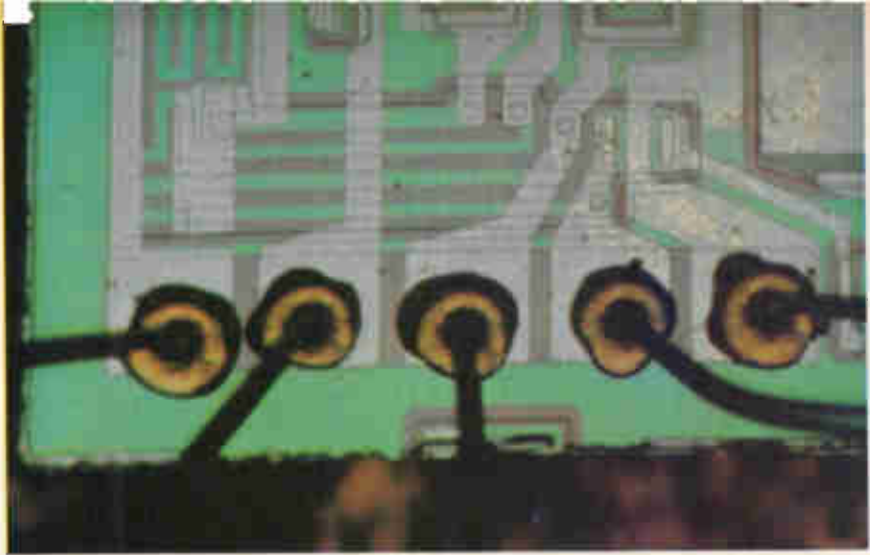

And bent wires should not have a bend radius of less than twice the wire diameter, since this would cause stress concentration and possible fracture.

Contamination

Some contamination is inevitable, but it is reasonable to ask whether a deposit on the chip is where it could be harmful, or whether a particle is big enough to bridge the gap between bonds or metalization. A residue on a diffused resistor, for example, can cause little harm. On the active region of a transistor, however, it's a different story. The IC may operate within its parameters, but if the slightest bit of moisture should enter the package, the residue may ionize and form a leakage path.

Of course, if there are loose particles anywhere in the package, the IC must be rejected. Attached metallic or abrasive particles or other foreign matter must span no more than three-quarters of the space between two adjacent exposed metalization paths, or between metalization and the oxide boundary at the edge of the chip. In practice, no distinction is made between conducting and non-conducting particles. It's assumed that all particles are potentially conducting.

Spec-ing the spec

In the Raytheon document, each visual inspection criterion is accompanied by requirements for the minimum magnification, the type of lighting, and the appropriate inspection point in the process cycle.

Relating the specification to the process cycle is particularly important, because it ensures that the inspection for any particular defect is made only after all stages at which it could crop up have passed. For example, inspection for scratches must be made just before the package is sealed, because scratches can appear up to this point. However, it's not mandatory that an inspection be made immediately after the last point in the process where the defect could turn up. Masking defects, for example, may be screened during the chip inspection or at the preseat visual inspection, at the manufacturer's option.

Putting teeth in it

A specification would have little value if there were no check to make sure the manufacturer is delivering as required. There are two effective methods for ensuring compliance.

First, and probably most important, a few IC's in each incoming lot are decapped and examined under a microscope. If any defect is found, a large sample is taken. From this sample, the percentage of defective IC's in the lot can be estimated. Ordinarily, Raytheon doesn't start shipping circuits back to the manufacturer when one or two IC's are found defective. But photographs are taken and the manufacturer is informed. [Some of these photos appear here and in "An IC morgue," *Electronics*, May 13, pp. 94-95.] Corrective action—and docu-

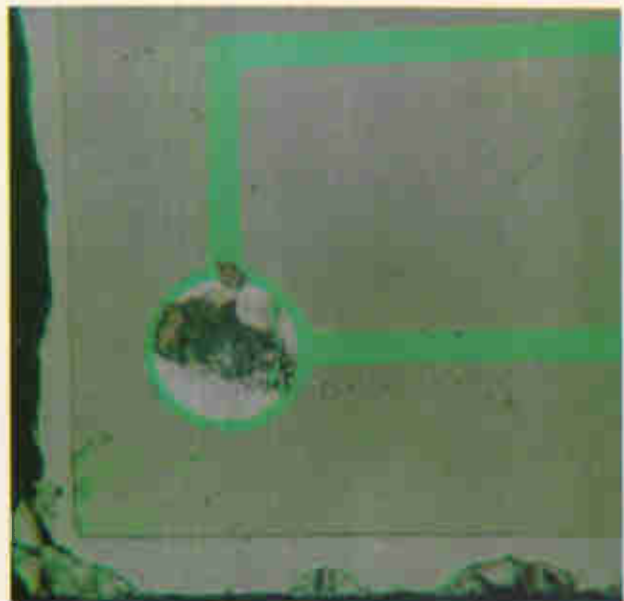

Advice from a vendor. The semicircular cracks at the lower edge of this chip are a rejection criterion suggested by an IC manufacturer during Raytheon's negotiations. They could give rise to loose particles of silicon during vibration or shock.

mentation of it—is requested. Because there is plain evidence of violation, manufacturers in general tend to be very cooperative. If the problem is severe, either in frequency or magnitude, the customer should return defective lots.

The second method is to make periodic visits to see if the process control parameters, the production and construction methods, and the visual inspection criteria correspond to the specification. This method will become increasingly important, because plastic-encapsulated IC's all but eliminate the possibility of visual sampling; it's quite difficult to open the package for inspection. So users of plastic IC's will have to put heavy emphasis on plant visits.

In monitoring compliance with certain specifications, intent is far more important than exact stipulation. Oxide uniformity is an example—it's impossible to spell out the gradations in color that are permissible or unacceptable. With contamination, too, it's not feasible to describe every possible particle and where it may or may not be. Thus the description of these criteria in the document is general. The requirements are necessarily subject to interpretation by the inspector. The definition of a workmanship defect is less exact than, for example, an electrical parameter that has a clear go/no-go indication.

How it was done

Developing a visual inspection specification was an ambitious—perhaps even a brash—undertaking. The details of the spec had to be based on the manufacturer's procedures. But because manufacturers don't provide data sheets on their inspection procedures, it was necessary to visit factories to learn the procedures first-hand. During these visits with the major IC manufacturers, visual inspection criteria were negotiated for each manufacturer. Finally, the process was repeated and a universal specification covering all vendors was negotiated.

The first reaction of many vendors was very negative. They were accustomed to selling their products as black boxes and looked on Raytheon's plan as interference in their operation. But they were approached from this point of view: Raytheon buys the product, Raytheon specifies the electrical parameters, why can't Raytheon specify the reliability? As it turned out, the main objection was to putting the requirements in writing. But this is precisely what was wanted: assurance that the vendor would do as he said and that the customer would have some recourse if he did not. At any rate, as the vendors learned that reason and compromise were the guidelines, they became cooperative.

After the first series of talks with a vendor, a spec was agreed upon that didn't significantly increase the quoted price of the IC's. On the other hand, it didn't contain all the provisions that Raytheon—at first—thought advisable. For example, there was a paragraph in the basic spec requiring that the IC chip be parallel, within 15°, to the

mounting surface. Because this numerical value was specified, there would have to be a way of measuring it, and this would mean an optical fixture. The manufacturer felt that this kind of measurement could not be made at low cost and was, in fact, unnecessary. It really doesn't matter if the value is 10° or 16°—the defect is a gross one, discernible to the naked eye. After this was pointed out, Raytheon revised the spec.

The sequence of events was repeated with other vendors. Discussions in each case resulted in a version of the basic spec that, because it was based on the vendor's own controls, didn't add significantly to the cost of the product. The discussions were not one-sided. Sometimes a vendor would point out deficiencies in Raytheon's spec. For example, the basic spec mentioned cracks in an active region, cracks that point toward a junction, and loose pieces of the chip. But, as one vendor pointed out, there was no mention of cracks that start from the edge and return to it, and thus delineate a piece of the chip that could later become a loose particle. And sometimes a vendor would suggest wording that was more easily adaptable to his visual criteria. Usually, these new ideas were incorporated in the basic spec.

The last stage

Arriving at these working specifications was only a beginning. Several difficulties remained:

- There was a record-keeping problem in identifying the manufacturer with his specification. The various specs were similar enough to be confusing and different enough not to work with the wrong vendor.

- The spec could not be called out on the print or control drawing; it had to be listed on the purchase order.

- Because quotations from vendors were not always based on the same requirements, there was some degree of unfairness in price comparisons. These disadvantages were anticipated at the very start of the program, and regarded as a necessary evil. But now the time was ripe to eliminate them. So another and final round of discussions with manufacturers took place, and the universal specification was arrived at.

The cost of reliability was discussed at this stage. Those manufacturers who had to deviate very far from their standard procedures because of the universal specification would encounter increased production costs and perhaps a slight decline in yield. However, the cost increase was usually slight. And the vendor could be given to understand that absorbing minor cost adjustments could become a factor in vendor selection.

In spite of the problems, Raytheon did negotiate a version acceptable to it and all the vendors. And the effort has been worth it; the improvement in the IC's is observable in the form of fewer failures and generally better appearance. And a more direct working relationship with the manufacturers has been a by-product.

Okay, okay, I'll admit your DCL is a better logic family, but we're already stuck with 54/7400's!

How many
ya need?

Signetics announces the immediate availability of a new line of integrated circuits in the 54/7400 series. The line has a superior package, silicone instead of epoxy. It's backed by extensive reliability data and an excellent sales and service organization that can deliver in quantity and quality.

But for your new designs, consider the advantages of Signetics' DCL, or 8000 series. This is a compatibly specified

family of DTL and TTL logic circuits, interface elements and monolithic sub-systems covering the needs of over 90% of all known digital IC applications. Presently, there are over 60 elements in the DCL family, including some exciting new complex arrays.

If you are interested in this superior DCL line, we ask you the same question we asked about the 54/7400's: how many ya need?

54/7400'S NOW AVAILABLE FROM SIGNETICS

Quad 2-Input NAND	5400/7400
Quad 2-Input NAND with Bare Collector	5401/7401
Quad 2-Input NOR	5402/7402
Triple 3-Input NAND	5410/7410
Dual 4-Input NAND	5420/7420
Eight Input NAND	5430/7430
Dual 4-Input Power NAND	5440/7440
Dual AND-OR Invert w/Expander	5450/7450
Dual AND-OR Invert without Expander	5451/7451
Single 4 wide 2-Input AND-OR Invert Gate Expandable	5453/7453
Quad 2 AND-OR Invert Not Expandable	5454/7454
Dual 4-Input Expander	5460/7460
Single Phase J-K Flip Flop	5470/7470
Single M.S. Flip Flop	5472/7472
Dual M.S. Flip Flop	5473/7473
Dual D Flip Flop	5474/7474
Dual M.S. Flip Flop Preset & Clear	5476/7476

More to come thrd quarter I

Signetics Integrated Circuits

A SUBSIDIARY OF CORNING GLASS WORKS

811 East Arques Ave., Sunnyvale, California 94086



MIL-T-713 calls for 22% to 32% wax coating on LACING TAPE.

- But what really is the right amount for trouble-free, tight-knot lacing?
- GUDEBROD KNOWS. They make yard after yard after yard exactly right!
- GUDEBROD TAPE cuts harness costs!
- Send for a sample.



Give the sample any comparative test you want. Let your harness crew try it. Send it to your lab. It's exactly what you'll get when you order Gudebrod tape—everytime.

You are often required to lace with tape that meets MIL-T Specs—with a specified range of wax content. But that's no assurance that you are using a tape that ties tight, holds tight, that probably won't be rejected—unless, of course, you have Gudebrod Gudelace. Like all Gudebrod Lacing Tapes it's manufactured under strict quality control including the wax coating. Every yard of Gudelace is impregnated exactly the same, exactly right. You can count on that—and on speedier, easier, better harnessing. That's where you save real money. Want to know more? Get in touch with Gudebrod.

GUDEBROD CABLE-LACER

The first hand tool engineered for wire harnessing. Handle holds bobbins, feeds tape as needed, grips tape for knotting. Speeds, eases harnessing. Pays for itself in time saving.



Area Code 215, WA 2-1122



GUDEBROD BROS. SILK CO., INC.

FOUNDED IN 1870

Electronics Division

12 SOUTH 12th STREET, PHILADELPHIA, PENNSYLVANIA 19107

NOW!

1/4

rack models

available in Lambda LR High Performance Series for rack or bench use

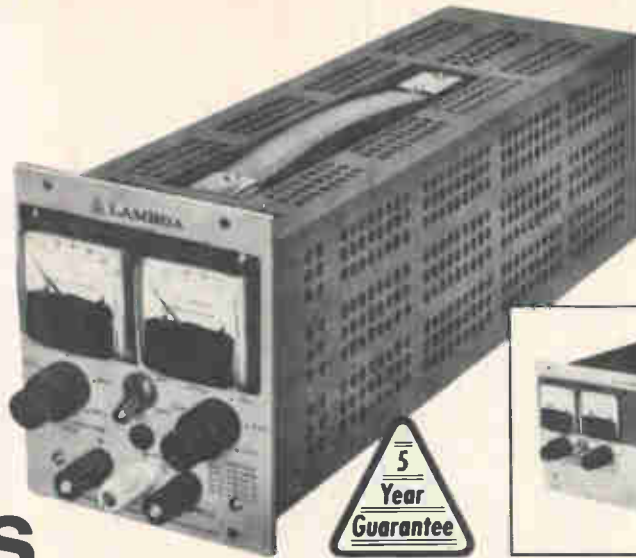

- 0.0005% plus 100 μ V regulation.
- 35 μ V rms ripple.
- AC Input: 105-132 VAC, 47-440 Hz (Ratings based on 55-65 Hz) 205-265 VAC on request at no extra charge ("-V" option).
- 2 meters monitor both voltage and current simultaneously and continuously.
- With Remote Programming
Accuracy—0.01% plus 1mV
Stability—0.001% plus 100 μ V for 8 hours
Temp. Coeff.—0.001% plus 10 μ V/ $^{\circ}$ C
- Guaranteed for 5 years. The only 5-year guarantee that includes labor as well as parts. Guarantee applies to operation at full published specifications at end of 5 years.
- Multi-Current-Rated.
- Only 5 $\frac{1}{4}$ " high. Convenient 1/4 and 1/2 rack sizes for rack or bench use.
- All-silicon design for maximum reliability.
- Convection cooled for convenience and reliability... no blowers or heat sinks.
- Remote programming by changes in voltage or resistance for convenience in systems, test equipment and automatic equipment applications.
- Auto Series/Auto Parallel with Master-Slave tracking
- Constant I/Constant V by automatic cross-over.
- Completely protected: short-circuit proof; continuously adjustable automatic current limiting.
- Overvoltage protection available as low cost add-on accessory.

FOUR 1/4-RACK MODELS

Model	Voltage Range	MAX. AMPS AT AMBIENT OF ¹				Price
		30 $^{\circ}$ C	40 $^{\circ}$ C	50 $^{\circ}$ C	60 $^{\circ}$ C	
LR-602-FM	0-20 VDC	1.1	.95	.80	.64	\$265
LR-603-FM	0-40 VDC	.80	.50	.42	.33	265
LR-605-FM	0-120 VDC	.23	.20	.17	.14	295
LR-606-FM	0-250 VDC	80ma	72ma	65ma	60ma	310

FOUR 1/2-RACK MODELS

Model	Voltage Range	MAX. AMPS AT AMBIENT OF ¹				Price ²
		30 $^{\circ}$ C	40 $^{\circ}$ C	50 $^{\circ}$ C	60 $^{\circ}$ C	
LR-612-FM	0-20 VDC	1.8A	1.6A	1.3A	1.1A	\$305
LR-613-FM	0-40 VDC	1.0A	0.9A	0.75A	0.6A	305
LR-615-FM	0-120 VDC	0.33A	0.29A	0.25A	0.21A	320
LR-616-FM	0-250 VDC	100ma	90ma	80ma	70ma	340

¹ Current rating applies over entire voltage range. Ratings based on 55-65 Hz operation.

² Prices are for metered models. LR Series models are not available without meters.

Prices F.O.B. factory, Melville, N. Y. All specifications and prices subject to change without notice.

OVERVOLTAGE PROTECTION

For Use With	Model	Adj. Volt. Range	Price
LR-602-FM, LR-612-FM	LH-OV-4	3-24 V	\$35
LR-603-FM, LR-613-FM	LH-OV-5	3-47 V	\$35

Write, wire, or call to order direct, for information, or for new Lambda Power Supplies catalog. LAMBDA Electronics Corp., 515 Broad Hollow Road, Melville, L. I., New York 11746, TEL. 516-694-4200, TWX 510-224-6484.

LAMBDA

SEE THIS NEW POWER SUPPLY AT WESCON - BOOTH #401-2, HOLLYWOOD PARK - PLUS A DRAMATIC NEW ANNOUNCEMENT OF A NEW CONCEPT IN POWER SUPPLIES AND POWER SUPPLY SYSTEMS.

Circle 111 on reader service card

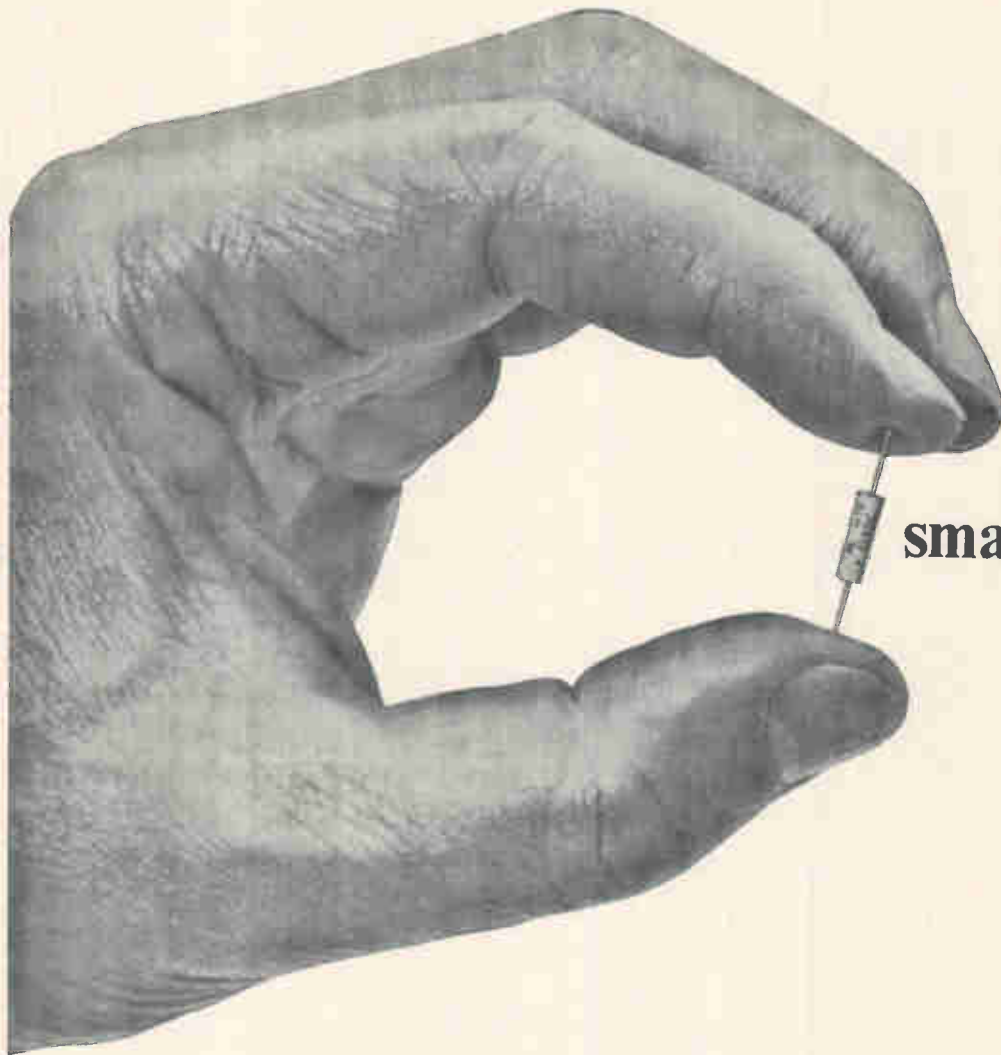

small wonder

No wonder Mallory MTP miniature wet tantalum capacitors are the delight of designers who are squeezed for space in computers and miniaturized electronic equipment. These commercial grade midgets pack up to 178,000 microfarad-volts per cubic inch . . . 5 times what you can get with solid tantalum.

The military version, MTPH, had only one catastrophic failure in 6,200,000 test hours, which calculates to a failure rate of .032%/1000 hours, MTBF of 3×10^6 hours, at 60% confidence level. Write for specs and consultation.

MALLORY

MALLORY CAPACITOR COMPANY

a division of P. R. MALLORY & CO. INC.
3029 E. Washington St., Indianapolis, Indiana 46206

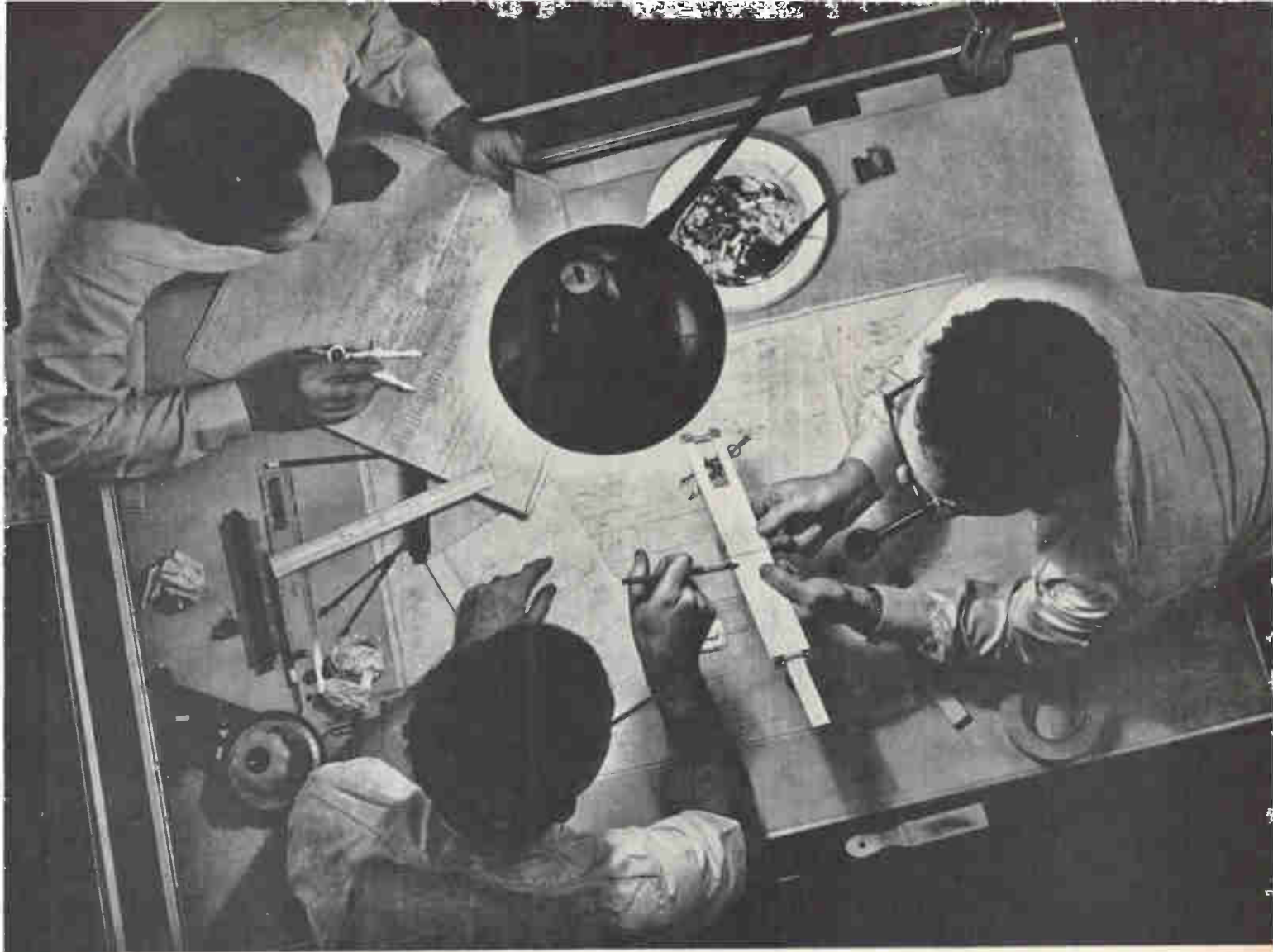

We've been copying other people's designs for 17 years.

And they love us for it.

After all, we're custom fabricators. And if we didn't copy designs exactly, we wouldn't be doing our job.

We do it every day. On transistor leads, computer memory core frames, connectors, pen caps, aerosol spray tips, razor blade dispensers, integrated circuit frames.

You name it, we copy it. To your precise specifications.

Whether it's precise stamping of high-tolerance, miniature metal shapes.

Or precise molding of intricate plastic parts.

Or precise forming of wire for critical electronics.

Or precise combining of metals, plastics and wire into complex assemblies.

And we've got nine plants, the most advanced equipment, and the best engineers and diemakers around to do it.

We'll even help you design the part. Then we'll build the dies, produce the parts, and do the assembly. A perfect copy every time.

That means you get the parts you want, the way you want them, when you want them—probably at less cost than you could do it for yourself.

So the next time you come up with a great new design, give us a call and we'll copy it.

Sylvania Metals & Chemicals, Parts Division, Warren, Pa. 16365.

CUSTOM PARTS BY

SYLVANIA
A DIVISION OF
GENERAL TELEPHONE & ELECTRONICS

Check your airborne radar application:

- () Weather Avoidance
- () Fire Control
- () Bomb/Nav
- () Terrain Following and Avoidance
- () Navigation and Landing
- () Beacons and Transponders

Now check the world's broadest line of coaxial magnetrons.

Litton's. These long-lived, highly efficient and stable coaxial magnetrons are available in a series of high power, pulse outputs at Ku-band and X-band. Tubes are available at fixed frequencies or in a number of tunable configurations for frequency agility. The tuning techniques include rapid wide band tuning for ECCM as well as dither for target enhancement. We offer two im-

portant services: fast reaction capability for new applications; extensive applications engineering to help systems designers choose the right tube and related equipment. Check out Electron Tube

Division. See what a difference coaxial magnetrons can make in your airborne radar systems design. 960 Industrial Road, San Carlos, California 94070 or 1035 Westminster Drive, Williamsport, Pennsylvania 17701.

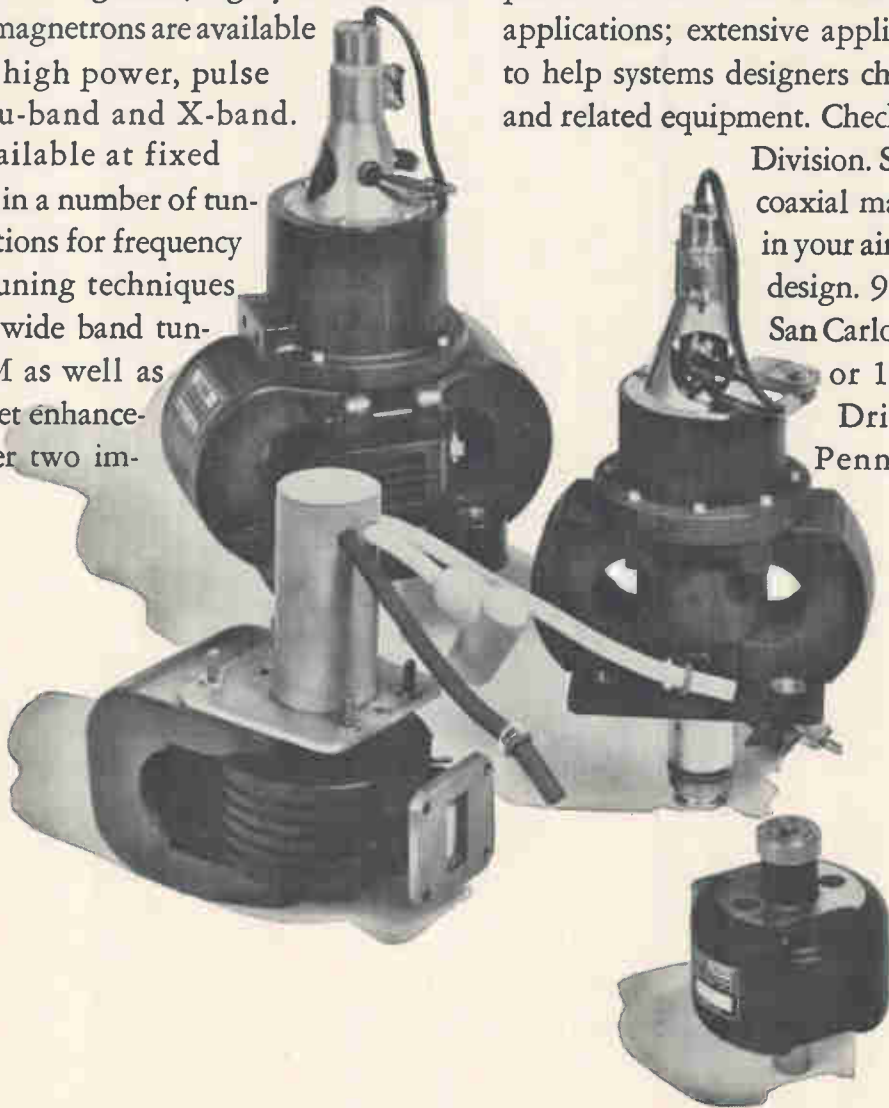

At WESCON visit our booth 3001.

 **LITTON INDUSTRIES**
ELECTRON TUBE DIVISION



Happiness is an Acopian power supply . . . because it's shipped in only 3 days.

Whether your application is op amps, ICs, logic circuits, relays, lamps or electronic measuring equipment, look to Acopian to meet your needs for AC to DC plug-in power supplies. Acopian's new catalog lists over 62,000 different supplies . . . all available for shipment within 3 days. Get your 16 pages of happiness by writing or calling Acopian Corp., Easton, Pennsylvania (215) 258-5441.



Circle 115 on reader service card

di/dt capability 10 times industry's best EVEN WITH LOW POWER GATE DRIVE



NATIONAL[®] INVENTS THE REGENERATIVE GATE* SCR

NATIONAL ELECTRONICS, INC. regenerative gate SCR is the only SCR that will give 600 amps/ μ sec. when tested according to JEDEC SUGGESTED STANDARD NO. 7 Section 5.1.2.4. This is a di/dt rating at three times the peak on-state current and $\frac{1}{2}$ the switching loss of any SCR now on the market. No sacrifice is required in gate drive, turn-on time, turn-off time or any other characteristic. Presently available in 55 amp and 110 amp SCRs.

NATIONAL[®] manufactures SCRs from 16 amp to 470 amp.

**Patent Pending*

REQUEST BULLETIN

NATIONAL
ELECTRONICS, INC.

a varian subsidiary

PHONE: (312) 232-4300 • GENEVA, ILLINOIS 60134

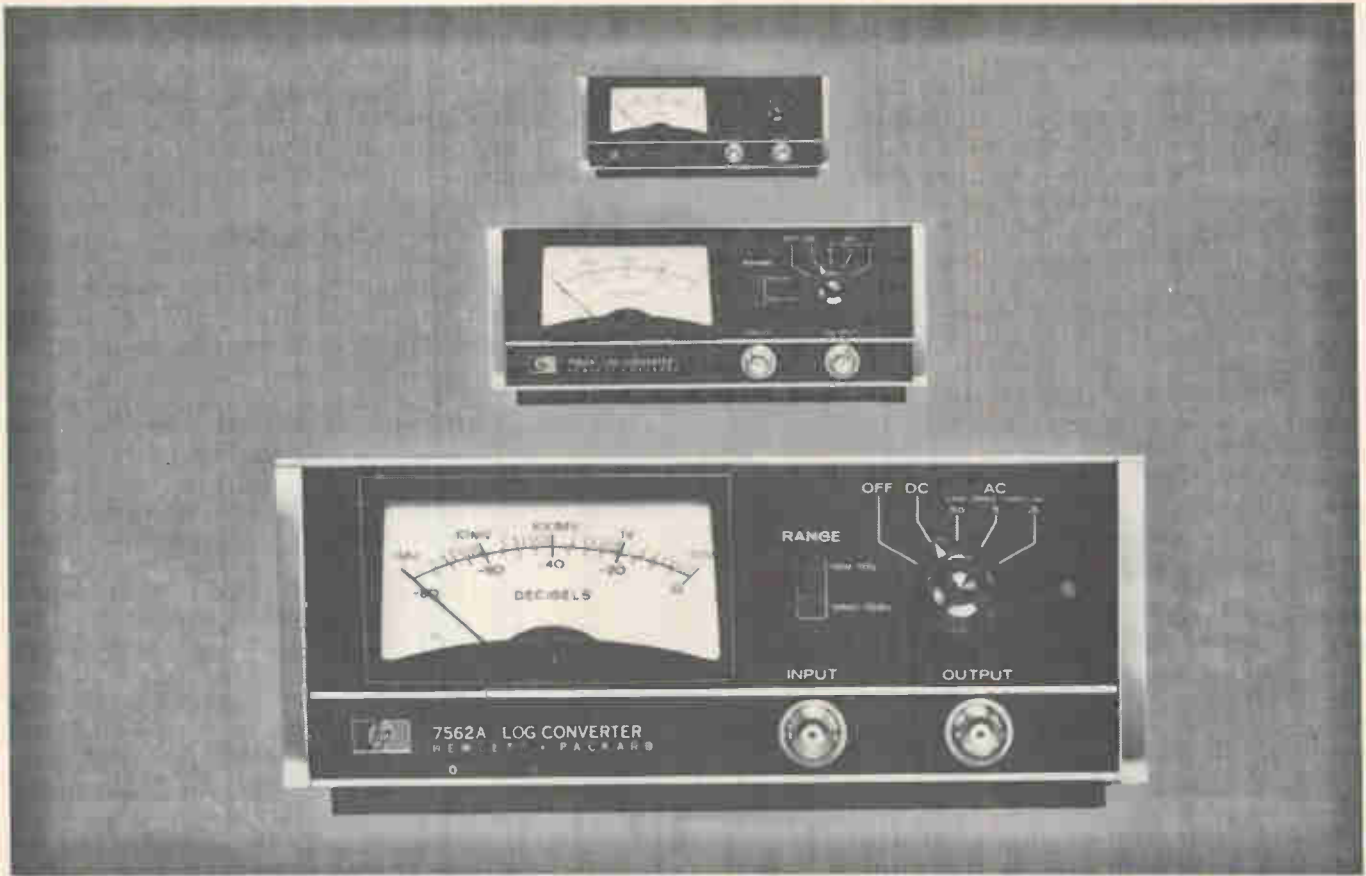

These ABC's spell more log converter performance.

You get more with the Hewlett-Packard 7562A Logarithmic Converter than with any other instrument of its kind. It provides DC logarithmic voltage output from AC or DC input signals, with 80 dB dynamic range, true RMS detection for increased accuracy and unprecedented 0.5 Hz to 100 kHz frequency coverage, in three ranges. Two input voltage ranges 1 mv-10 V or 10 mv-100 V. Fast response to 2 μ s DC rise time and 60 dB/sec AC slewing speed.

The 7562A is ideal for a wide range of demanding

A.
0.5 Hz to 100 kHz frequency range

B.
80 dB dynamic range

C.
True RMS

applications such as gain-frequency plotting with X-Y recorders, vibration analysis and semi-log or log-log plotting. Reliability is assured with rugged, compact, solid-state construction (including use of IC's). Use with scopes, X-Y and strip-chart recorders. A perfect companion for the new HP 3305A Logarithmic Sweep Oscillator. Price: \$995.

For more information, call your local HP field engineer or write Hewlett-Packard, Palo Alto, California 94304; Europe: 54 Route des Acacias, Geneva.

HEWLETT  PACKARD

GRAPHIC RECORDERS

measure

Measure the world of motion in any direction...instantly, accurately, dependably, in any application, telemetry or control, with United Control's highly reliable servoed miniature accelerometers. You name the application and the environment, we'll provide the best accelerometer. For more information, call or write United Control.

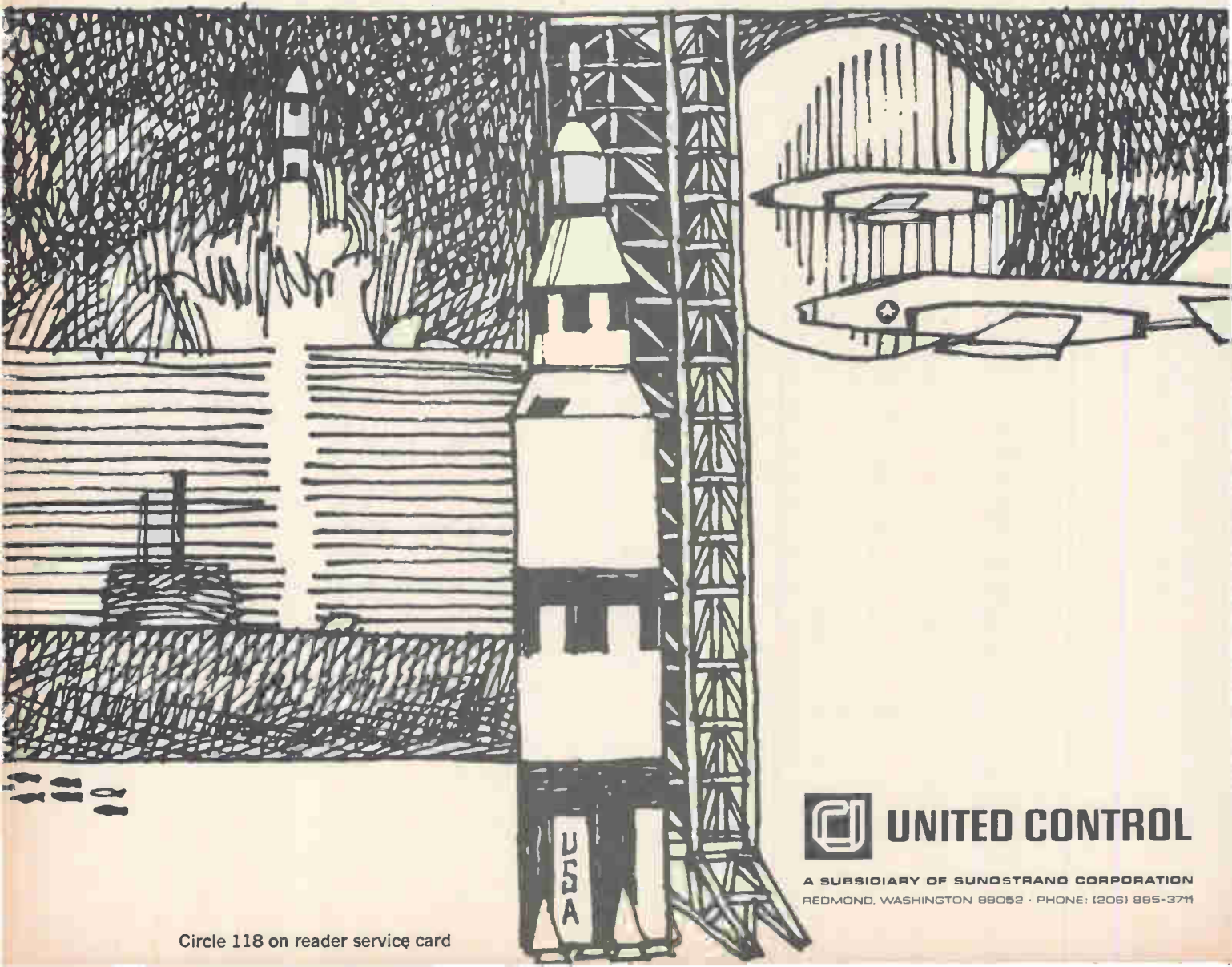

UNITED CONTROL

A SUBSIDIARY OF SUNOSTRAND CORPORATION
REDMOND, WASHINGTON 98052 • PHONE: (206) 885-3711

Circle 118 on reader service card

Probing the News

Telephony

Sylvania would rather switch . . .

While the military fought over a triservice specification for automatic systems, the company readied a 300- to 600-line tactical telephone exchange on its own

By James Brinton

Boston bureau manager

Automated electronic switching, long a reality in civilian telephone exchanges, has made little headway with the military. Undaunted, the Electronic Systems division of Sylvania Electric Products Inc., Needham Heights, Mass., has bet substantial time, money, and effort on breaking through a wall of indifference. The company has—with little official encouragement—developed a tactical telephone central office, designated TTC-(X). Sylvania officials even hope to pin down the will-o'-the-wisp triservice (Army, Air Force, and Marine

Corps) switching specification when its equipment makes the rounds of military procurement offices later this year.

Sylvania's tactical telephone central office is a 300-line to 600-line system weighing less than 5,000 pounds, which can be housed in a single, standard S-280 shelter. The equipment can be transported virtually anywhere by truck, helicopter, or airplane. Having arrived at a site, the TTC-(X) can be operational within two hours; it can work off its own batteries until a generator is installed.

The available evidence suggests that Sylvania's gamble on TTC-(X), which makes extensive use of integrated circuits, may pay off in a big way. The Army has been after tactical automated switching gear since 1956 when it awarded a short-lived contract to Stromberg-Carlson for a system. The International Telephone & Telegraph Corp. also held an Army development contract for a system called TTC-12, which may have been the first telephone switching apparatus to use integrated circuits. This feature may have been its downfall;

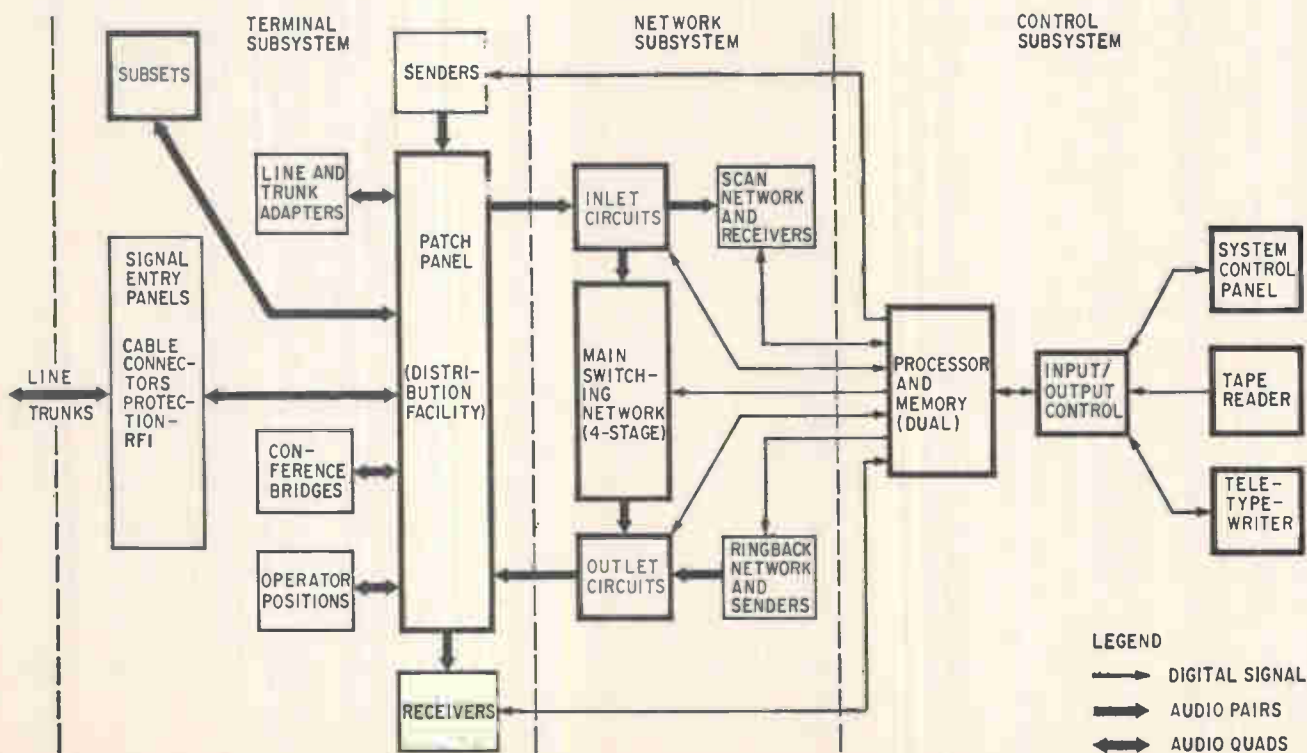

when funding ended, early last year, sources around the industry agreed that while ITT's engineering was sound, its pnpn diode cross-point and some of its IC's were too far beyond the state of the art for the military's tastes.

The Air Force can make do with less mobile equipment than the Army in some applications; this factor may explain why the North Electric Co., Galion, Ohio, won out over competitors in securing orders for the telephone exchange portion of the 412L European air defense system. Virtually a fixed-plant setup, the exchange is housed in three shelters. The Air Force bought six systems from North Electric and when Southeast Asia began heating up in the 1965-67 period, it went back for 24 more. However, it asked that the size be cut by one-third. The new two-shelter models are part of the 407L tactical air control system.

Underground. Though no formal specification has been written, the Air Force now wants a new system called the TTC-27—a single-shelter 300-line automatic central office which appears to be a carbon copy of Sylvania's TTC(X)—particularly to company spokesmen. This spec, quietly developed at the Rome Air Development Center in upstate New York, is being pushed hard by mavericks on the staff of the Electronic Systems division at Hanscom Field in Bedford, Mass. "Sylvania's equipment is the ultimate in switching gear," says a project engineer there. "The concept just needs some more research and development work."

The Marine Corps is putting its money where its mouth is. This month, the service is signing a contract for delivery of a version of Sylvania's gear, designated TTC-31, next August. The equipment will subsequently be shipped to Vietnam for a three-month trial.

"The whole Defense Department is pushing automated electronic switching because of reports that it's the single worst area in ground communications," says Lt. Col. Clyde S. DeLong Jr., the officer in charge of switching projects at the Marine Corps headquarters in Washington, D.C. "The troops are using 1950-vintage equipment now with step-by-step switches, manual cord and jack, or nondial tech-

niques. With Vietnam experience, Pentagon planners realized they had to have dial systems and so programs have moved on an expedited basis." The Marine Corps' gear will have stored-program control of switching but will not have subroutines for systems and technical controls, like automatic re-routing around a burned-out switch, until later.

Wrong number

On June 28, at Fort Monmouth, N.J., headquarters of its Electronics Command, the Army took a big step toward introducing solid-state automatic switching into its communications setup by issuing a \$4.1 million letter contract for two complete tactical systems each of which includes three switching centers and 900 subscriber sets for the Seventh Army in Europe. Dubbed Satss, for Seventh Army Tactical Switching System, the 300-line exchanges will be supplied over 18 months or more by North Electric. Satss uses a different sort of switching matrix than the TTC(X) and relies less on software than the TTC(X). Charles Conry, vice president of North Electric, says the company's Satss design is an offshoot of work that was done

earlier on a commercial equipment. The system is redundant with dual processors; subscriber services include call forwarding, hot-line priority, conference calls, and priority switching.

An Army spokesman says all three services will be watching the performance of Satss closely to gain familiarity with automatic switching systems; some of the data they develop may eventually affect the elusive triservice specification.

Sylvania competed for Satss and lost, but James F. Manix, who manages the company's communications switching marketing activities, isn't about to stop selling. He says that Sylvania was "at least a half a generation ahead of the other entrants, and more responsive to the potential needs of a triservice system." He gets some support from the military on this point. An Army officer says: "Sylvania's system was the most advanced in the competition. But procurement was based on cost and on risk. The North Electric system was not only cheapest, but also pushed least against the state of the art."

Early foot. Perhaps, then, Manix's reckoning of being half a gen-

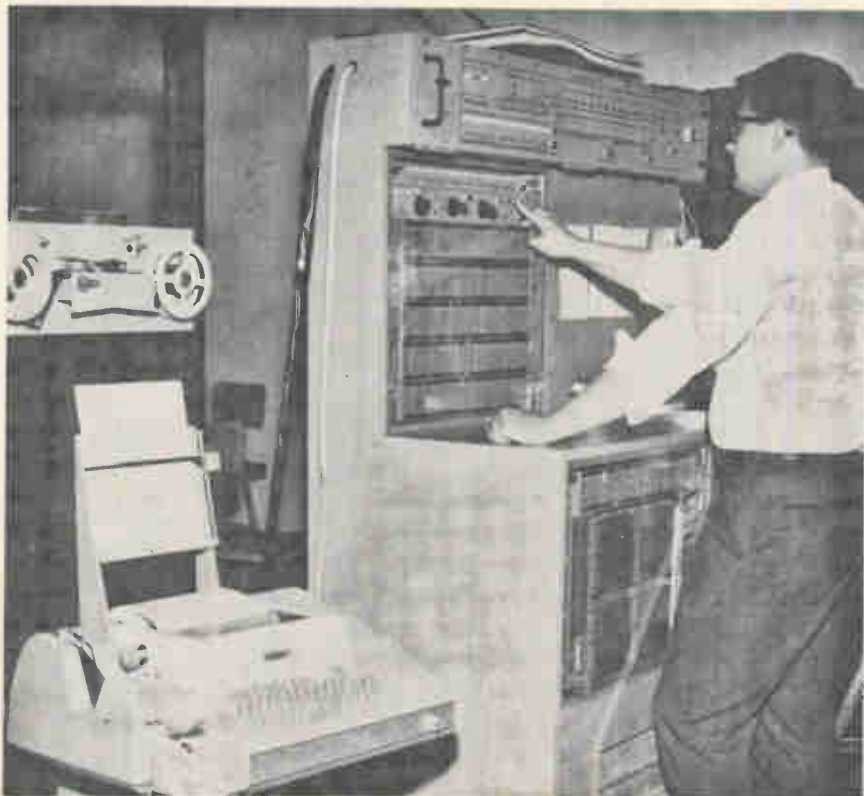

Checkout. Common control subsystem of tactical automatic telephone exchange that Sylvania hopes will attract triservice orders undergoes preproduction tests.

Three-way stretch on spec

For over two years, the Air Force, the Army, and the Marine Corps have been trying to specify a tactical electronic telephone exchange that each could live with. While there's still optimism about the possibility of developing such a specification, the demand for automatic telephone services is reaching a critical point, and the armed forces may have to go their separate ways before a triservice system can be worked out. The Air Force, for example, needs many special subscriber services like hot-lining, abbreviated dialing, and data transmission, to conduct its operations. The Marines also work with air controllers during close-support missions and could probably use broadband lines for their tactical data system center. The Army plans to handle its air operations without resorting to its tactical telephone network in most cases, and could thus settle for the least complex system.

Through an unofficial body, the Triservice Joint Coordinating Committee, the services monitor developments in switching systems, and try to iron out applications differences which might make a triservice spec impossible. An optimistic, but unhappy, member of the committee points out that civilian telephone companies are installing automatic switching systems while the military seems stalled. He feels the wrangle over differing needs could, and should, have been resolved a year ago. His answer to the apparent impasse is a programmable system, flexible enough to fit wide variations in application through software changes.

Last October, the services almost ordered contract definition of such a system. But this move has since been stalled—perhaps in tacit admission that the services' requirements are so different that one system just can't do it all. In addition, some committee members wonder if any single system could be cost effective. The consensus among the military, however, is that switchboards and electromechanical exchanges must go. If either the Marines or Air Force opt for their own systems, even the idea of a triservice spec may well die and the ideal of interservice commonality will have taken another hard blow on the chin.

eration up on his competitors is correct. But how does a company gain such a lead? Apparently, by starting early. According to Manix, Sylvania's Electronic Systems division has had a glimmer of a green light for its TTC-(X) efforts since the early 1960's and some development work dates back even further.

But without some kind of triservice specification, no company could, in perfect safety, do more than work on building blocks. Rather than quit, Sylvania set out to second-guess the spec.

During 1965 and 1966, Sylvania integrated its building blocks into an 18-line prototype system which was first demonstrated early in 1967. In February of 1967, the company won a study contract from the Marine Corps, and sent a group of engineers off to survey telephone communications in Vietnam.

But even before feedback from its engineers in Southeast Asia, management gave the Electronic

Systems division an okay to go ahead on a full-scale 300-line system in March of 1967. The system was designed to be flexible enough to satisfy most of the reasonable requirements in any anticipated triservice spec and be of assistance to the military in writing such a spec using data gathered from its operation.

Helping hand

Explaining Sylvania's approach, J. Prewitt Wehle, the company's program manager for communications switching systems, says that much of the delay in writing a triservice specification is due to a lack of information about the sort of operations that are required or possible. "Even now, more than 20 years after World War II, we're still using manual switchboards in Vietnam. The most advanced tactical systems use bulky, hard-to-maintain stepping switches," he says. "The military is so accus-

TRYGON HAS THE POWER

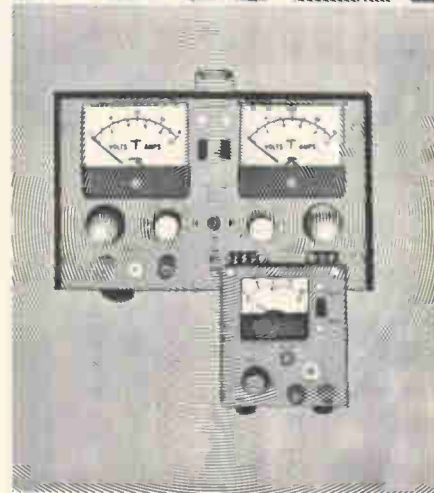

**to deliver these
two great laboratory
supplies immediately.**

Trygon's economy EAL and precision DL-series laboratory power supplies are available—right now—from 36 sales offices, nationwide. So when we say you'll have them, you can depend on it. You can also depend on them.

The versatile DL Series gives you two independent dual-range supplies (0-20V @ 1 amp or 0-40V @ 0.5 amps) in one half-rack package. And you can run them independently, in series or in parallel (from 20V @ 2 amps up to 80V @ 0.5 amps. All for \$249, only a few dollars more than comparable single-output units.

The compact EAL fits in a corner of your bench and your budget (only \$99) and comes in the four most commonly used laboratory voltage ranges: 0-10VDC @ 1.0 amp, 0-20VDC @ 500 mA, 0-32 @ 300 mA, and 0-50 @ 250 mA.

Both the EAL and the DL come complete with combination volt/ammeters and both give you .01% regulation, .05% stability.

Put Trygon power to work for you. Today. For the name of the sales office nearest you, call us collect.



TRYGON POWER SUPPLIES

111 Pleasant Avenue, Roosevelt, L.I., N.Y. 11575
Trygon GmbH 8 Munchen 60, Haidelweg 20, Germany
Write for Trygon 1968 Power Supply Handbook.

GLASS ENCLOSED Thermostatic DELAY RELAYS



by
AMPERITE

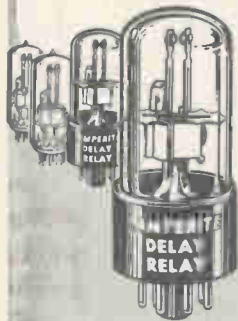

Offer true
hermetic
sealing —
— assure
maximum
stability
and life!

Delays: 2 to 180 seconds

Actuated by a heater, they operate on A.C., D.C., or Pulsating Current... Being hermetically sealed, they are not affected by altitude, moisture, or climate changes... SPST only — normally open or normally closed... Compensated for ambient temperature changes from -55° to +80°C... Heaters consume approximately 2 W. and may be operated continuously. The units are rugged, explosion-proof, long-lived, and inexpensive!
TYPES: Standard Radio Octal and 9-Pin Miniature... List Price, \$4.00
PROBLEM? Send for Bulletin No. TR-81.

AMPERITE

BALLAST REGULATORS

Hermetically sealed, they are not affected by changes in altitude, ambient temperature (-50° to +70° C.), or humidity... Rugged, light, compact, most inexpensive.

List Price, \$3.00

Write for
4-page
Technical
Bulletin
No. AB-51

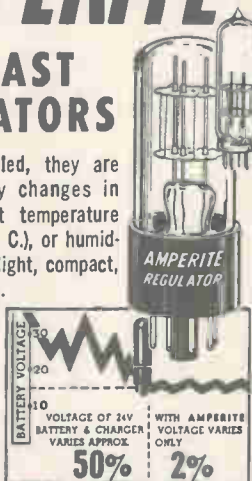

50%
2%

AMPERITE

600 PALISADE AVE., UNION CITY, N.J. 07087

Telephone: 201 Union 4-9503

In Canada: Atlas Radio Corp., Ltd.,
50 Wingold Ave., Toronto 10

... the diagnostic computer programs make TTC-(X) maintenance easier ...

tomed to this that it hasn't any feel for automatic gear. As a result, it has no way to specify what's needed."

The Sats procurement may familiarize the military with automatic systems, but Whele believes—not too surprisingly—TTC-(X) would probably do this better. The two general-purpose computers used in the TTC-(X) will not only control the switching system but also print out traffic data in terms of amount, priority, time of day, number of lost connections, and the like. It is almost impossible to get such data from operators on manual switchboards.

The computers will allow the armed forces to predict use patterns and gather data on what subscriber services—like dial-up conference calls and call forwarding—are most needed and useful. The TTC-(X) will include a number of these so-called special services.

This winter when Sylvania begins previewing its 300-line TTC-(X), installed in a small S-280 shelter, it will be showing a prototype as well as what it describes as a research tool. It is this latter feature that Sylvania marketing men hope will make the difference in the sales struggle.

Crux. Whele is quick to point out that TTC-(X) will stand on its own as a switching system. This is where that extra half-generation comes in. The heart of the system is the switching, or crosspoint, matrix—a nest of multiple interconnection semiconductor switches that follow instructions from the computer to route incoming traffic to the proper output terminals. The switches are integrated circuits, but Sylvania will give few details.

Whele says that unlike other electronic switching systems, the crosspoint matrix in the TTC-(X) is positively controlled. In other words, the computer fires each switch individually, recording in memory each firing and hence the route a call takes through the matrix.

Earlier systems, he says, didn't have positive control and therefore sometimes interrupted calls as the wrong crosspoint was fired or

switched off. In addition, earlier systems, in effect, left calls to find their own way through the matrix in an almost random fashion, with crosspoints firing on demand rather than at the behest of a controller.

Key role. The dual computers are in a way part of the positive control scheme in the TTC-(X). Only one machine is required to operate the exchange. In case of failure, it signals its mate—which otherwise runs self-test routines—to take over. In most cases, the off-line computer prints out a statement of its ills, and is repaired.

No calls are lost during such exchanges of control. According to Edwin G. Schneider, vice president for engineering at the Electronic Systems division, the crosspoints are of a latching type—they stay switched on or off, unless a triggering pulse is applied. Thus, while new calls cannot be completed during the momentary exchange between the two computers, no existing lines are dropped.

Diagnosticians. The computers test not only themselves, but also the switching system. If one of the several crosspoints on a printed circuit board should fail, the computer will route incoming calls through crosspoints on other boards. When the remaining calls passing through the faulty board are concluded, the machine will signal for a replacement by Teletype.

The computers are modified versions of the MSP-24 [Electronics, Aug. 5, p. 110] developed by Sylvania several years ago. The new versions have less arithmetic capacity and more memory—up to 64 kilobits of core memory in eight 8-kilobit plug-in units. Schneider says a good deal of the memory is used as a directory record and to prevent wrong numbers.

The memory also stores programs that allow the computer to operate the exchange with a mixed bag of equipment. For example, the TTC-(X) is equipped for push-button dialing rather than dial phones; a little extra software helps bridge the gap.

Masterful. While the idea of stored-program control isn't new

—civilian electronic switching systems use such an approach—the availability of extra services give battlefield commanders more flexibility. They should be able to dial up conference calls with five other parties—or more with the aid of a telephone operator—to interrupt low-priority conversations, to reach important subscribers by just lifting their phones off the hook or using abbreviated keying, or to have calls relayed to them by computer as they tour the front. In addition, the TTC-(X) would use multiple routing through other exchanges to reach subscribers in the event of breaks in its own direct line network. Finally, by changing a few circuit boards with input and output transformers, the operator of a TTC-(X) can convert a circuit from a 4-kilohertz voice link to a 108-khz data link. This feature should allow information rates as high as 90 kilobits per second to pass through the system says Schneider. And although it's designed for analog, or voice-like, transmission, the TTC-(X) should pass such pulse streams with little if any waveshape distortion, he says. While modulator-demodulator units would probably be necessary at data stations to allow the use of error-correcting codes, no digital-to-analog conversion would be needed for pulse-type information to pass through the TTC-(X). The extra bandwidth could also be used for scrambled, secure voice communications.

Maintenance is made easier by the diagnostic computer programs. A flashing signal and a Teletype printout tell the operator that a given circuit board must be replaced; service is never interrupted. To keep parts requirements low, the whole system is built using a maximum of 44 different printed circuit boards.

Now in its final stages of check-out, the 300 line TTC-(X) production prototype is presently relaying calls from one workbench to another at Sylvania's Needham Heights labs. Soon, engineers will begin packing the system into its bedroom-sized shelter, and not long afterward it will begin touring military installations in quest of a tri-service market—or at the least, a chance to help write the specifications for such an outlet.

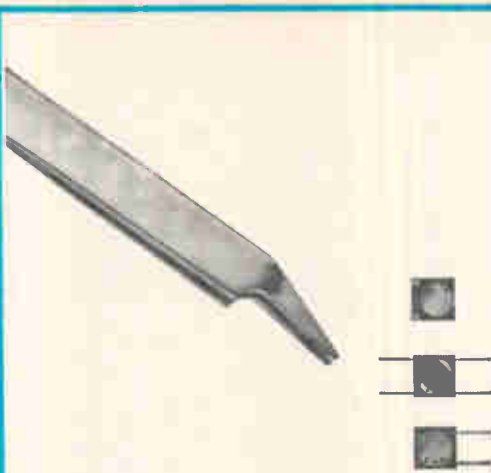

the
dynamic
trio

MICRO*i*TM

designed for inside and outside IC compatibility

Micro-i coils are produced in sizes to fit inside or outside IC's and are available in tolerances of 1% or better. These lightweight coils utilize a patented configuration which has no external magnetic field and have lead spacing conforming to EIA specifications. All Micro-i coils are color coded for easy assembly identification and are designed to meet MIL requirements.

SERIES 102, 152, 252 FOR INSIDE IC'S

- Gold plated tabs for in-house welding or bonding allowing more expedient assembly work.
- Designed specifically for thick or thin film hybrid substrates eliminating need for specially designed inductive devices.
- Height compatible for inside-sealed IC's.

VARIABLE

- Excellent resolution, enabling better tuning accuracy.
- Space-saving, non-retractable tuning eliminates need to increase overall package size.
- Available as an inductor, tuned circuit and transformer device.
- Vibration resistant.
- Choice of leads permits compatibility with printed circuit boards or thick or thin film hybrid substrates.
- Constructed to eliminate tuning mechanism failures.

Hi-Q

- Replacement for toroids because of its shielding and Hi-Q.
- Available as tuned circuit or transformer.
- Epoxy encapsulated for environmental protection.
- No core saturation problems.
- Optimum electrical characteristics at lower cost than toroids.
- Exceptionally low distributed capacity.

Write Department E-4 for further information on Micro-i

Delevan Electronics
/ Division



AMERICAN
PRECISION
INDUSTRIES INC.

270 QUAKER ROAD / EAST AURORA, NEW YORK 14052 / 716 652-3600

OTHER DIVISIONS OF AMERICAN PRECISION INDUSTRIES, INC. BASCO • DUSTEX •
ELECTRO-MECHANICAL PRODUCTS • MDELLER INSTRUMENT CO • DAFORD CORP

Automated subway: Hamburger special

West German city is testing control systems on a four-mile stretch of track within existing system; Siemens and AEG are competing for contract award

By John Gosch

Bonn bureau manager

Residents of Hamburg call the subway cars that shuttle between terminals along a four-mile stretch of track in the city's northeastern section "a ghost train." The rolling stock carries no passengers; it's crammed with electronic gear for trial runs on one of the world's most highly automated experimental subway tracks.

The tests, being conducted under the auspices of the Hamburger Hochbahn AG (HHA), operator of the big north German city's rapid transit network, will end next summer. At that time, a choice will be made between the two automated

train-control systems developed by Siemens AG and AEG-Telefunken—West Germany's top electronics concerns.

High stakes. Eventually, HHA plans to install electronic controls throughout the Hamburg subway network, which at present encompasses 51 miles of double track and 72 stations serving half a million people each weekday. Tracks are being added at a rate of about 1.2 miles a year. Unlike other large German engineering projects, the Hamburg job won't feature contract splitting. Whichever firm comes out ahead in the trials will be designated sole supplier of control equipment for the subway.

As for the total cost of such a control system, not even HHA's project planners have come up with exact estimates. They point out that it's too early to price a program that may take run through the 1980's. "But we think that the cost of applying automatic techniques to the network won't be any higher than what it would take to equip it with conventional control gear," says Arnold Mies, chief project engineer in HHA's technical development group. "Our prime objective right now is to try out a new technique with custom-tailored systems on a short piece of track. Once we have enough experience, an exact cost analysis can be made."

Hamburg's subway isn't the only one that's going to provide a big market for control equipment. Many other European cities are now considering rail lines of their own or automatic equipment for existing networks. Already, foreign experts are examining the equipment being used in the Hamburg

tests. And even teams from the Bay Area Rapid Transit District project in San Francisco have been around to take a look.

Four goals

HHA's primary goal in going to automation is to cut operating expenses. The company, the second largest rapid transit enterprise in West Germany, is one of the very few in the country that's not losing money. Company officials and the city of Hamburg, which holds the majority of HHA stock, want to keep things that way. To this end, four engineering aims have been defined: improved train sequencing; lower energy consumption; automated braking; and central monitoring of all operations.

Sequencing—the maintenance of certain distances between trains—is a crucial consideration in rapid transit systems both from the safety standpoint and because it determines how many trains can operate along a given length of track at any one time. In conventional railroading, sequencing is handled by a fixed-block signaling system. The line is divided into blocks that only one train at a time is allowed to occupy. Visual signals along the track tell motormen whether or not a train is in the block ahead. But this method of keeping trains apart is inflexible, especially where distances between stations are comparatively short.

To enhance flexibility—particularly during rush hours—HHA is turning the sequencing job over to electronic equipment. In the trials, digital circuitry continuously calculates distances between trains and generates "stop" and "go" signal pulses for the braking and pro-



On the track. Siemens control system is under test for the Hamburg subway.

pulsion mechanisms. Specifications are that trains with a maximum length of 394 feet traveling at 43.5 miles per hour must keep 787 feet apart. This figure is the approximate sum of the emergency braking distance—about 689 feet—and a safety factor of 85 to 98 feet.

Savings account. By assigning electronic equipment the job of making speed and timing calculations to control no-power coasting, HHA expects that as much as 20% less energy will be consumed. This would represent a tidy savings in view of the fact that the system now spends about \$1.5 million a year for d-c traction power—about 16% of its total operating budget. Officials note that on conventional networks, motormen often waste energy by reaching high speeds quickly and then slamming on the brakes at inopportune times. Besides, such slam-bang procedures make scheduling imprecise at best.

As far as automatic braking procedures are concerned, HHA isn't aiming at record accuracy. Tests have shown, however, that the electronic equipment being tried can stop a train within about 20 inches of a marked spot on the station platform 75% of the time—a performance exceeding HHA's specification of ± 39.4 inches. This accuracy isn't particularly spectacular, an AEG engineer on the project notes, since it can be achieved manually just as easily. But HHA wants to eliminate the guesswork involved and thus relieve the motorman of one of his most demanding tasks. Equally important is the fact that automated stopping also means energy savings and more accurate scheduling.

Keeping track. Finally, the company wants to monitor network operations from a central point. For that purpose, information on a train's position and identification number, as well as on over-all system status, is collected and shown on a display board at a central trackside control station. In the test setup, trains traveling anywhere along the four-mile experimental track can be located at a point on the board equivalent to a spot within 85 to 98 feet of their actual position.

HHA engineers, in cooperation with the Institute for Traffic Engineering and Railroad at Brun-

wick, developed an outline of an electronic train-control system to meet these various requirements. AEG and Siemens have each designed and built their own versions. Unlike electronic subway control systems in other European cities—Paris, Munich, West Berlin, Stockholm, and London, for instance—the one in Hamburg is fully integrated. "In our system every conceivable job involved in operating a subway train can be taken care of by electronics," says Juergen Lindner, HHA's number two man on the project.

When Lindner says everything, he means everything. Eventually, Hamburg's subway trains will operate without motormen. For the moment, however, a man will be kept aboard for emergencies and odd jobs as well as for psychological reasons. "People tend to feel safer with a driver around, even though automation has taken over his job," Lindner explains. "But when the commuters gain confidence in driverless operations, we'll take him off the train." To this end, circuitry will be available that automatically opens and closes doors, now the last preserve of the motorman.

Common cause

Both the Siemens and AEG designs have some features in common. Each uses line conductors laid continuously between the rails as transmission links between trains and trackside equipment. Critics maintain that a fixed-block system would be more reliable than the continuously laid installations since malfunctions would be confined to relatively small sections of track. However, engineers from Siemens, AEG, and HHA stoutly defend their choice on the grounds that the high reliability of modern electronic components makes massive breakdowns a remote possibility. To further minimize the chances of trouble, critical components will have backups. HHA reports no component failures since the trial runs got under way seven months ago.

Common to both systems is the fact that trains sense their position by counting mark points or loops the line conductors form at intervals between the rails. Digital circuits, either in the train or in trackside equipment, process speed

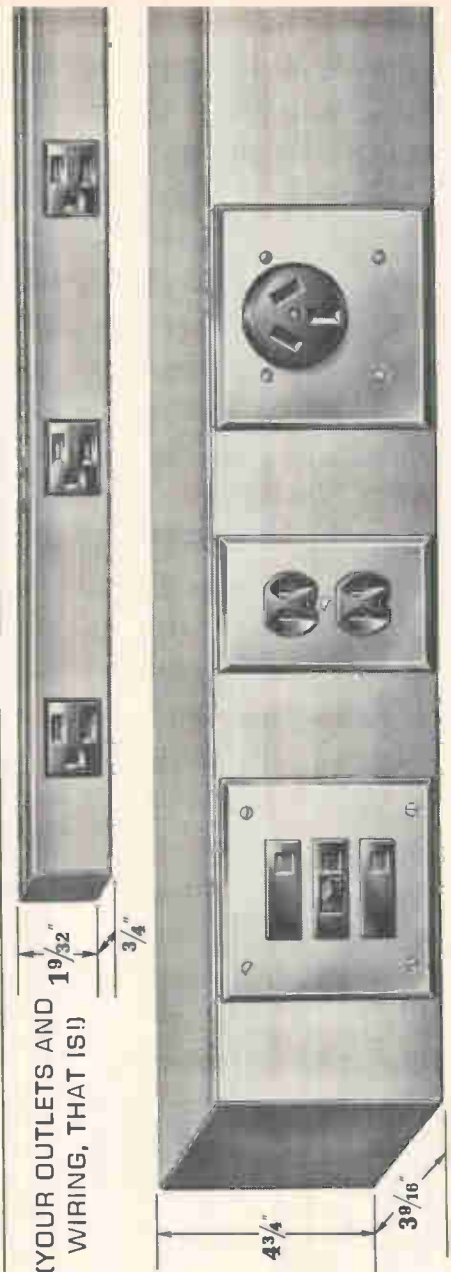

ORGANIZE!

PLUGMOLD® MULTIOUTLET SYSTEMS offer a versatile efficient way to organize electrical wiring and devices of all kinds. Build Plugmold into the products you design. Use it in lab and production areas.

Rugged, attractive Plugmold—in a variety of sizes—accommodates 14 to 2/0 AWG wire, devices to 60A, circuit breakers to 100A. U.L. listed. Send for bulletin.



THE WIREMOLD COMPANY / HARTFORD, CONNECTICUT 06110

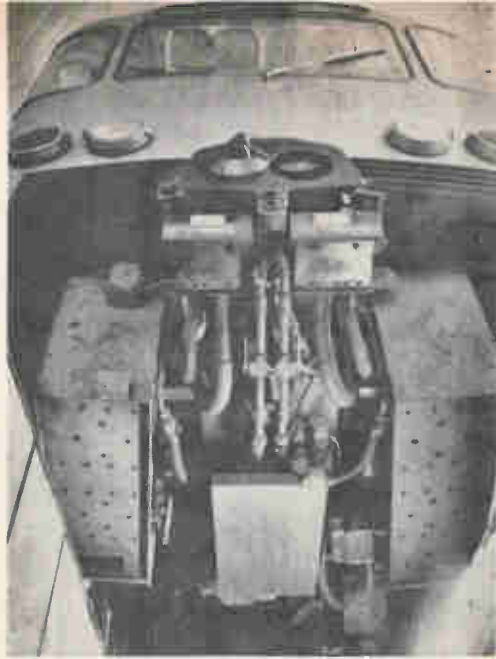

Boxed in. Antenna is mounted in oblong package on undercarriage in AEG system.

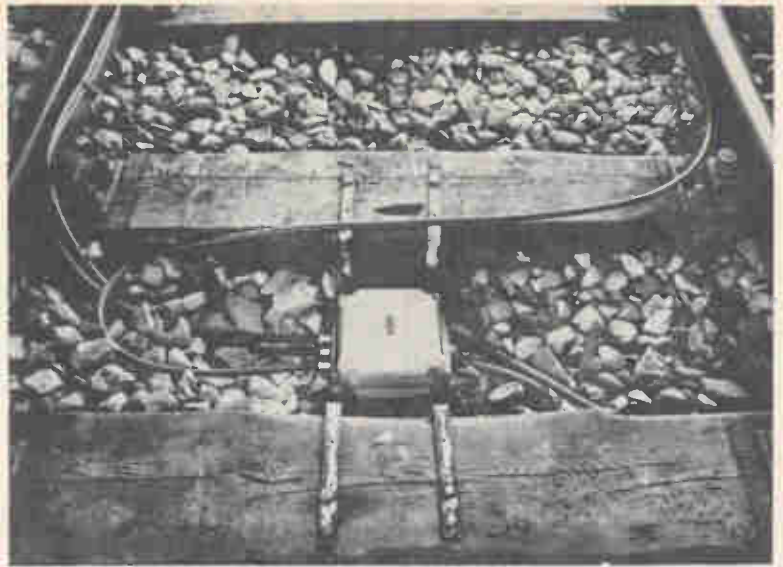

Trio: The AEG train-control system features a three-conductor approach; two are used for data transmission and one for position determination.

and position data, and, using such stored information as train schedules, distance between stations, maximum allowable speeds for particular track sections, and the like, they generate, commands for a train's braking and propulsion mechanisms. Both systems incorporate circuitry to monitor and correct faults.

Counterpoint. But there are differences between the two proposed systems and the way the two firms are tackling the automation job. It is these differences, along with financial considerations, that will ultimately determine the outcome of the contest.

AEG contends that it's advantageous to process as much data as possible on the train itself. "This way, we keep information exchange through line conductors to a minimum," says Helmut Linde, the company's chief project engineer for the Hamburg job. "That's an important consideration in electrically noisy environments like railroad facilities."

In keeping with this philosophy, AEG puts about as much hardware aboard the trains as it installs trackside. The circuits for generating brake and drive commands are on the train, for example, a setup which allows the feeding of these commands directly to the propulsion system.

In the Siemens system, brake and drive commands are generated by the trackside equipment and trans-

mitted to the train through the line conductors. The longer the messages, the more vulnerable they are to noise, AEG's Linde asserts. Another drawback, in his opinion, is that, since these signals must be sent to many trains in a future all-automated subway network, the equipment along the track must be designed with a large memory that can store the different braking characteristics of a variety of train models.

In AEG's system, each train has some extra circuitry. Linde concedes that this will run up the cost, but once modules are mass-produced, he adds, costs can be cut.

Says Rolf Beyersdorff, Siemens chief engineer on the Hamburg project: "Our aim is to keep as much equipment as possible off the trains. One reason, of course, is price. In addition, train-mounted equipment is subject to shock, vibrations, and temperature variations—a hostile environment for electronic components. Finally maintenance is easier if equipment is located largely in one readily accessible place rather than distributed among a multitude of cars."

Two way

Information exchange is accomplished in the Siemens system by two line conductors that each handle a 1,200-baud telegraphy-signal transmission channel. One channel is for trackside-to-train transmissions over a 36-kilohertz carrier

frequency, the other for train-to-trackside transmissions over a 56-khz carrier. There are also two f-m channels that use carrier frequencies of 75-khz and 85 khz, respectively, for two-way radio telephone communications between the train and the central control station.

The two conductors are installed along the rail foot and they cross each other every 85 feet, forming the references required for train position determinations. The train's receiving antenna, mounted on the undercarriage, detects these cross-points. The antenna has two coils displaced so that each picks up the voltage present in one of the branches that form the line conductor cross. These voltages are evaluated in the train-mounted circuit modules; voltage amplitudes, together with their relative phases, indicate position and whether the train is moving forward or backward.

Pulsating. For distance and speed measurements, two electronic pulse generators are used, each producing 64 pulses during one revolution of the train's drive shaft. The pulses are derived from ferrite cores installed around the perimeter of a train wheel. As the cores pass sensing devices, pulses are produced which are subsequently counted. The number per unit of time furnishes a gauge of train speed, while the total measures distance covered.

Both techniques supplement and



Brass 70-30; 12" diameter, .35" blank
One draw • 12,000 psi



Aluminum 5257-0;
12" diameter, .035" blank
One draw • 5,000 psi



Stainless Steel 304
12" diameter, .030" blank
Two draws • 14,000 psi



Cold Rolled Steel; 22" diameter, .024" blank
One draw • 7,000 psi



Aluminum 6061-0;
12" x 6 1/2", .062" blank
One draw • 10,000 psi



Stainless Steel 302;
7" diameter, .020" blank
One draw • 10,000 psi

PROFIT MINDED?

Perfection Mica's Hydroforming Service will economically and accurately form your metal parts to any size or shape . . . with minimum scrap and low tooling and finishing costs. Even difficult shapes of metal are formed easily. (A few typical examples are illustrated above). Equally efficient for high or low volume production runs . . . plus the quick changeover and low set-up charges traditional with hydroforming. Centrally located in the midwest for rapid delivery and low shipping costs.

If hydroforming fits your needs, send us your drawing and we'll fabricate to your requirements.

PERFECTION MICA COMPANY

1322 N. Elston Avenue, Chicago, Illinois 60622
Phone 312, EV 4-2122. TWX 910 221-0105.

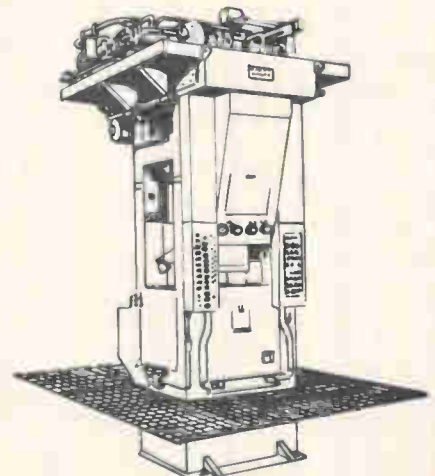

Eliminate Power Supply
Obsolescence...Simplify
Stocking Problems...Here are

More Ways to Get Wide Range DC Power from ERA



ERA's New Wide Range SLIM-TRAN® DC Power Module for 19" Rack Mount or Multiple Module Assembly

New Slim-Tran Power Modules AC/DC power supplies provide DC output over a wide, adjustable voltage range. Practical plug-in design permits use of as many as 7 units in a standard relay rack assembly or grouped in a multiple module configuration. A single model can serve many voltage requirements.

STANDARD MODELS

Output* Voltage DC	Current* 71°C	Model	Price
1-63	0-1 amp	ST1000	\$155.00
1-33 Dual	0-1 amp Dual	ST1000-2	\$195.00
1-33	0-2 amps	ST2000	\$175.00

*For higher current or voltage ratings two or more units may be connected in series or parallel.

SPECIFICATIONS

Ripple: Less than 800 microvolts RMS or 0.005% whichever is greater
Line Regulation: Less than 0.01% or 5 mV for full input change
Load Regulation: Less than 0.05% or 8 mV for 0-100% load change
Transient Response: Less than 50 microseconds
Operating Temperature: -20°C to +71°C free air, full ratings
Temperature Coefficient: Less than 0.01% or 3 mV per degree C

Write for Catalog #149



ELECTRONIC RESEARCH ASSOCIATES, INC.

67 Sand Park Road, Cedar Grove, N. J. 07009
Dept. EE-7 (201) 239-3000

SUBSIDIARIES: ERA Electric Co. ■ ERA Acoustics Corp.
■ ERA Dynamics Corp. ■ ERA Pacific, Inc.

correct each other. For instance, the crosspoint detection method eliminates errors that might occur as a result of wheel skippage. And counting pulses guarantees that the train-mounted equipment will sense the crosspoints.

Calling all cars. The trackside equipment cyclically calls all trains with a specific address which identifies an 85-foot section—the distance between crosspoints. Calls go out at least once every 350 milliseconds; if a train doesn't receive a call within a 1-second period it would automatically come to a stop.

All trains traveling along a certain section of track receive the calls, but only one answers—the one whose position code, as determined by crosspoint sensing, corresponds with the call code sent by the trackside equipment. When position and call codes jibe, the train's transmitter automatically comes on. The train then transmits its actual speed to the trackside equipment. Messages, with data on how much unoccupied track is ahead, the maximum speeds for particular portions of track, as well as braking and propulsion commands, which the train's receiver gets from the trackside equipment, are evaluated by the train's electronic circuitry.

These messages carry informa-

tion on how long a stretch of unoccupied track is ahead, maximum permissible speeds for particular sections, and braking and propulsion commands that are based on traffic conditions. Braking instructions are keyed to train characteristics.

To call trains, the trackside equipment stores the position of all



Due. The Siemens system uses two line conductors for information exchange.



Looking up. Engineers inspect undercarriage of subway car on which is mounted Siemens coil antenna that detects crosspoints along the track.

what's it really like to live in Wisconsin?

read our newspapers, **FREE** for **60** days

To make an industrial-site selection, you need all the facts and figures before making the decision. You would also like to know what living is really like in the place you are considering.

Nothing short of being here could give you the feel of everyday living in Wisconsin like reading our newspapers — from a different city every day or two — for 60 issues.

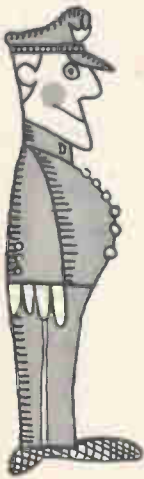

How better to take the pulse of our state, to hear the voice of our people? You'll see for yourself how citizens support good government. You'll see how editorial opinion varies or agrees from city to city. What our labor-industry situation actually is. What we charge for a dozen eggs. Or a house. Or a theater ticket. Read the schedules of our sailings to foreign ports. Nothing quite brings into focus the importance of the St. Lawrence Seaway to Wisconsin businessmen like the sound of such faraway destinations as Amsterdam, Porto Alegre, Helsinki, Kobe, Casablanca and Karachi. These and dozens more are served from

our fresh-water "ocean" ports. We average hundreds of departures yearly from Milwaukee alone. And at the end of your free sampling of Wisconsin dailies you'll be in a far better position to judge Wisconsin as expansionland for your company.

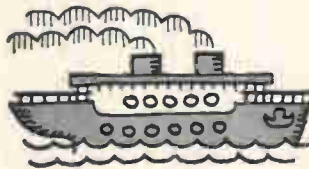

So ask your secretary to fill out the coupon. Or write us a note on your business letterhead, mentioning your title and telling us whether you'd like to have your 60 different issues of Wisconsin newspapers mailed to your home or office. We'll acknowledge promptly, with some interesting statistics and an official map so you can see where each newspaper comes from. Soon you'll have a clear and unbiased picture of what it's really like to live, work and do business in Wisconsin.

This invitation is open to all industrialists everywhere, except those now living in Wisconsin. (Sorry, neighbors.)



Division of
Economic Development
747 State Office Building
Madison, Wisconsin 53702

I think you're right. A 60-issue look at Wisconsin's newspapers should be most revealing. Please send me your free papers. I understand there is no obligation whatever.

Name.....Title.....

Firm Name.....

Kind of Business.....

Address.....

City.....State.....Zip.....

If you would prefer that papers be sent to your home, please include following information:

Home Address.....

City.....State.....Zip.....

(If different from that of your company)

WISCONSIN !

Resources which make Wisconsin outstanding

- **Vocational Education** / National leadership; reaches every area of the state; total enrollment of vocational and adult program, 230,000.
- **Transportation** / 11 out of 12 railroads operating in the state are Class I; have boat ties.
- **Government** / Clean, efficient government; merit principles in employment.
- **Utilities** / Electrical generating capacity of 4,400,000 kw; expected to increase to 6,000,000 kw by 1970. Natural gas available from south, west and north; all systems interconnected.
- **Trucking Service** / 180 authorized common carriers; overnight service to Chicago and Twin Cities.
- **Industrial Development** / 230 local industrial development groups to aid industry.
- **Highway System** / Excellent interstate, state and secondary road system.

What's an optical company doing in the electronics business?

Plenty.

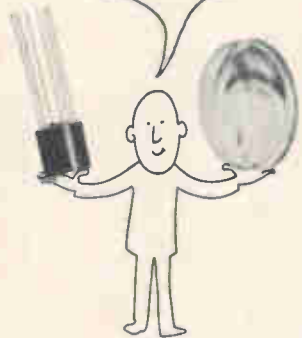

Because Varo Optical is a lot more than just a manufacturer of precision optics.

We're also one of the best single electro-optical design, development, and production sources in the country.

Varo can offer this broad capability because we're a design team of physicists, mathematicians, and optical, mechanical, and electrical engineers.

And we have the added capability of computerized lens design, plus a complete engineering model shop for pre-production prototypes, and the industry's most modern full-production facilities.

Two examples of instrumentation available to you are (1) the DETECTIRSCOPE, an IR viewer used to study silicon crystal stress patterns, and (2) a lens bench that has a folded autocollimator, and reads directly from the vernier from within .002 inches or .05 mm.

If you have electro-optic requirements, doesn't it make sense to call in an optical company like Varo?

We're optics experts.

Which means you don't have to be.



VARO OPTICAL, INC.,
VARO INDUSTRIAL PARK, 215 E. PROSPECT AVE.,
MOUNT PROSPECT, ILL. 60056
(312) 259-8100 763-6700

trains and continuously corrects position data as trains proceed along the track. Messages received from the trains tell the trackside equipment whether a particular train is still in the same 85-foot section, or whether it has already entered adjacent sections.

In addition to train position data, the trackside equipment stores information on speed limits for particular portions of the track as well as data on curves, slow-drive zones, work crews along the track, and the like. From this information the trackside equipment formulates propulsion and braking commands by successively scanning its storage elements and then figuring out lengths of unoccupied track and allowable speed limits. The most important piece of information is braking distance. This value, together with the train's braking characteristics, determines the required speed.

Tripartite

The AEG train-control system uses a three-conductor approach for exchanging information between the train and the trackside equipment. Two side-line conductors are installed between the rails for data transmission over two 600-baud channels. One channel, with a 55-khz carrier is for trackside-to-train transmissions, and the other, with a 65-khz carrier, is for train-to-trackside transmissions. The conductors cross each other at intervals to cancel out electric fields. The side-line conductors also accommodate two f-m channels for two-way telephone communications between the train and the central control station. Carrier frequencies are 85 khz and 95 khz.

The third conductor, for train position determinations, meanders between the other two, running along one side of the rail and then switching over to the opposite side. As a result, fixed-length sections are formed along AEG's section of test track.

In contrast with Siemens' voltage-amplitude and phase-detection techniques, AEG uses a so-called bifrequency method for determining train position. Two different frequencies—one 73 khz, the other 77 khz—become alternately effective in successive 98-foot sections. The train senses different

frequency signals as it moves along the track. After these signals are processed in the train's electronic equipment, the changes from one frequency to another are counted. The counting circuit is triggered by a signal from the trackside equipment the instant the train starts its run. The total number of frequency changes counted is a measure of the distance the train traveled from the time the counting began. The train's position, or its distance relative to the starting point, is transmitted to the trackside equipment.

No question. The bifrequency method affords nonambiguous criteria for train position determinations. Since the two frequencies alternate, one always characterizes, for example, an even number of 98-foot sections, while the other marks only odd numbers of such sections. This even-odd sequence provides an indication of whether a change in the last digit of the counter position is normal or whether the change stems from some kind of distortion.

In case of a counting error on one train the trackside equipment stops transmitting data, and emergency brakes are automatically applied. The last position stored at the trackside equipment will then be transmitted to following trains, advising them that the track ahead is blocked.

For the fine-position measurements, required for accurate stopping, the AEG system uses a pulse generator flanged to a wheel axle. This unit produces a voltage that's frequency-modulated by a slotted disk mounted on the axle. There is one coil on each side of that disk; the voltage coupling between the coils is continuously interrupted as the disk turns with the axle. The number of pulses produced during wheel revolutions measures the distance from the beginning of a 98-foot section.

Crosstalk. For data transmission, trackside equipment cyclically calls all trains with an address which identifies each one. Messages contain information on distances to other trains or obstacles ahead as well as data on maximum allowable speeds along specific sections of track. The messages, about 50 milliseconds long, are repeated every second.

Trains respond to the call by re-

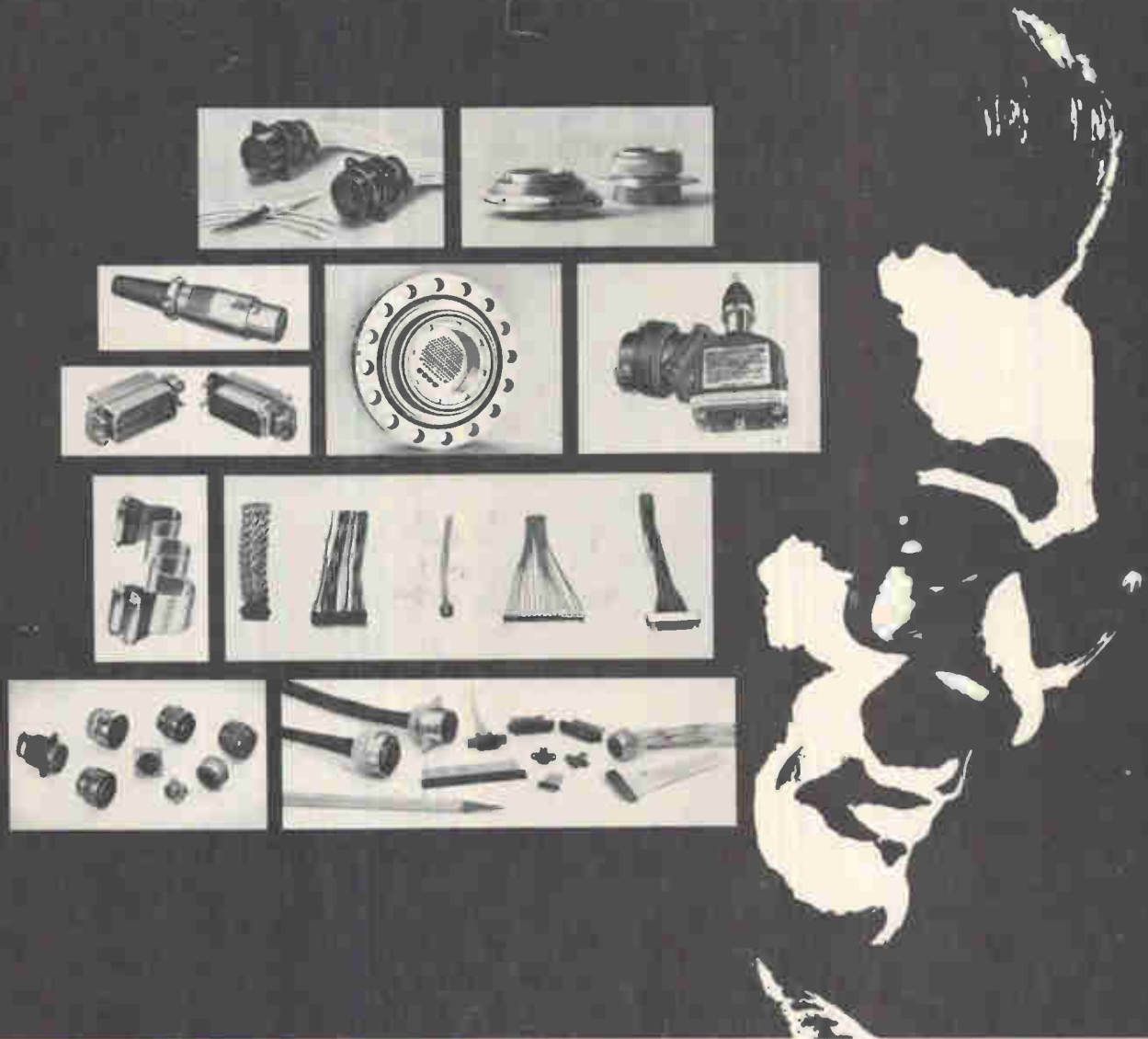

What you can imagine...ITT Cannon provides.

We've pioneered every important stage in connector design.

Imaginative engineering that's unmatched in the industry distinguishes ITT Cannon connectors as the standard for reliability in space vehicles, ground support equipment, or any application where highly engineered connectors are paramount requirements.

Backed by a rigorous reliability program, including identification and traceability when required, ITT Cannon offers the widest

selection of connectors available — for every application and environment — microminiature, subminiature, miniature, and standard to solve every conceivable connector problem such as hermetic sealing, heat, radiation, shock, vibration, non-outgassing.

ITT Cannon is also the foremost supplier of special, highly engineered connectors for missiles and space vehicles, including breakaway-umbilicals, interstage disconnects, harnesses,

and associated equipment. If you have a special requirement, contact ITT Cannon, the world's most experienced and imaginative manufacturer of electrical connectors.

Write for our "Connector Selection Guide." ITT Cannon Electric, 3208 Humboldt Street, Los Angeles, California 90031. A division of International Telephone and Telegraph Corporation.



CANNON ITT

JFD
UNICERAM - UFP SERIES:

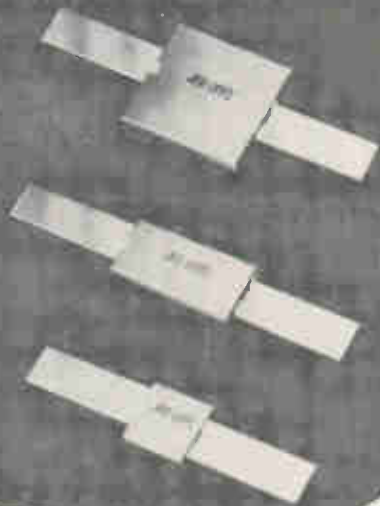

(illus. .65 actual size)

SMALLEST HIGH RF POWER CAPACITORS AVAILABLE!

JFD's Uniceram UFP Series offers the design engineer a broad line of miniaturized high voltage and high current fixed ceramic capacitors for use in RF circuits. These highly stable, small, reliable UFP's have been used up to 200 MHz. They are the ideal space-savers' for today's military communications, mobile, commercial broadcast and amateur radio transmitters.

UFP1's measure only $\frac{3}{4}$ " square X $\frac{1}{4}$ " thick. High Q 'Uniceram' proprietary ceramic material with special internal monolithic construction yields high power handling capabilities per unit volume. Glass encapsulation insures a moisture seal. Wide fine silver ribbon leads are used because of their low inductance and high RF current carrying capabilities.

- Capacitance values from 10 pf to 3,000 pf ($\pm .5$ pf for low capacitance values; $\pm 5\%$ and $\pm 10\%$ for higher values).
- Rated at 8 amperes at $+25^{\circ}\text{C}$ with derating for higher temperatures.
- Voltage rating (Typ.) at $+25^{\circ}\text{C}$ is 3,000vrms peak for values up to 150 pf (UFP1) and up to 330 pf (UFP3) with derating for higher temperatures.
- Q at 1 MHz and $+25^{\circ}\text{C}$ for values of 1,000 pf and smaller are 5,000 minimum.
- Typical UFP1 rating is 12 KVAR at $+25^{\circ}\text{C}$.
- Temperature coefficient at 1 MHz (-55°C to $+125^{\circ}\text{C}$) is $+95 \pm 25$ PPM/ $^{\circ}\text{C}$.

For additional information, write for catalog UNM-UFP-68.

"TODAY'S COMPONENTS BUILT FOR TOMORROW'S CHALLENGES"

JFD JFD ELECTRONICS CO. / COMPONENTS DIVISION
 15th Ave. at 62nd St. • Brooklyn, N.Y. 11219 / Phone 212-331-1000

Offices and subsidiaries in principal cities, world-wide.

porting actual positions, determined by bifrequency techniques. If there's no report from a train the trackside equipment repeats its call message at least three times in a row. Any interruption in the information flow between train and trackside equipment, or vice versa, is considered trouble.

The trackside equipment stores information on train position as well as work crews along the track and other obstacles. Using this stored information, together with the position data reported by other rolling stock, the trackside equipment determines how much unobstructed track there is ahead.

From this input the train's electronic equipment figures the maximum allowable train speed and generates suitable drive signals. These signals are sent directly to the train's brake and propulsion mechanism. The AEG system differs in this respect from Siemens' version in which propulsion and brake signals are generated in the trackside equipment and then sent to the train via conductors. Another distinction of the AEG system is that the circuits for storing braking characteristics and for generating the signals required in accurate stopping are on the train.

Linking the train-mounted equipment with the three conductors is a receiving and transmitting antenna mounted on the car's undercarriage. The unit consists of a large frame loop for data transmissions, two ferrite rods for position determination, and phone communications gear.

Final exams

During the trial runs, the test equipment on the trains logs data speed, running time between stations, distance traveled, energy consumed, and stopping accuracy. These parameters, punched out on the train on paper tape will be evaluated on a computer at HHA's administration headquarters. Results will be important in the choice of the train-control system for the automated subway network.

Trial runs on the four-mile double-track section take place at night and between rush hours. This way, normal commuter service is hardly affected. Siemens and Telefunken have been assigned one track each along the test section.

evening classes won't fit your schedule?

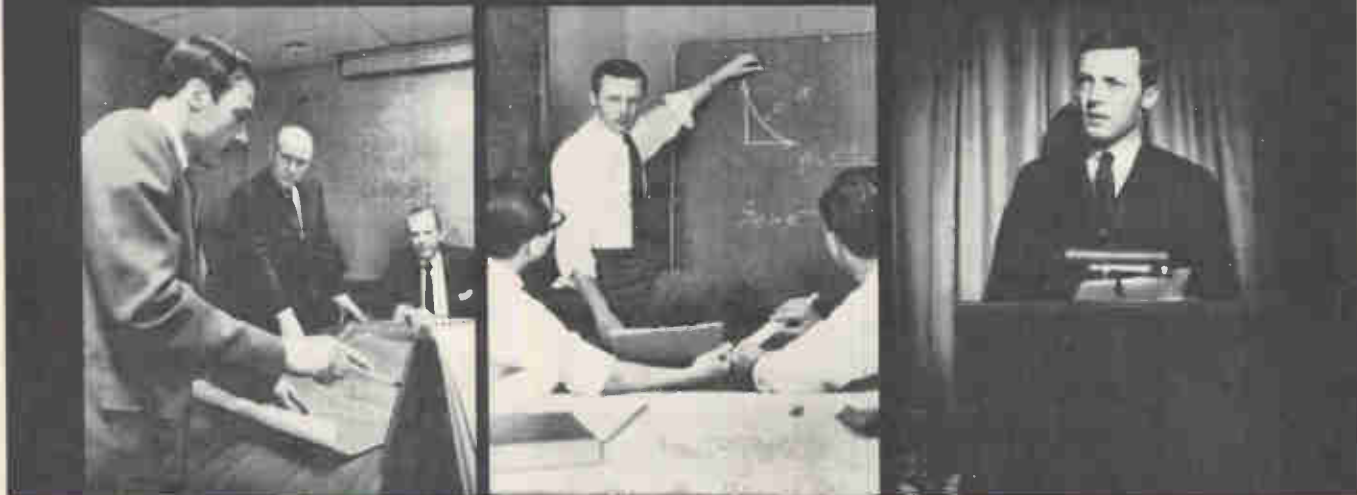

here's a practical way to keep up with new developments

Are irregular hours, travel and family obligations keeping you from attending classes—even though you worry about becoming technically obsolescent? Check into the Special Programs in Electronics for Engineers developed by CREI, the Home Study Division of the McGraw-Hill Book Company.

These are not simply courses, but comprehensive programs in advanced electronics offering major electives in such fields as:

Communications Engineering, Aeronautical and Navigational, Television Engineering, Automatic Control Engineering, Missile and Spacecraft Guidance, Radar and Sonar Engineering, Nuclear Instrumentation and Control, Computers.

Industry-recognized CREI Programs make it possible for you to catch up on new developments in electronics through study in your own home, at your own pace,

your own schedule. Free book gives complete information and details of technical material covered. For your copy, mail coupon below or write: CREI, Home Study Division, McGraw-Hill Book Company, Dept. 1832-G, 3224 Sixteenth St., N.W., Washington, D.C. 20010.

Founded 1927



Accredited Member of the National Home Study Council



CREI, Home Study Division, McGraw-Hill Book Company
Dept. 1832-G, 3224 Sixteenth St., N.W.
Washington, D.C. 20010

Send me free brochure describing CREI Programs in Electronics for Engineers.

NAME _____ AGE _____

ADDRESS _____

CITY _____ STATE _____ ZIP CODE _____

COMPANY _____

TITLE _____

DOUBLE THRESHOLD TIME DELAY

Magnetic circuit breakers permit accurate and reliable control circuits. The circuit shown allows an adjustable time delay responding to the average, (average, not rms) value of an overload, no trip below rated current, a time delay between 100% and 200% of rating, essentially zero delay above the adjustable limit. A 1/2 volt input corresponds to 100%. 1 volt input corresponds to about 200%. Between these limits time delay is furnished by C1-R2. R1 adjusts the first threshold, the 100% point.



Double Pole Breaker
Type APL 14-R

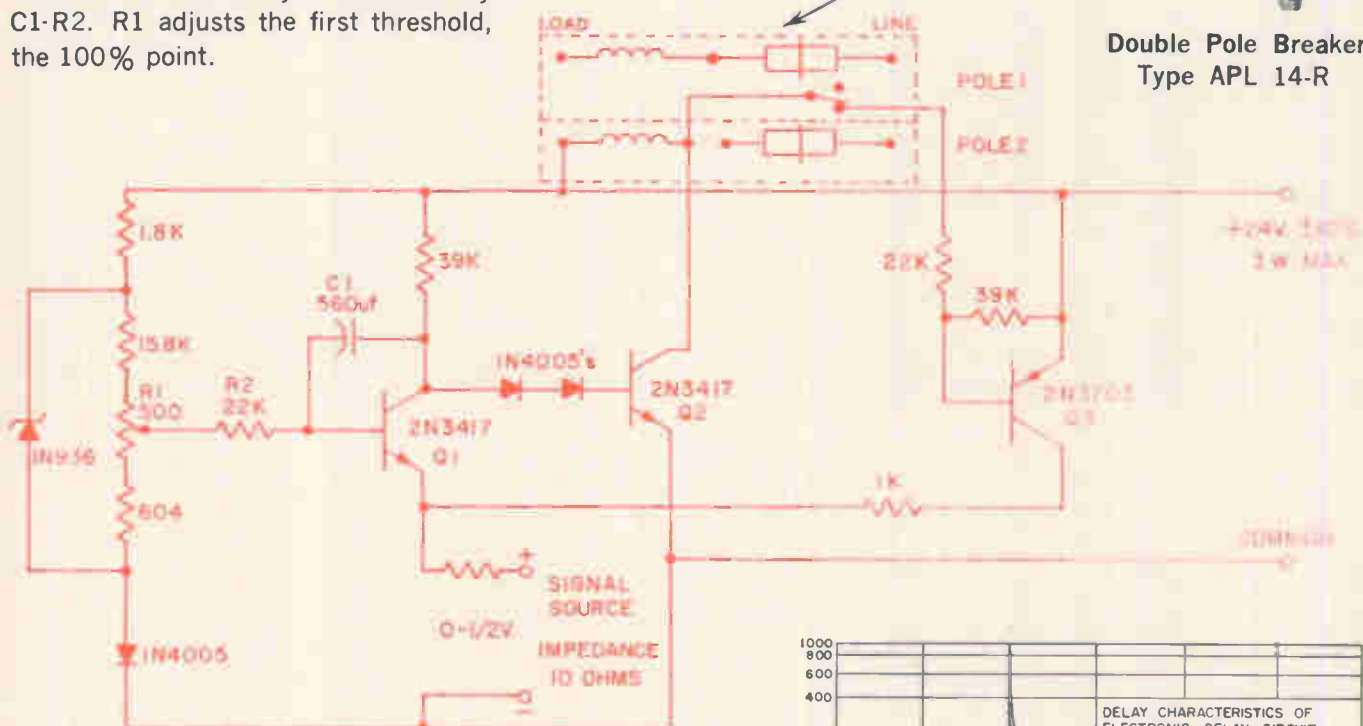

Electronic time delay circuit

Double threshold characteristic curve

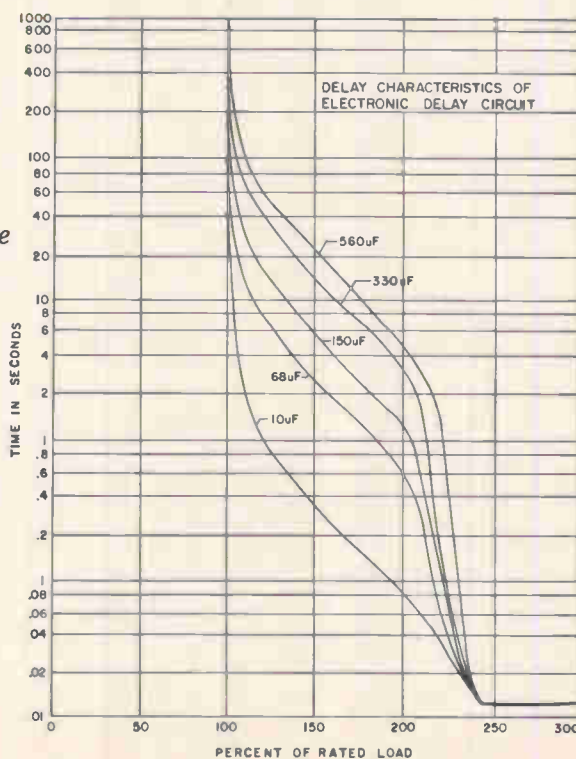

For further information on Airpax breakers, contact

**AIRPAX
ELECTRONICS**

Cambridge Division, Cambridge, Maryland 21613

Phone (301) 228-4600

TWX 710 865-9655

TELEX 8-7715

New Products

Components

Busbar blocks high-frequency noise

Interdigitation of laminated device's thin metal plates increases capacitance to 12,000 picofarads a square inch

By Owen Doyle

Assistant editor

For a long time, busbars had it easy. Their only job was to be a common point in an electrical system. Whether acting as the rallying spot for a circuit's ground leads or as the distribution center for input power, a busbar just had to conduct a signal. But modern busbars, especially those used in digital systems, must also protect a signal against high-frequency noise. How well the busbar does this job depends on how much capacitance it has—the more the better. And en-

gineers at Eldre Components Inc. say their new busbar has the most—12,000 picofarads per square inch of conductor surface.

Most of the signals in a digital system have high frequencies. And these signals are continually being switched. So a low-frequency line—like the one carrying d-c input power—is likely to pick up such high-speed noise as a-c radiation and switching transients. The question for the design engineer is how to protect the d-c lines without in-

creasing the size of the system.

Stack. At least part of the answer came when suppliers started making laminated busbars, which have capacitance in the picofarad range. A laminated busbar is a stack of metal plates, separated from each other by layers of dielectric. Terminals line the long edges of each plate and, usually, alternate plates are tied together and grounded. Signals enter through one or more terminals, flow down the long axis of the plate, and leave



Packed in. This busbar, which is 9.0 by 0.4 by 0.1 inches, has a total capacitance of 30,000 picofarads.

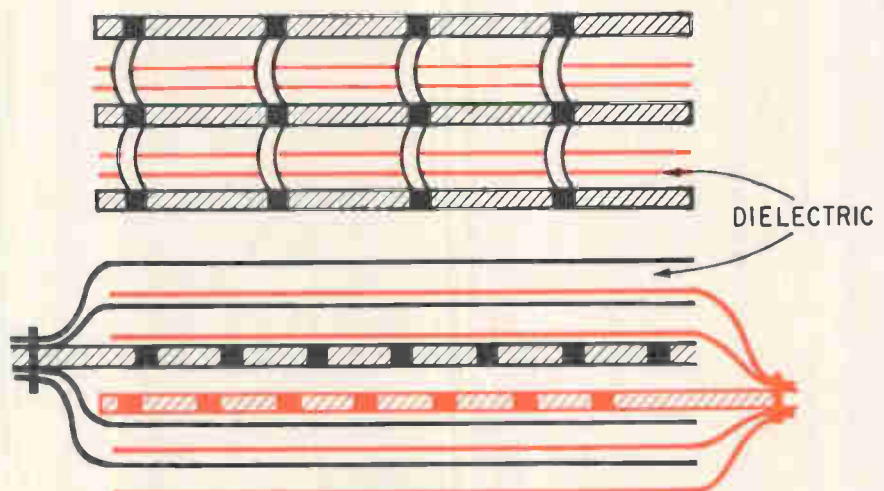

The reason why. Most laminated busbars are stacks of thick, metal plates. But a busbar's conductor area, hence its capacitance, is more when the conductors are thin strips of metal that are interlocked like fingers on folded hands.

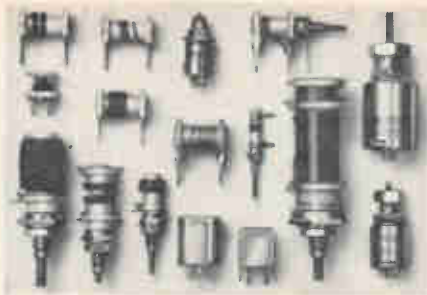

APPROX. 1/2 SIZE

How CAMBION® standard coils, chokes and filters help you kick the specials habit

Tune in the "reliables" . . . CAMBION regular, PC, shielded, tunable and fixed coils. More than 1,000 varieties, all standard, all ready to go straight from the shelf.

CAMBION standard coils and chokes come in groups with overlapping inductance values. Your design work's no longer a guessing game. And you don't have to blow your cool trying to out-smart unknown characteristics.

And with CAMBION coil forms, your in-house winding facility is IN. More than 1,500 types for conventional and printed circuits. Like . . . from stock!

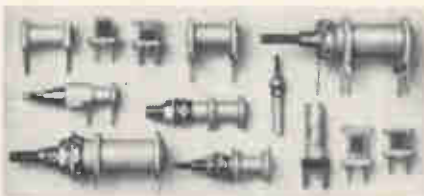

APPROX. 1/2 SIZE

For miniaturization midgets — CAMBION microminiature coils . . . only .250 square inches or smaller (that's a real small square).

Swing with CAMBION Doroids. These high frequency microelement inductors are available in 36 overlapping inductance ranges from .12 uh to 100 mh . . . with Toroid characteristics.

And for those of you who can't kick the specials habit, CAMBION has the design, engineering and manufacturing capability to solve your RF coil and transformer problems. Try us.

To turn our engineers on . . . call or write Cambridge Thermionic Corporation, 447 Concord Ave., Cambridge, Mass. 02138 Phone: (617) 491-5400. In Los Angeles, 8703 La Tijera Blvd. Phone: (213) 776-0472.

©REG U.S. PAT OFF

CAMBRIDGE THERMIONIC CORPORATION
CAMBION®

Standardize on CAMBION . . .
21,541 guaranteed electronic components

APPROX. 1/2 SIZE

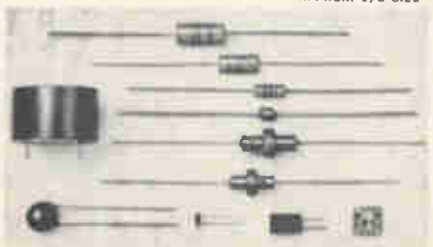

through other terminals.

Each metal-dielectric-metal section of the bar is a parallel-plate capacitor. So any current flowing in a signal plate sees two capacitive paths to ground through the dielectric.

The capacitance of a parallel-plate device goes up as plate area increases or as the distance between plates decreases. Eldre engineers say they have figured out a way to get more plates into a package than has been possible; the packing density of plates has until now been kept low by the need to keep them thick enough to support the terminals.

Short stack. In Eldre's busbar, all ground plates are tied together at one end of the busbar, and all the signal plates at the other end. Of course, this means that only one voltage level can be carried in a given busbar, but Eldre is going after the digital equipment market, where one level is sufficient.

Eldre's busbar has only two plates that are thick (10 mils): the middle ground plate and the middle signal plate. All the terminals are on these two plates. The other plates are just thin ribbons, 2 mils thick, fanning out from each end and forming an interdigitated pattern. The idea is simple, says Jack Erdle, company president (he named the company by reversing his last name). The hard part was developing economical manufacturing techniques.

Erdle expects the new busbars

to get their biggest welcome on printed-circuit cards used in digital systems; the busbar would carry the input d-c power to the integrated circuits. "Our tests show the busbar will take out any noise up to 1 megahertz, and I'm sure it can handle signals up to 10 Mhz," says Erdle. "Besides, our busbars are rigid; some of these cards are 9 or 12 inches long and are very flexible, so the busbar acts also as an integral supporting part of the card."

The impedance of the busbar is low since inductance is just 2 nanohenries per foot.

If the design engineer can be sure the power lines are protected against high-speed noise, things become a lot easier for him. For example, he doesn't have to use a lot of decoupling capacitors. This makes construction easier and reduces maintenance time; finding one bad capacitor can take quite a while. What's more, the capacitance of the Eldre busbar is distributed, so there'll be no reflection problems.

The first buyer was Autonetics. According to Erdle, this North American Rockwell Corp. division initially planned to use the busbar just on the p-c cards, but, seeing them work, decided to use them to replace harnesses in other parts of a system.

Not off-shelf. Eldre doesn't plan to make the high-capacitance bars as off-the-shelf items. Each customer will send in his requirements, and the order will be filled in two to

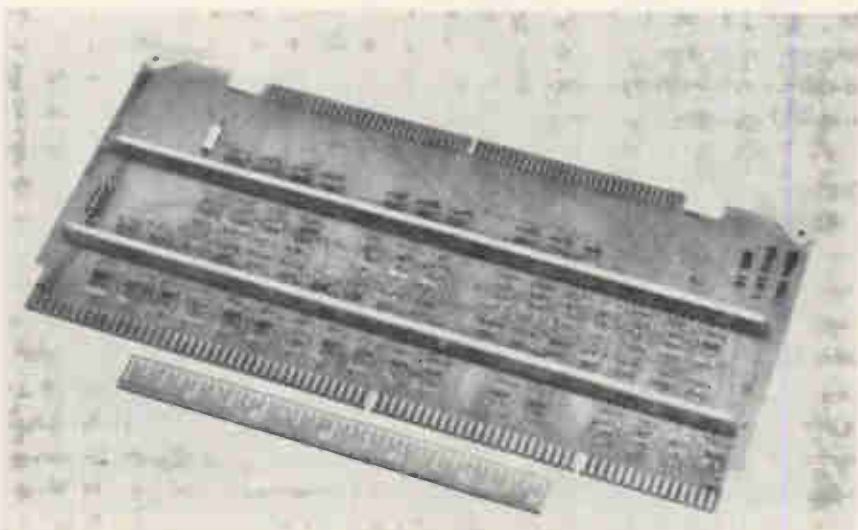

Power line. High-capacitance busbars supply noise-free power to rows of integrated circuits on a printed-circuit card. This card is part of a system built by Autonetics.

RJ11 space saver

(actual size)



It's new! Helitrim® Model 76P cermet trimming potentiometer is the industry's first $\frac{3}{4}$ " long trimmer with RJ11 style pin spacing.

It's a space saver – saving 40% of the board space required by conventional $1\frac{1}{4}$ " long models.

It's low-cost—only \$1.95 list.

And it's fully sealed.

Model 76P also provides essentially infinite resolution, setting ability to within $\pm 0.05\%$ of required voltage

and maximum freedom from catastrophic failure. It's available from local stock in standard resistance values from 10 ohms to 2 megohms.

For all of Model 76P's specifications, call your local Helipot representative. He'll give you all the answers and an evaluation sample.

Beckman®

INSTRUMENTS, INC.

HELIPOT DIVISION

FULLERTON, CALIFORNIA • 92634

INTERNATIONAL SUBSIDIARIES: GENEVA, MUNICH, GLENROTHES, SCOTLAND, TOKYO, PARIS, CAPE TOWN, LONDON, MEXICO CITY

A New X-Y Recorder...

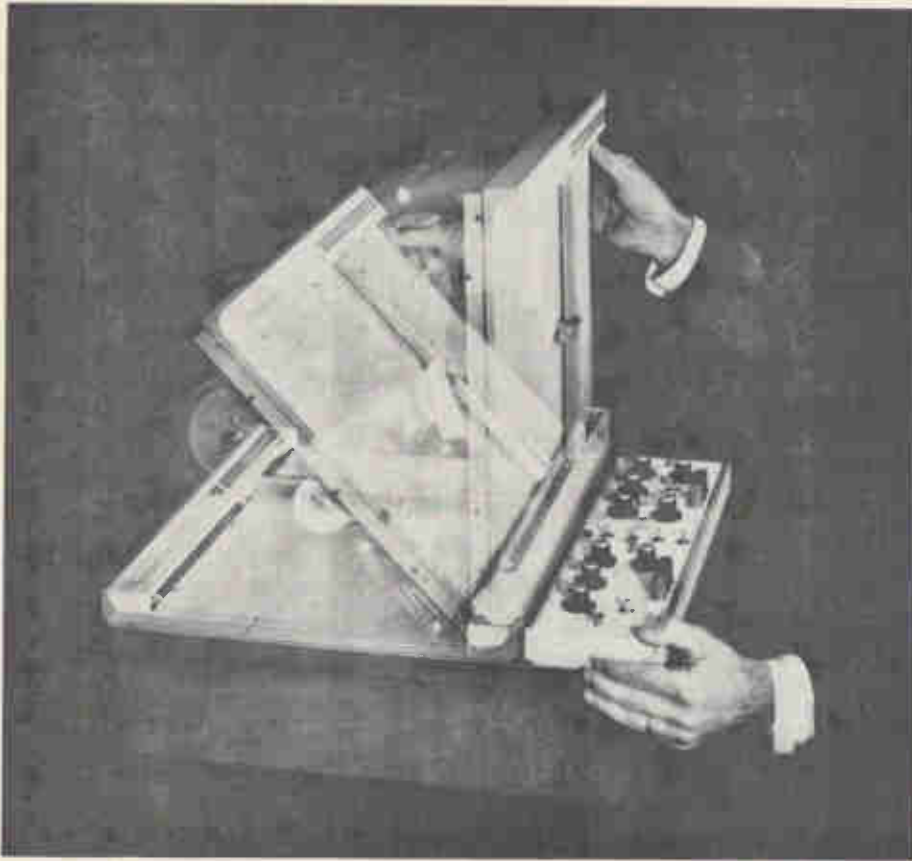

That's Easier To Operate

Easier to operate . . . easier to position . . . and meets top performance requirements. The *function/riter** recorder is more convenient than other X-Y plotters. You can operate this new TI recorder in five different positions to suit any application. Mount it in a 19-inch rack without adapters, stand it upright on a benchtop or position it flat with the writing surface horizontal, at a 45° or 90° tilt angle so you see the plot, even when you're sitting.

It's easy to change applications too. Three types of plug-in "function modules" allow you to plot inputs from 100 μ v to 50v, with time sweeps from 0.1 second/inch to 100 seconds/inch. All modules are interchangeable between X and Y axes. *Signal Input* module permits single-range millivolt recording. *Signal Control*

module offers 16 calibrated scale factors. *Time Base* module gives 10 time or voltage factors.

For more than four years, the servo system of the *function/riter* recorder has been use-proved in thousands of other TI instruments. Quieter operation of the vacuum hold down (for either 8½ x 11-inch or 11 x 17-inch paper), solid-state electronics, 20 inches/second slewing speed and accuracy of 0.2% of full scale are some of the other features that make this X-Y recorder an outstanding instrument to solve your plotting problems.

There's more to the story too. Find out by asking for complete data or a demonstration from your TI representative or the Industrial Products Division, P. O. Box 66027, Houston, Texas 77006 (713-349-2171).

*Trademark of Texas Instruments

TEXAS INSTRUMENTS
INCORPORATED

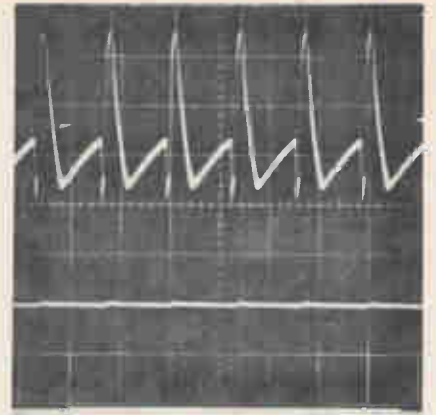

Down . . . Traces show a 2-volt peak-to-peak, 155-khz noise signal before and after it passes through busbar.

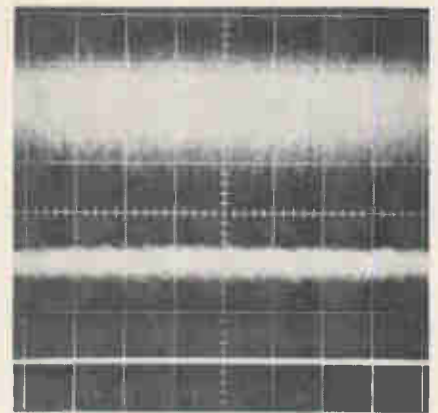

. . . and out. These are results when noise goes through twisted pair, standard busbar, or new busbar.

three months. The high-capacitance model, like all busbars, can be built in almost any shape. Price is determined by a number of factors, especially length and total capacitance. As an example, one of Eldre's standard 1,000-pf/in² 20-inch boards costs about \$3.50. A 9-inch high-capacitance bar costs about \$9, and a 15-incher from \$15 to \$18. "I'm looking around now for machines that will let us automate the process so the price can come down quite a bit," Erdle says.

Eldre will continue to make low-capacitance (1,200 pf/inch²) busbars. In fact, it will offer a line of these designed strictly for feeding d-c power to IC's mounted on a p-c card. The connection terminals on these bars fit through holes in the card and are then folded over. The bar can then be wave-soldered to the board.

Eldre Components Inc., 1239 University Ave., Rochester, N.Y. 14607 [338]

24 hours after we hear from you, you'll hear from us.

Name _____

Address _____

City _____ State _____ Zip _____

College _____

Degree _____ Year _____

I am interested in the following type of assignment:

I have had professional experience in the following area(s):

I have had a total of _____ years' experience.

AIRMAIL COUPON NOW TO:

Mr. Robert A. Martin
Head of Employment, Dept. 13
Hughes Aerospace Divisions,
11940 W. Jefferson Blvd.,
Culver City, California 90230

Join the team that designed the SURVEYOR

Opportunities for:

Electro-Optical Engineers
Aeronautical System Engineers
High-Frequency Design Engineers
Space Systems Engineers
Guidance and Control Engineers
Missile Systems Engineers
Component Engineers and
many other disciplines.

Current projects include:

PHOENIX, TOW, MAVERICK,
AIM-47A/AIM-4D Missile
Systems • Commercial and
Military COMMUNICATIONS
SATELLITES • APPLICATIONS
TECHNOLOGY SATELLITES •
and dozens of other important
programs and projects.

HUGHES

HUGHES AIRCRAFT COMPANY
AEROSPACE DIVISIONS

*An equal-opportunity employer
(U.S. citizenship required)*



BETTER QUALITY AND RELIABILITY THROUGH CONTROL

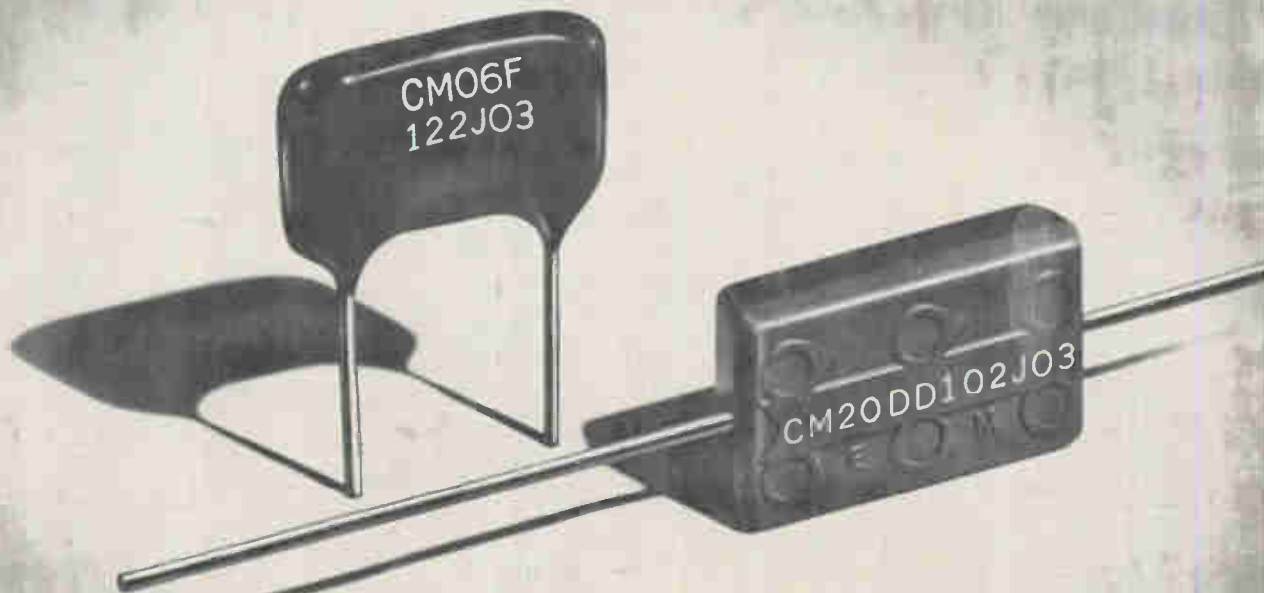

Shown 25% Actual Size

Capacitor Problems That Require A Lot Of Self-Control...Chemically Speaking

Problem 1: How to make sure the silver paste composition used for electrodes provides the best results for each electrical parameter in a given capacitor design?

Problem 2: How to improve the recognized moisture reliability of our dipped mica capacitors without adversely affecting life reliability?

Problem 3: How to upgrade the reliability of molded mica capacitors to equal that of dipped mica capacitors so designers can take advantage of body uniformity and axial lead design?

Solution: Chemical self-control! To do this we operate our own chemical manufacturing plant where we formulate silver pastes, phenolic dipping compounds, and epoxy molding compounds — all under strict controls.

Result: Dipped mica capacitors and molded mica capacitors of equally high reliability that operate up to 150°C. Send for technical literature and always insist on El-Menco brand capacitors . . . your assurance of better quality and reliability through control.

THE ELECTRO MOTIVE MFG. CO., INC.

WILLMANTIC, CONNECTICUT 06226

New Instruments Review



D-c differential voltmeter model 896A is a ruggedized unit that is waterproof, humidity proof, operates over a wide temperature range and meets applicable military specs for shock and vibration. Range is 0 to 1,000 v in 4 ranges with 10% overranging. Accuracy is $\pm 0.01\%$ of input. Price is \$2,000. John Fluke Manufacturing Co., P.O. Box 7428, Seattle, Wash. 98133. [361]



Nanovoltmeter model A-62 has full scale sensitivities to 300 nv. Accuracy is within $\pm 2\%$ of full scale. With source resistance of up to 500 ohms, 10 nv can be resolved. The input section is completely floating and guarded. It can be floated up to 300 v with 10^{12} ohms isolation. Price is \$745. Medistor Instrument Co., 4503 8th Ave. NW, Seattle, Wash. 98107. [362]



Frequency counter model 7015 is for portable use in the communications field. It has a direct counting range of 100 Mhz, while built-in automatic prescaler extends the upper range from 100 to 500 Mhz, thus providing continuous coverage into the uhf region. Net weight of the unit is 13 lbs. Price is \$1,975. Systron-Donner Corp., 888 Galindo St., Concord, Calif. 94520. [363]



Counter/timer CT-520P measures radio frequencies precisely. It can be used for measurement analysis and counting of periodic and random signal pulses of arbitrary wave shape within rated frequency characteristics of the instrument. It also measures physical events with respect to time. Intercontinental Electronics Corp., Macedon Center Rd., Fairport, N.Y. [364]



Direct reading 1-Mhz capacitance tester model 1206 features IC's for fast test time of 50 msec. It also has a 50% overrange which minimizes switching at often used test values, permitting faster testing. The unit provides direct digital readout of measurements to 0.001 pf and accuracies of $\pm 3/4\%$ of reading. Micro Instrument Co., 12901 Crenshaw Blvd., Hawthorne, Calif. [365]

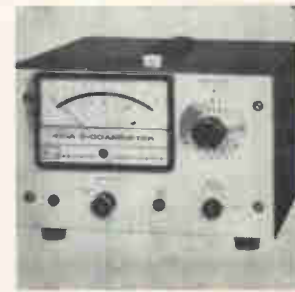

Solid state picoammeter 410A can be used for measuring and amplifying signals as low as 3×10^{-14} amp from ion gages, liquid-level gages, gas chromatographs, thickness gages, phototubes and mass spectrometers. On the 10^{-8} to 10^{-12} ampere ranges, zero drift with time is less than 0.5% of full scale per wk. Kelthley Instruments Inc., 28775 Aurora Rd., Cleveland. [366]

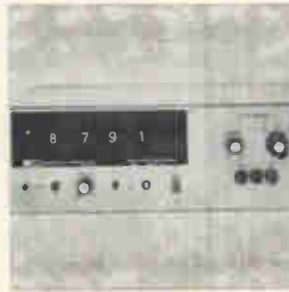

Compact, solid state, 4-digit DVM model 4230 is capable of 10 samples per sec with a readout accuracy of 0.01% over 3 d-c voltage ranges, without display "blinking" or "running numbers". It provides a measurement capability of 9.999, 99.99, 999.9 v full scale with manual range selection. Price is \$595. Trymetrics Corp., 204 Babylon Turnpike, Roosevelt, N.Y. 11575. [367]



Internal linearizing bridges and digitizing circuits are employed in the series 8114 temperature indicators to provide direct, 4-digit display of inputs from platinum temperature sensors. Resolution of 0.01° is achieved, with temperature displayed in degrees C or F. Prices start at \$1,595. California Instruments Corp., 3511 Midway Drive, San Diego, Calif. 92110. [368]

New instruments

Test is automatic—to a point

Capacitance bridge, designed for component inspection, has both self-balancing circuit and manual features

There is a hole in the capacitance bridge market. The \$5,000 fully automatic bridges operate with great speed, but offer only $\pm 0.1\%$ accuracy. Manual bridges can offer higher accuracy and up to six-digit resolution, but they require several minutes per measurement.

Between these extremes is a new bridge from Teradyne Inc., Boston. The K1 offers a combination of automatic and manual operation to speed measurement, while keeping accuracy high at 0.01% of reading. It determines capacitance, dissipation factor, and parallel conduct-



Wide ranging. The K1 measures from 0.01 picofarad to 10 microfarads.

ance with two-place resolution in less than 300 milliseconds: the other three digits appear after quick, noncritical adjustments.

FAST, ACCURATE COUNT/CONTROL

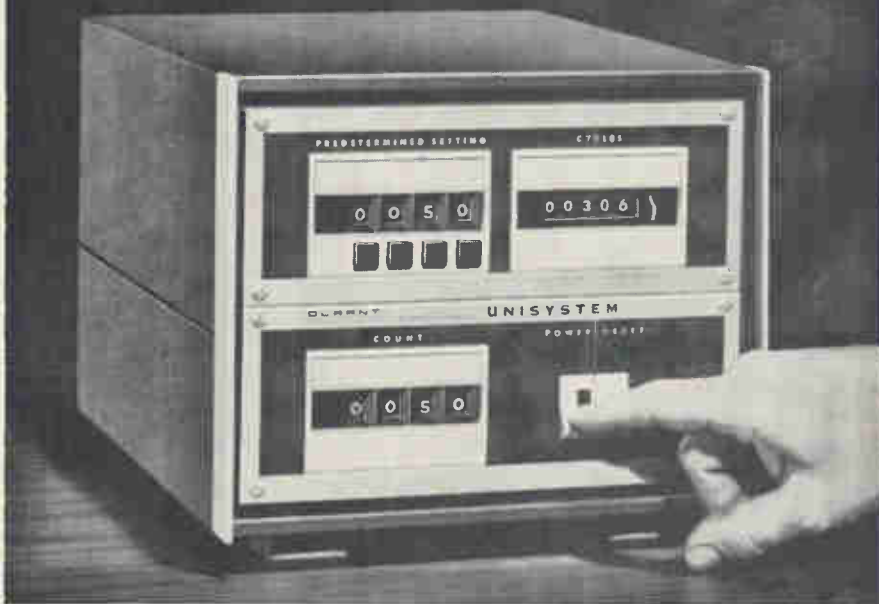

Durant Unisystem

It's the lowest cost and most thoroughly proven way for counting and controlling—and it's the most versatile. Durant Unisystem can be used for high speed counting, single and multiple level predetermining, repeat cycle predetermining, remote readout, data storage, programming, recording, batching, cycling, timing, time indication.

A complete series of models make these functions ideal for metering, processing, converting, testing or manufacturing of all kinds.

On every application, you get fast, accurate recording and controlling with speeds up to 40 cps. And exceptional reliability, because Unisystem is not subject to hours of usage. It's fail-safe — retains accumulated data even if power fails.

Unisystem is modular, too. Available in panel or desk mounted models.

For complete information on Unisystem, write for catalog 90-1, 622 North Cass St., Milwaukee, Wis. 53201.

UNISYSTEM MEETS YOUR NEEDS EXACTLY



Cabinet models assembled and wired — ready to install



Modules without cabinets for 19" rack mounting



Wired models without cabinets for 9 1/2" rack mounting



Individual Unipulser Decade counters for building your own systems

DURANT[®]
MANUFACTURING COMPANY

COUNT / CONTROL INSTRUMENTS
MECHANICAL / ELECTROMECHANICAL / ELECTRONIC
In Europe: Durant (Europa) N.V. Barneveld, Netherlands

... and the bridge helps plot drift curves ...

In exchange for dialing these knobs, says Teradyne, the user gets what amounts to a \$1,500 price rebate compared to the cost of a fully automatic bridge; the K1 costs \$3450.

Wide Range. The K1 is designed for component inspection over a wide range of values; for example, incoming inspection, quality control, and failure analysis engineers could test capacitors with values from 0.01 picofarad to 10 microfarads. The dissipation factors of capacitors and dielectric materials can be measured from a low of 0.00001 to a high of 1.0. Conductance can be gaged over a range of 10 picomhos to 0.1 mho. The K1 can also track low level conductivity and measure parallel inductance.

Because of its automatic balancing capability, it can be set to read out changes in any of these parameters with time or with temperature. A back panel chart recorder output helps take data in such applications.

Self-balancing. The K1 uses a ratio-arm bridge circuit, making its measurements by balancing the bridge as it switches to various internal standards. Range switching is automatic, and the bridge's logic automatically balances the bridge to the first two significant figures of the value. These are displayed on five-digit numerical indicators; each with a floating decimal point.

Below the indicator panels are three selector switches. After the bridge balances automatically, these are switched from the "auto" position to the numbers displayed from left to right on the indicator. Each time one of the knobs is set, another digit of resolution appears on the readout.

For operations like quality control in which only one of the bridge's five ranges is used, there are pushbuttons which disable the automatic range selector, making possible a resolution beyond the usual five digits. However, the bridge still nulls itself automatically.

Once a null has been established, the K1 can be set to track changes in the measured value. It

can be set automatically to null itself twice each second or to null itself at the cue of an external sensor—such as a temperature sensor during temperature coefficient measurements.

Bridge-type instruments are only as accurate as their standards. In the case of the K1, the capacitance standards are specified to have a temperature coefficient of 10 parts per million per degree centigrade; typically the figure is half that.

The 1-kilohertz oscillator used in the bridge is built for stability. Its drift is less than 30 parts per million.

All amplifier, detector and logic circuitry is built without provision for adjustment in circuit board assemblies which are guaranteed for 10 years. Teradyne says this is done, not only to keep the user from tinkering with the instrument and destroying its calibration, but also to build in as much accuracy as practical in the first place. Each K1 is delivered with a graph of its performance versus temperature and versus time—the results of an operational test. The new instrument will be shown at Wescon.

Teradyne Inc., 183 Essex St., Boston, Mass. 02111 [369]

New instruments

Wave synthesizer accurate to .01%

Offers 5-digit readout for checkout systems and telemetry tests

An accurate signal source is important to almost all systems, but it's absolutely vital in aircraft checkout. Two waveform synthesizers built by Wavetek Inc. are designed both for this growing market and for telemetry system tests and other operations where accurate frequency or signal sources are needed.

William Zongker, marketing man-

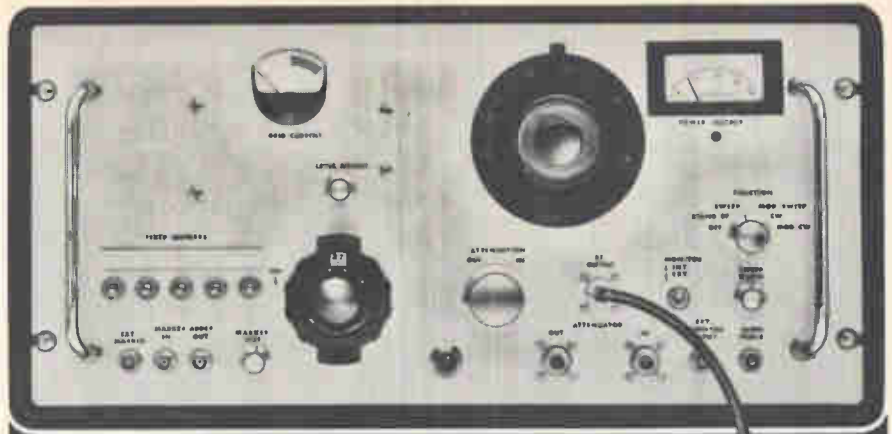

You don't need a sweep generator to run a high intensity lamp, but the 8-watt output of Telonic's new PD series sweep generators will allow you to test varactor multipliers, align high-power transmitter and amplifier chains, establish multi-test station swept signal distribution systems, and test high-loss and non-linear devices—among other things.

Four new instruments in this series cover frequencies to 1000 MHz, operate in swept and modulated RF, CW and modulated CW models, have continuously variable sweep width, automatic level control and birdy-by-pass marking system. All models are equipped with watt meter to read output directly.

Specifications

MODEL NO.	PD-2B	PD-3B	PD-7B	PD-8B
Center Frequency (MHz)	20-100	100-250	200-375	375-1000
Sweep Width	0.2-15%	0.2-15%	0.2-10%	0.2-15%
Peak Power Output				
Swept	8 watts minimum into 50 Ω			
CW	4 watts minimum into 50 Ω			
Flatness	± 0.5 dB w. internal leveling*			

* External leveling may be used with addition of optional accessory, Model 8500.

Catalog 70A contains complete specifications on the PD-(B) series and all other Telonic Sweep Generators plus an entire section on applications—Write today for your copy. Telonic Instruments, 60 N. First Avenue, Beech Grove, Indiana 46107. Tel: 317-787-3231, TWX—810-341-3202.

Telonic INSTRUMENTS A Division of
Telonic Industries, Inc.

The new Telonic PD Sweep Generators have an output of 8 WATTS minimum



Visit TELONIC at WESCON (Sports Arena), Booths 2107-2111.

This is the most powerful, yet easiest to use, calculating/computing system available. It's also the most versatile. You can create your own individualized system by selecting true building block modules from a family of peripheral devices larger than all competitive calculating products combined. Start with a basic 300 Series calculator if you like; add accessories as needs grow without worrying about compatibility, obsolescence, retraining or special program languages. The 370 will loop, branch, perform subroutines and manipulate arrays. You can have up to 480 steps of program storage and up to 64 separate data storage registers, also automatic typewriter or teletypewriter output, CRT graphic display and time-sharing basic keyboards for your associates.

The 370 solves these problems . . .

for Engineers and Scientists:
**Inversion of 6 x 6 Matrices,
 Roots of Equations,
 Up to 7 Simultaneous Equations,
 Fourier Analysis.**

for Statisticians:
**Mean, Variance and Standard Deviation,
 2nd-order Regression Analysis,
 Distributions such as:
 Binomial, Normal Probability, etc.**

And also:
**General Nth-order Regression,
 Multiple Regression,
 Analysis of Variance,
 Factorial Design.**

These and many other highly-useful programs are furnished free in a 250 page program library. Three volumes of basic calculator programs and a two-volume 370 reference manual are also offered. Call now for complete details.

**Solves problems
 ordinary calculators can't,
 full-scale computers
 shouldn't.**

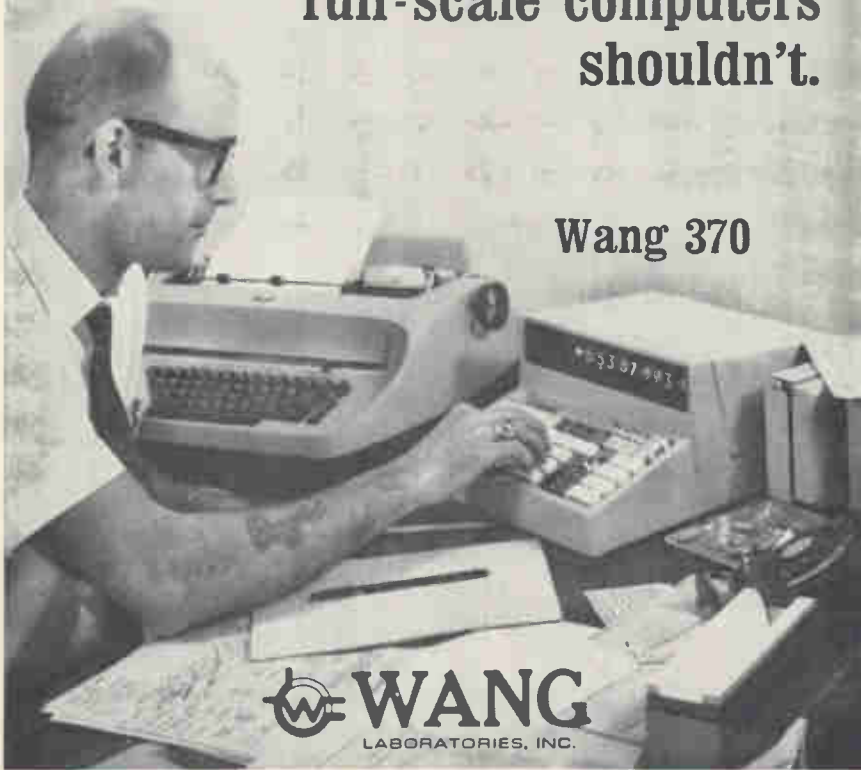

Wang 370



Dept. 8H, 836 North St., Tewksbury, Massachusetts 01876 • Tel. 617 851-7311

Call today for immediate trial:

(201) 241-0250	(216) 333-6611	(313) 278-4744	(416) 364-0327	(604) 685-2835	(703) 931-7878
(203) 223-7588	(301) 588-3711	(314) 727-0256	(504) 729-6858	(612) 881-5324	(713) 668-0275
(205) 595-0694	(301) 821-8212	(317) 631-0909	(505) 255-9042	(613) 224-4554	(716) 381-5440
(206) 622-2466	(303) 364-7361	(403) 266-1804	(512) 454-4324	(614) 488-9753	(717) 397-3212
(212) 682-5921	(304) 344-9431	(404) 457-6441	(513) 531-2729	(615) 588-5731	(805) 962-6112
(213) 278-3232	(305) 564-3785	(405) 842-7882	(514) 482-0737	(617) 851-7311	(901) 272-7488
(214) 361-4351	(305) 841-3691	(412) 366-1906	(518) 463-8877	(702) 322-4692	(916) 489-7326
(215) 642-4321	(312) 889-2254	(415) 454-4140	(602) 265-8747	(703) 877-5535	(919) 288-1695

Visit us at WESCON, Booth 3168-69.



Faraway setup. The model 157 can be programmed remotely.

ager, says the Wavetek synthesizers—models 157 and 170—offer .01% accuracy and 5-digit readout. "There's nothing else that compares with these instruments at the price—\$2,995 or \$1,995," he asserts. The 157 costs \$1,000 more because it's programable both manually and remotely. The 170 is programable by manual means only.

Frequency ranges from .001 hertz to 1 megahertz. Amplitude accuracy is 0.5%, amplitude resolution 3 digits. Zongker says the accuracy of most sine-wave oscillators or other frequency generators is 1%.

The instruments deliver sine, square, and triangular wave forms with a sine-wave spectral purity of 0.1%

The rise time of the programed output (square wave) is less than 100 nanoseconds. The linearity of the triangular wave is 99% up to 100 kilohertz and 95% at higher frequencies.

Separatist. The 157 has complete ground isolation, so that signal, power and programable ground are separate for differential operation. In use, an accurate center frequency is set up, and then modulation takes place around it up to 100 kilohertz. The instrument's calibrated output is 10 volts into 50 ohms.

A null meter on the front panel of both instruments is used for frequency sweeps. Zongker says that the design includes a technique developed last year for using analog methods to measure frequencies—the analog output is proportional to the frequency input. Another advantage of the instrument is its ability to trigger, sweep, or modulate wave forms.

Both instruments run off 115 or 230 volts $\pm 10\%$, from 48 to 420 hertz. Delivery time is 30 to 60 days. Both instruments will be shown for the first time at Wescon.

Wavetek Inc., 8159 Engineer Rd., San Diego, Calif. 92111 [370]

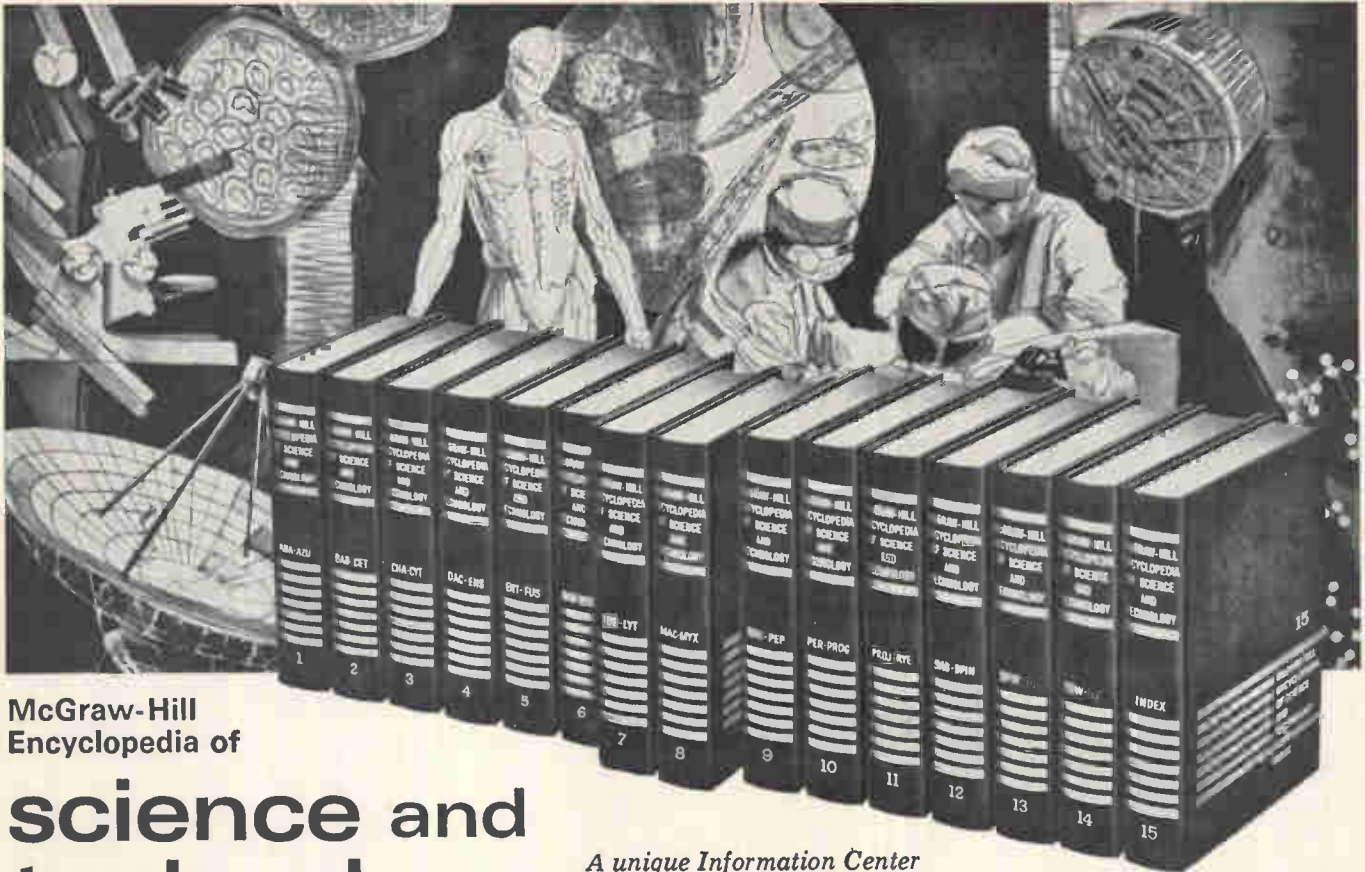

McGraw-Hill
Encyclopedia of

science and technology

*A unique Information Center
encompassing the entire range of today's scientific and engineering
knowledge in 15 volumes — 7,400 articles — 9,500 illustrations*

THE REVISED EDITION of the famed McGraw-Hill Encyclopedia of Science and Technology is available. This extraordinary set of books is the most respected, most widely-used reference for accurate, up-to-date information in any area of the physical, life, and earth sciences, and in all fields of engineering.

Here, you will find every theory, concept, term . . . every significant new discovery and technological advance . . . every important problem currently under study . . . gathered from the frontiers of scientific exploration around the globe. To obtain equivalent information, you would have to consult thousands of journals, textbooks, monographs, papers, proceedings of meetings. Now, in this unified science *Information Center*, it is as accessible as the nearest bookshelf.

For quick reference, systematic study, or leisurely browsing. This unique set of books is the first place to look for authoritative answers to questions on any scientific or engineering subject . . . whether you are concerned with theoretical aspects or practical applications . . . whether you require information on basic principles or advanced technology. It is invaluable for reviewing concepts, procedures, terms . . . or as a reliable research tool.

Prepared by more than 2,000 leaders of the scientific community. All articles are written by specialists of international reputation — in many cases, by the very person who made the actual discovery, proposed the original concept, or carried the research forward. Over 9,500 photographs, maps, drawings, and diagrams enhance and clarify the text. The multiple Index volume of over 100,000 entries and the cross-reference system of 40,000 citations make it easy to find the information you need quickly.

This authoritative reference library, with its timely yearbooks, helps you stay abreast of the whole spectrum of today's rapidly expanding technology. For the engineer, the scientist, the teacher, and the student, the *Encyclopedia of Science and Technology* has become the one indispensable reference.

Available direct from publisher. Simply mail the coupon to receive this incomparable 15-volume Encyclopedia for two weeks' examination, without obligation. Then, if you wish, you may purchase the set direct from the publisher on a convenient budget plan. Consult the coupon for full details, and send it today. McGraw-Hill Book Company, 330 West 42 Street, New York, N. Y. 10036.

HIGH PRAISE FOR REVISED EDITION
"Excellent . . . the star in its field."
—*Scientific American*
"It is the best fundamental science and technology reference work . . . Highly recommended."
—*Science Books*

Two new optional reference books also available... Now two highly useful new reference volumes are available in matching bindings. Their price is \$12.50 each to purchasers of the Encyclopedia. The comprehensive McGraw-Hill Basic Bibliography of Science and Technology lists and describes the outstanding current books in every scientific and technical field. The McGraw-Hill Modern Men of Science presents informative biographical and autobiographical articles on 426 leading contemporary scientists.



Examine the set without obligation
Mail this coupon today

McGraw-Hill Encyclopedia of
science and technology
McGraw-Hill Book Company
330 West 42 Street, New York, N.Y. 10036

Please send me for two weeks' trial examination, the revised edition of the famous McGraw-Hill Encyclopedia of Science and Technology.

I enclose my check or money order for \$10 as deposit, which will be considered my first payment. I will remit the balance in eighteen monthly payments of \$16.50 and a final payment of \$6.75 until the total price of \$313.75 is paid. I understand, however, that if I am not delighted with the set I may return it within two weeks for a refund of my deposit, and I will be under no further obligation.

Name.....

Address.....

City.....

State..... Zip.....

BN-104

Here is a brief sampling of the many fields covered:

Acoustics — Aeronautical Engineering — Agriculture and Soils — Analytical Chemistry — Animal Anatomy — Astronomy — Atomic, Molecular, Nuclear Physics — Biochemistry — Biophysics — Chemical Engineering — Civil Engineering — Classical Mechanics — Communications — Computers — Conservation — Cytology — Electrical Engineering — Electricity and Electromagnetism — Fluid Mechanics — Food Engineering — Forestry — Genetics and Evolution — Geology — Geophysics — Heat — Industrial Engineering — Inorganic Chemistry — Low-Temperature Physics — Machine Design — Mathematics — Mechanical Power Engineering — Medical Microbiology — Metallurgy — Meteorology — Mineralogy and Petrology — Mining Engineering — Naval Architecture — Nuclear Engineering — Oceanography — Optics — Organic Chemistry — Paleobotany and Paleontology — Petroleum Engineering — Physical Chemistry — Physiological and Experimental Psychology — Solid State Physics — Space Technology — Theoretical Physics — Zoology — plus thousands of other subjects in every scientific and engineering discipline.

We have quite a thing about transmission capacity. 108 50-baud channels. Like RECTIPLEX.

This new carrier telegraph system commenced service between Tokyo (KDD) and San Francisco (RCA) June 1968 and revolutionized transmission capacity and transmission rates.

The development of this brilliant innovation posed quite a few problems. We had to increase speed and capacity, and, at the same time, battle the high costs of for-hire cables and new-cable installation. In cooperation with K.D.D. we found the answer: RECTIPLEX, in which

a unique phase-modulation transmits 108 standard telegraph channels over a single voice band. The resulting transmission capacity is five times that of conventional multiplex systems, and combines economical capacity expansion with faster data transmission.

RECTIPLEX I lived up to the highest expectations. So will RECTIPLEX II, when it revolutionizes cable transmission between Tokyo (KDD) and New York (ITT) this September.



FUJITSU LIMITED

Communications and Electronics

Marunouchi, Tokyo, Japan

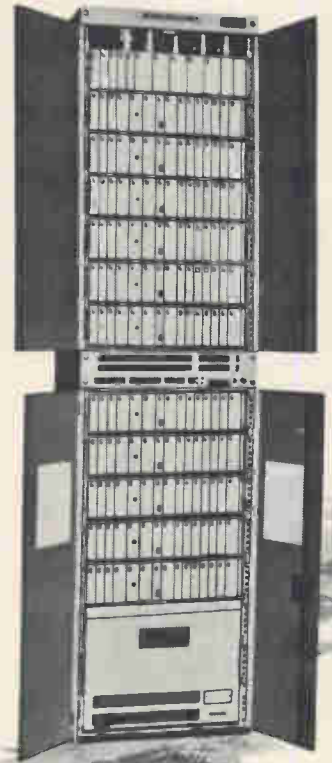

Main Products: Telephone Exchange Equipment Telephone Sets Carrier Transmission Equipment Radio Communication Equipment Space Electronics Equipment Data Communication Equipment Telemetry and Remote Control Equipment Computers (FACOM) and Peripheral Equipment Automatic Control Equipment (FANUC) Electric Indicators Electronic Components and Semiconductor Devices.

New Components Review

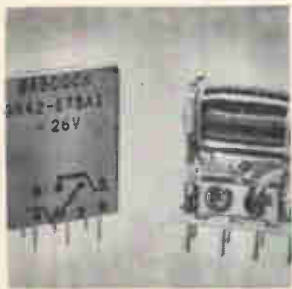

Welded crystal can relay BR42 is designed to meet MIL-R-5757. It is free of internal coil tape and adhesives, thus eliminating a major cause of relay contamination. It has universal contacts that switch dry circuit to 2-amp loads with the same contact set. Price is \$6.50 in 1,000 lots. Babcock Relays, Div. of Babcock Electronics Corp., 3501 Harbor Blvd., Costa Mesa, Calif. [341]



Medium duty relay JBJA offers small size, long life, and reliability. Standard silver contacts will switch 10 amps current for a minimum 250,000 operations or 4 amps for 2 million operations. They also possess a switched voltage rating of 380v a-c max. or 200 v d-c max. Typical operating times are from 4 to 7 msec. ITT Jennings Div. of ITT Corp., Box 1278, San Jose, Calif. [342]

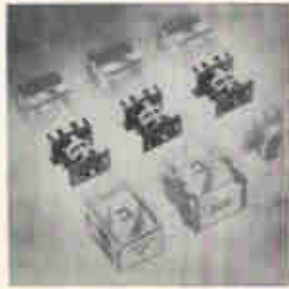

Magnetic holding coils, for snap-on assembly between series 10E, 12 and 19 pushbutton housings and standard 2 pdt or 4 pdt miniature switch modules, provide an economical method for achieving numerous electrical interlock, lock-in and lock-out circuits. Installations can be performed quickly without tools. Master Specialties Co., 1640 Monrovia Blvd., Costa Mesa, Calif. [343]



A sapphire-insulated vacuum feed-through limits vacuum leakage to less than 10^{-10} cc of helium per sec. The device, designed for the conductance of minute electrical currents between the atmosphere and vacuum-enclosed circuits, is expected to have wide application in the electronics and spectrometry fields. Cary Instruments, 2724 S. Peck Rd., Monrovia, Calif. [344]



Solid state time delay relay TDR2 is for industrial and commercial use in driving solenoids, relays, small motors and similar loads. With a repeat accuracy of 3%, timing ranges available are 0.1-10, 0.3-30, 0.6-60, 1.2-120, 1.8-180 sec, over a temperature range of 0° to +55°C. Maximum timing variation due to temperature is $\pm 4\%$. Tansitor Electronics Inc., Bennington, Vt. [345]



Fixed time delays ranging from 0.1 to 15 sec with accuracies of $\pm 5\%$ and $\pm 10\%$ are offered by a line of solid state time delay relays. Units have an output rating of 0.7 amp and a size volume of no more than 0.25 cu in. Weight is 0.5 oz. Input voltage range is 14 to 35 v d-c. Minimum holding current is 10 ma. ADC Electronics Corp., 1227 W. 254 St., Harbor City, Calif. [346]

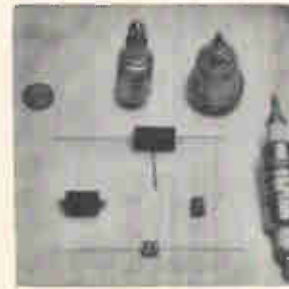

Precision spark gaps types 2009-01 through 2009-04 have voltage breakdown capability from 450 v to 1,500 v. All feature ultrafast response and insulation resistance of greater than 1,000 megohms. Maximum surge current handling capability of the line ranges from 10,000 to 40,000 amps on a 10 x 20 μ sec waveshape. Joslyn Electronic Systems, 6868 Cortona Drive, Goleta, Calif. [347]

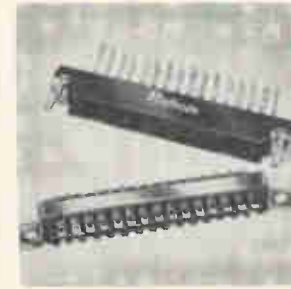

Two-part fork contact p-c connectors are designed to permit tying-in printed circuits directly to the unit's cabling. Features of the new series, available with either 31 or 41 contacts, include glass-filled diallyl phthalate Insulators, coated aluminum shells on the male connectors, and solder type terminals for wiring. Methode Electronics Inc., W. Wilson Ave., Chicago. [348]

New components

Switch contacts minimize contamination

Snap-action devices use gold alloy crosspoints for low-energy applications; calculator market is target

"How sweet it is!" may be an expression coined by Jackie Gleason, but it's fast catching on at the Cherry Electrical Products Corp. The tv comic's signature line perhaps best describes the company's feelings about its newest line of snap-action switches. Called the

Cherry gold-crosspoint series, the line is designed for dry-circuit applications and will make its bow at Wescon.

"The new switches are particularly attractive for desk-top calculators and computers requiring switching at low voltages and cur-

rents," says Frank A. Amendola, sales promotion manager at Cherry. Considering the potential market for such calculators—in the U.S. alone, sales are estimated at 800,000 units a year—the company believes its new switches will attract lively demands.

One of these snap switches—or at least an adaptation of it—has already found its way into an electronic calculator. The Hewlett-Packard Co. uses 68 Cherry crosspoint-switches in its model 9100A machine; the switches are variation of Cherry's S31, a single-pole, single-throw, normally open unit.

Is Your Budget Too Tight For Your Bandwidth?

\$284

○ Low Cost

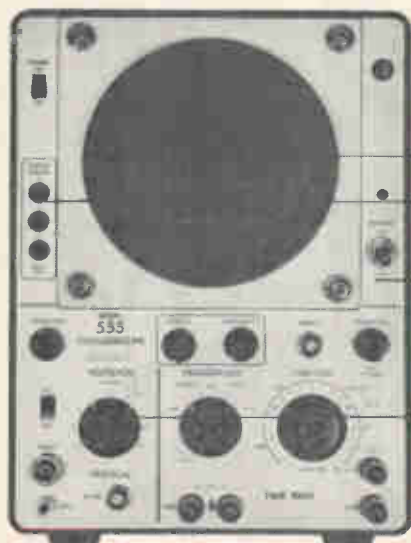

○ 8 cm x 10 cm Viewing Area

○ Voltage Calibrator

○ Solid State Reliability

○ 7 MHz Bandwidth

Try this one for size—Data Instruments Model 555. For any application, Production Line, Field or Laboratory, this scope is a perfect fit. Look at what it offers: (1) Performance. A 7 MHz bandwidth, and an extremely linear time base with variable controls over 19 calibrated ranges and a variety of triggering modes. (2) Display. A 5 inch Braun type tube with an edge lit, removable graticule provide highly precise and legible traces on an 8 x 10 centimeter viewing area. (3) Reliability. All attenuators are solid state and fully compensated. Backing up this solid state reliability is a full year's warranty and complete field and factory service.

Examine the specifications.

VERTICAL AMPLIFIER					
BANDWIDTH DC-7 MHz	SENSITIVITY/CM 20mv	ATTENUATOR 9 position	RISE TIME .05 μ s	ACCURACY \pm 5%	IMPEDANCE 1M Ω + 33pf
TIME BASE			CRT	PHYSICAL	
SWEEP/CM	TRIGGER	HORIZONTAL AMP.	DIA.	DIM. & WT.	
1 μ s-1 sec. (19 ranges)	20Hz-7MHz (20mv)	Exp. X5 2Hz-200KHz	5" (1600V)	8" x 10.5" x 16" 22 lbs.	

Look at the scope in action. Drop us a note and we'll arrange a demonstration in your plant. You'll find the 555 fits your bandwidth requirements comfortably. At \$284 its very comfortable indeed.

Data Instruments Division • 7300 Crescent Blvd. • Pennsauken, N.J. 08110
See it at WESCON Sports Arena, Booth 1123.

Available in four different types, sizes, and mountings—the E31 miniature, the E63 subminiature, the E53 rotary action, and the S31 open miniature—the new switches have lives measured in millions of operations, contact resistance comparable to that of reed switches, and almost no susceptibility to contact closure interference from foreign particles. But the big difference between conventional switches and the crosspoint line is in the contact. Cherry employs crossbar contacts, a concept almost as old as switches themselves and commonplace in telephone-switching circuits.

Noble mix. Two crosspoint, or crossbar, prisms—noble alloys 69% gold, 25% silver, and 6% plati-

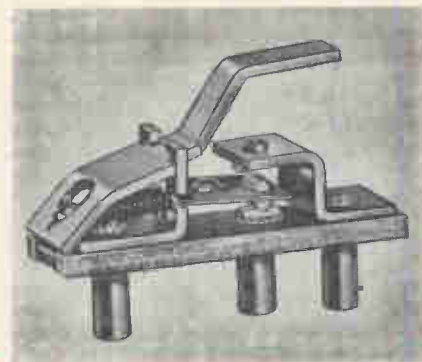

num—are microwelded at right angles to each other so the contacts cross on closure. This configuration provides high unit contact pressure and just about eliminates contact-closure interference. "The potential contamination area is reduced to 1% of the conventional 1/8-inch diameter contacts," Amendola notes. And reliability is enhanced, he adds, by the metallurgical bond formed by microwelding the prisms at right angles. Cherry's crosspoint approach does away with reeds, which require some method of activating the switching action—magnets, for instance. "But regardless of what method is chosen," Amendola says, "the installation cost tends to be high with reed types."

All four switches in Cherry's new line are single pole, and either single or double throw, double pole can be achieved by ganging two switches for multicircuits.

Cherry Electrical Products Corp., Highland Park, Ill. 60035 [349]

Photocells ain't what they used to be...



they're a heck of a lot better

Photocells are doing jobs today that they couldn't have done ten—five—
or even two years ago. There have been that many improvements!

HIGHER STABILITY
MORE UNIFORM RESPONSE TO COLOR TEMPERATURE
HIGHER SPEED RESPONSE
WIDER VARIETY OF PACKAGES AND SIZES
INCREASED EFFICIENCY
HIGHER LINEARITIES

Let us show you how the "light touch in automation and control" can
help solve your problems. Call (212) 684-5512 or write Clairex, 1239
Broadway, New York, N. Y. 10001.

CLAIREX ELECTRONICS INC.[®]

Making a ceramic tower base insulator to 9,000,000 lbs. ultimate strength isn't easy...

Lapp specializes in tough jobs.



That was one of our toughest. But, Lapp has designed and built hundreds of tower insulators. They range downward to 80,000 lbs. ultimate strength. In fact, Lapp insulators support most of the world's larger radio towers, both self-supporting and guyed masts.

Lapp has over 50 years of "know-how" and experience that won't cost you a cent when you bring your insulating problem to us. From drawing board to delivery you can count on Lapp to handle your tough tower . . . and antenna . . . insulating jobs.

Can we help? Lapp Insulator Co., Inc. LeRoy, N.Y. 14482.

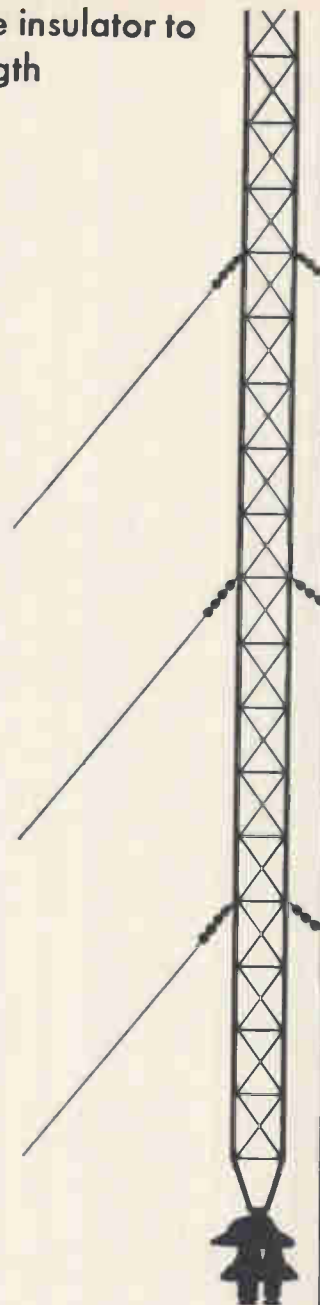

New components

Small, industrial relay costs \$10

Dpdt device in TO-5 package may cost less than \$7 in volume quantities

The space budget is shrinking, so many companies are trying to adapt their high-flying gadgets for down-to-earth applications. For example, the Industrial Products division of Deutsch-Filtors has modified its line of MIL-spec relays and produced what the company says is the first transistor-sized relay in a TO-5 can priced low enough for industrial use.

Most military relays in TO-5 cans sell for about \$20. The Deutsch relay goes for \$10 in single lots, and

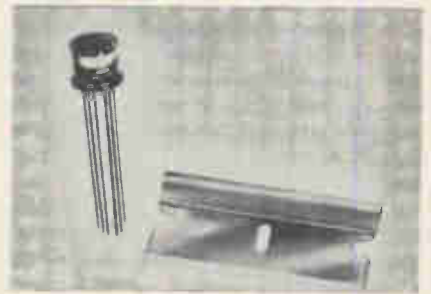

will probably be less than \$7 in volume quantities.

According to John Vetrano, the division's general manager, the big difference is that the old soldier is hermetically sealed while the new civilian just has a dust cover.

The relay is a double-pole, double-throw device, and can switch currents ranging from 1 amp down into the microamp region.

One million operations is the guaranteed life of the contacts when the relay handles 0.25 amp, and the mechanical part of the device is rated at 5 million operations. Close and release times are both 3 milliseconds. The relay is available with rated coil voltages of 6, 12, 24, or 48 volts d-c.

Deutsch-Filtors Industrial Products, Main St., Sag Harbor, N.Y. [350]

LAMBDA ANNOUNCES the new EE power package with the highest power available in a half-rack module!

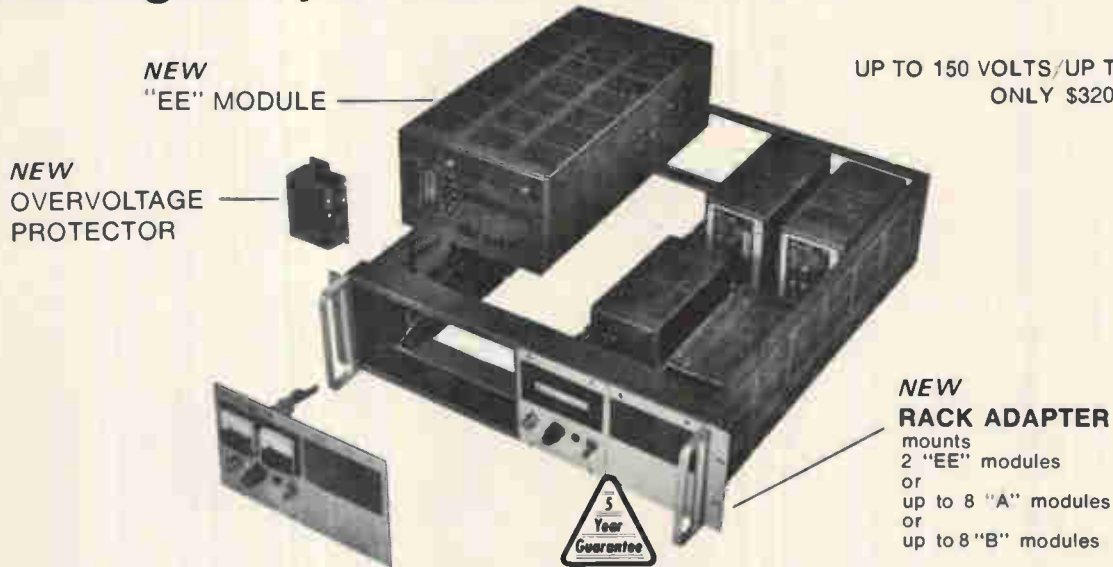

NOW THERE ARE 7 VERSATILE 5 YEAR-GUARANTEED CONVECTION-COOLED LM SERIES MODULES TO MEET ALL YOUR SYSTEM NEEDS.

FEATURES OF NEW "EE" POWER PACKAGE

- **MEET MIL. ENVIRONMENT SPECS**
Specify Lambda with assurance of meeting military requirements
 - RFI—MIL-I-16910 · Vibration: MIL-T4807A
 - Shock: MIL-E-4970A Proc. 1 & 2
 - Humidity: MIL-STD-810 Meth. 507
 - Temp. Shock: MIL-E-5272C (ASG) Proc. 1
 - Altitude: MIL-E-4970A (ASG) Proc. 1
 - Marking: MIL-STD-130 · Quality: MIL-Q-9858
- Fungus Proofing (optional):
all models available with MIL-V-173 varnish for all fungi nutrient components at \$10.00 surcharge.
- **THERMALLY PROTECTED AND SHORT CIRCUIT PROOF**
- **NO VOLTAGE SPIKES OR OVERSHOOT**
on turn-on, turn-off, or power failure.
- **WIDE INPUT VOLTAGE AND FREQUENCY RANGE**
105-132 VAC, 45-440 Hz (205-265 VAC, optional at no extra charge).
- **LINE REGULATION:** .05% + 4mV
- **LOAD REGULATION:** .03% + 3mV
- **RIPPLE AND NOISE:** 1mV rms; 3mV P to P
- **TEMP COEFF.:** .03% / °C
- **HIGH PERFORMANCE OPTION**
All models available with these specifications at \$15.00 surcharge:
 - **LINE REGULATION:** .01% + 1mV
 - **LOAD REGULATION:** .02% + 2mV
 - **RIPPLE AND NOISE:** 0.5 mV rms; 1.5mVp-to-p with 60 Hz input
 - **TEMP COEFF.:** .01% / °C

NEW ACCESSORIES FOR "EE" PACKAGE

- **Rack Adapters**
LRA-7 · 5¼" H x 19"W x 21"D. Price \$70.00
- **Chassis Slides**
Add suffix "-CS" to LRA Model number and add \$60.00 to price.
- **Panels**
5¼" x 8¾" Metered panel MP-50. Price \$55.00
5¼" x 8¾" Non-metered panel P-50. Price \$35.00
Add \$10.00 for fungus proofing.
- **Overvoltage Protectors**
LM-OV-7 3-8V 4¼"H x 2¼"W x 1¼"D \$75.
LM-OV-8 6-20V 4¼"H x 2¼"W x 1¼"D 75.
LM-OV-9 18-70V 4¼"H x 2¼"W x 1¼"D 75.

Package EE 4½" x 7½" x 17"

WIDE RANGE

Model	ADJ. VOLT. RANGE VDC	MAX AMPS AT AMBIENT OF: (°)				Price
		40°	50°	60°	71°	
LM-EE-0-7	0-7	16	13.5	11.2	9.2	\$320
LM-EE-0-14	0-14	10.2	8.6	7.3	6.1	320
LM-EE-0-32	0-32	5.2	4.4	3.8	3.2	320
LM-EE-0-60	0-60	2.9	2.45	2.15	1.85	320

FIXED VOLTAGE

Model	ADJ. VOLT. RANGE VDC	MAX AMPS AT AMBIENT OF: (°)				Price ²
		40° C	50° C	60° C	71° C	
LM-EE-3	3 ± 5%	33.0	29.0	25.0	20.5	\$320
LM-EE-3-P-6	3.6 ± 5%	32.0	26.0	22.0	18.3	320
LM-EE-4	4 ± 5%	32.0	26.0	22.0	18.3	320
LM-EE-4-P-5	4.5 ± 5%	31.0	24.6	20.8	17.3	320
LM-EE-5	5 ± 5%	31.0	24.6	20.8	17.3	320
LM-EE-6	6 ± 5%	30.0	24.6	20.8	17.3	320
LM-EE-8	8 ± 5%	28.0	23.5	19.7	16.5	320
LM-EE-10	10 ± 5%	24.0	20.4	16.8	13.8	320
LM-EE-12	12 ± 5%	21.0	19.0	16.1	13.2	320
LM-EE-15	15 ± 5%	19.0	18.0	15.5	12.7	320
LM-EE-18	18 ± 5%	16.5	14.8	12.4	10.1	320
LM-EE-20	20 ± 5%	15.2	13.7	11.8	9.7	320
LM-EE-24	24 ± 5%	14.0	12.5	10.8	9.0	320
LM-EE-28	28 ± 5%	13.0	11.5	9.8	8.2	320
LM-EE-36	36 ± 5%	10.4	9.8	8.6	7.1	320
LM-EE-48	48 ± 5%	7.7	7.1	6.5	5.4	320
LM-EE-100	100 ± 5%	3.3	3.0	2.5	2.1	350
LM-EE-120	120 ± 5%	3.0	2.7	2.2	1.9	350
LM-EE-150	150 ± 5%	2.2	2.0	1.75	1.50	350

NOTES:

¹ Current rating is from zero to 1 max. Current rating applies over entire output voltage range. Current rating applies for input voltage 105-132 VAC 55-65 Hz. For operation at 45-55 Hz delete 40° C rating. For operation at 360-440 Hz consult factory for ratings and specifications.

² Prices F.O.B. factory, Melville, N. Y. All specifications and prices subject to change without notice.

Write, wire, or call to order direct, for information, or for new Lambda Power Supplies catalog. LAMBDA Electronics Corp., 515 Broad Hollow Road, Melville, L. I., New York 11746, TEL. 516-694-4200, TWX 510-224-6484.

 **LAMBDA**

SEE THIS NEW POWER SUPPLY AT WESCON - BOOTH #401-2, HOLLYWOOD PARK - PLUS A DRAMATIC NEW ANNOUNCEMENT OF A NEW CONCEPT IN POWER SUPPLIES AND POWER SUPPLY SYSTEMS.

Circle 151 on reader service card

The product improvers.

Nine new TTL decoders expand complex function line

TI's new monolithic decoders will help you reduce costs and improve performance of your logic and display systems. These "product improvers" combine the speed and noise immunity of TTL with the overall economies of complex functions.

Four basic logic forms are offered: BCD-to-decimal, excess 3-to-decimal, excess 3 gray-to-decimal, and BCD-to-seven segment. Both active-high and active-low logic configurations are available.

All decoders have buffered inputs to reduce fan-in requirements.

And you have a choice of output configurations. Three of the decimal decoders (SN7442-44) use familiar totem-pole outputs for high capacitive drive while two others (SN7445 and SN74145) have high-performance output circuitry to drive display lamps or relays. Two of the seven-segment decoders (SN7446-47) drive display lamps directly while two others (SN7448-49) can drive large displays through external power transistors.

Two temperature ranges are offered...full military (Series 54) and industrial (Series 74).

All decoders except the SN7449 are available in either of TI's dual in-line packages . . . the low-cost plastic or ceramic hermetic. For space critical applications, the SN7449 is offered in the hermetic flat package.

For data sheets on any or all these new "product improvers" write on

your letterhead to Texas Instruments Incorporated, P. O. Box 5012, M.S. 980, Dallas, Texas 75222.



<p>SN5442/SN7442 BCD-to-decimal decoder.</p> <p>Active-low outputs. Fully compatible with all popular DTL and TTL logic.</p>	<p>SN5443/SN7443 Excess 3-to-decimal decoder.</p> <p>Active-low outputs. Fully compatible with all popular DTL and TTL logic.</p>	<p>SN5444/SN7444 Excess 3 gray-to-decimal decoder.</p> <p>Active-low outputs. Fully compatible with all popular DTL and TTL logic.</p>
<p>SN5445/SN7445 BCD-to-decimal decoder-driver.</p> <p>Active-low high-performance outputs. 30V breakdown, 80 mA sink-current capability for lamps, relays or memories.</p>	<p>SN54145/SN74145 BCD-to-decimal decoder-driver.</p> <p>Active-low high-performance outputs. 15V breakdown, 80 mA sink-current capability for lamps, relays or memories.</p>	<p>SN5446/SN7446 BCD-to-seven segment decoder-driver.</p> <p>Active-low, open-collector outputs. 30V breakdown, 20 mA sink-current capability to drive indicator segments.</p>
<p>SN5447/SN7447 BCD-to-seven segment decoder-driver.</p> <p>Active-low, open-collector outputs. 15V breakdown, 20 mA sink-current capability to drive indicator segments.</p>	<p>SN5448/SN7448 BCD-to-seven segment decoder-driver.</p> <p>Active-high, passive pull-up outputs. For current-sourcing applications to drive logic circuits or power transistors.</p>	<p>SN5449/SN7449 BCD-to-seven segment decoder-driver.</p> <p>Active-high, open-collector outputs. For current sourcing applications to drive logic circuits or power transistors.</p>

TEXAS INSTRUMENTS
INCORPORATED

New Semiconductors Review



Voltage variable capacitance diodes in the IN 5139-39A through IN5148-48A series provide Q's ranging from 200 to 350 at -4 v d-c, tuning ratios from 2.7 to 3.4, and center capacitance values from 6.1 to 51.7 pf. Maximum working voltage rating is 60 v d-c. Units are for uses such as voltage tuned filters. Crystalonics, A Teledyne Co., 147 Sherman St., Cambridge, Mass. [436]



Plastic phototransistor array FPA-700, for reading standard 8-channel punched paper tapes, consists of 9 NPN phototransistors in an 18-lead package designed for ease in handling and mounting. It operates at a temperature range of -40°C to +85°C. Price is \$21 each in quantities up to 99. Fairchild Semiconductor, 313 Fairchild Drive, Mountain View, Calif. [437]

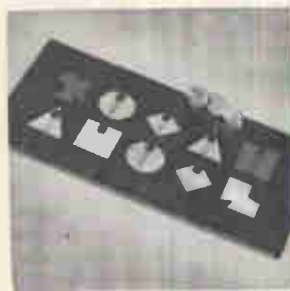

Plastic-packaged field-effect transistors MPF106 and MPF107 feature low noise figures of 2 db max. at 100 Mhz and 4 db max at 400 Mhz. They provide a power gain of 18 db min. at 100 Mhz and 10 db min. at 400 Mhz. Input and output capacitances are 5 pf max and 2 pf max. respectively. Price is 75 cents in 100 lots. Motorola Semiconductor Products Inc., Phoenix. [438]

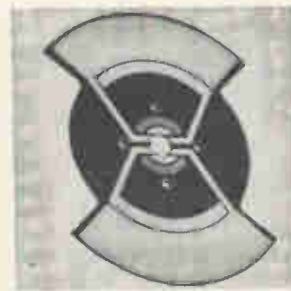

A Schottky barrier unit has an array of 8 circular segmented photodiodes on a 3-in. diameter circuit board. The photoexcited carrier transit time is 10^{-9} sec and capacity per unit area is 100 pf/cm². The unit is designed for use as an automatic shutter control on a high speed military camera. United Detector Technology, 1728 21st St., Santa Monica, Calif. [439]



Silicon PIN switching diodes of the series 47000 is represented by the 47004, which has a peak power of 15 kw with switching speed of less than 500 nano-seconds. Minimum breakdown voltage is 500 v. Units are suited for control applications including r-f switching, limiting, duplexing and phase shifting. Microwave Associates Inc., Burlington, Mass. [440]

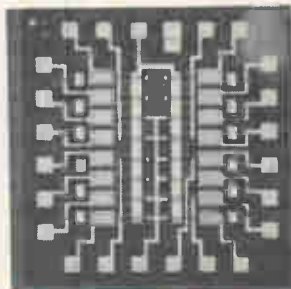

Monolithic MOSFET array HRM-2304 consists of 3 triple-input and 2 dual-input NOR gates. Input threshold voltages are nominally -2 v so that the chip may be used to interface DTL, TTL and RTL logic systems with higher level MOS logic arrays. Units measure 0.050 x 0.053 in. Price is \$12 each in 1,000 lots. Hughes Aircraft Co., 500 Superior Ave., Newport Beach, Calif. [441]

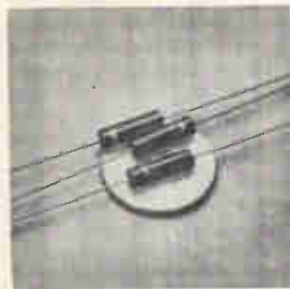

Multijunction rectifier called Mini-stac offers piv's of 3 kv to 7 kv. Average rectified current is 10 ma. Leakage current is 100 na and maximum junction capacitance is 1 pf. Maximum recovery time is 100 nsec. Units measure 0.400 x 0.120 in. Units are metallurgically bonded at high temperature giving high strength. Scmtech Corp., 652 Mitchell Rd., Newbury Park, Calif. [442]

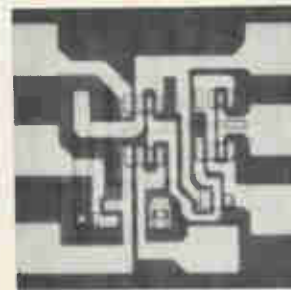

Model LM703 is a monolithic r-f/i-f amplifier. The circuit has a low internal feedback which guarantees a high stability-limited gain. Features include a forward transadmittance of 35 mmhos, input conductance of 0.03 mmho, output conductance of 0.02 mmho, and peak to peak output of 4 ma. National Semiconductor Corp., 2950 San Ysidro Way, Santa Clara, Calif. 95051. [443]

New semiconductors

TTL circuit has extra noise immunity

Dual-input IC gate uses additional transistor; output more accurately reflects input

Electrical noise has given many engineers headaches, but the pain it causes designers of integrated logic circuits for machine control and computer peripheral equipment is of a special intensity. Unwanted voltage and current spikes cause false commands in such IC's; the

transients can mislead a gate into triggering, unless it has high noise immunity.

Some relief is provided by transistor-transistor logic circuits, which have more noise immunity than other forms of logic. Even TTL succumbs in some applications, how-

ever, so a TTL circuit with improved immunity is desirable.

One such new circuit, a Wescon entry, is Sprague Electric Co's USX 1085, a quad-dual input NAND gate with at least half a volt more noise immunity than its counterparts.

The secret. Half a volt may sound small, but not when it's recalled that the immunity of equivalent circuits is about 1.1 volts. The immunity comes from an extra transistor in series with the inputs; three rather than two transistors must be turned on before the gate is triggered.

In NAND-type gates, output voltage is constant until input voltage

new miniature electronic pliers

HOLD, BEND, CUT
ALL FINE WIRES
WITH EASE



CHAIN NOSE AND
DIAGONAL CLOSE
CUTTING PLIERS

SPECIAL TIP
CUTTING PLIERS

RADIO AND TV PLIERS

Ideal for electronic, radio/TV, electrical service and assembly. Forged alloy steel construction. Precision machined. All have polished heads and shoulders. Comfortable "Cushion Grip" handles and coil spring openers speed work, reduce hand fatigue. Miniature round and flat nose pliers also available.

a complete line of regular pliers and snips, too

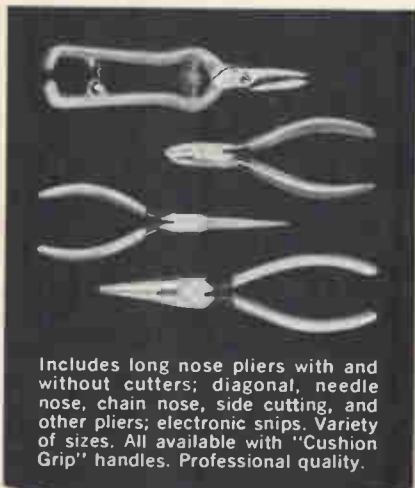

Includes long nose pliers with and without cutters; diagonal, needle nose, chain nose, side cutting, and other pliers; electronic snips. Variety of sizes. All available with "Cushion Grip" handles. Professional quality.

XCELITE®

XCELITE, INC., 130 Bank St., Orchard Park, N.Y. 14127
In Canada contact Charles W. Polnton, Ltd.

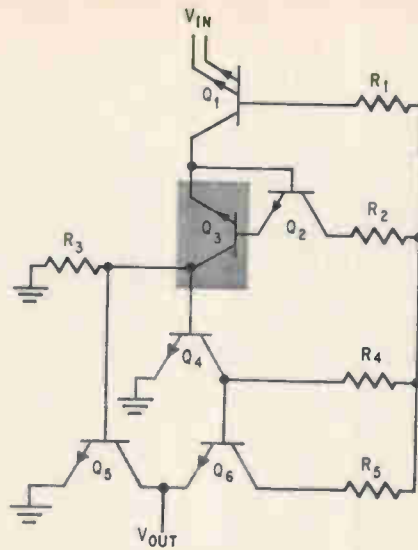

Self-defense. Extra transistor, Q3, and the configuration of Q4, Q5, and Q6 shield against false triggering.

reaches a determined value above ground—in this case, enough to turn on three transistors.

The bonus. This high level also ensures that the switch's output more accurately reflects its input. Thus, the gate not only resists being triggered unintentionally but also requires a more definite signal (higher voltage) to trigger itself.

The driver transistor feeding the gate's output stage is in phase with one of the output transistors (both are emitter-to-ground), and connected collector-to-base with the other. Thus, both of the output transistors can be fully turned on at the same time, therefore there's no current spike.

Sprague Electric Co., 125 Marshall St., North Adams, Mass. 02148 [444]

New semiconductors

Power level of SCR zooms

Device delivers 550 amps
and is rated to 1,500 v;
cost is \$150

Wescon's version of the carnival strongman may be a silicon controlled rectifier that will be shown by the semiconductor division of

VARISTORS PROTECT YOUR CIRCUITS

Silicon Varistors

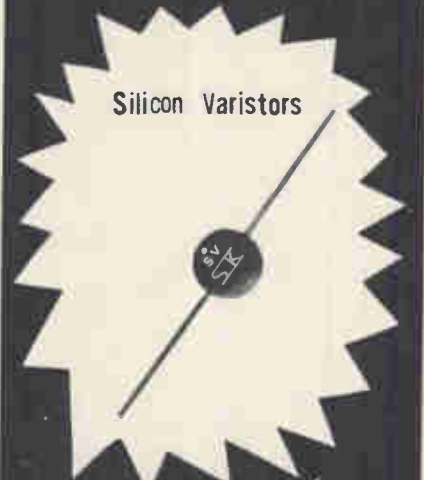

SiC Varistors



Si diodes, Si rectifiers,
Si transistors, Se rectifiers,
CdS photo cells, Power supplies.

Sanken®

TELEX: 0272-2323 (SANKELE TOK)
CABLE: SANKELE TOKYO Phone: 986-6151

1-22 8 NISHI- IKEBUKURO,
TOSHIMA-KU, TOKYO
SANKEN ELECTRIC CO., LTD.

Westinghouse Electric Corp. The company says its new device, called the 282, has the highest power rating of any commercially available SCR.

The 282 delivers an average of 550 amps and comes in models rated up to 1,500 volts, forward and reverse. The gate-firing current is 150 milliamps, and dv/dt is 300 v per microsecond. The 282 is 1-inch high and 1½ inches in diameter, and is water-cooled.

The 282 won't be the only high-power SCR Westinghouse will show. Also making the trip to Los Angeles will be the 270, a 350-amp version of the 282.

Both high-power devices—priced at \$150 in lots of 100—are aimed at such applications as motor controls and power-handling circuits in electroplating setups.

Other companies have prototypes of SCR's similar to the 282

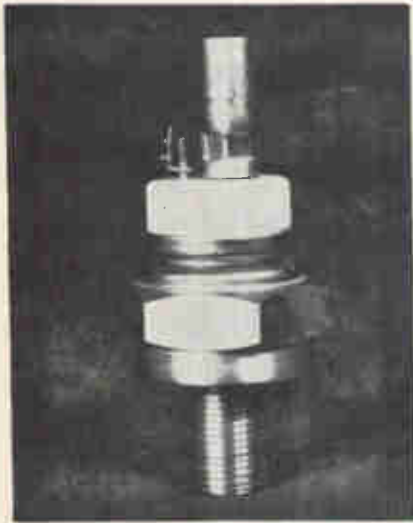

and 270, says Westinghouse, but no one else is producing 550-amp units in volume.

Woody Savage, Westinghouse sales engineer, estimates that the high-power market could, in five years, be as big as the medium unit market is today. He points out that an SCR like the 282 can replace two or more medium-power units which are connected in parallel.

Westinghouse expects to have a 1,000-amp average current water-cooled SCR for sale by the end of next year.

Westinghouse Electric Corp., Semiconductor Div., Youngwood, Pa. [445]

4.5V, 20 MIL LAMPS GIVE TUNG-SOL READOUTS LOW POWER DRAIN, MINIMUM HEAT, MAXIMUM RELIABILITY

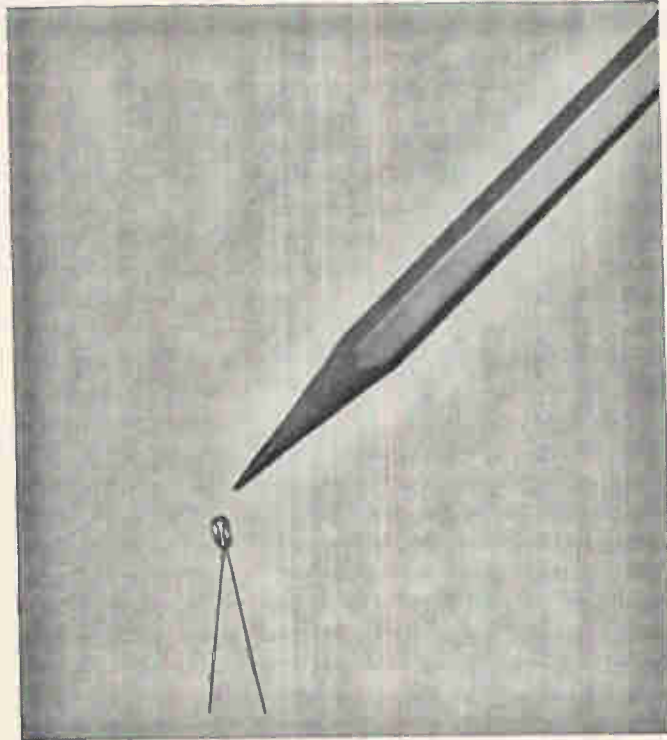

The new T-3/4 lamps used in Tung-Sol readouts, both digital and alphanumeric, provide important performance advantages without loss of effective brilliance. The low-power factor is especially advantageous where energy-source weight must be minimized—such as in aircraft and space vehicles.

Tung-Sol digital and alphanumeric readouts have excellent off-on contrast and a 150° viewing angle. They are designed to be intermixed. Write for brochure T-431, which contains 12 pages of detailed information. Tung-Sol Division, Wagner Electric Corporation, One Summer Avenue, Newark, N.J. 07104.

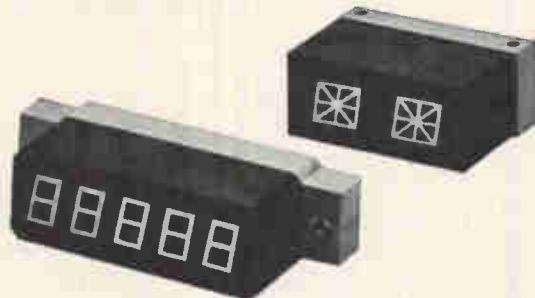

TUNG-SOL®

OPTIMUM CONTRAST
DIGITAL AND ALPHANUMERIC
READOUTS

© REG. T. H. WAGNER ELECTRIC CORPORATION

our subminiature relay line:

If you make electronic things (to MIL-R-5757), this is your group

SERIES D (10 amp, 2 pdt)—Most compact welded relay for use where size and performance are critical. 50g shock, 20g vibration.

SERIES CL (10 amp, 2 pdt)—Magnetic latch, all-welded relay. 50g shock, 20g vibration.

SERIES E (2 amp, 2 pdt)—All-welded half size relay for dry circuit/low level and 2 amp switching. 100g shock, 30g vibration.

SERIES G (2 amp, 2 pole)—All-welded, 150 grid relay only 0.32" x 0.310" x 0.610". 100g shock, 30g vibration.

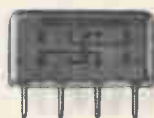

SERIES G quantities available October 1st.

If you make electrical things (to MIL-R-6106), this is your group

SERIES J (10 amp, 2 pdt)—Balanced-Force* relay for DC current. 100g shock, 30g vibration

SERIES JA (10 amp, 2 pdt)—Balanced-Force* relay for AC current. 100g shock, 30g vibration

SERIES K (10 amp, 4 pdt)—Balanced-Force* relay for DC current. 100g shock, 30g vibration.

SERIES C (10 amp, 2 pdt)—50g shock, 20g vibration.

SERIES KA (10 amp, 4 pdt)—Balanced-Force* relay for AC current. 100g shock, 30g vibration.

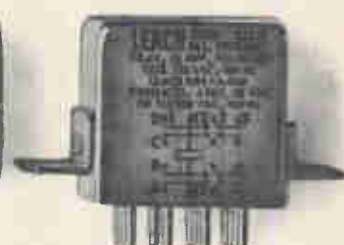
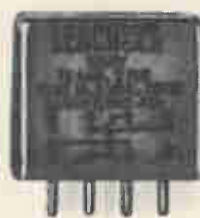
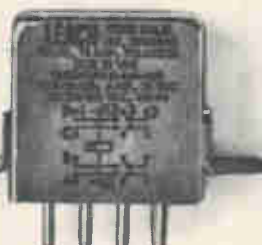

*Patent Pending.

Complete specs are yours for the asking. Write Leach Corporation, Relay Division, 5915 Avalon Boulevard, Los Angeles, California 90003. Telephone. (213) 232-8221.

LEACH

New Microwave Review



Solid state broadband amplifier model EBA1001 covers 10 to 400 Mhz. Noise figure is 8 db max.; gain, 20 db minimum; gain flatness, ± 0.5 db minimum; power output at 1 db gain compression, $+20$ dbm minimum; input vswr, 2.5 max.; output vswr, 2 max. The unit measures pulse, ECM, and RFI. E&M Laboratories, 7419 Greenbush Laboratories, N. Hollywood, Calif. [401]



Dual conical horn receiving antenna system operates over the 1.4 to 1.6 and 2.1 to 2.3 Ghz band. The vertically polarized horns are mounted on a remotely controlled elevation/azimuth dual axis positioner. The pedestal is capable of -10° to 190° positioning in elevation, 400° in azimuth; accuracy is $\pm 0.5^\circ$. Price is \$7,000. Andrew Corp., 10500 W. 153rd St., Orland Park, Ill. [402]

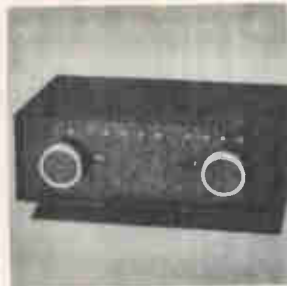

Miniature, 50-ohm rotary attenuators in the 500 series are for lab and accessory use. Model 550 covers 0 to 110 db in 1 db steps; model 570 covers 0 to 80 db in 1 db steps; model 560 covers 0 to 11 db in 0.1 db steps. They feature low vswr and flat frequency response from d-c to 2 Ghz. Prices range from \$225 to \$275. Texscan Corp., 2446 N. Shadeland Ave., Indianapolis. [403]



S-band ferrite switch model SSH5 has peak power handling capability of 500 kw. It operates at average power levels of 500 w, and has a switching speed of 1 msec. Isolation is 20 db minimum; insertion loss, 0.3 db maximum. Operating frequency is 2.9 to 3.1 Ghz. Vswr is 1.20 maximum. The unit weighs 15.2 lbs. Raytheon Co., 130 Willow St., Waltham, Mass. 02154. [404]

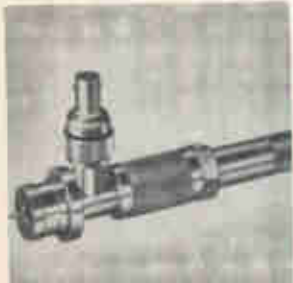

Universal r-f precision tunable probe model 229C is compatible with all coaxial and waveguide slotted lines with $3/4$ in. diameter standard mounting holes. It is tunable throughout the entire range of 0.90 to 18.0 Ghz. The r-f output from the probe enables it to be used with microwave receivers or other external detectors. Narda Microwave Corp., Commercial St., Plainville, N.Y. [405]

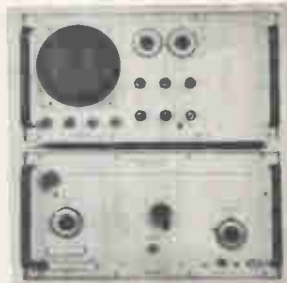

Microwave spectrum analyzer model SPA-3000 has a range of 10 Mhz to 40 Ghz and a 3-Ghz dispersion with no in-band multiple responses up to 9 Ghz. It has a built-in, continuously tunable, non-swept phase lock capability for high stability in the narrow dispersion ranges. Price is in the \$9,000 range. The Singer Co., Metrics Division, 915 Pembroke St., Bridgeport, Conn. [406]

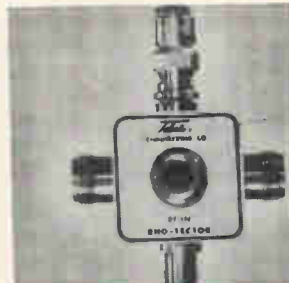

The TRB-16 Rho-Tector is an impedance comparator for measuring single point or swept vswr over a frequency range of 200 Mhz to 5 Ghz. It is equipped with connectors for r-f input, known impedance, unknown impedance, and output. Maximum power input allowable is 0.5 w. Price is \$375; delivery, 4 weeks. Telonic Engineering Co., Box 277, Laguna Beach, Calif. [407]



X-band solid state power generator E3288 is a low noise, electronically tuned device suited for local oscillator or test source use in commercial and military applications. Operating frequency is 8 to 11 Ghz with a tuning range of 400 Mhz. Power output is 10 mw. The unit operates from a -17.5 v stabilized supply. The M-O Valve Co. Ltd., Brook Green Works, London W.6. [408]

New microwave

Power circuits key to trim package

Market for small, light traveling-wave-tube amplifier seen in airborne ECM, telemetry, and communications

"The device has nothing in it that couldn't be built by any other company," concedes designer Robert Boschert at Microwave Associates (West) Inc.

The fact is, though, that other companies haven't developed or marketed an X-band traveling-

wave-tube amplifier that weighs but $3\frac{1}{2}$ pounds and measures only $1\frac{1}{8}$ by $1\frac{1}{8}$ by 12 inches. Microwave Associates calls its product the smallest and lightest amplifier of its type on the market and claims that it's half the weight of the competing device that's closest to it in

specifications.

In the design of this all-solid state—except for the tube—amplifier, most of the reduction in size and weight was accomplished in the power supply. "We used an extensive assortment of new circuits," says Boschert, "including field effect transistors, bipolar integrated circuits, and silicon controlled rectifiers."

The high voltages required by traveling-wave-tube amplifiers make the power-supply transformer the largest single obstacle to miniaturization. The company declines to say how this difficulty was overcome in its new amplifier, the MA-

Rent INSTRUMENTS FOR ANY EMERGENCY Rent INSTRUMENTS TO SAVE CAPITAL

You can save time and money and satisfy your short term equipment requirements by renting almost any kind of electronic instrument or small computer from Rentronix. Our rates are low . . . Our service is fast and easy to use. You simply select the instrument you want from our complete catalog, confirm its availability by a collect phone call or quotation request, and send us your purchase order for 30 days rental or more.

Your calibrated, fully maintained instrument will be on its way to you, transportation prepaid, anywhere in the United States within hours.

Get full information now at no obligation. Fill out the coupon or call collect, (301) 933-6655 for even faster service.

Rentronix

A DIVISION OF INMARK, INC.

11501 Huff Court
Kensington, Maryland 20795

Send me full information
I would like to rent a Model _____

from you for _____ months.
How much would it cost?

Name _____ Title _____

Company _____

Address _____

City & State _____ Zip _____



Rentronix

2782, but the best guess is that the conventional transformer was replaced by a series of solid state voltage multipliers.

Because of its size, the MA-2782 has found its way into several electronic countermeasures applications where dimensions and weight are critical. And the device is expected to find a ready market in airborne ECM operations. The wide variety of a-c and d-c line voltages from which the amplifier will operate encompasses the most common ground equipment and airborne supply voltages. On d-c, the unit is specified at ± 25 to 200 volts, and on a-c at 60 to 145 volts, or 40 to 440 hertz line frequency with 10-watt input power. Output gain at 10 millivolts is 25 decibels.

In addition to ECM, Boschert says the device will find uses in jobs where the 7-to-11-gigahertz band is employed and a 12-db noise figure is required. Telemetry, communications, input stages for radar, and matched-gain direction finding are applications.

Tentative company plans suggest that the techniques used to produce the MA-2782 will be applied in the near future to design instruments

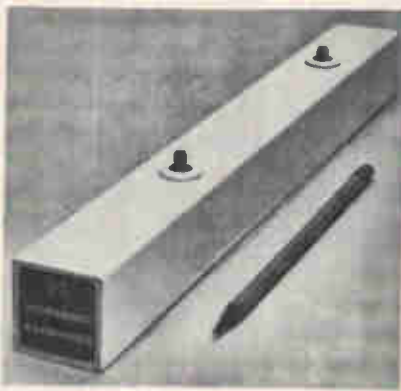

operating in the 2-to-4-Ghz and 4-to-8-Ghz bands.

Because only a few of the devices have been sold so far, the company hasn't yet set a standard price. The firm's marketing director, Phillip Hargrove, says the amplifier won't be offered off the shelf because technical requirements for blanking and modulation, plus variations in radio-frequency requirements and differing mounting configurations make customizing necessary.

Microwave Associates (West) Inc.,
Sunnyvale, Calif. [409]

New microwave

Radar testing with less weight

Pair of receivers
and pattern recorder
check out antennas

Lighten the load for the engineer who does antenna pattern testing. That's the job of two receivers and a recorder that Scientific-Atlanta Inc. will introduce at Wescon.

The new equipment won't give the engineer much more data than he could get from earlier products, but it's lighter and smaller than its predecessors, and these features can be critically important at remote sites.

Scientific-Atlanta's model 1740 receiver weighs only 75 pounds, but lightness isn't its only advantage. It's phase-locked to its incoming r-f signal and has a linear heterodyne detection system. The result is extremely stable automatic frequency control and high sensitivity.

The range of the 1740 is 100 down to 1.95 Ghz, but this can be lowered to 100 megahertz with an optional converter. A price hasn't been set for the 1740, but it will be under \$13,000, the company says.

For the engineer who can live with a receiver whose sensitivity is about 10 db's poorer than that of the 1740, Scientific-Atlanta has the model 1730. This receiver features automatic gain control but isn't phased-locked. Range is 20 Mhz to 100 Ghz, weight is 55 pounds, and price is around \$7,500.

Deliveries of both models will begin in about four months.

To put the signals picked up by either receiver to good use, the company has a 26-pound pattern recorder—an x-y recorder designed with pattern testing in mind. Usually one axis is controlled by the received signal and the other by the position signal from the antenna. The new unit is 10 inches wide and 11 inches deep.

Scientific-Atlanta Inc., Box 13654, Atlanta, Ga. [410]

MIL-R-27208



RT11

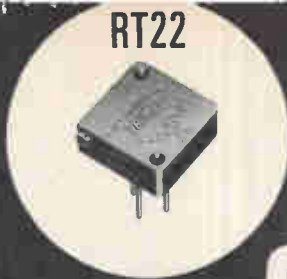

RT22

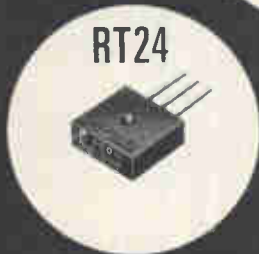

RT24



RT12

8 BOURNS MIL-SPEC MODELS...

MIL-R-22097



RJ22



RT10



RJ12



RJ11

count 'em!

...available from Distributor stocks, for immediate delivery!

These units not only meet the specs, they *beat* the specs . . . and they're all in distributor stocks ready for immediate delivery! All eight models have higher operating temperature, better shock and vibration performance, lower temperature coefficient, higher dielectric strength and insulation resistance than the specs call for.

Although MIL-R-27208 sets a maximum operating temperature of 150°C for wirewound units, Bourns gives you 175°C. And where MIL-R-22097 asks for 125°C in carbon units, Bourns gives you 150°C. Every Mil-Spec unit exceeds MIL-STD-202, Method 106, for cycling humidity. Specifically, insulation resistance is called out as 10 megohms; Bourns delivers 100 megohms. For vibration, the Mil-Spec requires 20G, but every Bourns unit must pass 30G. Yes, in all important parameters, Bourns surpasses the requirements.

When looking for a Mil-Spec potentiometer, investigate the eight Bourns models. You can depend on the fact that when it comes to Mil-Spec potentiometers — Bourns has a unit that meets and beats the specs. So don't short-change yourself . . . Don't Mil-Speculate — Specify Bourns!

Write for complete technical data today, or call your local Bourns office, representative or stocking distributor.



Circle 159 on reader service card

BOURNS, INC., TRIMPOT DIVISION • 1200 COLUMBIA AVE., RIVERSIDE, CALIF.
TELEPHONE (714) 684-1700 • TWX: 910 332-1252 • CABLE: BOURNSINC.

TRIMPOT® and Precision Potentiometers - Miniature Relays - Electronic Modules - Microcomponents.

110 contacts to the inch.

Socket to 'em!

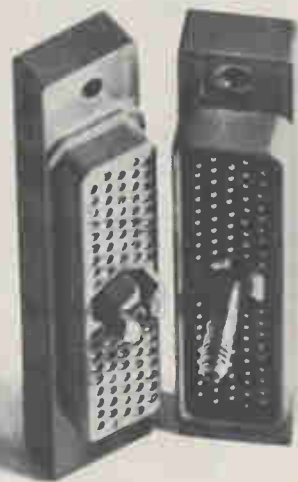

We make subminiatures so they're more subminiature.

Smaller. Lighter. More fully packed. 110 contacts to the inch, without sacrificing contact size or spacing.

It happened like most Hughes innovations. We couldn't find connectors small enough for our space jobs—so we made some small enough. Rugged enough.

That was the birth of PolarHex, our center jackscrew coupling mechanism. It insures perfect alignment, positive engaging

and polarizing.

Hughes subminiatures also feature crimp snap-in contacts with the industry's best retention system. The retaining clip is anchored to the contact, not the body—so it floats free for easy alignment.

They're available in environmental, non-environmental and potting versions. In arrangements to fit any requirement, from 14 to 244 size 22 contacts.

If you're up tight for space, write and say "socket to me."

Write Hughes Aircraft Co., Connecting Devices, 500 Superior Ave., Newport Beach, California 92663. Phone (714) 548-0671. TWX 714-642-1353.  Connecting Devices, part of Hughes Circuit Technologies. Including: Contour™ Cable; Semiconductors; Flip Chips/Equipment; Frequency Control Devices; Microelectronic Circuits; MOSFETs.

HUGHES

HUGHES AIRCRAFT COMPANY

If it's happening in connectors,
it probably started at Hughes.

New Production Equipment Review



Perforated-tape manual winders feature vacuum-lock base for quick attachment to any smooth surface. Units have brake tension adjustment for controlling the tape. Winders are available with split-flange reels for easy tape removal and storage. Prices start at \$45 and availability is 5 days after receipt of order. Data-Link Corp., 4546 El Camino Real, Los Altos, Calif. 94022. [421]

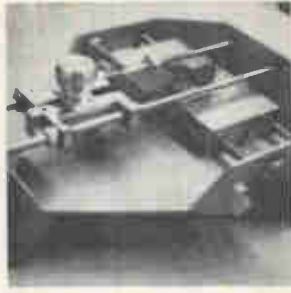

Ceramic/glass substrate scriber is useful for producers of hybrid circuits to scribe material into any rectangular size required. Work is inserted into a holding chuck and the operator makes a visual alignment by indexing the driving lead screw until scribe path coincides with diamond scribe. Price, \$590. Mechanization Associates, 2622 Frontage Rd., Mtn. View Calif. [422]



Automatic dicer Mark III dices one silicon, germanium, or titanium wafer every 80 seconds. Depending upon chip size, it can turn out more than 4,000 transistors, diodes, capacitors, or IC's in a little more than a minute. The dicing is accomplished by 0.002 in. cutting disks, precision spindle, and slurry bombardment. Taft-Pierce Mfg. Co., Mechanic Ave., Woonsocket, R.I. [423]



Sorter type 802 automatically inspects and sorts disk varistors and other disk components. It provides test rates to 7,200/hr. High yield is produced by accurate measurement achieved with 4-terminal (Kelvin) probe. Two separate terminals make contact with each side of disk. Contact resistance is below 50 milliohms. Daymarc Corp., 40 Bear Hill Rd., Waltham, Mass. [424]



Coil encapsulator ACE-100 coats stator, transformer and other coils through a 3-step operation. After the operator places the parts on the tooling, hooks up the coils and presses the start button, the pre-heat, dip and post cure cycles are performed automatically. Windings are uniformly coated at 100 per hr. Possis Machine Corp., 825 Rhode Island Ave. So., Minneapolis. [425]



Existing solder pot conversion to ultrasonic tinning is made possible by an add-on unit designed for all component lead tinning applications. Ultrasonic tinning results in cost savings by eliminating fluxing and cleaning steps, and improving shelf life and serviceability. The unit may be used with any type solder. The Redford Corp., 968 Albany-Shaker Road, Latham, N.Y. 12110. [426]

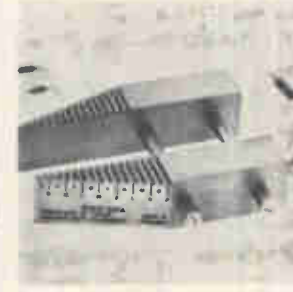

Lightweight aluminum clamp provides fast, accurate bending of resistor, capacitor and diode leads for printed circuit and allied uses. It cuts production time for lead bending by 50%. Leads may be up to 1 3/4 in. long and can be bent to within 1/16 in. of the ends of components. Price is \$12.95. Horizons International Co., E. Fuller at Middlefield Rd., Redwood City, Calif. [427]



Sputter etching system 8550 for thin film products uses r-f plasma-produced ions. As substrates move through the chamber, they can be cleaned by etching, coated with a resistor material such as tantalum, and then the resistor coating can be trimmed by etching. Price for basic system is \$12,900; delivery, 4 to 6 weeks. Materials Research Corp., Orangeburg, N.Y. 10962. [428]

New production equipment

Low-melting solder eases assembly

Bismuth alloy that softens at 209°F prevents damage to such heat-sensitive parts as IC's

The obvious way to solder heat-sensitive integrated circuits to a board without damaging the semiconductor chips is to reduce the melting point of the solder.

A few months ago, the Cerro Corp. introduced a solder that melts at 240° to 260°F. And the same

company now offers what it claims is the lowest melting solder yet in wire form, a bismuth-based alloy that softens at 209°F and is fully liquid above 212°.

To hold the new solder, the leads of the device must be pretinned. A touch of a low-temperature solder-

ing iron then makes the solder flow and bonds the leads to the circuit board.

The technique can be useful for components other than IC's, too. Some relays, for instance, employ nylon moldings as coil forms. After the coil has been wound, the lead wires are attached to pins inserted in the ends of the nylon form. But when the wire is wrapped around the pins and soldered, the pins' high thermal conductivity may allow the flow of enough heat to soften the nylon, resulting in a loose and insecure fit between the pins and the coil form. Cerro's new solder could be the answer here.

**SUPERIOR
COAXIAL
ATTENUATORS**

**sets
the standards**



Attenuator Sets are used worldwide as standards in labs and on production lines. Attenuator Sets include 4 or 8 specially selected and calibrated (at 1 GHz Intervals) 3, 6, 10, and 20 dB Precision Fixed Coaxial Attenuators. They are handsomely packaged with their individual laminated calibration data in a custom made walnut storage case.

MODEL	FREQ. RANGE (GHz)	MAX. VSWR
AS-4	DC-12.4	1.30
AS-5	DC-12.4	1.35
AS-6	DC-18.0	1.35-1.50
AS-7	DC-1.0-18.0	1.25-1.50

The attenuators contained in these sets have a broad frequency range (up to DC-18 GHz), a low temperature and power coefficient, high stability, stainless steel construction, and new DC-18.0 GHz Type N connectors. All attenuators are ruggedly constructed for maximum life and minimum wear.

Designers and
Manufacturers of Precision
Microwave Equipment
**WEINSCHEL
ENGINEERING**
Galthersburg, Maryland

(68-12)



Boiling point. Coil of solder softens and unwinds in boiling water. It will melt above 212° F.

The material, called Cerrosolder, is usually supplied in 1/8-inch diameter wire form. Its electrical conductivity is 2.9% that of copper, and its resistivity is 349 circular-mil ohms per foot.

The manufacturer quotes a price of \$35 for a 2-pound quantity of the solder, but says that the price will be much lower in larger quantities. Cerro will send foot-long samples of Cerrosolder upon letter-head request.

Cerro Copper & Brass, Rolling Place, Stamford, Conn. 06907 [429]

New production equipment

Molten resins speed fastening

Automatic applicator can replace manual, mechanical operations

Hot-melt materials are replacing such fasteners as staples, tape, glue, wire, and twine, and in doing so are reducing manufacturing costs and boosting production rates. Now versatility can be added to these advantages.

The Nordson Corp. has a new automatic hot-melt applicator that's used to melt and pump General

Mills Versalon resin at 420°F. The equipment provides a blanket of nitrogen over the molten resin to prevent contamination.

In one application, the model II-D is connected to a hot-melt gun on a semiautomatic coil-winding machine, which automatically wraps insulated copper wire on plastic cores. The coils move through the machine on an indexing table and, at a point 180° from the winding position, the wire ends are secured by a small dot of the resin, applied by the gun in only 1/4 second. Since the hot-melt material sets quickly as it loses heat, the coils are almost immediately ready for removal.

In another application, hot-melt is used to maintain a delicate television yoke adjustment. The resin is applied to a plastic form and a prewound copper coil from two sides by a pair of guns. The hot-melt locks the two parts of the assembly together after a technician has adjusted the position of the coil with the aid of a scope.

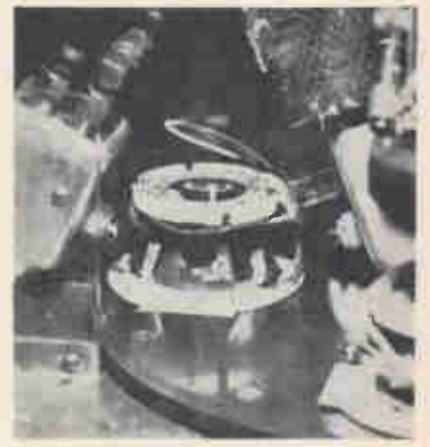

Two guns. Hot-melt is sprayed on tv yoke assembly to maintain adjustment.

Other hot-melt materials that can be applied by the equipment include potting compounds, sealants, waxes, and protective or stripable coating materials; any thermoplastic can be used, according to Nordson. These materials can be placed in the melting tank in the form of chunks, bricks, pellets, or granules. Besides simple fastening operations, the basic hot-melt equipment is suitable for seaming, potting, and insulating.

The II-D, exclusive of hoses and extrusion heads, costs about \$3,000.

Nordson Corp., Jackson St., Amherst, Ohio 44001 [430]

Going to IC's? Or Higher IF's?

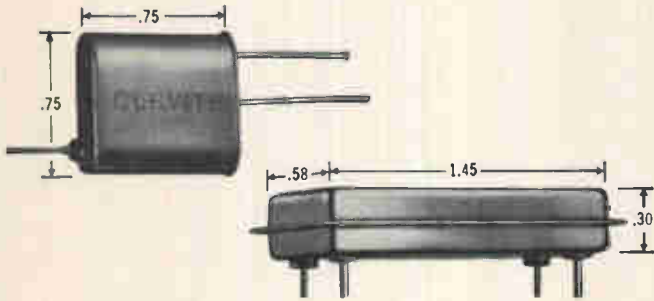

Go two ways with Monolithic Clevite Uni-Wafer Filters

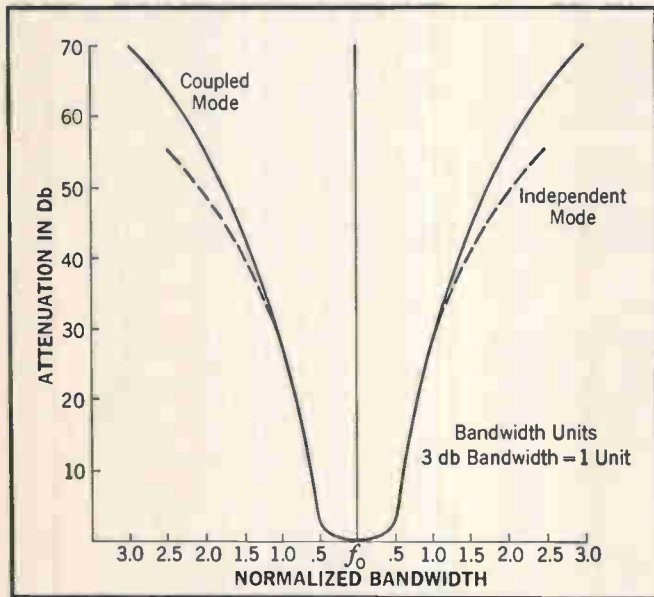

Go independent mode. Go coupled mode. You can go either mode with monolithic Clevite Uni-Wafer filters. They're smaller and more reliable (fewer interconnections) than conventional filters.

Clevite Uni-Wafer filters are ideal for matching IC circuitry in communications receivers operating in the VHF and UHF frequency ranges as well as in telemetry, radar and aerospace systems.

They are four-pole crystal filters with a choice of center frequencies ranging from 8 MHz to 75 MHz. They've been developed using Clevite's advanced engineering techniques and Clevite's original thin film approach to quartz filters. In this concept, arrays of resonators are achieved on a single quartz wafer with resonator isolation and spurious suppression controlled by the trapped energy principle.

So if you're going to IC's or higher IF's, go Clevite Uni-Wafer filters. They're available in both independent and coupled mode.

For more information and complete specification data, write: Clevite Corporation, Piezoelectric Division, 232 Forbes Road, Bedford, Ohio 44146.

CLEVITE

NEW SILICON

SCHOTTKY BARRIER PHOTODIODES

(1) PIN-5 .03 cm² active area (3) PIN-25 8 cm² active area
(2) PIN-8LC 1.0 cm² active area
(low capacity)

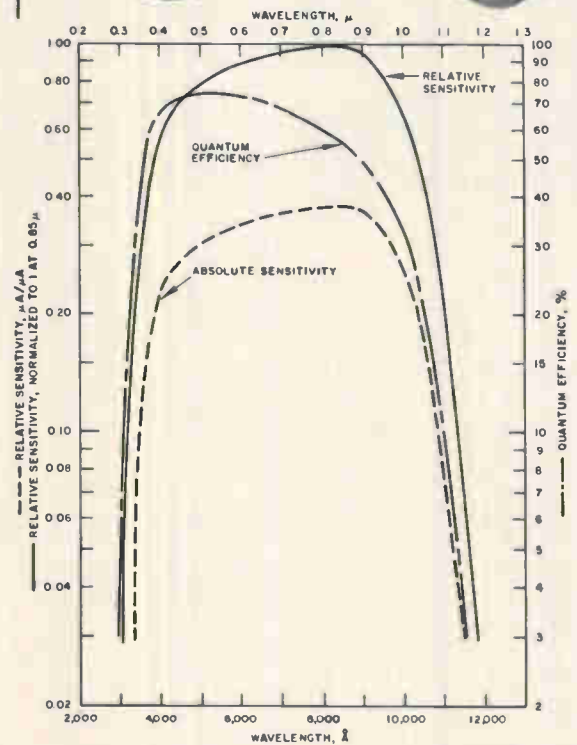
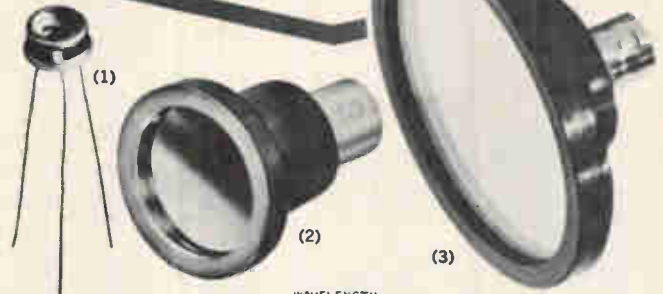

Response Time	to 1 nanosecond
†Detectivity (D*) (.9μ, 10 ³ Hz, 1 Hz) (cm. cps /watt)	5.6 x 10 ¹²
Leakage Current (90 volts applied)2 x 10 ⁻⁷ amp/cm ²
Capacitance	[to 15 pf/cm ² at 90 v.]
Linearity of Response	over 8 decades
N.E.P. (10 ³ Hz, 1 Hz)	10 ⁻¹³ watts

Reasonable pricing — Delivery from stock

Write for specifications on quadrant detectors and arrays with densities to 300 elements per inch. Single lengths to 10 inches, diameters to 2 inches. Special detectors optimized for 1.06μ, 1.15μ, and the ultra-violet.

† Refer to NOLC No. 2245, 15 May 1968, issued by
Naval Ordnance Laboratory, Corona, California

**UNITED DETECTOR
TECHNOLOGY** Box 5251,
Santa Monica, California 90405
Phone (213) 393-3785



SEE US AT WESCON BOOTH #3025

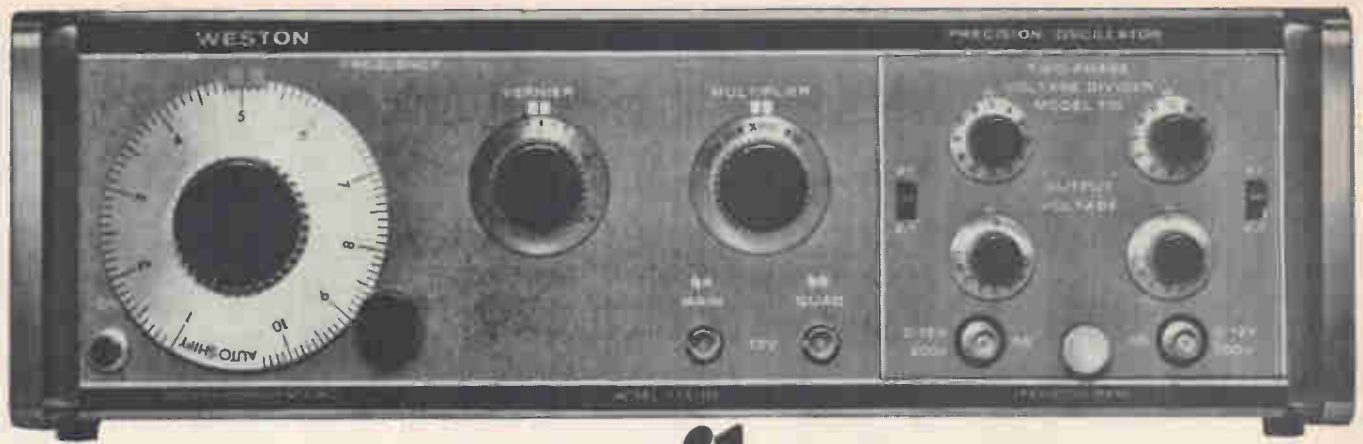

e unibus

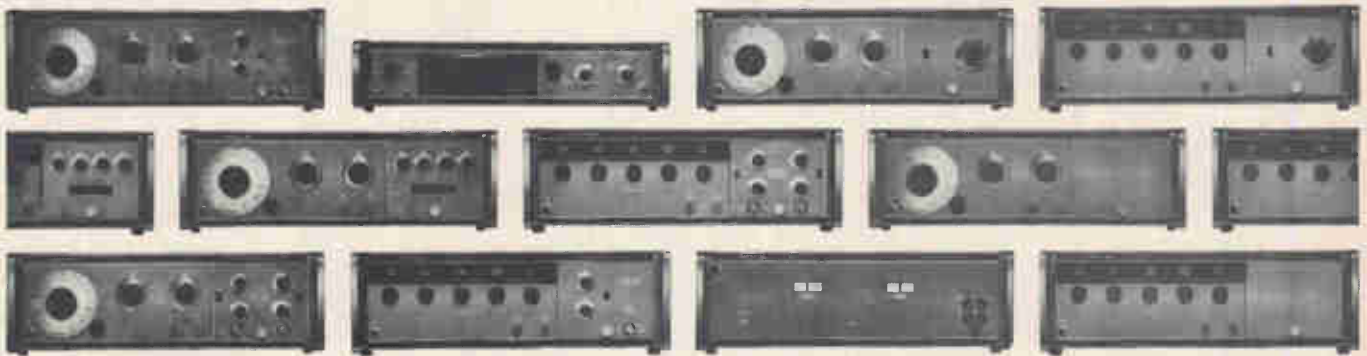

plurum

NOW . . . A MULTI-INSTRUMENT FLEXIBILITY FROM ONE BASIC PRECISION OSCILLATOR DESIGN.

This Latin you'll never find in a textbook, but we've made a spoonerism to make a point. From one . . . a single oscillator design with amazing stability and precision . . . have come many . . . a line of laboratory oscillators which are unmatched in performance and versatility. Now, with the added flexibility of plug-in modules and accessory equipment, one of these Weston-Lexington instruments can replace an entire labful of precision oscillators.

For general laboratory use . . . The Model CVO-100 precision oscillator provides frequencies from 10Hz to 100kHz with short-term stability of 20ppm, 0.01% distortion and amplitude flatness better than 0.01%, permitting applications never before possible with test oscillators. Has "zero" output impedance and can de-

liver 750 mw of power. Broad functional versatility is provided through a variety of plug-in modules.

For digital frequency selection and readout . . . The Model DVO-102 precision oscillator provides the additional accuracy and repeatability of decade frequency controls.

For long-term stability . . . The Model CVS-101 and DVS-103 oscillators (with decade controls) provide true absolute voltage accuracy and one-year stability of 100ppm.

For remote programmed output for system use . . . The Model RVO-104 oscillator is fully programmable, providing output settings from 10.0Hz to 109.9kHz.

For precision frequency setting and readout . . . The Model DRO-300 frequency computer (5Hz to 200kHz) permits oscillator setting and provides direct reading in Hz to an accuracy of .01% in 0.2 seconds.

For high-level output . . . The Model HVA-120 Amplifier extends the output level of the precision oscillators to 120 volts.

Plug-in Modules for use with oscillators:

Model 108 — Interconnection unit for basic oscillator operation.

Model 109 — Single-phase voltage divider.

Model 110 — Two-phase voltage divider.

Model 111 — Single-phase, high-resolution voltage divider.

Model 114 — 20ppm resolution, voltage standardizer.

Write today for our new literature on this extraordinary precision oscillator family. WESTON INSTRUMENTS DIVISION, Weston Instruments, Inc., Lexington, Mass. 02173.

a Schlumberger company
WESTON[®]

New Subassemblies Review



X-MOD analog-to-digital converters provide accuracies of 0.01% at 5,500 readings/sec with no storage effects or first error reading. Binary modes are available with sign plus 14, 11 and 8 bit resolution with accuracies from $\pm 0.01\%$ $\pm \frac{1}{2}$ least significant bit to $+0.4\% \pm \frac{1}{2}$ LSB. Delivery is 60 days. Preston Scientific Inc., 805 E. Cerritos Ave., Anaheim, Calif. [381]



FET differential amplifier model 13303 has a drift of $2 \mu\text{v}/^\circ\text{C}$. It has an input impedance of 100,000 megohms, and a d-c gain of 300,000. It is designed for use as a buffer or integrator where isolation is important. Its rated output is $\pm 10 \text{ v}$ at 5 ma; minimum; and input bias current is 15 pa. It measures 0.625 in. high. Zeltex Inc., 1000 Chalomar Road, Concord, Calif. [382]

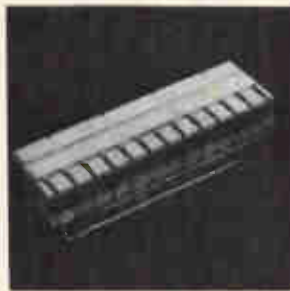

Thirteen-track flying magnetic head for disk memories provides reliable performance at packing densities up to 1,300 bits per inch. Track width is 0.015 in. spaced on 0.125 in. centers. Inductance is $40 \mu\text{h}$ per winding leg and gap length is $200 \mu\text{ in}$. Prices start at \$380 and vary with quantity. Applied Magnetics Corp., 75 Robin Hill Rd., Goleta, Calif. [383]



Custom-produced 16-segment bar-type readouts can display over 65,000 discrete patterns including a complete alphanumeric presentation, digraphs, and conventional symbols. Illumination for segments making up each character is supplied by light generated by lamp blocks. Tung-Sol Div. Wagner Electric Corp., 1 Summer Ave., Newark, N.J. 07104. [384]



Digital data simulator 912 (7 $\frac{1}{2}$ in. high by 13 $\frac{1}{2}$ in. wide) programs 960 bits of binary information at the front panel using 320 tiny octal-weighted programming pins. The 960 serial bits can be clocked out at rates to 10 Mhz. In the parallel mode, up to eighty 12 bit parallel words can be output at rates up to 5 Mhz. Moxon Electronics, 2309 Pontius Ave., Los Angeles. [385]

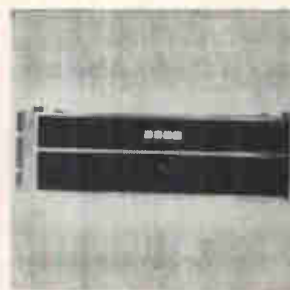

Data interface accepts parallel BCD data from as many as 24 input devices of up to 6 digits each. The output drives printers, paper tape, magnetic tape and card punches. Optional buffer storage allows data accumulation to resume during readout. A variety of input and output codes can be accommodated. Digital Automation Co., 68 Highway 31, Pennington, N.J. [386]



Analog-to-digital encoder model 1250, displacing only 6 cu in., can encode $\pm 10 \text{ v}$ input into 12 binary bits of data at the rate of $1 \mu\text{sec}$ per bit. Successive approximation measurement is used to provide a resolution of one part in 4,096 with an accuracy of $\pm 0.05\%$ in ambients ranging from 0° to 50°C . Phoenix Data Inc., 3065 W. Fairmount Ave., Phoenix. 02154. [387]



Gallium arsenide semiconductor laser model RSL-5 provides 4 w of c-w output power. It consists of a liquid helium dewar and a demountable semiconductor laser header. Output of the unit is at 8,400 angstroms and operating temperature is 4.2°K . Price is \$12,390 or \$4,245 without dewar with 60 day delivery. Raytheon Co., Foundry Ave., Waltham, Mass. 02154. [388]

New subassemblies

Read-only memory uses bipolar IC's

Link-removing technique permits production quantities to be tailor-made to each customer's specifications

Early this year, the Semiconductor Products division of Motorola Inc. introduced a custom 12-gate diode-transistor logic array for which the customer specifies the second-layer interconnection pattern. Motorola then makes a mask for that pattern by using computer-aided design

[Electronics, April 1, p. 105]. Now, some of the techniques developed to make the array are being used by the division's memory products group. The latest result is a 128-bit read-only memory that provides 16 eight-bit words of nonvolatile storage on an 88-by-85-mil bipolar

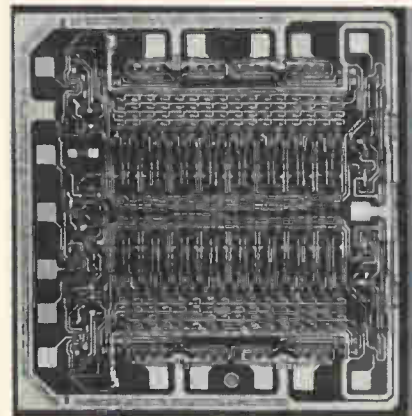

Unforgetting. The XC170 is a 128-bit read-only memory, compatible with DTL and TTL.

The tattletale.



Spills the beans about random signal amplitudes.

When is a random signal really random? Peer into the good ol' cathode ray tube and you'll see a confusing blotch. Plot spectral density and you'll get a straight line that glosses over telltale deviations.

What you need is an instrument that completely analyzes the amplitude distribution of complex random signals.

Our new Model 161 Amplitude Distribution Analyzer tells the whole truth about random signals — down to the very last peak. Nothing's masked, nothing's averaged. The tattletale talks your language — displacement strain, acceleration, what have you.

Doubled up, 161's reveal the exact nature of a transmission path.

Give us a whisper. We'll give you an earful on how the "tattletale"

can put an end to your waveform credibility gap.



The B & K Model 161
Amplitude Distribution Analyzer

B & K INSTRUMENTS, INC.
Bruel & Kjaer Precision Instruments
5111 West 164th Street • Cleveland, Ohio 44142
Telephone (216) 267 4800 • TWX (810) 421 8266

... the customer sends in a data card
telling where to put 0's, test points ...

monolithic chip—but with only one layer of metalization.

This is just the second product to come from the six-month-old group, and its first read-only memory. The novelty is that the customer simply furnishes Motorola with a punched card designating the data he wants entered into the memory. Motorola feeds this card into a computer that controls an automatic drafting machine.

When the card comes from the customer it contains only the location of logical 0's and test points on the finished device. Motorola makes and stocks chips containing all logical 1's, which are formed by connecting the emitters of storage-bit transistors and the bases of output transistors with metal links. "As long as the link is there, the data is a 1. By removing the metal link, we insert a 0," says Roger Helmick, product planner at Motorola.

Two weeks. He explains that the fabrication of the memory is conventional up to the point at which the customer's requirements are received. After metalization stores all 1's, the chip is passivated to protect its surface. Then a passivation mask is applied to expose the metal signal-connection pads and simultaneously open 128 slots above the metal bit links. The chip is then stored.

When the customer's data is received, a final mask is prepared and photoresist applied so that only the appropriate links are etched to form 0's. Helmick says that, at most, two weeks will be required after receipt of the customer's data card to complete a device.

Motorola says the memory, called the XC170, will cost less in quantities of 100 than equivalent non-bipolar arrays.

More compact. Read-only memories are particularly attractive for use as decoders in the control sections of computers. Motorola officials believe the XC170 can be made cheaper and more compact than other IC arrays, which are often used to perform the decoder function. Helmick says the 128-bit

format allows a variety of complex functions to be performed.

For example, the XC170 can be a seven-segment lamp decoder driving the incandescent lamps in a display after decoding binary-coded decimal data. It can also be a one-out-of-eight decoder. In this application, says Helmick, binary-coded decimal data is brought into the XC170, which has eight output lines. Words zero through seven might have one of the eight outputs high, and words eight through 15 would have only one output low, forming an inverting-noninverting decoder for a channel selection application in which the user wants to direct data to one of the eight channels.

The XC170 is made up of a 16-by-8 emitter-follower array. Eight transistor-transistor logic amplifier inverter circuits buffer the four-bit address and provide double-rail addressing to 16 word-select gates, which, in turn, perform the one-of-16 selection of the appropriate word in the read-only memory. An additional input gate—a four-input AND—is called the chip-enable gate. It turns the entire array on or off and provides for address expansion or timing signals for the memory array.

One other. The eight-bit output from the emitter-follower array is sensed and buffered by eight output buffers. The bit output from the memory chip comes from the collector of a transistor that is turned on when there is a 1 in the appropriate bit position of the word specified by the input address and the enable gate is true. The device is turned off when 0 appears in the appropriate bit position of the selected word or the enable gate is false.

Helmick says he knows of only one similar device on the market—a 256-bit read-only memory made by Fairchild Semiconductor. However, according to Helmick, Fairchild has to go into the photoem mask to insert data, while all Motorola has to do is remove the metal bit link.

Motorola Semiconductor Products Inc.,
P.O. Box 13408, Phoenix, Ariz. [389]

ultra fast photodiode

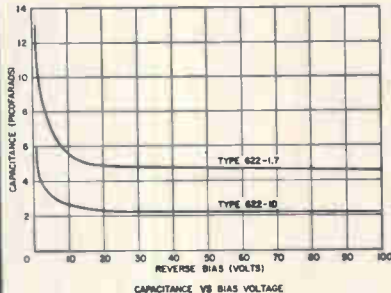

TYPE 622 Photodiode

A totally depleted silicon p-n junction device featuring:

- Rise time, approximately 3 nanoseconds (10-90% points)
- Capacitance, extremely low
2 picofarads (Type 622-1D)
5 picofarads (Type 622-1.7)
- Sensitivity (responsivity), better than 0.5 amp/watt at peak (0.85 microns)
- High detectivity, D^*
- High quantum efficiency between 0.4 and 1.15 microns
- Efficient operation in high optical background
- Surface-protected for long-term stability

Typical Applications

Pulsed laser detection in optical radar, range finding, and target illumination.

A highly versatile tool for work requiring high frequency response.

Sizes	Unit Prices
1 mm dia. (Type 622-1D)	\$60.00
1.7 x 1.7 mm (Type 622-1.7)	\$65.00

For larger size fast rise time detectors inquire about Models 663 and 671.

Packaging

TO-46 header with a flat window; positive and negative leads. Hermetically sealed for ruggedness and reliability.

Other Detector Types from ENL

ENL manufactures a broad range of silicon, germanium indium arsenide, and indium antimonide standard optical detector products. They range in wavelengths from 0.35 to 5.5 microns, and in peak wavelength response from 0.85 to 5.2 microns. From these basic capabilities, ENL offers a sophisticated design resource for custom detectors, including high-resolution arrays and mosaics containing more than 256 elements to the inch.

For Further Information

... about the Type 622 Silicon Photodiode and other optical detectors designed and manufactured by ENL, write to the address below.



ELECTRO-NUCLEAR LABORATORIES, INC.

115 Independence Drive, Menlo Park,
California 94025, Tel. (415) 322-8451



MORE PF'S PER SQUARE WITH
ALSiMAG[®]
CERAMIC
DICED CHIP CAPACITORS

Save valuable space with these unencapsulated chips fabricated from thin sections of AlSiMag ceramic dielectric materials, metallized and diced to capacitance. They are made in sizes as small as .020 x .020. In addition to saving space, you get maximum reliability and service life with these ceramic capacitors. They can be furnished in a wide range of sizes and capacitances to fit specific needs.

AlSiMag diced chip capacitors may be considered under three types:

- 1) **GENERAL PURPOSE** chips are made from Class 2, high dielectric constant dielectrics outlined in Bulletin No. 673, sent on request.
- 2) **TEMPERATURE STABLE** chips are for applications requiring close control of capacitance. They are made from Class 1, temperature compensating dielectrics.
- 3) **BY-PASS AND FILTERING** chips are made from the highest dielectric constant Class 2 dielectrics. They fit requirements of many circuits and also find use where capacitance variation is permissible.

All AlSiMag ceramic capacitors may be supplied with electrodes of silver, palladium-silver (migration resistant), and gold. Physical shapes other than squares are available. Bulletin No. 678 gives complete data on AlSiMag Diced Chip Capacitors.

If you work with capacitors of any type, Bulletin No. 673 is the most inclusive publication available on Dielectric Ceramics for Capacitors. Please use your business letterhead to request either or both bulletins.

American Lava Corporation **3M**
A SUBSIDIARY OF **3M** COMPANY

PHONE 265-3411 (Area 615), CHATTANOOGA, TENN. 37405

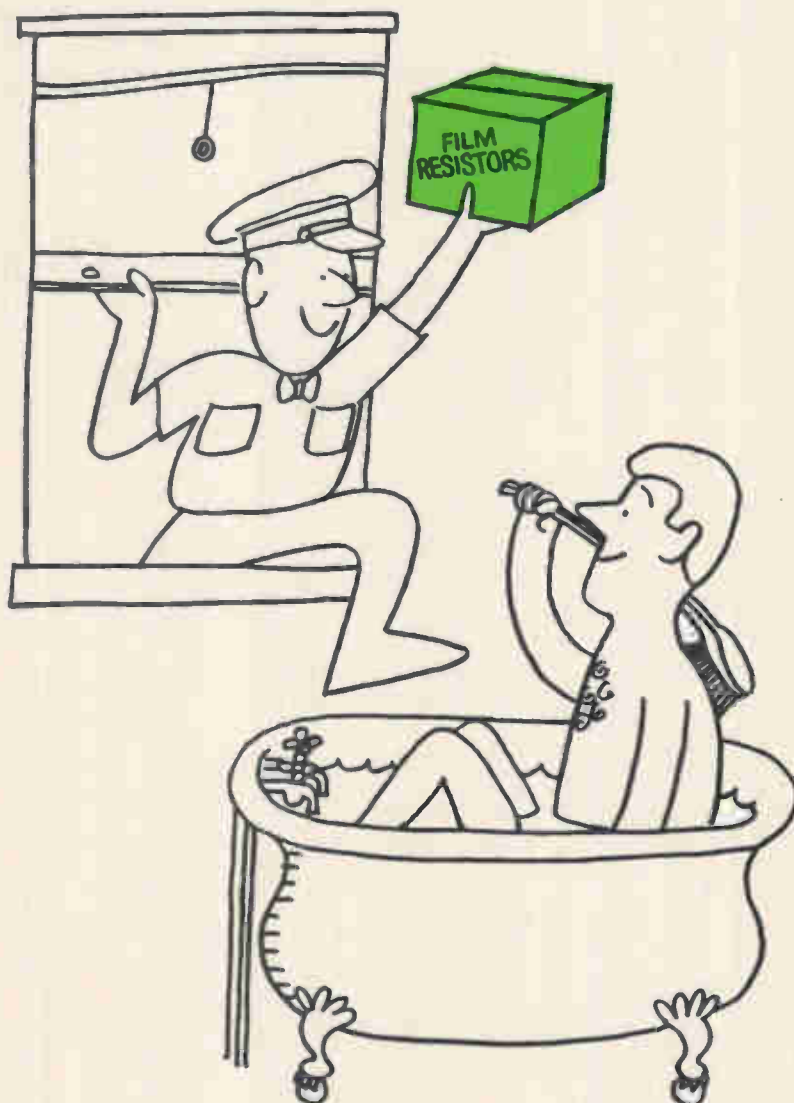

Our films really get to you

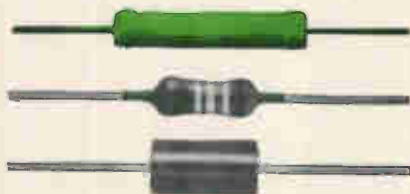

We deliver metal alloy and metal oxide film resistors fast. You get a full range of precision and semi-precision types when you want them. Mallory precision MAF in $\frac{1}{8}W$ and $\frac{1}{4}W$; semi-precision MAL in $\frac{1}{2}W$; metal oxide MOL's in 2W to 7W. Values ranging from 30.1 ohms to 499K. All are 100% inspected. Get prompt delivery from Mallory. For details, write or call Mallory Controls Company.

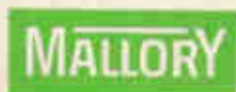

MALLORY CONTROLS COMPANY

a division of F. R. MALLORY & CO. INC.
Box 231, Frankfort, Indiana 46041

New subassemblies

New role planned for loran receiver

Device of standard design could be used as main part of \$100 frequency standard

If your icebergs are disappearing or your oscilloscope needs calibration, a small loran C receiver made by John M. Beukers Laboratories Inc. may help solve your problem. The devices were built for the Weather Bureau for use in tracking balloons, but John Beukers, the company's president, says the receiver could also be used as the main part of a low-cost frequency standard.

Loran C is a high-accuracy hyperbolic navigational system. Four loran C ground stations, scat-

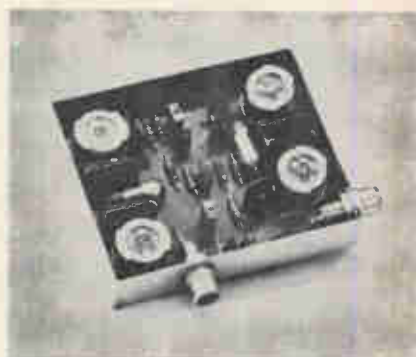

Listener. The receiver picks up the 100-khz signals sent by loran stations.

tered around the Northern Hemisphere, transmit pulses that contain several cycles of a 100-kilohertz signal generated by a cesium-beam standard.

The Weather Bureau has been testing a system in which the loran C signals are used to track its balloons. One of Beukers' receivers is carried aloft and uses loran signals to modulate the signal from the balloon's transmitter. According to Beukers, this loran C system can determine a balloon's relative position to within 5 meters. This kind of accuracy permits calculations not only of the balloon's

Blackstone beats tough cleaning problems.

Alone...



Blackstone VE 6.5

or in a gang.



Blackstone VE Units
in Modular Series

Ucon® SOLVENTS

Never before has so much cleaning flexibility been designed into an ultrasonic system!

Blackstone VE units, available singly with tank capacities of 1.9 and 6.5 gallons, or in modular series with tank capacities of 11.2 and 28 gallons, solve hundreds of cleaning problems, including . . .

- Printed circuit boards.
- Aircraft components.
- Automotive bearings and carburetors.
- Diesel parts.
- Electric motors.

And Blackstone VE units come complete with both ultrasonic and vapor rinse, 300 series stainless steel tanks, 0 to 100% power control (optional), filtering down to 5 microns, solid state automatically tuned generators, and the convenience of up-front service for easy access to the controls.

The Blackstone Challenge

Send us a sample of your work and a description of your cleaning process. If we cannot precision clean it to your complete satisfaction and lower your cleaning costs while doing it, we will not risk your good will by accepting your order.



BLACKSTONE ULTRASONICS, INC.

1400 Howard Street · Sheffield, Pa. 16347

Circle 169 on reader service card



NEW from Cramer



ADJUST-A-LOK STOOLS

Adjust to every worker like fine tools!

Cramer Adjust-A-Lok is immediately adjustable to any workers height. Just release the safety stop, and lift or lower. It can be done just that quick. Since fatigue is a critical factor in efficiency of seated workers, it's just good economics to provide tools that minimize fatigue. With Adjust-A-Lok every worker can find his own most comfortable and efficient level. 6 seat styles and 5 base types provide 30 available models. For more information: write V. P. Sales, Cramer Industries, Inc., 625 Adams, Kansas City, Kansas 66105.

Industrial supplier
inquiries invited



CRAMER INDUSTRIES INC.

A Subsidiary of USM Oil Co.

Cramer—The leader in style and quality



FASTENER KNOW-HOW

Here's complete design and application data on self-tapping TAP-LOK® inserts . . . the quickest, most practical and economical way to put strong threads in soft materials. Get your copy of this helpful 12-page catalog by writing: Groov-Pin Corporation, 1121 Hendricks Causeway, Ridgefield, N.J. 07657, WH-5-6780.

FASTENER DIVISION

GROOV-PIN CORP.

NOW THIS



replaces



**Phototube
+
Amplifier**

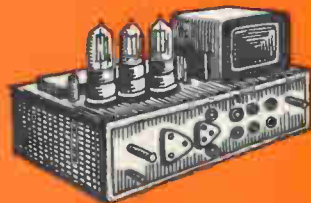

**VACTEC
Photocell
Amplifier
Module
(PAM)**

Consists of a solid state photocell and a high gain operational amplifier. Provides numerous advantages. ■ Higher sensitivity, ten times higher than old fashioned phototubes. ■ Broad spectral response, one cell covers entire visible spectrum. ■ 600V per lumen output (with 1 meg feedback resistor) ■ Direct drive for any recorder or insensitive voltmeter. ■ Vactec Photovoltaic cell operates in its most linear mode into the amplifier (less than 1% to 100 ftc) ■ Available with any size cell down to .250" dia.

PRICE less than \$40.00 each in quantity.

VACTEC, INC.

Specializing in Standard
CdS, CdSe, and Si types;
Custom engineering for
every Photocell need.

2423 Northline Ind. Blvd., Maryland Hts., Mo. 63042
Phone (314) 432-4200

Listed in FCC under "Test Components" and in EEC Sec. 3306.

**... as a frequency standard,
it has 1-in-10⁰ stability ...**

velocity but also of its acceleration.

Animals and buoys. The receiver, made with discrete components, is of standard design. It costs \$65 in small quantities, but making it as a thick-film hybrid could some day bring the price down to less than \$5, Beukers thinks.

If the receiver can help track balloons, there's no reason it can't help track other things, such as migratory animals, icebergs, and buoys.

But using the receiver as a frequency standard may be an even more important application. Beukers says that for less than \$100 an engineer could build a frequency source by combining a loran C receiver, a 6-foot whip antenna, divider circuits, and a phase-lock loop. Such a source would be accurate to one part in 10⁰ and thus adequate for many purposes, such as calibration of counters and of the time bases of oscilloscopes. Commercial frequency standards are more accurate but cost much more.

The receiver will be offered in four models. The ALC, intended for absolute-position telemetry, has a 40-khz bandwidth. The ILC has a 5-khz bandwidth and is for relative-position telemetry.

Omega, too. The OR 10 and OR 13 are for omega stations. Omega is a low-frequency navigational system, similar to loran in concept. The 10 receives 10.2 khz and the 13 picks up 13.6 khz; both have bandwidths of 120 to 150 hertz.

The ALC has a 60-decibel gain, and the others have 70 db. Each model has input and output impedances of 2 kilohms, peak-to-peak output of 4 volts, and a noise level 20 db less than the average atmospheric noise.

They're all the same size, 2¾ x 2¼ x ⅝ inches, and all require an input of 4 milliamps at 6 volts d-c. The loran units weight 110 grams and the omegas 103 grams. The ALC operates from -30° C to +55° C, the others from -75° C to +40° C.

John M. Beukers Laboratories Inc.,
Medford, N.Y. 11763 [390]



No monkey biz when you buy Security Filters from Captor

Captor Corporation is a specialist in the manufacture of communications, security and shielded room filters. Our goal is to satisfy the industry's long-standing needs: the need for a supplier who makes on-time deliveries... whose sales promises are fulfilled... whose products meet all applicable specifications... who gives good overall service. Captor offers one of the industry's most complete line of security filters, including units capable of carrying very large power line loads. Our security filters meet even more rigorous specifications than EMC filters, including DCA and FED-STD-222. If your requirements are unusual or unique, Captor engineers are available to evolve special filter designs. Now that you have an alternative, let Captor bid on your next security filter requirement!

Captor Corporation manufactures miniature filters... communications and security filters... custom-design filters, and other electronic components.

**CAPTOR
CORPORATION**

APPLICATION ENGINEERING DEPT.

5040 Dixie Highway, Tipp City, Ohio 45371

NEW ELECTRO DUAL PURPOSE INVERTER/CHARGER



DELIVERS 620 VA OUTPUT

The new ELECTRO TIC-620 inverter delivers a 620 VA output (120 volts, 5 amp nominal), from a 12 volt battery. It includes a built-in 25 amp charger. Thus the same unit is used to recharge its DC input source.

A three position switch provides low, medium and high charge rates.

An automatic shut-off protects both inverter and battery from damage when battery voltage decreases to 10.5 volts.

Positive reverse polarity protection is provided so no damage will result if positive-negative terminals are reversed.

Short Circuit Protection: Inverter automatically stops working with direct short on output.

TI-620 INVERTER ONLY

A model TI-620, without the built in charger, is also available at a reduced cost. Other specifications are identical to the TIC-620.

SEND FOR
COMPLETE
DATA AND
SPECIFICATIONS



ELECTRO INVERTERS

ELECTRO PRODUCTS LABORATORIES, INC.

6125-Y Howard Street, Chicago, Illinois 60648 • 312/647-8744

Circle 231 on reader service card

DO YOU WANT TO SELL IN THE UNITED KINGDOM AND EUROPE?

LEONARD WADSWORTH & COMPANY LIMITED, the well known U.K. importers and distributors of materials for the electronics industry, have set up a new facility specifically to handle U.S. manufactured components and equipment.

They wish to make contact with American producers who need a lively and technically oriented organization to sell their products in the U.K. and possibly other countries in Europe. Specific suggestions are:

1. Capacitors, preferably for specialized applications.
2. Equipment for manufacture and test of Capacitors.
3. Connectors particularly for printed wiring.
4. Accessories and hardware for integrated circuits.
5. Instruments and control equipment for electro-chemical industry.
6. Wires and cables for very high temperature application.
7. Switches of unique or special design.
8. Other components and equipment of advanced design.

Managing Director of parent Company will visit the U.S. in September to discuss arrangements.

Please contact us at:

Leonard Wadsworth & Co. Ltd.
Broadway House, Broadway
London S.W. 19. England.

Cables: Exwad London. Telephone: 01 542 4258. Telex: 264028.

LOW OHM SPACE TRAVELER

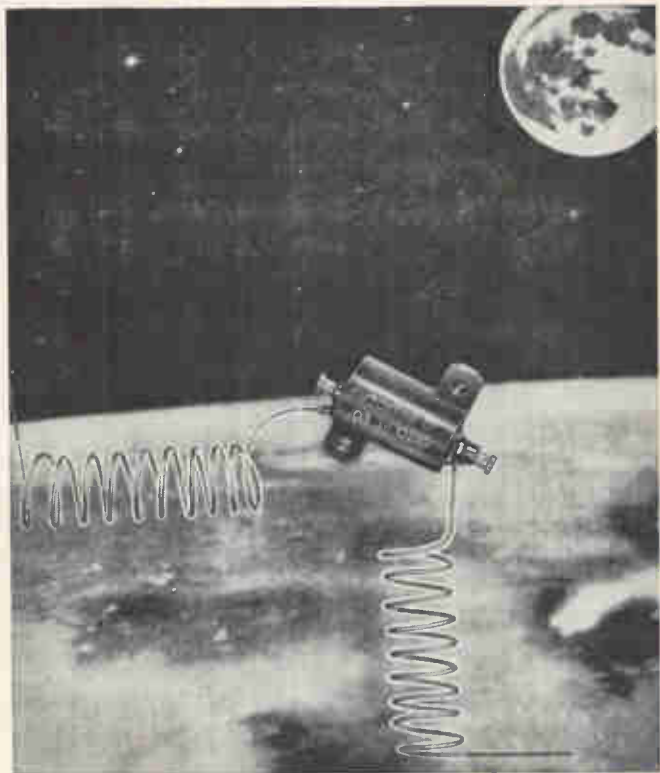

Resistor shown actual size

THIS SAGE RESISTOR

will travel 238,840 miles to play a leading role in one of the most dramatic events in world history.

The role is one vital to the successful operation of the EMU Portable Life Support System that will be carried by the first U.S. Astronauts to be landed on the moon.

The Hamilton Standard Division of United Aircraft Corporation has awarded SAGE a development contract for designing and producing current-sensing resistors based on the ultimate requirements in respect to:

RELIABILITY: Four terminal design... Multiple elements for redundancy... 3 watt dissipation in hard vacuum... Precious metal current terminals.

STABILITY: .03 ohms $\pm 1\%$ over complete temperature range of 0° F. to 160° F. and 0 through 10 ampere load.

This is another example of the role that SAGE is playing in custom-designing for highly sophisticated space electronics.

P.S. We design for down-to-earth applications also. Why not consult us regarding your resistor requirements?



SAGE

SAGE ELECTRONICS CORP.

Subsidiary of Gulton Industries, Inc.

BOX 3926 ROCHESTER, N. Y. 14610

Phone: (716) 586-8010



A Conference of Firsts in the Field of Telemetry

Technical Conference and Exhibit

New ideas and latest equipment in the fields of aerospace, industrial military, earth sciences, and life sciences.

Plan to attend
October 8, 9, 10, 1968
Hotel Ambassador Los Angeles



Circle 235 on reader service card

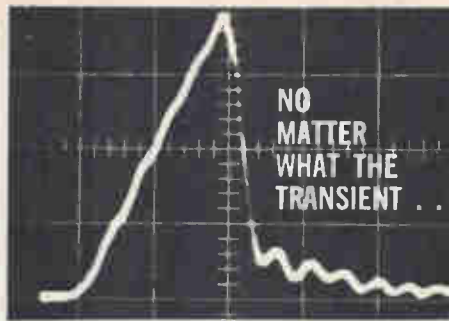

JOSLYN STOPS IT!

Joslyn Precision Spark Gaps act fast operate precisely at voltage breakdown specified every time no matter how long between transients will last virtually for the life of your product arresting capability spans wide current and voltage range complete protection . . . from stock or custom design. Just one of many surge arrester lines.

Write or call today for full information on these and other electronic surge protectors.



Division of Joslyn Mfg. and Supply Co.
SANTA BARBARA RESEARCH PARK
P.O. BOX 817 • GOLETA, CALIFORNIA 93017
TELEPHONE (805) 968-3551 ⁴⁴
Circle 236 on reader service card

New Books

Behind the times

Radiation Effects
W.F. Sheely, editor
Gordon & Breach
848 pp., \$52

This is one of the few records of symposium proceedings that has been skillfully arranged by an editor. The book, devoted to the study of radiation effects on materials used in the cores of nuclear reactors, includes the work of 43 authors, who cover five major areas of interest. The volume is based on a symposium sponsored by the nuclear metallurgy committee of the American Institute of Mining, Metallurgical and Petroleum Engineers.

Unfortunately, the work described was performed more than three years ago and can hardly be considered representative of the current state of the art. Although one can hardly dispute the facts presented, some of the interpretations were obviously made when understanding of radiation effects wasn't as advanced as it is today.

This collection covers the studies made in an attempt to solve the major problems that plague engineers who design reactors—for example, the difficulty of constructing reactor cores that can withstand high temperatures and the extremely high radiation doses encountered over even short operating periods.

The final three sections of the book, reporting on work done to determine the causes of core damage, are loaded with photomicrographs, tables, and charts of data. General topics in these sections are microstructural effects, swelling and fission gas release, and mechanical properties.

The first two sections deal with the more academic aspects of radiation damage, presenting the analytical and experimental work on atomic and solid state processes.

This book will be most useful to designers of nuclear reactors, but it should also help researchers in solid state physics. Nonspecialists probably won't have an overwhelming desire to own the book.

Joseph T. Finnell Jr.

Avco Corp.
Wilmington, Mass.

Improve your system reliability by installing GE photoelectric tape readers



PTR60 (Shown Above) and 70 Series:
—reliable, compact, "through the tape" Readers of field-proven design.
—choice of reading speeds up to 500 characters per second.

PTR80 (Shown Below) and 90 Series:
high performance readers designed for speeds up to 1000 characters per second. reflected light reading technique eliminates problems of variation in tape opacity and permits reading of both punched and printed tapes.



Install them and forget them. GE photoelectric tape readers give lasting service with minimum maintenance. Features include:

- no electrical adjustments
- unidirectional or bidirectional operation

- simple, complete controls
- all solid state components
- tape handlers available for entire reader line

Numerous options are offered to meet your special requirements. Mail today for full details. 837-04A

Mail to Mr. R. S. Holmes, Printer-Reader Business Section, General Electric Co., 511 North Broad St., Philadelphia, Pa. 19123

NAME _____
ADDRESS _____
COMPANY _____
CITY _____ STATE _____ ZIP _____

GENERAL  ELECTRIC

 Information Systems

Printer-Reader Business Section

New subassemblies

Energy delivered by the spoonful

Converter gives same charge every 100 microseconds to laser-firing capacitors

Aerospace and military systems have been getting a charge out of Wilmore Electronics Co. for some time. Now industrial systems can take their turn.

The company makes a d-c converter that charges the storage capacitors used with lasers, plasma thrusters, and other pulse-loaded systems.

Down to earth. Noting the increasing use of lasers in industry, Wilmore has started making commercial versions of its converter. These devices operate at inputs from 18 to 32 volts d-c. They charge capacitors rated at 0.1 microfarad and up, to voltages as high as 1,500 volts. The rate at which the converter feeds energy to the load is constant, and may be specified as 2, 20, 45, 100, 150, or 300 joules per second.

Instead of supplying a continuous charging current, Wilmore's converter dumps 10,000 pulses a second into the load. Every pulse contains the same amount of energy, determined by the charging rate, regardless of the size of the voltage across the capacitor.

In operation, the converter takes the input energy and stores it in the core of a multiwinding inductor. When the stored energy reaches a certain level, the input is disconnected and the energy flows into the capacitor.

A switching circuit joins the input to the primary, and disconnects the input when core energy reaches a pre-set level.

Never during the 100-microsecond operating cycle are the input and load magnetically coupled, so the input is protected against capacitor-charge transients.

Optional features include adjustable and multiple outputs.

Wilmore Electronics Co., Box 2973, Durham, N.C. 27705 [391]

We've got good connections in high places



Surveyor, Mariner, F-111, OGO, X-15, Apollo, LEM, and most other high flying programs rely on Cinch-Graphik printed circuitry for dependable electronic interconnections. The lunar surface, or 6000 miles above Mars, isn't the place to find out that circuitry doesn't perform to specs. That's why Cinch-Graphik maintains complete in-house facilities for NASA and MIL Spec testing. Cinch-Graphik's unequalled competence in producing single and multilayer printed circuits to these stringent requirements uniquely qualifies them to produce circuits for applications where "it has to be right."

CINCH-GRAFIK

D I V I S I O N O F U N I T E D - C A R R



200 South Turnbull Canyon Road, City of Industry (Los Angeles), Calif. 91744 • Phone (213) ED 3-1201. Sales offices in 33 principal cities throughout the United States, Great Britain, Canada, Australia and West Germany.

CONSISTING OF CINCH MANUFACTURING COMPANY, CINCH-GRAFIK, CINCH-MONADNOCK, CINCH-NULINE, UCINITE (ELECTRONICS) AND PLAXIAL CABLE DEPT.

Noise in the tunnel

Tunnel diode amplifiers as components in wide dynamic range systems

Art Leber and Herman Okean
Airborne Instruments Laboratory
Cutler-Hammer Inc.
Deer Park, N.Y.

Tunnel diode amplifiers are used primarily in the front-end assembly of microwave receivers, where they offer a relatively inexpensive approach to low-noise amplification. These amplifiers have been developed for narrowband, wideband, and octave bandwidth applications in the frequency range from 1 to 20 gigahertz. In addition, either single-stage or cascaded multiple-stage amplifiers can be constructed to obtain power gains ranging from 8 to 40 decibels or more.

Three diode materials are commercially available: gallium antimonide (GaSb), germanium (Ge), and gallium arsenide (GaAs).

The dynamic range capabilities

of microwave receivers with tunnel diode amplifiers are usually limited by saturation effects at high signal levels and by noise and bandwidth considerations at low signal levels. In addition, receiver performance can often be hurt by the presence of spurious (intermodulation and harmonic) signals generated by the tunnel diode, other nonlinear receiver components, or both.

The tunnel diode, a two-terminal semiconductor p-n junction device, exhibits a voltage-controlled incremental negative junction conductance over a significant range of its static current-voltage characteristic. When it's biased into its active region and embedded in a suitable external circuit, the diode can act as a linear power amplifier for small radio-frequency or microwave signals superimposed on the d-c bias voltage.

The key tunnel diode parameters, such as gain and noise constant de-

pend mostly on the material and its maximum negative conductance magnitude, G_M . Representative values of these parameters, calculated under typical conditions, show that:

- The potential amplifier bandwidth is essentially independent of diode material and impedance level.

- The noise figure depends chiefly on the material; GaSb diodes can have the lowest noise figure, followed by Ge and GaAs diodes in increasing 1-db steps.

- The amplifier's signal-handling capability, characterized by the gain saturation level, is primarily a function of the material and G_M .

At a constant value of G_M , GaAs diodes provide the highest gain saturation level, followed by Ge and GaSb diodes in decreasing 4-db steps. For a given diode material, the gain saturation level increases directly with increasing G_M .

In theory, an array of diodes can handle more power than one. The

CERMET TRIMMERS



Series 340 Top Adjust 1/4" x 1/4" x .220"
Cermet Trimmer

NEW FROM CTS

\$1.25 ea. in 1,000 lots down to
93c ea. in 50,000 lots.

50 Ω through 500K Ω .

$\pm 20\%$ tolerance.

3/4 watt @ 25°C; 1/2 watt @ 85°C, derated to no load @ 150°C.

Single turn.

Prototype Quantities From Stock.
Production Quantities: 4-6 weeks.

Order from: CTS of Berne, Inc., Berne, Indiana 46711.
(219) 589-3111.



CTS CORPORATION

Founded 1896



Series 360 Side Adjust 7/16" x 17/64" x 25/64"
Snap-in Type Cermet Trimmer

NEW FROM CTS

\$1.04 ea. in 1,000 lots down to
80c ea. in 50,000 lots.

50 Ω through 1 megohm.

$\pm 20\%$ tolerance.

1 watt @ 25°C; 1/2 watt @ 85°C, derated to no load @ 125°C.

Single turn.

Prototype Quantities From Stock.
Production Quantities: 4-6 weeks.

Order from: CTS of Berne, Inc., Berne, Indiana 46711.
(219) 589-3111.



CTS CORPORATION

Founded 1896

push-pull configuration is simplest; two identical diodes, connected in parallel, are biased with opposite polarities to produce a current-voltage characteristic with a wider bias range of linear behavior than a single diode. The maximum improvement over a single diode in gain saturation level is 6 decibels.

Another possible configuration is an $M \times M$ series-parallel array of identical tunnel diodes. This type of array has M^2 times the power-handling capability of the single-diode amplifier.

Presented at 1968 Western Electronic Show and Convention, Los Angeles, Aug. 20-23.

Cool news

Advance in superconducting electronic devices
Juri Matisoo
IBM Watson Research Center
Yorktown Heights, N.Y.

Superconductivity in a metal is an electronic state existing only at very low temperatures. (All known superconductors have transition temperatures below 20°K .) The state is characterized by infinite conduc-

tivity and by complete magnetic field exclusion, provided the temperature, current density, applied magnetic field, and frequency of any incident electromagnetic radiation lie below their respective critical values.

In the past, applications of superconductivity have all been based on infinite conductivity, or $B = 0$, or on the change in properties that occurs on transition from the superconducting to the normal state. For example, transformers, motors, and generators can be made with superconducting windings to minimize loss.

Unless a superconducting device is unique or offers a clear performance advantage, it cannot compete with room-temperature devices. Thus, only superconducting magnets are now in commercial use, and only the superconducting linear accelerator is in an advanced stage of development.

Recent developments in superconducting electronic devices have resulted from the discovery of tunneling between superconductors, both normal electron tunneling and

pair tunneling, or Josephson effect. Pair tunneling has been a particularly fruitful source of unique and high-performance devices for the electronics industry.

Devices that can be built on the basis of normal electron tunneling between superconductors include amplifiers and oscillators, mixers and detectors, quantum detectors of microwave and submillimeter wave radiation, as well as microwave phonon generators and detectors.

Electronic devices based on the tunneling of electron pairs and the modification of correlations among electrons in a superconductor include: gaussmeters with ultimate sensitivities of 10^{-9}g ; a galvanometer with a sensitivity of 10^{-15} volt (with a one-second time constant); a computer logic and memory element, the tunneling cryotron, which has a switching time appreciably less than 10^{-9} second, and a source of microwave and infrared radiation with an output power of approximately 10^{-11} watt.

Presented at 1968 Western Electronic Show and Convention, Los Angeles, Aug. 20-23.

CERMET TRIMMERS



Series 165-3/8" x 3/8" x 13/64" Cermet Trimmer

NEW FROM CTS

\$3.25 ea. in 1,000 lots down to
\$2.56 ea. in 50,000 lots.

50 Ω through 1 megohm.

$\pm 20\%$ tolerance.

1/2 watt @ 85°C derated to no load @ 150°C .

25 turns.

Prototype Quantities From Stock.
Production Quantities: 4-6 weeks.

Order from: CTS of Berne, Inc., Berne, Indiana 46711.
(219) 589-3111.



CTS CORPORATION
Founded 1896



Series 190-3/4" x .160" x .310" Cermet Trimmer

NEW FROM CTS

\$1.24 ea. in 1,000 lots down to
98c ea. in 50,000 lots.

50 Ω through 500K Ω .

$\pm 20\%$ tolerance.

1/2 watt @ 85°C derated to no load @ 125°C .

20 turns.

Prototype Quantities From Stock.
Production Quantities: 4-6 weeks.

Order from: CTS of Berne, Inc., Berne, Indiana 46711.
(219) 589-3111.



CTS CORPORATION
Founded 1896

**WHY SETTLE FOR LESS?
GET TOP
PERFORMANCE
WITH
DELTA'S FABULOUS
MARK® TEN**

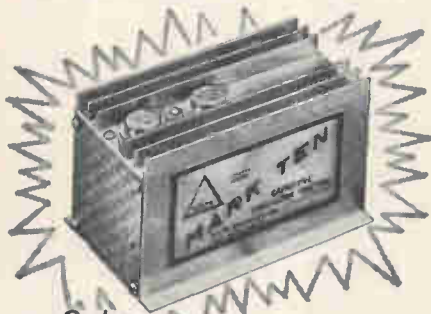

Only
\$44.95 CAPACITIVE
ppd. DISCHARGE

Deltakit - Only
\$29.95 ppd.

IGNITION SYSTEM

You read about the Mark Ten in the April issue of Popular Mechanics!

Now discover why even Detroit has finally come around. In 4 years of proven performance and reliability, the Mark Ten has set new records of ignition benefits. No wiring. And works on literally any type of gasoline engine. Buy the original, the genuine, the real McCoy — Mark Ten. From Delta. The true electronic solution to a major problem of engine operation.

READY FOR THESE BENEFITS?

- ▲ Dramatic Increase in Performance and in Fast Acceleration
- ▲ Promotes more Complete Combustion
- ▲ Points and Plugs last 3 to 10 Times Longer
- ▲ Up to 20% Mileage Increase (saves gas)

LITERATURE SENT BY RETURN MAIL
BETTER YET — ORDER TODAY!

DP 7-6

DELTA PRODUCTS, INC.

P.O. Box 1147 E • Grand Junction, Colo. 81501

Enclosed is \$_____. Ship prepaid.
Please send: Ship C.O.D.

Mark Tens (Delta Kit) @ \$29.95
(12 Volt Positive or Negative Ground Only)

Mark Tens (Assembled) @ \$44.95

6 Volt: Negative Ground only.
 12 Volt: Specify Positive Ground
 Negative Ground

Car Year _____ Make _____

Name _____

Address _____

City/State _____ Zip _____

New Literature

Multichannel analyzer. Hewlett-Packard Co., 1501 Page Mill Road, Palo Alto, Calif. 94304. A 12-page technical information note covers electronic applications for the model 5400A multichannel analyzer, an instrument used primarily for nuclear spectrometry. Circle 446 on reader service card.

Instrumentation. Monsanto Co., 620 Passaic Ave., West Caldwell, N.J. 07006, has released a condensed catalog of its "fourth generation" electronic instrumentation. [447]

Resistor networks. Halex Inc., 3500 W. Torrance Blvd., Torrance, Calif. 90509, offers a brochure on microminiature thin-film resistor networks. [448]

Industrial control timers. Clare-Electro-seal Corp., 946 North Ave., Des Plaines, Ill. 60016. Bulletin 1151 describes a line of low-cost industrial control timers. [449]

Cathode-ray tubes. Westinghouse Electric Corp., P.O. Box 284, Elmira, N.Y. 14902. A 16-page quick reference guide describes over 100 different cathode-ray tubes for industrial and military display applications. [450]

Counters and accumulators. Burroughs Corp., Box 1226, Plainfield, N.J. 07061. Bulletin 1115 gives detailed engineering information on a line of bidirectional counters and decimal accumulators. [451]

High-speed data set. Sangamo Electric Co., Springfield, Ill. 62705. A four-page bulletin describes the Transidata T201B, which transmits and receives data over voice bandwidth, leased or private lines at a fixed rate of 2,400 bits per second. [452]

Microwave frequency measurement. Micro-Now Instrument Co., 6124 N. Pulaski Road, Chicago 60646. A two-page application note discusses a technique by which very-high-accuracy measurements at microwave frequencies may be made, with only a nominal investment in equipment. [453]

Transducer instrumentation systems. B&F Instruments Inc., Cornwells Heights, Pa. 19020. Technical bulletin G-1 covers a line of products for signal conditioning and data acquisition systems. [454]

Frequency response tester. B&K Instruments Inc., 15111 W. 164th St., Cleveland 44142. Frequency-response test unit model 4409, for tape recorders and phonographs, is described in a specifications bulletin. [455]

D-c power supplies. Tung-Sol Division, Wagner Electric Corp., 630 W. Mount

Pleasant Ave., Livingston, N.J. 07039, offers data sheets on power supplies with 200- and 400-amp, 28-v d-c outputs. [456]

Encapsulation machine. Hull Corp., Hatboro, Pa. 19040. Bulletin B-181 describes the model 359-D combination transfer and compression semiautomatic molding and encapsulating machine. [457]

Microwave sweeper. Kruse-Storke Electronics, 790 Hemmeter Lane, Mountain View, Calif. 94040, has available a six-page brochure describing the model 5000 microwave sweep generator. [458]

Pressure switch. Consolidated Controls Corp., Bethel, Conn. 06801. A data sheet describes the type 6607A field-adjustable pressure switch. [459]

Tape cartridge machines. Tapecaster TCM, 12326 Wilkins Ave., Rockville, Md. 20851. A four-page brochure covers the series 700 tape cartridge machines. [460]

Heat-sink designer's kits. Astrodyne, Inc., 207 Cambridge St., Burlington, Mass. 01803. Three heat-sink designer's kits for high, medium and low power applications are described in a new bulletin. [461]

Color videotape recorder. Ampex Corp., 2201 Lunt Ave., Elk Grove Village, Ill. 60007. Brochure V67-14 describes specifications and uses of the VR-7800 solid state, portable, closed-circuit color videotape recorder. [462]

Miniature reed relays. Compac Engineering Inc., 810 East St., Hollister, Calif. 95023. Descriptive booklet Form 10-568 covers the half crystal-can size reed relay series 10. [463]

Instrument computers. Fabri-Tek Instruments Inc., 5225 Verona Rd. Madison, Wis. 53711, announces a 28-page brochure describing its 1060 series instrument computers and their associated plug-in modules. [464]

Pressure transducers. Consolidated Controls Corp., Bethel, Conn. 06801, has published a data sheet describing type 41SG3 strain-gage pressure transducers with pressure ranges to 10,000 psi and output up to 500 millivolts. [465]

Multilayer standards. National Technology Inc., 220 W. Central Ave., Santa Ana, Calif. 92707, offers a bulletin containing a complete summary of standards and criteria followed in the fabrication of its precision multilayer p-c boards. [466]

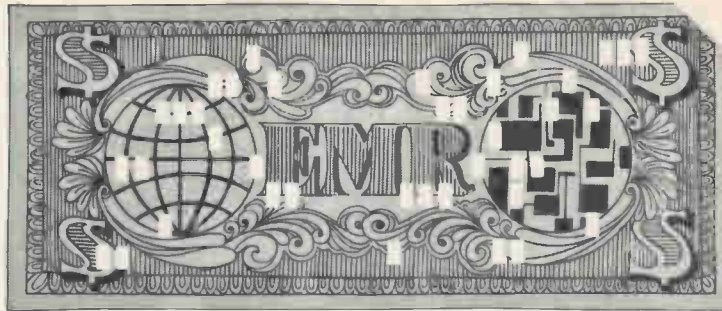

The cost of all this to you? Absolutely nothing. No fees or charges at any time.

Other advantages of EMR:

- Your resume is sent only to those companies that have a genuine requirement for your particular skills.
 - There is no general "broadcasting" in the hope "someone will be interested."
 - Your identity is protected because your name is released only according to your prior instructions. Your name can be deleted on request.
 - EMR's service is nationwide. You may be considered for job opportunities anywhere in the U.S.
- The Electronics Manpower Register is a powerful tool and should be considered when you are seriously seek-

ing a new position. And, although you may be reasonably happy in your present position, chances are that you might have that ideal job in mind.

This is why EMR makes good sense for you. If that job does turn up, you'll be there.

To get your name in the EMR file, just fill out the resume form and return to:

Electronics Manpower Register
330 West 42nd Street
New York, N. Y. 10036

Please enclose a copy of your resume if you have one. A detailed brochure further describing EMR will be sent to you.

Electronics Manpower Register

A computerized employment opportunity service

CONTINUED FROM OTHER SIDE				
Previous Position	Employer	City/State	From	To
Duties and accomplishments				
Previous Position	Employer	City/State	From	To
Duties and accomplishments				
GENERAL INFORMATION (Summarize your over-all qualifications and experience in your field. List any pertinent information not included above.)				
Current annual base salary	Total years of experience	Date available	U.S. Citizen <input type="checkbox"/>	Non U.S. Citizen <input type="checkbox"/>
My identity may be released to: Any employer <input type="checkbox"/>	All but my present employer	Have you security clearance?	Yes <input type="checkbox"/> No <input type="checkbox"/>	If yes, What level
Mail (with a copy of your resume, if you have one) to:				
Electronics Manpower Register 330 West 42nd Street, New York, N. Y. 10036			NO FEES OR CHARGES	
				EMR-2

In electronics it's Electronics magazine to sell used equipment!

Your advertisement will produce Results in Electronics. Engineers turn to Electronics magazine for the latest technical developments — and for the latest buying information. You can reach them inexpensively in Electronics Searchlight Section.

For information:
Searchlight Section
Classified Advertising Dept.
Post Office Box 12
New York 10036



EMPLOYMENT OPPORTUNITIES

CHIEF ELECTRICAL ENGINEER

A Non-defense Firm

If you are particularly interested in working with problems that challenge technical ingenuity in the design of electrical circuits and enjoy assignments which require self-sustained motivation, then our design projects will fulfill your needs. We prefer a person with a degree in Electrical Engineering or Physics with 10-20 years experience in circuit design, servo-mechanisms and a comprehensive state-of-the-art knowledge of digital techniques and solid state technology.

Our company is a leader in the planetarium field and has expanded into other areas of the educational market. We offer an interesting and rewarding, long term career for the right person.

Superior fringe benefits. Moving soon to a new plant in Chadds Ford, Pennsylvania—suburban Philadelphia.

Send resume to:

Engineering Manager

SPITZ LABORATORIES, INC.

A Division of McGraw-Hill

Yorklyn, Delaware 19736

An Equal Opportunity Employer

CIRCLE 966 ON READER SERVICE CARD

WHEN

Answering Advertisements

PLEASE do not send original letters, certificates or photographs. We cannot be responsible for their return. Please send photostat or carbon copies.

• EMPLOYMENT SERVICES

Florida/Nationwide EE's ME's IE's needed Electronics fields. Aerospace, Industrial Manufacturing. \$9—18,000. Tech. Div., Brodeur Personnel Service Inc., 3947 Blvd. Center Dr., Jacksonville, Fla. 32207.

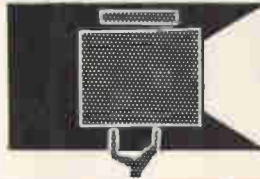

SEARCHLIGHT SECTION

- CLASSIFIED ADVERTISING • BUSINESS OPPORTUNITIES
- USED OR SURPLUS EQUIPMENT

New VACUUM PENCIL

for picking up miniature

\$7.50 ea

Selected Distributorships available.

PHILIP FISMAN COMPANY
7 CAMERON ST., WELLESLEY, MASSACHUSETTS

CIRCLE 967 ON READER SERVICE CARD

RADAR SYSTEMS GROUND AND AIRBORNE. AUTOMATIC TRACKING ANTENNA SYSTEMS. NIKE AJAX. NIKE MERCULES M-33. MSQ-1A. MPS-19. MPS-9. SCR 584. TPS-1D. TPS-2B. FAA-ASR-2. AIRBORNE SYSTEMS. APN-84. APN-102. APS-23. APS-27. APS-45. DPN-19. DIGITAL COMPUTERS. IBM 650. IBM 704.

LARGEST INVENTORY OF RADAR AND MICROWAVE EQUIPMENT IN THE WORLD.
RADIO RESEARCH INSTRUMENT CO.
45 WEST 45TH ST. N. Y. 10036 212-JU 6-4691

CIRCLE 968 ON READER SERVICE CARD

Mr. Used Equipment Dealer:

When you advertise in the Searchlight Section . . . You have hired your most persuasive salesman:

He's efficient . . . He thrives on long hours . . . His territory is the entire nation . . . and overseas . . . He doesn't see buyers of used and new surplus equipment: They see him—regularly. They depend on him.

He is Searchlight—The section of this publication where wise dealers advertise and list their stocks for sale.

SEARCHLIGHT SECTION

Classified Advertising Dept.

Post Office Box 12 • New York, N. Y. 10036

NOW HEAR THIS!

Glass-Amp*, the most widely used hermetic silicon rectifier in the history of the industry, now meets MIL-S-19500/365.

The benefits of the experience gained in producing over 100 million Glass-Amp rectifiers are now available to the producers of military equipments.



Write for complete information. (In Europe write: General Instrument Europe, Via Turati 28, Milano, Italy)

GENERAL INSTRUMENT CORPORATION • 600 WEST JOHN STREET, HICKSVILLE, L. I., NEW YORK

180 Circle 180 on reader service card

Electronics | August 19, 1968

Newsletter from Abroad

August 19, 1968

UK computer giant plans giant computer

International Computers Ltd. will have one of the world's largest computers for its top-of-the-line model.

The company has set a 1972 first-delivery date for its 1908A machine, which will be about one-and-a-half times more powerful than the largest standard model now offered by IBM, the 360/85.

The 1908A is a follow-on of the 1906A third-generation computer announced last fall by International Computers & Tabulators, one of the firms that joined forces to form ICL. The simplest version of the big ICL machine will sell for about \$3.5 million.

Apart from sheer size—the 1908A will have four times the capacity of its predecessor—the major difference between the two will be in the memory. Instead of a conventional core memory, the giant will have a thin-film main store with a cycle time of about 350 nanoseconds. It will be arranged in blocks of 128,000 words of 25 bits to get a total addressable store of 4 million words. ICL has yet to decide whether to use a plated-wire memory under development at the Plessey Co., one of its shareholders, or a conventional film-on-substrate layout in the works at Fabrikon Inc., a Minneapolis memory maker.

Emitter-coupled-logic packages for the big computer will be upgraded versions of the ICT-Motorola design devised for the 1906A [Electronics, Oct. 30, 1967, p. 170]. Shorter lead lengths, particularly, will cut the switching time for 1908A packages to less than 2 nanoseconds from 3 to 4 nanoseconds for 1906A versions.

Czechs and Soviets sign computer pact

Despite their political squabbles, the Czechs and the Russians look like eventual partners in data processing. Sources in Prague say the two governments agreed in late spring to cooperate in computer research and production.

Under the agreement, jointly designed computers would be produced in both Russia and Czechoslovakia starting in 1970. Other members of the East European bloc, presumably, could join the effort.

U.S. firm calls tune on HARP's future

It now looks as if a U.S. aerospace company—probably the Lockheed Aircraft Corp.—will end up in control of the Canadian-U.S. high-altitude research program (HARP) that originated at McGill University in Montreal.

HARP, which aims at slashing the cost of getting small payloads into space by shooting them into orbit with a naval gun, was weeded out of the 1968 Canadian space budget but limped along with private backing after its headquarters were shifted to the U.S. [Electronics, Sept. 4, 1967, p. 202].

This spring, a nonprofit Space Research Institute was set up to handle HARP, and it has since picked up some \$2 million in research contracts, largely from U.S. agencies.

The institute expects to wind up with from \$5 million to \$10 million in contracts before the year is out and there's a move afoot by a Canadian investment group to turn the organization into a commercial research operation. The group—the Bronfman family, which controls Seagrams Distillers—recently poured \$650,000 into the institute under a five-year

Newsletter from Abroad

loan. Because many of the U.S. contracts are classified, though, the Bronfman group expects to wind up as a minority shareholder in partnership with a U.S. aerospace firm.

Boost expected in French budget for communications

Much stronger markets for telecommunications hardware, process control equipment, and audio-visual aids seem likely for France as part of the aftermath of the country's early-summer rumpus.

To help pay for the wage increases won after the rash of strikes, the de Gaulle government will stretch out its space and arms programs. This is bad news for defense electronics companies, but next year's budget for the Ministry of Posts and Telecommunications, insiders predict, will call for more hardware than ever before.

Largely because substantial new government orders seem in the offing for them next year, two of the major telecommunications-equipment producers have been standouts recently on the generally lackluster Paris Bourse. They are Le Materiel Telephonique, an ITT subsidiary, and the Compagnie Industrielle des Telecommunications, an affiliate of the Compagnie Generale d'Electricite.

A spurt in hardware buying by the Ministry of Education also seems certain. Along with a restructuring of higher education, students at the Sorbonne—where the May-June troubles first erupted—and other universities are clamoring for more instructors and up-to-date teaching aids.

Jamaica to get satellite link

Britain's Cable & Wireless Ltd. will start looking next month in Jamaica for a place to set up a \$5 million communications satellite ground station, the first in store for the Caribbean.

The government-owned but commercially run communications carrier expects to have the station operating with Atlantic satellites, most likely Intelsat 3, by 1970. Cable & Wireless executives expect Jamaican traffic by then to be so heavy that there'll be no spare capacity for neighboring islands. If necessary, they say, Cable & Wireless may build other ground stations in the Caribbean.

The Marconi Co. already has the contracts for three Cable & Wireless ground stations and thus has the inside track for this fourth one.

Bonn consolidates aerospace research

The Kiesinger government's long drive to bolster West Germany's aerospace industry will now be backed up by a central research establishment. Three of the government's research organizations—in Goettingen, Brunswick, and Porz—have become a strong single facility with a staff of 2,500.

The new organization, the Federal Research and Experimental Institute for Aeronautical and Space Technology, will start out with an annual budget of \$23 million. A rise to \$25 million is on tap for 1969, according to Science Minister Gerhard Stoltenberg.

All the major advanced aerospace projects under way in Germany will be handled by the new establishment. They include the third stage of the Europa rocket, the Franco-German Symphonie communications satellite, and the German-American sun probe.

Addendum

The Philips Broadcast Equipment Corp., a subsidiary of Philips' Gloeilampenfabrieken, has acquired the rights to manufacture and market CBS Laboratories' backpack color tv camera [see story p. 74].



Just ask. Physician requests data on patient . . .

Sweden

Close watch

Even in a hospital's intensive-care ward, a patient's condition can deteriorate unnoticed until the slump is irreversible.

At least this state of affairs can be cured, though. Stockholm's Karolinska Hospital and Standard Radio & Telefon AB, Swedish subsidiary of the International Telephone and Telegraph Corp., have come up with a computer-controlled system that not only keeps a constant watch on intensive-care patients, but serves up data on such things as respiration and blood circulation instantly in graphic or numeric form or both. The hospital staff says the information is presented in exactly the form needed, and claims that the system saves time and reduces paperwork.

Fallout. The equipment is a by-product of Sweden's Stril-60 air-defense system. SRT engineers note that there are basic similarities be-

tween computing flight paths and displaying them on the one hand, and storing large amounts of medical data and displaying it on the other. The SRT Censor 908 com-

puter used in the medical system is very similar to the one installed for Stril-60.

There are three subsystems in the hospital setup—the Grafoskop, a desk-top cathode-ray display unit with a keyboard; the Interzet, a modulator-demodulator; and the control computer, with a multiaccess memory unit.

The Grafoskop is controlled by the Censor over a high-speed multiplexed channel. Data is stored in the computer's core memory, where it's scanned by a generator feeding the display unit. The Censor's memory includes the core for programs and input-output data and a channel system that permits parallel access by the processor and terminals on a priority basis. The central processor includes an arithmetic and control unit and a channel selector.

The memory itself is a ferrite core unit with a capacity of 12,000 40-bit words, but plans now call for a disk memory with a capacity

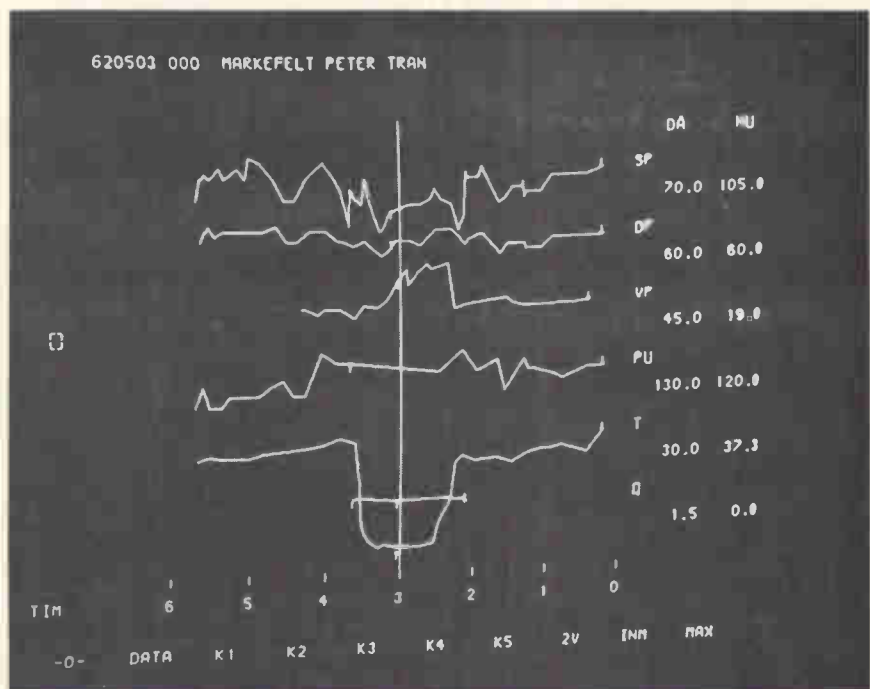

. . . and gets this graphic display showing condition over six hours.

of 2 million bytes—the equivalent of 500,000 40-bit words on a ferrite core.

Capacity. Each patient admitted to the hospital's intensive-care ward is placed under the system's surveillance. Currently, the equipment can monitor 28 variables in the condition of seven patients.

Since tests began last November, the equipment has monitored 150 patients. When expanded, the system will cover 2,000 a year and the number of variables checked will be increased to 127.

The display indicates basic condition, summary diagnosis, recent developments, plus any of four other kinds of information: circulation, fluid balance, laboratory variables, or blood-gas variables. This data is presented in the form of curves, with the two most recent readings expressed numerically. The time scale can be varied from a minute to a year.

The expanded system will cost the Stockholm hospital \$8,000 a month in rentals.

Instant weather

Not only has Sweden's Stril-60 air-defense system proved to be a boon to the medical profession there, but the Swedish Air Force itself now can get real-time weather maps from a system using basically the same hardware.

Previously, the Air Force's need for constantly updated maps meant artists on duty around the clock drawing and redrawing charts after each new report. Now, the maps can be produced in minutes by one man at a console as soon as data is received.

It goes in here. Weather information from all over Europe is sent to the weather center by teleprinter. It's then fed into a Marconi Myriad computer that predicts probable weather changes. Those predictions are converted by a Censor 908 computer (made by Standard Radio & Telefon AB) into graphic form for display as a series of maps showing various parts of the continent.

An operator at a keyboard retrieves different maps or combinations of maps. He can indicate with

a light pencil the exact areas of particular maps he wants reproduced in his finished drawing, and also the scale. In effect, he builds a map on the screen.

When he has all the detail needed, a photo is taken of a slave display's screen and reproduced on a transparent slide for enlargement and transmission via facsimile or phone line.



Where's the rain? This is the weather map displayed on the new real-time, multiaccess system developed for the Swedish Air Force. It uses two computers.

Latin America

Conference Call

When a Buenos Aires businessman calls Rio de Janeiro, he has to wait for the call to be routed through New York or a European city.

This situation has led to a lot of talk about building a telecommunications network for South America. Last year the idea was finally put on paper as part of the "Statement of Presidents" emerging from the Punta del Este summit meeting of the Organization of American States. Then, an OAS commission agreed on common standards for the future Interamerican Telecommunications Network.

Phase 2. Now ITN is beginning to move off paper and into being. At the recent third regular meeting of the commission in Rio de Janeiro, the network moved into its so-called second phase, the financing of feasibility studies for linking ex-

isting and future individual national systems that will eventually add up to ITN. The Interamerican Development Bank is giving impetus to ITN in the interest of promoting Latin American integration: it's helping to bankroll the cost—estimated at \$200 million to \$300 million—and will conduct the feasibility studies, which will be financed by the United Nations.

Plans call for ITN to be mainly a terrestrial microwave-relay network tying in with the U.S. and Canada via Central America and Mexico. It would also tie in with satellite communications via Intelsat 3. Nine Latin American countries have built or are building ground stations. Chile's was completed this month, and Brazil's is expected to be up by the end of the year. The aim is to have ITN's ground stations functioning by 1973.

Number please. Links that could become other parts of ITN are already in operation. Santiago, Chile, and Buenos Aires recently were tied by land lines, and Buenos Aires and Montevideo, Uruguay, by microwave. And the development bank has loaned Bolivia \$9.5 million to help modernize its communications, including a microwave system to become part of ITN.

Brazil is putting in a microwave network to link the southern state of Rio Grande with Sao Paulo, Brasilia, and northeast coastal cities. Finally, Brazil is also considering tying this in with a troposcatter system through the Amazon region that would reach North America via microwave stations in Guayana, Trinidad, and the Virgin Islands.

Dumping PAL?

By adopting its own version of West Germany's PAL (phase alternating line) color television system, Brazil effectively froze U.S. makers of color tv transmission equipment out of its market. However, Contel, that country's communications authority, has suddenly halted experimental color broadcasts until 1972. The move has produced optimism among U.S. vendors; they hope that Brazil is having second thoughts about PAL.

Actually, U.S. manufacturers have been warning Brazilian government officials that their PAL system would require costly decoding and encoding equipment to receive satellite color transmission from North America or Europe.

Spreading waves. Along with its effect on U.S. makers, Brazil's eventual decision might have an important bearing on plans for the Interamerican Telecommunications Network. Conversely, decisions regarding that network made at the recent meeting of the Interamerican Telecommunications Commission could go a long way toward influencing Brazil's selection of a color tv system.

France

Lowdown

When a radio altimeter is accurate to within 250 feet at an altitude of 5,000 feet, it's considered a good instrument. But that kind of measurement just won't do at low levels, especially during landing.

To give pilots a better reading, Telecommunications Radioelectriques et Telephoniques has developed two instruments—called the AHV-5 and AHV-6—that it hopes will increase the company's already deep penetration of the altimeter market when they're introduced about a year from now. The frequency-modulated devices are designed for altitudes up to 2,500 feet, but for military craft the maximum can be raised to 5,000 feet. TRT engineer Felix Le Fevre predicts mean time between failure will reach 4,000 hours under normal conditions.

Built in. Elaborate self-monitoring and self-calibrating systems are built into the devices. "Previously," says Le Fevre, "we added automatic monitoring to our altimeters. This time, we made it a basic part of the design."

An original approach to measuring altitude overcomes two shortcomings of the altimeters' predecessors, says TRT: the step effect

and slow-drift phenomena. And accuracy is also impressive. The margin of error is ± 1 foot at altitudes under 100 feet, 4% at 100 to 500 feet, and 5% at 500 to 5,000 feet.

The company already has scored commercially with the new instruments. The more advanced of the two, the AHV-5, will fly aboard the two preproduction Concorde supersonic transports, succeeding those that TRT put in the prototypes. This means that TRT has the market for production Concorde virtually sewed up. And the simpler AHV-6, designed primarily for military craft and helicopters, has been sold to Ekco Electronics of Britain.

Ekco, says TRT, probably will pick up licensing rights as well to promote the AHV-6 for general aircraft. Depending on optional equipment, the AHV-6 will sell for about \$7,000, the AHV-5 for \$9,500.

Keeping a beat. Both use the same new operating principle, which is the source of their reliability. Other frequency-modulated altimeters measure a beat frequency as a function of the plane's distance from the ground, Le Fevre says. "We, however, keep the beat frequency constant by controlling the linear modulation slope, and measure the time lag between signal transmission and reception." The measurement is then converted to a voltage to meet current altimeter standards.

This permits operation of reception circuits in optimal conditions, whatever the altitude, Le Fevre says, and allows greater sensitivity and greater protection against jamming and parasite signals. Because the device measures time continuously, he says, there's no step effect and the altimeter can operate on a narrower reception band than competing instruments.

TRT uses solid state electronics entirely, and no electromechanical or other moving parts except in the display. About 50% of the circuitry is IC.

The altimeters have a transmission power of 300 milliwatts and operate in the center of the altimeter frequency band (4,300 megahertz). Their response time is proportional to altitude—at 100 feet, the time is 50 milliseconds.

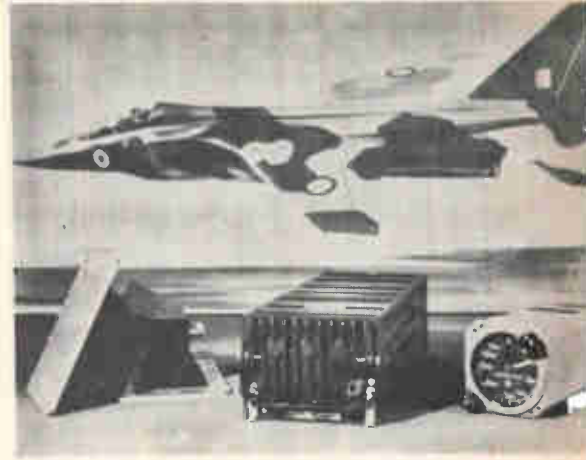

Looking down. New low-level altimeter by France's TRT offers accuracy and reliability— ± 1 foot under 100 feet and mean time between failures up to 4,000 hours.

Great Britain

Comeback

Cancellation or curtailment of a big space program sends tremors through the electronics industry. Large companies generally manage to recoup some of the loss, but to the small operators a major cut-back can mean quick death.

At least one small British company has not only avoided such a potential disaster but has come through with flying colors. Dynatel Ltd., a 20-man partly owned subsidiary of Electrical & Musical Industries Ltd., makes telemetry receiving and transmitting systems. Its equipment is in German and Spanish scientific sounding rockets and in the British Nimbus weather satellite system. The company's big hope, however, was the Esro and Eldo satellite and launcher programs that the British Government is phasing out.

Quick shift. After the initial shudder went through the company, Dynatel redirected its attention to the industrial telemetry market; it's now showing that techniques and equipment developed for space can have advantages in other environments.

Dynatel has just delivered to the laboratories of the Central Electricity Generating Board, the gov-

ernment corporation responsible for electricity production, a 48-channel data logger fitted with varactor-tuned radio receivers for data acquisition. These receivers are very much like receivers developed for the Spanish and German rockets. They can switch very quickly between frequencies, and Willie Fletcher, Dynatel's managing director, reckons that utilization of this characteristic to build up the acquisition system of the data logger enabled him to undercut his nearest rival for the contract by at least 15%.

The equipment will be used to log characteristics, mainly temperatures, in the components of a steam turbine. Forty-eight points on the turbine are fitted with sensors connected to voltage-controlled oscillators. The output of the oscillators modulates r-f transmissions from 16 transmitters, each with three subcarriers to make up the 48 channels.

Four equals 16. Four receivers pick up the 16 r-f frequencies. Each receiver is varactor tuned to four frequencies in turn, giving 16 frequencies in all. The reception sequence is along the row of receivers at the lowest varactor voltage—within a range of 1 to 5 volts—then along again at the next varactor voltage, and so on. The voltages in sequence are taken directly from the programming unit of the logger, and no separate source is necessary. Fletcher says this is one way to hold down cost.

Readout is available as a digital showing of the channel number and value, high-speed printout, and on paper or magnetic tape. These units set the maximum operating speed of the logger—one sample every 200 milliseconds—easily within the capability of the varactor tuning system. Resolution, says Fletcher, is better than 0.1% of full scale, and long-term stability is 0.1% per week.

Insect early warning

Swarms of locusts are much feared around the eastern Mediterranean, as any reader of the Old Testament knows. An average swarm weighs about 10,000 tons, and each locust

eats its own weight each day, so a village can see all its food for the coming year disappear in an hour.

The British Ministry of Overseas Development, grappling with the locust problem on behalf of 60 nations, is going to set up a kind of radar early-warning system to study locust habits and thus make it possible to predict their movements and possibly lead to a permanent radar swarming watch. It will be manned by Glenn Shaeffer, who has used radar to study bird flight [Electronics, Dec. 26, 1966, p. 169].

Watch on the desert. Next week, Shaeffer and his team will set up their gear in the southern Sahara area of the Niger Republic. He will take with him a small truck-mounted marine radar made by Associated Electrical Industries Ltd., with the slotted waveguide antenna replaced by a three-foot parabolic dish giving a 2.5° pencil beam. The set has peak pulse power of 20 kilowatts, a repetition rate of 2,000 pulses per second, and a pulse length variable from 50 nanoseconds to 1 microsecond. Shaeffer will use the fine pulse for close study; minimum range for single-locust detection will be about 15 yards. Using longer pulses, he has calculated, he will be able to detect

a single locust at about two miles and swarms up to 55 miles from ground level.

Around the world

Australia. That secret \$200 million U.S. space base nearing completion at Alice Springs is believed by Australian sources to be concerned with three major projects. They are the Manned Orbiting Laboratory, reconnaissance satellites, and the effort to counter the Soviet Union's fractional orbiting bombardment system. Angry Australians are asking Prime Minister Gorton to explain, in the words of one Sydney newspaper, by what right he kept from Parliament and the people knowledge of the installation "in an age when rockets and satellites can bring death from anywhere in moments."

Japan. The Mitsubishi Electric Corp., has built a computer to control a thermal power plant; it's the first such computer built by the company without foreign technical assistance. Two computers were built previously by Mitsubishi with help from the Westinghouse Electric Corp.

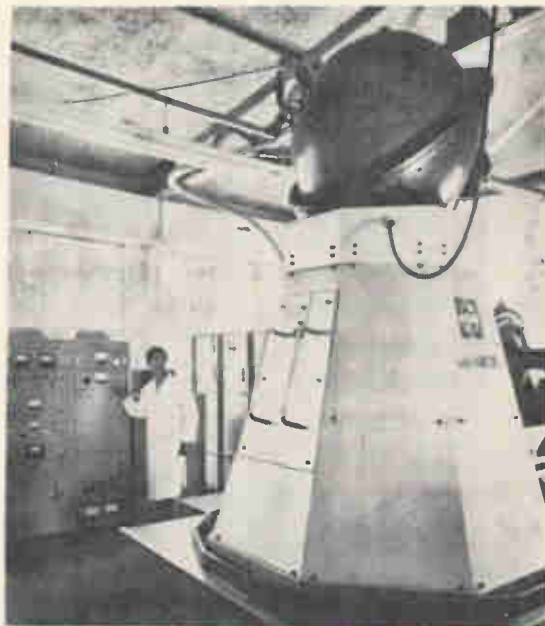

Lilliputian. New particle accelerator by Japan's Matsushita Electric Industrial Co. is about 12 feet tall, a third the height of conventional types. Called Hypertron 30, its accelerating voltage is 300 kilovolts, beam current is 30 milliamps.



TRW
Metallized
Mylar Capacitors

are different

The little things set them apart.

Things like superior electrical properties. Better environmental properties, too.

Things like variety. Tape-wrap, epoxy or hermetically sealed. Axial or radial leads. Voltages from 50 volts to 600 volts. Values from .001 mfd. to 10.0 mfd. And

tolerances to 1%.

And not so little things like unequalled experience in metallized mylar*. And the technical know-how to meet special requirements. They all add up to a big difference!

Contact any TRW distributor, or TRW Capacitors, Box 1000

Ogallala, Nebraska. Phone (308) 284-3611. TWX 910-620-0321. TRW Capacitors is a Division of TRW INC. *DU PONT REGISTERED TRADEMARK

TRW[®]



Advertising Sales Staff

Frank E. LeBeau [212] 971-6464
Advertising Sales Manager

Wallis Clarke [212] 971-2187
Assistant to sales manager
Donald J. Austermann [212] 971-3139
Promotion Manager

Warren H. Gardner [215] LO 8-6161
Eastern Advertising Sales Manager

Atlanta, Ga. 30309: Michael H. Miller, 1375
Peachtree St., N.E.
[404] 892-2868

Boston, Mass. 02116: William S. Hodgkinson
McGraw-Hill Building, Copley Square
[617] CO 2-1160

Cleveland, Ohio 44113: William J. Boyle, 55
Public Square, [216] SU 1-7000

New York, N.Y. 10036
500 Fifth Avenue
James R. Pierce [212] 971-3616
John A. Garland [212] 971-3617

Philadelphia, Pa. 19103:
Jeffrey M. Preston
Warren H. Gardner,
6 Penn Center Plaza,
[215] LO 8-6161

Pittsburgh, Pa. 15222: Warren H. Gardner,
4 Gateway Center, [412] 391-1314

Rochester, N.Y. 14534: William J. Boyle,
9 Greylock Ridge, Pittsford, N.Y.
[716] 586-5040

Donald R. Furth (312) MO 4-5800
Midwest Advertising Sales Manager

Chicago, Ill. 60611: Kenneth E. Nicklas
Ralph Hanning, 645 North Michigan Avenue,
[312] MO 4-5800

Dallas, Texas 75201: Richard P. Poole, 1800
Republic National Bank Tower,
[214] RI 7-9721

Houston, Texas 77002: Robert Wallin,
2270 Humble Bldg. [713] CA 4-8381

Detroit, Michigan 48226: Ralph Hanning,
856 Penobscot Building
[313] 962-1793

Minneapolis, Minn. 55402: 1104 Northstar
Center [612] 332-7425

St. Louis, Mo. 63105: Kenneth E. Nicklas,
The Clayton Tower, 7751 Carondelet Ave.
[314] PA 5-7285

James T. Hauptli [415] DO 2-4600
Western Advertising Sales Manager

Denver, Colo. 80202: Joseph C. Page, David
M. Watson, Tower Bldg., 1700 Broadway
[303] 255-5484

Los Angeles, Calif. 90017: Ian C. Hill,
John G. Zisch, 1125 W. 6th St.,
[213] HU 2-5450

Portland, Ore. 97204: James T. Hauptli,
Thomas McElhinny, 218 Mohawk Building,
222 S.W. Morrison Street,
Phone [503] 223-5118

San Francisco, Calif. 94111: James T. Hauptli,
Thomas McElhinny, 255 California Street,
[415] DO 2-4600

Pierre Braude Tel: 225 85 88: Paris
European Director

Paris: Ken Davey
88-90 Avenue Des Champs-Elysees, Paris 8
United Kingdom and Scandinavia

Brian Bowes Tel: Hyde Park 1451
34 Dover Street,
London W1

Milan: Robert Saidel
1 via Baracchini Phone 86-90-656

Brussels: F.I.H. Huntjens
27 Rue Ducale Tel: 136503
Frankfurt/Main: Hans Haller
Elsa-Brandstroem Str. 2
Phone 72 01 81

Geneva: Ken Davey
1, rue du Temple Phone: 31 95 60
Tokyo: Takeji Kinoshita 1 Kotohiracho
Shiba, Minato-Ku Tokyo [502] 0656
Osaka: Ryoji Kobayashi 163, Umegae-cho
Kita-ku [362] 8771

Business Department

Wallace C. Carmichael, Manager
[212] 971-3191

Stephen R. Weiss, Production Manager
[212] 971-2044

Thomas M. Egan,
Assistant Production Manager [212] 971-3140

Dorothy Carmesin, Contracts and Billings
[212] 971-2908

Frances Vallone, Reader Service Manager
[212] 971-2865

■ United Transformer Co.,
Div. of TRW, Inc. 2nd Cover
Fuller & Smith & Ross, Inc.

■ Unitrode Corp. 53
Silton Brothers, Inc.

■ Vactec, Inc. 170
Coleman & Assoc. Adv.

■ Varo, Inc. 130
Tracy-Locke Co., Inc.

Victoreen Instrument Co., The 56
Palm & Peterson, Inc.

Wadsworth & Co., Ltd., Leonard 171

■ Wang Laboratories 144
Impact Adv., Inc.

■ Weinschel Engineering Co. 162
E.G. White Adv., Inc.

Weston Instruments, Inc., 164
Lexington Div.

Larcom Randall Adv., Inc.

Wiremold Co., The 125
The Charles Brunelle Co.

Wisconsin, State of, 129
Division of Economic Development

The Cramer-Krasselt Co.

Xcellite, Inc. 154
Harold Warner Adv., Inc.

Classified Advertising

F.J. Eberle, Manager

EMPLOYMENT OPPORTUNITIES 177-179

Spitz Laboratories Inc. 179
A Div. of McGraw-Hill Inc.

EQUIPMENT

(Used or Surplus New)
For Sale 179

Fishman Company, P. 179

Radio Research Instrument Company 179

■ For more information on complete product
line see advertisement in the latest Elec-
tronics Buyer's Guide

□ Advertisers in Overseas Advertising Section
following Newsletter from Abroad

Electronics Buyers' Guide

George F. Werner, General Manager
[212] 971-2310

Robert M. Denmead,
Midwest Regional Manager
[312] MO 4-5800

Regina Hera, Directory Manager
[212] 971-2544

Thomas M. Egan, Production Manager
[212] 971-3140

Circulation Department

Isaac Slegel, Manager [212] 971-6057

Research Department

David Strassler, Manager [212] 971-6058
Chloe D. Glover, Research Associate
[212] 971-6057

High RF power, low distortion



The Hewlett-Packard 230A Signal Generator Power Amplifier delivers up to 4.5 watts of low distortion power from 10 to 500 MHz. It is ideal for meeting your high RF power requirements for applications such as receiver testing, wattmeter calibration, antenna testing, filter and component testing and attenuation measurements. The amplifier may be driven with any conventional signal source and will reproduce AM, FM and pulse modulation characteristics of the driver generator with minimum distortion. The instrument employs three tuned, cascaded stages of grounded-grid amplification fed from a regulated power supply. Price: \$1350. Application Note 76 discusses high and low-level applications. For your copy of this application note or more information about the amplifier, contact your local Hewlett-Packard field engineer or write: Hewlett-Packard, Rockaway Division, Green Pond Road, Rockaway, New Jersey 07866.

HEWLETT  PACKARD

SIGNAL SOURCES

1082



CONNECTORS ENLARGED TO SHOW DETAILS

• TRADE-MARK

We're not afraid to say it out loud: 'Design.'

BECAUSE ELCO MINIATURE CONNECTORS SET THE 'MINI' TREND IN OUR INDUSTRY.

The smaller our connectors become, the larger your interconnection parameters can grow. It all started, and still continues, with the Elco Varicon* Connector; followed closely by smaller, lighter, even more exotic versions such as the Elco Bicon* Connector; Miniature Rack-and-Panel Connectors; Receptacles for DIPs (Dual In-Line Packages); Miniature Card Edge Connectors; and much, much more. Today, our line encompasses countless miniature designs, for virtually every spacing need and every terminating technique—with emphasis on back panel automatic wire wrap. Our Miniature Connector literature demonstrates how big our "little" thinking can work in your favor. Write, wire, call or TWX us for it. Elco Corporation, Willow Grove, Pa. 19090; 215-659-7000; TWX 510-665-5573.



P.S.—FREE SAMPLE? Let us know after you read our literature. We'll be delighted to send you one.

EMF

ESTABLISHED RELIABILITY METAL FILM

Do more...faster...with Dale's flexible new program

Assured metal film reliability...good delivery. Dale gives you both with new EMF resistors. Operating from new expanded facilities, we are geared to supply the exact level of assured performance you require—with competence backed by eight years as a supplier of established reliability parts.

EMF SPECIFICATIONS

DALE TYPE	MIL-R-55182 TYPE	125°C RATING	MAX. WT. (Grams)	MAX. WORKING VOLTAGE
EMF 55	RNR 55	1/10 w	.35	200
EMF 60	RNR 60	1/8 w	.45	250
EMF 65	RNR 65	1/4 w	.84	300

Standard Tolerances: .1% (B), .25%, .5% (D) and 1% (F).

Applicable T.C. Code: T-1 (Char. K); T-2 (Char. H); T-9 (Char. J).

Resistance Range: 24.9 ohms to 1 megohm, depending on T.C. code and wattage

Power Rating: Based on 0.5% maximum ΔR in 2000 hours load life, 175° maximum operating temperature.

Failure Rate: Estimated at .1%. Goal is .001% to conditions of MIL-R-55182.

With Dale High-Reliability capability we can also zero in on your requirements in any of these four general areas:

- TX—12-hour burn-in (room temp.) at 2-2½ X rated power depending on size.
- 100% screening for short-time overload, temperature cycling and 100-hour burn-in.
- Testing to MIL-R-55182 requirements. Characteristic H, J, K.
- Special testing is available to meet your requirements for specific reliability programs. This includes 100% GARD screening which affords significant time/cost savings over typical 100-hour burn-in. Write for test report #19590.

Move faster with a real "pro" in established reliability. Call Dale at 402-564-3131 or write for new EMF Data Sheet.



DALE ELECTRONICS, INC.

1300 28th Avenue Columbus, Nebraska 68601

In Canada: Dale Electronics Canada, Ltd.

Circle 901 on reader service card



A "Refreshing" new Storage Tube

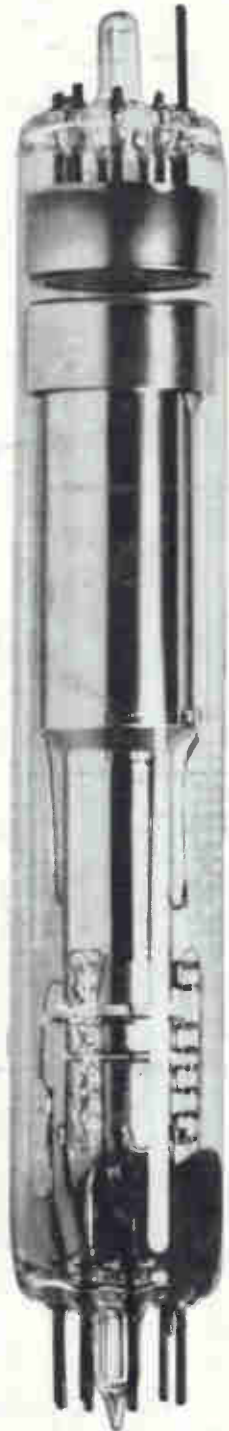

"Refresh" your alpha-numeric display with the exciting new Alphechon storage tube. Smaller than any other single-ended, non-destructive read-out storage tube previously available, this entirely new device can accept incoming signals (even over telephone wires), store them, and read them out as TV signals.

This small (6.75" long), low-cost tube is sure to become an important new component in data distribution and read-out systems where computer-generated alpha-numeric messages are to be displayed on conventional TV monitors.

Although the Alphechon storage tube is designed to operate over a wide range of input and output rates in a variety of operating modes, the Alphechon is characterized at a writing time of 1 TV frame, an erasing time of 1 TV frame, and may be continuously read out at TV rates for more than 2 minutes.

For more information on the Alphechon and other RCA Display Storage Tubes, see your RCA Representative or your RCA Industrial Tube Distributor. For technical data, write: RCA Electronic Components, Commercial Engineering, Section H-19Q-2, Harrison, N.J. 07029.

RCA