

Electronics®

Electronics is changing in the West: page 60
IC's improve differential amplifiers: page 75
Regulating anticorrosion systems: page 84

August 9, 1965

75 cents

A McGraw-Hill Publication

Below: Solid state stereo set
built in modules: page 88

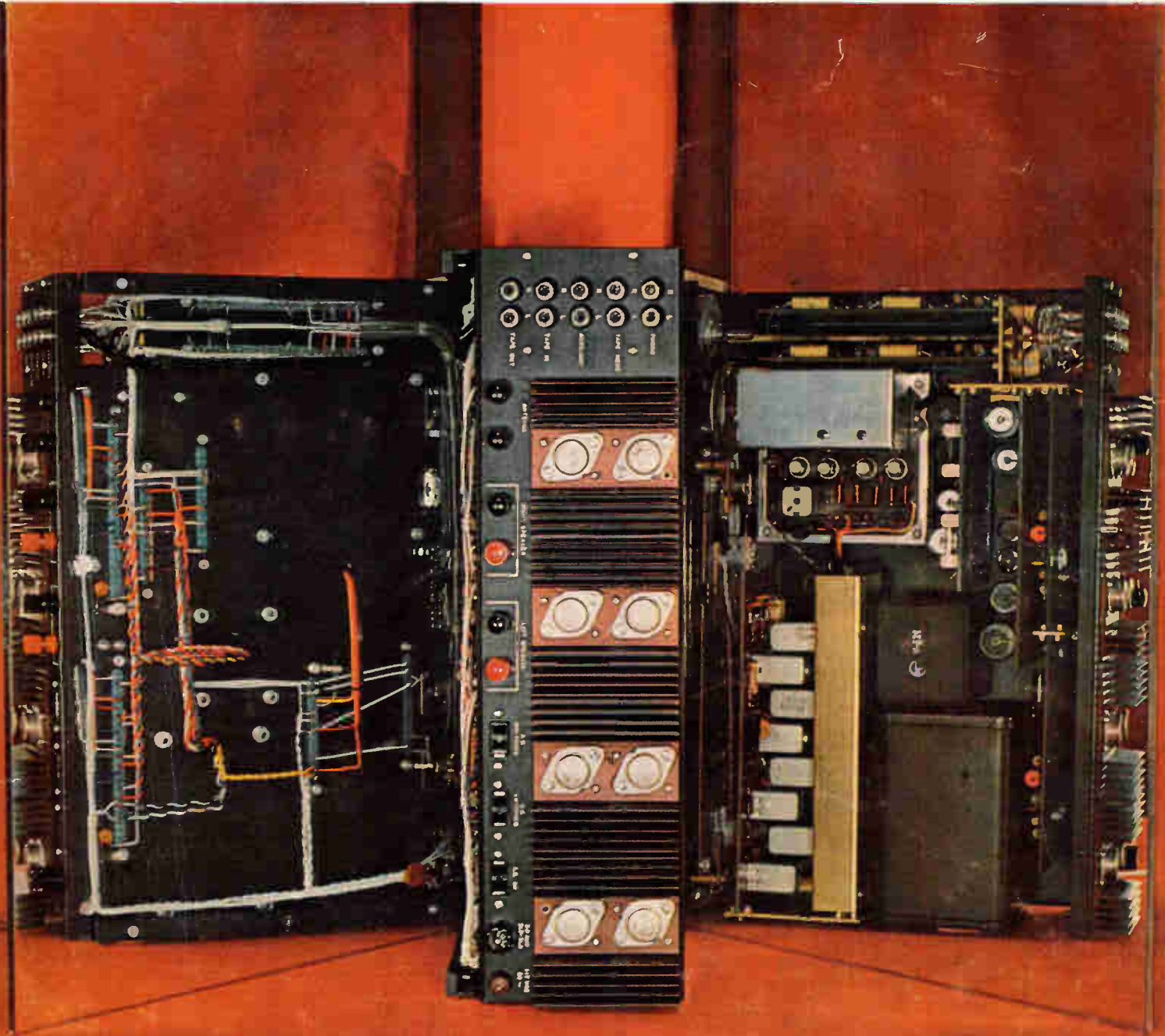

A Synthesizer for your Frequency Standard

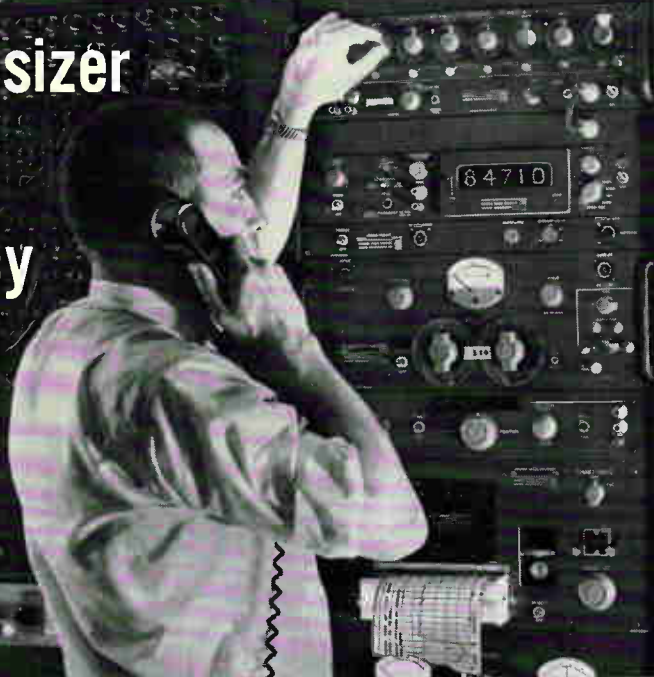

Of all the instruments in General Radio's frequency standard room, the one most often used is the 1162-A7C Coherent Decade Frequency Synthesizer. Since all development engineering areas are linked to the standard by a coaxial distribution system, an engineer has but to make a phone call for any frequency from 0.1 c/s to 1 Mc/s in increments of 0.1 c/s . . . a total of 10 million discrete frequencies. For this application, the internal oscillator of the Synthesizer is phase-locked to a 5-Mc Type 1115-B Standard-Frequency Oscillator to yield a frequency stability of better than 5 parts in 10^{-10} per day.

The technique described is very useful for applications requiring a single fixed-frequency signal for a relatively prolonged period or where the same frequency must be available at many locations simultaneously. Where full frequency selection is needed at one location, an additional Synthesizer can be made available for use right on the spot. Not so stable you say because the Synthesizer is no longer in the cozy environment provided for the frequency standard? No matter, since the Synthesizer at the bench can be phase-locked to the frequency standard through the coaxial distribution system. Locking can be accomplished with a frequency of 5 Mc/s or with any submultiple of 5 Mc/s down to 100 kc/s.



Coherent Decade Frequency Synthesizer, Type 1160 Series

Three basic models provide frequencies in steps to 100 kc/s, 1 Mc/s, and 12 Mc/s. Each of these models can be ordered with as few as three digit-decade modules to provide resolutions of 100 c/s, 1 kc/s, and 10 kc/s, respectively, or with up to seven decade modules for incremental resolutions of 0.01 c/s, 0.1 c/s, and 1 c/s.

In addition, a continuously adjustable decade is available for use to 1 Mc/s for continuous manual control of frequency or for sweep-frequency coverage of selected sections of the instrument's range up to 1 Mc/s. The "CAD" can also be calibrated to provide an extra two or three figures of resolution.

Remotely programmable modules can be substituted for the digit-decade modules. These modules accept either a biquinary or 10-line coded program, or can be used manually just like the standard digit decade modules.

Sixty different synthesizer combinations are available at prices ranging from \$3200 to \$6195 (in U.S.A.). All are equipped with internal, room-temperature, 5-Mc crystal oscillators ($2 \times 10^{-7}/^{\circ}\text{C}$) that can be easily phase-locked to an external standard.



Standard Frequency Oscillator, Type 1115-B

An all solid-state 5-Mc crystal oscillator with outputs of 5 Mc/s, 1 Mc/s, and 100 kc/s. Short-term stability is less than 1×10^{-11} for one-second samples. Aging is less than 5×10^{-10} per day after 30 days operation, less than 1×10^{-10} per day after one year. A change in output load from open circuit to short circuit causes a frequency deviation of less than 2×10^{-11} . A line-voltage change of ± 10 percent causes less than a 1×10^{-11} deviation. Spectral line width is less than 0.25 c/s at 10 Gc/s. Noise pedestal is less than -145 dB per $\sqrt{\text{c/s}}$ at 5 Mc/s.

Meets MIL STD 167 for vibration. Uses either ac or dc power: 90-130 V or 180-260 V, 40 to 2000 c/s, or 22-35 V dc. Supplied with internal rechargeable nickel-cadmium battery for 35-hour emergency standby operation. Price, \$2050 (in U.S.A.).

Write for Complete Information

IN CANADA: Toronto 247-2171, Montreal (Mt. Royal) 737-3673
IN EUROPE: Zurich, Switzerland - London, England



GENERAL RADIO COMPANY

WEST CONCORD, MASSACHUSETTS

BOSTON (W. Concord) 646-0550 NEW YORK, N. Y. (Ridgefield, N. J.) 964-2722 / 943-3140 CHICAGO (Oak Park) 848-9400 PHILADELPHIA (Ft. Washington) 646 8030 WASHINGTON, D.C. (Rockville, Md.) 946-1600 SYRACUSE 454-9323 DALLAS FL 7-4031 SAN FRANCISCO (Los Altos) 948-8233 LOS ANGELES 469-6201 ORLANDO, FLA. 425-4671 CLEVELAND 886-0150

Circle 900 on reader service card

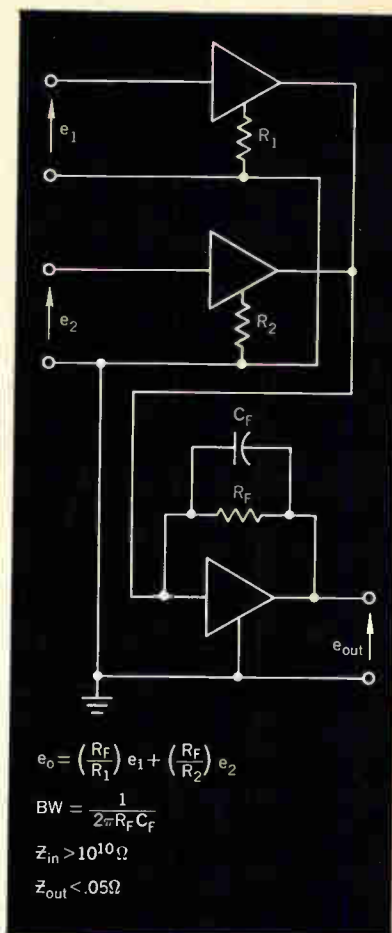
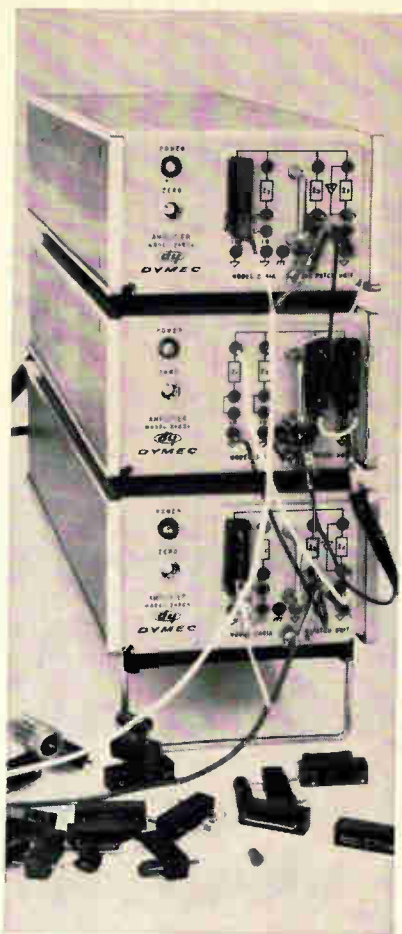
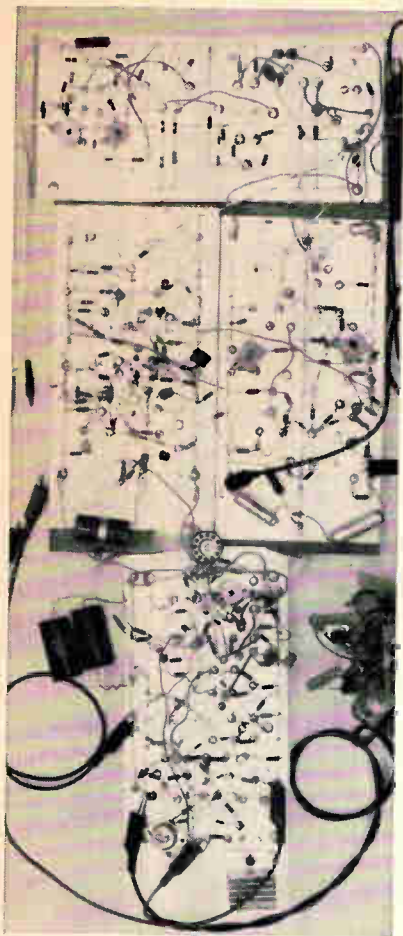

THIS OR THIS DOES THIS

Why not do it the quicker, more reliable way, at less cost ...with the Dymec solid-state DY-2460A Amplifier?

Of course, you can design and build the amplifier element of your newly designed circuit yourself. But, how long will you work on it...rather than on the original designs of your circuit? And, can you do it for \$445—the low cost of the DY-2460A?

Will your amplifier have high performance and reliability, with versatility to permit you to multiply, amplify, add, integrate, differentiate, isolate and invert? The general purpose DY-2460A is ready-made to perform these functions, complete with built-in power supply. Simply insert the appropriate plug-in unit into the front panel. The DY-2460A will supply an output of ± 10 v peak at 10 ma. Zero drift is less than 1 μ v per week, and noise less than 4 μ v peak to peak.

How about reliability? The DY-2460A utilizes a

photo-conductive chopper and all solid-state circuitry for maximum reliability. The photo chopper is inherently a long-life device, unaffected by mounting position and vibration. It is non-synchronous for elimination of all effects of ac pick-up. Production instrumentation is by far your most reliable choice.

We think the DY-2460A makes more sense. Ask your Dymec/Hewlett-Packard field engineer for details on how the DY-2460A can make your breadboarding more reliable and easier at less cost. Or write Dymec Division, 395 Page Mill Road, Palo Alto, California 94306. Phone (415) 326-1755, TWX 910-373-1296.

Price: DY-2460A Amplifier, \$445; DY-2461A-M1 Data Systems Plug-in, \$85; DY-2461A-M2 Bench-use Plug-in, \$125; DY-2461A-M3 Patch Unit Plug-in, \$75; DY-2461A-M4 Plus-one Gain Plug-in, \$35.

Data subject to change without notice. Prices f.o.b. factory.

**HEWLETT
PACKARD**  **DYMEC
DIVISION**

ADD

AUTORANGING **ac** TO **dc** MEASUREMENTS

WITH YOUR hp 3440A DIGITAL VOLTMETER

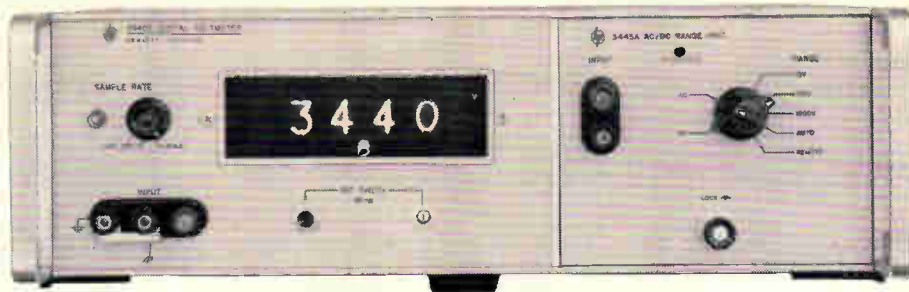

Now your Hewlett-Packard solid-state 3440A DVM lets you measure ac (50 cps to 100 kc) or dc signals 10 to 1000 volts full scale. Just connect directly to the input terminals of the 3445A, select manual range or automatic ranging—or program range remotely. Signal common may be connected up to 500 v dc above ground. Permanent test records are available on all functions, including polarity, decimal, function and overload, with accessory J74-562A Printer for a 1224 code (J76-562A for a 1248 code).

The specs tell the story of new versatility for the 3440A, \$1160, today's best DVM buy. Other plug-ins that make the 3440A your most flexible digital voltmeter include the 3441A Manual Ranger Selector, \$40; 3442A Automatic Range Selector, \$135; 3443A High-Gain/Autorange Unit, \$450; 3444A DC Multi-Function Unit, \$575. Then check your hp field engineer or write for complete data to Hewlett-Packard, Palo Alto, California 94304, Tel. (415) 326-7000; Europe: 54 Route des Acacias, Geneva; Canada: 8270 Mayrand Street, Montreal.

SPECIFICATIONS, 3445A (plugged into the 3440A)

- Voltage range** 4-digit full-scale readings of 9.999, 99.99 and 999.9 v; 5% overrange capability, indicator.
- Voltage accuracy (ac):** from 20°C to 30°C, including ±10% line variations. 50 cps—20 kc, ±0.1% of reading ±2 counts. 20 kc—50 kc, ±0.1% of full scale ±2 counts. 50 kc—100 kc, <±0.3% of full scale ±2 counts. Temperature coefficient = ±0.005%/°C from 0—20°C and 30—50°C.
- Voltage accuracy (dc):** ±0.05% of reading ±1 digit, including 10% line variation, +15°C to +40°C (±0.1% ±1 digit 0°C to +50°C).
- Range selection (ac):** Manual, automatic, remote; auto reading <2 sec; max. remote ranging time 40 msec.
- Range selection (dc):** Manual, automatic, remote; auto reading <1 sec; max. remote ranging time 40 msec.
- Function selection:** ac or dc, front panel.
- Input impedance:** 10 megs shunted by <20 pf, all ac ranges; 10.2 megs, dc.
- Input filter (dc):** response time <450 msec to a step function to within 99.95% of final value; 30 db ac rejection at 60 cps on 10, 100 and 1000 v ranges, increasing at 12 db/octave.

	10 v range	100 v range	1000 v range
Common mode	dc	90 db	70 db
rejection (dc):	60 cps	70 db	50 db
		50 db	30 db

Price: \$525.

Data subject to change without notice. Price f.o.b. factory

HEWLETT  **PACKARD**
An extra measure of quality

Electronics

August 9, 1965

Volume 38, Number 16

Page	4	Readers Comment
	8	People
	10	Meetings
	15	Editorial
	17	Electronics Newsletter
	41	Washington Newsletter
	131	New Products
	206	New Books
	208	Technical Abstracts
	217	New Literature

Electronics Review

Page	27	End of Ioran	30	Trick landing
	27	Tuning transistor	32	Getting a word in
	28	Candy bars on credit	34	Hide and seek
	29	Dial in style	35	Mauler scratched
	29	Monsanto's voltmeter	36	Electronics notes

Probing the News

107	Government spurs medical market
110	New format: Wescon/65
116	Mohole gets moving

Electronics Abroad

219	Anglo-French computer	220	Mixed blessing
219	NATO communications	221	Quiet cooperation
220	Dark horse	222	Slowing the carousel
		223	No cause for alarm
		223	Around the world

Technical articles

Regions	60	The changing face of the West Reaction to a curtailment of military spending is showing up in new products, new technology, new methods of operation
----------------	----	--

I. Design

Integrated circuits	75	Integrated circuits improve differential amplifiers They reduce the two major objections to differential amplifiers: cost and complexity Robert Hirschfeld, Motorola, Inc.
----------------------------	----	---

Circuit design	80	Designer's casebook Controlling scr firing angle regulates d-c load voltage; matching gate potential to FET pinchoff voltage; slow sweep generator controls camera shutter; transistor increases multiplier phototube sensitivity; improving Darlington speed
-----------------------	----	---

II. Application

Industrial electronics	84	Regulating bias on a ship's hull An electronic control system regulates voltage as speed and seawater change E.L. Littauer and O.G. O'Brien, Lockheed Aircraft Service Co.
Consumer electronics	88	A solid state stereo set built in modules (cover) Aerospace techniques make receiver easy to maintain and repair S. Messin and T.E. Nawalinski, Non-Linear Systems, Inc.

Communications	93	Making the antenna an active partner Circuit functions and antenna are combined in one structure James F. Rippin Jr., Air Force Systems Command
-----------------------	----	--

III. Manufacturing

Production	97	Production tips Pieces of plastic keep components clear of board; special electrode shapes solve welding problems
-------------------	----	---

Title R registered
U.S. Patent Office;
© copyright 1965
by McGraw-Hill, Inc.
All rights reserved,
including the right to
reproduce the contents
of this publication,
in whole or in part.

Electronics

Editor: Lewis H. Young

Senior editors

Technical: Samuel Weber

News: Kemp Anderson, Jr.

Senior associate editors: John F. Mason, George Sideris

Department editors

Advanced technology: Joan Blum

Avionics: W.J. Evanzia

Circuit design: Michael Elia

Components: Michael F. Tomaino

Computers: Wallace B. Riley

Consumer electronics: Richard Lipkin

Industrial electronics: Robert Cushman

Instrumentation: Carl Moskowitz

Manufacturing: George Sideris

Military electronics: John F. Mason

New products: William P. O'Brien

Solid state: Jerome Eimbinder

Space electronics: Peter R. Sigmund

Special projects: Richard M. Machol

Staff writer: Stanley Zarowin

Regional editors

Boston: Thomas Maguire, editor; Robin Carlson

Los Angeles: William B. Wallace, editor; June Ranill

San Francisco: Laurence D. Shergalis, Edmond G. Addeo, editors; Mary Jo Jadin

Copy editors

Howard Rausch, Sally Powell, Walter Barney

Graphic design

Art director: Saul Sussman

Assistant art director: Donna M. Marchyn

Editorial production: Ann Mella

Production editor: Arthur C. Miller

Editorial secretaries: Claire Benell, Mary D'Angelo, Lynn Emery, Kay Fontana, Carolyn Michnowicz, Lorraine Longo, Lorraine Werner

McGraw-Hill news service

Director: John Wilhelm; **Atlanta:** Fran Ridgeway; **Chicago:** Bruce Cross, Louis S. Gomolak;

Cleveland: Arthur Zimmerman; **Dallas:** Marvin Reid;

Detroit: Donald MacDonald; **Los Angeles:** Michael Murphy, Ron Lovell;

San Francisco: Margaret Ralston;

Seattle: Ray Bloomberg; **Washington:** Arthur L. Moore, Charles Gardner,

Herbert W. Cheshire, Seth Payne, Warren Burkett, Warren Kornberg

McGraw-Hill world news service

Bonn: Robert Dorang; **Brussels:** Arthur Erikson; **London:** John Shinn;

Mexico City: Wesley Perry; **Milan:** Bruce Bendow;

Moscow: Donald Winston; **Paris:** Dan Smith;

Rio de Janeiro: Leslie Warren; **Tokyo:** Marvin Petal, Charles Cohen

Circulation manager: Hugh J. Quinn

Reprints: T.M. Egan

Publisher: C.C. Randolph

Electronics: August 9, 1965, Vol. 38, No. 16

Printed at 99 North Broadway, Albany, N.Y.
Second class postage paid at Albany, N.Y.

Subscriptions are solicited only from those actively engaged in the field of the publication. Position and company connection must be indicated on orders. Subscription prices: United States and Possessions and Canada, \$6.00 one year, \$9.00 two years, \$12.00 three years. All other countries \$20.00 one year. Single copies, United States and Possessions and Canada 75¢. Single copies all other countries \$1.50.

Published every other Monday by McGraw-Hill Inc. 330 West 42nd Street, New York, N.Y. 10036. Founder: James H. McGraw, 1860-1948.

Subscribers: The Publisher, upon written request to our New York office from any subscriber, agrees to refund that part of the subscription price applying to copies not yet mailed. Please send change of address notices, subscription orders or complaints to Fulfillment Manager, Electronics, at the address below. Change of address notices should provide old as well as new address, including postal zone number if any. If possible, attach address label from recent issue. Allow one month for change to become effective.

Postmaster: Please send Form 3579 to Fulfillment Manager, Electronics, P.O. Box 430, Hightstown New Jersey 08520

Readers Comment

Old story?

To the Editor:

We were very interested to read the article on thin film magnetometers [June 28, 1965, p. 33] because we feel that the Lockheed proposal is not radically new in view of British patent 592,241, which was held by our subsidiary, Henry Hughes & Son Ltd. Based on an application filed in 1945, it has now expired. Our subsidiary had various patents in other territories outside the United Kingdom but most of these have now also expired.

E. Swinbank

Patent Department

S. Smith & Sons

London

More plain talk

To the Editor:

I was delighted to see a continuation of the dialogue on technological aids in education by L. P. Morris [July 26, p. 4] after my remarks, labeled "Plain Talk," in your June 28 issue.

Unfortunately, the fundamental correlation between the quality of our educational process and our continued strength and advancement as a nation has not penetrated the body politic to a degree that would stimulate vigorous constructive action. In part, this is due to the autonomy of the school districts and private institutions, coupled with their limited funds for exploration of new techniques.

Although I heartily support the autonomous school systems, I firmly believe that the information for the implementation of the new technology in education must be supplied to them by a national organization dedicated to the continuing study and implementation of the best in our technology.

The contributions of the several private foundations have been significant but their efforts are not coordinated into the total concept of the educational system. The participation of the Federal Government has likewise been on a piecemeal basis.

In my view there is a desperate need for a quasi-governmental co-

Now from Sprague!

LOW-COST, HERMETICALLY-SEALED

SEPT[®]

SILICON EPITAXIAL PLANAR TRANSISTORS

**A NEW LINE OF NPN QUALITY TRANSISTORS
IN TO-5 AND TO-18 CASES!**

**SUPERIOR TO EPOXY-ENCASED TRANSISTORS IN
MOISTURE RESISTANCE AND POWER CAPABILITY!**

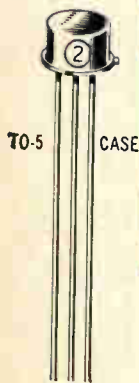

TYPE NO.		APPLICATION	BV _{CBO}	BV _{CEO}	h _{FE}	f _T
TO-5 CASE	TO-18 CASE					
TN53	TN54	High Voltage Switch, Amplifier, Gen. Purpose	75V	45V	50 min.	100 Mc
TN55	TN56	Low-level, Low-noise	40V	30V	60 min.	30 Mc
TN59	TN60	High Speed Switch	40V	30V	100 min.	100 Mc
TN61	TN62		High Speed Amplifier	40V	30V	50 min.
TN63	TN64			20V	20V	25 min.

For complete information, write to Technical Literature Service, Sprague Electric Company, 35 Marshall Street, North Adams, Mass. 01248

SPRAGUE COMPONENTS

TRANSISTORS
CAPACITORS
RESISTORS
INTEGRATED CIRCUITS
THIN-FILM MICROCIRCUITS
CS-5125

PULSE TRANSFORMERS
INTERFERENCE FILTERS
PULSE-FORMING NETWORKS
TOROIDAL INDUCTORS
ELECTRIC WAVE FILTERS

CERAMIC-BASE PRINTED NETWORKS
PACKAGED COMPONENT ASSEMBLIES
BOBBIN and TAPE WOUND MAGNETIC CORES
SILICON RECTIFIER GATE CONTROLS
FUNCTIONAL DIGITAL CIRCUITS



*Sprague' and '®' are registered trademarks of the Sprague Electric Co.

Powerlytic® Capacitors in 42 Case Sizes Insure Maximum Capacitance in Minimum Space



Designed to pack high capacitance into areas that provide limited space, tubular case Powerlytic Capacitors can be procured in 20 different sizes while cylindrical Powerlytics are available in 22 case sizes.

Smaller companion to Sprague's proven 36D cylindrical aluminum electrolytic, the Type 39D Powerlytic is well qualified for transistorized circuitry that requires maximum capacitance in case sizes ranging from $\frac{1}{2}$ " x $1\frac{1}{8}$ " to 1" x $3\frac{5}{8}$ ".

Type 39D tubular Powerlytics are designed for operation at temperatures up to 85 C. Their unique construction has welds at all critical anode and cathode terminals—there are no riveted or pressure connections. As a result, open circuits are prevented, even in the microvolt signal range.

Improved molded phenolic end seals contribute to an unusually long life (expectancy, 10 years or more) for type 39D Capacitors. They have low effective series resistance and low leakage current. Standard ratings include capacitance values to 18,000 μ F, in voltages from 3 to 450 VDC.

Type 36D cylindrical case Powerlytics, designed for space economy in applications such as computer power supplies, industrial controls, and high gain amplifiers, are available in case sizes from $1\frac{3}{8}$ " x $2\frac{1}{8}$ " to 3" x $5\frac{5}{8}$ ". Designed with reliable safety vents, Type 36D Powerlytics also have superior seals employing molded covers with recessed rubber gaskets. They are available in standard ratings from 3 to 450 VDC with capacitance values to 270,000 μ F.

For complete technical data on Type 36D or Type 39D Powerlytic Capacitors, write for Engineering Bulletins 3431B and 3415, respectively, to Technical Literature Service, Sprague Electric Co., 35 Marshall St., North Adams, Mass. 01248.

450-5142

ordinating agency staffed by the best minds in the country and serving as the communication link between the educational establishments and the industry developing and producing the technological aids.

N. A. Moerman
Roslyn Heights, N. Y.

Sierra contract

To the Editor:

After reading your article, "Blueprint for the 70's," [June 28, 1965, p. 31], we would like to point out that the Army is investigating the use of Sierra Research Corporation's stationkeeping equipment. A contract was awarded to Sierra on April 30, 1965, and announced in late June.

To quote from the contract, "The purpose of this specification is to procure models of readily available stationkeeping equipment (Sierra Research Corporation SNS-64/2), which is representative of the state of the art, for Army evaluation in a military potential test program. The basic intent of this program is to determine whether the utilization of this stationkeeping device provides the Army with an improved operation capability."

The SNS-64/2 stationkeeper has been designated AN/APN-169 Intraformation Positioning Set by the Air Force. They have recently completed a flight test program of this equipment in C-130 aircraft at Eglin AFB, Florida.

Jerome A. Davern
Sierra Research Corp.
Buffalo, N. Y.

▪ Station-keeping equipment for Army aircraft is a good market. Due to the lack of electronic aids to

formation flying, the 1st Cavalry Division at Fort Benning, Ga. is experimenting with Red Dog, which uses no electronics but depends on maintaining prescribed airspeeds, altitudes and schedules.

Flying fish

To the Editor:

Reading about the variable-depth sonar system [Dec. 28, 1964, p. 79] I was interested by the comment: "The cumbersome gear slows down the ship from which it operates."

I was a physicist for the headquarters, Pacific Missile Range, Point Mugu, Calif. from July 1962 to January 1965. While there I developed a "stable oceanographic fish".

The device is a devilfish shaped affair which "flies" underwater at speeds from 5 to 20 knots with 100 pounds of free lift.

The "fish" has a nonelectric, pressure-sensing depth controller which may be preset to any desired operating depth. In operation, the device may be loaded with 100 pounds of gear, set to "fly" at 200 feet, and towed at 15 knots with minimal drag.

Sea tests were not undertaken before I left and I do not believe they have been carried out since then. Pool and pressure tests proved quite satisfactory. In any event, the device belongs to the Navy and could possibly be obtained by contacting the geophysics officer, Code 3250, at PMR.

Sam Gerrish

Physicist
National Center for Atmospheric Research
Boulder, Colo.

SUBSCRIPTION SERVICE

Please include an Electronics Magazine address label to insure prompt service whenever you write us about your subscription.

Mail to: Fulfillment Manager
Electronics
P.O. Box 430
Hightstown, N.J. 08520

To subscribe mail this form with your payment and check new subscription renew my present subscription

Subscription rates: in the U.S.: 1 year, \$6; two years, \$9; three years, \$12. Subscription rates for foreign countries available on request

CHANGE OF ADDRESS

ATTACH
LABEL
HERE

If you are moving, please let us know five weeks before changing your address. Place magazine address label here, print your new address below.

name

address

city

state

zip code



who offers more semiconductor testing experience than TI?

NO ONE!

... and *you* can profit from *our* experience. Whether your automatic testing problem is in production, quality control, reliability, or evaluation, TI can solve it. Innovating state-of-the-art solutions is a regular occurrence at TI such as the technique for *dynamic* testing of transistors, diodes, integrated circuits and modules. It's our business to stay ahead.

TI-built test equipment is dependable, flexible, has anti-obsolescent features and is economical. It is backed by an engineering organization with more than a decade of experience in manufacturing, installing and servicing of semiconductor test equipment. For the latest information, write TI's test equipment specialists, the Industrial Products Group.

INDUSTRIAL
PRODUCTS
GROUP



TEXAS INSTRUMENTS

INCORPORATED

P. O. BOX 66027 HOUSTON, TEXAS 77006
118 RUE du RHONE GENEVA, SWITZERLAND

Hear a discussion of *DYNAMIC* testing benefits at WESCON: Thursday, August 26, Empire Room, Sir Francis Drake Hotel.

740

Rugged, Ceramic Beam Pentode for Critical Linear Amplifier Applications



Combine unique, rugged internal tube construction, Penta's patented vane-type suppressor grid, and low interelectrode capacitance and you have the new PL-8641 ceramic beam pentode. You will find it an ideal tube for critical linear applications.

As a Class-AB₂ amplifier, the new PL-8641 will deliver over 5500 watts of useful PEP output, with 5000 plate volts and 1000 volts on the screen grid. Plate dissipation is conservatively rated at 3000 watts.

A unique thoriated tungsten mesh filament is used in the PL-8641, permitting reasonable electrode spacings. This means a rugged, dependable tube.

These are the maximum ratings for the new PL-8641:

Filament Voltage	6.0 volts
Filament Current	85 amperes
Plate Voltage	5000 volts
Plate Current	2.0 amperes
Screen Voltage	1000 volts
Plate Dissipation	3000 watts

Write today for full details on this newest addition to the Penta line of dependable beam pentodes. The Penta Laboratories, Inc., 312 N. Nopal Street, Santa Barbara, California 93102.
A Subsidiary of Raytheon Company.



People

"You've got to remove the organizational barriers as much as possible so you can get a natural flow of ideas—especially with a company of this size," says **Arthur M. Bueche**, new director of the General Electric Co.'s Research and Development Center in Schenectady, N. Y.



The center, employing 700 engineers and scientists, was formed last month by combining GE's basic research lab and its applied technology lab under a single organizational roof.

To accomplish this idea exchange, he hopes GE will move its basic and applied research into a single building. The facilities are now several miles apart.

Bueche (pronounced BEE-ka) believes in the interdisciplinary approach to research. Specialists in one field, he says, must have easy direct access to specialists in another. When a material or a technique is developed in one section of a lab, researchers with various specialties should have an opportunity to apply it to their own fields.

But Bueche maintains that this does not mean decisions by committee. A research center must maintain an atmosphere in which an individual can try things on his own, he says. "If he's right about an idea, we'll know it, because it'll work," he explains.

The new research director, who was also given the title of vice president, holds a doctorate in chemistry. Chemists outnumber physicists and electronics engineers at the lab, he explains, because much of the basic work in electronics depends on understanding a material's chemistry.

Bueche joined GE as a research chemist in 1950, after three years as a research associate at Cornell University. In 1956 he moved into a managerial position. He has done research on the effects of high energy on polymeric materials.

TV Transmitting Tube For CHANNEL MOON, On Target, On Frequency

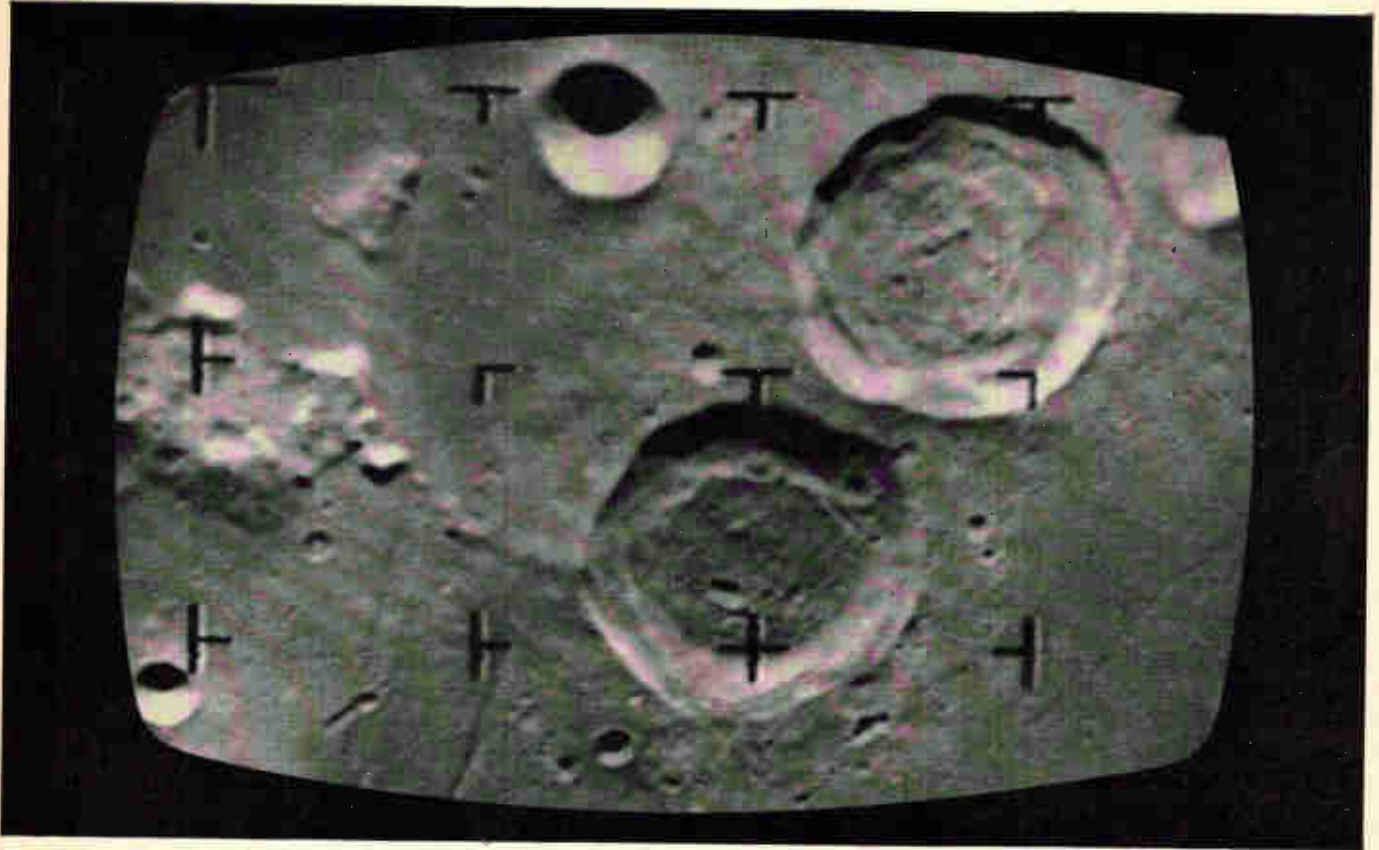

The ML-7855 frequency stable Machlett UHF planar triode transmitted all of the moon pictures—sharp and clear—for Rangers 7, 8, and 9. On frequency, and at full power within seconds, the ML-7855 powered TV transmitters have been an outstanding success. In space, in the military service, in the nation's airliners—wherever the highest reliability and performance is required, use of Machlett planar triodes demonstrates the continuing confidence in the capability of the Machlett organization. Whether you require high power/high voltage triodes or tetrodes, UHF planar triodes, X-ray tubes, vidicons, or need assistance in research or design development, write: The Machlett Laboratories, Inc., Springdale, Conn. 06879. An affiliate of Raytheon Company.

MACHLETT
ELECTRON TUBE SPECIALIST

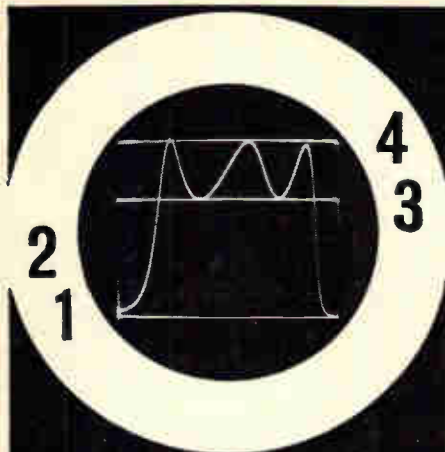

see **4** response
traces on single-
trace scope

measurement by comparison
up to 1,200 mc



NEW
JERROLD
SOLID-STATE
3-POSITION
COAXIAL SWITCHER

Model TC-3 \$295⁰⁰

Turn any single-trace oscilloscope into a 4-trace scope; insert two reference traces automatically in addition to test trace and baseline. These references have advantage of permanent relative accuracy over scribed or painted lines.

Results are repeatable, as accurate as your reference attenuators. Generator and scope drift do not affect accuracy of measurements. Frequency from dc to 1,200 mc extends usefulness of comparison technique well into the UHF band. The TC-3 Coaxial Switcher can save you thousands of dollars in speed and accuracy. Write for literature.



Industrial Products Division,
Philadelphia, Pa. 19132
In Canada: Jerrold Electronics,
60 Wingold Ave., Toronto 19, Ont.
Export: Rocke International,
13 E. 40th St., New York, N.Y. 10016

See us at WESCON Booth 3509-10-11

Meetings

Heat Transfer Conference, Heat Transfer Division of ASME, Energy Conversion and Transport Division of AIChE; Biltmore Hotel, Los Angeles, Aug. 8-11.

Techniques in Long-Range Planning, AMA; AMA Headquarters, NYC, Aug. 16-18.

Technical Instrumentation Symposium, U. S. Air Force Systems Command, SPIE; Jack Tar Hotel, San Francisco, Aug. 16-20.

American Astronautical Society National Meeting, AAS; Sheraton-Palace Hotel, San Francisco, Aug. 18-20.

International Conference on Energetics, Energetics Division of ASME; Unit. of Rochester, N.Y., Aug. 18-20.

Conference on Phenomena in Ionized Gases, Institute of Nuclear Sciences; Trade Union Building, Trg Marksa i Engelsa, Belgrad, Yugoslavia, Aug. 22-27.

International Conference on Medical Electronics, Japan Society of Medical Electronics and Biological Engineering; Tokyo, Aug. 22-27.

Electronic Circuit Packaging Symposium, EDN; San Francisco Hilton Hotel, San Francisco, Aug. 23-24.

Electron Devices Symposium, IEEE Electron Devices Group; Fairmont Hotel, San Francisco, Aug. 23-24.

Computing Machinery National Meeting, ACM; Sheraton-Cleveland Hotel, Cleveland, Aug. 24-26.

Western Electronic Show and Convention (WESCON/65), IEEE, WEMA; Cow Palace, San Francisco, Aug. 24-27.

The '65 Show, Industrial and Trade Fairs Ltd.; London, England, Aug. 24-Sept. 4.

Systems Engineering for Control System Design Symposium, IFAC; Tokyo, Aug. 25-26.

Radio-Products Fair, Stuttgarter Ausstellungs-GMBH; Stuttgart Kellesburg, Germany, Aug. 27-Sept. 5.

Antennas and Propagation International Symposium, IEEE; Sheraton Park Hotel, Washington, D.C. Aug. 30-Sept. 1.

Boulder Millimeter Wave and Far Infrared Conference, IEEE et al; Stanley Hotel, Estes Park, Colorado, Aug. 30-Sept. 1.

Opto-Electronic Components and Devices Symposium, Advisory Group for Aerospace Research and Development; Paris, Sept. 6-9.

Technical Conference on Materials Science and Technology in Integrated Electronics, Electronic Materials Committee, Institute of Metals Div. of the Metallurgical Society and San Francisco Section of the AIMMPE; St. Francis Hotel, San Francisco, Sept. 7-9.

International Electronic Exhibit INEL, Swiss Fair Authorities; Basel, Switzerland, Sept. 7-11.

Industrial Electronics and Control Instrumentation International Congress, IEEE; Sheraton Hotel, Philadelphia, Sept. 8-10.

International Inventors and New Products Exhibition, International Institute for Patent Products Limited; New York Coliseum, Sept. 9-12.

Electrical Insulation Conference, IEEE, NEMA; New York Hilton Hotel, New York, Sept. 13-16.

Joint Engineering Management Annual Conference, IEEE/ASME; New York Hilton Hotel, N. Y., Sept. 13-14.

Technical Association of the Pulp & Paper Industry Engineering Conference, Engineering Div. of Tappi; Leamington Hotel, Minneapolis, Minn., Sept. 13-16.

Engineering Materials and Design Conference, Industrial & Trade Fairs Ltd., Olympia, London, Sept. 13-17.

Call for papers

Aerospace Systems Conference, IEEE; Olympic Hotel, Seattle, Washington, July 11-15, 1966. **September 30** is deadline for submission of 4 copies of 250-word abstract to Thomas J. Martin, Technical Program Chairman, 3811 E. Howell St., Seattle, Wash. 98122.

Solid State Circuits Conference, IEEE, Univ. of Pennsylvania; Univ. of Pennsylvania and Sheraton Hotel, Philadelphia, February 9-11, 1966. **October 15** is deadline for submission of 35-word abstract and 500-word summary to Konrad H. Fischer, U.S. Army Electronics Command, Attn: AMSE-1-KL-1, Fort Monmouth, New Jersey 07703.

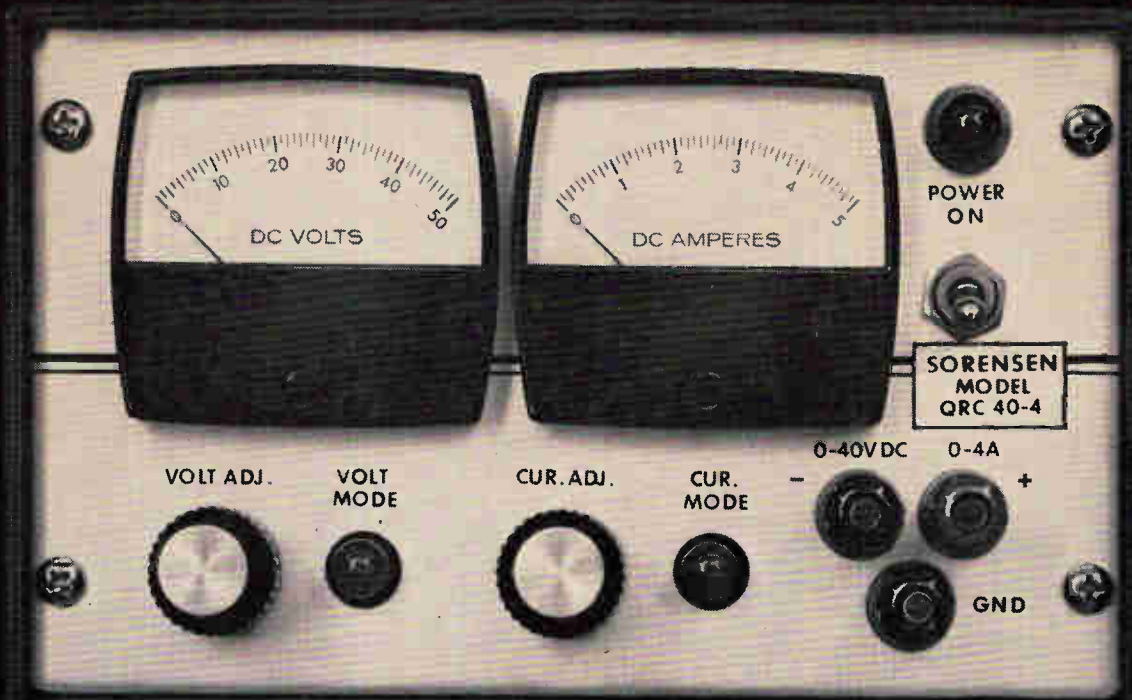

**WRITE A SPEC
FOR YOUR IDEAL
POWER SUPPLY**

**THEN Compare* IT TO
SORENSEN'S EXPANDED QRC SERIES...
NOW WITH 3 NEW MODELS**

First, start with voltage regulation of $\pm 0.005\%$ line and load combined ■ Then, add voltage ripple of 1 mv RMS ■ Current regulation of $\pm 0.05\%$ of maximum current output ■ Current ripple as low as 1 ma RMS ■ Transient response 50 μ sec. to return to ± 20 mv band ■ Excellent stability, typically 0.025% for 8 hours (after warm-up) ■ Resolution approximately 0.01% ■ Input versatility 105-125/201-239 VAC, 50 to 400 CPS ■

Constant voltage/constant current indicator lights ■ Vernier controls on both voltage and current adjustments ■ Output voltage and current meters ■ Voltage and current programming ■ Series/parallel operation ■ Remote sensing ■ No turn-on, turn-off overshoots ■ Plug-in control boards ■

Price? How about \$450 for 0-40 volts, 0-8 amps, in a 3½" high package? Still want to compare? For more information on the QRC series, call your local Sorensen representative, or write: Sorensen, A Unit of Raytheon Company, Richards Avenue, South Norwalk, Conn. ■ Or use Reader Service Number 200 ■

Then, build in every conceivable design feature like: High efficiency ■ Constant voltage/constant current crossover (so sharp the units never leave the specified regulation bands) ■



ELECTRICAL AND MECHANICAL SPECIFICATIONS

MODEL NUMBER	OUTPUT VOLTAGE RANGE (VDC)	OUTPUT CURRENT RANGE (AMPS)	CONSTANT VOLTAGE REG. (LINE & LOAD COMBINED)	CONSTANT VOLTAGE RIPPLE RMS	CONSTANT CURRENT RANGE	CONSTANT CURRENT REGULATION	CONSTANT CURRENT RIPPLE RMS	RACK HEIGHT (INCHES)	PRICE
QRC20-8	0-20	0-8	$\pm .005\%$ or ± 1 mv	1 mv	0-8	$\pm .05\%$ or ± 4 ma	2 ma	3½	\$410.00
QRC40-4	0-40	0-4	$\pm .005\%$ or ± 1 mv	1 mv	0-4	$\pm .05\%$ or ± 2 ma	1 ma	5¼†	315.00
QRC20-15	0-20	0-15	$\pm .005\%$ or ± 1 mv	1 mv	0-15	$\pm .05\%$ or ± 8 ma	4 ma	5¼	525.00
QRC40-8	0-40	0-8	$\pm .005\%$ or ± 1 mv	1 mv	0-8	$\pm .05\%$ or ± 4 ma	2 ma	3½	450.00
QRC20-30	0-20	0-30	$\pm .005\%$ or ± 1 mv	1 mv	0-30	$\pm .05\%$ or ± 16 ma	8 ma	7	700.00
QRC40-15	0-40	0-15	$\pm .005\%$ or ± 1 mv	1 mv	0-15	$\pm .05\%$ or ± 8 ma	4 ma	5¼	575.00
QRC40-30	0-40	0-30	$\pm .005\%$ or ± 1 mv	1 mv	0-30	$\pm .05\%$ or ± 16 ma	8 ma	7	775.00

†Half rack

This is Siemens

Never before has electrical engineering covered such a wide field as today. This extends from the thin magnetic films of high-speed memories to the mammoth dimensions of modern turbine generators. Electrical systems operate with subminiature waves only a thousandth of a millimeter in length as well as low-frequency waves up to several kilometers in length. Research has penetrated into a subtemperature region only a few degrees above absolute zero. For its plasma investigations it generates temperatures approaching that of the sun. Reactor technology harnesses the inmost forces of the atomic nucleus. Communications satellites circle the earth.

These extreme achievements give an idea of the broad range of our activities, which extend all the way from the study of first principles to the ultimate development of new products. That is why the Siemens Group keeps 15,000 of its employees assigned to R&D projects alone. The results of their efforts are of concrete benefit to all of our customers: every system that leaves our factories and every system we install reflects the sum total of the experience acquired and evaluated daily at our R&D laboratories.



Components Plant, Munich

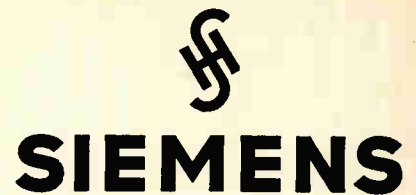

Siemens Polystyrene "Styroflex" Capacitors

"Mica" properties at "paper" prices

Unique properties of Polystyrene and the method of manufacture developed by Siemens (The polystyrene is stretched and stabilized in the stretched condition before winding. After winding, special heat treatment shrinks the film, forming a hard, stable body.) results in low cost STYROFLEX capacitors which offer:

Reliability: 1) against voltage breakdown (assured by tests on each unit at 3.3 times rated voltage). 2) in the microvolt range (assured by positive welded contacts between foil and leads).

Stability against change in capacitance over long periods of time is one result of the solidity and hardness of the capacitors... produced by the special film shrinking manufacturing process.

Low Self-Inductance: values as low as for extended-foil construction.

Low Dissipation Factor: usually even lower than for mica capacitors, making them especially suitable for filter circuits.

High Resistance to Humidity: polystyrene has the lowest water absorption coefficient of all capacitor dielectric materials.

Highest Insulation Resistance: higher than for any other kind of dielectric.

Immediate Shipment: substantial stocks are held in White Plains, N. Y.

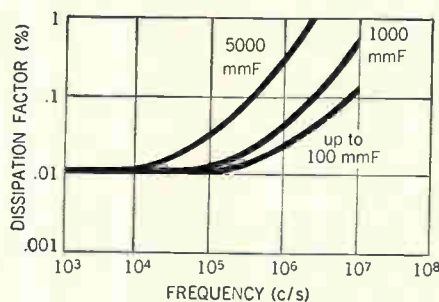
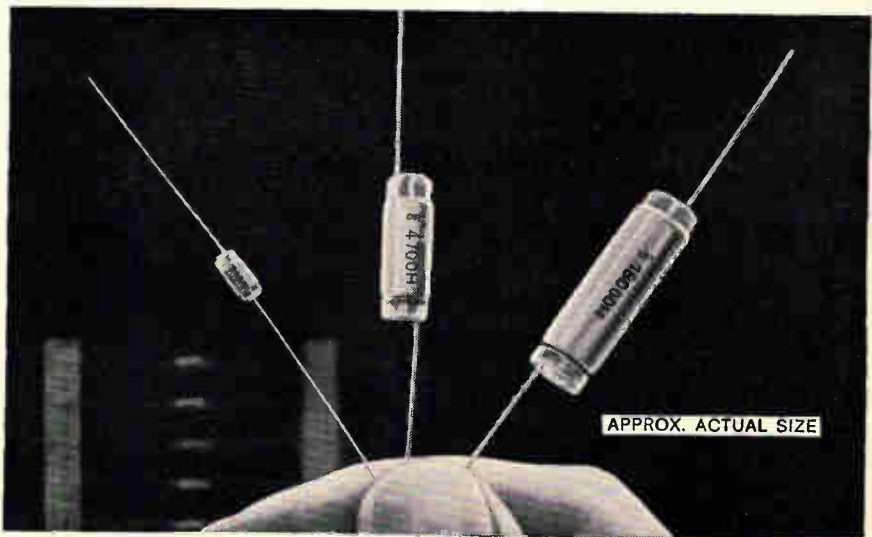

Low dissipation factor (usually even lower than for mica capacitors) is provided by Styroflex capacitors... making them specially suitable for filter circuits.

SIEMENS AMERICA INCORPORATED
Components Division
230 Ferris Avenue, White Plains, N. Y.

In Canada:

SIEMENS HALSKE SIEMENS SCHUCKERT (CANADA) LTD.
407 McGill Street, Montreal 1, P.Q.

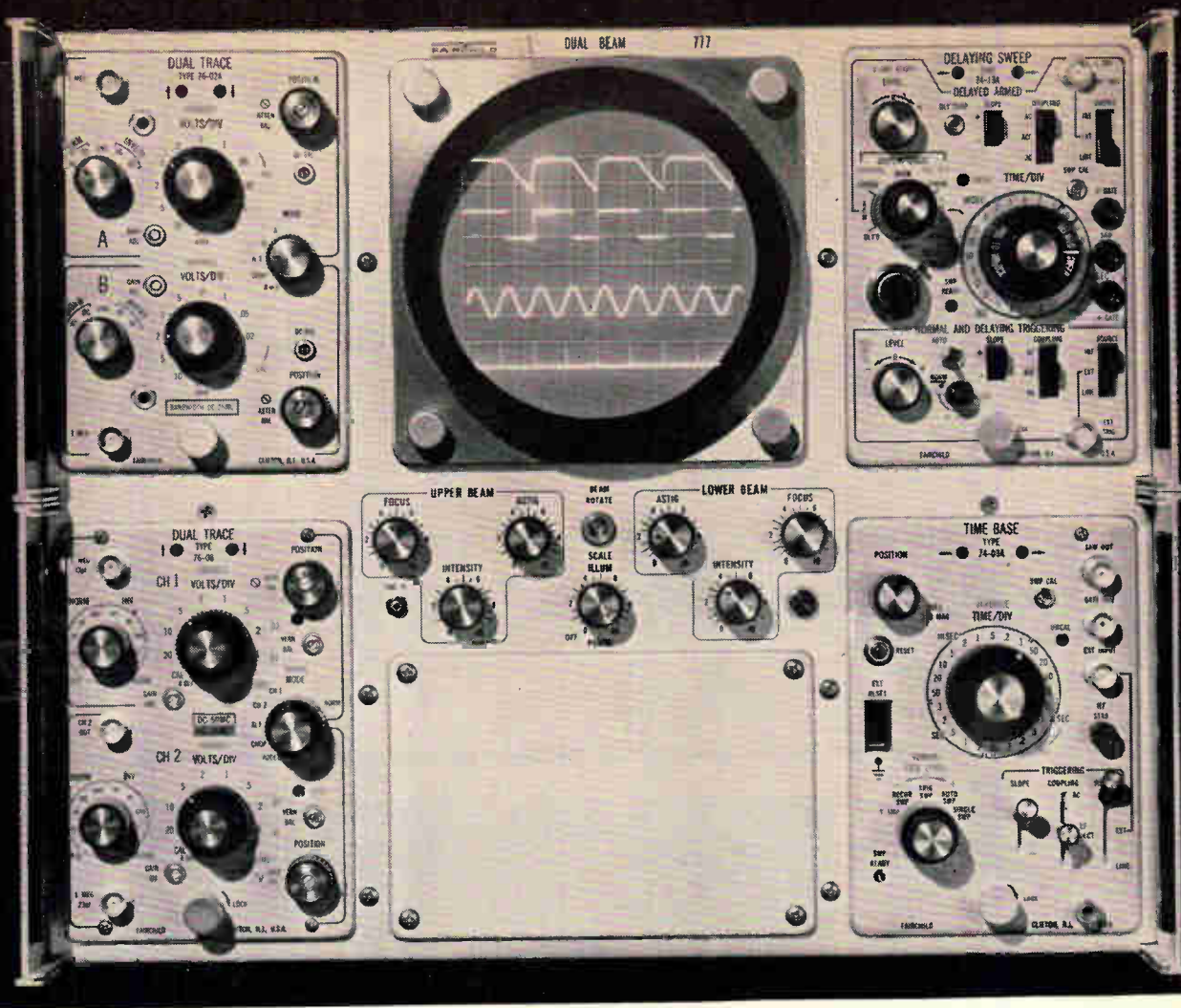

HOW MANY SCOPES CAN THIS ONE REPLACE?

A sizable number, depending upon the range of applications. For this is the Fairchild 777—the most versatile of all industrial scopes. The 777 is a dual beam, dual trace scope in which any four of 22 plug-ins are completely interchangeable in both X and Y cavities. These same plug-ins fit all Fairchild 765H Series scopes. They include DC-100 mc bandwidth, spectrum analyzer and raster display capabilities, sensitivity to 500 $\mu\text{v}/\text{cm}$, risetime to 3.5 ns.

Other features of the 777 include 6 x 10 cm display area for each beam with 5 cm overlap between beams for optimum resolution... unique 13 kv CRT with four independent deflection structures... solid state circuitry (with all deflection circuitry in the plug-ins)...light weight (44 lbs.)... environmentalized for rugged applications. Price (main frame): \$1,600 f.o.b. Clifton, N.J.



The 777 illustrates the Fairchild concept of value through versatility. One scope doing many tasks is only part of it. Future state-of-the-art capability is equally important because it helps you curb the high cost of Technological

Obsolescence. And finally, service. Fairchild has more service centers than any other scope manufacturer.

Ask your Fairchild Field Engineer for details on this and other new generation Fairchild scopes. Or write to Fairchild Instrumentation, 750 Bloomfield Ave., Clifton, N.J.

FAIRCHILD

INSTRUMENTATION
A DIVISION OF FAIRCHILD CAMERA
AND INSTRUMENT CORPORATION

*Technological Obsolescence

Circle 14 on reader service card

Editorial

Changing an image

Read

It is an unhappy paradox that the expansion of electronics, which makes it possible to reach out into space, to probe ocean depths, and link nations by satellite, has reduced the stature of the electronics engineer. And the fault is clearly his. By abandoning his responsibility in this most dynamic of professions, the engineer has created an intellectual and occupational void that the physical scientist is filling.

In the New York Times Sunday Book Review last month, Daniel Lang praised the intelligence and contribution of scientists in a torrent of words. Climaxing the buildup, he said, "The view persists that scientists are special, the ones who have demonstrated that the brain can be made to work." At the same time, he ticked off engineers with one damning sentence: "He is an engineer—that is a nuts-and-bolts man who is applying what is already known about nature."

Lang's disparaging comparison comes at a time when many electronics engineers are worrying about their image. At the headquarters of the Institute of Electrical and Electronic Engineers in New York, a group is wrestling with the problem of how to raise the general public's opinion of electronic's engineers. Earlier this year, a National Academy of Engineers was established to do much the same kind of prestige-raising for the profession. The concern is that scientists, particularly physicists and mathematicians, have dramatically upstaged electronics engineers in the space age and have stolen the spotlight. Complained one staff member of the IEEE, "It's always a scientist you see on television explaining a space shot, but when something goes wrong, it's an 'engineering failure'."

There's nothing new about physical scientists in electronics. In the infant days of the technology, many of the best-known innovators came from the physical sciences: Sir John Ambrose Fleming, the inventor of the electron tube and the thermionic rectifier, was a physicist; Charles P. Steinmetz, the genius at the General Electric Co., was trained as a mathematician. Even in

later years, physical scientists continued their contributions to electronics; thus the transistor, the maser and the laser have been the brain-children of physical scientists rather than engineers. But that is expected; physical scientists should be the people to explain the basic phenomena of nature and harness them for devices that are on the outpost of technology.

Today, something quite different and dangerous is happening. Physical scientists are taking over a lot of the jobs that are basically engineering in nature. Scientists hold most of the key positions on the Mariner 4 project (which took the pictures of Mars last month), Ranger shots, the Apollo moon program and others. Fifteen years ago, in the quiet academic atmosphere that was the habitat of the scientist, such projects would have been considered engineering work, and outside the province of the scientist.

The reason for the change is relatively simple but fundamental: most engineers are not practicing engineering. There is truth in the charge that too many are technicians working with nuts and bolts despite their handsomely engraved engineering diplomas and fancy titles. They have refused the challenge of the real engineering job—analyzing a situation to determine the technical problem and then bringing the technology to bear to solve it—for a much easier pursuit. They let others create while they crib circuits or build hardware from available components.

Such men have created a vacuum that scientists have rushed to fill. Along the way, the scientists have picked up higher pay, wider public recognition and the satisfaction of challenging work assignments.

Unless engineers do something positive, more and more scientists will be invading their domain. The answer does not lie in a publicity campaign program to sell the profession to the public; it is in performance. Engineers with curiosity, talent, imagination, and willingness to learn and work will not have to seek public acclaim. It will be given freely.

Symptoms of engineering apathy are all around us: too many engineers neither read technical journals and magazines nor attend technical meetings because they feel their formal learning ended when they left college. Many who do go to technical meetings write blatant puffs instead of sound, informative papers because they want to be considered commercially oriented. Not enough engineers care what is happening in electronics outside their own specialty. All too many are content with their routine work in a self-limiting and ever-narrowing area of the field.

No wonder the profession is earning a second-class reputation.

Attn. Servo System Designers:

Look at the Signal to Noise Ratios on these Clifton production-run Resolvers!

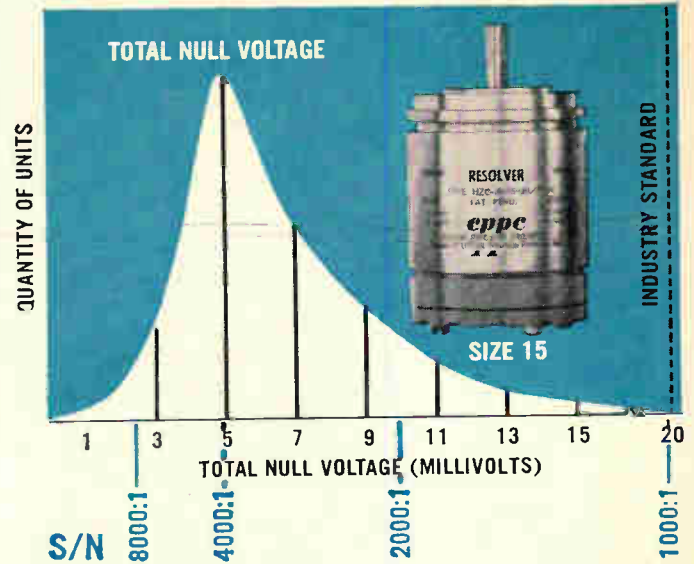
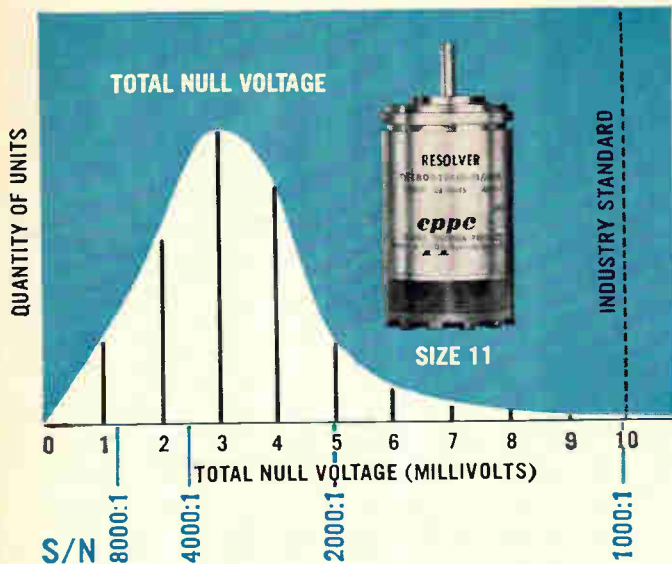

HIGH ACCURACY, TOO!

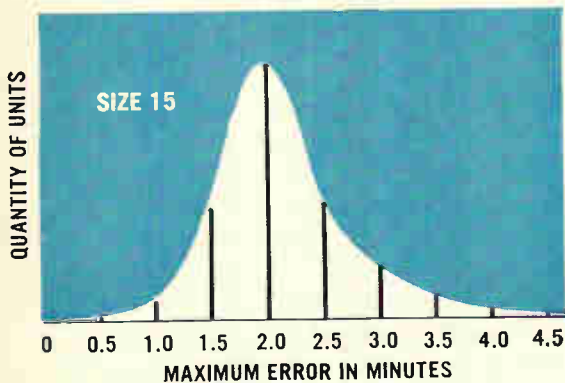
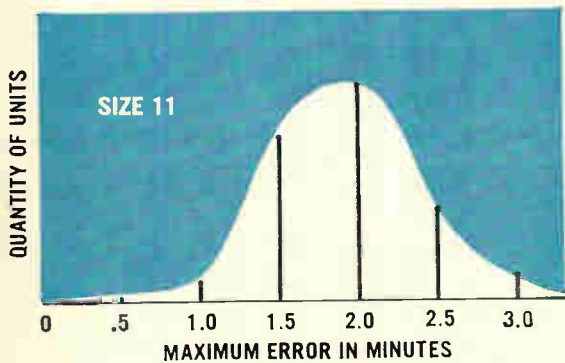

Clifton Precision continues to improve the nulls and accuracy on its Precision Computing Resolvers. A little close study of the curves shows that you are getting far better units than the industry standard and probably considerably better than your spec calls for. For instance, almost half of these production line units are exhibiting Signal to Noise ratios of 4000:1 min. About half of the units show max. errors of 2 minutes or less.

Why be satisfied with less than the best in Precision Computing Resolvers. These units cost no more than competitive units, sometimes less, and they give *better* nulls and accuracy in production quantities.

Clifton Precision Products, Division of Litton Industries, Clifton Heights, Pa., Colorado Springs, Colo.

**WHY BE SATISFIED WITH
LESS THAN THE BEST?**

eppe **CLIFTON** PRECISION PRODUCTS
DIVISION OF LITTON INDUSTRIES



Electronics Newsletter

August 9, 1965

Sparrow may take Phoenix's place

Rumors that the Navy may eliminate the Phoenix missile in favor of the Sparrow are becoming stronger [Electronics, June 14, p. 41]. The radar- and infrared-guided missile has run into design problems, as has the F-111B fighter plane on which it is to be used.

The Navy may not only order an upgrading of the radar-guided Sparrow so that it can do the job of the Phoenix, but also a new version of the F-4B and F-4C fighters, which carry the present Sparrow III. The Navy acknowledges that it has "on the drawing board" plans for an updated Sparrow that has better range and altitude capabilities than the Sparrow III. There is talk about an advanced F-4, called the F-4H, which, with an upgraded Sparrow, could accomplish the mission that is intended for the F-111B.

The British are reported to be interested in buying the F-4H and the improved Sparrow as a new weapons system more suitable for aircraft carrier operation than the heavier F-111B.

The F-4's are made by the McDonnell Aircraft Corp., the Raytheon Co. is prime contractor for the Sparrow, the Hughes Aircraft Co. has the Phoenix contract and the General Dynamics Corp. holds the F-111B order.

Ford considering IC speedometers

Detroit may soon turn to integrated circuits for use in instrument panels on cars and trucks. The Ford Motor Co. is considering an integrated-circuit speedometer-odometer—being developed by Stewart-Warner Microelectronics, Inc., a subsidiary of the Stewart-Warner Corp.—for use in future models of its Mustang.

Stewart-Warner says a producer of taxicab meters is also considering the use of IC's. The advantage in making these instruments all electronic instead of electromechanical, says Stewart-Warner, is that they are cheaper, more reliable and smaller.

Arrays of IC's cut computer costs

For years, computer makers have been predicting they could slash manufacturing costs by using monolithic arrays of integrated circuits. This claim is borne out by Honeywell, Inc.'s new flight computer, called Alert; almost half of its logic circuits are made of 10-circuit arrays in large, 40-lead flatpacks. The circuits, developed for Honeywell by Texas Instruments Incorporated, are called steering arrays because they gate signals into other logic circuits.

The logic system is made of 239 arrays and 960 conventional 14-lead flatpacks housing one to four logic circuits. Without the arrays, 2,035 packages would be needed instead of 1,199. The king-size circuits cost twice as much as the others, but Honeywell gets the equivalent of 2,035 packages for the cost of 1,438, a 33% saving. The 40-lead flatpacks also require about 35% fewer lead bonds and joints than regular flatpacks do.

The National Aeronautics and Space Administration and the Air Force will use the Alert for guidance, navigation and adaptive energy management experiments in NASA's supersonic research plane, the X-15A-3. Weighing only 37 pounds with a Biax-core memory of 4,096 24-bit words, the computer is a high-speed parallel machine. It can add in two microseconds—twice as fast as the IBM 7090. Honeywell hopes to sell the computer for weapons systems, particularly for Navy aircraft.

Electronics Newsletter

First test center for connectors

The Amphenol Corp. has opened a connector test center in Chicago. The facility is the first in the industry to test components under recently drawn guidelines to measure the reliability of connectors [Electronics, May 30, p. 17.] Production batches of connectors will be tested under various environmental conditions: heat, cold, humidity, vacuum and vibration.

The move to establish reliability standards, under the aegis of the Electronic Industries Association, follows complaints that connectors weren't meeting the standards sought by military and industrial users. The guidelines are being reviewed by the Defense Electronic Supply Center in Dayton, Ohio.

Bendix to supply air-control radios

The Air Force has settled on the Bendix Corp. to produce a lightweight forward air-controller radio that can communicate with any radio used by any government.

Prototypes of the radio, designated the PRC-72, will be produced by the Bendix radio division at Towson, Md., under a \$1.5-million contract. The Air Force may buy as many as 5,000 sets.

The PRC-72 is similar to the PRC-71 built by Sylvania Electric Products, Inc., only it will be much lighter. Sylvania is a subsidiary of the General Telephone & Electronics Corp.

The Air Force contract calls for the PRC-72 to weigh no more than 30 pounds—as little as 25 pounds if possible. The PRC-71, with case, bag and carrying kit weighs 55 pounds. The new radio is to replace the PRC-71 and the old, but still reliable, PRC-47, an even heavier unit with limited frequency coverage. Forward air-controller radios are portable sets used to communicate with aircraft from forward positions on the ground. But the PRC-71 and PRC-72, with their broad frequency capabilities, can fulfill a number of other communications tasks.

The contract is administered by the Oklahoma City Air Materiel Area at Tinker Air Force Base, Okla. The Rome Air Development Center at Rome, N.Y., has the engineering responsibility.

Comsat's revenue trails expectations

The Communications Satellite Corp.'s first payment for Early Bird service was so small that it underlined Comsat's disappointment in the initial commercial response to the satellite.

The amount, \$247,000 from the American Telephone & Telegraph Co., represented use of only 60 of the 240 Early Bird channels instead of the 100 channels that Comsat had hoped AT&T would use.

Comsat officials concede that Early Bird's traffic is far short of earlier expectations. Comsat had hoped to have 180 circuits in use by the end of this year, but so far only 61 are under lease.

Part of the difficulty appears to stem from the fact that Comsat's European partners, eager to protect their investment in underwater cables, are holding back development of ground stations and distribution links in Europe.

RCA to make 15-inch color tv

The Radio Corp. of America will follow the General Electric Co. into the small-size color television tube field. RCA will produce a 15-inch rectangular tube; earlier this year GE announced it would make an 11-inch rectangular tube.

Receivers with the RCA tubes should reach the market next spring; GE's sets are slated to be ready by Christmas.

Look to Newark for fast service on these new germanium transistors

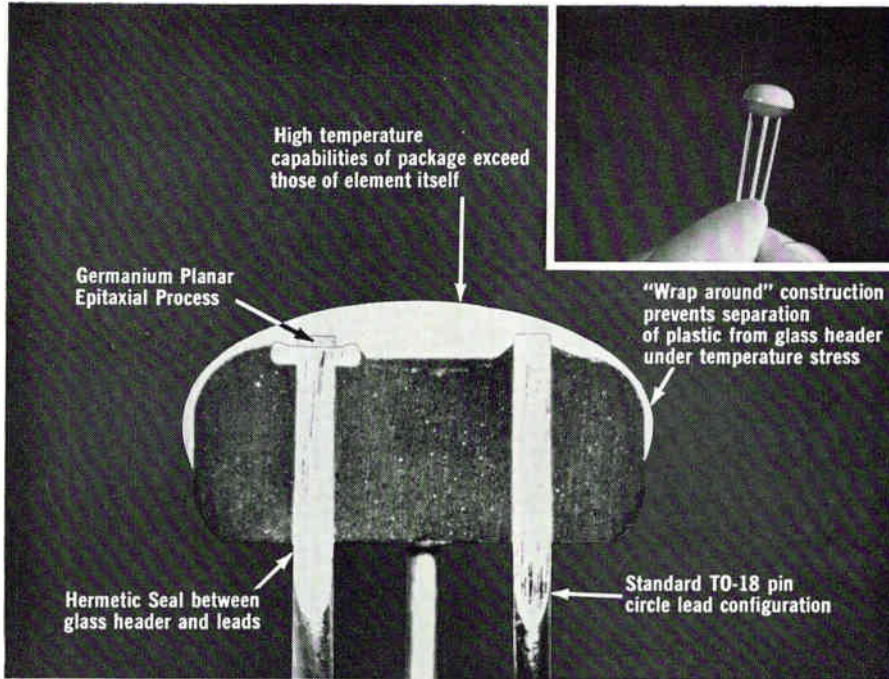

Rugged, low-noise TIXM101 ideal for high-frequency military and industrial circuits

Guaranteed noise figure of TI's new TIXM101 transistor is 2.6 db at 200 mc . . . 4.5 db at 1 Gc. Gain-bandwidth product (f_T) is guaranteed 1.5 Gc, giving your circuit more gain per stage at high frequencies. And planar-germanium construction allows the TIXM101 to withstand more than 40,000 G's in the critical Y_1 plane and 1500 G's shock. Call us for fast delivery of these very low-noise, rugged devices in hermetically sealed TO-18 package — especially useful for aerospace high-frequency amplifiers.

Improve your audio circuit reliability at no increase in cost with new economy germanium series

Low-noise of 4 db max at 1 kc, high breakdown voltage of 50 volts, and high gain of 120 min at 0.5 ma are features of a new TI series of pnp germanium alloy transistors. Packaged in a standard hermetically sealed TO-5, the TIXA01-05 economy series is ideal for low-noise, small-signal audio amplifier applications.

Economy plastic planar transistors reduce cost, improve performance in TV, FM and industrial circuits.

New pnp epitaxial-planar germanium economy transistors — TIXM01-08 — are designed for RF, oscillator, mixer, and IF applications in television and FM broadcast receivers and in industrial applications requiring low-noise, high-frequency amplifier devices. Low noise (2.8 db typical at 200 mc), high gain, forward AGC, low feedback capacitance, and low-cost plastic-and-glass package suggest use in many other applications as well. We have large stocks ready for immediate delivery. Specify TIXM01-04 for AM/FM; TIXM05-08 for TV.

And look to Newark first for prompt delivery on industry's broadest, most proven line of germanium transistors . . . from Texas Instruments

Why go to two or three narrow-line suppliers for your germanium requirements? A look to the leader first can save you both time and money. We stock, in depth, more than 150 types of TI germanium

small signal transistors . . . transistors proven in high-reliability programs backed by tens of millions of life-test hours. These include switching, amplifier, general purpose, and high-frequency de-

vices made by the alloy, mesa and planar epitaxial processes. Get biggest choice from our inventory of TI germanium transistors . . . by far industry's broadest, most proven line.

NEWARK
ELECTRONICS
CORPORATION

DETROIT 37, MICHIGAN
Newark-Ferguson Electronics, Inc.,
20700 Hubbell Avenue,
Area Code: 313, Phone: UN 1-6700

CHICAGO 6, ILLINOIS,
Newark Electronics Corporation,
Main Office and Warehouse,
223 West Madison Street,
Area Code: 213, Phone: ST 2-2944

GRAND RAPIDS, MICHIGAN,
Newark-Industrial Electronics Corp.,
2114 S. Division Ave.,
Area Code: 616, Phone: CH 1-5695

LOS ANGELES AREA,
Newark Electronics Co., Inc.,
4747 W. Century Blvd.,
Inglewood, Calif.,
Area Code: 213, Phone: OR 8-0441

CINCINNATI 10, OHIO,
Newark-Herrlinger Electronics Corp.,
112 East Liberty Street,
Area Code: 513, Phone: GA 1-5282

DENVER 22, COLORADO,
Newark-Denver Electronic
Supply Corporation,
2170 South Grape,
Area Code: 303, Phone: 757-3351

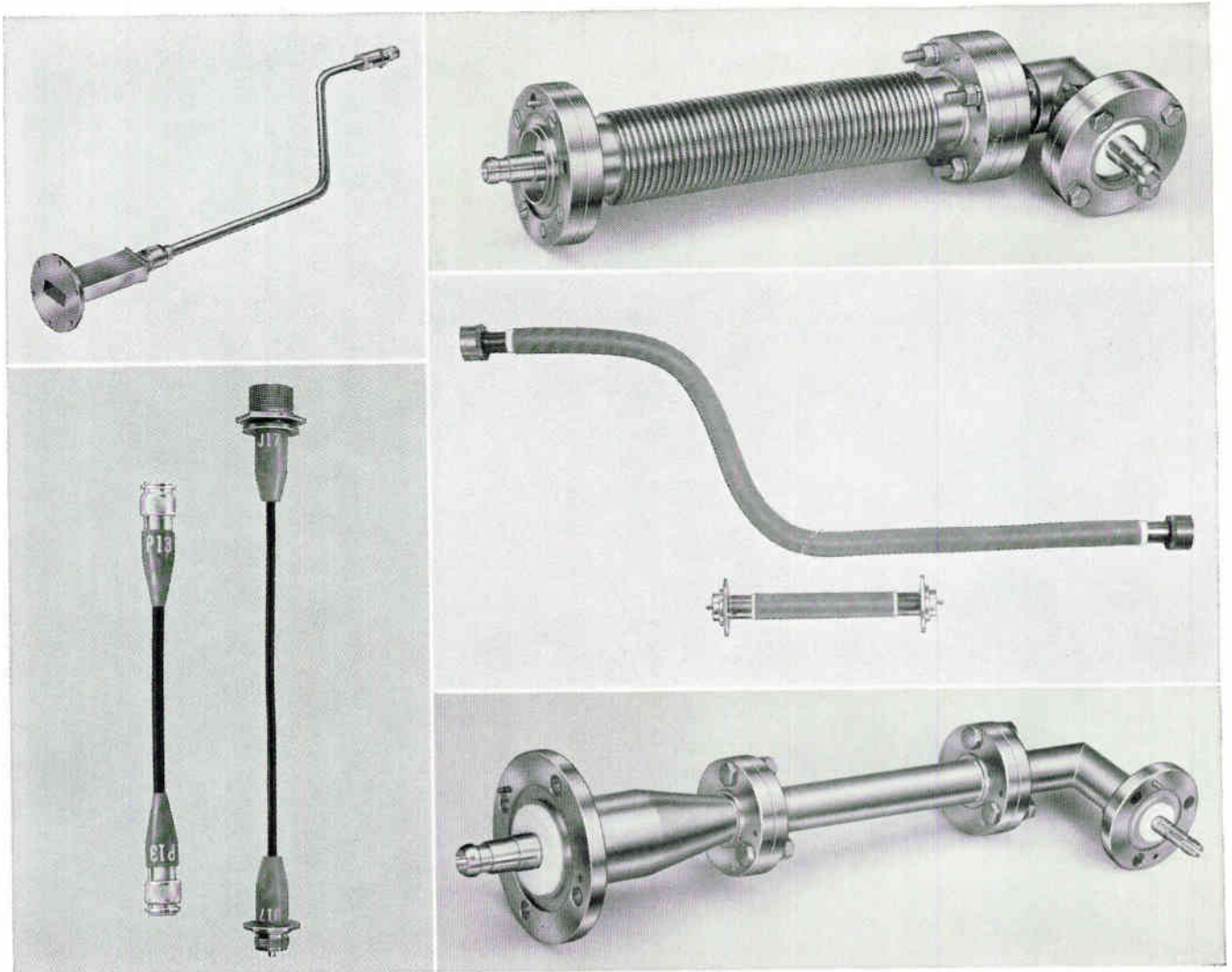

Coaxial cable assemblies. Ingenious solutions to very special installation and transmission problems.

Phelps Dodge Electronic's coaxial cables are available by the mile or by the foot. They are also available in unique, one-of-a-kind shapes and configurations which greatly extend application parameters. For instance, in transmitter installations, a cable assembly can eliminate the need for elbows and other high cost RF plumbing. In tight physical confines, or under difficult environmental conditions, a special cable assembly might well be the answer.

We have made hundreds. And, they are all different. Tracking antenna harnesses, as an ex-

ample, sections of cable which accurately place each antenna element in phase with other elements. Special local oscillator and receiver lines, each a section of Styroflex® coaxial cable cut to very tight electrical length for transition to waveguide. An airborne vibration isolator, an extremely flexible corrugated assembly connecting rigid line to shock mounted gear. Or, in equalizing and balancing networks. Matching sections.

We would like to hear about your needs. Write for Bulletin CC-1.

PHELPS DODGE ELECTRONIC PRODUCTS
NORTH HAVEN, CONNECTICUT



Obviously photography is the neat way to capture information and record data

You would like to try it. (You have heard that photographic processing is now so fuss-free and compact that it can go on all by itself in unmanned spacecraft.)

But photo-technology may not be your game. And your needs are special.

Wouldn't it be nice to talk them over with some fellow engineers who live photo-technology day in and day out?

You don't have to turn into any more of a photo-technologist yourself than you want to be. New developments can make such a carefree attitude realistic.

Tell us what you want to accomplish. If we think you're over-optimistic we'll tell you. Otherwise, we'll invite you to Rochester for conversations with the two or three men best qualified to tell you exactly what to do or whom

to see for the results you seek.

We have quite an assemblage of photo-engineers to draw on.

We are, after all,

Kodak

Call or write Eastman Kodak Company, Special Applications, Rochester, N.Y. 14650, 716-325-2000, Ext. 5129.



Introducing Item 11 in the Fluke '65 Pacesetter Line

New solid state voltage calibrator accurate to 0.003% with variable current limiting and overvoltage trip for absolute protection of all the equipment in your set-up. Line and load regulation, 0.0005% of setting. Panel meter monitors either output voltage or current. Easy to read seven digit dial-up. Weighs 40 lbs. Only 7 inches high. Price, \$2,490. It's a bargain!

More Model 332A Features and Specifications—Seven inline decade switches provide one-tenth part per million resolution on each voltage range. DC common mode error is less than 2 nanovolts per volt of common mode voltage (174 db CMR). Range is 0 to 1,111.1110 volts in steps as small as 1 microvolt. Output current is 0 to 50 milliamperes at any output voltage. Overcurrent protection automatically limits output current at any preset level between 1 ma and 60 ma. Overvoltage protection automatically disables output voltage if level exceeds setting of front panel control. The continuously variable overvoltage trip can be set to operate at any point from 10% to 110% of each range. Stability is $\pm 0.0015\%$ per week or $\pm 0.0025\%$ per six months. Temperature coefficient is 0.0002% of setting per °C from +20 to +40 °C. Ripple and noise are less than 20 μV rms on the 10 v range and less than 40 μV rms on the 1,000 v range.

FLUKE

FLUKE • Box 7428 • Seattle, Washington • Phone: (206) PR 6-1171 • TWX: (910) 449-2850



Circle 345 on reader service card.

Model 332A Voltage Calibrator

Introducing Item 12 in the Fluke '65 Pacesetter Line

Hot new receiver/comparator for frequency standardization gets world-wide VLF reception with 10 nanovolt sensitivity. Covers 240 channels from 8 kc to 31.9 kc plus 60 kc. Over 80 db dynamic range without AGC or operator adjustment allows proper operation over a range of signal level fluctuations 100 times greater than anything else on the market. Solid state integrated circuits and modular design assure long term reliability. Unique phase tracking servo with both chart and digital readout.

The Montronics Model 207-1 is a coherent VLF tracking receiver for calibration of laboratory and communications center frequency standards to DOD and NBS criteria. It is the only commercially available VLF receiver using integrated circuits. Multi-channel capability plus high sensitivity assures round-the-world reception of VLF signals for frequency standardization. The instrument has been especially designed for ease of use including both independent chart and digital readouts. Price \$2,925.

FLUKE
MONTRONICS, INC.
A SUBSIDIARY OF JOHN FLUKE MFG. CO., INC.

MONTRONICS • Box 7428 • Seattle, Wash. • Phone: (206) PR 6-3141 • TWX: (910) 449-2852

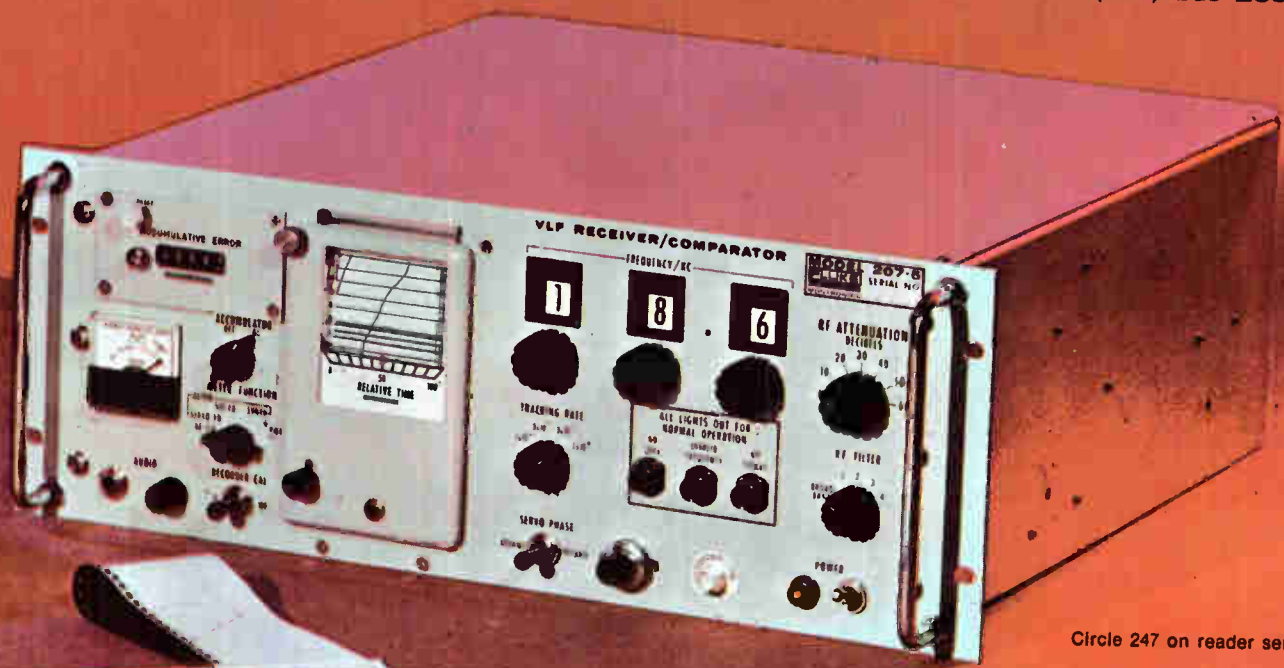

Circle 247 on reader service card.

Model 207 VLF Receiver/Comparator.

See it at WESCON, Booth #'s 4420, 4421, and 4422.

CRESCENT COST CUTTERS

When you've got cutters that snap-cut the toughest nickel ribbon wire as easy as a toothpick, assembly goes faster,

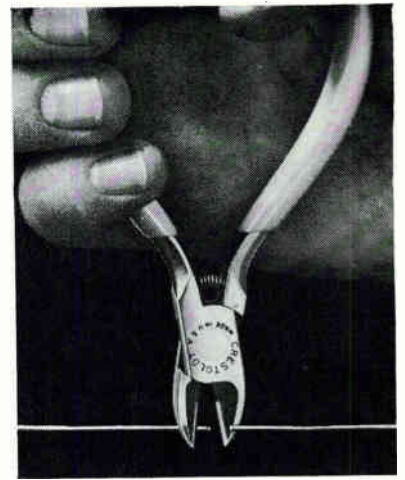

costs come down. Our 342 diagonal cutting pliers have the special cutting edge for it. These Crescent cutters feature a carbide-insert cutting edge, electronically induction hardened and hand

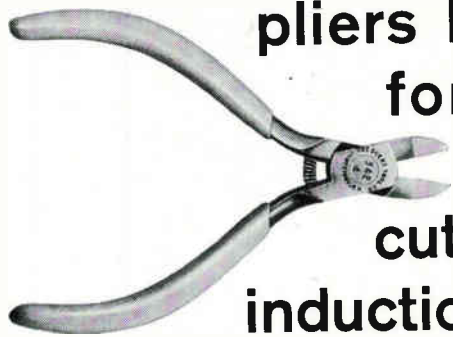

honed for fast, snap-cutting action... Lessens operator fatigue with cushion-grip handles and coil springs that instantly return the tool to its open position. Ask for Crescent. The name alone is your guarantee of superior quality on any hand tool.



Crescent has the edge... the hand honed, precision ground, electronically induction hardened edge in a full line of diagonal cutting pliers. Call your Crescent Distributor or Sales Representative for full details.



940 sc.



941 sc



942 sc



943 sc



945 sc



946 sc



947 sc

You are invited to visit the Crescent booth #434 at the Wescon Show August 24th-27th in the Cow Palace, San Francisco.

CRESCENT®

CRESCENT TOOL COMPANY / DIVISION OF CRESCENT NIAGARA CORPORATION / JAMESTOWN, NEW YORK

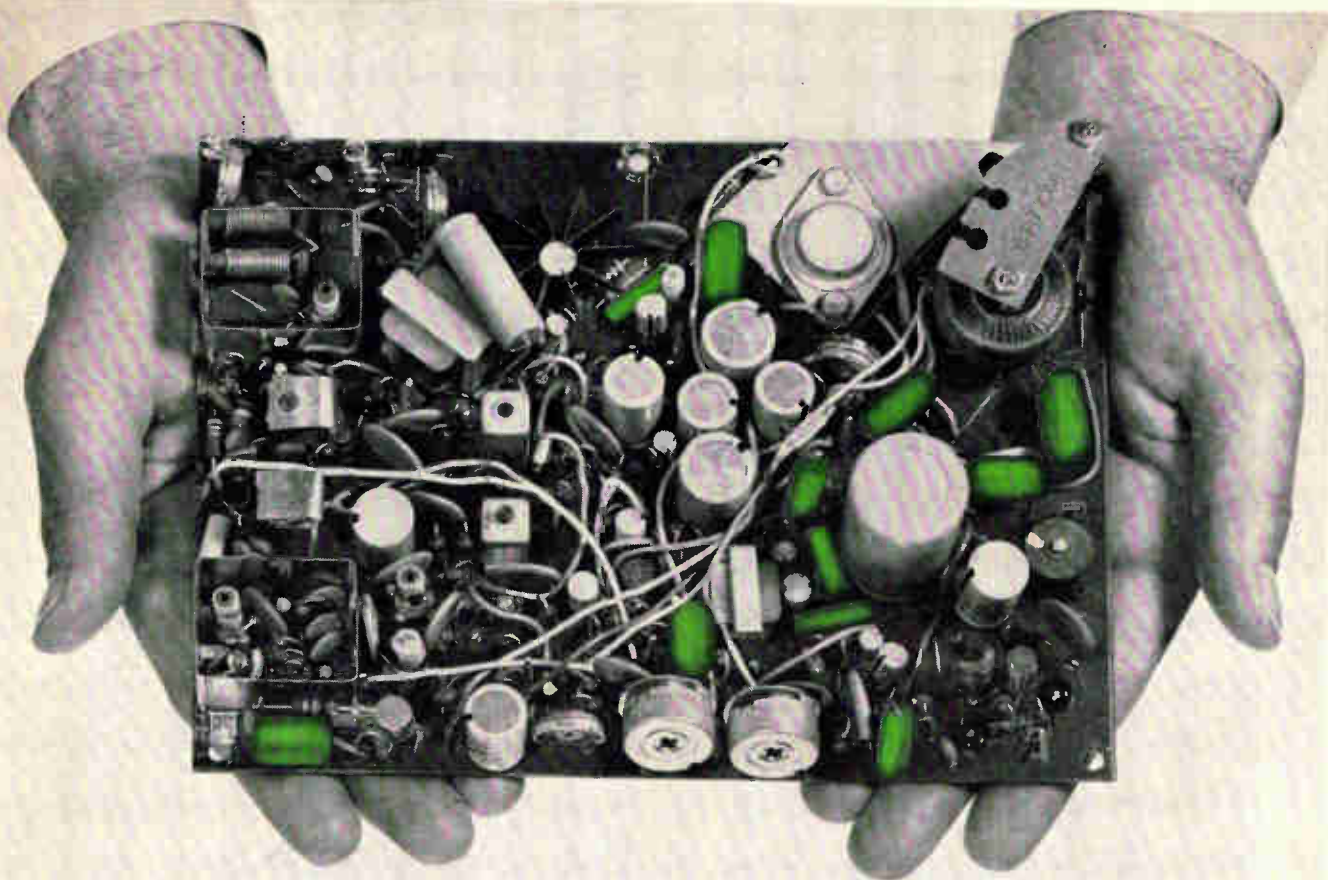

General Electric says size is important, but reliability is more important.

(Now you know two reasons why G.E.)
uses capacitors of Mylar® in its 9" TV.)

In its "play-anywhere" TV shown above, G.E. uses dipped, molded and wrap-and-fill capacitors of MYLAR*, and also capacitors that are self-cased units where extra wraps of MYLAR provide protection and anchorage for the leads. All are considerably smaller than paper capacitors of equivalent rating.

"But no matter how small they were," says Jim Nease, Component Engineer, "we wouldn't even consider using capacitors of MYLAR if they weren't reliable. Our tests have proven the outstanding reliability of these capacitors. That's the main reason we use them, not only in our 9" set, but throughout our line."

Reliability . . . reduced size. Two big reasons G.E. uses capacitors of MYLAR. But there's a third reason, too. Price. Capacitors of MYLAR cost no more, and often cost less than paper capacitors.

For more information to help you investigate the ways capacitors of MYLAR can help your designs for home entertainment and similar circuits, write Du Pont Co., Room 2797, Wilmington, Delaware 19898. In Canada: Du Pont of Canada, Ltd., P.O. Box 660, Montreal, Quebec.



Better Things for Better Living
...through Chemistry.

only DU PONT makes

MYLAR®
POLYESTER FILM

*DU PONT'S REGISTERED TRADEMARK FOR ITS POLYESTER FILM.

For the price of a plug-in you can have a scope.

\$242.

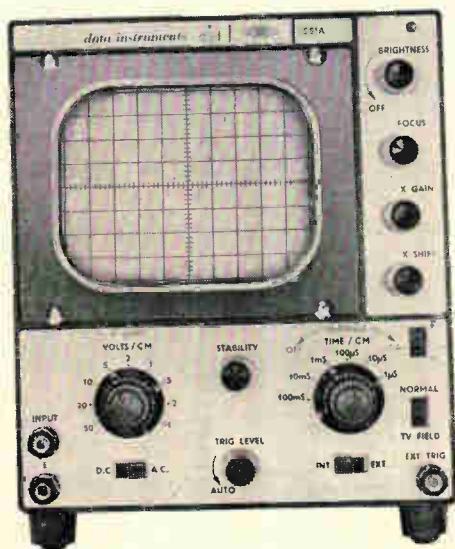

Here's a thought for plug-in collectors. This time how about another scope? Data Instruments S51A costs less than those super amplifiers, and you'll use it more often. The S51A bridges the gap between large display, high precision laboratory instruments, and smaller portable units of limited CRT size. It provides good reliability over a wide range of performance, and has a precision, flat face 5" CRT with a variety of phosphors. It also features efficient and reliable triggering facilities and a fairly wide bandwidth. Here are the specs.

data instruments



VERTICAL AMPLIFIER					
BANDWIDTH	SENSITIVITY/CM	IMPEDANCE	ACCURACY		
DC-3mc	100mv to 50v	1MΩ + 30pf	± 5%		
TIME BASE		CRT			PHYSICAL
SPEED/CM	TRIGGER & HOR. AMP.	DIA.	PHOSPHOR	VOLTS	DIM. & WT.
1μs — 100ms ± 5%	Exp. x 2 5cps-200kc	5"	P1 P7 + \$10	3.5kv	15½" x 8" x 7" 16 lbs.

The S51A is particularly suited to inspection, production control and monitoring applications. Its large screen and simplified controls make it an ideal educational instrument as well. Each unit has a full year warranty and field and factory service are provided.

Data Instruments Div. • 7300 Crescent Blvd. • Pennsauken, N.J.

Navigation

End of loran

Since the mid-1940's, ship captains and airplane pilots have relied on loran A, a radio-beacon navigation system, to fix their position. Yet loran has serious limitations. The 80 existing loran A stations can provide navigational fixes over only 15% of the earth's surface. Further, the beacons' medium and intermediate radio frequencies are often blocked by bad weather or atmospheric disturbances, and the signals cannot be received by submerged submarines.

Next year, though, the Defense Department is expected to begin replacing loran A with a \$100-million radio-beacon navigation system called Omega. Eight Omega stations (see map) could cover the entire earth. The system's very-low frequency signals, between 10.2 and 13.6 kilocycles, are relatively immune to bad weather and atmospheric disturbances and can reach about 40 feet beneath the surface of the ocean.

Long range. Omega provides navigational fixes accurate to within half a mile to a mile during the day and one to two miles at night at distances up to 9,000 miles. Loran A, which has a comparable accuracy, has a maximum range of only about 1,500 miles.

The Navy will test Omega during the first quarter of next year. Then, if Defense Secretary Robert S. McNamara approves, the Navy will start ordering equipment, so that the system will be in operation by the summer of 1966.

The Navy has one test station in Hawaii, and is building test stations in Norway and Trinidad. New stations are planned for the Minnesota-Wisconsin area, the Philippines, New Zealand, Mauritius Island near Madagascar and Tristan Island in the center of the



Proposed sites of worldwide Omega navigational system

South Atlantic Ocean.

Two receivers. Omega receivers for shipboard use cost from \$2,500 to \$5,000. The Nortronics division of the Northrop Corp. is building 10 of them for delivery to the Navy by the end of the year. Multipurpose receivers, for ship, plane, or submarine use, cost around \$20,000 per unit; the International Telephone & Telegraph Corp.'s Federal Laboratories is building 10 prototypes, also for delivery this year.

Within three years, the Navy wants to have a thousand of each kind of receiver. Eventually, every seagoing vessel will have one. Since the Omega system requires some manual computation, aircraft use will be confined at first to planes that carry navigators. A fully automatic system may be perfected later.

The Air Force may install the system in some of its planes, and the Federal Aviation Agency is also looking at Omega for private planes. Commercial airlines and merchant ships could also use Omega.

Up in the air. Although there is little doubt that Omega will eventually spell the end for loran A,

there is still some question as to whether Omega itself will be supplanted by still another navigational system; radio beacons transmitted from satellites.

Several government agencies and the Navy are planning a series of experiments within a year to test the feasibility of satellite navigation. And the Navy itself is conducting tests to see if its highly accurate, but expensive, Transit navigational satellite system, currently limited to use by ships, can be expanded to provide navigational fixes for airplanes.

Microelectronics

Tuning transistor

A brand new class of transistor, a bandpass device with a built-in tuning fork, promises to solve one of the most baffling problems in integrated-circuit design: the lack of high-Q frequency discrimination. The function is needed to tune circuits. Engineers at the Westing-

house Electric Corp.'s Research Laboratories believe that silicon monolithic circuits can be tuned by their new resonant gate transistor (RGT).

The device is made by techniques compatible with integrated-circuit processing. It is a surface field-effect transistor with a unique gate electrode: a tiny cantilevered beam, which, like a tuning fork, resonates at a specific frequency determined by its dimensions.

"Soon, not only wristwatches but also wrist radios may contain tuning forks," says W. E. Newell, manager of the new devices and applications section of the Westinghouse lab's information services department. The RGT may permit the use of silicon monolithic circuits in home radios and other equipment in which integrated circuits are not yet practical. In general, the RGT will be useful in radio receivers and low-frequency filters, for tone signaling, timing, remote control applications, and where a combination of tuning, logic, and amplification is required.

Prediction fulfilled. The use of a mechanical resonance to tune integrated circuits was predicted by Newell, then an engineering fellow at the Westinghouse Research and Development Center, in a March 13, 1964, article in *Electronics* titled "The frustrating problem of inductors in integrated circuits." The forecast was fulfilled recently with the invention of the RGT by two of his colleagues at the lab, H. C. Nathanson and R. A. Wickstrom.

The RGT beam's movement modulates the electric field between the transistor's source and drain, so the output frequency depends on the resonant frequency of the beam. The RGT can also amplify a signal, its developers report.

The higher the frequency, the smaller the beam has to be. RGT's with cantilevers 100 to 40 mils long have already been made and put to the test. They exhibited resonant frequencies over a range from 1 kilocycle to 45 kc and Q's of 100 to 750. The Q's (the figure of merit for a tuned circuit) correspond to bandwidths of 10 to 60 cycles per second. Voltage gains have ranged

up to 6 decibels.

Newell thinks that the cantilever structure can probably be used up to frequencies of one megacycle and that frequencies up to several hundred megacycles can be obtained by using other types of mechanically resonant structures.

Coils and feedback. In conventional circuits, tuning can be accomplished simply and cheaply by using an inductance coil. But nobody has successfully made a practical equivalent of a coil within the tiny confines of a single-chip silicon circuit. There are microminiature coils that can be assembled with hybrid circuits, but that's another breed of circuits [*Electronics*, May 31, 1964, p. 62] and another story.

Tuning could be accomplished in a monolithic circuit by resistor-capacitor feedback networks, but Newell points out that stable operation requires impractical tolerances for the circuit components.

Consumer electronics

Candy bars on credit

You can use a credit card to rent an automobile, buy an airline ticket or pay for a meal. Soon some fac-

tory and office workers will be able to use credit cards to buy a bag of peanuts or a candy bar from a vending machine.

This step in small credit was developed for the Automatic Canteen Co. of America by the Tateisi Electronic Co., whose Omron brand of industrial electronics is well known in Japan.

To get a bag of peanuts, or a cup of coffee, the buyer will insert his plastic credit card into an electronic reader in the machine. The card is coded with translucent dots and magnetic ink; if it is accepted, a "ready" sign lights up and the customer makes his selection. Information on the price and identity is relayed to a computer, which records the data on punched tape. The machine then returns the credit card to the customer.

Later, the punched tape is run through the company's accounting department computer and the total cost of the purchases can be deducted from the employee's paycheck.

Forget it. If a card is lost or stolen, its code is stricken from the memory so that if anyone tries to use the card, the machine will reject it. The computer can be reprogrammed in the event of such a loss within seconds.

Patrick L. O'Malley, president of Automatic Canteen, said the company expects to start distribution of the new machines within the year. Automatic Canteen controls about 65% of vending machine business in the nation's offices and factories. At this time, the credit system is practical only for this "captive market," O'Malley explains, but a credit card company might become interested in providing the service for public places.

Omron also has a prepaid system for use where billing is not practical or desirable, such as in schools or hospitals or where an employer does not wish to make additional payroll deductions. Here the customer buys a packet of tickets coded with magnetic ink to represent nickel, dime and quarter denominations, which the machine accepts as money.

Both prepaid and postpaid vending machines also accept coins.



A drink of soda; bill me later.

Dial in style

For years the Bell System has recognized that its basic telephone is an ugly duckling. Six years ago the company's designers came up with the Princess phone, a sleek little number that followed the same old principle of a handset for talking and listening and a cradle that contained the dial, switching circuits and bell. Now Bell has followed the lead of the Enicotor in Europe; the American company has introduced a dial-in-the-handset model, the Trimline, which will become available throughout much of the United States by 1967.

Except for the bell, the entire instrument has been packed into the sculptured Trimline—yet the handset weighs only two ounces more than the conventional phone's handset. The phone will be exhibited in the Museum of Modern Art's design collection in New York. This is an unusual honor for a consumer electronics product made in America.

The Trimline is manufactured by the Western Electric Co., manufacturing arm of the American Telephone & Telegraph Co.; its engineering design was performed by the Bell Telephone Laboratories and the styling is by the industrial design firm of Henry Dreyfuss & Co.

To achieve the small size, Bell uses a flexible printed circuit that fits into the curved handset; also a miniaturized dial.

The phone, which should be available in New York next year, will cost subscribers about \$5 for installation plus a \$1-a-month premium. This is 15 cents more per month than Bell charges for the Princess telephone.



Dial-in-the-handset telephone introduced by Bell System. Printed circuit fits into curved handset, which weighs only two ounces more than a conventional handset but contains the dial, wires, other gear.



electronics industry. Last November, Monsanto decided to make electronic equipment itself, and now it has introduced a four-digit voltmeter. Monsanto had a couple of surprises for the industry: its meter is the first made mostly with integrated circuits and the first with automatic ranging capabilities.

The instrument sells for \$1,975, a few hundred dollars less than similar instruments without automatic ranging.

Only the power supply is not made with integrated circuits, says Myron C. Pogue, manager of the company's electronics research division. "We wanted that big jump," he explains, "and integrated circuits gave it to us."

Integrated circuits add so much to the reliability of the instrument, says Pogue, that the company backs the product with a two-year warranty—twice that of digital voltmeters produced by other companies.

Up and down. The instrument is able to switch automatically between these ranges: 0 to 1.9999 volts, 1.9999 to 19.999 volts, 19.999 to 199.99 volts and 199.99 to 1,999.9 volts. Manual switching is also possible, with push buttons on the face of the instrument.

The meter has an accuracy of 0.01% plus or minus one count. Hence, at 1,999 volts, the instrument is accurate to within 1.2 volts.

Input impedance is 10 megohms on all ranges, and Monsanto claims a common mode rejection greater than 130 decibels.

The integrated circuits are being provided by the Semiconductor division of the Fairchild Camera & Instrument Corp., the Signetics Corp., and the Semiconductor division of Motorola, Inc.

Quicker than the eye

A man can perceive a flicker of light lasting one-thirtieth of a second; a flash faster than that goes by unnoticed. Yet oscilloscopes often produce transient waveforms that last only a few hundred nanoseconds—too short even to record on film.

Now fiber optics is being used to record oscilloscope flickers as short as 200 nanoseconds. The best previous system, using lenses, could capture flashes only as short as 10 microseconds; the speed was limited by the lenses' ability to gather the faint light and direct it onto the film. The light from the cathode-ray tube's phosphor coating must first pass through the tube's glass faceplate. Even with the best-made optical faceplates, the light losses are serious when the flashes are fast. The obvious solution, eliminating the faceplate and placing the film next to the phosphor coating, raises difficult and expensive design problems because a crt requires a vacuum to operate.

Focusing light. The optical-fiber technique was developed by the instrumentation division of the Fairchild Camera & Instrument Corp. The instrument uses the ends of the fiber bundles as the faceplate

Instrumentation

Monsanto's voltmeter

For years the Monsanto Co., a giant chemical producer, has been supplying many basic chemical ingredients, such as silicon, to the

Electronics Review

of the three-inch-diameter scope; the light then travels directly from the phosphor coating, through the glass fiber bundles and onto the film. Fairchild says the fiber bundles gather 40 times more light than an $f/1$ lens.

The Fairchild device, to be introduced Aug. 24 at the Wescon show in San Francisco was designed for the Air Force's Defense Atomic Support Agency as part of a nuclear detection system. The Air Force plans to connect 150 oscilloscopes to sensitive seismographs at underwater sites around the world. When a slight tremor, either man-made or natural, is detected by the seismographs, the signal will be displayed on the crt and recorded on film. Analysis of the crt's waveform can determine whether the tremor was natural or the result of a nuclear explosion.

In designing the instrument, Fairchild solved two major engineering problems: a chemical interaction between the glass, which binds together thousands of the seven-micron-wide fiber strands, and the fibers themselves; and the different thermal-expansion characteristics of the fiber-optics faceplate and the glass of the tube. However, Fairchild won't disclose how it solved these problems.

Avionics

Trick landing

The feasibility of all-weather landing systems has been established so well that even the pilots believe it; but believing and accepting are two different things, and the pilots tend to get nervous during an automatic landing if they can't see the runway. The Federal Aviation Agency plans tests on a system, called Microvision, that may bolster their confidence.

Microvision, which was developed by the Bendix Corp., is a system which seems to put blips of light along a runway. It could be a help in instrument or manual landing, but the FAA is chiefly interested in its application to the fully automatic all-weather sys-

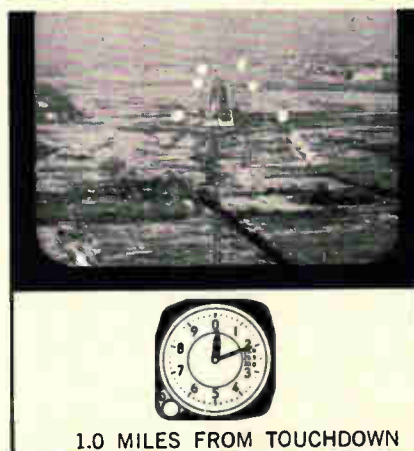
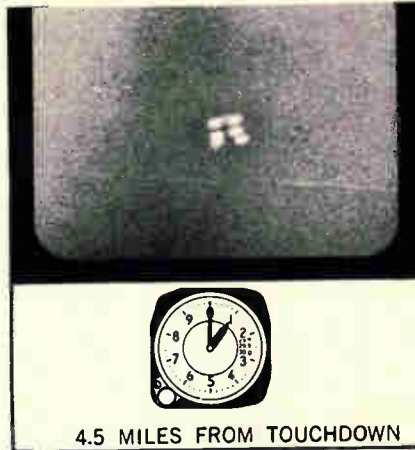

tems. The agency hopes that Microvision, or something like it, will lead to the certification of automatic landing systems for touchdown. At present, airlines can use automatic controls down to 200 feet, with half-mile visibility.

Make believe. Microvision tricks the pilot into thinking he sees runway lights, even in dense fog. Actually, he sees electronic signals transmitted by small microwave beacons situated on the edges of the runway. The signals are picked up in the plane, converted into light blips on a cathode-ray tube, and reflected on a transparent screen in front of the pilot. The



Pilot's view (left) as he approaches an airstrip equipped with Microvision, a system that aids in all-weather landings. Cockpit equipment (top) translates microwave signals received from the ground into blips that are superimposed on the view through the windshield of the plane.

blips are thus superimposed on the view through the windshield, and the pilot gets the illusion of seeing runway lights.

A pilot approaching a runway equipped with Microvision starts picking up signals about 10 miles out; at that time the dots of light appear as a straight line. Within five to seven miles, however, the lights take on the shape of the inverted V. The pilot can adjust the direction of his approach simply by watching the angle at which he is heading into the V.

Under the FAA contract, Bendix will install the beacons at the National Aviation Facilities Experi-

**DO IT YOURSELF
SILICON HIGH VOLTAGE
ASSEMBLIES**

with this basic "doorbell" rectifier module*

*Pat. Pending



POWER FEATURES

Stackable to 600 KV
Small Size - 5 KW per cu. in.
Heat Sink for Each Diode
Copper Base and Large Cooling Surface

ANTI-CORONA FEATURES

Vacuum Encapsulated
Smooth Polished Surfaces
Curved Profile to Provide Uniform Potential Gradient
Helical Internal Construction for Gradient Distribution

TRANSIENT PROTECTION FEATURES

Controlled Avalanche Diodes
Individual Voidless Glass Sealed Junctions
High Forward and Reverse Surge Capability

ALSO AVAILABLE IN FAST RECOVERY TYPES

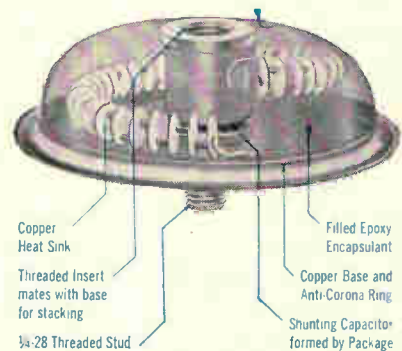

ONLY FOUR MODELS MAKE ALL THESE ASSEMBLIES:

UHV 15 15 KV at .8 A*	UHV 10 10 KV at 1.25 A*	UHV 5 5 KV at 2.5 A*	UHV 2.5 2.5 KV at 5.0 A*
--------------------------	----------------------------	-------------------------	-----------------------------

ALL IN STOCK AT THE FACTORY AND YOUR LOCAL COMPAR OFFICE

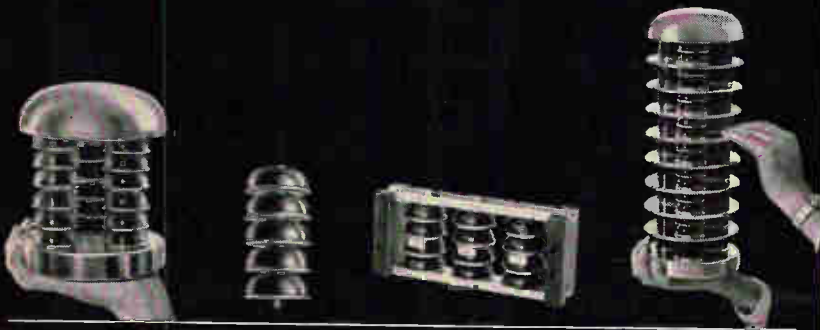

3 phase bridge
45 KV per leg
2.4 A output*

Stack
75 KV
.8 A output*

3 phase bridge
10 KV per leg
7.5 A output*

Cockroft-Walton
Multiplier
100 KV at 25 mA

*oil cooled ratings

SEND FOR NEW 12 PAGE ASSEMBLY CATALOG

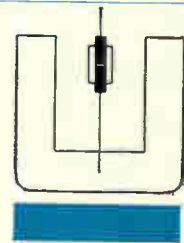

UNITRODE®
"better always/by design"

UNITRODE CORPORATION
540 Pleasant Street, Watertown,
Mass 02172 Telephone (617) 926-0400
TWX (710) 327-1296
Export - Dage Corporation

See us at WESCON Booth #1208

mental Center at Atlantic City, N. J., and the receiving gear in a government DC-7.

The military has also been interested in the system. Bendix says it has conducted, in cooperation with the Air Force, more than a thousand successful landings at airports around the country. The Army is currently testing the system for helicopters and the Navy is considering running tests soon aboard aircraft carriers. The military is particularly interested in Microvision's portability.

Communications

Getting a word in

"If you come up with a solution to the land mobile radio problem, you'll make a fortune," wryly comments Kenneth A. Cox, a member of the Federal Communications Commission. Cox is just teasing. He knows a solution to the problem of severe overcrowding on the airwaves is tantamount to finding a way to fit a quart of milk into an eight-ounce glass. There are about 1,500 available voice channels for each geographical area. And in many places, a single business radio channel may be packed with 50 to 60 fixed transmitters and between 400 and 500 mobile units.

Expanding the frequency bands, the obvious solution, is impossible because there is no more room in the radio spectrum. And no serious consideration is being given to restricting the number of users. But the FCC decided last year that if it can't solve the problem entirely, it can at least try to alleviate it [Electronics, Dec. 28, 1964, p. 84]. So it put a number of heads together—about 175 on a special industry-government advisory committee—and gave them the job. Task force reports are beginning to filter up toward the executive committee, which has until next March to make a final report.

More and more. The land mobile frequency bands—roughly 25 to 50 megacycles, 150 to 162 Mc and 450 to 470 Mc—are used by police,

taxi, businesses with radio-equipped service trucks, and the like. There are more than 2 million users in the United States, and that figure is growing at a record pace.

The chief problem is how to cram more users into the available space without increasing the already serious problem of interference. Here are some of the top-priority ideas that are being studied by the working panels:

Geographical allocations. Some additional space might be obtained by using a computer to allocate radio frequencies independent of service categories. Currently, the FCC sets up groups of frequencies

Tighter regulation of power. The FCC generally authorizes land mobile stations to operate at up to 600 watts, even if the applicant does not request full power. (The paperwork is simpler that way, and applications can be processed more quickly.)

When a land mobile operator encounters interference, he tends to increase his power to the limit. When every operator does this, nobody in the immediate area gains, and interference in neighboring areas gets worse. The question is whether tighter control of power authorization might at least reduce the interference between neighbor-



for each category, such as police or taxi service, and some categories are used less than others. Such allocation wouldn't help areas like New York or Los Angeles, where all categories are crowded.

Splitting channels. Land mobile channels, originally 120 kilocycles, have been divided and redivided to 30 Kc. Most engineers contend that nothing will be gained by another split, to 15 Kc; a chief reason is that the background noise level would become even more of a nuisance. But channel-splitting, combined with an effort to keep the transmitters on neighboring bands as far apart physically as possible, might provide some small relief, officials say.

ing cities.

Licensing operators. Some committee members believe that trained operators can get messages across and get off the air in less time than untrained operators. Less talk by everyone presumably would mean less congestion.

Sharing television channels. Engineers for land mobile operators and suppliers contend that they could share tv channel space on a limited basis without harmful interference. Engineers for broadcasters contend that such sharing is impossible. An FCC inquiry into the possibility has been concluded, but the question whether to recommend a test is still being debated on the staff level. In March



TRW POLYCARBONATE CAPACITORS DON'T DRIFT

14-58

Less than .01% T.C. from 0°C to + 125°C

TRW—acknowledged leader in film capacitors—continues its leadership with advanced polycarbonate types providing *mica-like stability* through 125°C.

This is a complete new line of low-TC devices designed for no-drift performance at elevated temperatures.

TRW polycarbonates are offered in a variety of styles to meet all design needs for operation from -55°C to 125°C.

- **WIDE-RANGE TEMPERATURE STABILITY**—< 1% capacitance change from 0°C to 125°C (positive or negative TC available).
- **LONG STABLE LIFE**—less than .1% drift after 10,000 hours.
- **CLOSE TOLERANCE**—available in capacity tolerances to ±.5%.
- **SMALL SIZE**—up to 90% less volume than paper dielectrics.
- **QUICK DELIVERY**—widely used styles available from stock.
- **MIL-C-19978 and MIL-C-27287** performance and ruggedness.

For full information phone, wire or write: 112 West First Street, Ogallala, Nebraska. Phone: 308-284-3611. TWX: 308-526-7816.

TRW CAPACITORS

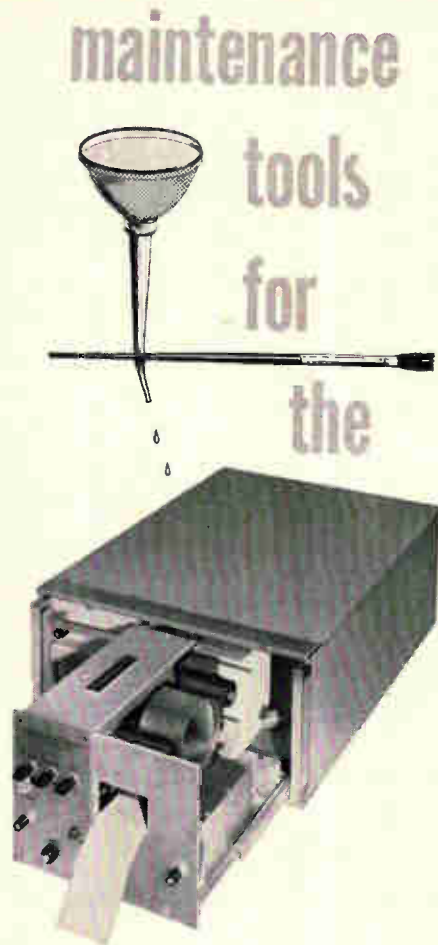

World's Fastest, Low-Cost Digital Printer

See it at WESCON Booth No. 1904

Apply several drops of oil to the drive-motor shaft-ends each year (or every fifty-million lines). Brush out any accumulated dust or lint. Clean the air filter periodically.

That's the extent of maintenance for a Franklin Model 1000 . . . the only digital printer that offers a printing rate of 40 lines per second (or less) at low, low, OEM prices.

REQUEST BULLETIN 2301



East Fourth St. • Bridgeport, Pa. 19405
A Division of the Anelex Corporation

1964, the FCC refused to turn over a vacant ultrahigh frequency tv channel to land mobile service. Although the move would have doubled the spectrum, the agency decided it would rather reserve the space for uhf television while it conducted a study of the over-all problem. The industry is expected to make another plea soon for some of the uhf spectrum.

Frequency allocation. At this time, the FCC does not assign specific frequencies; land mobile applicants are free to try to find a relatively uncrowded frequency within the band allotted to their specific service group, and then apply for a license. But in some services, unofficial frequency allocation committees working in cooperation with the commission have managed to make some dents in interference by suggesting appropriate power and frequency based on geographical separation.

Reducing man-made noise. A working group is conducting tests trying to pin down the extent of man-made "spectrum pollution" and to propose steps to reduce it. Reducing pollution might permit lower-power operations.

Standardized messages. Digital message systems might reduce the talk time. A working group is trying to determine whether such systems would be practical.

Space electronics

Hide and seek

It won't be as dramatic as a man's walk in space, but Gemini 5 will conduct a maneuver Aug. 19 that may contribute more to the success of the United States' proposed mission to the moon before 1970. Midway through the spacecraft's second orbit it will jettison a 77-pound electronic package; during the next two orbits it will try to maneuver to within 20 feet of the Radar Evaluation Pod (REP).

This fall, Gemini 6 will attempt to dock with another space capsule. Docking in orbit is a vital part of Project Apollo, the moon journey in

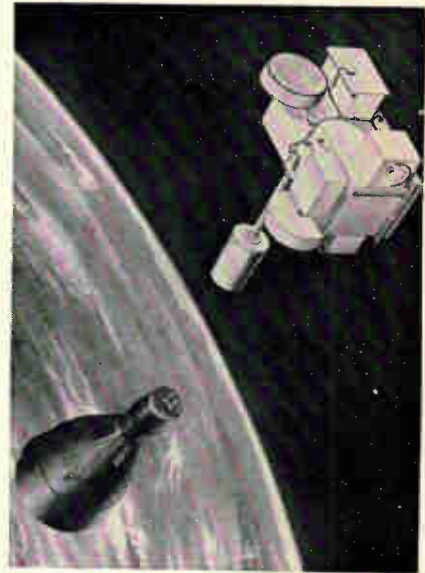

Waiting for a meeting in space

which astronauts will climb out of one space vehicle and into another.

Beacon in orbit. The electronics package, produced by the Westinghouse Electric Corp., is packed full of equipment to make it easy for the spacecraft to follow it through space. It contains an L-band transponder, which was designed to respond to signals transmitted by the tracking Gemini radar, and a bright flashing xenon light to make visual tracking easier for the astronauts.

The flight plan calls for the pod to be about 45 miles from the spacecraft when the astronauts start maneuvering to close the gap to about 20 feet in their fourth orbit.

Generally, the equipment on the REP is the same as the gear being designed for installation aboard an Agena vehicle, which will be the target of Gemini 6's docking experiment.

Six antennas. On the surface of REP will be two spiral antennas, which will rotate to produce a 70° beam for transmitting and receiving radar pulses. The REP also will carry a dipole antenna, which will rotate 360° as the pod rolls.

Four 70°-spiral antennas will be carried at the tip of the narrow neck of Gemini, one to transmit the radar pulses and the others to receive responses from the pod.

This radar system aboard Gemini will calculate the gap between the spacecraft and the pod by measur-

ing the time between transmitted and received pulses, and the pod's bearing will be measured by interferometer techniques.

Gemini's computer, which receives the range data in digital form, can then control the spacecraft's changes of velocity during its approach. The astronauts will also be able to control the approach themselves through data flashed on their cockpit display panel from a separate analog range measurement system.

Military electronics

Mauler scratched

During the past five years, the Defense Department has invested about \$200 million in the development of a mobile air-defense missile to protect front-line troops against high-speed enemy aircraft and short-range rockets. The missile, called Mauler, was to have been ready for field use by 1964 or 1965, but was held up by technical problems. The most vexing challenge was how to combine the missile's fire-control radar and guided-missile launchers on the same vehicle.

Although the Pentagon wouldn't disclose the exact nature of the problem, it did estimate the cost of getting Mauler into the air at \$180 million. At that point, dollar-conscious officials in the Defense Department asked: "Is it worth it?"

At month's end the answer came up: "No." And the Mauler was scratched.

Layoffs seen. The first to feel the brunt of the cancellation was the General Dynamics Corp., prime contractor. General Dynamics, which has 200 engineers working on the project, says there will be some layoffs.

The major subcontractors working on the project were the Raytheon Co., the FMC Corp. and the Burroughs Corp.

Although the system was killed, the Pentagon is taking a close look at the missile to see if it can save some of the pieces. High on the list are infrared and radar systems.

As a substitute for Mauler on the front lines, the Army is consider-

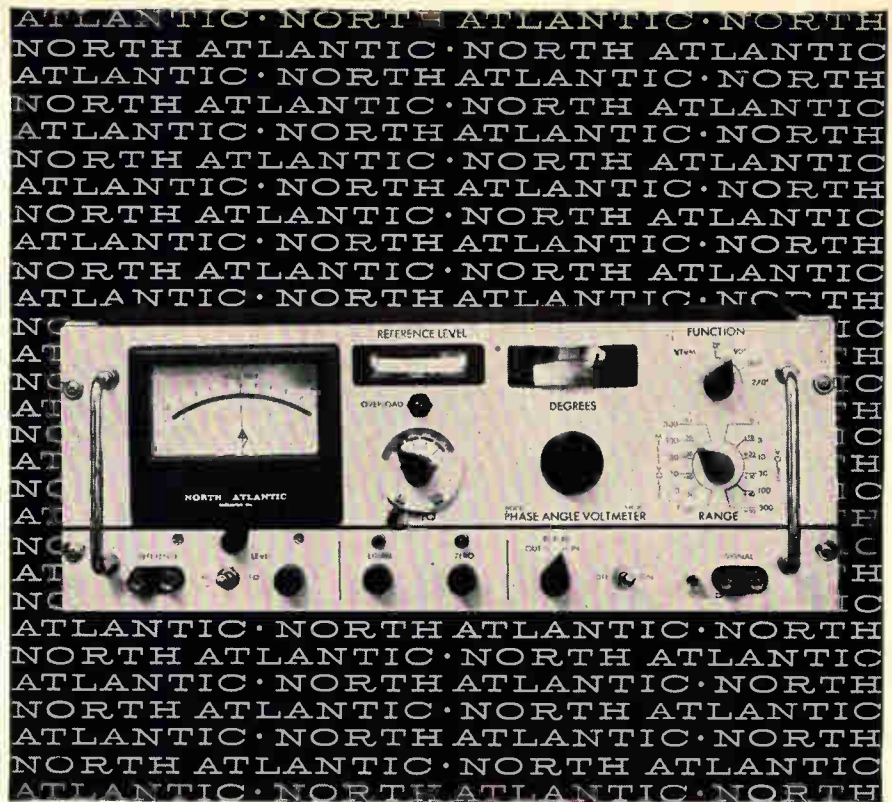

how to measure in-phase, quadrature and angle while sweeping frequency to 100 kc

North Atlantic's latest addition to the PAV line of Phase Angle Voltmeters* enables you to make measurements while frequency is varying over half-decades without recalibration. The VM-301 Broadband Phase Angle Voltmeter* provides complete coverage from 10 cps to 100 kc, and incorporates plug-in filters to reduce the effects of harmonics in the range of 50 cps to 10 kc with only 16 sets of filters. Vibration analysis and servo analysis are only two of the many applications for this unit. Abridged specifications are listed below:

Voltage Range.....	1 mv to 300 volts full scale
Voltage Accuracy.....	2% full scale
Phase Dial Range.....	0° to 90° with 0.1° resolution (plus 4 quadrants)
Phase Accuracy.....	0.25°
Input Impedance.....	10 megohms, 30µf for all ranges (signal and reference inputs)
Reference Level Range.....	0.15 to 130 volts
Harmonic Rejection.....	50 db
Nulling Sensitivity.....	less than 2 microvolts
Size.....	19" x 7" x 10" deep
Price.....	\$2290.00 plus \$160.00 per set of filters

North Atlantic's sales representative in your area can tell you all about this unit as well as other Phase Angle Voltmeters* for both production test and ground support applications. Send for our data sheet today.

*Trademark



NORTH ATLANTIC industries, inc.
TERMINAL DRIVE, PLAINVIEW, L. I., NEW YORK • OVERbrook 1-8600

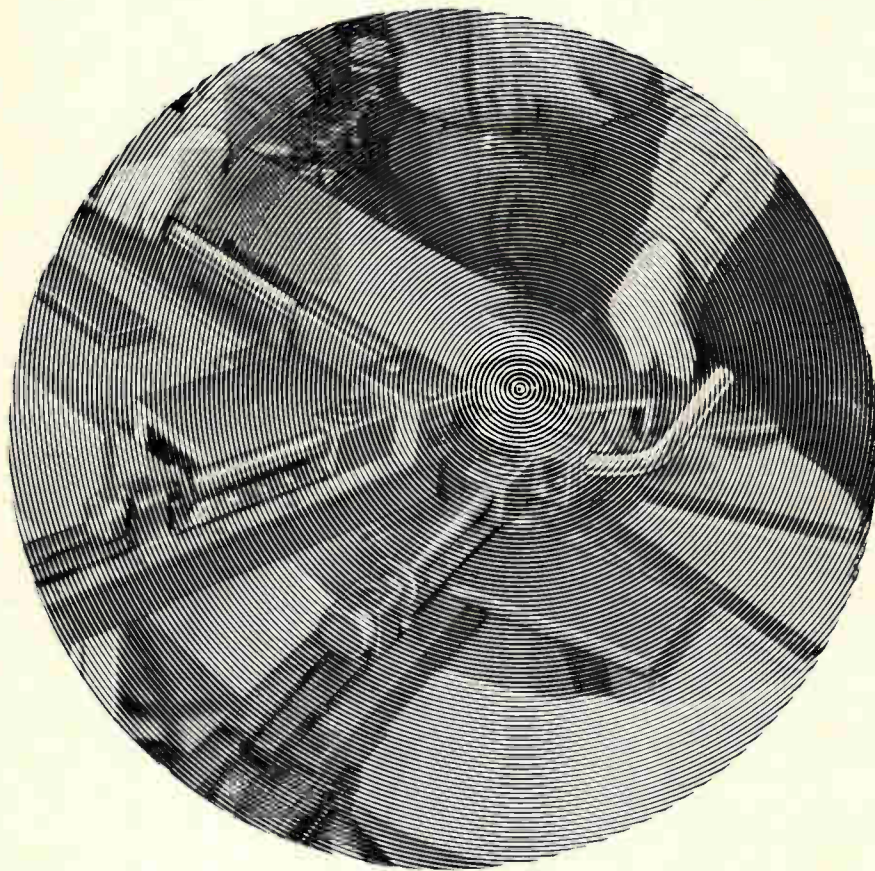

Bending Problems Disappear with Di-Acro

How? Start with the Di-Acro Bending Manual. 32 pages, 90 diagrams. Step-by-step proof that you can form angles, curves, eyes, scrolls, in all kinds of ductile materials. Seven basic bender models have solved over 400,000 bending problems to date. How about trying yours? See your distributor or write us.



DI-ACRO

A Division of Houdaille Industries, Inc.

458 Eighth Ave., Lake City, Minn. 55041

ing the use of modified 40-millimeter antiaircraft guns used before the Korean war and batteries of naval air-to-air Sidewinder missiles mounted on tracked vehicles for ground-to-air use.

The Army has already ordered an undisclosed number of the Sidewinders for use under the Army's designation of Chapparral. The Philco Corp. is the prime contractor for the missile, and the General Electric Co. provides the guidance control. Philco's Aeronautics division is in charge of the missile's conversion from a ship-based to a land-based weapon.

Electronics notes

▪ **Space IC's.** One of the first major uses of integrated circuits in a space vehicle's communications and data-handling systems is being planned for the Advanced Orbiting Solar Observatory (AOSO). Texas Instruments Incorporated, as subcontractor to the Republic Aviation Corp., is supplying 2,300 IC's for the satellite. Reliability tests over the past two years indicated an equivalent failure rate below that of discrete transistors. The project engineers are aiming for over-all reliability of 93% during the satellite's year in space.

▪ **Color tv in orbit.** The National Aeronautics and Space Administration is considering the use of color television in future space missions. The Manned Spacecraft Center in Houston is receiving bids later this month for a study of such a project.

▪ **Transponder space test.** The space agency has decided to test two-way voice communications between a ground station and an aircraft via its first Applications Technology Satellite, which is scheduled to be orbited late next year. The satellite will carry a very-high-frequency transponder with 30 watts of output power for relaying messages. NASA may also use the transponder to test a proposed navigation system in which ground stations could plot an aircraft's position from the ranging pulses that it sends to the satellite. Both the communication and navigation experiments would be done in conjunction with the Federal Aviation Agency.

HIGH VOLTAGE RECTIFIER ASSEMBLIES? MEDITATE NO LONGER... GENERAL INSTRUMENT OFFERS THE BROADEST LINE OF RECTIFIER ASSEMBLIES AVAILABLE

Including the following industry standards:

1. Silicon KILOPOTENTIAL COMPENSATED STACK ASSEMBLIES — PRV 20 KV to 200 KV to 1.0 Amp. — offering a unique patented structure for controlled voltage gradients in a modular stackable assembly.
2. Silicon CARTRIDGE RECTIFIERS — 1 KV to 30 KV at 350 mA. ALL MILITARY AND EIA types using controlled avalanche diodes in true glass hermetic seals with all interconnections welded.
3. Silicon PLUG-IN RECTIFIER FOR TUBE REPLACEMENTS. Using the exclusive GI Glass-Amp Rectifier — controlled avalanche characteristics — true glass hermetic seal — high surge current ratings.
4. CONTROLLED AVALANCHE Glass-Amp® HIGH VOLTAGE BLOCKS — 1 KV to 18 KV at 1.0 Amp. Pigtail and chassis-mounted styles in all rectifier configurations.
5. MINIATURE SILICON SINGLE PHASE BRIDGE RECTIFIER — PRV 5000 Volts at 200 mA. Smallest rectifier assemblies with true glass hermetic seal junctions.
6. SELENIUM VENTIL RECTIFIER — PRV 1 KV to 30 KV at 50 mA. Selenium Ventils and a complete line of Selenium Cartridges offer the best economy in solid-state high voltage rectifiers.

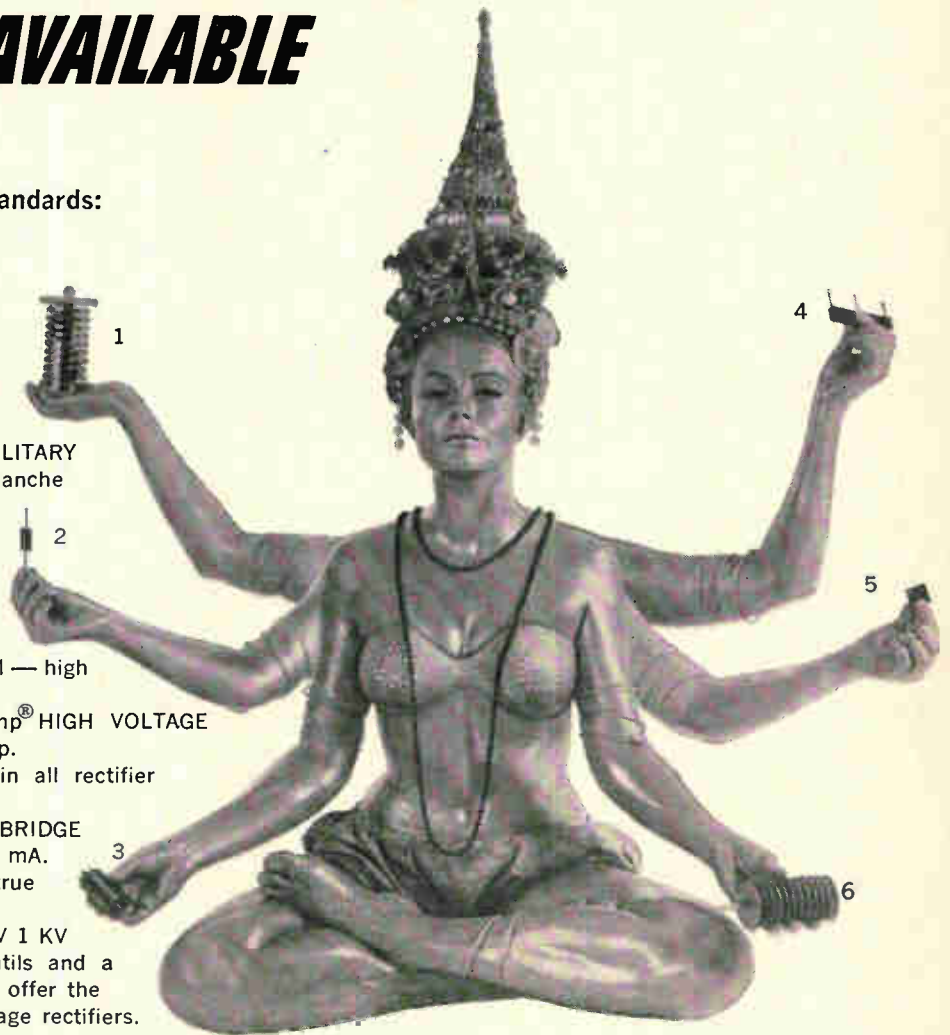

Write to General Instrument, the leader in controlled avalanche and compensated rectifier assemblies, for recommendations on your standard or custom requirements.

**GENERAL INSTRUMENT CORPORATION
SEMICONDUCTOR PRODUCTS GROUP**

600 West John Street, Hicksville, New York



One Low-Cost Series Of Digital Integrated Circuits Is Preferred For New Designs

THESE



(They're the Motorola MC350 series MECL* circuits with 6 nsec propagation delay and simultaneous complementary logic functions — priced as low as \$1.95 per circuit!)

Whether you're looking for fewer parts per system for reasons of economy or to minimize overall space requirements for your equipment, you satisfy both goals with the high-logic capability of the MC351-MC365 series Motorola-designed 6 nsec MECL integrated circuits — with simultaneous complementary functions at each gate (AND/NAND, OR/NOR)! You completely eliminate these extra inverter circuits.

This new current-mode computer complement, with fan-in and fan-out capability up to 25, also features a 0 to +75°C operating temperature range . . . offering new design freedom for most commercial equipment applications!

Best of all, when you look at individual circuit prices, you'll find these high-speed, complementary-logic MECL circuits priced competitively with others offering less than 1/3 the speed and no dual function logic capability . . . with individual circuits priced as low as \$1.95 in 100 quantities!

They're available from your local Motorola franchised semiconductor distributor or in production quantities through your nearest Motorola field office. For complete technical details on the MC350 series MECL circuit, write the Technical Information Center, Box 955, Phoenix, Arizona 85001.

*TM of Motorola Inc.

COMPARE THESE NEW LOW CIRCUIT PRICES

Type† Number	Circuit Function	Speed/Circuit (Typ)	Maximum Operating Frequency	Power Dissipation per Circuit (typ)	Noise Immunity	Operating Temperature Range	100-Up Price
MC351	5-Input Gate	6 nsec	30 mc	35 mW	400 mV	0 to +75°C	\$3.65
MC352	R-S Flip-Flop	6 nsec	30 mc	35 mW	400 mV	0 to +75°C	3.65
MC353	Half Adder	6 nsec	30 mc	60 mW	400 mV	0 to +75°C	4.75
MC354	Bias Driver	6 nsec	30 mc	18 mW	400 mV	0 to +75°C	1.95
MC355	Gate Expander	6 nsec	30 mc	—	400 mV	0 to +75°C	2.25
MC356	3-Input Gate	6 nsec	30 mc	35 mW	400 mV	0 to +75°C	2.85
MC357	3-Input Gate (no output resistors)	6 nsec	30 mc	13 mW	400 mV	0 to +75°C	2.85
MC358	J-K Flip-Flop	6 nsec	30 mc	52 mW	400 mV	0 to +75°C	7.60
MC359	Dual 2-Input Gate	6 nsec	30 mc	49 mW	400 mV	0 to +75°C	2.95
MC360	Dual 2-Input Gate	6 nsec	30 mc	49 mW	400 mV	0 to +75°C	2.95
MC361	Dual 2-Input Gate	6 nsec	30 mc	36 mW	400 mV	0 to +75°C	2.95
MC362	Dual 3-Input Gate	6 nsec	30 mc	49 mW	400 mV	0 to +75°C	4.00
MC363	Quad 2-Input Gate	6 nsec	30 mc	110 mW	400 mV	0 to +75°C	8.55*
MC364	J-K Flip-Flop	6 nsec	40 mc	114 mW	400 mV	0 to +75°C	9.25
MC365	Line Driver	—	—	230 mW	400 mV	0 to +75°C	7.35

†Add suffix letter "G" to type number for TO-5 package, "F" for flat package. (Slightly higher priced). *flat pkg. only.

**New J-K Flip-flop — Quad 2-Input Gate — Dual 3-Input Gate — Line Driver

... or Choose From These Other 92 Motorola Digital Integrated Circuits

FAMILY	SINGLE GATES	MULTIPLE GATES	BUFFERS AND DRIVERS	ADDERS	STORAGE ELEMENTS (R-S FLIP-FLOP)	J-K FLIP-FLOPS	EXTRA-ORDINARY FUNCTIONS
MILITARY DTL (MC200 Series) -55 to +125°C	MC201 4-Input NAND/NOR MC202 3-Input NAND/NOR MC203 6-Input AND	MC206 Dual 2-Input NAND/NOR MC207 2-3 Dual Input NAND/NOR MC208 2-3 Dual Input NAND/NOR MC212 Dual 3-Input NAND/NOR MC-213 Dual 3-Input NAND/NOR MC215 Dual 3-Input AND	MC204 3-Input Power Gate MC205 Line Driver		MC209 R-S Flip-Flop MC210 R-S Flip-Flop Split Capacitor		MC217 Dual 3 Expander
COMMERCIAL DTL (MC250 Series) 0 to +75°C	MC251 4-Input NAND/NOR MC252 3-Input NAND/NOR MC253 6-Input AND	MC256 Dual 2-Input NAND/NOR MC257 2-3 Dual Input NAND/NOR MC258 2-3 Dual Input NAND/NOR MC262 Dual 3-Input NAND/NOR MC263 Dual 3-Input NAND/NOR MC265 Dual 3-Input AND	MC254 3-Input Power Gate MC255 Line Driver		MC259 R-S Flip-Flop MC260 R-S Flip-Flop Split Capacitor		MC267 Dual 3 Expander
MILITARY MECL (MC300 Series) Current Mode 0 to +125°C	MC301 5-Input AND/OR-NAND/NOR MC306-MC307 3-Input Expandable AND/OR-NAND/NOR	MC309, MC310, MC311 Dual 2-Input NAND/NOR MC312 Dual 3-Input NAND/NOR MC313 Quad 2-Input NAND/NOR	MC315 Line Driver	MC303 Half Adder (Sum-NOR-Carry Outputs)	MC302 R-S Flip-Flop	MC308 J-K Flip-Flop MC314 J-K Flip-Flop	MC304 Bias Driver MC305 5-Input Expander
COMMERCIAL MECL (MC350 Series) Current Mode 0 to +75°C	MC351 5-Input AND/OR-NAND/NOR MC356-MC357 3-Input Expandable AND/OR-NAND/NOR	MC359, MC360, MC361 Dual 2-Input NAND/NOR MC362 Dual 3-Input NAND/NOR MC363 Quad 2-Input NAND/NOR	MC365 Line Driver	MC363 Half Adder (Sum-NOR-Carry Outputs)	MC352 R-S Flip-Flop	MC358 J-K Flip-Flop MC364 J-K Flip-Flop	MC354 Bias Driver MC355 5-Input Expander
MILITARY DCTL (MC900 Series) -55 to +125°C	MC903 3-Input NAND/NOR MC907 4-Input NAND/NOR	MC914 Dual 2-Input NAND/NOR MC915 Dual 3-Input NAND/NOR	MC900 Buffer	MC904 Half Adder	MC902 R-S Flip-Flop MC905 Gated R-S (with inverter) MC906 Gated R-S (without inverter)	MC916 J-K Flip-Flop	MC901 Counter Adapter
COMMERCIAL DCTL (MC800 Series) 0 to +100°C	MC803 3-Input NAND/NOR MC807 4-Input NAND/NOR	MC814 Dual 2-Input NAND/NOR MC815 Dual 3-Input NAND/NOR	MC800 Buffer	MC804 Half Adder	MC802 R-S Flip-Flop MC805 Gated R-S (with inverter) MC806 Gated R-S (without inverter)	MC816 J-K Flip-Flop	MC801 Counter Adapter
INDUSTRIAL DCTL/RTL (MC700 Series) +15 to +55°C	MC703 3-Input NAND/NOR MC707 4-Input NAND/NOR MC711 4-Input NAND/NOR	MC710 Dual 2-Input NAND/NOR MC714 Dual 2-Input NAND/NOR MC715 Dual 3-Input NAND/NOR MC718 Dual 3-Input NAND/NOR	MC700 Buffer MC709 Buffer	MC704 Half Adder MC708 Adder MC712 Half Adder	MC702 R-S Flip-Flop MC705 Gated R-S (with inverter) MC706 Gated R-S (without inverter) MC713 Type D Flip-Flop	MC723 J-K Flip-Flop	MC701 Counter Adapter MC721 Expander
MILITARY MILLIWATT RTL (MC908 Series) -55 to +125°C	MC911 4-Input NAND/NOR	MC910 Dual 2-Input NAND/NOR MC918 Dual 3-Input NAND/NOR	MC909 Buffer	MC908 Adder MC912 Half Adder	MC913 Type D Flip-Flop		MC921 Expander



MOTOROLA Semiconductor Products Inc.

BOX 955 • PHOENIX, ARIZONA 85001 • A SUBSIDIARY OF MOTOROLA INC.

"Visit Motorola's WE5CON Booth #3122-3125"



The only *solid-state* counters available? If any electronic counters can be considered *all* solid-state, they're the Beckman 6100 Series. These 2.5, 25, and 50-mc counters use *no* vacuum tubes in any form—even the digital display is solid-state. This spells superior reliability and value backed by these unparalleled benefits: Electroluminescent display guaranteed against catastrophic failure for *three years*. More plug-ins—*nine*—for greater versatility. Plug-ins do *not* just add basic functions but expand and add capabilities (trigger controls and time interval function are available on basic counters). Plug-ins include frequency extenders to 3 gc, integrating DVM, mode expander/preset, and preamplifier. *Active storage* provides BCD output data during next sampling. All these benefits *plus* Mil ratings at no extra cost. Plus standard functions of frequency, period, multiple-period average, ratio, multiple-ratio average, time interval, and random count measurements; automatic decimal point positioning and unit of measurement display. Prices of basic instruments start at \$1,960 and plug-ins from \$440. For your best value in counting, ask your Beckman Berkeley representative for a demonstration of a *truly* solid-state electronic counter—the 6100 Series.

Beckman® INSTRUMENTS, INC.
 BERKELEY DIVISION
 RICHMOND, CALIFORNIA • 94804

INTERNATIONAL SUBSIDIARIES: GENEVA, SWITZERLAND; MUNICH, GERMANY; GLENROTHES, SCOTLAND; PARIS, FRANCE; TOKYO, JAPAN; CAPETOWN, SOUTH AFRICA



See us at Wescon Booths 4221 and 4222

Washington Newsletter

August 9, 1965

**Billions
for escalation . . .**

The day President Johnson announced the escalation of the Vietnam effort, high government officials held a briefing for reporters on how much it will cost. Indications are the extra spending will hit nearly \$3 billion this fiscal year.

A bill for one extra billion is already before Congress. The new Vietnam moves mean that the Administration will ask another one to two billion dollars next January. In the meantime, there will be heavy transfers of funds from other defense programs to finance the Vietnam war. These borrowings will have to be made up in the January bill.

**. . . and more jobs
for engineers**

The extra defense spending means that engineers will be in a sellers' market for the first time in more than two years. Employment of engineers has been picking up gradually since September from a low about a year ago, and a shortage is anticipated. The Bureau of Labor Statistics sampled about a million engineers, found less than 2% unemployed. In communications, electronics components and other key defense-oriented industries, the BLS says, employment is less than 6% off its high in 1963.

Competition for engineers is intensifying among companies. New graduates are getting starting salaries up 3% from a year ago.

"Industries that dropped out of the competition when defense spending leveled off have been back in, feet first, since May," reports one statistician.

**DOD to intensify
contract grading**

The Defense Department will probably put into effect a major expansion of the "report card" system it uses to evaluate the performance of contractors.

Contractors involved in advanced development, engineering development and operational systems development are evaluated on how well they meet the technical, cost and schedule targets promised in their contracts.

Records already are kept on contractors engaged in development programs costing more than \$5 million for a single year or more than \$20 million for a single contract. Contractors with straight A's get future business and higher profits on completed work.

Additional development contracts would be brought under the evaluation program by lowering the existing dollar limitations to \$2 million for single-year cost and \$10 million for total cost. More significantly, performance evaluations would be extended to production work.

**Computer services
face FCC control**

The Federal Communications Commission already regulates the transmission of computer data over telephone or telegraph lines. Now it has an eye on data processing itself, when it is directed from remote consoles.

The agency is specifically interested in the new service being performed by companies like the Western Union Telegraph Co. and CEIR, Inc., which lease time on their giant computers to distant customers. The service is becoming more and more practical with the new generation of time-sharing computers.

In an effort to avoid FCC regulation, both companies say they will

Washington Newsletter

separate the computer charges and the line charges in their billing. If they were lumped together, the FCC would have an invitation to step in and fix rates; at present, the agency is questioning whether such a separation of charges can be made on a valid basis.

Comsat asks bids on five satellites

The Communications Satellite Corp. has called for industry proposals Aug. 13 to supply five synchronous satellites and four transportable ground stations to be used with the National Aeronautics and Space Administration's Apollo space program.

First deliveries must be within eight months. Comsat asked bidders to submit cost estimates for providing communications service to the National Communications System, which is handling the matter for NASA. Comsat would own the equipment.

Comsat is reported to be considering additional units that could bring the total to 25 satellites and nine ground stations.

Congressmen plan visit to Peking

While the United States and Red China drift nearer to an outright clash on the Vietnam issue, a congressional group is planning a trade mission to Peking. Chairman Warren G. Magnuson (D., Wash.) of the Senate Commerce Committee has confirmed that he will take a group of senators and representatives to the Red Chinese capital this fall. The talks will be the highest level of contact between the U.S. and Peking since the Communists took over.

The group will have the backing of the White House. It's likely that the talks will cover basic commodities only, but the establishment of any commercial relations with Peking might one day lead to the creation of electronics trade.

Magnuson's group also will hold trade talks in Moscow.

Viet war slows aerospace projects

Last week, when reporters pressed for status reports on several big programs affecting the electronics industry, Defense Department officials shouldered aside their questions. One insistent journalist was told: "We've been fighting a war around here."

The Pentagon is still delaying decisions on whether to try and build an antimissile missile, who will build the C-5A transport plane and what kind of manned orbiting laboratory will be built. Final details are still due on the long-pending \$2-billion agreement between Great Britain and the United States for Phantom fighters.

The first decision should be on whose engines will power the 700-passenger C-5A jet. For some time now, the General Electric Co. and the Pratt & Whitney division of the United Aircraft Corp. have been waiting word from the Pentagon on which of them will get the contract. Selection of the engine contractor will clear the way to the decision on the airframe contractor. The Douglas Aircraft Co., Lockheed Aircraft Corp. and Boeing Co. are competing for the job.

Although Pentagon officials insist that the Vietnam conflict will not delay any major U. S. programs, the sense of urgency about the supersonic transport plane and the antimissile missile decision seems to have diminished. However, the need to transport troops to brushfire wars gives the huge C-5A transport top priority at the Pentagon.

An open letter to users of 7 mm Precision Connectors:

Gentlemen:

If you have read some of the sales literature on precision connectors which extend coaxial techniques up to 18 GHz, you must be thoroughly confused by this time. Worse, you may have ordered connectors some time ago... and have yet to receive delivery.

This letter may serve to clarify matters.

The IEEE Sub-Committee on Precision Connectors has endeavored to standardize on a minimum number of sizes for precision connectors. Two sizes, 14 and 7 mm, have been selected.

From the early beginnings of this IEEE Committee, members of the engineering staff of Rohde & Schwarz participated as members of the Committee.

Standards Virtually Identical to Precifix

This is not surprising in view of the contribution which Rohde & Schwarz has made in the field of connectors. As a matter of fact, when the Committee was originally set up about five years ago, it established connector design principles which were virtually identical with those upon which the Rohde & Schwarz Dezifix and Precifix connectors were based. (Dr. Lothar Rohde had laid down these principles for sexless connectors about 20 years ago and developed these connectors as a prerequisite to the design of precision equipment above 30 MHz.) Connectors of this type have been built for ratings up to 100 kW.

The Committee's specifications require that the connectors (1) be sexless, (2) provide low VSWR, (3) have identical electrical and mechanical junction planes, and (4) exhibit low leakage.

Therefore, it should not come as a surprise that the new 7-mm standard proposed by the Committee is based on the Precifix Connector, as currently manufactured by Rohde & Schwarz. Production samples of the Precifix-A are now ready for immediate delivery.

Precifix-A Design for Precision Uses

The Precifix-A connector has been designed for use on precision measuring equipment and for frequencies up to 18 GHz. Its major features are:

- (1) Smallest possible dimensions: short length (19 mm), smallest diameter (20 mm), smallest weight (about 20 g).
- (2) Quick connect-disconnect, requiring less than one turn of the screw connection.
- (3) Extremely low leakage because of triple shielding.
- (4) Extremely low VSWR. (Values are well within the Committee's requirements.)
- (5) A crown facilitates mating of the connectors and protects the surface of the inner conductor. This crown is rotatable.
- (6) Finally, the design is backed up by 20 years of experience in the precision connector field.

Dezifix-A: A medium-price, high-quality 7-mm cable and equipment connector. In addition to the high precision Precifix version, there is need for a slightly less accurate and substantially less expensive type, which would possess the essential features of the Precifix-A and mate with it. Thus, the Dezifix-A has been developed. It will be used on cables such as RG8U, but also on equipments wherever an extremely low VSWR is not needed. It is easily distinguished from the Precifix-A by the fact that there is no crown.

Sample quantities of both Precifix-A and Dezifix-A are available from stock; production quantities are available for delivery starting 30 days after receipt of orders.

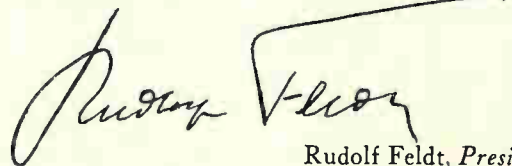

Rudolf Feldt, *President*

The 7-mm Precifix-A and Dezifix-A will be shown at Booth 4005-6/WESCON

ROHDE & SCHWARZ SALES CO., (USA), INC., 111 Lexington Ave., Passaic, N.J. 07056

Inquiries from outside the U.S.A. should be directed to: ROHDE & SCHWARZ, Muehldorfstrasse 15, 8 Muenchen 8, West Germany

Sigma relay idea of the month

How to avoid short circuits when reversing polarity of inductive loads.

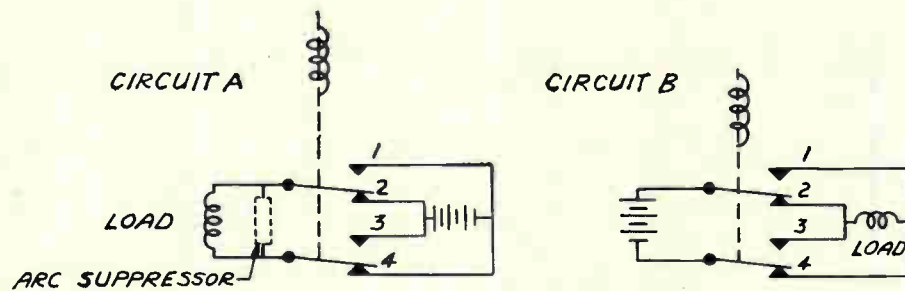

Circuits A and B are both commonly used for reversing polarity, but circuit A has an advantage not often recognized.

When reversing the polarity of a difficult load, such as a motor, a slight contact weld might delay the transfer of one pole while the other pole completes transfer. In circuit B this will short circuit the power supply resulting in catastrophic failure.

In circuit A a non-synchronous transfer would only short circuit the motor terminal. This is not harmful, and can be done deliberately with some relays, such as the

Sigma Series 42. Short circuiting the motor, known as "slugging," stops the motor more quickly, allowing faster reversals.

Neither circuit will prevent catastrophic failure if an arc is drawn across the contact gap, because this would short circuit the power supply.

Where arcing may be a problem, arc suppressors can be used.

If you have a relay idea or can show us how to improve this one, we'd like to hear from you. Your relay idea could be the next one we publish.

Sigma relay of the month

New, welded seal half-size crystal-can relay exceeds MIL-R-5757D/9.

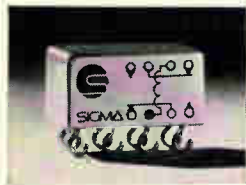

Actual Size

This new Sigma relay could have been introduced a year ago. It was every bit as good as competition, but our engineers weren't satisfied. They wanted something even better. They're satisfied now. You will be too.

Here's why:

The Series 36 is contamination-free. The cover is TIG welded to the header for complete flux-free cleanliness and a more dependable hermetic seal. Result: performance and reliability that exceed military and commercial requirements.

Design-centered for operation in the 100 ma to 400 ma range, the 36 is conservatively rated at 2 amps to dry circuit. Its small size and weight make it ideal for printed circuits and high-density packaging.

There are more advantages to the 36: 1. Extra durability—gold-plated silver-magnesium-nickel alloy contact *blades* minimize bounce, resist wear, and prolong life. 2. High efficiency—precise alignment of armature to pole pieces and reduced bobbin-wall thickness contribute to low operate power. 3. Outstanding environmental performance—balanced, low-inertia armature assures dependable, high-speed operation under severe conditions of shock and vibration.

Check out the distinctive features in the Sigma Series 36 for yourself—free of charge—against the types you may now be using. Just send for the new Sigma Series 36 bulletin and a free relay redemption certificate.



Tungsten Inert Gas welding of Series 36 relay prevents flux contamination.

SIGMA DIVISION  SIGMA INSTRUMENTS INC
Assured Reliability With Advanced Design/Braintree 85, Mass.

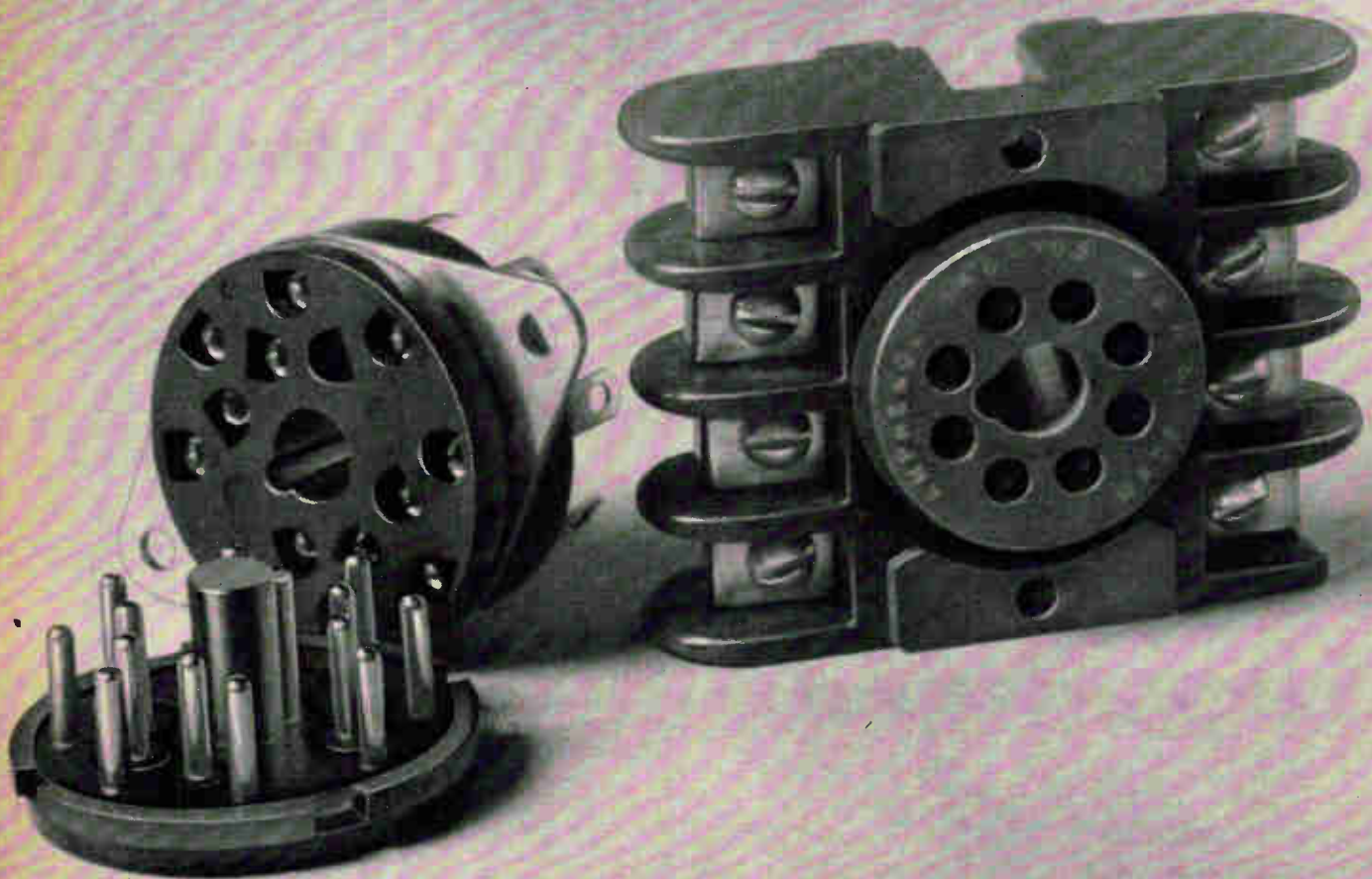

***Five different ideas on
How to Succeed
in Commercial Electronics***

Circle 46 on reader service card

1. NEW UL-CSA RECOGNIZED PLUG AND SOCKET can help you gain faster UL approval and reduce end item rejection risk.

Dozens of relay design and field servicing problems can be solved in vending machines, air conditioners, copy machines and control equipment. Available in individually keyed 8, 11, 14 pin configurations. Contact tails accept solderless terminations.

Amphenol Connector Division
1830 S. 54th Avenue
Chicago, Illinois 60650

2. SOLDERLESS RELAY SOCKET is for the engineer who has one eye on cutting costs; the other on increasing reliability.

Screw-type terminals are reversible: your assemblers mount it above or below a chassis. "Clover leaf" contacts keep resistance down. Best of all, this socket allows you to use wiring harnesses and lug-type connections to cut wiring time and costs.

3. NEW MICRO-RIBBON® RACK-AND-PANEL CONNECTOR.

Polarized shell helps lower assembly and servicing costs: 20% and 30% in some companies. Can't mismatch—even when ganged on multiple panels. Minimum need for visual alignment. Wedge-like contacts give fast, sure insertion. Self-cleaning action assures long service. (500 million contacts in use without a failure!)

4. NEW AUDIO-TYPE CONNECTOR

can upgrade quality "image" of your equipment. Available in economical bright nickel or familiar lustrous chrome finish.

Take your pick: 3, 4, or 6 contacts; cable-to-panel or cable-to-cable with positive screw-type coupling ring.

5. WRITE AMPHENOL Connector Division, 1830 S. 54th Ave., Chicago, Ill. for up-to-date connector ideas.

Amphenol

CONNECTOR DIVISION

amphenol corporation

Specify Amphenol . . . the leading name in cable, connectors, assemblies, RF switches, potentiometers, microelectronics

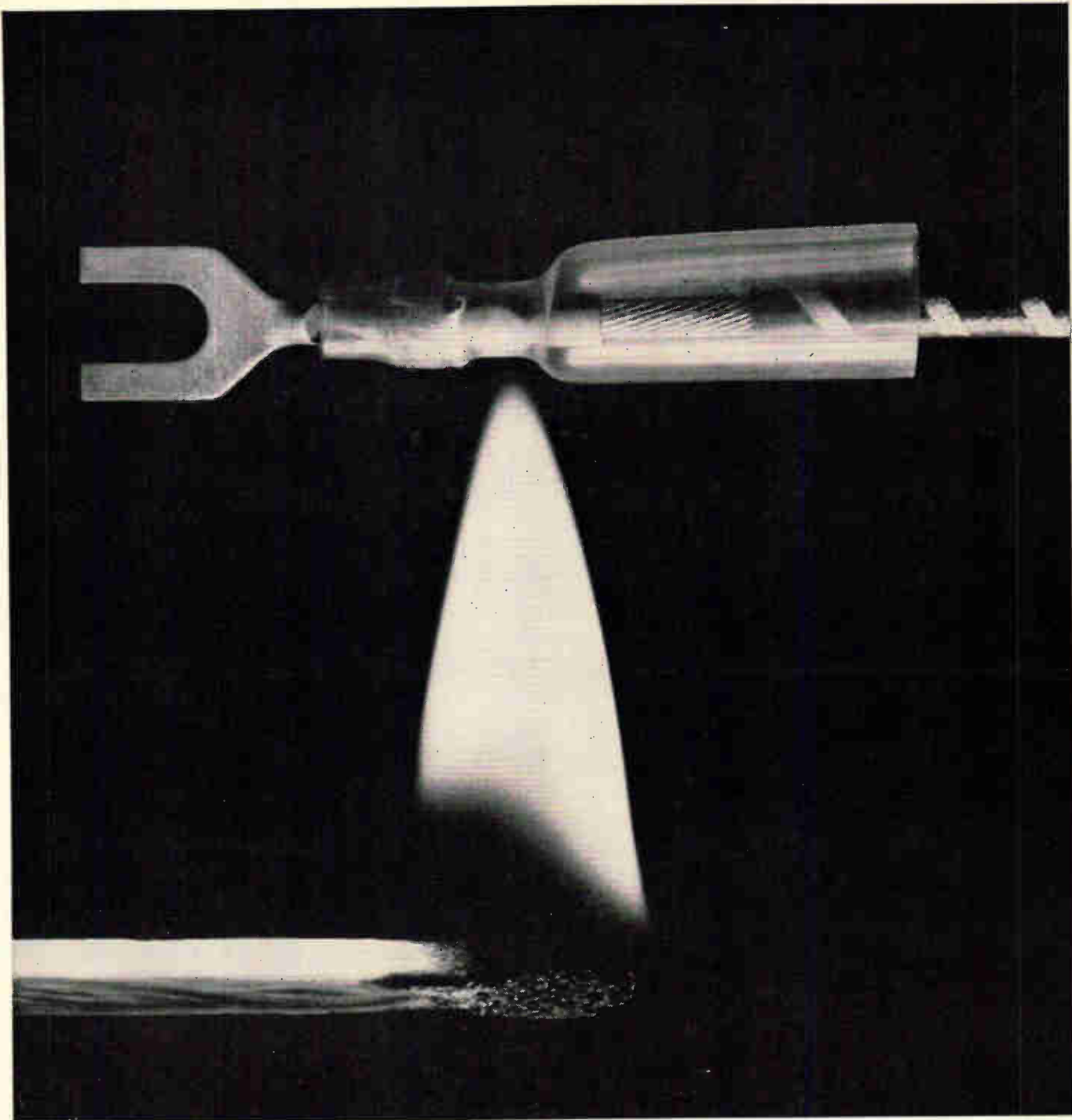

Who's Alpha Wire to take all the fun and guesswork out of heat shrinkable tubing?

In seven seconds, the diameter of this insulation tubing will shrink from .093" to precisely .045" and give you a tight mechanical bond. Without splitting. Without crushing.

You get predictable, controlled shrinkage. Alphlex FIT® irradiated tubing ends all the guesswork.

It won't melt at elevated temperatures (up to 350° C). Or split when shrunk over irregularly shaped objects.

It resists stress and solvents. Even the longitudinal

shrinkage is controlled (usually no more than 5%).

How do you use it? For insulating. Encapsulating. Splicing. Connecting. Jacketing. Capping. We have a type and size for every job.

Why does Alpha Wire get involved with irradiated tubing? Because we believe that making the best wire in the business is only half the story. The other half is being sensitive to your application problems.

Until now, heat shrinkable tubing was one of them.

Alpha Wire Headquarters: Elizabeth, New Jersey 07207. Write for our new 108-page catalog.
A Division of Loral Corporation

VALUE ENGINEERED FOR LOWER COST THRU SIMPLIFIED DESIGN

4 New 1/2" x 13/32"

High Performance Trimmers with Solder or Pin Terminals

Infinite resolution. Excellent high frequency performance characteristics. No catastrophic failures.

These four new additions to the extensive CTS trimmer line have many applications in High Performance Industrial and Military fields: computers, instruments, medical electronics, communications equipment, electronic machine controls, aerospace electronics, microwave transmission, etc.

Series 330



80¢

in production quantities
Priced lower than comparable wirewound trimmers.

Series 330P



85¢

- Proven Reliable CTS Carbon-Ceramic Resistance Element
- Far Exceeds Environmental Performance Spec of MIL-R-94B, Char. Y
- $\pm 8\%$ Humidity Stability
- 100 Ohms to 2.5 Megohms
- 3/8 Watt @ 70°C Derated to Zero Load @ 150°C
- Grounded Construction Available on Model 330

Series 330 Has Solder Terminals. Series 330P Has Pin Terminals on .100" Grid Configuration and Standoffs to Insulate Metal Cover From P. C. Board.

Write for Data Sheet 2330A

Series 630



\$1.50

in production quantities
Priced lower than comparable wirewound trimmers.

Series 630P



\$1.60

- Famous CTS CERMET™ Resistance Element
- Extreme Stability Under Severe Environmental Conditions
- $\pm 4\%$ Humidity Stability
- 20 Ohms to 2.5 Megohms
- 1/2 Watt @ 85°C Derated to Zero Load @ 150°C
- Low Noise—Long Life
- Extreme Overload Capacity
- Grounded Construction Available on Model 630

Series 630 Has Solder Terminals. Series 630P Has Pin Terminals on .100" Grid Configuration and Standoffs to Insulate Metal Cover From P. C. Board.

Write for Data Sheet 3630A



Founded 1896

CTS CORPORATION
Elkhart, Indiana

Sales Offices and Representatives conveniently located throughout the world.

Principal Products

Variable Resistors
Selector Switches
Loudspeakers
Trimming Potentiometers
Microminiature Components
& Circuit Packages
Crystals, Filters,
Oscillators & Ovens

Subsidiaries

CTS of Asheville, Inc., Skyland, N. C.
CTS of Berne, Inc., Berne, Indiana
CTS of Paducah, Inc., Paducah, Ky.
Chicago Telephone of California, Inc.,
South Pasadena, Calif.
CTS of Canada, Ltd., Streetsville, Ontario
CTS Microelectronics, Inc., Ridgefield, Conn.
CTS Research, Inc., Lafayette, Ind.
CTS Knights, Inc., Sandwich, Ill.



Small Size

Low Cost

More Switching Capacity at Lower Cost...

for Millions of Operations

CLARE

LB / LBP RELAYS

Check these CLARE LB/LBP features against your requirements:

- **6 Form C Contacts**
(Forms A, B and D also available)
- **Small Size: 1.33 cubic inches**
- **Contact Rating: 2 amperes to low level**
- **Twin contacts for reliability**
- **Direct PCB, or plug-in mounting**
- **Long life operation**

The new Type LB and LBP Relays are million-operation telephone type relays, offering extremely high quality performance at the lowest possible cost. They are ideal components for a variety of military, industrial and commercial applications, where limited space makes small size especially desirable. They provide wide application capability with a 6 form C contact arrangement. Contact forms A, B, and D are available if required. Twin contact construction provides two independent contact surfaces that assure greater contact reliability and performance. Must operate sensitivity for 6 form C is approximately 350 mw. Clear plastic cover with each LB and LBP relay; phenolic bottom plate also supplied with each LB relay.

Typical contact life ratings are: at 1.0 ampere, 28 vdc resistive, 10,000,000 operations; at 10 micro amperes, 10 millivolts, 250,000 operations with maximum contact resistance of 100 ohms.

Long Life Contact Versatility

Plug into wired chassis or printed circuit board

Mount directly on printed circuit

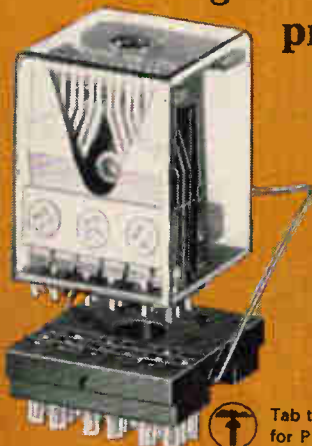

Type LBP Relay sockets offer choice of two terminal styles; elongated-hole solder type terminals for wired assemblies or tab terminals (insert) for PCB mounting. Maximum height for plug-in wired assembly mounting, 1½ inches; for PCB mounting, 1¼ inches. Relay shown actual size.

 Tab terminals for PCB mounting



Type LB Relay has tinned nickel silver terminals for direct PCB mounting. Volume: 1.33 cubic inches. Maximum mounted height, 1.24 inches. Relay shown actual size.

CONTACTS: Forms A, B, C or D. Up to 6 forms per relay

CONTACT LIFE: Mech.: 100,000,000 operations

Resistive Power Load (at 25°C):

Current (amperes)	Voltage	Life (operations)	Contact Form
1.0	28 vdc	10,000,000	C
1.0	28 vdc	100,000	C
.25	115 vac, 60 cps	50,000,000	C

Low Level Load (at 25°C):

Current	Voltage	Life (operations)	Contact Form
10 µa (closed circuit)	10 mv (open circuit)	250,000	C

(maximum contact resistance—100 ohms)

COILS

	Nominal Operating voltage	Resistance ± 10% @ 25°C
Single wound coils	5 to 100 vdc nominal	20 to 6550 ohms
Double wound coils (each coil)	4 to 75 vdc nominal	10/10 to 3275/3275 ohms

DIELECTRIC STRENGTH

500 vac rms, 60 cps
1000 vac as special

INSULATION RESISTANCE

500 K Megohms min.

SHOCK

OPERATING: 15g's 11 ms ½ sine wave, 10 µsec max. contact chatter

VIBRATION

OPERATING: 10g's 5-2000 cps, 10 µsec max. contact chatter

SENSITIVITY: Approximately 350 milliwatts—6 Form C or 4C2D contacts.

TYPICAL OPERATE, RELEASE AND BOUNCE TIME

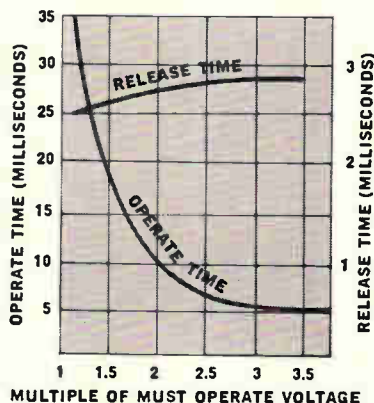

Contact Bounce

Normally open at operate
1.0 ms
Normally closed at release
3.0 ms

Notes

1. All values are typical
2. Switched battery voltage source
3. Coils not arc suppressed
4. Contact bounce not included in operate and release times.

NOTE—These specifications are condensed. For complete technical data see Data Sheet 552.

Address:
Group 08N5
C. P. CLARE & CO.
3101 Pratt Boulevard
Chicago, Illinois
60645



CEC Announces the VR-3800

**A modestly priced six-speed
switchable tape transport...with
six-speed switchable electronics**

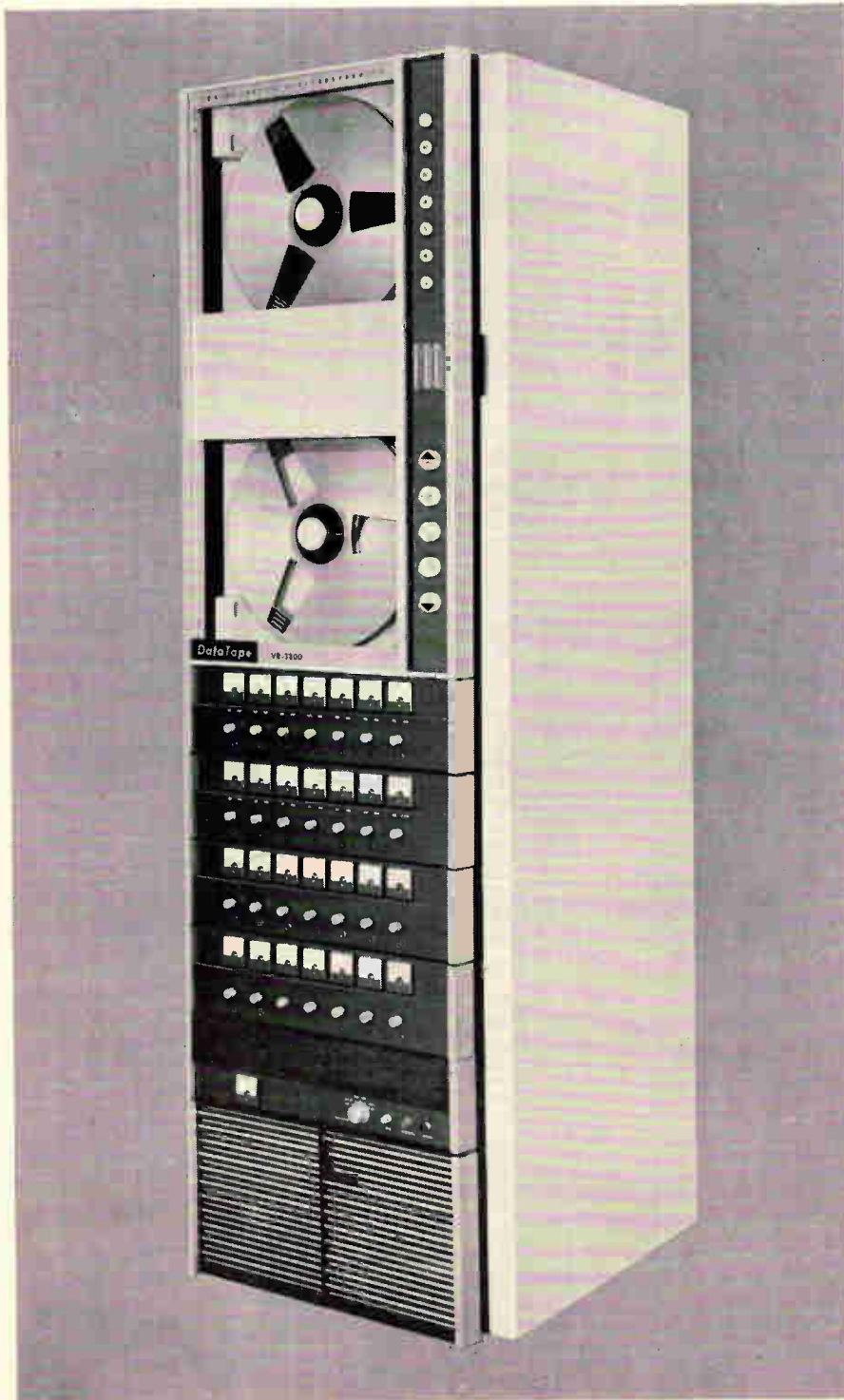

CEC's VR-3800 is the precise answer to a long-felt need. Namely, a magnetic tape recorder/reproducer that offers the basic advantages of CEC's top-rated systems at a *modest price*.

To users in most lab environments, this adds up to one important fact. The new VR-3800 is destined to become the work horse of midband recorders. For here is a recorder that is competitive in price with 100 kc class instruments, yet records up to 300 kc at 60 ips with unsurpassed reliability.

The VR-3800's outstanding features include:

- ▣ Six speeds to 60 ips; both transport and electronics electrically switchable. Speed sensitive plug-ins available for any number of transport speeds required. Buy only those you need, and save!
- ▣ Seven or fourteen channels may be used for data storage in the d-c to 300 kc frequency range.
- ▣ Extended wideband FM offers d-c to 40 kc at 60 ips. Standard FM from d-c to 20 kc at 60 ips.
- ▣ Longer lasting recording heads — smooth all-metal-front-surface design lasts up to 6 times longer than conventional heads, and reduces cleaning to a minimum.
- ▣ Record and reproduce amplifiers are solid-state, and the direct system is fully amplitude- and phase-equalized at all speeds, providing optimum square wave response.
- ▣ Signal-to-noise ratio is the highest; distortion the lowest.
- ▣ Tape tension constantly controlled by closed-loop servo control.
- ▣ Easy handling dynamic braking used exclusively. Fail-safe mechanical brakes used only when tape motion is stopped or power fails.

And—since all components are designed and manufactured by CEC, users realize the additional advantage of single-source responsibility.

For complete information about the VR-3800, call CEC or write for Bulletin 3800-X5.

CEC

Data Recorders Division

CONSOLIDATED ELECTRODYNAMICS

A SUBSIDIARY OF BELL & HOWELL/PASADENA, CALIF. 91109
INTERNATIONAL SUBSIDIARIES: WOKING, SURREY, ENGLAND
AND FRIEDBERG (HESSSEN), W. GERMANY

Just \$75 Buys You This Tiny, Adjustable TRIMPOT® Time-Delay Relay

Now—low price, small size and adjustability all in one! You can easily fit the Model 3908 industrial time-delay relay into both your system and your budget. With just a screwdriver, you can adjust it accurately over a range of 0.1 to 1.5 seconds; and by adding an external resistor or resistor-capacitor combination, you can boost the time delay to 200 seconds while retaining the adjustment feature. In addition, you can mount it in just one square inch and operate it continuously on less than 0.06 amps.

The Model 3908 is potted and has all-welded, solid-state circuitry. It is protected against operating-voltage transients. Even in the most difficult industrial applications, it performs with full Bourns reliability.

Bourns also offers you two MIL-SPEC subminiature time-delay relays, Model 3900 (DPDT) and Model 3907 (SPST NO-Solid State). All units are available from stock. Write **TODAY** for complete technical data!



MODEL 3908
Industrial Unit



MODEL 3900
MIL-SPEC Unit



MODEL 3907
MIL-SPEC Unit

Time-delay range:	0.1 to 200 secs.	0.1 to 200 secs.	0.1 to 200 secs.
Environment:	Industrial	MIL-R-5757D	MIL-R-5757D
Size:	1.0" x 1.0" x 0.7"	0.4" x 0.8" x 1.31"	0.4" x 0.8" x 1.0"
Output:	DPDT relay 1.0A resistive at 26.5 VDC, 85°C	DPDT relay 1.0A resistive at 26.5 VDC, 120°C	SPST NO—solid state 0.05A resistive at 26.5 VDC, 120°C
Nominal Voltage:	20 to 30 VDC	20 to 30 VDC	20 to 30 VDC
Operating Temp. range:	-40 to +85°C	-55 to +120°C	-55 to +120°C

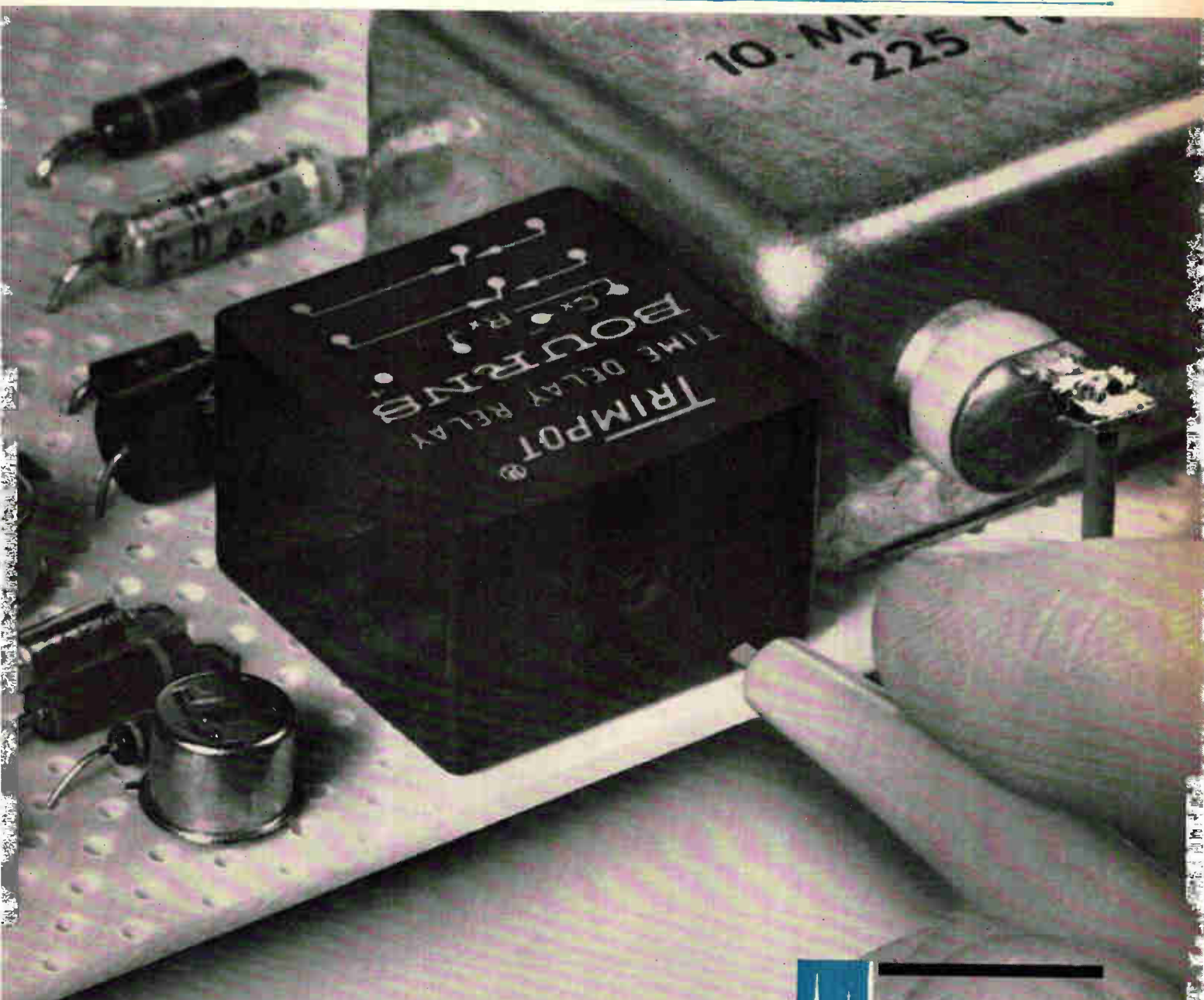

BOURNS

BOURNS, INC., TRIMPOT DIVISION
1200 COLUMBIA AVE., RIVERSIDE, CALIF.
PHONE 884-1700 • TWX: 714-682 9582
CABLE: BOURNSINC.

EAGLE ELECTRIC COUNTER

Batch count a predetermined number. Shut off or actuate a machine or machines.

Meter fluids by flowmeter. Control a shut-off or a mixing valve or valves.

Add-subtract count. Control of parking lot, hopper or conveyor section capacity.

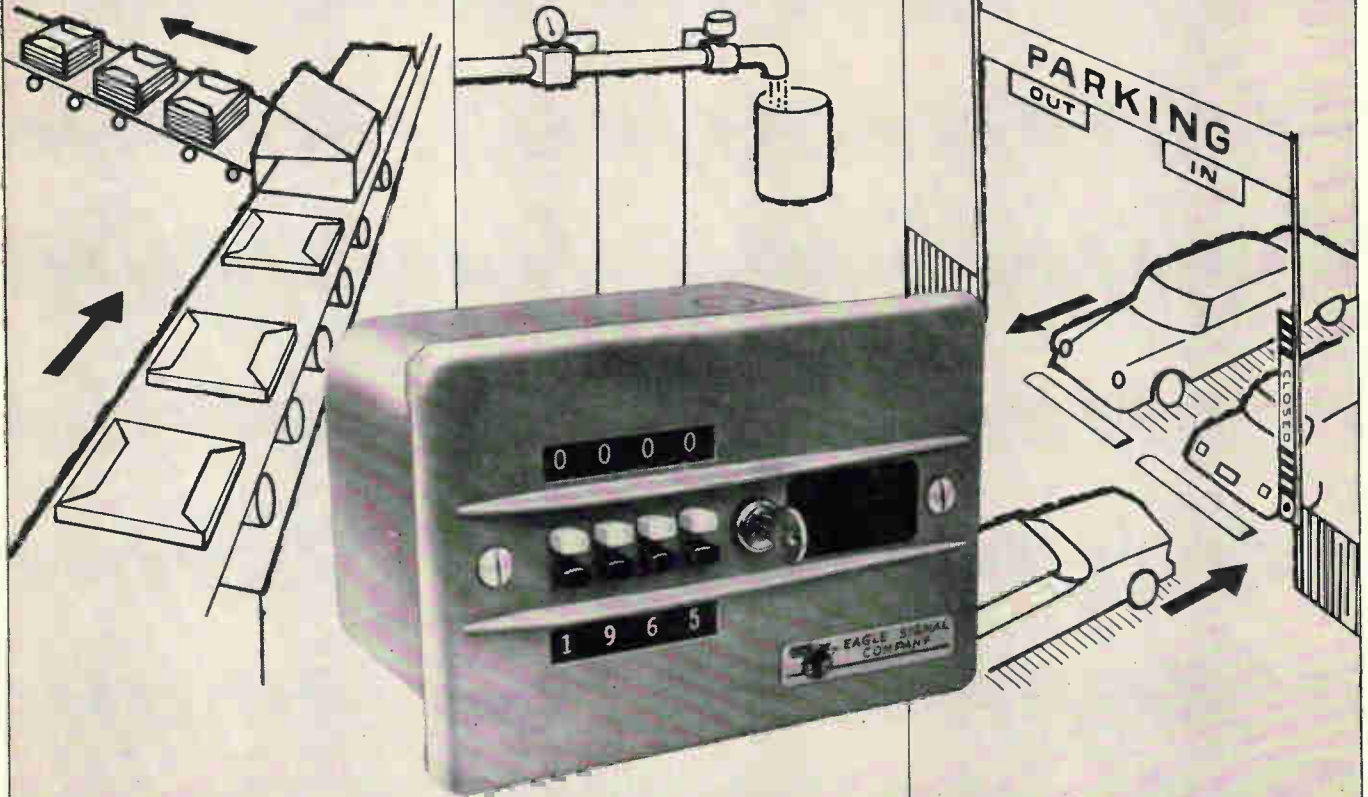

COUNTS...THEN CONTROLS

The HZ760 performs in three ways...as a batch counter...a continuous count counter...an add-subtract counter. Whether you count pills or automobile bodies, this is the unit for the job.

Functionally, the HZ760 registers counts by electric impulse from a limit switch, photoelectric cell, flow meter or similar device. At the preselected number of counts, *adjustable up to 9999*, the unit's control switch turns electronically or electrically controlled equipment on or off. **THERE IS NO RESET TIME.**

The HZ760 is a rugged counter designed for precise, industrial control. Among its outstanding features: pushbuttons to set count...keylock to prevent tampering...large, easy-to-read numerals...10 amp. load switches...counting speeds to 500 per minute...AC coils. HZ762 shaft driven units for revolution counting also available. Compare. You'll choose Eagle.

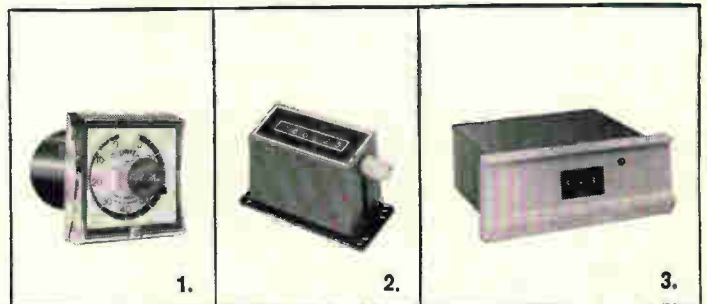

EAGLE's family of counters offers you a wide selection for your most exacting control problems: 1. 80 count plug-in automatic reset counter. 2. 6 digit electric count totalizer. 3. 3 digit electronic counter for high speed counting.

Contact Eagle Signal Division, E. W. Bliss Company, Federal Street, Davenport, Iowa.

BLISS  **EAGLE SIGNAL**

A DIVISION OF THE E W BLISS COMPANY

Electro-Mechanical, Electronic, Solid State Timing/Counting/Programming Controls General Purpose, Medium Power Relays

NEW EAGLE RELAYS

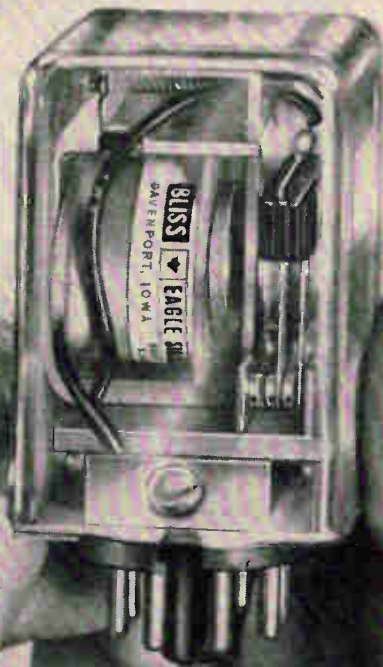

OVER 3,000 TYPES

COMPARE THEM...for Reliability

A unique, unrelenting inspection and quality control program guarantees that Eagle Relays will meet or exceed published specifications. This performance is backed by a solid one-year warranty.

COMPARE THEM...for Quality

Advanced design, engineering know-how and exacting manufacturing methods create relays of the highest quality...insuring reliable performance.

When you specify Eagle Relays, you also get unequalled service from a nation-wide network of experienced sales engineers and stocking distributors.

Compare. You'll choose Eagle.

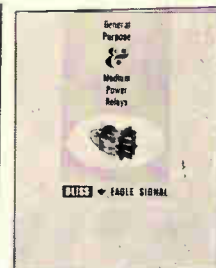
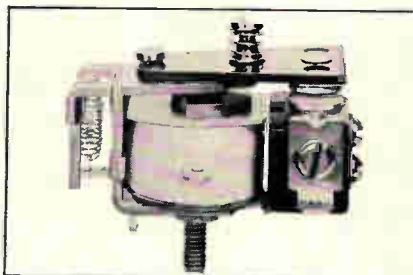

The 25PD Medium Power Relay, shown above, handles loads up to 25 Amps. with ease. It is available with a variety of coils and SPST NO-DB contacts. Get the complete story on Eagle Relays. Send for your free copy of our 16-page color catalog, today. Write to Eagle Signal Division, E. W. Bliss Co., Federal Street, Davenport, Iowa.

BLISS  **EAGLE SIGNAL**

A DIVISION OF THE E. W. BLISS COMPANY

Electro-Mechanical, Electronic, Solid State Timing/Counting/Programming Controls General Purpose, Medium Power Relays

**Last week,
you needed
a
switchlite.**



**Today,
you need a
pushbutton
switch.**



**Tomorrow, a
subminiature
toggle
switch.**



**Next Tuesday, a
hermetically-
sealed
switch.**



Good thing Control Switch is around to help.

We're unique among switch suppliers. No other manufacturer makes all the kinds of switches we make. And some don't make any of them.

When we're around to help, you can have your choice of:

- 3,150 toggle switches
- 4,200 pushbutton switches
- 1,240 hermetically-sealed switches
- 1,800 lighted pushbutton panel switches
- 460 basic precision switches
- 1,180 indicator lights.
- . . . plus countless more standard variations.

These are quality switches and switchlites . . . for computers, aircraft, missiles, controls, industrial and electrical equipment where performance standards demand the ultimate in reliability.

Keep your Control Switch distributor . . . or us . . . in mind. Today. Tomorrow. Next Tuesday.



CONTROL SWITCH DIVISION
1420 Delmar Drive, Folcroft, Pennsylvania 19032

30-DAY FREE TRIAL

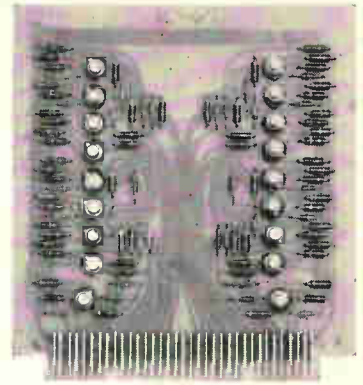

EVALUATE SPACE CRAFT'S 1Mc LOGIC CARDS

Gentlemen:

I hear you've had remarkable success in producing competitively priced logic cards with optimum function groupings that minimize system wiring. I'd like to have the following card(s) for a 30-day free shakedown in my lab:

- | | | |
|--|--|---|
| <input type="checkbox"/> NAND-2Z: 6 two-input NANDS
3 three-input NANDS | <input type="checkbox"/> OR-2Z: 6 three-diode clusters
2 two-diode clusters | <input type="checkbox"/> ULC-2Z: 6 Schmitt trigger /
buffer amplifier circuits for
universal level control |
| <input type="checkbox"/> NOR-2Z: 5 two-input NORS
3 three-input NORS | <input type="checkbox"/> UFF-2Z: 4 universal
Flip-Flops | <input type="checkbox"/> ND-2Z: Nixie Driver,
4-line input,
10-line output |
| <input type="checkbox"/> ADD-2Z: 4 half-adders
2 two-input NANDS | <input type="checkbox"/> SFF-2Z: 3 shift register
Flip-Flops | |
| <input type="checkbox"/> AND-2Z: 6 three-diode
clusters
2 two-diode clusters | <input type="checkbox"/> OS-2Z: 4 one-shot
multivibrators | COMMON SPECIFICATIONS:
Temperature, 0 to +50° C
Power supply, +6, -6, -15 VDC
Connector, 35-pin Elco Varicon
Operating freq., DC to 1 Mc |
| <input type="checkbox"/> RD-2Z: 8 relay drivers | <input type="checkbox"/> MV-2Z: 2 multivibrators | |
| | <input type="checkbox"/> CD-2Z: 8 capacity drivers | |

Name _____ Title _____
 Company _____
 Address _____
 City _____ State _____ Zip _____

SPACE CRAFT, INC.

8620 SOUTH MEMORIAL PARKWAY • HUNTSVILLE, ALABAMA 35802



newest Esterline Angus design breakthrough

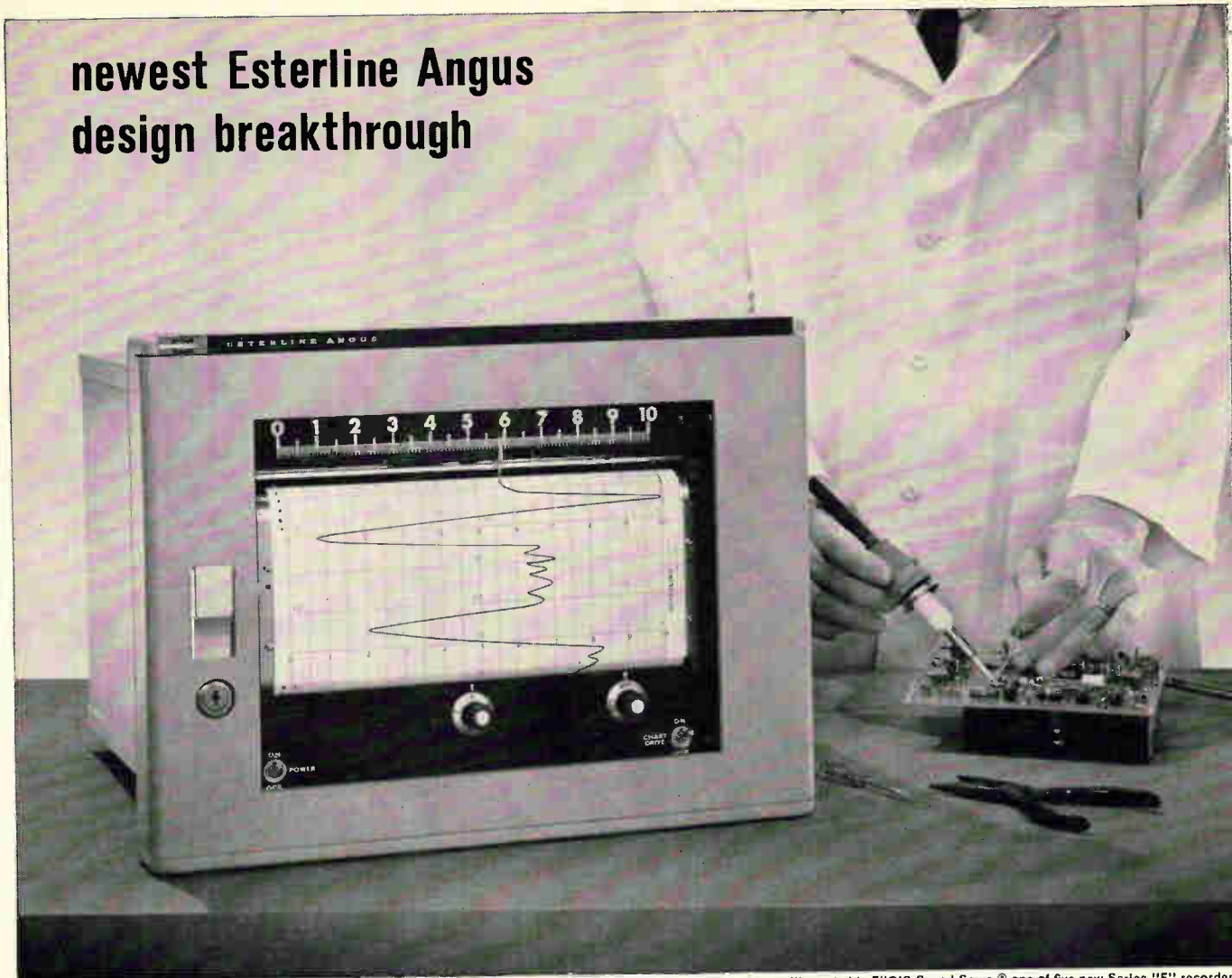

Illustrated is E1101S Speed Servo,® one of five new Series "E" recorders

1/5 second response over 10" span
+
inertial ink pump } = **the only wide chart
 Speed Servo®**

Never before has a servo recorder offered the versatility, dependability and reliability of the Wide Chart Esterline Angus Speed Servo.® It delivers:

- 1/5 second response over the full 10" span.
- spans as low as 1 MV.
- a servo mechanism with only one moving part . . . no drive cords to break or gears to wear.
- new inertial ink pump (patent applied for) provides skip-free writing at any pen speed.
- optional adjustable zero—adjustable span . . . zero displacement to ± 100 MV . . . spans from 1 to 100 MV.
- solid state amplifier.
- source impedance of 50,000 ohms.
- conductive plastic feedback potentiometer lasts thousands of hours longer than any wire wound potentiometer.

Our new Series "E" Catalog has the complete story. Write for it.

ESTERLINE ANGUS INSTRUMENT COMPANY, INC.
 Box 24000-E • Indianapolis, Indiana 46224



Open door shows automatic chart drive controls . . . dial any one of 15 speeds instantly . . . from 1/2" per hour to 8" per second without gear change, motor change or screw driver adjustments . . . sloped writing surface and chart tear off bar are featured.

See us at Wescon • Booths 3523—3524

ESTERLINE ANGUS

Excellence in instrumentation for over 60 years



Technical Articles

**Special report—
The changing face
of the West:
page 60**

Although the curtailment of military spending which started 2½ years ago hurt many electronics companies, it had one beneficial effect. It forced the industry to reconsider and to alter its methods of doing business. Now, the first signs of that change are showing up at Wescon in new products, new technology and new marketing techniques. During the same period of reduced government spending, integrated circuits grew up and a lot of producers settled in the West. Together, these influences have meant a change that can be seen in:

- I. Instrumentation
- II. Aerospace
- III. Microwave
- IV. Integrated circuits

**Integrated circuits improve
differential amplifiers—
and vice versa:
page 74**

Integrated circuitry reduces the two major objections to the use of differential amplifiers: their high cost and the complexity of circuits in which they are used. Happily, the configuration is particularly suited for overcoming variations in resistivity between chips, a problem inherent in monolithic integrated circuits.

**Regulating bias on a
ship's hull:
page 84**

In the battle to prevent ships' bottoms from corroding, engineers have tried a variety of methods from special paints to electric techniques. Conventional cathodic protection doesn't work well because the voltage required depends on many variables. A new electronic control system varies the voltage so that cathodic protection is effective.

**A solid state stereo set
built in modules:
page 88**

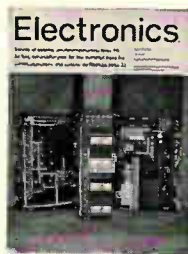

Wiring in most consumer products is a confusing maze that makes maintenance and repair a headache. Now an instrument company that used to work primarily for aerospace and military contractors has put together a high quality stereo receiver using the packaging techniques it developed for precision digital voltmeters. Not only is the receiver easy to maintain, but because of some unique circuit design, it works even when several circuits are out. Cover photographer Vincent Pollizotto angled some mirrors to obtain a triple view of the set and show its neat wiring.

-
- Coming
August 23**
- A look at the overlay transistor
 - What's happening to automatic checkout equipment
 - Aluminum bonding for integrated circuits
 - Microwaves on the industrial production line

The changing face of the West

At Wescon, along with equipment, electronics companies will exhibit a new attitude that's more aggressive, more businesslike and less dependent on military spending

Out West from Seattle to Phoenix, electronics companies have met the most serious threat yet to their existence with the potent weapon of change. Through necessity, they have become more cost-conscious, more efficiency-minded. Forced to become self-reliant, they are learning the value of independence. No longer do they lean on a single giant customer—the military—for money, inspiration, projects, specifications and dynamism. For the first time, almost every company is doing some organized thinking about its future, its products and its markets.

The change in the West is more than skin deep. Buffeted by the decline in military spending that started about two and a half years ago, electronics companies had to revamp their basic structure and operating philosophy or go under. Because diversification takes a long time to pay off, the results of this painful transition are only now emerging clearly; and they will be on view for the first time at the Western Electronic Show and Convention (Wescon), in San Francisco, Aug. 24 to 27. They will be seen in the new products on display, in their engineering, in the new customers for whom they are intended, and in the aggressive marketing efforts to sell them.

I. The instrument makers

To makers of electronic instruments, the impact of reduced military spending came as an unpleasant surprise, because instruments are not shown as a separate category in defense spending. Instrument money is buried in over-all project funds and gross military spending plans. In addition, many of the customers that instrument companies thought were in commercial or industrial fields turned out to be suppliers to military contractors whose business started plummeting unexpectedly. Instrument sales

followed suit. As Noel Eldred, marketing vice president of the Hewlett Packard Co. put it, "Customers who used to buy \$100,000 worth of instruments a year regularly suddenly cut back to \$1,000 a year or nothing."

Some instrument companies have resorted to strange innovations to fight this kind of slump:

- The Giannini Controls Corp., a Los Angeles company that specialized in aircraft and missile fuel control systems, has developed four new electronic instruments for industrial markets: 1) to measure and control the opacity of paper, 2) to determine the percentage of solids in chemical slurries, 3) to measure the thickness of plastic pipe and films, and 4) to be used for ultrasonic switching.

- Non-Linear Systems, Inc., in Delmar, Calif., a producer of measurement systems and digital voltmeters, has designed a high quality stereo receiver which will go on the market later this month (see page 88). By the end of the year, the company hopes to have perfected an electronic teaching machine it has been working on since early in 1965.

- The Cubic Corp., whose interferometer tracking systems have been installed on all the missile ranges, has just delivered a new magnetic tape recording system to be installed on a locomotive of the Southern Pacific Railroad. Later this year, the company will offer a full line of systems to tape locomotive maintenance records.

- Sierra Electronics, a division of the Philco Corp., whose products have been for the measurement of carrier transmission lines or for the generation and measurement of r-f power, now makes an infrared scanner for industrial applications. Later this year it will complete development of an infrared camera for medical diagnosis.

Not all the changes involve radical new products, however. Some companies have standardized their product lines to eliminate custom building; others have narrowed their product lines to a few offerings so they can manufacture components in larger volume; still others have added additional equipment to a component or subassembly so they can offer customers a complete system.

Reported and written by William B. Wallace, Los Angeles Regional Editor; Laurence D. Shergalis and Edmond G. Addeo, San Francisco Regional Editors; and Lewis H. Young, Editor.



Electronic equipment centers in the West.

The Berkeley division of Beckman Instruments, Inc., for example, standardized its counter designs so a customer has his choice of six different devices, which vary in price from about \$800 to almost \$1,600, with increasing capability. Each starts as the same device, but the addition of standard modules increases capability.

And the Dymec division of Hewlett-Packard applies the same approach to its data systems. Joseph Rodgers, engineering sales manager, points out that Dymec used to spend as much as \$6,000 for custom engineering in a \$16,000 analog scanning, voice-to-frequency converter in which only a counter would be standard. Today the same system would sell for \$10,000 to \$12,000, because it is built of standard components with practically no development engineering.

To narrow its offerings of instrument tape recorders, the Ampex Corp. put only three models in the line it introduced last month to replace the seven models of its older line. Giannini Controls streamlined its package of torque motors, limiting it to two models by dropping all specialty motors.

Still selling the military

Though diversification and new products are often-stated goals, almost all the instrument companies that grew up with military business still keep one hand in the military market. But they've had to change their approach, because defense procurement has shifted direction.

Most importantly, the military has become cost-conscious. The services are buying off-the-shelf hardware instead of developing it from scratch. Big systems contracts are being awarded on a fixed-fee-plus-incentive basis instead of cost-plus-fixed-fee. Though few instrument companies win such contracts, their customers do, and the buyers have put on the pressure to cut costs while improving reliability and delivery. Despite the emphasis on lower costs, however, military buyers are looking for ever-higher performance and sophistication in the instruments they buy.

Off-the-shelf

Some instruments companies are adjusting to the shortage of military funds by selling off-the-shelf gear instead of specially-developed equipment. Dymec reports that some of its standard commercial data acquisition systems are going into applications that used to require equipment built to military specifications. A good example is ground support equipment. It's not difficult, the military has found, to supply a satisfactory environment for instrumentation. Airborne and shipboard gear, however, still must meet military specifications.

But this relaxation has encouraged companies like Dymec to add to their commercial lines, thus giving them products they can sell to industrial customers as well as military ones. Two and a half years ago, Dymec started developing a standard line of data acquisition systems. Since then, it has rounded out its systems by adding accessories.

At Wescon, Dymec will introduce an on-line plotter that will position data points almost as fast as its data acquisition system can acquire them. Rodgers believes the device's most attractive feature is the price: under \$20,000. Plotters capable of the same accuracy and speed have cost more than \$100,000.

More performance

Even though money has been tight, the military services have been demanding better performance

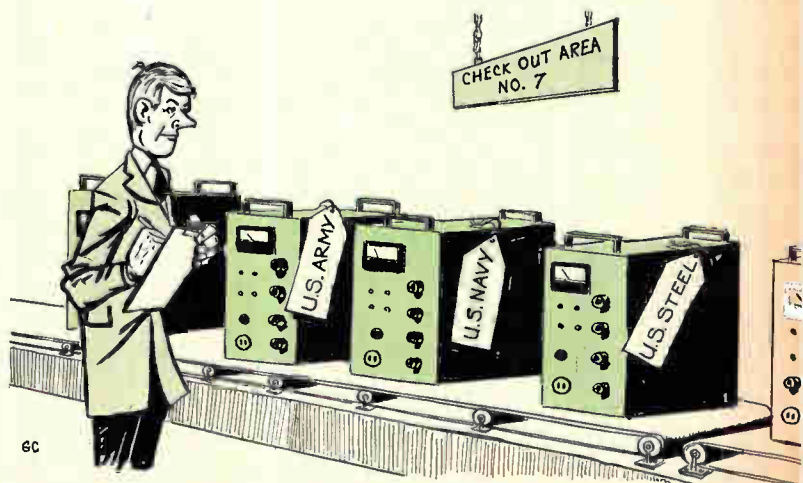

Off-the-shelf items go to military or industrial buyers.

from electronic equipment. Edward Clare, vice president of marketing at the Kintel division of Cohu Electronics, Inc., sees the challenge this way: "You have to be able to give the same or better performance for long periods of time at less cost."

The demand for high performance has stepped up the need for laboratory and calibration equipment to assure that systems are delivering the promised high performance. Clare says, "We see more insistence on meeting claims of performance."



Cohu's Edward Clare: "... give the same or better performance at less cost... more insistence on meeting claims of performance..."

For example, Kintel's 304 precision d-c voltage standard has been designed so that it maintains accuracy within 30 parts per million for six months to a year. To build such a reference, the company selects its components, mainly zener diodes and resistors, by statistical methods, and tests incoming components rigorously every hour for hundreds of hours. Components that pass this severe test are wired into the reference; others go into parts of the standard with wider tolerances, such as pre-regulators.

At Wescon, Seattle's John Fluke Manufacturing Co. will show a new Model 332 calibrator with an accuracy of 30 parts per million.

Similarly, the demand for high performance has stimulated interest in atomic time frequency standards built by Varian Associates' Quantum Electronics division.

Today, the atomic oscillator is in about the same stage of development as the quartz oscillator, which it replaces, was in 1920, when it had been put into its first applications. Since the atomic oscillator is free of drift—unlike the quartz oscillator, which drifts in time—it can be used in a system that must operate accurately without adjustment for long periods. The cost of an atomic oscillator is nearly ten times that of a quartz oscillator—\$10,000 versus \$1,000—but an atomic frequency source is only about 30% more costly over-all than a source with a quartz unit, needing fewer components.

Though Varian has had a line of atomic frequency standards for a couple of years—a rubidium frequency standard, a cesium beam tube, and a hydrogen maser—applications with a demand for such rigorous frequency control are just appearing. Space tracking systems can use them in timing applications and for the accurate control of frequencies, and they are being considered for navigation communication systems for the first time.

Earlier this year, Varian received a \$674,000 contract from the National Aeronautics and Space Administration for off-the-shelf atomic frequency standards that will be incorporated in the tracking and data acquisition system for the Apollo project.

Arthur O. McCoubrey, manager of engineering applications at the Quantum Electronics division, commenting on the significance of NASA's purchase of commercial equipment says, "In previous programs, NASA would have ordered equipment built with only approved components. But procurement is shifting to ground installations in support of communications, so off-the-shelf hardware is satisfactory."

Another trend affecting space instrumentation, according to McCoubrey, is NASA's preference for functional specifications for instruments instead of detail specifications. "They tell us what the equipment has to do and let us get there any way we can," he explains.

At Wescon, Varian will introduce its first major accessory for its line of atomic frequency standards: a frequency combiner that puts five precision standards in one unit so any one can be removed for maintenance without shutting down the timing system.

Increase in sophistication

The application of atomic frequency standards illustrates another of the changes in the West: Instruments are getting more sophisticated and more complicated. And they have far greater capability. Proof that this is happening, according to



H-P's David Packard: "... Instruments are getting more sophisticated and more complex... Make an instrument as general purpose as possible..."

David Packard, chairman of the board of Hewlett-Packard, is that prices on instruments have jumped. "Today we have more products in the \$7,000 to \$10,000 class," he says.

Because Hewlett-Packard products are ubiquitous, the company felt the pinch of reduced military spending as much as anybody. To offset it, H-P has done a lot of things—increased its overseas business sharply, entered new markets by acquiring companies with technological experience different from its own, and diversified its product offerings by adding instruments it never sold before. When it adds a new instrument, the company is careful not to introduce a "me-too" product. Thus, Packard boasts that the company's "new spectrum analyzer [introduced last year] is far more sophisticated than anything on the market."

Part of the trend Packard has noted is the move to a more expensive but more general instrument to replace several, each of which did a specific job. "Today, you make an instrument as general-purpose as possible," he says, "even if the user has to make only one measurement. It's not only a matter of cost but of reliability. The first, second or third instrument off the production line is never as good as the thousandth. As production continues you can correct a lot of difficulties with new instruments."

As if to prove his point Tektronix, Inc., a competitor in Portland, Ore., acquired the Pentrix Co. two years ago, a purchase which led to a line of spectrum analyzers that plug into Tektronix's oscilloscopes.

Packard also sees industry interest growing in automated test systems, another area of sophisticated instrumentation. He believes programed testing will represent a rich market in a few years.

At Eldorado

"Funds are limited, so the military services don't have the money for big changes," says Arch Montgomery, assistant to the president of Eldorado Electronics. Because of that, Eldorado is updating older electronic equipment for the services instead of replacing it. In one project, the company has improved the accuracy of an old Navy radar, whose analog presentation was only about 5% accurate, by digitizing it. For about \$10,000 a unit (compared to about \$40,000 for a new one) Eldorado can improve the accuracy to pinpoint proportions, ± 2 yards in 7 miles. The company hopes to sell the design to the Navy for minesweeping jobs.

With the improved radar, says Montgomery, a sweeper could spot oil drum mines the Vietcong are using. These are difficult to find because the waves generated by a minesweeper moving close to the drum can detonate it. The mine, which is made of a 55-gallon oil drum, floats unstably because the top half is filled with explosive while the bottom half is filled with air. Wave motion tips it over to detonate it. With the new radar, however, the mines could be spotted at distances far enough away so the waves generated by the minesweeping



Electronic equipment for the individual soldier is a good market because, "As soon as you give a piece of equipment to a soldier, it's gone."

ship will not tip the drums floating in the sea.

Eldorado has also plunged heavily into developing electronics for limited warfare. Montgomery likes the look of the limited warfare market because of its sales continuity. He says, "Limited warfare represents a continuous market. As soon as you give a piece of electronic gear to a soldier, it's gone. You have a good market for replacements as long as the equipment has life with the military."

Prospecting for new markets

By far the most marked change in the West is the movement of companies traditionally tied to defense markets into industrial, consumer, medical and educational markets. Almost every instrument company on the Coast has a pet new project or new product area.

- Some are acquiring companies with technological background in areas unfamiliar to the purchaser. Thus, Hewlett-Packard bought the Sanborn Co. to help enter the medical instrumentation market; Giannini purchased Cramer Controls (timers), Powertron (ultrasonic components) and Conrac (professional television monitors).

- Some have built on their own technology to expand into new areas. At the Scientific and Process Instruments division of Beckman Instruments, for example, there has always been interest in measurement and medicine. Two years ago, Beckman put the two together, forming a physiological measurement group to study a new area. A year later the company was able to go into commercial production with three products: a new "skin" electrode for making electrocardiograms, a blood flow instrument, and a monitoring system to prevent brain damage to unborn infants during the mother's labor. The three have led to ancillary products, such as a biological amplifier for use with the new ECG electrodes. Its signal-to-noise-ratio is such that the amplifier can measure 1 microvolt over a bandwidth of 0.1 cycles to 100 cycles.

- Some have acquired outside companies and then combined the purchased firms' products and

"AND HOW DOES THE MACHINE SAY WE'RE FEELING TODAY?"

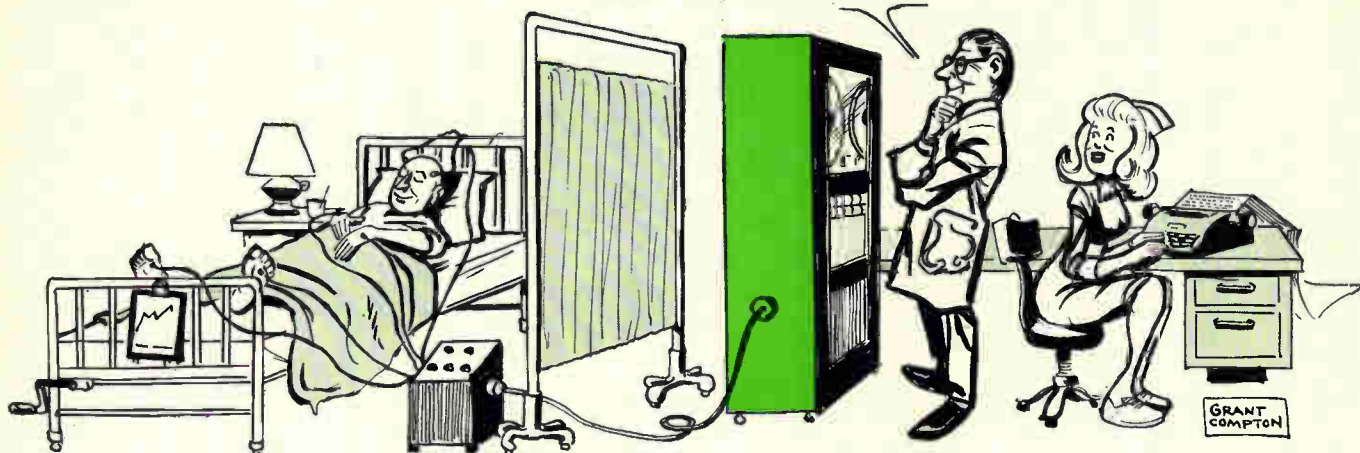

techniques with their own specialties to develop new markets. An interesting example is the Ampex Corp., which purchased Mandrell, a geological survey and research company, almost two years ago. Ampex developed a specialized digital tape handler for the new company. When Ampex discovered that Mandrell's main data processing problem was "digging out a signal buried in noise" it turned its newly combined technology to antisubmarine warfare and medical work, where the data processing problem is the same. Says Edmund J. Kearne, director of product planning, "Same bandwidth, same kind of signal buried in noise. It's the same problem."

Medical invasion

To Spacelabs, Inc., moving into medical markets from aerospace business was as natural as looking for more business. Formed in 1957 to do medical engineering in the space program, the company found that a lot of medical problems were akin to those solved by its space instrumentation.

James Reeves, executive vice president, says, "In the Gemini and Apollo projects, the problem was this: put a sensor on a spaceman and then diagnose him even if he's hundreds of thousands of miles away. You can't see him, you can't touch him, you can't ask him questions."



Spacelabs' James Reeves: "... Finally we are seeing a recognition that technology has something for medicine ..."

Spacelabs put the same logic to work at Andrews Air Force Base Hospital, where the commanding general wanted a central monitoring system for cardiac patients. The system had to measure heart rate, and take electrocardiograms while a patient was walking about the hospital, then telemeter the data—along with the patient's location at the instant—to a centrally located panel where all data is recorded on magnetic tape [Electronics, July 12, 1965, p. 113].

For this job, Spacelabs developed a one-pound radio transmitter and special ECG electrodes. Total cost for the six-patient system was \$146,000. Now the company believes it can reduce the cost of the system to \$4,000 to \$10,000 a patient, depending on a hospital's requirements.

Reeves believes the time is right to diversify into medical instrumentation. "Finally, we are seeing a recognition that technology has something to offer medicine," he says. "A lag has existed because technologically inclined companies have not tried to understand the clinician's problem." The key, according to Reeves is the clinician. "It is still his judgment that diagnoses the patient's ills and cures them."

Beckman Instruments' diversification into medical electronics has taken an unusual twist: The company is emphasizing preventive and predictive measurements—the measurement of healthy people as well as sick ones.

In addition to developing measurement devices, Beckman sees a great future in data processing for the medical profession. At the Scientific and Process Instruments division, S. B. Spracklin, technical operations manager, says, "The medical profession has a lot of reasons for collecting large volumes of data. First, for teaching: By recording all the key physiological variables during an operation, you can play back the operation for students, exactly the way it took place. Second, a carefully edited record of a complex operation like heart surgery would be invaluable to research. And finally, some of the data is essential to warn of shock and coma during an operation. Small changes in certain

components of the blood, for example, can put a patient into shock quickly."

Two of Beckman's current projects illustrate the scope of the company's interests. One, in data processing, is trying to learn how much raw data should be processed before it goes back to the doctor. A second, in measurement, is aimed at developing an instrument to measure blood flow and its relation to arteriosclerosis. Spracklin believes the doctor may be able to predict this disease with the right instrument.

Industrial invasion

One company that has moved rapidly into industrial markets is Giannini Controls, whose 1964 sales of \$30 million were split 60% military, 40% industrial. That's a big change from the situation in 1960, when 88% of the company's \$15.7 million of sales were military products, only 12% industrial.

At Giannini, the decline in military spending is just one of the reasons for the switch to industrial products. An even more pressing one is profit. Last year, 60% of the company's profit came from its industrial business even though it accounted for only 40% of total sales. Says Giannini's vice president for marketing, Edward F. Rushlow, "The avionics business is healthy, but it's not as profitable as industrial sales." And this year, he notes, "avionics prices are very competitive." In fact, price pressure on gyros has been so great that Giannini's sale of gyros has plummeted.

Rushlow doesn't bemoan the loss because he has a flock of new products to sell to new customers. Some of these new devices came directly from the company's aerospace work. For example, Giannini's Control Nucleonics division had developed a radioactive instrument to measure the amount of propellant that would be left in the Lunar Experimental Module and the Apollo capsule when both are subjected to zero weight conditions. The company applied what it had learned on this project to a new industrial product, a low-cost radioactive gage to measure the thickness of plastic sheet and tubing. The first unit went to work in a pipe factory last November and worked so well that Rushlow was able to offer the instrument commercially last May. Nine units have been sold since then at a

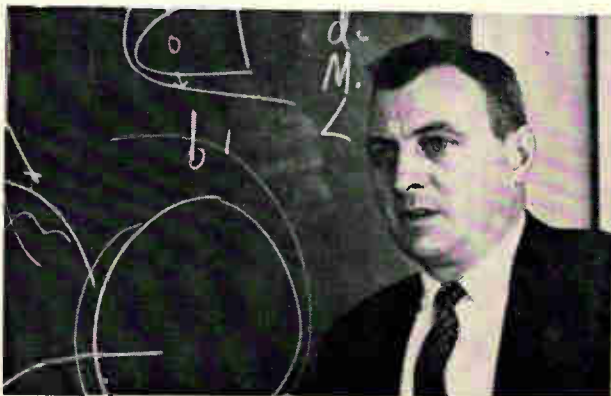

Giannini's Edward F. Rushlow: "... Avionics business is recognition that technology has something for medicine..."

price of \$3,000 each—a bargain, according to Rushlow, since other, similar gages cost at least five times as much.

Another industrial product that had its start in military dress is Giannini's ultrasonic switch, originally developed for the Atlas, Titan and Polaris missiles. It sensed the absence of fuel when ultrasonic waves emitted by the switch were able to reach a probe. An industrial version, redesigned to cut the cost, has been sold to an oil company for its tanker fleet; to help unload the cargoes of fuel. The industrial switch has two probes: one tells when to slow down pumps and the other when to shut off so the pumps don't cavitate and destroy themselves pumping air.

Still another modification of Giannini's ultrasonic work has resulted in an on-line percent-solids indicator. Rushlow hopes to sell this device to the paper industry and sewage plants.

The Consolidated Electrodynamics Corp. is trying to crash the industrial market with a product that descends directly from work done for aerospace projects.

Its new 5-124 industrial oscillograph system, currently being market-tested, is a packaged unit that can measure 18 variables and provide a direct readout on paper for a customer who is not skilled in sophisticated instrumentation. The system is put together so that a user can simply plug it into the device to be checked and turn it on; it also has a patch panel so that a different measurement can be made merely by changing the panel. During the market test, CEC has put a \$15,000 price tag on the new system.

As more electronics companies move into industrial markets, industrial buyers are developing a greater interest in what electronics has to offer. Kintel, which had built a radiation-resistant television camera as a specialty item for several years, was able to introduce a standard product line of these cameras last year because the market had grown up to support it.

Pitfalls

But cracking the industrial market is no cinch, a lot of companies are finding. One of the biggest problems is that the industrial customer is so different from the military buyer. He is far less expert about electronics and data processing; he spends more time choosing his instruments; he has less money to spend; he wants to know how much the new equipment will save; he wants a supplier to deliver a complete system rather than have to buy the parts himself and put them together. To design products to satisfy such a customer, the supplier must understand the user's problems. As a result, a lot of instrument companies are beefing up their application engineering departments.

Then, too, turning a military-oriented company around to thinking of industrial or medical or educational markets takes a lot of doing. Consolidated Electrodynamics' vice president of marketing, Eugene Moscarel, warns, "You can't take an organi-

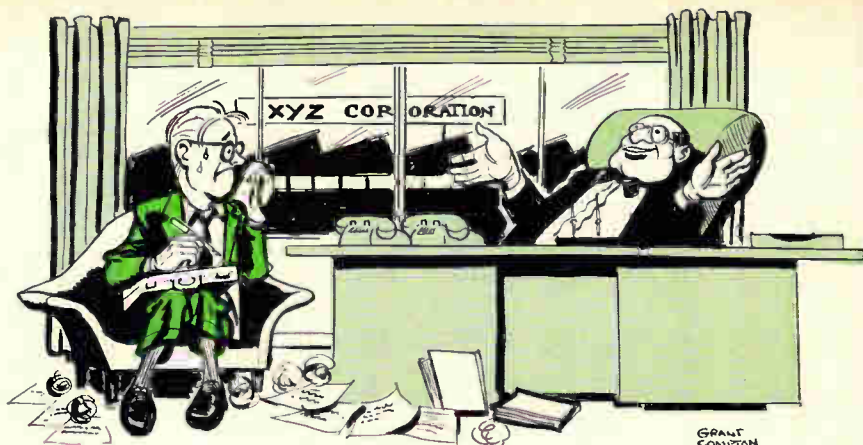
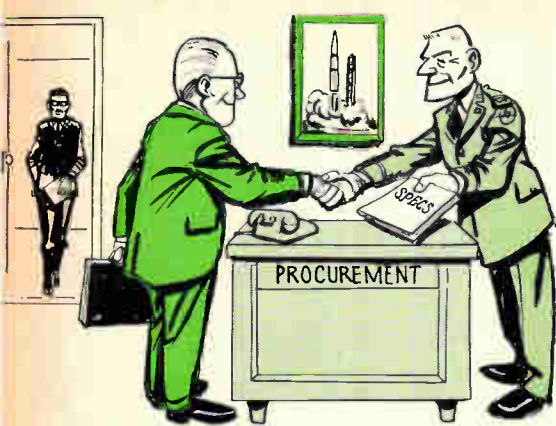

Military and industrial customers are different: the latter ask more questions and have less money to spend.

zation that is saturated in military work and pull the shades suddenly. It takes a whole new concept to reach new markets."

CEC has had its share of disappointments while building its industrial business up to 40% of total sales, from 30% a couple of years ago. Earlier this year, for example, the company received an inquiry from a commercial airline for an onboard maintenance monitor to record variables of engine performance on the new DC-9, which will carry no flight engineer to do this. The company had no hardware available but, because the market looked promising, CEC put together a task force to solve the problem.

In 4½ weeks of crash work, the new product group identified the system's requirements, designed a system and made a proposal, which turned out to be the low bid. Nevertheless, CEC lost the order. Moscaret thinks it may have been because his task force, accustomed to thinking in terms of the military, didn't understand the user's concept of maintenance and what was happening in the field of commercial aircraft instrumentation. Its system recorded variables measured in voltages; the DC-9 will carry instrumentation that measures in terms of frequency and phase angle.

Marketing obstacle

As if these difficulties were not enough, electronics companies are finding a need for a different

approach to marketing. Reeves of Spacelabs points out, "It takes about a year to make a sale to a hospital, because it makes decisions slowly and a lot of people are involved: heart surgeons, administrators, cardiologists, anesthetists." Eldorado's Montgomery puts it even more bluntly, "We'd like to diversify into bioinstrumentation, but we don't have the marketing force."

At Beckman, a lot of engineers used to complain, "We've got some good products to sell, but no way of selling them." That's why Beckman has been reorganized so that its Berkeley division will sell some of the components that go into other divisions' end products. Some examples: Offner division's recorders and Systems division's analog-to-digital converter and new amplexer.

The amplexer illustrates what can happen. Designed for Beckman's telemetry systems, it is a combination of a low-cost d-c differential amplifier and a commutator, with built-in filter to allow variable gain and accurate cutoff of frequency. At the Systems division, engineers always thought it was a good product and, now that Berkeley is marketing it, a lot of people agree. Sales of units are running about 300 per month, at a price from \$300 to \$400 each.

Nearly every instrument company is exploring the possible use of integrated circuits, but fewer are using them than would like to. The reason is that most of their applications require analog circuits and there are few available.

Though changes are taking place in every part of the instrument maker's organization, nothing shows what is happening more dramatically than the rush of new products. This year, Beckman's Berkeley division will introduce 21 new products, more than in any year in its history. CEC's Process Control Instruments division will introduce 27. Thirty months ago, Berkeley's products were frequency counters and accessories for government projects; most were bench-type instruments. Today, Berkeley is adding an instrument to its basic counter to make a subsystem which is going into a data system. And its customers range from the government to steel mills.

No wonder CEC's Moscaret calls 1965 a year of transition.



CEC's Eugene Moscaret: "... You can't take an organization that is saturated in military work and pull the shades suddenly. It takes a whole new concept to reach new markets..."

II. Aerospace contractors

At the giant aerospace combines, executives like to think it's business as usual. They pretend that the changes in military spending haven't affected them at all, and that only the small, single-product-oriented, poorly financed companies have suffered. In reality, the big aerospace contractors have had to change their methods of operation as drastically as anybody. No company in the aerospace industry is doing business the way it did 30 months ago.

The change from cost-plus-fixed-fee contracts to fixed-price-plus-incentive or firm-fixed-price has forced aerospace companies to become truly cost-conscious for the first time. It has forced them to trim their engineering staffs and to use facilities more efficiently. The cost-plus contract is rapidly disappearing. In 1960, roughly 40% of the contracts won by aerospace companies were cost-plus; by last year the figure had slid to 12% and was still declining.

Though the military remains the aerospace industry's biggest customer, the pattern of projects has changed. There are more projects being let, but each involves tiny sums compared to the giant hundred-million-dollar programs the West Coast companies have been used to. Consequently, less work is being subcontracted. With fewer dollars to spend, the primes are doing more in-house development work, buying only off-the-shelf instruments and components from electronics companies.

Another reason for doing less work on the outside is that the government's well-publicized cost-cutting program has changed the pattern of procurement. A company used to be able to "buy" a research and development contract below cost and then make back the loss on the production contract that followed. Today, the follow-on production contract is very likely to be awarded to another company.

Into space

A combination of circumstances has lured many of the aerospace firms into work for the National Aeronautics and Space Administration. First, space projects and missile programs have a lot in common technically. In San Diego, for example, even though the Atlas missile has been phased out, the Convair division of General Dynamics is producing more Atlas vehicles than ever for NASA, which uses them as boosters for space probes.

More significantly, the space program has reached a point on the West Coast where NASA is looking for companies to serve as prime contractors. Previously, NASA centers or organizations that operated under contract to NASA have managed the big projects.

On the West Coast, the usual manager has been the Jet Propulsion Laboratory of the California Institute of Technology. It has run the Pioneer, Explorer, Ranger and Mariner programs for NASA, doing much of the hardware development itself

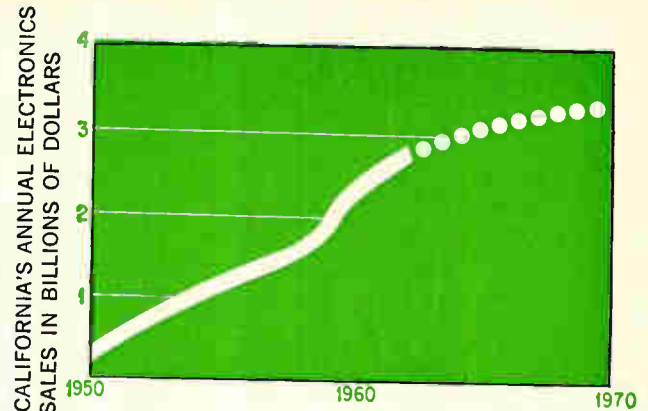

Signs of the times in California is the slowing of the rate of growth of electronics in the state.

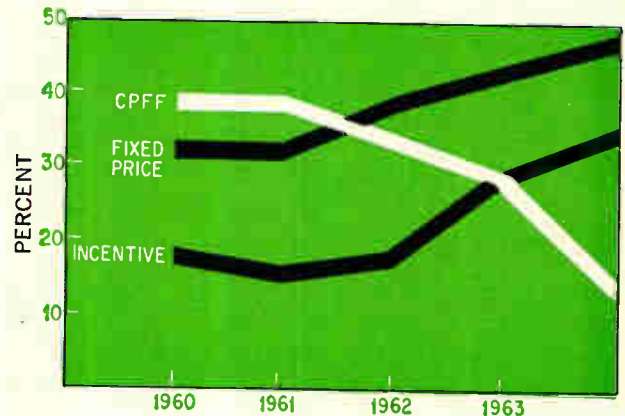

Decline in cost-plus-fixed fee contracts is squeezing prime contractors and their suppliers of electronic gear.

and buying only small quantities from outside suppliers. For example, in the Ranger program, which took the close-up pictures of the moon, television cameras supplied by the Radio Corporation of America made the pictures—but the rest of the equipment and the vehicle were built, tested, and flown by JPL.

A. R. Luedecke, deputy director of JPL, describes the new look this way: "In a sense, the projects to be undertaken are of substantially greater magnitude and involve a capacity beyond that possessed by the Lab [JPL]. It makes good sense to change because we will be able to take increasing advantage of the capacity of the industry and enable industry to pick up a greater part of the space load."

One of the first companies to benefit from the change is the Hughes Aircraft Co., which has the prime contract for the Surveyor program to put an exploring probe on the moon. JPL will continue to manage the program but will not do any manufacturing or much testing. Such a limiting of the role of organizations like JPL will release nearly 75% of the funds for unmanned space programs to industrial companies; that's almost an exact reversal of the current distribution of funds.

Corporate and product diversification

Only a few ambitious aerospace companies have struck out in new directions, diversifying into

JPL's A.R. Luedecke:
"... Projects to be undertaken are of substantially greater magnitude and involve a capacity beyond that possessed by the Lab..."



radically different arenas such as oceanography, political-social projects, or traffic control.

A very few had started diversifying long before the current dip in military spending, because defense business has always been chancy. Thus Aerojet General Corp., a subsidiary of the General Tire Co. whose main business is building rocket engines, has had a division concentrating on industrial automation equipment for over five years. The Lockheed Corp., which started acquiring companies outside of the aerospace field around 1960, so far has bought an electronics firm (Stavid Engineering in New Jersey), a shipyard, and a rocket engine plant; and Litton Industries has diversified into business machines, telephone equipment, facsimile machines and other industrial and commercial products.

Some of these bolder companies have now started to diversify by a more difficult route: putting their own technological capabilities to work. Much of this work will be done for the government—but not for the Pentagon. Earlier this spring, Lockheed announced plans for an oceanography division in San Diego. And at the Missiles and Space Co., in Sunnyvale, Lockheed engineers are working on a project for the state of California to study the flow of information in government.

To introduce some of its defense-oriented companies into nondefense business, California has commissioned two other projects. A subsidiary of Aerojet-General, the Space General Corp., which had developed a biological warfare warning system for the military, is studying how aerospace technology, particularly systems engineering and management, can be applied to the war on juvenile delinquency. And at the North American Aviation Co., engineers who used to work on missile projects are studying the transportation of freight and people in the nation's big cities.

Military work has already pushed North American into enough areas that have commercial or industrial potential so that the company has assigned to its Navan division the responsibility for selling the rights to such products or licensing them. North American's own plunge into selling commercial products directly—most notably the

Recomp computer developed originally by the company's Autonetics division for aircraft control—was not a success.

Diversifying in the military

Many aerospace contractors, however, feel no great compulsion to turn from military work, which they feel they understand. To them, military cutbacks are an old story. Almost every giant contractor can point to one recent cutback that hurt. In 1959, for example, when the Navajo project was cancelled, North American saw 40% of the Autonetics division's activity wiped out. When the Pentagon cancelled the Skybolt project in 1962, it chopped off 33% of the sales of Douglas Aircraft Corp., the prime contractor, which had to lay off 6,000 people immediately.

Most often the reaction to such hardships is "there will be another project along." Thus, after losing Navajo, Autonetics picked up the Minuteman project, which now represents 50% of its business. Douglas won the S-IVB stage of the Saturn rocket engine for project Apollo.

Yet other contractors believe it is risky to wait for that next project. A few have started working on their own to replace lost business. One is Hughes Aircraft.

The cancellation of the F-108 supersonic interceptor (in 1959) for which Hughes was supplying the fire control, was the biggest single blow in its history, a company executive recalls. "After this, we were literally without a product. We were forced to take a long hard look at our prospects and chart a new course," he adds.

Hughes spent \$15 million of its own money to develop new capability and expand its product line. One result was the construction of the first laser at Hughes in 1960. Now, instead of one customer and a few product lines, the company has about 80 product lines, which are sold to industrial customers and government agencies, including NASA and all three military services.

Planned diversification such as this, financed by the company instead of the government, is one of the reasons why aerospace executives believe the industry is finally showing signs of maturity.

III. Microwave companies

For the first time in nearly two years, West Coast microwave companies can see glimmers of hope. The gloom of the past 30 months is being dispelled by two developments: Microwave companies are putting their technology to work in new areas, and a switch to solid state components has stimulated design activity.

Microwave companies were hit harder than most other military suppliers. Not only did they suffer the same plateauing or dipping of military spending, but when they finished a lot of the giant warning systems and communications projects that had nurtured their growth, there were no new

projects to replace the old ones. Then too, microwave tube makers were delivered a paralyzing jolt when Pentagon planners juggled defense purchasing practices to reflect the three to five times longer life, up to 10,000 hours, of microwave tubes. Figuring the longer life, computers found the military services had a huge inventory of tubes and the planners stopped ordering replacements.

In the face of such adversity, many West Coast microwave companies folded, merged or were bought out. For example, there were seven microwave tube manufacturers in the San Francisco Bay Area just one year ago; by the end of the summer the number will be down to three if all current plans go through—Litton, Varian Associates and Watkins-Johnson.

A year ago, the Microwave Electronics Corp. purchased Sylvania's Microwave Tube division; now, a couple of firms are dickering to buy MEC. Varian Associates' merger with Eitel-McCullough, Inc., is under way. And the General Electric Co. is considering shutting up its West Coast shop at Palo Alto and moving to the company's tube headquarters in Owensboro, Ky.

At the Hewlett-Packard Co., which makes microwave instruments and hardware, John Young, general manager of the Microwave division, describes the microwave picture on the West Coast this way: "Our sales are up 30% because there are fewer companies left and we have introduced a lot of new products."

Clearly, it is the new product that is selling, and Young feels this shows the industry has a long distance to go to improve. He notes, "The demand is still weak for standard products like wave guides. Other tried and true products are not selling well either, and that is the basis of what's really happening in the industry."

Finding new applications

Among those companies that have worked to help themselves, the biggest effort has gone into finding new applications for microwave technology, applications that range from food processing to chemical analysis, and into developing new products.

Litton Industries, already turning out microwave ovens for restaurants and the home, has stepped up this activity, simplifying design and improving

components to cut costs and better reliability. In addition, it is trying to apply microwave technology to underwater sensing and to information storage. Hewlett-Packard has entered the chemical instrumentation field with a microwave spectrometer that can identify gases and liquids by determining their molecular structure. And a division of Datapulse, Inc., DeMornay-Bonardi, which used to make only microwave components, has developed a microwave interferometer for plasma research.

Microwave ovens have already won acceptance in the institutional and restaurant market, but few home owners are willing to pay the current high price for them. Litton hopes the development of less expensive components and a buildup of volume will drive the price down to a point where microwave ranges can compete with conventional electric ranges.

Eitel-McCullough also has an active program to employ microwaves in industrial applications, primarily for cooking, food processing and material processing. Now that the company is merging with Varian Associates, its efforts will probably be consolidated with those of the parent company, which has considered the use of microwaves in freeze drying.

One reason freeze drying is such a tempting application is that use of microwaves for the heating component of the operation would offer a real advantage over conventional methods. Simply, the object in freeze drying is to supply enough heat to evaporate water from a substance in a vacuum. Normally, the heat comes from gently warmed pans on which the substance lies. But as drying takes place and particles solidify, the solid portion acts as an insulator, which makes it difficult to evaporate the water from the center. Microwave energy, of course, could penetrate into the center no matter how much heat-insulating material surrounded it. The big problem so far has been to develop a method of coupling the microwave energy to the material to be processed. Ideally, processors would like a universal method of coupling so they could use the same equipment to freeze-dry coffee and orange juice, for example.

In the meantime, Litton has added two other areas to its diversification efforts: oceanography and information handling. Says Litton's John F. Hull, "The problem of scanning a beam of microwave energy is closely related to that of scanning a beam of ultrasonic energy." As yet, the company has not developed any new hardware.

It has, however, produced some better storage tubes for handling information. Mainly, the company has adapted the techniques for manufacturing high-power microwave tubes rather than evolving a radical new design—such techniques as metalizing, ceramic-to-metal seals, and cathode assembly procedures.

Starting from scratch

The first thing Hewlett-Packard had to do before it perfected its microwave spectrometer was to



H-P's John Young: "... Sales are up 30% because there are fewer companies left and we have introduced a lot of new products ..."

learn what the analysis problem was. It found that certain hydrocarbon compounds could not be identified when they were together because their structural differences were too slight to be separated by conventional optical spectroscopy techniques. In its spectrometer, H-P determines the rotational frequency of a molecule because no two molecules have the same frequency. Since the rotational energy of such molecules is in the microwave spectrum, the molecules can be identified by noting the energy they absorb as the instrument sweeps from 8.2 Gc to 12.4 Gc.

DeMornay-Bonardi's new microwave interferometer has been used to investigate the properties of exhaust gases from rockets. Operating at about 70 Gc, the system measures such properties as temperature, pressure and density by determining how much the gas or plasma attenuates the microwave signal and causes phase shift as the microwave energy is transmitted from one horn antenna through the gas to a second horn antenna.

Solid state comes to microwave

"The military is insisting on solid state microwave sources. By 1970, all such systems will be solid state." That's an estimate of the near future by Jack Melchior, general manager of HP Associates, the Hewlett-Packard subsidiary that develops and produces solid state products. But his possibly prejudiced view is shared by many other westerners in the microwave field. Varian Associates, Microwave Electronics and the Watkins-Johnson Co. are among those investigating new solid state microwave components. And semiconductor producers make their job easier by introducing devices capable of handling higher and higher frequencies. The rush is such that Hewlett-Packard's chairman, David Packard, believes "small klystron tubes are just about at the end of the road as more gear goes solid state."

One major pressure on microwave suppliers—is increasing reliability—is accelerating the move to solid state. Even the improved long life of tubes is not sufficient. "In communications, tube life has always been a problem. If the equipment is located

out in a wilderness, a tube failure can cause real trouble," Melchior explains. In a satellite, the reliability requirements are even tougher. Once the vehicle is launched, there's no replacing a tube.

Hewlett-Packard has set itself a firm, if ambitious task. Says Melchior, "We have a five-year program to be the world's leader in solid state microwave." At the end of that time, H-P intends to supply solid state equipment for the generation, control and detection of microwaves.

Microwave Electronics Corp., Palo Alto, has had more modest plans. In its program to miniaturize microwave, the company developed a line of solid state delay lines which reduce the number of components required in conventional methods of delaying signals. Primarily, the new devices can delay signals at microwave frequencies instead of introducing the delay at i-f with a lumped constant delay line, as is done in many radar systems.

Even though Watkins-Johnson is getting almost twice as many orders for backward wave oscillators and low-noise traveling-wave tubes as it can ship, the company has launched an investigation of solid state phenomena and devices, particularly bulk semiconductor effects, the Gunn effect, and reed diodes.

By next year, it expects to be selling a line of miniature oscillators built of integrated circuits. The yttrium-iron-garnet tuned devices will cover the range from 1 to 18 Gc. W-J is far enough along with its work to describe how these integrated oscillators will be constructed: Stripline conductors will be deposited on a silicone or other insulating substrate; YIG spheres will be dropped at the appropriate points; meantime, active semiconductor devices will be formed as an integral part of the device.

Ferrite integrated cubes

Some microwave companies believe there is little likelihood that there will ever be a monolithic integrated circuit of semiconductor material for microwave applications so they are examining the possibility of building integrated microwave systems from ferrite materials instead. Probably the most ambitious suggestion along this line comes from Western Microwave Laboratories, Inc., in Santa Clara. "I see no reason why all the components cannot be integrated into one large component—the microwave analogy of the solid state integrated circuit; it is already possible to build a complete receiver front end in a one-inch cube," says Harold D. Tenney, a Western Microwave vice president.

Most of the work in ferrites is not so way out. For example, ferrite devices seem to be the answer for a low-cost phase shifter in phased array radar. Until recently, phased array work was stalled for want of a device whose price would be right; YIG devices require too much power in a phased array that might require thousands of them. Although Western Microwave is doing its phased array development work on the West Coast, it is setting

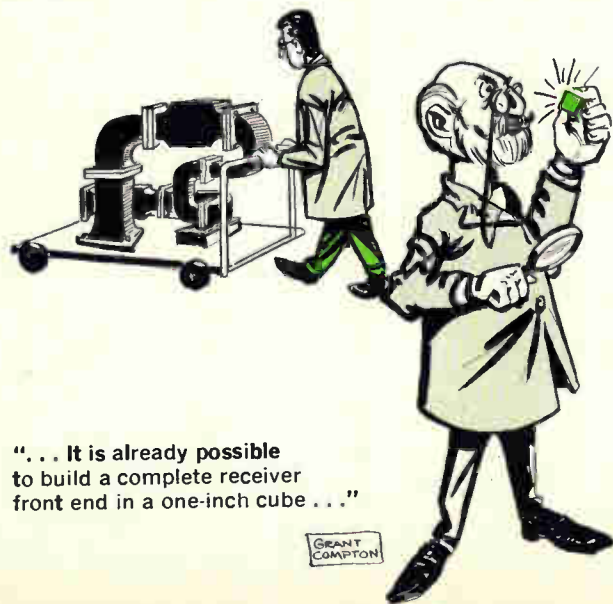

"... It is already possible to build a complete receiver front end in a one-inch cube ..."

GRANT COMPTON

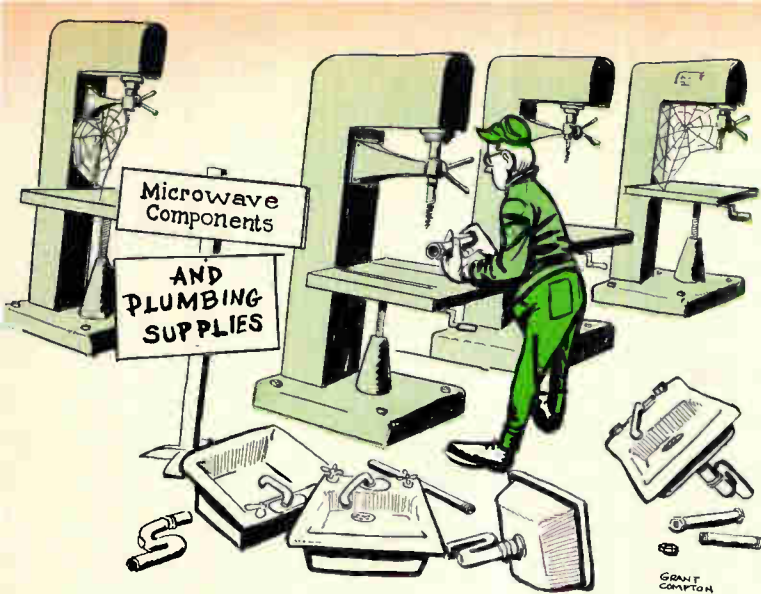

One problem remains: putting machine tools to work.

up a production facility in Puerto Rico where manufacturing costs are lower.

Higher frequencies

While the microwave industry struggles to work out of its depression, the users continue to press for higher-frequency systems, thus creating a new market. Steadily, the frequency requirements increase. By 1970, most telemetry systems will move up to the 1.5 to 5.2 Gc band from its current frequency range of 216 Mc to 260 Mc. Even air traffic radars are being pushed into higher frequencies. The Federal Aviation Agency has recently decided to move its radars that work in the 2,700 to 2,950 Mc range to the 5,400 to 5,900 Mc band. Higher frequencies look attractive for space-to-space communication systems, too.

Pushing to these higher frequencies has increased the demand for some new designs, for example, parametric amplifiers for ground equipment and tunnel diode amplifiers for airborne gear. The requirement most often noted is for low-noise parametric amplifiers. Since most of these demand low-temperature cooling to keep noise levels low, Western Microwave has developed the first liquid-helium-cooled circulator to cool parametric amplifiers.

Elsewhere in the West, efforts are under way to develop parametric amplifiers that can operate at higher temperatures and still have low-noise characteristics.

Computers and machine tools

In one other interesting change that marks what's happening on the West Coast these days, microwave designers are using less cookbook engineering and more science. The technology is better understood, and engineers are better trained. One manifestation of this is the use of computers to solve microwave tube design problems. Varian, for example, establishes tube parameters and predicts performance with a computer. At Litton, both analog and digital computers have been pressed into tube development to design electron guns and focusing structures and to calculate electron trajectory.

As the microwave industry changes in the West, it leaves behind one giant structure that must be put to use. That is the huge investment in precision machine tools which were used to turn out the plumbing for microwave systems. Both the reduction of the market and the move to solid state have left great investments in machining capacity on the West Coast.

So far, the best answer has been for a company to build other kinds of products with its excess capacity. Hewlett-Packard, for example, put its microwave division machinists to work building precision instrumentation tape decks. And Data-pulse, Inc., in Inglewood, Calif., moved its KRS division, which makes precision tape recorders, into quarters adjacent to its DeMornay-Bonardi Microwave division in Pasadena to increase the efficiency of use of D-B's machine tools.

IV. Integrated circuits

From makers of integrated circuits out West there never is heard a discouraging word because the business picture is bright. In San Francisco, electronics executives are saying that before long the Bay area will be to integrated circuits what Detroit is to automobiles. These IC producers have good reason for a pleased view of the present and an optimistic appraisal of the future. In 1965 they will make and sell more integrated circuits than have been produced in the entire history of integrated circuits.

Two and a half years ago, when military spending started to decline, the IC was something of a curiosity; the industry was neither old enough nor big enough to be badly hurt by the cutback. Nonetheless, the curtailment of military and space funds did have one important effect on IC makers; it



Around the tip of San Francisco Bay, a concentration of integrated circuit producers has built up.

dictated the route they were to travel. During the past 30 months many of them have gone from an uncertain beginning to a profitable operation. They've done it by catering meticulously to commercial and industrial buyers. This emphasis, together with the unchallenged advantages of integrated circuits for many applications, has paid off handsomely.

The success of the integrated circuit means that the West Coast has a mass-produced product that can be sold all over the world. Mass production in the electronics industry has been the province of the component houses in the East up to now.

As the map on page 71 shows, the greatest concentration of integrated-circuit producers is in the San Francisco Bay area: the Fairchild Camera & Instrument Corp., Union Carbide Corp., Raytheon Co. and Amelco Semiconductor Co. are in Mountain View; the Signetics Corp., Stewart-Warner Corp. and Siliconix, Inc. are in Sunnyvale; Shockley Labs of the International Telephone and Telegraph Corp. is in Palo Alto, and General Micro-Electronics, Inc. and the Molectro Corp. are in Santa Clara. Molectro makes the circuits only up to the wafer stage, then ships them east to the parent National Semiconductor Corp. in Connecticut.

From this Bay area come most of the IC's made and sold in the nation. For example, its weekly production near the end of 1964 was more than 40,000 units; in a comparable period the rest of the industry turned out about 15,000 units.

Of the six largest IC producers, four—Fairchild, Signetics, Motorola, Inc. and Stewart-Warner—are in the West. Although Motorola is in Phoenix, Ariz., it is considered part of the West Coast picture. The other two giants are Texas Instruments and the Westinghouse Electric Corp.'s Molecular Electronics division. Reliable industry sources estimate that 1964 sales for Fairchild, Signetics and Motorola, respectively, were \$9 million, \$6 million and \$4 million; Texas Instruments led them all with sales of \$11 million.

Not for sale

Further south, Los Angeles is alive with IC activity. There's one big difference, however—most of their IC's aren't for sale. For example, Hughes Aircraft Co., the Autonetics division of North American Aviation, Inc., and TRW, Inc., have highly sophisticated and expensive in-house IC capabilities but, for the most part, they buy their integrated circuits from outside sources. To meet military and space contract requirements these companies have spent a lot of money to develop IC research and development. They reason that they need complete knowledge of IC technology to achieve the best designs and to evaluate accurately what the suppliers are doing. These in-house IC capabilities do not threaten, so far, the potential sales of the IC manufacturers.

"Whenever a circuit we need is available on the outside, we buy it," says L. A. Darling, man-

ager of microelectronics for TRW. "The fierce competition in this business has driven prices down to the point where it's now more advantageous to us to buy them outside than to make them ourselves." Darling says that TRW buys about 75% of its IC's, and the purpose of its in-house capability is to "allow us to respond as quickly as possible with our designs to the changing technology in the integrated circuit field."

Increased commercial business for the integrated-circuit industry has made in-house IC capabilities essential at TRW. Darling says, "It used to be that you could give a custom spec to an IC maker and he'd grab it and concentrate on it. Nowadays, due to the upturn in commercial volume, most of the major producers are reluctant to take the time for highly sophisticated custom work. So we do it ourselves, to cut down design time."

Autonetics has much the same point of view. According to Richard C. Platzek, manager of its microelectronic operations, "One of the things we think we do well is manage highly complex systems. But how do you manage a complex system without your own technology? We think our own data helps to accomplish this." Platzek also feels that the aerospace industry can be credited with accelerating IC technology: "What circuit designers have to learn during the transistor-to-integrated-circuit changeover is far less than they had to learn when we went from vacuum tubes to transistors."

The upward trend

An analysis of the IC industry shows that 1965 began with a sharp increase in marketing activity, and everything points to a continued climb of both the unit and dollar sales curves. This is a far cry from 1962 when almost no integrated circuits were sold, certainly no commercial circuits. At that time the average price was about \$50 a circuit, and most of them were being manufactured for the Minuteman missile.

In 1963, test circuits started selling, but most of the half-million circuits sold that year were for the military, and the price was still high. In 1964, 2.2 million circuits were sold, 500,000 in December alone, and prices came down sharply to the \$5 range. So far this year, 1964's total sales figure has already been surpassed, and industry officials agree that slightly more than 6 million circuits will be sold—an average of 500,000 circuits per month for the industry. Fairchild, one of the IC leaders, is already averaging 180,000 circuits a month.

What's more, the increase in sales this year over last will be almost exclusively for commercial applications. This means—to the satisfaction of IC makers and West Coast businessmen—that the low-profit, low-volume military market will no longer dominate the field; the high-volume, high-profit commercial market has finally arrived. And the economy of the West Coast-centered IC industry will be the chief beneficiary.



Fairchild's Robert Noyce: "... shipping more integrated circuits right now than the whole industry did a year ago ..."

"It has only now become profitable for the major IC makers to operate," reports Robert N. Noyce, group vice president of Fairchild's Semiconductor and Instrumentation divisions. "After building toward our present status over the past few years, we can now deliver at good profit margins in large volumes. Fairchild alone, for example, is shipping more circuits right now than the whole industry shipped a year ago."

The reason for the boom, according to Noyce, is that it is "now cheaper to do any digital job with integrated circuits than with discrete components." William B. Hogle, executive vice president of Stewart-Warner, and James F. Riley, president of the Signetics Corp., agree. Says Hogle: "Diode transistor logic has grabbed the market since 1963. Speeds are faster and prices are more reasonable, which means that discrete components will gradually be replaced." Riley comments, "The dramatic improvement in industry backlog is finally bringing demand to an even level with capacity. We've had to accelerate our round-the-clock operation, despite yield improvements."

This theme is borne out by the rising number of commercial firms converting electronic equipment to IC designs, firms ranging in size from the smallest specialty house to huge corporations like the Radio Corp. of America, whose Spectra 70 computer line is designed around both RCA's own and Fairchild's integrated circuits.

"The industrial market, especially for digital equipment, is going to soar," reports C. J. Goodman, sales vice president of Motorola Semiconductor. "The military always starts the technology going, but it often fades from the picture when commercial industry's high-volume buying takes over. Maybe I'm being too hard-core on the subject, but I don't see any reason why integrated circuits won't follow the same applications and sales path that transistors did starting in 1948."

Adds C. Lester Hogan, vice president and general manager of Motorola's semiconductor operation, "One of the industry's biggest problems for the immediate future will be how to keep up with the skyrocketing demand."

Charles E. Sporck, general manager of Fairchild's Semiconductor division, agrees. "At the present rate at which designers are using integrated circuits, the commercial market this year will represent about 75% of the total circuit sales," he says. "This is quite significant to the industry when you consider that in late '62 the yield for, say, a half-shift register was only one circuit shipped for each wafer put into the process. Today, for the same circuit, about 60% of the circuits deposited on each wafer are usable—and the circuits are cheaper and more reliable."

E. Nevin Kather, marketing manager of Raytheon's Components division and a vice president of the company, sees the inherent high reliability of IC's as the prime reason for the expanding market these days.

"Military applications," he says, "lead the way, but commercial and industrial applications using digital integrated circuits now probably account for more than 30% of the microelectronic sales dollar. When the technical design problems for producing a wider range of resistor values and more practical capacitor values in linear circuits are overcome, and as manufacturing cost reductions continue, the commercial and industrial applications will account for an ever larger share of microelectronic production."

Raytheon recently expanded its integrated circuit manufacturing facilities at Mountain View after reaching an agreement with Westinghouse to manufacture a line of diode transistor logic devices of Westinghouse design. Frederick J. Wills, Jr., manager of Raytheon's Semiconductor Operation, sees the arrangement as "trend-setting" and believes "it should serve as a spur to accelerate the already widening use of integrated circuits."

The price is right

But the most important single factor that has spurred the commercial market boom is pricing. Commercial users, not sharing the government's



Motorola's C. Lester Hogan: "... Industry's biggest problem will be keeping up with skyrocketing demand ..."

willingness to pay enormous prices for the sake of decreased size and increased reliability, shied away from IC's at the beginning, when the government was clamoring for them. While the government was using circuits for Minuteman, Polaris, TFX, Phoenix and Apollo circuitry and computers, industry was content to stay with discrete components—the low cost of transistors, for example, kept total costs down and buoyed profits. Today, however, in the words of Richard E. Lee, president of Siliconix, "Commercial industry would be crazy not to design with integrated circuits now that the prices have come down."

West Coast firms are starting to gear up for the big changeover to IC's. The Hewlett-Packard Co., in Palo Alto, the trend-setter among U.S. instrument makers, is considering developing its own IC capability and using IC's in its designs. Fairchild Instrumentation division, also in Palo Alto, is one of the largest users of IC's in the world, and up to very recently was the Fairchild Semiconductor division's biggest customer.

The Ampex Corp., maker of tape recorders and associated equipment, will also change to IC's. In its first application, an integrated-circuit amplifier will be mounted right on the recording head of a recorder to cut the cable loss from head to amplifier. Ampex is one of the companies that would use more integrated circuits if analog circuits were available. Eldorado Electronics, and Zeltex, Inc., both in Concord, are using IC's in their instruments. Fairchild recently received a \$1-million order for IC's from Scientific Data Systems, Inc., of Los Angeles and a \$2-million order from the Sperry Rand Corp. The company also has more than \$1 million in orders from Advanced Scientific Instruments, of Minneapolis, and the Milgo Electronic Corp., of Miami, Fla. In the Los Angeles area, the Bunker Ramo Corp. and Litton Industries are already using IC's, and the National Cash Register Co. and Beckman Instruments, Inc., are contemplating a changeover.

Changing techniques

Although no technological advancements spectacular enough to be called breakthroughs have been made since the development of the epitaxial process about two and a half years ago, the bright business picture has been highlighted by some new techniques. Chief among them:

- **Face bonding:** A method by which a circuit chip is "flipped over" to make connections directly to the bottom of a substrate by means of an already-deposited interconnection pattern. This technique reduces assembly costs greatly, but the special tooling required makes it profitable only for large-volume users, such as commercial computer makers. Frances Hugle, director of research for Stewart-Warner, thinks tooling costs will be lowered significantly as more companies learn how to apply the flip-chip technique.

- **Metal oxide semiconductors:** The MOS field effect transistor made with silicon diffuses many

circuit functions on a single monolithic chip and allows increased functional complexity per chip—up to 30 to 50 times that of a conventional double-diffused IC—such as the 100-bit shift register developed by General Micro-Electronics, on a 66- by 106-mil chip.

- **Dielectric isolation:** A technique that uses an oxide coating to isolate various parts of a circuit; this technique achieves the isolation without the use of reverse-biased p-n junctions and permits a faster circuit by reducing parasitic capacitances.

- **Mask-making:** IC makers have achieved masking resolutions of 0.1 mil and better. Two years ago the best was 0.5 mil.

Cloudless sky

Based on market projections, it's the opinion of major IC makers as well as some smaller specialty firms that their good business is going to get better. Prices will continue to drop but should level off after a round of competitive price cutting foreseen at Wescon. New applications will continue and there will be new customers—commercial computers, process control equipment, linear devices, peripheral electronic data processing equipment, medical electronics, communications, instruments, sensors and solid state microwave devices will be using integrated circuits before long. Consumer electronics producers will continue to be the last to take advantage of technological advances; they probably won't start using IC's for at least three or four years.

Signetics, one of the companies enjoying a record year, has projected sales for the integrated circuit industry for the next three years. Starting with the 6-million-unit sale predicted for 1965, it estimates the following growth:

Integrated circuits in millions		
	Commercial computers	Total
1966	3.4	13.4
1967	11.4	27.4
1968	15.0	37.5

According to the Signetics survey, the percentage of military usage will decline; by 1968 it will be less than 20% of the total.

"The biggest impact in the next two years will be made in the production of commercial computers," says James F. Riley, president of Signetics. "And after the logic applications, IC's will be applied to the peripheral equipment. This will be the largest single market for integrated circuits."

From all indications, the West Coast will be ready for it.

Reprints of this report are available. See the reader service card at the back of this issue.

© copyright 1965, Electronics © A McGraw-Hill Publication

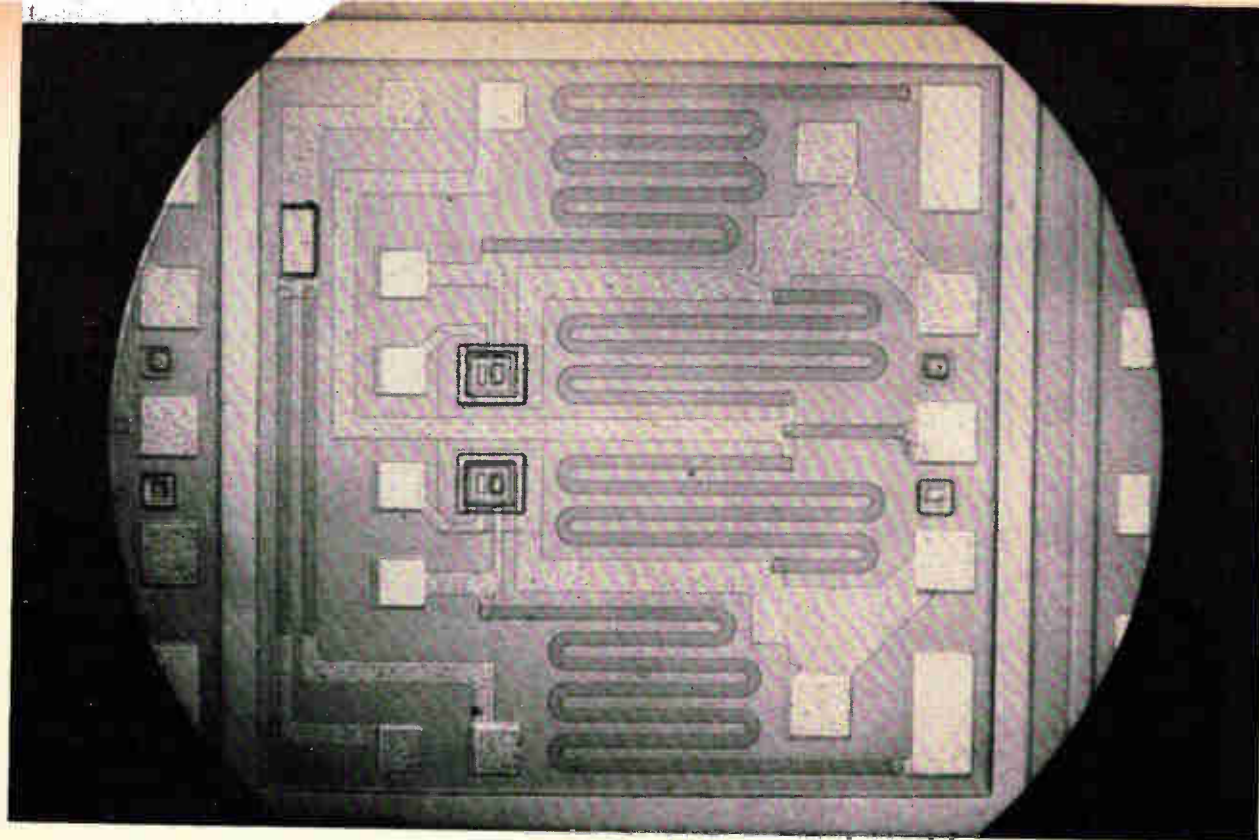

Solid state

IC's improve differential amplifiers—and vice versa

Monolithic devices reduce a balanced amplifier's offset voltage 75%. The amplifier, in turn, helps to overcome a perennial problem in integrated circuitry

By Robert Hirschfeld

Motorola, Inc., Phoenix, Ariz.

Differential amplifiers are being improved with the use of integrated circuits. And the differential or balanced amplifier, in turn, can help to produce better integrated circuits.

Integrated circuitry reduces the two major objections to the use of differential amplifiers: their high cost and the complexity of circuits in which they are being used. The circle is completed by the fact that the differential configuration is particularly suitable for overcoming a problem inherent in integrated circuits: variations in parameter values between chips.

Balanced amplifiers offer many advantages over the unbalanced kind. Particularly important in cir-

cuits using semiconductor devices is the balanced amplifier's ability to nullify the effects of variations in operating temperature and in power supply. This is because the balanced amplifier's performance is determined by the differences in parameters of similar components, rather than by the absolute values of the components.

To designers of microelectronic equipment, these advantages are often outweighed by cost and complexity. Now integrated circuitry reduces both objections. It allows mass production at relatively low cost, and does away with the need for delicate adjustments of the circuit into which a differential amplifier is applied. More important, monolithic

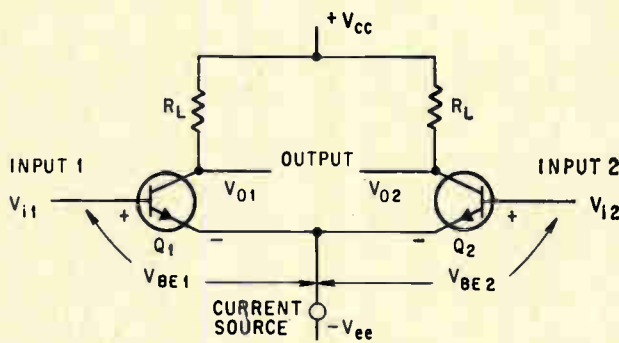

Typical differential amplifier circuit. Input signals are V_{i1} and V_{i2} ; differential output voltage is $(V_{o1} - V_{o2})$.

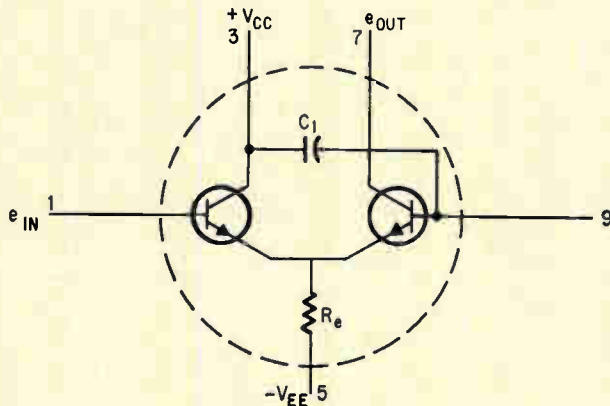

Simple differential r-f amplifier. Advantages of this single-ended circuit over a single-transistor tuned stage include higher power gain, negligible parasitic effects, symmetrical transfer characteristics, lower admittance, greater stability, easier alignment and fewer components. One circuit of this type provides a 26-decibel power gain and a 4-decibel noise figure at 100 megacycles. Automatic gain control is easily achieved by varying V_{EE} which in turn determines the current level.

differential amplifiers have been found to be superior to circuits built with discrete-component devices in many respects.

Superiority of monolithic devices

One big advantage is the fact that input offset voltage is generally lower with a monolithic device. Input offset voltage is the difference in potential across the input terminals that provides a differential output voltage of zero. In an ideal differential amplifier, the offset voltage is zero because the two halves of the amplifier are identical.

For a monolithic circuit, the typical initial input offset voltage at 25°C is less than five millivolts compared with more than 20 millivolts for a similar circuit made with discrete components. The input offset voltage-temperature drift is less than five microvolts per degree centigrade, compared with more than 10 microvolts per degree for the discrete-component circuit.

Advantages of differential amplifiers

Balanced amplifiers find their principal use in three applications: in high-gain d-c circuits where it is not feasible to overcome thermal and biasing problems with capacitive and transformer coupling,

in comparators where measurements are made with respect to reference levels other than ground, and in amplifiers where elimination of ambient noise is important.

A differential stage has many advantages in audio and radio-frequency amplifiers. It is easy to bias in a tuned cascade circuit because the bias is set completely by the constant current source that feeds the common-emitter connection point between the transistors. Excellent automatic gain control is achieved by varying the current available from the current source.

Because the differential amplifier's transfer characteristics are inherently symmetrical, symmetrical limiting can be achieved. If the components are truly matched, all even-order distortion products of the signal are completely suppressed. With one input used for the signal, the other input may conveniently be used for the injection of feedback. A typical differential audio amplifier integrated circuit with a one-watt output is shown on page 78.

In digital applications, logic using differential circuitry is superior to conventional logic circuits. Current can be diverted into whichever of two differential amplifier pairs has the greater bias voltage; the turn-on time required to activate a differential logic stage can be in the order of a few nanoseconds, and the current level can be set so that saturation is never reached. Thus, switching speeds can be obtained that are higher than that provided by saturated logic systems, with the added feature of excellent thermal stability. Moreover, a row of matched transistors can be made permitting the building of circuits with redundant sections. This makes it possible to build complex computer circuitry with high fan-in and fan-out.

Use of discrete transistors

The ideal differential amplifier consists of two identical elements (transistors) connected as shown on this page. For example, the gain (h_{fc}) and the d-c base-emitter voltage drop (V_{BE}) of each of the two elements should be the same. Input and output admittances for each element should be symmetrical, and the common-emitter connection point should be fed by an ideal current source—one that remains constant regardless of the load into which it operates. Any deviation from symmetry causes poor common-mode rejection; under this condition, identical signals applied to both inputs could produce a differential output.

With usual manufacturing tolerances, randomly selected discrete transistors cannot be expected to have identical characteristics. Current gains may vary as much as 50%, and base-emitter voltage drops (V_{BE}) may differ at room temperature by as much as 100 millivolts at the same current level. There may also be differences in the rate at which the device parameters change as functions of temperature and time. These differences in characteristics are functions of most of the metallurgical and chemical processes involved in the fabrication of the transistors, and of differences in the semi-

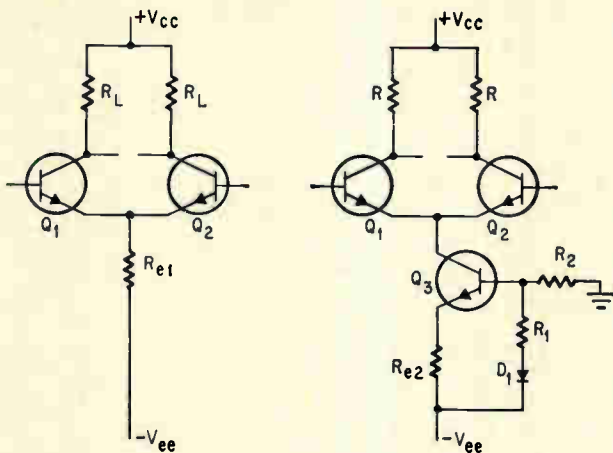

Tenfold increase in impedance results from substituting transistor (diagram at right) for emitter resistor in diagram at left. Limitations of monolithic circuits restrict size of resistor R_{e1} to about 20,000 ohms. Transistor increases impedance to 200,000 ohms or more. Only 1% of area needed by 200,000 ohm resistor is used.

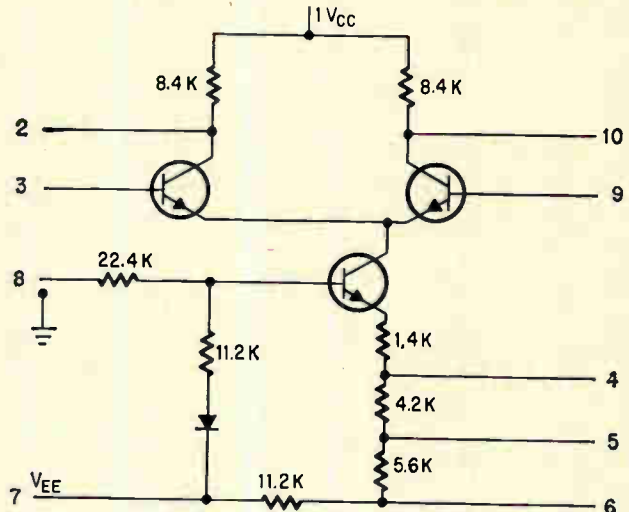

Monolithic differential amplifier MC1525 uses this basic circuit. Additional resistors have been included, which the customer may use or omit depending on the current level of operation. Numbers on the circuit identify leads.

conductor materials from which the devices are made. Moreover, the two transistors in a discrete differential amplifier do not always operate at the same temperature, because they are physically separated.

Close matching in integrated circuits

In contrast to the discrete-component circuit with its random distribution of parameters, the integrated circuit is a predictable model. The typical integrated-circuit chip is about 0.05 inch square and is fabricated, with hundreds like it, by a set of successive epitaxial growths, diffusions and vapor platings using very precise photographic masks.

When a differential amplifier is constructed on a silicon chip, its components are so close together that their temperatures are practically identical. Because precision masking techniques allow elements to be matched geometrically, the elements are very nearly matched electrically. Most important, any process—such as the diffusion processes

—causes only slight variations across the wafer and a negligible amount between adjacent elements. The resulting integrated circuits are better matched than would be possible in a typical discrete circuit.

For a circuit using discrete components, it is possible to hand-pick components to achieve reasonably well-matched V_{BE} and h_{fe} , but this is a slow and expensive procedure. Moreover, thermal tracking—symmetrical reaction to temperature variations—is nearly impossible to achieve with a discrete circuit.

On the other hand, while initial tolerances and thermal tracking can be held within very close limits with an integrated differential amplifier, minute localized surface defects on the silicon wafer cause the initial values of parameters V_{BE} and h_{fe} to vary over the wafer with a statistical distribution. Thus, from a given integrated-circuit wafer, a certain percentage of amplifier chips will have unacceptable initial V_{BE} or h_{fe} mismatches, a much larger percentage will have excellent

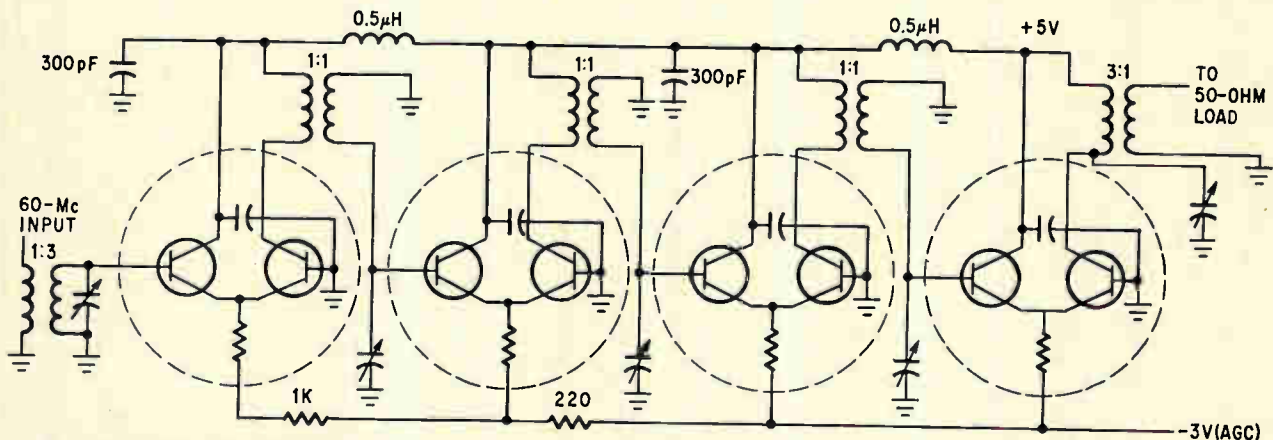

60-Mc intermediate-frequency f-m limiter formed by four differential-amplifier integrated circuits. The circuit provides 80-db power gain at 60 Mc, with a 6-Mc bandwidth and a 6-db noise figure. With microminiature toroid transformers and compact trimmer capacitors, the entire i-f strip package is about 0.2 by 1.2 by 2.3 inches.

matching characteristics and a few will perform exceptionally well. To select the best-matched units, and to reject those outside the desired range of tolerances, each chip should be screened carefully.

Chain reaction

When better differential amplifiers are built with integrated circuits, the amplifiers in turn can be used to produce better integrated circuits by helping to overcome variations in resistivity between widely separated chips on the same wafer or chips from different wafers—a problem inherent in integrated circuits.

The integrated circuit is fabricated by maskings, diffusions and vapor platings that are far more complex than those required for ordinary transistors. Even with the most careful control, a certain degree of variation from wafer to wafer is unavoidable. Since the resistivity of ordinary silicon varies 20% or more from design values, widely differing bias voltages may be required in individual integrated circuits in which the biasing is determined by a single diffused resistor.

Voltage divider techniques employing a pair of resistors can be used to eliminate this problem. In integrated circuits the resistance ratio of two adjacent resistors generally falls within 1% or 2% of the designed ratio, since the ratio is almost wholly determined by the component geometry, which can be closely controlled. For example, consider a voltage divider made of two diffused resistors: a 1,000-ohm and a 100-ohm resistor forming

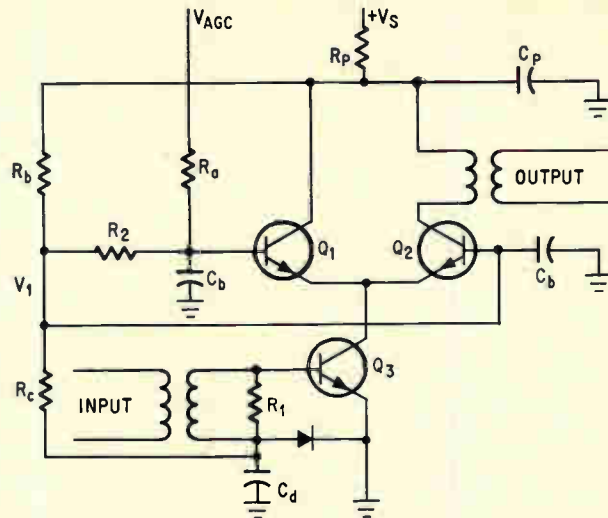

This circuit maintains constant impedance levels while shunting the signal into either the output transistor or the non-output side of a differential pair. This minimizes problem of bandwidth variation and interstage detuning with automatic gain control in tuned i-f cascade amplifiers. The AGC, applied as a differential d-c voltage between the bases, determines the amount of signal shunted to each side. Stage gain is 20 db at 60 Mc.

a 10-to-1 ratio. If the masks are laid out accurately, these resistors will exhibit the 10-to-1 ratio even if the actual resistivity of the material is 1.3 times the design value, in which case the resistors' actual values will be 1,300 and 130 ohms.

Unfortunately, this capability to produce resistor pairs with closely matching resistance ratios may

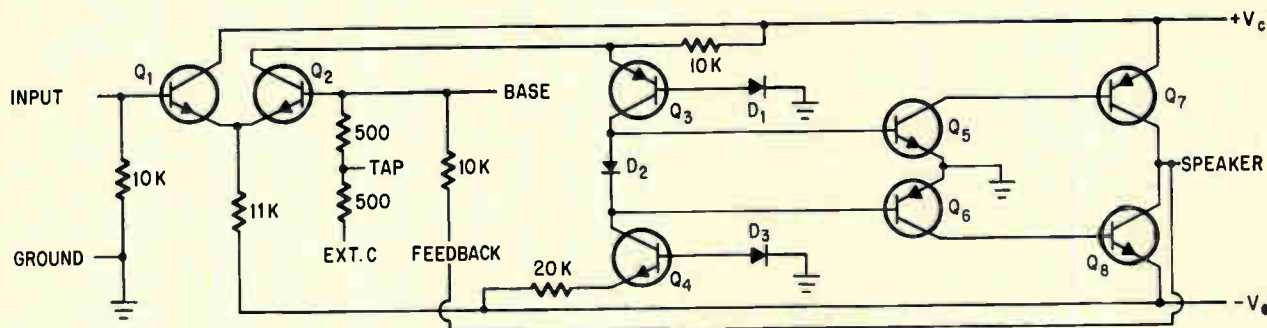

One-watt integrated-circuit audio amplifier has negative d-c and a-c feedback applied to one side of a differential input stage; signal is applied to the other side. With balanced power supplies, the output d-c voltage remains at ground potential, allowing a loudspeaker to be driven directly without a large d-c decoupling capacitor. The integrated circuit is the MC1524, a commercially available multi-chip device.

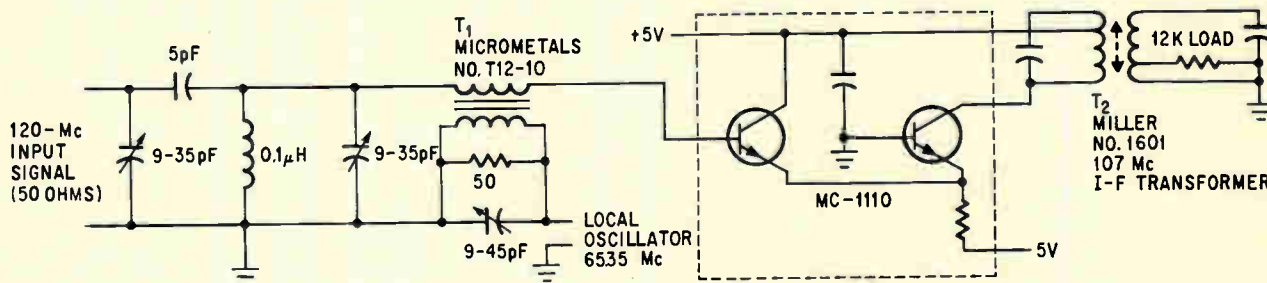

Differential amplifier integrated circuit used as harmonic mixer. Local oscillator operates at half of the intended mixing frequency, and odd-order harmonics are canceled in the mixer. Wide separation of oscillator and signal frequencies allows more effective rejection of spurious responses. A conversion gain of 33 db from 120 Mc to 10.7 Mc can be attained with available integrated circuits such as MC-1110. Low-frequency crystals can reduce cost in vhf range.

be decreased by the effects of the metallization that is used to interconnect parts of the circuit. The metallization adds a finite contact resistance wherever it touches a resistor. If the contact resistance is 10 ohms, the ratio for the first set of resistors mentioned previously would be 1,010 to 110 ohms, or 9.18 to 1. However if the resistors are of the same value, adding two ohms of contact resistance does not affect the 1:1 desired ratio.

Whenever unexpected variations occur for one element in a differential amplifier, the same variations should occur for the other element. In this way, the use of differential amplifiers makes biasing of the integrated circuits a less critical factor.

Obtaining high impedance

Another problem in the use of integrated circuits is the difficulty of achieving high impedance levels. In discrete-component circuits this is accomplished by biasing with high-value resistors. With integrated circuitry, the available range of monolithic resistors is restricted by the resistivity of the material and by the physical size of the resistor on the chip. With a material of given resistivity, the resistance of one square is the same regardless of the size of the square. To double this resistance, it is necessary to use a two-square rectangle.

Since this resistance is independent of the size of the squares, it is desirable to make the squares as small as possible. In practice, the resolution of the photographic equipment used in manufacturing integrated circuits dictates the smallest width of a line that can be reproduced reliably. Even with the most advanced technology, resistors greater than 20,000 ohms usually are too large in area.

The solution is to substitute transistors for resistors wherever possible. For example, if a 200-ohm resistor and a transistor with a beta of 100 are placed in series with the transistor emitter, the impedance would be about the same as with a 200,000-ohm resistor but the components would occupy only 1% of the area.

This saving of valuable space is somewhat offset by the introduction of additional variables. One approach to neutralizing these variables is to introduce a matched diode in the biasing network. A diode is selected whose temperature characteristic is the same as the transistor's base-to-emitter junction characteristic; therefore the diode balances variations in the more important parameters such as base-emitter voltage (V_{BE}). For complete balance, however, it is better to use a differential amplifier, because even if variables are introduced in each of the symmetrical elements, the variables will cancel each other.

At present, the breakdown voltages that can be achieved in monolithic devices are lower than those possible with discrete devices. When a differential output with a floating load is used, the available output voltage swing for a given maximum supply voltage is doubled because the voltage imposed on the load can be almost equal to the supply voltage on one half-cycle, and the same magnitude voltage

but with opposite polarity can be supplied on the other half cycle, giving a peak-to-peak swing of nearly twice the supply voltage across the load.

Circuit layout on the chip

For best performance in a monolithic differential amplifier, careful consideration must be given to the physical layout of the chip. The cardinal rule is symmetry wherever possible. Ideally, the chip is bisected and the circuit constructed symmetrically about this center line.

Economy of chip area, however, often dictates that two resistors have different shapes; such variations usually lead to inferior performance, especially when a pair of resistors have a different number of right angle bends. Since doping levels may vary slightly even across a single chip, symmetrical pairs of transistors and resistors should be placed as close together as layout considerations will permit. As chip sizes is made smaller, across-the-chip variations become less significant and the requirement for close spacing may be relaxed.

Thermal paths in the silicon deserve careful attention. If a particular element such as a load resistor is expected to produce a temperature gradient across the chip, other component pairs should be placed along the isothermal lines so that corresponding elements will remain at the same temperature.

If a current-source transistor is to be used instead of a large resistor, the current source's temperature stability can be improved when a diode is used in the base-bias divider. Such a diode should be closely matched to the base-to-emitter junction of the current-source transistor. The match will be best if the diode is actually the base-to-emitter junction of a transistor identical to the current-source device, and if the diode is conducting the same current as the current source.

For high frequency, symmetrical construction and layout are important for the interconnecting metallization and for the bonding pads, because stray capacitances must be kept equal on both sides of the circuit. This should maintain good high-frequency performance and high common-mode rejection.

Various combinations of npn and pnp differential chips in multichip integrated circuits are also possible. For example a multichip comparator can be built, which employs a pnp differential amplifier pair on one chip and an npn differential amplifier pair on a second chip.

The author



Robert Hirschfeld is an applications engineer specializing in linear integrated-circuit applications. In addition to designing differential amplifier systems, he is also engaged in designing with audio-amplifier integrated circuits.

Circuit design

Designer's casebook

Designer's casebook is a regular feature in Electronics. Readers are invited to submit novel circuit ideas, packaging schemes, or other unusual solutions to design problems. Description should be short. We'll pay \$50 for each item published.

Controlling scr firing angle regulates d-c load voltage

By Roman S. Krochmal* and William Weber
General Instrument Corp., Newark, N.J.

With a constant load, the circuit below provides a constant d-c output voltage over a wide range of a-c voltage inputs. The circuit can be applied as a simple regulator for a heater or a lamp.

The regulator consists of a unijunction transistor trigger circuit that fires a silicon controlled rectifier at a specific time in each half-cycle of the input voltage. When the emitter voltage of the ujt reaches its peak point voltage V_p , the emitter-to-base-one resistance becomes very low (5 to 20 ohms). The peak point voltage V_p equals $\eta V_{bb} + V_d$ where η is the intrinsic standoff ratio (typical values are between 0.47 and 0.75), V_{bb} is the interbase voltage, and V_d is the forward voltage drop of a typical diode (0.7 volts).

As the interbase voltage increases, so does the peak point voltage, so that the scr firing angle increases when the input voltage increases, and decreases with decreasing input voltage. The resulting average voltage appears across the load R_L .

Zener diode D_5 maintains a constant capacitor

* Now with Circle-O-Phonic Corp., New York, N.Y.

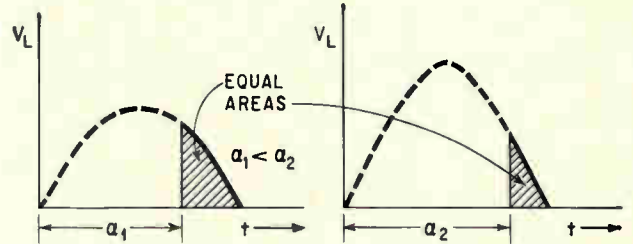

Voltage across load is represented by shaded areas. Equal shaded areas mean that average load voltage is constant.

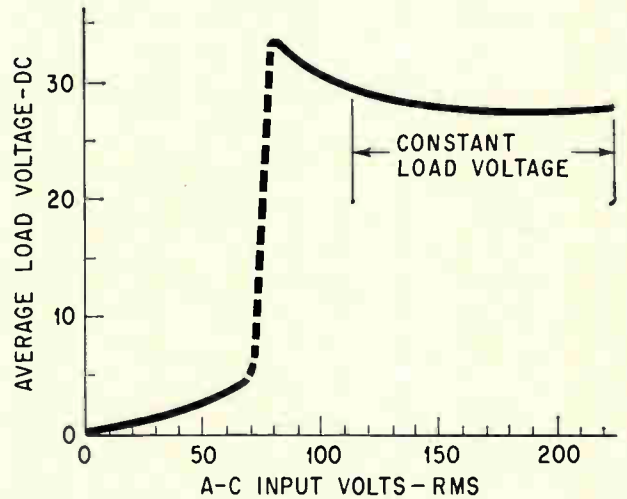

Regulation curve shows that the average load voltage is constant at about 30 volts, as the input a-c voltage varies from 100 to 200 volts rms.

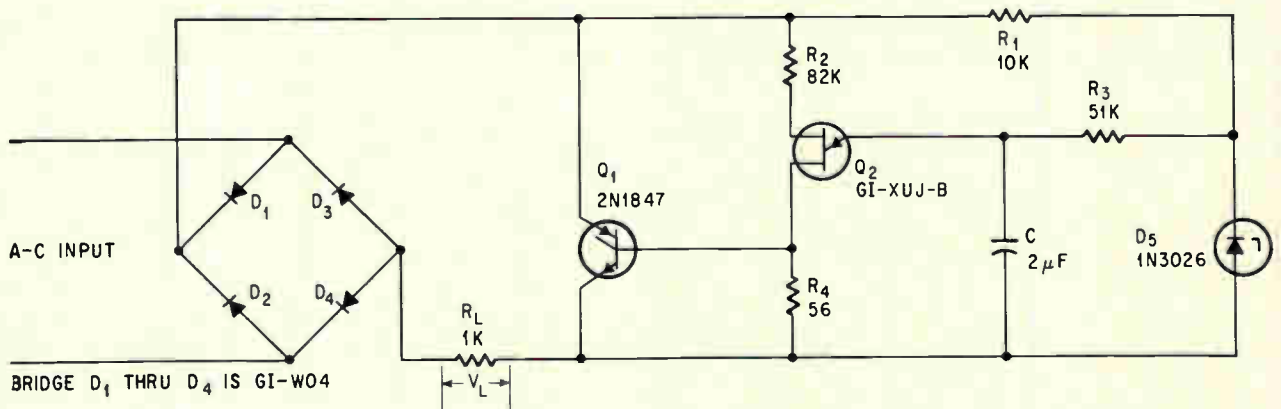

Firing angle of the silicon controlled rectifier varies with amplitude of the input a-c voltage; this variation maintains constant average voltage across load R_L . Load voltage can be adjusted by changing the value of R_1 .

charging rate, which makes the ujt emitter voltage increase at the same linear rate, regardless of the input voltage.

When the applied voltage is less than 70 volts rms, the ujt doesn't fire. In this case, the voltage across the load results from the voltage divider formed by R_1 , D_5 and the load itself. This is represented by the lower corner of the regulation curve. The dashed part of the regulation curve indicates that the unijunction will fire randomly between 70

and 75 volts.

The value of R_2 is chosen to limit the ujt inter-base voltage to less than 35 volts, its maximum rating. The zener voltage and R_3 -C time constant control the firing angle. R_4 limits scr gate current.

The average voltage across the load can be adjusted by changing the value of R_1 .

For the values shown, the voltage across R_2 is 30 volts d-c, ± 1.5 volts, for line voltage varying from 100 to 200 volts a-c.

Matching gate potential to FET pinchoff voltage

By Bruce R. Smith and Irving C. Chase

Crystalonics, Inc., Cambridge, Mass.

When an increase in a field-effect transistor's drain-to-source voltage causes little or no increase in drain current, the FET's pinchoff voltage has been reached. But it is not easy to determine this voltage, since it lies towards the end of the knee of the voltage-current curve. Direct measurement cannot obtain values for V_{PO} accurate to better than plus or minus one volt.

However, it is possible to find a gate voltage which is equal in value to the pinchoff voltage. The circuit at right shows how this gate voltage may be applied and measured conveniently.

Analysis of the characteristic FET curves has shown that the gate voltage which holds drain current below 0.1 microamp is approximately equal to, though opposite in polarity from, the pinchoff voltage. Readout on a voltmeter connected from gate to ground gives a value which matches the pinchoff voltage.

When a FET is inserted in the circuit, the drain voltage V_1 approaches zero. The drain is connected to both the noninverting input of the Philbrick amplifier and a reference voltage V_2 , which is connected to the inverting input of the amplifier. Since the drain is close to zero volts, the amplifier produces a negative output potential, which is applied to the gate of the FET under test, an n-channel type, turning it off.

When the amplifier input voltages are balanced, there is a voltage difference $V_{CC} - V_2$ across the 10-megohm drain resistor. The circuit is designed so that this voltage corresponds to the magnitude of drain current change specified at V_{PO} . In this case, with $V_{CC} - V_2 = 1$ volt, $I_D = 0.1$ microamp.

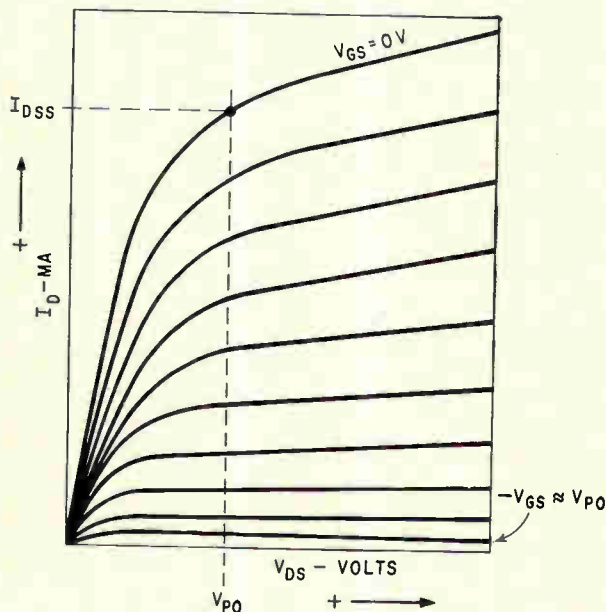

Typical FET drain characteristics. V_{PO} is drain voltage that causes little or no change in I_D when $V_{GS} = 0V$.

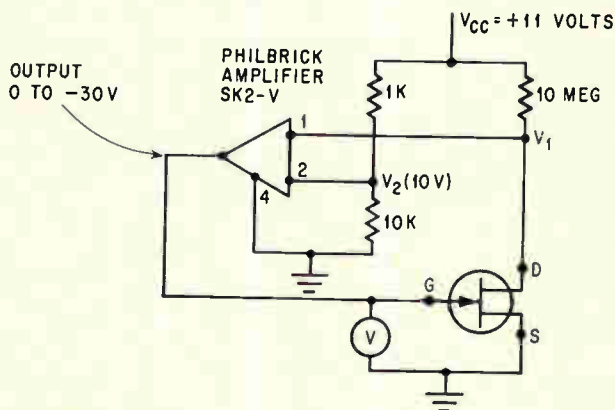

FET drain-to-source pinchoff voltage is obtained indirectly, by measuring gate-to-source voltage that causes $I_D = 0.1$ microamperes.

The pinchoff voltage of p-channel FET's can be measured by changing the polarity of V_{CC} and reversing the inputs to the amplifier.

Slow sweep generator controls camera shutter

By Robert L. Nuckolls, III

Cessna Aircraft Co., Wichita

This slow speed sweep generator controls the shutter of a camera that photographs radiation data on a calibrated oscilloscope.

The sweep generator starts, and opens the shutter of a 35 millimeter camera, when a radiation pellet on a conveyor belt passes a photocell. As the pellet continues its travel, it is scanned by a succession of radiation detector tubes, each of which is sensitive to different kinds and energy levels of radiation. The output of the detector tubes is applied to the vertical deflection amplifier of a d-c oscilloscope where the data is photographed. The sweep generator is timed to close the shutter when the pellet passes the last detector. The sweep generator resets itself and the next sweep period doesn't start until another pellet passes the photocell.

In the circuit diagram below, transistor Q_1 is a constant current source that linearly charges ca-

pacitor C_1 , and Q_2 is an emitter follower. C_1 is clamped to nearly ground potential by the collector current of Q_5 through diodes D_1 and D_2 . Transistors Q_3 and Q_4 form an unsymmetrical, bistable multivibrator that starts and stops the sweep period.

When there is no start pulse, Q_5 conducts. When a start pulse is applied at the input terminal, the multivibrator begins the sweep. The voltage on C_1 rises at a linear rate to a limit of -12 volts with respect to ground.

A low hysteresis Schmitt trigger, Q_3 and Q_4 , senses the output voltage through voltage divider, R_a . When the voltage on C_1 rises to the lower threshold level (determined by the setting of R_a), the Schmitt trigger changes states— Q_3 turns on and Q_4 turns off, causing the collector of Q_4 to go negative. This negative voltage change is coupled back to transistor Q_5 , turning on Q_5 and thereby resetting the sweep generator for the next input pulse.

Sweep speed is determined by R_a and C_1 . When $R_a = 4$ kilohms and $C_1 = 1000 \mu\text{fd}$, the sweep rate is about 1 volt per second. Sweep amplitude, determined by the setting of R_a , is adjustable from -0.5 to -11.0 volts.

This circuit can delay the start of a second sweep generator, since it also provides a delayed pulse at output terminal C.

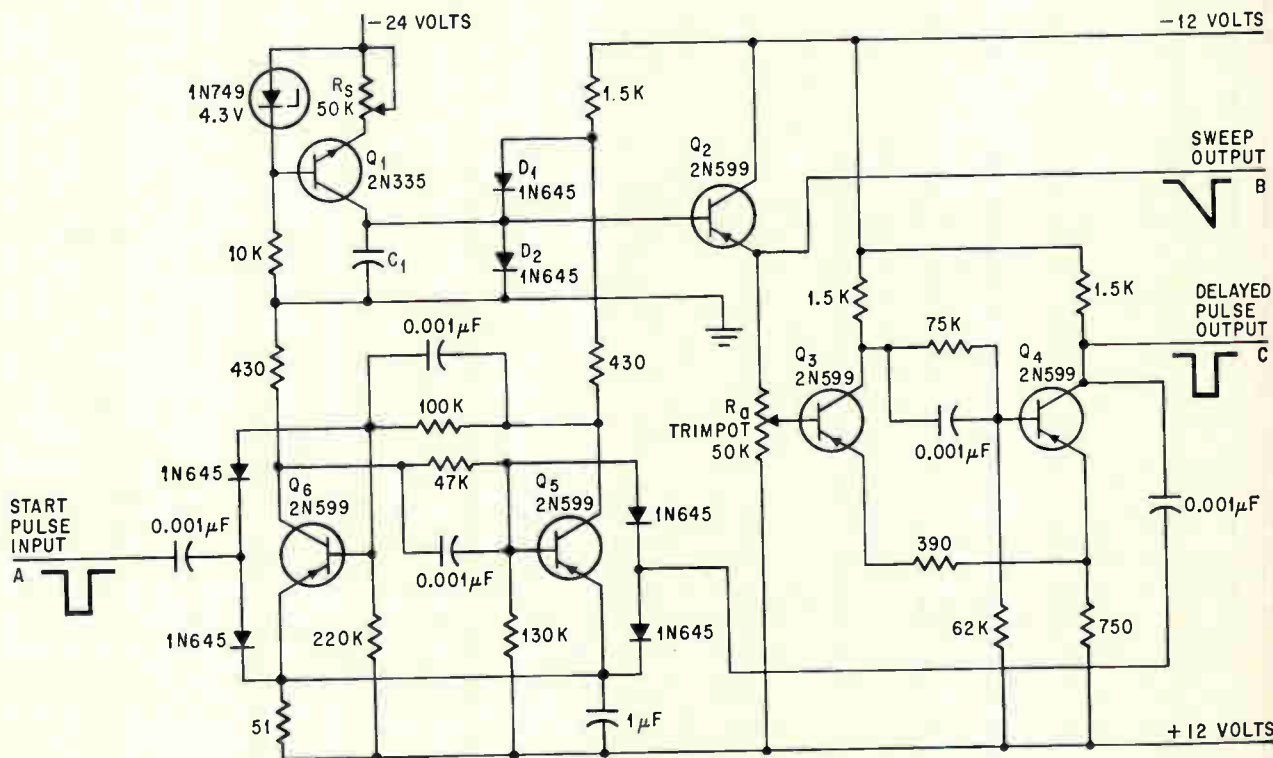

Slow speed sweep generator can be used to keep a camera shutter open to photograph radiation patterns on an oscilloscope. Speed of sweep is determined by R_a and C_1 .

Transistor increases multiplier phototube sensitivity

By Robert A. Kawcyn
University of Illinois, Champaign

The voltage change across a phototube will give an index of small differences in light level even in the presence of a constant light source such as daylight or a d-c lamp. The measurement may be made more easily with a load resistance that provides a relatively large voltage change for a small change in light level.

In terms of the anode characteristics for a typical multiplier tube shown at the right, the problem is to obtain the largest possible response, ΔE_o , to a peak change in light intensity ΔF from a constant intensity F_3 .

If a large load resistance, R_1 , is connected to the anode of the phototube, the voltage change in the saturation region will be low and the response will be nonlinear.

Decreasing the value of the load resistor will restore linear response, but sensitivity, as measured by ΔE_o for R_2 , is still small.

But if the collector-base junction of a pnp transistor is connected to the anode, the high dynamic impedance of the transistor's collector can be biased so that the load-line is almost horizontal as it intersects the phototube's characteristic curves. The result is a large output voltage swing for

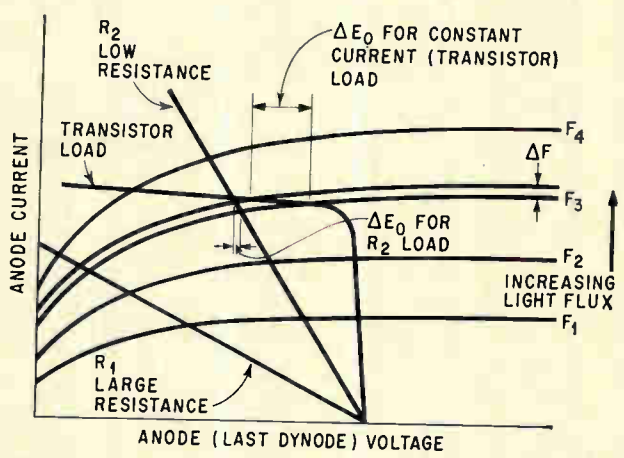

Multiplier phototube characteristics. Sensitivity is greater with a transistor load than with a resistor load.

small changes in light level.

The transistor load-line rapidly becomes nonlinear for higher anode voltages, but adjusting the emitter current will adjust the transistor load-line up or down on the light-level curves.

The method was tested with a 931A multiplier phototube and a 2N1132 transistor. The photocathode was exposed to laboratory room lighting of 150- and 200-watt incandescent lamps, which at 60-cycle current exhibited a 120-cycle light modulation. With a 100-kilohm resistor as the anode load, the best response to the modulation was 1.7 volts peak-to-peak at a quiescent potential of 25 volts d-c. Under identical lighting, the resistor was replaced by the collector-base junction of the 2N1132, and the emitter current was adjusted so that the voltage change was 13 volts peak-to-peak.

Improving Darlington speed

By Michael Cianciola
Kearfott division, General Precision, Inc.
in Marcos, Calif.

The switching time of a conventional Darlington circuit can be greatly reduced by adding an extra transistor and a resistor.

In a conventional Darlington circuit, the turn-off time is relatively long because of the charge stored in the base of the output transistor.

But in the circuit diagram at the right, the propagation delay through Q_3 is negligible since it always draws approximately the same base current. Thus, the distribution of charge in Q_3 's base changes only slightly when it switches. Therefore, base drive is available for the output transistor Q_2 within 2 or 3

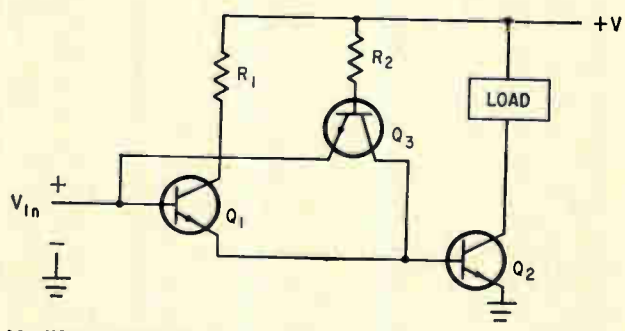

Modified Darlington switch has extra transistor.

nanoseconds after a positive input voltage is applied.

When the input voltage is removed, Q_3 provides a path for turn-off base current from Q_2 . The turn-off base current of Q_2 is the collector current of Q_3 , which is approximately $\beta_3 I_{b3}$. Hence, excess base charge is readily removed, resulting in fast turn-off.

Regulating bias on a ship's hull

Cathodic protection can prevent corrosion on steel plates, but the voltage applied must be controlled within precise limits under different conditions of temperature, vessel speed, and salinity of the seawater

By Ernest L. Littauer and Owen G. O'Brien

Lockheed Aircraft Service Co., a division of the Lockheed Aircraft Corp., Ontario, Calif.

It would be more than misleading to describe an ocean liner like the Queen Mary as an enormous wet-cell battery, but in one respect, that's exactly what it is. Local impurities in a ship's steel hull divide the surface into areas of different electrical potential and the interaction of these anodic and cathodic areas with sea water causes corrosion.

It is possible to prevent corrosion by biasing the entire hull, making it into a giant cathode. Such a system requires accurate electronic control to keep the voltage at the right level for varying conditions of ship speed and sea water temperature and salinity.

In a typical cathodic protection system, power is constantly fed to electrodes on the hull under water. The exact amount of power required varies with the condition of the ship's paint, the chemical composition of the seawater and the speed of the ship. Under these widely varying conditions, an automatic electronic control is required to keep the

hull biased at about 200 millivolts, $\pm 10\%$, over the entire wetted area. Too small a voltage would not stop corrosion and too large a voltage would cause hydrogen bubbles at the hull surface that would lift the paint off.

Anodic corrosion

Corrosion of metal occurs only in anodic areas, which become pitted when they lose positive ions into the electrolyte. (In a uniform metal surface, the anodic and cathodic areas are microscopically small, and the corrosion appears uniform.) To protect against corrosion, therefore, it is only necessary to force the entire steel surface into a cathodic state. This is possible with a permanent anode system that employs chemically inert external electrodes. The entire hull is biased to a lower potential; since it then contains no anodic areas, it will not corrode.

Traditionally, hulls have been protected by paint, which acts as a very high series resistance in the path of the corrosion current. But paint wears off, and a vessel must be periodically drydocked, scraped, and repainted.

The cathode system can be installed for the price of a single paint job—\$10,000 for a typical tanker. It will pay for itself in drydock and painting expenses in two years. With cathodic protection, ships could be operated without paint at all, but the power requirements at 20-knot speeds would be excessive (as much as 30 milliamperes per square foot) and the salt encrustations and barnacles that would build up without the usual coat of anti-fouling paint would increase the skin friction.

Control system

The electronic anti-corrosion system is best explained in terms of the components used around the control loop, as shown in the over-all schematic across the top of pages 86 and 87.

The small feedback electrode senses the relative

The authors



Ernest L. Littauer is the electrochemical member of the author team. He came to the United States from England in 1963, when he learned that Lockheed was one of the few companies working on electronically-regulated corrosion control systems. He lives in Hollywood and is a sports car buff.



Owen G. O'Brien is the electronic member of the team. However, recently he's been spending more time in traveling than in circuit and system design. In the past year he has been to Japan to supervise the installation of an anticorrosion system on a larger tanker and in Europe on an extensive sales tour.

Corrosion control by cathodic protection

<p>Physical picture</p>				
<p>Circuit representation</p>	<p>UNINHIBITED CORROSION</p>	<p>PARTIAL CANCELLATION $E_C < E_A$</p>	<p>NOTE THAT $E_C < E_A$</p>	<p>CAN ADJUST E_P FOR COMPLETE CANCELLATION</p>
<p>Description of corrosion experiments</p>	<p>(A) Elementary wet cell formed by copper and steel in salt water</p>	<p>(B) Zinc strip protects steel</p>	<p>(C) How steel can form battery by itself</p>	<p>(D) Modern cathodic protection system</p>

A—Anodic area
C—Cathodic area

Cu—Copper
St—Steel
Zn—Zinc

E_C —Cathode potential
 E_A —Anode potential
 R_C —Cathode resistance

R_A —Anode resistance
 E_P —Protection potential
 R_P —Protection resistance

The corrosion of a ship's hull occurs for the same reason that the anode of an electrochemical cell is eaten away. If a strip of steel and a strip of copper are placed in an electrolyte and electrically connected, as in sketch A of the illustration above, a current will flow because the two metals are of different potential. Steel is negative with respect to copper, but the steel will become the anode because it is the source of the positive current through the cell.

Steel atoms lose electrons through the electrical circuit. The atoms, which are now positively charged ions, are no longer locked into the crystalline structure of the steel, and go off into the solution looking for

electrons that will make them stable again. Loss of the atoms pits the steel and eventually eats it away.

The rust that most people think of as corrosion occurs when the positive steel ions regain equilibrium by joining with oxygen, either dissolved in the water or produced by electrolysis by the cell. Rust or iron oxide is not the cause of the steel's disintegration, but an indication that it has occurred.

The corrosion of the steel can be stopped by preventing the "electron robbery." If a zinc strip is placed in the solution (sketch B), it will have a potential relative to the steel's. The zinc thus becomes the anode for the

system, and will supply the electrons for the current flow to both the copper and the steel; the steel has been turned into a cathode and is no longer being robbed of electrons.

Sacrificial zinc strips have been used on ships for cathodic protection. But the same effect can be produced by supplying a protective voltage from an external source, through a protective anode that will supply current through the electrolyte without being consumed.

In ship corrosion, local impurities in the steel make up the cathodic and anodic areas (sketch C), and the protection system would be designed as in sketch D. The added voltage source is what is regulated.

voltage between the sea water and the hull. It is the single most critical item, for its accuracy determines the accuracy of the complete system.

Yet it is difficult for the electrode to draw sensing current without an opposing polarization potential being created due to chemical factors such as the buildup of hydrogen or oxygen at the electrode's surface. Since this polarization may be large, compared to the millivolt levels the system is trying

to sense, it cannot be tolerated.

The polarization is proportional to the current drain. A silver electrode coated with silver chloride will operate with current drain or input of a few microamperes per square centimeter; this factor and silver's chemical characteristics will keep the opposing emf down to a few millivolts.

High system loop gain rather than high input impedance assures the small current drain. To

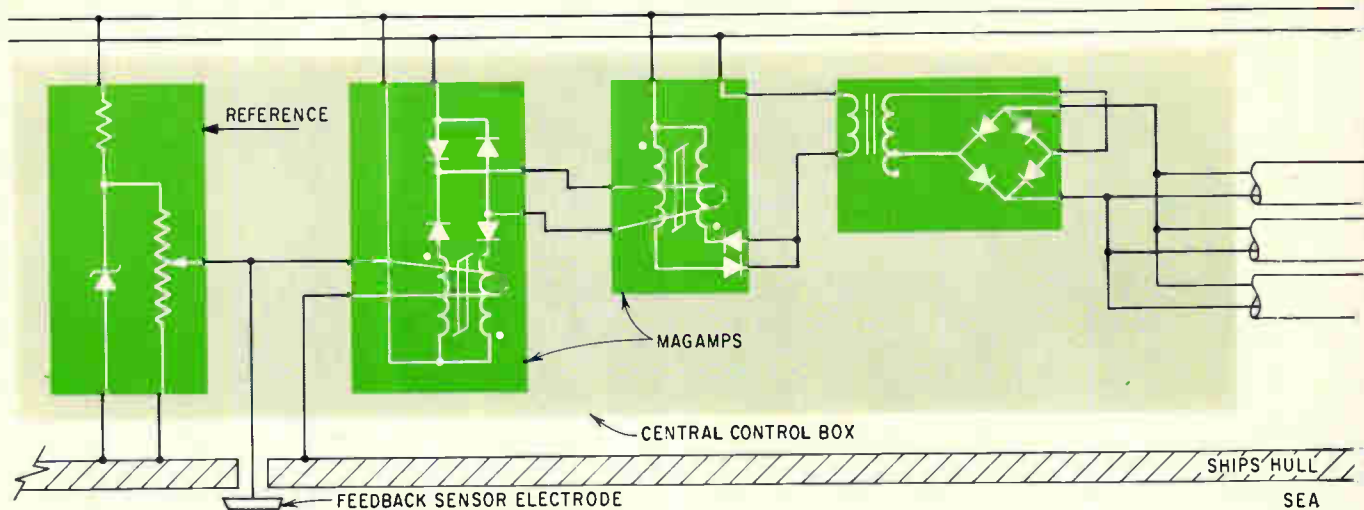

Anticorrosion system laid out partly as a pictorial representation of how the equipment would be installed on a ship and partly as the classic feedback control system diagram. The steel hull of the ship is the system signal and power ground. The reference voltage at the left commands the amount of voltage difference to be impressed on the hull. The

wipe away any polarization which does build up, and to prevent the sensing electrode from being dissipated away as an anode, the current is reversed during alternating half-cycles of the ship's regular 60 cps power supply. The reversal acts as a "rejuvenation cycle" to form a new silver chloride surface on the electrode.

Reference voltage

The reference, or command voltage, comes from a temperature-compensated zener diode, which is typically divided down to a 200-300 millivolt setting. When this adds to the 550-millivolt potential that normally exists between the sensing electrode and the hull the required 820-millivolt system input signal will exist relative to the hull ground.

Magnetic amplifiers

Magnetic amplifiers and saturable reactors are used throughout the system. Silicon controlled rectifiers could have been used; they would probably have lower first costs and other attractive features such as better power factors, but scr's have yet to demonstrate that they can match magamps on the basis of ability to withstand momentary overloads, and long-term stability.

Magamps are transformer-like devices that can amplify because a small input signal can vary the saturation of their nonlinear magnetic cores and thus vary the impedance of the output winding. This in turn gates more or less of the alternating line current to the load.

The two signal-level magnetic amplifiers in the central control box are of conventional design. They deliver a 10^6 current gain.

Diodes block waveforms

Blocking diodes in the output windings permit only half the alternating current waveform to get

through. During the off half-cycle, a direct current signal in the control winding sets up the flux level in the core. This determines how much additional current must be supplied to the output windings to switch the core into its saturated state.

The higher the control current, the higher the preset flux level and the sooner the core will be

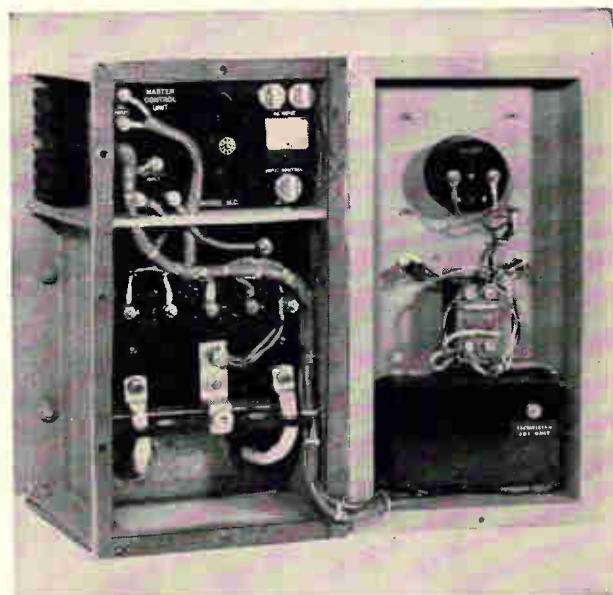

Shipboard equipment must be rugged. The master controller is bolted into this steep-plate box. The meter that indicates the bias level is placed in view of the crew on the front of the box door, but most of the control adjustments are hidden away inside. The reference zener is located at the upper portion of the box and the magamps are below. The magamps are ideal for this environment as they have the best long-term stability and best ability to absorb fault transients of any amplifier. Still, differential transistor input stages followed by scr power drivers are now being developed to replace the magamps in future corrosion-protection systems. The all solid-state systems will cost less.

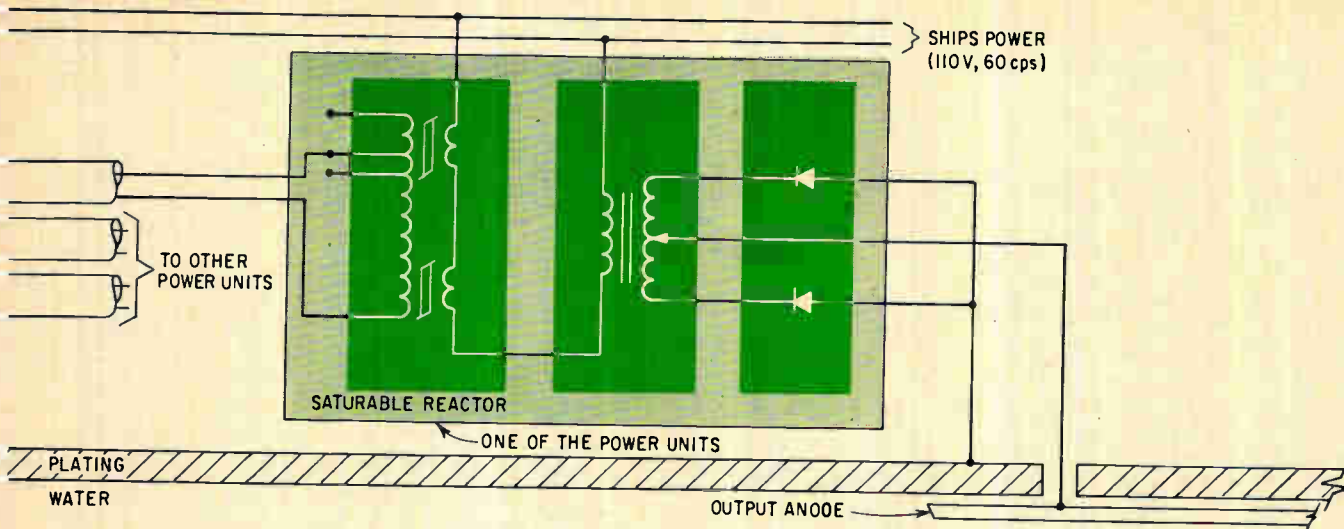

magnetic amplifier chain raises the power level to the several kilovolt-ampere level needed to drive the output anodes. These anodes supply the ion-current flow in the sea water that interacts with the ship's hull to change its voltage several hundred millivolts. The feedback sensor electrode measures the actual hull-seawater voltage differential.

completely switched into saturation.

The input magnetic amplifier has a 20-micro-ampere bias current in an additional winding (not shown in the schematic). This puts the core just at its saturation point, so that in the absence of any other signal it will fire immediately and deliver full power to the control windings of the second magamp.

Any voltage difference between the reference and feedback sensor produces a current that acts to turn the first magamp off. Input signals from 0.05 to 5 microamperes will operate the first magamp over its full range.

The second magamp feeds a full-wave rectifier to produce the direct-current signal that is distributed to the power output units throughout the ship.

Low-cost distribution

In a system which is physically spread out, there is a definite advantage to accomplishing the final power amplification directly at the point where the power is to be used. A separate and possibly redundant amplifier is required for each final unit, but the delayed amplification saves on the cost of the distribution system.

With separate amplifiers, the signal can be distributed at a 0.5 ampere, 90-volt level, even though it will be applied at up to 500-ampere, 12-volt levels. The 0.5 amp signal level is high enough to avoid noise problems yet low enough so that relatively small and therefore low-cost cabling can be used for the long runs. The relatively high 90-volt potential of the signal helps to minimize the resistive power losses.

The full 5-ampere signal from the master unit saturates the slave-unit reactors and causes them to deliver full power to the output anodes outside the ship's hull. A large number of turns are used on the slave unit reactors to permit the current gain of 100 and power gain of 15. The transformer and

rectifier at the reactor's output provides the 12 volts d-c needed to drive the output anodes.

Output anodes

The anodes are formed from a number of 68-inch long sections joined into longer strips and fastened outside the hull so that the control action is distributed in a reasonably even manner. The anodes are insulated from the hull so that the output current path is through the sea water.

Anodes made of lead with embedded platinum pins will not corrode away. The lead combination reacts in salt water to form a lead-dioxide surface coating. This coating has an extremely high conductivity—higher than that of some pure metals—and is capable of giving off high currents (60 amperes for each 68-inch length) with only 2.2 volts of opposing polarization.

The amount of power that must be pumped into the anodes runs between 0.1 and 10 milliamperes for each square foot of underwater surface. For a medium-sized T-2 tanker, which has a wetted surface of about 52,500 square feet, the total current will then vary from 5.25 to 525 amperes.

Stationary objects

Roughly 100 ships are now using electronic corrosion protection systems and in the future few ships will be built without them.

But the method also has applications for stationary objects, such as bridge piers, tunnels, offshore oil rigs, and canal locks. Here the operating conditions are less severe, since the nature of the seawater does not change greatly and there are no problems of ship velocity to consider.

Once installed, the stationary objects cannot be repainted; but as the paint wears away, protective layers of calcium and magnesium salts build up on the surface, and keep the protective current down to an economical 3 milliamperes per square foot.

A solid state stereo set built in modules

A defense-oriented firm will invade the consumer market with a high-quality instrument constructed with the same techniques it used in making digital voltmeters. The set is easy to repair, works even when some circuits are out

By Sam Messin and Thomas E. Nawalinski

Non-Linear Systems, Inc., Del Mar, Calif.

From digital voltmeters to stereo sets is not such a long jump as it may seem. A West Coast company, Non-Linear Systems, Inc., is using the same modular techniques it developed for its dvm to produce a solid state stereo tuner-amplifier. Every major circuit function in the set is in a separate, electronically independent, plug-in module, and any failure can be repaired in minutes merely by replacing the defective module.

Since the failures will be isolated, the unaffected modules will still work. Pull out the multiplex module and you can still listen to monaural f-m. Pull out a module in the f-m tuner, and the amplifiers will still work for tape or records. If any module in one audio channel is removed, the other channel is available for monaural sound.

NLS is a defense-oriented company, and it was the shrinking defense market that led to its decision to market a consumer product. The company's instruments are of high quality and are expensive,

and its stereo set will be the same. At \$695, it will be in the range of the most expensive set made, the McIntosh. But NLS felt that its production techniques were more suited to the quality market than the popular market, and that there was more chance for a new name in the high-price area, where only a few manufacturers compete.

The company feels that its modular construction will be a real selling point. Hi-fi buffs might be tempted by a set which will still work even though part of it is on the blink. Also, the technique will let NLS use existing machinery for production.

The combination set will be on the market in September; the company plans to make separate f-m tuners and amplifiers in the future.

Sectioning the circuit

Each block in the diagram of the stereo f-m tuner-amplifier combination on the opposite page represents a separate circuit module. The photograph at the top of the page clearly shows these plug-in boards. Sectioning the circuit in this manner evolved over a two-year period.

The f-m tuner is separated into three modules: the radio-frequency front end, the intermediate-frequency amplifier, and the multiplexer. The left-channel supply also powers the tuner modules.

Circuitry for each 40-watt (rms) audio channel, with the exception of the power output transistors and driver transformer, is separated into two printed circuit boards, the preamplifier and audio driver modules. The four output transistors for each audio channel are mounted on heat sinks at the rear of the chassis, outside the cabinet.

The preamplifier, audio driver and power supply boards in the left and right channels are identical and interchangeable. For maximum reliability, the power transformer has separate secondary windings for each power supply.

Each circuit board has its own zener or transistor

The authors



Thomas E. Nawalinski, now sales promotion manager for Non-Linear Systems, Inc., came to NLS from the General Dynamics Corp. in 1956 as chief applications engineer. He has written eight magazine articles and a 60-page text on digital voltmeters for the NLS catalogue.



Sam Messin, who now heads the high-fidelity project at NLS, has been designing radar and audio circuits for 20 years. He also marketed his own audio product, the Mercury Disc Charger, a static discharger for phonograph records. Messin was previously manager of the instrument assembly department at NLS.

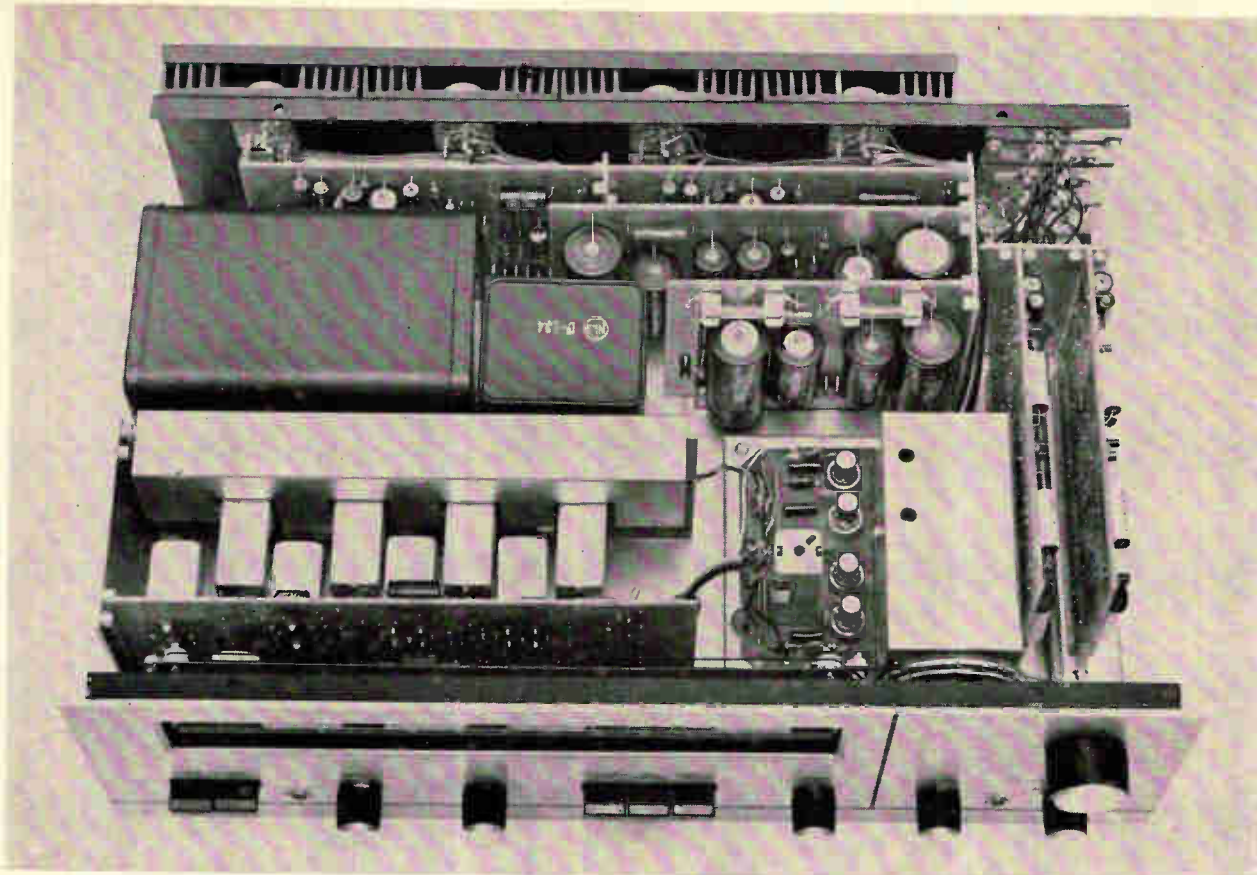

Vertically mounted plug-in printed-circuit boards reduce space requirements. The two cases at upper left are the power and driver transformers. Stereo receiver and dual 40-watt amplifiers fit in 18 in. x 11 in. x 6½ in. cabinet.

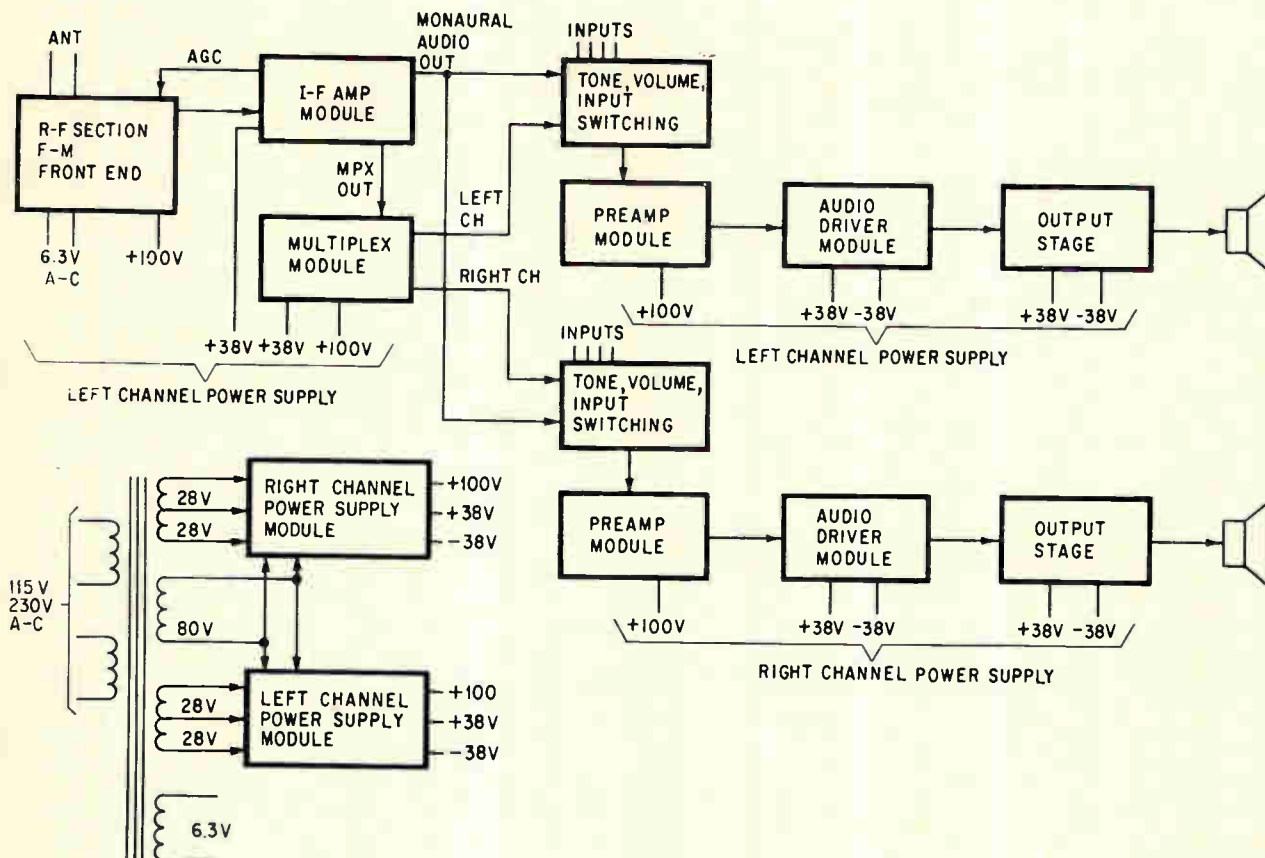

Stereo f-m tuner-amplifier combination is made up of removable circuit boards, each of which is represented above by a block. Exceptions are the controls, switches and output stages, which are not on separate boards.

voltage regulator to prevent interaction between boards through a common power supply. Even a short-circuited board will not affect its power supply, which continues to supply the other modules.

NLS engineers specified gold-plated, scissor-type connectors for the printed circuits. The circuit boards themselves are made from epoxy-impregnated glass fibers which retain their strength even when subjected to soldering and flexing. Wiring is limited to the interconnection of modules, controls and external connectors; point-to-point wiring is virtually eliminated by the printed circuits.

R-f section

Nuvistors were used in the r-f section because their performance is superior to presently available equivalent transistor circuits.

A pair of nuvistor triodes serve as an r-f cascode amplifier; a low-noise triode nuvistor is the mixer; and a fourth nuvistor serves as a local oscillator. Frequency drift is kept within 20 kilocycles by a temperature compensating capacitor.

I-f amplifier

Five transistors in the intermediate-frequency module amplify the mixer output from the r-f section. The last two transistors act as limiters and feed a wideband ratio detector which uses two matched diodes. The ratio detector output is amplified, as shown above, by a transistor with a split load in the emitter and collector circuits.

The emitter circuit provides a low impedance output to the multiplex module, while the collector feeds a deemphasis network for the monaural f-m output. In this way, stereo and monaural f-m are completely separated, so that removing the multiplex module has no effect on monaural reception.

Multiplexer

The low impedance output from the i-f module feeds the multiplex module shown at right. In the presence of a multiplex signal, this output contains the 19-kc pilot frequency and the stereo signals.

Adding the composite signals to the regenerated subcarrier forms a 38-kc amplitude-modulated signal containing right and left channel information.

Specifications

F-m tuner

Sensitivity, 30 db quieting	2.5 uv
Drift (maximum)	20.0 kc
Stereo separation at 10 kc	25.0 db
Stereo separation at 1 kc	35.0 db

Stereo amplifier

Frequency response, ± 1 db	20 cps—20 kc
Total harmonic distortion at full power	0.7%
Rms power per channel	40 watts
Hum and noise	-70 db
Phono sensitivity	2.7 mv
Tape head sensitivity	4, 8, 16 ohms
Output impedance	25 mv

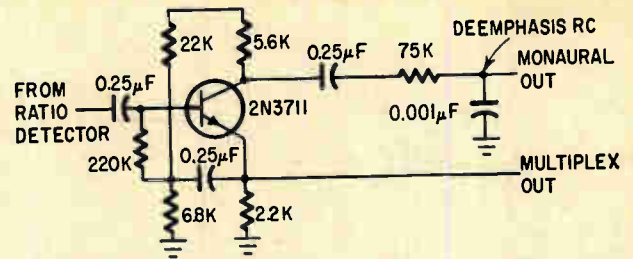

Final stage of i-f amplifier module has two outputs to allow independent operation of monaural f-m.

The subcarrier is regenerated by selecting, amplifying, limiting, and doubling the 19-kc signal.

The multiplexer cannot operate when there is no multiplex signal or when the 19-kc signal is below an acceptable power level. In this case, f-m reception is monaural. Rectification of the 19-kc signal provides the turn-on voltage to the frequency doubler, thus automatically providing stereo operation.

When the frequency doubler is on, a neon lamp driven by a transistor indicates stereo reception. A second neon lamp limits the voltage to protect the transistor when the stereo signal is absent.

Preamplifier

The audio preamplifier on page 92 uses both a zener diode and a transistor regulator for failure decoupling and voltage regulation. The phonograph and tape inputs feed a direct-coupled, low-noise pair of transistors which shape the audio in accordance with the RIAA-phonograph and NAB-tape playback-equalization curves. Switching in different resistance-capacitance circuits in the equalizing network provides the appropriate feedback. A 27-volt collector supply enables the transistors to handle large inputs without overload. Input switching selects either the output of this transistor pair, the tuner, or another external signal and feeds it to the balance and volume controls.

Bootstrapped emitter followers allow high impedance external signals to be used, and minimize loading of the high impedance controls. The emitter follower is direct-coupled to the following amplifier that drives a feedback bass and treble circuit. Another bootstrapped emitter follower places a minimum load on the tone circuits and is again coupled directly to the output amplifier of the module. The amplifier compensates for losses in the tone circuits and provides sufficient signal to drive the following driver module board.

The tone circuits are the Boxandall type; the bass control affects only the low frequencies; the treble control, the high frequencies. Controls at the center position give a flat response. Adjusting the controls first boosts (or cuts) only the ends of the audio spectrum, while the rest of the band remains flat. Further advancing of the controls affects more central frequencies as well.

Audio driver and output

A pnp-npn transistor pair provides voltage regu-

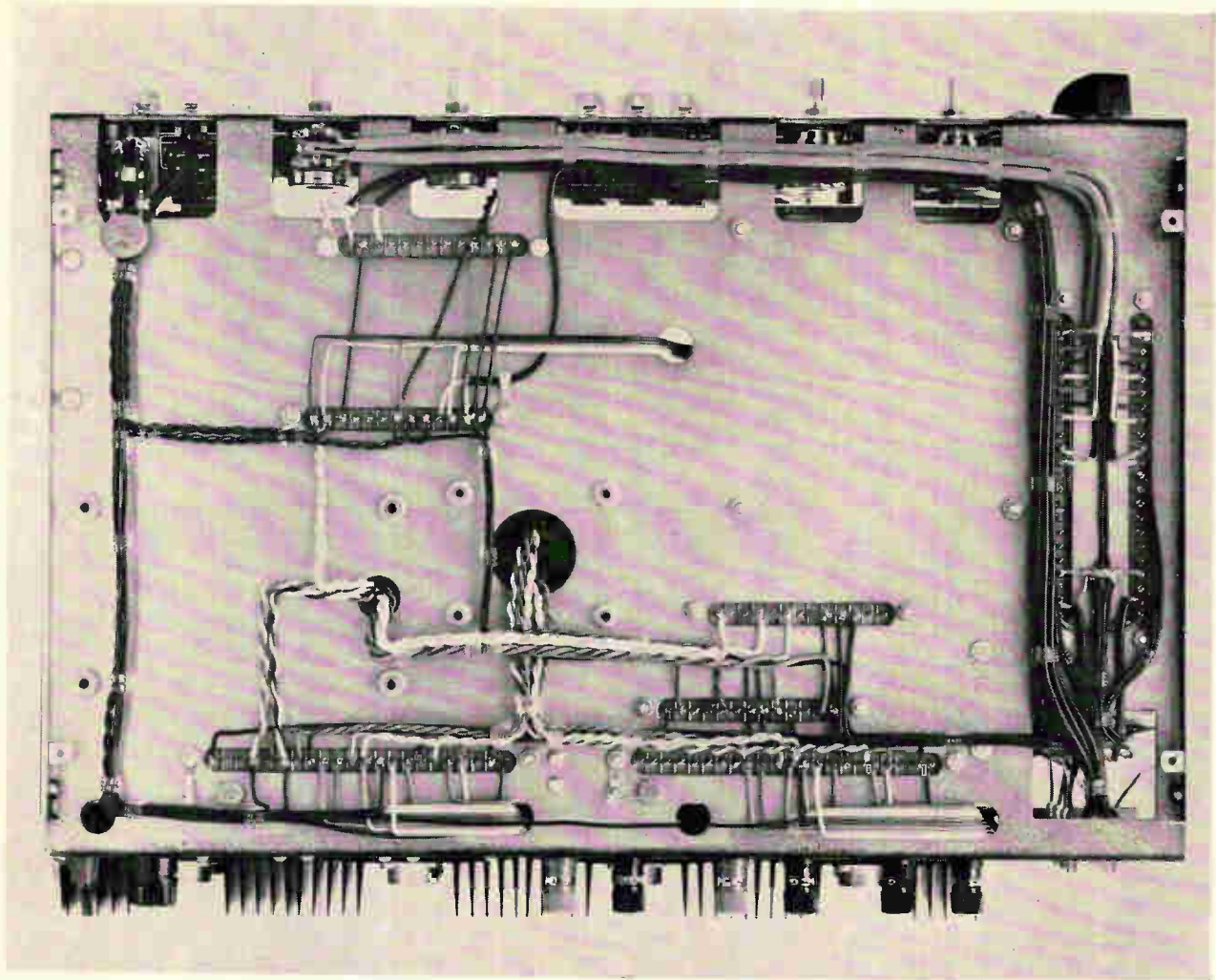

Chassis wiring is limited to the interconnection of modules, controls and external connectors. Heat sinks for output transistors can be seen outside the cabinet.

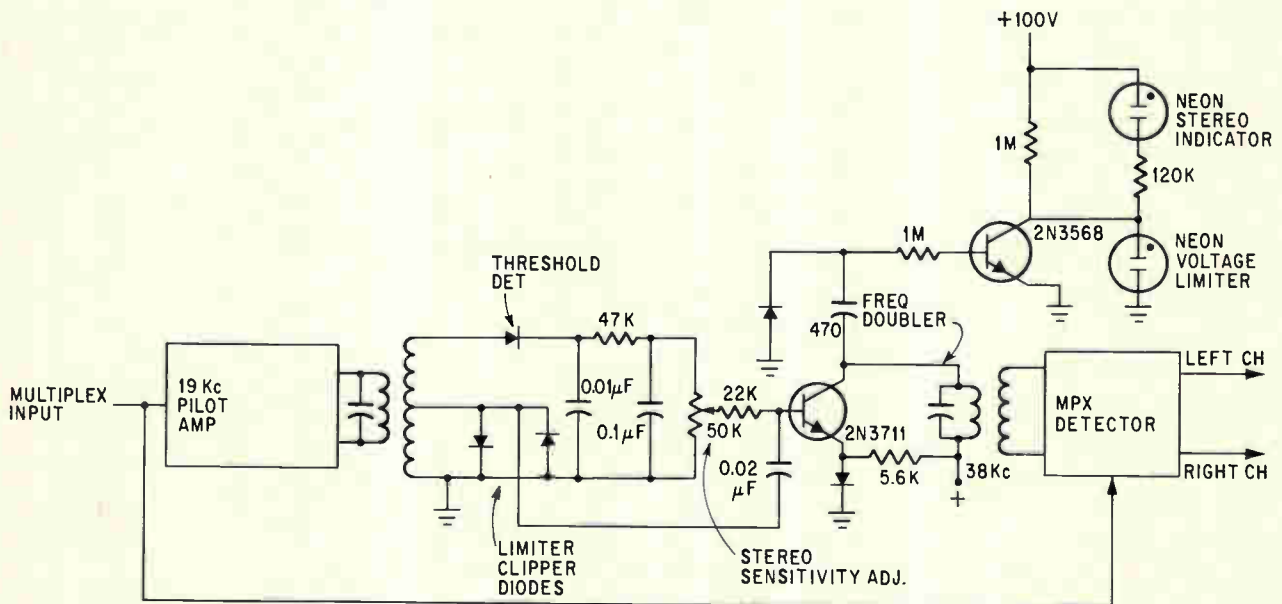

Multiplex module is prevented from operating when multiplex signal is below an acceptable power level. In this case, f-m reception is monaural.

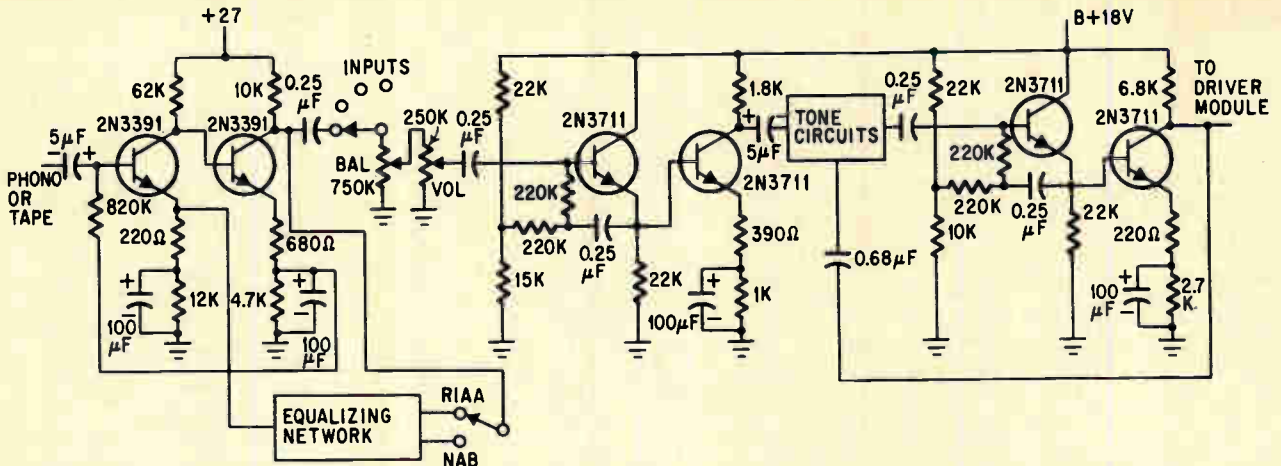

Preamplifier module connects with all switches and controls, which are mounted on the front of the chassis.

lation, filtering, turn-on time delay and decoupling for the audio driver module shown below.

The time delay prevents spurious noises from appearing at the output when the equipment is switched on.

All of the remaining audio components are on this module, except for a driver transformer on the chassis and the output transistors on heat sinks.

Output stage

The output stage is a push-pull type for low distortion, with a single-ended output for transformerless connection to a speaker. Two transistors in series are used to amplify each half-cycle of the signal so that less peak inverse voltage is across each transistor. This provides a safety margin against secondary breakdown at high power.

Since each transistor pair can take more voltage than a single transistor, less current is needed for a particular power output. Regulation is much easier and more reliable with low-current supplies.

Biasing resistors used in this amplification stage are mounted on the audio driver module.

A driver transformer which isolates the power

transistors from earlier stages maintains a low impedance between base and emitter of the output transistors, so that there is less chance of thermal runaway. The transformer also isolates the output stages from earlier stages where a failure might, in turn, destroy the output stage. The output transistors operate in a voltage and current feedback loop, reducing distortion. A short circuit in the output will cause the current feedback loop to reduce the gain to a safe level, protecting the output stage.

The use of two identical power supplies provides better voltage regulation and increased power output per channel.

Each supply provides three full-wave rectified voltages: positive and negative 38 volts and 100 volts. Positive and negative power supplies are fused, but each output has separate filter capacitors.

Self-service

The circuit isolation not only isolates failures, but also allows the owner of the equipment to determine which module has failed within minutes.

For example, if the left audio channel fails, the owner has only to replace each circuit board in that channel with the identical board from the right channel until the defective module is located.

If there is no audio output at all, it is almost certain that either the power transformer primary windings or the 80-volt common secondary have failed or the primary is not being energized.

For most repairs, the owner of the equipment need only mail the defunct circuit board back to the factory or exchange it for a replacement board at the distributor. Stocking circuit boards will be no problem for the distributor, since a handful of circuit boards will serve all models. Audio and power supply modules will fit both the amplifier and tuner-amplifier models. R-f, i-f and multiplex modules for the tuner-amplifier fit the tuner.

The modular design also protects the instrument against obsolescence. If NLS improves the circuitry or performance, the owner may improve his own set merely by buying a new module, rather than replacing the whole set.

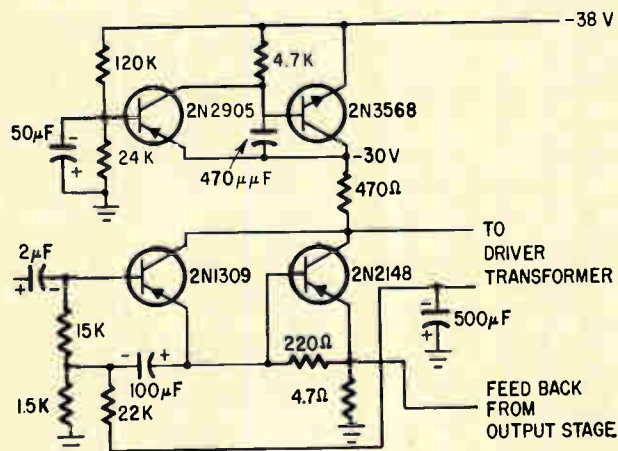

Audio driven module, simplified above, is a complete audio amplifier except for the driver transformer and output transistors mounted on the chassis.

Making the antenna an active partner

New design combines antenna and circuit functions in one structure for communications systems and improves equipment performance

By James F. Rippin Jr, Air Force Systems Command,
Wright-Patterson Air Force Base, Ohio

Designers of communications gear need no longer think of antennas as passive elements to be designed independently of other system components. Many limits in gain, size, weight and signal-to-noise ratio now associated with radio equipment may be overcome by integrating antenna and circuit functions in a single structure. The Air Force Avionics Laboratory at Wright Field has tested the integration concept in devices that use the antenna structure as an active circuit element. The approach can be used in amplifiers, mixers or detectors.

No doubt this method will be applied to the design of a variety of military and commercial products. These could include personal-size transceivers for policemen, doctors and others, and mobile communications stations with inflatable or other antennas that can be erected quickly. One important application may be for compact telemetry and communications gear aboard space vehicles.

Antennafiers

Initially conceived by E. M. Turner of the Air Force Avionics Laboratory, the integrated antenna-circuit was developed primarily by the antenna laboratory of the Ohio State University. First came the device called an antennaverter (from integrated antenna and heterodyne converter) that uses a mixer diode at the feed point of a dual-arm conical spiral antenna.¹ The spiral elements of the antenna

The author



James F. Rippin, of the antennaradome group at the Air Force Avionics Laboratory, is working on design techniques for advanced electromagnetic reconnaissance, communication and jamming. Although Rippin is an electrical engineer, he has done considerable work in the areas of chemical materials and nuclear radiation.

are coaxial lines serving as transmission lines for local oscillator and intermediate-frequency signals. Since there is no transmission line between mixer and antenna, mismatches at particular frequencies are eliminated and radio-frequency loss is reduced.

The next device was dubbed antennafier, for in-

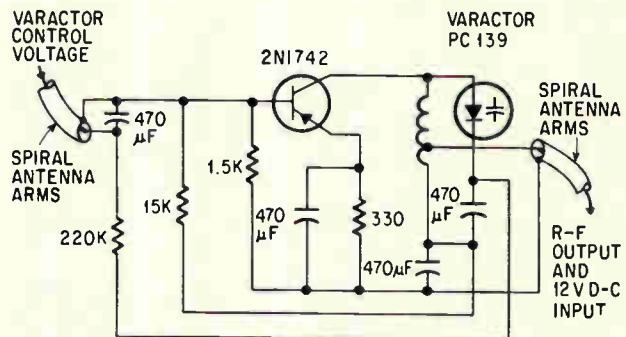

Varactor-tuned transistor amplifier is built into the tip of a conical spiral antenna. Antenna arms are formed by the external sheath of a coaxial cable.

tegrated antenna and amplifier. The varactor-tuned transistor amplifier shown above has been built into the tip of a conical spiral antenna as in the antennaverter.² The amplifier frequency can be tuned over the range from 120 Mc to 240 Mc by varying the varactor voltage from 0 to 40 volts d-c. About 10 decibels of circuit gain are obtained throughout most of the frequency range. A cyclical variation of beamwidth and gain occurs, however. This probably results from reflected currents on the antenna structure. Half-wave dipoles for 125, 148, 175 and 225 Mc have been built at Ohio State to be used as standards of comparison to measure spot-noise temperatures and gains at various frequencies throughout the tuning range.

Ohio State University researchers have done considerable theoretical and experimental investigation of dipole antennafiers, using both transistors and

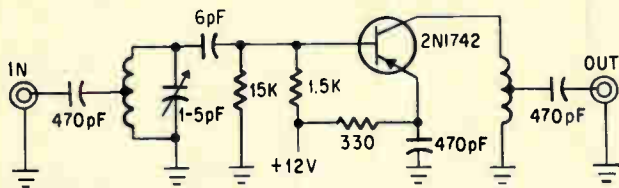

Vhf transistor, which forms the active portion of the dipole antennafier, in a test amplifier.

tunnel diodes as the active circuit element. Dipoles were chosen as the antenna element because the design theory is well documented and the fabrication is not difficult.

Measuring performance

Parameters of interest in the specification of an antennafier are pattern, gain and noise temperature. Patterns are measured and interpreted in the same way as ordinary antenna patterns, but gain and noise temperature are not as easy to specify. The gain of an antennafier is a function of both antenna and circuit gain, and is usually measured in terms of gain over a half-wave reference dipole. In the simple spiral antennafier, the circuit gain can be separated from the antenna gain, but in more complicated cases, such as antennafier arrays, this separation becomes difficult and it is necessary to specify pattern and gain independently.

Measuring the noise temperature of an antennafier is even more difficult than measuring gain. In conventional receiving systems, a direct measurement of noise temperature with respect to input terminals can be made on a receiver and the effective noise contribution, due to losses in the antenna and matching circuits, can be measured and added. However, this approach is not applicable to antennafiers generally, because no such set of input terminals to the receiver exists. The only related parameter that can be measured easily is the field-strength sensitivity (defined as the power density of the electromagnetic wave in which the antennafier must be immersed to provide a signal output equal to noise output). This measurement is then

repeated using a reference dipole and a receiver of known noise temperature. The resulting ratio of field-strength sensitivities, along with the measured power gain of the antennafier and the effective antenna temperatures, is sufficient to determine the effective noise temperature of the antennafier using this expression:

$$T_a = T_e (FSSR - 1) + T_r (FSSR - 1/G)$$

where

T_a = antennafier noise temperature

T_e = reference dipole noise temperature

T_r = noise temperature of the receiving system following the antennafier

G = gain of the antennafier

FSSR = field-strength sensitivity ratio

Gamma-match dipoles

Two transistorized dipole antennafiers designed and fabricated at Ohio State University³ are shown below. The transistor amplifier on the left operates with fixed bias for maximum gain or minimum noise temperature. In the other, the technique of forward automatic gain control (agc) makes possible a variable-gain antennafier. It is used where gain control is required, as in arrays.

Each antennafier, is a resonant half-wave dipole with a gamma-matched feed connected directly to the base of the transistor. The length of the gamma rod—and hence its inductance—and the resonating capacitance are adjusted for proper matching between the antenna and the transistor. The transistor then sees a pure resistance. Because the gamma rod is connected to a single side of the dipole, circulating currents and asymmetric patterns result. These currents are eliminated by the quarter-wavelength choke shown in the diagram.

The output circuit is a parallel-resonant tank, using the parasitic output capacitance of the transistor for optimum bandwidth. The 50-ohm coaxial output is tapped part-way up from the cold end of this tank circuit for an impedance match.

Other points could be tapped to increase or decrease bandwidth in the output circuit but at the expense of power gain. Hence, maximum power

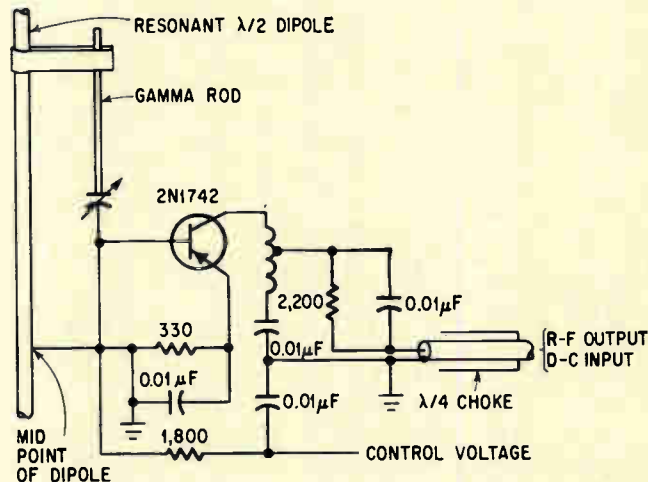
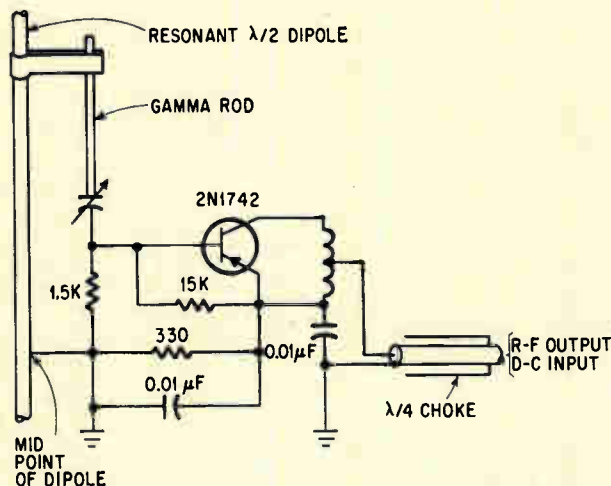

Transistorized dipole antennafiers. Fixed gain is shown at left; controllable gain by external voltage, at right.

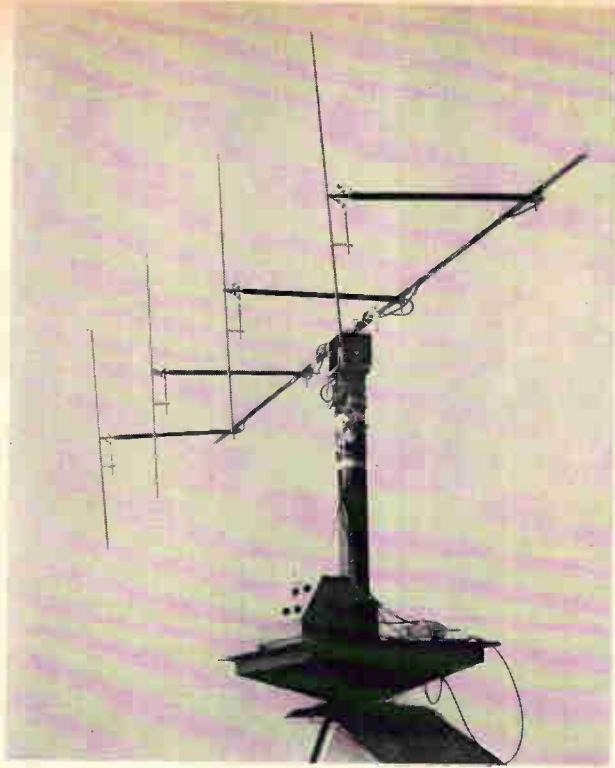

Steerable-beam array made up of four antenna elements spaced a half-wavelength apart. Beam position could be controlled by a series of four ganged potentiometers.

transfer is associated with a particular bandwidth. The condition of matched impedances is chosen here. This choice results in half-power bandwidth of about 20 Mc corresponding to an operating Q of about 7.5. At these bandwidth limits, the antenna voltage standing-wave ratio (vswr) is so low that the total bandwidth is determined primarily by the operating Q of the collector circuit. For the 2N1742 transistor amplifier the power supply, isolated from the r-f by a blocking network, is 12 volts d-c.

The active portion of the circuit centers on the 2N1742 vhf transistor. Operating unneutralized at 146 Mc in the test circuit on page 94, selected units produce up to 12.5 db gain with 4-db noise figure, when adjusted for best noise performance.

Antenna arrays

Of the many beam-steering methods in use or being evaluated for the future, one of the most promising for receiver applications is an array of antenna elements with integrated gain and phase-shift circuits. A photograph of one such array, consisting of four identical half-wave dipole antenna elements operating at 148 Mc, is shown above.⁴ The schematic diagram on page 96 shows one element of this array. The dipole antenna is connected by a gamma-match directly into the base of the T2028 vhf transistor.

An adjustment of control voltage A varies the amount of forward bias between emitter and base. A pi network with reactive elements couples the transistor to the transmission line. This transforms the transistor output resistance to the characteristic impedance of the line while also providing any desired phase shift. A bias variation of 0 to -45

volts for control voltages B and C gives approximately a 180° phase-shift range with adequate matching. The relationship between phase shift and varactor control voltages is relatively simple. The approximate phase shift could be produced from a series of ganged potentiometers with appropriately tapered winding that relates beam position to shaft rotation.

In close-spaced, shaped-beam or optimum-gain arrays, the amplitudes and phases of the individual elements must be maintained accurately despite thermal expansion, contraction, mechanical loading and vibration in the feed network and radiating elements. In arrays of antenna elements there is the additional problem of the instabilities introduced by the amplifiers and their associated circuits.

Solutions to these amplitude and phase-lock problems are being sought at Ohio State University where work continues with the 148-Mc four-element dipole antenna array previously described. Researchers have reduced considerably the effects of amplitude and phase instabilities in r-f amplifiers and feedlines with an r-f phase and amplitude reference signal.

An r-f transmitter whose output frequency differs slightly from that of the received signal is mounted in front of the array. Beating together, the transmitter frequency and the received frequency produce an intermediate frequency. Automatic amplitude and phase-control equipment operates more accurately and measurement is easier at this frequency than at the received radio frequency.

Another result of the work at the university is the increase in directivity of arrays incorporating amplitude and phase-lock circuits. Beamwidths of 33° to 38° have been achieved with an array of three dipole-amplifier units spaced uniformly over a half-wavelength. A conventional three-element array spaced over a one-wavelength aperture has a beamwidth of about 35°; but it is twice the size. When distance between elements is reduced, interaction between them increases and phasing control is more difficult.

Antennas in space

Now that transistorized antenna circuits for array beam-shaping and positioning have proved feasible, researchers are working on antennas for space vehicles. Studies have just begun at Ohio State on a transistorized slot antenna that operates at 1,000 Mc. It will include amplitude and phase-lock circuits for use in future arrays and will use the Philco L5431 coaxial transistor, which can be flush-mounted on the antenna cavity wall. Additionally, this transistor has desirable gain-versus-voltage characteristics, also important in array designs.

As a preliminary study for the 1,000-Mc antenna, a 420-Mc T-bar-fed slot antenna was built and tested.⁵ The amplifier circuit, shown on page 96, has a gain of 10 db and a noise figure of 7.8 db. The 3-db bandwidth of the amplifier is 100 Mc. Although the noise figure is somewhat high, it can

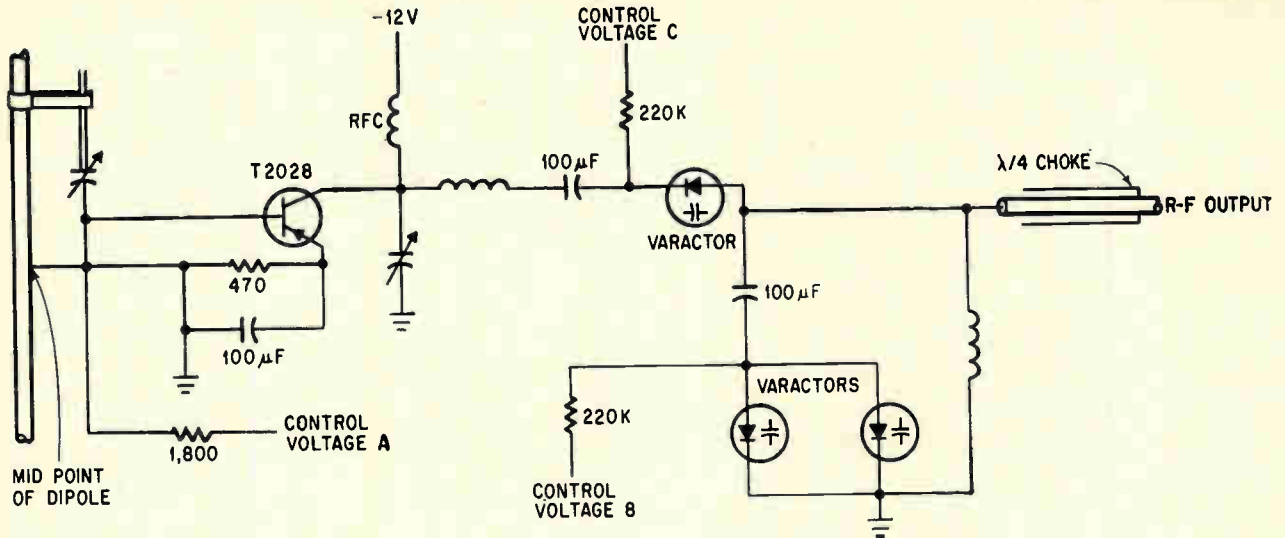

Dipole antenna with phase shifter is one element of steerable-beam array.

be lowered by adjusting the transistor bias. The integrated transistorized slot antenna gives a gain of 10 db over the slot itself and produces no change in the slot antenna pattern.

Other areas being investigated include circuit modifications to extend the dynamic range of transistorized antenna amplifiers and methods of separating the output frequency spectrum of a planar spiral antenna into channels, each of which contains integrated solid state signal-processing circuitry.

Parametric antennas

Researchers in the antenna systems laboratory at the University of New Hampshire, under the sponsorship of the Air Force Cambridge Research Laboratories, are developing design techniques for vhf-uhf parametric amplifier antennas (parants).⁶ Models with the varactor amplifier built inside a coaxial dipole operate at 54 Mc and 108 Mc. The respective bandwidths are approximately 0.5 Mc and 1.5 Mc and the system gains range from 10 to 20 db. By adjusting the pump frequency and varactor diode bias, it is possible to tune these low-noise amplifiers over a 3% to 5% frequency range. The upper frequency limit for this design lies between 500 Mc and 800 Mc. For higher frequencies the researchers plan to use the dual of the dipole or slot form of parametric amplifier antenna. They are also evaluating, for experimental design purposes, a 365-Mc slot parant.

Commercial hardware

Smyth Research Associates of San Diego, Calif. manufactures a series of monopole receiving antennas with built-in amplifiers that are solid state, low-noise and fixed-tuned. At specified frequencies within the range of 100 Mc to 500 Mc, the SRA-1011 electronic monopole antenna virtually eliminates the increase in system noise figure caused by transmission line losses between the antenna and receiver. A preamplifier, designated SRA-821B, is built into the antenna structure.

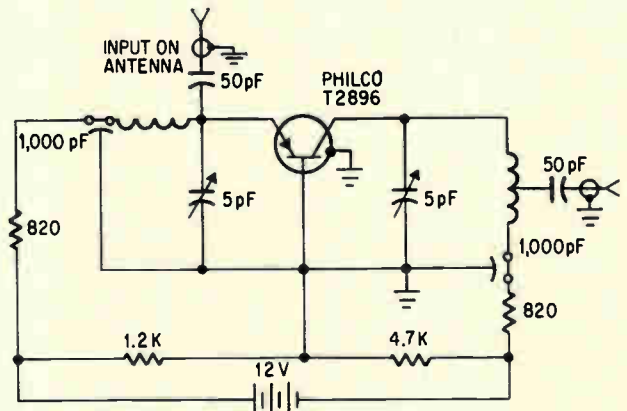

Amplifier in experimental 420-Mc slot antenna has 10 db gain and noise figure of 7.8 db; bandwidth is 100 Mc.

The antenna-amplifiers series, with a nominal bandwidth of 10%, has a typical gain of 35 db at 100 Mc ranging downward to 25 db at 500 Mc. Corresponding noise figures are 2 db and 4 db. These antenna-preamplifier combinations are particularly useful when the antenna has to be installed at a considerable distance from the receiver. Telemetry reception, satellite monitoring and air-to-ground communications are typical applications.

References

1. J.R. Copeland and W.J. Robertson "Antennaversers and Antennafiers," *Electronics*, pp. 68-71, Oct. 6, 1961.
2. Interim Engineering Report, Sept. 1, 1963 to Nov. 30, 1963, Contract AF 33(657)-10386, Ohio State University Research Foundation Report 1566-7, Dec. 1, 1963.
3. W.J. Robertson, and J. R. Copeland "The Transistorized Dipole Antennafier," Ohio State University Research Foundation Report 1566-2, May 15, 1963.
4. J.D. Young (OSURF Antenna Lab.), "Antennafiers for Beam-Steering Arrays," Presented at the Fourteenth Annual Symposium USAF Antenna Research and Development Program, Monticello, Ill., October 1964.
5. Interim Engineering Report, June 1, 1964 to Aug. 31, 1964, Contract AF 33(657)-10386, Ohio State University Research Foundation Report 1566-13.
6. Albert D. Frost, "Parametric Amplifier Antenna Structures," University of New Hampshire Final Engineering Report of Contract AF 19(628)-307, February 1962 to September 1964. AFRL-64-648, Sept. 1, 1964.

Production tips

Production tips is a regular feature in Electronics. Readers are invited to submit brief descriptions of new and practical processes, assembly or test methods, and unusual solutions to electronics manufacturing and packaging problems. We'll pay \$50 for each item published.

Pieces of plastic keep components clear of board

Here are two ways to keep standoff components at the desired height above a printed circuit board during flow or dip soldering: wedge a small block of Styrofoam under the component after the leads are crimped under the board, or mount the components in a small, molded block of plastic.

The first technique leaves the board clear, since the Styrofoam dissolves in solvents normally used for board cleaning after soldering. The second method allows parts to be packed more compactly on the board and is particularly useful when an assembly is to be potted, since the plastic becomes a filler and reduces the volume of potting compound required.

The Styrofoam method was devised by John Felch, general foreman of the assembly and wiring department in the surface radar and navigation operation of the Raytheon Co. Raytheon estimates this operation will save more than \$20,000 during the next 12 months by using the method.

Styrofoam is cut in sheets as thick as the required standoff height. The assembler cuts off small pieces and wedges them under the components. The foam plastic is easier to position than matchsticks or toothpicks, which have to be removed after soldering. Boards assembled with the alternative methods are shown above.

The previous method was to tack-solder the leads after crimping. The tack solder frequently loosened during flow soldering, causing components to be dislocated and requiring touchups that took 30 minutes to an hour per board. Excessive touchup, causing board delamination or spoilage, scrapped up to 50 boards a year. With the new method, Raytheon reports, touchup and spoilage are negligible, cold-solder joints due to hand soldering are eliminated, and plated-through holes are required in fewer of the assembled boards.

Molded plastic mounts are used by Electronic Associates Inc. in small card assemblies that are to be potted. They can be used for any small axial-lead component, but the chief use is to mount glass-bodied diodes, which are heat sensitive. The problem, explains Alex Alessi, of EAI, is keeping

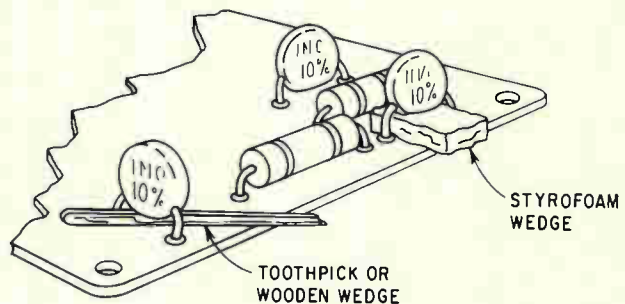
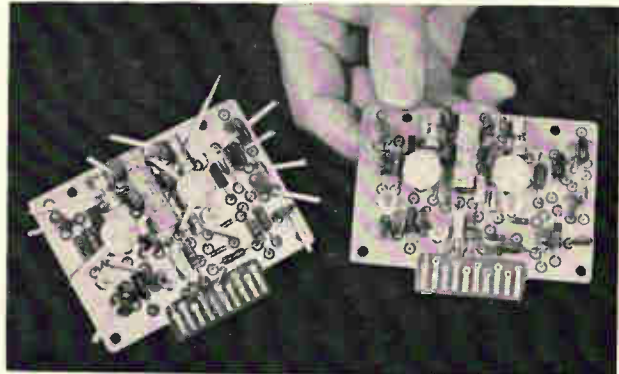

Toothpicks will raise components off board but they must be removed after soldering. Styrofoam blocks, shown on the board at right in the photo above, melt away. Placement of the foam pads is shown in the sketch.

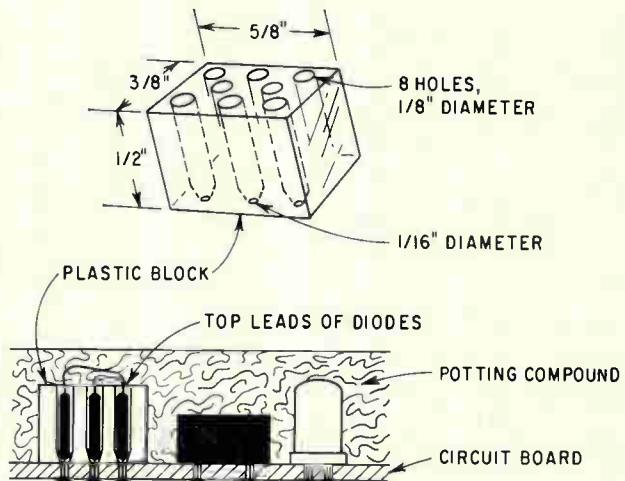

Molded plastic blocks let axial-lead components stand vertically, provide clearance and help in potting. Leads of several diodes can be run through nearby hole.

diodes clear of the board during soldering.

One lead of a diode is inserted in a hole and the diode body is dropped into the hole. The hole funnels down about an 1/8th inch above the bottom, so the diode body becomes seated at that point. The other lead of the diode is bent over and inserted into the circuit board through an adjacent hole. If the diode leads are to be joined,

two leads can be inserted into the same hole, as shown in the drawing on page 97. Since this can usually be done, the final assembly is more compact than when components are mounted flat on the board, particularly if the module requires other components as high as the block. EAI, for example, combines the blocks with welded cord-wood modules plugged into a circuit board.

Special electrode shapes solve welding problems

By John R. Sosoka

Weldmatic Division, Unitek Corp., Monrovia, Calif.

Terminating stranded wire by welding it is a well-known and basically simple process, but there are times when special electrode shapes and termination techniques make welding even easier.

The simplest, most commonly used method of lap welding a wire to a chassis or other termination is with a flat electrode, as illustrated at right. This flat electrode is the easiest to maintain, but it has the disadvantage of spreading the strands and producing a stress concentration at the edge of the weld, which may result in poor flex strength.

Several alternatives to flat electrodes have been devised. The electrode shapes and appearance of the welds are shown. These are:

- **Chisel-shaped electrode.** This shape eliminates the stress concentration problem by eliminating the sharp angle at the edge of the electrode face. It also requires less force and energy than a flat weld. For best results, the chisel shape should be curved, but a trapezoidal shape is satisfactory.
- **Grooved electrode.** When it is essential that deformation and spreading of the wire be minimized, this shape can be used.
- **Saddle electrode.** This shape combines the advantages of the chisel and grooved shapes; that is, it minimizes spreading, welds all the strands, eliminates stress concentration and lowers the force and pressure needed. Welds are made without loose strands.
- **Splicing electrode.** Stranded wire cannot be butt welded because the ends of the strands in two wires usually won't align with each other. The ends of the wires would have to be fused first, by soldering or welding. It is simpler and faster to overlap the two stranded ends and forge them together between two grooved electrodes. The welded joint is very strong. Moreover, if the radii of the grooves are approximately the same as the wires',

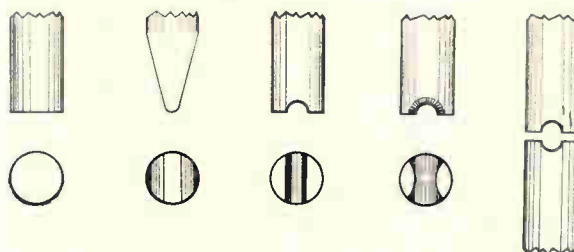

Five shapes for electrodes and the welds they make.

Left to right: conventional flat electrode, chisel-shaped electrode, grooved electrode, saddle electrode and pair of grooved electrodes used for splicing two stranded wires by forging ends of the wires together.

the joint will be the same diameter after welding and forging, as the original wire.

Some form of strain relief is desirable if the welded wire will be subjected to severe vibration or flexing. If the wire is to be welded to a pin, it can be wrapped around the pin before welding.

Another method is to enclose the wire end by slipping it into an eyelet or piece of tubing, or wrapping the end with a folded-over piece of foil and welding through the assembly. The foil should be stiff enough to prevent the wire from flexing at the edge of the weld. A chisel electrode is best for this type of weld.

The latter method also insures against loose strands. Another way of preventing loose strands is to fuse the strands by soldering, brazing or welding before the final weld is made.

While these techniques have been developed for capacitor-discharge welders, they can be adapted to other resistance-welding methods.

With Philbrick's new modular electronic packaging you can design systems that

can grow

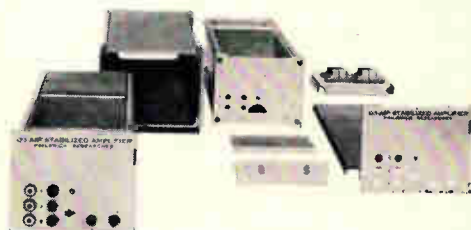

and Grow

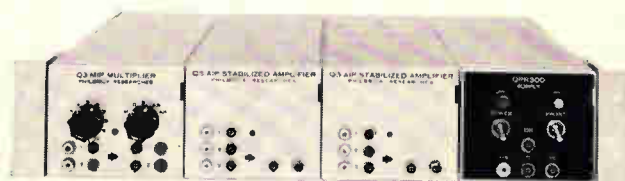

and GROW

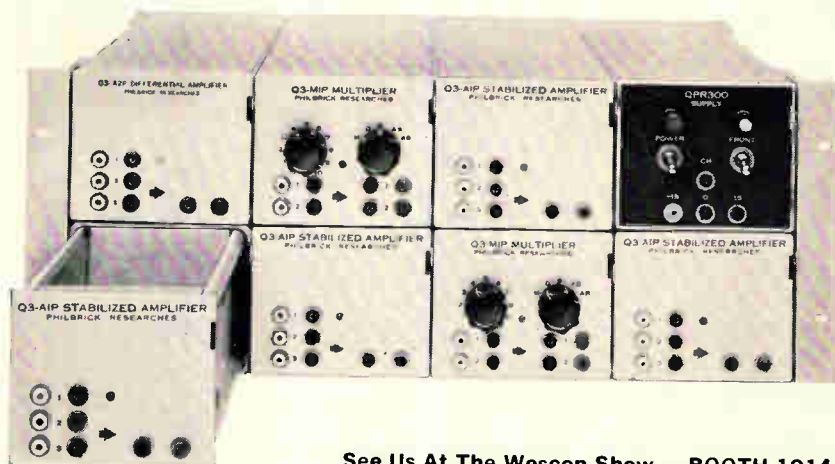

See Us At The Wescon Show — BOOTH 1914

... for the Q3 system is founded on a matrix of receptacles which may in principle extend to any desired height or width. You can build your own analog circuits into Q3 modules using all manner of modular hardware now in stock or work with an array of standard Philbrick instruments already in Q3 modules. For complete information, phone the nearest Philbrick engineering repre-

sentative or get in touch with Philbrick Researches, 22-G Allied Drive at Route 128, Dedham, Massachusetts 02026. Phone (617) 329-1600.

Engineering Representatives

Ala.: Huntsville 536-8393; Ariz.: Phoenix 265-3629; Cal.: Los Angeles (213) 937-0780, Palo Alto (415) 326-9800, San Diego 222-1121; Colo.: Denver 733-3701; Conn.: Stratford 378-0435; Fla.: Ft. Lauderdale 564-8000, Orlando 425-5505; Ill.: Chicago 676-1100; Ind.:

Indianapolis 356-4249; La.: New Orleans 242-5575; Md.: Baltimore 727-1999; Mass.: Wakefield 245-5100; Mich.: Detroit 838-7324; Minn.: Minneapolis 545-4481; Mo.: Kansas City 381-2122, St. Louis 966-3646; N.M.: Albuquerque 268-3941; N.Y.: DeWitt (315) 446-0220, Lancaster (716) TF 5-6188, Valley Stream (516) 561-7791; N.C.: Winston-Salem 725-5384; Ohio: Dayton 298-9964, Westlake 871-8000; Pa.: Norristown 735-3520, Pittsburgh 371-1231; Tex.: Dallas 526-8316, Houston 781-1441; Utah: Salt Lake City 466-4924; Va.: Alexandria 836-1800, Wash.: Seattle 723-3320; EXPORT: N.Y.: New York (212) 246-2133.

CANADA: Quebec: Montreal 482-9750, Ontario: Toronto RU 9-4325.

ELECTRONIC ANALOG COMPUTING EQUIPMENT for MODELLING, MEASURING, MANIPULATING and MUCH ELSE



PHILBRICK

You can save a lot of troublesome circuit engineering with the AE Series OCS Relay. We've "packaged" most of the programming!

AE's Series OCS Relay is low in cost and no bigger than a pack of king-size cigarettes. But it can save you a lot of engineering time.

This little relay can do the work of a whole battery of solid-state devices. And it won't lose its memory in a power failure or a circuit interruption.

"Packaged" programming. The AE Series OCS will follow or initiate a prescribed series of events or cycles at 30 steps per second impulse-controlled—or 65 per second self-interrupted. You can set up any programming sequence on one to eight cams, with as many as 36 on-and-off steps per cam. And each cam, tailored to your specifications, will actuate as many as six contact springs.

Can AE help take the "snags" out of your job? Our engineers are ready to work with you, to find the most practical and economical solution to any circuit-transfer problem.

There's a lot of helpful application information in the 160-page book, "How to Use Rotary Stepping Switches." Just ask your AE representative. Or write Director, Relay Control Equipment Sales, Automatic Electric, Northlake, Illinois 60164.

AUTOMATIC ELECTRIC

SUBSIDIARY OF
GENERAL TELEPHONE & ELECTRONICS GTE

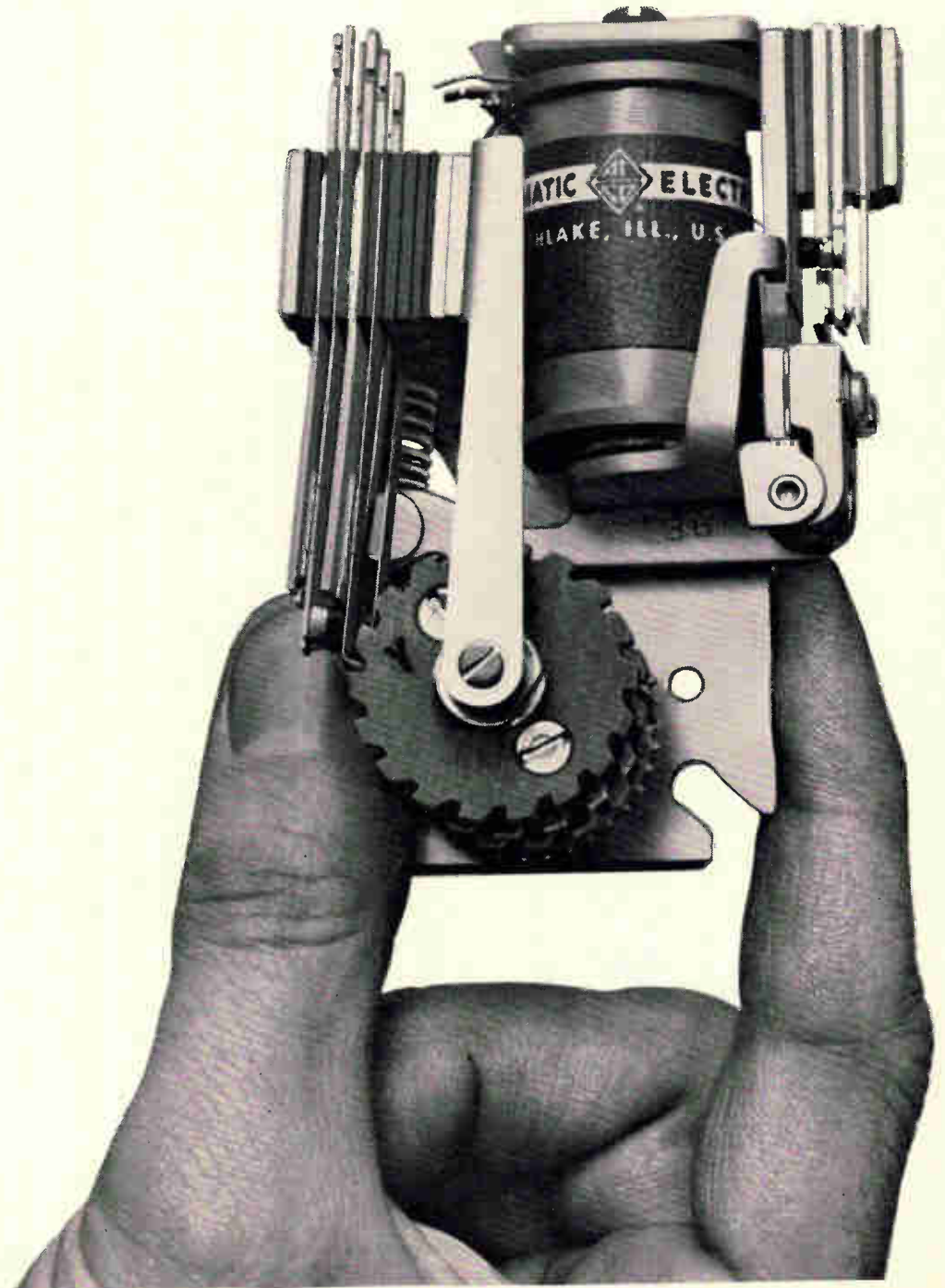

Sometimes we wonder

How anyone justifies the purchase of any other **SSB Analysis System** when he can get the **Years-Ahead Engineering, Modular Expandability** and virtually **Unlimited Versatility** of the **Polarad 2836** or **2936**. We can only assume that such features as: ■ 10 cps—40 MC Frequency Range ■ Better than 0.01% Resettability — **plus** Resolution Down to 7 cps! ■ Crystal Stability — Unique 2-Tone RF Synthesis ■ Unique Lin/Log/Power Display (on 5½" x 4½" rectangular CRT) are not as widely known as they ought to be.

You Achieve Great Economy because each Polarad module performs an independent test function. For a demo or quote call your local Polarad sales engineer or call us directly at (212) EX 2-4500.

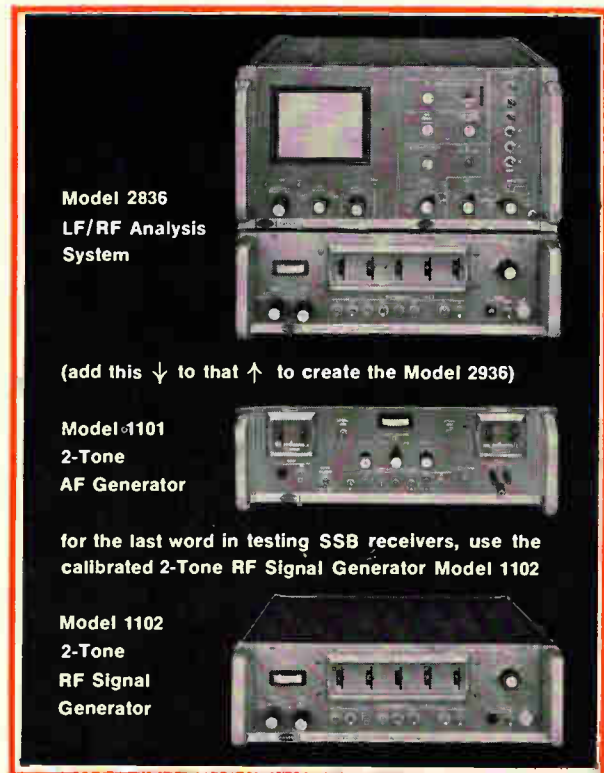

World Leader in
Microwave
Instrumentation

POLARAD

ELECTRONIC INSTRUMENTS

A Division of Polarad Electronics Corporation
34-02 QUEENS BOULEVARD
LONG ISLAND CITY, NEW YORK 11101

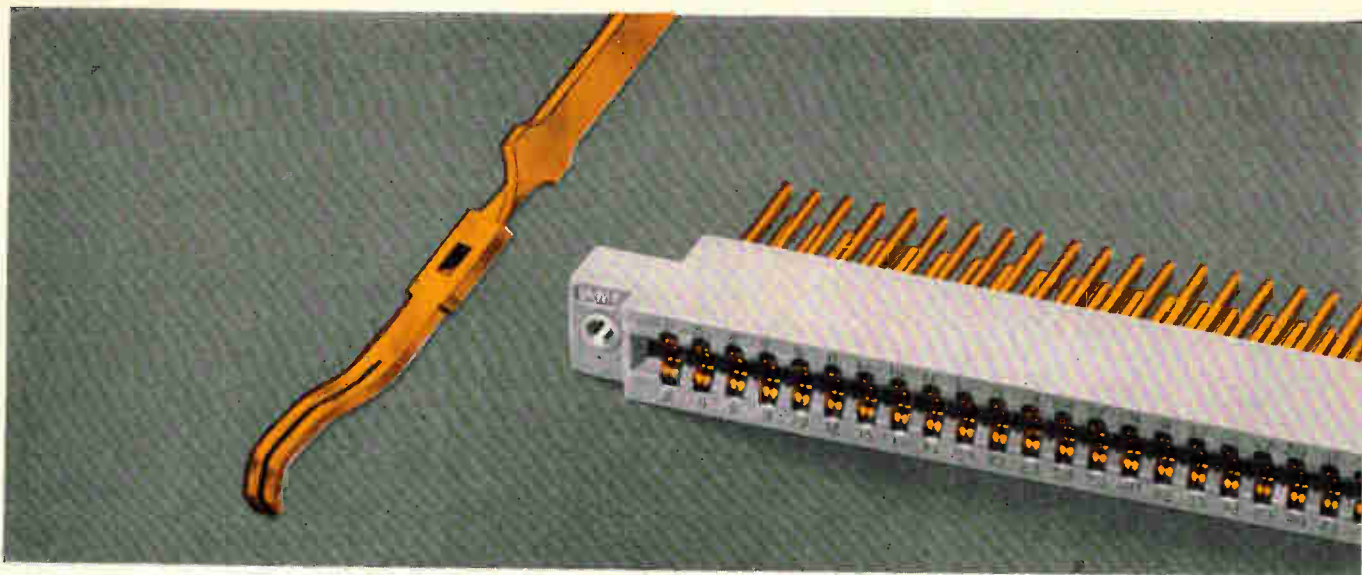

Pardon our redundancy, but you asked for it!

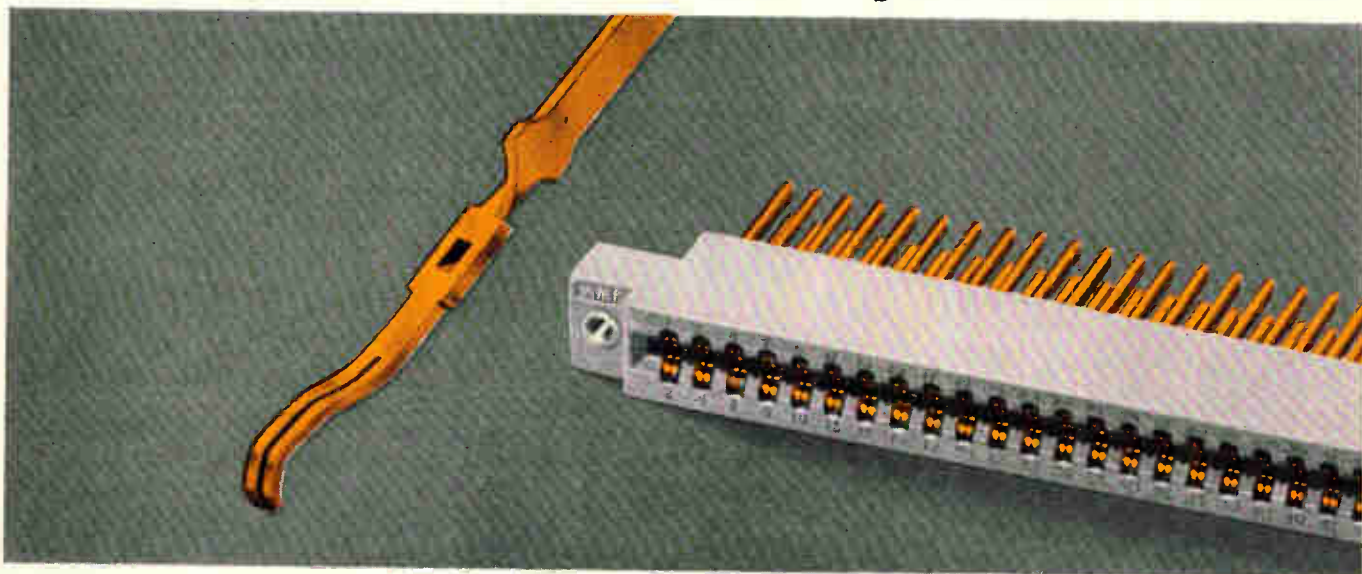

We're referring to the contacts in our new TERMI-TWIST★ Printed Circuit Connector. In addition to all their other advantages, they're bifurcated for redundancy.

Now, with TERMI-TWIST contacts, you may use automated point-to-point wiring techniques and have the benefits of AMP's gold-over-nickel plating—plus contact redundancy. Yet, they're designed for cost savings from the front bifurcated contact through the center twist locking section right back to the rear post which accommodates AMP's new TERMI-POINT★ clip wiring devices.

For reliability, the phosphor-bronze contacts are plated with gold over nickel, including a .000030" gold plating on the critical contact areas. Thanks to their 90° twist and square shoulder design, the contacts are positively aligned and firmly locked in the housing. Contact removal, however, is easily accomplished with ordinary long nose pliers.

These low-cost TERMI-TWIST Connectors are available in either diallyl phthalate or phenolic housings in sizes which include 15, 22, 31, or 43 contact positions, with contacts loaded on one or both sides. They are designed with a contact density of .156" for convenient replacement of existing panel mounted connectors.

Take a look at these TERMI-TWIST Connector features:

- Economy—low initial and per-line cost
- Wiring compatibility—use TERMI-POINT clips; or solder, weld, or wrap
- Flexibility—accepts printed circuit boards from .054" to .071" thick
- Quality—meets mechanical and electrical requirements of MIL-C-21097
- Reliability—Gold-over-nickel plating and high contact force
- Versatility—optional automatic machine or hand tooling

If you've been asking around for an economical and reliable board edge connector that's compatible with automated application, don't overlook this TERMI-TWIST Connector. Write for complete details today.

*Trademark of AMP Incorporated



A-MP★ products and engineering assistance available through subsidiary companies in: Australia • Canada • England • France • Holland • Italy • Japan • Mexico • Spain • West Germany

Visit us at the WESCON Show Booths 2609-11 and 2519

WIDEST FREQUENCY RANGE EVER

791D FM DEVIATION METER

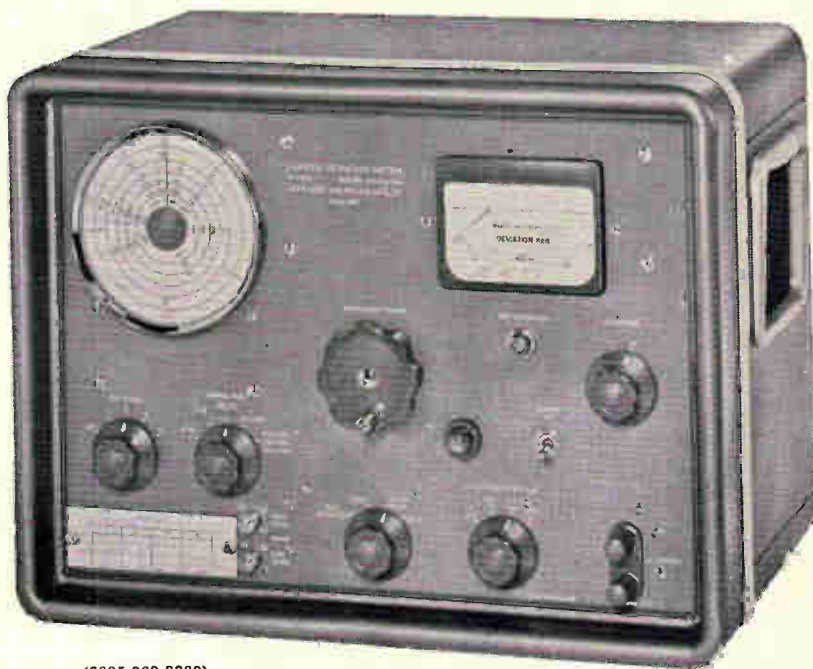

(6625-060-3320)
(6625-060-4300)

Marconi Instruments Deviation Meter Model 791D covers 4 mc to 1024 mc. Crystal lock on local oscillator gives less than 20 cps FM noise anywhere over band. Deviation up to ± 125 kc; demodulated output has less than 0.2% distortion.

READER SERVICE CARD NO. 309

Product Highlights

FROM MARCONI INSTRUMENTS FAMILY OF TELECOMMUNICATIONS MEASUREMENT EQUIPMENT

MODEL NO.	DESCRIPTION	RANGE	READER SERVICE CARD NO.
2002	Transistorized Signal Generator	10 kc to 72 mc	302
1245-6-7	Q-Meter and Oscillators	1 kc to 300 mc	303
995A/2M	FM/AM Signal Generator	1.5 mc to 220 mc	304
2090	Noise Loading Test Set (Transistorized)	Up to 2700 Channels	305
7816	Twelve Channel Noise Generator	300 cps to 3400 cps for mux/demux	306
1313	1/4% Universal Bridge	7 Decade Ranges LCR	307
Autospec	Telegraph Error Correcting Equipment	Up to 75 Bauds	308

Available Upon Request
... Marconi Instrumentation. A technical Information Bulletin Issued Quarterly.

READER SERVICE CARD NO.
310



A Good Name for Good Measure

MARCONI INSTRUMENTS

DIVISION OF ENGLISH ELECTRIC CORPORATION • 111 CEDAR LANE • ENGLEWOOD, NEW JERSEY

Main Plant—St. Albans, England

See us at Wescon Booth 3607-8

Can you use TC ZENER DIODES with CERTIFIED VOLTAGE-STABILITY of <10 PPM/1000 hours?

STABILITY CURVE OF TYPICAL DICKSON 1N4895 DIODE

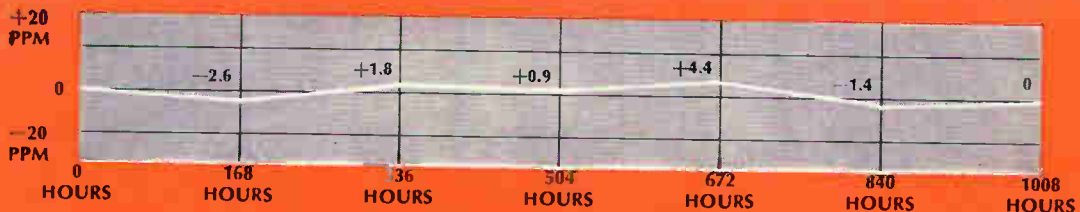

NEW DICKSON LOW IMPEDANCE 6.35 VOLT SERIES OFFERS THREE OUTSTANDING REFERENCE VOLTAGE STABILITY LEVELS

■ Take your choice! This new Dickson series of ultra-stable 400mW temperature compensated reference diodes offers certified voltage-time stabilities of 10 PPM, 20 PPM, and 50 PPM/1000 hours.

■ All devices in the series are subjected to Dickson's 1000 hour stability test sequence. And, for the first time, stringent test conditions and minimum equipment accuracies are tightly specified in device registration data. Every factor of environment, both ambient and electrical, are specified and controlled to "standards laboratory" accuracy.

■ A certificate is supplied with each diode giving —

- a — the reference voltage as measured at 168 hour intervals during the 1,000 hour operating period.
- b — the voltage drift as referenced to "zero hour" in both μ V and PPM.
- c — a chart of the relative voltage drift in PPM (Sample chart is shown above).
- d — The detailed format and explanation of the 1000 hour stability test sequence.

■ Needless to say, these units are ideal for critical applications requiring absolute assurance of maximum stability.

VISIT WESCON BOOTH 1013-14

See Dickson "Lifeguard" diodes sealed and tested at the Dickson booth . . . and, if you like, make your own sample.



DICKSON

ELECTRONICS CORPORATION

310 WELLS FARGO, SCOTTSDALE, ARIZONA
PHONE (602) 947-5751, TWX 602-949-0146

Manufacturers of quality zener diodes, rectifiers, tantalum capacitors, solid state circuit breakers, field effect transistors.



LIFEGUARD*

PROCESS

■ One of the major factors in the extreme stability of the Dickson 1N4890-1N4895A series is the "Lifeguard" process. This exclusive, proven production technique contributes to a level of reliability and stability that exceeds that of comparable devices available today.

DICKSON 6.35 VOLT TEMPERATURE COMPENSATED REFERENCE DIODES

JEDEC NUMBER	VOLTAGE TEMPERATURE STABILITY mV	MAXIMUM TEMPERATURE COEFFICIENT %/°C	VOLTAGE-TIME STABILITY ZERO-TO-PEAK %/1000 HRS
1N4890	5.0	0.001	0.005
1N4890A	10.0	0.001	0.005
1N4891	2.5	0.0005	0.005
1N4891A	5.0	0.0005	0.005
1N4892	5.0	0.001	0.002
1N4892A	10.0	0.001	0.002
1N4893	2.5	0.0005	0.002
1N4893A	5.0	0.0005	0.002
1N4894	5.0	0.001	0.001
1N4894A	10.0	0.001	0.001
1N4895	2.5	0.0005	0.001
1N4895A	5.0	0.0005	0.001

■ Temperature Range — "A" suffix = -55 to +100°C
No suffix = +25 to +100°C

■ Reference Voltage 6.35V \pm 5%

■ Zener Test Current 7.5mA \pm 0.01mA

■ Dynamic Impedance 10 Ohms at I_{ac} = 0.75mA

* a trademark of Dickson Electronics

for integrated circuits...

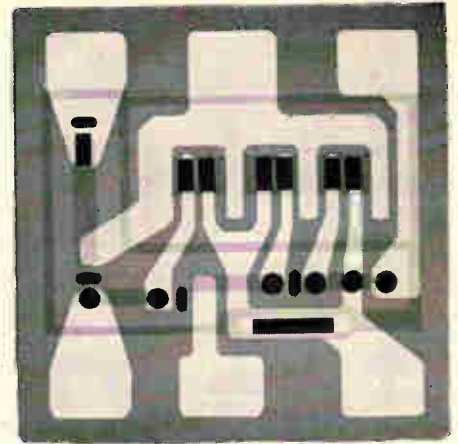

uncased Ceralam® close tolerance capacitors

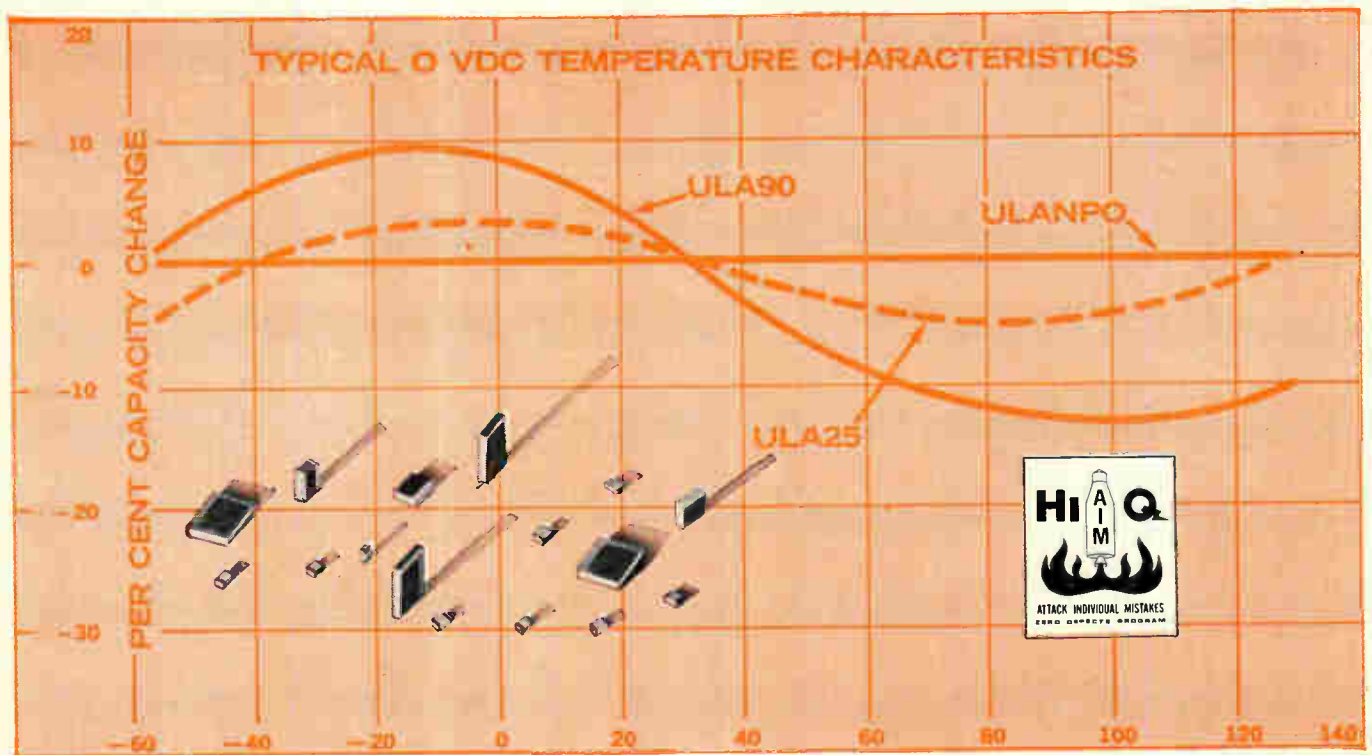

The CERALAM capacitor is a rugged, monolithic block of ceramic dielectric and metallic plate laminated into an extremely dense unit. Because of their unique structure they can be supplied unencapsulated, ready to solder into the circuitry, saving appreciably on volume.

The high ratio of capacity-to-volume achieved in CERALAM capacitors allows unusually small sizes suited to hybrid circuitry. They are also suitable because their unique construction permits an unlimited selection of geometric configuration to facilitate packaging in the hybrid circuit. CERALAMs also offer a wide range of dielectric properties: body NPO's of 0 to ± 30 ppm TC for high stability; for no

measurable aging effect; temperature compensating dielectrics, intermittent stability dielectrics; and high dielectric constant ceramics which yield very high capacity-to-volume ratios.

Some capacitors are just stumbling blocks in the way of hybrid circuit design. Replace them with CERALAM "blocks." Write us. We'll be happy to help.



AEROVOX
CORPORATION
OLEAN, N. Y.

Probing the News

Medical electronics

Government spurs medical market

Hospitals and labs rely increasingly on electronics. Sales now total \$500 million a year and are growing steadily

By Carl Moskowitz

Instrumentation Editor

A flashing light alerts a nurse on the main floor of a New York hospital. She checks a meter under the light on the electronic monitor dis-

play, and notices that patient 305's pulse has speeded up to a dangerous rate. She flips a switch and talks into a transmitter; on the third floor another nurse uses her pocket transceiver to signal that she is on her way to the patient. Automatic monitoring has saved nearly an hour—and perhaps a man's life.

In Boston, a young doctor swings

an ultrasonic detector to a girl's temple and presses a button. A nearby screen displays distances from the detector to various parts of the brain. From the displacement of the brain's midline it is clear even to the inexperienced doctor that a tumor is present. The discovery has been made early enough to permit a cure.

Contributions to this nationwide roundup were made by Thomas Maguire in Boston, Louis S. Gomolak, Chicago, Frank W. Pitman in Denver, Donald MacDonald in Detroit, June Ranill in Los Angeles, Mary Jo Jadin in San Francisco and Warren Burkett in Washington.



Enhancetron, developed by Nuclear Data Inc., measures patient's retinal responses to light.

Such accomplishments are becoming more and more common as electronic equipment finds increasing applications in medicine and biology. From a \$100-million-a-year segment in 1958, medical electronics has blossomed into a full-fledged business whose 1965 sales are expected to total \$500 million; by 1970 it is expected to be a billion-dollar-a-year market.

I. Analyzing the market

The government is by far the biggest customer for medical electronics. Over the next three years, the National Institutes of Health plan to establish 25 regional centers for heart research, with extensive electronic instrumentation costing about \$130 million. This is in addition to the NIH's regular expenditures for electronics, which will total about \$200 million this year alone, according to J. H. U. Brown, assistant chief of operations in the institute's division of research facilities and resources.

The government's stress on medical research is clear from the fact that this field receives \$1 of every \$8 spent by the government for all research and development.

Another big segment of the medical electronics market is the space program. The National Aeronautics and Space Administration spends about \$50 million a year in this field, and the Air Force spends \$2.6 million more. Much of this work is too specialized to make much impact on the commercial market, but some developments are finding their way into hospitals. One example is a system for telemetering electrocardiograms [Electronics, Apr. 5, pp. 99-105]; it was developed for use with astronauts, but has been modified for use in hospitals.

Private medicine. Whatever happens on the federal level, the future of medical electronics depends on the hospital market. "Hospitals make the medical electronics market," says Raymond A. Gripe, president of the Burdick Corp., a small but respected hospital-supply company in Milton, Wis.

Hospitals need electronic equipment to save time—which can mean life—and to save labor, also vital in a time of shortage of trained personnel. The hospitals also have

money to spend, much of it federal; the government pays up to two-thirds the cost of equipment in nonprofit hospitals.

Physicians also constitute a market; they're especially interested in diagnostic devices that have proved useful in hospitals.

Research. Medical research requires electronic equipment that is more sophisticated than any used for diagnosis or treatment. Research centers are buying such gear as high-intensity x-ray machines, laser devices, specialized ultrasonic equipment and thermographs. There's one advantage in designing for research rather than for diagnosis: the equipment doesn't have to be proven out as extensively because life doesn't depend on the research instrument.

Researchers are also buying equipment developed for other fields. Several years ago Nuclear Data, Inc., developed a device to measure accurately the atomic mass of particles. Now the machine, called the Enhancetron, is used at the Eye Research Foundation in Bethesda, Md., to measure precisely the vision of nearly-blind patients. Dr. R. H. Peckman of the foundation says the Enhancetron replaces systems that require the implantation of transducers in the retina or the placing of a metal-rimmed lens over the cornea. It uses electrodes on the eyelid to transmit the electrical signals that the retina generates when stimulated by light. The Enhancetron separates these signals from background noise.

At the Squibb Institute of Medical Research at New Brunswick, N. J., the Enhancetron is used to study the effects of drugs on animals. Transducers attached to the brain of a normal cat report the electrical response to light, heat or cold. The cat is then given the drug and the experiment is repeated.

II. What the hospitals buy

Hospitals use electronic equipment for two kinds of tasks: monitoring and diagnosing. Electronic monitoring devices keep track of such indicators of a patient's condition as his pulse rate, temperature, metabolism, and certain heart conditions; it also informs a nurse at a central surveillance panel

whether a patient is awake or asleep, or whether a patient in traction has moved.

The medical electronics division of Gulton Industries, Inc., has built a system that collects data from up to 20 patients, records it and displays it at a central console; it also sounds an alarm if some condition has changed dangerously.

Heart monitor. The x-ray department of the General Electric Co. has built a monitor that keeps a constant check on the heart rate and sounds an alarm if the patient's heart speeds up or slows down beyond predetermined safe limits. The machine also alerts the nurse when there are indications that the heart is about to stop beating.

An advanced monitoring system for heart patients will be installed at the Cardiovascular Surgery Center to be built at Methodist Hospital in Houston, Texas. The center will have eight operating rooms, all with the latest electronic sensors that feed into a computer at a central monitoring room. The data collected during an operation will be continuously compared with data that was obtained earlier from the same patient. The data-processing center can monitor eight operations at once. Statham Instruments, Inc., will equip the center.

Sensors in each operating room will include needle and syringe transducers for measuring blood pressure and, for the first time in a clinical application, a periarterial transducer to measure blood pressure and flow at the same time.

Long-range monitor. One monitor system helps hospital personnel to see quickly the exact nature of a condition that is changing too slowly to observe directly. It employs an oscilloscope and magnetic tape recorder that records slowly but can be played back faster. The equipment was built by the Spinco division of Beckman Instruments, Inc.

Transducers coupled with transistorized telemetry transmitters are used to monitor ambulatory patients or those on whom wires would impose unwanted restrictions [Electronics, June 14, p. 111].

Diagnostic devices. Ultrasonics is showing promise in early, accurate diagnosis; some specialists believe that it may someday replace



Scientist watches readout of electron-spin resonance device (to his left) that is testing a sample of human tissue for cancer. The device detects malignancy because of the peculiar way the diseased tissue reacts in an intensive magnetic field.

x-ray [Electronics, Feb. 3, 1961, p. 49]. Ultrasonic devices can be used to study soft tissue and to detect most foreign material in the body; they have no detrimental effects and they don't require film. All of these are advantages over x-rays.

Ultrasonics' ability to detect soft tissue is what makes it valuable in detecting brain tumors. It is being used for this purpose at the Peter

Bent Brigham Hospital in Boston.

Another technique that is proving useful in diagnosis is electron-spin resonance. At the Henry Ford Hospital in Detroit, doctors have used the technique to detect cancer earlier than they could with a biopsy; this is because cancerous tissue reacts in a peculiar but detectable manner, to a high-intensity magnetic field.

Other diagnostic instruments be-

ing developed are the cytoanalyzer, which screens and analyzes cells to detect malignancies; the oximeter, which determines the degree of oxygenation of the blood; a blood-cell counter and a densitometer. For all these instruments, readout can be visual on a dial or meter, or in printed form. The information is quantitative and can rarely be misinterpreted, even by a layman.

Recording x-rays. At the Stanford Medical Center, a video-tape recorder has been installed in the x-ray room. It enables doctors to view the x-rays while they are being taken, also to select one frame of interest from the recorder, and analyze it more carefully without waiting for a film to be developed.

Researchers at the University of Michigan's School of Dentistry are studying dental problems with the help of an artificial tooth crammed with electronic sensors and transmitters. The tooth is inserted in place of the upper first molar. When the patient eats, the implanted transmitters broadcast descriptions of the play of forces on the tooth's surface. This information, the researchers say, should contribute to existing knowledge about dental problems.

Computer analysis. "The hottest area in medical electronics is computer analysis," declares Edward Reible, manager of clinical medicine for the Nuclear-Chicago Corp. Computers are proving valuable in four major areas:

- Mathematical analysis and simulation of biological systems. A mathematical model of the human respiratory system has been constructed by bioengineers at the Case Institute of Technology. With a computer, it shows how the respiratory system reacts to such conditions as increased carbon-dioxide content, lack of oxygen, and restriction of the air passage. Mathematical models for other organs, such as the heart, also are being used with computers.

- Statistical analysis and interpretation of clinical data. The computer is a natural tool for retaining details on many case histories at once, also for collecting experimental data and for drawing conclusions on the effectiveness of drugs.

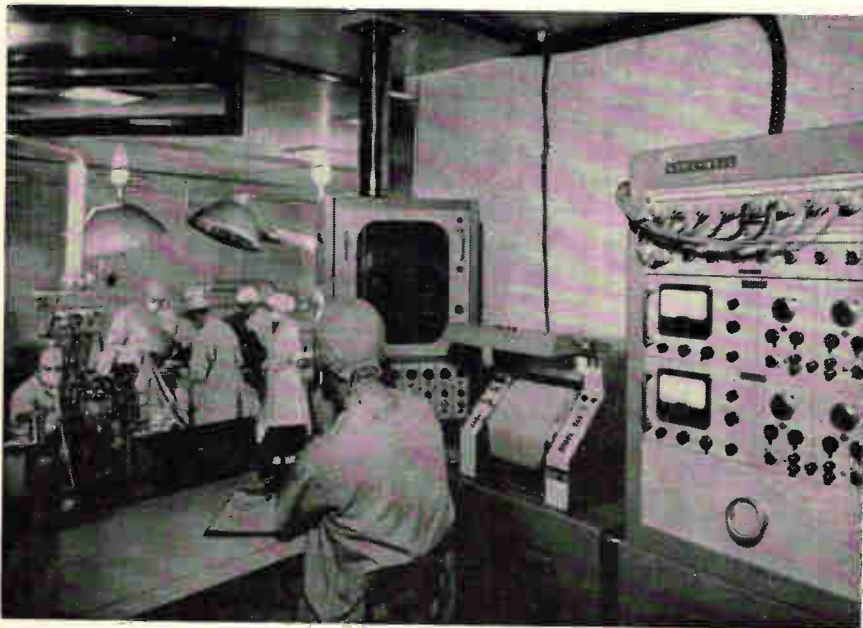

During heart operation, condition of the heart is monitored by doctor (foreground) on the oscilloscope in front of him. The graphic recorder at his right makes a permanent record.

▪ Diagnostic assistance. Tests are being made to determine how well a computer can diagnose a disease. The patient's symptoms are fed into the computer along with his medical history, and the computer comes up with a diagnosis; it also recommends additional tests when necessary.

▪ Medical library information system. To help the doctor find information in a mountain of printed matter, the National Library of Medicine has contracted with the General Electric Co. to develop a computerized system for storing and retrieving medical information. Known as Medlars, for medical literature analysis and retrieval system, the system stores indexed information on magnetic tape. On command to a digital computer, the desired information is withdrawn from the storage unit and fed into a high-speed composition device that produces photograph masters for reproduction. The first of these units went into service last year. The National Library of Medicine hopes to create a nationwide network to provide this service. It is also looking into computerized translations, automated abstracting and indexing.

III. Market problems

Medical electronics is not an easy market to enter. Doctors seldom understand electronics and it's even rarer for them to think in terms of electronic solutions to their problems. By the same token, engineers don't understand doctors' needs and can't always come up with helpful devices.

To remedy this situation, the National Institutes of Health is spending \$15 million this year for graduate programs in 12 schools to train bioengineers—people familiar with medicine and engineering. If it works, the program probably will be expanded.

Young doctors are more open to accepting electronic aids than are older physicians; the latter often feel that the equipment they have is adequate.

Companies of prestige and good reputations find it easier to sell to doctors. Often a well-regarded company can continue selling a product to hospitals even after superior equipment has been made available

from a lesser-known concern.

Mergers. To take advantage of the magic of reputation, several well-known drug companies whose products are respected by the medical profession have acquired electronics divisions; these include Abbott Laboratories, Miles Laboratories, Inc., Carter Products, Inc., Warner-Lambert Pharmaceutical Co. and Smith, Kline & French Laboratories.

Despite its growth, medical electronics is not the solution for every electronics company in search of diversification. The market rarely lends itself to mass production. Standard, off-the-shelf gear usually needs so many modifications that

big companies seldom find it profitable to make them; most medical electronics equipment is custom-made.

Most medical instruments are made by companies with fewer than 500 employees and annual sales of less than \$10 million. Many companies are much smaller, having been founded to produce a device that may have been developed by an engineer and a doctor working together, or by a doctor interested in electronics.

It seems clear that medical electronics has a healthy future. But it's a long-range future, definitely not appealing to a seeker of fast sales and immediately large profits.

Meetings

New format: Wescon/65

Despite innovation of one-topic technical sessions, one-sided views and warmed-over material may keep attendance down

By Lewis H. Young,

Editor

Although the number of people attending the Western Electronics Show and Conference has risen year after year, the attendance at the technical sessions has been declining. Last year, less than 10% of those who attended the show stopped off to listen to the technical papers.

To find out what was wrong, Wescon impresario Donald Larson analyzed the attendance, conducted personal interviews, and mailed out questionnaires. His conclusion: make the sessions specific rather than general. "Nobody," says Larson, "who is interested in field effect transistors will sit through a two-hour session on electronic devices to hear one paper on FET's."

Visitors to this year's four special sessions and 20 contributed sessions are promised, therefore, discussions of such specific subjects as: all of the photographs of Mars taken by Mariner 4; silicon-

sapphire integrated circuits for micropower use; the reliability of integrated circuits in the Minuteman program; and smaller power supplies for space application.

I. Accent the specific

Making sessions more specific was tougher than the Wescon planners anticipated. So, instead of making a general call for papers, they decided to ask various people, each an authority on a specific subject, to organize the session dealing with that topic. The result is a program whose quality goes up and down like the streets of San Francisco.

For example, Wescon asked University of California faculty member A. W. Trivelpiece to organize the session on new power sources. Trivelpiece assembled an impressive group of speakers to cover the topic in depth: Hans Mark of the University of California will dis-

Continued on page 113

Here's what insulation of MYLAR® meant in: ballast transformers...relays

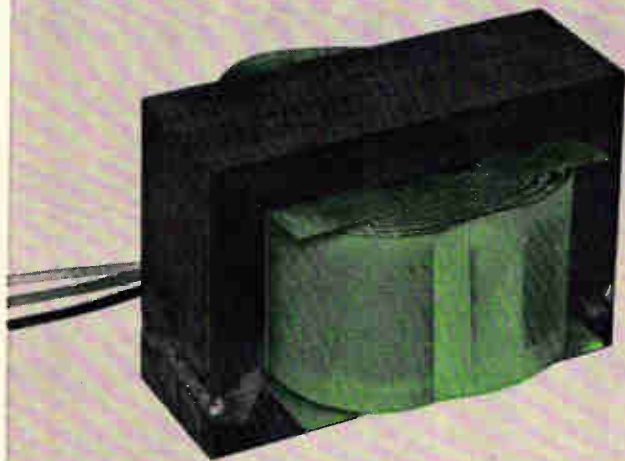

- tripled life of guarantee against failure
- upgraded rating to Class B

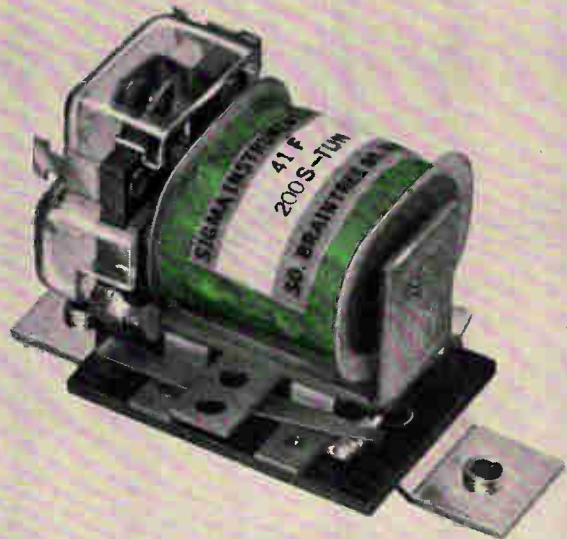

- 50% increase in thermal range
- smaller coil
- longer coil life

Whatever your insulation needs—motors, bus bars, capacitors, relays, transformers, wire and cable—chances are good you can benefit from the ability of MYLAR* to:

- improve insulation performance
- lower costs
- provide greater design capability

This is because MYLAR offers you a unique combination of properties in thin, flexible film form. With MYLAR you can replace heavier, bulkier insulation materials to design smaller, lighter components which have greater insulation resistance.

For the same reason, it's possible to lower insulation costs because often less MYLAR is required for a given insulation value.

Also, the excellent working strength of MYLAR can mean lower reject rates and

faster production speeds for you.

New "Fact File" available!

To get started on your evaluation of MYLAR, send for your copy of the "Fact File". This compact reference piece contains complete technical data, cost comparisons of MYLAR versus other insulation materials, film samples and information on several recent applications. Write Du Pont Co., Room 2796C, Wilmington, Delaware 19898. (In Canada: Du Pont of Canada Ltd., P.O. Box 660, Montreal, Que.)

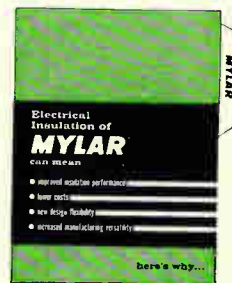

DU PONT'S REGISTERED TRADEMARK FOR ITS POLYESTER FILM.

Lambda Announces

a complete line of

all-silicon MODULAR power supplies

**VOLTAGES UP TO 60 VDC
0.08 AMPS. TO 8.3 AMPS.**

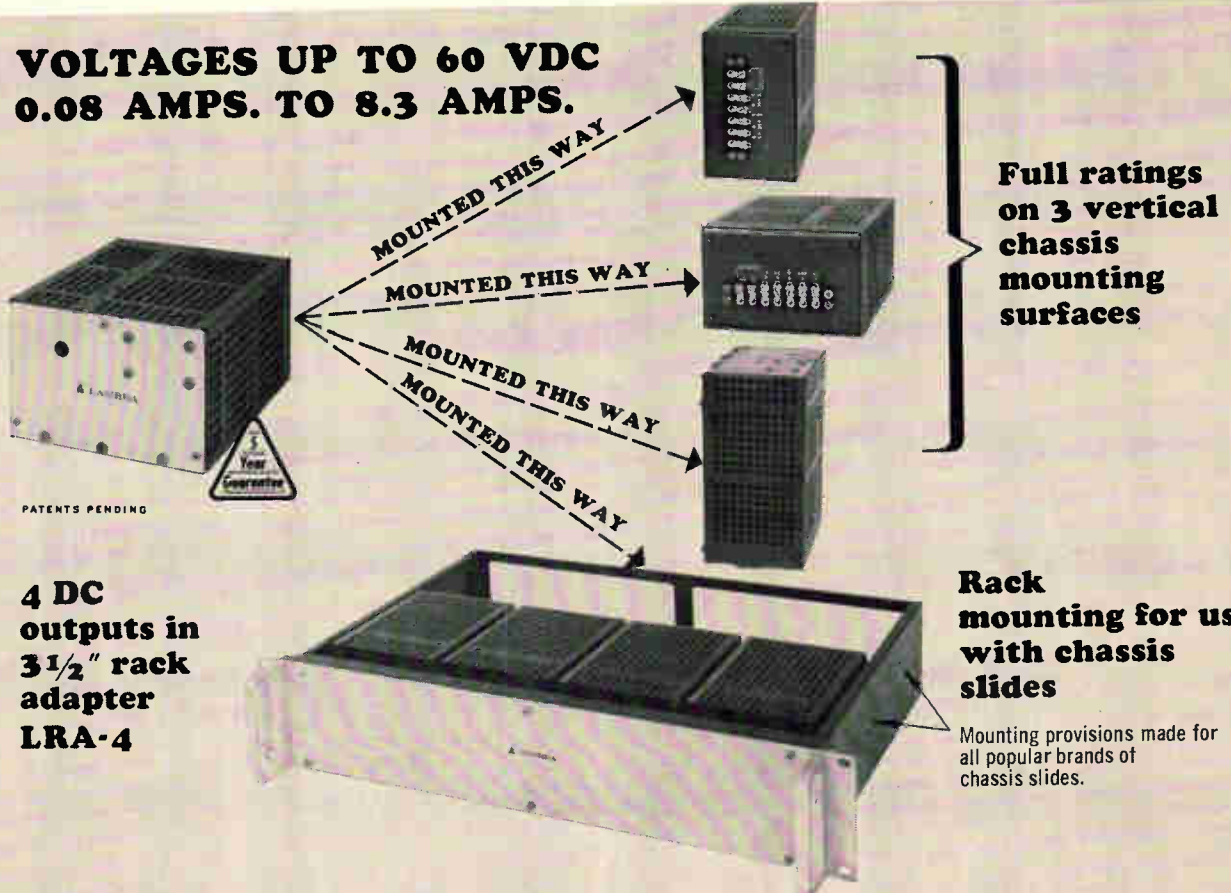

PATENTS PENDING

**4 DC
outputs in
3 1/2" rack
adapter
LRA-4**

**Rack
mounting for use
with chassis
slides**

Mounting provisions made for
all popular brands of
chassis slides.

- **Maximum amps per dollar—starting at \$79.00**
- **Multi-Position-Rated™—3 mounting surfaces**
- **Multi-Current-Rated™ for 40°C, 50°C, 60°C, 71°C ambients**

- A-C INPUT 105-132 VAC, 45-440 cps
- REGULATION—Line .05% + 4 mv
—Load .03% + 3 mv
- RIPPLE — 1 mv rms — 3 mv
peak-to-peak
- REMOTE PROGRAMING
200 ohms/volt over voltage range
- NO VOLTAGE SPIKES OR OVERSHOOT
on "turn on, turn off" or power failure
- TEMPERATURE COEFFICIENT — .03%/°C
- MEET RFI SPECIFICATIONS — MIL-I-16910
- THERMALLY PROTECTED AND SHORT
CIRCUIT PROOF — CURRENT LIMITING
- REMOTE SENSING
- RACK ADAPTERS AVAILABLE
- MAXIMUM RATINGS WITHOUT EXTERNAL
HEAT SINKING OR FORCED AIR



LAMBDA ELECTRONICS CORP.

515 BROAD HOLLOW ROAD, MELVILLE, L. I., NEW YORK • 11749

Circle 112 on reader service card

Be Sure to Visit Us at the WESCON Show Booths 2814-15

LM Series available in 4 package sizes for chassis and rack mounting

Package A 3 1/8" x 3 1/16" x 6 1/2"

Model Number	VDC	CURRENT RANGE AT AMBIENT OF: (1)				Price
		40°C	50°C	80°C	71°C	
LM 201	0-7(2)	0-0.85A	0-0.75A	0-0.70A	0-0.55A	\$ 79.00
LM 202	0-7(2)	0-1.7A	0-1.5A	0-1.4A	0-1.1A	99.00
LM 203	0-14(3)	0-0.45A	0-0.40A	0-0.38A	0-0.28A	79.00
LM 204	0-14(3)	0-0.90A	0-0.80A	0-0.75A	0-0.55A	99.00
LM 205	0-32(4)	0-0.25A	0-0.23A	0-0.20A	0-0.15A	79.00
LM 206	0-32(4)	0-0.50A	0-0.45A	0-0.40A	0-0.30A	99.00
LM 207	0-60	0-0.13A	0-0.12A	0-0.11A	0-0.08A	89.00
LM 208	0-60	0-0.25A	0-0.23A	0-0.21A	0-0.16A	109.00

Package B 3 1/8" x 4 7/8" x 6 1/2"

LM 217	8.5-14	0-2.1A	0-1.9A	0-1.7A	0-1.3A	\$119.00
LM 218	13-23	0-1.5A	0-1.3A	0-1.2A	0-1.0A	119.00
LM 219	22-32	0-1.2A	0-1.1A	0-1.0A	0-0.80A	119.00
LM 220	30-60	0-0.70A	0-0.65A	0-0.60A	0-0.45A	129.00

Package C 3 1/8" x 4 7/8" x 9 1/2"

LM 225	0-7(2)	0-4.0A	0-3.6A	0-3.0A	0-2.4A	\$139.00
LM 226	8.5-14	0-3.3A	0-3.0A	0-2.5A	0-2.0A	139.00
LM 227	13-23	0-2.3A	0-2.1A	0-1.7A	0-1.4A	139.00
LM 228	22-32	0-2.0A	0-1.8A	0-1.5A	0-1.2A	139.00
LM 229	30-60	0-1.1A	0-1.0A	0-0.80A	0-0.60A	149.00

Package D 4 7/8" x 7 3/4" x 9 1/2"

LM 234	0-7(2)	0-8.3A	0-7.3A	0-6.5A	0-5.5A	\$199.00
LM 235	8.5-14	0-7.7A	0-6.8A	0-6.0A	0-4.8A	199.00
LM 236	13-23	0-5.8A	0-5.1A	0-4.5A	0-3.6A	209.00
LM 237	22-32	0-5.0A	0-4.4A	0-3.9A	0-3.1A	219.00
LM 238	30-60	0-2.6A	0-2.3A	0-2.0A	0-1.6A	239.00

(1) Current rating applies over entire voltage range and at 55 to 65 cps. For operation at AC input of 45-55 cps and 360-440 cps, derate output current 10%.

(2) Can be operated at 0-10 VDC—derate output current 30%.

(3) Can be operated at 0-20 VDC—derate output current 30%.

(4) Can be operated at 0-40 VDC—derate output current 30%.

 **LAMBDA**
ELECTRONICS CORP.

Continued from page 110

cuss new uses for fission energy; Arthur Kantrowitz of the Avco Corp. will report on magnetohydrodynamic power generation; and Princeton University's Amasa S. Bishop will wrap up the meeting with a report on recent developments in the field of controlled fusion. It sounds like a good session on a specific topic because of the possibility that the speakers, each with a different background, will not have the homogenized view expected at too many of the other sessions.

Singleminded. Unfortunately, the program committee also asked individual companies to organize technical sessions. The predictable result: too many sessions dealing with a single company's products. Tektronix, Inc. arranged the session on portable and storage oscilloscopes; the four papers to be given were written by Tektronix personnel. The session on integrated circuits was organized by Texas Instruments Incorporated, and the material in the six papers is limited to TI devices.

The same criticism can be made of the sessions on brushless d-c motors, field effect transistors (even though two companies prepared the papers), time domain reflectometry and voltage measurements—d-c to microwave, electronic packaging in the Pershing weapon system, and a new generation of data processing systems.

A good example of the flaw in Wescon's new program policy is the session on laser applications organized by the Electronics Laboratory of Stanford University. Every paper—six in all—is from a representative of Stanford. According to W. L. Huntley, who is chairman of the session, one of the highlights will be a demonstration of the hologram technique, taking three-dimensional pictures with a laser. Holograms are a recent development for Stanford, but they're old hat to laser experts at the Massachusetts Institute of Technology and the University of Michigan [Electronics, Nov. 30, 1964, p. 86] and to readers of technical journals.

Warmed over. Wescon's new policy on papers will be subject to the criticism traditionally leveled at other electronics technical meet-

Wescon technical sessions

- Tues., Aug. 24. Morning**
1. Low power integrated circuits
 2. Militarized parallel computer
 3. Portable and storage oscilloscopes
 4. Mariner Mars subsystem
 5. Brushless d-c motors

- Tues., Aug. 24. Afternoon**
- A. New power sources

- Wed., Aug. 25. Morning**
6. Field effect transistors
 7. Results from project Echo
 8. Time domain measurements
 9. The Norad story
 10. Packaging in the Pershing missile

- Wed., Aug. 25. Afternoon**
- B. Computer aided design

- Thurs., Aug. 26. Morning**
11. Integrated circuits
 12. New data processing system
 13. Laser applications
 14. Aerospace communications and telemetry
 15. Medical electronics

- Thurs., Aug. 26. Afternoon**
- C. Lasers—state of the art

- Fri., Aug. 27. Morning**
- 16A. Single crystal thin film semiconductors
 17. Computer-controlled industrial systems
 18. Advanced memory
 19. Synchronous satellite
 20. Power supply design

- Fri., Aug. 27. Afternoon**
- 16B. Failure of gold bonds in IC's
 - D. Computer-controlled systems

ings: that the material presented is a rehash of what is already well known. For example, the session invitingly labeled "Latest concepts and system applications of single-crystal thin film semiconductors" does not live up to its billing. The papers that are scheduled describe processing techniques that have not only been discussed at previous technical meetings—the thin film device symposium and the electrochemical conference—but are already published.

II. Worth hearing

One redeeming feature of this session, however, for those interested in micropower circuits, is a paper on silicon-sapphire integrated microcircuits and micropower concepts by Robert W. Downing of the Autonetics division of North American Aviation, Inc. Downing will explain why circuits built by depositing active and passive elements of silicon on sap-



Need a slippery electrical grade polyester film? ask about "SCOTCHPAR"



When you want an electrical grade film with a smooth, slippery surface — call for "SCOTCHPAR" polyester film. But, you may not be a "slippery" customer. In that case let us know your special requirements. We can customize this film in other ways — thick or thin . . . clear or opaque . . . releasable or bondable. Our laboratories are famous for their capacity to modify a product for a specific function. Contact: 3M Co., Film & Allied Products Division, 2501 Hudson Rd., St. Paul, Minnesota, Dept. ICL-85.

Scotchpar® electrical grade
BRAND polyester film

"SCOTCHPAR" IS A REG. TM. OF 3M CO.

3M
COMPANY

phire crystals are better than any other thin film micropower circuits.

In effect, despite the new approach to program planning, visitors to Wescon will be on the familiar, frustrating obstacle course that characterizes electronics conferences. To help them jump hurdles, here are some presentations that seem worthwhile:

- **Session 4.** Officials of the Jet Propulsion Laboratory have promised that the full set of 21 pictures of Mars taken by Mariner 4 will be shown and discussed.

- **Session 11.** Charles Phipps of Texas Instruments will discuss the reliability of the integrated circuits used in the Minuteman 2 program. Phipps says that the information he will present has never before been made public.

- **Session 20.** Another first public report will come from Bruce Gladstone of Gulton Industries, Inc. He will give the result of a study, conducted for the National Aeronautics and Space Administration, on power supply systems for satellites.

Great expectations. When asked their opinion of the new program at Wescon, some exhibitors and many veteran visitors to the show expressed varying degrees of cynicism regarding the technical sessions. Their general view seems to be summed up in the French epigram, which declares that "the more things change, the more they remain the same."

No such doubt assails the Wescon hierarchy, whose official attitude is one of determined optimism. Speaking of the technical sessions, Ted Shields, assistant manager of the show, said, "An attendance of 10,000 won't surprise us." The attendance last year was considerably less; about 3,000.

No hullabaloo. Concerned with a lack of dignity at the annual West Coast conclave, the organizers have imposed some new restrictions on exhibitors. For example, Wescon is discouraging the carnival atmosphere. There will be less of the sideshow technique that lures visitors with the something-for-nothing bit. It is encouraging exhibitors to replace the pretty girl models with serious engineering types who can answer questions about the products on display. This may be the step that will generate the most controversy at Wescon.

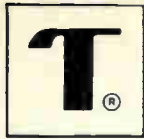

Wherever
there's
electronics
there's
Transitron

FIRST COMMERCIAL HLTTTL CIRCUITS INTRODUCED BY TRANSITRON

Line Specially Developed to Meet Commercial Needs

High Level Transistor Transistor Logic has already become established as the state-of-the-art for saturated switching in military and industrial applications.

In developing a low-cost version of the premium military series, Transitron has placed HLTTTL performance within practical reach for the designer of commercial equipment.

Not Production Fallout

It should be emphasized that the cost reductions involved did not involve the chips themselves, which are actually identical to those used in the premium series. The savings lie primarily in the packaging and in the use of conservative specifications.

All units are packaged in an economical but extremely reliable hermetic, 8-lead TO-5 can, and are assembled by means of automated, high-volume production techniques previously perfected in transistor manufacturing operations.

The use of performance specifications which are well within the design limits of the circuit chips has resulted in high production yields and has reduced the requirement for extensive testing.

With their outstanding combination of good fanout, speed, noise protection and capacitive driving capability, these circuits constitute the most flexible and logically powerful line ever introduced for commercial use.

NEW LOW-COST SERIES USES MIL-TYPE CHIPS

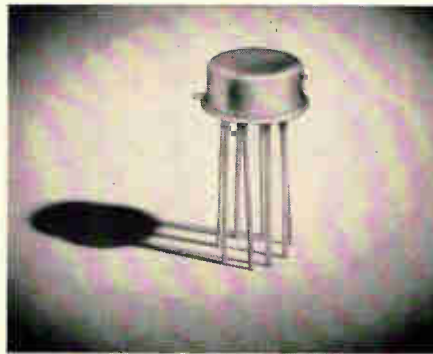

Commercial HLTTTL circuits are packaged in this hermetically-welded TO-5 can with 1/2" leads.

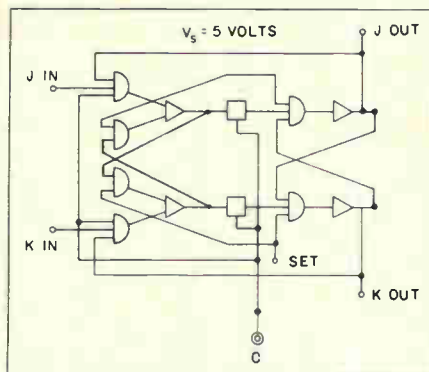

Block diagram of new commercial HLTTTL master-slave flip-flop.

Wakefield, Mass. — A new series of HLTTTL integrated circuits, specifically manufactured for use in commercial equipment, has been announced by Transitron.

The new low-price line includes single 4 input and dual 2 input NAND gates; dual 2 input OR gates; single 3 input NAND gate, expandable; 4 input expander, single 4 input line and lamp drivers; a gated 2 phase flip-flop; and a master-slave JK flip-flop.

The standard line is supplied for a temperature range of +15°C to +55°C, but is also available in ranges up to -55°C to +125°C with corresponding increase in price.

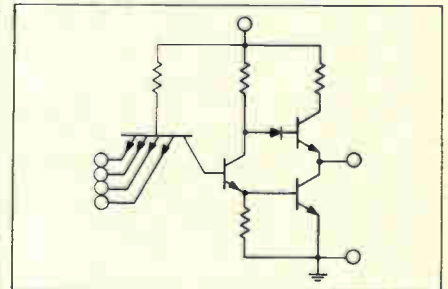

Single 4 input NAND/NOR gate

Excellent Performance Characteristics

The new series provides an excellent combination of performance characteristics. A minimum fanout of 20 is provided by the line and lamp drivers, while the gate circuits have a minimum fanout of 7. Maximum propagation delay is 25 nsec (with a fanout of 1 and a capacitive load of 15 pf). Noise immunity is 300 mv minimum, 800 mv typical.

The master-slave JK flip-flop has a minimum counting frequency of 10 mc and a minimum clock pulse width requirement of 40 nsec. The gated 2 phase flip-flop provides a 20 mc typical counting frequency; 12 nsec typical propagation delay.

All the above products are now available through your Transitron distributor.

See the new HLTTTL Series and other new semiconductor products at WESCON — Transitron Booth #2418.

Commercial HLTTTL Series — Quantity Price Data

	1-24	25-99	100-999	1,000-up
TNG 3031 — Single 4 input NAND Gate	\$4.45	\$3.80	\$3.00	\$2.40
TNG 3131 — Dual 2 input NAND Gate	6.25	5.30	4.20	3.35
TNG 3231 — Dual 2 input NAND/OR Gate	5.50	4.65	3.70	2.95
TNG 3331 — Single 4 input Line Driver	5.50	4.65	3.70	2.95
TNG 3431 — Single 4 input Lamp Driver	5.50	4.65	3.70	2.95
TNG 4031 — 4 input AND Expander Gate	3.15	2.70	2.10	1.70
TNG 4131 — Single 3 input NAND Gate, Expandable	5.50	4.65	3.70	2.95
TFF 3031 — Gated 2 phase flip-flop	7.75	6.60	5.20	4.15
TFF 3131 — 2 input Master-Slave JK flip-flop	11.00	9.35	7.40	5.90

CALL YOUR NEAREST TRANSITRON SALES ENGINEER — Baltimore: (301) Chesapeake 3-3220 • Boston: (617) 245-5640 • Camden: (609) Ulysses 4-7082 • Chicago: (312) Village 8-5556 • Dallas: (214) Fleetwood 7-9448 • Dayton: (513) 224-9651 • Detroit: (313) 838-5884 • Kansas City: (913) Endicott 2-6640 • Los Angeles: (213) Madison 9-2551 • Minneapolis: (612) 927-7923 • New York: (914) 834-8000 • Orlando: (305) Cherry 1-4526 • Phoenix: (602) 277-3366 • San Francisco: (415) 961-1954 • Syracuse: (315) Howard 3-4502 • Canada: Toronto 18, (416) Clifford 9-5461

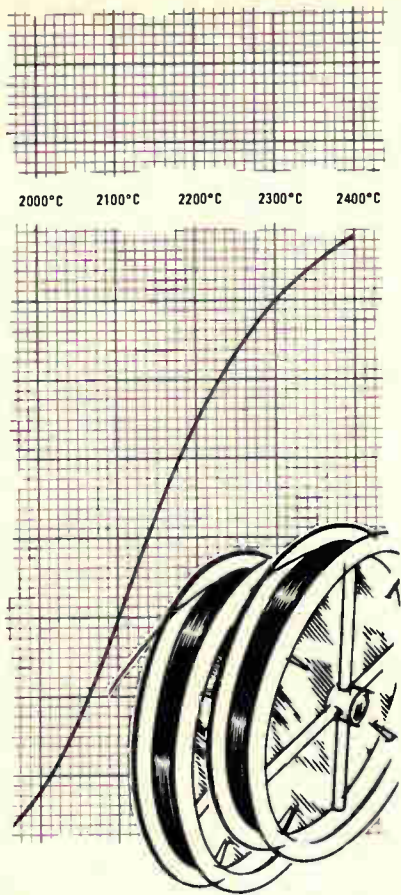

the facts about the Tungsten 3% Rhenium vs Tungsten 25% Thermocouples

Measuring high temperatures to 2400°C? Here are the reasons why engineers and scientists are relying on Engelhard's all-new matched High Temperature Thermocouple Wire:

This tungsten-ruthenium combination is furnished to an established EMF curve. With superior accuracy, reproducibility, and ductility, it is specially heat treated before shipment, to guarantee EMF accuracy without sacrificing ductility.

Preferred applications include: high temperature metal testing, stress rupture testing, combustion studies, nuclear environments, and measure of temperature in thermo-electric devices.

Write today for Bulletin EI-6268 detailing Engelhard's all-new Tungsten Rhenium Thermocouple Wire. Also available is Bulletin EI-6074, detailing Noble Metal Thermocouple Wire for use in temperature to +2000°C.

3373



Instrumentation

Mohole gets moving

Electronic gear will keep the drill platform steady and make measurements in the hole in the bottom of the sea

A New York woman who got wind of the fact that scientists were going to drill a hole in the bottom of the sea wrote to the Daily News last winter that if someone didn't put a stop to the plan, the whole ocean would drain away and the world would be left high and dry.

That particular problem has never bothered the National Science Foundation, which is in charge of Project Mohole and is more concerned with getting the necessary electronics gear developed and the special drill platform built. The job has not been easy, for despite some initial brilliant successes, Mohole has been dawdling along since 1959, plagued by administrative snarls. At times it has seemed that it was the project, rather than the Pacific, that would disappear down the drain. But with the opening of bids last month for construction of the platform, Mohole seems to be off the ground.

Electronics plays a dual role in the program. A system designed by Honeywell, Inc., will keep the drill platform steady over the hole, and instruments designed by a number of companies will collect data and perform other underwater sensing tasks. So far, \$3 million has been spent on electronics; that figure will eventually rise to \$10 million, 10% of the entire cost of the Mohole project.

Bids are in. A San Diego, Calif., company, the National Steel and Shipbuilding Co., was low bidder on the platform at \$29,967,000.

Three other companies submitted bids and the NSF has 90 days to accept one of the bids or reject them all.

The NSF was somewhat shocked at the size of the bids, which ranged up to \$45 million. Even National Steel was several million over the estimate, and the extra cost may require a stretchout of Mohole's funding.

I. Dig we must

Scientists know a lot about the earth's core and the mantle which surrounds it (and forms 84% of the earth's total volume); but their information comes from seismic waves, variations in the earth's magnetic field, extrapolation of data on the nature of meteorites, and rocks spewed up by volcanoes.

The prime mission of Mohole is to obtain a more or less continuous core of crust and mantle, 3 miles long and 2½ inches in diameter, which will be tangible evidence of the nature of the earth's origins and geologic history. The magnetic properties of the various layers, for instance, can provide information on the shifting of the magnetic poles. Temperature measurement will have a bearing on the question of whether the earth is cooling off or is still heating up from radioactive fuels. The very nature of the moho (the boundary between the crust and the mantle; see the editorial box below) can provide useful information on continental drift.

Hole in the moho

"Mohole" was so named because the project entails drilling a hole through the moho, the boundary between the earth's crust and the mantle beneath. The word "moho" itself is a cropped expression for the mohorovicic discontinuity, which was named for Andrija Mohorovicic, the Yugoslavian geologist who discovered it in 1909.

The moho is about 25 miles below the surface of land areas, but only about three miles below the ocean floor where project Mohole will be carried out.

Mohole will also provide information from three other areas:

- **Logging.** For radioactive and electronic "logging" of the crustal and mantel rocks in place, a logging cable will measure resistivity, temperature, thermal conductivity, magnetic intensity and susceptibility, rock stress, and seismic properties such as the velocity of sound at various levels.

- **Oceanography.** Since the drilling platform will be in place for 2¼ to 3 years, it offers a fine base from which to gather data on deep current flows.

- **Long-term measurement.** After the hole is drilled, an instrument package will be left in it to report by telemetry on magnetic and seismic activity, temperature, and rock strain.

II. Steady as she goes

Honeywell had a tricky problem in designing a system to keep the drilling platform steady in mid-ocean. The site where the Mohole will be drilled, in 14,000 feet of water about 170 miles northeast of Hawaii, was chosen partly because of its normally calm surface conditions. Winds and underwater currents, however, will tend to move the platform and snap the drill string. The Honeywell system employs underwater acoustic beacons and transponders, linked to a computer, to keep the drill rig in position.

The theoretical requirement was for the platform to stay within a 350-foot radius in 12,000 feet of water, or a 500-foot radius in 18,000 feet, in winds of 33 knots (force 7 on the Beaufort scale) and surface currents of three knots in the same direction as the wind.

Moreover, the system had to have high reliability, for it will take 2½ to 3 years to drill the 14,000 to 17,000 feet down to the mantle. The equipment used in phase one of Mohole, when a converted Navy barge drilled 750 feet into the crust in 11,000 feet of water in 1961, was unsuitable for the main project.

The drilling rig itself was designed for Brown and Root, Inc., of Houston, Texas, the prime contractor, by Gibbs & Cox, Inc., of New York. It is a self-propelled platform, 279 by 234 feet, supported by six columns, each 31 feet

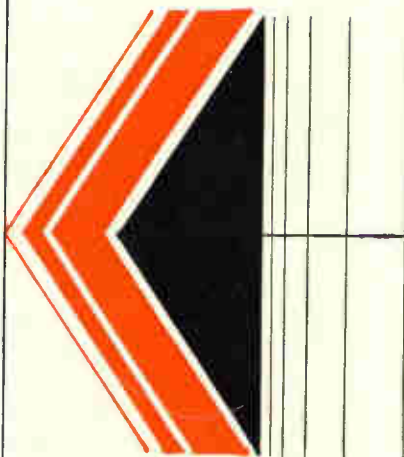

IT'S NEW RJ2A



High Current Ceramic Vacuum Relay

The era of ceramic vacuum relays was first ushered in by Jennings with the introduction of the fabulous 50 kw interruptive RF10. Now comes the equally great RJ2A with outstanding design features of its own.

In the RJ2A Jennings has combined field-proven patented design with two important additions not usually found in lesser relays.

1. A thorough knowledge of the problems involved in designing relays for high voltage airborne, mobile or marine communications systems.
2. The best combination of elements; vacuum for unchanging, low, contact resistance and high voltage withstand, copper to carry high current, and ceramic to withstand shock and high temperature.

In such applications as airborne electronic systems these advantages are invaluable. Especially for antenna switching, switching between antenna couplers, tap changing on RF coils, switching between transmitter and receiver, or pulse forming networks. The proof of superiority is evident in the following ratings which reflect only the minimum capabilities of the relay.

Contact Arrangement	SPDT
Operating Voltage (60 cycles)	12 KV peak
16 mc	8 KV peak
Test Voltage (60 cycles)	18 KV peak
Continuous Current	
60 cycle	25 Amps RMS
16 mc	15 Amps RMS
Contact Resistance	.012 Ohm
Net Weight	3 oz. Nom.

We will be pleased to send you more detailed information about the RJ2A and the rest of our complete line of vacuum transfer relays.

RELIABILITY MEANS VACUUM-
VACUUM MEANS

ITT Jennings

JENNINGS RADIO MFG. CORP., 970 McLAUGHLIN AVE., SAN JOSE, CALIF. 95108, PHONE 292-4025

HERE'S AN OPPORTUNITY

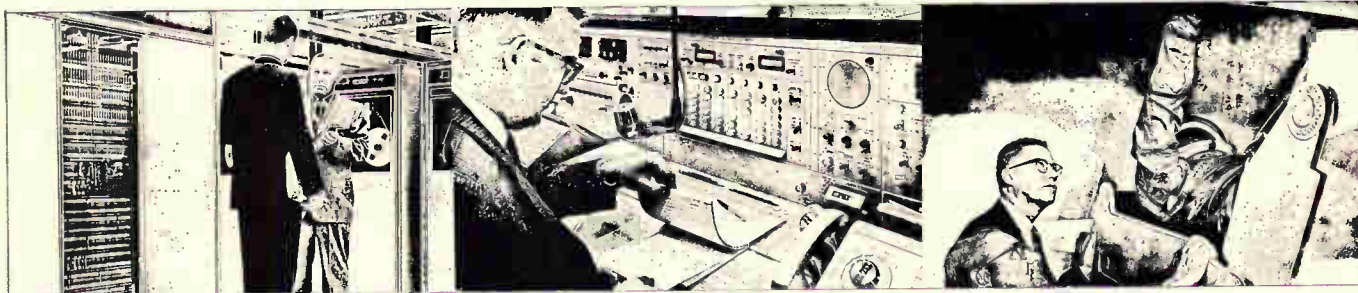

TO IMPROVE YOUR FUTURE

... Both professionally and personally. Every project at Collins is the most demanding in its area of industry, and we need professionals to continue the growth this level of qual-

ity has created. Living and working conditions—and compensation—are commensurate with these standards. These listings are current.

SEND RESUME FOR PROMPT INFORMATION

CIRCUIT DESIGN ENGINEERS — For design of general communications equipment. Prefer solid state and/or digital experience. Project assignments will involve HF through M/W frequency ranges in military, commercial or space programs. B.S.E.E. or M.S.E.E. required. (Cedar Rapids, Dallas and Newport Beach)

RELIABILITY ENGINEERS—(M.E. and E.E.) — M.E.'s to perform stress and dimensional analysis on antenna structures, hydraulic drive systems and electronic packaging. E.E.'s with experience in design and component application to handle qualification and acceptance test analysis and component engineering on high reliability space programs. B.S.E.E. or B.S.M.E. required. (Cedar Rapids, Dallas and Newport Beach)

INDUSTRIAL ENGINEERS — B.S.I.E. or B.S.M.E. with industrial option. Should have experience in manufacturing methods and procedures, work station analysis, facilities planning or material handling. MTM application and training highly desirable. (Cedar Rapids, Dallas and Newport Beach)

MECHANICAL ENGINEERS — B.S.M.E. or higher level degree for various positions including machine design with emphasis on large or small mechanisms, stress analysis, dynamics analysis, design of hydraulic circuits, selection of hydraulic components, and electro mechanical packaging. (Dallas)

RF SYSTEMS ENGINEERS — B.S.E.E. with experience in RF Systems including receivers, transmitters, and antennas in the VHF-UHF frequency range. Of specific interest is experience in phase locked loop receivers, high power transmitters, tracking (monopulse) antenna systems, and tracking system analysis. (Dallas)

POWER SYSTEMS DESIGN ENGINEERS — Power Systems Design Engineers to de-

sign large power systems including high voltage DC power supplies for 10 KW and above transmitters. Familiarity with high power outdoor components desired. We desire B.S.E.E. or M.S.E.E. with four years or more power systems or power component experience plus the ability to use an analytical approach to the design of the above systems. (Dallas)

TRANSMITTER DESIGN ENGINEERS — Position involving design of high power transmitters and high voltage DC power supplies. Must be capable of applying filter theory to optimize design of high power transmitters. MF and HF frequency range. B.S.E.E. required; post graduate work desirable. Understanding of computer control of transmitter systems helpful. (Dallas)

ANTENNA DESIGN ENGINEERS — B.S.E.E. with experience with tracking antennas, aircraft, and space antennas, including antenna pattern and impedance measurements. Some openings for individuals with experience in HF and VHF measurement techniques. Background in network and electromagnetic theory is desirable. (Dallas)

COMMUNICATIONS SYSTEMS ENGINEERS (E.E. and M.E.) — Mechanical Engineers should have experience with design of mechanical components used in transportable and fixed station communication systems. Electrical Engineers should be experienced in digital data transmission, airborne transportable or fixed station HF/SSB, or microwave communication systems. Degree required. (Dallas)

MICROWAVE DESIGN ENGINEERS — Microwave Design Engineers with active development background in solid state RF sources; knowledge of wave guide techniques desirable. B.S.E.E. required. (Dallas)

FIELD SUPPORT ENGINEERS — Openings for field engineers with installation and check-out experience in one or more of the following: high density microwave systems, toll terminal equipment, cable and open wire multiplex, monopulse tracking techniques, phase locked loop receivers, parametric amplifiers, Cassegrain feeds, tropospheric scatter systems. Considerable travel involved; some outside continental U.S. and some without family. (Dallas)

MECHANICAL DESIGN ENGINEERS — Must have minimum of four years experience in electronic packaging, preferably in subminiature solid state components, close tolerancing, and high environmental and reliability standards. B.S.M.E. required. (Cedar Rapids and Newport Beach)

COST ESTIMATE ADMINISTRATION — Opening for management-minded man capable of association with all levels of management. Must be able to provide strong administrative support in schedule and quality control of commercial product estimating and government bidding. Degree in Business Administration, Industrial Management, Industrial Engineering or Accounting is preferred. A minimum of two years experience in a similar position is required. (Cedar Rapids)

COMMUNICATION/COMPUTATION/CONTROL



COLLINS RADIO COMPANY
An equal opportunity employer

in diameter, which rest on two cigar-shaped submarine hulls 390 feet long and 35 feet in diameter.

III. Leave it to the computer

Three major subsystems will keep this nautical freak in place: a long baseline sonar positioning system, two short baseline sonars, and a two-channel analog computer.

There are also a radar subsystem, for manual reference to four moored buoys; a standard ship-board gyrocompass system, to determine heading; and a display and control console, where a pilot can manually override the com-

puter. The actual force to stabilize the platform will come from the two main propellers, at the stern of the hulls, and six positioning propellers, one at the base of each column.

Long baseline sonar. A transducer suspended below the platform and four transponders on the ocean floor at a radius from the drill hole approximately equal to the water depth (14,000 feet) form the heart of the principal sonar system. Each transponder returns its signal on a different frequency, to permit positive identification; the interval between transmission and reception depends on the slant

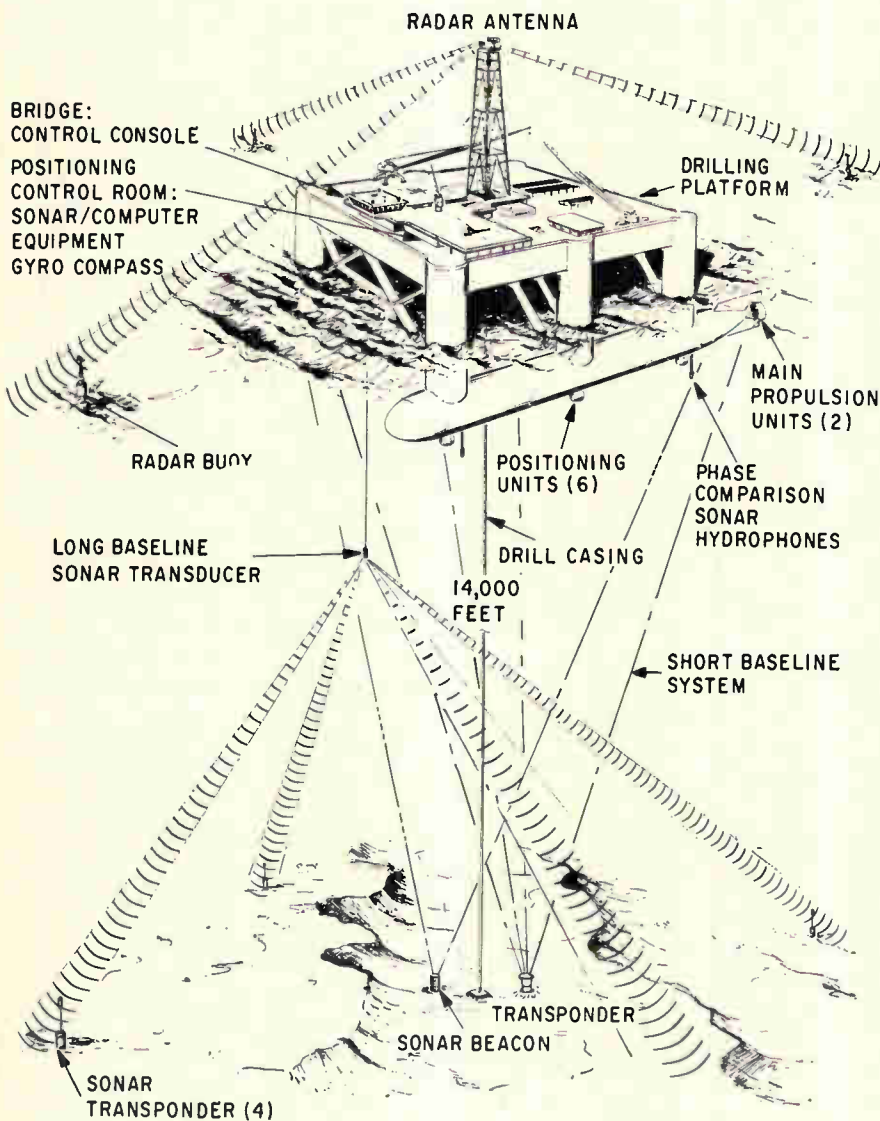

System of long baseline and short baseline sonars, plus an analog computer, runs positioning propellers to keep the Mohole drilling platform in place. Transponders for long baseline system are on a radius from the drill hole about equal to the depth of the water, 14,000 feet. The short baseline systems use hydrophones at the corners of the platform; one operates on phase comparison, the other on a time base. All three sonar systems deliver analog voltages to the computer, which continuously determines the correct thrust for the positioning propellers. The radar is used for manual positioning; it is not accurate enough to be linked to the computer.

"Get Acquainted" Offer

If you'll tell us more about yourself through the confidential resume below, we'll know where to send you this booklet telling more about ourselves.



Send resume to Manager,
Professional Employment,
Collins Radio Company

Cedar Rapids, Iowa
Dallas, Texas
Newport Beach, California

CHECK LISTINGS

Name _____ Home Address _____ Phone _____

City & State _____

Present Position, Company _____

Primary Experience Area _____ No. of years _____

Education: EE _____ ME _____ Math _____ Physics _____ Chemistry _____

Bus. Adm. _____ Other _____

Degree: BS _____ MS _____ PhD _____

school, date school, date school, date

Please attach any pertinent information

3

Precision Control of Heat & Light



RFL MODEL 50 UNIVERSAL INDICATING Proportional Controller

Solid state circuits provide smoothly modulated, stepless and automatic control of power

The Model 50 is a high gain, wide range instrument for accurate temperature indication (2% of scale length in degrees on the 5-inch mirror-scale TBS meter) and precise control ($\pm 0.1^\circ\text{F}$ for 50% load change).

It controls single phase power to 100 KW; delta and Y three phase loads to 300 KW at 115, 230 and 440 volts. Practically any sensor can be used whose resistance changes in the range of 50-7000 ohms due to application of heat or light.

A variety of thermistor, single crystal and platinum elements is available from RFL in stock probe configurations for gas, liquid or contact applications. A typical range for one platinum sensor is -150°F to 1000°F .

SCR protection is standard; options include fail-safe, upper/lower limit control and shut-down/alarm features.

Complete technical details and prices on the Model 50 and our full line of controllers and electrical thermometers are available on request from Radio Frequency Laboratories, Inc.



range between the platform and transponder.

Short baseline. Honeywell will supplement its own phase comparison sonar with a time base sonar being developed by the General Motors Corp.; the aim is redundancy for continued operation over the 2½ to 3 year period. Each short baseline system will employ a beacon on the ocean floor near the drill hole and hydrophones at each corner of the platform. Honeywell's beacon will transmit a continuous modulated signal; if the paths between the beacon and each phone are of different lengths, a small phase difference will be apparent between each pair of phones. Phase-compare-and-compute circuits will generate an analog voltage for the computer.

Computer runs the show. The computer accepts voltages from all three sonars to determine the amount of thrust required from the positioning units, and to control the units.

The S-band radar will not be tied into the computer line because it uses four deep-moored buoys as references, and the buoys will wander too much to provide the required accuracy. The radar will be useful for plotting ranges and bearings for positioning the platform manually in emergencies.

Computer outputs representing port and starboard propeller azimuth and thrust, and main propeller thrust, will be displayed on dials at the console, and an operator can control the positioning units by manipulating these dials.

The positioning system, which will cost \$1.5 million, is being built

at the California Ordnance Center of Honeywell's Military Products Group. It will be ready next spring; the actual completion date depends somewhat on the progress of the drill platform itself.

IV. Reentry problem

Even with the elaborate positioning system, engineers at Brown and Root expect that at some time during the drilling they will lose mechanical contact with the hole. The Research division of General Motors is working on a system to regain it.

The drill string will enter the hole through a funnel-shaped landing base. For reentry, the string will be positioned by a hydraulic jet. An instrument package bearing an echo-ranging sonar system and an indexing unit are lowered through the pipe. When the package reaches the drill bit, a transducer pokes through the center hole and is indexed in position for scanning.

The transducer rotates and radiates acoustic pulses into the water at 15° intervals; these signals are bounced off acoustic reflectors on the landing base, and transmitted up the logging cable. Range and bearing are displayed on a cathode-ray tube. An operator at the surface then adjusts water flow through a nozzle near the bit to snake the bit toward the hole. The hydraulic jet will deliver 1,000 pounds of thrust.

Brown and Root may incorporate a television camera to back up the sonar system, but no decision has been made yet on whether the string will actually carry such an

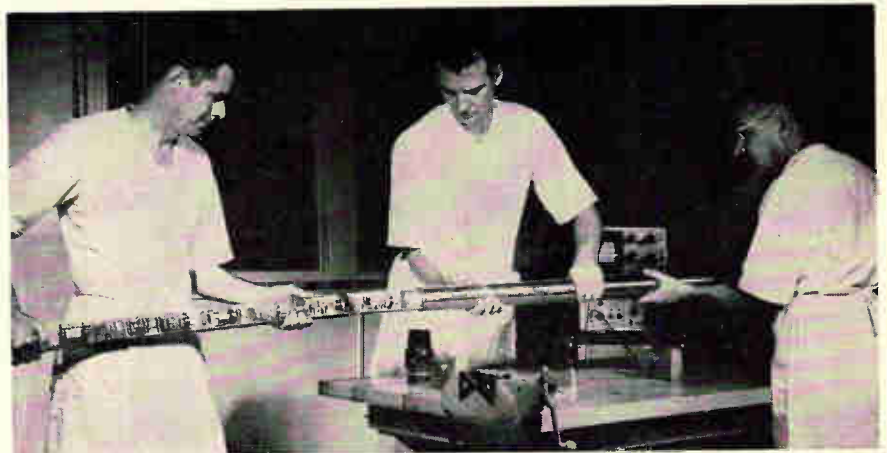

Logging cable for Mohole is jammed with instruments for measuring the properties of crustal and mantle rocks in place.

“eye.” A solid state Westinghouse camera and a camera developed by the Shell Oil Co. for looking down a well are under consideration.

V. Measuring the hole

The mohole will be drilled with a turbocorer, a modification of a Russian turbodrill which rotates only the bit, rather than the entire drill string. The Lane Wells division of Dresser Industries has developed an instrument package to report on the performance of the drill; the package will ride on the same seven-conductor armored cable that retrieves the core barrel and is used for logging.

The lower sensing assembly measures revolutions per minute with a group of eight magnets that rotate around a coil; other transducers measure heat, pressure on the bit, and pull on the cable. An inclinometer—basically a potentiometer—will measure the angle of the turbocorer during drilling, so that the hole may be reasonably straight.

How much core? The most unusual sensor measures core recovery. A spring and chain attached to the core barrel will activate a linear voltage differential transponder calibrated so that 50 feet of core travel equals 10 inches of sensor travel.

The device gives one measurement of the rate of penetration, as well as determining the amount of core obtained.

The magnetic properties of the core will tell scientists little unless they know the geographic orientation which the core had when it was still part of the earth. Brown and Root is working on an inertial reference system which uses a gyrocompass rather than a magnetic compass to obtain an unambiguous orientation of the core.

The inertial reference system will be used in conjunction with a device to take a “bite” out of the side of the hole, from which residual magnetism, a remnant of eras when the earth had different magnetic poles, may be distinguished from present terrestrial magnetism.

Electronics will also play a role in the protection of the drill string itself. AMF Tuboscope, Inc., will provide a system that combines in

Acme Electric STOCK MODEL POWER SUPPLIES ARE ENGINEERED TO CUSTOM DESIGN PERFORMANCE

Acme Electric magnetically regulated power supplies were designed for industrial control and systems applications where high reliability of performance is of prime importance.

Simplicity of design, employing a minimum of components, avoids the possibility of failure present in more complex circuits. Components are conservatively rated for continuous duty at full output under conditions of industrial use.

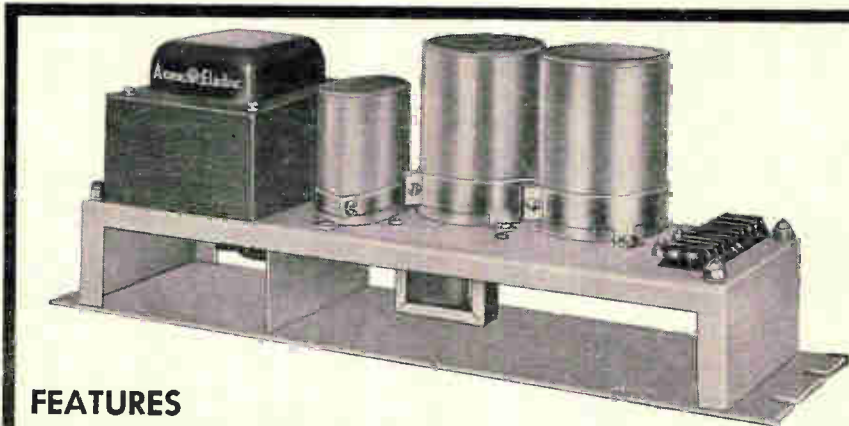

FEATURES

All solid state components for stability and reliability. Convection cooled — no fan or other moving parts. Available for operation on 50 cycles as well as standard 60-cycle frequency. May be paralleled in operation for multiplying current capacity. Fast response to line and load changes.

REGULATION

Line: $\pm 1\%$ for $\pm 13\%$ line voltage change. Load: $\pm 2\%$ for any load change between $\frac{1}{2}$ load and full load. Ripple: 1% RMS maximum. Operating temperature range: 0°C. to 50°C.

PARTIAL LISTING OF STOCK MODELS AVAILABLE SINGLE PHASE, 100-130 VOLTS; INPUT, 60 OR 50 CYCLES

CATALOG NUMBER	D.C. OUTPUT			CATALOG NUMBER	D.C. OUTPUT		
	Volts	Amps	Watts		Volts	Amps	Watts
PS-47509	10	4	40	PS-47638	28	8	224
PS-47508	15	2	30	PS-47712	28	25	700
PS-41422	24	2	48	PS-41424	48	4	192
PS-41423	24	6	144	PS-47519	48	10	480
PS-47125	24	15	360	PS-47718	100	4	400
PS-47173	24	25	600	PS-41425	125	2	250
PS-1-47127	24	50	1200	PS-47457	125	6	750
PS-1-47461	24	75	1800	PS-41426	150	2	300
PS-1-47200	24	100	2400	PS-41427	200	1	200
PS-47202	26	4	104	PS-41428	250	1	250

Acme Electric

Engineers and Builders of...

317 Water Street, Cuba, New York
Canadian Representative: Polygon Services, Ltd.
50 Northline Road, Toronto 16, Ont.

SAA-3854-3154

REGULATED POWER SUPPLIES
STATIC POWER RECTIFIERS
VOLTAGE STABILIZERS
VOLTAGE REGULATORS

REMEMBER **RESE**
FOR **MAGNETIC CORE MEMORIES**

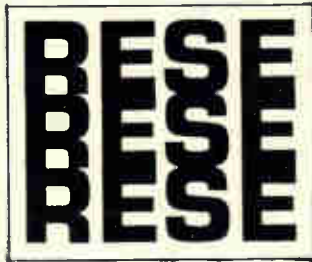

RE RESE ENGINEERING INC.

A and Courtland Streets, Philadelphia, Pa. 19120 (215) GL5-9000

Circle 215 on reader service card

YOKE SPECIALISTS

FOR INFORMATION DISPLAYS

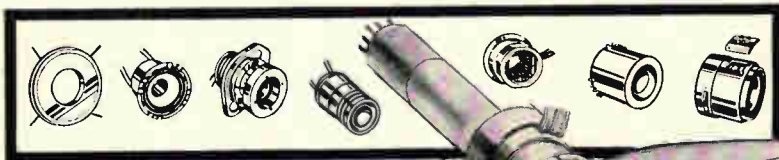

Syntronic's devotion to precision and attention to detail assure skillfully engineered deflection yokes in prototype or full production quantities. A complete line of value engineered yokes offer cost saving solutions to your CRT projects. Consult scientifically oriented Syntronic Yoke Specialists for the right yoke for your display.

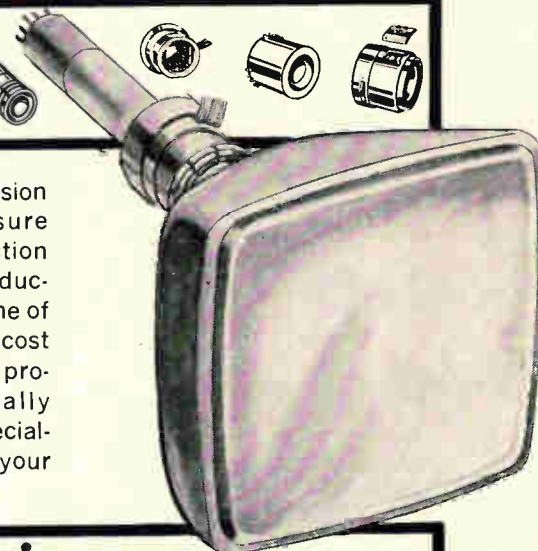

Syntronic INSTRUMENTS, INC.
100 Industrial Road, Addison, Ill.
Phone: Area 312, 543-6444

a single probe instruments to measure eddy current and to obtain magnetic, sonic, and x-ray data on pipe strength.

The logging cable, which is basically similar to the ones used in oil well drilling, is being built by Schlumberger, Inc.

VI. Undersea package

When the hole is drilled, an instrument package will be left in it to measure seismic waves, temperature, rock strain, and magnetic activity over a six-month period. Brown and Root has not yet decided exactly what instruments will go into the package, principally because of the difficulty of obtaining components that will withstand the 200°C temperatures expected. But the downhole package should provide important data, since it will be able to operate without the environmental disturbance of the drill.

The seismological information will be of particular value, since it will be free of the reflected waves which complicate the interpretation of measurements made on the surface.

Texaco Experiment, Inc., a division of Texaco, Inc., has two sub-contracts for developing the package.

VII. Onward and downward

Merely building the drilling platform for Mohole will take two years, and there will be preliminary borings at half a dozen underwater locations before the main hole is begun.

Even if all goes well, it will be, therefore, another five or six years before the first core is brought up from the mantle.

Nevertheless, the fact that Mohole is at least getting electronic and drilling hardware indicates that the hole will be dug. Two years ago, when the Budget Bureau made the NSF cut off all expenditures on the project until questions on its administration and goals could be cleared up, the prospects for reaching the mantle were far worse than those for reaching the moon.

The final indignity, of course, would be if the ocean did drain out through the hole. If that happens, no one can say we weren't warned.



DEUTSCH
sky-high value in
down-to-earth
electrical connectors for...

**GROUND SUPPORT
TEST EQUIPMENT
INSTRUMENTATION
COMPUTERS**

Heavy-duty, solid-plastic inserts... crimp-type contacts... front or rear insertion/removal... fail-safe tools... **easy assembly**. ■ Round, rectangular, or square... threaded, bayonet, or push-pull coupling... rack and panel or quick disconnect... **whatever the application**.

*If your ground-based system is up in the air,
your local Deutschman can help anchor it terra firmly.*

DEUTSCH
ELECTRONIC COMPONENTS DIVISION • Municipal Airport • Banning, California

ADVANCED NON-ENVIRONMENTAL MINIATURE AND SUBMINIATURE ELECTRICAL CONNECTORS

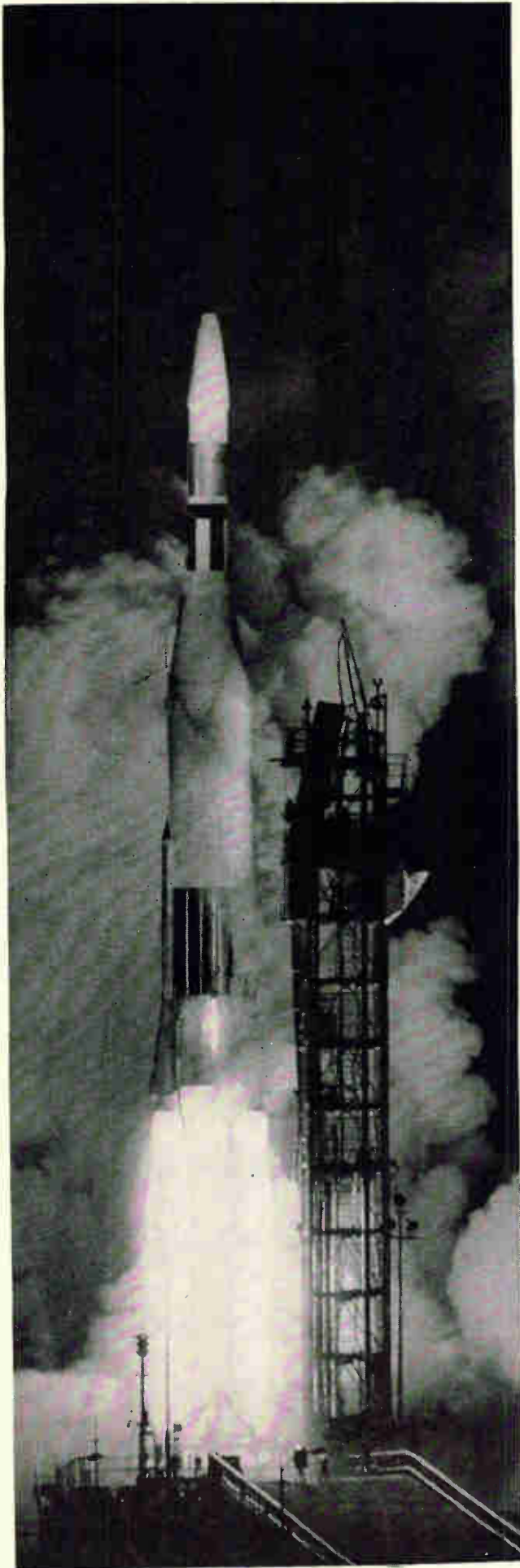

***Before all systems
are 'Go'...
All systems go
AnSCO***

Before countdown, umbilical launching towers at Cape Kennedy must get a thorough radiographic okay with AnSCO Superay® 'B' X-ray film.

Besides Uncle Sam, many prime contractors prefer AnSCO Superay 'B' for radiographic inspection. Why? Because it gives Class I detail and high contrast with plenty of speed.

Ask your AnSCO Products Representative how you can put AnSCO X-ray films and chemicals to work in your inspection operation. Or write: Dept. E-8.

gaf

GENERAL ANILINE & FILM CORPORATION

140 WEST 51 STREET • NEW YORK 10020

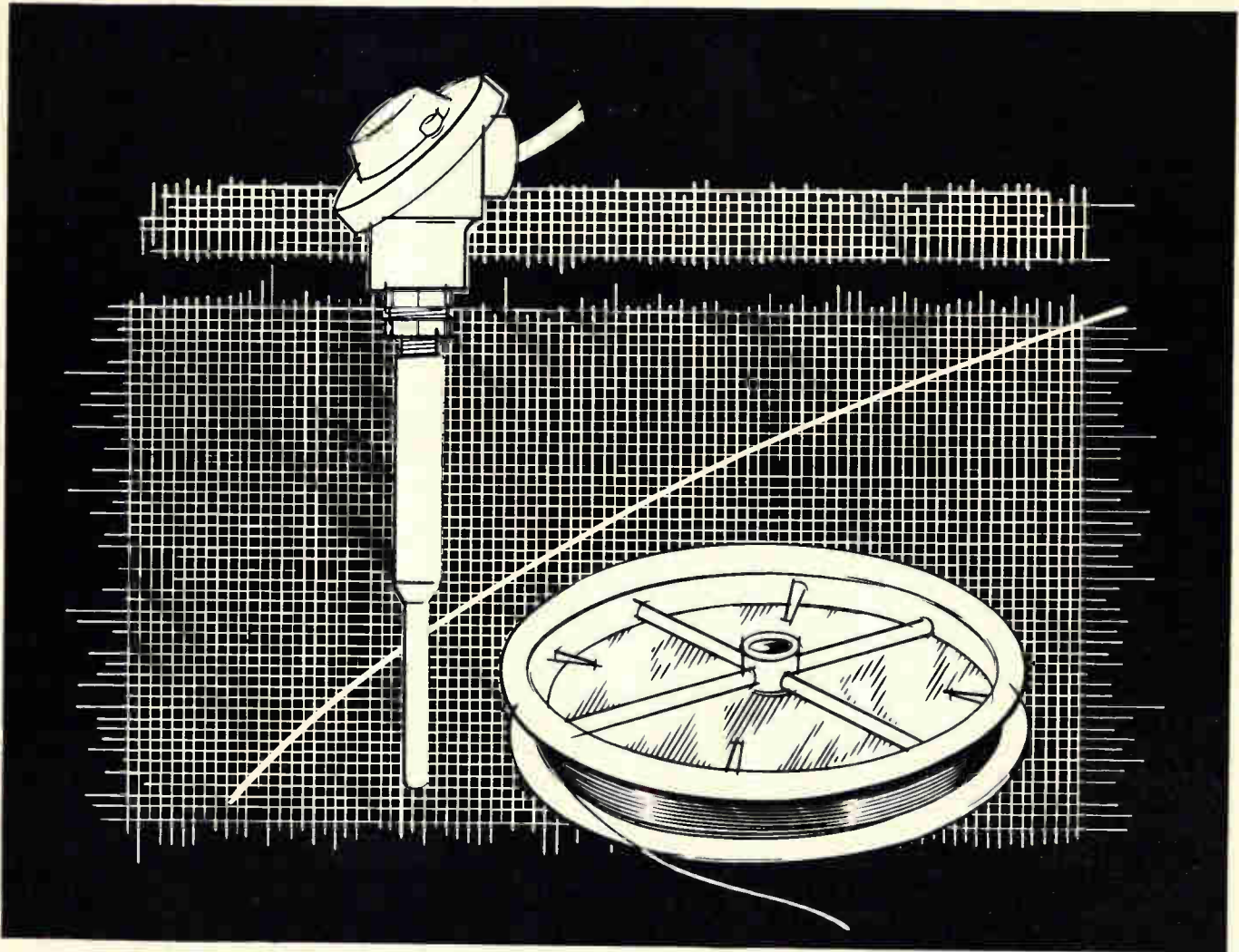

ENGELHARD Thermocouple Wire
for high temperature measurement — up to 2400°C.
9 calibrated combinations cover this
temperature range.

An exceptionally wide range of thermocouple systems from Engelhard—each composed of matched thermoelectric materials manufactured and tested to insure accuracy, stability and reproducibility. Our modern Standards Laboratory maintains equipment and standards whose calibration is directly traceable to National Bureau of Standards.

Whatever your thermocouple requirements may be—thermoelements only, matched couples, low temperature elements, resistance wire, resistance temperature devices, or noble metal tubing—Engelhard will fill them.

Choose from our large selection of noble metal combinations—all backed by Engelhard's uncompromising standards for metallurgical excellence!

Noble Metal Thermocouples*	Temperature Range °C.
Platinum 10% Rhodium vs Platinum	Up to 1500° continuous Up to 1750° intermittent
Platinum 13% Rhodium vs Platinum	Up to 1500° continuous Up to 1750° intermittent
Platinel®—Platinel = 5355 vs Platinel = 7674	Up to 1200° continuous Up to 1300° intermittent
Platinum 13% Rhodium vs Platinum 1% Rhodium	Up to 1600° continuous
Platinum 20% Rhodium vs Platinum 5% Rhodium	Up to 1700° continuous
Platinum 30% Rhodium vs Platinum 6% Rhodium	To just above 1700° continuous
Platinum 40% Rhodium vs Platinum 20% Rhodium	Up to 1800° continuous
Iridium 40% Rhodium vs Iridium Iridium 50% Rhodium vs Iridium Iridium 60% Rhodium vs Iridium	Up to 2000° continuous
Tungsten 3% Rhenium vs Tungsten 25% Rhenium	Up to 2400° continuous

*Registered

*Temperature vs EMF tables furnished on request.

Call or write our Technical Service Department for any of these descriptive bulletins:
 EI-6074-1—Noble Metal Thermocouple Wire.
 EI-6084 —Fibro Thermocouple Wire.
 EI-6268 —Tungsten 3% Rhenium vs Tungsten 25% Rhenium High Temperature Thermocouple Wire.
 EI-6325 —Platinel Technical Data.

ENGELHARD
INDUSTRIES, INC.
EXECUTIVE OFFICES:
113 Astor Street, Newark, New Jersey 07114

302A



If your
Airfreight
shipments play
second fiddle
to passengers...

BETTER CALL A MAN ABOUT A TIGER!

Let's face it. You're paying for *airfreight* service. Why should your cargo take a back seat to passengers? At Tigers, airfreight is our business—our *only* business. So, we give your airfreight the same top priority passenger lines give to people. But, that's not all! Every Tigerservice is geared to save *you* time, money, effort and worry. That's why it makes sense to ship airfreight with The Airfreight Specialist. Call us for proof: You can't afford *not* to ship Tigers!

Get these Tiger Extras!

Wholesale "Blocked Space" Rates—save up to 15% coast-to-coast and to Chicago ■ Exclusive Advance Manifest Data System—lets you know where your shipment is at any time and when it will be delivered ■ Only Coast-to-Coast All-Cargo Flights with Nonstop Service Both Ways ■ Swingtail CL-44s—only airfreighter that can carry shipments up to 84 feet long!

FLYING TIGER LINE

THE AIRFREIGHT SPECIALIST



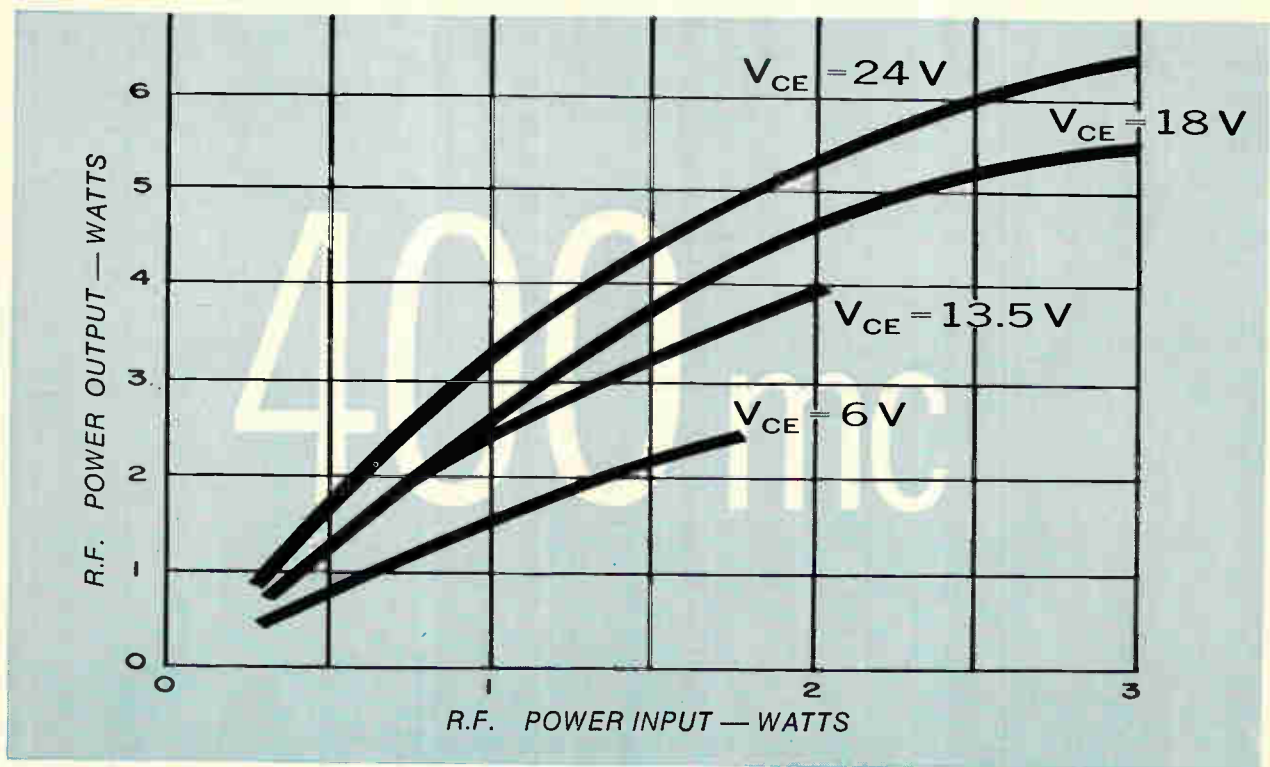

18 VOLTS IN, 5 WATTS OUT, NO EMITTER TUNING.

Push 18 volts into ITT's new 3TE350 silicon transistor and you get a handsome 5 watts out at 400 mc. Without risking the hazards of emitter tuning. Even in mobile equipment, where low supply voltage is a fact of life, it delivers high power at high frequency.

There's no phony gain in this performance either, no oscillation problems, no instability at other frequencies; and no added cost, complexity, or wasted space due to emitter tuning components.

You get just power, stable power, at your frequency, with your supply voltage, to make your design go.

To learn more about the 3TE350 and other silicon power transistors, write: Dept. 10, ITT Semiconductors, Division of International Telephone and Telegraph Corporation, 3301 Electronics Way, West Palm Beach, Florida.

Look for us at WESCON, booths 2807-2808

semiconductors division

ITT

The performance of PRINTED MOTORS begins where ordinary motors leave off!



Precision Printed Motors—high performance printed armature servo motors in 10 standard sizes.



New Low Cost "U" Series — 4 models of printed armature motors at greatly reduced prices.



The Incredyne — cylindrical armature motor with the fastest possible speed of response.



Minertia Motors—low inertia, slotless armature dc motors in sizes up to 200 h.p.

Are you designing tomorrow's electromechanical systems with horse and buggy motors?

Maybe you're not aware of the recent revolution in the design of high performance actuators that has made the problems and limitations of traditional motors obsolete and unnecessary. Unique advantages offered by PMI's complete line of precision and industrial servo motors include:

- Low inertia/high torque capability armatures give exceptionally fast speed of response.
- Wide speed ranges, typically 0 to 3000 rpm.
- Smooth, cogging-free torque, even at very low speeds; allows direct coupling of the motor to the load.

- Linear speed/torque characteristics, from no load to stall.
- Low mechanical and electrical time constants; armature inductance less than 100 microhenries.
- Low voltage/high current operation; allows simple, solid state control.

For information on any or all of PMI's high performance actuators, call or write: Printed Motors, Inc., Glen Cove, New York, (516) OR 6-8000.



PRINTED MOTORS, INC.

GLEN COVE, NEW YORK

Engineering, Manufacturing and Sales by:

Photocircuits CORPORATION

SIMPLEST ...

MOST EFFICIENT ...

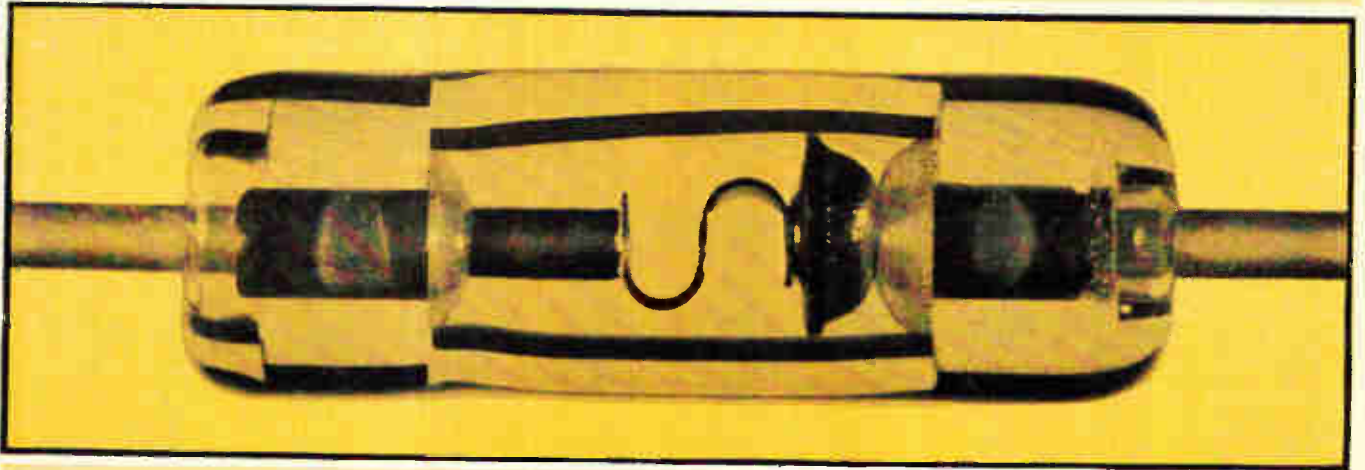

Two Terminal – Solid State *MEMORY*

ITT SEMICONDUCTORS

FOUR-LAYER DIODES

Basic Alarm Circuit

Figure 1 shows a basic alarm circuit that lights a signal lamp when either a momentary or a steady alarm condition occurs. This circuit eliminates contact chatter problems and allows low power circuits to energize high current lamps.

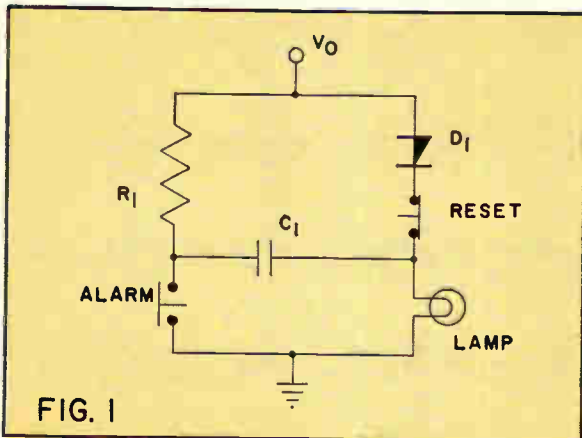

How It Works

The operating cycle for the circuit is as follows: In the pre-alarm condition, C_1 charges up to the supply voltage (V_0). The switching voltage (V_s) of the 4-layer diode (D_1) is selected to be greater than V_0 and less than $2V_0$. D_1 is OFF in the pre-alarm condition. When a momentary or a continuous alarm condition occurs, the normally open alarm contacts close. These can be mechanical, electro-mechanical or electronic, as long as point "A" of C_1 is grounded, momentarily, so as to drive D_1 above V_s . D_1 turns ON and switches the supply voltage across the signal lamp. The holding current of D_1 (I_h) is selected to be less than the current required by the signal lamp. When the alarm condition is corrected, the normally closed reset contacts are opened and the circuit returns to its original state.

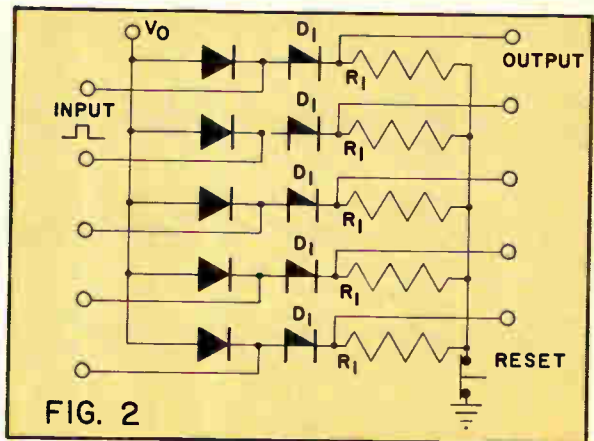

Storage Circuit

The use of 4-layer diodes in a basic memory or storage circuit is shown in figure 2. A momentary pulse on any of the inputs will produce a DC level change at any of its outputs until the entire memory is reset by interrupting a single circuit.

Operation

The switching voltage of the 4-layer diodes is selected to be greater than the supply voltage (V_0). A momentary positive pulse on any of the input lines will turn ON the associated 4-layer diode which will conduct through R_1 . The positive output level developed across R_1 will remain until all the 4-layer diodes are reset by opening the common return circuit. Write for additional application information including design data for alarm circuits, memory units, core drivers, etc. Ask for bulletin E-507. ITT Semiconductors Division, International Telephone and Telegraph Corporation.

ITT

semiconductors division

WEST PALM BEACH, FLORIDA . . . SHOCKLEY LABORATORIES, PALO ALTO CALIFORNIA . . . LAWRENCE, MASSACHUSETTS





If you can find one **HIGH RELIABILITY** resistor
that's best for all reliability applications

...specify it

We don't think you will.

Only IRC matches all reliability applications... can recommend without bias.

 <p>ULTRA RELIABILITY METAL FILM Type XLT for MIL-R-38101, MIL-R-55182 and Minuteman. Failure rate of .0001/1000 hours, full rated load at 125°C, at 60% confidence. 4 ratings and 3 T.C.'s available.</p>	 <p>HIGH RELIABILITY METAL FILM Type GEM for MIL-R-55182 and wide commercial applications. Failure rate of .01%/1000 hours, full rated load at 125°C, at 60% confidence. Hermetic glass seal. 4 ratings and 2 T.C.'s.</p>	<p>ASSURED RELIABILITY COATED METAL FILM Type CC for MIL-R-55182. 100% screening for reliability. Failure rate of .0056%/1000 hours, full rated load at 125°C, at 60% confidence. 3 ratings and 8 T.C.'s.</p>	<p>ESTABLISHED RELIABILITY CARBON COMPOSITION Type GBT for MIL-R-39008, levels M, P and R. ½ watt RCR 20 style. Failure rate of .0006%/1000 hours, full rated load at 70°C, at 60% confidence. 5% tolerance.</p>
--	---	--	---

Write for *High Reliability resistor data* . . . complete information in handy form.



INTERNATIONAL RESISTANCE COMPANY

Circle 130 on reader service card

PHILADELPHIA, PA. 19108

Frequency counter with a memory

Device checks minimum/maximum performance requirements, stores high and low readings and gives instantaneous display

A frequency counter that not only displays instantaneous readings, but also simultaneously stores information on maximum and minimum readings until reset, has been developed by Micro Instruments Co. The electronic memory is of the binary register type, and thus will store the high/low information indefinitely.

"To our knowledge, our Model 5400 is the only instrument of its kind available," says Ben Beneteau, president of Micro. "Its principal advantage is its ability to store maximum and minimum readings."

With appropriate transducers, the counter can measure any physical parameter with minimum/maximum performance requirements, such as the pressure in the fuel tank of a missile.

The major problem encountered in the design of the counter was in the development of the logic. "This will be an integrated circuit system when these circuits are more economical," says Beneteau. The instrument was designed with this in mind, but currently uses Fairchild discrete silicon transistors.

The input signal to the counter is passed through an attenuator and amplifier/shaper and then to the normal six-decade register. At the end of each count, and immediately prior to display, a high-limit and low-limit digital comparator sample the bit information in each decade of the normal register.

If the digital information stored in the high-limit comparator is less than that in the normal register, a transfer pulse is applied to transfer the higher reading to the maximum storage register. If the stored information is higher than that in the normal register, application of the transfer pulse will cause no change. A similar action stores the



low value in the minimum register.

A solid state, 4-pole, 3-position switch selects the binary data from one of the registers and directs this information to a binary-to-decimal converter and then to a Nixie display. A control on the front panel or activation of a remote control permits any of the three readings—maximum, minimum, or instantaneous—to be displayed or printed. The stored readings are not lost in this action, and will remain in the instrument until it is reset. The instantaneous and maximum/minimum registers are reset by pushing a button on the front panel, or by a remote command from the rear of the counter.

Principal applications are those in which frequency deviations must be recorded. A very high stability crystal oscillator is used as a time base. This oscillator is mounted in a temperature-controlled oven, stabilizing it to a few parts in 10^8 .

Firms purchasing the counter to date have used it for voltage controlled stability measurements. The company is now negotiating for the sale of the instrument for use with telemetry equipment, checking frequency spill-over from channel to channel.

The counter, which will be introduced at Wescon, sells for \$2,495.

Specifications

Time base frequency stability	1 Mc ± 5 parts in 10^8 for temperatures 10° to 50°C $\pm 1/2$ part in 10^8 for $\pm 10\%$ line changes ± 2 parts in 10^7 /month aging
Input	Two channels, 20 cps to greater than 2 Mc
Units	Reads in cps
Time base	0.1, 1, 10 seconds
Dimensions	17 inches wide, $5\frac{1}{4}$ inches high, 16 inches deep
Weight	Net 30 lbs, shipping 45 lbs.

Micro Instrument Co., 13100 Crenshaw Blvd., Gardena, Calif.
Circle 349 on reader service card.

Panel-mounted propeller fans

Series 1PB65 panel-mounted propeller fans are designed to satisfy the requirements of systems needing high-performance ventilation and cooling at a low cost. The units are engineered for thousands of hours of continuous service-free duty.

The fans are self-contained and may be mounted for vertical or horizontal operation, inside or outside the cabinet. Units are available for push or pull airflow. Installation time and effort are negligible. Both sides of the fan feature protective grilles.

■ To be shown at Wescon.
McLean Engineering Laboratories, P.O. Box 228, Princeton, N.J. [350]

New Components and Hardware

Precision co-ax connector works to 18 Gc



You can buy
the amazing new
Skipper[®]
for less than
\$400 in quantities

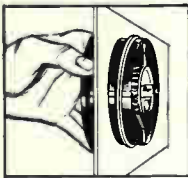

■ Time and money saving installation—just cut-out hole for fan and slide neoprene rubber mounting ring over venturi—and the Skipper is instantly secured in position. No mounting holes to drill... no nuts and bolts to handle.

- Complete selection of matching accessories available—line cord and plug, finger guards, etc.
- Styling and reliability—unmistakably ROTRON.
- Designed to meet U.L. Approval.
- Impedance Protected.
- And it's quiet! Only 39 db SIL.
- Constructed of unbreakable polymer and die cast aluminum.
- Built-in heat sink for cool running motor and longer life.
- For operation at ambient temperatures up to 140°F (60°C).
- Measures just 5¼" in diameter by only 1¼" in depth.
- Just 5/6 lb.—lightweight.
- Alternate mounting arrangements.
- Mounts easily anywhere—on any panel thickness (even glass).
- Available in 115V—60 CPS—1 φ (other ratings available).

Write, wire or call today for complete details to...

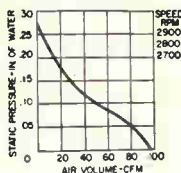

ROTRON MANUFACTURING COMPANY, INC.
WOODSTOCK, NEW YORK
West Coast: ROTRON/PACIFIC, Glendale, California
Canada: THE HOOVER CO., LTD., Hamilton, Ontario
Rotron-Vacetric Europe (N.V.) Breda, The Netherlands
Export Sales: AURICOMA INTERNATIONAL GROUP

VISIT ROTRON WESCON BOOTH 3014-3015

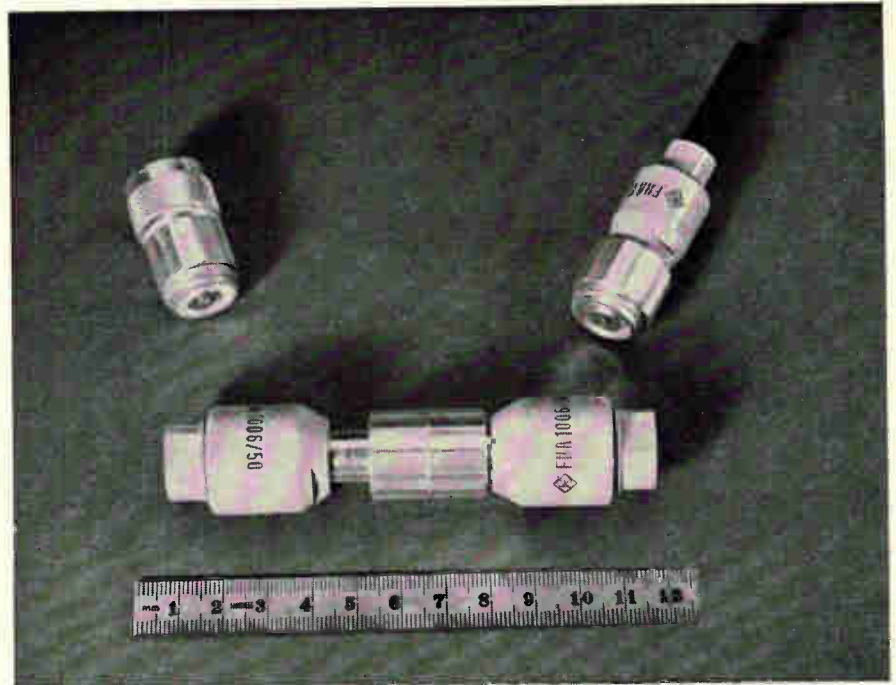

In microwave applications, a coaxial connector has a demanding job, particularly where precise measurements are required. It must withstand thousands of make and break operations and still:

- Maintain extremely low voltage standing wave ratio;
- Always establish a well-defined electrical plane of reference coincident with the same mechanical plane of reference;
- Reduce signal leakage to an insignificant amount.

Rohde & Schwarz of Munich, Germany, has introduced two precision connectors that meet the rigid specifications of the Precision Connector Committee of the IEEE. The Precifix A, designed for use with rigid coaxial lines, operates up to 18 gigacycles with a voltage standing-wave ratio of only 1.035. The Dezifix A, which mates with the Precifix A but with slightly lower tolerances (vswr about 1.16 at 18 Gc), is used with flexible coaxial transmission lines. Both types are parts of a seven-millimeter coaxial system developed by Rohde & Schwarz, in which each coaxial component has an inner conductor whose outer diameter is 3 mm, and

an outer conductor with an inside diameter.

The connectors are sexless; that is, there is no difference between a plug and socket. When a connection is made, the inner and outer conductors butt together and are locked in place by a compression nut. The inner conductor is spring-loaded; when a pair are connected, the two inner conductors are compressed and the electrical reference plane coincides exactly with the junction plane. This makes possible accurate measurements of electrical length and phase, and making and breaking connections without changing the phase relationship. The coupling unit has a double thread, for quick connect or disconnect in less than one turn; this is especially important in the handling of rigid lines.

Rohde & Schwarz says Precifix A probably will be used principally in measuring and calibrating equipment up to 18 Gc in the field of impedance measuring devices, standard signal generators, phase measuring devices, and filters.

Lack of precision connectors has limited the accuracy or calibration of precision measuring instruments

**This is a new Shallcross one-inch rotary switch.
It is electro-mechanically superior, competitively priced,
specified in minutes and delivered in hours.**

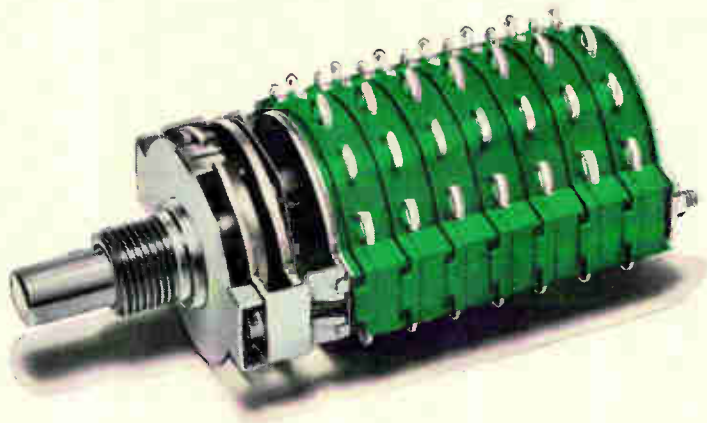

Otherwise it's like the others in its class.

A lot of people have liked our switches for a long time, but in some cases, they couldn't afford to pay for the extra quality we built into them.

So we figured out a way to make our new one-inch switches economical without sacrificing quality.

Our Series 1 line contains the superior materials, construction and performance expected in all Shallcross switches. Some of its features are: Low switching noise,

low thermal EMF, high insulation resistance, positive long-life detenting, superior contact resistance versus load versus life ratings, rugged terminals, enhanced voltage breakdown characteristics, and the most definitive electro-mechanical ratings in the industry.

The Series 1 has specification sheets as well as a comprehensive order code to make it easier to specify and order. (Your control draw-

ings can be created in minutes.)

Six Shallcross distributors throughout the nation provide 24-hour delivery on these and other Shallcross switches. You no longer have to use inferior switches because you can't afford Shallcross quality. Compare performance, specification ease, pricing, availability and cataloging, and we believe you will conclude that the Series 1 is a standout in its classification.



SHALLCROSS MANUFACTURING COMPANY

SELMA, NORTH CAROLINA / TEL. 919-965-2341

this is a tube that's used to guide a wire

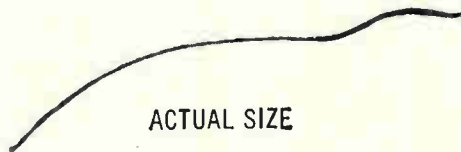

ACTUAL SIZE

we start with tungsten wire .0005" and draw copper tubing over it at .0036" diameter. Wall thickness is .0015".

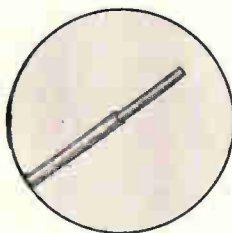

MAGNIFIED

... You don't have to be a nut on miniaturization to deal with Uniform Tubes, however. We work just as carefully with big "chunkers" of tubing up to .625" O.D. The point we make is that Uniform Tubes' capabilities in *metallurgy*, as it applies to tube drawing and forming, is worthy of your consideration.

Throw us your challenge. Chances are we have met it already on other projects. One more thing we promise you . . . *Quality in Quantity*. Phone or write for prompt action. 501



UNIFORM TUBES, INC.

Collegeville, Pa. • (215) 489-7293 • TWX 215-277-1673

New Components

and of laboratory standards. In the new connectors, low vswr is maintained by holding the dimensional tolerances to ± 0.004 mm on the inner conductors and ± 0.008 mm on the outer conductors. Triple shielding of the Precifix A keeps leakage well below the 120 decibels specified by the Precision Connector Committee.

Specifications

Frequency	Typical vswr	
	Precifix A	Dezifix A
10 Gc	1.015	1.075
18 Gc	1.035	1.16
Frequency range	0 to 18 Gc	
Characteristic impedance	50 ohms	
Power handling		
100 megacycles	250 watts	
1 gigacycle	150 watts	
Contact resistance		
inner conductor	1 milliohm	
outer conductor	0.05 milliohm	
Temperature range	-40° to 70° C	
Length of Dezifix A, including cable	Approx 60 mm	
Length of Precifix A	Approx 16 mm	
Price of Dezifix A	\$9.50	
Price of Precifix	\$35	

Rohde & Schwarz, Munich, West Germany; Rhode & Schwarz Sales Co. (U.S.A.), Inc., 111 Lexington Ave., Passaic, N.J. [351]

Power connectors meet MIL-C-38300



Miniature circular power connectors are now being produced according to Air Force Qualified Products Listing (QPL) 38300-1 Apr. 9, 1965. Some of the configurations included in the QPL were the following 48 series Ultra-Mate connectors: size 22 shell, 55-contact bayonet and threaded coupling; 10 shell, 5-contact bayonet; 12 shell, 12-contact bayonet; 14 shell, 7-contact bayonet; and 22 shell, 19-contact bayonet. These connectors are listed to the X level of reliability.

The 48 series connectors with socket inserts of glass-filled epoxy, combine the positive reliability of

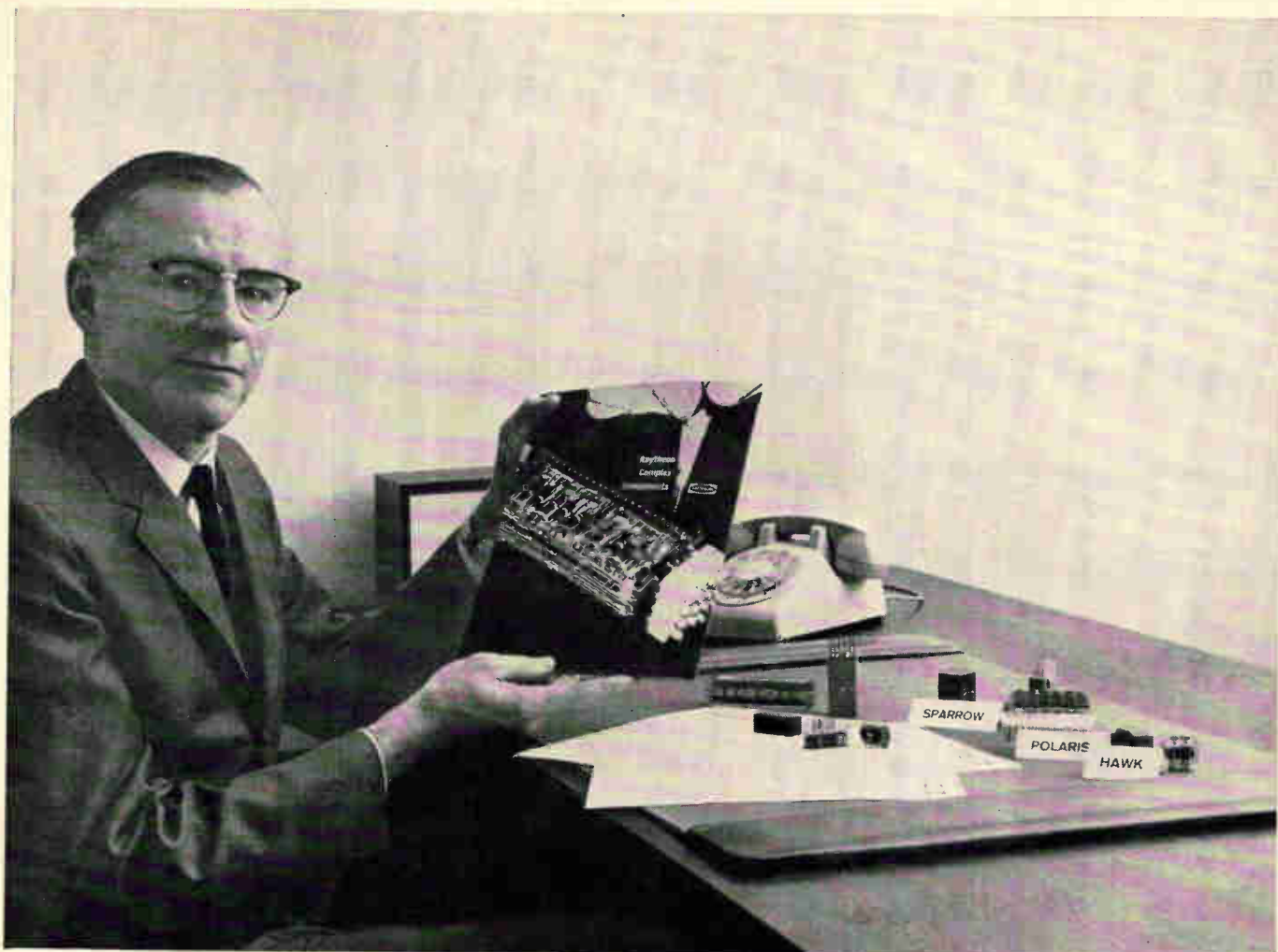

Howard Burgess, Product Specialist — Circuit Modules. On his desk are typical circuit modules including types made for Polaris, Hawk and Sparrow.

Ask Howard Burgess to send you this fact-filled brochure about circuit modules

Howard knows more about our Total Engineering Approach to making circuit modules than anyone else at Raytheon.

Which is an important reason for asking for this brochure.

In it you'll find an explanation of how we design from your block diagram, schematic, black box or retrofit specifications. And how we keep your requirements firmly in mind throughout design, manufacture and test. (Quality control at Raytheon begins with spectrographic, gravimetric, microscopic, X-ray analyses of in-coming materials.)

It will also tell you how engineers like

Howard determine whether your modules should be encapsulated in epoxies or pre-molded shells . . . or filled under vacuum . . . or welded or soldered (by hand, dip or flow).

And how our specialists can devise an encapsulation formula for you. Or analyze your light transmission or thermo-conductivity requirements.

Just send the reader service card for a copy of this Circuit Module Brochure. It even contains forms on which you can outline your problem — get suggestions and quotes from Raytheon. Or write to Howard Burgess at the address below.

RAYTHEON

Raytheon Company, Components Division,
Industrial Components Operation,
Lexington, Mass. 02173

**WHAT'S NEW
in
OPERATIONAL
AMPLIFIERS
at
BURR-BROWN?**



PLENTY!

- 1. NEW FET MODULE SERIES**
New FET amplifiers offering wide bandwidth, low noise, low input capacitance, extremely high and extremely stable input resistance . . . in 1.8" x 1.2" x 0.6" and 1.0" x 1.0" x 0.7" packages.
- 2. NEW FET CHOPPER-STABILIZED UNIT**
Model 1608A provides improved low drift performance for applications requiring maximum stability.
- 3. NEW POWER AMPLIFIER**
A second-generation all-silicon power booster, Model 1634A designed to increase operational amplifier output current capability.
- 4. NEW TRANSDUCER AMPLIFIER**
A new higher-output differential DC amplifier specifically designed for transducer applications.
- 5. NEW FUNCTIONAL MODULES**
Sample and hold, multiplier/divider, log converters and other new functional modules in rack mounting packages . . . up to 16 modules per 3 1/2" x 19" rack space.



**FOR TECHNICAL
BULLETINS**
write, wire or
phone Burr-Brown
or VISIT
WESCON BOOTH
#3008-9

BURR-BROWN

RESEARCH CORPORATION
INTERNATIONAL AIRPORT INDUSTRIAL PARK
BOX 11400, TUCSON, ARIZONA 85706
PHONE: 602-294-1431 • TWX: 910-952-1111

FOR COMPLETE INFORMATION
CALL YOUR NEAREST

BURR-BROWN

REPRESENTATIVE

AGINCOURT, ONTARIO Electromechanical Products (416) 293-7011	LATHRUP VILLAGE, MICH. Sheridan Associates, Inc. (313) 353-3822
ALBANY, N. Y. J. A. Reagan Co. (518) 436-9649	MIAMI NBS Incorporated (305) 444-1118
ALBUQUERQUE Williams Associates, Inc. (505) 255-1638	MILFORD, CONN. Measurement Equipment Co. (203) 874-9222
ANCHORAGE Arva Incorporated (907) 272-5231	NEW HARTFORD, N. Y. J. A. Reagan Co. (315) 735-3775
BINGHAMPTON, N. Y. J. A. Reagan Co. (607) 723-9661	ORLANDO, FLORIDA NBS Incorporated (305) 423-4856
BUFFALO J. A. Reagan Co. (716) 632-2727	PHOENIX Williams Associates, Inc. (602) 254-6085
BURLINGTON, N. C. NBS Incorporated (919) 584-6129	PORTLAND, OREGON Arva Incorporated (503) CA 2-7337
CAMDEN, N. J. QED Electronics, Inc. (609) 365-2450	SALT LAKE CITY Williams Associates, Inc. (801) 466-8709
CHICAGO Loren F. Green & Assn. (312) AV 6-6824	SAN JOSE, CALIFORNIA W. K. Geist Company (415) 968-1608
CINCINNATI Sheridan Associates, Inc. (513) 761-5432	SEATTLE Arva Incorporated (206) MA 2-0177
CLEVELAND Sheridan Associates, Inc. (216) 884-2001	SILVER SPRING, MD. QED Electronics, Inc. (301) JU 8-8134
DALLAS Southwest Electronic Industries (214) EM 3-1671	TULSA Southwest Electronic Industries (918) TE 5-2481
DAYTON Sheridan Associates, Inc. (513) 277-8911	VANCOUVER Arva Incorporated (604) RE 6-6377
DENVER Williams Associates, Inc. (303) 388-4391	WAKEFIELD, MASS. Measurement Equipment Co. (617) 245-4870
GLENDALE, CALIFORNIA W. K. Geist Company (213) 245-9501	YONKERS, N. Y. QED Electronics (914) YO 8-2200
HOUSTON Southwest Electronic Industries (713) WA 8-5251	OVERSEAS Frazar & Hansen Ltd. 150 California Street San Francisco 11, Calif.
HUNTSVILLE, ALA. NBS Incorporated (205) 852-9101	

FOREIGN REPRESENTATIVES

AUSTRALIA Kenelec Imports Canterbury E7, Victoria	GERMANY Dipl. Ing. Ernst Fey Hunuchen, Germany
DENMARK V. H. Prins Glostrup, Denmark	HOLLAND AIR Parts International N.V. Ryswyk (Z.H.)
ENGLAND Environmental Equipment Ltd Wokingham Berks, England	SWITZERLAND Telemeter Electronic AB Zurich 3, Switzerland
FRANCE Septa Paris 2E, France	

**BURR-BROWN
EASTERN REGIONAL OFFICE**

Wakefield, Mass.
(617) 245-0350
Donald Bruck

New Components

go-no-go closed entry with the convenience, speed and ease of front servicing. Use of the most advanced materials available plus complete environmental sealing enable these high performance units to operate continuously at 200°C; take short exposures up to 800°C; withstand thermal shock cycling from -55 to 260°C; and support, 1,500 v rms from sea level to 350,000 ft.

The connectors also maintain electrical and environmental integrity during and after zero to 200 cps vibration, 15 g, while exposed to 200°C and -55°C respectively. The connectors also resist corrosion, ozone and dust. Tamper-proof contacts, available in sizes 12, 16 and 20, conform to MIL-C-26636.

■ To be introduced at Wescon. Amphenol Connector Division, 1830 S. 54th Ave., Chicago, Ill. [352]

**Medium power relay
handles 25 amps**

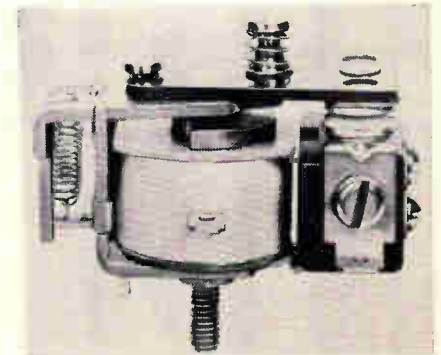

A medium power relay, the 25PD rated at 25 amps, is said to offer greater reliability and better performance than other competitively priced relays. The manufacturer claims extremely long mechanical life for the relay; electrical life is dependent on load characteristics. An important advantage is lower pull-in voltages (d-c: 75% of nominal voltage; a-c: 76% of nominal voltage).

Designed for continuous spst, normally-open db switching on a-c or d-c inputs, the 25PD relays are rated at a load of 25 amps at 115/230 v a-c, 60 cycle resistive, 1 1/2

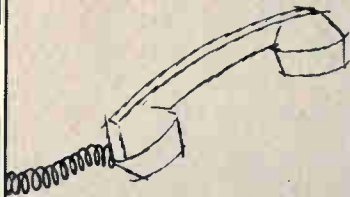

CALL YOUR AUTHORIZED
ERIE DISTRIBUTOR FOR...

ERIE SUBMINIATURE MONOBLOC* CAPACITORS

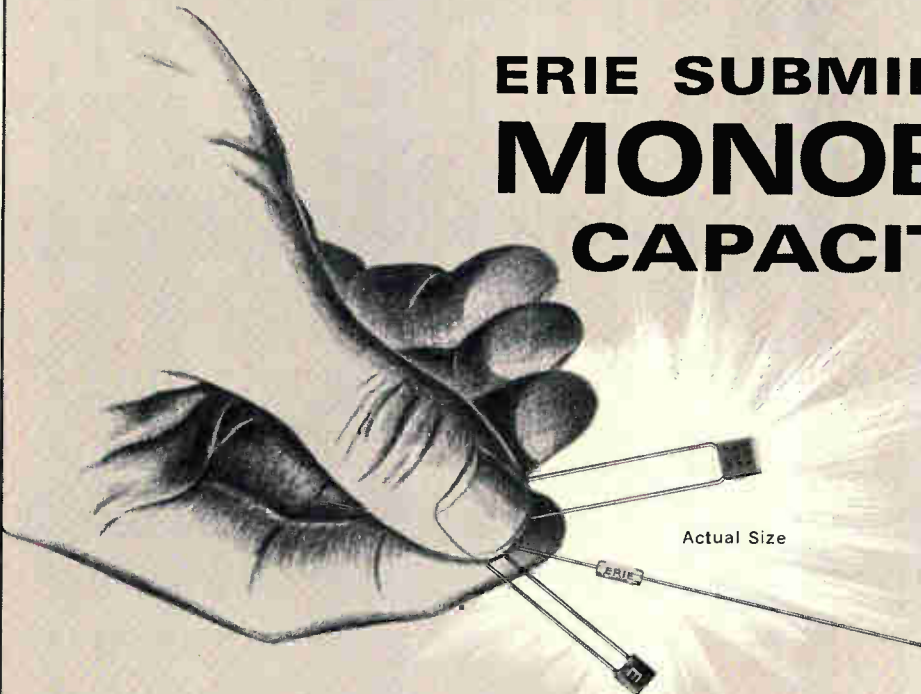

Featuring CAPACITANCE-TO-VOLUME RATIO TO 20 MF/CU. IN.
IN SUBMINIATURE, VERY RELIABLE CERAMIC CAPACITORS

Erie's new in-stock MONOBLOC ceramic film capacitors represent the most significant design advance in more than a decade. Now, Erie's exclusive Monobloc Process, in which very thin films of ceramic can be bonded into solid structures, permits virtually unlimited range of capacitance values, characteristics and sizes to suit exacting design requirements . . . most of which are stocked by your authorized Erie Distributor. Monobloc Capacitors provide volumetric efficiencies from 10 to 100 times the capacitance (to 20 mf/cu. in.) attainable in conventional components of the same size . . . and still meet Established Reliability specifications for Aerospace, Military and Commercial applications.

We stock these subminiature Erie Monobloc Capacitors encapsulated to suit the design engineers' needs; hermetically sealed, glass encased . . . precision molded . . . and phenolic coated as illustrated at right.

Design Advantages . . .

Volumetric efficiency to 20 mf/cu. in. . . Capacitance values from 10 pf. to .5 mfd . . . IR at room temperature—100 K megohms . . . 100 WVDC . . . High Reliability.

*Tradename of Erie Technological Products, Inc.

**ERIE MONOBLOC
CAPACITORS
IN-STOCK**
Commercial and Military

- Hermetically Sealed Glass Encased Types
- Precision Molded Types
- Phenolic Coated Types Weecons

**ERIE
TECHNOLOGICAL
PRODUCTS, INC.**



- **CAPACITORS**
Subminiature Monobloc
Tubular and Disc Ceramicons
Stand-Off
Feed-Thru
Mica
Film
Solid Tantalum
Trimmers (Ceramic, Glass, Quartz)
- **FILTERS**
Broad Band EMI Filters
EMI Filters (High Freq., Low Pass)
Multi Section Filters
- **SEMICONDUCTORS**
Silicon Diodes (Diffused Junction)
Germanium Diodes
Silicon Rectifiers
Semiconductor Assemblies

Advanced Components Through Increased Volumetric Efficiency

Formerly
Erie Resistor
Corporation

644 West 12th Street
Erie, Pennsylvania

**MEASURE
SOUND LEVELS
OVER THE FULL
DYNAMIC RANGE
WITH MASSA
SOUND PRESSURE
MICROPHONES**

Rocket Eng
Jet Plan
at Take-Off

Large Sir

Large
Pneuma
Riveter

Heavy

Su

Hea

N

C

Q

Q

Bra

Ru

(Quiet Night)

2×10^6

10^6

+100

10^5

10^4

10^3

+50 (bar)

RMS Sound Pressure (Dynes per cm²)



M-125
Freq. Range Cps
20-30,000

MK-103
Freq. Range Cps
20-30,000

M-141
Freq. Range Cps
20-30,000

M-215
Freq. Range Cps
20-70,000

M-213
Freq. Range Cps
20-100,000

Massa Sound Pressure Microphones provide accurate and reliable sound pressure measurements from low levels to the ultrasonic region under practically any acoustic environment. Important features include:

- Linear Dynamic Ranges to sound pressures in excess of 200 db (re: 0.0002 microbars).
- No D.C. Polarizing required.
- Exclusive ADP (Ammonium Dihydrogen Phosphate) Crystals for uniform reliability, stability, and accuracy.
- Frequency Ranges from 20 cps to 100,000 cps.
- Omni-Directional to high frequencies for sure pickup of sound in difficult areas.
- Near Infinite Acoustic Impedance or no loading of the sound field.

Complete Portable Systems are also available for use where reliable measurements must be made at inconvenient locations.

Write for FREE Pocket Size Sound Level Measurement Chart



MASSA DIVISION
DYNAMICS CORPORATION OF AMERICA
HINGHAM, MASS. 02043

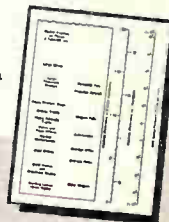

New Components

hp at 115/230 v a-c motor-inductive. Small in size, they weigh only 2¾ oz. Standard contact material is silver cadmium oxide alloy with other materials available on request. Contact size is ¾ in. in diameter.

The a-c version of the 25PD handles operating voltages of 4 to 250; contact capacity is 0.03 to 10 amps; and temperature range is -55° to +60°C. The d-c version has operating voltages of 2 to 130; contact capacity is 0.03 to 10 amps; and temperature range is -55° to +70°C. Coil voltages on the a-c style range from 6 to 230, and on the d-c from 6 to 110. Coil resistance ranges from 3 to 6,200 ohms.

▪ To be introduced at Wescon. Eagle Signal Division, E. W. Bliss Co., Federal St., Davenport, Iowa. [353]

**Lightweight C-cores
occupy small space**



A line of C-cores now on the market is made of Supermendur, a space age alloy of 2% vanadium, 49% iron and 49% cobalt, that permits practical savings in volume from 15% to 40% and weight from 10% to 30%. Performance capability is comparable to C-cores that are ½ larger.

The Supermendur C-cores, used primarily for R&D space projects because of the cost of the alloy, are now being made available by the firm for such applications as magnetic amplifiers, small power and pulse type transformers, chokes, inverters/converters, saturable reactors and miniature and subminiature electrical/electronic applications.

The cores, made of 4 mil Supermendur, range in weight from 0.04

**Now
 an
 SCR**

**for
 under
 50¢**



C106 SCR with single-ended flat leads



C106 SCR with double-ended flat leads



C106 SCR with flat leads and heat sink tab

Shown actual size.

General Electric—first with economy line transistors—announces the first low cost SCR—the C106. It's plastic encapsulated, all planar, passivated . . . and rated up to 200 volts at 2.0 amps.

General Electric's new C106 SCR's cost under 50¢ in volume quantities—about one-half the price of present "low cost" SCR's. Now you can afford to take another look at:

Low cost solid state circuits for appliances . . . electric ranges, dryers, sewing machines and hand mixers. Low cost solid state circuits for automobile ignitions and indicator lights. Low cost solid state circuits for computers . . . vending machines . . . electric light dimmers . . . display signs . . . industrial motor and temperature controls.

And there's no cost/performance trade-off with the new C106 SCR's. They're actually more sensitive than

higher-priced units. For example, it only takes a 200 microamp/0.8 volt signal to trigger a C106. And the C106 small package is designed for application versatility with several lead configurations for easy mounting in any circuit.

See GE's new C106 SCR's displayed for the first time at the WESCON Show, Booths 1410-1411. Or for engineering samples, quantity availability and specification: contact your nearest GE Electronic Component Regional Sales Office, or write to Section 220-19, General Electric Company, 1 River Road, Schenectady, N. Y. 12305. In Canada: Canadian General Electric, 189 Dufferin Street, Toronto, Ont. Export: Electronic Component Sales, IGE Export Division, 159 Madison Ave., New York, N. Y. 10016

ELECTRONIC COMPONENTS DIVISION

GENERAL  ELECTRIC

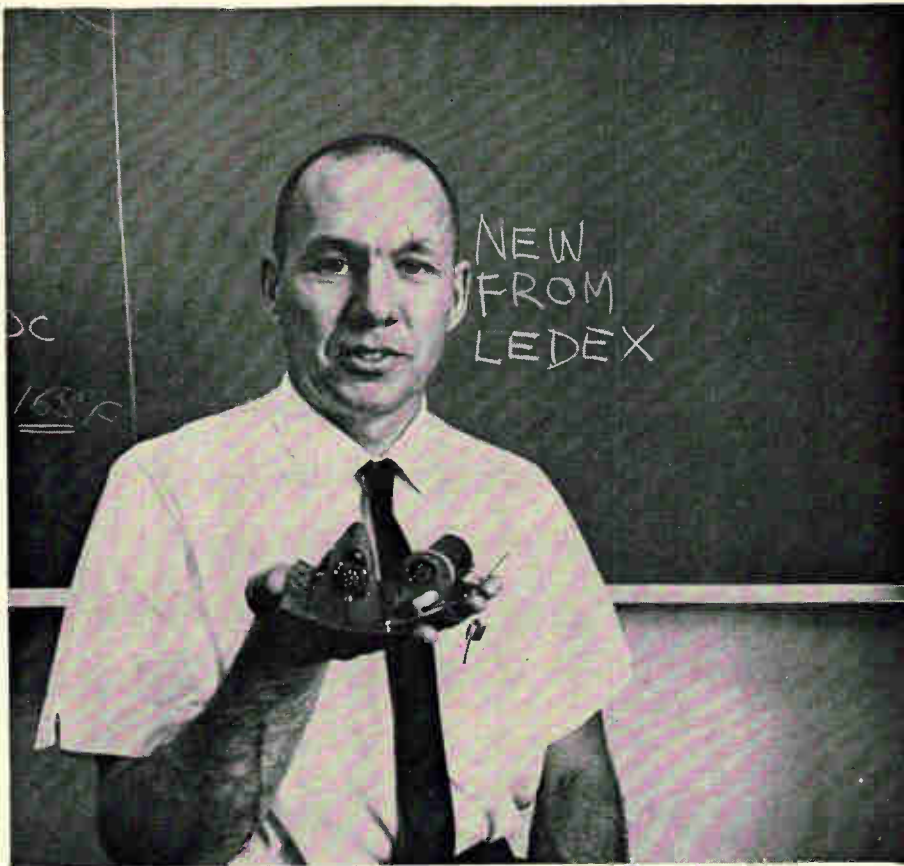

Here are two new intervalometers, one solid state, one electromechanical

Both of these recycling timers are completely interchangeable in form, fit and function. Both are capable of optional single or ripple firing of seven rockets at 15 millisecond intervals.

The electromechanical version on the right uses a miniature Ledex two-deck switch. The solid state system uses ramp voltage controlled SCR circuits, with a current detector added for single fire.

The solid state intervalometer operates from a built-in ramp generator or a charging capacitor. It climbs through six stages from 0 to 18 volts, and it energizes a new circuit every 3 volts. We can design this model to operate at intervals that range from 1 millisecond in length to 2 seconds... up to 14 seconds for the complete cycle.

Any way you want your time switching solution... solid state, electromechanical, or a combination of the most favorable characteristics of both... there are people around here to deliver it. We design and supply remote control components and packaged solutions to both military and industrial users.

Send for latest information on Intervalometers and Programmers. Write us or call 513-224-9891.

Sincerely,
Garl McHenry
 Senior Development Engineer

P.S. Come to us whenever you need a big solution in a small package.



LEDEX INC., 123 WEBSTER STREET, DAYTON, OHIO 45402
 Designers & Manufacturers Electronic & Electro-Mechanical Components
 & Remote Control Switching Systems

See Exhibit at WESCON Show—Booth 2205

New Components

lb up to 3.93 lbs; strip widths from 3/8 in. through 1 3/4 in.; build up from 1/16 in. to 1 1/8 in.; window widths from 1/4 in. to 1 3/8 in.; window lengths from 5/8 in. to 3 in.

■ To be introduced at Wescon. The Arnold Engineering Co., P.O. Box G, Marengo, Ill., 60152. [354]

Small vacuum switch withstands high power



A vacuum switch has been developed for high-voltage r-f switching. Type RP230A is less than 5 1/2 in. long and 1 5/8 in. in diameter but it will withstand 50 kv peak test voltage and carry continuous r-f currents of 40 amps rms at 30 Mc. Switch inductance is less than 0.05 μh; contact capacitance, only 1.3 pf.

The RP230A may be obtained with a simple, efficient actuating mechanism or the vacuum enclosed contacts may be purchased separately. The unit is said to be unexcelled for such applications as antenna and reflector rod switching, tap changing r-f coils, and capacitor switching in r-f circuits.

■ To be introduced at Wescon. Jennings Radio Mfg. Corp., P.O. Box 1278, San Jose, Calif., 95108. [355]

Field-adjustable programming switch



An ultraminiature programming switch, called the MiniActan, has been announced. It is said to be

New voltage source provides 0.003% accuracy in standards lab or field

*A practical DC voltage standard stable to better
than 15 ppm per week*

A portable, rugged DC voltage standard now is available with 0.003% absolute accuracy and commensurate short and long-term stability. It has a warm-up time of 15 minutes or less, a 2 ppm/°C ambient temperature coefficient and better than 1 ppm/V stability with respect to power line (115V AC) variations.

Direct voltage settings

Calibrations formerly requiring the accuracy and stability of a shielded potentiometer, resistance ratio box, light beam galvanometer and an adjustable voltage supply now can be made *directly* by setting the desired voltage on the front panel dials of the Model 304. Tedious potentiometer standardizations and galvanometer nullings are eliminated.

Low noise, wide voltage range

Noise level less than 20 μV rms makes this the quietest voltage standard on the market... of prime importance in every standards lab. Output voltage

levels with the Model 304 range from 0 to 1,222.2221 volts. Voltage settings are made in three decade ranges, with increments as small as one microvolt. Stability is better than 0.0015% of the setting for 7 days (plus 0.0001% of full scale to 20 μV). Once calibrated, only a readily noticeable failure can cause a departure from specified accuracy. And calibration couldn't be simpler: follow the simple self-checking linearization procedure, then null against an NBS-certified cell through a sensitive electronic galvanometer (such as Cohu's Model 208R Micro-multimeter).

Voltage accuracy of the Cohu 304 is within 0.003% of setting, plus 10 μV on the 10-volt range, 20 μV on the 100-volt range, and 40 μV on the 1000-volt range. It's designed for standard 19-inch rack-mounting or bench-top use, and weighs only 50 pounds. Operation is fast and simple, with measurements taking only a fraction of the time required by classic procedures. And you get up to 50 ma output current at any voltage; separate voltage sampling terminals maintain calibration accuracy. Further details are available from engineering representatives in all major cities.

See us at WESCON, booth 3923



DC VOLTAGE STANDARD	Model 304
ACCURACY	Within 0.003% of setting
STABILITY	Within 15 ppm/7 days, 25 ppm/6 months
RANGE	0-1,222.2221 volts
VOLTAGE STEPS	Small as 1 μV .
NOISE	Less than 20 μV rms on 10 V range; Less than 40 μV rms on 1000 V range
CURRENT	Up to 50 ma
PRICE	\$3995 F.O.B. San Diego, Calif. Additional export charge.

COHU Box 623
ELECTRONICS, INC. San Diego, Calif. 92112
KINTEL DIVISION Phone 714-277-6700

AIRPAX

CP CIRCUIT PROTECTORS

WITH UL RECOGNITION

... for consumer appliances and industrial applications



The Type CP electromagnetic circuit protector is Underwriters' Laboratory tested and recognized for motor and appliance protection. ■ This low cost protector is for use with loads up to 20 amps at 32 volts DC, 7½ amps at 250 volts AC and 15 amps at 125 volts AC. ■ CP protectors may be supplied with instantaneous, fast or slow trip characteristics. Current ratings down to 50 ma permit use in electronic circuits and instruments.

USES

- Office Machines
- Computers
- Consumer Appliances
- Vending Machines
- Electrical/Electronic Instrumentation

FEATURES

- Screw terminals or spade lugs (lugs have holes for #12 wire or clip-on connectors can be used)
- Toggle boss is round to simplify panel mount
- Trip-free handle action
- Trip point unaffected by temperature
- Life in excess of 10000 operations

WESCON BOOTHS 2719-2720



Phone 228-4600 (301)

TWX 301 228-3558

CAMBRIDGE DIVISION • CAMBRIDGE, MARYLAND

New Components

a breakthrough in both size and cost in the programing switch area.

The unit is completely field adjustable. It measures only 3½ in. long by 2¾ in. wide by 3¼ in. high, controls up to 10 circuits, and features 60 independent program positions.

Price, complete with timing motor is \$65, and less in quantities.

■ To be introduced at Wescon.
Sealectro Corp., 225 Hoyt St., Mamaroneck, N.Y., 10543. [356]

Interconnect system for subassemblies

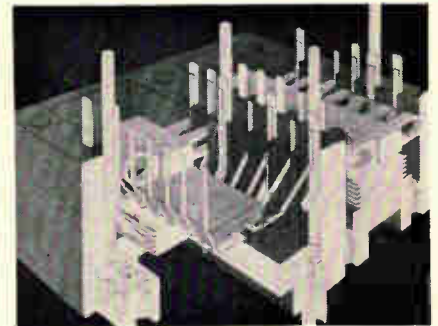

As many as 20 flatpacks and 14 layers of interconnect wiring can be packaged in 1.2 cubic inches with the Omni-Comb interconnection system. The system consists of five basic off-the-shelf parts that can be combined in a prototype or production stage to produce analog or digital subassemblies in practically infinite variety.

Molded diallyl phthalate carrier, as the structural body, contains Kovar or copper interconnecting combs, a hermaphroditic external connector and its insulator, and semirigid retaining clip. Both integrated circuits and discrete components can be soldered or welded into the carrier for a permanent connection. The package is 0.300 by 0.950 by 4.00 inches and can be plugged or dip-soldered onto a parent board.

The Omni-Comb system is available immediately in a kit, with instructions and special tools for prototype or quantity production.

■ To be introduced at Wescon.
Elco Corp., Willow Grove, Pa., 19090. [357]

These New MOTOROLA PNP Silicon Power Transistors can be plugged right into your present High-Current Sockets!

They're Rated Up To 10 Amperes and 150 Watts . . . which is the highest power rating presently available for PNP silicon devices.

They Are Thermally Stable . . . junction operating temperature range of from -65°C to $+200^{\circ}\text{C}$

They Are Fast Switching . . . $f_T = 4 \text{ Mc}$

They Display Low-Leakage Currents At High Temperatures . . . 10 mA @ 150°C

All Safe Area Limits Are Specified

YOU GET ALL THESE BENEFITS . . . AT A PRICE THAT MAKES PNP SILICON POWER TRANSISTORS ECONOMICALLY PRACTICAL FOR YOUR IMMEDIATE APPLICATION!

You won't need a key to Fort Knox to use these Silicon Power Transistors in your new designs, or to substitute them for equivalent Germanium units (where higher temperature stability, faster switching and lower leakage current will improve your overall circuits' performance).

THEY'LL OUTPERFORM ANY POWER TRANSISTORS YOU'VE PREVIOUSLY USED

. . . A brash claim? Just check the basic specs listed below, then call your franchised MOTOROLA distributor for evaluation units. He has them in stock now, available for immediate delivery.

ELECTRICAL RATINGS (TO-3 CASE) — P_D @ $T_c = 25^{\circ}\text{C}$ — 150 WATTS

Type No.	I_C (max) Amps	V_{CE0} (volts)	h_{FE} @ $I_C = 1\text{A}$	$V_{CE(sat)}$ max. (volt)
2N3789	10	60	25-90	1 @ 4 A
2N3790	10	80	25-90	1 @ 4 A
2N3791	10	60	50-150	1 @ 4 A
2N3792	10	80	50-150	1 @ 4 A

$f_T = 4 \text{ Mc}$

MEDIUM POWER DRIVER (TO-66 CASE) P_D @ $T_c = 100^{\circ}\text{C}$ — 10 WATTS

			h_{FE} @ $I_C = 250 \text{ mA}$	
MJ2253	1	60	20-100	0.6 @ 1 A
MJ2254	1	80	20-100	0.6 @ 1 A

$f_T = 2 \text{ Mc}$

Plug-Them-In and see for yourself why MOTOROLA PNP Silicon, 10 Ampere, Power Transistors are the just right answer to your need for Performance At A Reasonable Price!



MOTOROLA
Semiconductors

BOX 955, DEPT 59 • PHOENIX, ARIZ 85001

"Visit Motorola's WESCON Booth #3122-3125!"



FET amplifies at 500 Mc

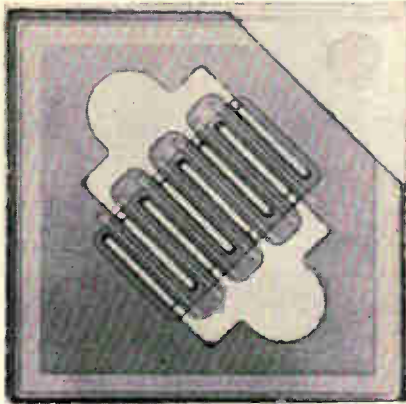

Until six months ago, the highest frequency at which a field-effect transistor could operate as an amplifier was 300 megacycles per second. To overcome this 300-Mc barrier, Texas Instruments Incorporated engineers investigated several geometries which could produce higher transconductance-to-capacitance ratios. They found that interdigitated geometry, in conjunction with epitaxially deposited junction areas, met the requirements, and combined these two techniques in the 2N3823.

This n-channel device combines the inherent advantages of FET structure—low noise, high input impedance, excellent cross modulation performance and low leakage current—with useful power gain up to 500 Mc.

The spot noise figure for the 2N3823 is typically 1.5 db at 100 Mc, 2 db at 200 Mc, and 3.5 db (4.5 db maximum) at 500 Mc. The 2N3823 has a cross-modulation of 1% for a one-millivolt signal at 200 Mc and for a 200-millivolt signal at 150 Mc.

The 2N3823 is available in a 4-lead TO-18 package. A matched-pair version is also available in a TO-5 case; this device is designated the TIS25-27. The device has interchangeable drain and source leads, so that it can be used in high-speed multiplex and sample-hold circuits and can replace older devices with nonstandard lead configurations. Typical applications are in uhf and vhf mixers, f-m tuners, if-rf amplifiers and low-

noise wideband amplifiers.

TI is currently in volume production on both new FETs. They will be introduced at Wescon.

Specifications

Typical power gain:	
at 200 Mc and 10-Mc bandwidth	16 db
at 500 Mc and 5-mc bandwidth	11 db
Transconductance	3,500 to 6,000 umhos
Typical input capacitance	4.8 pF
Typical leakage current	10 picoamperes
Price:	
1-99 units, each	\$12.90
100-999 units, each	\$8.60

Texas Instruments Incorporated, P. O. Box 5012, Dallas, Texas. [371]

Avalanche-type bridge rectifiers

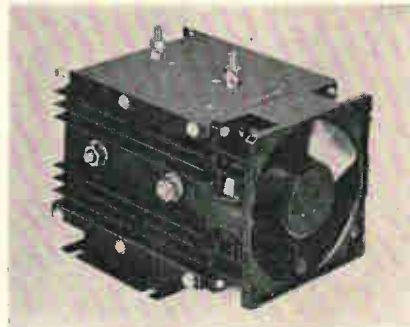

A series of single- and three-phase bridge rectifiers is announced. All rectifiers used in the assemblies have avalanche characteristics for improved reverse characteristics and maximum overvoltage capability.

Over 100 different units provide current ratings from 12 to 67.5 amps in convection cooled types and 70 to 500 amps in forced air cooled units. The single-phase bridges are for use in power supplies with from 30 to 360 v d-c output, and the 3-phase bridges for 45 to 560 v d-c output.

Size ranges from approximately 2 $\frac{3}{8}$ in. by 3 in. by 5 in. in a 15-amp bridge to 6 $\frac{1}{2}$ in. by 10 $\frac{1}{2}$ in. by 12 in. for a 500-amp bridge. Efficient convection or fan cooling combined with conservative rectifier design



DELCO RADIO SEMICONDUCTORS AVAILABLE AT THESE DISTRIBUTORS

EAST

BINGHAMTON, N. Y.—Federal Electronics
P. O. Box 1208/PI 8-8211
PHILADELPHIA 23, PENN.
Almo Industrial Electronics, Inc.
412 North 6th Street/WA 2-5918
PITTSBURGH 6, PENN.—Radio Parts Company, Inc.
6401 Penn Ave./361-4600
NEWTON 58, MASS.—Greene-Shaw Company
341 Watertown Street/WO 9-8900
CLIFTON, N. J.—Eastern Radio Corporation
312 Clifton Avenue/471-6600
NEW YORK 36, N. Y.—Harvey Radio Company, Inc.
103 West 43rd Street/JU 2-1500
BALTIMORE 1, MD.—Radio Electric Service Company
5 North Howard Street/LE 9-3835

SOUTH

BIRMINGHAM 5, ALA.
Forbes Distributing Company, Inc.
2610 Third Avenue, South/AL 1-4104
WEST PALM BEACH, FLA.—Goddard, Inc.
1309 North Dixie/TE 3-5701
RICHMOND 20, VA.—Meridian Electronics, Inc.
1001 West Broad Street/353-6648

MIDWEST

BATTLE CREEK, MICH.—Electronic Supply Corporation
94 Hamblin Ave./P. O. Box 430/965-1241
INDIANAPOLIS 25, IND.
Graham Electronics Supply, Inc.
122 South Senate Avenue/ME 4-8486
CLEVELAND 1, OHIO—The W. M. Pattison Supply Co.
Industrial Electronics Division
777 Rockwell Avenue/621-7320
CHICAGO 30, ILL.—Merquip Electronics, Inc.
4939 North Elston Avenue/AV 2-5400
CINCINNATI 10, OHIO—United Radio, Inc.
7713 Reinhold Drive/241-6530
KANSAS CITY 11, MO.—Walters Radio Supply, Inc.
3635 Main Street/JE 1-7015
ST. LOUIS 17, MO.

Electronic Components for Industry Co.
2605 South Hanley Road/MI 7-5505

WEST

DALLAS 1, TEXAS—Adleta Company
1907 McKinney Ave./RI 2-8257
HOUSTON 1, TEXAS—Harrison Equipment Company, Inc.
1422 San Jacinto Street/CA 4-9131
SAN DIEGO 1, CAL.
Electronic Components of San Diego
2060 India Street, Box 2710/232-8951
LOS ANGELES 15, CAL.—Radio Products Sales, Inc.
1501 South Hill Street/RI 8-1271
LOS ANGELES, CAL. 90022—Kierulff Electronics
2585 Commerce Way/OV 5-5511
MOUNTAIN VIEW, CAL.—Kierulff Electronics
2484 Middlefield Road/968-6292
DENVER, COLO.—L. B. Walker Radio Company
300 Bryant Street/WE 5-2401
SEATTLE 1, WASH.—C & G Electronics Company
2600 2nd Ave./Main 4-4354
PHOENIX, ARIZ.—Midland Specialty Co., Inc.
1930 North 22nd Ave./258-4531
ALBUQUERQUE, N.M.—Midland Specialty Co., Inc.
1712 Lomas Blvd., N.E./247-2486
TUCSON, ARIZ.—Midland Specialty Co., Inc.
951 South Park Ave./MA 4-2315

Ask for a complete catalog

DELCO RADIO

DIVISION OF GENERAL MOTORS • KOKOMO, INDIANA

Get ready to change your thinking about high energy circuits.



Now you can operate directly from rectified line voltage, reduce current, use fewer components, improve efficiency. All with Delco Radio's new 400V silicon power transistors—DTS 413 and DTS 423. And they're priced low—less than 3¢ a volt even in sample quantities.

A wealth of applications are possible. Vertical and horizontal TV outputs, for instance. High voltage high effi-

RATINGS	DTS 413	DTS 423
VOLTAGE		
V _{CEO}	400 V	400 V
V _{CEO} (Sus)	325 V (Min)	325 V (Min)
V _{CE} (Sat)	0.8 (Max)	0.8 (Max)
	0.3 (Typ)	0.3 (Typ)
CURRENT		
I _C (Cont)	2.0A (Max)	3.5A (Max)
I _C (Peak)	5.0A (Max)	10.0A (Max)
I _B (Cont)	1.0A (Max)	2.0A (Max)
POWER	75 W (Max)	100 W (Max)
FREQUENCY RESPONSE		
f _t	6 MC (Typ)	5 MC (Typ)

See applications for these and other Delco semiconductors at WESCON booths 1313-1314

ciency regulators and converters, single stage audio outputs, to name a few more.

And our standard TO-3 package dissipates more heat (junction to heat sink 1.0°C per watt).

Your Delco Radio Semiconductor distributor has these two new 400V silicon power transistors on his shelf. Call him today for data sheets, prices and delivery.

FIELD SALES OFFICES

UNION, NEW JERSEY*
Box 1018 Chestnut Station
(201) 637-3770
SYRACUSE, NEW YORK
1054 James Street
(315) 472-2668

DETROIT, MICHIGAN
57 Harper Avenue
(313) 873-6560
CHICAGO, ILLINOIS*
5151 N. Harlem Avenue
(312) 775-5411

SANTA MONICA, CALIFORNIA
726 Santa Monica Blvd.
(213) 870-8807
General Sales Office:
700 E. Firmin, Kokomo, Ind.
(317) 452-8211—Ext. 500

*Office includes field lab and resident engineer for applications assistance.

DELCO RADIO

Division of General Motors
Kokomo, Indiana

RMC

HIGH STABILITY, TYPE JE

DISCAPS

are Practically Immune to Severe Temperature Change

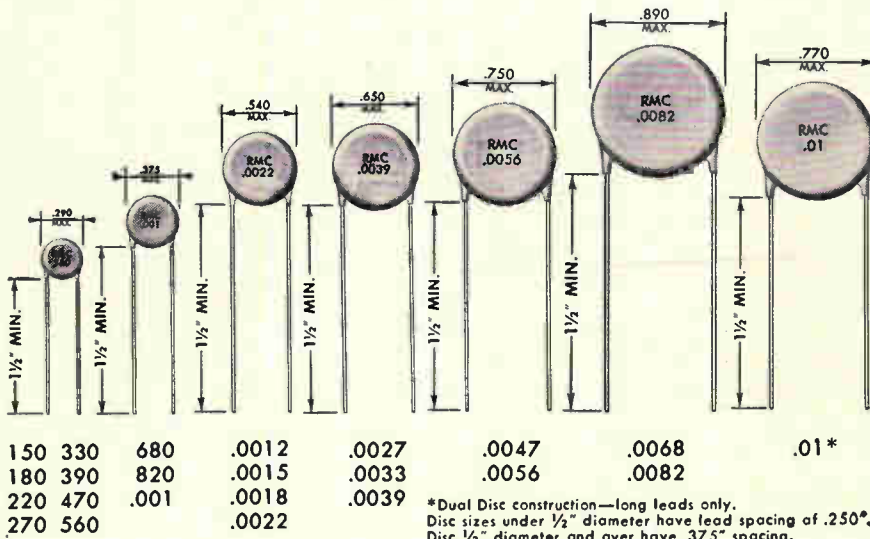

Specifications

CAPACITANCE: Within tolerance @ 1KC and 25°C.

CAPACITANCE TOLERANCES: +10%, +20% or +80 - 20%

WORKING VOLTAGE: 500 VDC

POWER FACTOR: 2.0% @ 1KC

INSULATION RESISTANCE: Greater than 7500 Megohms @ 500 VDC

TEMPERATURE COEFFICIENT: Z5E, Y5E

FLASH TEST: 1250 VDC for one second

LIFE TEST: Per EIA RS-198 Class II

POWER FACTOR AFTER HUMIDITY: 3.0% @ 1KC

INSULATION RESISTANCE AFTER HUMIDITY: Greater than 1000 Megohms @ 500 VDC

BODY INSULATION: Durez phenolic -- vacuum wax impregnated

LEAD STYLES AVAILABLE: Long lead - #22 tinned copper -, fin-lock, kinked lead plug-in and pin type plug-in

RMC Type JE Discaps exhibit only $\approx 4.7\%$ capacitance change over the extended -30° to $+85^\circ\text{C}$ temperature range. These capacitors are especially suited for use in mobile communication and like equipment. Typical usage in R-C response shaping networks and feedback loops, in addition to conventional applications, is indicated.

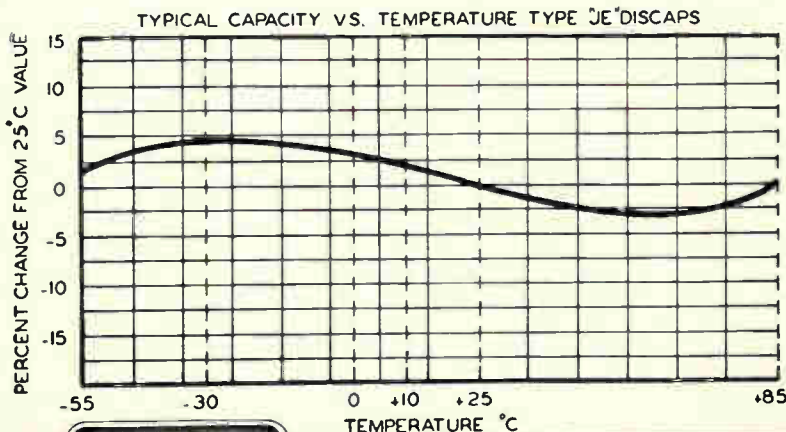

DISCAP CERAMIC CAPACITORS

RMC

RADIO MATERIALS COMPANY
A DIVISION OF P. R. MALLORY & CO., INC.
GENERAL OFFICE: 4242 W. Bryn Mawr Ave., Chicago 46, Ill.
Two RMC Plants Devoted Exclusively to Ceramic Capacitors
FACTORIES AT CHICAGO, ILL. AND ATTICA, IND.

New Semiconductors

permits these assemblies to be rated at full output at 50°C , providing a maximum margin of safety.

▪ To be introduced at Wescon.
Sarkes Tarzian Inc., 415 N. College Ave., Bloomington, Ind. [372]

Whiskerless zener in miniature package

A whiskerless zener, now available, is one-tenth the size of a standard DO-7 package. The glass-body unit with hermetic seal is designed to meet or exceed environmental requirements of MIL-S-19500B.

The first zeners in the current line will be rated up to 500 milliwatts and are characterized by low dynamic impedance and low leakage ($0.01 \mu\text{a}$). Other characteristics include voltages to 100 v with excellent regulation, reverse current is $0.05 \mu\text{a}$ at 25 v, and zener impedance is 46 ohms.

▪ To be introduced at Wescon.
Transitron Electronic Corp., 168 Albion St., Wakefield, Mass. [373]

Diffused junction diodes mounted in heat sinks

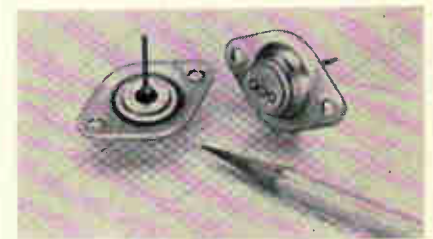

A series of diffused-junction, 25-amp silicon power diodes are mounted in heat sinks identical to the TO-3 case configuration, yet are competitive in price to unmounted press-fit diodes. Designated P50S through P400S, the diodes are rated 25 amps output at 100°C in piv ratings from 50 to 400 v, and are available in forward or reverse polarity.

The TO-3 configuration permits mounting to printed-circuit boards, chassis or additional heat sinks by drilling three small holes, compared with the complex method of drilling large, precision holes in

What's Wrong With This Circuit?

Object: To turn lamp on and off from several remote locations.

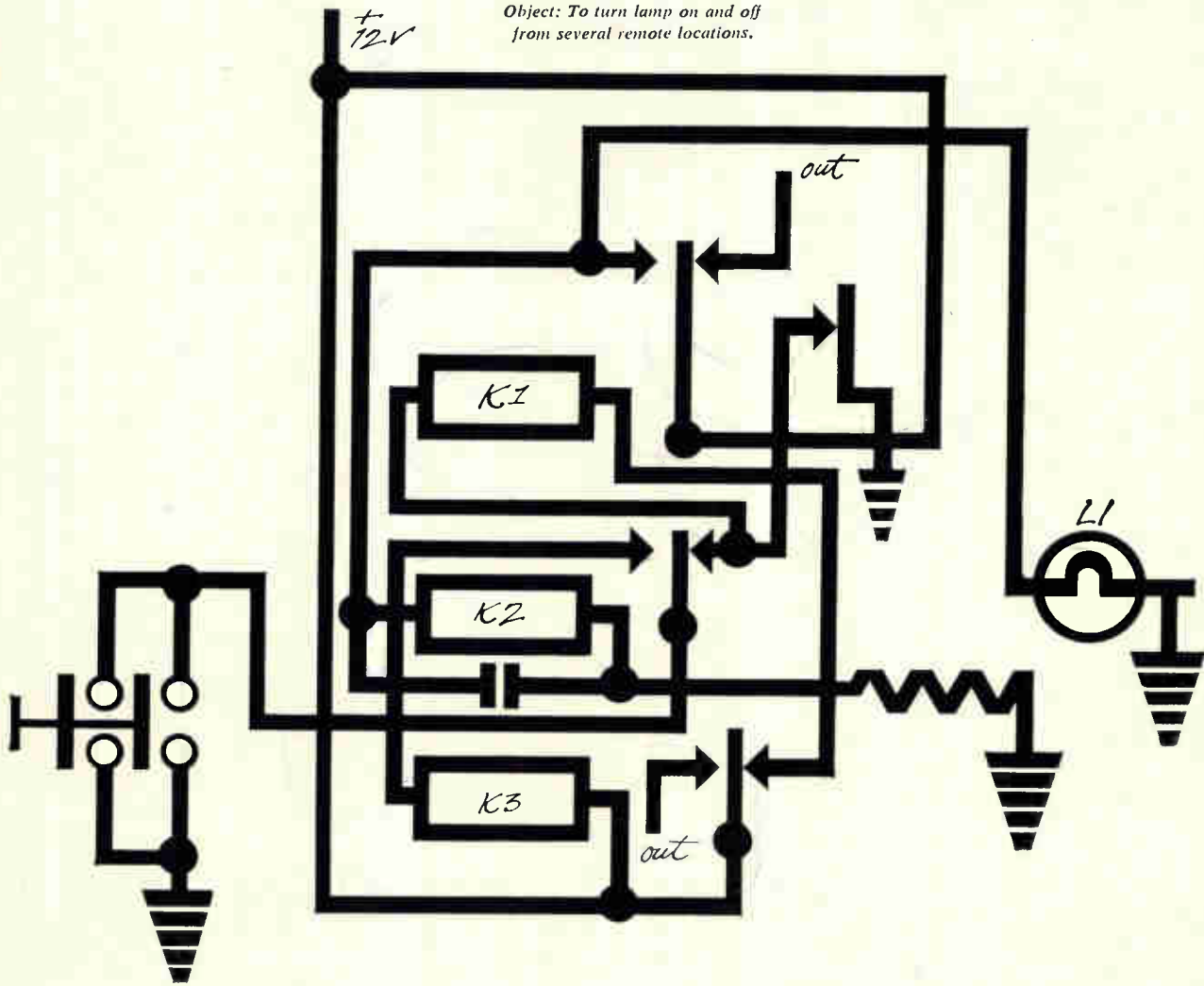

Enter The Big Leach Wescon Circuit Contest

So you think you're a circuit expert! Well here's your chance to prove it. Gain Fame! Astound your colleagues! Find happiness! We've designed 10 circuits, deliberately calculated to challenge your analytical ability. To test your perception. Each contains a major error. Some are fairly obvious. Others maddeningly subtle. All, without exception, are wrong. You can study the circuits at the Leach Exhibit No. 2307-2308 at WESCON and pick up your entry form. While you're there, you'll probably be interested in hearing about our 5 new sub-miniature relays and three new power contractors. Find and define the errors in all 10 circuits. Send us the results of your deliberations by October 1st, 1965. You'll win the Universally Coveted Leach Achievement Certificate. You can frame it, cover a crack in your office wall or even wrap a small sandwich in it. How about that? WIN this handsome document as evidence of your superior circuit analysis prowess: If you're not going to WESCON, this handy coupon will get you a contest Entry Form by return mail.



PLEASE SEND ME MY
CIRCUIT CONTEST
ENTRY FORM

Name _____

Company _____

Street _____

City _____ State _____

(and hurry!)

LEACH CORPORATION

RELAY DIVISION: 5915 Avalon Boulevard, Los Angeles 3, California. Phone: (213) 232-8221 Export: LEACH INTERNATIONAL, S.A.

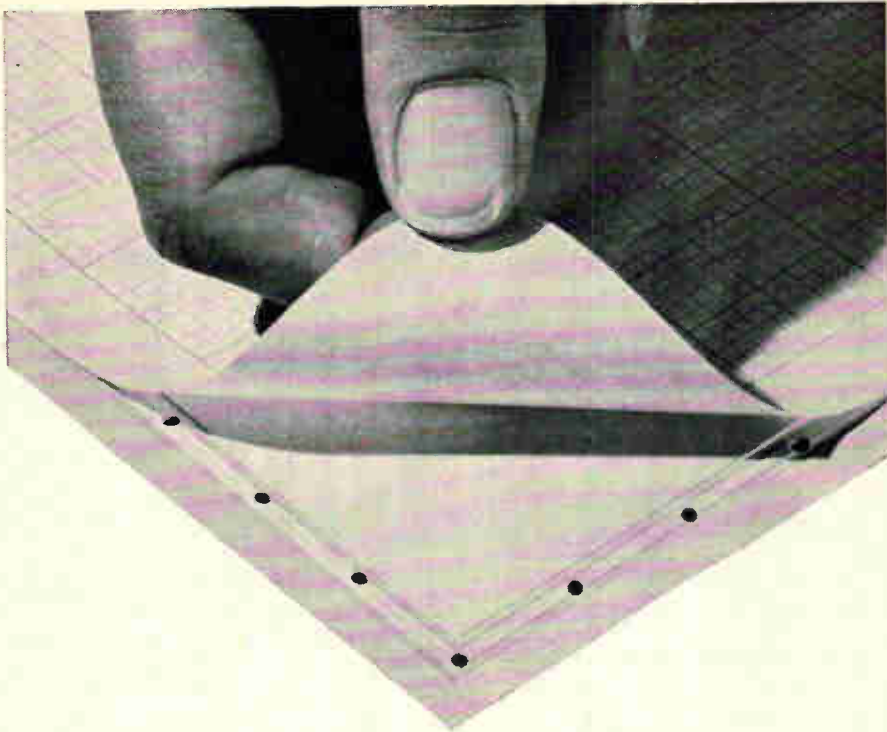

IN X-Y PLOTTERS IT'S THE HOLD-DOWN (GRAPH PAPER, THAT IS) THAT COUNTS

Paper hold-down is an important element in your plotter... graph paper, that is... not stamps, business cards, etc.

Our new low-pressure vacuum hold-down system was designed with just this requirement in mind. No clog... no dust or dirt problems... maintenance free operation. This system holds your graph paper effectively, and it will perform efficiently at sea level or on any mountain you pick.

There are varied approaches to this problem; all good, depending on what you want to hold. We chose our low-pres-

sure system because it is the most reliable, most economical method of securing standard graph paper. Your graphic output is our business, and we pay particular attention to see that only the pen moves on PLOTAMATIC plotters.

Check our complete line of PLOTAMATIC* X-Y Plotters for your applications... 8½" x 11" and 11" x 17" models, to 16 d-c input, greater recording periods and plotting rates, continuously variable time sweeps and that new paper hold-down system we've been talking about. Write or call for immediate information.

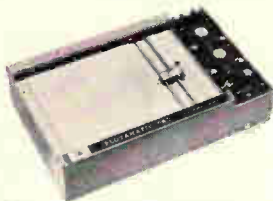

PLOTAMATIC Model 690



PLOTAMATIC Model 800A



PLOTAMATIC Model 850, with exclusive Symbol Printer

DATA EQUIPMENT COMPANY
DIVISION OF BBN CORPORATION (DELAWARE)
2126 South Lyon Street, Santa Ana, California 92705
Tel: (714) 546-5300 TWX: 714 546-0437



SEE OUR NEW PLOTAMATICS
IN ACTION AT
WESCON BOOTH NO. 3610.

*T.M. DATA EQUIPMENT CO.

New Semiconductors

thick heat dissipators to accept press-fit diodes. The manufacturer says its controlled-press-fit technique for mounting the diodes to the TO-3 heat sink assures a perfect fit, eliminates the possibility of diode damage inherent in other methods, and provides a short, efficient thermal path from crystal to heat dissipator.

Price is 45 cents to \$1.56, depending upon piv rating and quantity. Alpha Components Corp., 4222 Glencoe, Venice, Calif. [374]

High-voltage rectifiers with fast recovery



Series 7701X diffused silicon rectifiers is in production, featuring high voltage and fast recovery time. Piv ratings are 2 to 20 kv with a guaranteed reverse recovery time of 300 nsec maximum at forward current of 2 ma and reverse current of 2 ma.

The epoxy-encapsulated package provides a dielectric strength of 400 volts per mil and an electrical insulation resistance of 3×10^{12} ohms at 95°C and 95% relative humidity. Tinned copper leads allow easy soldering with high electrical and thermal conductance. Varo Inc., 2201 Walnut St., Garland, Texas, 75041. [375]

Silicon glass diodes can deliver 6,000 v

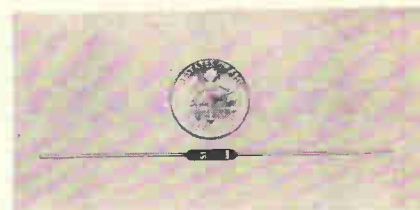

A line of silicon glass diodes combines low junction capacitance (0.2 pf) with low inverse leakage

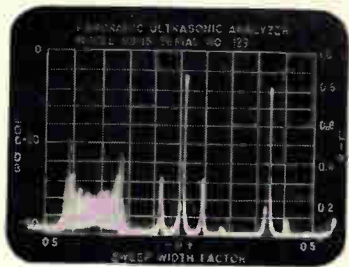

Analyze signals with Confidence 0.5 cps to 75 gc

Panoramic[®] Spectrum Analyzers — instruments you can use with *confidence!* Built into each is a tradition of pioneering in swept band analysis which began when the first *Panoramic* analyzer made history more than twenty-five years ago! Since then, you've come to expect from *Panoramic* instruments the most advanced techniques in spectrum analysis — and *proven* instrumentation.

Cover the Spectrum with Confidence — illustrations at right are typical of more than 75 versatile *Panoramic* instruments providing the widest selection of performance features. This unequalled choice enables you to exercise the most exacting criteria in selecting equipment to meet your most critical needs.

Analyze with Confidence and Convenience — with these proven features: "quick-look" wideband log scan, stable narrow band analysis, automatic optimized resolution, *directly-calibrated* CRT, self-checking calibrations, built-in chart recorder — and the special capabilities of filter response plotting, and spectral density systems for random signal measurements, assure you of graphic, precise analysis of virtually any signal.

Plug In with Confidence — the new *Panoramic* TA-2, modularized, battery or ac-operated, spectrum analyzer with unique design integrity from input to readout. Interchangeable plug-in modules provide rapid signal measurements — sonic through RF. The analyses are rock-stable and *directly-calibrated* on exceptionally bright, highly-persistent CRT display. The portable TA-2 (or the rack mount RTA-5) are advanced analyzers you can use in the laboratory or for on-the-spot field testing — *with confidence!*

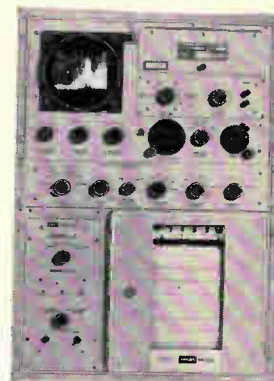

Sonic Spectrum Analysis
5 cps to 22,500 cps



Audio through RF Spectrum Analysis
200 cps to 25 mc

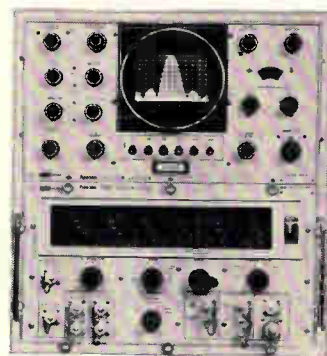

HF • VHF • UHF • Microwave Analysis
10 mc to 75 gc



FOR DETAILED
INFORMATION
ON OVER 100
INSTRUMENTS
WRITE FOR ...

New Panoramic[®] Catalog P-51

For additional information contact your local sales representative or Metrics Application Specialist.



THE SINGER COMPANY
METRICS DIVISION

915 PEMBROKE ST., BRIDGEPORT, CONNECTICUT
PHONE (203) 366-3201 • TWX 710-453-3483

Design and production of PANORAMIC • SENSITIVE RESEARCH • EMPIRE • GERTSCH Instruments for measurement

P-65-9



FEATURES:

- Inherently rugged
- Long operating life
- Reliable operation
- High resolution
- Wide spectral range
- Variable scan rate
- No information storage
- Wide dynamic range
- Multiple scan modes
- Fast turn-on time
- Low power requirements
- Minimum image distortion
- No raster burn-in
- Long shelf life

ITT IMAGE DISSECTORS—Type F-4011 Vidisector is the latest in ITT's growing family of image dissectors which provide wide spectral response from near infrared to far ultraviolet.

Resolves 1500 TV lines for outer space and industrial applications

Here's a new line of high-resolution image dissectors developed by ITT Industrial Laboratories for a wide variety of applications ranging from electronic star trackers to flaw detectors for industrial process control, from electronically-scanned spectrometers to slide projector readers.

The resolution of these rugged TV camera tubes approaches the theoretical limit for their type—over 1500 lines per inch at 20% signal amplitude, 1000 lines per inch at 50% signal amplitude. ITT Vidisectors operate with standard commercial focusing and deflection coil systems.

And, because ITT Vidisectors do

not store information, the scan rate and raster size can be varied as desired. For the same reason, these tubes do not have to remain stationary during the total frame time to achieve full resolution.

ITT Industrial Laboratories offers a family of three basic image dissectors with 1-inch, 1½-inch and 4½-inch diameters. They can be readily modified to fit a wide variety of applications. We will be happy to work with you on specific applications problems.

For complete information on ITT Vidisectors, write or telephone Industrial Laboratories Division, International Telephone and Telegraph Corporation, 3700 East Pontiac Street, Fort Wayne, Ind.

industrial laboratories division



New Semiconductors

characteristics (5 ma at 6,000 v). Reverse recovery time is 0.2 μ sec. Maximum forward current rating is 25 ma for the 6,000-v series to 50 ma for the 1,000-v series. Included in the wide variety of applications are laser power supplies, pulse detectors and infrared power supplies.

Construction features include a fused glass hermetic seal for high reliability under extreme environmental conditions. The units are 0.4 in. long and 0.115 in. in diameter. This size, and weight of ¼ gram, make the device suitable for airborne applications. The glass body is fully insulated. Leads are of gold-plated dumet.

Semicon Inc., Box 328, Sweetwater Ave., Bedford, Mass., 01730. [376]

One-watt zener diodes occupy 0.0016 cu. in.

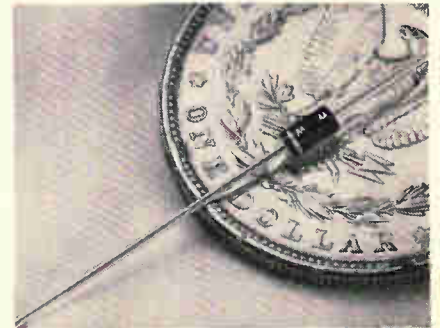

A one-watt zener diode occupies only 0.0016 cubic inches (about the size of a ¼-watt diode) and is priced below one dollar. The IN4728-64 zener series has a 1-w rating at 50°C ambient and is capable of up to 3 w with heat sink. The devices are available in voltages from 3.3 to 100 v in standard tolerances of $\pm 5\%$ and $\pm 10\%$.

Units feature silicon oxide-passivated dice and silver leads for cooler, more reliable operation. Nail-head lead construction makes them able to withstand high shock and acceleration levels as well as high current surges during overload conditions.

The Surmetic encapsulation is self-insulating and consists of void-free, flame-proof silicone polymer plastic material. This package



TOUGH, LOW-LOSS MIL-P-17091 POLYAMIDE IN

17 DIFFERENT TYPE CONNECTORS (COUNT 'EM)

PICK THE APPLICATION JOHNSON HAS THE CONNECTOR!

Tough, low-loss line of high voltage connectors offers design features that are important to you! Complete line includes jacks, binding posts and solderless plugs for most commercial and military applications—the choice of engineers everywhere! Johnson connectors are highly resistant to extremes of shock, vibration, temperature and moisture. Other features: Voltage breakdowns to 12,500 volts DC; shockproof polyamide construction in 10 attractive colors; functional design and precision production techniques for top quality at low cost! Write today on company letterhead for sample and complete information.

1. Solderless Banana Plug 2. Deluxe Tip Jack 3. Standard Metal Clad Tip Jack 4. Solderless Tip Plug 5. Standard Tip Jack 6. Jack and Sleeve Assembly 7. Heavy Duty Binding Post 8. Military Metal-Clad Tip Jack 9. Set Screw Banana Plug 10. Rapid-Mount Tip Jack 11. Banana Jack 12. Solderless Dual Banana Plug 13. 15 Amp. Binding Post 14. Sub-Miniature Long Handle Tip Plug 15. Sub-Miniature Vertical Jack 16. Sub-Miniature Tip Plug 17. Sub-Miniature Horizontal Jack.

Designed for Printed Circuit Use! Miniature tip jacks are available in horizontal and vertical types—provide easy access and positive electrical contact. 5 amps. maximum current carrying capacity. Operating voltage is 1500 volts RMS at sea level; 350 volts RMS at 50,000 ft. Contact resistance is less than 2 milliohms. Capacitance between two adjacent jacks is less than 1 mmf. at 1 MC. Available in 10 colors



WRITE FOR CATALOG 984!
Complete specification and prices on all Johnson electronic components.



E. F. JOHNSON COMPANY

3009 Tenth Ave. S.W. • Waseca, Minnesota 56093

HERE'S WHY*

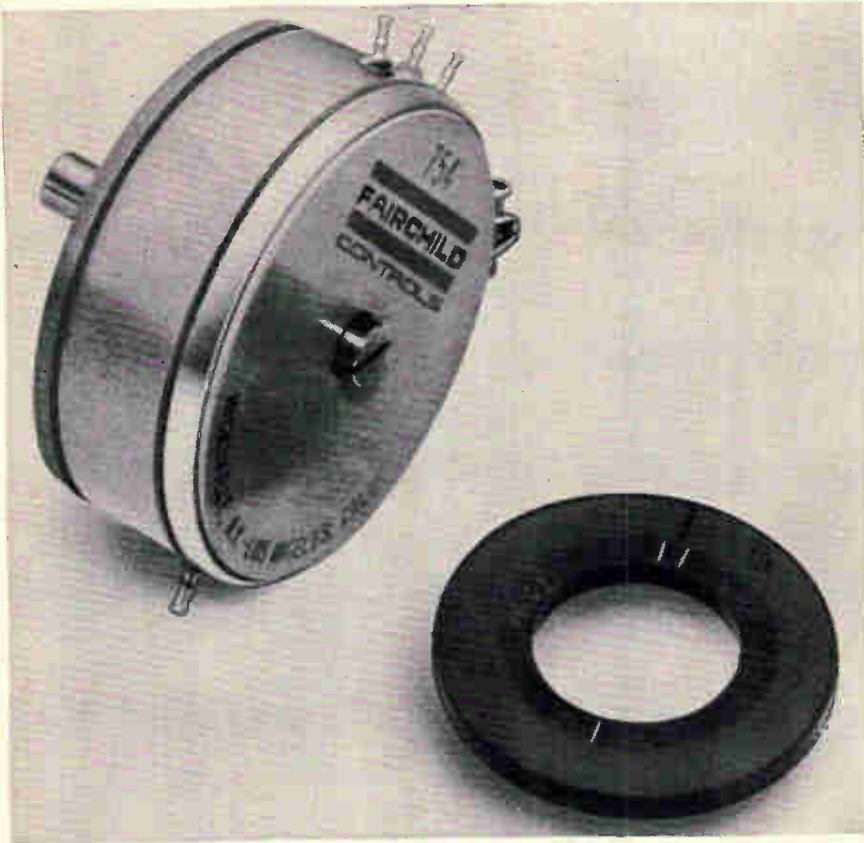

FAIRCHILD CONDUCTIVE PLASTIC POTENTIOMETERS ARE BETTER!

- * Over 20 years experience making precision linear and non-linear potentiometers.
- * Exclusive co-molding process using proprietary materials and methods assures superior life, low noise, HIGH HUMIDITY PERFORMANCE, extreme temperature operation, radiation proof—
 - Life—1/4 billion revolutions at 600 rpm
 - Low Noise—Exceeds MIL-R-39023 requirements over life
 - Humidity—95-100% RH at +71°C for 240 hours
 - Temperature—Can sustain -320°F and +300°F for 50 hours and cycling, without failure or degradation
 - Radiation—Integrated fast thermal neutron flux ($E > .3\text{MEV}$) for 100 hours—no substantial degradation of performance
- * Exceptional physical environmental characteristics—
 - Vibration—15 G's, 10-2000 cps; Acceleration—50 G's;
 - Shock 50 G's, 11 ms
- * Complete line availability—linears, non-linears, sine-cosines, standard and ultra-short cup lengths. Sizes from 7/8" through 3".

Whether you're designing a new system or seeking a replacement potentiometer, you can be assured of a BETTER potentiometer—Wirewound or Conductive Plastic, from FAIRCHILD.

Send for complete data today and for test reports, please write on company letterhead.

FAIRCHILD
CONTROLS
A DIVISION OF FAIRCHILD CAMERA AND INSTRUMENT CORPORATION
225 PARK AVENUE, HICKSVILLE, L. I., NEW YORK
TELEPHONE: (516) 938-5600 • TWX: (516) 433-9146
CABLE: FAIRCON-HICKSVILLE, NEW YORK, U. S. A.

New Semiconductors

meets all military environmental specifications, according to the manufacturer.

Motorola Semiconductor Products, Inc.
Box 955, Phoenix, Ariz., 85001. [377]

Integrated choppers limit offset voltage

A dual-emitter chopper has been developed for designers who require the lowest possible offset voltage. It is said to improve on the specifications of the ST5610 series announced earlier this year.

Offset voltage is limited to 10 μV , dynamic resistance to 25 ohms, tracking to 0.2 μV per degree centigrade from 0° to 100°C, and minimum BV_{FE} is 20 v. Channel-stopping guard rings, metal over oxide covering the emitter junction, and all-aluminum wire bonding provide stability and reliability.

The 3N120 is immediately available in four-lead TO-18 packaging, and can also be made available in a variety of standard or custom packages. Availability is off-the-shelf. Price in quantities of 1 to 99 is \$24 apiece; 100 to 999, \$16 each. Transatron Electronic Corp., 168 Albion St., Wakefield, Mass. [378]

High-reliability zener diodes

A line of 50-watt zener diodes, the 50T series, provides 35 voltage ratings from 6.8 to 200 v. The manufacturer describes the units as having unusually large junctions and lower impedance in the avalanche region for increased reliability.

The zeners are in hermetically sealed stud-mounting cases which are 0.425 in. in diameter. The large 1/4-28 stud and 9/16-in. hex base effectively conduct heat away from the junction to the heat sink.

Pricing is said to be from 9% to 18% less than comparable zeners; all voltage ratings from 6.8 to 200 v d-c are the same price. Tolerances of 5%, 10% and 20% are available. Prices range from \$4.80 to \$5.80 on 100 lots, depending on tolerance.

Sarkes Tarzian Inc., 415 North College Ave., Bloomington, Ind. [379]

DEEP SPACE AT "GROUND ZERO"

When NASA's astronauts board their Gemini spacecraft it will be with the feeling of old hands at familiar jobs. Even ground crews will operate with the facility of seasoned experts. This is the way it must be, even though it will be a first for both men and machines—each person, each system functioning in unison.

McDonnell engineers designed and built the trainers and simulators for Gemini's orbital rendezvous missions as well as launch, orbital flight and reentry.

The Gemini Mission Simulator is one example of how the skills and facilities of McDonnell Electronics Division are applied to mirror desired situations through true simulation.

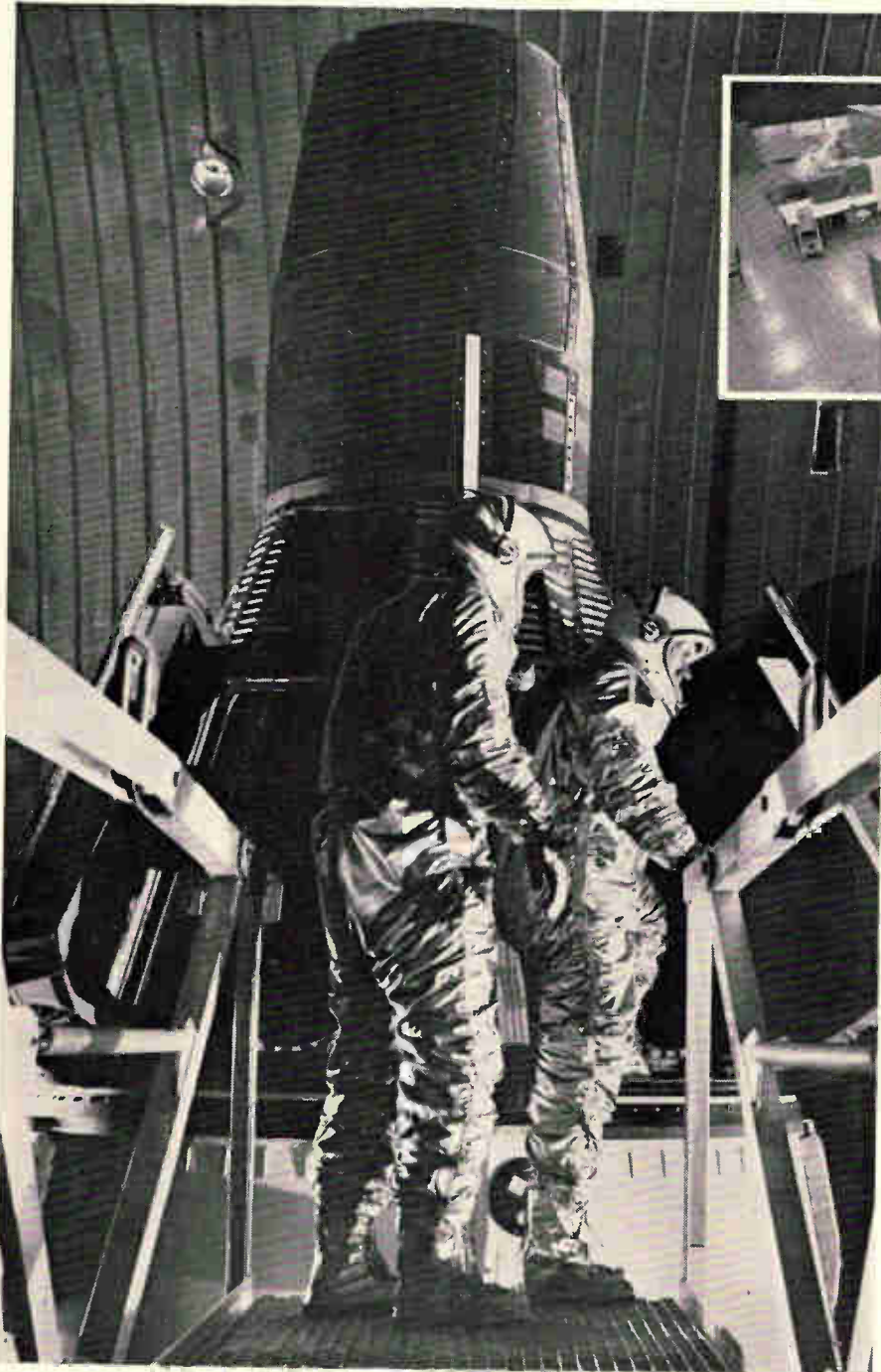

GEMINI MISSION SIMULATOR

Our brochure, "Skill in Electronics" will show you why McDonnell is a leader in end-mission related electronics such as Trainers and Simulators.

Write to:

MCDONNELL ELECTRONICS DIVISION

DEPT. 946 • BOX 516 • ST. LOUIS, MISSOURI 63166

APPLYING ELECTRONICS AS AN INTERDISCIPLINARY SCIENCE

HOW'S YOUR THERMISTOR IQ?

Want to learn more about these versatile, precision sensors? Here's FREE literature to help you.

CAPSULE THERMISTOR COURSE BOOK

Ten quick, painless lessons on precision thermistors, their characteristics, and how they are used. Illustrates basic thermistor circuits, compares thermistors with other sensors, gives typical circuit design calculations, etc.

Ask for F.E.I. CAPSULE THERMISTOR COURSE BOOK.



THERMISTOR FACT FOLDER



An illustrated booklet which describes various thermistor types, including F.E.I. ISO-CURVE* interchangeable thermistors, and how to apply them in measurement and control circuits.

Ask for F.E.I. THERMISTOR FACT FOLDER.

*MADE UNDER PAT. 3109227 AND OTHERS. ISO-CURVE IS A TRADEMARK OF F.E.I.

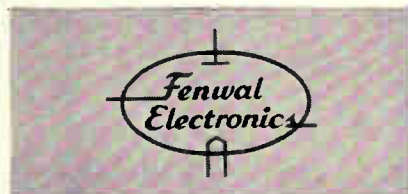

63 FOUNTAIN STREET, FRAMINGHAM, MASS.

New Instruments

Electrometer keeps high impedance off null



Precise voltage measurements from high impedance sources require a measuring instrument with an even higher input impedance. Available potentiometric electrometers and differential voltmeters have an input impedance characteristic which falls off when the meter is not at null, but Keithley Instruments of Cleveland will introduce at Wescon a new potentiometric electrometer that maintains a high input impedance at all times. The model 630 can be used to measure voltages from sources with impedances as high as 10^{10} ohms.

Keithley's new unit achieves this high input impedance with a guarded vibrating-reed null detector instead of the more common meter-isolation amplifier combination. This design approach results in an almost infinite impedance at null, 10^{15} ohms at 1% off null, and a minimum of 10^{13} ohms under any other condition (10^9 ohms is about the highest input impedance currently available). At this high impedance, the Keithley instrument draws negligible current, thereby avoiding loading and polarizing of the source. For example, at 0.5 volt off null, the model 630 draws only 0.05 picoampere.

The new instrument is self-contained, having its own potentiometer, voltage reference and null detector. D-c voltages can be measured to an accuracy of 0.01% between 300 millivolts and 500

volts, and within 30 microvolts from 1 to 300 millivolts. In addition, the instrument can be used as a direct reading voltmeter when extreme accuracy is not necessary. With an external precision resistor, the unit can be used to measure currents in the picoampere range.

The extremely high input impedance makes the model 630 ideal for measuring potentials from piezoelectric crystals, electrochemical cells, biological cells, pH electrodes, and other high impedance sources, the company says.

Certification traceable to the National Bureau of Standards is available.

Specifications

Range potentiometric	1.0 millivolts to 100 volts fullscale
voltmeter	0.5 to 500 volts full scale
Accuracy potentiometric	$\pm 0.01\%$ above 300 millivolts
voltmeter	$\pm 3\%$ of full scale
Size	5½" x 17½" x 13½"
Weight	24 pounds
Price	\$1575
Delivery	60 days

Keithley Instruments, 12415 Euclid Ave., Cleveland 6, Ohio [381]

Digital voltmeter has 4-unit resolution

The silicon series of digital voltmeters consists of four basic units with 11 different plug-in function heads. The four basic units provide accuracy of 0.05% of reading ± 1

DOUBLE-BARREL NEWSBREAK IN INFINITE-RESOLUTION POTENTIOMETERS



EXCLUSIVE
NEW PALIRIUM®
ELEMENTS—
PROVEN
TRIMPOT®
MODEL 224
MIL-SPEC
PACKAGE

NOW — INFINITE ADJUSTABILITY IN A 2-OHM POTENTIOMETER!

Now you can bring the convenience of infinite adjustability to applications that have always required an arduous fixed-resistance approach. The new TRIMPOT Model 3053, with its exclusive PALIRIUM film element, overcomes the problems in resolution and contact resistance that heretofore have made a low-resistance unit of this kind impossible. Stability of the infinite-resolution Model 3053 is outstanding, enhanced by an unusually low temperature coefficient and the time-proven Mil-Spec configuration of Bourns' famous TRIMPOT Model 224. This potentiometer should help you develop new circuit-design approaches.

Total resistance range:	2Ω to 200Ω
Resolution:	Infinite
Power rating:	½ W @ 70°C
Contact resistance variation:	3% or 1Ω max.
Temp. coefficient:	2Ω: -100 to +600 PPM/°C max. 5Ω: -100 to +400 PPM/°C max. 10Ω to 100Ω: -100 to +300 PPM/°C max.
Max. operating temperature:	175°C
Environmental stability:	2% resistance shift
Load life stability:	2% resistance shift

NOW — TWICE THE STABILITY IN RESISTANCES UP TO 1 MEGOHM!

At the other end of the scale, TRIMPOT Model 3052 offers you two to four times the stability of competitive high-performance potentiometers over the resistance range of 2K to 1 megohm. Like the companion low-resistance unit, Model 3052 features the approved Mil-Spec configuration of Bourns' high-temperature, humidity-proof Model 224. Its spec of 500 maximum applied volts is approximately 60 per cent better than that of other available units, and its total resistance tolerance of ±10% cuts the usual competitive figure in half. The new high-resistance, infinite-resolution element is also available in Model 3012 with the popular 1¼" x 5/16" x 1/4" package. The prices? Less than you've been paying!

Total resistance range, ohms:	2K to 1 Meg.
Resolution:	Infinite
Power rating:	1 W @ 70°C
Contact resistance variation:	2.5% max.
Temp. Coefficient:	25 to 175°C: ±100 PPM/°C max. +25 to -65°C: +100 to -300 PPM/°C max.
Max. operating temperature:	175°C
Environmental stability:	2% resistance shift
Load life stability:	3% resistance shift

AVAILABLE IMMEDIATELY FROM FACTORY STOCK AT COMPETITIVE PRICES.



ACTUAL SIZE

Write for latest TRIMPOT
potentiometer summary brochure.

TRIMPOT® means BOURNS — BOURNS means QUALITY

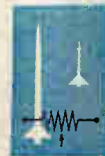

BOURNS

BOURNS, INC., TRIMPOT DIVISION
1200 COLUMBIA AVE., RIVERSIDE, CALIF.
PHONE 684-1700 · TWX: 714-682 9582
CABLE: BOURNSINC.

TRIMPOT is a registered trademark of Bourns, Inc.

NEW ELECTRONIC NANOVOLT NULL DETECTOR

Keithley simplifies
measurements
using high
accuracy
potentiometers
and bridges

Here's an all-new instrument created especially for sensitive potentiometers and bridges. The 147 electronic null detector gives you resolution of 0.01 microvolt with a 300 ohm source resistance; 0.003 microvolt with 10 ohms. Zero shift of less than 1×10^{-10} volt per ohm; drift under 25 nanovolts per day; and high line frequency rejection make the 147 a remarkable, universal replacement for even the finest galvanometer systems.

Electronic circuitry provides up to 100 microvolts of zero suppression and makes the 147 immune to mechanical vibrations. Overloads of 60 million times, at maximum sensitivity, are shrugged off in 20 seconds. It's a rugged, easy-to-use package requiring no auxiliary devices and—it works on line or battery.

The 147 is an ultra-sensitive voltmeter, too, with 2% full scale accuracy, an output voltage of 1 volt and a noise level of less than 3 nanovolts, peak-to-peak, on the most sensitive range.

Write today for more information and your free copy of "The Use of Keithley Null Detectors with High Resolution Potentiometers and Bridges".

MODEL 147 FEATURES

5000:1 ac input rejection
<15 nv zero shift with source resistance to 300 ohms
30 nanovolts (0.03 μ v) full scale sensitivity
180 db ac line frequency rejection
10¹⁰ ohms input isolation shunted by 0.001 μ fd

\$1275

OTHER KEITHLEY INSTRUMENTS

for null detector or microvoltmeter applications

MODEL	SENSITIVITY (μ v)	PRICE
148	0.01	\$1275
149	0.1	\$ 895
150A	1.0	\$ 750
151	100	\$ 490



**KEITHLEY
INSTRUMENTS**

12415 Euclid Avenue • Cleveland 6, Ohio

electrometers / differential voltmeters / picoammeters / calibration devices

New Instruments

count. The series 4,000 basic unit gives four-digit resolution with the accuracy of reading maintained over a 50°C range by a simple front-panel adjustment. Three different types of print-out capabilities are available to drive mechanical printers.

A variety of compatible plug-in heads are available, providing d-c voltage measurements from 0.1 to 1,000 v full scale. These heads are available in single or multiple-range models with manual or automatic ranging capabilities.

Series 4,000 digital voltmeters are packaged to fit into a standard 19-in. relay rack for systems applications; panel height is 5¼ in. Prices for a basic unit with one plug-in function head start at \$755; delivery is four weeks.

▪ To be introduced at Wescon.
Trymetrics Corp., 204 Babylon Turnpike, Roosevelt, N.Y. [382]

Digital phase meter has 0° to 360° range



Type 524A2 digital phase meter offers phase angle in degrees directly represented in four digits. Phase reading is independent of the ratio of signal amplitude. Analog or digital output is available for external recorder or programmable systems.

Also featured are no frequency adjustment over a wide range, from 20 cps to 500 kc; no ambiguity or instability in the vicinity of 0° or 360°; relative accuracy of $\pm 0.1^\circ$ (± 1 digit) for symmetrical waveforms of any shape.

This instrument can be used for plotting phase versus frequency of an unknown network from 20 cps to 500 kc, plotting envelope delay curve with r-f sweep oscillator, am-



RESISTOR PROVING GROUND: MOISTURE RESISTANCE

For 120 hours Stackpole resistors are drenched in 100% relative humidity at 66°C, in the toughest moisture resistance test the Industry can offer. Still they work perfectly. Such severe testing indicates the care and control that goes into the continual resistor development program. Additional tests are conducted to determine load life and noise

level. Maybe some aspect of our in-depth testing interests you. If so, let our resistor development engineer discuss it with you. Write or call: Don Kirkpatrick, Manager-Engineering, Electronic Components Division, Stackpole Carbon Company, St. Marys, Pennsylvania. Telephone 814 834-1521. TWX 814 826-4808.



When Quality, Dependability,
and Service are
Prime Requirements:

SPECIFY
PENDAR
SWITCHES AND INDICATORS

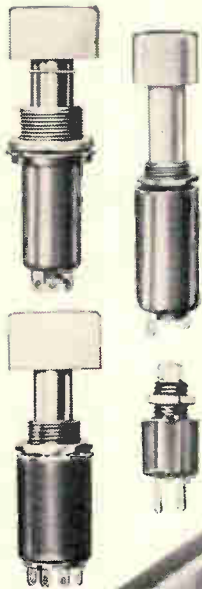
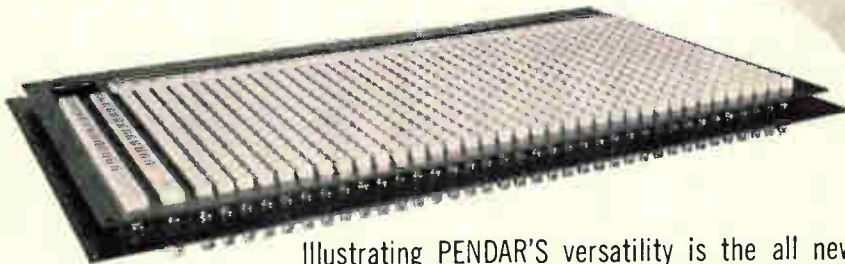

Illustrating PENDAR'S versatility is the all new sub-miniature pushbutton switch above, (P/N 301), $\frac{3}{8}$ " in diameter and less than 1" overall length. This unit is especially adaptable to panels and consoles where space is limited. Units available in either illuminated or non-illuminated, momentary or push-push types.

The 682 station gang switch assembly (above) is one of many multi-station units designed and constructed by PENDAR to meet mil-spec requirements. PENDAR custom panels, frames, and module assemblies are available with a broad variety of electrical/mechanical tracking actions and applicable switching sequences. They are designed for compactness, reliability, and long life.

If complex switching systems are your problem, contact PENDAR where "service" has top priority.

Contact your local representative for a visual demonstration of PENDAR switches



PENDAR will be at
WESCON Visit our
complete display,
booth 1223

manufacturers of precision-made pushbutton switches and indicators

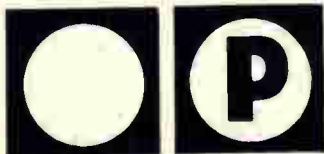

PENDAR, INC.

P. O. BOX 1014 Coeur d'Alene, Idaho
Area Code 208-SP 3-7311 — TWX 999-9613

New Instruments

plitude modulated, at frequencies up to microwave, and as a standard phase meter with 5-digit d-c voltmeter as readout at accuracy of $\pm 0.03^\circ$, phase computer for system control.

Type 524A2 is priced at \$965 without the digital voltmeter; \$2,265 with dvm; delivery is from stock.

▪ To be introduced at Wescon. Ad-Yu Electronics, Inc., 249 Terhune Ave., Passaic, N.J. [383]

Swept-frequency scope shows log display

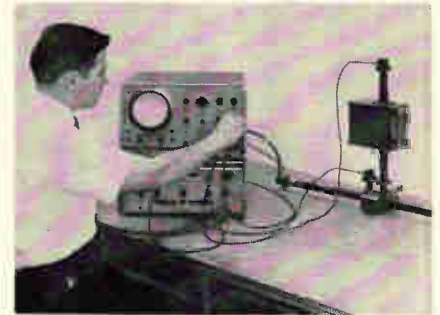

Frequency-response curves and return loss curves, calibrated directly in decibels, are traced out continuously during microwave swept-frequency tests by a plug-in model 1416A for the model 140A oscilloscope.

Model 1416A swept-frequency indicator speeds and simplifies such measurements as attenuation versus frequency or reflection coefficient versus frequency, when the indicator's horizontal circuits are swept by the sweep oscillator in a test array, and the indicator's vertical circuits respond to the output of an appropriately connected detector. Reflection coefficients as low as 0.05 are easily read.

The directly decibel-calibrated display is accurate to 5%, with reference to the crystal detector's r-f input. Dynamic range of the logarithmic presentation can be as much as 30 db. Linear display may also be selected with the bandwidth variable to reduce noise effects. Calibrated d-c offset control brings any desired portion of the trace onto the screen while steadily



Double Your CB
TALK POWER
TALK POWER

**With This Inexpensive
 Collins Mechanical Filter!**

That's just the improvement this mechanical filter will make in many cases!

Tailored especially for CB use, this unit gives you selectivity of 6 kc @ 3 db and 20 kc @ 60 db, particularly important in the face of overcrowded and overlapping CB frequencies. The electrical and mechanical stability inherent in all Collins filters comes with it, too, along with freedom from ageing, breakdown or drift that often accompanies extreme temperature or long, continuous service.

For complete information on this new CB mechanical filter, contact Components Sales Department, Collins Radio Company, 19700 Jamboree Road, Newport Beach, California. Telephone 714-549-2911.

Low cost sideband and mobile FM filters also available.

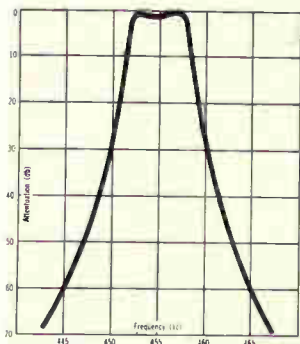

COMMUNICATION / COMPUTATION / CONTROL



COLLINS RADIO COMPANY
 WORLD HEADQUARTERS / DALLAS, TEXAS

DIVIDE POWER 4 WAYS / 8 WAYS



Improve system performance and save significant space and weight with these new 4-way, 8-way hybrid, binary power dividers. A single 8-H unit does the work of SEVEN transmission line hybrids. A 4-H unit replaces THREE hybrids. No two ways about them . . . but 4-ways and 8-ways to split and add power with excellent isolation (30 db minimum from 2 to 400 Mc).

Beam forming in large, ground-based antenna arrays plus power splitting into balanced coherent signals and multiplexing are several uses. That's why clever systems designers are joining a unique 4-H Club. Direct your application for membership to attention of:

Earl Russell,
4-H Club Program Director,
(617) 899-3145.

*and Subtract bulk, Add reliability, Multiply efficiency.

SPECIFICATIONS

(Model No. indicates characteristic impedance)

4H-50	8H-50	2-32 Mc
4H-75	8H-75	2-32 Mc
4V-50	8V-50	20-200 Mc
4U-50	8U-50	200-400 Mc

Isolation 30 db (min.)

Insertion Loss 0.5 db (4-way),
1.0 db (8-way)

VSWR 1.3 (max.)

Phase Bal.† 1.0° max.

Amplitude Bal.† 0.2 db max.

Weight 4-H Series — 4 oz.,
8-H Series — 8 oz.

Size 1½ and 2 cubic
inches respectively

†measured between isolated ports

ADAMS-RUSSELL CO., INC.

280 BEAR HILL RD., WALTHAM, MASS. 02154
(617) 899-3145



International Sales:
TECHNICAL RESOURCES, INC.
600 MAIN ST., WALTHAM, MASS.

New Instruments

maintaining its reference to off-screen responses for measurements of high resolution. X and Y outputs make permanent records on recorder.

Price of the 1416A is \$675. Deliveries are expected to begin in September.

▪ To be introduced at Wescon.
Hewlett-Packard Corp., 1501 Page Mill Road, Palo Alto, Calif., 94304. [384]

Fast-writing storage scope



Type 549 oscilloscope combines the features of the 545B with the added versatility of storage capability. It has what is believed to be the fastest-writing bistable storage crt. The 6-cm by 10-cm display area is divided into two 3-cm by 10-cm independently controlled targets for split-screen applications, plus a nonstoring "locate" zone at the left and a "run-over" storage area at the right.

Independent target control of each half of the screen allows one stored trace to be retained while conventional display, stored display or enhanced display is obtained on the other half of the screen.

Another useful feature is the automatic-erase circuit which can be set to erase the display on either or both halves of the screen at pre-set intervals. The period between erasures can be varied between 0.5 and 5 sec. A manual erase button is also provided for each half of the screen, as well as provision for remote erase.

Type 549 uses any of the manufacturer's established letter-series

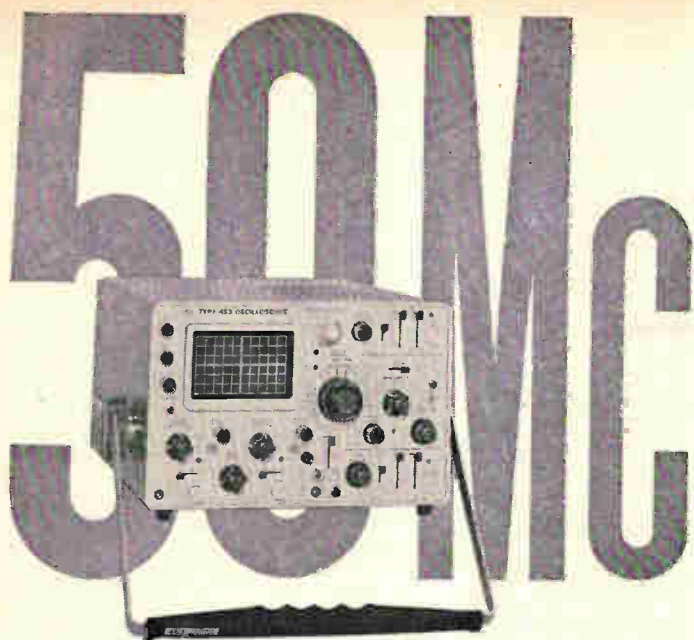

portability

with Dual-Trace and Sweep Delay



Here's the new portable oscilloscope for DC-to-50 Mc applications. It operates almost anywhere—and under severe environmental conditions. It's small and light—with overall dimensions of 7¼" high x 12½" wide x 22½" deep (including extended carrying handle), and weighs less than 29 pounds.

Performance features include:

Bandwidth (with new P6010 Probe)

20 mv/div through 10 v/div > 50 Mc

10 mv/div > 45 Mc

5 mv/div > 40 Mc

1 mv/div > 25 Mc (Channels cascaded)

Sweep Rates—5 sec/div to 10 nsec/div (with 10X Mag.)

Calibrated Sweep Delay—50 sec to 1 μsec.

CRT—New 4" rectangular, operating at 10 kv.

X-Y Operation—DC to > 5 Mc, 5 mv/div through 10 v/div.

Triggering—To 50 Mc, from Channel 1 or combined signals (both sweeps).

Type 453 Oscilloscope U.S. Sales Price f.o.b. Beaverton, Oregon . . . \$1,950

SEE THE LATEST TEKTRONIX INSTRUMENTS AT WESCON BOOTH 3818-3822.

TO PLANES

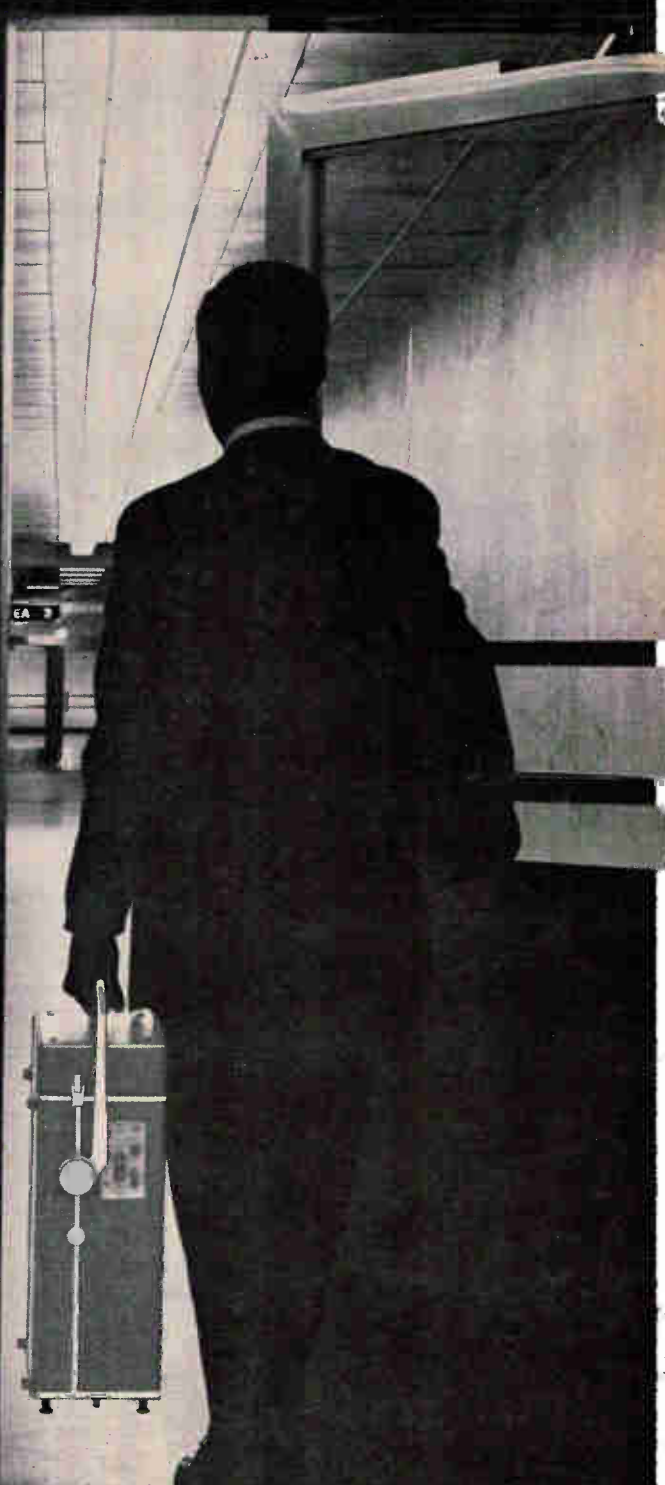

new
453
from

tektronix



INTEGRATED OPERATIONAL AMPLIFIER FROM AMELCO IS A STEP AHEAD

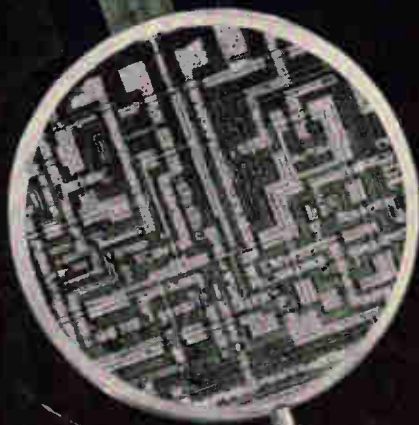

NOW you can obtain the advantages of high reliability and small size inherent in monolithic diffused integrated circuits and still get an output voltage swing of 20 volts. This and other important parameter limits given below are all available — from stock — in the A13-251. The budget saving price is \$44.50 for small quantities and \$35.50 for 100 or more.

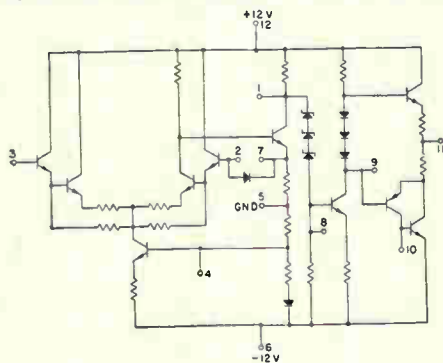

CASE INTERNALLY CONNECTED TO -12V

SPECIFICATIONS

- ▲ OUTPUT SWING = 20 volts
- ▲ INPUT IMPEDANCE = 1 Meg
- ▲ GAIN = 20,000
- ▲ BANDWIDTH = 10 Mc
- ▲ OFFSET = 5 mV (UNTRIMMED)
- ▲ DRIFT = 25 μ V/ $^{\circ}$ C & 5.0 nA/ $^{\circ}$ C
- ▲ CMR = 80 db
- ▲ TEMPERATURE RANGE
-55 $^{\circ}$ C to +125 $^{\circ}$ C



**AMELCO
SEMICONDUCTOR**

DIVISION OF TELEDYNE, INC.
1300 TERRA BELLA AVE., MOUNTAIN VIEW, CALIFORNIA

Mail Address: P. O. Box 1030, Mountain View, Calif./Phone: (415) 968-9241/TWX: (415) 969-9112/Telex: 033-914

New Instruments

or 1-series plug-ins for either general-purpose or highly specialized applications in the d-c to 30-Mc area. It also accepts new spectrum analyzer units, making it the first storage-type spectrum analyzer. Other features include calibrated sweep delay from 1 μ sec to 10 sec, single-sweep, X5 sweep magnifier, and complete full-passband triggering facilities. The unit measures 17 in. high, 13 in. wide, 24 in. deep; weight is approximately 65 lb without plug-ins. Price is \$2,375 without plug-in.

■ To be introduced at Wescon. Tektronix, Inc., P.O. Box 500, Beaverton, Ore., 97005. [385]

Lower price tag on digital voltmeter

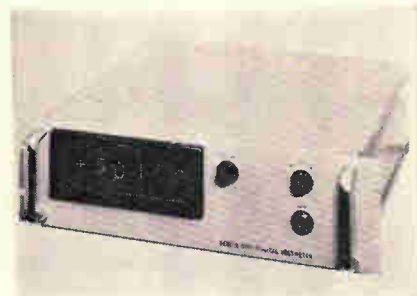

A full 5-digit digital voltmeter, the model 5015, is reported to cost far less than any other automatic 5-digit dvm. Price of the nearest competing model is \$2,990, 50% higher than the model 5015's price of \$1,985. The new instrument will enable highly precise automatic measurements of electrical and physical parameters in applications where price was formerly prohibitive. Applications are found in industrial, scientific and military fields.

Ranges are $\pm 9.9999/99.999/999.99$ v (microvolts, ohms, and a-c are measured using accessories). Range and polarity selection are automatic. Common-mode rejection is 100 db at 60 cps. The unit offers differential input—either input terminal can be floated 1,000 v above chassis. Signal noise rejection is supplied by both an input filter and a sensitivity control. Accuracy is $\pm(0.01\%$ of reading

Kyocera



New Ceramic Products from:

Alumina	Forsterite	Zircon
Beryllia	Steatite	Cordierite
Magnesia	Mullite	Multiform Glass

for Better Performance

For further information, please contact

MARUBENI-IDA(America)Inc.
Los Angeles Branch 530 West Sixth Street
Los Angeles 14, Calif. MAison 8-6271

KYOTO CERAMIC CO., LTD.

11, Haramachi, Nishinokyo, Nakagyo-ku, Kyoto, Japan.

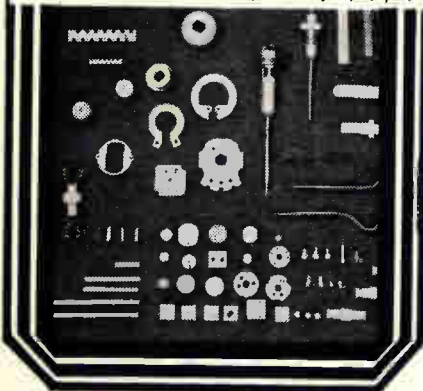

Circle 253 on reader service card

"SPECIALS"

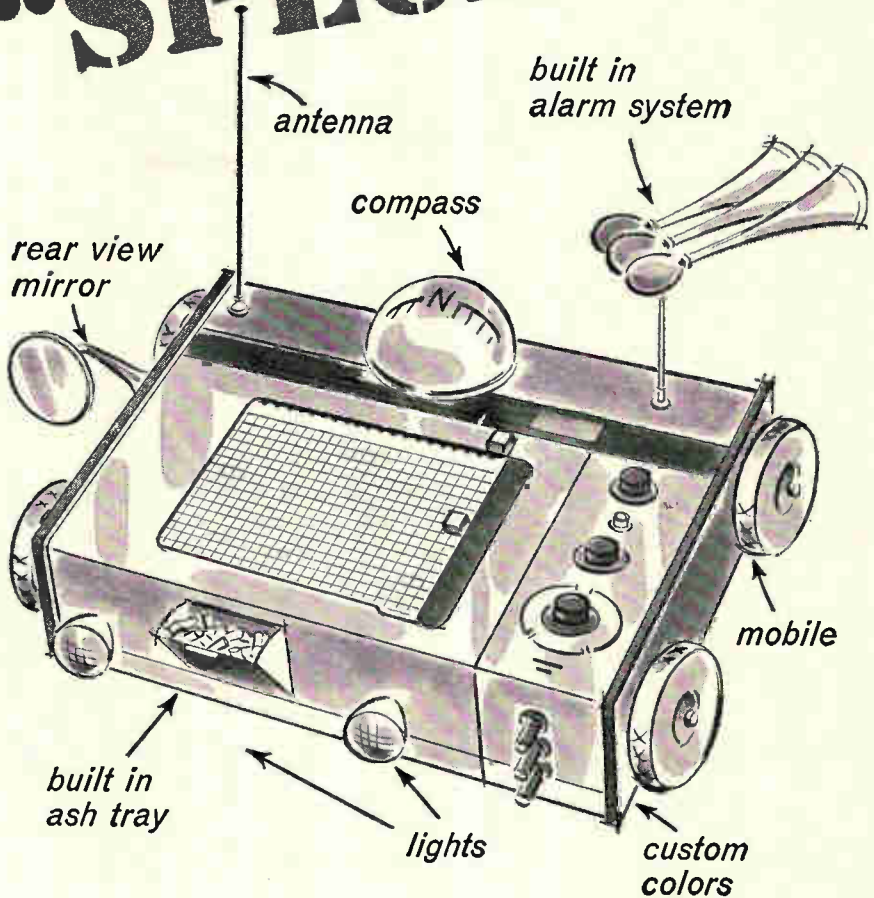

IN V.O.M. RECORDERS

Ever seen a Recorder that looks like this? Neither have we—yet! But we've made just about every other modification in the book for our customers—with 1 range, 2 ranges, with push-button zero, with different scales, and with special chart papers. We've painted them custom colors, put a variety of customer designations on them. You name it, we'll do it! Just let us know what, and the quantity. We'll work up a quote that'll be a pleasant surprise to you.

There are a goodly number of people who buy the standard instruments without modification, singly and in O.E.M. quantities. Boring, really, but we *do* fill these orders along with the specials. The standard Bausch & Lomb V.O.M. Recorder is a 5 inch Strip Chart Recorder that will record volts, ohms and milliamps directly. It has 5 built-in chart speeds, built-in event marker, built-in take-up reel, 5 voltage ranges, 6 linear ohms scales, 4 D.C. current ranges. Full scale sensitivity is 10mv, 2.5mv or 500 microvolts depending on the model selected. It has a number of other advantages, too. And, we have accessories, a variety of them, that make our recorders so versatile it hurts (other recorder manufacturers, that is!).

If you want further information on our standard recorders, so that you can tell us how you want them changed, write for Catalog 37-2068. Bausch & Lomb, 61420 Bausch Street, Rochester, New York 14602.

BAUSCH & LOMB

Circle 163 on reader service card

163

STOP
AT THE
BAUSCH & LOMB
BOOTH NO. 3918,
WESCON SHOW,
TO SEE THESE
VERSATILE
RECORDERS
AND PICK UP
YOUR \$25 VALUE
PURCHASE
CERTIFICATE

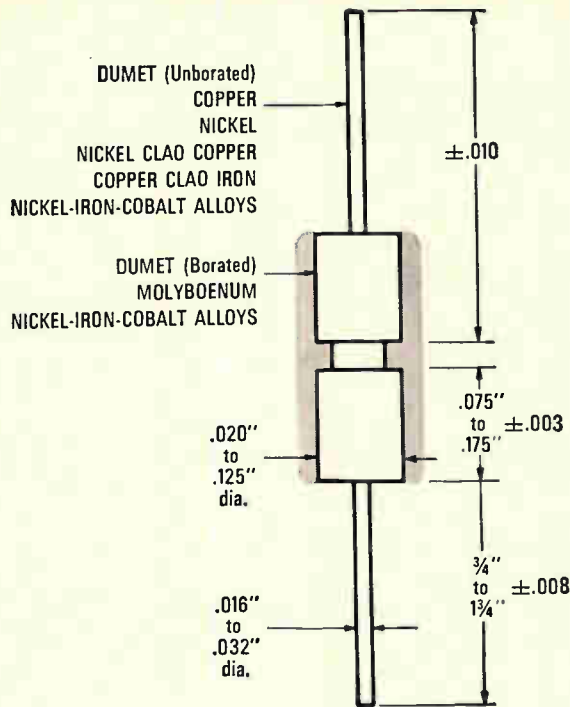

See General Electric for All Sizes of Slug Leads

Welded leads and assemblies for diodes and rectifiers.

To meet the rigid requirements of today's commercial and military markets...and do it economically...use General Electric slug leads.

Close tolerances are held on all G-E slug leads to minimize problems with parts feeding and assembly. Dumet slug diameters are held to tolerance of $\pm .0006$ in. on sizes below .040 in., $\pm .001$ on larger sizes. Molybdenum slug diameters are held to $\pm .001$ in.

Weld knots are strong. A minimum of six 90 degree bends can be made with a 1 lb. weight. Weld knot sizes are closely controlled. Weld splash of a 20 mil pigtail joined to a 40 mil slug is less than the slug diameter. At the lead wire next to the weld, T.I.R. is held to .006 in. or less to assure accurate alignment in assembly.

General Electric slug leads meet 1% AQL specifications for individual defects and 4% cumulative level.

General Electric is the world's largest producer of butt welded lead wires for the electronics industry. No matter what your needs, General Electric can supply the welded parts you need.

For best results and utmost economy in your production requirements, write or call: General Electric Co., Lamp Metals and Components Dept., 21800 Tungsten Road, Cleveland, Ohio 44117. Tel. (216) 266-2971.

Progress Is Our Most Important Product

GENERAL  ELECTRIC

New Instruments

+ 0.001% of full scale).

Transistor circuits are used throughout, and are on interchangeable, plug-in boards of heavy epoxy-fiberglass. The most critical components (digitizing relays) were tested the equivalent of 40 years use at one reading each 4 seconds, 8 hours per day, 7 days per week, and there were no failures.

▪ To be introduced at Wescon. Non-Linear Systems, Inc., P.O. Box 728, Del Mar, Calif. [386]

X-Y plotter features servo-amp design

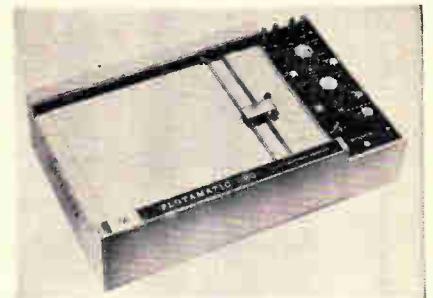

Completely solid state, and with a front-panel function control, the Plotamatic model 690, 8½ by 11 in. low-cost, analog X-Y plotter, produces automatic plots of voltage/voltage or voltage/time functions from a wide variety of d-c voltage inputs.

New servo-amplifier design provides greater reliability and frequency response, with full scale accuracies, to $\pm 0.5\%$ and individual range calibration to 0.1%. Reference voltage is provided with long-life mercury batteries. The 12 voltage ranges include 0.5 through 50 mv/in. and 0.1 through 5 v/in., with continuous vernier on all ranges. Full scale zero adjustment plus 100% offset is provided.

Standard features include electric pen lift, scaled follow-up potentiometers, new non-clog vacuum paper hold-down, and easily replaceable ink cartridge. Optional equipment includes remote pen lift, retransmitting potentiometers and metric calibration. Table and

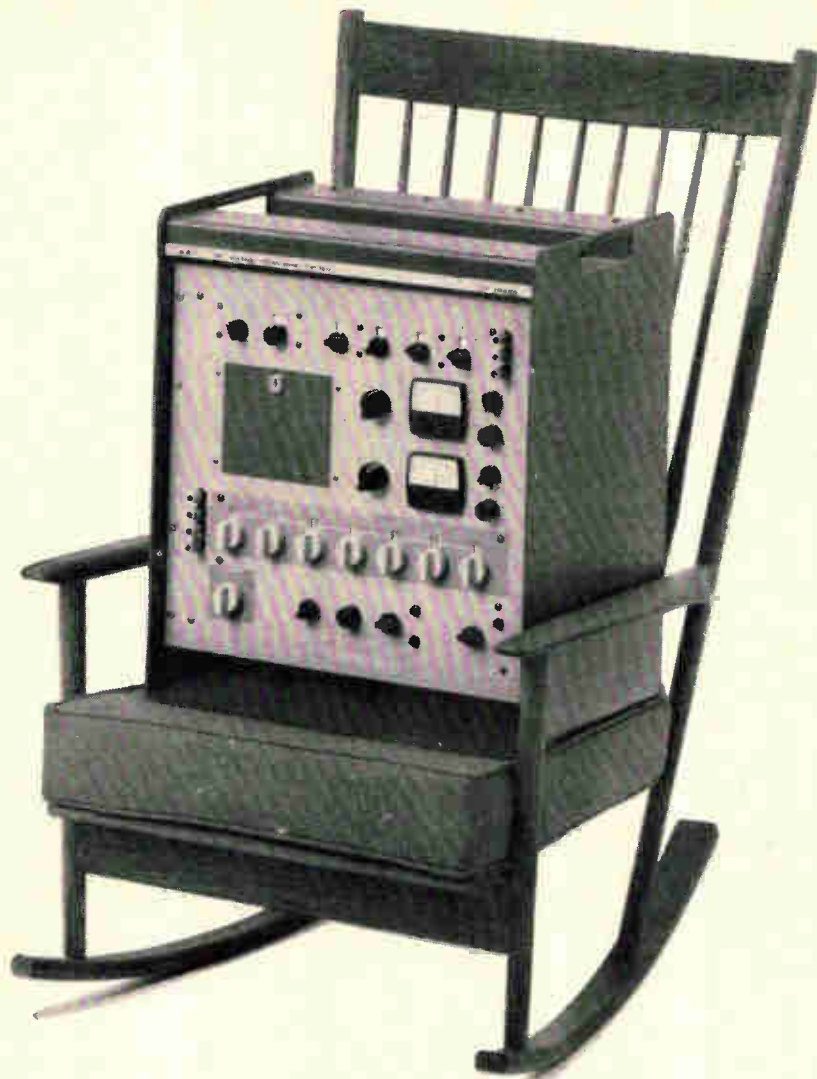

Voltmother

This self-calibrating system can tend your entire brood of dc voltage sources and measuring devices—with 5 ppm accuracy.

Our new 1045A DC Voltage Measuring System is designed to serve as your final authority on voltages ranging from above 1100 volts down to less than a volt. This range used to require two or more separate instruments.

The system's accuracy—5 ppm with 7 place resolution—is the best you can get. For all this range and accuracy, you don't have to be a fuss-budget with the 1045A. Even a fledgling technician can fly with six-place accuracy.

No external calibration is required to verify the system's accuracy. It functions as a voltage comparator, comparing voltages to saturated reference standard cells. As an added safeguard, the voltage of the standard cells is continuously monitored during the measurement.

Think of the many voltage devices used in your plant or lab that you rely on for consistently accurate readings: decade power supplies, potentiometric and digital volt-

mers, X-Y Recorders, pH meters, thermocouples, electrometers, reference voltage power supplies...

If the behavior of any of these instruments is open to question, consider how they might respond to the discipline of a good Voltmother. ESI, 13900 NW Science Park Drive, Portland, Oregon (97229).

The ESI 1045A Voltage Measuring System combines a direct-reading potentiometer, direct-reading standard cell comparator, and guarded voltbox. Price: \$4,200					
	1000V	100V	10V	1V	0.1V
Limit of Error at Specified Voltages (in ppm)	11.7	4.1	3.6	4.6	21
Probable Error* (in ppm)	2.6	0.9	0.8	1.0	4.7

*At least one-half of all measurements will be more accurate than the probable error.

Instruments—Room D-16
Components, Booth 2909

Electro Scientific Industries **esi**

JUST CUT TO PATTERN

Netic & Co-Netic Magnetic Shields



HAND FORM IN SECONDS

A great convenience to design engineers, packaging engineers, R/D, etc. A fast inexpensive empirical tool to determine and shield the necessary components of systems. Use multiple layers if needed. Thicknesses from .002". Also widely used in automated or manual production line techniques.

Netic attenuates high intensity fields, Co-Netic low intensity fields. Permanently Pre-Annealed. Not affected by bending, vibration or shock. Minimum retentivity. Increases systems reliability.



MAGNETIC SHIELD DIVISION

Perfection Mica Company

1322 N. ELSTON AVENUE, CHICAGO, ILLINOIS 60622

ORIGINATORS OF PERMANENTLY EFFECTIVE NETIC CO-NETIC MAGNETIC SHIELDING

Circle 220 on reader service card



Order Your Copy Now of The Complete 1964 Electronics Index To Volume 37

This new 40 page index has 4 sections:

Catalogs all articles—technical features, news letter items, Electronics Review, Electronics Abroad, and Probing the News stories.

Authors index, Corporate reference index and Advertisers index.

Price is \$1.00. Send for your copy of this useful reference guide. today.

Send to: Electronics Reprint Dept., 330 W. 42nd Street New York, N. Y. 10036

Send me copie(s) of the complete 1964 index at \$1.00 each.

Name

Number & Street

City, State

Zip Code

New Instruments

rack-mount versions are available. Price for the table model is \$1,200.

▪ To be introduced at Wescon. Data Equipment Co., 2126 So. Lyon St., Santa Ana, Calif. [387]

Self-contained pulse generator



Type 1398-A pulse generator is a self-contained, general-purpose pulse source featuring rise and fall times under 5 nsec, 60-ma positive and negative pulses that can be supplied simultaneously, a prf range from 2.5 cps to 1.2 Mc, and a duration range of 0.1 μ sec to 1.1 sec. Positive and negative 8-volt, 150-nsec prepulses and a delayed-sync pulse are also supplied at front-panel terminals.

The pulse generator, which includes a built-in power supply, is only 12 by 5 $\frac{1}{4}$ by 8 $\frac{1}{4}$ in. and sells in the U. S. for \$535.

▪ To be introduced at Wescon. General Radio Co., West Concord, Mass. [388]

Signal generator has range of 4 to 300 Mc

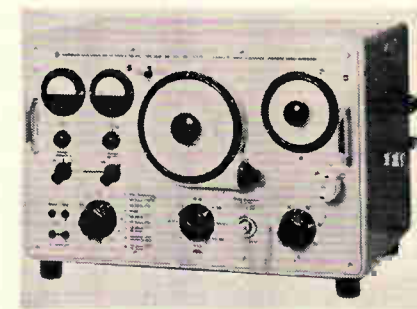

A standard signal generator now available, type SMAF, can be amplitude- and frequency-modulated, simultaneously a-m/f-m modulated, or externally modulated by a

How come we can reduce our NIXIE® tube prices and double the warranty at the same time?

Here's how:

Our price reduction has come about as a result of increased volume in present markets and expansion of new markets made possible by the development of driver circuits and packages which are lower cost and more reliable than other techniques. Particularly in the area of industrial control, the new display packages (Nixie tubes with driver/decoder and counter modules using our new hybrid circuits) make electronic displays and systems commercially feasible in applications where price was previously a limiting factor.

And we haven't been testing our long life Nixie tubes for 8 years for nothing. These tubes have been on life tests since 1957



Our popular 1" Rectangular tube (type 8422) is now the same price as the standard round.

1-99
\$15.75
100-499
\$13.40
500-999
\$11.00
1000+
\$8.75

with **no failures**. We're not the least bit concerned about being able to back up our warranty. Since we're so sure of our product—why not pass that assurance along to our customers? We want them to know they're buying proven reliability when they buy a Nixie tube.

Not in projection, edgelit or electroluminescent display types can you find such a combination of low cost and reliability. So—new markets, new volume, new techniques add up to new low prices to **you**.

Write today for your copy of the new Nixie tube price list and we'll send you our latest catalog to boot.

Only Burroughs manufactures Nixie Tubes



Burroughs Corporation / ELECTRONIC COMPONENTS DIVISION
PLAINFIELD, NEW JERSEY

ASPIRIN
can't cure the
R & D HEADACHES
that call for a
Coax-i-kit

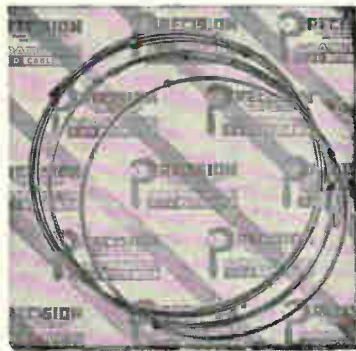

Keep One on Your Shelf

When you suddenly need an experimental bit of semi-rigid coaxial cable, you haven't got time for PO's, letters to the mill, and shipping delays. Then is when a Precision Tube Company COAX-I-KIT on your shelf is worth dollars in the bank. There are four COAX-I-KITS, each containing lengths of different types of COAXITUBE, Precision's semi-rigid metal-shielded coaxial cable for low-loss RF transmission and other high frequency applications. Order the kits that fit your needs. They're priced at only \$20 each, postpaid.

A Three ten-foot coils of 50-ohm cables (one each of '141', '085', '056' sizes) all with Teflon dielectric. Inner conductors of silvered copper & copperweld; outer conductors, copper.

B Four four-foot lengths of 50-ohm cables (two each of RG-87A and RG-143 equivalents) all with Teflon dielectric, silvered inner conductor, and copper outer conductor.

C Two ten-foot coils of 50-ohm, high performance cables (one each of '141' and '085' sizes) with Teflon dielectric; dimension tolerances, $\pm .001$ "; concentricity, within .003".

D Four four-foot lengths of 50-ohm cables (two each of RG-87A and RG-143 equivalents) — as Kit B, but with aluminum outer conductors.

BUY IT—TRY IT Phone or write for your kits; we'll bill you later. Or ask for our folder that describes them in more detail.

YOUR BEST DECISION:



New Instruments

stereo/f-m signal in conformance with FCC standards. It supplies a continuously variable frequency of 4 to 300 Mc and a continuously adjustable output voltage from 0.05 μ v to 50 mv.

The SMAF can be used in the development and production of a-m and f-m receivers. For measurements of tv receivers, it produces the picture carrier while the modulation voltage corresponding to the picture content must be fed externally. The 0- to 6.5-Mc video modulation bandwidth is suitable for this purpose.

■ To be introduced at Wescon. Rohde & Schwarz, 111 Lexington Ave., Passaic, N.J. [389]

Kelvin bridge shows resistance deviations



A self-contained instrument, the model B-40 Kelvin bridge comparator, requires no external batteries or external null detectors. Resistance deviations are read directly from the meter without making a null adjustment. The meter ranges are $\pm 1\%$, $\pm 0.1\%$ and $\pm 0.01\%$ full scale.

This concept allows even production personnel to set up and make resistance readings to 10 ppm accuracy. Recovery time permits 600 resistors to be checked in an hour. The self-contained power supply provides excitation voltage of 1, 3 or 10 volts.

Used for incoming inspection, this instrument provides accuracies that are otherwise attainable only in standards laboratories, the company says. An external standard resistor is required. Model B-40 sells for \$675 and is available in 20 to 30 days.

■ To be introduced at Wescon. Medistor Instrument Co., 1443 N. Northlake Way, Seattle, Wash. [390]



340 pages
\$12.00

This comprehensive introduction to commercial semiconductor junction devices provides a basic understanding of junction properties and their application in a wide variety of single- and multijunction configurations. The book focuses on the formation of the planar junction and its behavior in low-frequency commercial devices such as diodes, amplifiers, and switches. It thoroughly explores the relation of commercial nomenclature and practice to the phenomenological behavior of the junction structure.

Other McGraw-Hill books . . .

SILICON SEMICONDUCTOR TECHNOLOGY by W. R. Runyan. Provides comprehensive coverage of silicon as applied to semiconductor technology. 277 pp., \$16.50

FIELD-EFFECT TRANSISTORS by Leonce J. Sevin. Gives practical data on the theory, characterization, and application of field-effect transistors. 138 pp., \$10.00

AN INTRODUCTION TO SEMICONDUCTOR ELECTRONICS by Rajendra P. Nanavati. Basic help both in transistor circuit design and device engineering. 440 pp., \$12.50

SEMICONDUCTOR NETWORK ANALYSIS AND DESIGN by Vasil Uzunoglu. Presents valuable tools for the design of networks using transistors and semiconductors. 375 pp., \$12.50

BUY THESE BOOKS AT YOUR BOOKSTORE OR MAIL THIS COUPON

McGraw-Hill Book Co., Dept. 23-L-89
330 West 42 Street, New York, N.Y. 10036

Send me book(s) checked below for 10 days on approval. In 10 days I will pay for book(s) I keep, plus few cents for delivery costs, and return unwanted book(s) postpaid. **SAVE MONEY:** we pay delivery costs if you remit with coupon; same examination and return privilege.

- Burford & Verner—Semiconductor Junctions & Devices, \$12.00
- Runyan—Silicon Semicon. Tech., \$16.50
- Sevin—Field-Effect Transit., \$10.00
- Nanavati—An Intro. to Semicon. Elec., \$12.50
- Uzunoglu—Semicon. Network Any., \$12.50

NAME (print) _____

ADDRESS _____

CITY _____

STATE _____ ZIP _____

For prices outside U.S., write McGraw-Hill Intl., N.Y.C. 23-L-89

ANNOUNCING



The best buy in digital voltmeters since NLS invented them

4 digits

$\pm 0.01\%$ precision

high common mode rejection

transistor circuits



\$985

What's the catch? There isn't any. That's the beauty of the new NLS 5005—a "big-league" digital voltmeter selling at a stunningly low price.

So how does NLS do it? Basically, through volume production and a breakthrough in relay technology (3 years in the making).

Here's what you get with every NLS 5005 (these are standard features—not options):

- Full 4-digit resolution.
- Accuracy of $\pm 0.01\%$ of reading ± 1 digit—no other 4-digit dvm is more accurate . . . at any price.
- High common mode rejection—106 db min. @ 60 cps, even with 1k Ω source unbalance.
- Input filter.

- Automatic ranges of $\pm 9.999/99.99/999.9$ v.
- All-transistor circuitry.
- High temperature operation—in tests above 150°F, it continued to operate.
- Nearly twice the speed of stepping switch meters — 0.6 sec/rdg avg.

And using standard NLS dvm accessories, the 5005 measures AC, Ω and microvolts.

NEED MORE SENSITIVITY? Order one of the 5005's companions, the 5010 (\$1285) or 5014 (\$1745); added ranges are ± 9999 v. (auto) and ± 99.99 mv (manual) respectively. Printer output and dc ratio measurements are extra cost options in all models.

For delivery, data or a demo — call NLS now!

See us at WESCON, Booth 4301-02



Originator of the Digital Voltmeter

non-linear systems, inc.

Del Mar, California, Phone: (714) 755-1134 TWX: 714-277-3191



**BUILD
YOUR
FUTURE**

At the NCR Electronics Division, you build your career on hardware — not hope. Advanced developments like CRAM and the NCR 315 RMC Rod Memory Computer — the first commercially available computer with an all-thin-film main memory — are a marketplace reality. (And bear in mind that the NCR marketplace consists of more than 120 countries!) If you want to combine career stability with go-ahead, on-line opportunity... if you want to earn a good living while enjoying the good Southern California life... look into the opportunities on the page at the right.

**IN
WORLD-WIDE
BUSINESS
AUTOMATION
AT NCR,
LOS
ANGELES**

NCR

ELECTRONICS DIVISION

Laser welder also drills and trims metal

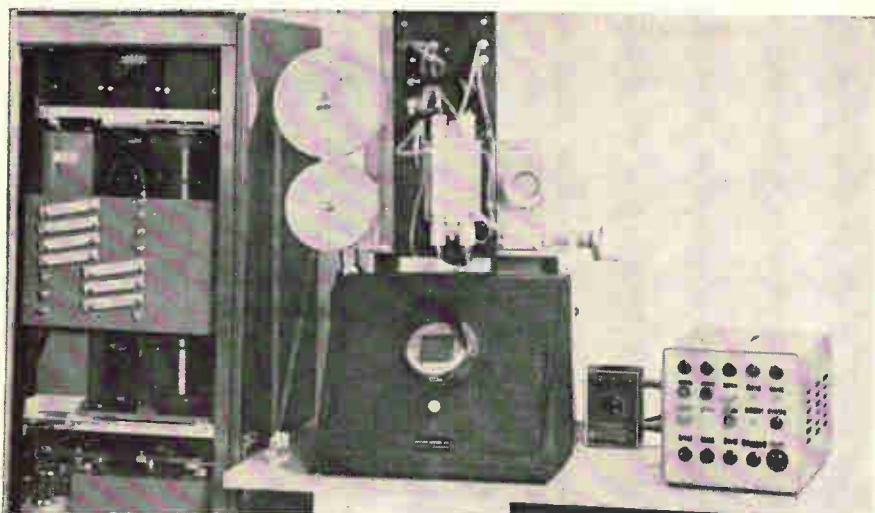

A laser welder that also drills and removes metal has been introduced by Applied Lasers, Inc. To perfect the system, the company had to overcome a problem as old as laser technology: how to vary pulse intensities enough to perform different metalworking tasks.

Applied Lasers worked out a pulse-forming network to control the amount and rate at which a ruby laser emits energy. Changing the position of bus bars on the pulse-former panel changes the number of capacitors and inductors in the line. In this way, the circuit's impedance is kept constant while the pulse intensity, which depends on the amount of energy stored by the capacitors, is varied.

The versatility of the Model 1010c2 welder is increased by a work table that is adjustable in three planes, so that the work can be positioned precisely. The laser head moves in two planes.

The laser lenses are protected by a Mylar tape that advances continuously in front of them. Without the tape, the lenses could be pitted by back-spattering from the metal workpiece.

A viewing screen enables the user to watch the progress of his machining operation. A picture of the work piece, magnified five times, is shown on the screen.

Prices start at \$14,000 for the

complete package, including a dual elliptical-cavity laser head, 10-kilowatt power supply, water recirculator, viewing screen, lens system with variable focal length, and rotating protective tape. Delivery is in 45 days.

Pulse length can be varied from 0.5 to 4 milliseconds. A pulse of 0.5 to 1.5-millisecond duration will remove metal from gyroscopes to balance them, or drill holes in an exotic metal such as titanium. Energy bursts of 3 to 4 milliseconds are required for welding with penetrations of .02 to .03 inch.

A 20-kilowatt power supply is available, giving a user a choice of 50 joules at one pulse per second or 10 joules at four pulses per second. The flashlamp that pumps the ruby laser will last for 100,000 to 200,000 discharges. The split elliptical-cavity design of the laser head allows the lamp to be replaced without disturbing lens alignment.

Specifications

Power supply	10 or 20 kw
Pulse length	.05-4 ms
Pulse intensity (with 20 kw power supply)	50 joules (1 pulse per second) and 10 joules (4 pulses/sec.)
Flashlamp life	100,000-200,000 discharges
Price	\$14,000
Delivery	45 days

Applied Lasers, Inc., 72 Maple St., Stoneham, Mass. [401]



DIGITAL SYSTEMS OPPORTUNITIES AT NCR, LOS ANGELES

ADVANCED COMPUTER DEVELOPMENT SYSTEMS DESIGN / Senior-level positions in advanced development and preliminary design of beyond-the-state-of-the-art data processing equipment. Considerable experience required in the over-all system design and integration of commercial computing equipment. BSEE required with advanced degree highly desirable.

MEMORY DEVELOPMENT / Positions will entail analysis and design of advanced thin-film memory systems, both linear select and coincident current. Also advanced random-access development on magnetic-card and disk-file systems. Requires BSEE, with advanced degree desired.

LOGIC AND CIRCUIT DESIGN / Openings are available for design of advanced integrated-circuit computers, buffering systems, on-line computing and transmission systems, and computer peripheral equipment. BSEE and good knowledge of state-of-the-art required.

MECHANISMS DESIGN / Senior-level positions available which entail working with new techniques for development of advanced high-speed random-access memories. Work requires five years' experience in servomechanisms and BSEE or BS in physics; or considerable experience in high-speed mechanisms and BSME and MSEE or BSEE and MSME.

PRODUCT ENGINEERING

ELECTRONIC PRODUCT ENGINEERS / These positions require a BSEE degree with experience in designing digital computer equipment and in maintaining liaison with manufacturing.

PACKAGING / These positions entail layout and design of packaging for computer systems. Applicants must have previous experience with electronic computers or electromechanical devices. Background in miniaturization utilizing thin films and integrated circuits is desirable. BSEE required.

PROGRAMMING DEVELOPMENT

SOFTWARE PROGRAMMERS / Positions entail development of software for various computer input/output routines, operating systems and monitors. Applicants must have previous programming experience with machine language on a large file computer.

DESIGN AUTOMATION PROGRAMMERS / Positions require previous experience in programming for design automation, good understanding of engineering and hardware problems, and BS degree in math, engineering or related field.

ARRANGE NOW FOR INTERVIEWS AT WESCON, SAN FRANCISCO, AUG. 24-27

Openings above are in Los Angeles. Additional openings in Dayton, Ohio, for mechanical, electrical and chemical engineers, physicists, chemists (MS or PhD level). Send resume to Bill Holloway, Technical Placement, or, if time doesn't permit, call collect.

The National Cash Register Company

NCR

ELECTRONICS DIVISION

2816 W. El Segundo Blvd., Hawthorne, Calif.
Telephone: Area Code 213-757-5111

An equal-opportunity employer



NEW
remote
sampling
head
measures

100 ps risetime
(3500 mc)

at
your
circuit



REMOTE dual feedthrough sampling head (for the Lumatron Model 120A Sampling Oscilloscope) brings the sampling to your circuit, eliminating hookup cable losses and distortions. You measure what is actually taking place at your circuit. In addition, the straight feedthrough coax is free of distortions caused by elbow bends.

FAST risetimes less than 0.1 ns can be displayed and measured with fidelity with less than 4 mv noise (reduced by smoothing) through calibrated ranges of 2-200 mv/cm . . . a NOT CAL light warns when the 3:1 vernier is in use.

MATED with the standard Lumatron Model 2170 Horizontal Unit the Oscilloscope has over 4 Kmc triggering . . . plus an unusual 60 ns of viewing range at a sweep speed of 1 ns/cm and faster using the delay controls . . . and all the convenience of the basic Model 120A Oscilloscope . . . at no added cost.

AUTOMATED readout of a 100 ps risetime oscilloscope is possible with the use of a Model 2440 Automatic Waveform Reader inserted in the "3rd plug-in" compartment of the 120A Oscilloscope (lower right section). The Remote Sampling Head is brought to the test fixture for maximum response.

PRE-TRIGGER can be provided in the Oscilloscope frame by inserting a Model 2305 Pre-Trigger Pulse Generator in the "3rd Plug-in" compartment (lower right section). The Generator provides a delayed 1 ns R.T. output to drive the circuit under test with ± 25 V max. (2305A to ± 40 V).

HIGH-IMPEDANCE operation is possible using a standard oscilloscope probe by terminating the feed through Sampler with an impedance higher than 50 ohms. (normal 30 mc oscilloscope probes give a few ns risetime when used with the 2161)

Lumatron Nanosecond Instruments are manufactured by
General Applied Science Laboratories, Inc.
Merrick and Stewart Avenues, Westbury, L. I., N. Y. • 516-ED 3-6960

(ask for Russ Janes, Instrument Sales Manager)

VISIT BOOTH 3519 at WESCON

New Subassemblies

Operational amplifier features high speed



An all-silicon d-c operational amplifier, model 1510, has a bandwidth of 30 Mc with full power response to 1 Mc and a slewing rate of 100 v per μ sec. Output is ± 10 v at 30 ma with only 12 ma quiescent drain from the nominal ± 15 v external power supply. D-c gain of 30,000 and stability of $\pm 10 \mu$ v/ $^{\circ}$ C and ± 0.5 na/ $^{\circ}$ C are typical.

The high-speed response of the 1510 suits it for sample and hold, or pulse train amplification.

Accessories, including connectors, power supplies, and rack mounting hardware, are available for the 1.8 in. by 2.4 in. by 0.6 in. epoxy cast module. Model 1510 is priced at \$135 with a 10% discount for quantities of 10. Shipment is from stock in small quantities to 3 weeks for production quantities.

▪ To be introduced at Wescon.
Burr-Brown Research Corp., 6730 S. Tucson Blvd., Box 11400, Tucson, Ariz., 85706. [402]

Modular power supply reduces ripple

An extra-filtered version of the PRM series modular d-c power supply is available. The PRM-180F is a high-power, line-regulated series of modules supplying up to 180 watts of low-cost power with low ripple. This module features the Flux-O-Tran line regulating transformer plus versatile mounting provisions.

This design group utilizes an extra ripple filter providing an order

Another New High Order of Reliability!

El-Menco

* MYLAR-PAPER DIPPED CAPACITORS

TYPE MFD

ASSURE A LOW FAILURE RATE OF Only 1 Failure in 7,168,000 Unit-Hours for 0.1 MFD Capacitors*

14,336,000

Setting A New High Standard Of Performance!

★ Life tests have proved that El-Menco Mylar-Paper Dipped Capacitors — tested at 105°C with rated voltage applied — have yielded a failure rate of only 1 per 1,433,600 unit-hours for 1.0 MFD. Since the number of unit-hours of these capacitors is inversely proportional to the capacitance, 0.1 MFD El-Menco Mylar-Paper Dipped Capacitors will yield ONLY 1 FAILURE IN 14,336,000 UNIT-HOURS.

CAPACITANCE AND VOLTAGE CHART

• Five case sizes in working voltages and ranges:

200 WVDC —	.018 to .5 MFD
400 WVDC —	.0082 to .33 MFD
600 WVDC —	.0018 to .25 MFD
1000 WVDC —	.001 to .1 MFD
1600 WVDC —	.001 to .05 MFD

SPECIFICATIONS

- **TOLERANCES:** 10% and 20%. Closer tolerances available on request.
- **INSULATION:** Durez phenolic, epoxy vacuum impregnated.
- **LEADS:** No. 20 B & S (.032") annealed copper clad steel wire crimped leads for printed circuit application.
- **DIELECTRIC STRENGTH:** 2 or 2½ times rated voltage, depending upon working voltage.
- **INSULATION RESISTANCE AT 25°C:** For .05MFD or less, 100,000 megohms minimum. Greater than .05MFD, 5000 megohm-microfarads.
- **INSULATION RESISTANCE AT 105°C:** For .05MFD or less, 1400 megohms minimum. Greater than .05MFD, 70 megohm-microfarads.
- **POWER FACTOR AT 25°C:** 1.0% maximum at 1 KC

These capacitors will exceed all the electrical requirements of E. I. A. specification RS-164 and Military specifications MIL-C-91B and MIL-C-25C.

Write for Technical Brochure

MINIMUM LIFE EXPECTANCY FOR **1.0 MFD* MYLAR-PAPER DIPPED CAPACITORS AS A FUNCTION OF VOLTAGE & TEMPERATURE

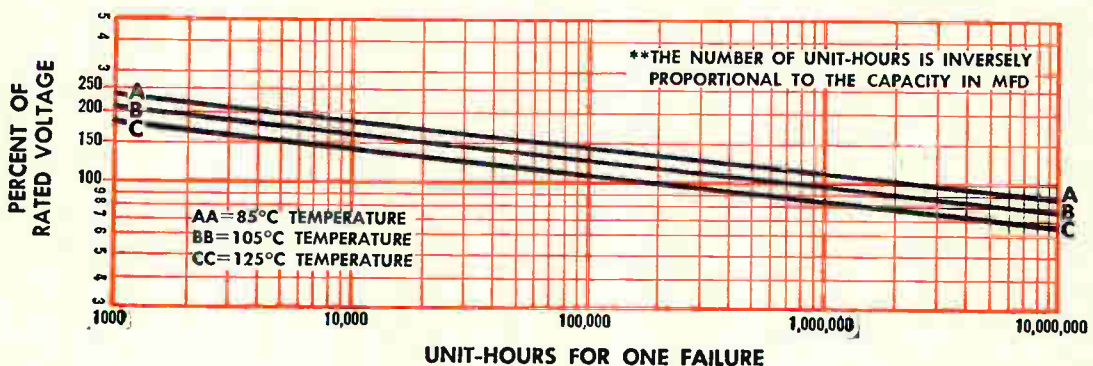

* Registered Trade Mark of DuPont Co.

THE ELECTRO MOTIVE MFG. CO., INC.

WILLIMANTIC, CONNECTICUT

Dipped Mica • Molded Mica • Silvered Mica Films • Mica Trimmers & Padders
Mylar-Paper Dipped • Paper Dipped • Mylar Dipped • Tubular Paper

ARCO ELECTRONICS, INC., Community Drive,
Great Neck, L. I., New York
Exclusive Supplier to Jobbers and Distributors
in the U. S. and Canada

West Coast Manufacturers Contact
COLLINS & HYDE CO. 1020 Corporation Way
Palo Alto, California
5380 Whittier Boulevard, Los Angeles, California

MANUFACTURERS OF
El-Menco
Capacitors

GET ALL 5



IN 1 NEW PHOTOCELL...

Now, the 5 best characteristics of CdSe and CdS are combined in 1 new Clairex CdS photosensitive material, the type "5H".

1. High speed (1-2 millisecond response)
2. Low temperature coefficient (0.5%/°C)
3. Low memory (15 X lower than CdSe)
4. High linearity (slope of 0.9 from 0.1 to 100 FC)
5. Uniform color temperature response (100% - 106%, 2854°K-6700°K)

Detailed information on type "5H" photocells plus the new Clairex 16 page Designers' Manual free on request.

CLAIREX

"The LIGHT Touch in Automotion and Control"

8 West 30 Street, New York, N. Y. 10001, 212 MU 4-0940

Circle 227 on reader service card

IF YOUR PROBLEM IS SPEED CONTROL

YOUR SOLUTION IS ELECTRO-CRAFT

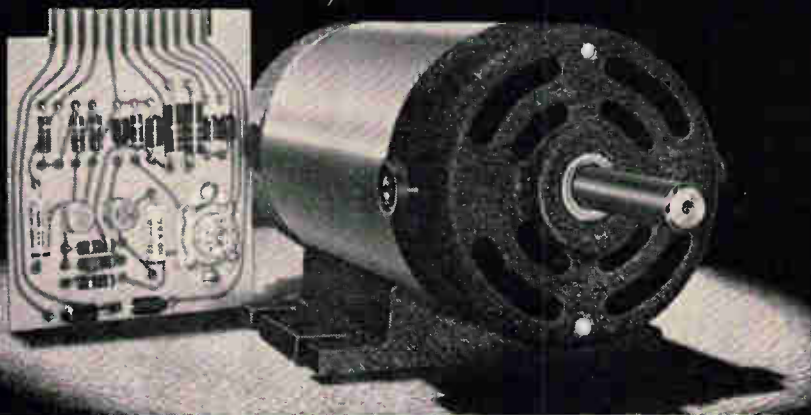

ELECTRO-CRAFT manufactures a new, low-cost, transistorized, wide range motor speed control system called the MOTOMATIC. ■ Motor speed can be set either manually or automatically in a 1000:1 speed range, and once set, remains within 2% stability regardless of changes in line voltage or load conditions. This represents superior performance to any other industrial motor speed control system. ■ MOTOMATIC speed control systems are available in various sizes, speed and load ranges. ■ MOTOMATIC has improved the products of hundreds of users. How about yours? Write today.



**ELECTRO-CRAFT
CORPORATION**

1600 South Second Street, Hopkins, Minn.

New Subassemblies

of magnitude ripple reduction over the parent PRM-180 series. Specifications for the PRM-180 F series include voltage and current ratings from 6.3 v at 25 amps to 120 v at 1.5 amps.

■ To be introduced at Wescon. Kepco, Inc., 131-38 Sanford Ave., Flushing, N.Y., 11352. [403]

Lumped constant sealed delay line



Model 3D2-10 lumped constant delay line features a hermetically sealed case. Delay time is 200 nsec $\pm 3\%$; impedance, 100 ohms; temperature range, -55° to $+105^\circ\text{C}$; size, 1 inch long by 0.4 inch o-d. Units have glass to metal terminals, nickel plated case, and meet MIL-D-23859. Price is \$13 in small quantities; delivery, 2 weeks.

Data Delay Devices, 62 Railroad Ave., Paterson, N.J., 07501. [404]

Bandpass filters offered in 2 models



Models 330B and 330N are variable electronic bandpass filters covering the frequency ranges 0.02 cps to 2 kc and 0.2 cps to 20 kc, with separate controls for each cutoff frequency to permit a choice of optimum response for transient waveform studies as well as for continuous-frequency filtering. Up-



There's only one way to go...computerized filter and transformer design

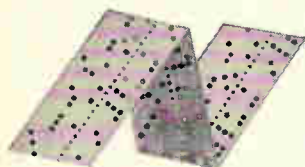

Here's the newest, shortest way to accuracy and top performance in filters and transformers: design by computers.

It's your fastest route. Computer designs take minutes instead of hours. No crossroads or by-passes, either. Computer design explores possible approaches, guides you straight to the best solution when you're in a hurry.

And no detouring for trial-and-error prototype costs. Designs are "performance tested" before production starts. Genisco's computer method searches through existing designs and singles out any that can be used.

Your filters and transformers arrive on time and at lower shipping cost because Genisco plants are on the map in key market areas. Price quotations are fast and accurate. There's never any guessing about costs with Genisco computer design of filters and transformers.

Find out how this new design capability can put you on the right track. Write today for complete information.

TRANSFORMERS

Transonic and CEECO

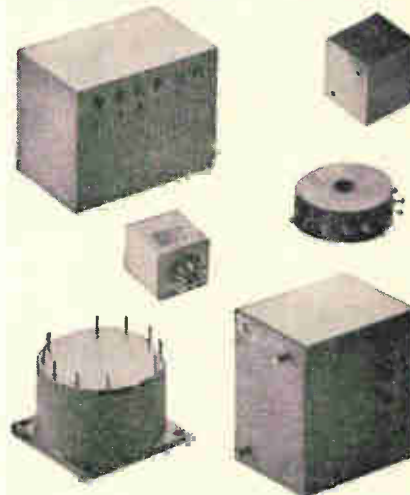

RFI & ELECTRONIC WAVE FILTERS

Genistron

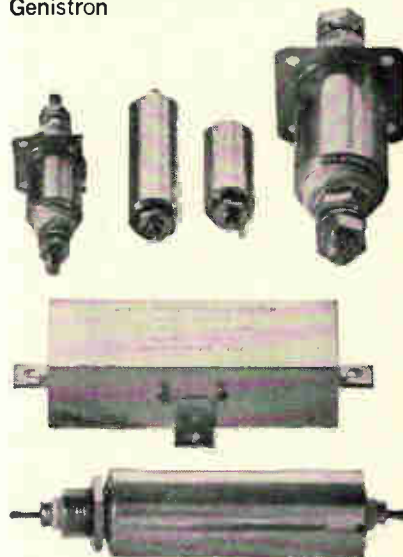

RESISTORS & NETWORKS

Genistron

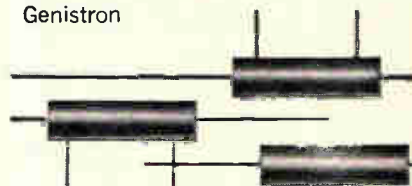

ELECTRONIC COMPONENTS DIVISION

WESTERN UNITED STATES

6320 West Arizona Circle
Los Angeles, Calif. 90045
Phone: (213) 776-1411 TWX: 213-670-4765

EASTERN UNITED STATES

111 Gateway Road
Bensenville, Ill. 60106
Phone: (312) 766-6550 TWX 312-766-7048

Genisco

TECHNOLOGY CORPORATION



See us at WESCON, Booth 1624-25

want big
performance

from a small
portable oscillograph?

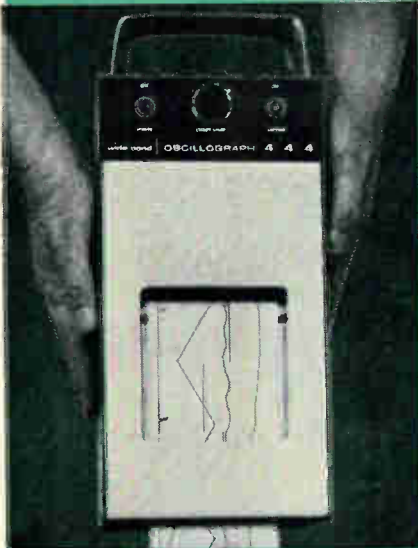

the new
Century 444
has it!

BETTER OPTICS MAKES THE DIFFERENCE: Superior optics by CENTURY means greatest efficiency from the low heat tungsten bulb light source — this means less DC power — smaller power supply — less cost — less weight.

SPECIFY THE CENTURY 444 for the finest in a small*, portable, light weight (15 lbs.), precision six channel wide band oscillograph.

* $(12\frac{1}{2}'' L \times 5\frac{5}{8}'' H \times 6\frac{1}{4}'' W)$

Send for the
Century 444
brochure
containing
detailed
specifications.



CENTURY

ELECTRONICS & INSTRUMENTS

Subsidiary of Century Geophysical Corp.
6540 E. Apache St., Tulsa, Oklahoma 74115

New Subassemblies

per and lower cutoff frequencies are independently adjustable over the entire frequency range of each instrument, with an attenuation rate of 24 db per octave outside the pass band. A front panel switch allows selection of 1 v or 10 v rms maximum input amplitude.

Application areas include vibration and shock-test instrumentation, rejection of interference in communication channels, geophysical and seismological studies, and general audiofrequency work, as well as phonocardiography and similar pulsed-signal research. Price for the model 330B is \$595; for model 330N \$550. Availability is from stock to 3 weeks.

▪ To be introduced at Wescon.
Krohn-Hite Corp., 580 Massachusetts Ave., Cambridge, Mass., 02139. [405]



Spiral antenna is cavity-backed

A cavity-backed spiral antenna, with bandwidth capability of 10:1, was never before commercially available. Prior to this development, the manufacturer reports, cavity-backed spiral antennas were effective over a bandwidth of only approximately 2:1. Because of this breakthrough, spiral antennas are now available with performance characteristics far superior to the conical helix, conical spiral, cavity backed log periodic, and other frequency independent antennas over comparable bands.

Typical applications include airborne surveillance, electronic countermeasures, and as broadband feeds for parabolic reflectors

VITREOSIL®

PURE FUSED
QUARTZ
TAKES
MORE
SHOCK,
HEAT
AND
ACID

THAN GLASS
OR PORCELAIN —

RESISTS
TEMPERATURES TO
1050°C —

HANDLES
MOST HOT ACIDS
WITHOUT ETCHING —

WITHSTANDS
CONSTANT THERMAL
SHOCK —

EXCELLENT
ELECTRICAL AND
OPTICAL
PROPERTIES —

LABORATORY AND
INDUSTRIAL WARE —

SPECIAL
FABRICATION —

SPECTROSIL®
FOR PURITY

ASK FOR
32 PAGE FREE
CATALOG —

THERMAL
AMERICAN
FUSED QUARTZ CO.

RT. 202 AND
CHANGE BRIDGE RD.
MONTVILLE, N. J.

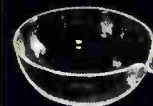

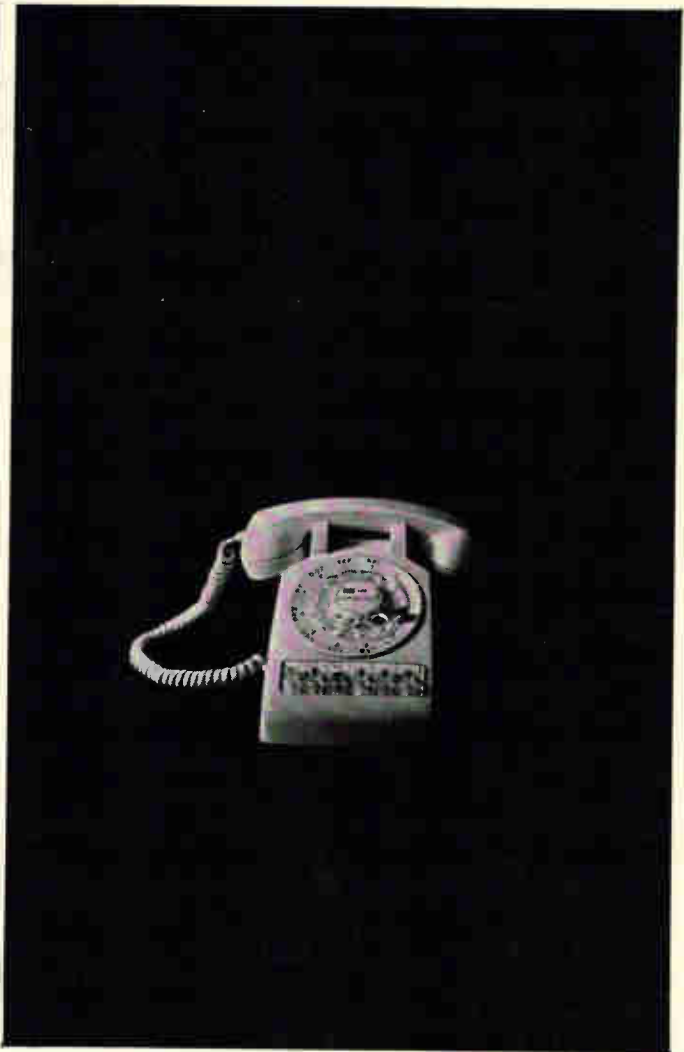

You may never need Heinemann circuit breakers overnight.

But now you can get delivery that fast. On one or one hundred.

Effective immediately, a phone call to any of twenty-six hand-picked distributors will get you the Heinemann circuit breaker you want—and the quantity you want it in—at off-the-shelf speed. Each electrical- and electronic-equipment distributor listed here has a good stock of the most popular breakers in the Heinemann line . . . breakers you're likely to specify often and want in a hurry. □ Want to know precisely what Heinemann models are offered in this new, nationwide set-up? The authorized distributor nearest you will be happy to furnish a complete list. Overnight, if you need it.

AUTHORIZED STOCKING DISTRIBUTORS

California

State Electric Supply
Oakland (415) 836-1717
Fisher Switches Inc.
Palo Alto (415) 321-4080
Wesco Electronics
Pasadena (213) 795-9161

Georgia

Electro-Tech, Inc.
Atlanta (404) 758-7205

Kentucky

E & H Electric Supply Co.
Louisville (502) 587-0991
Marine Electric Co.
Louisville (502) 587-6511

Louisiana

Hall-Mark Electronics Corp.
New Orleans (504) 242-7581

Maryland

D & H Distributing Co.
Baltimore (301) 727-5100

Massachusetts

Apparatus Service Co.
Allston (617) 782-7440
Electrical Supply Corp.
Cambridge (617) 491-3300

T. F. Cushing Inc.
Springfield (413) 788-7341
Alpha Electronics Service
Wellesley Hills (617) 235-6710

Missouri

Precision Electronic Devices, Inc.
Kansas City (816) DE 3-5524

New Jersey

Alpha Electronics Service
Pennsauken (609) NO 2-1310
Federated Purchaser Corp.
Springfield (201) 376-8900

New York

Federal Electronics
Binghamton (607) PI 8-8211
Schweber Electronics
Westbury (516) ED 4-7474

North Carolina

Electro-Tech Inc.
Charlotte (704) 333-0326

Ohio

The Midwest Equipment Co.
Cincinnati (513) 821-1687

Pennsylvania

West Chester Electric Supply Co.
West Chester (215) 696-7500

Texas

Warren Electric Co.
Beaumont (713) TE 3-9405
Nelson Electric Supply Co.
Dallas (214) RI 1-6341
Hall-Mark Electronics
Garland (214) 276-8531
Hall-Mark Electronics
Houston (713) 781-0011
Warren Electric Co.
Houston (713) CA 5-0971
The Perry Shankle Co.
San Antonio (512) CA 3-1801

HEINEMANN ELECTRIC COMPANY

Trenton, New Jersey 08602

Limitron Fuses

...for the Protection
of Semi-Conductor Rectifiers



LIMITRON fuses provide extremely fast opening on overload and fault currents, with a high degree of restriction of the let-thru current.

If each SCR and individual diode is protected by a proper size Limitron fuse, the fuse will open to protect the unit when the current drawn exceeds the rating of the unit. Thus the SCR or individual diode is taken out of the circuit before damage can be done to other diodes in the rectifier.

For full information and opening time charts ask for BUSS Bulletin HLS.

See us at The Wescon Show Booth 2525

MORE **BUSS QUALITY** FUSES

BUSSMANN MFG. DIVISION
McGraw-Edison Co., St. Louis, Mo. 63107

For Protection of

Circle 179 on reader service card

LABORATORY BENCH PLATES



for laser applications; electronic equipment; laboratory and production testing

STABLE, precision mounting surfaces for laboratory equipment. Finish machined on six sides to overall flatness of 0.002 in. Drilled and tapped clamping holes (T-slots available).

Standard 3 x 6 ft. plates assemble to any required size or shape. 40 in. high with steel stand. Storage shelf below.

Cast semi-steel plate is 6 1/2 in. thick. 30,000 p.s.i. tensile strength — 160-180 Brinell hardness. Electroless nickel plating available.

Write for Specification 3-003-65



LAKE SHORE, Inc.

IRON MOUNTAIN, MICHIGAN 49801
Phone: 906 • 774-1500

178

Circle 178 on reader service card



Metronix

REGULATED DC POWER SUPPLIES

- Regulation: 0.01% or 20 mV (line or load)
- Ripple: 3 mV p-p



Model 521A
1-18V DC, 0.5A

MODEL	VOLT	AMPS
541A	1-35V	0.25A
545	1-35V	0.5A
531	0-35V	1A
75	0-35V	5A

Metronix Corp.

76, Chofuchidoricho, Ota-ku, Tokyo, Japan

Circle 254 on reader service card

New Subassemblies

with minimum phase center shift. Available in a variety of sizes, this antenna is of rugged construction and designed for flush mounting. Minimum gain is 5 db, and vswr is 2:1 maximum.

▪ To be introduced at Wescon. American Electronic Laboratories, Inc., P.O. Box 552, Lansdale, Pa. [406]

Tapped delay line small, inexpensive

Model 3DT-09-500 tapped delay line features miniature size and low cost. Specifications include: delay time, 900 nsec; taps, every 100 nsec; impedance, 500 ohms; temperature range, -55° to $+125^{\circ}\text{C}$; size, 0.375 to 0.750 by 3 in. Terminals are spaced to fit 0.1-in. grid printed-circuit board. Units meet

MIL-D-23859. Price is \$12 in small quantities; delivery is in 10 days. Data Delay Devices, 62 Railroad Ave., Paterson, N.J., 07501. [407]

Punched tape reader and spooler system

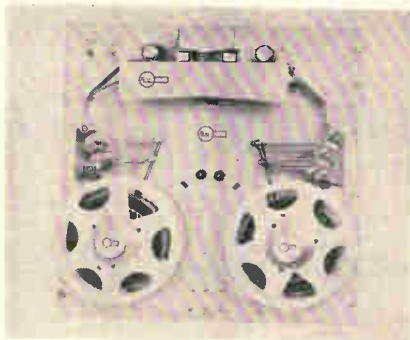

A high-speed photocell punched tape reader and matching tape spooler is announced. The units are designed as input devices for numerical control systems, digital computers, automatic drafting ma-

chines, automatic circuit evaluators, or other systems requiring reliable, high-speed punched tape reading.

The reader is available in either unidirectional or bidirectional models that operate at speeds to 700 characters per second. The spooler features bidirectional rewind from push-button or remote control at 200 inches per second.

The unidirectional model RR-702 reader is priced at \$1,440 and the bidirectional model costs \$1,585. Model RS-702 spooler costs \$1,495.

▪ To be introduced at Wescon. REMEX/Rheem Electronics, 5250 West El Segundo Blvd., Hawthorne, Calif. [408]

Booster amplifier increases reliability

A powerful silicon-transistor booster amplifier is designed for use where the ultimate in reliability

Semi-Conductor Rectifiers

Limitron Fuses

...for the Protection
of Semi-Conductor Rectifiers

LIMITRON fuses are available in ampere sizes up to 800 and voltages up to 600.

They come in various types and sizes to fit various types of application.

Should you have a special problem, our staff of fuse engineers are ready to assist you at any time.

For full information on LIMITRON fuses for the Protection of Semi-Conductor Rectifiers ask for BUSS Bulletin HLS.

See us at the WESCON Show Booth 2525

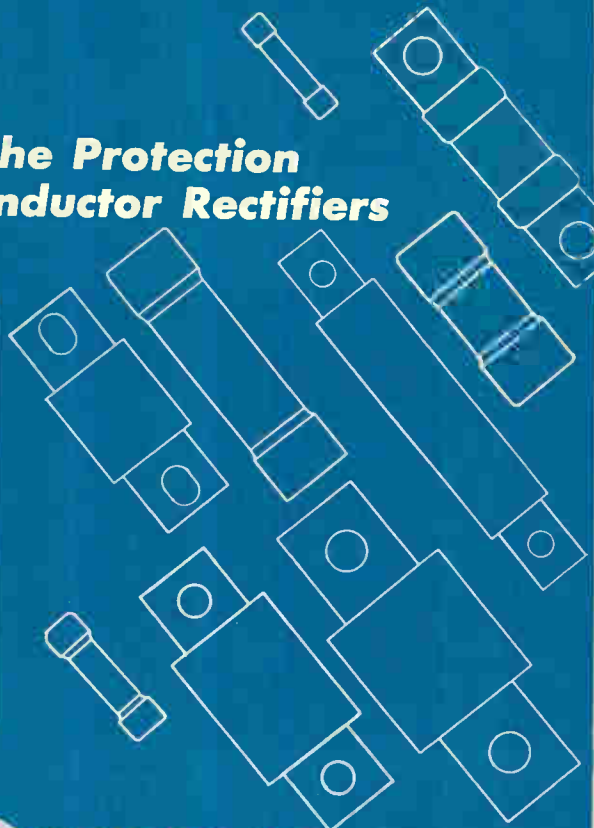

MORE **BUSS** QUALITY FUSES

BUSSMANN MFG. DIVISION
McGraw-Edison Co., St. Louis, Mo. 63107

Measure Transients of less than 1 μ s



Model 440A PEAK LOK Transient Reading Voltmeter reads and holds the largest signal received over any selected period of time. Pulses shorter than 1 μ s are measured and the reading accurately held until reset.

DC coupling is provided and input ranges from 0.1 volt to 1000 volts may be selected manually. Polarity may also be selected with a front panel switch.

The PEAK LOK Model 440A can be manually or electronically reset. Visual output is on taut-band mirror-backed meter. Output for logging—low impedance 0 to +5 volts with 1% absolute accuracy. Portable or rack mounted versions are available. The Model 440A utilizes Control Data's unique ANALOK* Analog Memory technique. Silicon semiconductors are used throughout to insure reliability in operating temperatures from 0° to +50°C.

*Trademark

FOR INFORMATION on the Model 440A PEAK LOK contact:

ADCOMP Corporation, Dept. 101
20945 Plummer St.
Chatsworth, Calif.

(Area code 213, 341-4635)

See us at Booth 2003 WESCON

ADCOMP CORPORATION
SUBSIDIARY OF

CONTROL DATA
CORPORATION

New Subassemblies

is required. Model MT100—said to be ideally suited for sound systems in industrial plants, airports, stadiums and schools—features exceptionally wide-range response characteristics and the ability to parallel any number of amplifiers to multiply power output.

The unit provides 100-w output at 1% distortion with a power curve from 29 to 20,000 cps \pm 1 db at 5%. It may be operated from a 12 to 16-v d-c source as well as a 117-v a-c power supply. Input sensitivity is about $\frac{3}{4}$ of a volt, and the amplifier may be driven from a high or low impedance line.

A unique feature, according to the manufacturer, is a 115-v output tap for industrial applications, where the MT100 may be used as a power source—with an audio signal generator—to drive servos, motors, vibration tables and ultrasonic equipment. Virtually any frequency or voltage may be obtained.

Bogen Communications division of Lear Siegler, Inc., Paramus, N.J. [409]

Single decade printer is easily zeroed

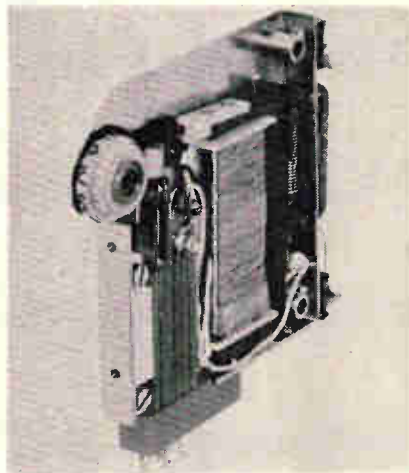

Model WR-25 single decade printer incorporates an escape mechanism that permits the counter to be zeroed with only one 400-msec pulse. Presently, all similarly designed printers must provide a series of pulses in order to be zeroed.

Units are available for 24- or 60-v d-c operation, and may be obtained as loose decades to be built

FAMOUS ENCAPSULATING TECHNIQUES

with hull



... and by HULL



Now it's fashionable to claim second place. You can see we go a step further and show you why we're only second in encapsulating.

Hull encapsulating techniques are for components like diodes, resistors, delay lines, chokes, capacitors, pulse transformers. Our processes are direct encapsulation by transfer molding, by vacuum potting, and by continuous dispensing.

The "Hull Package"

We provide you a whole package (engineering, compound selection, design of molds and fixtures, Hull-developed encapsulating presses, and the working set-up).

And, we provide specific field-proved equipment: Vacuum units for potting and encapsulating with short pot life resins. The Blendmaster series of continuous metering, mixing and dispensing systems. And, of course, Hull transfer molding presses—standard or custom made.

HULL CORPORATION, 5035 Davisville Road, Hatboro, Pa. 19040. Or, phone: (215) 675-5000.

See our booth at WESCON or I.N.E.L., Basel, Switzerland

H-3R2



Circle 229 on reader service card

...and now from Amperex—
 for all your intermittent, short-talk Mobile Communications Designs
A JOB-RATED TUBE AT A JOB-RATED PRICE

It's the new Amperex 8637, a long-life, radiation-cooled, beam-power twin-tetrode. It's the world's first JOB-RATED tube for 60 watt intermittent brief-talk, mobile transmitter service. (It delivers 72 watts from less than 3 watts drive power under PTTS* conditions.) Its quality is strictly in keeping with Amperex standards of excellence and yet it is only a fraction of the size of conventional tubes and costs only one-third the price.

It can be used as an RF power amplifier, oscillator and frequency-multiplier in communications equipment up to 175 Mc.

In other words, the new 8637 is just plain unbeatable for the economical and compact design of high-quality, push-to-talk gear for delivery trucks, emergency repair vehicles, taxicabs, marine, fire, police and avionics.

For complete data, write: Amperex Electronic Corporation, Tube Division, Hicksville, Long Island, N. Y. 11802.

ALL THIS—and AMPEREX QUALITY, TOO
 (One 8637 Push-Pull)

Frequency	175 Mc
DC Plate Voltage	600 volts
DC Grid #2 Voltage	200 volts
Grid #1 Voltage	-75 volts
DC Plate Current	210 ma
DC Grid #1 Current	3 ma
Drive Power	3 watts
Plate Input Power	126 watts
Useful Power Output	72 watts

*PUSH-TO-TALK SERVICE, MAX. DUTY CYCLE 1 MIN. ON, 4 MINS. OFF.

Amperex®

IN CANADA: PHILIPS ELECTRON DEVICES, 116 VANDERHOOF, TORONTO

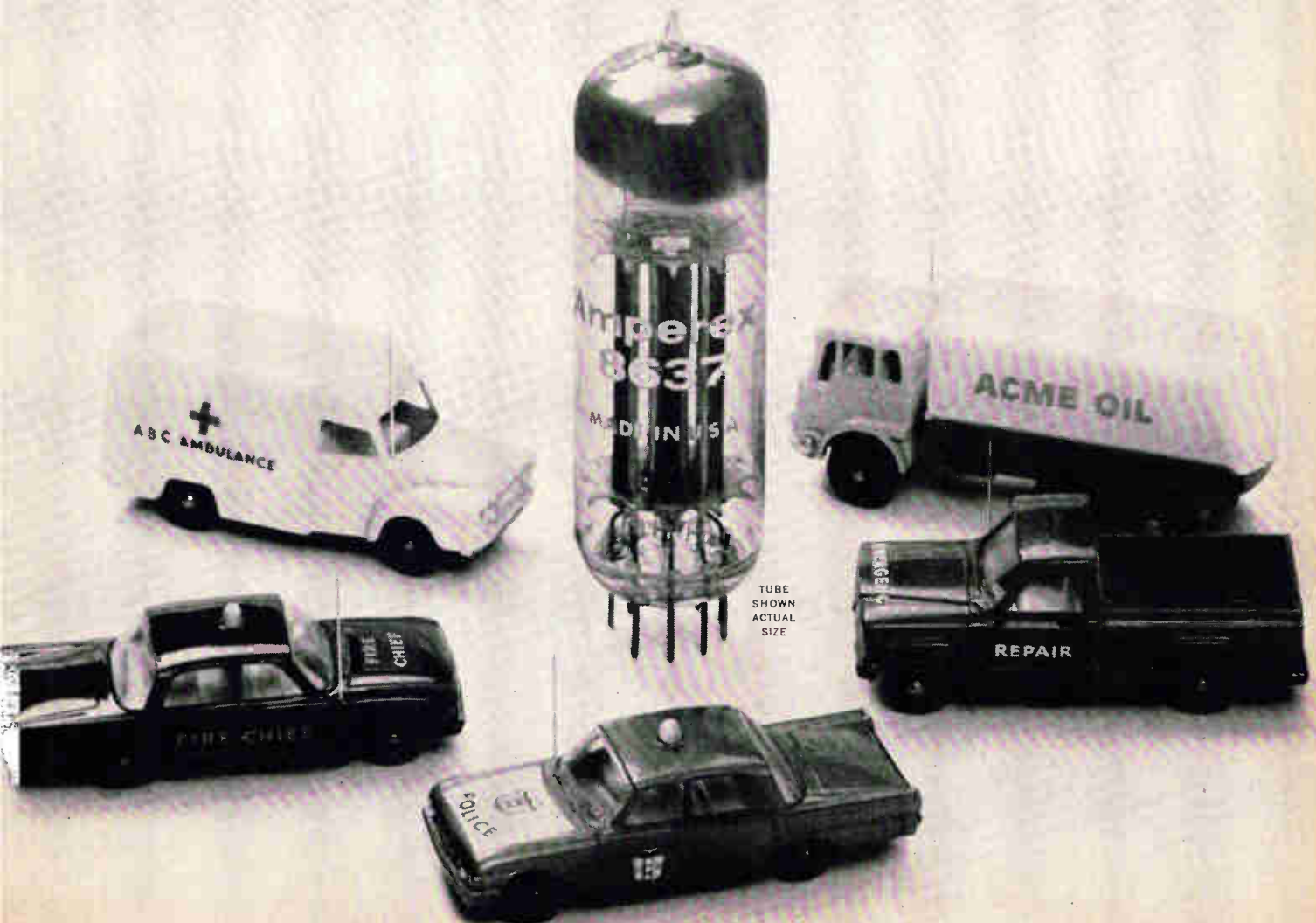



DROPS

varactor prices

AS MUCH AS 65%!

"INCREDIBLE" you might say, knowing that AEL quality has always been outstanding in the industry. The fact is, not one iota of quality is missing, we assure you.

"JUST A FEW TYPES" you might suppose. Wrong . . . price reductions are effective on the most complete line of varactors in the industry.

"HOW DO THEY DO IT?" you might ask. Ultra-refined cost cutting production techniques and tremendous volume have replaced expensive slow hand operations.

"HOW FAST CAN I GET AEL VARACTORS?" A good question. AEL gives you speedy stock to two-week delivery every time.

"TELL ME MORE ABOUT AEL VARACTORS" Okay . . . read on . . .

- Types available . . . standard double ended cartridge and pill (or button) package.
- Frequency range . . . packages with cut-off frequencies up to 180 Gc.
- Breakdown voltages . . . 160 V max.
- Junction capacitance . . . 0.1 pf to 16 pf or higher.

"GREAT . . . BUT WHAT ABOUT MY CUSTOM REQUIREMENTS?" As always AEL continues to provide any type of state-of-the-art varactor to meet your exact specifications.

"IS LITERATURE AVAILABLE?" Absolutely. Send for our new technical bulletin and schedule of new sizzling low prices . . . at once.

SEE US AT **WESCON** BOOTH 1715

or write to



American Electronic Laboratories, Inc.
P. O. BOX 552, LANSDALE, PENNSYLVANIA 19446 • PHONE: (215) 822-2929

Circle 182 on reader service card

**HELP YOUR POST OFFICE
TO SERVE YOU BETTER
BY
MAILING EARLY IN THE DAY
NATIONWIDE IMPROVED MAIL SERVICE
PROGRAM**

New Subassemblies

into customer's systems, or combined with a power supply, paper and ribbon feed to form complete digital recorders.

Other features include speeds up to 25 cps and electrical digital transfer to cascade into the following decade between 9 and 0. The over-all dimensions of one decade unit are 2½ in. by 3 in. by ⅝ in.

▪ To be introduced at Wescon.
Hengstler Numerics, Inc., 318-320 Bergen Blvd., Palisades Park, N.J. [410]

Cavity amplifier can deliver 30 watts

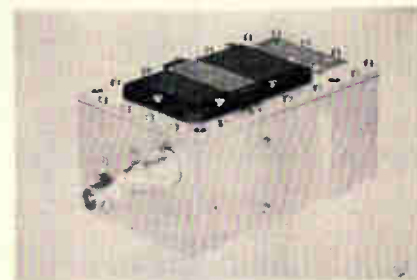

Combining solid state devices and vacuum tubes for optimum reliability, this cavity amplifier delivers 30 watts output power in a severe aerospace environment. The 30-ounce unit operates at signal frequencies from 215 to 265 Mc. Gain is 10 db minimum.

Designed to withstand either an open or shorted load without damage to the amplifier or its associated power supply, the model P40-215/265L requires no blowers. An rf filter is included to meet MIL-I-6181D. The new r-f cavity power amplifier accepts 50-ohm input power from 1.5 to 4.0 w, requires a 500-v plate power source.

Resdel Engineering Corp., 990 South Fair Oaks Ave., Pasadena, Calif. [411]

Low-level amplifier offers 5 options

The 391 series low-level d-c differential amplifier offers a building-block concept with five options providing a high degree of flexibility at low cost. The basic unit contains a single gain between 10 and 1,000 and a single bandwidth

COMPONENT COMMENTS *From Speer*



In order to accommodate the 10,000-hour failure-rate level determination load life test (shown above) as well as the other special tests required by MIL-R-39008, Speer recently added 28,000 square feet of quality control and inspection facilities to its Bradford, Pennsylvania, resistor plant.

How to be sure that a resistor will shape up to MIL-R-39008

The problem, as we see it, is twofold. First: how can the resistor manufacturer be sure? And second: how can you, the purchaser, be sure?

First things first. The new MIL-R-39008 "Established Reliability" specification is a challenge to the manufacturer to achieve higher standards of accuracy and reliability than were required by the earlier MIL-R-11 military specs. Not only are the MIL-R-39008 tests more extensive and more exacting; they're also decidedly more time-consuming. (Example? Up to 630 million unit test hours are required to extend qualification to the lowest of the new failure-rate levels. With MIL-R-11, failure-rate level determination was not even required.)

We at Speer had a sneaking suspicion that we possessed the broad background and the resistor know-how to achieve these new standards of accuracy and reliability. And now, at last, we've completed sufficient long-term life testing to determine that our 5-stripe resistors *can* indeed "shape up" to MIL-R-39008's rugged military standards.

So far, so good. But how do we now assure *you* of our resistors' Established Reliability? Five colorful stripes aren't adequate assurance. Neither are glowing adjectives.

So we've decided to do more—and that's why each shipment of our 5-stripe resistors comes to you with a lot quality certificate to document its performance. Automatically generated data from each test group is maintained for detailed reference.

If you'd like to pursue this subject of Established Reliability still further, we invite you to send for our technical article entitled "How the New 'Tri-Service' Specification MIL-R-39008 Applies to Resistors." To get a copy, use the coupon.

SPEER CARBON COMPANY

St. Marys, Pennsylvania

Speer Carbon Co. is a Division of Air Reduction Company, Inc.

- Rush "How the New 'Tri-Service' Specification MIL-R-39008 Applies to Resistors."
- Rush "The Jeffers Inductor Handbook."
- Arrange for me to receive reprints of "Component Comments."

Name _____
 Title _____
 Company _____
 Address _____
 City _____
 State _____ Zip _____

Our inductor capabilities are an open book

We have just discovered that our Jeffers Electronics Division is not a group to be trifled with.

In a recent issue of "Component Comments," we presented a feature on "The Speer Resistor Handbook." When our Jeffers associates got wind of this, they reminded us, a trifle tartly, that "The Jeffers Inductor Handbook" is equally fascinating.

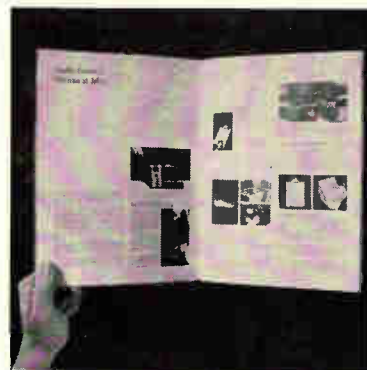

Interior view of our free, 16-page, lavishly illustrated "Inductor Handbook."

And so it is. This colorful 16-page brochure takes you through the entire Jeffers inductor plant—from the automated manufacturing operation and the application engineering services to the Established Reliability Program and the comprehensive Quality Control & Inspection Program. (Did you know, for example, that there are continuous patrol checks at every manufacturing step?) You'll also learn how our standard catalog inductors have performed under MIL-C-15305 test conditions.

As you can see, our Jeffers Division's inductor capabilities are an open book. If you'd like a copy, just mail us the coupon.

SEE OUR DEMONSTRATION, BOOTH 1020, WESCON SHOW, AUG. 24-27, 1965

LASER DIODE PULSER LDS-II

0 to 20 Amps
Peak Pulse Current
5 MICROSECONDS

Pulse Width
PULSE REPETITION
RATE VARIABLE From
100 to 10,000 CPS

**ALL SOLID STATE
ONLY \$650**

CW Room Temperature

LASER RODS

Thresholds of only
800 Watts
Yttrium Aluminum
Garnets
Calcium Tungstate
and others

**YOUR COMPLETE
HEADQUARTERS
GAS LASER SYSTEMS
LASER DIODE SYSTEMS
ACCESSORIES
OVER 650 KINDS
OF
SINGLE CRYSTALS**

For Complete Literature
Write Dept. 6

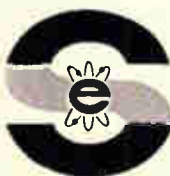

emi-elements, inc.

Saxonburg Boulevard,
Saxonburg, Pa.
Phone: 412-352-1548

New Subassemblies

of 100 kc. Prices of the basic unit start at \$390.

The five options are: seven switched gains, five switched gains with full interpolating vernier, dual output, eight switched bandwidths, and triple-output, high-level multiplex switch for remote switching of second output.

Redcor Corp., 7800 Deering Ave., P.O. Box 1031, Canoga Park, Calif. [412]

Indicators display elapsed time



Instantaneous zero reset by a convenient face-mounted push button is featured by these microminiature elapsed time indicators. The units offer a three-digit display of hours or hours and tenths. They may also be allowed to recycle automatically and thus count beyond 999, or 99.9, as applicable, if desired. The indicators are synchronous motor driven.

Models LM19202 and LM19203 operate on 115 v a-c, 400 cps, and read to 99.9 and 999 hours, respectively. Models LM19204 and LM-19205 operate on 26 v a-c, 400 cps, with the same respective readouts. Units are hermetically sealed and meet applicable requirements of MIL-M-7793C. Timing tolerance is ± 1 digit at 400 cps.

All models measure $\frac{5}{8}$ in. square in cross section by $1\frac{1}{2}$ in. long, with an oval front mounting flange having $1\frac{5}{16}$ in. by $\frac{7}{8}$ in. axes.

These indicators are especially suited for such applications as counting of component or system service hours, testing-time indications, or convenient indication of interval lengths for repetitive observations.

The A.W. Haydon Co., 232 North Elm St., Waterbury, Conn., 06720. [413]

NEON GLOW LAMP NEON BRACKET LAMP

(ACTUAL SIZE)

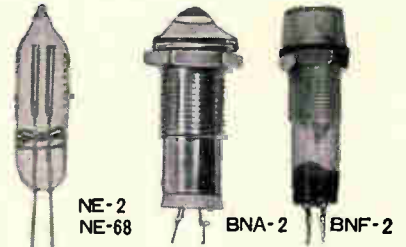

GLOW LAMP

Model	Breakdown Voltage (V)	Design Current (mA)
NE-2	AC75. Max 50 AC. Average	0.3
NE-2H	"	1.5
NE-68	DC-60~90	0.3
NE-96	DC-120~150	0.5

BRACKET LAMP

Model	Breakdown Voltage (V)	Design Current (mA)
BNA-2	AC75. Max AC50. Average	0.3
BNF-2	"	"



**OKAYA
MUSEN CO., LTD.**

2-2 Kamidori Sibuya-ku, Tokyo, Japan
Tel: (400) 8 5 1 1

Circle 230 on reader service card

SHIZUKI CAPACITORS

Injection Polypropylene Resin
Molded Metallized Lacquer Film
Capacitors (-30°C +85°C)

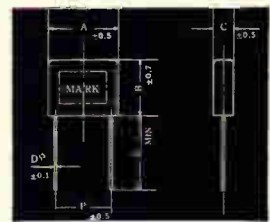

50 volts D.C. Working unit: mm

TYPE	CAP	A	B	C	D	P
PML-0.47/50	*0.47 μ F	14.0	14.0	5.0	0.6	10.0
PML-0.5/50	0.5 μ F	14.0	14.0	5.0	0.6	10.0
PML-0.68/50	*0.68 μ F	19.5	16.0	5.5	0.6	15.0
PML-1.0/50	*1.0 μ F	19.5	16.0	5.5	0.6	15.0
PML-1.5/50	*1.5 μ F	24.0	19.0	6.5	0.7	19.0
PML-2.0/50	2.0 μ F	24.0	19.0	6.5	0.7	19.0
PML-2.2/50	*2.2 μ F	24.0	19.0	6.5	0.7	19.0
PML-3.3/50	*3.3 μ F	30.0	20.0	7.0	0.7	25.0
PML-6.8/50	*6.8 μ F	31.0	23.0	10.0	0.8	25.0

*STANDARD

- ◇ Lacquer Film Capacitors ◇ Mylar Capacitors
- ◇ Metallized Paper Capacitors for Motor running, fluorescent ballasts ◇ Noise Suppression Capacitors
- ◇ Ignition Capacitors ◇ Miniature Electrolytic Capacitors



SHIZUKI ELECTRICAL MFG. CO., LTD.
HEAD OFFICE: TAISHA-CHO, NISHINOMIYA, JAPAN
CABLE ADDRESS: "CAPACITOR" NISHINOMIYA
TOKYO FACTORY: 10-7, ARAIYUKU, OTA-KU, TOKYO

Circle 231 on reader service card
Electronics | August 9, 1965



EVERYONE KNOWS A DECENT TRIMMER COSTS MORE THAN A BUCK (EVERYONE BUT HELIPOT)

Here's a great new trimmer, the Model 62 Helitrim[®], with a foxy combination of fine performance and low price. Only 0.250 inches in diameter and 0.250 inches high, it's one of the world's two smallest trimmers (both are from Helipot)!

Power rating is $\frac{1}{2}$ watt at 70°C. It's packaged in a sealed metal housing. And it has a Cermet element, which means essentially infinite resolution at resistance values from 10 ohms to 1 megohm.

Cunningly priced below a dollar in large quantity, single units start at \$1.75. Delivery details and other data are available from your local Helipot[®] sales rep.

Beckman[®]

INSTRUMENTS, INC.

HELIPOT DIVISION

FULLERTON, CALIFORNIA • 92634

INTERNATIONAL SUBSIDIARIES: GENEVA, SWITZERLAND;
MUNICH, GERMANY; GLENROTHES, SCOTLAND; PARIS, FRANCE;
TOKYO, JAPAN; CAPE TOWN, SOUTH AFRICA.

LFE ULTRASTABLE MICROWAVE INSTRUMENTATION

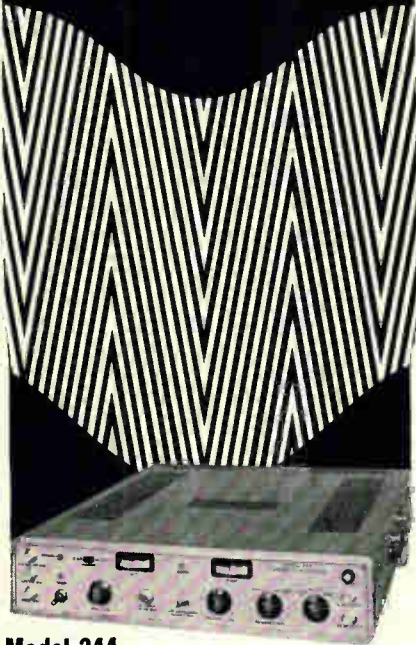

Model 244 TUNABLE COHERENT SYNCHRONIZER and MARKER GENERATOR

One coherent reference covers 2 Gc to 15 Gc continuously. Will phase-lock BWO tubes, klystrons, VTMs, Triodes and Voltage Tunable Solid State Sources. Stability — Short Term 5 part 10^7 — Long Term 1 part 10^7 . Use of external quartz or cesium standard would provide stabilities in order of 1 part 10^{10} . As Marker Generator 10 mc and 50 mc markers selectable over 85 mc to 15,000 mc range. Model 244 is also usable as a transfer oscillator when coupled with a standard 10 mc counter.

This instrument is typical of the advanced instrumentation available off-the-shelf from LFE, including phase-locked and other oscillators, frequency and pulse stability testers, and noise measuring equipment. Custom-engineered instrumentation for even more critical requirements.

Incidentally, one of our secrets (which we share with other leaders in instrument and systems design) is our advanced components group, which delights in taking on the really tough problems in delay lines and associated circuitry, transformers, temperature controllers and amplifiers.

For full information on Model 244, and other ultrastable microwave instrumentation, write to:

WESCON Booth 4212



LFE ELECTRONICS

A Division of Laboratory For Electronics, Inc.
WALTHAM, MASSACHUSETTS 02154

Microwave Measurement & Signal Generation Equipment • Delay Lines
Filters • Transformers • Amplifiers, and Associated Electronics

New Microwave

Antenna polarizes linearly or circularly

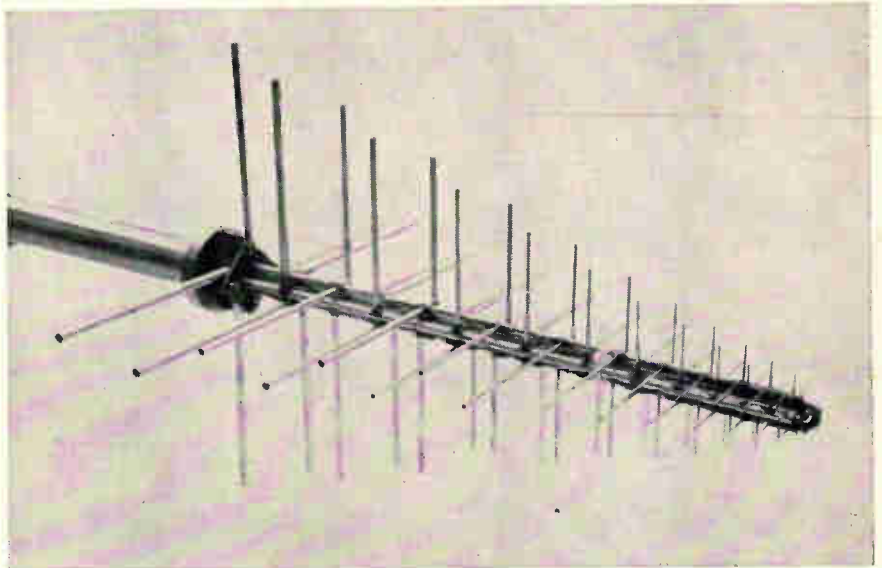

Take two log-periodic antennas, mount them at right angles to each other on a common axis so that their radiation patterns are independent, and the result is an unusually versatile antenna. It combines the broadband characteristic of log-periodics with an ability to provide any field pattern polarization or combination of polarizations.

According to American Electronic Laboratories, its new APX 254 crossed log-periodic antenna has at least 25 db isolation between linear planes and has a variety of uses in telemetry, electronic countermeasures, air surveillance and polarization diversity communications systems, and as a transmitting source for antenna test ranges.

The antennas are designed to operate by themselves or as feeds for parabolic reflectors, and can receive or radiate selected polarization patterns over frequency bands of 10:1.

The elements of each log-periodic antenna are supported by two metal booms, one of which contains a coaxial cable that feeds the antenna. The center conductor of the cable is connected to the other boom to provide a balanced feed.

When the inputs to each antenna

are phase-shifted 90° by a hybrid coupler, the cross antenna can receive or radiate circular polarization, either left-hand or right-hand.

Since the log-periodic antenna operates on a frequency-independent scaling principle, it maintains nearly constant pattern and impedance characteristics over theoretically unlimited bandwidths. In practice, maximum frequency range is usually limited by physical considerations such as size. Maximum length of the elements is approximately one-half wavelength at the lowest frequency of operation. The APX 254 operates in the frequency range of 400 Mc to 4 Gc, but antennas that operate as low as 20 Mc are available.

The antenna will be introduced at Wescon.

Specifications

H-plane beamwidth	90°
E-plane beamwidth	60°
Front-to-back ratio	Greater than 20 db
Side lobe rejection	-18 db minimum
Vswr	Less than 2:1 (referenced to 50 ohms)
Antenna gain	Greater than 7 db and constant over the beamwidth
Price	\$995
Delivery	60 days

American Electronic Laboratories, Inc.,
P.O. Box 552, Lansdale, Pa. [421]

Did you ever wish someone would combine the best cleaning features of fluorocarbon solvents and water detergents?

Someone did! It's called FREON® T-WD 602.

FREON T-WD 602 solvent* is a stable dispersion of water in FREON® TF that combines the cleaning power of water detergents with the unique properties of FREON fluorocarbon solvents. It cleans organic and inorganic soils at the same time...and cleans better than water detergents alone.

Here's why:

Lower surface tension—Water has a surface tension of 72 dynes per centimeter. With a detergent, this drops to approx. 30. But FREON T-WD 602 has a surface tension of only 19.5 dynes! It easily penetrates even the most microscopic pores and crevices to dissolve and wash away contaminants that water and detergents can never reach...and its high density floats particulate matter away.

Quick drying—FREON T-WD 602 helps speed up production. Parts come out clean, dry and ready to handle. No extra drying procedures are needed.

Leaves no residue—Parts cleaned in FREON T-WD 602 followed by a FREON TF vapor rinse dry without leaving any residue.

Can be re-used—You can renew the FREON T-WD 602 bath just by letting it settle, skimming off soils and replacing with an equal volume of water.

FREON T-WD 602 is ideal for cleaning complex assemblies where a com-

bination of organic and inorganic soils exists. It is one of a group of "tailored" solvents for special cleaning problems based on FREON TF. For more information, mail the coupon.

*Process and composition patents applied for.



BETTER THINGS FOR BETTER LIVING
...THROUGH CHEMISTRY



Du Pont Co., Room 2908E
Wilmington, Delaware 19898

Please send complete information on
 FREON T-WD 602; the other FREON
"tailored" solvents. I am interested in
cleaning _____

Name _____ Title _____

Company _____

Address _____

City _____ State _____ Zip _____

In Europe, mail to: Du Pont de Nemours International S.A.,
"Freon" Prod. Div., 81 route de l'Aire, Geneva, Switzerland

NEW BILEY

Miniature Crystal Oscillator Modules

Maintain Close Tolerance without Temperature Control

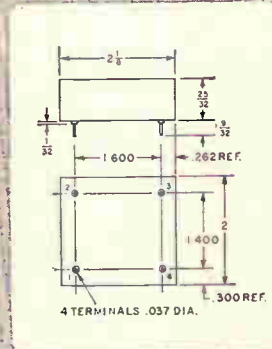

A precision quartz crystal and solid state oscillator circuitry are encapsulated in modules for flat mounting on PC boards. Optimum design assures accurate output by elimination of spurious response and correlation considerations. Frequency Range: 15 kc to 100 mc

Bulletin No. 541A



If you buy quality

BILEY ELECTRIC COMPANY

Union Station Bldg. • Erie, Pennsylvania

See us at Wescon, August 24-27, San Francisco, Calif., Booth No. 2721

Circle 232 on reader service card

New Microwave

YIG filters offered
in 6 coaxial models



A series of tracked/isolated YIG electronically tunable microwave filters are said to offer lower insertion loss, improved tracking characteristics, broader bandpass and lighter weight than those introduced by the manufacturer a year ago. The 2200 series units provide two r-f filter sections within the same magnetic tuning structure—a concept that enables the units to be used in advanced electronic equipment, such as doppler radars, ecm/eccm systems and frequency agility radars.

Six coaxial models cover the frequency range from 250 Mc to 12.4 Gc. All units can be swept over their full tuning range at speeds to at least 100 cps and at higher speeds over narrower frequency ranges. Section to section isolation is a minimum of 70 db. All models are magnetically shielded and meet applicable specifications of MIL-E-5400 and MIL-E-5272.

▪ To be introduced at Wescon.
Advanced Products, Loral Electronic Systems, 825 Bronx River Ave., New York, 10472. [422]

Parametric amplifier
designed for 2.2-2.3 Gc

Model R-2000 paramp is designed for the telemetry band, 2.2 to 2.3 Gc. A simple double-tuned circuit technique provides a gain of 20 ± 1 db over 130 Mc. Band-pass ripple is adjustable externally, yielding typical values of ± 0.5 db over 100 Mc and ± 0.1 db over 50 Mc. The bandpass symmetry is almost in-

Transmitting and Receiving Antennas
Transmission Lines and Matching Networks
Supporting Towers and Masts
Dummy Loads and Termination Resistors
World-wide Tower and Antenna Installation
Antenna Switches and Control Consoles
Insulators, Connectors, Guys, Catenaries

This 33-year concentration under one roof of sophisticated equipment and staff for the design, fabrication and installation of complete antenna and tower systems anywhere in the world may be your good fortune.

TRYLON
INCORPORATED
formerly WIND TURBINE COMPANY

Elverson, Pa. 19520 (215) 942-2981 — International Division, 750 Third Avenue, New York, N.Y. 10017, U.S.A.

Today — Raytheon Microwave Technology is Solving These Problems —

Industry today faces increasingly complex scientific problems, that frequently require the application of new disciplines. Here are some from the field of electronics which have been solved by Raytheon microwave technology. Their solutions may provide insights that can be helpful to you.

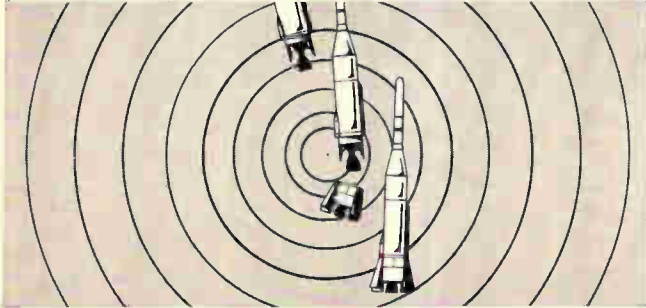

Problem: Pinpoint a space probe's initial track so accurately that any deviation can be corrected instantaneously.

The slightest deviation in a Mariner's course, during the first few seconds of launch and initial parking orbit, can send the Mariner soaring far from its target: Mars. This tracking problem is solved by using two totally integrated solid-state units: a telemetry frequency converter and a tunnel diode amplifier.

The converter has a 2200-2300 Mc input signal and output frequency of 300-400 Mc. Because it is mounted directly on an antenna, it requires a special housing to resist weather and withstand shock and vibration.

The tunnel diode amplifier (used as a front end to the converter) operates over a frequency range of 2200-2300 Mc with 30 db of maximum gain and 3.5 db of maximum noise figure. This unit has special characteristics for extending the dynamic range when tracking at close ranges.

Both the frequency converter and the tunnel diode amplifier are made by The Micro State Electronics Corporation, a subsidiary of Raytheon Company.

Problem: Develop an X-band circulator, to operate at twice the power ever achieved, for the Haystack Microwave Research Facility developed by the M.I.T. Lincoln Laboratory for the U.S. Air Force.

Building an X-band circulator — operable at an average power of 100 kilowatts CW — indicates the ability of Raytheon circulator technology to keep pace with high power tube developments.

The 4-port differential phase shift circulator has a vital role in the Haystack system. In addition to operating as a duplexer, it serves as an isolator — efficiently handling the high power output of the klystron tube and protecting it against reverse power damage. Isolation is greater than 20 db; insertion loss is a maximum of 0.25 db. Thus, less than 10% of the reverse power returns to the klystron and more than 95% of the forward power is transferred through the circulator.

To build this circulator required special manufacturing abilities involving sophisticated flanging, cooling and plating techniques. It also meant developing an unusual power divider.

The device, designed for applications as a duplexer and/or isolator, is a product of the Special Microwave Devices Operation, Raytheon Company.

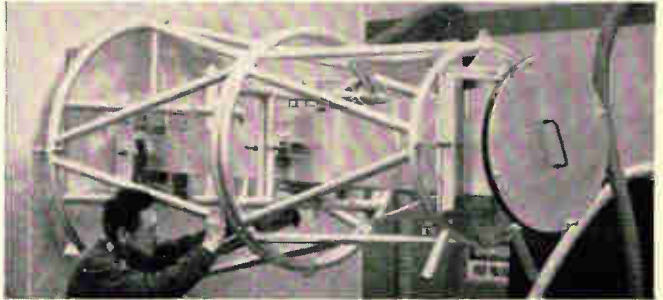

Problem: Build an isolator that can continuously protect a synchrotron's RF generator from damaging reverse power surges.

This problem was posed in 1961, with the construction of the Cambridge Electron Accelerator operated jointly by Harvard University and M.I.T. It was solved by installing a Raytheon UHF isolator that has operated dependably ever since, permitting continuous studies of high energy physics with electrons accelerated at rates up to 6.0 BEV (billion electron volts) and traveling at near the velocity of light (0.999,999,996c).

The insertion loss of the isolator is held to only 0.35 db, allowing 92% of the power to be transferred from the transmitter to the accelerating ring.

The isolator also absorbs power surges reflected from the accelerating system, preventing them from traveling backward to the RF generator. The actual value of isolation is 13.5 db — vital because with this isolation only 1/20th of the forward power can come back to the generator.

This high power Type IUH11 Isolator is made by the Special Microwave Devices Operation, Raytheon Company.

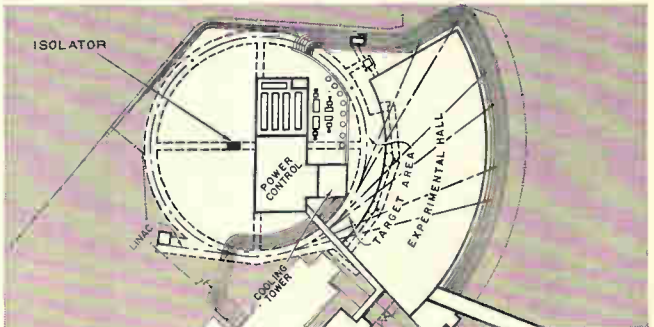

Write us in detail about your problem. Data about specific products is available by contacting Raytheon Company, Microwave and Power Tube Division, Department 3035, Waltham, Massachusetts 02154

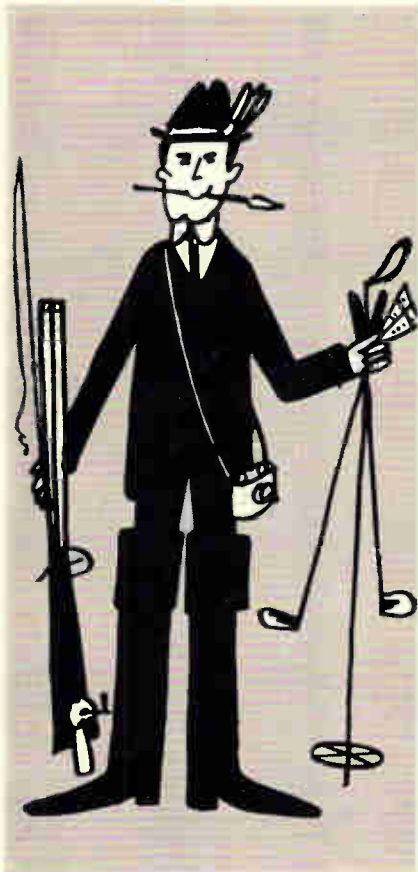

livability

(an industrial location advantage)

There's fun-filled living for you and your employes when you locate your plant in prosperous WESTern PENNSylvania. Ski on nearby slopes . . . fish for wary trout and bass . . . hunt big and small game . . . water-ski . . . listen to music by a top symphony orchestra . . . go to art festivals, operas and straw hat theaters . . . or visit reminders of a romantic past. Large and small industrial sites are available,

many on rivers and streams. There's room to spread out . . . room to live and grow, so locate your operation in WESTern PENNSylvania.



WEST PENN POWER
an operating unit of ALLEGHENY POWER SYSTEM

Area Development Department, Room 5611
WEST PENN POWER—Greensburg, Pa. 15602
Phone: 412—837-3000

In strict confidence, I'd like details about WESTern PENNSylvania's: 4-Season Livability Favorable Tax Climate
 Financing Plans Pre-production Training Industrial Properties and Shell Buildings

Name _____
Title _____
Company _____
Address _____
City _____ State _____
Code _____ Phone _____

New Microwave

dependent of pump level.

The noise figure of the paramp is typically 1.75 db including a five-port circulator, and the input vswr is less than 1.5. The pump tube has a 5,000-hour warranty. A single diode is used which can be conveniently replaced in the field. The circulator-paramp combination weighs 2 lbs 6 oz.

Micromega Corp., 4134 DelRey Ave., Venice, Calif. [423]

Kilowatt twt operates at X-band

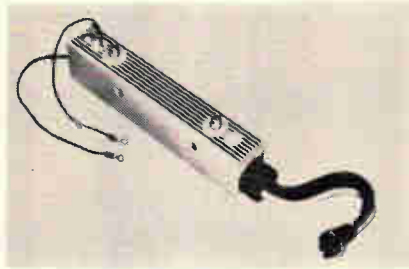

A full-kilowatt, X-band traveling wave tube, the QKW1132, has a unifilar, helix-type wave propagating structure and employs an integral permanent magnet. The rated 1-kw output with an average gain of 40 db applies over the tube's frequency range of 7 to 11 Gc. The conduction-cooled twt is designed for pulse operation with a maximum duty cycle of 0.01. Output vswr is 2:1.

R-f input impedance is 50 ohms. Both connectors are TNC female type. The QKW1132 is of ruggedized ceramic-metal construction permitting operation in hot, cold, and high-altitude environments. Raytheon Co., Microwave and Power Tube Division, Waltham, Mass. [424]

Co-ax diode limiters have broad bandwidth

A family of coaxial diode limiters now available features broad bandwidth, fast recovery, and extremely low leakage power over 1 to 4, 4 to 7, and 7 to 11 Gc frequency ranges. Input peak power ranges from 50 to 100 w; average power, from 1 to 15 watts. Maximum recovery

Frustrated about

MAGNETS?



CALL

PERMAG

We stock all sizes, all shapes, all grades, for all uses . . . all ready for 24-HOUR DELIVERY. Including soft magnetic materials — now available for the first time in small, less-than-mill-run quantities. Also, magnets engineered and fabricated to your needs. Write for catalog and data sheets.

PERMAG PACIFIC CORP. 6178 W. Jefferson Blvd., Los Angeles, Calif. 90016 Phone: Area Code 213 VERmont 7-4479 TWX: 213 836-0445

PERMAG CENTRAL CORP. 5301 D Otto Ave. Rosemont, Des Plaines, Illinois 60018 Phone: Area Code 312 678-1120

PERMAG CORP. 88-06 Van Wyck Expressway Jamaica, New York 11418 Phone: Area Code 212 OLYmpia 7-1818 / TWX: 212 479-3654

Circle 233 on reader service card

TAMURA'S COUNTERS

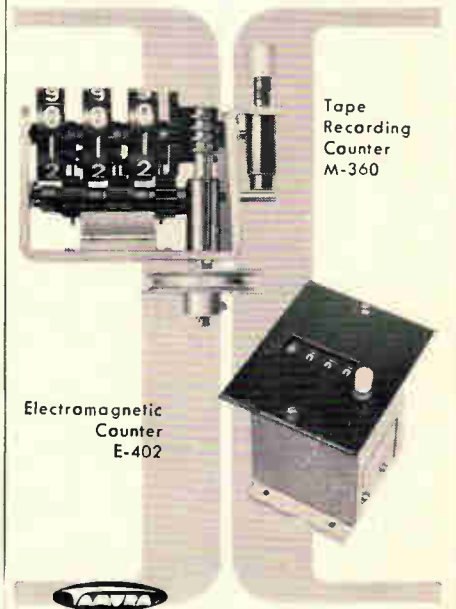

Electromagnetic Counter
E-402

Tape Recording Counter
M-360

Tamura Electric Works Ltd.

364, Shimomeguro-2, Meguro-ku, Tokyo, Japan
Cable Address: TAMURAELEC TOKYO
Tel: Tokyo (491) 7101

Most synchros couldn't stand up under the supersonic temperatures of the Concorde and B-70 if they had to.

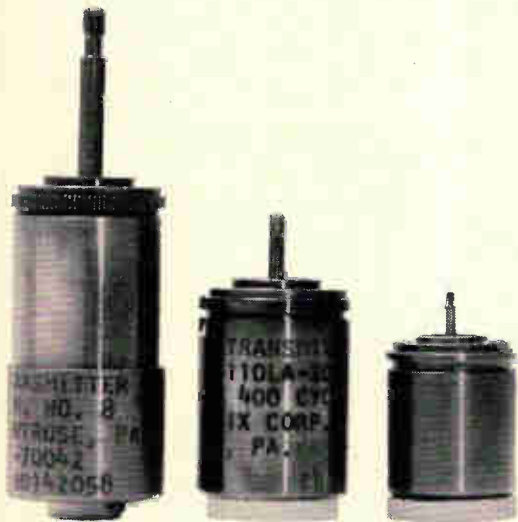

These have to.

Hand an ordinary synchro a job like that and it probably wouldn't get off the ground. That's why these Bendix synchros were made the heart of the remote indicating systems on the new Concorde and Air Force B-70. Here, Bendix synchros are exposed to the most torturous flight temperatures. (Up to 800 degrees F!) And they come

through with flying colors. Mission after mission after mission.

The clincher's this: Even if your application doesn't call for that much high-temperature stamina, you'll get equally dependable performance from any of our hundreds more synchros. Some have tolerances as close as 50 millionths of an inch. Others resist

nuclear radiation. Some fit space and missile applications to a "T." So there's sure to be one with features you'll go for. More information? Phone 717 278-1161, Montrose, Penna. Send for new catalog.



Montrose Division



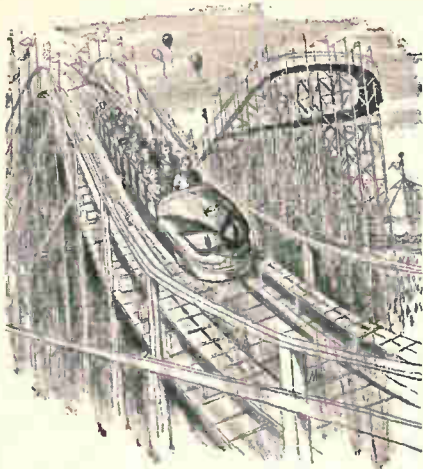

Interested in a better RIDE?

... then look to IsoMode!

For 23 years we have been manufacturing vibration control devices, not only to make things ride easier, but to control noise and shock.

Our experience? Just about anything you can think of — miniature mounts for electronic instrumentation — packaging mounts to insure your product reaching its destination in the same condition it left your plant — aircraft engine mounts (we made the mounts for the Boeing 727) — outboard engine mounts, in fact the roller coaster is about the only thing we haven't attempted, but we're willing to give it a try.

We would like to put our shock and vibration experience to work for you. Just write, phone, wire, or TWX and stand by for action, we'll have the answer for you.

Please send Free "POSITIVE MOTION CONTROL" Brochure



Name _____
Firm _____
Address _____
City _____ State _____
Dept. _____

IsoMode

DIVISION

CAL/VII
3310 VANOWEN STREET / BURBANK, CALIFORNIA 91504
(213) 849-7181 TWX 213-846-5004
(Formerly: Vibration Control Division—MB Electronics)

New Microwave

time is 100 nsec; typical insertion loss, 0.7 db; and minimum isolation, 23 db. Coaxial diode limiters are used in passive electronic countermeasure radar receivers and broadband tracking radar receivers where they protect sensitive, low noise preamplifiers or mixer diodes from strong, spurious, nearby signals.

Microwave Associates, Inc., Burlington, Mass. [425]

Manually operated waveguide switch

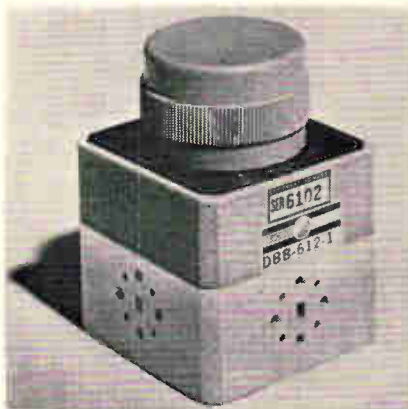

A B size (50 to 75 Gc) manually operated waveguide switch, model DBB-612/614-1, offers maximum insertion loss of 0.2 db, typical isolation of 65 db, and typical vswr of 1. Total weight of the switch is 12 oz. It is 2 in. square by 2 1/4 in. high. Both single-pole double-throw and double-pole double-throw configurations are available.

Large knurled control knobs permit easy switching. A spring-loaded detent mechanism forces the rotor to a fully open port position, and the switch cannot be stopped between ports. Indicator terminals for panel indicator lights or interlock are available.

Environmental requirements of MIL-T-21200 are met or surpassed. The switch may be pressurized to 30 psig with not more than 1/8-in. diameter bubble per sec leakage on immersion test. Storage temperature is -55° to 110°C. Operating temperature is -40° to 100°C.

Applications include bench tests, ground support systems, radar,

we are your best bet
for electronic materials

"What did you say?"
"WE SAID, WE ARE
YOUR BEST BET
FOR ELECTRONIC
MATERIALS!"

We are a primary fabricator and supplier of high purity metals and alloys, compound semiconductors and thermoelectric cooling materials.

PHONE AREA CODE 509 747-6111
TWX 509-328-1464 Telex 032 610

IMMEDIATE SHIPMENT BY AIR PRE-PAID

COMINCO PRODUCTS, INC.

electronic materials division
818 West Riverside Ave.,
Spokane, Washington 99201

5603

Circle 235 on reader service card

Introducing... Slide Regulator Type SD from Matsunaga

Matsunaga Type SD regulates voltage from zero to any one required—linearly without steps. Its internal construction consists of a ring-like iron core a single-layer winding, and a carbon brush. The carbon brush slides easily and smoothly on the winding wire to determine the amount of voltage. Capacities range from 100 vA to 10 kVA. Ruggedly built and easy to operate for a wide range of applications.



Stand Type :
Single-phase
Capacity :
100 vA~10 kVA
Input Voltage :
120V 220V 240V
Output Voltage :
0~130V 0~240V
0~280V

**MATSUNAGA
MANUFACTURING CO., LTD.**

No. 7, 2 chome, Himonya, Meguro-ku, Tokyo Japan

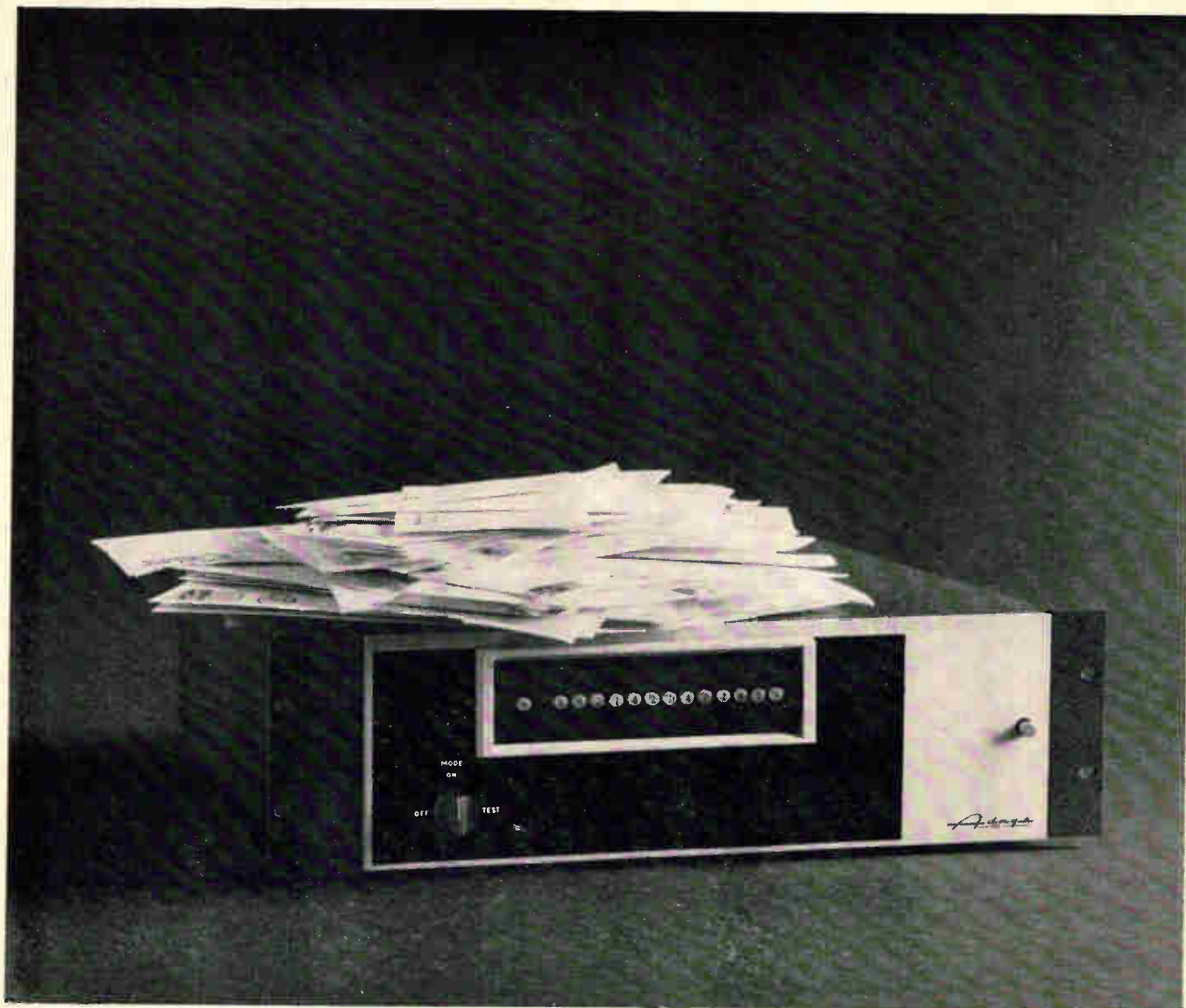

A complete 14-bit A-to-D conversion in under 4 μ sec... that's something to write about!

We're delighted with the overwhelming number of inquiries we've received about our two new additions to the Adage VOLDICON™ line of voltage digitizers.

The high-speed, high-resolution VT13-AB and ultra high-speed VT7-AB are based on a novel design combining techniques of successive approximation and parallel threshold decoding. The VT13-AB ac-

complishes a 14-bit analog-to-digital conversion in less than 4 microseconds. The 8-bit VT7-AB performs a complete conversion in under 800 nanoseconds.

A full line of data systems components, including other A-to-D converters, D-to-A converters, multiplexers, operational amplifiers, and digital logic, is available from Adage, Inc. These components use

all-solid-state circuitry and are designed and tested to meet the most demanding requirements for accuracy and reliability.

Why not add your inquiry to the many we've already received? We would be pleased to send you a technical brochure on the VT13-AB and VT7-AB. Call or write I. R. Schwartz, Vice President 783-1100, area code 617.

Adage, Inc. welcomes employment inquiries from professional engineers.

Adage
INC.

1079 Commonwealth Avenue Boston, Massachusetts 02215

You
can
SEE
why
they're
Best...



**MEPCO FH Series
Hermetically Sealed,
Glass Enclosed
METAL FILM
RESISTORS**

High reliability resistors for demanding requirements of aerospace and military electronics fields. Conform to MIL-R-55182.

For complete information and detailed specifications, write:

MEPCO, INC.

Morristown, New Jersey 07960
Phone (201) 539-2000
TWX (201) 538-6709



New Microwave

telemetry, radio astronomy, and microwave communications. Price is \$450; availability, stock to 4 weeks.

DeMornay-Bonardi, division of Data-pulse Inc., 780 South Arroyo Parkway, Pasadena, Calif., 91105. [426]

**Microwave filters
have 1.15 vswr**



The 500FN series of bandpass filters has a maximum vswr of 1.15 at center frequency and a minimum rejection of 77 db at center frequency ± 13 Mc.

The 3-db bandwidth is 5 Mc ± 0.2 Mc, and insertion loss for the six-section units is 2.5 db nominal. Load vswr is 1.03 maximum. The filters are available in seven frequency ranges between 500 Mc and 1 Gc (fixed tuned) or they may be individually tuned to any frequency within the range of the unit.

Because of their low vswr and high selectivity, this series of filters is especially suited to multiplexing where many discrete frequency settings at close intervals are required. Over-all dimensions are 10.5 by 6.5 by 2 in. Unit price is \$450 to \$600. Delivery is in 30 days.

Frequency Engineering Laboratories, Farmingdale, N.J. [427]

**R-f detector
covers d-c to 1.3 Gc**

A compact r-f detector is available covering the d-c to 1.3 Gc range and offering flat response and low vswr. Model 997-A detector is said to have a unique mechanical arrangement which permits simple reversing of the crystal. Either posi-

Now twice as many



Couch 0.1 oz. rotary relays

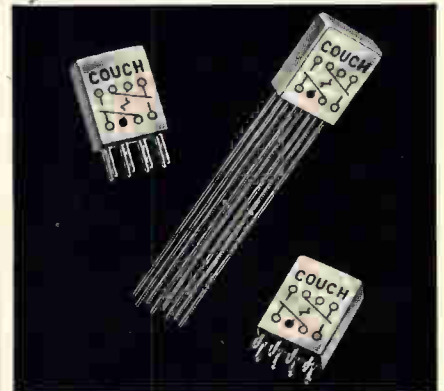

**each available in
3 terminal styles . . .**

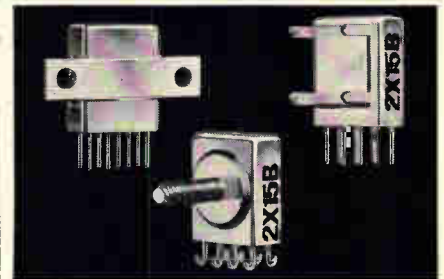

and in many mounting styles

We now offer a full line of SPDT relays, type 1X, to match our DPDT, type 2X, relay line. Except for coil data, specifications are identical for both types:

	2X	1X
Size	0.2" x .4" x .5"	same
Terminal Spacing	1/10" grid	same
Rating	0.5 amp @ 30 VDC	same
Coil Operating Power	150 mw	70 mw
Coil Resistance	60 to 4000 ohms	125 to 4000 ohms
Temperature	-65°C to +125°C	same
Vibration	20 G	same
Shock	75 G	same

Write for Data Sheets No. 9 and 10

RUGGED ROTARY RELAYS  Dynamically and Statically Balanced

COUCH ORDNANCE INC.

3 Arlington Street, North Quincy 71, Mass., Area Code 617.
CYpress 8-4147 A subsidiary of S. H. COUCH COMPANY, INC

NEW ELGENCO 3 BAND 20 cps to 5 mc RANDOM NOISE GENERATOR



MODEL 602A

- Symmetrical wave form
- Non-clipped wave form
- Constant output Z
- All Solid State
- \$290

SPECIFICATIONS: MODEL 602A — GAUSSIAN DISTRIBUTION: Symmetrical non-clipped wave form all ranges. **FREQUENCY RANGES:** 20 cps to 20 kc, 20 cps to 500 kc, and 20 cps to 5 mc. **OUTPUT SPECTRUM:** Uniform from 20 cps to 20 kc within ± 1 db, 20 cps to 500 kc within ± 3 db, 500 kc to 5 mc within ± 8 db. **OUTPUT VOLTAGE:** Maximum open circuit at least 3 volts for 20 kc range, 2 volts 500 kc range, and 1 volt 5 mc range. **TYPICAL SPECTRAL DENSITY (with 1 volt rms output):** 5 mv/ $\sqrt{\text{cps}}$ for 20 kc range, 1.2 mv/ $\sqrt{\text{cps}}$ 500 kc range, and 0.4 mv/ $\sqrt{\text{cps}}$ 5 mc range. **CONTINUOUS AMPLITUDE CONTROL — FIVE POSITION OUTPUT ATTENUATOR:** X1.0, X0.1, X.01, X.001, and X.0001; Accuracy $\pm 3\%$ to 100 kc, $\pm 10\%$ to 5 mc. **OUTPUT IMPEDANCE:** Constant 900 ohms on direct output; 200 ohms on step attenuated output. **OUTPUT VOLTMETER:** 0-5 volt, calibrated to read rms value of Gaussian noise. **Operating Temperature:** 0 to 50 degrees C. **POWER REQUIREMENTS:** 115/230 volts $\pm 10/20$ volts, 50 to 1,000 cps, approx. 5 watts; rechargeable battery option available. **DIMENSIONS:** 5 1/4" high x 8 3/8" wide x 11" deep. Panel height for 19" relay-rack mounting is 5 1/4". **PRICE:** \$290. **DELIVERY:** Stock to 30 days.

OTHER MODELS: 610A 10 cps to 5 mc — \$1175; 603A 20 cps to 5 mc — \$495; 301A - DC to 40 cps — \$1995; 321A DC to 120 cps — \$2095; 311A DC to 40 cps and 10 cps to 20 kc — \$2395; 312A DC to 120 cps and 10 cps to 20 kc — \$2495; 331A 10 cps to 20 kc — \$1295.



ELGENCO INCORPORATED

1550 EUCLID ST. • SANTA MONICA, CALIF. • (213) 451-1635

For more than 10 years Noise Generators have been our major endeavor.

Circle 238 on reader service card

Weld, Solder and Bond with this Versatile Machine!

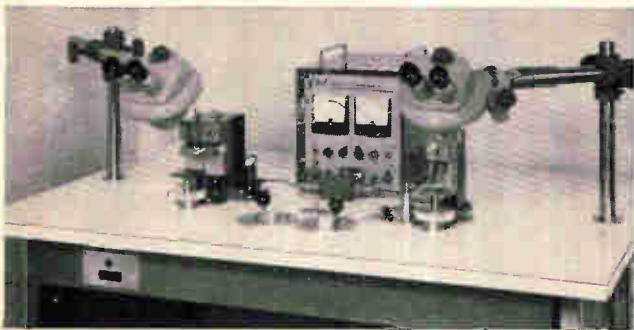

Weltek's new Model 750 can be set up in minutes to do micro-miniature welding, controlled soldering or "nail head" bonding. With this one piece of equipment you can solder or weld flat packs to p.c. boards, do module welding, point-to-point microsoldering or bond a wire to a transistor chip! The possibilities are unlimited. The 750 can do *all* of your miniature joining work... in the lab or in production. And it is reasonably priced.

SEE IT AT THE WESCON SHOW
We'll be at Booth 137, Cow Palace, San Francisco, August 24-27. Bring samples.

Precision Bonders

by **WELLS ELECTRONICS, INC.**

1701 S. Main Street, South Bend, Indiana, U.S.A.

Circle 239 on reader service card

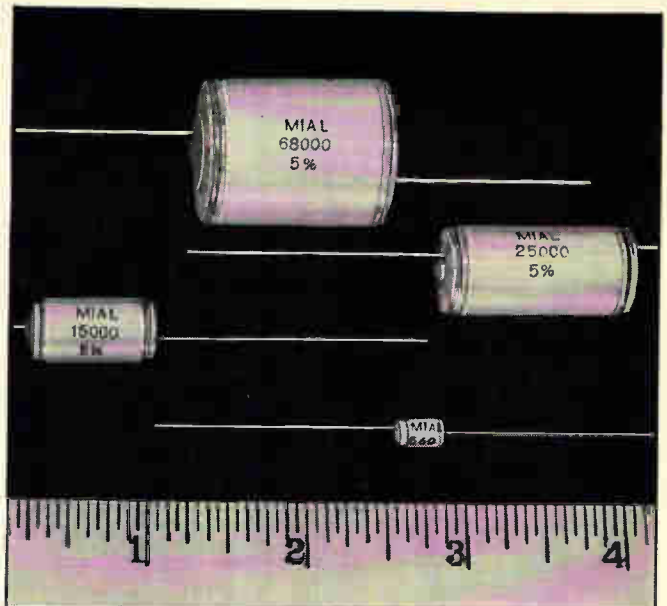

NEW MIAL general purpose polystyrene capacitor with more than 500,000 megs leakage resistance!

The MIAL Style 611 general purpose polystyrene capacitor outperforms all other film capacitor or mica units—yet costs less! Ideally suited for TV, radio, stereo and instrumentation applications requiring long life, high reliability, and complete freedom from drift.

- Capacitance Range: 20 to 100,000 pF
- Temperature Coefficient: N150 ± 50 ppm/ $^{\circ}$ C
- Capacity Tolerance: from ± 1 pF to $\pm 20\%$
- Voltage Range: 33VDCW to 1000 VDCW
- Q Factor: Over 2,000 at 100 KC $+25^{\circ}$ C

Polystyrene Capacitors

MIAL

Write today for new complete catalog. Gives environmental, electrical and mechanical characteristics, charts and dimensions.



MIAL

U. S. A., I N C.

165F FRANKLIN AVENUE, NUTLEY, N.J. 07110 • (201) 667-1600-1601

Circle 195 on reader service card

195

**DISTRIBUTORS:
ARE YOU PLAYING
THE OLD SHELL GAME
...AND COMING UP
A LOSER?**

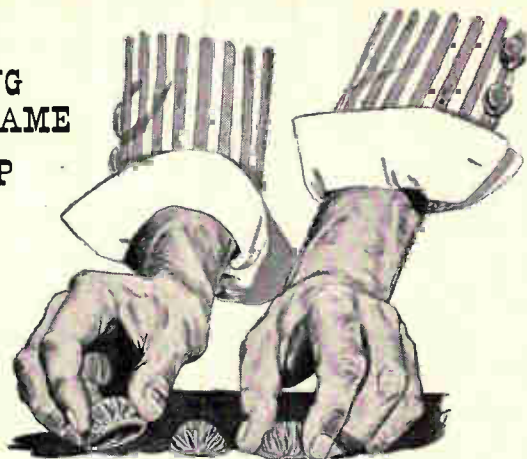

AND A LOSER YOU ARE when required by the manufacturer to maintain extensive inventories. There's no need to gamble on overstocking with Western Transistor. We have all the semi-conductors you'll need... 6,000 types... more than any other three manufacturers combined... and they're ready for delivery to you at your request immediately. And Western's new production facilities guarantee the highest quality components at the lowest prices in the industry. Certainly something a potential "winner" should look into!!

Lowest Cost... Highest Quality... Immediate Availability

Be a Western Distributor ...

The One Source for All Your Customers' Semi-Conductor Needs!!

Visit us at the WESCON SHOW, Booth #1012



WESTERN TRANSISTOR CORPORATION

DEPT. D-1 • 11581 FEDERAL DR. • EL MONTE, CALIF. 91731 • PHONE: 442-5507

Circle 240 on reader service card

MITSUMI COMPONENTS

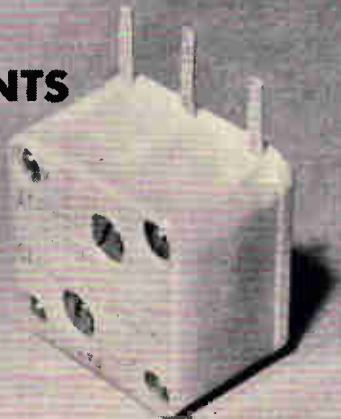

New Precision Variable Capacitor

Model PVC-LX20T Polyvaricon is AM two gang miniature-sized Polyethylene Variable Capacitor which has a capacity tolerance $\pm (1\text{pF} + 1\%)$. Maximum variable capacity is 140pF ANT., 82pF OSC. "Q" characteristics is over 500 at 10Mc 50pF. Trimmer capacity is over 8pF. The Dimension being 20mm \times 20mm \times 13mm.

Main Products

Polyvaricon • IFT • Oscillator coil • Antenna coil • Composite coil
• Special coil • Micro motor • Synchronous motor • Variable resistor
• Trimming potentiometer • FM tuner • TV tuner • Various sockets • CdS photoconductive cell.



MITSUMI ELECTRIC CO., LTD.

New York office: 11 Broadway, New York, N.Y. 10004, U.S.A.
Phone: HA-5-3085, 3086

Main office: 1056, Koadachi, Komae-machi, Kitatama-gun,
Tokyo, Japan Phone: Tokyo 415-6211/23

New Microwave

tive or negative polarity outputs may be measured without being subject to the different characteristics of two separate crystals.

Conversion efficiency is approximately 0.8 at 1 v output. Input impedance is 50 ohms; vswr, 1.15 to 1; maximum input voltage, 3 v rms; type of detection, half-wave; output polarity, negative or positive; case dimensions, 1 $\frac{3}{4}$ in. by $\frac{3}{4}$ in. by $\frac{3}{4}$ in.; weight, 3 oz.

Kay Electric Co., Pine Brook, Morris County, N.J. [428]

Co-ax phase trimmer can operate at 4 Gc



A noise-free coaxial phase trimmer, model Rf311 has no sliding metal-to-metal contacts. It is used as a coaxial line stretcher where a fine control of phase of a microwave signal is required. Control is manual with a micrometer drive for ease of calibration and assurance of resettability. A lock nut on the micrometer prevents accidental change of setting.

The electrical line length between the input and output connectors is controlled by varying the actual length of the center conductor in a slab-line type of transmission line. The maximum operating frequency is above 4.0 Gc, the phase change range 12 $^{\circ}$ /Gc, and the approximate calibration 0.07 $^{\circ}$ per Gc per 0.001 in. on the micrometer. The left hand connector is type N male and the right hand connector type N female, with max vswr 1.3 to 1. The maximum

Mariner IV looks at Mars thru a GEC vidicon . . .

The GEC 1343-010 Vidicon will be used to pick up approximately 22 pictures of the Mars surface during the 30-minute fly-by planned for mid-July, 1965. The tube will be exposed once for 200 milliseconds every 48 seconds, and the image stored on the storage surface of the tube will be read out over a period of 24 seconds without any loss of detail. The GEC 1343-010 Vidicon will operate over a temperature range from -40°C to $+50^{\circ}\text{C}$. Developed especially for Mariner, GEC's 1343-010 is quite a vidicon!

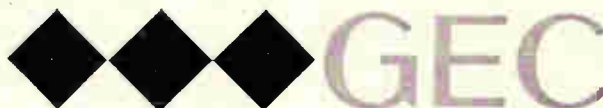

GENERAL ELECTRODYNAMICS CORPORATION

4430 FOREST LANE • GARLAND, TEXAS 75041 • BR 6-1161

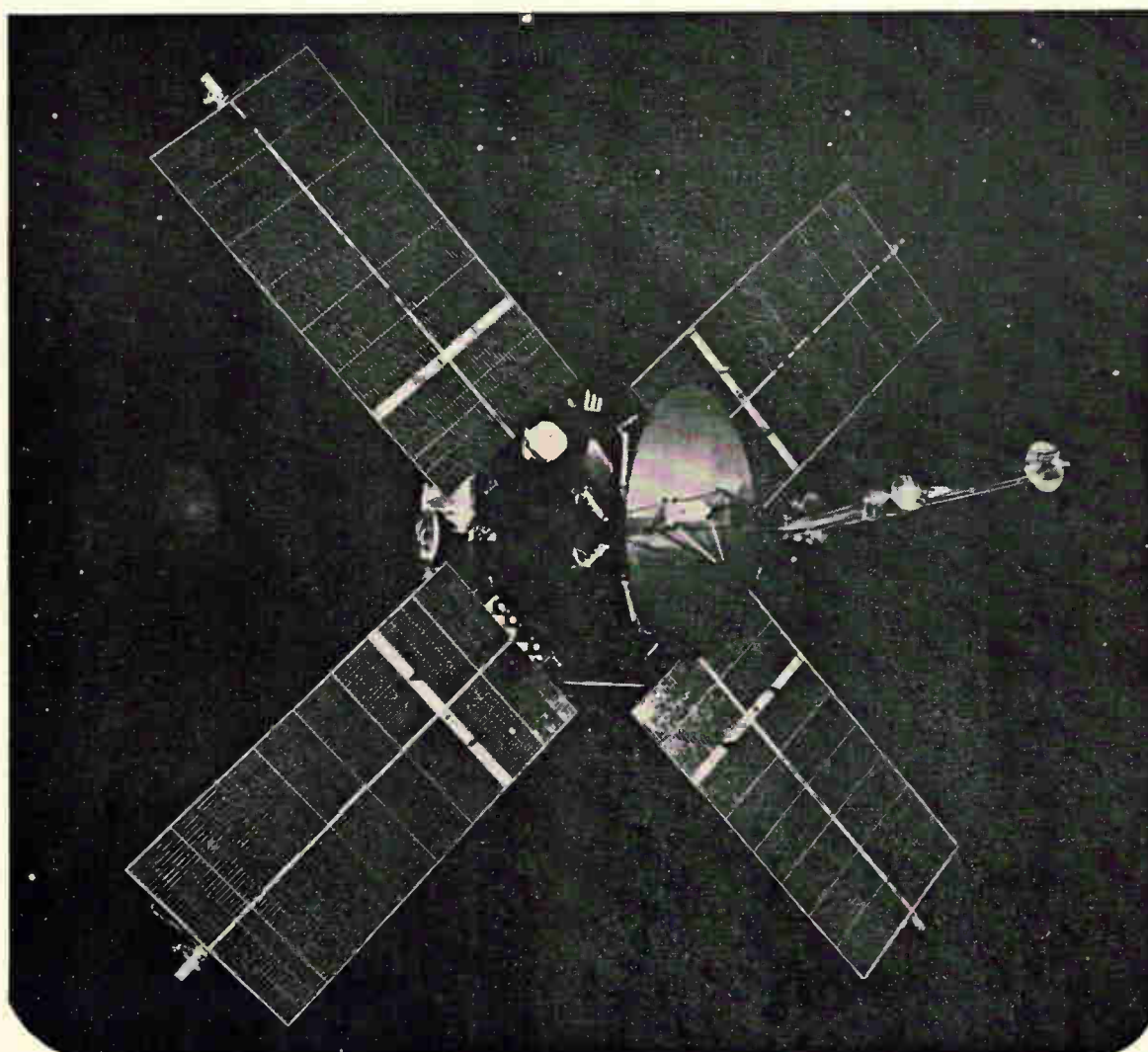

visit GEC at WESCON, booths 1707 and 1708

If you're starting from scratch this way...

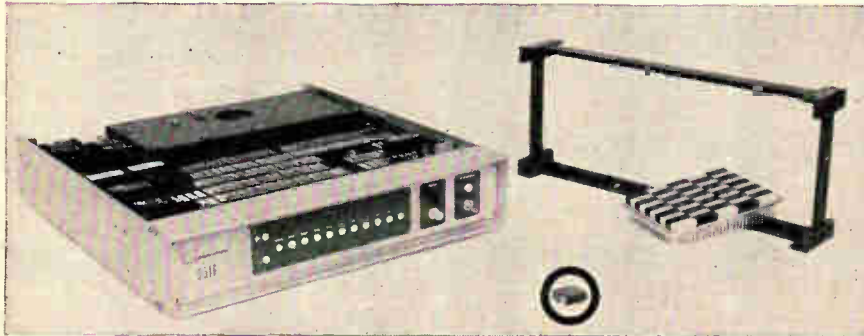

Check the advantages of Radiation's pre-engineered packaging and plug-in modules

- Packaging density compares with integrated circuits
- Cold solder joints and complex wiring eliminated—all components are welded and interconnections made by manual or automatic wirewrap
- Spare parts and logistics reduced drastically
- Circuits are individually encapsu-

lated plug-in units, 0.4"x1"x1.1"

- High reliability—up to 5,330,000 hours MTBF

CUT COST on both logic circuits and mounting hardware. For example, a 1 Mc 4-input NOR is priced at \$5.00. Hardware for mounting 400 NOR's is only \$370.00. For more specification data or price information write:

See our complete line of data processing building blocks and communications maintenance/operation equipment at WESCON, Booths 2207-2208 and ISA Instrument-Automation Conference Booth 2014.



**RADIATION
INCORPORATED**

Products Division • Dept. EL-08 • P.O. Box 220 • Melbourne, Florida • Ph. (305) 727-3711
Circle 198 on reader service card

To order reprints: Fill in, cut out coupon below, insert in envelope and mail to: **Electronics Reprint Dept., 330 W. 42nd Street, New York, N.Y. 10036**

Reprint order form

For listing of reprints available see the Reader Service Card.

Unijunction Transistors

Send me reprints of Key no. R-74 at 50¢ each.

For reprints of previous special reports fill in below:

Send me reprints of Key No.(s) @¢ each.

(For prices, see Reader Service Card)

Name

Number of street

City, State, Zip code

New Microwave

insertion loss is 0.5 db. Dimensions are 3 by 4 by 3/4 in., exclusive of connectors and micrometer. Price is \$145.

RfDynamics, Inc., 51 Harbor Ave., Nashua, N.H. [429]

Fixed attenuator pads for test-bench use

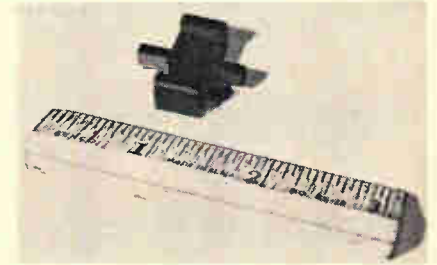

These fixed attenuator pads cover EIA waveguide sizes WR28 to WR90. The units, spanning the frequency range 8.5 to 37 Gc, have a maximum vswr in most cases of 1.20 or less and find wide application in test bench set-ups and local oscillator portions of waveguide subassemblies due to their compact size and excellent electrical characteristics.

Microwave Development Laboratories, Inc., 87 Crescent Road, Needham Heights, Mass. [430]

Low-vswr adapter spans 5.3 to 8.2 Gc

A coaxial-to-waveguide adapter has been developed for systems or laboratory use. Model SC460A has an extremely low 1.15 maximum vswr over the complete frequency range from 5.3 to 8.2 Gc.

One end of this adapter terminates in a type N female connector and the other in a UG441/U cover flange. The body consists of a one-piece aluminum casting. Power can be transmitted in either direction.

Models are also available with TNC and OSM miniature connectors. Delivery is stock to 4 weeks. Price is \$50 (1 to 5 units).

Antenna & Radome Research Associates, 27 Bond St., Westbury, N.Y., 11590. [431]

2 of a series

TRANSCOIL SOLVES SERVO PROBLEMS

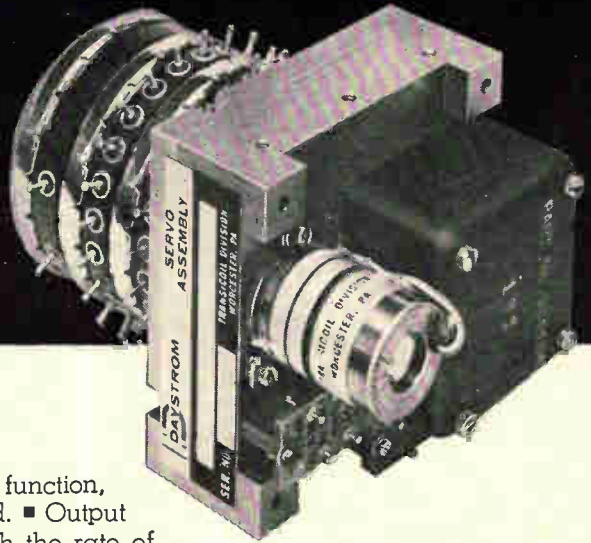
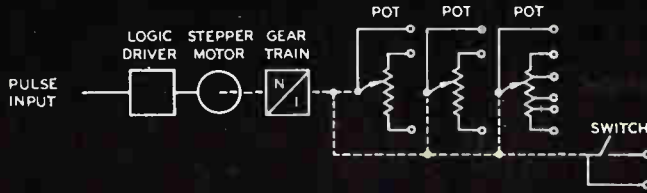

Transcoil digital pot drive

Transcoil incremental servos effectively perform an integration function, since they produce a finite shaft motion for each input command. ■ Output of this servo package is an analog function synchronous with the rate of input pulses to the stepper motor. Extremely low time constant is assured because the unit accelerates to full speed in less than one pulse. Stopping time is equally short. ■ This compact unit includes a size 8 stepper motor, precision gear reduction, solid state logic driver, and a 3-gang tapped pot with internal limit switch. ■ The assembly, except for pot, is manufactured by Transcoil. It offers the quality and reliability typical of Transcoil's broad line of standard and special-purpose servo assemblies. ■ Write for our 16-page brochure, SERVO ASSEMBLIES. It describes Transcoil products and design capabilities.

QUALITY BY DESIGN

 **WESTON INSTRUMENTS, INC.**

WESTON TRANSCOIL
Worcester, Pennsylvania 19490

Circle 243 on reader service card

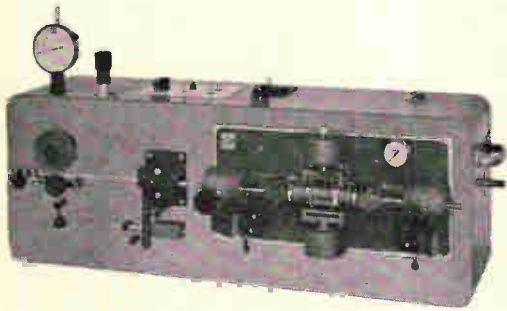

Cut your wire preparation costs with high-speed wire strippers

Eubanks wire strippers are noted for easy set-up changes, high-speed operation, and clean stripping without nicking or scraping. Whether you need battery cables, printed circuit board jumpers, leads for electric watches, coaxial cables, or washing machine harnesses, chances are excellent that we have a machine to meet your requirements. Pictured is our Model 87 Utility Wire Stripper, which produces up to 12,000 leads an hour. Write for free information on this and other Eubanks wire stripping machines to Eubanks Engineering Co., 225 W. Duarte Rd., Monrovia, California.



EUBANKS
ENGINEERING COMPANY

Circle 244 on reader service card

SAPPHIRE SUBSTRATE PRICE BREAKTHROUGH

We have heard many times, "If only sapphire substrates were priced below a dollar . . ." WELL, NOW THEY ARE. We have been convinced that sapphire substrates could play an important role in the microcircuit field, and have devoted considerable effort to reduce manufacturing costs to an interesting level. Here is an indication of our progress:

Until September 30, 1965, we will accept orders for lots of 100 substrates .310" square by .010" thick, polished one side to better than 1 microinch surface, other side ground, made of single crystal synthetic sapphire, for a lot price of

\$100

There it is, the \$1.00 level mentioned so often. In large quantities, prices are substantially below \$1.00. Serious inquiries are invited. What are some of the reasons sapphire is superior to ceramics as a substrate?

- sapphire is single crystal material, completely uniform from lot to lot.
- a superior surface finish can be routinely applied to sapphire.
- thermal conductivity is appreciably higher than ceramics.
- more reliable and higher performance circuits can be manufactured.

Additional details of the properties of sapphire are given in our bulletin, "A Summary of Available Data on the Physical Properties of Synthetic Sapphire," free on request. Inquire for additional information on sapphire substrates, sapphire parts, or other optical materials.



ADOLF MELLER COMPANY

P. O. Box 6001-E
Providence, R. I. 02904
Tel. (401) 331-3717

Circle 199 on reader service card 199

AT LAST!



A Temperature Chamber You Can Set... and Forget!

Here is the first temperature chamber that's really automatic. You set it to the desired temperature and the Mark III does the rest. Without human decisions, it heats or cools automatically to maintain the set temperature—even in the presence of heat generated by parts under test.

Another exclusive—an ease and flexibility of programming never before possible. Complex heat/cool cycles like the one below are routine... ranging from -300°F to $+1000^{\circ}\text{F}$.

This plus provable $1/10^{\circ}\text{F}$ control... positive protection against "runaways"... all solid state design... low gradients throughout the entire test volume... and more—at competitive prices. Three sizes starting at \$785.

Contact Delta or your nearby Delta/Non-Linear Systems office on the Mark III or any problem involving accurate control of environments. It's our specialty.

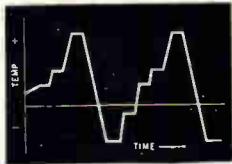

See us at WESCON, Booth 4303



The Environmental Control People

8000 Fletcher Parkway • La Mesa, Calif.
Phone: (714) 465-4141

Overseas Representative: Microwave International Corp., 420 Lexington Ave., New York, N.Y., U.S.A.
Cable: Microken—N.Y.

New Production Equipment

The moving needle bonds

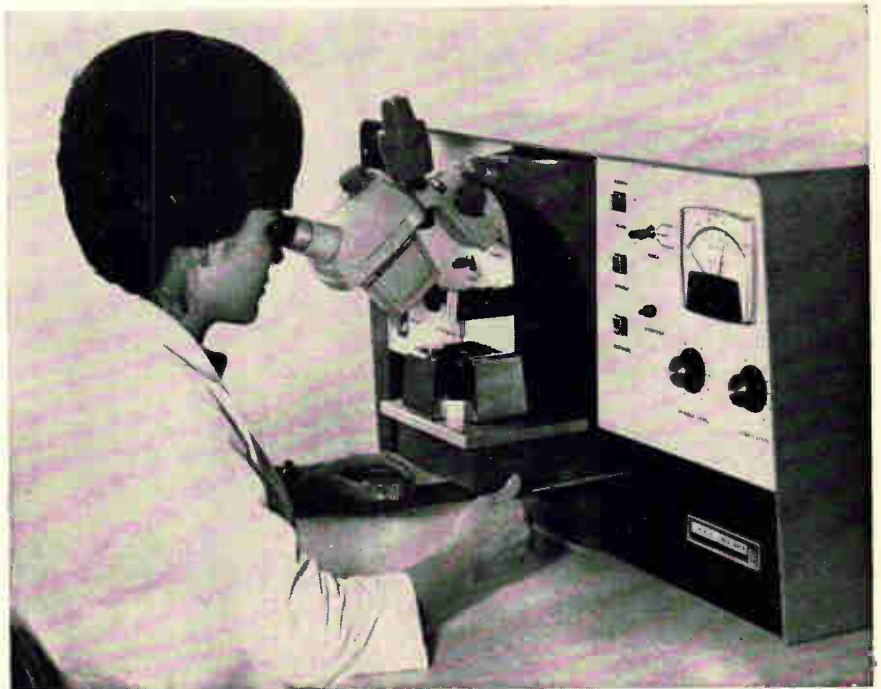

"We've got more manipulation than anybody," says a spokesman for the Hevi-Duty Heating Equipment Co., referring to a new line of semiconductor die and wire bonders.

The die bonder, which is used to mount dice on package headers or on the substrates of hybrid microcircuits, has a moving vacuum needle instead of the usual moving stage. After the operator picks up a die with the needle, she can move it in any direction and rotate it 370° with a floating lever that she works with her left hand. A right-hand control stick actuates the bonding action. It takes 5 seconds to select and bond a die. The operator can continually watch the moving die in a mirror which moves in concert with the needle.

Hevi-Duty says that the bonder is extremely versatile. Dice can be mounted on regular transistor headers, flatpacks, the big TO-3 diamond headers for high-power devices, or in the large, special packages used for hybrid circuits.

The die is automatically "scrubbed" on the header to promote eutectic alloy bonding and is pulsed

vertically or laterally as bonding pressure is applied. Pulsing is done by a patented device which pits pneumatic forces against the operation of an electromagnetic coil.

For wire, a capillary bonding tool replaces the vacuum needle and mirror arrangement. The header can be rotated so that the wire can be pulled straight to the nearest post, without turns, after a bond is made. Wedge, stitch, or ball bonds can also be made.

A wire cutoff shear or torch operates automatically. Wire threading is also automatic.

Each bonder is made in a manual and automatic model. The manual models use a vacuum to seat the header and a vertical heating column. The automatic ones have a horizontal furnace, header carriers and indexing belts. Index distances can be varied by changing spacers on the belts.

The manual machines can be converted to automatic models by unplugging the bonding station and replacing it with the automatic transport system.

Hevi-Duty has not yet an-

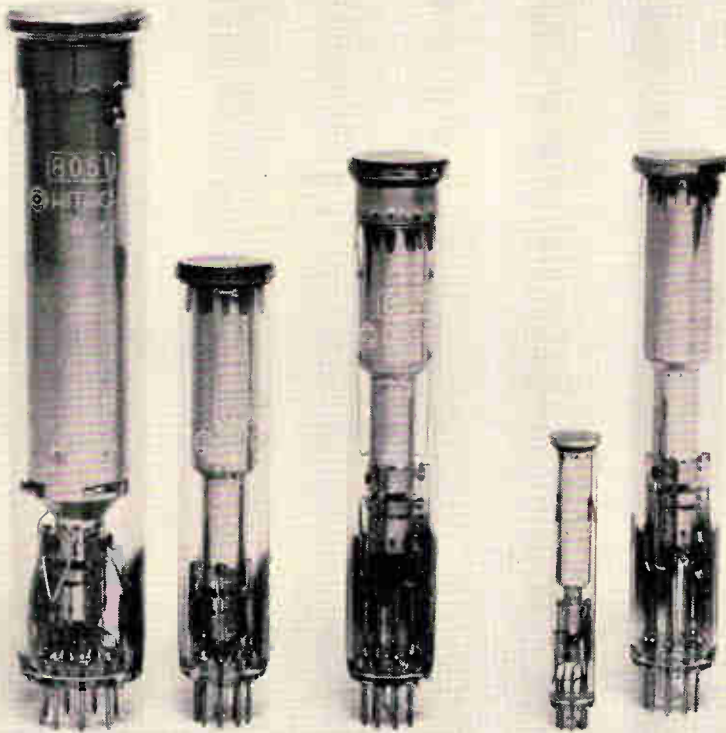

seeing is believing

HITACHI VIDICONS (as featured in the table below) are available for use in a wide variety of fields . . . Broadcasting live B/W or color T.V. pictures. Closed circuit T.V. for industrial and domestic use. Professional usage in the field of Medicine, Nursing, Law, Banking etc.

Hitachi Vidicons enjoy ultra high resolution and sensitivity, are small in size and are priced very reasonably. If seeing is believing, let Hitachi Vidicons prove their superior performance. Write now for complete technical data and quotations.

Type Number	Dia. of Face plate (inch)	Sensitivity* Signal Current (μ A)	Resolution† (Line Number)	Outstanding Features
4427	$\frac{1}{2}$	0.1 avg	450	Smallest type
7038	1	0.1	600	Standard type
7262A	1	0.2	600	Small size, Low Heater power
7735A	1	0.2	600	High Sensitivity
8051	$1\frac{1}{2}$	0.1	1200	High Resolution
8507	1	0.2	900	Mesh Separated High Sensitivity, High Resolution
8521	$1\frac{1}{2}$	0.2	1200	High Sensitivity, High Resolution
8572	1	0.1	900	Mesh Separated, High Resolution

* Values when a dark current=0.02 μ A at 10 lx.

† Values at the centre of faceplate.



HITACHI SALES CORPORATION: 333, N. Michigan Avenue, Chicago 1, Ill., U.S.A. Tel: 726-4572/4 / 666, 5th Avenue, New York, N.Y. 10019, U.S.A. Tel: 581-8844 / 12715, S. Daphne Avenue, Hawthorne, Calif., U.S.A. Tel: 757-8143 HITACHI, LTD., DUESSELDORF OFFICE: Graf Adolf Strasse 37, Duesseldorf, West Germany Tel: 10846

ONE OF 25 NEW 3 WATT MINIATURE POWER SUPPLIES

from **t**ransformer
electronics
Company

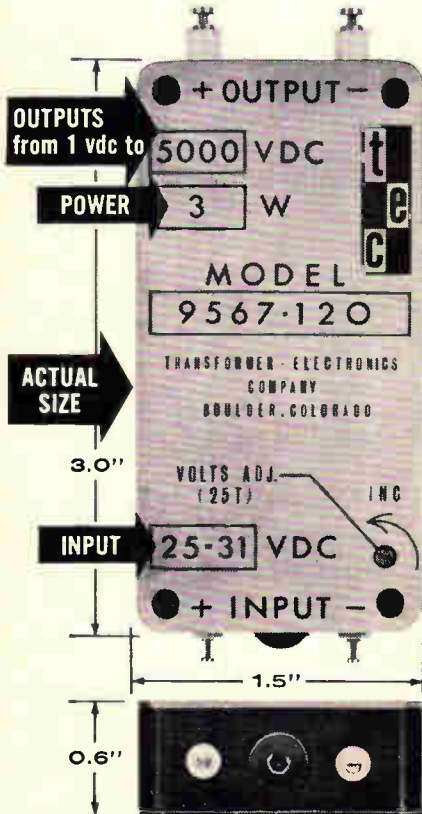

THE 9567 SERIES fulfills many requirements where DC-DC and DC-AC voltage conversion is required. Predominant features are: light weight (4 oz.)... low cost (prices start at \$150.00)... all silicon semiconductors... black anodized aluminum case... silicon rubber encapsulation... transient, reversed polarity and short circuit protection...

INPUT: 25-31 VDC (output regulated to 0.25%)

OUTPUTS: 1.5 VDC to 5000 VDC
± 15 VDC to ± 100 VDC (dual output)
1.5 VAC to 1000 VAC (3 to 5 kc)
(adjustable ± 10%)

POWER: 3 WATTS

TEMPERATURE: -55 to 100°C

FOR ADDITIONAL INFORMATION CONTACT:

**TRANSFORMER
ELECTRONICS
COMPANY**

BOULDER INDUSTRIAL PARK
BOULDER, COLORADO
TWX 303 443-2561 • PHONE (303) 442-3837

**POWER SUPPLIES • INVERTERS
CONVERTERS • TRANSFORMERS**

Production Equipment

nounced prices. Units will be available from stock after their Wescon introduction.

Lindberg/Hevi-Duty Marketing Services, Basic Products Corp., 304 Hart St., Watertown, Wis. 53094. [451]

Modular weld station works automatically



A complete weld station now available offers push-button selection of both energy and force settings. Designed for high-speed production welding applications, this modular automatic weld station (MAWS) provides instant selection of six highly repeatable weld conditions. The result is fewer decisions for the operator, reduced fatigue, fewer rejects.

The station consists of voltage-regulated multipulse power supply, which mounts under the workbench to keep work area unobstructed; miniature welding head with integral electromechanical force transducer; remote program selector; foot-pedal actuator; and all required mounting hardware.

The operator selects one of the six preset weld conditions located on the remote program selector. Energy is continuously adjustable from 0.7 to 100 watt-seconds; force continuously adjusts from 1 to 12 lbs. Standard (0.0021 sec), normal (0.0035 sec), and long (0.0078 sec) pulse durations are available at the turn of a switch. Pilot lights indicate which pulse is being used. Welding repetition rate is 150 welds per minute at 0.5 watt-sec; 80 welds per minute at 100 watt-sec.

Mirror-backed watt-second meter and weld/setup switch are conveniently located on the front

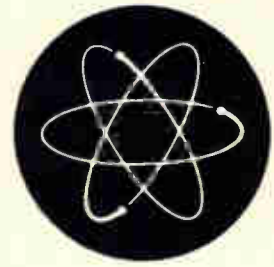

LOOK AT LOCKHEED IN AGE ELECTRONIC SYSTEMS

Lockheed Missiles & Space Company has immediate need in Aerospace Ground-support Equipment Electronics for qualified engineers able to meet the following qualifications:

Must be able to project AGE systems from concept to point of sale. Will develop specifications and reports, direct technical proposal activity, lead other engineers, and improve or correct their concepts into a workable and saleable hardware system.

AGE systems include launch base equipment, computer controlled data processing systems, and digital hardline command systems.

Requires knowledge of magnetic interference problems, space systems testing experience, and perhaps some digital systems background plus, of course, a degree in Electrical Engineering. Ideally, we are looking for technical level supervisory types who would rather apply their technical knowledge in a practical manner.

Please write Mr. K. R. Kiddoo, Professional Placement Manager, Lockheed Missiles & Space Company, 462 Industrial Relations Building, Post Office Box 504, Sunnyvale, California.

LOCKHEED
MISSILES & SPACE COMPANY
A GROUP DIVISION OF LOCKHEED AIRCRAFT CORPORATION

An equal opportunity employer

Mitsubishi Photo-Conductive Cells For Long Life

As with all Mitsubishi electronic components, these photo-conductive cells are made from only the finest materials—and manufactured under a quality control program which assures you of continuous, trouble-free performance. Mitsubishi Three Diamonds mark, Japan's most famous product symbol, is your guarantee of top quality components.



PZC-3107

A miniature slug type, cadmium sulfide, low voltage cell. Especially applicable to camera equipment. Hermetically sealed, moisture proof and long lived.



PZC-7103

Especially applicable to automatic relays and automatic switching equipment, this moisture proof cell is designed for a power application of approximately 0.3 W.



PZE-3101G

A glass sealed, slug type, selenic cadmium cell, designed for photoelectric measuring devices, control circuits, non-contact relays etc.

PHOTO-CONDUCTIVE CELLS

Specifications		PZC-3107	PZC-7103	PZE-3101G
Max. Rating	Voltage (V)	100	200	50
	Power (W)	0.03	0.3	0.01
	Temperature (°C)	-75~+60	-75~+60	-40~+40
Max. Dimension	Thickness (inch)	0.12	0.32	0.52
	Diameter (inch)	0.37	1.10	0.26
Resistance (at 25°C)	100 lux	5 KΩ	1.6 KΩ	70 KΩ
	10 lux	20 KΩ	8 KΩ	—
	1 lux	80 KΩ	40 KΩ	—
	Dark (after 30 sec)	1 MΩ	5 MΩ	1,000 MΩ



MITSUBISHI ELECTRIC CORPORATION

Head Office: Mitsubishi Denki Bldg., Marunouchi, Tokyo. Cable Address: MELCO TOKYO

Circle 249 on reader service card

POWER RHEOSTATS

Wire-wound ring-core solidly bound to flat ceramic core porcelain base with durable vitreous enamel.

Can be made to your specification.

Wattages 10, 25, 50, 75, 100, 200, 300, 500, 1000W.



WIRE-WOUND, VITREOUS ENAMELED AND CEMENT-COATED FIXED AND SEMI-FIXED RESISTORS

Lug terminal type. Stock-mounting flat type. Respective adjustable and center-tapped types.



Cement-coated resistor, made for model racing-car controller.

for further information, please write to:
YAGISHITA ELECTRIC CO., LTD.

Sales Dept.: 13, 3-chome, Azabu-ikura, Minato-ku, Tokyo, Japan. Tel: 583-5363



Circle 248 on reader service card

Speed-up
Wire Marking

with a

KINGSLEY
Wire & Tube
Marking Machine

right in your plant!



Write
for
Details

Now you can permanently mark wire or tubing directly on the insulation... quickly... economically... right in your own plant!

Cut costs and speed production with the same machine that has consistently proven so successful in the aircraft/missile field.



KINGSLEY
MACHINES

850 CAHUENGA • (213) 469-7243
HOLLYWOOD, CAL. 90038

A-207

Circle 203 on reader service card

203

NEW FROM PATWIN

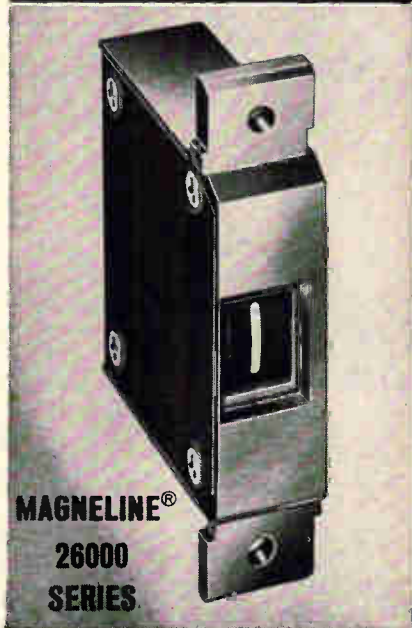

MAGNELINE®
26000
SERIES

This indicator operates without decoders or drive circuits

If your output data is coded 2 out of 5, you can use the new MAGNELINE 26000 Series digital indicators without drive circuits or decoders. This new series also has these MAGNELINE features: long life, reliability, inherent memory, and excellent readability in all kinds of light.

SEE IT AT
BOOTH 2305
WESCON SHOW

PATWIN
ELECTRONICS

A DIVISION OF
THE PATENT BUTTON COMPANY

WATERBURY, CONN. 06720

Production Equipment

panel of the remote program selector. Force and energy adjustment screws are located on the bottom panel of the program selector to prevent inadvertent changes. A dual weld head interconnector accessory permits the use of two welding heads. Price is \$1,952. Weldmatic Division/Unitek, 950 Royal Oaks Drive, Monrovia, Calif. [452]

Terminal trip device is easy to operate



This triggering device is reported to speed up the application of terminals to wires by 40% to 65%. Applicable to wires as fine as 26 gage stranded, the terminal trip device uses a mechanically actuated sensing plate to energize a highly sensitive switch. The switch, in turn, cycles ordinary terminal installation tooling.

Design of the device offers several important advantages. It can be installed on a wide range of terminaling machines in approximately one hour, including attachment to existing tooling for the machines. Thus the terminal trip needs no special tooling and requires no interruption of production. Since it eliminates all electrical contact between the operator-held wire, uses no grids or labyrinths, and does away with foot switches, it requires considerably less skill or accuracy on the part of the operator and greatly diminishes operator fatigue.

As an option, however, a foot pedal may be connected, in series with the trip circuit rendering the trip device inactive until the pedal is depressed. Because the terminal trip utilizes direct axial pressure, it also improves the electromechanical properties of connections, rejecting splayed wires that present too few strands.

Electric Products Co., Niles, Mich. [453]

Telrex

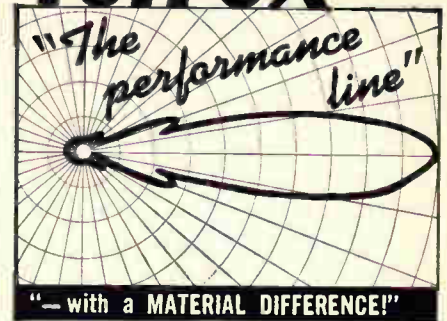

The Choice of the Discriminating Communication Engineer . . . the Man who Never Settles for Anything Less than THE-VERY-BEST!

telrex "BEAMED-POWER" ANTENNAS and ANTENNA SYSTEMS

Provide optimum performance and reliability per element, per dollar. Antennas from 500 Kc to 1500 Mc. Free PL88 condensed data and pricing catalog, describes military and commercial antennas, systems, accessories, Towers, Masts, Rotators, "Baluns" and transmission line data.

Communication and TV Antennas
SINCE 1921 **telrex**
LABORATORIES
Asbury Park 41, New Jersey, U.S.A.
Circle 250 on reader service card

NEW! and NOW!

IRRADIATED

Polyolefin Shrinkable Tubing PENNTUBE† V

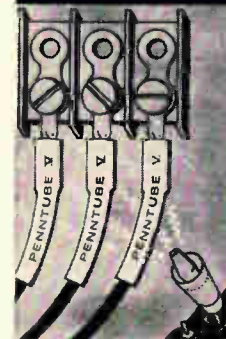

from
PENNSYLVANIA
FLUOROCARBON
COMPANY

2:1 shrink ratio.
Meets
all applicable
specifications.

Write for product data
sheet and free sample
NOW!

**PENNSYLVANIA
FLUOROCARBON CO., INC.**
Holley Street & Madison Ave.,
Clifton Heights, Pa.
Phone: (215) MADison 2-2300
TWX: 215-623-1577

Export Dept. Room 5710 Empire State Bldg. N.Y. 1, N.Y.

One source for:

TEFLON* TFE
Shrinkable
(Penntube-I-E)

TEFLON FEP
Shrinkable
(Penntube-IISMT)

IRRADIATED
Polyolefin Shrinkable
(Penntube V)

*DuPont Reg. T.M.

†Penna. Fluorocarbon Reg. T.M.

**Where do
Electronics
Engineers go
if they're
interested in
RFI work?**

**To Chicago, if they're
looking for the leader.**

As a member of the IIT Research Institute team, you'll see more advanced developments in RFI technology being applied than anywhere else in the country. Programs are conducted at all levels of applied research—from establishment of requirements and concepts to fabrication and check-out of complete equipment and systems. Applications range from complex systems for weaponry or space, to components, devices and sub-systems.

We expect you to contribute your ideas. Last year, for

example, one out of 6 programs in the works was company sponsored. And, of over 1250 separate projects during the year, 65% stemmed originally from a staff member's idea. You'll be working with equipment and facilities that represent the most advanced in the business today. And, you'll be exposed to specialized conferences sponsored jointly by IITRI and military agencies. Recent examples are "Physics of Failure", "Electromagnetic Compatibility", "Communications Satellites", "Impact of Microelectronics", and "Self Organizing Systems".

Our current emphasis is indicated in the following job descriptions. Each position calls for a BSEE with an MSEE preferred. Engineers are required immediately . . .

- To work on critical component areas in millimeter wave systems. Ability to supervise up to four associates desired. 3 to 6 years experience in MICROWAVE SYSTEMS AND COMPONENT DEVELOPMENT, L-band through millimeter wave frequencies. Experience in propagation and antennas helpful; solid theoretical background plus knowledge of measurement procedures required.
- To work on interference problems involving electromagnetic penetration of cables, systems, etc. Long range programs require background in ELECTROMAGNETIC THEORY INCLUDING TRANSMISSION LINES AND ANTENNA ANALYSIS. Experience with lab instrumentation and good background in experimentation helpful; must have had some supervisory responsibility.
- To conduct electromagnetic compatibility studies involving 2 to 4 junior engineers and technicians. 3 to 6 years experience in SYSTEMS ANALYSIS required; must have some supervisory and experimental experience plus firm theoretical capability.
- To work on programs dealing with undesired interactions between electronic equipments. 1 to 4 years experience in field theory, transmission lines, and circuit design primarily in COMMUNICATIONS FROM HF THROUGH VHF. Experience in shielding, bonding, and grounding helpful; firm analytical capability plus experimental experience required.
- To work on RF FRONT ENDS FOR MILLIMETER WAVE SYSTEMS. Require good background in field theory, transmission lines, antennas, and/or propagation. Firm theoretical plus experimental knowledge required. 3 to 5 years experience and demonstrated capability to conduct individual research desired.
- To work on programs dealing with undesired interactions between equipments in the AUDIO THROUGH UHF RANGE. Recent grad required with interest in electromagnetic field theory including transmission lines. Areas of interest involve analytical and experimental work in cable coupling, shielding, bonding, grounding and antenna/transmission line coupling. Interest in circuit design, filter theory and propagation desired. Prefer man with excellent academic standing and desire to continue graduate studies.
- To work on undesired cable coupling, field penetration, and spurious emanations problems. Recent grad required with interests in ELECTROMAGNETIC THEORY, MICROWAVE COMPONENTS, AND/OR ANTENNAS. Outstanding academic standing plus desire to continue graduate studies preferred.

These positions offer free graduate study and excellent opportunity for advancement. Salaries and benefits are fully competitive with industry. Send a resume of your background and interests to Mr. Ron C. Seipp.



10 West 35th Street, Chicago, Illinois 60616

An Equal Opportunity Employer

**ONLY
AUTOMATIC
OFFERS
ALL 5!**



WEDGE-LOCK™*



WEDGE-CRIMP™



X-CRIMP™



ECONO-CRIMP™



WEDGE-EZE™

*PATENTED

*economical!
reliable! efficient!*
**rf coaxial
connectors**

Now you can select the connector which best meets your requirements!

They can be supplied in most of the standard connector styles and series from Micro-miniature through LC/LT, and for virtually all popular cables from 1/16" through 9/16" diameter.

Write or phone for literature . . .

automatic
METAL PRODUCTS CORPORATION
323 Berry Street, B'klyn 11, N. Y. Tel: (212) EV 8-6057

New Books

Components

Capacitors, Magnetic Circuits and Transformers
Leander W. Matsch
Prentice-Hall, Inc.
350 pp., \$16

The author intended that this book show the relationship between pure theory and its application to practical hardware. But the book is better on theory than on application.

The derivation of equations, for instance, is presented in an excellent and orderly fashion. At the beginning of each topic, many pages are devoted to theoretical aspects; but after the reader's appetite is whetted by an interesting introduction to the hardware section, the discussion is concluded prematurely.

The first chapter is primarily concerned with a review of the fundamental physics of force, work, and energy and their relationship to passive resistance-inductance-capacitance circuits.

The second chapter, which is the only one that covers capacitors, neglects many important practical problems and physical structures. For example, no mention is made of the mechanism of temperature rise due to excessive ripple across a capacitor. The very significant subjects of tantalum capacitors, sintered slug construction, the influence of frequency on a-c impedance, or causes of the apparent loss of capacitance at higher frequencies are all omitted. Complex relative permittivity is explained, but complex relative permeability is not.

Many of the diagrams and curves are valuable; one example is a curve of time versus power required to store energy in a capacitor in an RC network. However, symbols in some diagrams may lead to confusion. Current flow is shown by an arrowhead directly in the circuit branch involved instead of the more usual practice of showing the arrow alongside the branch. This may easily cause confusion in circuits containing diodes. In one of the transformer diagrams shown, for example, a reader might think that a rectifier circuit rather than a self-saturated magnetic am-

plifier was being discussed.

One large chapter (about a fifth of the text) deals with magnetic circuits. In the analysis of magnetic materials, there is only a brief mention of the extremely important subject of ferrites. Illustrations of the practical uses of ferrites in cores, rods, antennas and isolators are missing.

Three of the seven chapters are about iron core reactors and transformers. The derivations of the fundamental equations are based largely on the assumption of linear permeability of the magnetic material. The reader is guided through the complexities of magnetic circuit problems by numerous excellent examples.

Some areas, however, may be confusing. The reader for example, may not be aware of the necessary mathematical manipulation that relates the complex series circuit for an iron-core reactor to its parallel equivalent, yet both circuits are shown as interchangeable, without explanation.

Again, the information concerning hardware is incomplete. The reader is not made aware of the different types of windings (for example layer or bobbin) and when to use which. Practical information concerning current density, wire sizes, temperature rise, wasteless punching of laminations, and the inductance of chokes for various d-c operating levels is missing. The section on audio transformers is inadequate and somewhat erroneous; for example the statement is made that in most cases the leakage reactance and the winding capacitance can be ignored. The interesting section on multiphase transformers ignores the role of the interphase transformer and the important "Scott T" connection.

The last chapter is an introduction to the saturable reactor. Theory is covered, but the explanation of the firing angle concept is too vague and may not be understood by the reader who does not have previous knowledge of this device. The saturable reactor constructed with non-square-loop material is omitted completely. The concept of feedback (in magnetic amplifiers) is also omitted.

David Morris

Kearfott Division
General Precision Aerospace,
Little Falls, N.J.

Air Traffic Control

people needed in MITRE's Washington, D.C. office to provide system engineering assistance to the Federal Aviation Agency. Work areas include broad level system design, computer program operational specification, configuration management, system integration and system test planning.

Communications

people needed who can help conceive new communications systems, recommend development programs, and analyze special communications requirements generated by new systems concepts. Work areas include systems planning, range instrumentation, tactical air control and survivable communications.

National Military Command System

people needed for systems analysis and feasibility studies, communications systems analysis, systems design, integration, and verification.

Sensor Systems

people needed to support theoretical and experimental programs on advanced radar and optical detection and tracking systems; feasibility and technique analysis, systems synthesis and performance evaluation.

Computer Programming

people needed with experience in the development and support of monitors, compilers, real-time simulations, time-sharing systems, etc.

Systems Analysis

people with experience in military systems or operations analysis with a background in physics, mathematics, operations research, or industrial management.

Systems engineers needed for work on these vital projects



MITRE works on the basic design and general system engineering of complex information, control, sensor, and communications systems of national importance. An important part of its mission is the development of new techniques in these areas and advancement of the general technology. If you have three or more years' experience and a degree in electronics, mathematics or physics, write in confidence to Vice President — Technical Operations, The MITRE Corporation, Box 208BB, Bedford, Mass.

Pioneer in the design and development of command and control systems, MITRE was chartered in 1958 to serve only the United States Government. An independent nonprofit corporation, MITRE is technical advisor and systems engineer for the Electronic Systems Division of the Air Force Systems Command, and also serves the Department of Defense, and the Federal Aviation Agency.

THE
MITRE
CORPORATION
An Equal Opportunity Employer

SIDE-LOOKING RADAR SYSTEMS ANALYSTS

New programs at HUGHES are generating opportunities for Systems Analysts experienced in high-resolution data gathering, data transfer and data processing systems. Openings exist for Systems Engineers, Mathematicians and Physicists qualified in synthetic array radars, optical, and other data collection systems (IR, Electro-Optical, SIGINT and others). Assignments include:

Senior Systems Scientist with 20 years' electronic systems experience—at least 10 years relevant to side-looking radar systems. Applicants will be considered for important program management responsibilities. M. S. or Ph. D. degree required.

Senior Systems Analysts with 10 years' electronic systems experience—at least 5 years relevant to high-resolution systems pre-design and evaluation. Applicants will be considered for assignments in concept formulation; single and multi-sensor applications; data transmission, processing and interpretation; systems integration and performance evaluation. M. S. or Ph. D. required.

Systems Analysts with 5 years' experience in: detection of signals in noise, optimum filter theory, non-linear signal processing, information theory, MTI and doppler systems analysis. B. S. or M. S. required.

Please airmail your resume to:

MR. ROBERT A. MARTIN
Head of Employment
Hughes Aerospace Divisions
11940 W. Jefferson Blvd.
Culver City 58, California

Creating a new world with electronics

HUGHES

HUGHES AIRCRAFT COMPANY
AEROSPACE DIVISIONS

U. S. CITIZENSHIP REQUIRED
An equal opportunity employer.

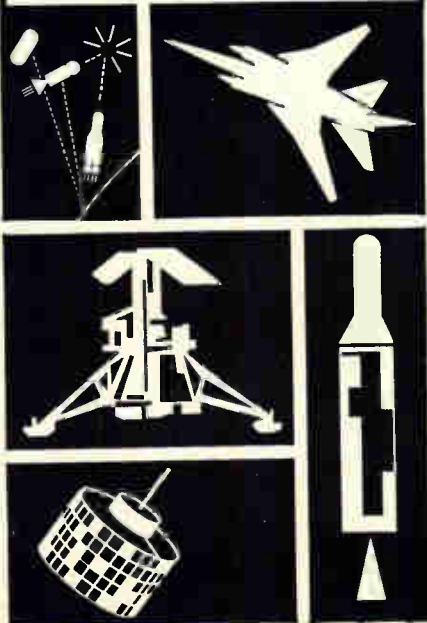

Technical Abstracts

Lasers or microwaves?

Lasers versus microwaves in space communications
S. Gubin, R. B. Marsten, and D. Silverman,
Radio Corp. of America, Astro-Electronics Division, Princeton, N.J.

To evaluate spacecraft-to-spacecraft and spacecraft-to-earth communications via laser versus microwave systems, the authors consider the projected state of these arts in 1970. They contrast each technology's ability to contribute to the performance of a spacecraft communications payload, assuming that the one with more communications load per unit of payload weight has the advantage. Three basic factors are the power supply subsystem, antenna subsystem, and stabilization subsystem.

Based on comparison of projected performance data for the three main types of lasers and for some specific materials, the study indicates that a c-w gas laser would require a 0.3-inch lens as a spacecraft antenna, while microwave systems would need antennas of 12 to 16 feet in diameter. But because this laser has an efficiency of only 0.1% to 0.2%, versus 40% to 50% for microwave tubes, the net d-c power advantage would be almost 30 db in favor of microwaves.

The signal-to-noise ratio for coherent beams is improved by about 3 db over that of incoherent operation, but the weight and complexity of coherent systems are thought to be too great to justify this gain.

Modulation of laser light is an important aspect of lasers in communication, and an effective power of 5 to 50 watts d-c would have to be supplied for this purpose.

The lens system that will focus and collimate the laser beam for a spacecraft-to-spacecraft mission should have a large capture area and be capable of an accuracy of about 5 arc-seconds. A receiving telescope must have this same degree of resolution to generate error signals at the output of a quadrant multiplier phototube.

Optical components with a low coefficient of thermal expansion and a large thermal mass are desir-

able. They should be thermally isolated to maintain diffraction-limited resolution during the environmental changes of the mission. The solar energy collector needed for a laser receiver would have more restrictions than a good microwave antenna, because solar collectors require near-optical quality surfaces.

Laser systems can only support a transmission rate of 4.26×10^2 bits of information per second and microwave systems 1.86×10^5 bits per second; thus the microwave mode is capable of at least 26 db better transmission performance than the laser. The structure containing the laser system would be heavier than that for microwaves.

Presented at the National Space Navigation and Spacecraft Communications Meeting, Houston, Tex., April 29-30.

Magnetic latching relay

The design and manufacture of a latching general-purpose wire spring relay
F. S. Ford, Western Electric Co., Columbus, Ohio

A magnetic latching relay that operates on a specified square voltage pulse of about 10 milliseconds and remains latched for indefinite periods without consuming any power has economic advantages over conventional types. The new electromagnetic relay with a latching type semipermanent magnetic steel core lends itself well to pulsed operation in the communication field.

The relay is held in the actual position by a permanent magnetic bias in the core structure. While the present design uses only a primary winding coil, energized in either the positive or negative direction to actuate or release the controls, effective operation can also be obtained by energizing primary winding to close the relay and releasing it by energizing secondary winding.

With machines, tools, and facilities available for mass production, the major problem lay in proper choice of a magnetic core and armature structure that could be blanked without tooling changes. Successive tests of various core materials showed that C-1045 steel

GRADUATE ELECTRICAL/ELECTRONIC ENGINEERS — BS, MS, PHD —
ARE NEEDED FOR PERMANENT ASSIGNMENT IN

SYSTEMS TECHNOLOGY

INFORMATION TECHNOLOGY — Radar, Displays

ELECTRICAL AND ELECTRONIC SYSTEMS — ECM, Reliability

STABILITY, GUIDANCE AND CONTROL — Guidance and Control,
Digital Computers, Flight Controls

SYSTEMS LABORATORY — Circuit Design, Microelectronics, Flight Test
Instrumentation, Mechanical Design

OTHER POSITIONS ARE AVAILABLE ALSO FOR QUALIFIED,
EXPERIENCED, GRADUATE ENGINEERS AND SCIENTISTS

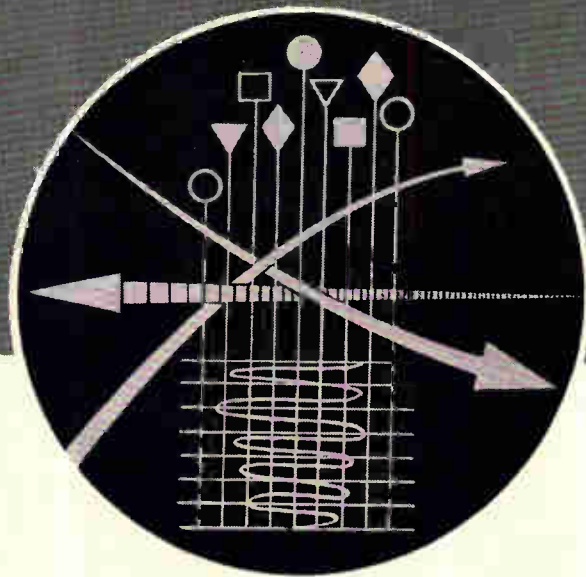

In systems technology, capable, qualified engineers and scientists are needed for assignment to research and development projects involving space vehicles and systems, and other programs — including the F-111 Tactical Fighter. The opportunity for advancement is immediate and continuing.

We urge you to investigate the chance to exercise your ability with a professional group that is backed by the very finest facilities. Write to Mr. J. B. Ellis, Industrial Relations Administrator-Engineering, P. O. Box 748-T, Fort Worth, Texas. An equal opportunity employer.

GENERAL DYNAMICS

FORT WORTH

FORT WORTH, TEXAS

90% of all Japanese ITV cameras use COSMICAR lenses.

COSMICAR
INDUSTRIAL OPTICS



For your vidicon, image orthicon and professional movie cameras, Cosmucar lenses are available in focal lengths from 12.5mm up to 1000mm.

New zoom lenses are now available.



ICHIZUKA OPTICAL CO., LTD.

2-568, SHIMOOCHIAI, SHINJUKU-KU, TOKYO

CABLE ADDRESS: "MOVIEKINO TOKYO"

Circle 252 on reader service card

MICO

NEW SIX-RATIO
STANDARD ENGRAVER

CAT. NO.
259

FOR LIGHT
AND MEDIUM
DUTY WORK

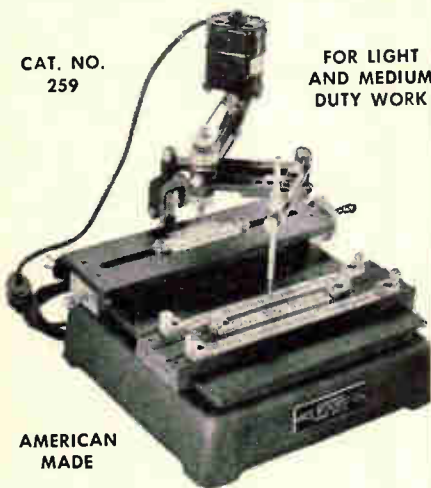

AMERICAN
MADE

- Engineered for ruggedness and simplicity.
- Six pantograph ratios—from 1.5:1 to 4:1.
- Ball-bearing spindle uses $\frac{1}{8}$ " shank cutters and has true .250" micrometer depth control.
- Sturdy one-piece ratio studs anchor in ESNA stop-nuts for quick locking of pantograph arms.
- Master copy and work right-side up—in full view of operator. Raising stylus raises cutter.
- Attachments available for increasing versatility.

Send for bulletins and prices

MICO INSTRUMENT CO.

77 Trowbridge St.

Cambridge 38, Mass.

Primo
NEW PRODUCT!

Super High Sensitivity

DYNAMIC
MICROPHONE

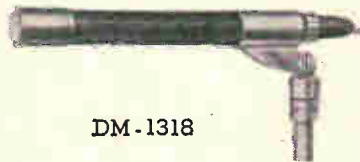

DM-1318

SPECIFICATIONS

- Cartridge: DM-15 (DYNAMIC TYPE)
- Frequency Response: 50~15,000 c/s
- Deviation: ± 4 dB
- Impedance: 600 Ω
- Sensitivity: -74 dB

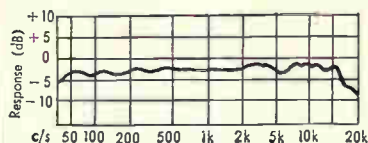

For catalog write to:

PRIMO CO., LTD.

2043 MURE, MITAKASHI, TOKYO, JAPAN

Technical Abstracts

provided adequate magnetic latching properties, and the material could be punched and die-formed without tooling changes.

The tension of the springs used in the existing relays had to be adjusted to meet the specified release time for magnetic latching.

Presented at the Electromagnetic Relay Conference, Oklahoma State University, Stillwater, Okla., April 27-29.

High-speed glass sealing

What is new in sealing glasses
Francis W. Martin,
Corning Glass Works, Corning, N.Y.

Glass that heats itself by the absorption of infrared energy from a tungsten-iodine lamp is expected to find numerous applications for sealing electronic components in a controlled atmosphere. The glass is made infrared-absorbent by the addition of iron oxide.

The use of a lamp as a heat source allows greater freedom in sealing fixture design. The lamp beam can be away from the parts to be sealed and the radiant energy focused on the sealing glass. The conventional electrically heated sealing coil must be close to the work. Focusing the infrared energy can also lessen the heat rise in temperature-sensitive devices and speed up the sealing process.

One such glass, Code 9362, has been used to seal nickel-iron leads in dry-reed switches and Dumet leads in diodes. Another, Code 4070, can be used to seal molybdenum leads of diodes.

[Editor's note: the sealing technique was developed by the Western Electric Co. and reported in the April, 1965, issue of "The Western Electric Engineer." The report stated that the technique may reduce dry-reed switch sealing time from 40 seconds for clear glass heated by resistance coils to 8 seconds for the infrared-absorbing glass. The method had previously been tried experimentally for encapsulating deposited-carbon resistors. Two operators could encapsulate 200 resistors an hour with the experimental apparatus.]

Presented at the American Scientific Glassblowers Symposium, San Francisco, June 30.

TO YOUR SPECS

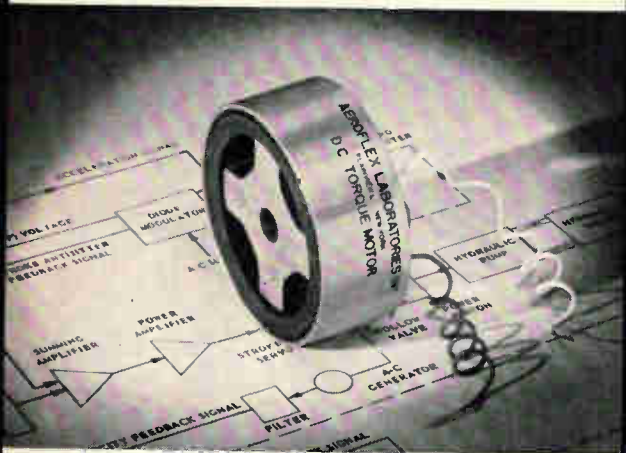

BRUSHLESS

Complete DC Torquer Servo Systems

... in many different sizes and shapes ■ ranging from the Jet Vane Actuator used on the Ranger and Mariner spacecraft ■ to Synchro Drive Oscillators and Signal Data Converters for the F-111 ■ and Automatic Throttle Controls for diesel locomotives.

This capability ranges in experience from 1 oz. in. torquers and associated servo control components to giant 10,000 lb. torque motors complete with drive systems for radio telescope and tracking control.

For detailed information on how this capability can help you save money and time, write to Dept. RZ-182.



AEROFLEX LABORATORIES INCORPORATED
SOUTH SERVICE ROAD • PLAINVIEW • LONG ISLAND • NEW YORK 11803

Circle 255 on reader service card



MINIATURIZED COMPONENTS

Micro Resonant Reed Selector

FUJITSU micro resonant reed selector of the single-reed plug-in type, composed of a composite tuning-fork type vibrator, driving system, contacts, and their supporting structures. Possessing a high degree of sensitivity and stability, it serves all phases of usages as the conventional reed selector in diverse types of tele-controlling and mobile radio systems.

Frequency: 50 channels in 15 c/s spacing in the frequency range of 472.5 c/s~1207.5 c/s
 Coil impedance: 280 ohms $\angle 35^\circ = 15\%$ at 1000 c/s, 20°C Standard driving current: I_a : 2.5 ma Selectivity: Inoperative at a current of less than 7 ma in a frequency range deviating more than ± 15 c/s from the nominal frequency f Band width: Class A: $f \pm 1.5$ c/s min at standard driving current. Class B: $f \pm 1.3$ c/s min at standard driving current Temperature range: Class A: -10~50°C. Class B: 0~40°C Contact ratio: 2% min at f and 2.4 ma Life: Over 100,000 operations when driving current is turned on for 1 second and turned off for 2 seconds in an ordinary circuit Insulation and dielectric withstanding voltage: 10 megohms min at dc 100V, dc 100V 1 minute at 20°C, 80%

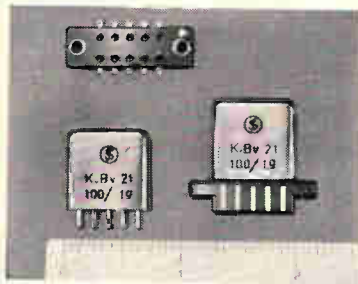

Polar Relay Type 21

Fujitsu Polar Relay Type 21 is a hermetically sealed, highly sensitive subminiature polar relay with high speed and long service life. The size of this Type 21 is only 1/10th as large as the conventional polar relays. It has extremely efficient magnetic circuits, high stability against external magnetic

fields and unique chatter free contact mechanism. This polar relay is widely applicable to small size, lightweight communication equipment and control equipment for carrier telephony, telegraphy, data transmission in telemetry, automatic control and data processing.

Subminiature Type: 3cm³ High Sensitivity: 0.7 mw Long Life: 100 million operations High Speed: 1.5 ms

For further information, please write to:



FUJITSU LIMITED

Communications and Electronics
Marunouchi, Chiyoda-ku, Tokyo, Japan

Circle 211 on reader service card

211

Ω

7

NEW FROM IEE

μ

+

WORLD'S SMALLEST REAR-PROJECTION READOUT GIVES YOU CHARACTERS THIS BIG



Shown actual size

The new Series 340 is the smallest rear-projection readout in the world! It's just 3/4" x 1/2" x 2"—yet its 3/8" characters are clear, sharp, and easily read.

Only IEE's patented rear-projection readouts give you your choice of any type face, symbol, color. Anything you can put on film! Use the single-plane Series 340 anywhere you need maximum clarity in minimum space.

Send for complete technical information.



INDUSTRIAL ELECTRONIC ENGINEERS, INC.
7720 Leona Avenue • Van Nuys, California
Phone: (213) 787-0311 • TWX (213) 781-8115

Representatives in Principal Cities
See IEE at Wescon, Booth 2501

A

4

1 VOLT

3

8

GO

Circle 256 on reader service card

Gauguin escaped to Tahiti to do his most important work



Engineers come to California

Sometimes you have to move before you do your best work. We know it's true, because some of our best EE's have come from somewhere else.

They come to Sylvania/Mountain View because they find excitement in having their experience and training tested by tough state-of-the-art problems. They come because they feel they are capable of contributing some creative solutions to those problems. Once here, they discover the satisfaction of seeing a project through from breadboard to production model. But not beyond. Once it goes into production, they go on to something else.

If this kind of atmosphere interests you and you have six to ten years' experience, preferably with an advanced degree or two, we are interested in you. We need qualified engineers to work on electronic warfare, electronic countermeasure systems, including intelligence systems, reconnaissance and anti-intrusion systems. See listing at right for some specific openings.

You will enjoy the convenience of San Francisco (just 40 miles north of Mountain View). For educational advancement, Stanford and other prominent universities are located nearby.

From an occupation, recreation, and education standpoint, you'll find all the necessary ingredients for you to do your best work at Sylvania/Mountain View. If you'd like more specific information about the work you might do with us, send a resumé to Manager — Professional Staffing, P. O. Box 188EL, Sylvania Electronic Systems—West, Mountain View, California.

He'll see that you get a prompt, frank (and confidential) reply.

Transmitters/Transceivers

Design and develop a wide variety of compact, wide band, versatile transmitters and sophisticated small automated ECM systems.

Work emphasizes solid-state RF circuits and equipment design in all frequency ranges with challenges in all types of circuit and equipment design problems.

Receivers

Design and develop solid-state circuitry for all types of receivers involving IF, RF, low noise, video, DC amplifier design. Applications will include latest solid-state and microwave components in both linear and non-linear circuits.

Signal Processing

Design and development of solid-state circuitry for low-noise, high-gain analog equipment and state-of-the-art digital techniques for use in complex signal analyzers, threat recognition, logic and decision circuitry.

Microwaves

Design and develop microwave components for experimental electronic warfare systems. Advanced solid-state components design such as tunnel diode oscillators and amplifiers, varactor devices.

Antennas

Design and develop broadband compact antennas such as horn and log periodic antennas of low frequency to millimeter range for ECM tracking and direction finding systems.

Optics

Investigate devices and techniques for modulation and demodulation of lasers for application in optical systems. Design and evaluation of optical receiving systems both coherent and incoherent in the visual and infrared regions.

GT&E

GENERAL TELEPHONE & ELECTRONICS
Total Communications from a single source through

SYLVANIA ELECTRONIC SYSTEMS

An Equal Opportunity Employer

OPERATION

EXPANSION

One of America's most exciting aerospace companies offers move-ahead career openings!

Perhaps you have been keeping up-to-date on Hamilton Standard via reports in national newsmagazines, professional publications and newspapers. The company is constantly making news. An intense product diversification program started over ten years ago has paid off resoundingly! The Division has scored important successes in a wide range of areas: space life support systems, engine controls, environmental conditioning systems for manned aircraft, many other aerospace and commercial systems and components, aircraft and missile propulsion systems, ground support equipment, electronics and electron beam machines. Result? We have *several hundred new openings* for engineers at all levels of experience... senior men as well as recent college graduates. We not only offer exceptional advancement opportunity, but the "bonus" of enriched living in the charming Connecticut countryside. Among the many openings:

SR. EXPERIMENTAL TEST ENGINEERS, BSEE, with experience in R&D testing of electronic control systems involving circuit or system design and/or transistor analog/digital circuit design. To plan, conduct and evaluate product development programs in field of electronic systems applicable to stabilization and navigation equipment, aircraft and missile flight controls, aircraft and rocket engine controls and other related systems.

ELECTRONICS DESIGN ENGINEER with experience in discreet type or digital controls design. Oriented in both analytical and hardware phases of design activity involved in closed loop digital control systems. Product applications involve jet fuel controls, synchphasers, cabin pressure controls and similar aircraft and aerospace closed loop systems. Requires BSEE; MSEE preferred.

POWER SUPPLY ENGINEER, BS in Electrical or Electronic Engineering with 4 to 6 years design-development-test experience in power conversion generating systems. Will work with all levels

of project engineers and customers. Will conceive and monitor all major electrical design for power supplies. Should be familiar with as many of the following as possible: switching characteristics of transistors, silicon controlled rectifiers, four layer and turnol diodes, circuit applications of semiconductors, transformers, interstage and power voltage regulators, single and polyphase circuits, heat transfer, packaging, power generating specifications.

INSTRUMENTATION ENGINEERS to specify, design and develop electrical/electronic instruments and systems for the measurement and/or control of functional, structural, environmental and physiological quantities associated with aerospace components and support systems. Involves design of both the product and test instrumentation. Requires experience in electronic circuit and control system design, and knowledge of transducers, analog and digital data handling systems, semiconductor circuitry and telemetry.

SEMICONDUCTOR DEVICES ENGINEER to develop semiconductor devices (such as junction devices applicable to transistors and diodes). Involves feasibility studies as well as making devices for pilot line operations.

ELECTRONICS ENGINEER, RELIABILITY to perform reliability and maintainability analyses including apportionment and prediction on a wide variety of electronic equipment including computers and controls related to both commercial and military programs including NASA. Should have BSEE with experience in electronics design review with emphasis on semiconductor circuitry. Desirable if candidate has circuit design and manufacturing background. Potential as Group Leader.

TO ARRANGE AN EARLY INTERVIEW, please forward your resume, including present salary, to Mr. H. F. Wakeman, Personnel Department, Hamilton Standard, Windsor Locks, Connecticut. We are an equal opportunity employer.

**Hamilton
Standard**

**U
A**
DIVISION OF UNITED AIRCRAFT CORPORATION

COMPUTER ENGINEERS

LOGIC	COMMAND
CHECKOUT	PACCS
CONTROL	NAVIGATION
DATA PROCESSING	ASW
AWAC	LANGUAGE
TERRAIN AVOIDANCE	MARK II
DISPLAY	APOLLO
MMM	SATURN
MAN-MACHINE INTERFACE	WEAPONS CONTROL
	A-NEW
MONITORING	
COMMUNICATIONS	

CHALLENGE YOUR IMAGINATION?

If your answer is yes, you should investigate the CAREER OPPORTUNITIES at RCA Burlington. Here you will be at the forefront of Aerospace Computer Development. In the preliminary design engineering group, you will develop new concepts on a day-by-day basis. You will draw on experience in control computers and associated systems. If you have technical competence in such areas as Logic Design, Circuit Design, Memory Design or Digital System Design, you will be able to determine feasibility and direct the effort of others. Skills in Aerospace Computer Applications involving Navigation, Fire Control, Data Processing, Detection Systems, Man/Machine Interface Techniques, or Computer Interface Techniques and Devices are desirable.

Responsibilities will include major contributions on advanced computer application studies, report and proposal presentations, both written and oral, and close support of the marketing activity.

To arrange a confidential interview with engineering management, send your resume to:

EMPLOYMENT MANAGER
Aerospace Systems Division, Dept. 5-16
RADIO CORPORATION OF AMERICA
Burlington, Mass.

An Equal Opportunity Employer



The Most Trusted Name in Electronics

SEEKING A LEADERSHIP POSITION ?

If so, one of these demanding descriptions may fit you

■ **SECTION MANAGER, TRANSMITTERS.** To direct aggressive development programs for UHF, high power and state-of-the-art miniaturized RF transmitters. He should have ten years of experience in the design and engineering supervision of military communications equipment: it should have given him personal drive, demonstrated leadership ability, unusual technical understanding and keen administrative insight.

■ **SENIOR STAFF ENGINEERS, RECEIVERS.** Leadership capability sufficient for immediate assumption of key roles in vigorous development programs for solid-state microminiature receivers. Positions require six to eight years of experience and in-depth knowledge of receiver design fundamentals.

■ **PROJECT ENGINEERS, SPACE INSTRUMENTATION.** Technical ability of the very highest order is required. Six to eight years of experience, preferably data handling, control, or analog instrumentation.

■ **MICROELECTRONICS SPECIALISTS.** Senior- and intermediate-level responsibilities in a rapidly expanding microminiaturization and thin-film program. Sound technical knowledge and demonstrated supervisory skill required.

If you qualify, there's a leadership position open for you at Electronic Communications, Inc. You can increase your professional rewards and personal satisfaction by contacting ECI today.

ECI has built a solid, successful reputation in airborne communications, multiplexing and space instrumentation. The Company offers pleasant living conditions and unusual educational and cultural opportunities in St. Petersburg, Florida. And it offers you a chance to participate in further growth through technological contribution. Call collect Duane Meyer (813) 347-1121, or send him your resume at ECI, Box 12248B, St. Petersburg, Florida 33733. (An equal opportunity employer.)



ELECTRONIC COMMUNICATIONS, INC.
St. Petersburg, Florida

ENGINEER MANAGER

Promotions in our organization have created a vacancy for a person technically well grounded and creative and suited for management responsibility.

Your technical background should include digital circuitry, memory and power supplies design and evidence of advanced circuit technology planning. Two to four years of successful previous management responsibility should also be present. Generally, the man we want will have been in the profession 8-10 years after receiving his EE degree.

The general assignment is Technical Manager of circuit design and analysis involving semiconductors, integrated circuits, electronic memories and power supplies, and design automation utilizing EDP.

Your response will be treated promptly and in complete confidence. Write to:

T. F. Wade, Technical Placement
The National Cash Register Co.
Main & K Streets, Dayton, Ohio 45409

An Equal Opportunity Employer

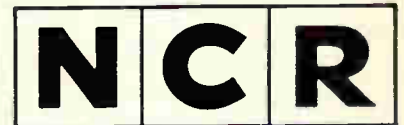

Applied Research Manager Microelectronics and Semiconductors

An experienced manager holding a Ph.D. or M.S. in Electrical Engineering, Physics, or Physical Chemistry is needed to manage the applied research effort in microelectronics and advanced semiconductor devices for Corning's growing Electronic Products Division in Raleigh, North Carolina.

For the person with management background and actual design and development experience in the technology and application of semiconductor devices, this position offers an exceptional opportunity to assist in program selection and to direct our in-house sponsored efforts.

Corning's contributions in electronics have played a great part in the company's recent spectacular growth. If you feel you can do the job, tell us why. Salary is open, of course.

Send resume in confidence to Dr. C. B. Wakeman, Director of Electronic Research, Corning Glass Works, Raleigh, North Carolina.

An Equal Opportunity Employer

CORNING

Corning Glass Works
Electronic Products
Raleigh, N. C.

EMPLOYMENT OPPORTUNITIES

The advertisements in this section include all employment opportunities—executive, management, technical, selling, office, skilled, manual, etc.

Look in the forward section of the magazine for additional Employment Opportunities advertising.

— RATES —

DISPLAYED: The advertising rate is \$52.00 per inch for all advertising appearing on other than a contract basis. Contract rates quoted on request.

An advertising inch is measured 7/8" vertically on a column—3 columns—30 inches to a page.

Subject to Agency Commission.

UNDISPLAYED: \$2.70 per line, minimum 3 lines. To figure advance payment count 5 average words as a line. Box numbers—count as 1 line.

Discount of 10% if full payment is made in advance for 4 consecutive insertions.

Not subject to Agency Commission.

Send new ads to:

ELECTRONICS

Class. Adv. Div., P.O. Box 12, N.Y., N.Y. 10036

INSTRUMENT TECHNICIANS

THE OAK RIDGE NATIONAL LABORATORY

Highly skilled instrument technicians to assist in the installation and maintenance of process control instrumentation systems and devices for chemical pilot plants, nuclear reactors and other large experimental installations.

High school education, plus additional training in either the physical sciences, instrumentation, or electronics, and at least 4 years experience in installation and maintenance of complex instrumentation and control systems. Entrance rate \$3.39 per hour; \$3.45 per hour after six months. Reasonable interview and relocation expenses paid by Company.

Excellent Working Conditions and Employee Benefit Plans

An Equal Opportunity Employer

Send detailed resume to:

Central Employment Office

UNION CARBIDE CORPORATION
Nuclear Division
P. O. Box M

Oak Ridge, Tennessee 37831





E. E.'s
for FEE-PAID Positions
WRITE US FIRST!
Use our confidential application for professional, individualized service... a complete national technical employment agency.
ATOMIC PERSONNEL, INC.
Suite 1207L, 1518 Walnut St., Phila. 2, Pa.

POSITION VACANT

Electronics Engineer for design of air traffic communication and navigation aid systems. Must be qualified for planning, design, and specifications. P-7117, Electronics.

ENGINEERS AND SALES ENGINEERS

While you are at Wescon you should plan to visit the research and engineering facility at AMPEX CORPORATION, leader in magnetic tape recording, to discuss how your career and our development programs can compliment one another. Our programs vary from recording Mars photographs to storing video pictures in a computer memory with every product a new challenge.

Call us at (415) 367-2500 or send a resume in confidence to:

C. R. Moody, Employment Mgr.,

AMPEX CORPORATION

401 Broadway, Redwood City, Calif. 94062

An Equal Opportunity Employer

- ADAGE VOLDICON Model V16-AD
High Speed, all semi-conductor, analog voltage input to digital output converters. Nixie display giving + or - sign plus 4 decimal units. .3250.00
- HEWLETT PACKARD Test Oscillator
Model 650 AR Freq. range 10 cy to 10 mc. .350.00
- HEWLETT PACKARD Oscilloscope Model 120 A
Gen Lab Scope DC to 200 KC. .225.00
- HEWLETT PACKARD Oscilloscope Model 150 A
Gen Lab & High Freq. scope. DC to 10 MC with Model 154 A Voltage current pre amp. .650.00
- GENERAL RADIO Power Amplifier
Model 1233 A. .275.00
- GENERAL RADIO Standard Frequency Multipliers
Model 1112 A 1, 10, 100 MC. .750.00
Model 1112 B 1000 MC. .650.00
- WILTRON CO. Phase Indicator
Model 305 with Model F 301. .1250.00
- STODDART AIRCRAFT RADIO Model NM 20 B
Radio Frequency Interference Meter. Freq. range 15 KC to 25 MC with AC Power Supply and Antennas. .1250.00
- SCIENTIFIC ATLANTA Model 121 B-3
Antenna Pattern Recorder. .1450.00
- KINTEL Model 501-B
Digital DC Voltmeter. Range ± .0001 to ± 1000 DC volts. .1450.00
- GULTON INDUSTRIES Accelerometers
Model A-395-TU—with Decade Amplifier F-408 M
Range .1g. to 800g with factory calibration charts .295.00
Model A-380 M with Decade Amplifier F-408 M
Range .1g. to 500 g with factory calibration charts .295.00
- H-H STICHT CO. (ELECTRONIC INST. LTD.)
Model 29-A Megohmmeter Range 300 KOHM to 20 million megohms with test voltages @ 85 or 500 volts. .350.00

See previous issues for more equipment.
Send for Flyers.

All material in excellent condition. All prices F.O.B. San Francisco, Cal. subject to prior sale. Send for Listing and Flyers.

Marty's Mart

1236 Market St., San Francisco 3, California
Phone: UNDERhill 3-1215

CIRCLE 952 ON READER SERVICE CARD

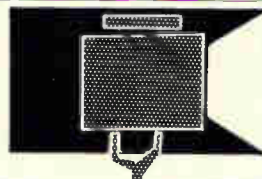

SEARCHLIGHT SECTION

- CLASSIFIED ADVERTISING • BUSINESS OPPORTUNITIES
- USED OR SURPLUS EQUIPMENT



FREE CATALOG!
NEARLY 4,000 BUYS
FOR INDUSTRY

OPTICS! SCIENCE! MATH!
GIANT 148 PAGES

Many on-the-job helps... Quality Control Aids! Write for this completely new, 1965 Catalog. New items, new categories, new illustrations. 148 easy-to-read pages packed with hundreds of charts, diagrams, illustrations. A treasure-house of optical and scientific information... unusual bargains galore. Optics for industry, research labs, design engineers, experimenters, hobbyists! Instruments for checking, measuring—to speed work, improve quality, cut production costs. We give you facts: what it is—how it works—where it's used!

COMPARATORS, MAGNIFIERS, MICROSCOPES

Hard-to-get war surplus bargains—ingenious scientific tools—imported—domestic. Thousands of components: lenses, prisms, wedges, mirrors, mounts—accessories of all descriptions. Dozens of instruments: magnifiers, stereo microscopes, tele-

MAIL COUPON FOR FREE CATALOG "EX"!

EDMUND SCIENTIFIC CO., Barrington, N. J.

Please send FREE Giant 148-page Catalog 'EX'

NAME

ADDRESS

CITYZONE.....STATE.....

No obligation.
EDMUND SCIENTIFIC CO.
Barrington, N. J.

CIRCLE 951 ON READER SERVICE CARD

AUTOTRACK ANTENNA MOUNT

360 degree azimuth, 210 degree elevation sweep with better than 1 mil. accuracy. Missile velocity acceleration and slewing rates. Amplidyne and servo control. Will handle up to 20 ft. dish. Supplied complete with control chassis. In stock—immediate delivery. Used world over by NASA, USAF. TYPE JIP-61 B. SCR-584. NIKE AJAX mounts also in stock plus several airborne trackers.

SCR 584 AUTOMATIC TRACKING RADARS

Our 584s in like new condition, ready to go, and in stock for immediate delivery. Ideal for telemetry research and development, missile tracking, satellite tracking, balloon tracking. Used on Atlantic Missile Range, Pacific Missile Range, N.A.S.A., Walllops Island, A.B.M.A. Write us. Fully Desc. MIT Rad. Lab. Series, Vol. 1, pgs. 207-210, 228, 284-286. Compl. inst. Bk. avail. \$25.00 each.

AN/GPG-1

SKYSWEEP TRACKER

3 km. automatic tracking radar system. Complete package with indicator system. Full target acquisition and automatic tracking. Input 115 volts 60 cycle. New. In stock for immediate delivery. Entire System 6' long, 3' wide, 10' high. Ideal for infrared Tracker, Drone Tracker, Missile, Tracker, R. & D.



PULSE MODULATORS

MIT MODEL 9 PULSER

1 MEGAWATT—HARD TUBE

Output 25 kv 40 amp. Duty cycle .002. Pulse lengths 25 to 2 microsec. Also .5 to 3 microsec. and 1 to .5 microsec. Uses 6C21. Input 115v 60 cycle AC. Mfr. GE. Complete with driver and high voltage power supply. Ref: MIT Rad. Lab. Series, Vol. 5, pgs. 152-160.

2 MEGAWATT PULSER

Output 30 kv at 70 amp. Duty cycle .001. Rep rates: 1 microsec. 600 pps. 1 and 2 microsec. Uses 5948 hydrogen thyratron. Input 120/208 VAC 60 cycle. Mfr. GE. Complete with high voltage power supply.

MIT MODEL 3 PULSER

Output: 144 kv (12 kv at 12 amp.) Duty ratio: .001 max. Pulse duration: .5, 1 and 2 microsec. Input: 115 v 400 cps 2000 cps and 24 vdc. \$325 ea. Full desc. Vol. 5, MIT Rad. Lab. series, pg. 140.

250KW HARD TUBE PULSER

Output 16 kv 16 amp. duty cycle .002. Pulses can be coded. Uses 5D21, 715C or 4P160A. Input 115 v 60 cycle ac. incl. H.V. pwr supply \$1200 ea.

5949 THYRATRON AGING RACK

Compl. Chatham Electronics Console incl. 15 kv power supply & PFN's. \$1800.

MICROWAVE SYSTEMS

E-4 FIRE CONTROL SYSTEM

Hughes Aircraft X Band. Complete. In stock.

C-BAND RADAR

250 KW output, C-band, PPI indicator, 5C22 thyratron modulator. Antenna hi gain parabolo section. Input 115 volts 60 cycle AC. complete \$2750.00.

300 TO 2400MC RF PKG.

300 to 2400 MC CW. Tuneable. Transmitter 10 to 30 Watts. Output. As new \$475.

500KW "L" BAND RADAR

500 kw 1220-1359 mcs. 160 nautical mile search range P.P.I. and A Scopes. MTL thyratron mod. 5J26 magnetron. Complete system.

PHILCO MICROWAVE LINKS

C Band Microwave Link terminal bays and repeater bays in stock. New \$1500 each or \$2500 per pr.

100—800MC. CW SOURCE

150 watts CW nominal output 115 V 60 Cy AC input. \$1600.

100KW 3CM. RADAR

Complete 100 kw output airborne system with AMTL 5C22 thyr. mod. 4J52 magnetron, PPI. 360 deg az sweep, 60 deg. elev. sweep, gyro stabilizer, hi-gain rcvr. Complete with all plugs and cables.

M-33 AUTO-TRACK RADAR SYSTEM

X band with plotting board, automatic range tracking, etc. Complete with 1 megawatt acq. radar.

INFRARED SOURCES

Collimated radiation simulator and transistorized temp. controller. Temp. range. 200-600 degree C. Absolute Accuracy ± 3 degree C. Type AN/USM. \$1975 New.

3KW RCA PHONE & TELEG XMTR

2—30 MC. 10 Autotone channels plus MO. Input 220 vac. 50/60 cycles.



**Radio-Research
Instrument Co.**
550 5th Ave. New York 36, N.Y.
Tel. JUdson 6-4691

CIRCLE 953 ON READER SERVICE CARD

SYNCHROS • GENERATORS INVERTORS • SERVOS

23TR6 Torque Receiver	\$32.50
23TX6 Torque Transmitter	32.50
23CX6 Control Transmitter	32.50
1 F Motor 115/90 V. 60 Cy	24.95
1 G Generator 115 V. 60 Cy	24.95
1 HDG Differential Gen.	24.95
5 G Navy Ord. Size 115 V. 60 Cy.	24.95
5 F Navy Ord. Size 115 V. 60 Cy.	24.95
6 G Navy Ord. Size 115 V. 60 Cy.	29.50
7 G Navy Ord. Size 115 V. 60 Cy.	39.50
Bendix Invertor E-1617-1, 24V. Input, 115V. 400 Cy. 3 Ph. s50 V.A. Output	25.00
Jack-Heintz Invertor E-1617-1, 24V. Input Output 115/230 V. 1/3 Ph. 400 Cy. 2250 V.A.	75.00
General Electric E-1823- 120/208 V. 400 Cy. Generator 60 KVA	250.00
Jack-Heintz Invertor E-1725-1 24V. Input, Output 115/230 V. 1/3 Ph. 400 Cy. 2250 V.A.	75.00
Westinghouse, Generator 120/208 V. 3 Ph. 400 Cy.	75.00
Pioneer Instrument Invertor 12123-1A Input 24 V. Output 115 V. 3 Ph. 400 Cy.	25.00
Elinco Generator PM2	18.95
Deihl FPE49-7 Servo Motor & Tach.	29.95
Deihl PM Motor 27.5 VDC	4.95

AC MOTORS • DC MOTORS
FANS-BLOWERS • RESOLVERS
GEARED MOTORS • ACTUATORS
LARGE STOCK OF ROTATING DEVICES

All Items F.O.B. Oakland

Send for Free Catalog

(On Company Letterhead, Please)

ELECTRO GADGET SUPPLY

Doolittle & Langley Streets

Oakland Airport Oakland, Calif.

Phone 562-6641

CIRCLE 954 ON READER SERVICE CARD

ELECTRON TUBES

KLYSTRONS • ATR & TR • MAGNETRONS
SUBMINIATURES • C.R.T. • T.W.T. • 5000-
6000 SERIES

• SEND FOR NEW CATALOG A2 •

A & A ELECTRONICS CORP.

1063 PERRY ANNEX
WHITTIER, CALIF.

696-7544

CIRCLE 955 ON READER SERVICE CARD

TEST EQUIPMENT

For over 20 years specializing in top brands only. Write for our latest listing. We buy complete inventories.



ELECTRONIC SALES

1413 Howard Street, Chicago, Illinois 60626
Telephone ROGers Park 4-0600

CIRCLE 956 ON READER SERVICE CARD

SMALL AD but BIG STOCK

of choice test equipment
and surplus electronics

Higher Quality—Lower Costs

Get our advice on your problem

ENGINEERING ASSOCIATES

434 Patterson Road — Dayton 19, Ohio

CIRCLE 957 ON READER SERVICE CARD

“SEARCHLIGHT” IS

Opportunity Advertising

—to help you get what you want—to help you sell what you no longer need.

Take Advantage Of It

“THINK SEARCHLIGHT FIRST”

For Every Business Want

SEARCHLIGHT EQUIPMENT LOCATING SERVICE

No Cost or Obligation

This service is designed to help you, the reader of SEARCHLIGHT SECTION, to locate used or rebuilt equipment not currently advertised.

HOW TO USE: Check the ads in this SEARCHLIGHT SECTION to see if what you want is advertised. If not, print clearly the specifications of the equipment and/or components wanted on the coupon below, or on your own letterhead.

THIS IS A SERVICE TO OUR READERS. THIS PUBLICATION DOES NOT BUY, SELL OR STOCK EQUIPMENT OR MATERIALS OF ANY TYPE. Your requirements will be brought promptly to the attention of the used equipment dealers advertising in this section. You will receive replies directly from them.

Obviously, the list of such advertisers is limited by comparison with the over 63,000 subscribers to ELECTRONICS, all directly engaged in the electronics industry. A small 'EQUIPMENT WANTED' advertisement in the SEARCHLIGHT SECTION will bring your needs to the attention of ALL who read ELECTRONICS. The cost is low . . . just \$27.25 per advertising inch— $\frac{7}{8}$ " x 2-3/16".

SEARCHLIGHT EQUIPMENT LOCATING SERVICE

CLASSIFIED ADVERTISING

c/o Electronics

P. O. Box 12, New York, N. Y., 10036

Please help us to locate the following used equipment:

NAME _____

TITLE _____

COMPANY _____

STREET _____

CITY _____

STATE _____ ZIP CODE _____

New Literature

A-c motors. Globe Industries, Inc., 1784 Stanley Ave., Dayton, Ohio, 45404. Bulletin B-2702 gives engineering and dimensional data on the FC type compact Mil-Spec a-c motors. Circle 461 on reader service card

Timing modules. The A.W. Haydon Co., 232 North Elm St., Waterbury, Conn., 06720. Bulletin ESF 311 describes crystal-can, solid state variable timing modules capable of controlling loads up to 100 ma at 28 v d-c over a temperature range of -55° to $+125^{\circ}$ C. [462]

Optics and electronics. Farrand Optical Co., Inc., Bronx Blvd., & East 238th St., New York, N.Y., 10470, offers a 14-page brochure that describes many advanced, state-of-the-art systems in the areas of optics and electronics. [463]

Micrologic circuit modules. Systems Engineering Laboratories, Inc., P.O. Box 9148, Fort Lauderdale, Fla., 33310. Typical applications of the 8500 series micrologic modules are described in a comprehensive, 40-page booklet. [464]

Environmental lab equipment. Gulton Industries, 212 Durham Ave., Metuchen, N.J. Bulletin GC002 describes and illustrates the company's products for environmental laboratories. [465]

Transistor selector guide. Motorola Semiconductor Products Inc., Box 955, Phoenix, Ariz., 85001. A new silicon transistor selection guide permits the user to choose easily the high-frequency amplifier or switching device that most closely fits his exact performance requirements. [466]

Telemetry systems equipment. Astrodata, Inc., 240 E. Palais Road, Anaheim, Calif. Two brochures now available introduce the model 600 pam/pdm signal simulator-calibrator and model 603 pam/pdm telemetry decommutator systems equipment. [467]

Diode capacitance curve tracer. American Electronic Laboratories, Inc., P.O. Box 552, Lansdale, Pa., 19446, announces technical bulletin 100-6 on the model 438 diode capacitance curve tracer for use with a number of voltage variable capacitance devices. [468]

Multiswitches. Switchcraft, Inc., 5555 N. Elston Ave., Chicago, Ill., 60630. Catalog S-323 provides complete engineering specification information about such items as illumination, styles and shapes of push buttons, stack module design, and many other multiswitch design requirements. [469]

Power inverters. CML, Inc., 350 Leland Ave., Plainfield, N.J., has published bulletin DA65 on a line of solid state d-c to a-c power inverters for a wide range of ground and air uses. [470]

Integrated circuits. High Reliability Circuit Systems, 1853 N. Raymond Ave., Anaheim, Calif. Bulletin 1002 tells how flatpack integrated circuits are being manufactured in high density, low weight, microminiaturized packages through parallel gap welding techniques. [471]

Frequency to d-c converter. Solid State Electronics Corp., 15321 Rayen St., Sepulveda, Calif., 91343, has released a bulletin describing its series 400KF normalized Freqmeter, a solid state frequency to d-c converter. [472]

Epoxy compound. H.V. Hardman Co., Inc., 600 Cortlandt St., Belleville, N.J., offers a data sheet on Epocap 3434, a two part, heat curing epoxy system whose low viscosity and wetting characteristics provide excellent penetration into finely wound coils. [473]

R-f connectors. Kings Electronics Co., Inc., 40 Marbledale Road, Tuckahoe, N.Y., has published a comprehensive handbook describing its extensive line of K-Grip Jr. r-f crimp connectors. [474]

Sensitive relays. Filtors, Inc., East Northport, N.Y. A two-page bulletin contains detailed information on sensitive JW relays for dry circuit, minimum current or power applications. [475]

Differential transformer. Gulton Industries, 212 Durham Ave., Metuchen, N.J. A high output, linear differential transformer with proven performance characteristics is illustrated and described in bulletin K102. [476]

D-c servo controller. Moog Servocontrols, Inc., Proner Airport, East Aurora, N.Y., 14052. Engineering data sheet 82-137 gives design information on a new d-c servo controller and discusses its uses in closed-loop servo systems requiring d-c control. [477]

Static inverters. The Linton Co., Inc., 2412 Reddie Drive, Wheaton, Md., 20902, has available the second in a series of technical bulletins for its FR-6000 series static inverters. [478]

Transmitters. American Electronic Laboratories, Inc., P.O. Box 552, Lansdale, Pa., 19446, offers a four-page technical bulletin on the models FM-5KA and FM-7.5KA transmitters. [479]

Core Memory stacks. Fabri-Tek Inc., Amery, Wisc. More than 2,000 different coincident-current core memory stacks can be specified with the help of bulletin 6533, now available. [480]

Thumbwheel switches. Oak Electro/Netics Corp., Crystal Lake, Ill., 60014. Rocker type thumbwheel switches for individual or modular mounting are described in bulletin SP-202. [481]

Honeywell Solitron DEVICES, INC.

A New Name in POWER TRANSISTORS

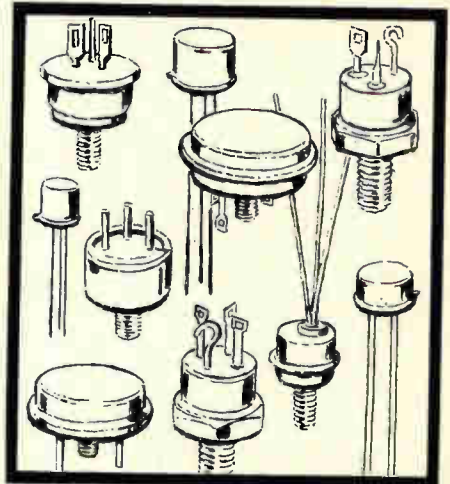

The recent purchase of the Honeywell Semiconductor Products Division by Solitron was carried out so efficiently and smoothly that there has been no break in the continuity of effort to supply the same superior devices under Honeywell license. In fact, far-reaching expansion plans are under way to make certain that the stringent test requirements of many of the major programs for which the Solitron Transistor Division is presently supplying parts are complied with. In effect, this will decrease the lead time necessitated due to the tight scheduling of test rack positions.

The initial response to the improved service, quality control, delivery and lower cost has been gratifying, and Solitron will continue to make the necessary capital expenditures to broaden both the silicon and germanium product lines, expedite deliveries, and reduce prices where indicated. For short-form transistor catalog and complete catalog on rectifiers, zeners, and other semiconductor products, contact your local Solitron representative, or:

Solitron DEVICES, INC.

256 Oak Tree Road • Tappan, New York 10983
914-359-5050

Transistor Division:
1177 Blue Heron Blvd. • Riviera Beach, Florida
305-848-4311

See us during WESCON at Fairmont Hotel

There are over 100,000* versions
of Standard Telonic Filters
that can be shipped 3 days A.R.O.

Specials take a few minutes longer!

TELONIC RF and MICROWAVE FILTERS

30 MHz to 6 GHz • Low Pass • Band Pass •
Tubular • Cavity • Interdigital • Tunable

Telonic's modular method of construction permits fast response to your normal filter requirements, and greatly simplifies production of non-standard units. Chances are, however, your "special" is actually a filter that we've built before; and even if it's a special-special, our computer facility can deliver the design to manufacturing literally in minutes, assuring you of rapid order processing.

Combine that kind of service with the dependability and performance Telonic Filters always deliver and it's apparent why they are consistently specified by leading O.E.M.'s and service agencies.

SPECIFICATION SUMMARY:

SERIES	FREQUENCY RANGE	INSERTION LOSS	VSWR	NOM. IMPEDANCE
TLP, TLA, TLC, TLR, TLS Low Pass Tubular	30 Mc to 3 Gc (Cut-off)	.05 to .2 db/ Section	1.5/1 Max (Pass Band)	50 ohms
TBP, TBA, TBC Band Pass Tubular	30 Mc to 2.5 Gc (Center Frequency)	.05 to 2 db/ Section	1.5/1 Max	50 ohms
TCF, TCA TSF, TIF, TCC Band Pass Cavity & Interdigital	30 Mc to 6 Gc (Center Frequency)	.15 to 1.0 Typical Loss Constant	1.5/1 Max	50 ohms
TTF, TTA Band Pass Tunable	48 Mc to 3000 Mc (Full Octave)	0.5 to 3 db/ Typical	1.5/1 Max	50 ohms

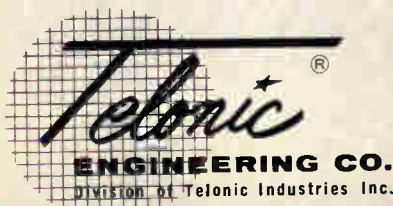

* FILTER DESIGN RULE



This new Filter Design Slide Rule enables quick determination of the exact Telonic filter model to meet your requirements, standard or special. It's yours for the asking — just write, wire or call.

480 Mermaid Street, Laguna Beach, California 92651, Tel: (714) Hy 4-7581 Twx (714) 673-1120

See Telonic at WESCON, booths 4114-4118



Electronics Abroad

Volume 38
Number 16

France

Anglo-French computer

Britain and France are planning to combine their computer technologies in an attempt to challenge United States companies' domination of the European market.

With quiet encouragement from their governments, two British companies and one from France have agreed to form a consortium whose principal goal could be the world's biggest computer.

The governments acknowledge that they are considering the proposal, but decline to discuss it. To be effective, the joint effort probably would require government funds.

The companies. The British participants are that country's leaders in the computer field: International Computers and Tabulators, Ltd. (ICT) and English Electric-Leo-Marconi Computers, Ltd., a subsidiary of the English Electric Co. The French participant is Citec, a holding company formed by two of France's biggest electronics concerns, Compagnie Generale de Telegraphie Sans Fil (CSF) and Compagnie Generale d'Electricite (CGE).

Whose idea was the consortium? Apparently the French Government's. Like Britain, France is worried about Europe's ability to compete with American computer technology. Unlike Britain, France has been rebuffed in an attempt to buy an American scientific computer larger than any made in Europe, even by U. S. companies.

Several months ago, the French Government tried to buy a large computer from an American company. The company refused to sell, explaining that it would be unable to get an export license from the U. S. Government because the computer could be used to advance France's capability in nuclear

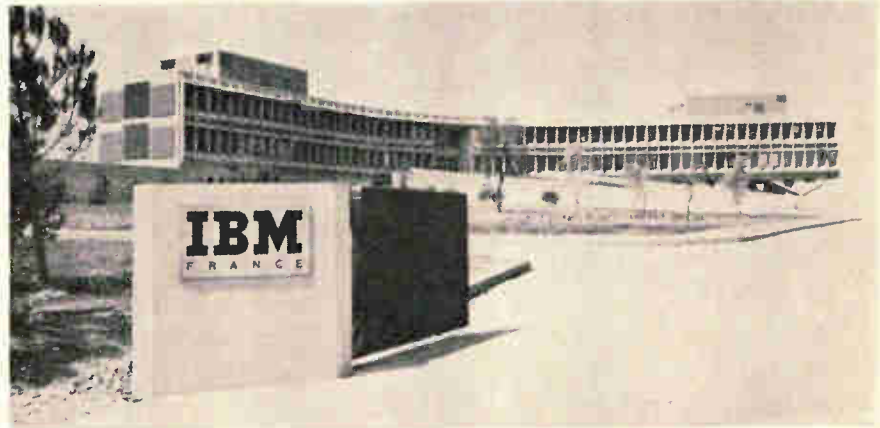

IBM-France laboratory at La Gaude symbolizes American companies' domination of European computer market. Scientists and engineers of International Business Machines Corp. are seeking ways in which computers can communicate over hundreds of miles.

weapons. France has developed an atomic bomb but has refused to sign the nuclear test-ban treaty.

President de Gaulle was furious. He decided that France would build her own—preferably with British help.

U. S. policy. In Washington, specialists confirm the existence of an American ban on exports of huge scientific computers to France, among other countries. Some of the authority to do this is spelled out in the Export Control Act, but most of the power is subtle, unofficial—and thoroughly effective.

Licenses to export computers depend, among other things, on considerations of national security and foreign policy. Jurisdiction is exercised by two government departments: the Commerce Department through its office of export control, and the State Department through its munitions control office. The Atomic Energy Commission also may act in an advisory capacity.

The computer. A spokesman for ICT says the consortium plans to build a computer that's bigger than the CDC 6600, which is being used at Cern (European Organization for Nuclear Research) at Geneva. The manufacturer, the Control Data Corp., calls this com-

puter the largest in use anywhere.

The ICT spokesman says the consortium expects to sell about 20 such machines in Europe. They would be used in astronomy and meteorology, as well as in solving complex scientific problems.

NATO communications

The North Atlantic Treaty Organization is planning an extensive modernization of its communications network over the next decade. By 1968 it expects to spend about \$170 million on electronic equipment; installation probably will continue well into the 1970's.

Bidding already has begun on a second automatic message-switching system, similar to the Tare (telegraphic automatic relay equipment) system that has been installed at NATO's southern district headquarters in Naples. The new equipment will be installed at Fontainebleau, headquarters for central Europe. Tare was built by the International Telephone and Telegraph Corp. and cost \$4 million to \$5 million.

The switching centers will make extensive use of stored-program data processors. At first most of the processors will be punched-

card systems; later magnetic tape will be used.

More microwave. In about a year, microwave systems will be ordered to improve communications between points commanded by Fontainebleau. This contract is expected to be worth about \$20 million. NATO probably will keep the present ratio of 50% military links and 50% leased telephone lines, but will employ more troposcatter facilities in the military network and rely less on wire communications. It will also increase its use of high-frequency, single-sideband radio.

NATO is determined to spread its business among member countries as much as possible. "There is going to be a lot of interaction between American and European firms," one official promises.

Bidding procedures may follow that used for Nadge, the air-defense ground-environment system under which computers will be able to direct air defense automatically. Bidding for Nadge is based on a NATO requirement that member countries must receive contracts in the same proportion as their contributions to the cost of this \$280-million project. Three consortiums have submitted bids; they are led by the Westinghouse Electric Corp., Litton Industries, Inc., and Hughes Aircraft Corp.

Switzerland

Dark horse

The world's first all-electronic watch has been developed by an American inventor for a Swiss watch company. The timepiece employs integrated circuitry made by Texas Instruments Incorporated.

The Swiss company, Solvil & Titus of Geneva, seems to have stolen a march on the Swiss Federation of Clock and Watch Manufacturers, which has been conducting a well-financed, highly publicized effort since last fall to develop an electronic watch at its new research center near Neu-

chatel [Electronics, Jan. 25, p. 155].

Due in 1966. Herbert S. Polin designed the watch—called the Soltronic—at his laboratories in New York and Geneva. He says the watch should be on the market in about a year, and cost about \$150 initially. If the demand is great enough and if the integrated circuits can be mass-produced cheaply enough, he adds, the Soltronic may some day be the least-expensive watch made. It will be assembled in Geneva with circuits produced by Texas Instruments in Dallas after TI solves some packaging and production problems.

The nearest thing to an electronic watch up to now is the Accutron, manufactured by the Bulova Watch Co. It uses a transistorized circuit to control an electromagnetic tuning fork that moves the hands.

Four-layer sandwich. The Soltronic, which has no moving parts, is constructed in four layers. The first layer is an electrochemical cell that divides the pulses into one-a-second, one-a-minute and one-an-hour signals. A switching layer employs these timed signals to make the display layer, or face of the watch, glow; each section represents a unit of time—an hour, minute or second. The watch is battery-powered.

Polin also plans to patent the electroluminescent faces needed to show the time. He says he has developed two types, both bright enough to be visible in full sunlight.

User's guide. The user sets his watch with a two-position switch in the location that would be occupied by a stem in a conventional timepiece. When he pulls the switch out to one position, the oscillator speeds up considerably to make up for lost time. When the dial indicates nearly the correct time, he sets the switch at another position; this slows down the oscillator so he can zero in on the precise time.

While the watch is on the user's wrist, his body temperature keeps the prime oscillator at a constant frequency. When he takes the watch off at night, however, he must put it on a heated tray to

maintain the same temperature.

Polin also invented the Soltronic all-electronic clock, which is sold in Europe but which has not been marketed in the United States.

Western Europe

Mixed blessing

As European industry moves steadily but warily into microelectronics, it is developing an ambivalent attitude toward United States technology. Many companies look to American affiliates to keep them ahead of their competitors; at the same time, the industry as a whole worries about American domination.

In Britain, the microelectronics unit of Elliott-Automation, Ltd., has announced plans to build a \$2.8-million factory and laboratory in Scotland. Elliott has access, through a license, to all the microelectronics knowledge of the Fairchild Camera & Instrument Corp. in the United States.

But one British specialist, who asked that his name be withheld, sees in agreements like Elliott's a lack of initiative in British Research. "It's a bloody shame," he says, "that hardly any British company is prepared to invest in microelectronics on a sufficient scale. If the situation is not soon altered, the British industry could be entirely dependent on U. S.-designed components."

French fears. Integrated logic circuits, made in America and packaged in Hong Kong, are sold in France for \$2 to \$3 while similar components made in France cost \$8 to \$10. The reason: the Americans are mass-producing the circuits while the French are still manufacturing them in sample quantities.

France's major producers are Compagnie Générale de Télégraphie Sans Fil (CSF) and la Radiotechnique, the latter a subsidiary of Philips Gloeilampenfabrieken N.V. of the Netherlands. There are two other big semicon-

ductor companies: Texas Instruments Incorporated and Société Européenne des Semiconducteurs (Sesco), a joint venture of Compagnie Française Thomson-Houston and the General Electric Co.

U. S. inroads. Società Generale Semiconduttori (SGS), an Italian company in which Fairchild has one-third interest, is building a semiconductor plant in France. And Motorola, Inc., will build a factory "somewhere in Europe"; industry specialists expect "somewhere" to be eastern France.

"The entrance of these American firms makes us nervous," declares Xavier Ameil, assistant director of CFT's physical-chemical research department. "We may have a terrific battle that will not end until some French firms die."

Jean Marie, product manager for semiconductors at Radiotechnique, estimates the U. S. lead in microelectronics at two years.

The computer field, which accounts for 25% of France's semiconductor production, is dominated by the International Business Machines Corp. IBM already produces

components for its System 360 machine in the United States, and could decide one day to use its own products in France too. France's second-ranking computer maker, Compagnie des Machines Bull—which is owned by General Electric—could decide to buy all of its components from GE.

Italian trio. Only three Italian companies are known to be working on microelectronics; all have strong U. S. connections.

Italy's biggest semiconductor company, SGS, began producing integrated circuits last spring at the British plant owned by its subsidiary, SGS-Fairchild, Ltd. The British company will build another plant that is scheduled to start production of silicon planar integrated circuits in mid-1966. SGS also is setting up a facility in Italy to develop integrated circuits for special customer applications throughout Europe. This will be SGS's first attempt at R&D in integrated circuits; until now, all its technology has come from Fairchild.

Ing. C. Olivetti & Co., which owns one-third of SGS, claims to

have solved problems of stability and reproducibility of contacts at its own research facilities, but won't say how. Olivetti is also secretive about its claim to be using "photoresistive elements" in series with each diode to obtain semipermanent memories. Olivetti's research in microelectronics is conducted by Olivetti-General Electric, in which the General Electric Co. has majority interest.

Selenia, an affiliate of the Raytheon Co., says it plans a "considerable" expansion next month of its 1½-year-old project for developing thin-film techniques; the company also says it is ready to expand into thick-film circuits. Selenia's microcircuits are only for its own use.

Australia

Quiet cooperation

Competition in space monopolizes the headlines around the world while, almost unremarked, technologically advanced countries expand their cooperation in meteorology.

At points as distant and disparate as Australia and India, international programs are supported by the United States, the Soviet Union, France and other nations.

In Australia, the World Meteorological Organization has picked Melbourne as one terminus in a global weather-forecasting network; the others are Washington and Moscow. The joint venture in India is a rocket-launching facility to study atmospheric conditions over the equator.

In Australia. As Southern Hemisphere partner in the world network, the Melbourne station will handle information from Australia, Pacific islands, ships at sea and meteorological stations in Brasilia, Brazil and in Nairobi, Kenya. It will prepare meteorological analyses and prediction charts, and issue daily bulletins and monthly and seasonal summaries. A computer will send the data every six hours to Washington and Moscow, and will supply details as required by



Achievement of British microelectronics is Marconi Co.'s desk-size Myriad computer measuring 6 by 3 by 2½ feet. It has 4,096-word capacity, can add and subtract in 2.5 microseconds and multiply in 10 microseconds. Maximum time before failure is said to be 30,000 hours, compared with 3,500 hours for most conventional models. First model has been sold to Royal Radar Establishment at Malvern.

Acts fast at set point

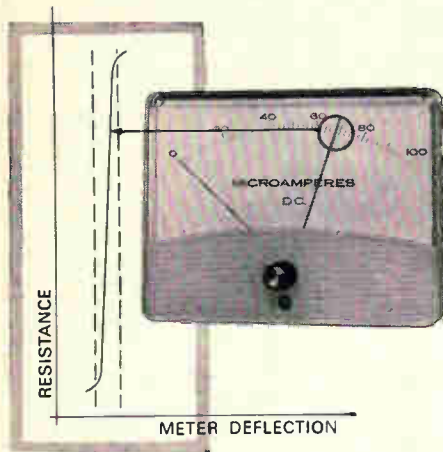

Almost instantaneous—that's the response at set point of API's contactless (optical) meter-relay.

Highly efficient use of internal light results in a "slope" of at least 100 to 1 between the extremes of resistance of a photoconductor. This ratio insures fast response (see curve above).

Above all, API's contactless meter-relay is simple and direct in operation—and therefore reliable and easy to apply. It's sophisticated but not complicated.

You don't have to be an engineer to use it—but engineers appreciate it most.

Details we almost take for granted

It's unaffected by ambient light
 ■ Indicates continuously, either side of set point ■ Inherently fail-safe ■ Unamplified signal from any variable ■ Set points can be as close as 1/2% of full-scale ■ Pre-packaged circuits available.

Ever get so much for so little? All popular current and voltage ranges, including AC, plus temperature controlling models. Many in stock for fast shipment.

Ask for Bulletin 48
 VISIT WESCON BOOTH 4121-22

api
INSTRUMENTS CO.

Formerly Assembly Products, Inc.
 CHESTERLAND, OHIO - PHONE: 216-423-3131

Electronics Abroad

other regional weather centers.

The Commonwealth Bureau of Meteorology has been receiving bids from the U. S. and Britain on a \$4.5-million computer whose specifications closely resemble those of the Control Data Corp. 6600. The specs call for 32 words of high-speed store, more than one instruction per word, capability for modular expansion, not less than 35 bits per word, main-store access time less than 3 microseconds, random-access backing store with capacity of about 10 million characters, and average access time less than 100 milliseconds.

Melbourne expects to rely on conventional telecommunications for four or five years; then it will use weather satellites as another source of meteorological information. It also plans to use weather satellites to relay information from automated ground stations.

In India. Since November, 1963, twenty-seven different types of rockets have been launched from Thumba Beach, a cluster of fishing villages on India's southwest coast. The rockets include American-built Nike-Apaches and French Centaures. The data from space is fed into a Minsk 2 digital computer made in Russia.

A United Nations committee has recommended that the world body sponsor the project, which is coordinated by the Indian National Committee for Space Research.

U. S.-trained scientists. India's Atomic Energy Establishment has begun to produce Centaure sounding rockets under license from Sud Aviation of France. Indian scientists in charge of the Thumba project have been trained in the United States.

The Soviet computer, one of the first to be shown in the West, has a 4,000-word memory and performs 5,000 to 6,000 operations a second. External facilities can increase the memory to 800,000 words. The Minsk 2 runs through its internal memory in 24 microseconds.

From the United States, the National Aeronautics and Space Administration has provided radar, launch pads, telemetry and other electronic equipment.

Great Britain

Slowing the carrousel

A digital tachometer is measuring the speeds of diesel-electric locomotives on British railroads more accurately than most speedometers measure car speeds on the highways. The system developed by Associated Electrical Industries, Ltd., is accurate up to 98.25% at full-scale deflection of a speedometer. The system operates at speeds as slow as 0.2 mile an hour.

The transistorized system's next task will be to control speeds automatically on carrousel trains—slow-moving vehicles that transport coal at power stations.

Transmitter on axle. The system counts revolutions per minute of a train wheel, and integrates that figure into miles an hour. An electromagnetic probe on the axle generates pulses from the rotation of a toothed wheel. After amplification and waveform shaping by an axle-mounted transmitter, equal-amplitude pulses are fed to the electronic tachometer. A moving-coil meter inside the tachometer integrates the pulses so that the mean current in the meter is proportional to the pulse frequency and hence to the speed.

By means of a calibrated shunt across the meter, the system can be adjusted for wheel wear and for different wheel diameters between 36 and 48 inches. Mileage is recorded by a capacitor discharge circuit that activates an electromagnetic counter.

For speed control, AEI says it uses sensitive relays to weaken the field of the locomotive's drive motors automatically. Delay circuits prevent premature operation of these relays when the wheels are spinning, during start-up for example.

U. S. system. The closest counterpart in the United States seems to be a system to control speeds of "slave locomotives," auxiliary unmanned engines in the middle of long trains. The system was developed jointly by the Southern Railway and by the Westinghouse Air Brake Co.

The American technique controls the slave's speed automatically from signals received from push-pull sensors on the couplers in the front and rear of the slave. When a predetermined level of push or pull is exceeded, the slave is either slowed down or speeded up.

No cause for alarm

Britain's decision to lop \$280 million off this year's expenditures caused little concern among electronics companies. The biggest reductions are expected in capital spending by nationalized industries and in some military outlays. No contracts will be canceled, the government says.

A spokesman for the Hawker Siddeley Group, Ltd., said the measures "won't have any pronounced effect on us." An official of the Electronics Engineering Association, Britain's equivalent of the Institute of Electrical and Electronics Engineers in the United States, describes the action as "cutting out the nonessentials."

Around the world

Indonesia. The Philco Corp. has given up a proposed contract to build a 12-station tropospheric scatter system for the Indonesian Army. The transaction, valued at \$10 million to \$20 million, began as part of the United States aid program in 1960, when relations between the two countries were more cordial. Now President Sukarno is willing to pay for the equipment, but the State Department won't permit its sale for 9 of the 12 proposed sites because they are considered too close to staging areas where Indonesia may be preparing attacks on Malaysia. A Philco spokesman says the transaction is in a "very very dead file."

Mideast. The Israeli Cabinet has approved a domestic television service, scheduled to start in two years. Israel's 30,000 tv-set owners now have a choice of programs originating in the United Arab Republic and in Lebanon.

Complete line of faster, field-proven

MULTIPLEXERS A/D-D/A CONVERTERS BY CONTROL DATA

When you require speed and performance, don't settle for less than your long-range needs. The broad line of products developed by Adcomp, a subsidiary of Control Data, now makes it possible to select the instrument for your *specific* application. Here are typical models:



HIGH SPEED MULTIPLEXERS

Silicon solid-state switches are used in multiplexers to obtain high speed and low offset voltage. The Model 402 32-channel Multiplexer offers a speed of 500,000 samples per second with a maximum offset voltage of 250 μ v max. Linearity is better than 0.001% and input impedance is 100 megohms min. Input ranges from ± 1 to ± 100 volts are available.

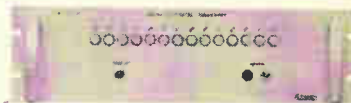

ANALOG TO DIGITAL CONVERTERS

Analog to Digital Converters are available with resolutions from 8 to 14 bits, and 50 to 250,000 conversions per second. A number of inputs are offered up to ± 100 volts. Digital output is binary. Integral sample and holds and extremely stable reference supplies provide exceptional accuracy and stability.



DIGITAL TO ANALOG CONVERTERS

These instruments incorporate the finest components obtainable. For example, high accuracy and temperature stability are obtained with a precision resistance ladder immersed in oil. Various models offer resolutions from 8 to 14 bits, absolute accuracy to $\pm 0.015\%$ and an update rate up to 300 kc. Buffer amplifiers are available for various output voltages and drive capabilities.

FOR INFORMATION concerning these and other ADCOMP instruments, contact: ADCOMP CORPORATION, Dept. 302, 20945 Plummer St., Chatsworth, California 91311 (Area code 213, 341-4635)

ADCOMP CORPORATION

SUBSIDIARY OF

CONTROL DATA

CORPORATION

Electronics advertisers

August 9, 1965



■ General Electric Co., Lamp Metals & Components Division Dix & Eaton Incorporated	164	Lake Shore, Inc. The Cramer-Krasselt Company	178	Phelps Dodge Electronic Products Corporation	20
General Electrodynamics Corporation Evans, Young, Wyatt Inc.	197	■ Lambda Electronics Corporation Michel Cather Inc.	112, 113	■ Philbrick Researches Inc., George A. Culver Advertising Inc.	99
General Instrument Corporation Norman Allen Associates Inc.	37	■ Leach Corporation Jay Chait & Associates	147	■ Polard Electronics Corporation Keyes, Martin & Company	101
General Radio Company K.E. Morang Company	2nd Cover	Ledex Inc. Yeck and Yeck	140	■ Precision Tube Company Inc. George Moll Advertising	168
Genisco Technology Corporation Getz and Sandborg Inc.	175	Lockheed Missiles & Space Company McCann-Erickson Inc.	202	■ Primo Company Ltd. General Advertising Agency	210
Gries Reproducer Co. Harold Marshall Adv., Co., Inc.	224			Printed Motors Inc. Sub. of Photocircuits Corporation Duncan-Brooks Inc.	128
Heinemann Electric Company Thomas R. Sundheim Inc.	177	Machlett Laboratories Inc., The Fuller & Smith & Ross Inc.	9	Radiation Inc. G.M. Basford Company	198
■ Hewlett Packard Company Lennen & Newell Inc.	2	Marconi Instruments, Ltd. Armand Richards Advertising Agcy.	104	Radio Corporation of America Al Paul Lefton Company	4th Cover
Hitachi Ltd. Dentsu Advertising Ltd	201	■ Massa, A Div. of Dynamics Corporation of America L.K. Frank Co. Inc.	138	■ Radio Frequency Laboratories Inc. J.A. Brady & Company	120
Hughes Aircraft Company Foote, Cone & Belding Inc.	208	Matsunaga Manufacturing Co. Ltd. Asia Advertising Agency Inc.	192	■ Radio Materials Co. Div. of P.R. Mallory Co. Inc. Rosenbloom/Elias Associates Inc.	146
■ Hull Corporation The Michener Company	180	McDonnell Electronic Equipment Div. John Patrick Starrs Inc.	153	Raytheon Company Fuller & Smith & Ross Inc.	135, 189
		McGraw-Hill Book Company Inc. Meller Company, Adolf Dean & Herr Inc.	168 199	Rese Engineering Inc. Joseph Gering/Graphic Design Associates	122
		Mepco Inc. Ray Ellis Advertising Corporation	194	Rohde & Schwarz Inc. Ted Gravenston, Inc.	43
		Metronix Inc. Standard Advertising Inc.	178	■ Rotron Mfg. Company Inc. Lescarbours Advertising Inc.	132
Industrial Electronic Engineers Inc. Gumpertz, Bentley & Dolan Adv.	211	M.I.A.L. Inc. Keyes, Martin Company	195		
■ Ichizuka Optical Company Ltd. Matsushita Inc.	210	Mico Instrument Company	210	■ Semi-Elements, Inc. Axelband, & Brown Associates.	184
International Resistance Company Arndt, Preston, Chapin, Lamb & Keen Inc.	130	Minnesota Mining & Mfg. Company Scotchpar Division Klau-Van Pietersom-Dunlap Inc.	114 207	Shallcross Mfg. Company J.T. Howard Advertising Agency Inc.	133
ITT Components, Industrial Laboratories Division West, Weir & Bartel Inc.	150	Mitre Corporation Bresnick Company Inc.	203	Shizuki Electric Works Co., Ltd. New Asia Trading News Agency, Ltd.	184
ITT Research Institute Deutsch & Shea Inc.	205	■ Mitsubishi Electric Corporation Hakuhodo Inc.	203	■ Siemens America Inc. Mann-Wesley Inc. Advertising	12, 13
ITT Semiconductors Division West, Weir & Bartel Inc.	127, 129	■ Mitsumi Electric Co., Ltd. Dentsu Advertising Ltd.	196	Sigma Instruments, Inc. The Marschalk Company Inc.	44, 45
Isomode Division of Cal/Val Research & Development Corporation Packard/Mitchell Advertising Inc.	192	Motorola Semiconductor Products Inc. Lane and Bird Advertising Inc.	38, 39, 143	■ Singer Company, Metrics Division Hepler & Gibney Inc.	149
				Solitron Devices Inc. Armand Richards Advertising Agency	217
		National Cash Register Company Allen, Dorsey, & Hatfield Inc.	170, 171	■ Sorensen Incorporated Fuller & Smith & Ross Inc.	11
■ Jennings Radio. Manufacturing Corporation L.H. Waldron Advertising	117	■ Non-Linear Systems Inc. Barnes Chase Advertising Agency	169	Space Craft Inc. Neals & Hickok Incorporated	57
Jerrold Electronics Corporation Irving Gould Advertising Inc.	10	North Atlantic Industries, Inc. Murray Heyert Associates	35	Speer Carbon Company Hazard Advertising Company	183
Johnson Company, E.F. Firestone Advertising Inc.	151			Sprague Electric Company The Harry P. Bridge Co.	5, 6
Jonathan Manufacturing Co. Leland Oliver Co., Inc.	224	Okaya Musen Company Ltd. K.K. Kyoei Kokoku Sha Adv. Agency	184	Stackpole Carbon Company Meek and Thomas Inc.	157
				■ Syntronic Instruments Inc. Burton Browne Advertising	122
Keithley Instruments Inc. The Bayless Kerr Company	156				
Kingsley Machines Company Nides Cini Advertising Inc.	203	■ Patwin Electronics Company Graceman Advertising Inc.	204	TRW Electronics Fuller & Smith & Ross Inc.	33
■ Kyoto Ceramic Company Ltd. Daiko Advertising Inc.	163	■ Pendar Inc. Showacre, Coons, Shotwell, Adams Inc.	158	Tamura Electric Works Ltd. Asia Advertising Agency Inc.	190
		Pennsylvania Fluorocarbon Company Ernest William Greenfield Inc.	204	■ Tektronix Inc. Hugh Dwight Adv. Inc.	161
		Penta Laboratories Inc. Fuller & Smith & Ross Inc.	8	Telrex Laboratories George Homer Martin Associates	204
■ Laboratory for Electronics Inc. Hepler & Gibney Advertising	186	■ Permag Corporation Schneider Allen Walsh	190	■ Telonic Engineering Company Jansen Associates	218
		Perfection Mica Company, Magnetic Shield Division Burton Browne Advertising	166		

Executive, editorial, circulation and advertising offices: McGraw-Hill Building, 330 West 42nd Street, New York, N.Y., 10036. Telephone Area Code 212-971-3333. Teletype TWX N.Y. 212-640-4646. Cable: McGrawhill, N.Y. Officers of the Publications Division: Shelton Fisher, President; Vice Presidents: Joseph H. Allen, Operations; Robert F. Boger, Administration; John R. Callahan, Editorial; Ervin E. DeGraff, Circulation; Donald C. McGraw, Jr., Advertising Sales; Angelo R. Venezia, Marketing. Officers of the Corporation: Donald C. McGraw, President; L. Keith Goodrich and Hugh J. Kelly, Executive Vice Presidents; John J. Cooke, Vice President and Secretary; John L. McGraw, Treasurer. Title R registered U.S. Patent Office; © copyright 1965 by McGraw-Hill, Inc. All rights reserved, including the right to reproduce the contents of this publication, in whole or in part.

A true primary-type pressure standard



CEC's 6-201 Primary Pressure Standard has long been accepted as the finest of all pneumatic piston gages.

The following advantages explain why the 6-201 has no equal today:

- ☐ Resolution—better than 0.002% of reading.
- ☐ Thermal coefficient of sensitivity—0.0012% of reading per degree F.
- ☐ Pressure ranges—0.015% of reading for 1.5, 5, 15, 50 psi; 0.025% of reading for 150 or 500 psi.
- ☐ Humidity—0 to 80% relative.
- ☐ Lightweight, portable, weighs only 22 lbs complete.
- ☐ Accuracy not dependent on operator technique.

**All that — plus
this important new accessory:**

A specially designed filter has been perfected which minimizes piston-cylinder cleaning of CEC Primary Pressure Standards.

The filter, which is included with each new 6-201 basic assembly, attaches directly to the input pressure fitting. Furthermore, the filter assembly is available to all present 6-201 users for retrofit at a nominal cost.

For complete information, call or write for CEC Bulletin 6201-X7.

CEC

Transducer Division

CONSOLIDATED ELECTRODYNAMICS

A SUBSIDIARY OF BELL & HOWELL/PASADENA, CALIF. 91109
INTERNATIONAL SUBSIDIARIES: WOKING, SURREY, ENGLAND
AND FRIEDBERG (HESSEN), W. GERMANY

Texas Instruments Incorporated, Industrial Products Group Robinson-Gerrard Inc.	7
Texas Instruments Incorporated, Semiconductor Components Division Don L. Baxter Inc.	19
Thermal American Fused Quartz Company Kniep Associates	176
Transformer Electronics Company	202
Transitron Electronic Corporation Larcom Randall Adv. Inc.	115
■ Trylon Incorporated George Moll Adv. Inc.	188



■ Uniform Tubes Inc. The Michener Company Advertising Unitrode Corporation Electronic Marketing Assistance	134 31
---	-----------

Wells Electronics Inc. Weco Advertising	195
Western Transistor Corporation Alden Advertising of California Inc.	196
West Penn Power Company Fuller & Smith & Ross Inc.	190
Weston Instruments Incorporated Basford Inc.	199

Yagishita Electric Co. Ltd. Fuji Agency	203
--	-----

Classified Advertising

F. J. Eberle, Business Mgr.	
EMPLOYMENT OPPORTUNITIES EQUIPMENT (Used or Surplus New) For Sale	212-215 215-216

Advertisers Index

A & A Electronics Corp.	216
Ampex	215
Atomic Personnel Inc.	215
Corning Glass Works	214
Edmund Scientific Co.	215
Electro Gadget Supply	216
Electronic Communications Inc. Engineering Associates	214 216
Hamilton Standard Div. of United Aircraft	213
Marty's Mart	215
National Cash Reg. Co.	214
Norman Electronic Sales	216
Radio Corporation of America Inc.	214
Radio Research Instrument Co.	216
Sylvania Electronics Systems—West	212
Union Carbide Corporation	215

Advertising sales staff

Gordon Jones [212] 971-2210
Advertising sales manager

Atlanta, Ga. 30309: Gus H. Krimsier,
Michael H. Miller, 1375 Peachtree St. N.E.,
[404] TR 5-0523

Boston, Mass. 02116: William S. Hodgkinson
McGraw-Hill Building, Copley Square,
[617] CO 2-1160

Chicago, Ill. 60611: Robert M. Denmead,
J. Bradley MacKimm
645 North Michigan Avenue,
[312] MO 4-5800

Cleveland, Ohio 44113: Paul T. Fegley, 55
Public Square, [216] SU 1-7000

Dallas, Texas 75201: Richard P. Poole, The
Vaughn Building, 1712 Commerce Street,
[214] RI 7-9721

Denver, Colo. 80202: Joseph C. Page, David
M. Watson, Tower Bldg., 1700 Broadway,
[303] AL 5-2981

Houston, Texas 77025: Kenneth George,
2270 Humble Bldg.,
[713] CA 4-8381

Los Angeles, Calif. 90017: Ashley P.
Hartman, John G. Zisch, 1125 W. 6th St.,
[213] HU 2-5450

New York, N. Y. 10036:
Donald R. Furth [212] 971-3615
Frank LeBeau [212] 571-3615
George F. Werner [212] 971-3615
500 Fifth Avenue

Philadelphia, Pa. 19103: William J. Boyle,
Warren H. Gardner, 6 Penn Center Plaza,
[215] LO 8-6161

San Francisco, Calif. 94111:
James T. Hauptli, 255 California Street,
[415] DO 2-4600

London W1: John W. Patten, Edwin S.
Murphy Jr., 34 Dover Street,
Hyde Park 1451

Milan: 1, via
Baracchini Phone: 86-90-617

Frankfurt/Main: Gerd Hinske, 85
Westendstrasse Phone: 77 26 65 and
77 30 59

Geneva: Michael R. Zeynel, Joseph Wuensch,
2 Place du Port 244275

Paris VIII: Denis Jacob, 17 Avenue
Matignon ALMA-0452

Tokyo: Nobuyuki Sato
Shiba, Minato-Ku (502) 0656

Osaka: Kazutaka, Miura, 163, Umegee-cho,
Kilita-ku [362] 8771

Nagoya: International Media Representatives,
Yamagishi Bldg., 13, 2-Chome,
Oike-cho Naka-ku

Hugh J. Quinn: [212] 971-2335
Manager Electronics Buyers' Guide

David M. Tempest: [212] 971-3139
Promotion manager

Milton Drake: [212] 971-3485
Market research manager

Wallace C. Carmichael [212] 971-3191
Business manager

Theodore R. Geipel: [212] 971-2044
Production manager

■ For more information on complete product line see advertisement in the latest Electronics Buyers' Guide

Another Brush Innovation in Recording

The **Very** versatile
Brush
Mark 842.

For people who never know
what they'll be
recording next!

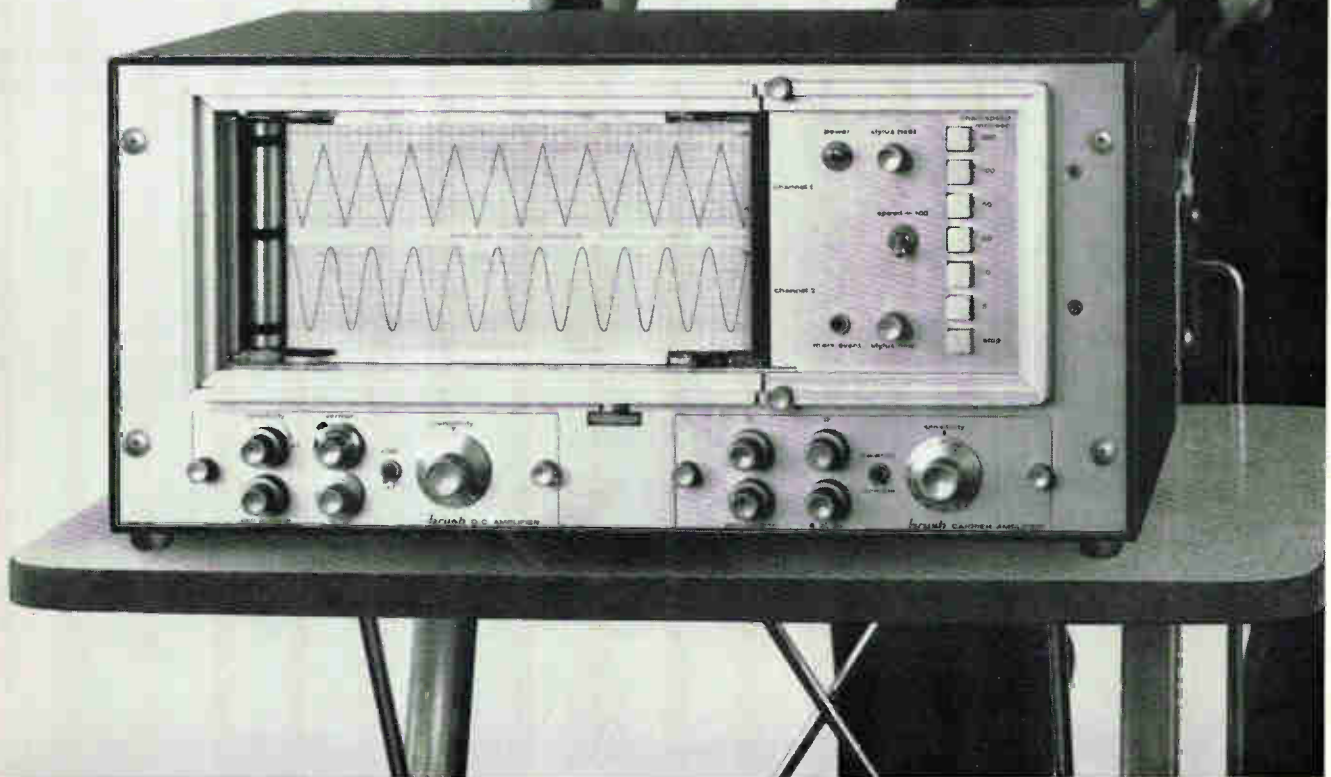

You know what we mean.

Recording requirements change. So it makes sense to buy a recorder you can change with them. Like the Brush Mark 842. See the two pre-amplifiers right below the display and controls? They're the interchangeable plug-in type. Brush gives you a choice of nine. Plus a pick of seven conversion couplers. And *any* mounting arrangement

you can think of. Lets you match the new Mark 842 to whatever recording job comes along. Great performance, too. Highest useable frequency response of *any* direct writing recorder . . . 75 cps full scale; flat to 150 cps at reduced amplitude. 1/2% Linearity. All solid state electronics. High torque penmotors. Rugged, crisp-writing styli to assure razor-sharp traces

of unmatched reproducibility. Pushbutton choice of 12 writing speeds. All yours in the clean, neat, easy-to-operate Mark 842. Built by Brush to meet your recording needs for years to come. Ask your local Brush Sales Engineer for a demonstration. A new brochure is yours for the asking. Brush Instruments Division, Clevite Corporation, 37th & Perkins, Cleveland, Ohio 44114.

brush INSTRUMENTS DIVISION

CLEVITE

Circle 901 on reader service card

Drive color-TV
picture tubes
*with ONLY TWO stages
of video amplification*

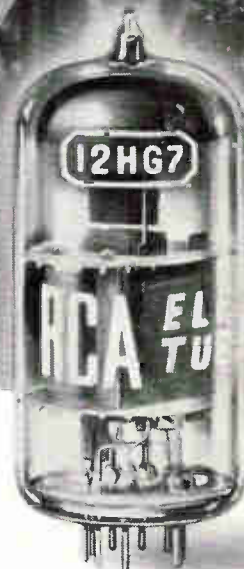

Now, you can eliminate one stage and reduce the number of components in your video-amplifier circuit with the new RCA-12HG7 COLOR-TV RECEIVING TUBE. This FRAME-GRID, Sharp-Cutoff Pentode offers these benefits to the circuit designer:

- high transconductance—32,000 μmhos —provided by the FRAME-GRID construction, permits you to drive the color-TV picture tube with only two stages of video amplification.
- high dissipation capability—10 watts (maximum) plate-dissipation rating eliminates the need for a series plate-circuit dropping resistor and its associated by-pass capacitor. Greater margin between maximum rating and usual operating values will contribute to greater reliability and longer life expectancy.
- high plate current "knee" characteristic—permits high output and good linearity over a "B" supply voltage range of 270 volts to 400 volts or more.
- RCA Dark Heater—reduces temperature and contributes to long life and dependable performance.

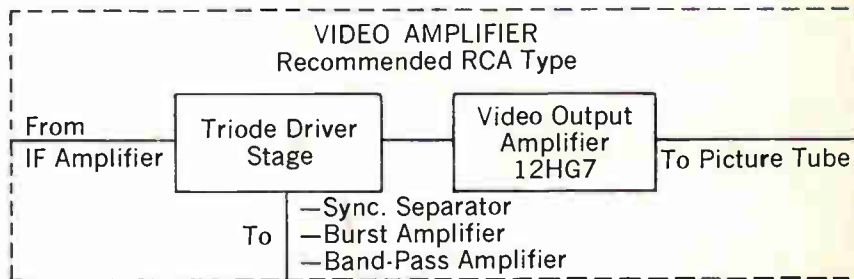

RCA's knowledge and experience in color television have led to the design and selection of tubes, such as the RCA-12HG7, which offer the color-TV set manufacturer the best combination of price, performance and reliability on the market today. For more information on the RCA-12HG7 and other RCA COLOR-TV RECEIVING TUBES, call your nearest RCA District Office or write RCA Commercial Engineering, Harrison, New Jersey 07029.

RCA ELECTRONIC COMPONENTS AND DEVICES, HARRISON, NEW JERSEY

RCA DISTRICT OFFICES—OEM SALES: EAST, 32 Green St., Newark, N. J. 07102, (201) 485-3900 • MID-ATLANTIC, 605 Marlton Pike, Haddonfield, N. J. 08034, (609) 428-4802 • MID-CENTRAL, 2511 East 46th St., Bldg. Q2, Atkinson Square, Indianapolis, Ind. 46205, (317) 546-4001 • CENTRAL, 446 East Howard Ave., Des Plaines, Ill. 60018, (312) 827-0033 • WEST, 6363 Sunset Blvd., Hollywood, Calif. 90028, (213) 461-9171 • INTERNATIONAL OPERATIONS, RCA International Division: Central and Terminal Aves., Clark, N. J. 07066, (201) 382-1000 • 118 Rue du Rhone, Geneva, Switzerland, 35 75 00.



The Most Trusted Name in Electronics