

electronics

engineering edition

**Magnetic Amplifier
Drives Indicator**

...p 114

**Calibrating Missile-
Test Camera**

...p 93



Billing Telephone Calls Automatically ...p 96

12 different -hp- oscillators

highest quality, outstanding value
complete coverage 0.008 cps to 10 MC
each designed to do a specific job best
stable RC circuit pioneered by -hp-



201C—designed for high quality audio tests. Covers 20 cps to 20 KC. Output 3 watts/42.5 volts. \$225.00



200J—extreme accuracy for interpolation and frequency measurements. Covers 6 cps to 6 KC, output 160 mw/10 volts; 20 volts open circuit. \$275.00



202C—replaces famous 202B for low frequency measurements 1 cps to 100 KC. Output 160 mw/10 volts; 20 volts open circuit. \$300.00



202A—for vibration analysis, servo tests, other jlf measurements. 0.008 to 1,200 cps. Output 20 mw/10 volts. \$465.00



200CD—popular precision instrument for audio and ultrasonic tests. 5 cps to 600 KC; output 160 mw/10 volts; 20 volts open circuit. \$160.00

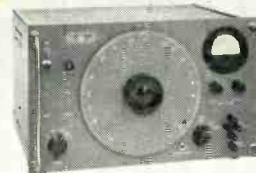

233A—carrier test oscillator covering frequencies 50 cps to 500 KC. Output 3 watts/600 ohms. \$475.00



650A—highly stable, wide band; 10 cps to 10 MC. For audio, supersonic, video, rf measurements. Output 15 mw/3 volts. Frequency response flat ± 1 db. \$490.00



200AB—for audio tests, 20 cps to 40 KC. Output 1 watt/24.5 volts. Simple to use, compact, rugged. \$130.00

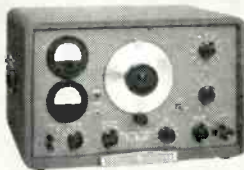

205AG—time-tested convenience for high power tests, gain measurements. 20 cps to 20 KC, 5 watts output. \$440.00

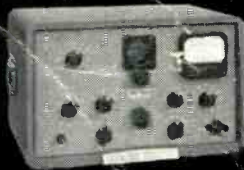

206A—widely-used for high quality, high accuracy audio tests. Very low distortion. Covers 20 cps to 2C KC, output ± 15 dbm. \$565.00



200T—custom-engineered for telemetry, carrier current tests. 250 cps to 100 KC, output 160 mw/10 volts; 20 volts open circuit. \$350.00



207A—low cost sweep oscillator, continuous output 20 cps to 20 KC, flat response, low distortion. May be mo or driven, or coupled to recorder. \$275.00

HEWLETT-PACKARD COMPANY

4056A Page Mill Road • Palo Alto, California, U.S.A.
Cable "HEWPACK" • Davenport 5-4451

Field engineers in all principal areas

— hp — at IRE
Top of escalators as you enter show

complete coverage, outstanding value

ISSUE AT A GLANCE

H. W. MATEER, *Publisher*

W. W. MacDONALD, *Editor*

Managing Editor, John M. Carroll.

Feature Editor, John Markus.

Associate Editors: John M. Kinn, Jr., Frank Leary, Michael F. Tomaino, Howard K. Janis, Sylvester P. Carter, Haig A. Manoogian, Roland J. Charest, Donald C. Hoefler, William P. O'Brien, George Sideris, Edward DeJongh, John F. Mason, Barry Miller, E. A. Scutari, William E. Bushor, Ronald K. Jurgen.

Pacific Coast Editor (Los Angeles) Harold C. Hood; *Midwestern Editor* (Chicago) Harold Harris; *New England Editor* (Boston) Thomas Maguire.

Art Director, Harry Phillips, Roy Thompsen.

Production Editor, John C. Wright, Jr. Bernice Duffy, Jean L. Matin.

Editorial Assistants: Gloria J. Filippone, Arlene Schilp, Noreen Hennessy, Phylis A. Cronin, Barbara Habermann.

JAMES GIRDWOOD, *Advertising Sales Manager*. R. S. Quint, *Assistant Advertising Sales Manager and Buyer's Guide Manager*. Fred Stewart, *Promotion Manager*. Frank H. Ward, *Business Manager*. George E. Pomeroy, *Classified Manager*. Jean Heiges, *Research*.
New York: Donald H. Miller, Henry M. Shaw, Martin J. Gallay, Boston: Wm. S. Hodgkinson. Philadelphia: James T. Hauptli. Chicago: Bruce Winner, Walter M. Luce. Cleveland: Warren H. Gardner. San Francisco: T. H. Carmody, R. C. Alcorn. Los Angeles: Carl W. Dysinger, D. A. McMillan. Denver: J. Patten. Atlanta: M. Miller. Dallas: Gordon L. Jones. London: Herbert Lagler.

Billing Telephone Calls Automatically. Electronic switching system handles subscriber lines, provides toll trunk. Magnetic drums, center, store toll information until disconnect. Then it is punched out on tape, left. See p 96. **COVER**

Business Briefs **p 7**

Electronics Newsletter	p 7	Analog Helps Design Autos	p 14
Figures of the Week	p 7	Military Electronics	p 14
Vanguard Gear in Explorer	p 8	Sound Waves Weld Seams	p 14
Data Gathering Goes This Way	p 8	Jets Boosting Computer Calls	p 16
Steady Measure of Cosmic Rays	p 8	Financial Roundup	p 16
For Discovering Temperatures	p 8	System Counts Press Runs	p 18
Two Systems Get Meteorite Facts	p 12	Meetings Ahead	p 18
Washington Outlook	p 12		

Diode Counter Calibrates Missile Testing Camera. Film speed of shutterless 35-mm camera for smear photography is calibrated in ft per sec by frequency tachometer with loaded-diode counter. **p 93**
By Samuel E. Dorsey

Digital System Bills Telephone Calls. Automatic message-registering system bills local and toll calls for phone company. **p 96**
By Raymond C. P. Hinton

Bar Chart Aids Tv Camera Focusing. Optimum electronic focus of tv cameras and film chains is effected by scanning chart and adjusting focus controls for maximum response of peaks on waveform monitor. **p 100**
By Glen Southworth

Intruder Alarm Uses Phase-Sensitive Detector. Pulsed-light and synchronous-demodulation burglar alarm system operates in all types of ambient light conditions **p 102**
By S. Bagno and J. Fasal

Transistorized P-A System Adjusts to Aircraft Noise. Aircraft passenger-address system uses single preamplifier and up to five adjustable power amplifiers for uniform audio distribution throughout cabin area. **p 106**
By J. M. Tewksbury

Print Timer Controls Density and Contrast. Electronic timer uses phantatron circuit to control both exposure time and contrast of photographic print **p 108**
By James D. Weir

Integrator-Amplifier for Core Measurements. Miller-type integrator, in conjunction with 80-db amplifier, provides quick and easy grading and matching of magnetic cores..... p 110
By Charles E. Goodell

Magnetic Amplifier Drives Gyro Indicator. Three-stage fast-response magnetic servo amplifier occupies only 22 cu in. in airborne gyroscope indicator p 114
By Clifford C. Voice

Crystal Oscillator Has Variable Frequency. Two-stage crystal oscillator with variable capacitor in series with crystal permits small variation of oscillation frequency p 118
By G. A. Gedney and G. M. Davidson

Radar System Planning. Performance is forecast on the basis of a hypothetical combination of operating conditions..... p 120
By Chester W. Young

Designing Stability Into Transistor Circuits. Charts and nomographs simplify circuit calculations necessary for stable transistor operation at elevated junction temperatures p 122
By Stanley Schenkerman

Electrons at Work..... p 126

Ion Trap Protects Cathode..... p 126 By W. R. Aiken and R. E. Heller	Flexible Light Source..... p 128
Circuit Tests Tube Capacitance... p 126 By Harvey L. Morgan	Missile Antenna Design..... p 131 By Howard Estep

Component Design p 136

Memory Meter Retains Reading... p 136	Liquid Filled Pots..... p 138
High Power Transistor Servo... p 136	Switch Withstands Vibration... p 140

Production Techniques p 142

Photolithography Makes Transistors p 142 By J. R. Nail and J. W. Lathrop	Flanges Feed Cutting Coolant... p 144
Design Trends p 142	Casting in Continuous Strips... p 145 By E. Natkins

New Products p 148

New Literature of the Week..... p 176

Plants and People..... p 178

News of Reps..... p 192

New Books p 194

Thumbnail Review p 198

Comment p 199

Index to Advertisers..... p 210

Published weekly, with alternating engineering and business editions, and with a BUYERS' GUIDE issue in mid-June, by McGraw-Hill Publishing Company, Inc., James H. McGraw (1860-1948) Founder.

Executive, Editorial, Circulation and Advertising Offices: McGraw-Hill Building, 330 W. 42 St., New York 36, N. Y.

Longacre-4-3000. Publication Office 99-129 North Broadway, Albany 1, N. Y. See panel below for directions regarding subscription on change of address. Donald C. McGraw, President; Joseph A. Gerardi, Executive Vice President; L. Keith Goodrich, Vice President and Treasurer; John J. Cooke, Secretary; Nelson Bond, Executive Vice President, Publications Division; Ralph B. Smith, Vice President and Editorial Director; Joseph H. Allen, Vice President and Director of Advertising Sales; A. R. Venezian, Vice President and Circulation Coordinator.

Single copies \$1.00 for Engineering Edition and 50¢ for Business Edition in United States and possessions, and Canada; \$2.00 and \$1.00 for all other foreign countries. Buyers' Guide \$3.00. Subscription rates—United States and possessions, \$6.00 a year; \$9.00 for two years; \$12.00 for three years. Canada, \$10.00 a year, \$16 for two years; \$20.00 for three years. All other countries \$20.00 a year, \$30.00 for two years; \$40.00 for three years. Three year rates, accepted on renewals only. Second class mail privileges authorized at Albany, N. Y. Printed in U.S.A. Copyright 1958 by McGraw-Hill Publishing Co., Inc.—All Rights Reserved. Title registered in U. S. Patent Office. BRANCH OFFICES: 520 North Michigan Avenue, Chicago 11; 68 Post Street, San Francisco 4; McGraw-Hill House, London E. C. 4; National Press Bldg., Washington, D. C. 4; Architects Bldg., 17th & Sansom Sts., Philadelphia 3; 1111 Henry W. Oliver Bldg., Pittsburgh 22; 1510 Hanna Bldg., Cleveland 15; 856 Penobscot Bldg., Detroit 26; 3615 Olive St., St. Louis 8; 350 Park Square Bldg., Boston 16; 1321 Rhodes Haverly Bldg., Atlanta 3; 1125 West Sixth St., Los Angeles 17; 1740 Broadway, Denver 2. ELECTRONICS is indexed regularly in The Engineering Index.

Subscriptions: Address correspondence to Subscription Manager, Electronics, 330 W. 42nd St., New York 36, N. Y. Allow one month for changes of address, stating old as well as new address. Subscriptions are solicited only from persons engaged in theory, research, design, production, management, maintenance and use of electronics and industrial control components, parts and products. Position and company connection must be indicated on subscription orders.

Postmaster: please send form 3579 to Electronics, 330 W. 42 St., New York 36, N. Y.



Member ABP and ABC



type 874



... the Best Buy in Coaxial Connectors

Quick Connect and Disconnect...

They plug smoothly into each other.
No twisting or threading is required.
Ideal for rapid changes in laboratory setups.

Identical Mates...

No male or female connectors.
Eliminates searches for mating plugs.



Positive Connection...

Strong friction grip provided
by multiple spring fingers for
uniform 50-ohm coaxial section.

Low VSWR...

Less than 1.05 up to 4000 Mc.



a Wide Variety of Adaptors...



874-QBJ and QBP

874-QCJ and QCP

874-QHJ and QHP

874-QLJ and QLP

874-QNP and QNJ

874-QUJ and QUP

... for both male and female versions of N, C, BNC, HN, LC, and UHF connectors.

Many Accessories...

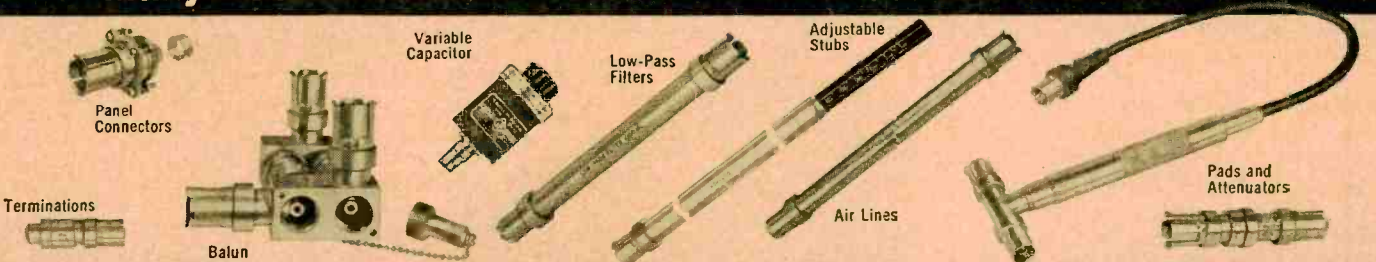

Panel Connectors

Variable Capacitor

Low-Pass Filters

Adjustable Stubs

Terminations

Balun

Air Lines

Pads and Attenuators

and Well-Integrated Measuring Instruments.

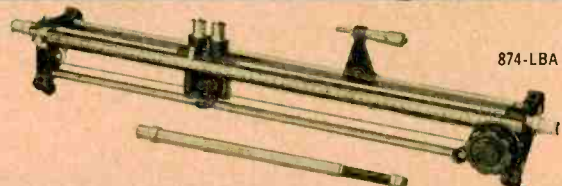

874-LBA Slotted Line



16Q2-B Admittance Meter

...and All at Low Cost Basic connector costs only \$1.25

GENERAL RADIO Company

275 Massachusetts Avenue, Cambridge 39, Mass., U.S.A.



Write for the G-R
VHF-UHF Bulletin.

All G-R Products
are now covered by a

2-Year Warranty

Broad Avenue at Linden, Ridgefield, N. J. NEW YORK AREA 1000 N. Seward St. LOS ANGELES 38
 8055 13th St. Silver Spring, Md. WASHINGTON, D. C. 1150 York Road, Abington, Pa. PHILADELPHIA
 1182 Los Altos Ave., Los Altos, Calif. SAN FRANCISCO 6605 W. North Ave., Oak Park, Ill. CHICAGO
 In CANADA: 99 Floral Parkway, TORONTO 15
 CIRCLE 62 READERS SERVICE CARD

TIMERS...SPECIAL DELIVERY

Standard or special— Industrial Timer makes rapid deliveries on all models

Sometimes you need a standard model timer . . . other times you need a special. Either way we can give you the extra rapid service you may need because of the efficient way we design, manufacture and stock timers for industrial applications.

To meet *all* of the widely varying needs of our customers we manufacture a complete line of timers in the four broad classifications illustrated here:

1. TIME DELAY TIMERS
2. INTERVAL TIMERS
3. RE-CYCLING TIMERS
4. RUNNING TIME METERS

From these we have already developed 20 basic types which can be combined in endless number of ways . . . to date, our engineers have combined them into over 1000 different models. So what might seem to be a special timer requirement to you, will very often be a standard timer in our large stock, and that is the reason we have the ability to fill special orders so quickly. And as far as standard timers are concerned we can give overnight service if necessary.

So, for the utmost in all-around service depend on us for this outstanding combination: deliveries "Immediate on Standards . . . First on Specials".

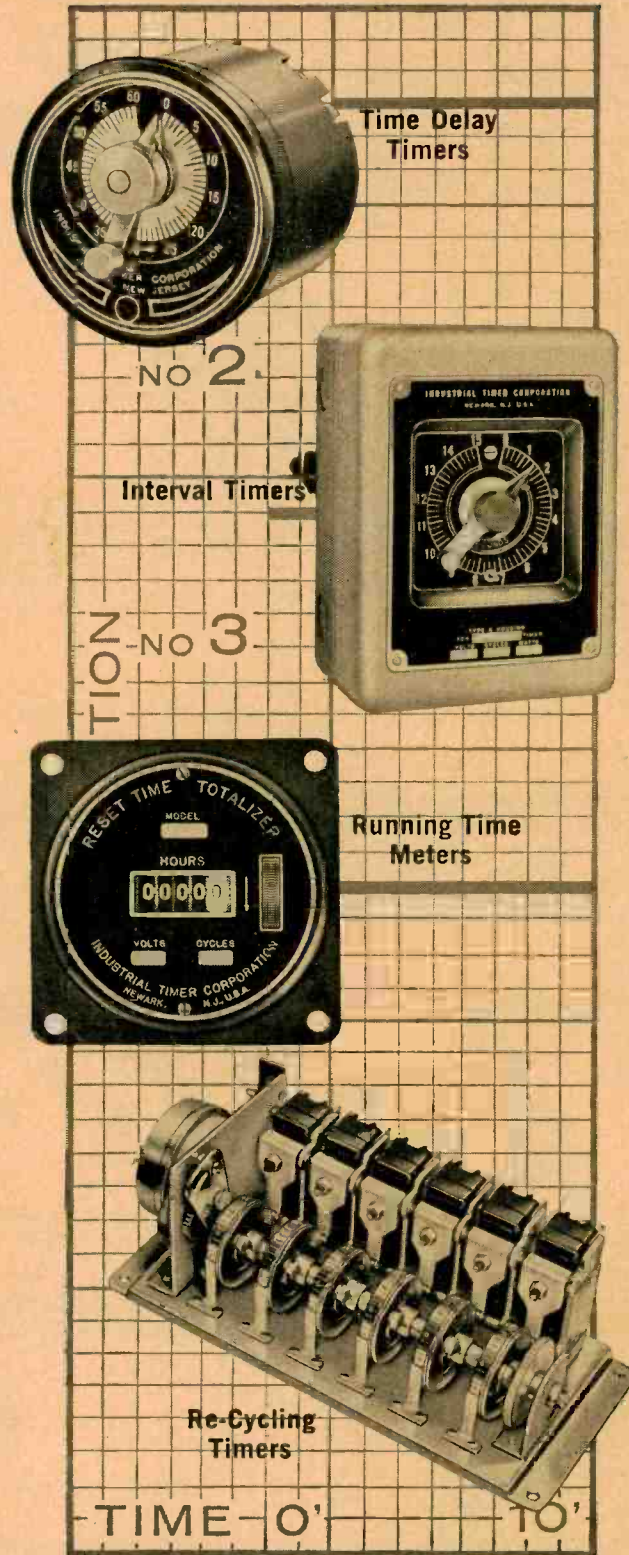

Speed up your automatic control projects — profit by our timing application experience

No need to let timing problems delay you in your automatic control projects when you can place them with us and get faster solutions. Even though no two automatic control jobs are ever exactly alike, and even though the timer requirements of each are very different we have established an excellent record in helping out in these situations.

20 years of experience in analyzing complex timer applications has provided us with the special knowledge required to give our customers the right answer in near-record time.

Our large stock of standard and combination timers enables us very often to fill orders for these requirements without any time loss because we have already developed so many new combinations specifically for automatic control functions.

Extra special automatic control timer — this calls for original designing. Our engineers will go right to work and get the job done. That's the way we grow and we like it.

Whatever your control problem, you have everything to gain by submitting it to our timer specialists. They'll come up with the answer — almost with the speed of automatic control itself.

*Timers that Control
the Pulse Beat of Industry*



INDUSTRIAL TIMER CORPORATION
1409 McCARTER HIGHWAY, NEWARK 4, N. J.

new

Transistorized Power Supplies



Model Q28-1

Model Q28-1

Output: 18 to 36 (28 nominal) VDC,
0 to 1 amp.

Regulation: $\pm 0.25\%$ for line and load
change combined

Ripple: 0.01% maximum

Response time: 50 microseconds

\$195 in cabinet

\$400 in dual rack mount

(illustrated)

Model Q6-2

Output: 4.5 to 8 (6 nominal) VDC,
0 to 2 amps.

Regulation: $\pm 0.25\%$ for line and load
change combined

Ripple: 0.02% maximum

Response time: 50 microseconds

\$165 in cabinet

LOW-VOLTAGE HIGH-CURRENT DC POWER SUPPLIES

with the PERFORMANCE of **ALL-TRANSISTOR CIRCUITRY**

DC sources of utmost reliability, minimum ripple, and very fast response —with nominal voltages of 6, 12, 28 volts at 0 to 4 amp output—all in lighter, *smaller* packages. And these new, compact power packs are fitted with the Zener diode reference circuit that assures the $\pm 0.25\%$ regulation accuracy and high stability. The 2 to 1 output voltage range gives these supplies an application range that is unsurpassed.

The all-transistor design provides the excellent ripple and response properties that rule out line and load transients. An exclusive protective circuit prevents short-circuit damage to the transistors. All models are low in cost, coming in single or dual rack mount, or in cabinets.

Full information on this important advance in low voltage, high current technology is now in print. Ask your Sorensen representative for full data, or let us mail it to you directly.

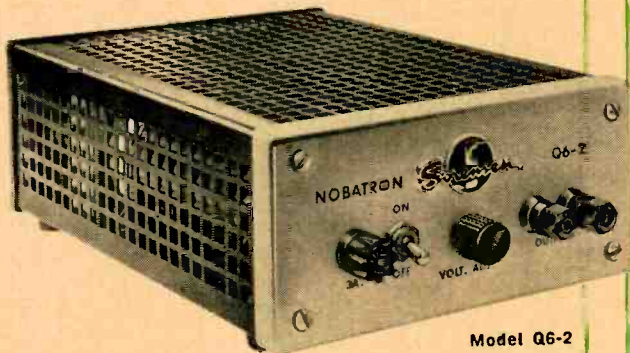

Model Q6-2



SORENSEN & COMPANY, Inc. Richards Avenue, South Norwalk, Connecticut

CONTROLLED POWER FOR
RESEARCH AND INDUSTRY



These RELIABLE COMPUTER TRANSISTORS

are:

- designed** for computer service
- made** for computer service
- tested** for computer service
- dependable** in computer service
- proved** in computer service

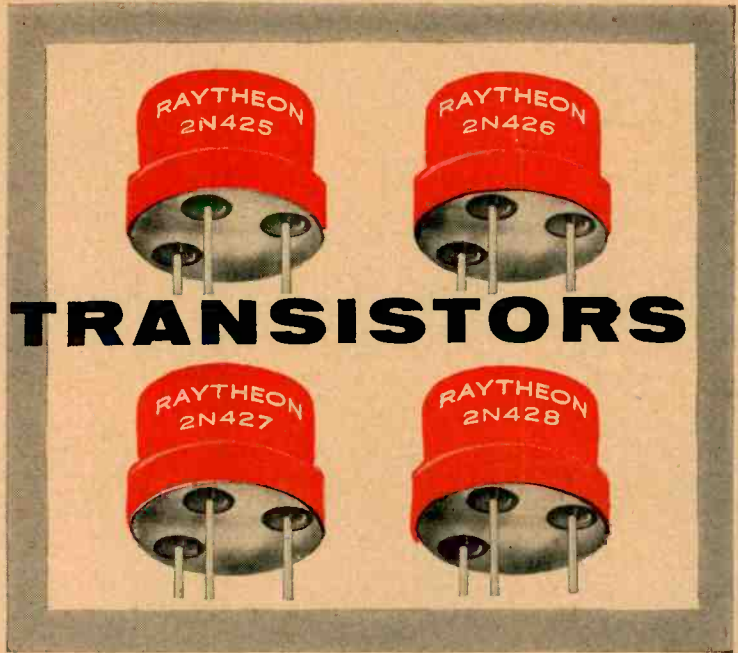

Raytheon Reliable Computer Transistors (PNP Germanium, in the JEDEC 30 package) are in good supply, and are available to the stringent requirements of new Signal Corps specifications, including electrical, mechanical and environmental tests.

Two hundred of these Transistors (fifty of each type) produced no failures and negligible characteristic change in thousand hour life tests equally divided between operation and storage. Here are typical results for 25 units, type 2N427:

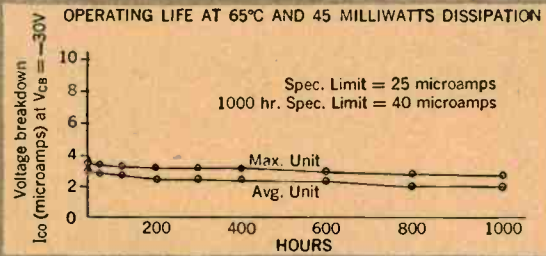
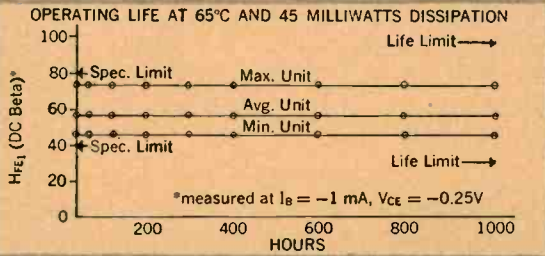

1000 hour storage life tests at 85°C are equally satisfactory

I_{CO} is measured at maximum rated collector-base voltage. Life tests for I_{CO} and I_{EO} demonstrate that the maximum ratings for V_{CB} and V_{EB} do not decrease with life. All other electrical characteristics important in computer applications are equally well controlled. In addition to the usual 25°C tests, H_{FE1} is controlled at -55°C and at +70°C while I_{CO} is also checked at +70°C.

In addition, all these Raytheon Computer Transistors measure up to such rigid MIL-T-19500A mechanical and environmental requirements as:

- LEAD SOLDER DIP TEST (par. 4.6.23)
- TEMPERATURE CYCLING: 5 cycles from -65°C to +160°C (par. 4.6.24)
- MOISTURE RESISTANCE: tests hermetic seal (par. 4.6.26)
- SHOCK: 500G (par. 4.6.28)

- CENTRIFUGE: 20,000G (par. 4.6.29)
- VIBRATION (Fatigue): 10G, 60 cycles (par. 4.6.30)
- VIBRATION (Noise) (par. 4.6.31)
- SALT SPRAY (Corrosion) (par. 4.6.35)
- LEAD FATIGUE (par. 4.6.36)

Type	V_{CB} max. volts	V_{CE} max. volts	$f_{\alpha b}$ ave. Mc	H_{FE1} ave. $I_b = 1$ ma $V_{CE} = -0.25$ V	H_{FE2} ave. $I_b = 10$ ma $V_{CE} = -0.35$ V	Rise Time* max. μ sec	Dissipation Coefficient	
							In Air °C/mw	In Sink °C/mw
2N425	-30	-20	4	30	18	1.0	0.4	0.18
2N426	-30	-18	6	40	24	0.55	0.4	0.18
2N427	-30	-15	11	55	30	0.44	0.4	0.18
2N428	-30	-12	17	80	40	0.33	0.4	0.18

* $I_c = 50$ ma; $I_b = 5$ ma; $R_i = 200 \Omega$; $I_b = 5$ ma; Grounded Emitter Circuit; $T = 25^\circ$ C

CHARACTERISTIC DATA AVAILABLE ON REQUEST



SEMICONDUCTOR DIVISION
Silicon and Germanium Diodes and Transistors • Silicon Rectifiers

- Newton, Mass.: 55 Chapel St., Bigelow 4-7500
- New York: 589 Fifth Ave., Plaza 9-3900
- Chicago: 9501 Grand Ave., Franklin Park, NAional 5-6130
- Los Angeles: 5236 Santa Monica Blvd., NORmandy 5-4221

ELECTRONICS NEWSLETTER

● Chief scientist of USAF ballistic missiles program, Simon Ramo, indicated last Thursday that advanced computers may be more important in a race for survival than space supremacy.

“Total brainpower,” Ramo told the AIEE winter general meeting in New York, will determine scientific progress. “That brainpower is not set just by the number of human brains in each nation, but rather how these brains are used and how they are supplemented by synthetic intelligence devices. I think we are ahead of the Russians today in the techniques that extend and make more useful each brain and each pair of eyes.”

● Still no word on who's to direct Defense Department's Advanced Research Projects Agency. Guided missile director Holaday is serving temporarily. Although Secretary McElroy has not yet spelled out agency's duties, strong fears have already been expressed such an agency might be too powerful.

Principal criticism of the proposed space agency is that it might tend to play down the peaceful aspects of space research, concentrate only on anti-missile missile and other military work. Many believe the two should be separated. Sen. Clinton P. Anderson (D., N.M.) and Rep. Carl T. Durham, (D., N.C.), for example, want the Atomic Energy Commission to have authority over a space-for-peace program. They

have introduced legislation to this effect.

Then there is support also for the thesis of the National Advisory Committee for Aeronautics, which wants to engage in a “cooperative effort” with the Defense Department, National Science Foundation and National Academy of Sciences. NACA is concerned lest the need for space research for peaceful purposes becomes “submerged” from the public view.

● American-Soviet accord providing for exchanges of technicians, teachers and others, appears to stay clear of electronics. Iron and steel, iron ore mining and plastics are among the industries singled out.

Agreement also calls for reciprocal visits by scientists, but does not spell out any specific fields. These details will be settled in Moscow this year by the presidents of the National Academy of Sciences of the U. S. and the Soviet Academy of Sciences. Individual and group exchanges are in addition to attendance by U. S. and Russian scientists at international conferences in both countries.

● Defense Department is up in the air on atomic planes. Joint Congressional Atomic Energy subcommittee's hearing of Deputy Defense Secretary Quarles has been postponed until the middle of this month at the department's request to allow more time for a decision on how to proceed.

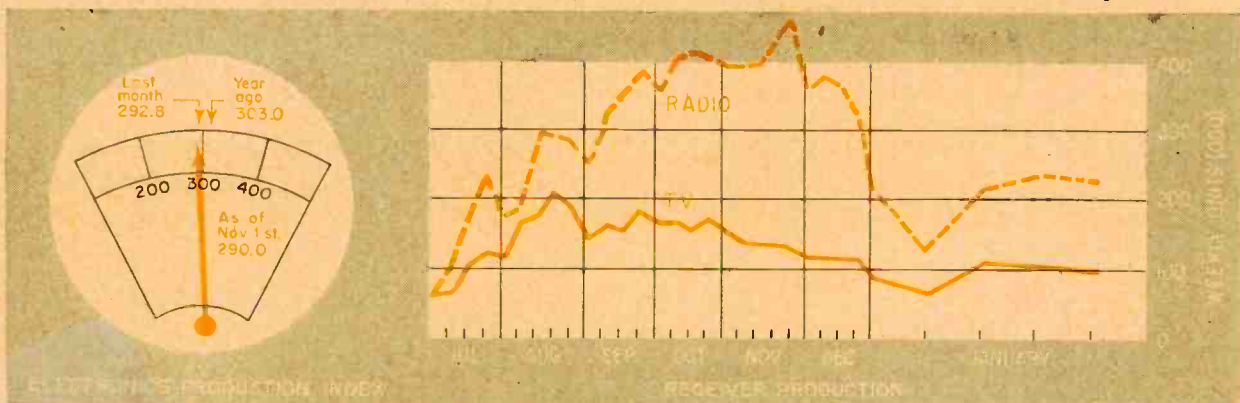

FIGURES OF THE WEEK

RECEIVER PRODUCTION

(Source: EIA)	Jan. 24, '58	Jan. 17, '58	Jan. 25, '57
Television sets, total	103,444	108,806	111,921
Radio sets, total	232,845	239,133	302,863
Auto sets	80,036	79,578	147,948

STOCK PRICE AVERAGES

(Source: Standard & Poor's)	Jan. 29, '58	Jan. 22, '58	Jan. 30, '57
Radio-tv & electronics	46.14	44.92	47.38
Radio broadcasters	59.08	58.25	63.06

FIGURES OF THE YEAR

	1957	1956	Percent Change
Receiving tube sales	428,638,000	429,846,000	- 0.3
Transistor production	25,965,000	11,232,000	+131.2
Cathode-ray tube sales	9,076,982	10,191,545	- 10.9
Television set production	5,825,404	6,760,045	- 13.8
Radio set production	13,634,402	12,266,591	+ 11.2

LATEST MONTHLY FIGURES

EMPLOYMENT AND PAYROLLS

(Source: Bur. Labor Statistics)	Oct. '57	Sept. '57	Oct. '56
Prod. workers, comm. equip.	412,000-p	417,900-r	413,100
Av. wkly. earnings, comm.	\$76.44 -p	\$78.40 -r	\$78.12
Av. wkly. earnings, radio	\$74.40 -p	\$76.02 -r	\$75.70
Av. wkly. hours, comm. ...	39.0 -p	40.0 -r	40.9
Av. wkly. hours, radio ...	39.0 -p	39.8 -r	40.7

TRANSISTOR SALES

(Source: EIA)	Nov. '57	Oct. '57	Nov. '56
Unit sales	3,578,700	3,544,000	1,829,000
Value	\$6,989,000	\$7,075,000	\$5,559,000

TUBE SALES

(Source: EIA)	Nov. '57	Oct. '57	Nov. '56
Receiving tubes, units	39,950,000	47,075,000	39,489,000
Receiving tubes, value	\$33,166,000	\$38,421,000	\$31,476,000
Picture tubes, units	772,801	995,629	957,765
Picture tubes, value	\$15,138,438	\$19,495,574	\$16,014,839

Vanguard Gear In Explorer

Army's globe-circling satellite carries Navy circuits. Here's a roundup of electronics' role as U. S. moon parade begins



Explorer I's instruments (left) get a final checkup before roaring aloft. In artist's sketch (right) instrumentation in the earth-circling U. S. satellite is identified.

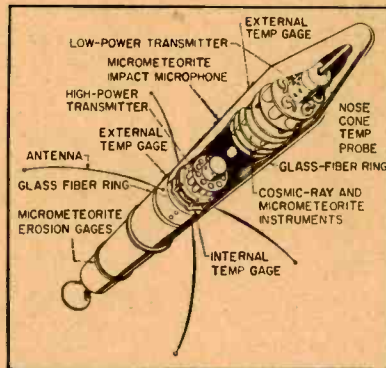

FIRST of Army's satellites, Explorer I, is carrying out the intended mission of Navy's second satellite, using measurement circuitry originally planned for Vanguard II, ELECTRONICS learns.

Circuitry, developed for the spherical Vanguard II by Air Force Cambridge Research Center and the State University of Iowa, has been modified to fit into its new javelin-like Army carrier by Jet Propulsion Labs.

Carried aloft by a Chrysler-built Jupiter-C, guided by Ford Instrument's inertial system, the satellite, locked to its final stage rocket, is 79 in. long and 6 in. in diameter. Total weight is 30.8 lb. The satellite itself is 30 in. long, weighs 18.13 lb. Instrumentation weighs 11 lb.

Explorer I is investigating three areas: cosmic rays, density and size of micrometeorites, and temperatures both inside and outside the satellite's shell. (Mission for Explorer II is the same, though a different telemetering technique is employed.)

As for Vanguard satellites, plans now call for firing four of the originally-scheduled five 20 in. spheres. Officials say Vanguard II will be skipped, since Explorer I is performing its duties. Vanguard I is primarily concerned with ultra-violet radiation.

... For Measuring Temperatures ...

LOS ANGELES—CAL TECH's Jet Propulsion Labs' major contribution was putting the satellite together. It was also responsible for the temperature sensing devices both inside and outside the shell.

Explorer I has two transmitters, each powered by its own batteries (Explorer II is designed for one transmitter. A tape recorder is carried to store data that can be telemetered in a short burst when queried.) Explorer I details:

(1) Frequency — 108.00 mc; power—10 milliwatts; expected life two months, data transmitted—skin temperatures on forward area, nose cone during launching, cosmic rays, micrometeorites.

(2) Frequency — 108.03 mc; power—60 milliwatts; expected life—two weeks; data transmitted—skin temp on rear area, internal temp, cosmic rays, micrometeorites.

External skin temperatures are expected to range from -100°C to $+140^{\circ}\text{C}$. To maintain an average inside temperature of from 0 to 50°C , the forward area of the satellite shell is partially covered with 8 strips of zirconium oxide, each $\frac{1}{4}$ in. wide. Also, an insulating space exists between the outer skin of the shell and the glass fiber that

surrounds the instruments.

The entire electronic package was tested to withstand up to 100 G's.

... Getting Data This Way ...

WASHINGTON—PROCEDURE for tracking and calculating Explorer I's orbit is the same as set up for Vanguard and later used for the two Soviet Sputniks.

Twelve Minitrack stations send in position reports to the Naval Research Laboratory. Position data culled for reliability is sent on by NRL to the IBM Computing Center. A 704 computer calculates and forecasts the satellite's orbit.

Experiment data are recorded on magnetic tapes at the Minitrack stations and also at six Microlock tracking stations around the world. Tapes are then sent to Jet Propulsion Labs in Los Angeles and to IGY headquarters in Washington. Data from all experiments are recorded and forwarded to the corresponding sponsoring agency.

... Counting Cosmic Rays ...

IOWA CITY, IOWA—DATA on cosmic rays are being received by the State University of Iowa's James A. Van Allen. A continuous cosmic ray count is measured by a Geiger counter and telemetered by both transmitters.

Total count of cosmic rays hitting the Geiger counter has been scaled down by 32 so that each unit of the 32 cosmic ray count will cause a step change in frequency. Average counting rate produces approximately 32 pulses a second, which causes a frequency change once each second.

The system is capable of transmitting cosmic ray information at 40 times the normal rate if such activity occurs during intense solar or magnetic storms.

Explorer II carries the same equipment.

First cosmic ray data—showing 20 counts per second—came from

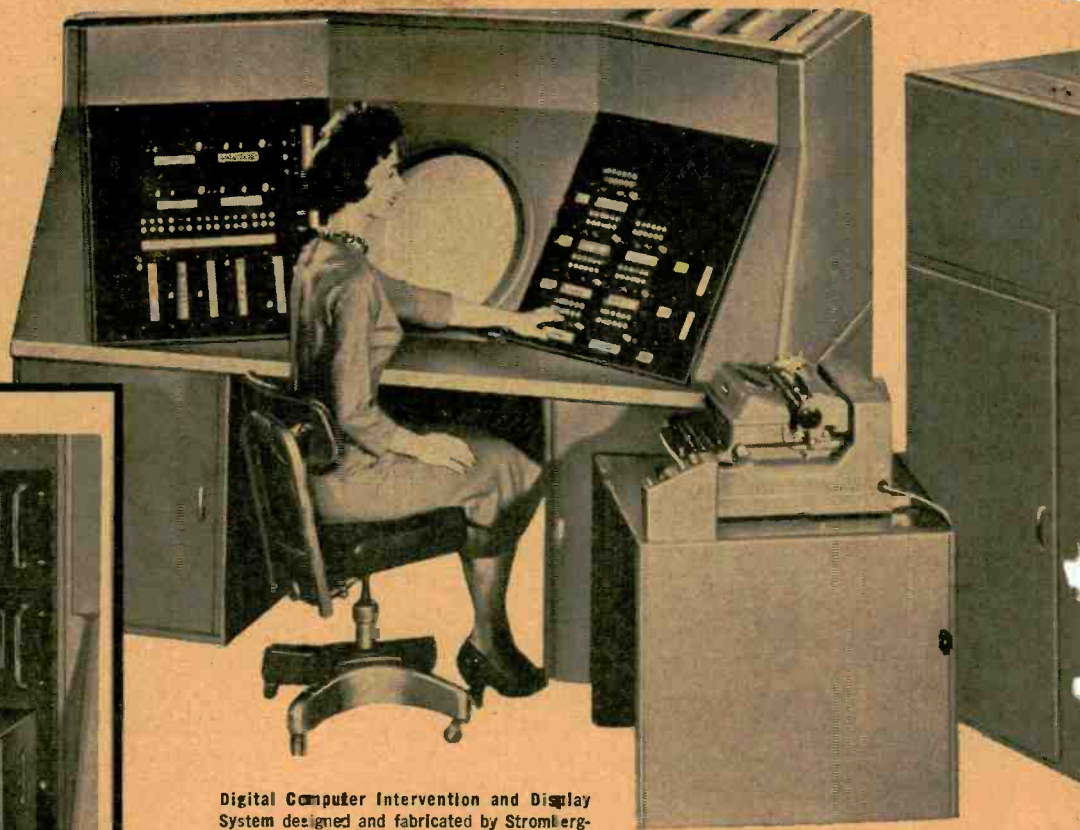

Digital Computer Intervention and Display System designed and fabricated by Stromberg-Carlson Company, a Division of General Dynamics Corporation, for the Air Proving Ground Center (ARDC) Armament Division, Eglin Air Force Base. The system is built around the CHARACTRON® Shaped Beam Tube, designed by Stromberg-Carlson for high-speed information display and micro-film recording.

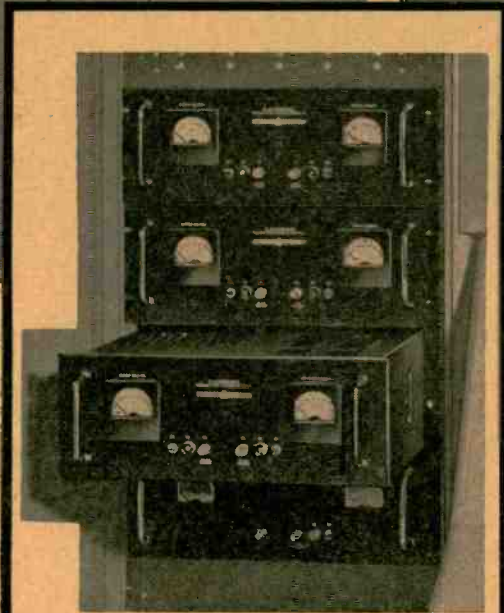

C-800 Lambda Com-Pak Power Supplies used in the Eglin Air Force Base installation require only 7" front panel height.

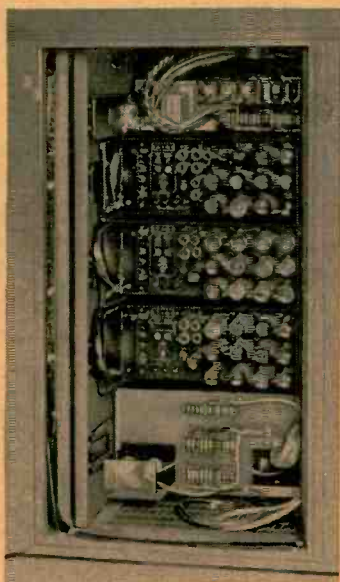

Easy servicing. All wiring, tubes and other components are readily accessible. You can reach them easily, service them fast.

COM-PAK® SUPPLIES SAVE PANEL SPACE

Models through 1.5 amperes

Three voltage ranges: 0-200, 125-325, 525-525 VDC

- C-200 series— 200 MA—5¼" panel height—from \$159.50
- C-400 series— 400 MA—5¼" panel height—from 244.50
- C-800 series— 800 MA—7" panel height—from 315.00
- C-1500 series—1500 MA—8¾" panel height—from 550.00

Where power supply dependability is vital

Stromberg-Carlson specifies standard Lambda power supplies for Air Force Digital Computer Intervention & Display System

Standard Lambda power supplies are components of the Digital Computer Intervention and Display System associated with the UNIVAC Scientific Computer at the Air Proving Ground Center (ARDC) Armament Division, Eglin Air Force Base, Florida.

Available for immediate delivery, Lambda power supplies from stock are being used in major rocket and missile programs, among other military projects. They are specified also for more industrial and research applications than the ten next-most-popular makes combined.

Send for the current Lambda catalog. It covers the complete new Com-Pak series, as well as other rack, bench and portable models, for all needs through 1.5 amperes.



LAMBDA Electronics Corp.

11-11 131 STREET • COLLEGE POINT 56, NEW YORK
INDEPENDENCE 1-8500 Cable Address: Lambdatron, New York

*CHARACTRON is a trade-mark of Stromberg-Carlson, a Division of General Dynamics Corporation, registered in the U.S. Patent Office.

CIRCLE 73 READERS SERVICE CARD

ENGINEERING REPORT

A Case History of Environmental Control

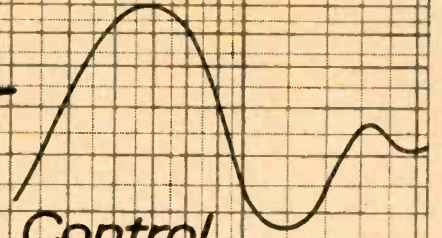

PROBLEM

**VIBRATION • SHOCK
AND COOLING**

GUIDED MISSILE RELIABILITY

PROTECTION OF FUEL CONTROL EQUIPMENT from destructive vibration and shock in high temperature propulsion section of IRBM missiles.

SOLUTION

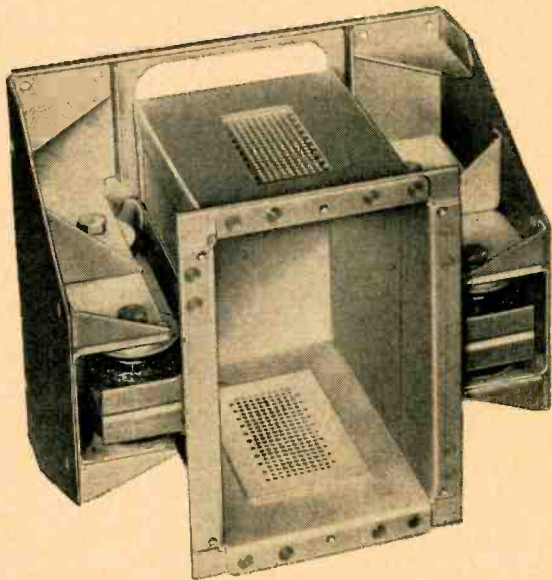

MODEL 1322 FOR REDSTONE AND JUPITER MISSILES developed and produced in quantity for Redstone Arsenal and Chrysler Corporation.

ENGINEERED MOUNTING SYSTEM MODEL 1322:

Robinson Model 1322 is a center-of-gravity all-metal mounting. Providing consistent performance regardless of high or low temperature extremes, this design incorporates highly damped Met-L-Flex resilient elements. All-attitude, multi-directional protection is assured.

SPECIAL FEATURES:

1. Ventilation screens at top and bottom of mounting enclosure allow the flow of cooling air, thereby extending the range of environmental protection.
2. Versatile mounting design facilitates adaptation to a wide range of components of varying dimensions.

PERFORMANCE:

Model 1322 protects against the rugged environment in the propulsion section of large rocket-type missiles. **Vibration, shock and acceleration forces** are controlled by the mounting system through a careful combination of spring rate and damping design characteristics. Natural frequency of model shown is 16 c.p.s. for an impressed excursion of .060 ins. and equipment weight of 8 lbs.

RESULT:

Adequate protection provided and reliability accomplished for vital elements of fuel control equipment through a light-weight standardized mounting system design. (Approximately six (6) systems installed in each Jupiter missile.)

ROBINSON

AVIATION, INC.

Teterboro, New Jersey

West Coast Engineering Office, Santa Monica, California

ROBINSON CONTROL IS RELIABILITY CONTROL

an observation 300 miles over New Mexico.

... Systems Get Meteor Facts ...

BOSTON—DATA on the size and density of micrometeorites are being studied at the Geophysics Research Directorate, Air Force Cambridge Research Center.

Explorer I uses two systems to get the data: grid detectors that determine density, and an acoustic system that detects size as well as density. They were developed respectively by Edward Manning and Maurice Dubin.

(1) Density: 12 grids are arranged on an insulated ring that goes around the aft, outside portion of the satellite, flush with the skin. Each grid has a total surface of one sq cm and consists of 500 windings.

When a micrometeorite larger than 1/100,000 in. smashes into it, the continuous filament breaks. This causes a small increase in frequency in the low-power transmitter.

Since the surface area of each grid is known, the number of collisions that strike during any certain time indicates, by arithmetic, the density of meteoritic particles in the space through which the satellite has moved. (Four grids were broken immediately after launching. Whether due to launching shock or to micrometeorites can best be judged later by what happens to the remaining eight.) System weighs 10 oz.

(2) Density and size: The 16-oz acoustical detector consists of a crystal microphone mounted against the skin of the satellite and connected to an amplifier and scaler. The microphone is in spring contact with the outer shell of the satellite.

When a particle of sufficient size and momentum hits the shell, the amplified pulse actuates the scaler. Output of the scaler controls the frequency of one telemetry channel of the high-power transmitter. When frequency changes from low to high it means the satellite has hit a large particle.

The device is capable of detecting a wide range of particle sizes

WASHINGTON OUTLOOK

A NEW TREND in weapon development and production has gently started. It could put more small and medium-sized firms in the running for prime defense contracts for important new weapons systems.

Idea involves organizing a team of specialty companies to make a joint bid on a systems contract. So far, the Air Force has awarded two such development contracts:

Stavid Engineering, Inc., last July was awarded a phase-one prime contract for development of a defensive antimissile system, project DAMS (ELECTRONICS, Nov. 20, '57). Stavid is both the system contractor and the electronic specialist on the project. Its team members—they are not subcontractors in the conventional sense—are Olin Mathieson Chemical Corp., Bausch & Lomb Optical Co. and United Shoe Machinery Co. Last December, the team—in Stavid's name—was awarded a phase-two contract for more advanced development work.

Last month, Hoffman Electronics Corp. (ELECTRONICS, Nov. 10, '57) was awarded an \$11-million prime contract to develop a complete airborne electronic reconnaissance system known as Tall Tom. Its team members: Stanford Research Institute, Sanders Associates, Cornell Aeronautical Lab., Filtron Co., Inc., Radiation, Inc., Siegler Corp.'s Olympic Radio & Television div., and Lockheed Aircraft Services, Inc.

In Stavid's case, the electronics company negotiated with the Air Force for the group, and assumed complete responsibility for performance on the contract. Among themselves, however, the four companies agreed that each was to have an equal say in the management of the overall project.

● The Pentagon has made what many observers consider a puzzling decision on how to run the anti-ICBM defense project. Defense Secy. McElroy has divided responsibility on the project between the Air Force and Army.

To the Air Force goes responsibility for developing early warning and defense acquisition radars and data handling equipment. To the Army goes responsibility for working on the missile itself, the launching system and target tracking radars.

Up to now, the two services have each backed up a complete anti-ICBM system: the Army, the Nike Zeus under development by Western Electric and Douglas Aircraft; the Air Force, the Wizard under development by RCA and General Dynamics' Convair div.

The Nike Zeus project got started earlier, as an outgrowth of the two operational Nike Ajax and Nike Hercules air defense systems. The project's head start over Wizard is considered the basic reason for McElroy's new decision.

Some critics—notably Air Force partisans—question the advisability of separating the two functions, argue that this will slow down development of a total anti-ICBM defense system. Indeed, some observers look at the decision as an interim one which will be more fully resolved when the Defense Dept.'s new Advanced Research Projects Agency opens shop. ARPA has been delegated responsibility for the project, but has yet to start operations as an agency independent of the military services. Service opposition—plus some unanticipated and unfavorable Congressional reaction—have delayed ARPA's official organization.

UNIT RECTIFIERS

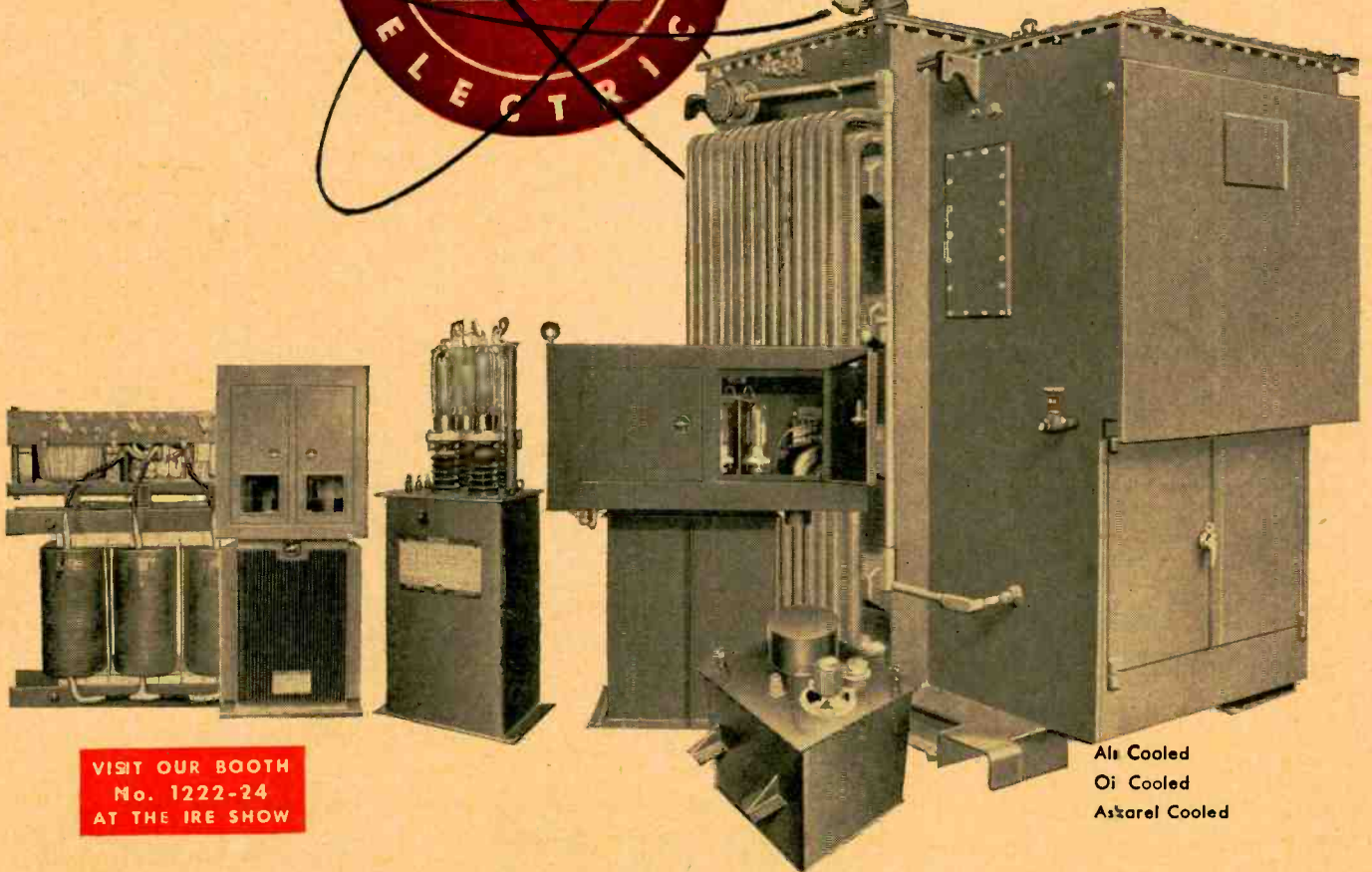

VISIT OUR BOOTH
No. 1222-24
AT THE IRE SHOW

Alc Cooled
Oi Cooled
Astarel Cooled

... meet all essential requirements of AC to DC voltage conversion:

Moloney's advanced design means:

Reduced Weight • Easier Handling • Versatile Installation.

You save engineering time and transmitter cabinet space . . . and you save the cost of individual rectifier components with Moloney Unit Rectifiers.

Moloney Unit Rectifiers are available with vacuum tube, gas tube, or dry-plate rectifier elements. DC ratings from 2 KW through 10,000 KW and up — voltages of 1 KV through 250 KV and up — frequencies from 25 through 400 cycles and other special frequencies — and optional automatic or manual load-tap-changing equipment. *Specify Moloney.*

ME86-20



Write for Catalog SR 208 "HyperCares for Magnetic Components" and Catalog ST 3506 "Magnetic Components for Electronic Applications."

M O L O N E Y E L E C T R I C C O M P A N Y

Plate and Filament Transformers • Chokes • Unit Rectifiers • Modulation Transformers and Reactors • Pulse Transformers and Charging Chokes • HyperCares for Magnetic Components Developmental Magnetic Components • Power and Distribution Transformers

SALES OFFICES IN ALL PRINCIPAL CITIES • FACTORIES AT 5390 BIRCHER BLVD., ST. LOUIS 20, MO., AND TORONTO, ONT., CANADA

ELECTRONICS engineering edition — February 14, 1958

CIRCLE 76 READERS SERVICE CARD

13

of moderate density, almost down to the size at which cosmic or meteoric dust is blown out of the solar system by radiation pressure—one micron.

When Vanguard, which failed again Feb. 5, does go up, it will transmit on the same frequencies as Explorer. No confusion is expected, since the satellites' orbits will differ.



Corrective driving motions introduced through steering wheel to computer (left) cause miniature car on simulator (right) to give immediate visual indication of vehicle response as . . .

Analog Helps Design Autos

RESPONSE CHARACTERISTICS of steering and control systems for automobiles are now studied before the actual design phase begins. Technique using an analog computer resembles, in principle, that used by aircraft designers who fly synthetic airplanes mathematically.

The new device, developed by GM's research staff, simulates an auto moving down a highway.

Equations representing lateral vehicular motion have been developed. They mathematically describe entire steering or handling system response to driver reactions.

Continuous solution of the equations is effected by the analog computer for any steering wheel input parameters. The computer is linked to an automobile handling simulator which controls a miniature car through a servomechanism system.

Cars of different weight distribution, suspension properties, wheel bases or tire characteristics can be accommodated by adjustment of controls on the computer.

MILITARY ELECTRONICS

- Prevailing atmosphere among industry and government officials at New York's Institute of the Aeronautical Sciences' 26th Annual Meeting was impatience to get on with the big push ahead. Tempering this, however, was the healthy attitude that red-tape delays could be put to good use. Initial planning could be restudied for possible improvement.

- Electronic countermeasure equipment for Boeing's B-52 long-range bomber is described as "revolutionary" by USAF Gen. Levine. Sperry is ECM weapon system manager, responsible for development and production.

- Digital fire control computers for Minneapolis-Honeywell's anti-submarine rocket ASROC (ELECTRONICS, Dec. 1, '57) will be built by Librascope under \$12-million Navy contract.

- Electronic reconnaissance system, designated Tall Tom (AN/ALD-3), will be engineered by Hoffman Electronics under \$11

million USAF contract. Tall Tom will detect, record and examine transmissions over a wide range of frequencies. Data collected will be processed through computers for further analysis. Seven associate companies in the project are: Cornell Aeronautical Labs, Filtron, Lockheed Aircraft Services, Olympic Radio & Television div. of Siegler, Radiation, Sanders Associates and Stanford Research Institute.

- An aid to electronic countermeasures, utilizing a single-gun recording storage tube with search radar, has been developed by Raytheon. The system enables the operator to emit radiation for a single antenna rotation but retain the picture for up to ten minutes. Besides being a problem for enemy countermeasure receivers, the system has a navigational advantage. Instead of taking an airborne fix on constantly moving ground objects, the navigator gets a stationary ground picture related to a split second in time.

Sound Waves Weld Seams

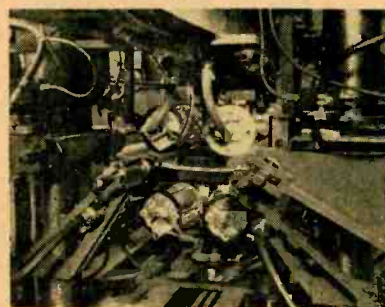
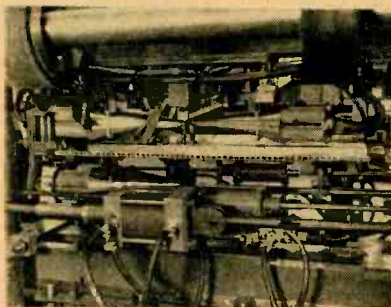

Corrugated aluminum foil is welded to 30-in. wide aluminum extrusion by interface molecular fusion. Close-up shows transducers and acoustic horns

AN AUTOMATICALLY-CONTROLLED ultrasonic continuous seam welder which welds aluminum to aluminum and other metals has been developed by Gulton Industries.

The 3-ton machine cold-welds heavy corrugated aluminum foil to both sides of a 30 inches wide semi-circular extrusion needed for a classified government project. It can weld on 11 different radii.

Four seams are welded simul-

taneously by eight welding heads. Rate of travel, 50 inches a minute, totals 200 inches a minute. The performance is considered similar to hot welders.

The first machine cost over \$100,000 to develop. Gulton expects subsequent models to cost around \$15,000, including \$7,000 to \$8,000 for ultrasonic generators and welding heads.

A wide market is seen—not in

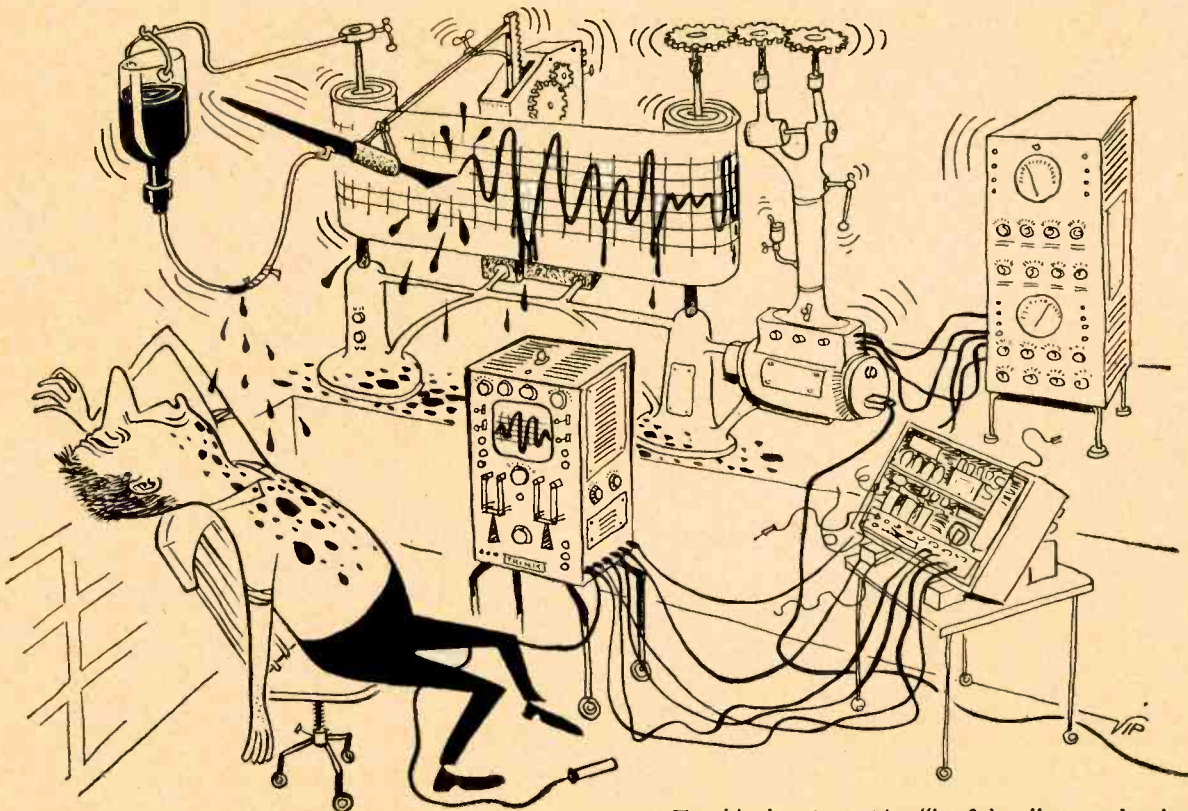

PROBLEM: Trouble Shooting

Trouble shooting with a "beefed-up" pen and stylus recorder can cause as much trouble as the original malady—thereby compounding the felony. Also, conventional recorders cannot capture high-frequency transients because of comparatively slow response.

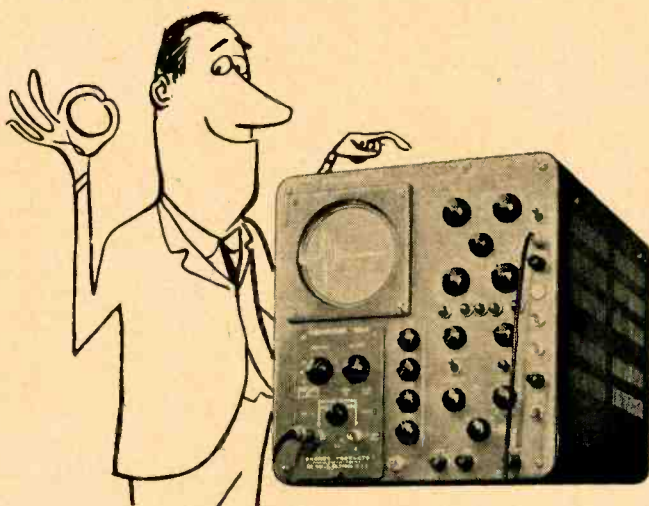

SOLUTION: The Hughes MEMO-SCOPE® Oscilloscope can instantly "freeze" any number of selected traces. A storage type oscilloscope, it retains displays brilliantly *until intentionally erased*. Faithful reproduction of transients is assured always... for the electron beam has no appreciable weight, as opposed to the mass of mechanical recorder movement.

HUGHES MEMO-SCOPE OSCILLOSCOPE

STORAGE TUBE—5-inch diameter Memotron® Direct Display Cathode Ray Storage Tube. Writing speed for storage: 125,000 inches per second. The optional Speed Enhancement Feature multiplies writing speed approximately four times.

OPTIONAL PREAMPLIFIER EQUIPMENT—High Sensitivity, Differential Input, Type HS/6: 1 millivolt to 50 volts per division. Dual Trace Type WB/DI/11: 10 millivolts to 50 volts per division. Four independent positions may be selected for single or double channel performance and chopped or alternate sweeps.

We are sure you will want to see this "transient recorder with a memory" in action. A Hughes representative in your local area will arrange a demonstration in your company. Please write now to:

HUGHES PRODUCTS MEMO-SCOPE Oscilloscope
International Airport Station, Los Angeles 45, California

Creating a new world with ELECTRONICS

HUGHES PRODUCTS

competition with other welding methods, but with manufacturers who have not been using aluminum because of joining difficulties.

Ultrasonic power is supplied by 2 2-kw generators which operate alternately as the heads move back and forth. Each head receives 500 watts. The heads consist of 4 solid barium titanate transducers, a horn which amplifies the vibrations and a welding tool fixed at right angles to the horn.

To keep the heads and workpiece acoustically tuned, barium titanate accelerometers are mounted on each horn. The feedback signal is proportional to the strength of the vibrations. The generators are designed to hunt for the maximum signal strength.

Jets Boosting Computer Calls

RECENT entry into the commercial jet field by major flight simulator manufacturers has provided a growing market for high quality electronic components. With the commercial jet age bowing in with a sonic boom, the world's airlines are leaning heavily on flight simulators to train their crews in the

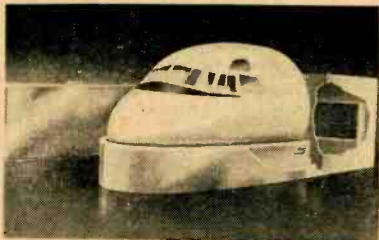

Artist's concept of Link's forthcoming Lockheed Electra simulator. Cockpit is exact replica of the actual plane

complexities of high-speed jet flight.

Basically a giant analog computer, the simulator employs thousands of vacuum tubes, precision potentiometers, servo motors and relays to realistically reproduce most of the conditions of flight in an authentic environment on the ground.

Long used by the military and the airlines to avoid the expensive and often fatal consequences of a "goof" on training flights, the com-

FINANCIAL ROUNDUP

- **Norden-Ketay**, electronic systems designer of Stamford, Conn., and **Solar Aircraft** of San Diego, Calif., announce merger plans subject to stockholder approval. Proposed plan calls for exchange of 230,000 shares of Solar common stock for all of the 1,293,193 Norden-Ketay shares outstanding. The exchange ratio would be about one share of Solar for each 5.62 shares of Norden-Ketay.

Solar is a major designer and maker of aircraft and missile engine assemblies, airframe components, small gas turbine engines and expansion joints.

Hard-hit by loss of government contracts last fall and the resulting drain on working capital, Norden-Ketay management was forced to seek additional capital funds in order to preserve the organization, comments Paul Adams, chairman of Norden-Ketay.

- **Singer Manufacturing Corp.**, well-known sewing machine manufacturer of Elizabeth, N. J., purchases all of the common stock of **Haller, Raymond & Brown** from **Topp Industries**, electronic manufacturer of Beverly Hills, Calif. Topp received \$2,075,000 for the stock of its Pennsylvania research and development division. In addition, Topp will receive \$375,000 in repayment of advances to HR&B.

Topp will use the cash received to re-invest in the expansion of present business and to acquire new companies. However, new companies acquired will have a higher margin of profit than the necessarily R&D profits of HR&B, says B. F. Gira, president of Topp.

Singer plans to manufacture military and industrial electronic equipment developed by HR&B. In this way it will utilize excess capacity at plants in Conn. and N.J. created by declines in foreign and domestic sewing machine sales. Singer was a producer of electronic equipment developed by others during World War II.

- **National Aeronautical Corp.**, Fort Washington, Pa., plans to increase authorized common stock from 150,000 to 1,000,000 shares. The firm's common stock will be split five-for-one, if the increase is approved by stockholders at the annual meeting in two weeks.

- **Siegler Corp.**, Anaheim, Calif., acquires all of the stock of its subsidiary, **Sancor Corp.** of Santa Barbara, Calif. Siegler previously had a 79 percent interest in Sancor, which makes aircraft and missile ground handling equipment. Its manufacturing facilities will be relocated in a new plant, adjacent to the Siegler-owned Hufford Corp. in El Segundo, Calif.

mercial lines are buying this complex and costly gear to prepare for the debut of such glamor aircraft as Boeing's 707, Douglas' DC-8, Lockheed's Electra, and Convair's 880, all of which will be hurtling regularly through the air by 1960. With advanced simulator training, jet crews will be well schooled before they ever set foot in the actual plane.

Both Curtiss-Wright's Electronics Division and Link Aviation have firm orders for jet and prop-jet transport simulators from major world airlines, with first deliveries scheduled for 1958. Curtiss-Wright has been building commercial simulators since 1948, and Link moved into the area last year. An-



Link's approach to visual simulation problem. Tv camera at left reacts to pilot's manipulations

other major simulator outfit, Erco Division of ACF Industries, restricts its activities to the military, hoping to tap a potentially lucrative missile simulator market, utilizing their manned aircraft simulator experience.

Flight simulators are big busi-



FILMISTOR[☆]

C A R B O N F I L M R E S I S T O R S

SPRAGUE 403E
2 MEGΩ
±1% 1W

SPRAGUE 402E
1 MEGΩ
±1% 1/2W

SPRAGUE 404E
10 MEGΩ
±1% 2W

**THESE FILMISTORS PROVIDE
THE STABILITY YOU WANT
UNDER THE TOUGHEST LOAD
AND HUMIDITY CONDITIONS**

SPRAGUE[®]
the trademark of reliability

WRITE FOR BULLETIN NO. 7010
SPRAGUE ELECTRIC COMPANY
35 MARSHALL STREET
NORTH ADAMS, MASSACHUSETTS

☆ TRADE MARK REG.

SPRAGUE COMPONENTS: CAPACITORS • RESISTORS • MAGNETIC COMPONENTS • TRANSISTORS
INTERFERENCE FILTERS • PULSE NETWORKS • HIGH TEMPERATURE MAGNET WIRE • PRINTED CIRCUITS

ness, amounting to somewhere between 40 and 50 million dollars a year. Selling price for one custom-tailored unit ranges from \$750,000 to \$1,500,000, with delivery from 14 to 18 months.

One airline official estimates cost-per-hour operation of a Boeing 707 is \$2,700; for the same hour in a simulator—\$45.

Both Curtiss-Wright and Link are in advanced stages of adding a new dimension—visual simulation—to their product.

Using closed circuit tv and a complex optical and projection system, what the pilot sees as he approaches the runway and lands his plane is effectively reproduced before his eyes. It is expected that this feature will be of immense value in familiarizing pilots with approach and landing conditions at the major airports.

System Counts Press Runs

TRANSISTORIZED counting system is being installed in the *Detroit News* printing plant to program the newspaper's press production.

It is the first use of a new RCA system which can total the output of 40 different production, processing or packaging operations. Each of 40 channels will handle 3,000 units a minute.

The *Detroit News* installation has 12 channels, one for each of 11 conveyors carrying papers from the press and a spare channel.

Switches at each conveyor input sense folded edges of passing newspapers, generating a signal which goes to a centrally-located totalizer.

The signals are stored for a split second in electronic memories and then relayed to dividers. The divid-



Newspaper mail room supervisor sets printing order on totalizer, waits for signal run is complete

ers emit a signal for each 100 papers, moving a recording dial. When the pre-set number of copies of an edition is released, pressroom superintendent is automatically instructed to stop the presses.

MEETINGS AHEAD

Feb. 14-15: Cleveland Electronics Conference, Fifth Annual, IRE, AIEE, ISA, CPS, Masonic Auditorium, Cleveland, Ohio.

Feb. 17-19: Military-Industrial Conf., "Strategy of the Future," Conrad Hilton Hotel, Chicago.

Feb. 20-21: Conf. on Transistor and Solid State Circuitry, PGCT, AIEE, Univ. of Penn., Phila., Pa.

Mar. 17-21: 1958 Nuclear Congress, Engineers Joint Council, AICE, and Atomfair, Atomic Industrial Forum, International Amphitheatre, Chicago.

Mar. 24-27: IRE National Convention, All Prof. Groups, Waldorf-Astoria Hotel and N.Y. Coliseum, N.Y.C.

Mar. 31-Apr. 2: Southwest District Meeting of AIEE, Mayo Hotel, Tulsa, Oklahoma.

Apr. 2-4: Conf. on Automatic Optimization, PGAC, ASME, AICHE, ISA, Univ. of Delaware, Newark, Del.

Apr. 8-10: Symposium on Electronic Waveguides, Microwave

FEBRUARY						
S	M	T	W	T	F	S
						1
2	3	4	5	6	7	8
9	10	11	12	13	14	15
16	17	18	19	20	21	22
23	24	25	26	27	28	

MARCH						
S	M	T	W	T	F	S
						1
2	3	4	5	6	7	8
9	10	11	12	13	14	15
16	17	18	19	20	21	22
23	24	25	26	27	28	29

APRIL						
S	M	T	W	T	F	S
						1
2	3	4	5	6	7	8
9	10	11	12	13	14	15
16	17	18	19	20	21	22
23	24	25	26	27	28	29
30						

Research Institute of Brooklyn Polytechnic Inst., IRE, held at Engineering Societies Bldg., N.Y.C.

Apr. 10-12: Tenth Southwestern IRE Conference and Electronics Show. St. Anthony Hotel and Municipal Auditorium, San Antonio, Texas.

Apr. 14-16: Conf. on Automatic Techniques, IRE, ASME, Statler Hotel, Detroit, Mich.

Apr. 17-18: Second Annual Technical Meeting, Institute of Environmental Engineers, Hotel New Yorker, N.Y.C.

Apr. 18-19: Twelfth Annual Spring Tech. Conf. on Television and Transistors, Engineering Society of Cincinnati Bldg., Cincinnati.

Apr. 20-24: Scientific Apparatus Makers, 40th Annual Meeting, El Mirador Hotel, Palm Springs, California.

Apr. 21-25: Society of Motion Picture and Television Engineers, 83rd Convention, Ambassador Hotel, Los Angeles.

Apr. 22-24: 1958 Electronic Components Conf., IRE, AIEE; Theme: "Reliable Application of Component Parts," Ambassador Hotel, Los Angeles.

Apr. 24-26: National Academy of Sciences, U.S. National Comm., International Scientific Radio Union, Spring Meeting, National Bureau of Standards, Wash., D.C.

Apr. 28-May 1: Sixth Annual Semiconductor Symposium of the Electrochemical Society, Statler Hotel, N.Y.C.

Apr. 29-30: Symposium on Electronic Scanning of Antennas, AFCRC and Rome Air Devel. Command, L. G. Hanscom Field, Bedford, Mass.

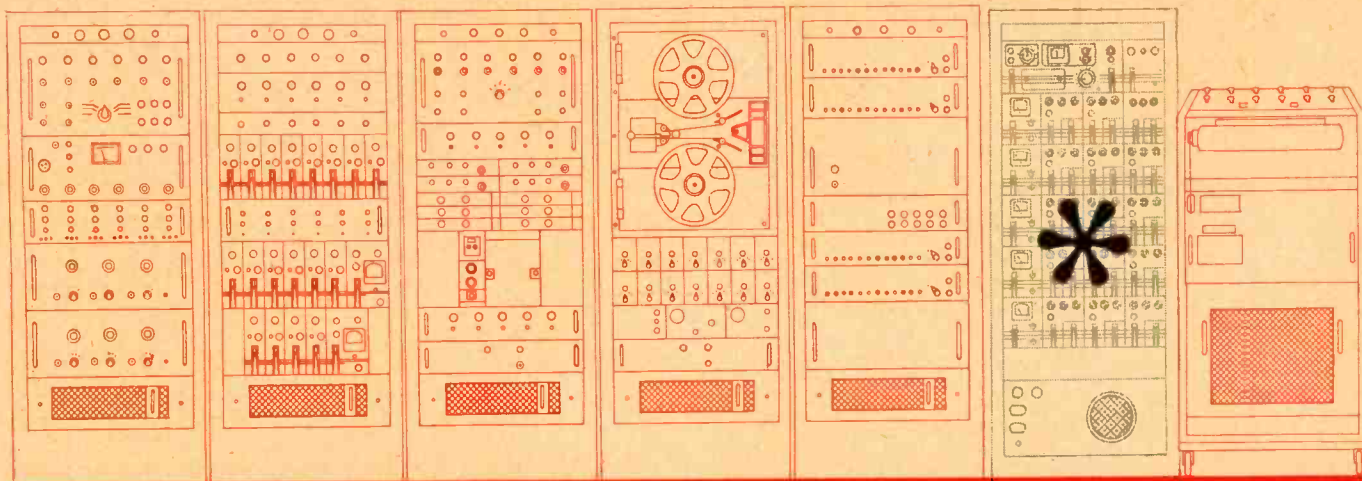

HALLAMORE PHASE-LOCK DISCRIMINATORS

ELIMINATE SYSTEM ERRORS...AFFORD ECONOMY AND SPACE SAVING ADVANTAGES—

This Hallamore developed building-block type FM instrumentation system is designed to condition and calibrate signals from any combination, or multiples, of the following transducers: potentiometers, flow pickup, bridge, thermocouples, or differential transformers. Hallamore manufactured elements in the system include DC amplifiers, SCO summers, universal calibrator, calibrator test instrument, timing system and the discriminator station. Hallamore phase-lock discriminators, Model 0162, reduce subcarrier frequency information to output data, relatively undisturbed by noisy signals which contribute to the inefficiency of pulse counting type discriminators.

Designed around a concept entirely new to the telemetry field, the Model 0162 phase-lock discriminator eliminates signal suppression by noise, non-linearity by filtering, and thresholding at low signal-to-noise levels. In addition, the unit occupies less space, reduces overall system cost, and assists in the simplification of operational procedures. For complete specifications and operational data, write Hallamore Electronics Co., Dept. 24J, 8352 Brookhurst Avenue, Anaheim, Calif.

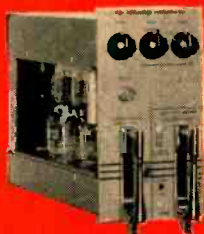
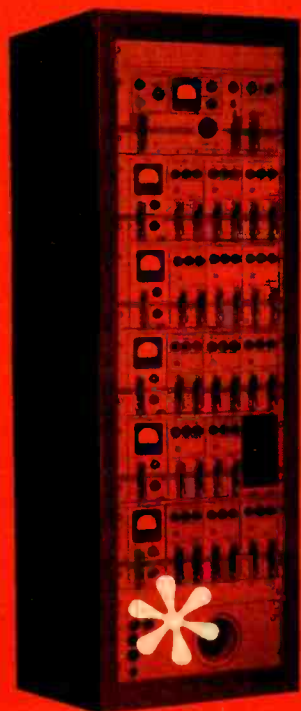

HALLAMORE ELECTRONICS COMPANY



a division of the SIEGLER CORPORATION

SPEED

Research and Development!



PRECISION Trimmer Piston Capacitors

for expediting experimental circuitry design



actual size

**Miniaturization • Automation • Navigation
Communication • Guidance Systems • Missiles
Telemetry • Radar • Nucleonics • Computers**

At your fingertips the JFD Trimmers you want when you want them—when you keep these versatile JFD Piston Capacitor Kits on hand. Complete with electrical characteristic charts and handy dust-proof styrene case. Also available—comprehensive PK260 Laboratory Assortment—260 essential JFD Piston Capacitors in compact metal cabinet. Write for engineering bulletins.



No. PK10 KIT Glass & Quartz Trimmers (Panel Mount Type)		
Cat. No.	Quantity	Cap. (mmf)
VC5	1	0.6-6
VC11	1	0.8-10
VC12	1	9-21
VC1G	1	0.7-9
VC3G	1	0.7-9
VC4G	1	0.8-18
VC8GA	1	1-8
VC11G	1	0.6 to 14
VC13GA	1	1.5-12
VC30G	1	0.8 to 30

No. PK13 KIT Miniature Printed Circuit Trimmers (4 Wire Lead Type)		
Cat. No.	Quantity	Cap. (mmf)
VC9GW	1	0.8-8.5
VC10GW	1	0.8-4.5
VC31GW	1	0.8-12
VC32GW	1	0.8-18
VC43GW	1	0.8-30

No. PK14 KIT Glass Dielectric Split Stator Trimmers (Standard Panel Mount Type)		
Cat. No.	Quantity	Cap. (mmf)
VC16G	2	*0.8-2.5
		0.5-5.0
VC17G	2	*1.1-4.5
		0.6-8.5
VC18G	1	*1.8-7.5
		0.7-14.0

No. PK15 KIT Quartz Dielectric Split Stator Trimmers (Standard Panel Mount Type)		
Cat. No.	Quantity	Cap. (mmf)
VC80	1	*0.4-1.0
		0.3-2.0
VC81	1	*0.6-1.6
		0.4-3.2
VC82	1	*0.85-2.8
		0.5-5.5
VC83	1	*3.0-6.0
		4.8-11.0

No. PK16 KIT Glass Dielectric Trimmers (Standard Panel Mount Type)		
Cat. No.	Quantity	Cap. (mmf)
VC1G	1	0.7-9
VC3G	1	0.7-9
VC4G	1	0.8-18
VC5G	1	0.8-18
VC6GA	1	0.8-18
VC7G	1	2-30
VC11G	1	0.6-14
VC13GA	1	1.5-12
VC30G	1	0.8-30

No. PK17 KIT Quartz Dielectric Trimmers (Standard Panel Mount Type)		
Cat. No.	Quantity	Cap. (mmf)
VC2	1	0.7-4.5
VC5	1	0.6-6
VC11	1	0.8-10
VC12	1	9-21

No. PK12 KIT Miniature Printed Circuit Trimmers (Lug and Lead Type)		
Cat. No.	Quantity	Cap. (mmf)
VC9G	1	0.8-8.5
VC10G	1	0.8-4.5
VC31G	1	0.8-12
VC32G	1	0.8-18
VC43G	1	0.8-30

• PLATE TO PLATE



Pioneers in Electronics since 1929

ELECTRONICS CORP.

Brooklyn 4, New York

JFD INTERNATIONAL
15 Moore Street
New York, N.Y.

JFD CANADA LTD.
51 McCormack Street
Toronto, Ontario, Canada

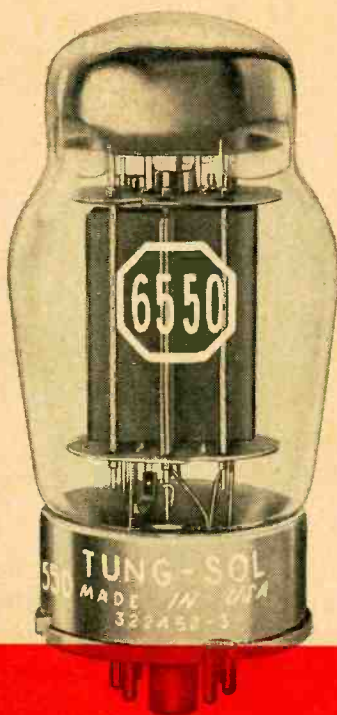

RESEARCH, DESIGN, DEVELOPMENT
AND QUALITY PRODUCTION IN VOLUME

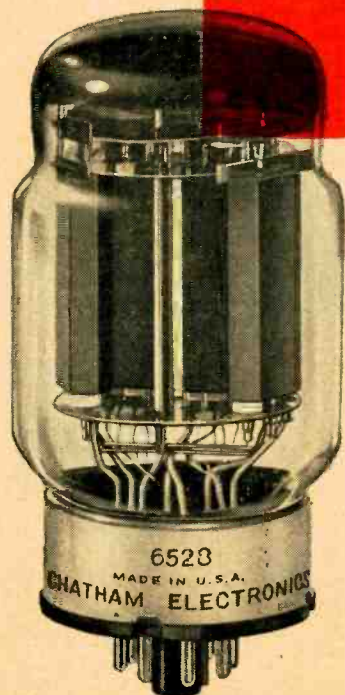

TUNG-SOL®

ELECTRON TUBE DIVISION  **TUNG-SOL ELECTRIC INC., NEWARK 4, N. J.**

SALES OFFICES: ATLANTA, GA.; COLUMBUS, OHIO; CULVER CITY, CALIF.; DALLAS, TEX.; DENVER, COLO.; DETROIT, MICH.;
IRVINGTON, N. J.; LIVINGSTON, N. J.; MELROSE PARK, ILL.; NEWARK, N. J.; SEATTLE, WASH. CANADA: TORONTO, ONT.

ALL VIDEO TRANSMISSION TEST

STANDARDS in a suitcase



The Original Full Rack and the Portable Unit Produce the same Precise Test Signals.



TELECHROME
INCORPORATED

Model 1003-B

Video Transmission Test Signal Generator

- ★ Completely self contained ★ Portable
- ★ Multi-frequency burst ★ Stairstep ★ Modulated stairstep
- ★ White window ★ Composite sync ★ Regulated power supply.

Now, Telechrome Video Transmission Test Equipment is available as a completely portable 12 1/2" standard-rack mounting unit.

Everyday these Test Signals generated by Telechrome equipment, are transmitted Coast-to-Coast by NBC, CBS, ABC, the Bell System, Canadian Bell and leading independent TV stations throughout the U.S. and Canada. Hundreds of network affiliated TV stations and telephone TV centers thus check incoming video signals.

The compact, inexpensive, portable Model 1003-B is all that is required to generate signals for local and remote performance checking of your entire video, cable, or microwave facilities.

DELIVERY 30 DAYS

Literature on the above and more than 100 additional instruments for monochrome and color TV by TELECHROME are available on request.

The Nation's Leading Supplier of Color TV Equipment
28 Ranick Drive Amityville, N. Y.

Lincoln 1-3600

TELECHROME
INCORPORATED



MULTI-FREQUENCY BURST AMPLITUDE vs FREQUENCY. Check wide band coaxial cables, microwave links, individual units and complete TV systems for frequency response characteristics without points to point checking or sweep generator.

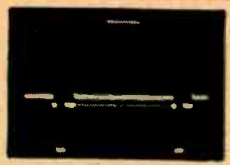

WHITE WINDOW
LOW & HIGH FREQUENCY CHARACTERISTICS. Determine ringing, smears, steps, low frequency tilt, phase shift, mismatched terminations, etc. in TV signals or systems.



STAIRSTEP SIGNAL modulated by crystal controlled 3.579 mc for differential amplitude and differential phase measurement. Checks amplitude linearity, differential amplitude linearity and differential phase of any unit or system.

Model 1003-C includes variable duty cycle stairstep (10-90% average picture level).

Model 608-A HI-LO CROSS FILTER for Signal analysis.



MODULATED STAIRSTEP signal thru high pass filter. Checks differential amplitude.



MODULATED STAIRSTEP signal thru low pass filter. Checks linearity.

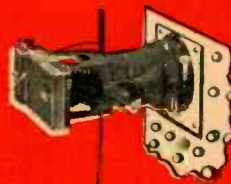

1521-A OSCILLOSCOPE CAMERA—Polaroid type for instantaneous 1 to 1 ratio photo-recording from any TV oscilloscope.



1004-A VIDEO TRANSMISSION TEST SIGNAL RECEIVER for precise differential phase and gain measurements. Companion for use with 1003-B.

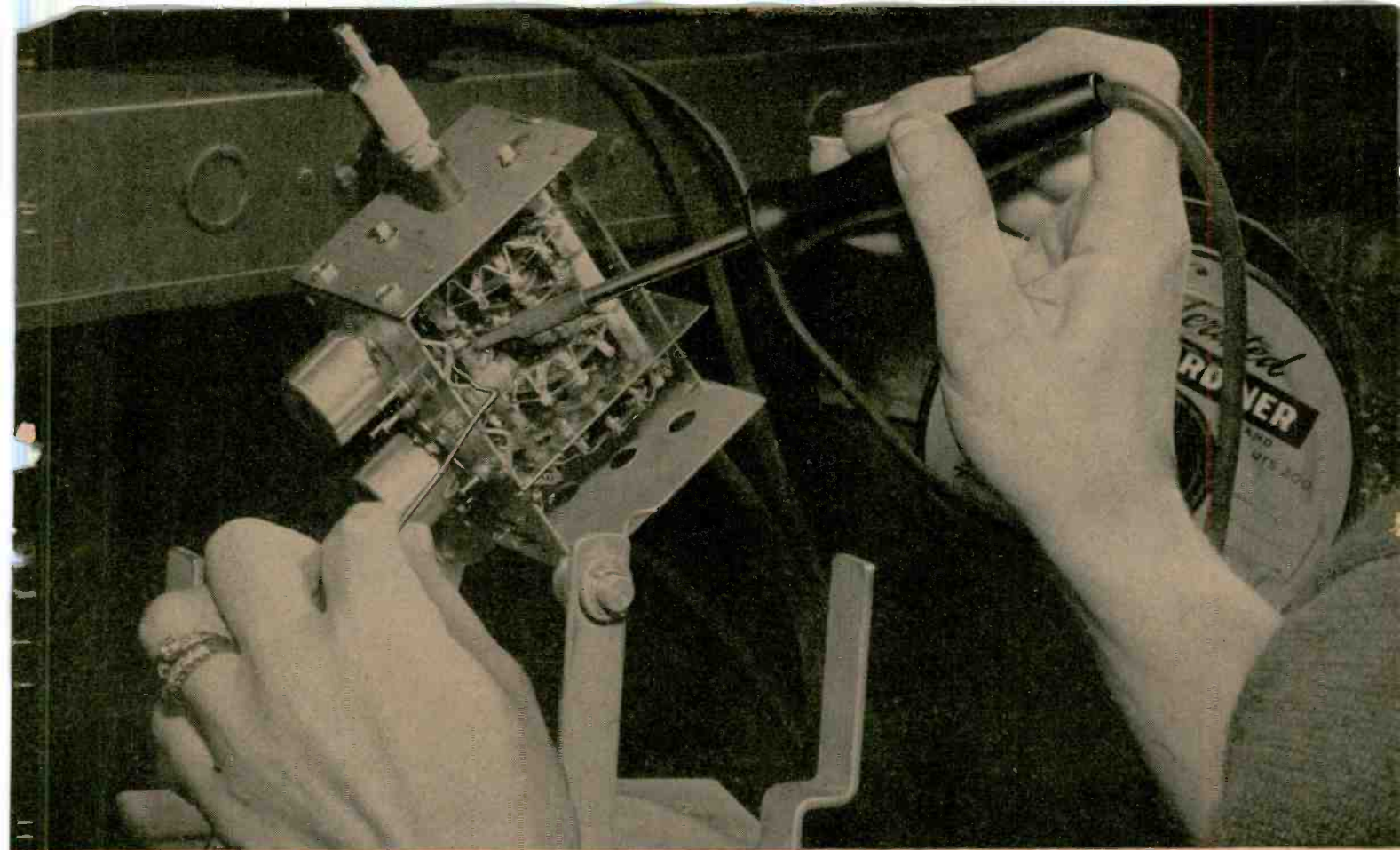

"IT'S SIMPLE ECONOMICS," says Mr. Robert R. Keller, Process Engineer at Sarkes Tarzian Inc., well known electronics components manufacturer in Bloomington, Indiana. "We have an average of 185 General Electric Midget soldering irons in operation on our television tuner assembly lines. We find the G-E Midget iron more efficient than our heavier irons on many operations. Each iron solders an average of 85,000 joints every year. Some irons solder as many as 150,000 joints

per year. Compared to maintenance and replacement costs on other soldering irons we have tested and used, we save approximately \$57.50 per year on each iron. Our present annual saving with all the G-E Midget irons is about \$10,600." Sarkes Tarzian Inc., found that the rugged ironclad copper tips on the Midget last from six to nine months, provide fast, concentrated heat with reduced risk of loosening nearby joints.

Every Year, 185 General Electric Midget Irons Save Over \$57 Each At Sarkes Tarzian Company

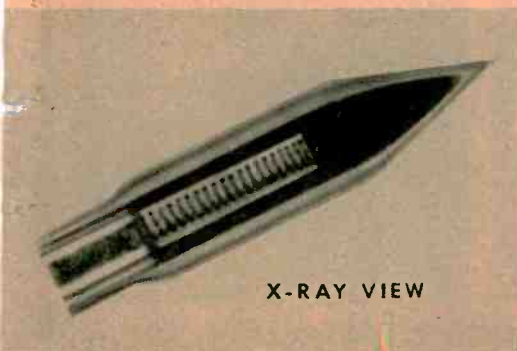

X-RAY VIEW

RAPID HEAT TRANSFER is achieved through a rugged tubular heater located in ironclad tip. Result: the General Electric Midget's heat efficiency is 90%.

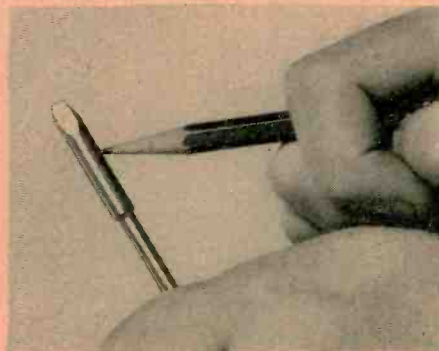

IRONCLAD TIP needs no filing. And by actual production-line test, General Electric ironclad tips last up to ten times longer than ordinary tips.

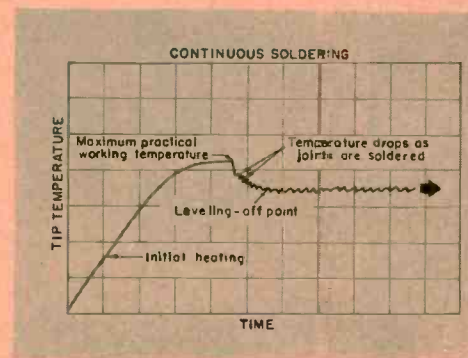

CONTINUOUS SOLDERING with the G-E Midget iron is easy, certain. Temperature is maintained well above minimum practical soldering temperature.

Write for GED-3553, General Electric Industrial Soldering Irons, Section 724-5, General Electric Co., Schenectady 5, N. Y.

GENERAL ELECTRIC

CIRCLE 83 READERS SERVICE CARD

Behind the quality of Phelps Dodge **FORMVAR...**

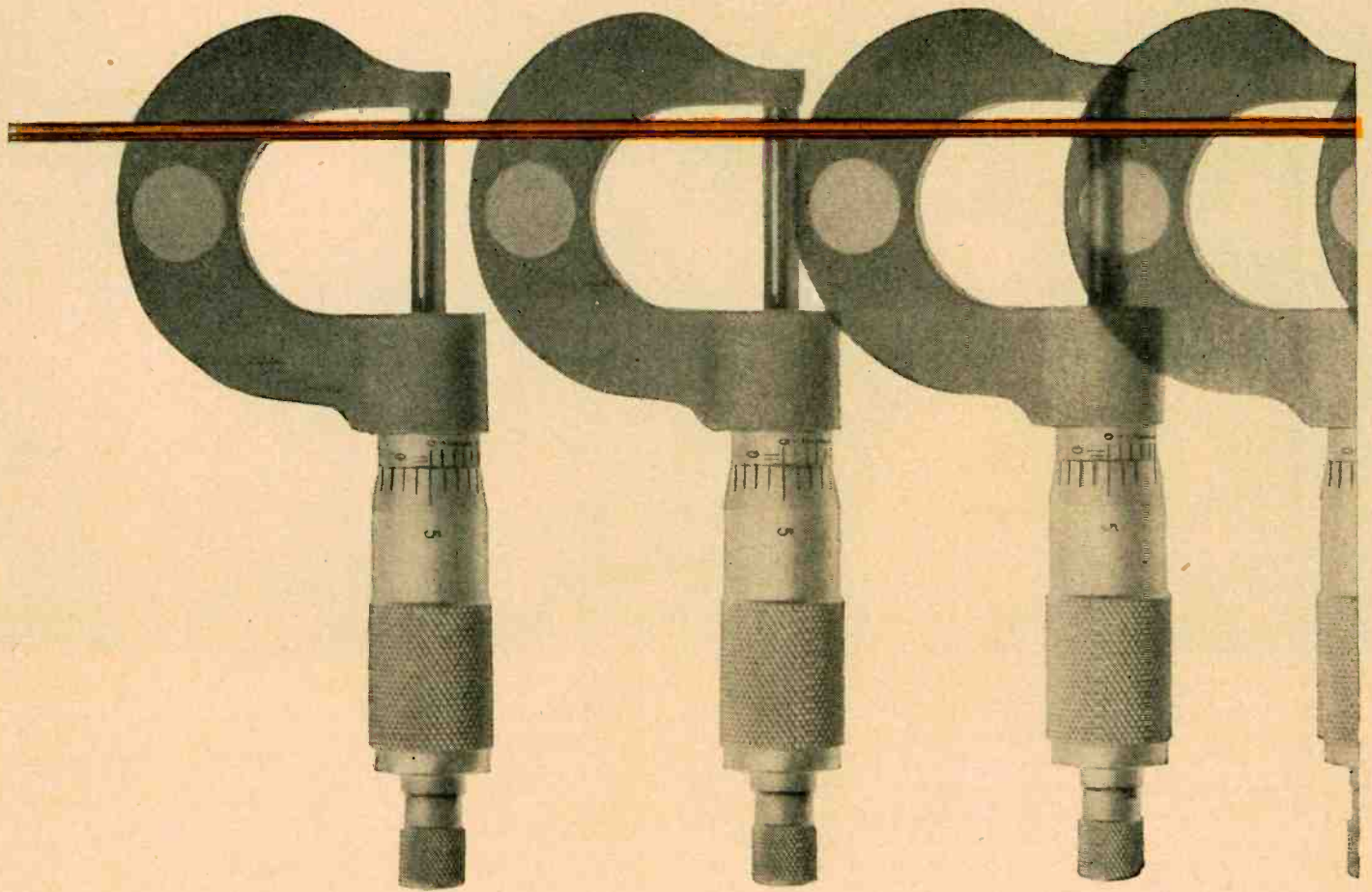

CAREFUL CONTROL OF FINELY

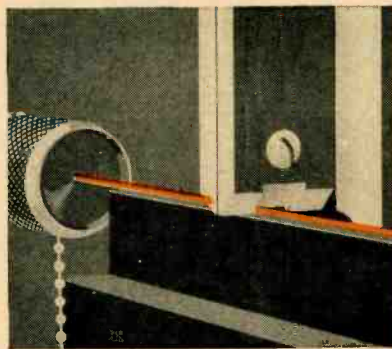

Abrasion resistance

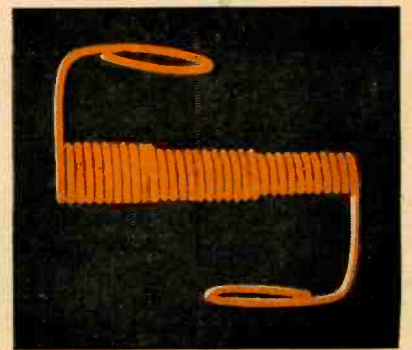

Film flexibility

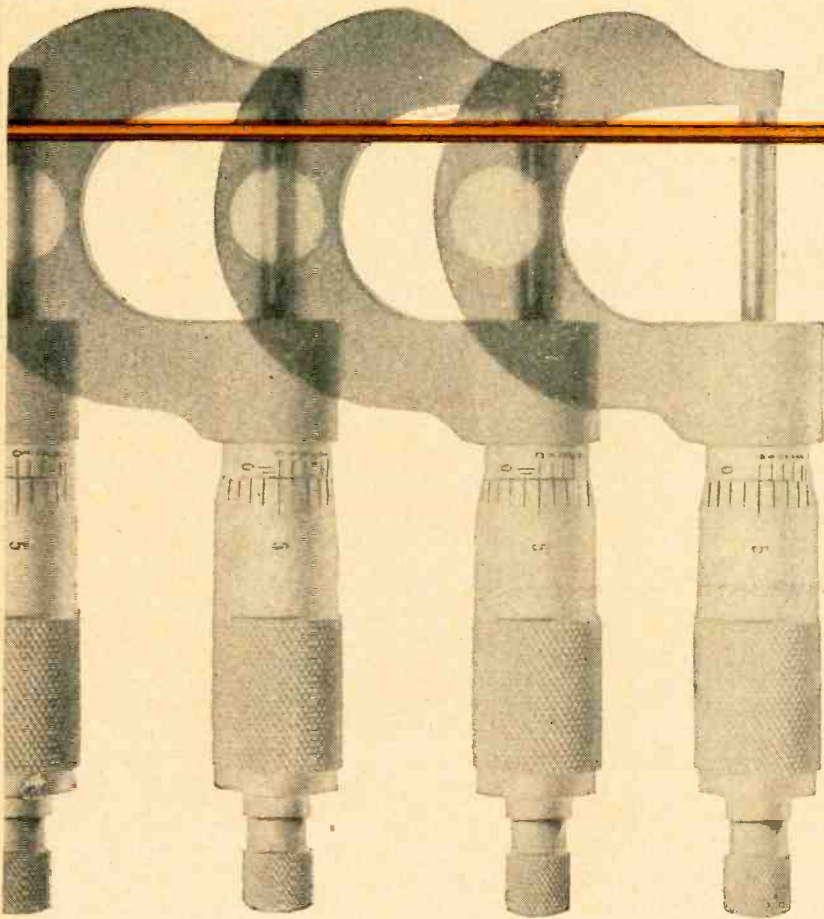

BALANCED PROPERTIES

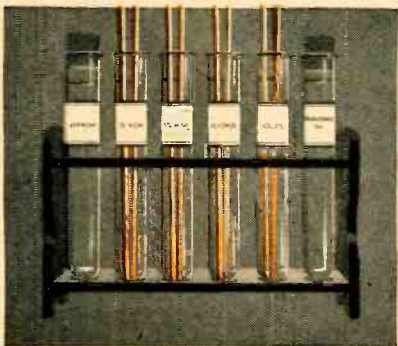

Solvent resistance

Phelps Dodge Formvar magnet wire has a high quality and balance of essential properties that are the result of carefully controlled testing throughout the manufacturing process. These balanced properties offer greater abrasion resistance, exceptional film flexibility, improved solvent resistance and high product uniformity—factors that serve to make Phelps Dodge Formvar the standard “yardstick” for the electrical equipment industry. Phelps Dodge Formvar is available in round, square and rectangular shapes.

Any time magnet wire is your problem, consult Phelps Dodge for the quickest, easiest answer!

PHELPS DODGE COPPER PRODUCTS CORPORATION

INCA MANUFACTURING DIVISION

FORT WAYNE, INDIANA



FIRST FOR
LASTING QUALITY
—FROM MINE
TO MARKET!

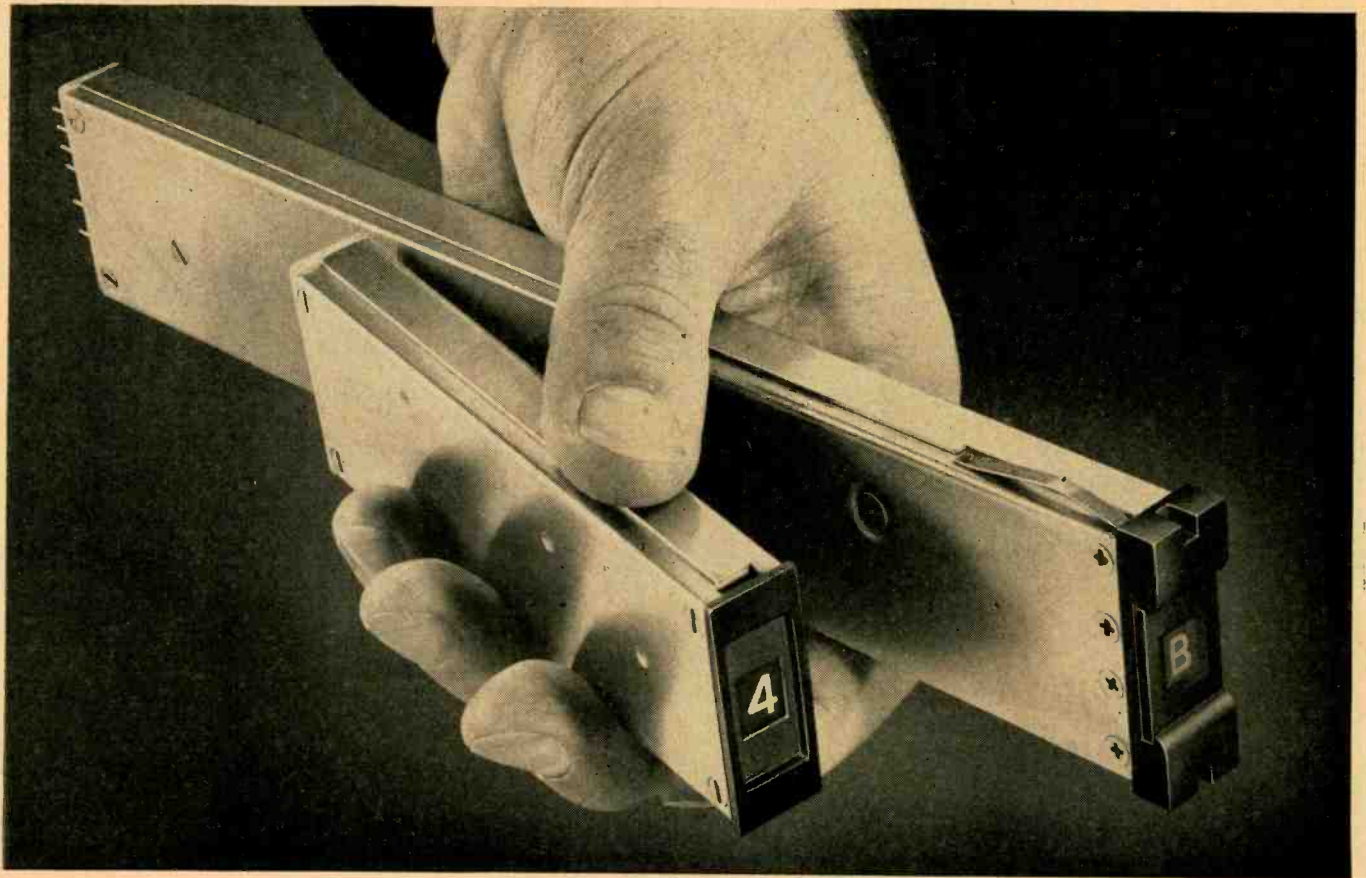

Digital indicator (left) can display a possible 16 characters and is about half the size of the Alpha-numerical indicator (right) which displays 64 characters.

UNION INDICATORS permit direct readout of binary data

UNION Digital and Alpha-numerical indicators are controlled by binary code signals employing a minimum number of control wires, and respond to simultaneous binary switching combinations.

These indicators are electro-mechanical, D.C.-operated, readout devices for displaying characters in accordance with a predetermined code. The character display may be made to suit user's requirements.

Indicators are designed for plug-in mounting in a row so that data or messages of any desired length can be stored, displayed or transmitted at will. The indicators can be applied to the output of digital computers, teletype receiving equipment in conjunction with a buffer storage unit, telemetering systems, or wherever data needs to be displayed.

Two important features of these indicators are their inherent storage and transmitting characteristics which provide for data entry and retransmission. The indicators can be used to accept data from a source, free the

source for other programs, and disseminate the data from one indicator to another as required. For each binary bit stored, an external relay can be eliminated.

UNION indicators have provided economic and reliable advantages in data display applications associated with Air Traffic Control, Navigation, Telemetering, Fire Control and similar Airborne and Surface Instrumentation displays.

Write for Bulletin No. 1015 for complete information.

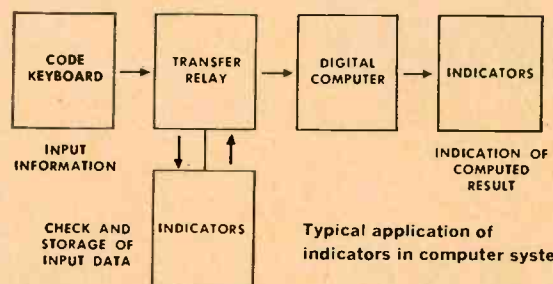

UNION SWITCH & SIGNAL
DIVISION OF WESTINGHOUSE AIR BRAKE COMPANY
PITTSBURGH 18, PENNSYLVANIA

GENERAL TRANSISTOR'S PRODUCTION

Breakthru

PNP	NPN	NPN
2N 315	2N 356	2N 444
2N 316	2N 357	2N 445
2N 317	2N 358	2N 446
		2N 447

- NEW MODERN PLANTS
- EXPANDED FACILITIES
- STREAMLINED ORGANIZATION
- STEPPED-UP PRODUCTION
- INCREASED LABOR FORCE
- APPLIED RESEARCH

Modern success stories don't "happen," they're caused — that's why General Transistor started "Operation Breakthru" 10 months ago.

Management recognized that a surge of increased business could strain manufacturing and quality control facilities. Before a bind could develop, "operation breakthru" was inaugurated . . . and can now be called a complete success.

Another modern manufacturing plant was added to General Transistor's 3 plants — this additional facility increases storage area, expands the quality control section and enlarges the manufacturing space. Additional equipment and machinery have been purchased. Technical and labor force have been increased to satisfy the demand of industry.

Operation breakthru is a success — your assurance of continued reliable production, prompt deliveries and realistic prices.

The management and employees of General Transistor wish to thank their customers for making

GENERAL TRANSISTOR—"THE FASTEST GROWING NAME IN TRANSISTORS"
Write today for complete all types list wall chart.



GENERAL TRANSISTOR CORP.

91-27 138TH PLACE JAMAICA 36, NEW YORK

In Canada: Desser E-E Ltd., 441 St. Francis Xavier, Montreal 1, Quebec
FOR IMMEDIATE DELIVERY FROM STOCK, CONTACT YOUR NEAREST AUTHORIZED GENERAL TRANSISTOR DISTRIBUTOR OR GENERAL TRANSISTOR DISTRIBUTING CORP. 95-27 SUTPHIN BLVD. JAMAICA 35, NEW YORK
FOR EXPORT: GENERAL TRANSISTOR INTERNATIONAL CORP.
91-27 138TH PLACE JAMAICA 35, NEW YORK

©N

SOLA CONSTANT VOLTAGE DC POWER SUPPLY is shown here with its three major components indicated. This assembly is a typical standard design rated at 125 volts, 2 amperes, and is mounted on a standard, 19" relay rack chassis only 5 1/4" high.

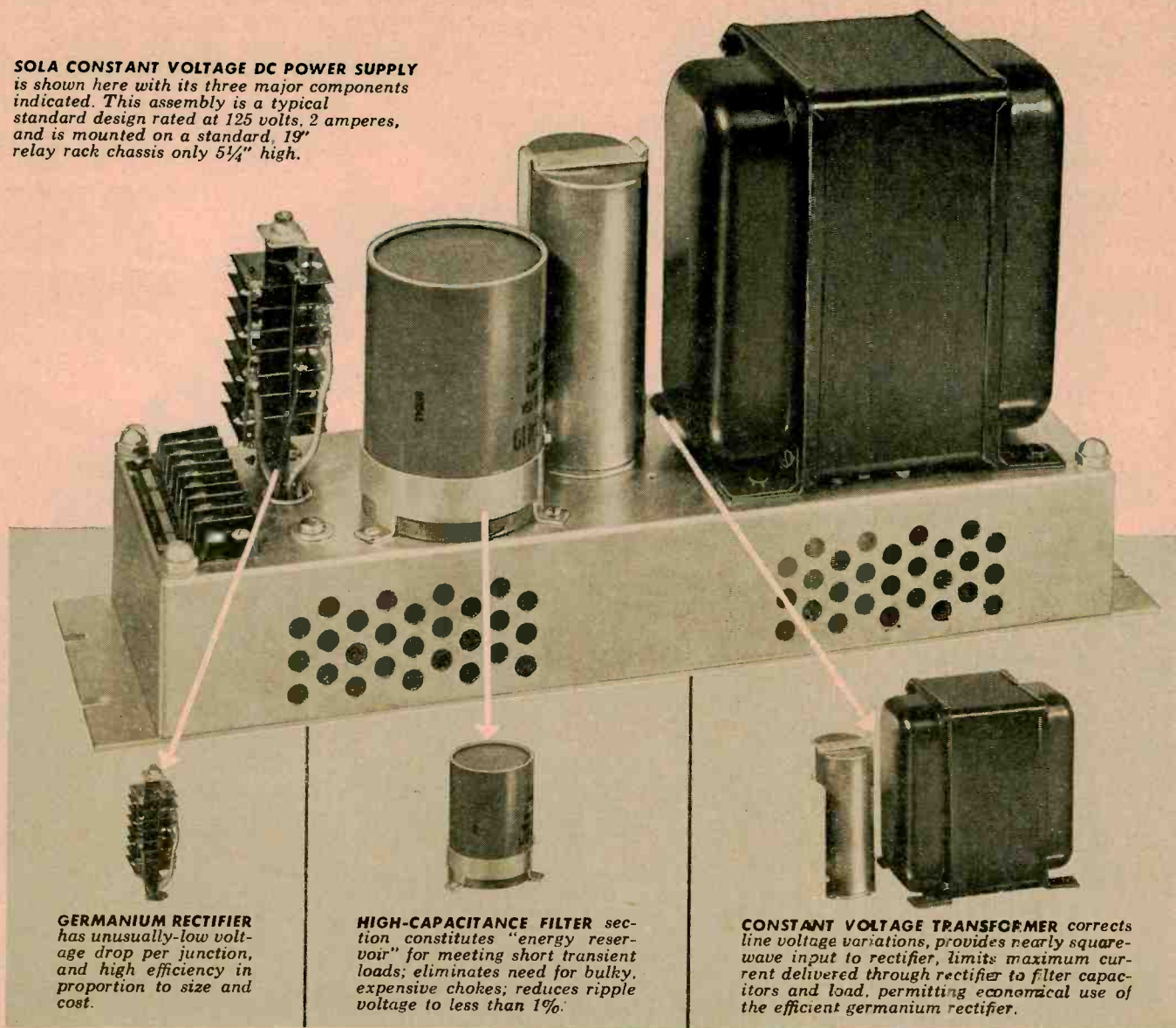

GERMANIUM RECTIFIER has unusually-low voltage drop per junction, and high efficiency in proportion to size and cost.

HIGH-CAPACITANCE FILTER section constitutes "energy reservoir" for meeting short transient loads; eliminates need for bulky, expensive chokes; reduces ripple voltage to less than 1%.

CONSTANT VOLTAGE TRANSFORMER corrects line voltage variations, provides nearly square-wave input to rectifier, limits maximum current delivered through rectifier to filter capacitors and load, permitting economical use of the efficient germanium rectifier.

2 amps of 125v regulated dc power in only 5 1/4" of relay-rack height

Exceptional performance under intermittent, variable, pulse, or high-amperage loads is a prime advantage of the new static-magnetic, Sola Constant Voltage DC Power Supply. Its design simplicity — possible because of the mutual support and protection provided by the combination of its three basic components — provides compact size, low weight, and moderate price in proportion to power output and performance.

Output of these power supplies is regulated within $\pm 1\%$ for line voltage variations of up to $\pm 10\%$. They

are available in six stock models, in ratings ranging from 24 volts at six amperes to 250 volts at one ampere. Also, design-and-assembly service for special ratings is offered to meet the specific requirements of equipment manufacturers.

Your area representative, listed below, is part of a nationwide organization maintained to provide you with prompt service. He'll be happy to supply further information on stock or special Sola Constant Voltage DC Power Supplies.

SOLA *Constant Voltage*
DC POWER SUPPLIES

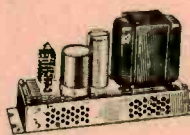

Write for Bulletin 7B-CV-235
SOLA ELECTRIC CO.
4633 W. 16th Street
Chicago 50, Illinois

CONSTANT VOLTAGE TRANSFORMERS • LIGHTING TRANSFORMERS • CONSTANT VOLTAGE DC POWER SUPPLIES
SOLA ELECTRIC CO., 4633 West 16th Street, Chicago 50, Illinois, Blshop 2-1414 • BRANCH OFFICES: Boston, Mass.; Cleveland, Ohio; Kansas City, Mo.; Los Angeles, Calif.; New York, N. Y.; Philadelphia, Pa.; San Francisco, Calif.; Wallingford, Conn. • Representatives in Other Principal Cities
Sola Electric (Canada) Ltd., Toronto 17, Ontario: 102 Laird Drive, Mayfair 4554

**SEE HOW
BRAND
ELECTRICAL
INSULATING
TUBINGS**

**assure product performance
for major manufacturers**

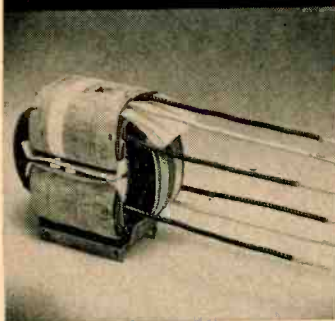

**At United Transformer
New York, New York**

To assure long service life, U.T.C. covers the leads of their high temperature transformers with Turbo 117® silicone rubber coated glass tubing. A Class H material with outstanding heat resistance and low temperature flexibility, the five available grades meet NEMA VS1-1957 and the performance requirements of MIL-I-3190A.



**At Allis-Chalmers
Norwood, Ohio**

For stator connections in their semi-enclosed slot motors, Allis-Chalmers uses Turbofuf® a highly flexible, heat resistant, vinyl coated glass tubing. This Class B material is supplied in two grades meeting all requirements of the NEMA VS1-1957 and the MIL-I-3190A specifications.

**At IBM
Poughkeepsie, N. Y.**

Where high temperature plastic tubing is necessary as capacitor lead insulation in their electric accounting machines, IBM counts on Turbotherm® 105 or Turbofans® 105 U/L approved extruded tubing. In addition, Turbofans 105 tubing meets the requirements of MIL-I-631C, Grade c, Class II, Category 1.



**At American Bosch
Springfield, Mass.**

Miniature electric windshield wiper motors require moisture resistant insulation, so American Bosch chooses Turbo® varnished tubing, a cotton or rayon braid coated with a tough, organic varnish. Manufactured in five grades it meets the Class A requirements of MIL-I-3190A, ASTM D-372, and NEMA VS1-1957.

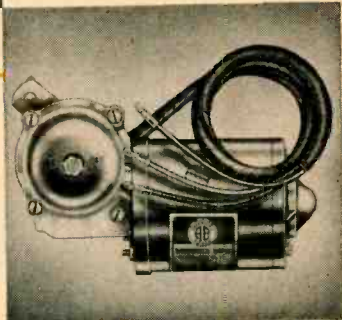

**At Lockheed
Marietta, Georgia**

To provide low temperature abrasion protection for wiring assemblies, Lockheed uses Turbozone® 40 extruded plastic tubing for use in the C-130 Hercules. This tubing meets the requirements of MIL-I-7444A(2) and is available in three size ranges — from .022" to 2.500" inside diameter.



**At Avco's Crosley Div.
Cincinnati, Ohio**

For applications ranging from test and fire control equipment to navigational and radar units, Crosley selects Turbolox® 76 general purpose plastic tubing, a flame and fungus resistant material operable from -40°C to +80°C. This tubing meets MIL-I-631C, Grade a, Class I, Category 1 and ASTM D-922.

High dielectric strength; flame, fungus, moisture, solvent or abrasion resistance; low temperature flexibility; high temperature operation; chemical inertness . . . whatever your requirement in a coated textile or an extruded plastic tubing, there is a Brand product to meet your specifications. Turbo tubings are manufactured in all standard colors and a range of sizes #24 (.022") to 2½" I.D. Produced with engineer-supervised techniques, subjected to continuous in-process inspection testing, Turbo tubings meet and exceed all applicable military and commercial specifications. Samples are available, your inquiry is invited.

**THE WILLIAM BRAND
& CO., INCORPORATED**

WILLIMANTIC 3,  CONNECTICUT

electrical and electronic wires and cables • harnesses and cable assemblies • plastic and coated insulating tubings identification markers

Be sure to visit the Brand Suite at the Barbizon Plaza Hotel during the I. R. E. Show.

now, with basic modules build...

DIGITAL VOLTMETERS



DIGITAL OHMMETERS



DIGITAL RATIO METERS

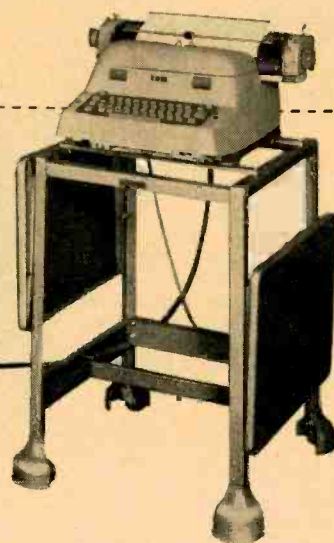

or a COMPLETE DIGITAL, MISSILE ELECTRICAL CHECKOUT SYSTEM

for measuring DC to 0.01%, AC to 0.1%, Ohms to 0.01%, DC ratios to 0.01% and AC ratios to 0.02%

Standard, off-the-shelf modules never become obsolete—provide maximum versatility. As needs change, simply regroup old modules or add new ones. Your system is always current at minimum cost and engineering. Internal construction is also modularized for ease of maintenance.

Fully transistorized circuits result in increased reliability, reduced power consumption, low heat dissipation, miniaturized packages, and eliminate radio noise and line transients.

Important new specifications—Wider, dynamic ranges cover all voltages from 100 microvolts to 1,000 volts; resistance from 10 milliohms to 10 megohms. Input power frequencies from 50 to 400 cycles. New balance logic speeds down ranging. Automatic AC ranging from 30 to 10,000 cycles. Use of transistors increases switch life by a factor of three.

Wide selection of input and output modules for operating printers, IBM punches, etc., can be accommodated without modifications. All contacts are accessible at rear panels with connectors. With plug-in modules, digitized data is provided in printed form, punched cards or tape without modification to basic measuring instruments.



This Short Form Catalog gives complete specifications on both basic and auxiliary modules. Send for it... today.

**ELECTRO
INSTRUMENTS**
INC.

3794 Rosecrans Street
San Diego, California

crystal filters by BURNELL & CO., INC.

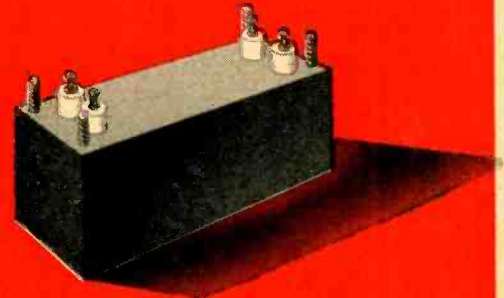

Like fine jewels, crystal filters are synonymous with stability, permanence and reliability. With the development of advanced production techniques and circuitry by Burnell & Co., they offer vast potential in electronic communications, telemetry, and remote control applications.

Depending on band width and frequency, they may be composed entirely of crystals, or in complex networks, combine quartz crystal elements with stabilized toroidal coils to produce the desired band width and shape factor. Frequency has been extended from low range to the megacycle spectrum so that Burnell Crystal Filters now provide the solution to myriad problems formerly insoluble with even the best of toroidal components.

Economical, standardized complex designs of lattice networks and their three terminal network derivatives preclude high developmental costs. Packaging encompasses a wide range in standard, miniature and sub-miniature sizes with considerable latitude in permissive impedance range from required transistor usage to pentode operation. Whether your crystal filter is of standard design or calls for custom specifications, our facilities are at your disposal. Write for new Burnell Crystal Filter Bulletin, XT-455.

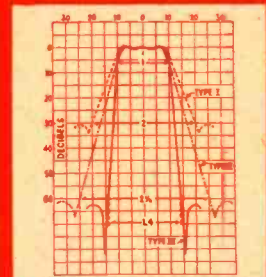

WIDE BAND CRYSTAL FILTER

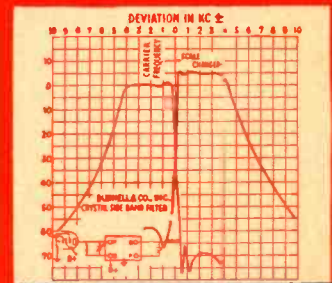

SINGLE SIDE BAND CRYSTAL FILTER

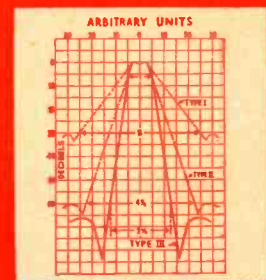

NARROW BAND CRYSTAL FILTER

Burnell & Co., Inc.
first in toroids, filters and related networks



EASTERN DIVISION, Dept. E-2
10 PELHAM PARKWAY
PELHAM MANOR, NEW YORK
PELHAM 8-5000
PACIFIC DIVISION
720 MISSION ST.
SOUTH PASADENA, CALIF.
RYAN 1-2841

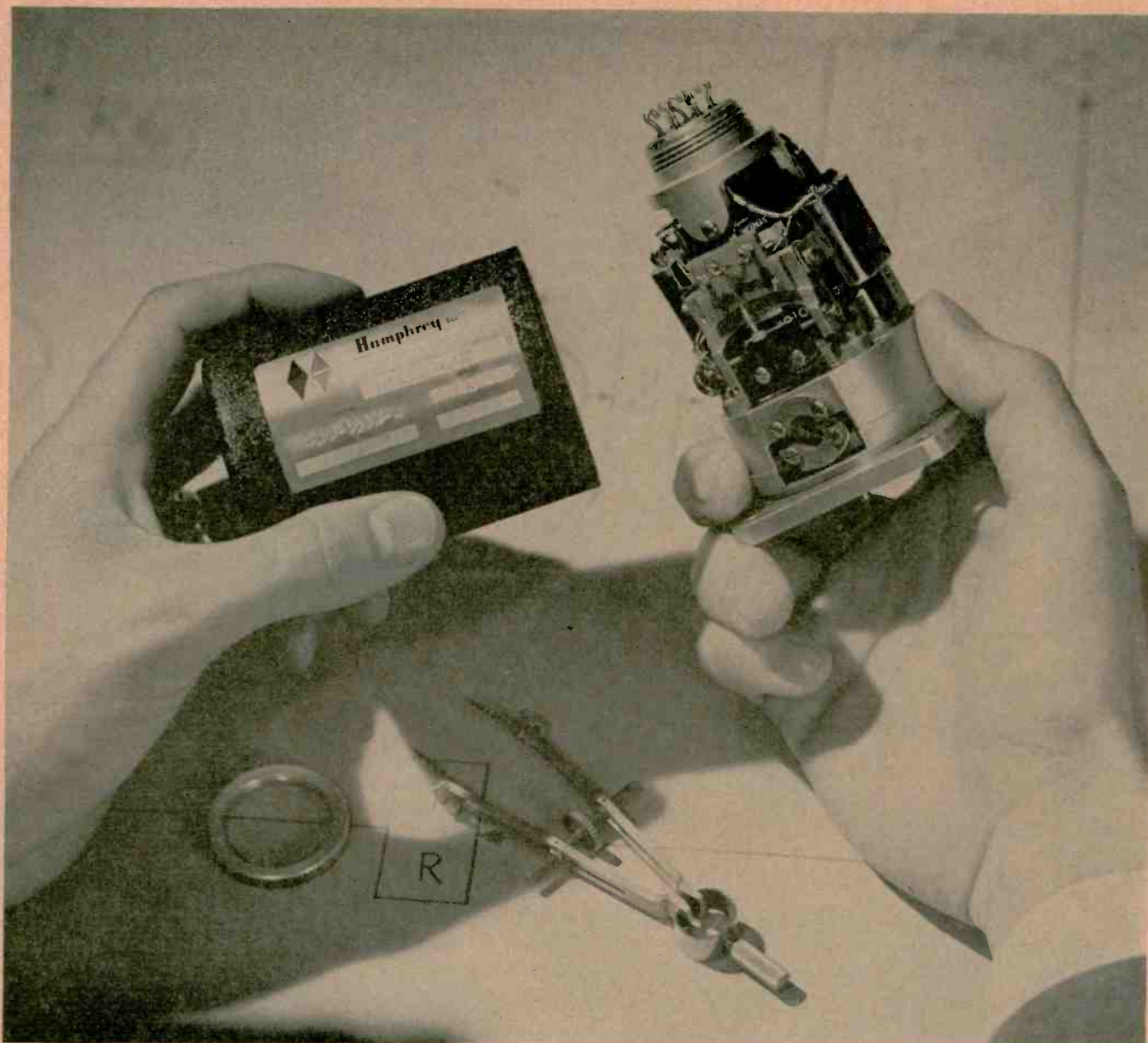

NEW RATE SWITCHES OFFER SUPERIOR SENSITIVITY

New rate switches now in production at Humphrey, Inc. for virtually all major missile programs offer rate ranges from 1° per second to 500° per second. A rate switch can also be supplied that has external adjustments for rate, saving time and money on experimental programs.

Rate switches are available for either a-c or d-c power. They are equipped with primary switches that handle up

to 100 ma. For higher ratings, the instruments can be furnished with built-in relays.

These rate switches withstand tough environmental conditions. Typical specifications are: temperature— -65°F to $+165^\circ\text{F}$; acceleration—80G; shock—80G for 5 milliseconds; and vibration— $\pm 10\text{G}$ to 2000 cps.

Write and tell us about your rate switch requirements.

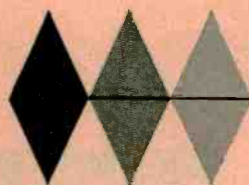

Humphrey Inc.

ELECTRO-MECHANICAL INSTRUMENTS

DEPT. E-28 2805 CANON STREET
SAN DIEGO 6, CALIFORNIA

FOR COMPLETE SYSTEMS, SPECIFY HUMPHREY GYROSCOPES, ACCELEROMETERS, POTENTIOMETERS

Electron Tube News

- from SYLVANIA

Engineering New Developments—Everywhere in Electronics

IN MOBILE COMMUNICATIONS...

Sylvania designs the 12EK6, an RF-IF pentode for auto radio and two-way radio applications

Type 12EK6, a Sylvania-originated T-5½ RF-IF pentode, is available for wide application in vehicular radio. Originally intended for use in 12-volt AM or FM service, the type is finding growing application in two-way radio service for commercial, industrial, amateur and experimental mobile communications.

The new 12EK6 features high gain in IF and RF applications. It is controlled for operation at both 10.0 v and 15.9 v. These maximum ratings provide an increased safety factor for the wide voltage variations possible in mobile power supply systems. The 12EK6 is life-tested at the maximum rating of 15.9 v. to insure top performance.

The new 12DY8 is a triode-tetrode designed for relay service in signal-seeker 12-volt hybrid auto radios

Sylvania introduces the 12DY8, a triode-tetrode specifically controlled for operating relays in signal-seeking hybrid auto radio. The new tube combines in one T-6½ package all of the requirements for signal-seeking operations, including cutoff controls at high supply voltage and zero bias plate control at low supply conditions.

Type 12DY8 can also be used as an audio amplifier-transistor driver in hybrid auto radios. Although primarily intended for automotive service, the new audio power tetrode is applicable wherever a 5 ma. relay on a 12 v system is used.

As in the new 12EK6, the heater ratings of the 12DY8 span the entire 10.0 volts- 15.9 volts range to provide a greater safety factor for possible wide variations in fluctuating battery system supply voltages.

Type 12EC8, Sylvania's first mixer for FM service in hybrid communications receivers

New triode-pentode, type 12EC8, is now in production for broad application wherever 12-volt or 26-volt systems are in use. The 12EC8 is particularly well suited for good mixing action through the 100 MC FM band.

By superimposing even higher quality controls on its already exacting tube manufacturing processes, Sylvania has been able to insure steady long-life operation for the 12EC8.

As with Sylvania's other new tubes for vehicular communications, the heater ratings of the 12EC8 have been extended to cover the range from 10.0 volts to 15.9 volts—for an added safety factor in battery system operation.

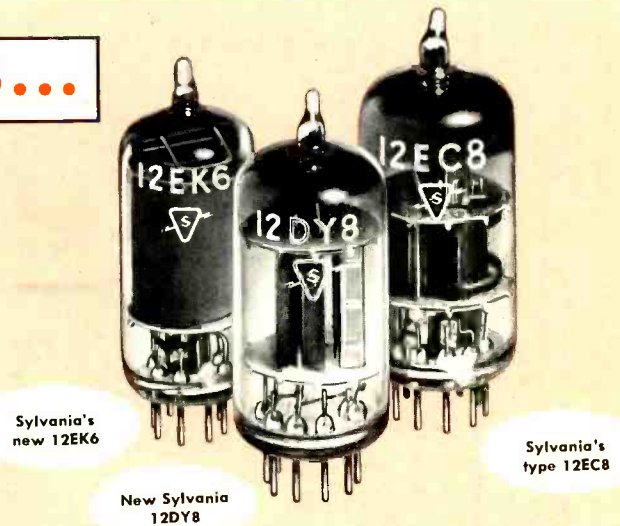

Sylvania's new 12EK6

New Sylvania 12DY8

Sylvania's type 12EC8

Type 12EK6 Typical Operating Conditions & Characteristics

Plate voltage	12.6 volts
Grid #1 voltage	0
Grid #2 voltage	12.6 volts
Grid #1 resistor	2.2 megohms
Transconductance	4200 umhos
Plate resistance (approx.)	40,000 ohms
Plate current	4.4 ma.
Screen current	2.0 ma.
Grid #1 voltage for $I_b=10 \mu a.$	-4.2 volts
Direct Interelectrode Capacitances Without Shield	
Input to plate: (g1 to p) max.	0.032 uuf max.
Input: g1 to (h+k+g²+g³)	10.0 uuf
Output: p to (h+k+g²+g³)	5.5 uuf

Type 12DY8 Typical operating conditions and characteristics

	Triode	Tetrode
Plate Voltage	12.6	12.6 volts
Grid #1 voltage	0	0
Grid #2 voltage	—	12.6 volts
Grid #1 resistor	—	2.2 megohms
Grid #1 resistor bypass condenser	—	1.0 uuf
Transconductance	1,500	5,400 umhos
Amplification Factor	20	—
Plate resistance (approx.)	15,000	4,000 ohms
Zero Signal Plate Current	1.0	14 ma
Zero Signal Screen Current	—	3 ma
Relay Pull-In Plate Current	—	5 ma. min.
Eb-Ec2-Er=10 volts; Ec1=0; Rp=1500 ohms; Rg=10 meg.		
Relay Drop Out Plate Current	—	3 ma. max.
Eb-Ec2-Er=15 volts; Ec1=-5.5 volts; Rg1=0; Rp=1500 ohms.		

Type 12EC8 Typical Operating Conditions and Characteristics

	Triode	Pentode
Plate Voltage	12.6	12.6 volts
Grid #2 voltage	—	12.6 volts
Grid #1 voltage	0	0
Grid #1 Resistor	4,700	33,000 ohms
Amplification Factor	25	—
Plate resistance (approx.)	6,000	750,000 ohms
Transconductance	4,700	2,000 umhos
Plate current	2.4	0.66 ma
Grid #2 current	—	0.28 ma
Grid #1 voltage for $I_b=10 \mu a.$ (approx.)	-2.2	-1.6 volts

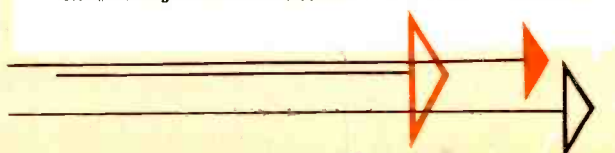

Engineering New Developments

IN TELEVISION...

Sylvania upgrades the 10DE7 for a better safety factor in 110° deflection circuits

A new 10DE7 to give a better safety factor in 110° vertical deflection circuits has been designed by Sylvania. Most important upgrading in the new tube is:

- **Peak pulse plate voltage**—raised from 1,000 to 1,500 volts. The reserve power of the 10DE7 is achieved through use of a newly designed plate which has been increased in size to provide greater power handling capacity.

Special care in manufacturing and extensive tests have paved the way for the increased peak pulse plate voltage in Sylvania's 10DE7.

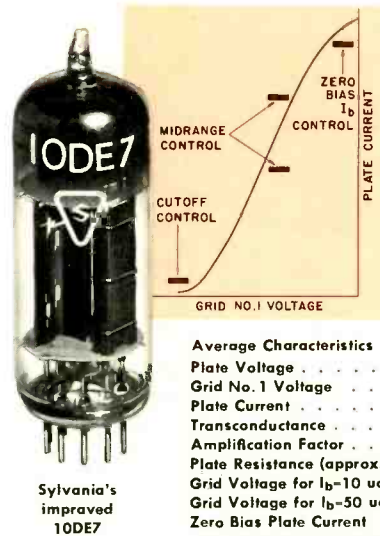

The transfer characteristics in the new 10DE7 are rigidly controlled for proper vertical deflection operation.

Average Characteristics	Triode No. 1	Triode No. 2
Plate Voltage	250	150 volts
Grid No. 1 Voltage	-11	-17.5 volts
Plate Current	5.5	35 ma
Transconductance	2,000	6,500 umhos
Amplification Factor	17.5	6.0
Plate Resistance (approx.)	8,750	925 ohms
Grid Voltage for $I_b=10 \mu a$	-20	— volts
Grid Voltage for $I_b=50 \mu a$	—	-44 volts
Zero Bias Plate Current		
$E_b=60 \text{ V}/E_c=0$ (Inst. Values)	—	80 ma

Nine types are added to Sylvania's extensive line of receiving tubes for complete coverage of TV set requirements

Sylvania expands its broad line of TV receiving tubes with the addition of nine new types:

- **Types 6CX8 and 8CX8**, triode and sharp cutoff video pentodes. The pentode section of these types is designed for use as a video amplifier. The triode section is adaptable to a wide range of low frequency amplifier and oscillator applications.
- **Types 6DT5 and 12DT5**, miniature beam power pentodes featuring high zero bias plate current for 110° vertical deflection service. They are designed for superior performance with both plate and screen

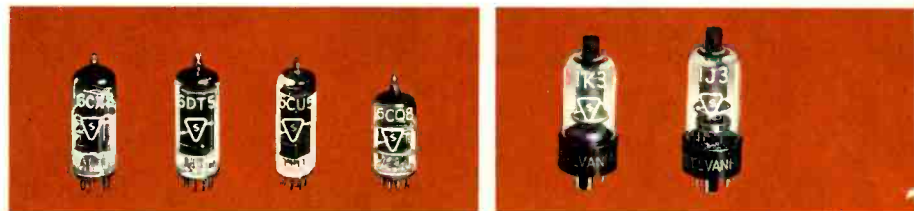

operating at the B power supply potential.

- **Types 6CU5 and 12CU5**, miniature beam power pentodes for TV audio output in low B+ TV receivers. Both the 6CU5 and 12CU5 exhibit characteristics similar to those of the 50C5.
- **Type 6CQ8**, medium mu triode and sharp cutoff pentode for use in series string TV receivers. It is intended as a

combined vhf oscillator and mixer tube.

- **Types 1J3 and 1K3**, high voltage rectifiers. The 1K3 is the short bulb version of the 1J3 and has identical characteristics.

These timely new additions indicate why more manufacturers contact Sylvania for complete tube service from one convenient source.

IN GUIDED MISSILE TYPES...

Full line of guided missile types is now in factory production to meet expanding military needs

Sylvania expands production of its Guided Missile line to meet growing military requirements as the U. S. missile program moves into high gear.

The entire line of Sylvania Guided Missile tubes from type 6943 to 6948 is designed specifically to meet and surpass the most stringent military specifications. The Guided Missile line passes Sylvania's many exacting quality tests such as the White Noise Tests, flicker shorts tests and fatigue tests.

Type No.	Description
6788	Pentode audio voltage amplifier
6943	Sharp cutoff RF pentode
6944	Semi-remote cutoff RF pentode
6945	Audio beam power pentode
6946	Medium mu single triode
6947	Double, medium mu triode
6948	Double, high mu triode

Sylvania's Guided Missile tube line goes into mass production



Everywhere in Electronics

IN RELIABLE TUBES...



New engineering booklet tells the story behind the Gold Brand lines

Sylvania's New Gold Brand booklet

Sylvania offers a new booklet on its Gold Brand lines with a full run-down on the characteristics, specifications, ratings and production techniques for the reliable tubes. The booklet tells why the Gold Brand has become the sign of premium dependability in reliable receiving tubes. It shows the extra critical specifications that are met throughout the entire manufacturing process. It illustrates how the Gold Brand has become the industry's assurance of military and industrial tubes with extra reliability and excellent performance.

For full information on Sylvania reliable tubes send for your copy of the new Gold Brand booklet.

IN INDUSTRIAL AND MILITARY C-R TUBES...

New multi-gun tube development nears completion as Sylvania pushes military and commercial designs

Out of Sylvania's broad basic experience in color TV picture tubes come new developments in multi-gun cathode-ray tubes for commercial and military applications. Sylvania engineers are now completing development of the type 6DP7 shown, an intricate triple gun C-R-T designed for special military purposes. Other multi-gun developmental types incorporating as many as five separate guns are in development.

For airborne use, Sylvania is developing the 5BCP7, a miniaturized lightweight C-R-T that meets the stringent requirements of today's aircraft.

Whatever the need in special cathode-ray tubes—from multi-gun types to wide-angle special-phosphor tubes—Sylvania's engineering know-how and unsurpassed manufacturing facilities can meet it. Discuss your special C-R tube problem with Sylvania's Industrial and Military Cathode-Ray Tube Department.

IN VIDEO AMPLIFIERS...

Sylvania introduces type 6EB8, a high mu triode—sharp cutoff pentode in a T-6½ envelope

Type 6EB8 is a high mu triode, sharp cutoff video pentode. The pentode section is controlled for low knee characteristics and high zero bias plate current. It provides substantially higher video output than its predecessors.

Sylvania's new 6EB8 may also be used to excellent advantage in oscilloscopes and other visual presentation instruments.



New Sylvania type 6EB8

Typical Operating Conditions and Characteristics, Class A1 Amplifier

	Triode	Pentode
Plate voltage	250	200 volts
Grid #2 voltage	—	125 volts
Grid #1 voltage	-2	0 volts
Cathode bias resistor	—	68 ohms
Amplification factor	100	—
Plate resistance (approx.)	34,000	75,000 ohms
Transconductance	2,700	12,500 umhos
Plate current	2	25 ma
Grid #2 current	—	7.0 ma
Grid #1 voltage (approx.) for Ib-100 ua	—	-9 Vdc
Grid #1 voltage (approx.) for Ib-20 ua	-5	— Vdc
Zero Bias: With Eb-40 V; and Ec2-125 V; (Instantaneous values)		40 ma
Plate Current		15 ma
Grid #2 current		

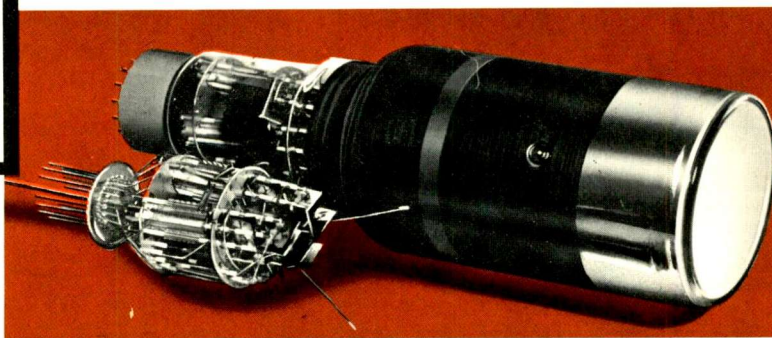

Developmental model of multi-gun 6DP7

Postage
Will be Paid
by
Addressee

No
Postage Stamp
Necessary
if Mailed in the
United States

BUSINESS REPLY CARD
(First Class Permit No. 46687, New York 19, N.Y.)

SYLVANIA ELECTRIC PRODUCTS INC.
1740 Broadway
New York 19, N. Y.



Engineering New Developments Everywhere in Electronics

IN 110° PICTURE TUBES . . .

Sylvania replaces hand tipping with a new automatic exhaust tip sealing process that increases 110° picture tube reliability

Sylvania adds new and greater uniformity and reliability to its 110° picture tube line with an automatic tipping process. Now all Sylvania 110° types incorporate the rugged squared seal shown.

The extreme rigidity of the new ruggedized exhaust tip seal virtually eliminates cracking or breakage possibilities. By automating the old hand tipping process, uniform reliability is assured for complete tube runs.

The new automatic sealing process allows

greater control of tip length as well as shape. This is of particular benefit where rigid pin bases are used. It results in more highly uniform base fitting and pin alignment.

Improvements such as the new tipping process indicate why Sylvania continues to lead the way in 110° picture tubes. All Sylvania 110° types, from the 14's and 17's to the newest 24's now incorporate the squared exhaust tip seal. In 110° picture tubes, it pays to specify Sylvania.

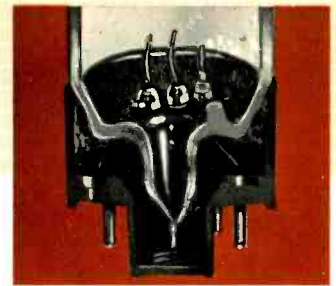

1. "Old" Hand-Tip—Cross section of earlier style base showing seal obtained employing previously used hand tipping



2. "New" Automatic Tip—Cross section of conventional base used on 110° picture tubes



3. "New" Automatic Tip—Cross section of rigid pin base used on 110° picture tubes

IN NEW HEATER DESIGN . . .

Sylvania now offers the design engineer a broader horizon within which to explore, with the development of a sound and proven 300 ma., 6.3 volt heater for picture tubes.

Originally developed for export markets, the 300 ma., 6.3 volt heater can be made available in sample 90° and 110° tubes for the design engineer's evaluation.

SYLVANIA

Sylvania Electric Products Inc.
1740 Broadway, New York 19, N. Y.
In Canada: Sylvania Electric (Canada) Ltd.
Shell Tower Bldg., Montreal

LIGHTING • TELEVISION • RADIO • ELECTRONICS • PHOTOGRAPHY • ATOMIC ENERGY • CHEMISTRY-METALLURGY

Please send additional information on the items checked below:

- | | | |
|---------------------------------------|--|--|
| <input type="checkbox"/> Type 10DE7 | <input type="checkbox"/> Types 6/12DT5 | <input type="checkbox"/> 110° Picture Tubes |
| <input type="checkbox"/> Type 12EK6 | <input type="checkbox"/> Types 6/12CU5 | <input type="checkbox"/> Industrial and Military |
| <input type="checkbox"/> Type 12DY8 | <input type="checkbox"/> Type 6CQ8 | <input type="checkbox"/> C-R Tubes |
| <input type="checkbox"/> Type 12EC8 | <input type="checkbox"/> Types 1J3, 1K3 | <input type="checkbox"/> The 300 ma., 6.3 volt |
| <input type="checkbox"/> Type 6EB8 | <input type="checkbox"/> Gold Brand Brochure | <input type="checkbox"/> heater |
| <input type="checkbox"/> Types 6/8CX8 | <input type="checkbox"/> Guided Missile Line | |

Name _____

Address _____

Company _____

Use this handy
business reply card
to request
additional information
on these important new
Sylvania developments

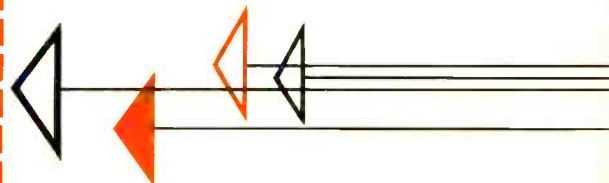



Silicone Dielectrics

ELECTRICAL AND ELECTRONIC NEWS No. 16

New Reference Guide To Aid You

Most complete reference guide to silicones ever produced, describes Dow Corning silicone products now available in commercial quantities: fluids, lubricants, resins, adhesives, varnishes, dielectrics, rubber, water repellents, textile finishes, leather treatments, and other specialized forms.

Its 16 pages are filled with data and illustrations suggesting ways in which you can cut costs, simplify designs, improve performance and add new sales appeal to your products with Dow Corning Silicones.

Cross-indexed for handy reference, this all-new 1958 Guide includes properties and uses for the many new silicone dielectrics developed in recent months. A "must" for every design reference file, you can obtain your Free Copy by circling No. 62

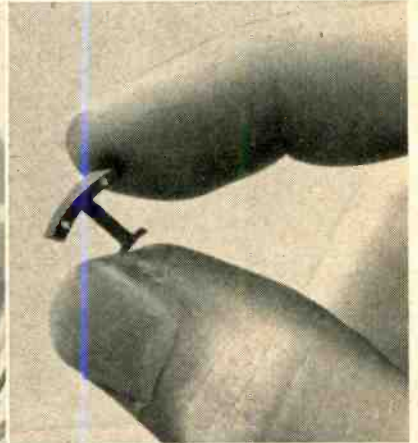
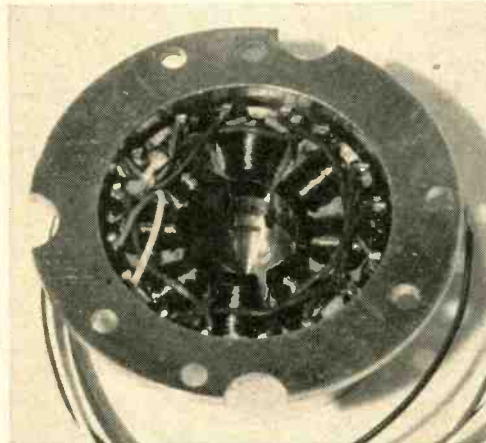

SILICONE DIELECTRICS AID MINIATURIZATION

Silicone dielectrics help designers reduce the size and weight of miniature motors while increasing their dependability. Case in point: the new Servo motors produced by the Aeronautical Division of Minneapolis-Honeywell.

Containing what is believed to be the smallest stator coils ever wound for an ac motor, this entire motor is no larger than

a golf ball. It weighs a mere 2 ounces, operates at controlled speeds ranging from zero to 11,000 rpm and develops a stall-torque of 0.75 ounce-inches.

Despite their miniature size, the motors withstand operational temperatures of 500 F and higher because they are fully insulated with heat-stable Dow Corning Silicones. Wound on bobbins, the tiny stator coils are held in place and insulated from the frame by terminal supports molded from Dow Corning 301 Molding Compound to assure adequate mechanical strength.

The miniature Servo motors drive calibrators, synchros, indicators and other assemblies for Honeywell's fuel measurement, automatic flight control and other aircraft instrument and engine control systems. They present a "Tom Thumb" illustration of the adage, "Dow Corning Silicones give motors more muscles . . . more power per pound." No. 63

New "Shape-it-yourself" Silastic Vulcanizes at Room Temperature

A new, room temperature vulcanizing silicone rubber with excellent handling characteristics and durability is now available from Dow Corning.

The new rubber, Silastic® RTV 501, stays rubbery from -70 to 500 F and has exceptional resistance to moisture and weather. These and the other properties shown below make Silastic RTV 501 ideal for encapsulating electric and electronic

*T. M. REG. U. S. PAT. OFF

assemblies and for general potting, sealing and caulking applications.

Typical Properties of Silastic RTV 501	
Serviceable temperature range	-70 to 500 F
Electric strength, volts/mil	300 to 500
Dielectric constant, 10 ² cycles per second	2.6
Dissipation factor, 10 ² cycles per second	0.01
Water absorption after 70 hours at 212 F, percent	Nil

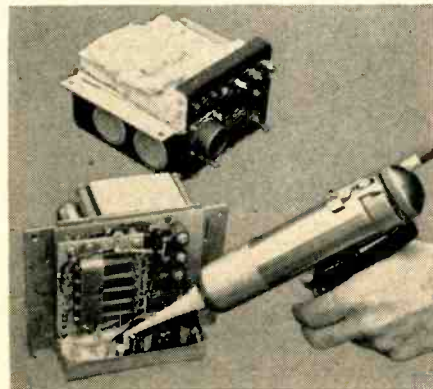

Easy to process, the new silicone rubber has a long shelf life and mixes easily with the recommended catalyst. The two ingredients can be blended either manually or mechanically as long as three hours before being used. Both the fluid polymer and catalyst have a viscosity of approximately 60,000 centistokes. Silastic RTV 501 cures at room temperatures within 24 hours and attains maximum physical properties in only 2 to 3 days. No. 64

Send Coupon for More Information

DOW CORNING CORPORATION - Dept. 482
Midland, Michigan

Please send me 62 63 64

NAME _____

TITLE _____

COMPANY _____

STREET _____

CITY _____ ZONE _____ STATE _____

ATLANTA • BOSTON • CHICAGO • CLEVELAND • DALLAS • DETROIT • LOS ANGELES • NEW YORK • WASHINGTON, D. C.
Canada: Dow Corning Silicones Ltd., Toronto; Great Britain: Midland Silicones Ltd., London; France: St. Gobain, Paris

THE WORLD'S FIRST CARD-OPERATED MILL, PROMISES YOU BETTER STEEL—AUTOMATICALLY



HIGHER QUALITY
MORE
UNIFORM SIZE
BETTER
PHYSICAL PROPERTIES



New method provides a large file of schedules for various types of steel.



General Electric engineers, working closely with AL personnel, developed and installed the control systems which regulate the mill.

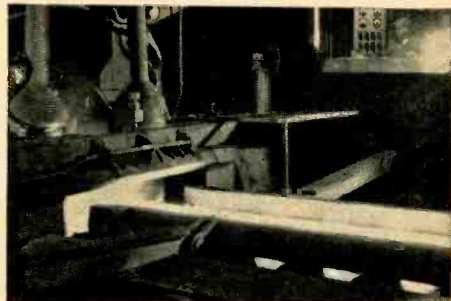

Better quality, more uniform steel is the result.

A NEW punch-card control system, recently installed on the 56" universal roughing mill at Allegheny Ludlum's Brackenridge, Pa. plant, is advancing mill standards of quality control.

Here's how it works: Allegheny Ludlum rolling experts predetermine optimum rolling procedures for the type of steel desired and translate this data into punches on an IBM card. These punches represent the proper screwdown settings, mill speed and number of passes. When the mill schedule calls for it, the mill operator in the pulpit simply selects the proper card, inserts it into the card reader, and he is ready to roll. As the operator makes each pass, the mill is automatically adjusted for each additional pass required. The rolled material is held uniformly to desired dimensions, and day in, day out it proves to have better, more constant physical properties.

It's easy to see how this kind of progress fits into your interest in consistent high quality. By performing rolling operations exactly the same way time after time, this new unit further assures Allegheny Ludlum customers that they are getting the best possible product from the industry's pioneer producer.

Let us talk over your requirements with you. Write us, or call the Allegheny Ludlum sales office nearest you, and an AL sales engineer will help you with any problem. *Allegheny Ludlum Steel Corporation, Oliver Building, Pittsburgh 22, Pennsylvania.*

WSW 6626

PIONEERING on the Horizons of Steel
Allegheny Ludlum





**PROTECTING
AVIONIC
SYSTEMS
FROM**

JANUS:
*protector of
doors to heaven*

Temperature, Pressure, Moisture, Dust

Expanding aircraft performance creates new problems in protecting electronic equipment under extreme altitude and ambient conditions. Eastern's long experience in the field helps you to recommend electronic gear with confidence that performance will be reliable at temperatures from -55°C to $+55^{\circ}\text{C}$; from zero to over 70,000 feet.

Cooling Units, with or without refrigeration cycles, provide safe operating temperature limits in electronic equipment. Pressurization Units that meet government specifications maintain proper operating pressures at various altitudes, and utilize dehydrators that remove moisture and dust from ambient air. A program of research and development continually expands performance ranges to provide customized units to meet your needs.

When your problem is to make your electronic equipment perform efficiently under tough conditions, meet the challenge by asking Eastern for complete and creative engineering help.

Write for Eastern
AVIONICS BULLETIN 340



REFRIGERATION COOLING UNIT

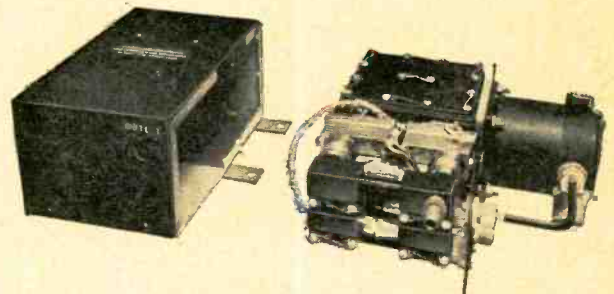

1500 SERIES PRESSURIZATION UNIT



Eastern

INDUSTRIES, INC.

100 Skiff St. Hamden 14, Conn.

West Coast Office: 1608 Centinela Avenue — Inglewood 3, California — Phone ORegon 8-3958

PROBLEM:

How to incorporate fast programming and maintenance into a circuit analyzer.

SOLUTION:

Adaption of Grant Slides to major operating sections.

Dit-mco, Inc., recently developed a new, large capacity mobile Circuit Analyzer built expressly for field use. Subject to generally adverse field conditions, it was necessary for the equipment to stand up under wear, be easily maintained, yet have operating parts quickly accessible. To achieve this, Dit-mco had the switching sections, power supply, detector unit and relay control section mounted on Grant Slides. Grant Slides solved the maintenance problem by permitting extremely fast inspection of the internal components of the equipment.

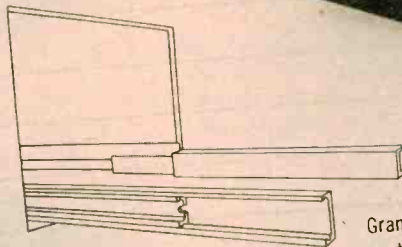
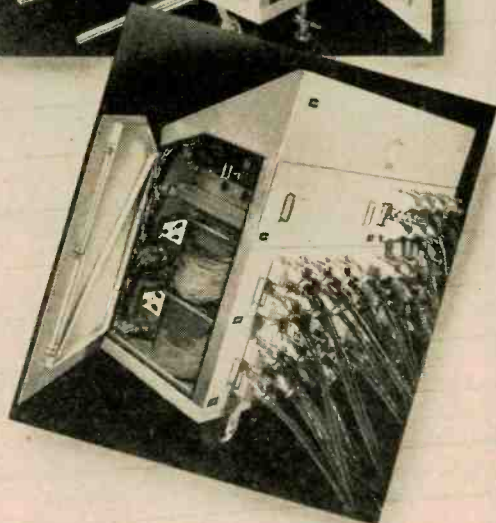

Grant No. 380 Slide recommended for leads up to 500 lb./pair.
Write for complete technical data on the wide range of Grant Slides.

Courtesy Dit-mco, Inc. Kansas City, Mo

GRANT INDUSTRIAL SLIDES

Grant Pulley & Hardware Corp.
23 High Street, West Nyack, New York
944 Long Beach Ave., Los Angeles, California



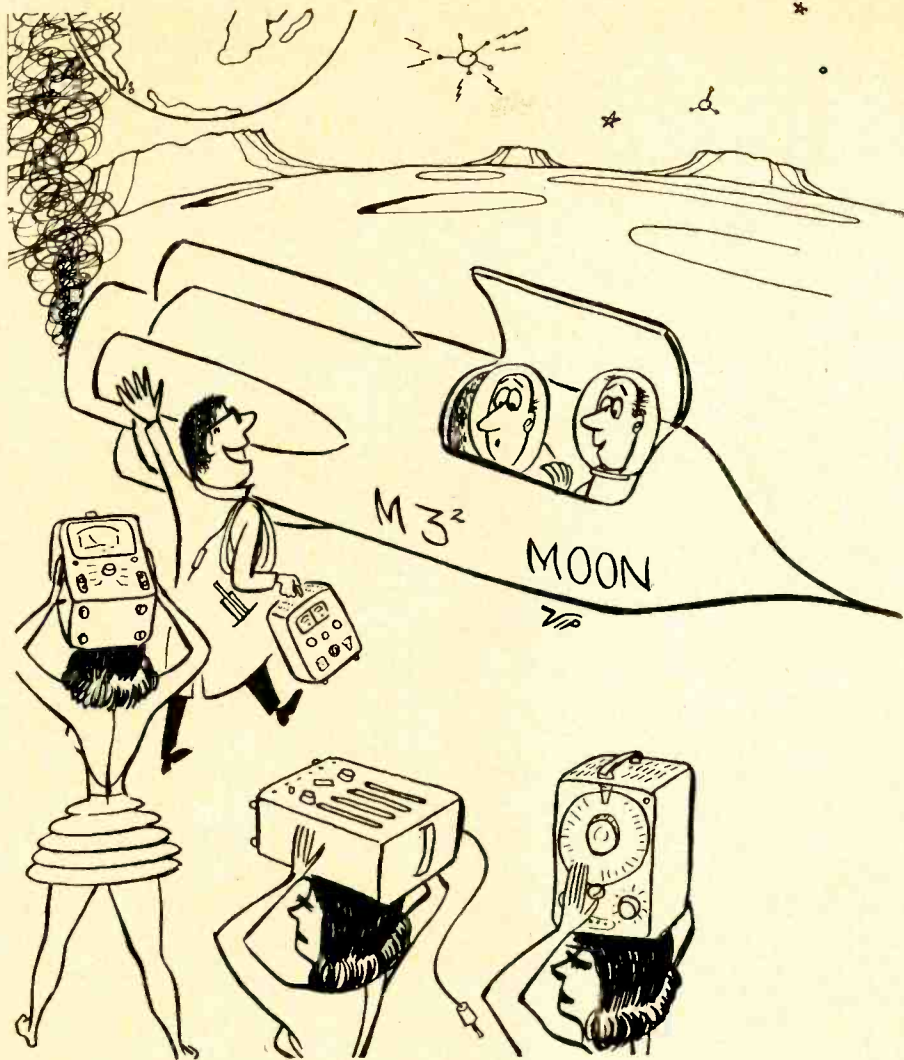

Everywhere—but everywhere— there's a friendly *-hp-* engineer

All across North America, in almost every part of Europe, in Japan, Australia and New Zealand, in Africa—literally throughout the Free World—there's an *-hp-* representative as near as your telephone.

-hp- representatives are broadly experienced instrumentation engineers who have been trained and re-trained at Hewlett-Packard's plant in California. Annually these men return to California from all parts of the world for refresher work, and instruction in application and operation of new instrumentation.

It is a simple fact that the *-hp-* representative's organization is the best trained, best informed and most helpful electronic instrument engineering group in the world. Call your *-hp-* representative for complete engineering information, sales or service on Hewlett-Packard equipment as applied to your measuring problems.

HEWLETT-PACKARD COMPANY

4625A PAGE MILL ROAD • PALO ALTO, CALIFORNIA, U.S.A.
Cable "HEWPACK" • DAVenport 5-4451

4625

-hp- at IRE, top of escalators as you enter show



means complete coverage in service, too!

■ (Factory-level service and repairs available)

EASTERN SEABOARD

Asbury Park, N. J., I. E. Robinson Company, 905 Main St., KE 1-3150. **Baltimore, Md.**, Harman Associates, Inc., 635 St. Johns Rd., HO 7-2290. **Boston Area** ■, Burlington, Mass., Yewell Associates, Inc., Middlesex Turnpike, BR 2-9000. **Bridgeport 8, Conn.**, Yewell Associates, Inc., 1101 E. Main St., FO 6-3456. **Camp Hill, Pa.**, I. E. Robinson Company, 2120 Market St., RE 7-6791. **Englewood, N. J.**, R. M. C. Associates, 391 Grand Ave., LO 7-3933. **New York 21, N. Y.** ■, R. M. C. Associates, 236 E. 75th St., TR 9-2023. **Philadelphia Area** ■, Upper Darby, Pa., I. E. Robinson Company, 7404 West Chester Pike, SH 8-1294. **Pittsburgh 22, Pa.**, S. Sterling Company, Rm. 815, Park Bldg., 355 Fifth Ave., AT 1-9248. **Syracuse 1, N. Y.** ■, J. D. Ryerson Associates, Inc., P. O. Box 1400, GI 6-1771. **Washington, D. C. Area** ■, Rockville, Md., Harman Associates, Inc., Rockville Pike and Rollins Ave., DE 2-5705.

SOUTHEASTERN STATES

Atlanta 5, Ga., Bivins & Caldwell, 3133 Maple Dr., N.E., CE 3-7522. **Fort Myers, Fla.** ■, Arthur Lynch & Associates, 35 W. North Shore Ave., ED 2-1109. **High Point, N. C.** ■, Bivins & Caldwell, Inc., 1923 N. Main St., Tel.: 2-6873.

CENTRAL, SOUTH CENTRAL STATES

Chicago 45, Ill. ■, Crossley Associates, Inc., 2711 W. Howard St., SH 3-8500. **Cleveland 21, Ohio**, S. Sterling Company, 4311 Mayfield Rd., EV 2-4114. **Dayton 19, Ohio** ■, Crossley Associates, Inc., 53 Park Ave., AX 9-3594. **Detroit 35, Mich.** ■, S. Sterling Company, 15310 W. McNichols Rd., BR 3-2900. **Indianapolis 20, Ind.**, Crossley Associates, Inc., 5320 N. College Ave., CL 1-9255. **Kansas City 30, Mo.**, Harris-Hanson Company, 7916 Paseo Blvd., HI 4-9494. **St. Louis 17, Mo.** ■, Harris-Hanson Company, 2814 So. Brentwood Blvd., MI 7-4350. **St. Paul 14, Minn.** ■, Crossley Associates, Inc., 842 Raymond Ave., MI 6-7881. **Dallas 9, Tex.** ■, Earl Lipscomb Associates, P. O. Box 7084, FL 7-1881 and ED 2-6667. **Houston 5, Tex.**, Earl Lipscomb Associates, P. O. Box 6573, JA 4-9303.

WESTERN STATES

Albuquerque, N. M. ■, Neely Enterprises, 107 Washington St., S.E., AL 5-5586. **Denver 10, Colo.**, Lahana & Company, 1886 S. Broadway, PE 3-3791. **Las Cruces, N. M.**, Neely Enterprises, 126 S. Water St., JA 6-2486. **Los Angeles, Calif.** ■, Neely Enterprises, 3939 Lankershim Blvd., North Hollywood, Calif., ST 7-0721. **Phoenix, Ariz.** ■, Neely Enterprises, 641 E. Missouri, CR 4-5431. **Portland 9, Ore.**, ARVA, 1238 N. W. Glisan, CA 7-1281. **Sacramento 14, Calif.** ■, Neely Enterprises, 1317 - 15th St., GI 2-8901. **San Diego 6, Calif.** ■, Neely Enterprises, 1055 Shafter St., AC 3-8106. **San Francisco Area** ■, San Carlos, Calif., Neely Enterprises, 501 Laurel St., LY 1-2626. **Seattle 99, Wash.**, ARVA, 120 W. Thomas St., MU 7337. **Tucson, Ariz.**, Neely Enterprises, 232 So. Tucson Blvd., MA 3-2564.

CANADA

Toronto 10, Ontario ■, Atlas Radio Corporation, Ltd., 50 Wingold Ave., RU 1-6174. **Vancouver 2, B. C.**, Atlas Radio Corporation, Ltd., 106-525 Seymour St., MU 3-5848. **Winnipeg, Manitoba**, Atlas Radio Corporation, Ltd., 505 McIntyre Bldg.

OVERSEAS

Belgium, Société Belge Radio - Electrique, 66, Chaussée de Ruisbroek, Forest-Bruxelles, Tel: 444810/44. **Denmark**, Tage Olsen A/S, Centrumsgaarden, Room 133, 6D, Vesterbrogade, Copenhagen V., Tel: Palae 1369 and 1343. **Finland**, Into O/Y, 11 Meritullinkatu, Helsinki, Tel: 621 425 and 35 125. **France** ■, Radio Equipements, 65 rue de Richelieu, Paris 2ème, Tel: Richelieu 49-88. **Germany**, Schneider, Henly & Co., Muenchen 59, Gross-Nabas-Strasse 11, Tel: 46277. **Italy**, Dott. Ing. Mario Vianello, Via L. Anelli 13, Milano, Telef. 553.081. **Netherlands**, C. N. Road N.V., Cort van der Lindenstr. 13, Rijswijk, Z.H. **Portugal**, Senatejo Industrial, Lda., Rua do Alecrim, 46-S/Loja, Lisbon, Tel: 34446. **Spain**, Compañia Auxiliar de Comercio y Navegación, S.A., "AUCONA", Alcalá 63, Madrid, Tel. 25 17 35. **Sweden** ■, Erik Ferner AB, Björnsonsgratan 197, Bromma, Stockholm, Tel: 37 42 77 - 37 77 00. **Switzerland** ■, Max Paul Frey, Hangweg 27, Berne-Liebfeld, Tel: (031) 63.36.45. **United Kingdom** ■, Livingston Laboratories, Retcor St., London, N. 19, England, Tel: Archway 6251. **Yugoslavia**, Belram Electronics, 43 Ch. de Charleroi, Brussels, Belgium, Tel: 38.12.40. **Australia** ■, Geo. H. Sample & Son Pty. Ltd., 17-19 Anthony St., Melbourne, C.1, Tel: FJ4138 (3 Lines), 280 Castlereagh St., Sydney, Tel: MA 6281 (3 Lines). **Formosa**, Far-Eastern Company, No. 6 Nanyang St., Taipei, Taiwan, Tel: 27876. **India**, The Scientific Instrument Company, Ltd., 6, Tej Bahadur Sapru Rd., Allahabad 1; 240, Dr. Dadabhai Naoroji Rd., Bombay 1; 11, Esplanade East, Calcutta 1; B-7, Ajmeri Gate Extn., New Delhi 1; 30, Mount Road, Madras 2. **Japan**, Seki & Company, Ltd., Kanai Bldg., No. 1 Kanda Higashi-Fukudacho, Chiyoda-ku, Tokyo, Tel. Kayabacho (66) 0828-3012-4712. **New Zealand**, Geo. H. Sample & Son (N.Z.) Ltd., 431 Mount Albert Road, Mount Roskill S.1, Auckland, Tel: 89-439. **Union of South Africa**, F. H. Flanter & Co., 4, Buitencingle St., Cape Town, Tel. 2-1510.

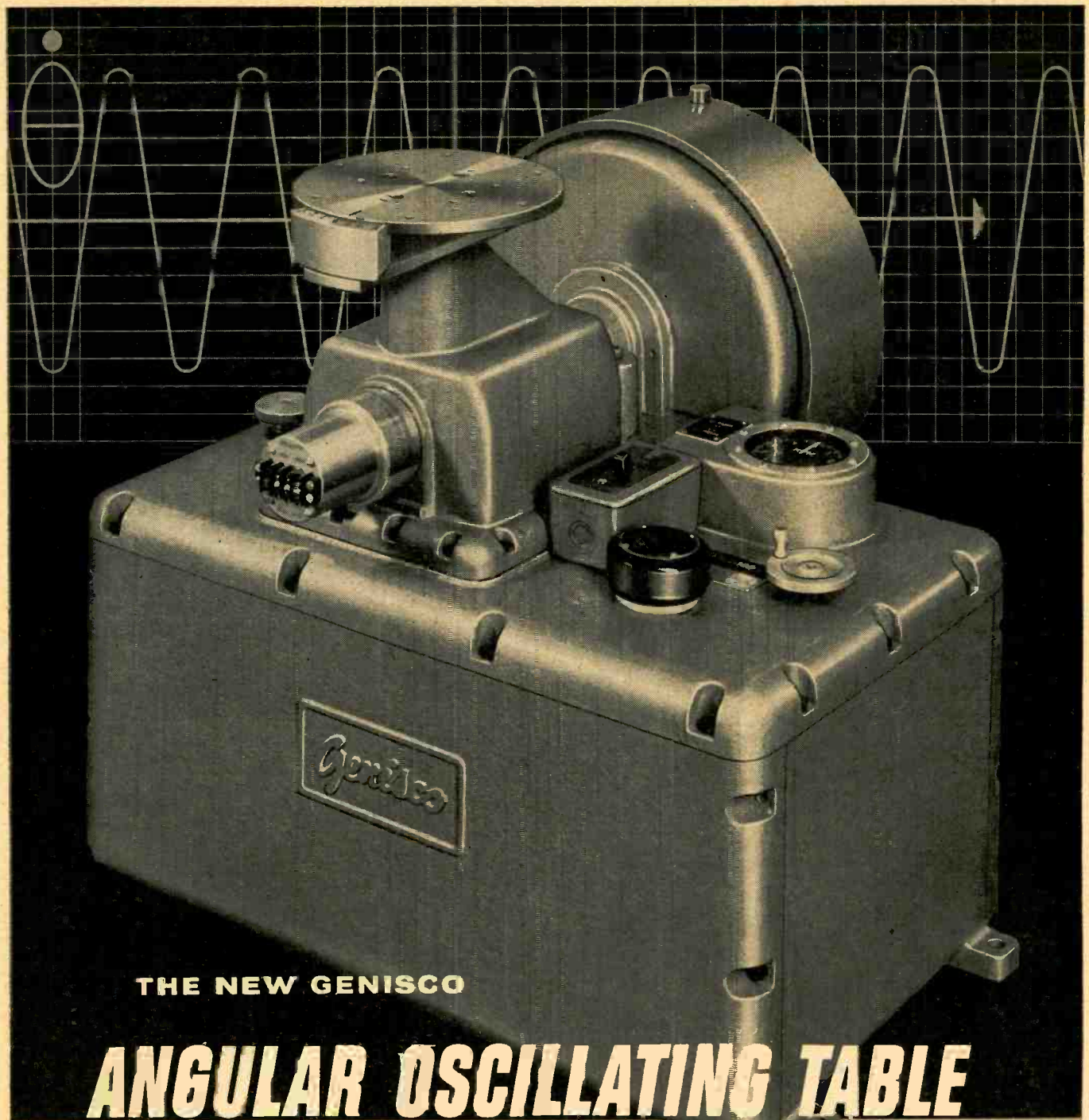

THE NEW GENISCO

ANGULAR OSCILLATING TABLE

Generates a precise sinusoidal function accurate to within 0.1% at excursions up to $\pm 2^\circ$, 0.5% up to $\pm 10^\circ$, and 1% up to $\pm 15^\circ$.

This newest Genisco machine utilizes a unique conical crank mechanism to generate an angular oscillation which closely corresponds to a theoretical sinusoidal waveform. A precision sine-cosine resolver coupled to the crankshaft can be used to bring a test instrument output signal and the oscillating table output signal into coincidence for direct reading of phase lag angle.

The extreme accuracy of the Model B386 Oscillating Table makes it particularly suited for evaluating the damping and response characteristics of angular accelerometers and rate gyros. The Model B386 can also be used for calibrating peak angular velocities and peak accelerations to the accuracy of the known angular excursion and frequency. Within its range, the machine can double as an environmental angular shake table.

For complete information and performance specifications, write to—

Brief specifications

Angular Excursion—Initially adjustable from zero to $\pm 15^\circ$.

Frequency Range—Continuously variable from 0.02 to 3 cps in the low range; 0.2 to 30 cps in the high range.

Accuracy:

Angular Excursion—within 30 minutes of arc.
Frequency Indication—within 1% with tachometer within 0.1% with stroboscope.

Payload Capacity—100 lb. deadweight; 750 lb.-in. under dynamic conditions. Protected against dynamic over load by replaceable shear pins.

Vibration Isolation:

Vertical Displacement—0.003" max. at any frequency.
Lateral Displacement—0.001" max. at any frequency.

Platform Diameter: 8"
Approx. Weight: 400 lb.

Genisco
INCORPORATED

2253 FEDERAL AVE., LOS ANGELES 64, CALIFORNIA

See how
the facts speak
for themselves

hcd ^{*}RADIO RECEPTOR Petti-Sel SELENIUM RECTIFIERS are revolutionizing the field!

* high current density



Standard
rectifier

RRco. Petti-Sel
rectifier

- ▶ 100,000 hours estimated life
- ▶ Lower voltage drop
- ▶ Higher current density
- ▶ Less reverse leakage
- ▶ Smaller size

Both rectifiers are rated at 26V, 8 amps,
but notice the significant space saving in the
compact Petti-Sel unit.

compare the size ...

compare the specs ...

STANDARD SELENIUM RECTIFIERS								
NOMINAL CELL SIZE (INCHES)		RRco. CELL CODE	Continuous DC Amperes at 35° C Ambient					
Vert.	Horiz.		SINGLE PHASE			THREE PHASE		
			Half Wave	Center Tap	Bridge	Half Wave	Center Tap	Bridge
1.0	1.0	M	.11	.22	.22	.29	.40	.33
1 1/6	1 1/6	P	.23	.45	.45	.60	.81	.67
1.5	1.5	Q	.45	.90	.90	1.2	1.6	1.3
2	2	S	.70	1.4	1.4	1.8	2.5	2.1
3	3	U	1.6	3.2	3.2	4.2	5.8	4.8
3 3/8	3 3/8	V	2.0	4.0	4.0	5.3	7.2	6.0
4	4	W	3.0	6.0	6.0	8.0	10.8	9.0
4.5	5	G	3.75	7.5	7.5	10.0	13.5	11.2
4 1/4	6	T	4.2	8.5	8.5	11.0	15.0	12.5
5	6	H	5.0	10.0	10.0	13.3	18.0	15.0
6	7 1/4	L	7.5	15.0	15.0	20.0	27.0	22.5

RRco. PETTI-SEL SELENIUM RECTIFIERS								
NOMINAL CELL SIZE (INCHES)		RRco. CELL CODE	Continuous DC Amperes at 35° C Ambient					
Vert.	Horiz.		SINGLE PHASE			THREE PHASE		
			Half Wave	Center Tap	Bridge	Half Wave	Center Tap	Bridge
1.0	1.0	6	0.2	0.4	0.4	0.6	1.0	0.6
1.3	1.3	11	0.5	1.0	1.0	1.5	2.5	1.5
1.6	1.6	16	0.75	1.5	1.5	2.25	3.75	2.25
2	2	25	1.25	2.5	2.5	3.75	6.25	3.75
2.6	2.6	44	2.25	4.5	4.5	6.75	11.25	6.75
4	4	100	4	8	8	12	20	12
4	8	200	8	16	16	24	40	24
4	12	300	12	24	24	36	60	36
8	8	402	16	32	32	48	80	48
8	12	600	22.5	45.0	45.0	67.5	112.5	67.5
8	16	800	30.0	60.0	60.0	90	150	90

In case you haven't noticed, the yellow and gray areas denote actual comparative sizes of the two rectifier types.

and compare the prices! HCD Petti-Sel rectifiers, developed in Western Germany by Siemens and now made in the U.S. by Radio Receptor, offer many important electrical advantages over standard types plus economic advantages.

See us at our booths
#2211 - 2213 - 2215 -
2217 at the I.R.E. Show

See for yourself - We'll be glad to send you further information on this remarkable new rectifier line. Submit your requirements to Section E-2R.

Radio and
Electronic Products
Since 1922



Semiconductor Division
RADIO RECEPTOR COMPANY, INC.
Subsidiary of General Instrument Corporation

240 WYTHE AVENUE, BROOKLYN 11, N. Y. • EVergreen 8-6000

Radio Receptor products for Industry and Government:
Germanium and Silicon Diodes, Selenium Rectifiers, Thermatron Dielectric
Heating Generators and Presses, Communications, Radar and Navigation Equipment

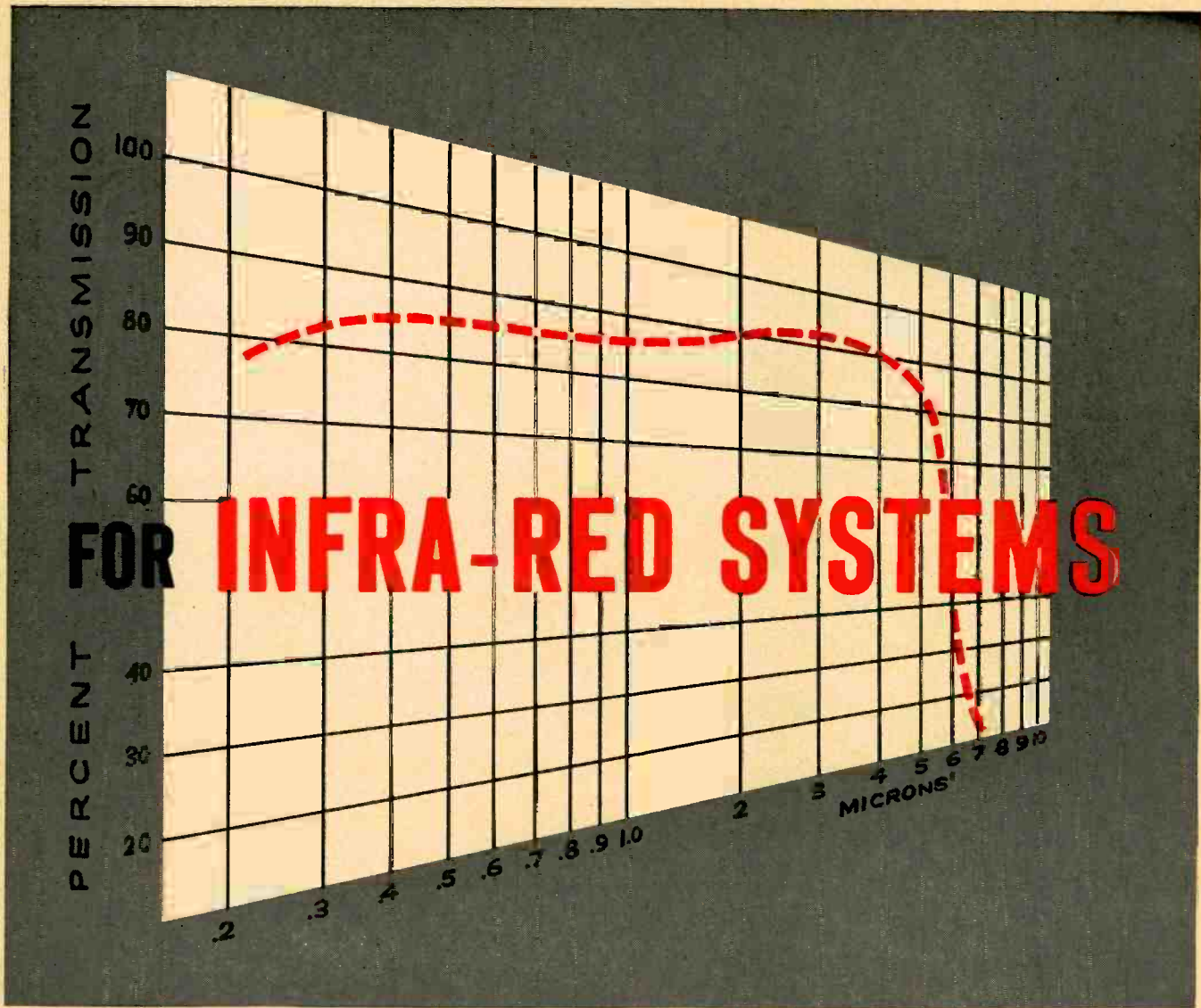

SPECIFY **LINDE** Sapphire

TRADE-MARK

LINDE Sapphire is ...

Hard—Moh 9
 Transparent, single crystal, pure aluminum oxide
 Nonporous—0% porosity
 Easily sealed to metals and ceramics
 Priced competitively with sintered materials

LINDE Sapphire has ...

Strength at elevated temperatures
 High melting point—2040° C.
 Excellent IR transmission at high temperatures (above 500° C.)

LINDE Sapphire is available as ...

Windows
 Domes
 Rods and tubes
 Special shapes—to order

For more information about LINDE Sapphire . . . Write "Crystals Dept. BD-22," LINDE COMPANY, Division of Union Carbide Corporation, 30 East 42nd Street, New York 17, N. Y. *In Canada:* Linde Company, Division of Union Carbide Canada Limited

Linde



ENGINEERS AND SCIENTISTS interested in working in Synthetic Crystal Sales & Development, contact Mr. A. K. Seemann, Linde Company, 30 E. 42nd St., New York 17, N.Y.

The terms "Linde" and "Union Carbide" are registered trade-marks of Union Carbide Corporation.

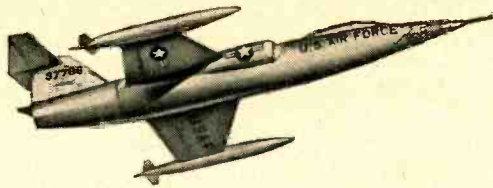

**SEARCH
IDENTIFY
COMPUTE
COMMUNICATE
INTERCEPT**



Now—from General Electric—tubes to military specifications for entire systems!

This means computers too, because General Electric's 5-Star 6829—the industry's first tube built and tested to a military computer-tube specification—is the final link in the chain.

Here is a twin triode with exceptional ruggedness and reliability—the reliability that only tubes can give. It is specifically intended for ground and airborne military use. Similar in characteristics to standard computer Type 5965, the 5-Star 6829 is designed for high-speed circuits—has high permeance, balanced, sharp cut-off qualities, and low heater power requirement (.45 amp at 6.3 v).

Specify—for military computer applications—tubes backed by General Electric's 7-year record of

primacy in computer-tube development! First manufacturer to design and introduce special computer tubes: General Electric. First builder of high-reliability computer types: General Electric. More G-E computer tubes have been built and installed than any other make. Many G-E 5844's—the first computer tubes—still are operating, *after more than 50,000 hours' active service.*

For computers—for other electronic equipment—G-E 5-Star Tubes, miniatures and subminiatures, offer proved performance, proved dependability, plus a wide range of types to meet every socket requirement. Get further facts from any office of the G-E Receiving Tube Department below.

EASTERN REGION

200 Main Avenue, Clifton, New Jersey
Phones: (Clifton) GRegory 3-6387
(N.Y.C.) Wlconsin 7-4065, 6, 7, 8

CENTRAL REGION

3800 North Milwaukee Avenue
Chicago 41, Illinois
Phone: SPring 7-1600

WESTERN REGION

11840 West Olympic Boulevard
Los Angeles 64, California
Phones: GRanite 9-7765; BRadshaw 2-8566

Progress Is Our Most Important Product

GENERAL  ELECTRIC

12-11-202

CIRCLE 10 READERS SERVICE CARD

#2 This picture shows slightly less than one minute of a record perhaps 10 minutes long.
 It is a good interferometer record, though not quite as "pretty" as #1. It has a very good record of WWV timing signals.

this is a record of Sputnik

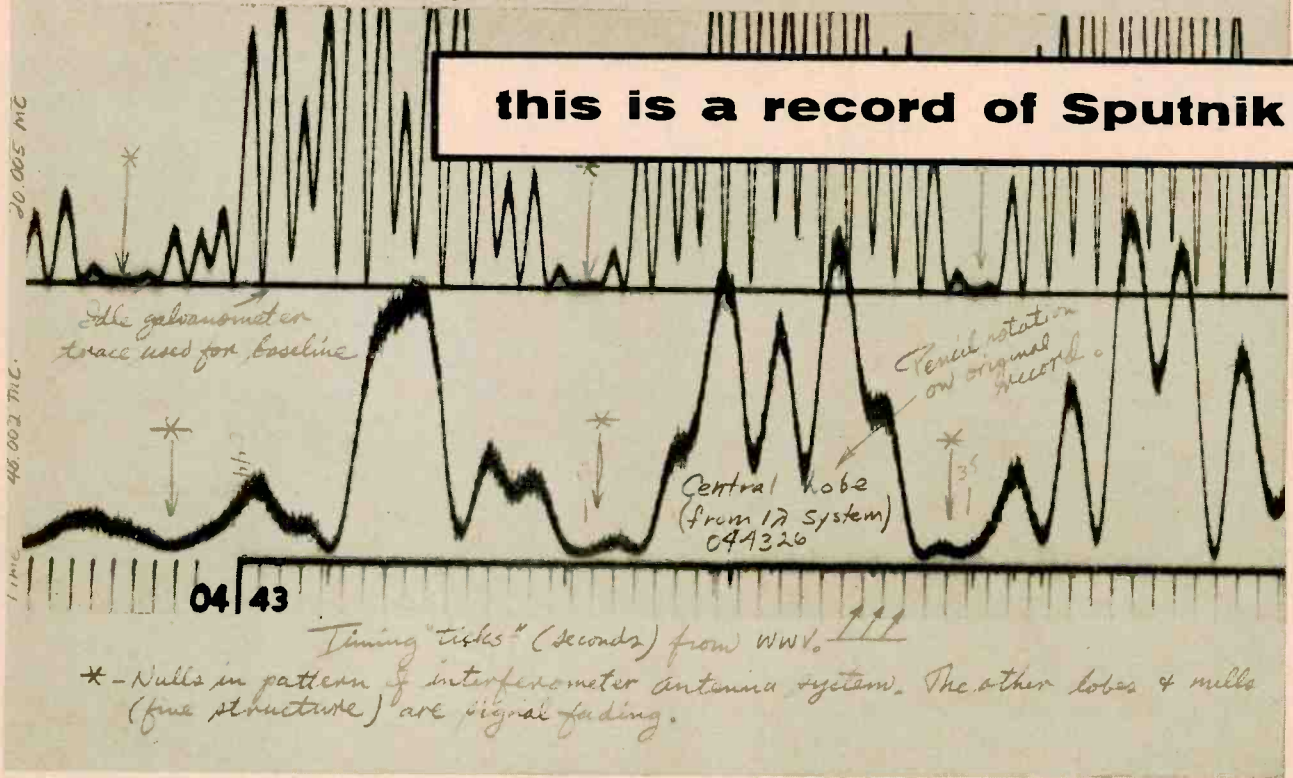

The Visicorder has charted the orbit of Sputnik I

A Model 906 Honeywell Visicorder Oscillograph wrote this record of the signals from Sputnik I for the Department of Electrical Engineering at the University of Illinois at Urbana. The marginal notes are those of Edgar Hayden, the research associate who took the record.

Interferometer-type antenna systems (2 dipole elements $\frac{1}{2}$ wavelength above ground spaced several wavelengths along a north-south baseline) received the two signals for communications-type radio receivers. The beat oscillators generated audio output signals, a semi-conductor bridge circuit rectified them, and the d-c output, filtered by an R-C network with a time constant of about .003 seconds, was used to drive the Visicorder galvanometers directly.

The Visicorder, teamed with the interferometer antenna, quickly established a record of the orbit of Sputnik I.

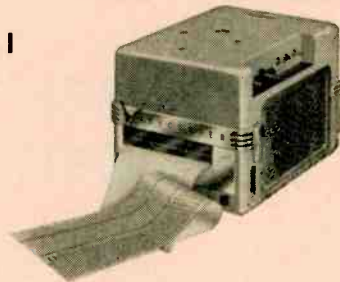

The Honeywell Visicorder is the first high-frequency, high-sensitivity direct recording oscillograph. In laboratories and in the field everywhere, instantly-readable Visicorder records are pointing the way to new advances in product design, rocketry, computing, control, nucleonics... in any field where high speed variables are under study. To record high frequency variables—and monitor them as they are recorded—use the Visicorder Oscillograph. Call your nearest Minneapolis Honeywell Industrial Sales Office for a demonstration.

Honeywell



Heiland Division



Better Things for Better Living
through Chemistry

ELECTRONIC DESIGN

LATEST PROPERTY AND APPLICATION DATA ON

TEFLON[®]

fluorocarbon
resins

NEWS

Components miniaturized with **TEFLON**[®] provide high thermal and electrical ratings

TFE-fluorocarbon resins

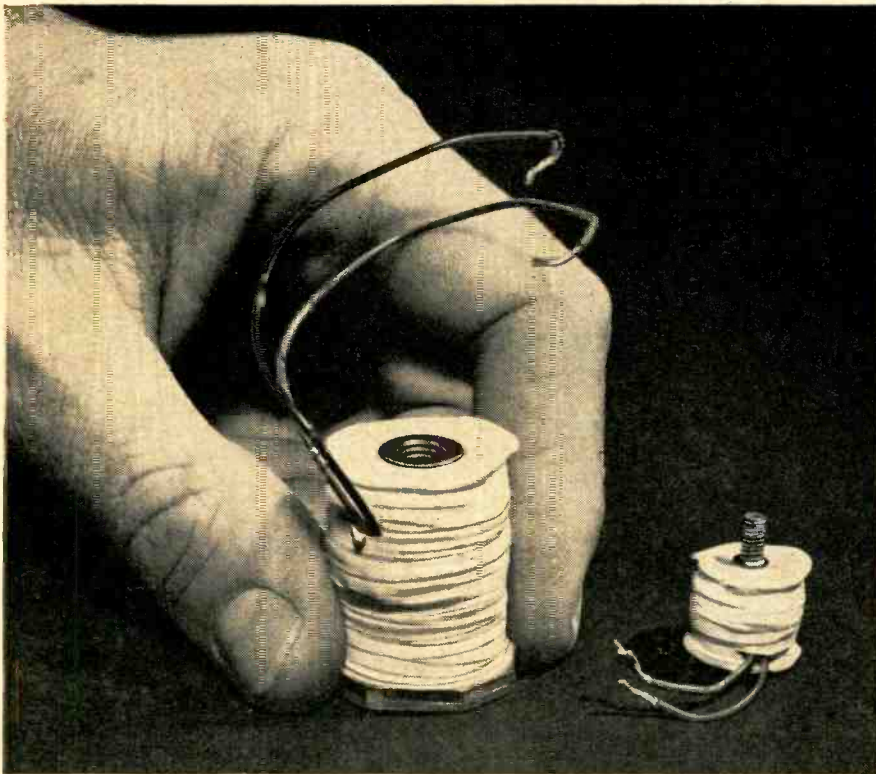

MINIATURE COILS pack more power into a tiny space, due to the outstanding dielectric and thermal properties of TEFLON resins.

(Coils made with TEFLON TFE-fluorocarbon resins manufactured by Tur-Bo Jet Products, Inc., San Gabriel, California.)

The problem of getting more ampere turns into a winding without increasing its size is solved by the use of TEFLON TFE resins. Now, subminiature coils can be built for continuous, efficient operation at -68° to 260°C . using extremely fine-gauge wire insulated with a TEFLON resin. These resins remain tough and non-brittle even in contact with low-boiling liquefied gases. As for dielectric strength, they are rated for 500 to 4000 volts per mil, depending on thickness.

In addition, TEFLON resins have coil processing advantages possessed by no other resin. The coils shown are baked out at 300°C . under vacuum, assuring thorough de-gassing to maximum operating temperature. Varnishes, adhesives and other gas-producing materials are eliminated, reducing contamination of relay contacts. Since TEFLON resins have practically zero moisture absorption, their dimensions and dielectric constant are stable in service. Virtually no chemical affects these resins, and they will not react with coil metals.

If you require smaller components with no sacrifice in performance or power, why not see what these resins can do? Every designer and engineer should know the facts on TEFLON resins as dielectrics.

Write to: E. I. du Pont de Nemours & Co. (Inc.), Polychemicals Department, Room 172, Du Pont Building, Wilmington 98, Delaware. In Canada: Du Pont Company of Canada (1956) Ltd., P. O. Box 660, Montreal, Quebec.

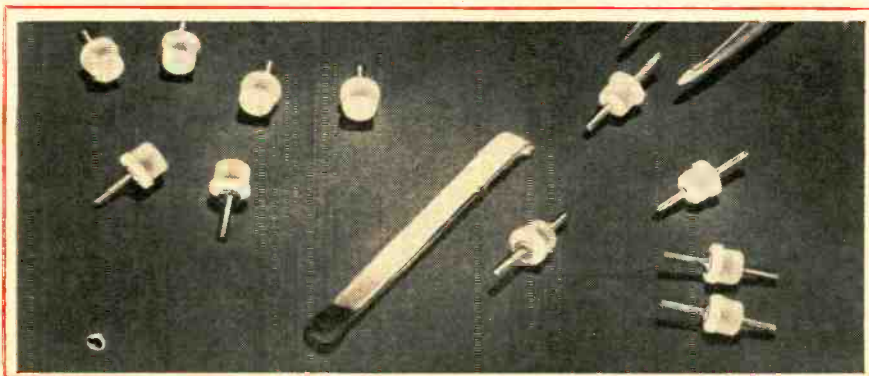

Subminiature terminals speed electronics assembly

STAND-OFF AND FEED-THROUGH TERMINALS suitable for subminiature components are now made possible by Du Pont TEFLON TFE-fluorocarbon resins. The new terminals are rapidly installed by pushing them into place with a simple "corking" motion. A

manufacturer of IF amplifiers for guided missiles found these terminals much more immune to damage from shock and vibration than the glass-insulated terminals they replaced. (Terminals manufactured by Tri-Point Plastics, Inc., Albertson, L. I., New York.)

TEFLON[®]

is a registered trademark . . .

TEFLON is Du Pont's registered trademark for its fluorocarbon resins, including the TFE (tetrafluoroethylene) resins discussed herein. This registered trademark should not be used as an adjective to describe any product, nor should it be used in whole, or in part, as a trademark for a product of another concern.

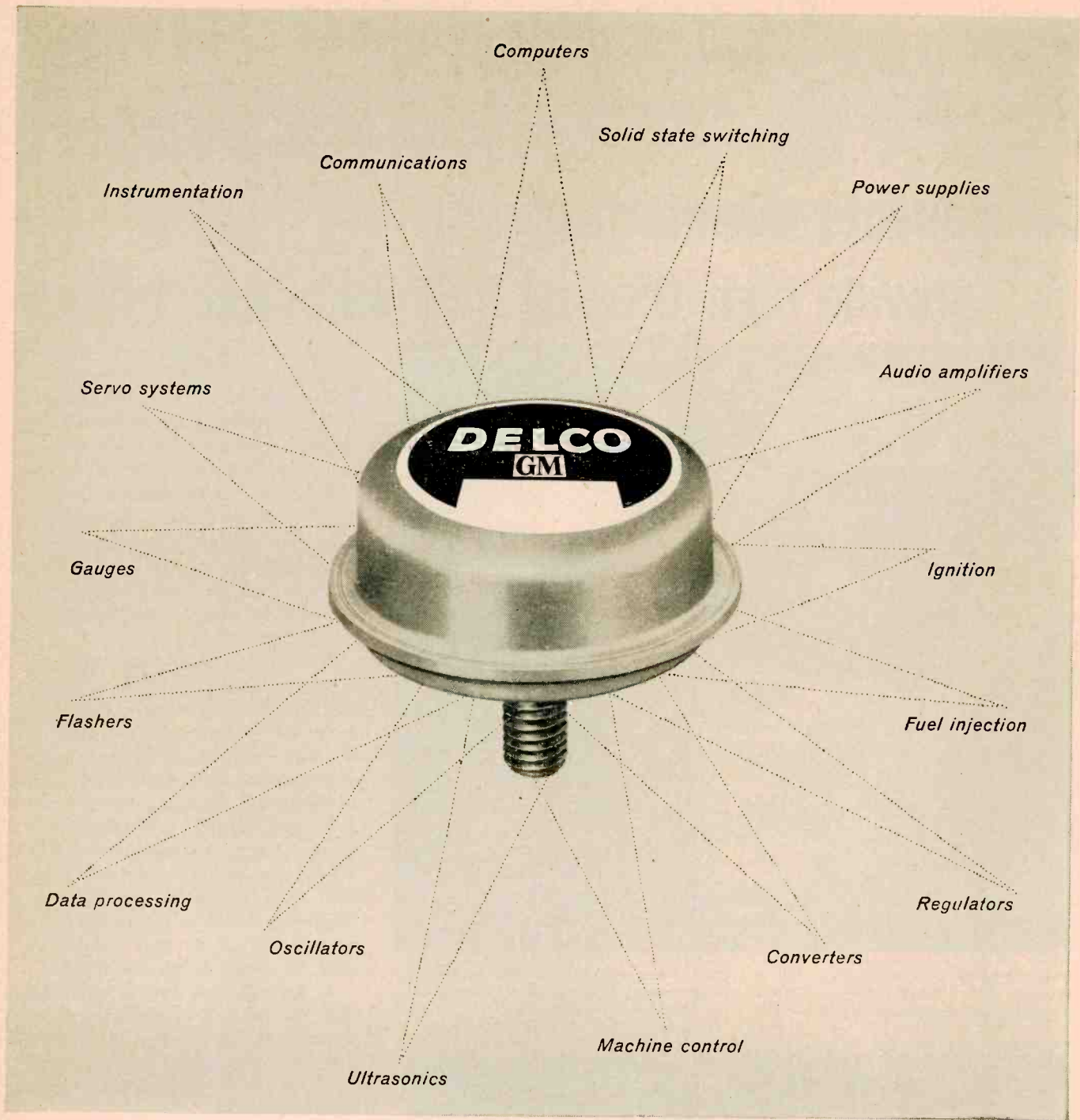

Wherever you require high power, consider

DELCO HIGH POWER TRANSISTORS

Thousands of Delco high power germanium transistors are produced daily as engineers find new applications for them. In switching, regulation, or power supplies—in almost any circuit that requires high power—Delco transistors are adding new meaning to compactness, long life and reliability.

All Delco transistors are 13-ampere types and, as a family, they offer a collector voltage range from 40 to 100 volts. Each is characterized by uniformly low saturation resistance and

high gain at high current levels. Normalizing insures their fine performance and uniformity regardless of age. Also important—all Delco transistors are in volume production and readily available at moderate cost.

For complete data contact us at Kokomo, Indiana or at one of our conveniently located offices in Newark, New Jersey or Santa Monica, California. Engineering and application assistance is yours for the asking.

DELCO RADIO

DIVISION OF GENERAL MOTORS, KOKOMO, INDIANA

Critical Seal

PROBLEMS?



Compression
Seals

Multiple
Headers



Sealed Terminals



Condenser End Seals



Threaded Seals

Transistor
Closures



Miniature Closures



Color Coded Terminals

* Manufactured under
Canadian Patent 523,390
United Kingdom Patent
734,583 and Licensed
under U.S. Patent 2561520

Complete Facilities to Meet
Your Hermetic Seal Requirements

E-I GLASS-TO-METAL SEALS*

Standard, miniature or sub-miniature, E-I sealed terminals are available for every commercial or military requirement. E-I super-rugged compression seals meet the most critical specifications and provide maximum immunity to vibration, mechanical shock and wide temperature and pressure changes.

In addition to hundreds of economical standard terminals and closures, E-I offers complete service on custom seals or will seal components of your own manufacture. Request catalog today, or consult E-I on your specific hermetic seal requirements.

Check These 8 Design Advantages

- Cushioned Glass Construction
- High Dielectric Strength
- Design Standardization
- Vacuum Tight Sealing
- Vibration Resistant
- Super Durability
- Maximum Rigidity
- Miniaturization

ELECTRICAL INDUSTRIES



A Division of Philips Electronics, Inc. — MURRAY HILL, NEW JERSEY



temperature stable in every use

RMC TYPE JL DISCAPS

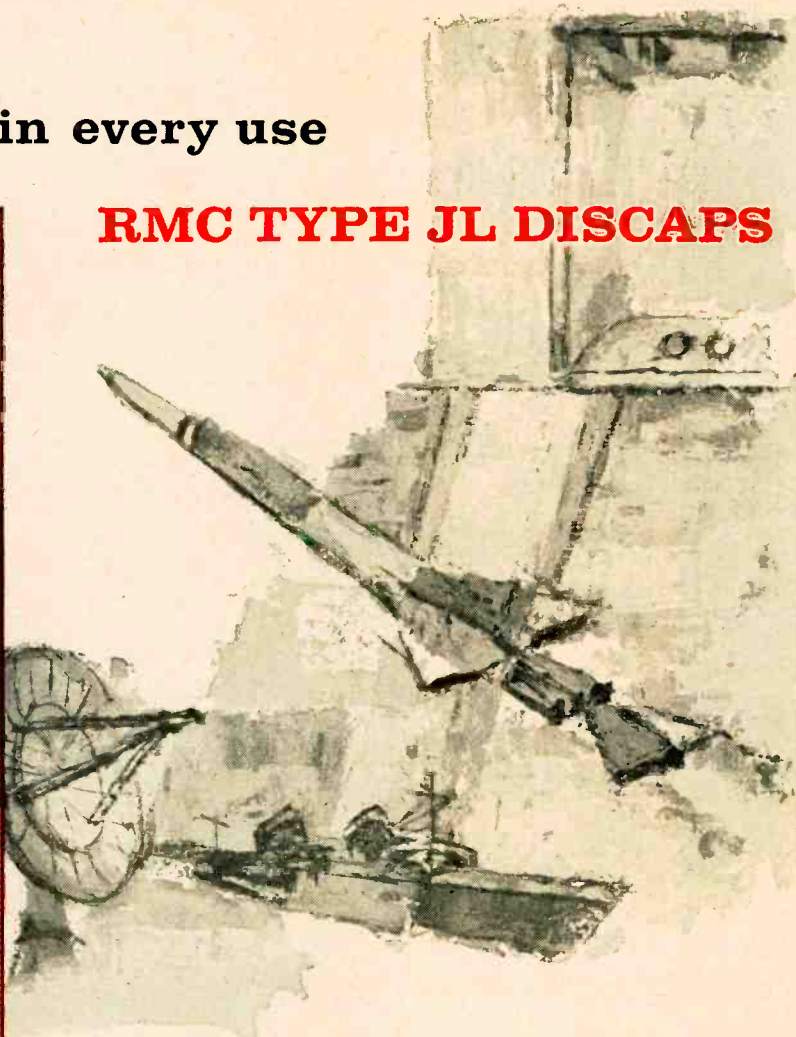

Type JL DISCAPS are especially designed for applications requiring a minimum capacity change as temperature varies between -60°C and $+110^{\circ}\text{C}$. The maximum change between these extremes is only $\pm 7.5\%$ of capacity at 25°C .

With a standard working voltage of 1000 V.D.C., Type JL DISCAPS are ideal cost saving replacements for paper or general purpose mica capacitors.

Write on your letterhead for samples and additional data.

DISCAP
CERAMIC
CAPACITORS



RADIO MATERIALS COMPANY
A DIVISION OF P. R. MALLORY & CO., INC.
GENERAL OFFICE: 3325 N. California Ave., Chicago 18, Ill.
Two RMC Plants Devoted Exclusively to Ceramic Capacitors
FACTORIES AT CHICAGO, ILL. AND ATTICA, IND.

12 POPULAR MODELS FROM OUR STOCK OF OVER A MILLION RELAYS

LATCH and RESET



Advance 

BQA



Automatic Electric 

TYPE 45

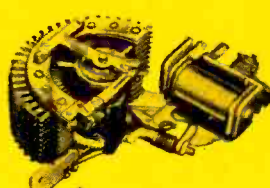

TYPE J



C. F. Clare

M E R

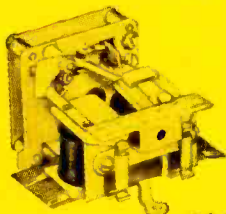

Guardian Electric 

CERAMIC KEYING

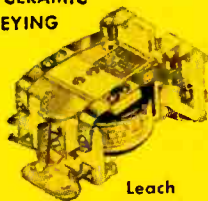

Leach 

DC ACTUATOR

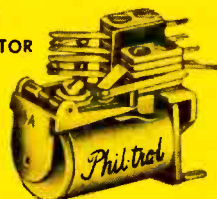

Phillips Control 

TYPE 20



C. P. CLARE

REVERSING CONTACTOR



Struthers-Dunn 

DC CONTRACTOR

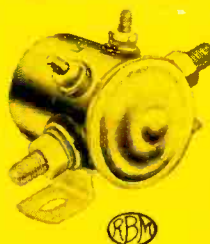



710 MINIATURE



TERADO 

Order from the world's most complete stock of...

Relays

Why order from several sources when you can buy all your relays from us!

Save the cost of multiple purchase orders, delivery dates and payments. Save confusion and delay waiting for relays to be manufactured. We have over a million latest models in stock. Specify the contact arrangement and coil rating you need. No order is too small, nor too big. All relays are new, inspected and unconditionally guaranteed as represented.

FOR 24 HOUR DELIVERY
CALL WEST CHICAGO 1100

For Relay Catalog C-8
Phone or Write



RELAY SALES, INC.

P. O. Box 186 A Route 64 at E.J. & E.R.R. West Chicago, Ill

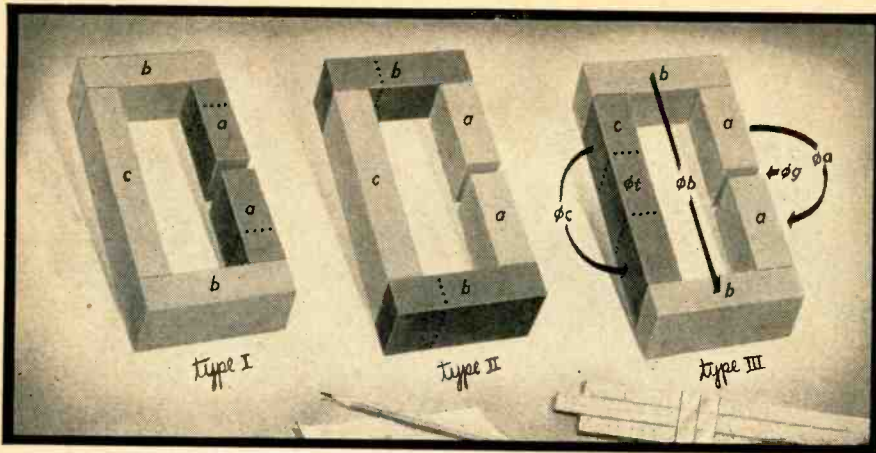

How You Can Save Time Estimating Leakage Factors for Magnetic Circuits

Computing even approximate values for leakage flux in magnetic circuits is a time consuming job. The research department of Indiana Steel recently undertook a series of studies, supported by the U.S. Air Force, to simplify these computations. Dr. R. K. Tenzer reported the results of this work, which reduce the time in computing leakage flux up to 90% by diminishing the number of mathematical operations necessary.

The investigations were done on circuits with permanent magnets; the results were also found applicable to unsaturated electromagnetic circuits when the coil-covered parts were treated as permanent magnet parts.

After checking values obtained by this method with actual measured values for many Type I, II, and III magnetic circuits, deviations were found to be less than $\pm 10\%$.

Leakage Flux, Leakage Factor

Because of magnetic leakage, only a part of the total flux through the neutral zone of the permanent magnet is found in the air gap. The difference between these two values is known as leakage flux. Mathematically this is:

$$\phi_L = \phi_t - \phi_g \quad (1)$$

In practical design, leakage is best considered as a factor stated thus:

$$\sigma = \frac{\phi_t}{\phi_g} = 1 + \frac{\phi_L}{\phi_g} \quad (2)$$

For simplification, the flux can be assumed to follow three basic, probable paths: ϕ_a between parts *a*, ϕ_b between parts *b*, and ϕ_c along part *c*. The equation above then becomes:

$$\sigma = 1 + \frac{\phi_a + \phi_b + \phi_c}{\phi_g} \quad (3)$$

With $\phi = mmf \times P$, this formula can be written:

$$\sigma = 1 + \frac{1}{P_g} \left(\frac{mmf_a}{mmf_g} P_a + \frac{mmf_b}{mmf_g} P_b + \frac{mmf_c}{mmf_g} P_c \right) \quad (4)$$

Letting the *mmf* ratios be denoted by *K*,

$$\sigma = 1 + \frac{1}{P_g} (K_a P_a + K_b P_b + K_c P_c) \quad (5)$$

This becomes the basic equation for numerical calculations of leakage factors after introducing simple expressions for leakage permeances and *mmf* ratios.

Simplified Leakage Permeances

The following formulas have been found satisfactory for leakage permeances between soft steel parts:

$$P_a = 1.7 \times U_a \times \frac{a}{a + L_g} \quad \text{where } U \text{ is cross-section perimeter;} \quad (6)$$

$$P_b = 1.4 \times b \times \sqrt{\frac{U_b}{c} + .25} \quad (7)$$

where U_b/c is greater than .25 and less than 4. The total length of part *b* is used.

Since permanent magnets have a neutral zone which does not contribute to leakage, the value of 2/3 of the magnet's total length is used when computing leakage permeances—this is the effective length *a'* and *b'* to compute *P'*; thus the two equations above become:

$$P'_a = 1.7 U_a \frac{.67a}{.67a + L_g} \quad (6a)$$

and

$$P'_b = 1.4 \times .67b \sqrt{\frac{U_b}{c} + .25} = .67 P_b \quad (7a)$$

When part *c* consists of a permanent magnet (Type III) its permeance can be calculated as:

$$P_c = .5 U_c \quad (8)$$

The permeance of the air gap itself is

$$P_g = A_g / L_g \quad (9)$$

Simplified MMF Ratios

Simplifying the *mmf* ratios is done by neglecting the reluctance in soft steel parts; so

$$mmf_a = mmf_b = mmf_g \text{ or } K_a = K_b = 1 \text{ (} mmf_c = 0 \text{ so } K_c = 0 \text{).} \quad (10)$$

Since the *mmf* along permanent magnet parts is not constant, integral values (\overline{mmf}) are used. Experiments showed that 2/3 of the \overline{mmf}_g was the effective *mmf* for leakage flux between permanent magnet parts; thus

$$\overline{mmf}_a = \overline{mmf}_b = \overline{mmf}_c = 2/3 \overline{mmf}_g$$

or

$$K_a = K_b = K_c = 2/3. \quad (11)$$

Basic Formulas

By inserting the permeances for soft steel into equation (5), the general formula becomes:

$$\sigma = 1 + \frac{L_g}{A_g} \left(K_a \times 1.7 U_a \frac{a}{a + L_g} + K_b \times 1.4 b \sqrt{\frac{U_b}{c} + .25} + K_c \times .5 U_c \right) \quad (12)$$

This formula contains only constants and dimensions; and by the two following rules this can be modified into the three basic equations for the Type I, Type II, and Type III circuits.

Rules: (1) For leakage flux paths between soft steel parts, use total lengths and constant *K* of 1. (2) For leakage flux paths between permanent magnet parts, use 2/3 of lengths and *K* of .67.

The following provide the leakage factors for the three types of circuits:

Type I:

$$\sigma = 1 + \frac{L_g}{A_g} \times .67 \times 1.7 U_a \frac{.67a}{.67a + L_g}$$

Type II:

$$\sigma = 1 + \frac{L_g}{A_g} \left(1.7 U_a \frac{a}{a + L_g} + .67 \times .67 \times 1.4 b \sqrt{\frac{U_b}{c} + .25} \right)$$

Type III:

$$\sigma = 1 + \frac{L_g}{A_g} \left(1.7 U_a \frac{a}{a + L_g} + 1.4 b \sqrt{\frac{U_b}{c} + .25} + .67 \times .5 U_c \right)$$

For variations on these basic formulas, write today for the April-June issue of *Applied Magnetism* which also shows examples of the formulas in use.

NEW DESIGN MANUAL READY

Write today for your copy of the newest edition of the Indiana Permanent Magnet Design Manual No. 6. Write to Dept. A-2.



THE INDIANA STEEL PRODUCTS COMPANY
VALPARAISO, INDIANA

THE WORLD'S LARGEST MANUFACTURER
OF PERMANENT MAGNETS

INDIANA
PERMANENT
MAGNETS

In Canada... The Indiana Steel Products Company of Canada Limited, Kitchener, Ontario

THOMAS A.

EDISON

current sensitive
d.c. relays operate
on microamps...
carry load of 1/3 amp

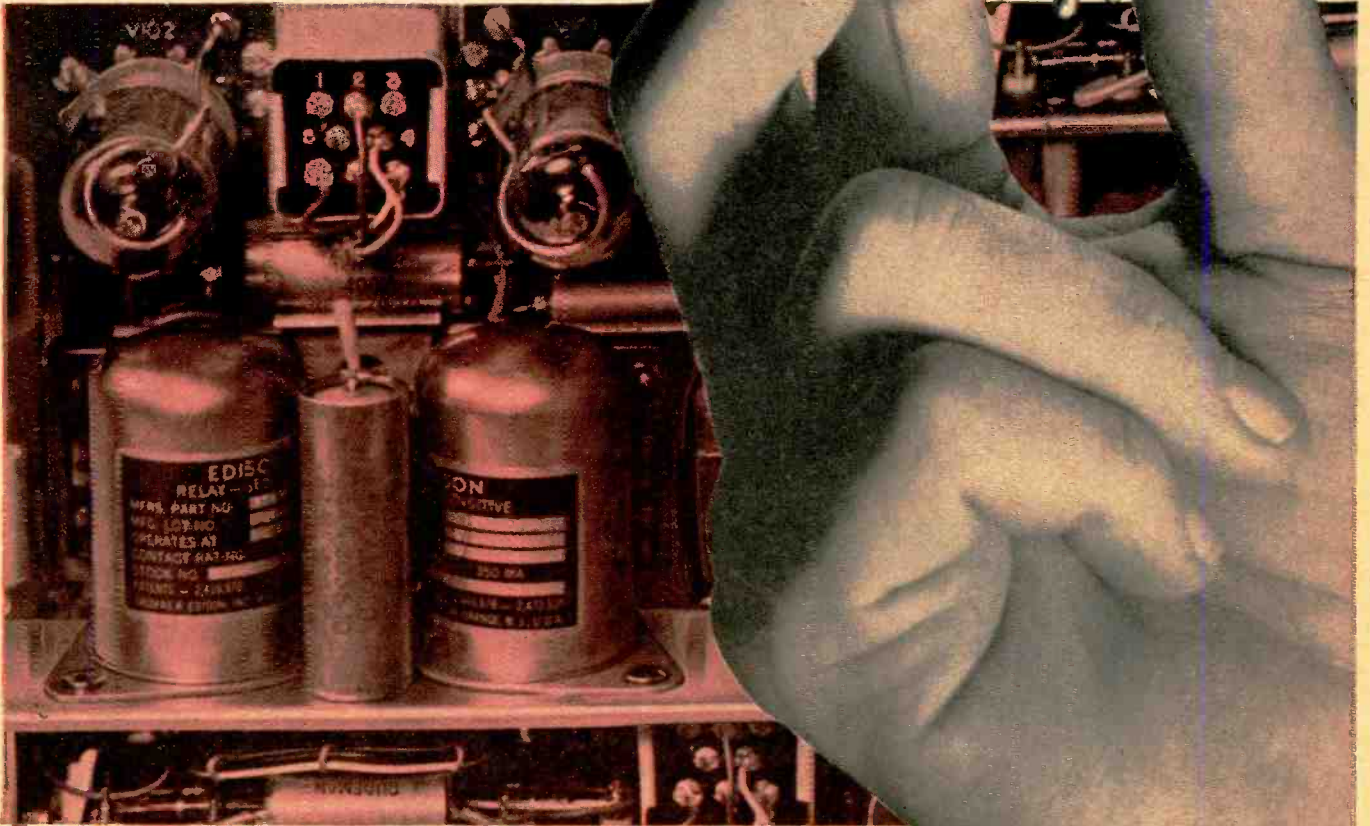

This meter-type relay is capable of operating on an input power of 25 microwatts—and on even less power in special applications. When the relay is factory-adjusted for the special conditions to be encountered, sensitivities down to 1 microwatt are possible.

Edison sensitive relays can replace a vacuum tube amplifier in many applications, and offer important savings in weight and cost. Because of their low operating power level, they can be run directly from a thermocouple or photocell output—and are ideal for uses involving servo motors operating from vacuum tube plate circuits. Between the input power to the operating coils and the load capacity of its own contacts, these relays make possible a power amplification factor in excess of 500,000 to 1.

For complete data on Edison Sensitive Relays, write for Bulletin No. 3037.

Thomas A. Edison Industries
INSTRUMENT DIVISION

54 LAKESIDE AVENUE, WEST ORANGE, N. J.



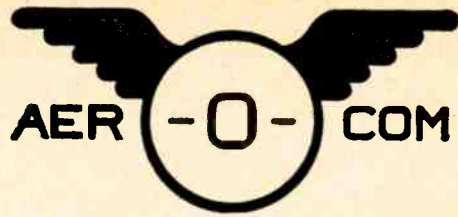

DEFINITELY DEPENDABLE!

Aerocom's Dual Automatic Radio Beacon

Reliability is built into every part of this dual 1000-watt aerophare unit. Ruggedly constructed and conservatively rated, it provides trouble-free unattended service, and at truly low operating and maintenance cost. It operates in the frequency range 200-415 kcs, using plug-in crystal for desired frequency.

Uses single phase power supply, nominal 220 volts, 50 or 60 cycles. Consists of two 1 kw transmitters with keyer (2 keyers if desired), automatic transfer unit and weatherproof antenna tuner. Each transmitter housed in separate standard rack cabinet, with controls in rack cabinet between the transmitters.

Nominal carrier power is 1000 watts. High level plate modulation of final amplifier is used, giving 30%-35% tone modulation. P-T switch interrupts tone, permitting voice operation. Operates in ambient temperatures from -35°C to 50°C, humidity up to 95%.

Standby transmitter is placed in operation when main transmitter suffers loss (or low level) of carrier power or modulation, or continuous (30 sec.) tone. Audible indication in monitoring receiver tells when standby transmitter is in operation.

Antenna may be either vertical tower or symmetrical T type.

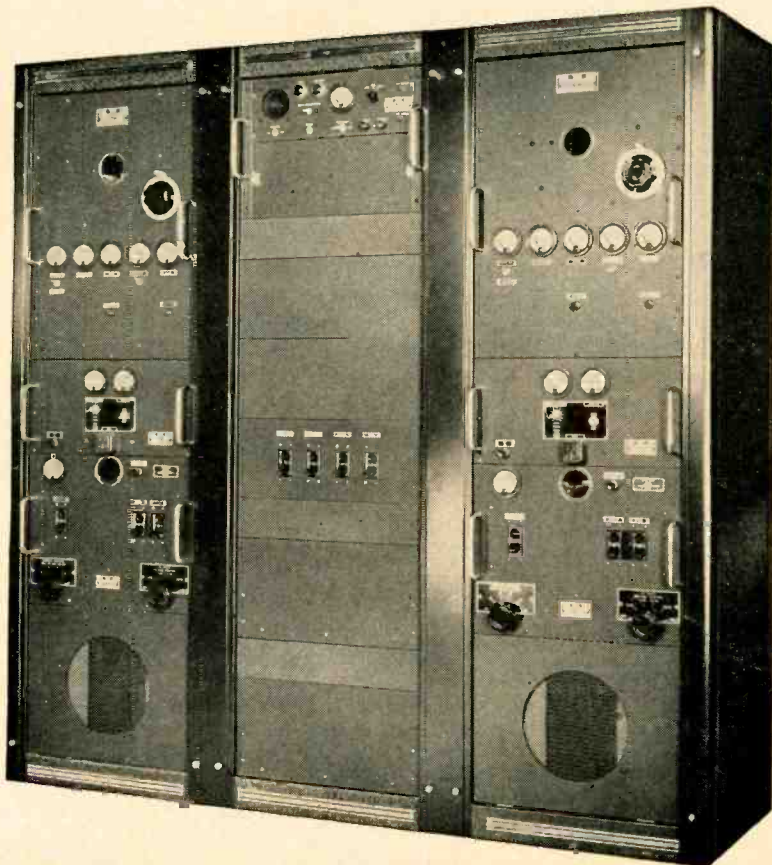

Also available in
50 WATT
100 WATT
and
4 KILOWATT
models

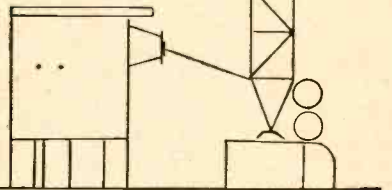

A-101



3090 S. W. 37th AVENUE · MIAMI, FLORIDA

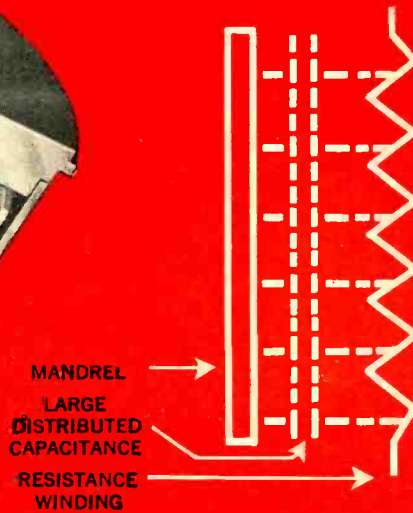
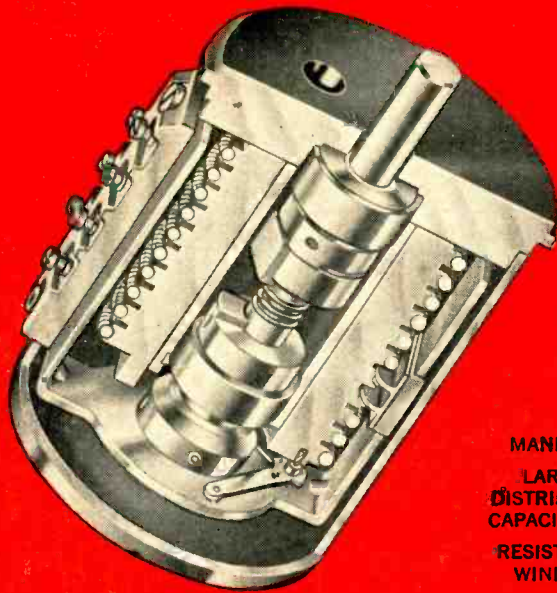

Phase Shift Compensation Eliminated In New HELIPOT® Precision Potentiometers

SPECIAL D-H ALLOYS MAKE AIR-CORE WINDINGS PRACTICAL!

Helipot's purpose in designing its new, air-core wound series 7700 Potentiometers was to make possible operation at higher frequencies with 0° phase shift—thereby eliminating compensation circuitry.

In nearly all multi-turn potentiometers, resistance wire is wound on an insulated copper-wire mandrel. This type of mandrel is used because it has uniform diameter, good heat conductivity and high thermal capacity. However, a disadvantage of such construction is the relatively large distributed capacitance between the resistance winding and the mandrel. When such a potentiometer is used as an AC voltage divider, the output generally differs in phase and magnitude from the desired output. This interferes with the effective use of high accuracy potentiometers unless compensation is applied somewhere in the circuit.

Helipot engineers desired to eliminate these problems by eliminating the copper-wire mandrel. But the elimination of the mandrel also

eliminated the support for the winding. Needed, therefore, was a type of wire that would make a self-supporting air-core winding.

At Helipot's request, Driver-Harris went to work with these specifications: The wire must be of dependable uniform hardness so that in stretching it, equal spacing between turns is obtained, free of creep. This is essential to linearity. The wire also must be of unvarying diameter for uniform resistance. And its surface must be extremely clean—free of oxide coating to minimize contact "noise".

Driver-Harris produced the wire—a special hard-drawn form of Karma® and Nichrome® V. And Helipot produced its new 10-turn series 7700 potentiometers in a resistance range from 200 to 5000 ohms. With this radically new air-core winding, linearity approaches the resolution of the unit without resort to padding or shunting. And phase shift in AC circuitry is reduced to less than 0.1°.

Since 1899, Driver-Harris has produced 132 special-purpose alloys in just this fashion—in answer to a particular problem and extraordinary specifications. If your own engineering and product development plans currently hinge upon a special alloy—why not bring your problem to Driver-Harris. Your inquiry is invited.

•T.M. REG. U.S. PAT. OFF.



Driver-Harris* Company

HARRISON, NEW JERSEY • BRANCHES: Chicago, Detroit, Cleveland, Louisville

Distributor: ANGUS-CAMPBELL, INC., Los Angeles, San Francisco

In Canada: The B. GREENING WIRE COMPANY, Ltd., Hamilton, Ontario

MAKERS OF THE MOST COMPLETE LINE OF ALLOYS FOR THE ELECTRICAL, ELECTRONIC, AND HEAT-TREATING INDUSTRIES

"FIGURE OF MERIT"

MEASUREMENTS

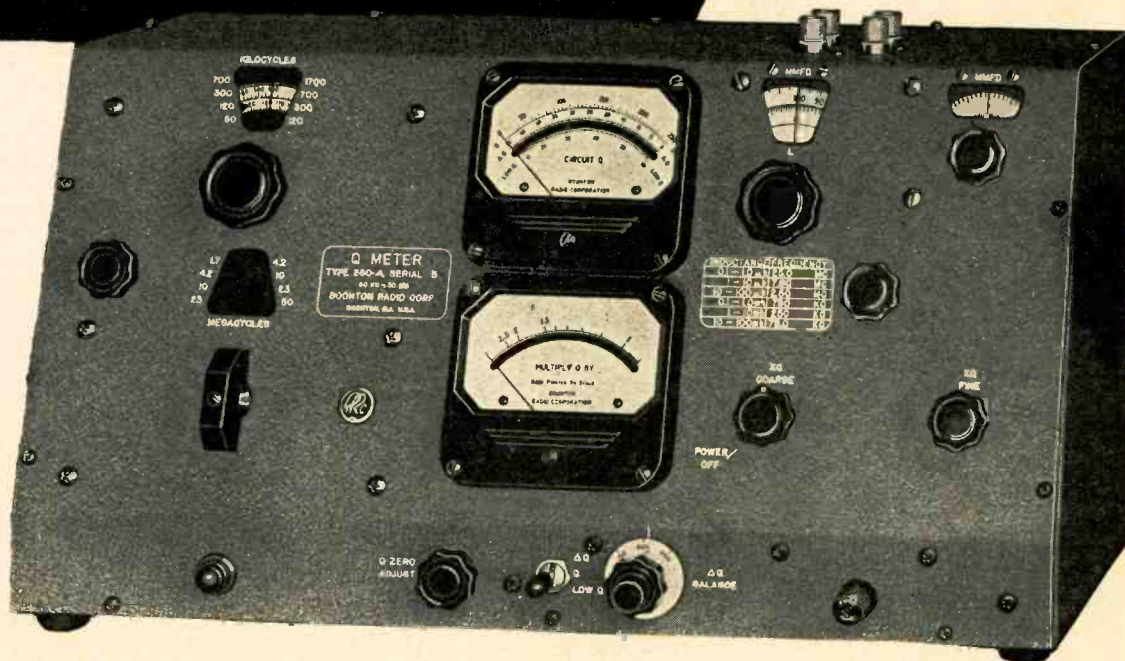

Q-METER
Type 260-A

Use this versatile Q-METER TYPE 260-A for determining the "FIGURE OF MERIT" (Q) of inductors, capacitors, the selectivity and gain of a resonant circuit, and other circuit parameters associated with Q.

DIELECTRIC PROPERTIES

Measure dissipation factor and dielectric constant of various insulating materials easily, efficiently, and with good accuracy.

FEATURES

LO Q SCALE: permits Q readings down to a value of 10.

Δ Q SCALE: reads the difference in Q of two circuits or components up to a value of 125.

All indications on large meters with parallax correction and accuracy of $\pm 1\%$ full scale.

Thermocouple for indicating current inserted into measuring circuit redesigned for high burnout point well above operating current. Oscillator maximum output level adjusted to minimize possibility of thermocouple failure.

SPECIFICATIONS

FREQUENCY RANGE: 50 Kc to 50 Mc continuously variable in eight ranges.

FREQUENCY ACCURACY: Approx. $\pm 1\%$.

RANGE OF Q MEASUREMENTS: 10 to 625

RANGE OF DIFFERENCE Q MEASUREMENTS: 0 to 125.

INTERNAL RESONATING CAPACITANCE RANGE:

MAIN TUNING DIAL: 30 to 450 mmf. (direct reading) calibrated in 1.0 mmf. increments from 30 to 100 mmf; 5.0 mmf. increments from 100 to 450 mmf.
VERNIER: -3.0 to $+3.0$ mmf. (direct reading) calibrated to 0.1 mmf. increments.

ACCURACY OF RESONATING CAPACITOR:

MAIN TUNING DIAL: Approximately $\pm 1\%$ or 1.0 mmf, whichever is the greater.
VERNIER: ± 0.1 mmf.

PRICE: \$775.00 F. O. B. Factory

BOONTON
BRC RADIO
CORPORATION

Boonton, New Jersey



EAR TO THE ENEMY

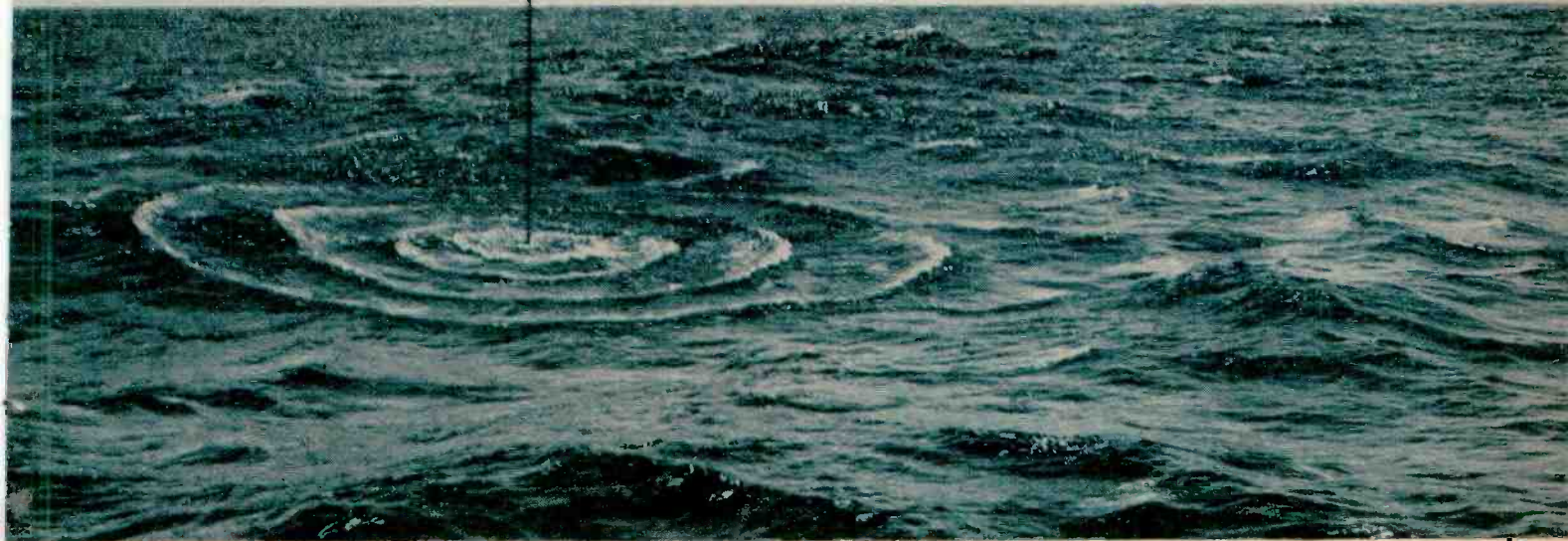

DUNKING SONAR — LISTENING SONAR — ECHO RANGING SONAR — LIGHTWEIGHT TORPEDOS

For the past twelve years Bendix-Pacific has been a principal U. S. Navy source for Sonar and Anti-Submarine Warfare systems and sub-systems. This equipment, including many types of listening and detecting sonar and lightweight torpedos, has been developed and produced by Bendix-Pacific. Contributions to this vital area of our defense program also include creative engineering for new, advanced systems for our underwater defenses.



Practical CBS Transistor Home-Study Course

Learn all about transistors by using them



PREPARE NOW FOR THE FUTURE!

Let's face it. Transistors are here . . . now! Advancement opportunities are waiting for those who know all about their basic fundamentals. Are you ready?

This new, profusely illustrated Transistor Home-Study Course, a CBS first, was written to make it easy for you to learn by using transistors. Service-dealers . . . technicians . . . and engineers find this residence-course-at-home both fast and fascinating. What you learn you remember because you do it yourself . . . instructions are included for building several practical transistor devices. Course was written for CBS by A. C. W. Saunders, a well-known educator and author.

Check the table of contents. Then read how easy it is for you to start your Transistor Course today.

CBS Transistor Course Includes

- Ten intensive lessons (with 3-ring binder) . . . up-to-date, complete
- Simplified basic theory . . . how transistors work
- Practical experiments and servicing techniques for: Amplifiers . . . applications in all fundamental circuits
Oscillators . . . a-f, r-f, relaxation, multivibrator, special TV
Rectifiers . . . diode and transistor rectifiers and detectors
Practical commercial applications . . . immediate and future
- With free correction and consulting service . . . and up-to-date supplements for certified graduates

HOW TO GET IT

Call your CBS Tube distributor. He'll tell you how to get the CBS Transistor Home-Study Course, PA-175. See him, or write us . . . today!

ELECTRON TUBES



SEMICONDUCTORS

CBS - HYTRON, Danvers, Mass.
A Division of
Columbia Broadcasting System, Inc.



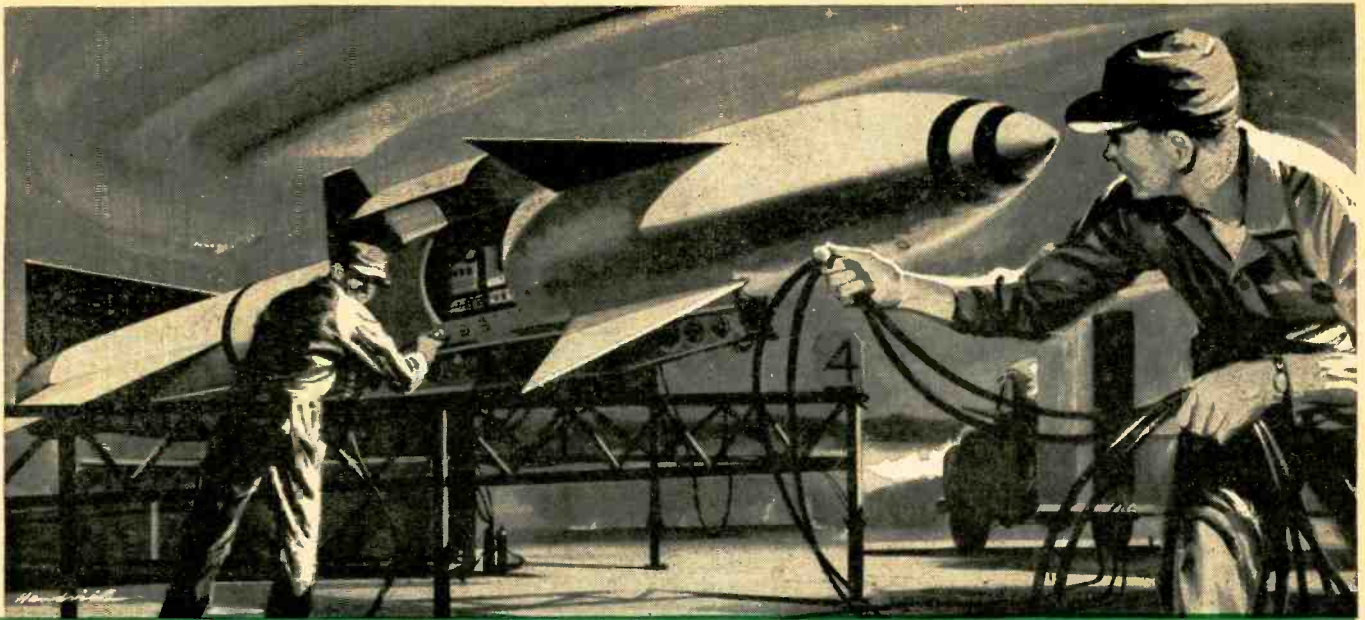

Sperry SRV-38 klystron FOR TEST AND RADAR EQUIPMENT

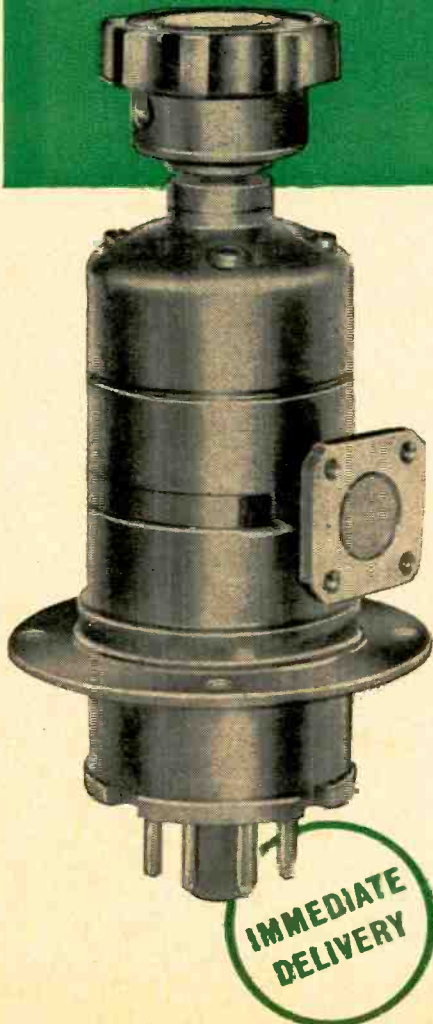

Now in production... a Sperry reflex oscillator klystron offering the high precision required for all types of test equipment and radars. Its frequency is adjustable to finer than 1 mc over its operating range of 33 to 36 kmc. And the SRV-38's conservative cathode design means it will maintain its accuracy and precision over an extended service life.

- Because of its long life, power and

frequency stability, low voltage requirements, ruggedness and wide tuning range, the SRV-38 has had wide use as both a power source in test sets and on the bench, and also as a local oscillator in ground, shipborne and airborne radar equipments.

- The SRV-38 is now available for immediate delivery. For more information, write or phone the nearest Sperry district office for data sheet.

GENERAL CHARACTERISTICS OF SRV-38

Frequency Range	33 to 36 kmc
Output Power	8.5 to 40 mw
Electronic Tuning Range (at 34.8 kmc).....	60 to 150 mc
Hysteresis	Less than 2%
Beam Voltage	425 v
Reflector Voltage Range.....	0 to -400 v

SPERRY ELECTRONIC TUBE DIVISION
GYROSCOPE COMPANY
Great Neck, New York

DIVISION OF SPERRY RAND CORPORATION

BROOKLYN • CLEVELAND • NEW ORLEANS • LOS ANGELES •
SAN FRANCISCO • SEATTLE. IN CANADA: SPERRY GYROSCOPE
COMPANY OF CANADA, LTD., MONTREAL, QUEBEC.

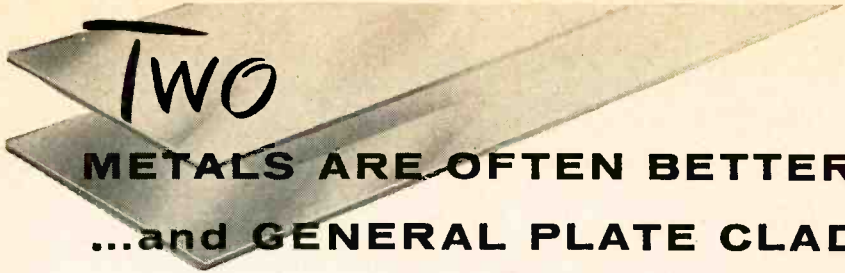

TWO METALS ARE OFTEN BETTER THAN ONE ...and GENERAL PLATE CLAD METALS

for brazing are a case in point—

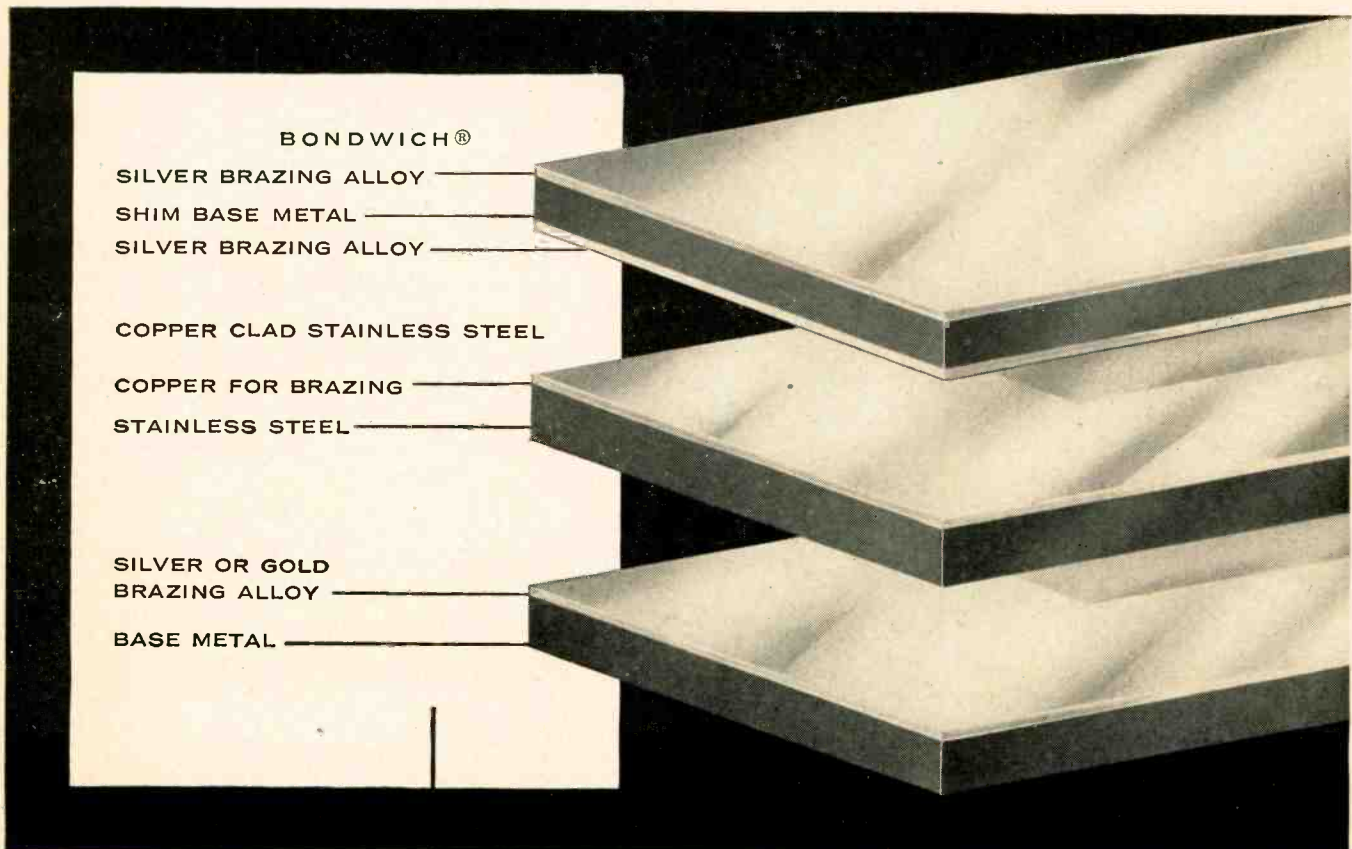

General Plate can supply you with many clad metals made specially for brazing ... copper clad stainless steel, silver brazing alloys, clad stainless and non-ferrous metals. Also, soft solders clad on nickel and copper. All are made by permanently bonding a solid layer of brazing metal on one or both sides of the parent metal — which can be either base, precious or clad metal.

Here's how you benefit by using these metals —

- 100% coverage because brazing metal is completely wetted on parent metal
- Low assembly costs — brazing alloy is already preplaced on metals being joined
- No excess of brazing metal — good appearing joints
- Stronger joints — usually require less thickness of brazing alloy than when separate brazing foil used
- Brazing metals available to suit all types of heating atmospheres

General Plate can furnish you with a wide selection of metals clad with brazing alloys to fill your requirements. Write for Bulletins.

You can profit by using General Plate clad metals.

METALS & CONTROLS CORPORATION
 General Plate Division 1302 Forest Street, Attleboro, Mass.
 FIELD OFFICES: NEW YORK. CHICAGO. DETROIT. MILWAUKEE. LOS ANGELES

Forget the Amplifier



If your design utilizes an amplifier to boost a minute signal for relay operation — or, if you have 'shelved' some new product idea because the cost, space requirement and other drawbacks of amplifiers made the design impractical — *Sensitrol relays are for you.* For these tiny, ultra-sensitive relays, which operate direct on input signals as slight as 1 millivolt or $\frac{1}{2}$ microampere, and handle substantial wattage at 110 volts, entirely replace amplifiers, vacuum tubes and auxiliary power supplies. They are available with single or double contacts, fixed or adjustable, manual or solenoid reset. For engineering assistance in adapting Sensitrol relays to present products, or new problems you have in mind, call your nearest Weston representative, or write for the Sensitrol bulletin B-25-B . . . *Weston Electrical Instrument Corporation, 614 Frelinghuysen Avenue, Newark 5, N. J.*

**Boost feeble
input signals
with compact**

***Sensitrol[®]
relays***

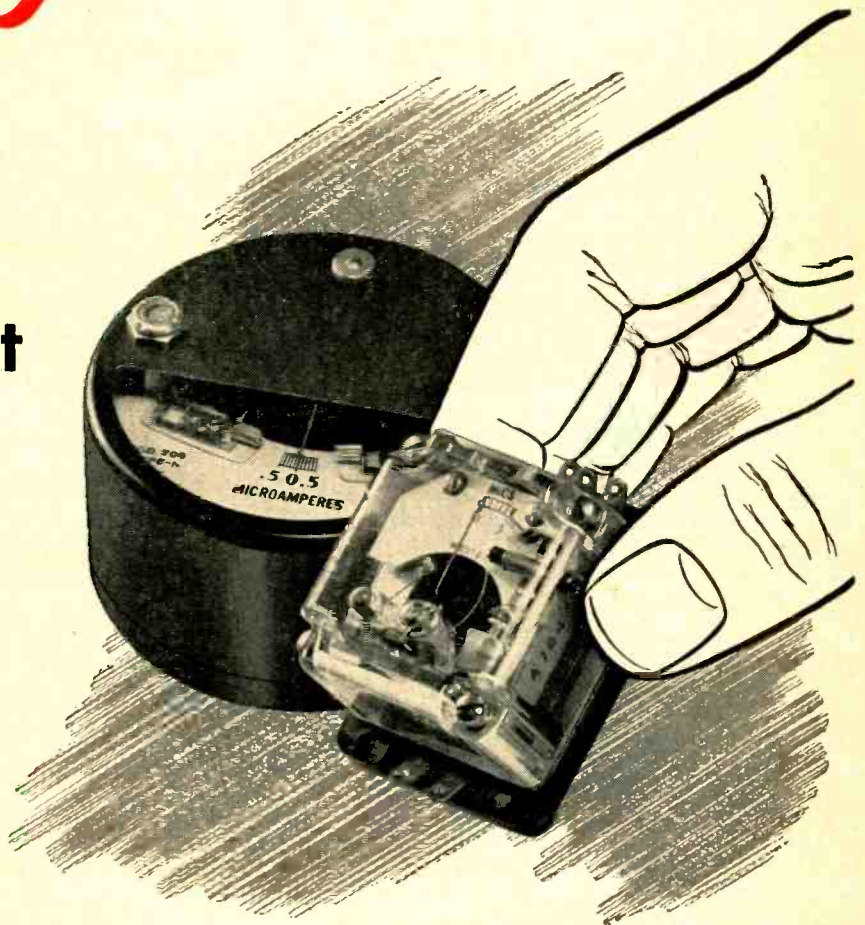

WESTON

Instruments



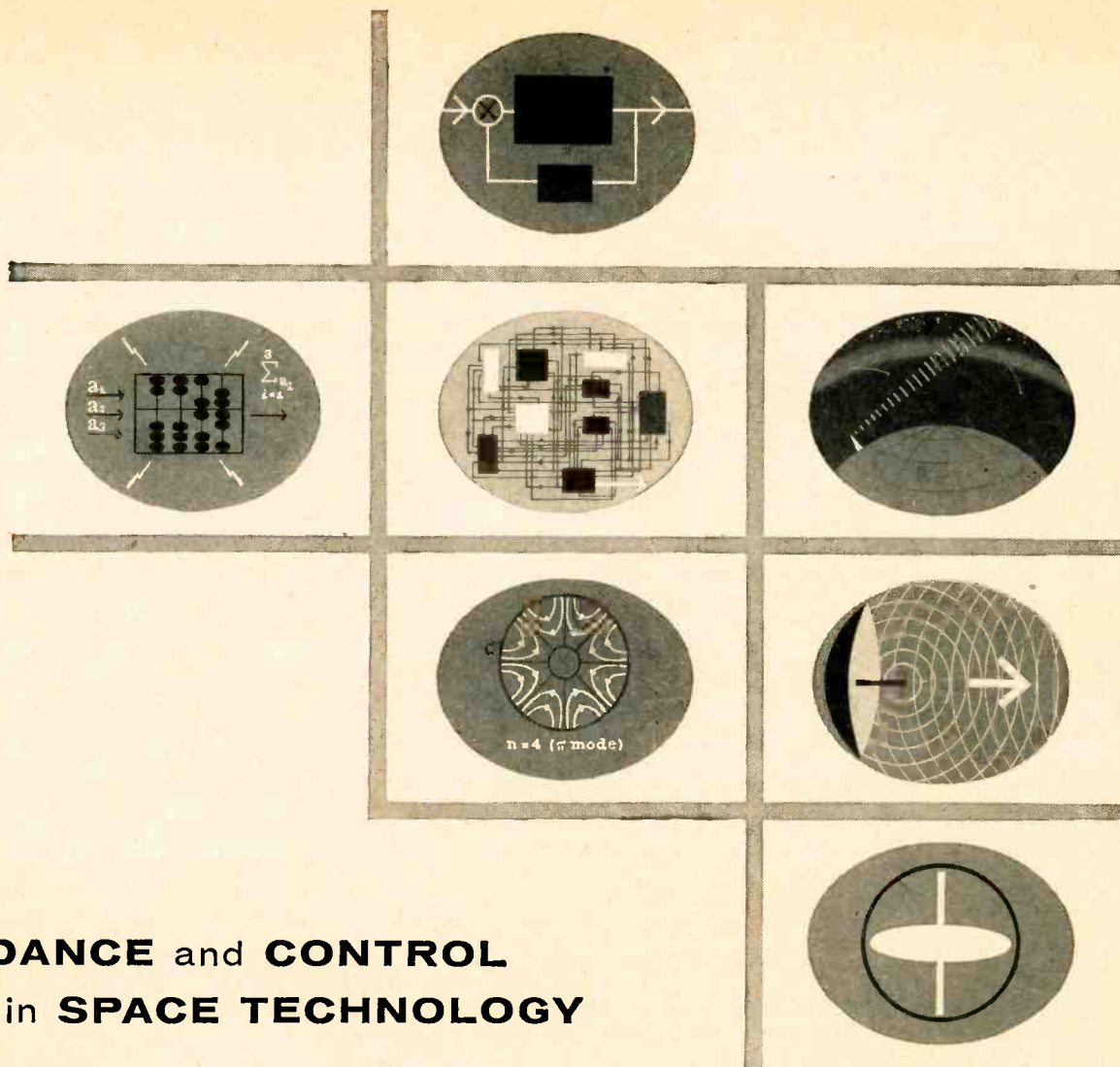

GUIDANCE and CONTROL in SPACE TECHNOLOGY

It is becoming increasingly apparent that many of the techniques and analyses, and much of the equipment, developed for the present Air Force ICBM-IRBM programs will have a wide future application in space technology. For instance, many of the guidance and control techniques for ICBM's are applicable to the space vehicles of the near future.

An important element of these applications is precision. The precision required of the guidance and control system for vehicles aimed at the moon or one of the planets is not substantially greater than that required for the Air Force ICBM-IRBM programs. And, the precision needed to guide a vehicle into a near-circular orbit of Earth is even less than that required for ICBM's.

The problem of communication with lunar and planetary vehicles is, of course, made more difficult by the much greater distances involved. This, however, is not an insurmountable difficulty if today's trends continue in the use of higher transmitted power, narrower communication bandwidths and amplifiers with very low noise-figures.

The problems of operating electronic equipment in the space beyond our atmosphere are already encountered on present ballistic missile trajectories. The principal difference in the case of space vehicle applications is the

requirement for longer equipment lifetimes. Electronic equipment and power supplies will have to last for several hours or days or weeks, instead of a few minutes, under conditions of vacuum pressure, zero "g" fields, and bombardment by micrometeorites, high-energy particles, and radiation.

The preceding examples serve to illustrate some of the ways in which the ICBM-IRBM programs are advancing the basic techniques of space technology.

Since 1954, Space Technology Laboratories has been providing over-all systems engineering for these programs. Both in support of this responsibility and in anticipation of future system requirements, the Laboratories are presently engaged in a wide variety of advanced analytical and experimental work directed toward the exploration of new approaches in space vehicle electronics, propulsion, and structures.

The scope of STL's work requires a staff of unusual technical breadth and competence. Engineers and scientists who are interested in advanced experimental development projects (as distinct from development for manufacturing, in which STL is not engaged) are invited to investigate the many opportunities on the Laboratories' Technical Staff.

SPACE TECHNOLOGY LABORATORIES

A Division of The Ramo-Wooldridge Corporation

5730 ARBOR VITAE STREET • LOS ANGELES 45, CALIFORNIA

Waldes Truarc Retaining Ring eliminates 7 parts, saves \$8.88 in sub-assembly of aerial reconnaissance camera

Gordon Enterprises, No. Hollywood, California, saved the Navy almost 1 1/2 million dollars on 500 cameras. Gordon rebuilt new, efficient "CA" series out of Navy-owned obsolete models. Critical parts are now held together by Waldes Truarc Retaining Rings.

Truarc Rings are trouble-free, will not change position during operation. Accuracy is limited only by groove and ring dimension tolerances. And standardized Truarc Rings are quickly interchangeable in overhaul which now takes only 11 minutes, can be handled by unskilled technicians.

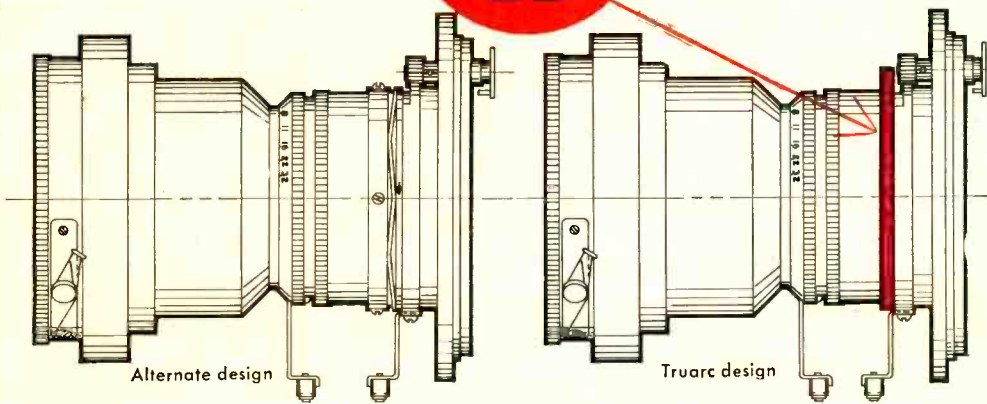
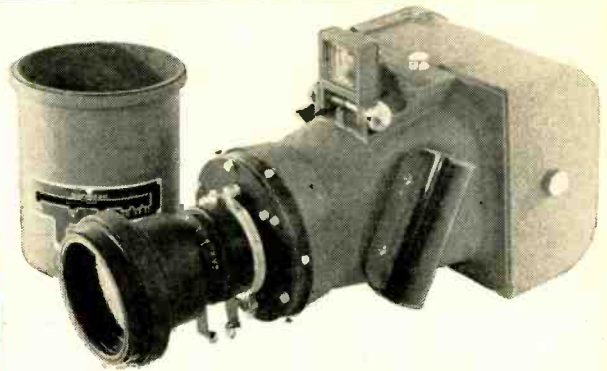

Truarc 5100-287 ring retains shutter speed adjustment mechanism on the Lens Adapter Plate Assembly which mounts and locks the lens

and shutter assemblies accurately to camera body. Alternate design required retaining washer, spring, collar and 4 locking screws.

Weight Saving: 7.25 oz.

Assembly Time

Saving: 6 1/2 min.

DOLLAR SAVINGS:

Material \$.93

Fabrication 6.88

Inspection 1.07

Total \$8.88

Whatever you make, there's a Waldes Truarc Ring designed to save you material, machining and labor costs, and to improve the functioning of your product.

In Truarc, you get

Complete Selection: 36 functionally different types. As many as 97 standard sizes within a ring type. 5 metal specifications and 14 different finishes. All types available quickly from leading OEM distributors in 90 stocking points throughout the U.S. and Canada.

Controlled Quality from engineering and raw mate-

rials through to the finished product. Every step in manufacture watched and checked in Waldes' own modern plant.

Field Engineering Service: More than 30 engineering-minded factory representatives and 700 field men are at your call.

Design and Engineering Service not only helps you select the proper type of ring for your purpose, but also helps you use it most efficiently. Send us your blueprints today...let our Truarc engineers help you solve design, assembly and production problems...without obligation.

For precision internal grooving and undercutting . . . Waldes Truarc Grooving Tool!

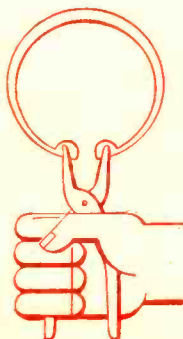

WALDES
TRUARC[®]
RETAINING RINGS

WALDES KOHINOOR, INC.
47-16 AUSTEL PLACE, L. I. C. 1, N. Y.

New Catalog →

Waldes Kohinoor, Inc., 47-16 Austel Place, L. I. C. 1, N. Y.
Please send new, descriptive catalog showing all types of Truarc rings and representative case history applications. (Please print)

Name

Title

Company

Business Address

City Zone State **E020**

WALDES TRUARC Retaining Rings, Grooving Tools, Pliers, Applicators and Dispensers are protected by one or more of the following U.S. Patents: 2,382,948; 2,411,426; 2,411,761; 2,416,852; 2,420,921; 2,428,341; 2,439,785; 2,441,846; 2,455,165; 2,483,379; 2,483,380; 2,483,383; 2,487,802; 2,487,803; 2,491,306; 2,491,310; 2,509,081; 2,544,631; 2,546,616; 2,547,263; 2,558,704; 2,574,034; 2,577,319; 2,595,787, and other U.S. Patents pending. Equal patent protection established in foreign countries.

New *KSR** Capacitors give you

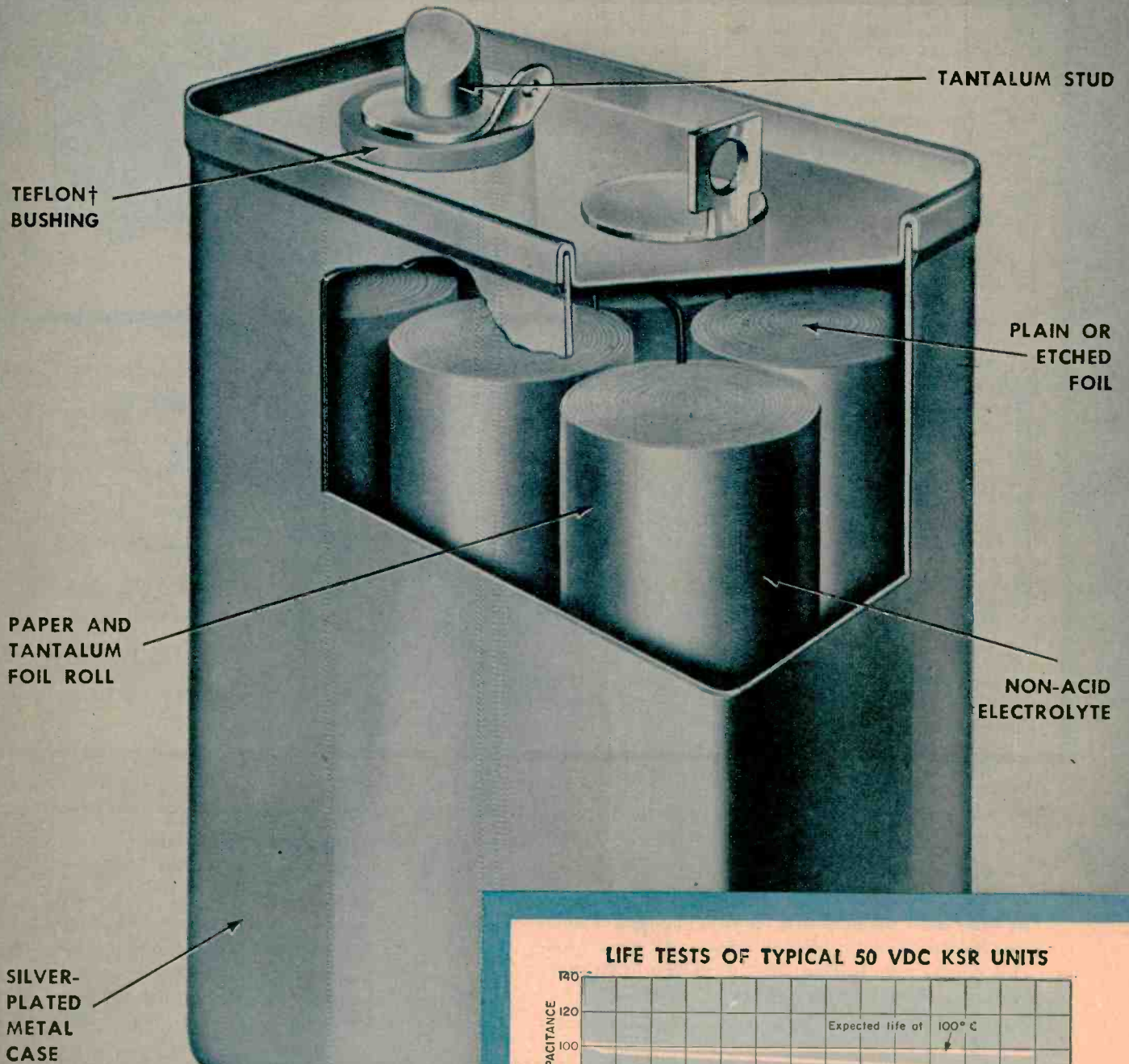

LIFE TESTS OF TYPICAL 50 VDC KSR UNITS

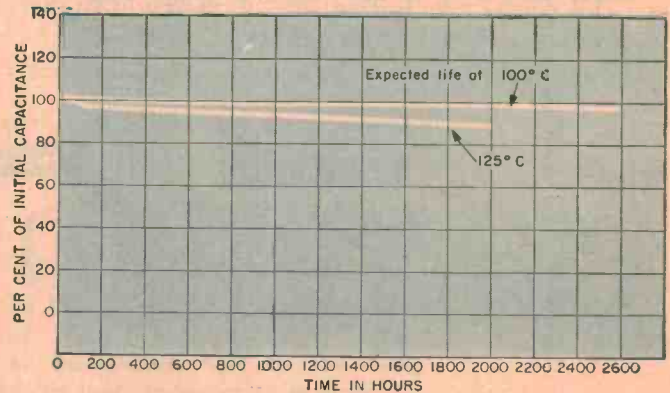

After operating at 125°C for 2000 hours, capacitance of a typical KSR unit is reduced only 12%.

†Registered trademark of DuPont

more μf in lighter, smaller cases

**With the new King Size Rectangular unit
you can get up to 3500 microfarads
in one G-E Tantalytic^{††} capacitor**

Now General Electric offers a completely new Tantalytic capacitor for use in computers, missiles, radar, and airborne electronic equipment—the King Size Rectangular Capacitor. This unit offers more joules per size, weight, and cost than any other tantalum capacitor available.

On a volt-microfarad basis, the new KSR's are 40% lighter, 30% smaller, and 40% less expensive than other 125°C rectangular capacitors. Compared with 125°C cylindrical designs, KSR's may be as much as 50% lighter, 30% smaller, and 15% lower in cost.

Like other General Electric Tantalytic capacitors, the KSR units offer "bulk capacitance," i.e., high volt-microfarads in an extremely small case. Now, one King Size Rectangular capacitor can often be used where several lower rated units were needed before. As a result of this bulk capacitance, costly connections are reduced and extra mounting brackets are eliminated.

* Trademark of General Electric Co.

In addition to the great size and weight advantages, the KSR capacitors offer these outstanding features:

- High reliability from -55°C to $+125^{\circ}\text{C}$.
- Polar or non-polar construction; plain or etched foil.
- Long operating life at 125°C ; extra long life at 85°C .
- Excellent shock and vibration characteristics.
- Non-acid electrolyte for long shelf life.
- Dual temperature and voltage ratings.

KSR Tantalytic capacitors are now available in three case sizes: 1.375 inches, 2 inches, and 2.5 inches in height. All three have the same base size: 1.316 inches by .75 inch. For more information on these new capacitors or for assistance with your capacitor applications, contact your General Electric Apparatus Sales Office. Or write to General Electric Co., Section 449-3, Schenectady, N.Y.

†† Registered trademark of General Electric Co.

Progress Is Our Most Important Product

GENERAL  ELECTRIC

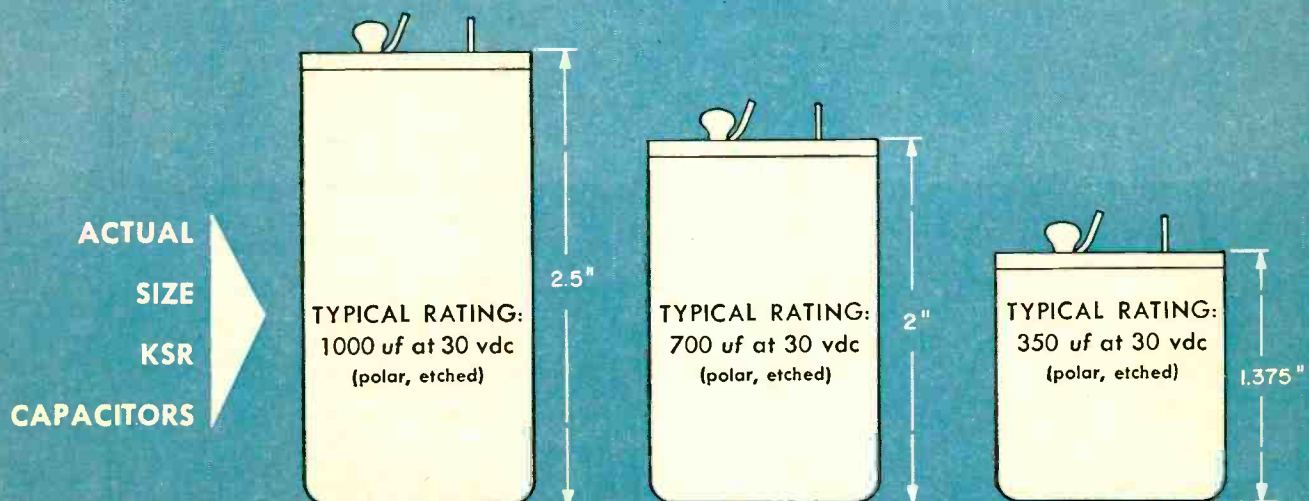

Multi-track magnetic recording reproducing heads...

Laboratory-designed, precision-built by Davies

Series	Track Data		Crosstalk (db)	Number of Tracks for Various Tape Widths									
	Width (Mils)	Spacing C to C (Mils)		¼	½	¾	1	1¼	1½	1¾	2		
700	50	140	-60*	2	4	5	7	9	11	13	14		
800	40	125	-60*	2	4	6	8	10	12	14	16		
1000	40	100	-55*	3	5	8	10	13	15	18	20		
1200	32	85	-50*	3	6	9	12	15	18	21	24		
1300	26	78	-40**	3	6	10	13	16	19	23	26		
1400	40	72	-40**	3	7	10	14	17	21	24	28		
S1400	32	70	-40**	3	7	10	14	17	21	24	28		
1600	32	62	-35**	4	8	12	16	20	24	28	32		
2000	20	50	-35**	5	10	15	20	25	30	35	40		

*For Direct Recording, 1000cps

**For Digital Pulse Recording



MODEL 1206 DP



MODEL 814 A

Davies multi-track recording and reproducing heads for magnetic tape data recording are offered in a wide selection of designs for every practical tape service.

Davies single-stack heads are precisely aligned for those applications requiring coincidence of time and phase among tracks. Gap alignment is held to within ± 0.1 mil per inch of tape width.

For services requiring a large number of tracks, but where time and phase displacement can be tolerated, Davies 700, 800 and 1000 Series Heads can be interleaved to provide 14, 16, or 20 tracks on 1" tape.

All-metal tape contact area on Models with the "P" designation (1206 DP above) essentially eliminate oxide build-up at high tape speeds.

In all types, plastic encapsulation protects and preserves the characteristics, even under adverse environmental conditions such as shock, vibration and extremes of temperature and humidity.

Select the appropriate recording/reproducing head from the condensed chart. Complete technical and application information may be obtained by writing Minneapolis-Honeywell Regulator Co., Davies Laboratories Division, 10721 Hanna Street, Beltsville, Md.

Honeywell



DAVIES LABORATORIES DIVISION

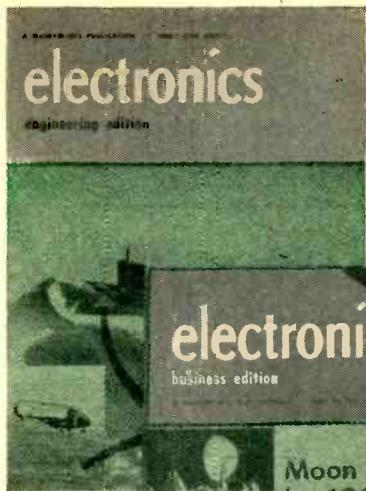

The Big Show Issue (Engineering Edition)



The Convention Week Issue (Business Edition)



increase your sales with... **electronics**



1. **electronics** MARCH 14th PRE-CONVENTION ISSUE
FINAL ADVERTISING CLOSING DATE — FEB. 21st

Every year advertisers who exhibit at the Radio Engineering Show use **electronics** Pre-Convention issues to direct more attention to their booths.

Editorially, the March 14th (Engineering) issue will contain a listing of exhibitors plus a detailed program. Over 52,000 *qualified* paid subscribers (the circulation goal for early 1958) will receive this "Pre-Convention Guidebook" up to a *full week* in advance of the show . . . they'll use it to plan their time at the show!

Non-exhibitors describe products and services in the "show atmosphere" which is conducive to greater sales influence.

Exhibitors' Bonus: Your advertisements in this issue of **electronics** will be indexed in a section of *Advertisers Who Are Exhibitors* to serve as a handy reference for show visitors.

2. **electronics** MARCH 21st CONVENTION WEEK ISSUE
FINAL ADVERTISING CLOSING DATE — FEB. 28th

NEW for 1958 . . . **electronics**, as a weekly magazine, now publishes a special CONVENTION WEEK Issue!

This important issue (a Business Edition) will contain a last minute pre-show story offering advertisers a second opportunity to reach their prospects and customers with special Convention sales messages, creating the best conditions for maximum readership of your product story.

Sales-building suggestion: For maximum impact, use both the March 14th and the March 21st issues of **electronics**!

RADIO ENGINEERING SHOW ISSUES

The **Biggest, Most Important** Radio Engineering Convention To Date!

Over 850 exhibitors are expected to display thousands of the newest electronic products and equipments at the '58 Radio Engineering Show (New York Coliseum, March 24-28). During these four days over 58,000 "buy-minded" engineers, will attend . . . pre-select your audience, *direct* them to your display through the pages of **electronics** two *big* Convention Issues.

Only **electronics** sells all three: Design/Production/Management

. . . key buyers among users and makers of electronic equipment!

electronics

now published every week!

A McGraw-Hill Publication

330 W. 42nd Street • New York 36, N.Y.

NUCLEAR ENERGY BALLISTICS RADAR RESEARCH

RIBET DESJARDINS

SYNCHROSCOPE 204 A

The synchroscope 204 A, an apparatus of very high performance, is unique in making it possible to record ultra-rapid phenomena reaching several thousand kilometers-second. It offers the same characteristics of precision and safe operation that have secured the universal reputation of the Electronic Department of the Ribet-Desjardins Company.

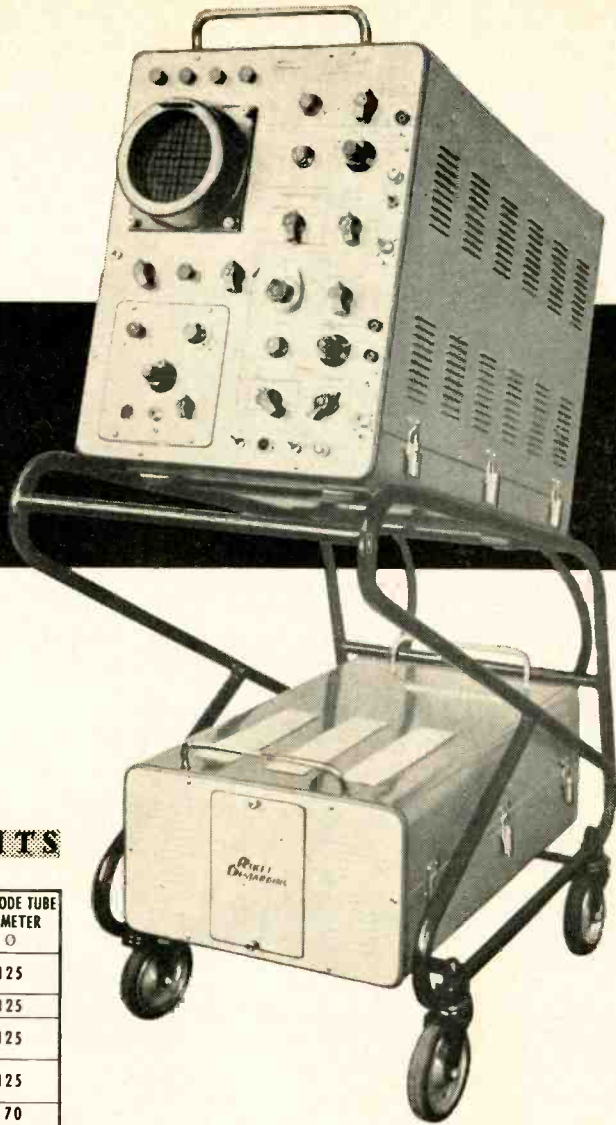

6 6 2 0

MEASURE AND CONTROL UNITS I - OSCILLOSCOPES AND SYNCHROSCOPES

MODELS	CHANNELS	RANGE	AMPLI V		RESPONSE LAG μ s	MARKER	CATHODE TUBE DIAMETER ϕ
			Passing Band cps - mc	Sensitivity mV p to p/cm			
204 A	1	0.01 μ s/cm-4s/cm	0 - 50	50	0.007	Calibrated + 100 μ s	125
251 A	2	0.02 μ s/cm - 10 s/cm	0 - 30	50	0.02	Calibrated	125
252 BL	1	0.1 μ s/cm-4 ms/cm	0 - 10 10 - 10	80 50	0.04	0.05 μ s-1000 μ s	125
254 A	2	0.1 μ s/cm-1 s/cm 0.1 μ s/cm-1 s/cm	0 - 4 0 - 10	20 50	0.12 0.045	Calibrated	125
255 A	1	0.3 μ s/cm-0.01 s/cm	0 - 4	150	0.12	0.4 μ s-4 ms	70
256 A	1	1 μ s/cm-1 s/cm	0 - 1	15	—	—	90
256 A	2	1 μ s/cm-1 s/cm	0 - 0.8	50	—	Calibrated	90
258 A	1	2 μ s/cm-20 ms/cm	50 - 1	50	—	—	70
264 B	2	1 μ s/cm-0.05 s/cm	10 - 2	4	—	—	90
267 B	1	1 μ s/cm-0.1 s/cm	0 - 1 20 - 0.8	250 8	—	—	90
268 A	1	10 cps - 30 kc	50 - 1	45	—	—	70

II - GENERATORS AND WOBBLERS

MODELS	FREQUENCY RANGE	SIGNAL	PRECISION	MODULATION	VOLTAGE	PRECISION
406 B	20 cps - 200 kc		+/- 1.5 %	—	20 or 2 x 10 V	3 %
409 A	10 - 300 mcs		>0.1 % min. quartz marker	FM	0.1 V	—
410 A	0 - 250 mcs		>0.1 % min. quartz marker	FM	0.1 V	—
411 A	0 - 320 mcs		>0.1 % min. quartz marker	FM	0.2 V and 0.1 V	—
428 A	100 kcs - 30 mc		>1 % min.	AM	0.1 V constant level	—
476 A	100 kcs - 26 mc		>1 % min. and >2 % min.	FM	0.1 V	—
457 B	5 cps - 50 kc K = A/a : 2-20		2 %	—	10V z int. 100V z ext.	+/- 5 %
458 A	5 cps - 50 kc (repeat) 0.5 μ s - 10.000 μ s		5 %	—	2 x 50 V z int.	+/- 5 %

III - SUPPLY - MEGOHMMETERS - SUNDRY UNITS

MODELS	DESCRIPTION AND GENERAL FEATURES
111 C	100 ³ - 400 ³ : 200 mA 108 ³ - 15 mA. Heating 1 ³ .3 - 25 V up to 6 amps.
114 A	100 ³ - 250 ³ : 150 mA 150 ³ - 10 mA. Heating 6.3 V, 3 amps.
674 B	5 Mahm - 100 kMohm in 4 measuring ranges at 280 V. cont. controlled
803 B	Pressure and Vibration Detector for fluids and solids
804 B	Static and Dynamic Extensometric Units
805 A	Magnetic detection of faults in composition and treatment in large components
806 A	Magnetic detection of faults in composition and treatment in small parts
713 A	Cathodic Oscilloscope with 5 or 6 curves for all industrial investigations

Ribet-Desjardins are, among others, suppliers for :

The French Atomic Energy Authority, National French Center for Scientific Research, the Marcel Dassault Aircraft Works, the Bretigny Flight Test Center, the French National Defence, SNCF (the French Railways), Oerlikon (Switzerland), Transmission Services for the Belgian and Netherlands Armies, the Universities of Liege and Brussels, Polish and Yugoslav Central Purchasing Authorities, Brandt Company, French Public Health (neuro-biologic services for hospitals).

In order to receive technical particulars on the equipment of interest to you please write to

RIBET DESJARDINS

MEASURE - CONTROL DEPARTMENT
13-17, Rue Périer, Montrouge (Seine), France
Tel. ALE. 24-40 - CODE WORD : PILACELECT, MONTRouGE

plug it in anywhere! copy anything

LETTERS, INVOICES
RECEIPTS, CHARTS, BLUE PRINTS
BIDS, PHOTOGRAPHS
REPORTS, QUOTATIONS, ETC.



THE NEW ALL-ELECTRIC

APÉCO *Auto-Stat*
DIAL-A-MATIC

Instant photocopies of anything written, printed, typed, drawn or photographed—right in your own office

So fast . . . so convenient . . . so easy! Exclusive "Magic Touch" dial control assures perfect black-on-white copies of anything every time. Clear sharp copies from any original up to 15" wide, any length or color on opaque or transparent paper—printed on one or both sides. Made of stainless steel, it is handsome, compact, and light weight. Offers hundreds of time and money saving uses for every business at a price well within the budget of even the smallest firm.

*Styled by
Charles E. Jones & Assoc.*

JUST TURN THE DIAL
It automatically makes all adjustments to copy anything

Have you read this

**New
Free
Book?**

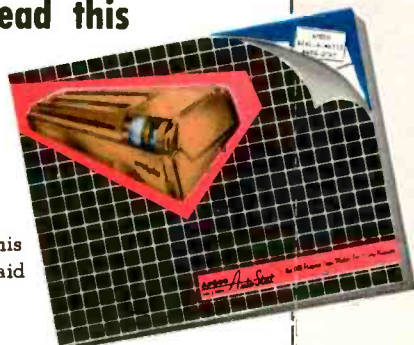

For your free book tear off and mail this Air Mail Postage Paid reply card today.

American Photocopy Equipment Co.
1920 W. Peterson Ave., Chicago 26, Ill.

American Photocopy Equipment Co.
1920 W. Peterson Ave., Chicago 26, Ill.

E-28

Rush me, without obligation, your new free book on the improved all-electric Apeco Dial-A-Matic Auto-Stat. I understand this book explains office photocopying applications in detail and shows how my business can greatly benefit by the use of this modern copy-maker.

Company _____ Type of Bus. _____

Address _____

City _____ Zone _____ State _____

Individual _____ Title _____

In Canada: Apeco of Canada, Ltd. 134 Park Lawn Rd., Toronto, Ont.

the all-purpose INSTANT copy-maker

APÉCO *Auto-Stat*[®]
DIAL-A-MATIC

Find out how you can save time and money by speeding production . . . by cutting costly office paper work . . . by expediting shipping and receiving—plus hundreds of other ways of increasing the efficiency of your business with Apeco Auto-Stat copying. It's all in this new free book. Send for your copy today.

Have you read this NEW FREE BOOK?

16 full color pages to tell you how you can use the Apeco Dial-A-Matic Auto-Stat in your business.



First Class Permit
No. 26670
(Sec. 4.9 P. L. & R.)
Chicago 26, Ill.

BUSINESS REPLY CARD

5¢ postage will be paid by—

AMERICAN PHOTOCOPY EQUIPMENT CO.

1920 W. Peterson Ave.

Chicago 26, Ill.

GET YOUR FREE BOOK

Mail this Postage Paid

Air Mail Reply Card Today!

TRANSFORMERS INCORPORATED has consistently designed and manufactured precision transformers that solved the transformer problems of its customers. What are YOUR problems?

PRECISION

TRANSFORMER

PROBLEMS?

SIZE AND WEIGHT

ACCURACY

RELIABILITY

Because of advances in transformer design calculation methods and technique, Transformers, Incorporated can accurately establish the size and weight of the required transformer from your performance specifications, without the expensive and time consuming construction and testing of prototypes. These same advances in transformer design engineering have enabled Transformers, Incorporated to produce the smallest and lightest precision transformers available. This is particularly important in this era of miniaturization, peculiar space envelopes, and rigid weight requirements.

Transformers, Incorporated designs and manufactures transformers with a measured voltage ratio accuracy of up to five parts per million (0.0005%) at room temperatures and under no-load condition, with comparable accuracies at other temperatures and loads. These accuracies can be maintained in all production quantities from one to one thousand—or any other quantity that you may require. The ability of Transformers, Incorporated to maintain specified accuracies has been consistently proven by samples submitted to the U. S. Bureau of Standards Testing Laboratory.

Each and every transformer is individually inspected and electrically tested, and samples are subjected to the required environmental tests, to ensure the highest degree of reliability. These methods far exceed the usual sampling techniques of most quality control systems, and enable Transformers, Incorporated to guarantee that every precision transformer will meet or exceed customer specifications.

Relieve your engineering department of the arduous task of designing precision transformers. Phone ENDICOTT, NEW YORK 8-3311, collect. Ask for Tres Park. There's no obligation.

Partial List of SATISFIED CUSTOMERS: Ballantine Laboratories • Bell Aircraft • Boeing Airplane Company • Curtiss-Wright • Daystrom Instrument • Dumont Laboratories • General Electric • Hughes Aircraft • IBM • Kollsman Instrument • Link Aviation • Leeds & Northrup Massachusetts Institute of Technology • Melpar, Inc. • Norden-Ketay • Raytheon • Sperry-Gyroscope • Sylvania . . . and others.

T **TRANSFORMERS, INCORPORATED**

200 Stage Road, Vestal, N.Y.

TRIPLETT

Reliability... through 15,631 accepted types

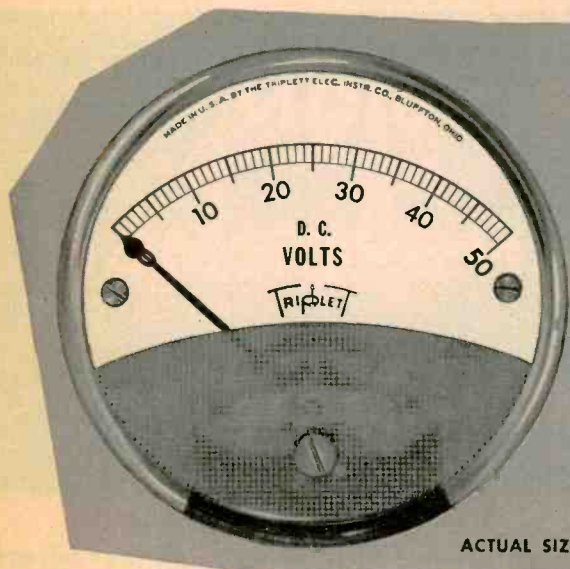

ACTUAL SIZE

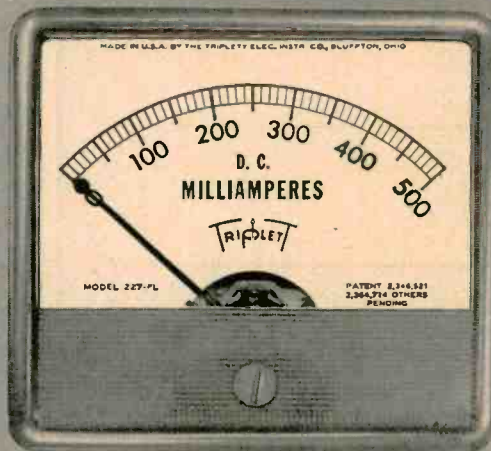
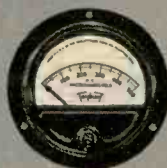

ACTUAL SIZE

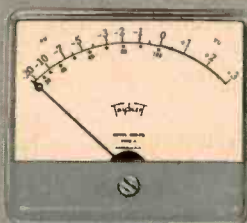
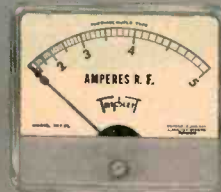

Clear plastic (PL) meters feature;

- Longer scale length
- Visibility unlimited
- Light unobstructed—no shadows
- Interchangeability—universal
- Appearance revolutionized

UNIQUE FEATURES AND CHARACTERISTICS

These guarantee superior quality in *all* TRIPLETT meters:

- High torque to weight ratio for extra rugged movement. Specially developed bearings withstand severe vibration and reduce friction to a minimum.
- Bearings are microscopically graded not only for depth and radius, but also for *polish*. Only best quality jewels are used.
- Unique hardening method assures uniformly hard pivots.
- High flux scientifically aged alnico magnets for greatest permeability. Micrometrically balanced all metal frame construction protects bearings against vibration from any direction.

- Simplicity of frame construction assures easy, accurate alignment in servicing.
- Dials are all metal—no paper dials are ever used—will not become abrasive, warp, crack or discolor under normal conditions. (Printing presses in Triplett's own plant allow fast, inexpensive service on special dial requirements.)
- Extra strong ribbed pointers precisely balanced with triple "slide and lock" adjusting weights.
- Insulations provide extra allowance for breakdown voltages.
- All metal parts processed, all molded parts pre-cured to eliminate distortions from stresses and strains.

TRIPLETT ELECTRICAL INSTRUMENT COMPANY • 52 years of experience • BLUFFTON, OHIO

Triplett design and development facilities are available for your special requirements for meters and test equipment.

Constantin QUALITY GLASS-TO-METAL SEALS . . .

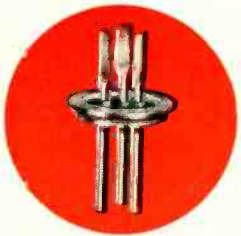
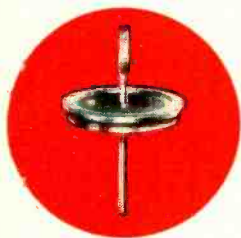
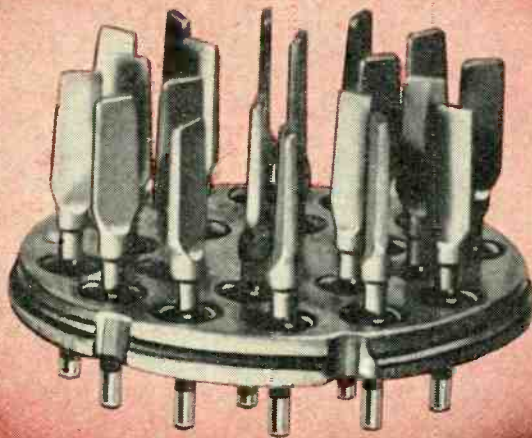

New glass-to-metal seal matches solderless type connectors

Good news for relay and other manufacturers of complex electronic components!

Constantin has the best answer for design engineers looking for glass-to-metal seals that match standard solderless type connectors. What's more these quality units mate quickly and easily with female lugs. Time-consuming soldering techniques are eliminated; leads will not deform or pull loose — especially important in harness work or work requiring quick solderless multiple connections.

Besides this particular unit, Constantin designs and manufactures a complete line of glass-to-metal seals ranging from . . . multi-headers . . . end seals . . . single headers . . . transistor mounts and covers . . . connectors . . . terminals . . . crystal holders . . . to complete electro-mechanical assemblies. All these components are precision engineered and quality control is carefully maintained by critical inspection. In fact Constantin's versatile engineering and production experience has resulted in many unique seal designs which have since become industry standards.

Constantin invites you to see for yourself by writing for more information.



"QUALITY WITH CONFIDENCE"

L. L. Constantin & Co.

**MANUFACTURING
ENGINEERS**

GENERAL OFFICES: ROUTE 46, LODI, NEW JERSEY

PLANTS: ● 187 SARGEANT AVE., CLIFTON, N. J.
● ROUTE 46, LODI, N. J.
● 6TH AND CAPITOL STS., SADDLE BROOK, N. J.



meters for every

Custom-built or Stock, Simpson Offers a Complete Line

To meet your special requirements, Simpson can build electrical panel meters in many combinations of size, range, type, and style. For meters in small quantities, you can select from 60,000 stock units (over 900 sizes and types) available for *immediate delivery* through your Electronic Distributor. Many stock models now have the *self shielded* Core Magnet Meter Movement.

These fine panel instruments are known throughout industry for their ruggedness and long-lived accuracy. Write today for Technical Manual No. 17.



SIMPSON ELECTRIC COMPANY
5200 W. Kinzie St., Chicago 44, Ill.
Phone: EStebrook 9-1121
In Canada:
Bach-Simpson Ltd., London, Ontario

instruments that stay accurate

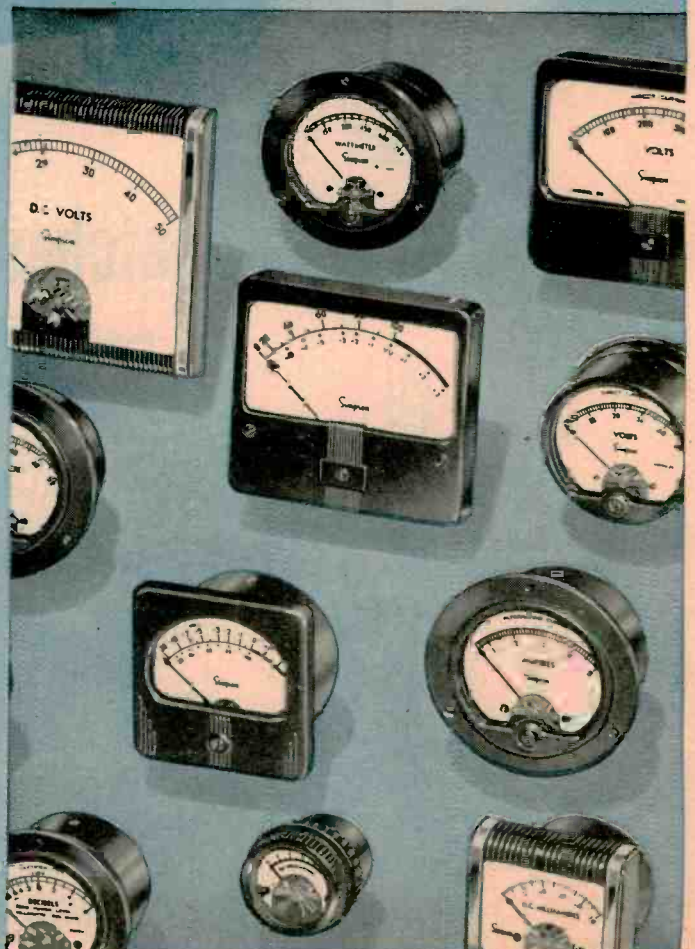

new



EDGEWISE

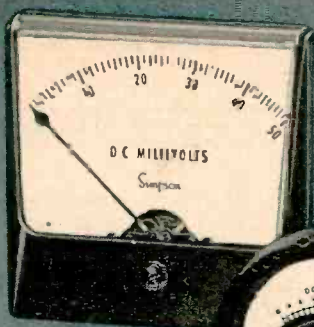

WIDE-VUE

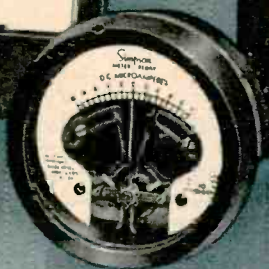

METER RELAY



ELAPSED TIME

need . . . Simpson

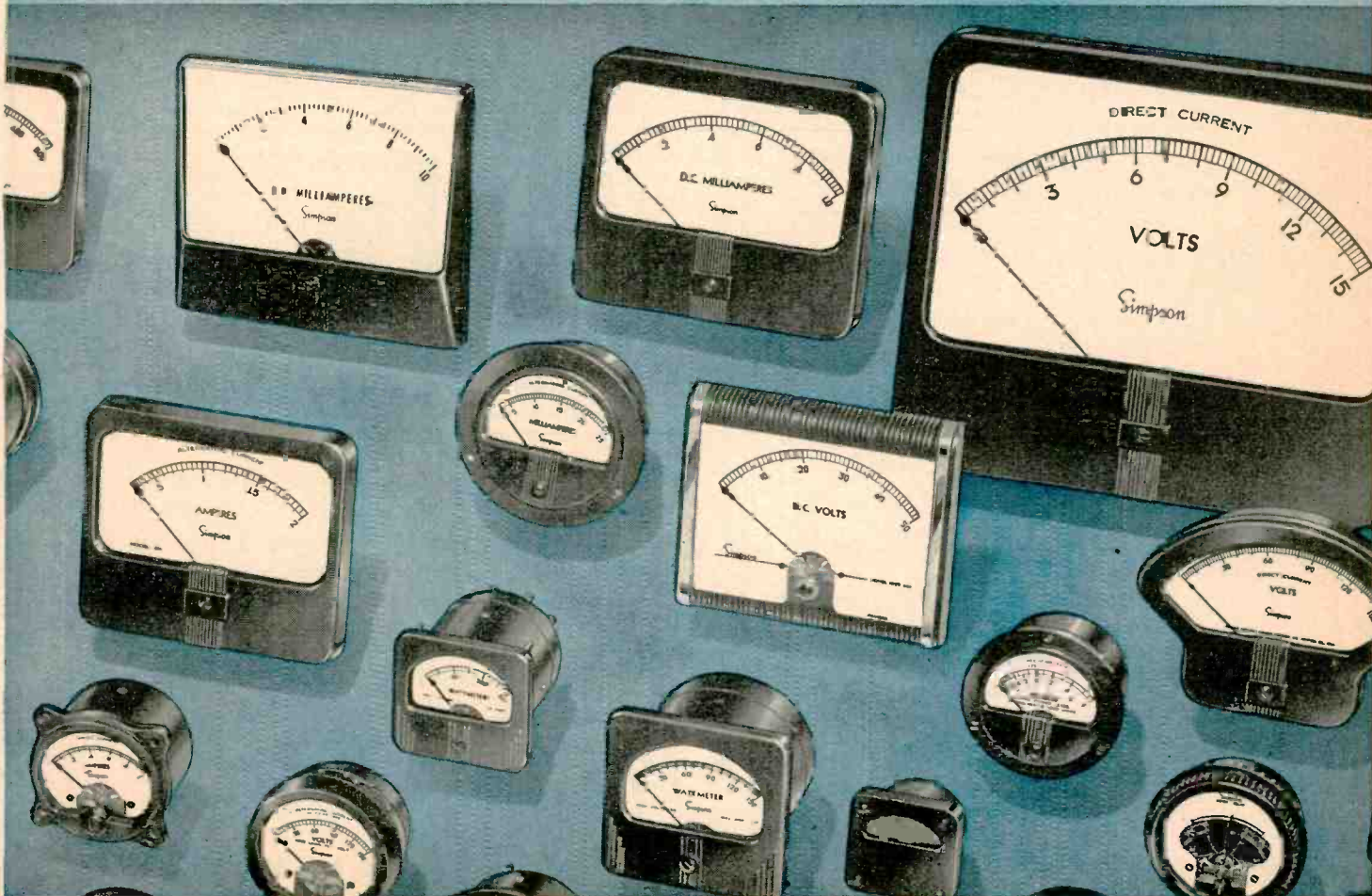

FREQUENCY STANDARDS

PRECISION FORK UNIT TYPE 50



*3 1/8" high
400 - 1000 cy.

Size 1" dia. x 3 3/4" H.* Wght., 4 oz.
Frequencies: 240 to 1000 cycles
Accuracies:—
Type 50 ($\pm 0.02\%$ at -65° to 85°C)
Type R50 ($\pm 0.002\%$ at 15° to 35°C)
Double triode and 5 pigtail parts required
Input, Tube heater voltage and B voltage
Output, approx. 5V into 200,000 ohms

FREQUENCY STANDARD TYPE 50L



Size 3 3/4" x 4 1/2" x 5 1/2" High
Weight, 2 lbs.
Frequencies: 50, 60, 75 or 100 cycles
Accuracies:—
Type 50L ($\pm 0.02\%$ at -65° to 85°C)
Type R50L ($\pm 0.002\%$ at 15° to 35°C)
Output, 3V into 200,000 ohms
Input, 150 to 300V, B (6V at .6 amps.)

PRECISION FORK UNIT TYPE 2003



*3 1/2" high
400 to 500 cy.
optional

Size 1 1/2" dia. x 4 1/2" H.* Wght. 8 oz.
Frequencies: 200 to 4000 cycles
Accuracies:—
Type 2003 ($\pm 0.02\%$ at -65° to 85°C)
Type R2003 ($\pm 0.002\%$ at 15° to 35°C)
Type W2003 ($\pm 0.005\%$ at -65° to 85°C)
Double triode and 5 pigtail parts required
Input and output same as Type 50, above

FREQUENCY STANDARD TYPE 2005



Size, 8" x 8" x 7 1/4" High
Weight, 14 lbs.
Frequencies: 50 to 400 cycles
(Specify)
Accuracy: $\pm 0.001\%$ from 20° to 30°C
Output, 10 Watts at 115 Volts
Input, 115V. (50 to 400 cycles)

FREQUENCY STANDARD TYPE 2007-6 **NEW**



TRANSISTORIZED, Silicon Type
Size 1 1/2" dia. x 3 1/2" H. Wght. 7 ozs.
Frequencies: 400 — 500 or 1000 cycles
Accuracies:
2007-6 ($\pm 0.02\%$ at -50° to $+85^{\circ}\text{C}$)
R2007-6 ($\pm 0.002\%$ at $+15^{\circ}$ to $+35^{\circ}\text{C}$)
W2007-6 ($\pm 0.005\%$ at -65° to $+125^{\circ}\text{C}$)
Input: 10 to 30 Volts, D. C., at 6 ma.
Output: Multitap, 75 to 100,000 ohms

FREQUENCY STANDARD TYPE 2121A

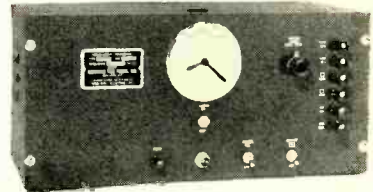

Size
8 3/4" x 19" panel
Weight, 25 lbs.
Output: 115V
60 cycles, 10 Watt
Accuracy:
 $\pm 0.001\%$ from 20° to 30°C
Input, 115V (50 to 400 cycles)

FREQUENCY STANDARD TYPE 2001-2



Size 3 3/4" x 4 1/2" x 6" H., Wght. 26 oz.
Frequencies: 200 to 3000 cycles
Accuracy: $\pm 0.001\%$ at 20° to 30°C
Output: 5V. at 250,000 ohms
Input: Heater voltage, 6.3 - 12 - 28
B voltage, 100 to 300 V., at 5 to 10 ma.

FREQUENCY STANDARD TYPE 2111C

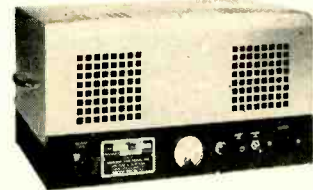

Size, with cover
10" x 17" x 9" H.
Panel model
10" x 19" x 8 3/4" H.
Weight, 25 lbs.
Frequencies: 50 to 1000 cycles
Accuracy: ($\pm 0.002\%$ at 15° to 35°C)
Output: 115V, 75W. Input: 115V, 50 to 75 cycles.

ACCESSORY UNITS for TYPE 2001-2



L—For low frequencies
multi-vibrator type, 40-200 cy.
D—For low frequencies
counter type, 40-200 cy.
H—For high freqs, up to 20 KC.
M—Power Amplifier, 2W output.
P—Power supply.

This organization makes frequency standards within a range of 30 to 30,000 cycles. They are used extensively by aviation, industry, government departments, armed forces—where maximum accuracy and durability are required.

WHEN REQUESTING INFORMATION
PLEASE SPECIFY TYPE NUMBER

American Time Products, Inc.

Watch  Master
Timing Systems

Telephone: PLaza 7-1430

580 Fifth Ave., New York 36, N. Y.

Smaller
than a
postage
stamp!

(except in thickness, of course)

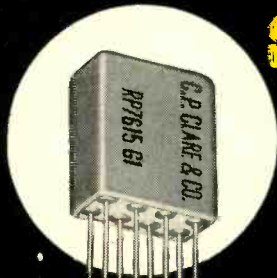

-the new

CLARE Type F RELAY

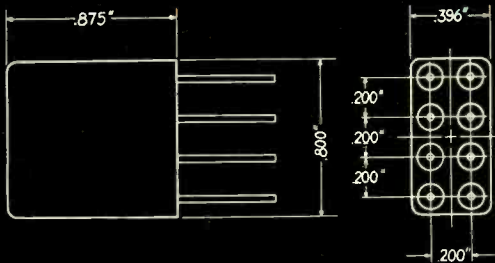

SPECIFICATIONS:

Ambient Temperature.....	-65° C to +125° C.
Shock.....	50 Gs for 11 milliseconds.
Vibration.....	5-75 cps at maximum excursion of 1/8-inch, 75-2000 cps at 20 Gs acceleration.
Dielectric Strength.....	Sea level—1000 volts rms between terminals and frame, and between adjacent circuits; 750 volts rms between contacts of a set. At 80,000 ft., 350 volts rms.
Insulation Resistance.....	1000 megohms minimum at 125° C.
Coils.....	Coils up to 10,000 ohms available for a wide range of voltages or currents.
Nominal Operating Power.....	.250 milliwatts.
Pickup Time.....	3.5 milliseconds nominal.
Dropout Time.....	1.5 milliseconds nominal.
Contact Arrangement.....	2 pdt (2 form C).
Contact Rating.....	3 amps resistive at 28 volts d-c or 115 volts a-c; also for low-level applications.
Contact Resistance.....	0.050 ohm maximum.
Contact Life.....	500,000 operations minimum at 2 amps; 100,000 operations minimum at 3 amps.
Enclosure.....	Hermetically sealed, filled with dry nitrogen at 1 atmosphere pressure.
Mounting.....	All popular mounting arrangements available.
Terminals.....	Printed circuit; solder; plug-in (matching socket available). Variations of printed-circuit terminal length on 1/10-inch grid spacing available.
Weight.....	17 grams.
Military Specifications.....	MIL-R-25018; MIL-R-5757C, except as to contact overload.

This new hermetically sealed relay—no bigger than a postage stamp—is Clare's response to the insistent demand of the military and of industry for a smaller and lighter relay stalwart enough to withstand extremes of temperature, heavy shock, and severe vibration, yet fast and more than moderately sensitive.

Without any assertions of superior design, materials or workmanship, the factual specifications at the left tell how closely this relay is geared to the needs of today's advanced circuit designers. Important to many engineers will be the fact that the contacts—rated at 3 amperes—are proven also for low-energy-level circuit applications. Designers of printed-circuit layouts will note that the terminal arrangement is nicely suited to 1/10-inch grid spacing.

For complete information send for Bulletin 124. Write or call: C. P. Clare & Co., 3101 Pratt Blvd., Chicago 45, Illinois. In Canada: C. P. Clare Canada Ltd., 2700 Jane Street, Toronto 15. Cable Address: CLARELAY.

CLARE RELAYS

FIRST in the industrial field

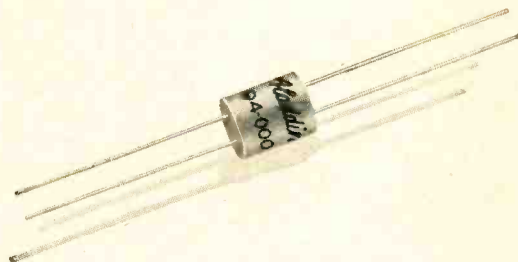

more and more people are thinking of Aladdin as the standard of the electronic industry in pulse transformers

ALADDIN:

- supplies an Encyclopedia of pulse circuits, specifications, terminology and available styles;
- makes micro-miniature (transistor size) units;
- offers a comprehensive product line
- sells standard, commercial units, at mass-production prices.

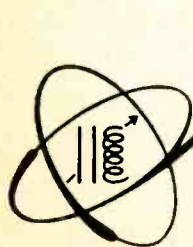

Aladdin® **ELECTRONICS**

A Division of Aladdin Industries, Inc.

717 Murfreesboro Road, Nashville 2, Tenn.; Tarrytown, N. Y.; Pasadena, Calif.

**PRECIOUS
METAL
CONTACTS
PROVIDE LONG
OPERATING
LIFE AND
UNVARYING
PERFORMANCE**

Progressive research development policies, coupled with vast experience in related fields, enable BAKER to apply its know-how in precious metals to meet the diverse problems accompanying the selection of precious metal contacts to suit individual requirements. The following BAKER precious metal materials serve to illustrate what BAKER's research departments make available in SILVER, PLATINUM, PALLADIUM and GOLD, in pure or alloy form, for supply as wire, rod, sheet, and as fabricated forms, such as rivets, discs, solderbacks, welding types, overlay, edgelay, inlay and irregular shapes.

SILVER AND SILVER ALLOYS

One of the most widely used materials for electrical contacts, SILVER provides high resistance to atmospheric corrosion. Silver Alloys—which contain base metals to achieve specific properties—provide other modified characteristics, such as increased resistance to arc erosion, sticking and metal transfer.

PLATINUM AND PLATINUM ALLOYS

Offering a higher resistance to tarnish and corrosion than any other contact material, the contact resistance of platinum can be maintained at a low value throughout its operating life. Platinum alloys provide higher melting points and hardness, greater resistance to deformation, longer life and increased resistance to sticking and metal transfer.

Write for complete catalog material and details.

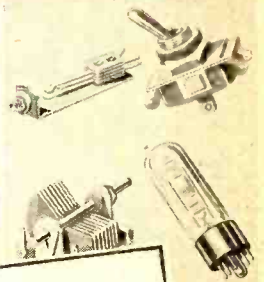
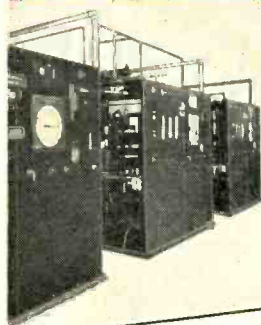
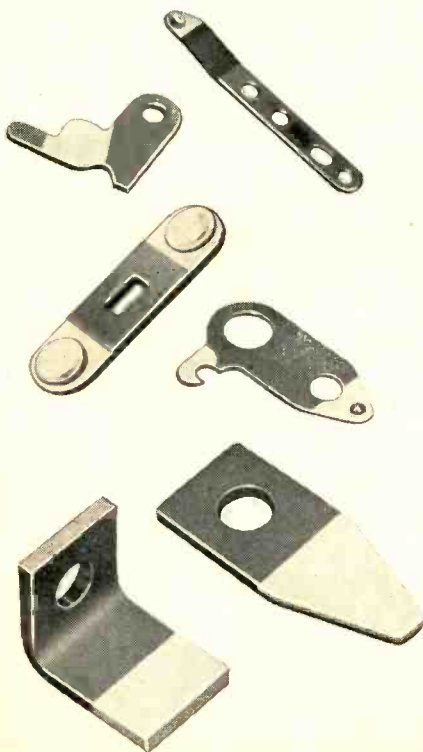

BAKER & CO., INC.
WILL HENCEFORTH BE DESIGNATED AS
ENGELHARD INDUSTRIES, INC.

BAKER CONTACT DIVISION

✱
113 ASTOR STREET
NEWARK 2, NEW JERSEY

CHICAGO

ENGELHARD INDUSTRIES

provides
white,
surface
to cor-

RESEARCH MAINTAINS BAKER'S LEADERSHIP IN PRECIOUS METALS



When the U. S. Army moves up Kleinschmidt is in the van

Kleinschmidt page printers and reperforator teletypewriters receive and transmit teletyped communications wherever a truck can roll.

As division headquarters advances in the field, it is imperative that communications with outlying units be maintained without interruption. Kleinschmidt teletypewriters and related equipment, installed in a U. S. Army cargo truck and transmitting by radio, provide a message center that meets every demand of mobility and dependable two-way communications. These Kleinschmidt units, developed in cooperation with the U. S. Army Signal Corps, furnish

sender and recipient with an identical teletyped original, eliminating misinterpretation and speeding the required action.

Research and development of equipment for transmitting and receiving printed communications has been a continuing project at Kleinschmidt for almost 60 years. This unparalleled store of experience, now joined with that of Smith-Corona Inc, holds promise of immeasurable new advances in electronic communications.

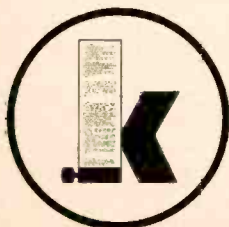

KLEINSCHMIDT LABORATORIES, INC.

PIONEER IN TELETYPE COMMUNICATIONS EQUIPMENT

A SUBSIDIARY OF SMITH-CORONA INC • DEERFIELD, ILLINOIS

**NEW... A complete system
for measuring and recording
MICROWAVE ANTENNA PATTERNS**



400 to 22,000 mc

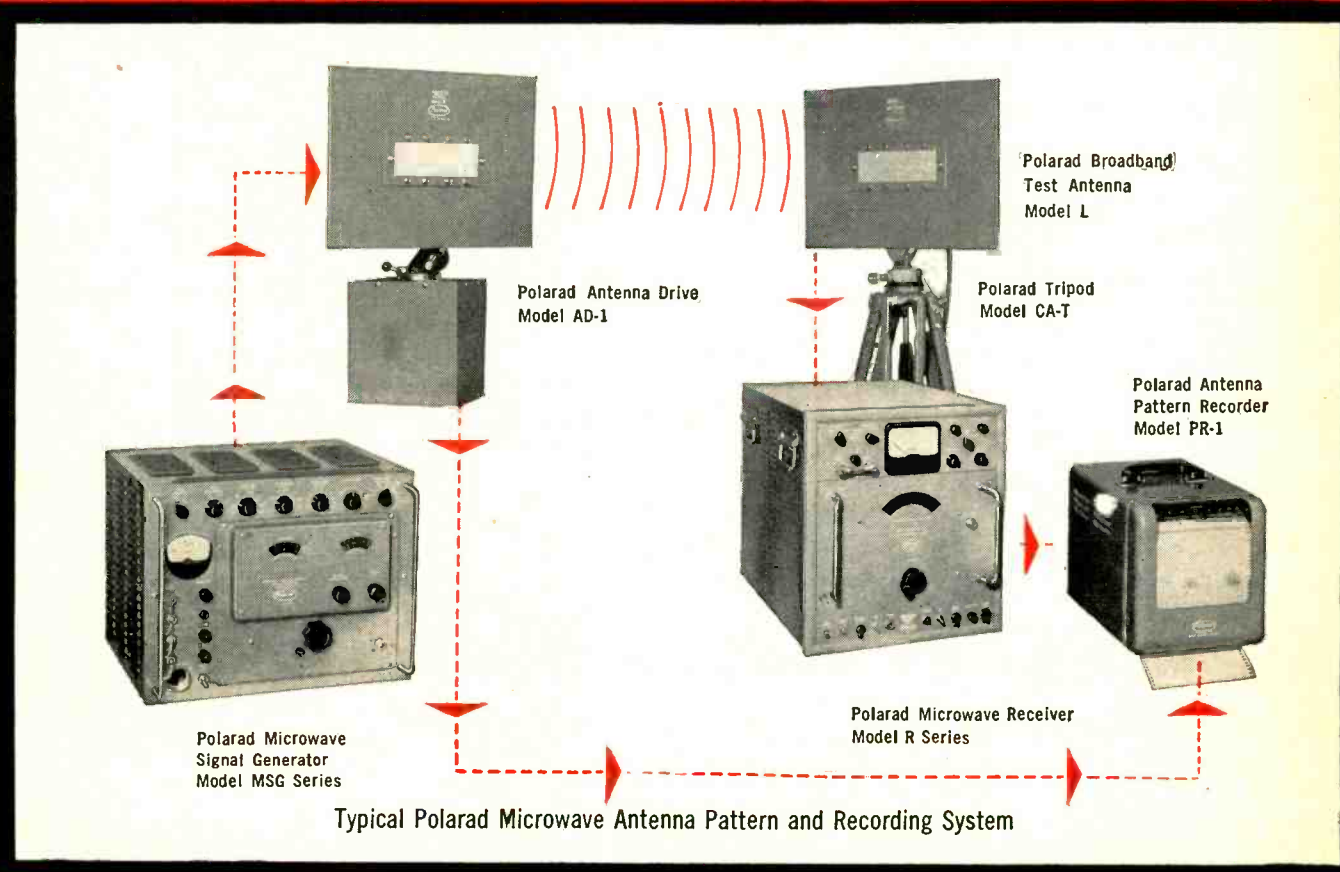

Typical Polarad Microwave Antenna Pattern and Recording System

The Polarad Microwave Antenna Pattern Measuring and Recording System is a highly sensitive system with a large dynamic range enabling detection and plotting of nulls which are 60 db down from the direction of maximum directivity.

The system is composed of standard Polarad test instruments. A selection can be made from the wide range of Polarad signal sources, and generators, and the Polarad Model R Microwave Receiver can be equipped to accommodate any band within the range 400 to 22,000 mc. A full range of calibrated and test antennas is available to work into these components.

The Polarad Antenna Drive Model AD-1 is equipped to mount a Polarad test antenna and drive it at a rate of 25/36 rpm with an angle of scan adjustable from 0° to 360° with automatic recycling of the antenna within desired limits. The

synchro-generator in the unit is linked to the synchro-motor that controls movement of the chart in the Antenna Pattern Recorder, Model PR-1.

The Polarad Antenna Pattern Recorder is a DC, two axis rectangular recorder operating a chart calibrated from 0 to 70 db on one axis, and degrees of rotation on the other. The pen servo system is driven by the output of the Model R Receiver.

SYSTEM FEATURES:

- Over 60 db dynamic r-f range
- Sensitivity greater than -80 dbm, through X-Band
- High stability
- Frequency range 400 to 22,000 mc

Specifications of the various system components available on request.

POLARAD ELECTRONICS CORPORATION

43-20 34th Street, Long Island City 1, New York

REPRESENTATIVES: Abington, Albany, Atlanta, Baltimore, Boeing Field, Chicago, Cleveland, Dayton, Denver, Detroit, Englewood, Fort Worth, Kansas City, Los Angeles, Portland, Rochester, St. Louis, Stamford, Sunnyvale, Syracuse, Washington, D. C., Westbury, Westwood, Wichita, Winston-Salem, Canada: Amprior, Toronto, Montreal. Resident Representatives in Principal Foreign Cities.

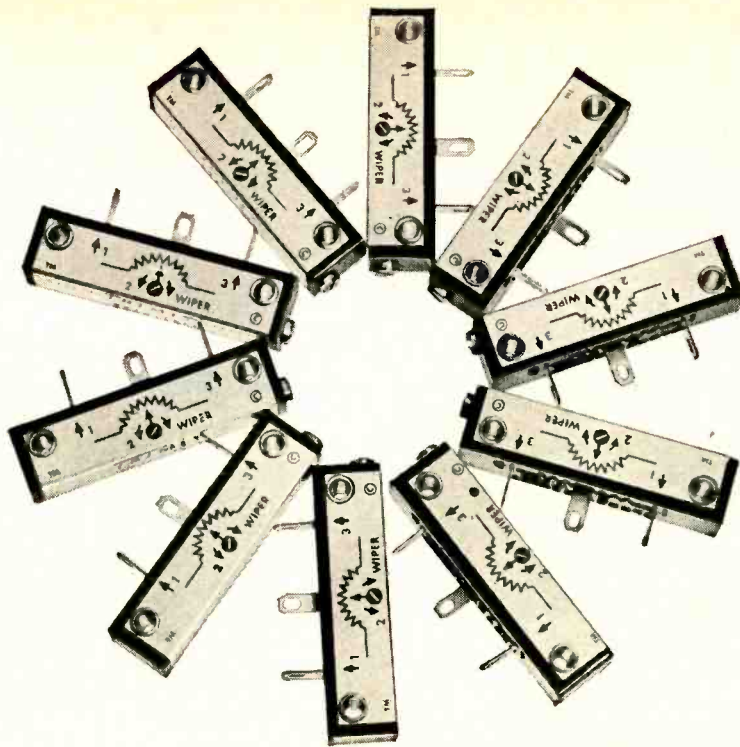

HERE'S **TRIMIT**[®] ... A NEW TYPE OF ADJUSTMENT POTENTIOMETER
 FOR COMPUTERS, CONTROLS, COMMUNICATIONS, TEST EQUIPMENT

Compared with the average control-type single-turn rotary potentiometer, TRIMIT adjustment accuracy is a 33:1 improvement.

TRIMIT provides 9000° of rotation instead of 270°.

Easier repeatability, too.

TRIMIT geometry is a 6:1 to 12:1 improvement—you can mount 12 units in a panel area of only 1 square inch. They fit flat against printed circuits, into tight corners, between components.

The screwdriver-adjusted TRIMIT settings are extremely stable.

The screw-actuated mechanism is virtually immune to shock or vibration.

Write today for more information on TRIMIT.



BOURNS
 Laboratories, Inc.

P.O. Box 2112 • Riverside, California

ORIGINATOR OF TRIMPOT[®] AND POTENTIOMETER INSTRUMENTS



MODEL 372 SLIDING COAXIAL TERMINATIONS

This equipment, available only from Narda, provides the most convenient means for evaluating the residual VSWR of coaxial slotted lines. VSWR of the element is 1.05 or less; covers range from 2000 to 12,400 mc.

N Connector, male or female **\$110** C Connector, male or female **\$116**



MODEL 371 FIXED COAXIAL TERMINATION

This Narda coaxial termination is the first and only to cover the entire frequency range from S to X band. Same range and element VSWR as above.

N Connector, male or female **\$55** C Connector, male or female **\$58**

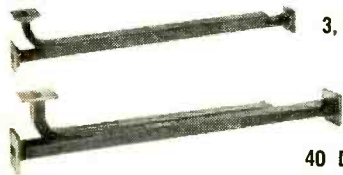

3, 6, 10 and 20 DB

40 DB HIGH POWER

HIGH DIRECTIVITY COUPLERS

The 40 db High Power Coupler is another exclusive Narda product. Similar to standard types, except that coupling irises are in the narrow wall, it may be used at full rated power of the waveguide size. Nominal coupling value is 40 db; directivity 40 db. Directivity for 3, 6, 10 and 20 db couplers is also 40 db. Standard cover flanges on primary line; low VSWR termination and standard cover flange on secondary. All bands covering frequencies from 2600 to 18,000 mc.



STANDARD REFLECTIONS

Narda offers five values of reflections for each of six different waveguide sizes... the most complete choice we know of! Provides calibrated reflections or VSWR's for use in standardizing reflectometers or calibrating slotted line impedance meters.

SPECIFICATIONS

Reflection Coefficient	0.00	0.05	0.10	0.15	0.20
Accuracy	0.002	0.0025	0.0035	0.0045	0.007
VSWR Equivalent	1.00	1.105	1.222	1.353	1.50

Models for 2.60 to 18.0 kmc, from \$125 to \$300

Microwave engineers—

Where can you use these exclusive features offered by narda?

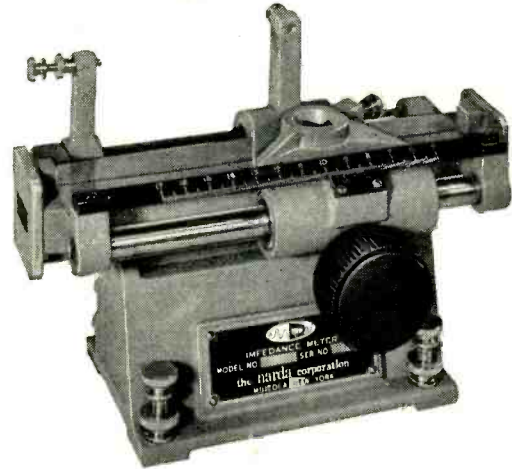

Waveguide and Coaxial IMPEDANCE METERS

Exclusively in Narda Waveguide and Coaxial Impedance Meters, the carriage mounting and drive mechanism are integral with the precisely machined transmission line casting. This insures permanent accuracy and freedom from slope errors—no more tedious adjustment or possibility of misalignment.

Other features include angle-mounted scale and vernier for optimum visibility; readily removable supporting pedestal; and smooth carriage travel action. Waveguide models, accurate for VSWR's of 1.01, are available for complete coverage from 2600 to 18,000 mc; N or C Connector coaxial models, from 1500 to 12,400 mc.

WAVEGUIDE IMPEDANCE METERS

Frequency (kmc)	Narda Model	Residual VSWR	Price
2.6 — 3.95	224	1.01	\$425
3.95 — 5.85	223		350
5.3 — 8.2	222		325
7.05 — 10.0	221		270
8.2 — 12.4	220		250
12.4 — 18.0	219		270

COAXIAL IMPEDANCE METERS

Frequency (kmc)	Connectors (One Male, One Female)	Narda Model	Price
1.5 to 12.4	Series N	231	\$360
1.5 to 12.4	Series C	232	390

Complete Coaxial and Waveguide Instrumentation for Microwaves and UHF—including:

- | | | |
|----------------------|---------------|----------------------|
| DIRECTIONAL COUPLERS | TUNERS | ATTENUATORS |
| TERMINATIONS | ECHO BOXES | STANDARD REFLECTIONS |
| FREQUENCY METERS | SLOTTED LINES | BOLOMETERS |
| HORNS | BENDS | THERMISTORS |

MAIL COUPON TODAY FOR FREE CATALOG AND NAME OF NEAREST REPRESENTATIVE

The Narda Microwave Corporation
160 Herricks Road
Mineola, N. Y.
Dept. E-1



NAME _____

COMPANY _____

ADDRESS _____

CITY _____ ZONE _____ STATE _____



the narda
microwave corporation

160 HERRICKS ROAD, MINEOLA, N. Y. • PIONEER 6-4650

Electronic Cooling Package...by AiResearch



SPECIFICATIONS OF TYPICAL AIRESEARCH COOLING PACKAGE

Air Flow	60 CFM
Fan Air Inlet Pressure	18 PSIA
Fan Pressure Rise	1.2 inches water
Heat Exchanger Pressure Drop	1.0 inches water
Liquid	Water
	Methanol (70% Methanol)
Liquid Flow	0.4 GPM
Heat Rejection*	300 Watts
Fan Power	30 Watts, 110 V., single phase, 400 cycle
Package envelope dimensions	7 x 6 x 3 inches
Package wet weight	2.5 lbs.

*Assumes Class A (85°C.) electronic components, liquid inlet temperature to heat exchanger, 55°C. Includes heat from fan motor.

This high performance AiResearch package cools sealed and pressurized electronic equipment. The fan circulates air through the liquid cooled heat exchanger and over electronic components in a hermetically sealed module. Air cooled units are also available. Fan and heat exchanger are designed, built and packaged by AiResearch for matched performance. Package size is tailored to your individual cooling requirements.

The Garrett Corporation, through its AiResearch Manufacturing divisions, is an industry leader in components and cooling systems for aircraft, missiles and nuclear applications. This wide experience is now being offered to the electronics industry to provide a cooling package to meet any cooling requirement. Send us details of your problem or contact the nearest Airsupply or Aero Engineering office for further information.



THE GARRETT CORPORATION

AiResearch Manufacturing Divisions

Los Angeles 45, California • Phoenix, Arizona

AERO ENGINEERING OFFICES:

MINEOLA • ATLANTA • BALTIMORE • BOSTON • CHICAGO • CINCINNATI • COLUMBUS
DETROIT • INDIANAPOLIS • PHILADELPHIA • ST. LOUIS • SYRACUSE • WINTER PARK

AIRSUPPLY OFFICES:

BEVERLY HILLS • DENVER • FT. WORTH • KANSAS CITY • SAN DIEGO • SAN FRANCISCO
SEATTLE • TULSA • WICHITA

Setting the standards by which other resistors will be judged!

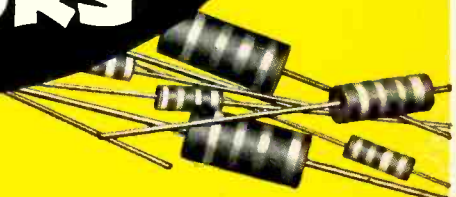
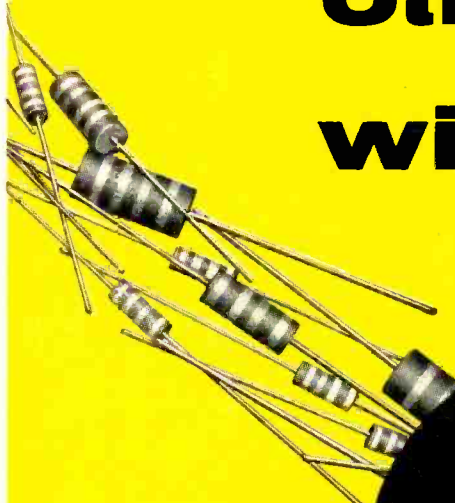

A major resistor development for major
military and commercial equipment producers

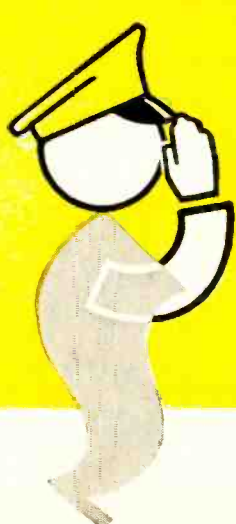

Write for Coldite 70+ Resistor Bulletin. Samples for Approval Tests on request to quantity users. Prompt deliveries on small quantities from leading distributors in many cities.

In MIL-R-11B Styles

RC-20
($\frac{1}{2}$ -watt)

RC-32
(1-watt)

RC-42
(2-watts)

Electronic Components Division • STACKPOLE CARBON COMPANY, St. Marys, Pa.

BRUSHES for all rotating electrical equipment • Custom Engineered CONTACTS • FIXED & VARIABLE RESISTORS • Snap & Slide SWITCHES • Ceramag® Ferromagnetic CORES • IRON CORES • Ceramagnet® Ceramic PERMANENT MAGNETS • VOLTAGE REGULATOR DISCS • POWER TUBE ANODES • and dozens of carbon, graphite and metal powder specialties.

OHMITE®

RITEOHM®

New Metal Film

Write for Bulletin 155A

A new kind of precision resistor with these important features:

Full 1/4-watt Rating at 150°C Ambient These new units may be used at full rated wattage in higher ambients than other types of precision film resistors. Rated at 1/2 watt at 125°C.

Excellent High-Frequency Characteristics Ohmite Metal Film units can be used in high-frequency and pulse circuitry for which wire-wound precision resistors are unsuitable.

Low Temperature Coefficient of Resistance Standard temperature coefficient is 0 ± 30 ppm/°C ($0 \pm .003\%/^{\circ}\text{C}$) over a wide range of -55°C to +190°C (25°C reference ambient) regardless of resistance value.

Long Term Load and Shelf Stability A temperature of +150°C is used in Ohmite load life and temperature cycling tests, which is considerably above MIL requirements.

Resistance Range Two sizes provide over-all range of 100 ohms to 300K ohms. The smaller unit provides resistances from 100 ohms to 150K ohms; larger unit covers the range from 150K to 300K ohms.

Ohmite Metal Film Resistors constitute a major advance in precision resistor technology and represent a radical departure in construction from wire-wound precision resistors. They employ no wire for the resistance element, yet feature excellent stability and noise level comparable to wire-wound units. Thus they are ideal for high-gain electronic circuits.

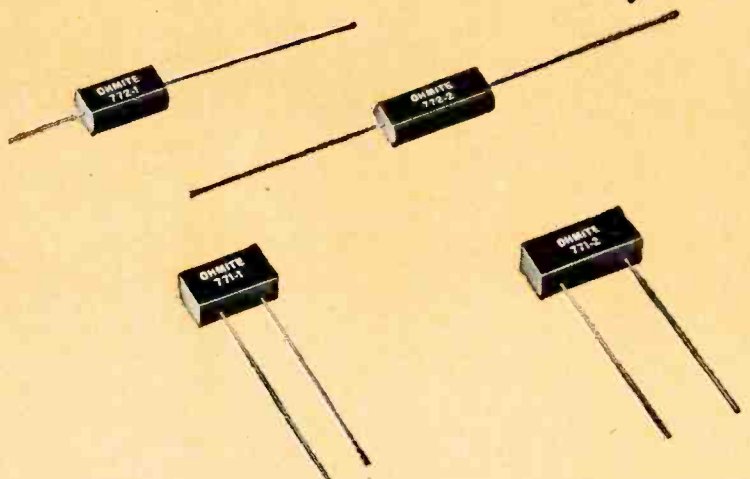

RITEOHM SERIES 77

CONFORMS TO $\frac{5}{16}$ " DIA. CIRCULAR SHAPE

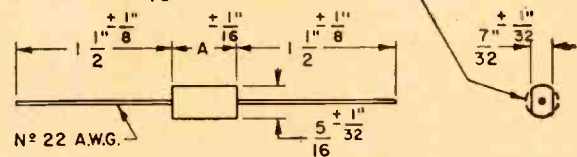

AXIAL LEAD TYPE	DIM. "A"
772-1	5/8"
772-2	13/16"

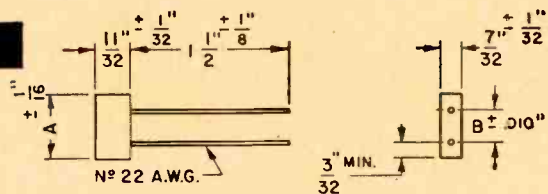

RADIAL LEAD TYPE	DIM. "A"	DIM. "B"
771-1	5/8"	.300
771-2	13/16"	.500

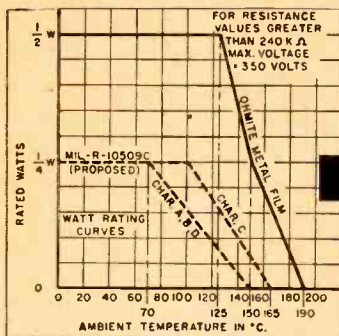

Dimensions and Styles

Watt rating chart for all types. At lower ambients, units may be uprated within voltage limitations.

Construction and Principle of Operation

The resistance element of Ohmite Metal Film Resistors consists of a thin film of special metal alloy permanently bonded onto a high-quality glass substrate. Terminal leads are securely fixed to the re-

sistance element for positive, trouble-free connections. The entire assembly is hermetically sealed in a special moisture-resistant, high-temperature, plastic case with a special high-temperature Ohmite resin. Terminal leads may be axial or radial as shown.

PRECISION RESISTORS

Wire-Wound

Write for Bulletins 145 and 154

COMPLETELY ENCAPSULATED TYPES

Series 85 and 86: Exceed MIL-R-93A, Amendment 2, at 125°C ambient

Ohmite Riteohm® Resistors have the resistance wire welded to the terminals by a patented Ohmite process. The resistance wire is fused to the terminal lug, giving a perfect and permanently stable electrical connection. This is extremely important in eliminating noise in audio circuits or instability in other highly sensitive circuits.

The encapsulating resin, which encloses *all* parts, is specially Ohmite-compounded. Its coefficient of expansion closely matches that of the bobbin, wire, and terminals—preventing internal movement and possible damage to the resistance wire. In addition, terminals remain firmly sealed in the resin, preventing the entrance of moisture into the windings.

Series 85, axial lead type, features tolerances to $\pm 0.1\%$. Resistance to 3.0 megohms. Many stock sizes available.

Series 86, radial lug terminals, features tolerances to $\pm 0.1\%$. Resistance to 2.2 megohms. Many stock sizes available.

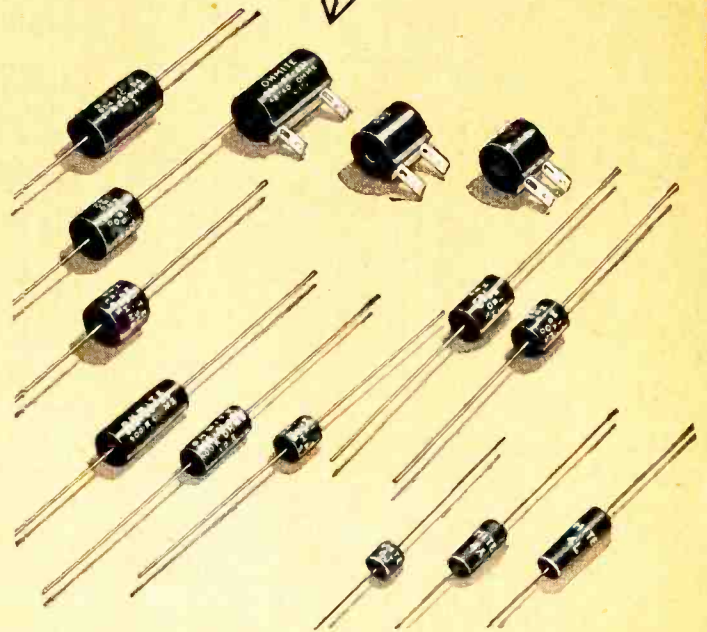

Varnish impregnated types

Series 83, precision Riteohm® resistors, feature specially enameled, alloy-resistance wire which is pie-wound on ceramic bobbins. Resistance to 2.6 megohms; radial wire leads. Units are vacuum-impregnated with a special varnish for protection against humidity.

Series 84, precision resistors, like Series 83, are vacuum-impregnated with a special varnish for optimum protection against humidity. Resistance to 4.8 megohms; radial terminal lugs.

Other types of terminations also available.

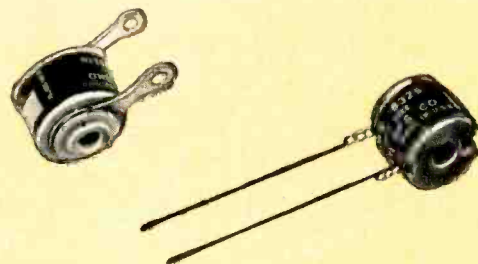

Vitreous-enameled types

Ohmite vitreous-enameled resistors are space-wound in a single layer on a ceramic tube. Any of these resistors can be furnished to precision tolerances in sizes from 3 watts to 200 watts, in various terminal types, and in a wide range of resistance values.



BE RIGHT WITH

OHMITE®

QUALITY
Components

RHEOSTATS RESISTORS RELAYS
TAP SWITCHES TANTALUM CAPACITORS
R. F. CHOKES VARIABLE TRANSFORMERS

OHMITE MANUFACTURING COMPANY

3610 Howard Street, Skokie, Illinois



Infra-red photoconductive cells of exceptional sensitivity



These two cells can be classed among the most outstanding recent British achievements in electronics. Specially designed for detecting infra-red radiations, they combine an unusually high order of sensitivity with an extremely fast response peaked at a wavelength of 2-3 microns. Their spectral range extends beyond the usual limits of infra-red detectors down to the red end of the visible spectrum.

The high signal-to-noise ratios of the 61SV and the 61RV make them ideal for measuring small temperature variations of relatively low heat sources down to 100°C. Additionally, their small size and rugged construction qualify them for the majority of infra-red applications in industry.

For further technical information and advice on the use of these outstanding photocells please write to either of the distributing companies listed here.

Principal characteristics

	61SV	61RV
Peak spectral response	2.5 μ	2.5 μ
Spectral range	0.3 to 3.5 μ	0.7 to 4.5 μ
Cell resistance (maximum)	4M Ω	150k Ω
Max. applied voltage	250V	100V
Minimum detectable power at 2 \pm 0.5 μ	5.5 x 10 ⁻¹¹ W	2.6 x 10 ⁻¹⁰ W
Time constant	75 μ secs.	15 μ secs.
Construction	Lead Sulphide	Lead Selenide
	(uncooled)	(uncooled)

Supplies available from: in the U.S.A.

International Electronics Corporation,
Dept. E2, 81, Spring Street, N.Y. 12,
New York, U.S.A.

in Canada

Rogers Majestic Electronics Limited,
Dept. 1B, 11-19 Brentcliffe Road,
Toronto 17,
Ontario, Canada.

Mullard is the Trade Mark of Mullard Limited and is registered in most of the principal countries of the world.



Mullard

ELECTRONIC TUBES

used throughout the world

MULLARD OVERSEAS LTD., MULLARD HOUSE, TORRINGTON PLACE, LONDON, ENGLAND
MEV 55

A bird in hand...



**RADAR INTELLIGENCE
FOR ALL APPLICATIONS**
Produced at
DAYSTROM INSTRUMENT

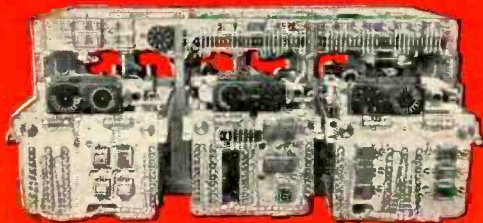

Fire Control Computer

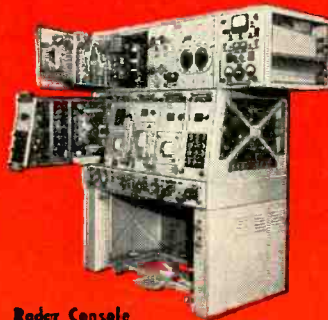

Radar Console



Radar Antenna

Daystrom Instrument meets today's rigid requirements for Missile Control Equipment.

Our engineers and production specialists are qualified, ready and anxious to assist in your programs. Our new 350,000 sq. ft. plant is completely equipped with the most modern manufacturing and test facilities for the production of electronic and electro-mechanical products.

Be among our satisfied customers in the Armed Services and Industry. Contact us for complete information on how we can help you.

Remember—Reliability Is A Must At Daystrom Instrument.



DAYSTROM INSTRUMENT

Division of Daystrom, Inc.

ARCHBALD, PENNA.

IN CANADA: Daystrom Ltd., 840 Caledonia Rd., Toronto 10, Canada
EXPORT: Daystrom International, 100 Empire Street, Newark 12, N. J.

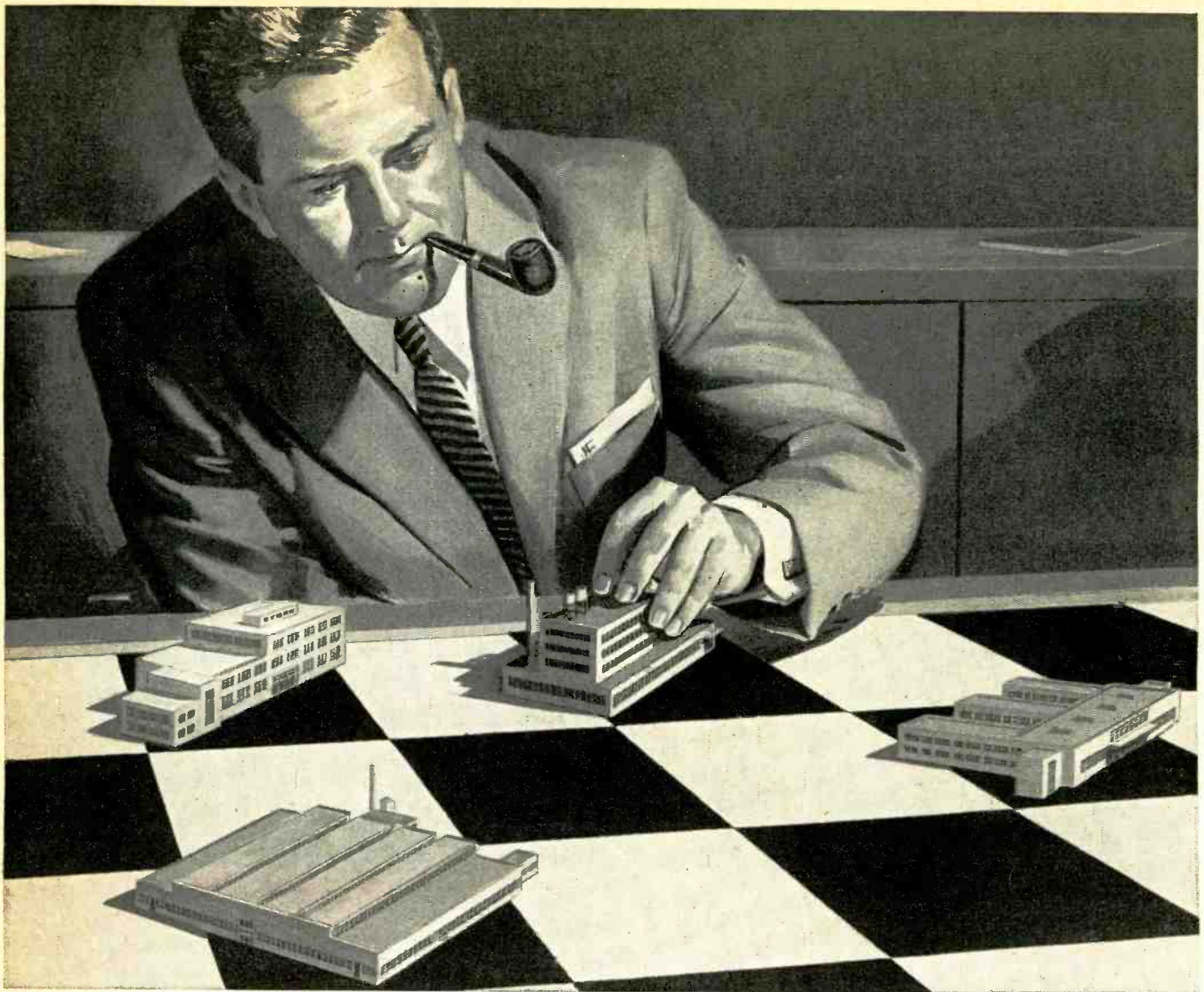

How to manage a system

For greater efficiency in carrying out the new weapons systems concept, military procurement officers work through central management contractors.

The Stromberg-Carlson Electronics Division is very proud to have been selected by the United States Air Force as a major systems management contractor.

These are some of our qualifications:

1. An established systems management group deep in managerial skill and experience;
2. An organizational setup under which the systems manager reports directly to the Vice President in charge of the Division;

3. An outstanding security record achieved in working with all the military services;
4. Strategic location close to major supply sources and convenient to all types of transportation.

Our manufacturing facilities and experience go hand in hand with systems management ability to qualify us as prime and sub-contractors, too.

The systems concept, which applies to military hardware *today*, can apply with equal force to civilian goods *tomorrow*. Stromberg-Carlson is ready . . . now, or any time.

"There is nothing finer than a Stromberg-Carlson"



STROMBERG-CARLSON

A DIVISION OF GENERAL DYNAMICS CORPORATION

1464 N. Goodman Street • Rochester 3, N. Y.



Electronic and communication products for home, industry and defense

eppe has shipped over 23,000 size 8 synchros

Field Tests Prove their Built-In Reliability

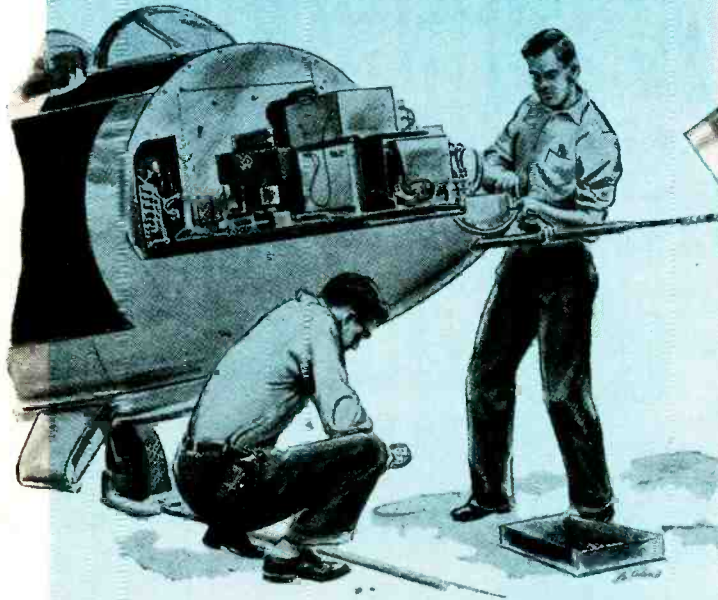

and...
made provision to deliver
much larger quantities
with their new Colorado
Springs synchro facility

Why not buy fully proven size 8 synchros? Clifton Precision size 8 units have been designed, developed, in production 2 years and are now being built into field equipment tested and accepted by end-use agencies.

Such acceptance made it necessary for us to establish another plant in Colorado Springs to produce size 8 synchros.

Accuracies not exceeding 7 minutes max. of error are guaranteed.

A full line of size 8 rotary components is available including AC and DC motors, linear transformers and motor generators.

For full information write or call Sales Department, SUNset 9-7521 (Suburban Philadelphia) or our representatives.

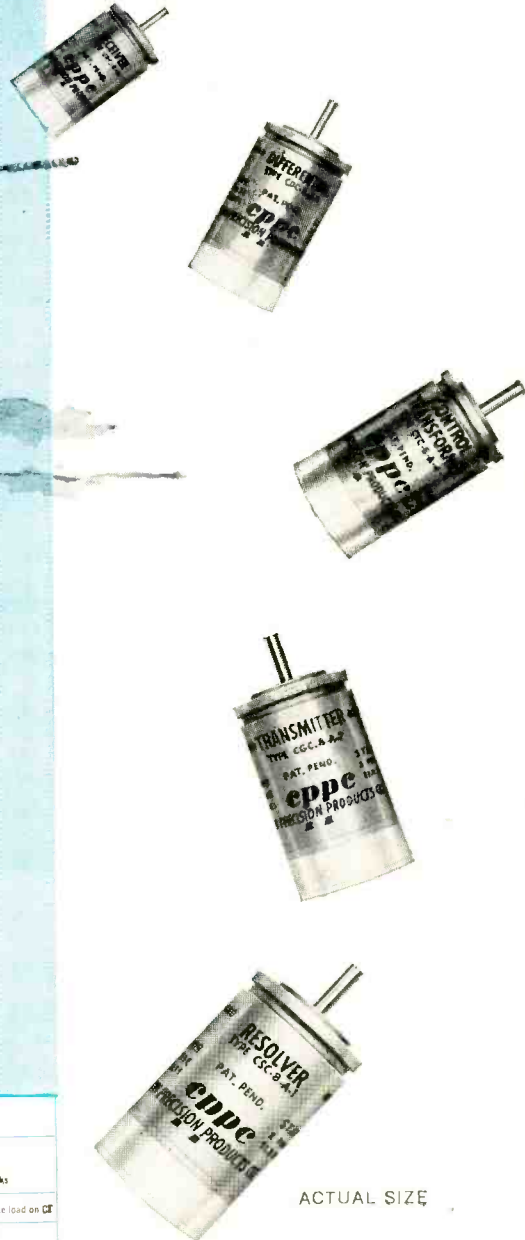

ACTUAL SIZE

TYPICAL SYSTEM MEASUREMENTS

	Input Voltage (Volts)	Input Current (Amperes)	Input Power (Watts)	Output Voltage (Volts)	Sensitivity (MV deg.)	IMPEDANCE		Phase Shift (deg.)	Remarks
						Input	Output		
Transmitter → Control Transformer	26	.111	.74	22.5	393	58 - j226	626 + j233	19	High Impedance load on CT
Transmitter → Control Transformer	26	.111	.75	21.6	377	58 + j226		19	50' load on CT
Transmitter → Control Transformer	26	.110	.83	19.2	335	64 + j221		17	5' load on CT
Transmitter → Differential → CT	26	.334	1.78	19.5	340		745 + j364	40	Output to High Impedance
Electrical Resolver → Electrical Resolver	11.8	.115		7	120			52	Input to stator
Electrical Resolver → Electrical Resolver	26			15	250			52	Input to rotor

Clifton Precision Products Co., Inc.
Clifton Heights
Pennsylvania



High Precision Frequency Standards

**± 20 PARTS PER
MILLION
MAXIMUM FREQUENCY
DEVIATION**

From -55°C

To +100°C

- All units are self contained
- Two standard types available, operating from 12 VDC or 30 VDC
- Extremely small size 1 $\frac{5}{8}$ " x 1 $\frac{5}{8}$ " x 2 $\frac{3}{8}$ "
- Light weight—8 ounces
- Completely transistorized circuitry provides low power drain



- Any frequency available from 400 CPS to 8 KC
- Complete frequency stabilization in 30 seconds upon application of power
- Output of 4 volts RMS into a 10K Ω load.

Accurate Instruments type MAFC frequency standard

A NEW CONCEPT IN TUNING FORK FREQUENCY STANDARDS

Tolerance of plus or minus 50 parts per million from absolute frequency can be maintained under any combination of the following:

- *Temperature from -55°C to plus 100°C*
- *Power supply deviation ± 15%*
- *Operation in any position*

Units can be designed to your most exacting specifications—prompt attention given to prototype manufacture. Send your specifications for complete detailed information and price consideration.

Prices of standard units range from \$180.00 to \$275.00 depending upon temperature range and frequency tolerance.

ACCURATE INSTRUMENT COMPANY, INC.

2422 BRANARD STREET • HOUSTON, TEXAS • PHONE JA 3-2712

SUPERIOR TUBE ADDS 5 NEW GLASS SEALING ALLOYS TO STANDARD LINE



Now Superior offers glass sealing alloy tubing with expansion characteristics to meet practically any glass sealing requirement. These five new analyses are in addition to six already in the line. Superior also offers titanium tubing for ceramic-to-metal seals. All are

available in quantities as small as 50 ft. and are cold drawn to close tolerances. Size limits in most cases from .012 to 1 1/8 in. OD. Write or send coupon for new Data Memorandum 15 giving technical information on all these alloys and the known applications for them.

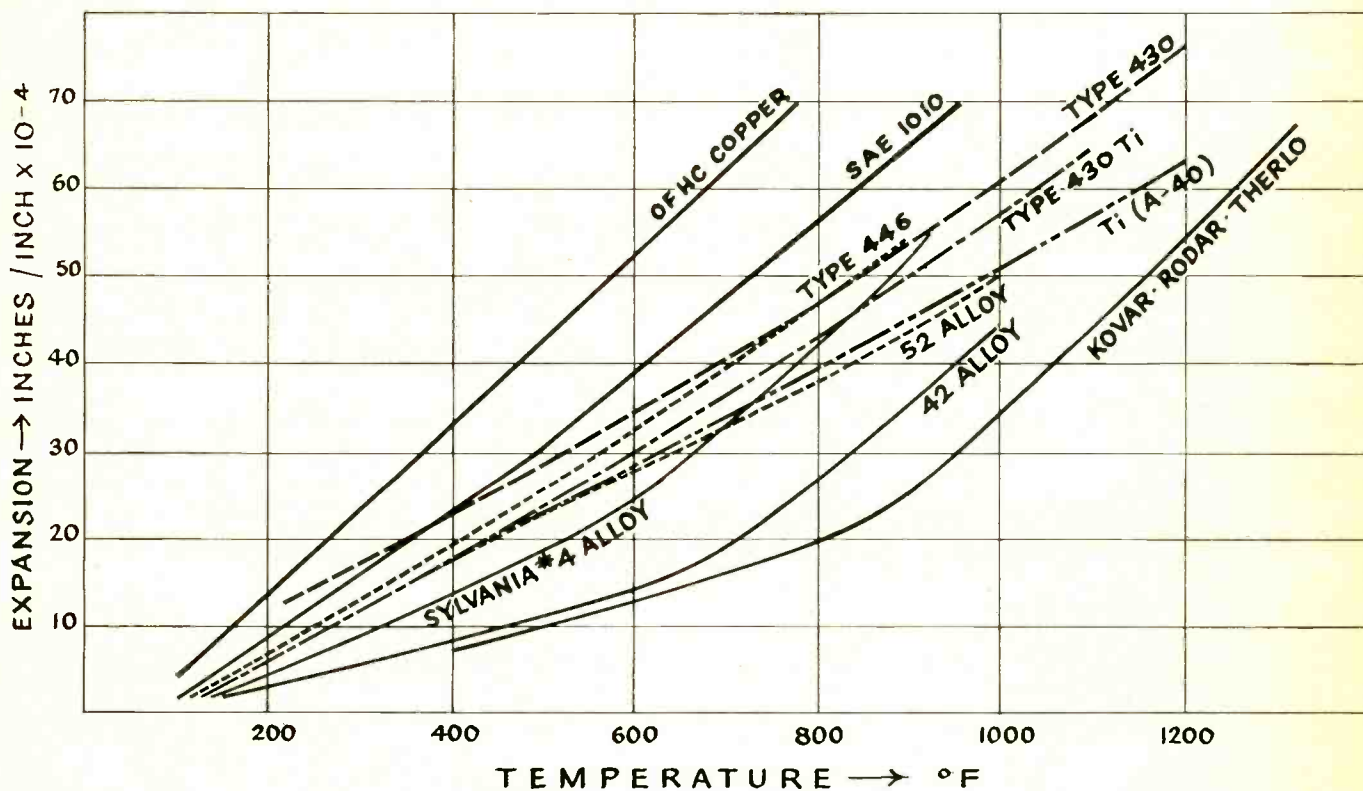

APPROXIMATE EXPANSION CURVES OF VARIOUS METALS

Superior Tube

The big name in small tubing
NORRISTOWN, PA.

Johnson & Hoffman Mfg. Corp., Mineola, N.Y.—an affiliated company making precision metal stampings and deep-drawn parts.

*Stocked and sold by the Stupakoff Division of the Carborundum Co., Latrobe, Pa. T.M. Reg. U.S. Pat. Off., Westinghouse Electric Corp.

†T.M. Reg. U.S. Pat. Off., Wilbur B. Driver Co.

‡T.M. Reg. U.S. Pat. Off., Driver-Harris Co.

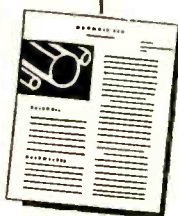

SUPERIOR TUBE CO.
2500 Germantown Ave., Norristown, Pa.

Send me a copy of new Data Memorandum 15, on glass sealing alloys.

Name _____

Company _____

Street _____

City _____ Zone _____ State _____

PRD

PRESENTS

THE PACEMAKER LINE

These advanced design Spectrum Analyzers introduce the new PACEMAKER line of microwave equipment—developed and built by PRD, the largest manufacturer of microwave instrumentation for test and research purposes. The entire PACEMAKER line is featured by simplicity of operation, even higher accuracy than before, greater strength factors—and the lower price levels that result from volume manufacturing.

The new PACEMAKER Spectrum Analyzer comes in 3 models, covering the S, C, and X bands. Their range of performance makes them valuable for precise spectrum measurements—also other applications such as high VSWR, leakage, and loss evaluation, and analysis of radar, radio relay, and other signals. The bezel of the 5" cathode-ray tube carries hood and camera mounting provision and scale illumination sources.

Call your PRD representative for the full story on the new Spectrum Analyzers—and the other PACEMAKER items. You'll be surprised at the quick delivery for all PRD equipment... and you'll be delighted at the lower costs on this finer line.



POLYTECHNIC RESEARCH & DEVELOPMENT CO., INC.
202 Tillary Street, Brooklyn 1, N. Y., UL 2-6800



THE PACEMAKER SPECTRUM ANALYZERS

Freq. Ranges: X, C, S, Bands
IF Center Freq. 40 mc/s
IF Bandwidth 40 kc/s
Sensitivity -80 dbm. min.
Sweep Range 3 to 30 cps
Freq. dispersion < 40 kc/s/inch
IF Attenuation 65 db
RF Attenuation 100 db

PRICES:

X-BAND MODEL 860-X: \$1,975.
S-BAND MODEL 860-S: \$2,375.
C-BAND MODEL 860-C: \$2,700.



Type 159

LEVEL SET ATTENUATORS

Twelve types, all new, all completely shielded. Frequency range from 2.6 to 18 kmc.



Type 1116

SLIDING WAVEGUIDE TERMINATION

Ten new types, covering frequency range from 2.6 to 40 kmc, with maximum VSWR of 1.01.



Type 320-A

SLIDING SHORTS

Four types (non-contacting). Short-circuiting plunger travel extends over half a wavelength covering frequencies from 12.4 to 75 kmc. VSWR in excess of 40 to 1.



Type 408

HIGH DIRECTIVITY COUPLER

Six types. Frequency range from 2.6 to 18 kmc. Directivity of 40 db, with average coupling of 10 ±0.3 db.



Type 648-A

THERMISTOR MOUNT
Maximum VSWR of 1.75 and covering the 12.4 to 18 kmc frequency range.

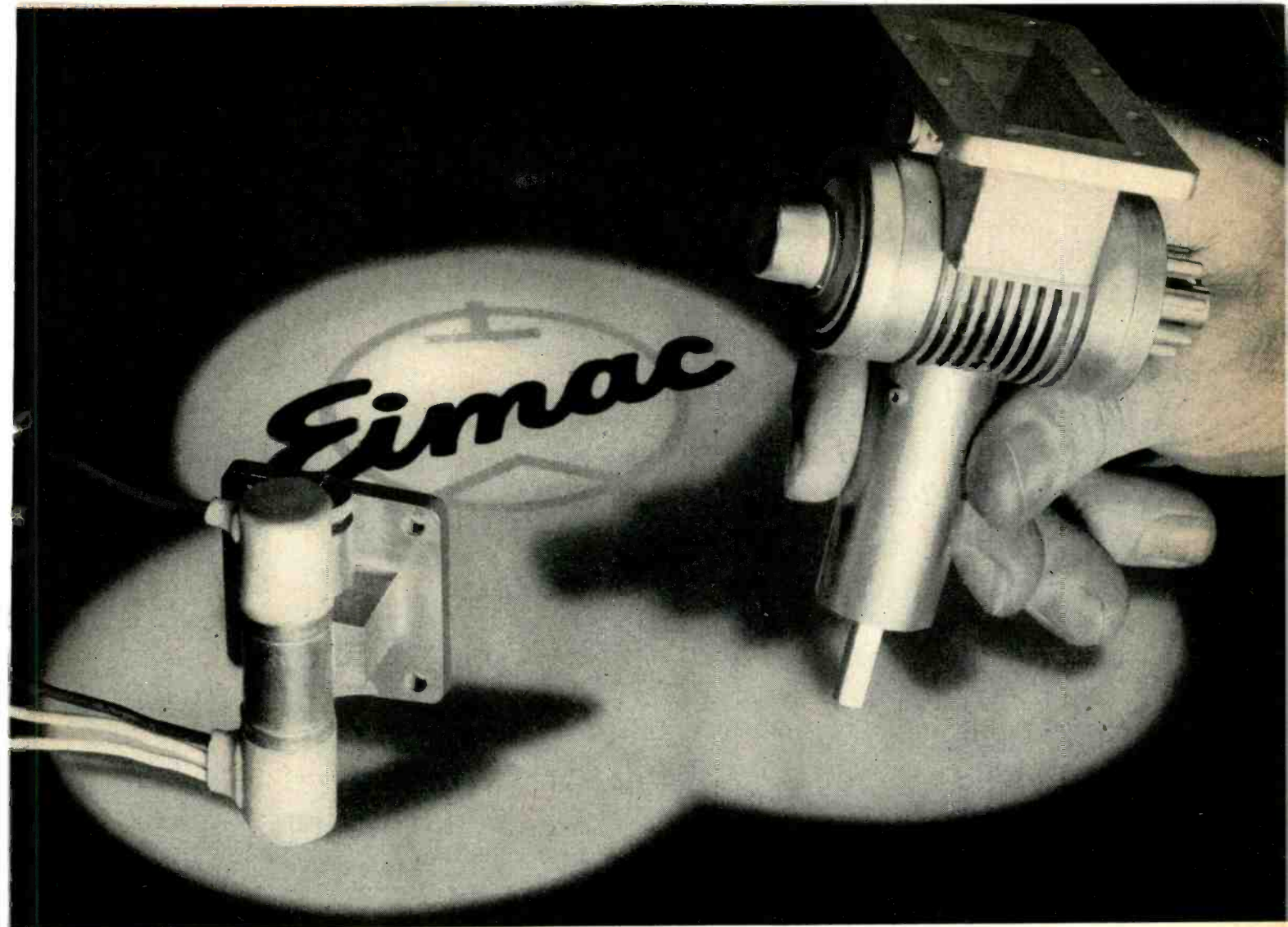

1K20 Series X and K Band Klystron (left)
1K125CA C Band Klystron (right)

Eimac Announces . . .

Five New Ceramic Reflex Klystrons

Two important frequency ranges in the C, X and K bands are now covered by Eimac reflex klystrons. Eimac's advanced stacked ceramic design gives these tubes exceptional ruggedness and frequency stability.

The four new tubes of the 1K20 series cover 8500 to 11,700 Mc., at power levels up to 50 milliwatts. They are specifically designed for use in the severe environment of air-borne and missile radar systems. They will withstand vibration levels of 15G in any reference plane, with less than 100 kilocycle frequency deviation. Low beam voltage requirement and simple radiation cooling minimize the weight and complexity of associated equipment.

A new C-band tube, the 1K125CA covers 3700 to 4400 Mc. Power levels up to 2 watts make this tube ideal for reliable broadband point-to-point communication. Tuning by dielectric slug rather than variable RF gap avoids sensitivity to shock and vibration. Integral-finned cooler and higher operating temperature ratings minimize cooling requirements.

Eimac know-how in the field of ceramic-metal tube design now brings compactness, ruggedness, high performance and reliability to these important microwave frequencies.

More information on Eimac reflex klystrons is available from our Application Engineering Department

EITEL-McCULLOUGH, INC.

SAN BRUNO · CALIFORNIA

Eimac First with ceramic tubes that can take it



GENERAL CHARACTERISTICS

Type	Freq. Range Mc.	Beam Voltage	Power Output Range	Reflector Voltage
1K125CA	3700-4400	1000 Vdc	1.5 to 2.0 W	0 to -1000 Vdc
1K20XS	8500-9300	300 Vdc	25 to 50 mW	0 to -250 Vdc
1K20XK	9200-10,000	300 Vdc	25 to 50 mW	0 to -250 Vdc
1K20XD	10,000-10,800	300 Vdc	25 to 50 mW	0 to -250 Vdc
1K20KA	10,700-11,700	300 Vdc	25 to 50 mW	0 to -250 Vdc

Additional Frequency Coverage to be announced soon

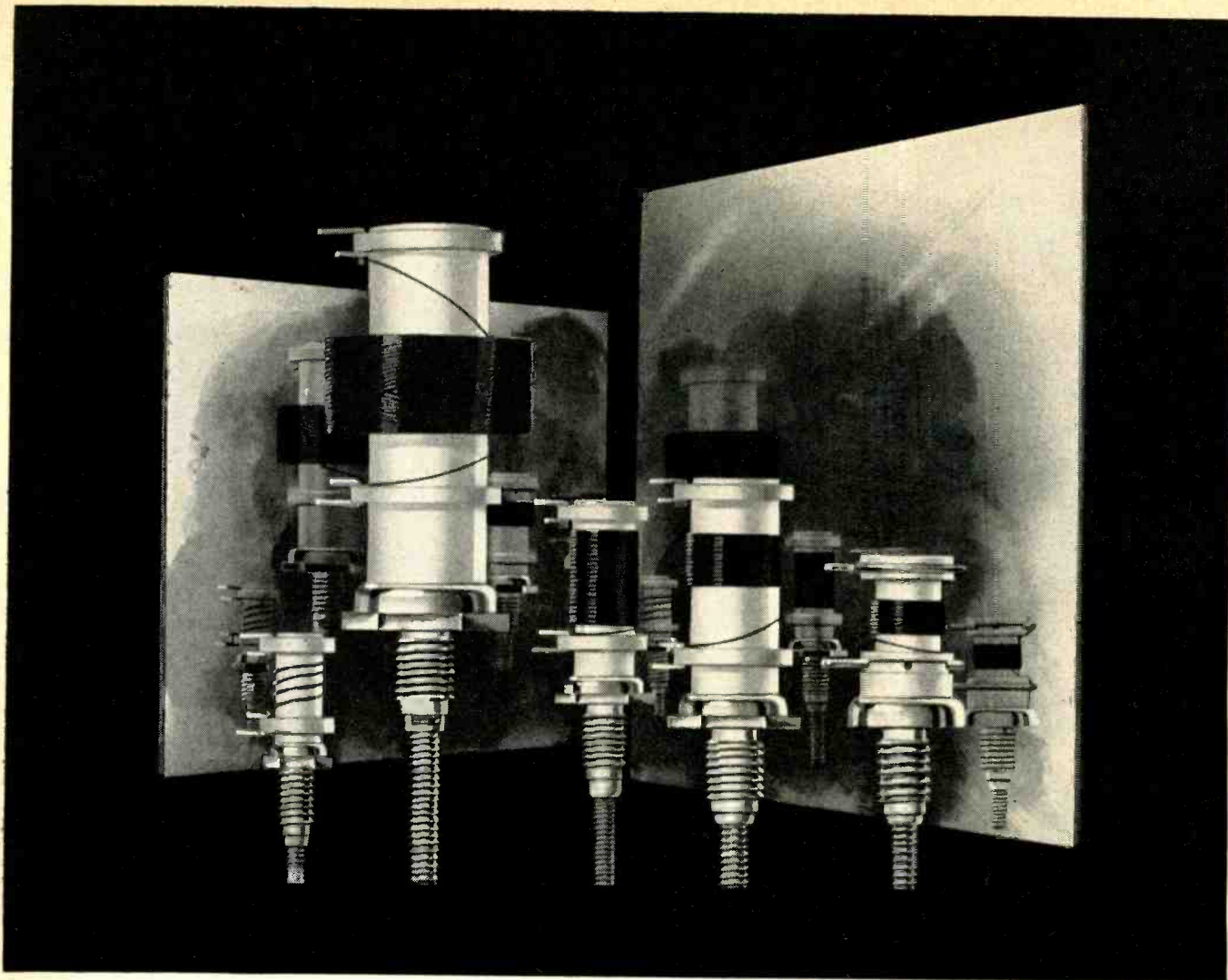

Cambion® coil forms with Perma-Torq® Tensioning Device are designated PLST, PLS-6, PLS-5, PLS-7, PLS-8 and are factory assembled to mounting studs. The units are completely interchangeable with Cambion's LST, LS-5, LS-6, LS-7 and LS-8.

Reliability is their family resemblance

Here's a reliable family of coil forms ready to meet your specifications. These Perma-Torq Tensioning Devices on Cambion coil forms allow locking of tuning cores while still tunable — and you can depend upon them to do their job well.

This built-in dependability is a result of Cambion's unique design plus quality control — that meets or betters government specifications.

Perma-Torq is a compression spring of heat treated beryllium copper, that has a very high resistance to fatigue and keeps coils tuned as set — even under extreme vibration and shock. The device also allows for immediate readjustment — without removal or loosening of any mounting nut or locking spring.

Quality control and features like the above are just two of the reasons why Cambion can offer you guaranteed standard or custom electronic components — whose performance you can rely upon.

Cambion researchers and practical experts are always available to help you

solve your component problems. For all specifications and prices, write Cambridge Thermionic Corporation, 437 Concord Avenue, Cambridge 38, Mass. West Coast stocks maintained by E. V. Roberts and Associates, Inc., 5068 West Washington Blvd., Los Angeles 16, and 1560 Laurel St., San Carlos, Calif.

Cambion's new printed circuit coil forms are ideal for high temperature work and horizontal mounted panels. Equipped with Perma-Torq locking device for set tuning, the tuning core is affixed to the form at one end through a brass housing, thus eliminating internally threaded forms and cores and resulting in a more precise element with finer tuning. The coils, 2550, 2540, 2530 and 2525, are ceramic units with silicone fibreglas collars which have terminals for mounting on printed circuit boards.

*Patent pending.

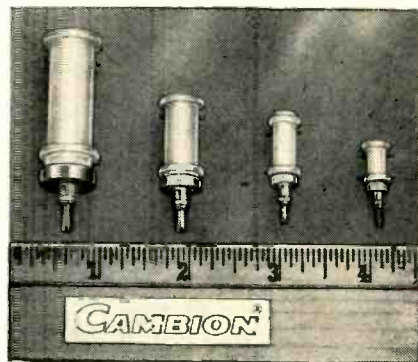

CAMBRIDGE THERMIONIC CORPORATION
CAMBION®



Makers of guaranteed electronic components, custom or standard

SILICON ZENER DIODES!

for every
circuit!

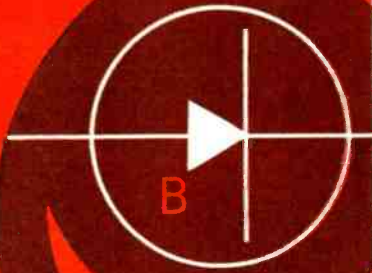

International

Rectifier Corp.



XV Plot of Reverse Breakdown Characteristics Supplied with Each Diode!

Here's the *versatile* zener line—a type for every application—coupled with a new service conceived to conserve engineering time! Excellent characteristics, especially in terms of low impedance values, hermetic sealing, all-welded construction and a high thermal capacity package qualify these diodes for your consideration. Receiving a plot of characteristics *with each diode* eliminates guesswork and tedious testing on your part—means more time for creative engineering. Inquire further about these diodes... and the special application services we are prepared to offer you.



EXECUTIVE OFFICES: EL SEGUNDO, CALIFORNIA • PHONE OREGON 8-6281 • CABLE RECTUSA

NEW YORK AREA OFFICE: 132 EAST 10TH ST., PHONE TRAFALGAR 9-3330 • CHICAGO AREA OFFICE: 205 W. WACKER DR., PHONE FRANKLIN 2-3888 • NEW ENGLAND AREA OFFICE: 17 DUNSTER STREET, CAMBRIDGE, MASS., PHONE UNIVERSITY 4-6520 • PENNSYLVANIA AREA OFFICE: SUBURBAN SQUARE BUILDING, ARDMORE, PENNA., PHONE MIDWAY 9-1428

WORLD'S LARGEST SUPPLIER OF INDUSTRIAL METALLIC RECTIFIERS • SELENIUM • GERMANIUM • SILICON

CIRCLE 60 READERS SERVICE CARD

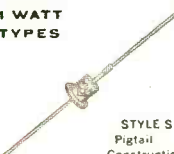
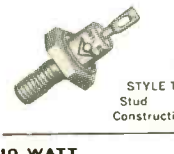
VOLTAGE REGULATOR TYPES

	INT'L DIODE TYPE	ZENER VOLTAGE RANGE	I _Z MAX. ma	DYNAMIC IMPEDANCE		NOMINAL TEMP. COEFFICIENT %/°C
				Z _Z (OHMS)	@ I _Z ma	
500 MILLIWATT TYPES 	MZ 3.9	3.6-4.3	125	1.5	25	-01
	MZ 4.7	4.3-5.1	100	1.5	20	0
	MZ 5.6	5.1-6.2	90	2.3	17.5	+03
	MZ 6.8	6.2-7.5	75	3	15	+05
	MZ 8.2	7.5-9.1	60	4.5	12.5	+06
	MZ 10	9.1-11	50	6.8	10	+07
	MZ 12	11-13	40	12	7.5	+075
	MZ 15	13-16	33	23	6	+08
	MZ 18	16-20	27	45	5	+085
	MZ 22	20-24	23	70	4.5	+09
MZ 27	24-30	18	90	3.5	+095	
1 WATT TYPES 	1Z 3.9	3.6-4.3	250	1	50	-04
	1Z 4.7	4.3-5.1	200	1	40	0
	1Z 5.6	5.1-6.2	175	1.5	35	+03
	1Z 6.8	6.2-7.5	150	2	30	+05
	1Z 8.2	7.5-9.1	120	3	25	+06
	1Z 10	9.1-11	100	4.5	20	+07
	1Z 12	11-13	80	7.5	15	+075
	1Z 15	13-16	65	15	13	+08
	1Z 18	16-20	55	30	10	+085
	1Z 22	20-24	45	45	9	+09
1Z 27	24-30	35	60	7	+095	
3.5 WATT TYPES 	3Z 3.9	3.6-4.3	850	.5	150	-04
	3Z 4.7	4.3-5.1	700	.5	125	0
	3Z 5.6	5.1-6.2	625	.75	110	+03
	3Z 6.8	6.2-7.5	525	1	100	+05
	3Z 8.2	7.5-9.1	425	1.5	80	+06
	3Z 10	9.1-11	350	2.5	70	+07
	3Z 12	11-13	275	4	50	+075
	3Z 15	13-16	225	7.5	40	+08
	3Z 18	16-20	200	15	35	+085
	3Z 22	20-24	160	22.5	30	+09
3Z 27	24-30	125	30	25	+095	
10 WATT TYPES 	10Z 3.9	3.6-4.3	2500	.25	500	-04
	10Z 4.7	4.3-5.1	2000	.25	400	0
	10Z 5.6	5.1-6.2	1750	.4	350	+03
	10Z 6.8	6.2-7.5	1500	.5	300	+05
	10Z 8.2	7.5-9.1	1200	.75	250	+06
	10Z 10	9.1-11	1000	1.25	200	+07
	10Z 12	11-13	850	2	170	+075
	10Z 15	13-16	650	4	140	+08
	10Z 18	16-20	550	7.5	110	+085
	10Z 22	20-24	450	12	90	+09
10Z 27	24-30	350	15	70	+095	
DOUBLE ANODE TYPES 	ZZ 3.9	3.6-4.3	110	3	22	-045
	ZZ 4.7	4.3-5.1	90	4	18	-01
	ZZ 5.6	5.1-6.2	70	5	14	0
	ZZ 6.8	6.2-7.5	60	10	12	+025
	ZZ 8.2	7.5-9.1	50	15	10	+035
	ZZ 10	9.1-11	40	25	8	+05
	ZZ 12	11-13	30	40	7.5	+06
	ZZ 15	13-16	25	60	5	+07
	ZZ 18	16-20	20	80	4	+08
	ZZ 22	20-24	16	125	3.5	+09
ZZ 27	24-30	13	200	3	+095	
MULTIPLE JUNCTION TYPES HIGH VOLTAGE 5 WATT	HZ 27	24-30	200	7	40	0
	HZ 33	30-36	150	10	30	+03
	HZ 47	43-51	110	20	22	+06
	HZ 68	62-75	75	60	14	+075
	HZ 100	91-110	50	180	10	+085
HZ 150	130-160	35	370	7	+095	

REFERENCE ELEMENT TYPES

	IN 430	8.0-8.8	50	15	10	±.002 -55°to+100°C
	IN 430A	8.0-8.8	50	15	10	±.001 -55°to+100°C
	IN 430B	8.0-8.8	50	15	10	±.001 -55°to+150°C



Meet the buzzin' cousin of a

Mallory *Vibrator*

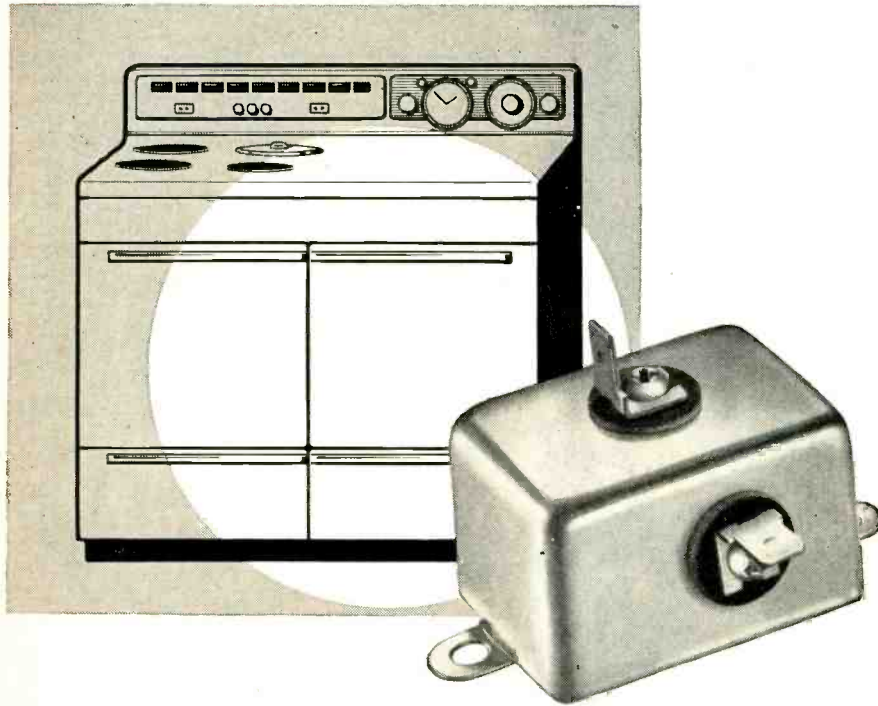

A major appliance manufacturer recently had need for an economical buzzer-type alarm to act as a high-temperature signal on an oven.

The manufacturer turned to Mallory—pioneer in the automobile vibrator industry—for aid in designing this electromechanical device. The idea sounded challenging . . . so, we put our quarter-century of vibrator experience to work.

Literally overnight, we came up with a simple, practical design which we're now economically producing . . . and we have a new and satisfied customer.

Maybe you, too, have need for components that might be considered "buzzin' cousins" to a vibrator . . . not only in the home appliance field, but perhaps for industrial products. If so, there's a wealth of experience and engineering ability in Mallory's Vibrator Division that can help solve problems you may have in electro-magnetic or electromechanical devices. Let's talk it over!

Serving Industry with These Products:

Electromechanical — Resistors • Switches • Tuning Devices • Vibrators
Electrochemical — Capacitors • Mercury and Zinc-Carbon Batteries
Metallurgical — Contacts • Special Metals • Welding Materials

Parts distributors in all major cities stock Mallory standard components for your convenience.

Expect more...get more from

P. R. MALLORY & CO. Inc.
MALLORY

P. R. MALLORY & CO. Inc., INDIANAPOLIS 6, INDIANA

Diode Counter Calibrates Missile Testing Camera

Speed of continuously moving film in shutterless 35-mm camera used for smear photography is calibrated in fps by frequency tachometer. Heart of meter is loaded-diode counter whose amplified output drives pen oscillograph. Though developed for specific camera, instrument may be used with any camera having similar focusing provisions

By **SAMUEL E. DORSEY** Research Department, U. S. Naval Ordnance Test Station, China Lake, California

INCREASED TEST-MISSILE velocities have created photographic instrumentation problems in the vicinity of the launching guns. As the old multiple flash technique using a background of reflective sheeting proved inadequate, a

practical alternative was found in smear photography.

Knowledge of the film speed in the camera is a must in the smear technique. If the speed is too slow, the smear image is foreshortened; if the speed is excessive, the image

obtained is greatly lengthened.

The principles of smear photography can be described by reference to Fig. 1. Illumination is provided by an incandescent tungsten wire on one side of the expected missile path. To the other side and

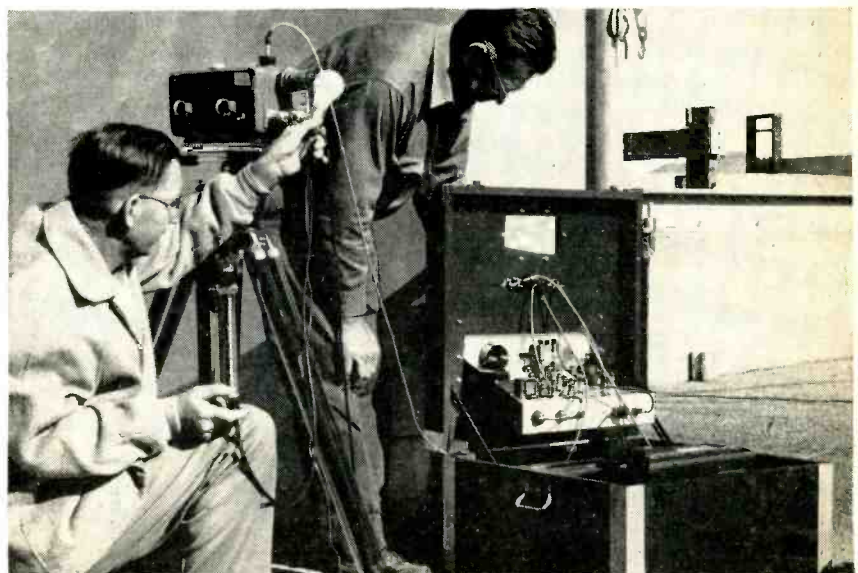
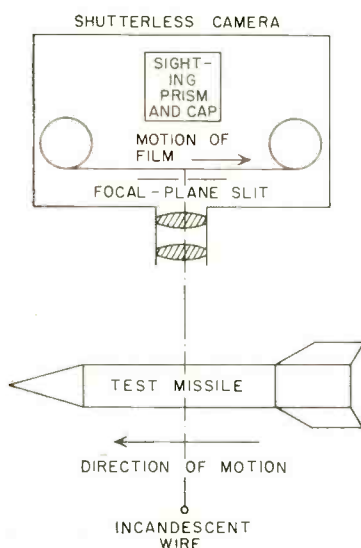

FIG. 1—Basic arrangement for smear photography of high-velocity missiles

Engineers use incandescent lamp to calibrate shutterless camera film speed before photographing actual test-missile flight

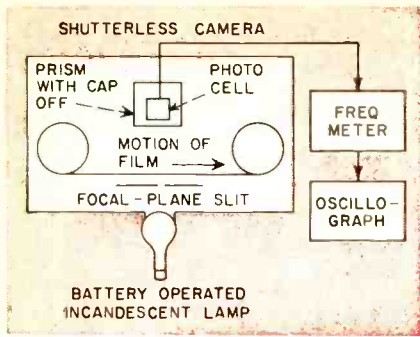

FIG. 2—Setup for camera calibration. Photocell replaces prism cap during test

on a level with the expected missile path is placed a 35-mm Warrick camera. The camera is oriented so that light from the wire passes through the focal-plane slit to the film. Behind the film are a prism and side lens intended for camera orientation. The direction of motion of the film in the camera is opposite to that of the missile. As the test object passes between the wire and the camera, its silhouette is smeared on to the film.

Camera Calibration

The Warrick camera incorporates a film-speed adjustment rheostat. However, the speed is also dependent upon the length and the resistance of the line supplying the camera motor, as well as the voltage and regulation of the power source. Therefore the film speed must be calibrated for every camera setup prior to firing.

Elements of the film speed calibrating and recording system are shown in Fig. 2. The camera lens is replaced by an incandescent lamp, which is battery-operated to eliminate the effects of a-c ripple.

A photo-cell replacing the camera prism cap picks up film speed during calibration from a specially prepared film which is run through the camera. The signal thus obtained is utilized by the photocell to drive a frequency meter whose output is recorded on the paper-strip chart in the oscillograph.

Figure 3 shows a section of the test film. It is prepared in a standard shutter-type movie camera.

This prepared film is run through the Warrick shutterless camera for film speed calibration.

The diaphragm slit in the Warrick has been opened to the width

of a dark area on the test film. As the photocell drives the frequency meter, it in turn drives the oscillograph which records the frequency of the light pulsations on its chart. The reading, when divided by 16, gives the speed of the film in ft per sec. This factor is necessary as there are 16 light and dark areas per foot of calibrating film.

Tachometer

Figure 4 is the complete circuit diagram of the film speed tachometer.

The photosensitive device used is a T.I. type 700 phototransistor

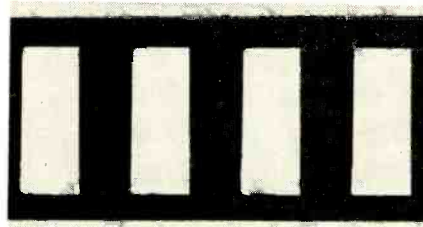

FIG. 3—Section of test film prepared in standard shutter-type camera

mounted on the end of a coaxial cable. When SET STANDARD switch S_1 is in the OPERATE position, the photocell drives the three-stage overdriven audio amplifier which converts the input signal from the photocell into square waves of the same frequency. When both SET ZERO switch S_2 and S_1 are in the OPERATE position, the output of the overdriven audio amplifier feeds the diode counter circuit.

The diode counter circuit, plus loading resistors R_1 and R_2 , is the heart of the tachometer. The signal out of the overdriven amplifier is essentially a series of square waves as shown in the simplified diagram of Fig. 5A; the voltage swings in sudden jumps from the saturation value to the cutoff value in the plate circuit of the second triode in the overdriven amplifier. These square waves of voltage are represented as having a low value of e_b and a swing of e_x .

Capacitor C_s represents frequency-determining units C_{s1} to C_{s6} .

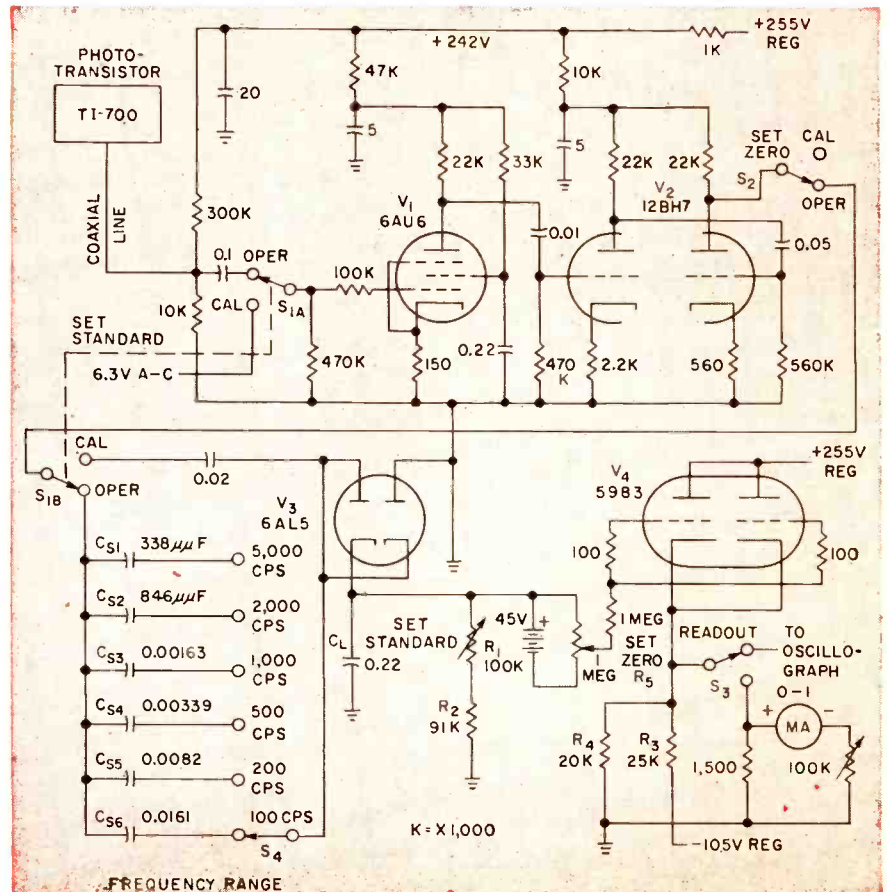

FIG. 4—Overdriven amplifier converts photocell output into square wave input for diode-counter tachometer

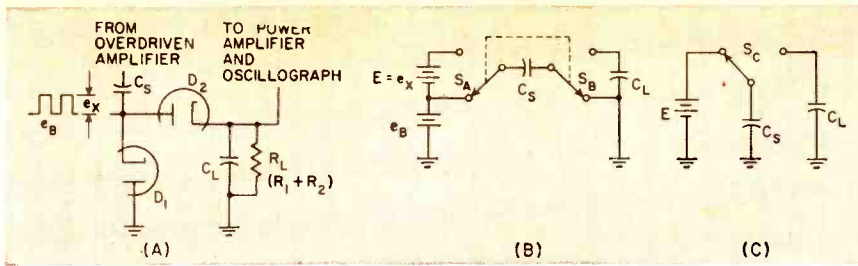

FIG. 5—Action of diode counter (A) is represented by equivalent switch circuits (B, C). Combination of R_L , C_L gives output voltage proportional to frequency

The counter diode action is represented by the equivalent switch circuit in Fig. 5B. It is assumed that each switching action is followed by a period of quiescence long enough to allow equilibrium to be attained.

Repeated actuation of S_A is equivalent to the action of the square waves of voltage out of the overdriven amplifier, alternately connecting the left-hand side of C_S to e_n and $(e_n + E)$.

The actions of the diodes in Fig. 5A can also be represented by switching. Connected to the right-hand side of C_S is S_B which is grounded when S_A is on battery e_n .

When S_A is on $(e_n + E)$, the right-hand side of C_S is connected by S_B to the top of capacitor C_L . When the voltage out of the overdriven amplifier is low, D_1 conducts to ground and D_2 is cut off. When the voltage out of the amplifier is high, D_1 is cut off and D_2 conducts into C_L . Figure 5B may be simplified to Fig. 5C without changing the counter diode action by a series of logical deductions and a mathematical treatment of the tachometer.

In Fig. 5A, resistor R_L discharges C_L at a rate proportional to its voltage, while the counter diode action tends to increase the charge on C_L at a rate proportional to the frequency of the signal from

the overdriven amplifier. This combination produces a voltage which is fed through power amplifier V_1 in Fig. 4 to an oscillograph.

In the cathode circuit of V_1 , S_3 selects either the oscillograph output or the meter on the panel of the tachometer. To balance the meter or oscillograph to zero, a negative current is supplied from the power supply through R_3 and R_1 to the cathode circuit of V_1 .

Counter Calibration

The tachometer - oscillograph combination was set to zero by placing SET ZERO switch S_2 in its CALIBRATE position and adjusting SET ZERO potentiometer R_2 . The motor of the oscillograph was kept running so that its pen wrote on that coarse line of the oscillograph chart chosen as the zero line. Switch S_2 was then returned to its OPERATE position.

For standardization, SET STANDARD switch S_1 was placed in its CALIBRATE position and with the oscillograph motor running, potentiometer R_1 was adjusted so the indicating pen of the oscillograph was on the coarse line chosen to represent 0.8 of full scale.

The output of an audio oscillator was then substituted for the phototransistor in the input terminals of the tachometer. With the tachom-

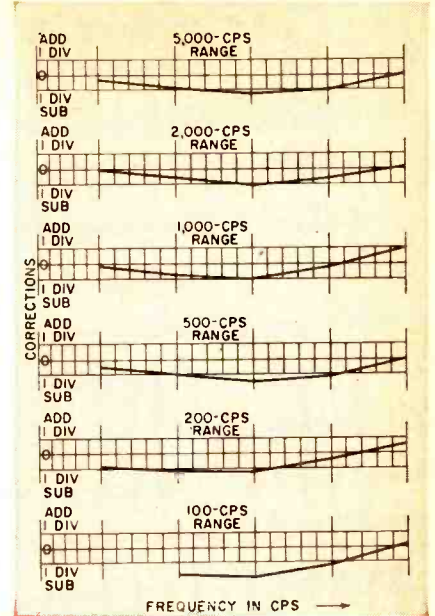

FIG. 6—Typical correction curves for different film speeds and scale factors. Speeds in ft per second are obtained by dividing ordinate values by 16

eter FREQUENCY RANGE switch at each of its settings, the frequency dial of the oscillator was adjusted so that the indicating pen was directly on the coarse lines of the chart paper chosen to represent 0.2, 0.4, 0.6 and 0.8 of full scale.

From the data collected, the set of correction curves shown in Fig. 6 was prepared. The long vertical lines on this graph represent the coarse lines and the short vertical lines, the fine lines on the oscillograph record.

Figure 7 shows five camera calibration charts made with a Brush BL-202 direct-inking two-pen recorder oscillograph but utilizing only one pen.

The steep trailing edge and rounding off are characteristics of the measuring equipment. The start of the trailing edge represents the point at which the film completes its run in the camera.

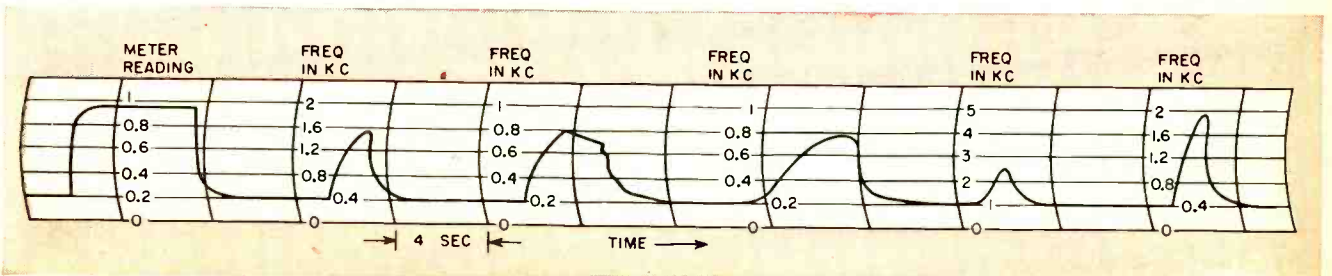

FIG. 7—Camera calibration charts. Steep trailing edge and round off are characteristics of measuring equipment

Automatic Digital System

Digital computer, used in conjunction with dial telephone system, records all data necessary to bill the subscriber. High-speed digital system includes a magnetic drum and an identification matrix equipped for 400 lines and 15 trunk-repeater adaptors. Clock track on drum provides system synchronization. System output is punched on paper tape for use by business machines

ENABLING telephone subscribers to dial both local and toll calls without the service of the phone company operator, the automatic message-registering (AMR) system described in this article identifies the subscriber, times the call and records all necessary billing data which can be processed by

automatic accounting machines.

The system employs high-speed electronic digital data processing techniques. A large proportion of the system is common equipment used on a time-sharing basis by the individual telephone circuits that carry the calls requiring ticketing.

Since many telephone calls are

in progress within a central office at a time, the various items of information necessary to determine the charges, such as the number dialed, calling subscriber identity, time at which conversation commences and time at which the call ends, occur at random times. The registration equipment must either accept these items of information on its common storage medium as they arrive, or store information in a temporary store associated with the speech path or trunk over which the call is being made and then transfer them all at once, and in correct order, to the common storage medium when the call is terminated. Temporary storage per trunk is used in the system. Since it is necessary to store about one hundred binary bits in each temporary store, the cost per bit must be low.

Magnetic Storage

Probably the most inexpensive storage medium and one of the easiest to use is a magnetic medium. Magnetic tape is cheaper on a per bit basis than either a magnetic drum or magnetic cores but, since this temporary storage must be on a per trunk basis, one magnetic tape transport mechanism would be necessary per trunk hence this possibility was rejected as uneconomical. With a magnetic drum, only a portion of a track needs to be allocated to a trunk and therefore one drum can be made to serve a large number of trunks. Of course, a drum would have to be supplied if there were only one trunk and this would

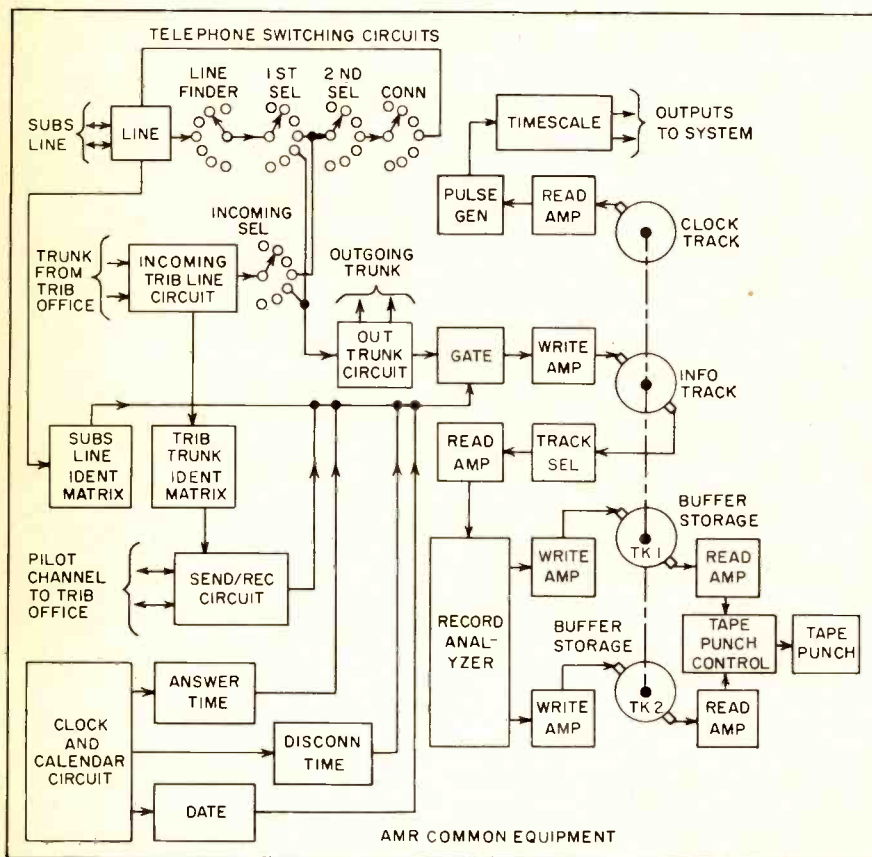

FIG. 1—Block diagram of automatic message registering system tied into telephone switching circuits. Information to be recorded such as the number dialed, time called subscriber answers, time calling subscriber hangs up and date, is fed to system from the telephone switching equipment

Bills Telephone Calls

By **RAYMOND C. P. HINTON**

Executive Engineer
Federal Telecommunication Laboratories
Executive Engineer

clearly have a detrimental effect on the economy of the system. Nevertheless, it was felt that in most cases there would be a sufficiently large number of trunks for the magnetic drum to prove economical.

Synchronization

Synchronization throughout the system shown in Fig. 1 is achieved by a clock track on the drum upon which is recorded a phase-modulated, non-return-to-zero signal corresponding to a ONE for every elemental or bit position around the periphery of the drum except for the first position where a ZERO is recorded.

This clock track is read and amplified by a conventional amplifier. The last stage of the amplifier is a Schmitt trigger that generates the square wave output shown in Fig. 2. This output is differentiated and used to synchronize a free-running multivibrator that produces the master pulses used in the system.

Synchronizing an astable device was preferred to triggering a monostable device as it is inherently less liable to miss producing a pulse or to produce an extra one in the output stream of master pulses. Furthermore, when the ZERO from the clock track is read, a pulse is produced in approximately the correct position in the output stream and this stream when gated with the output of the Schmitt trigger produces one pulse per revolution of the drum.

These master pulses, 16- μ sec wide, 9,000 pps, are fed to a 600-position timescale (since 600 bits

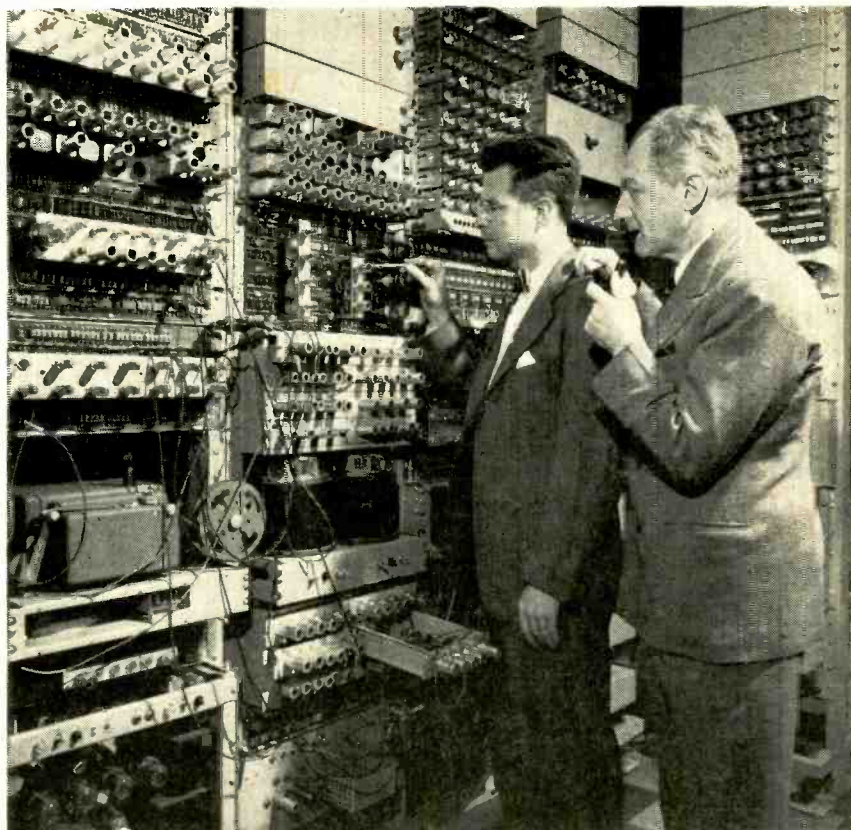

FRONT COVER—Typical installation includes an identification matrix equipped for 400 lines and 15 trunk-repeater adapters

are to be recorded on each track), composed of cold-cathode gas tubes of two types. One is a single element device, a number of which can be formed into a ring counter while the other is a ten element counter, which by strapping can be made into a five-way counter as shown in Fig. 3 and Fig. 4.

Time Division

Four stages of division are used in the timescale, a divide-by-four stage, a divide-by-six stage and two divide-by-five stages. The various combinations of outputs from these four stages produce 600 discrete outputs by conventional diode gating, hence any one of the 600 pulses in the master stream can be selected. This enables any one bit around the periphery of the magnetic drum to be selected for reading or writing. Furthermore, the one pulse per drum revolution obtained previously should coincide

with only one output combination of these combinations. If it does not do so the timescale misstepped, hence an alarm can be given or the timescale can be reset automatically to its correct position.

Phase-modulation, non-return-to-zero recording was chosen because such a signal is a balanced waveform whatever the information to be written may be and hence a-c coupling can be used throughout.

Drum Recorder

The information to be recorded is obtained from the telephone switching equipment itself or from conventional telephone switching type circuits that work in conjunction with the switching equipment. It is gated with appropriate timescale positions so that the writing circuit may record each discrete piece of information in its correct elemental position on the drum. Four bits are used to record each

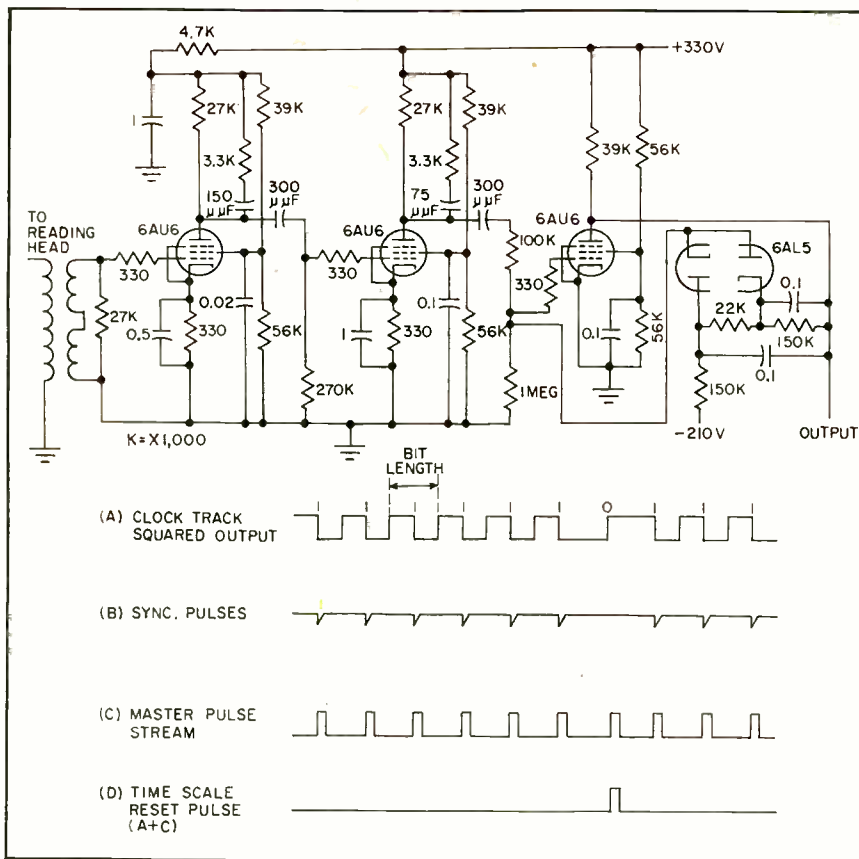

FIG. 2—Amplifier reads clock track of magnetic drum. Schmitt trigger circuit generates square wave output. Differentiated signal synchronizes master free-running mv

decimal digit and all information pertaining to calls on a particular trunk is recorded on a section of a track allocated to that trunk.

Calling Number

The calling number is obtained from a rectifier matrix in the following manner. In a single instant, a positive potential is applied to one and only one of many outgoing office trunks. This potential feeds back through the telephone switching train and arrives at and marks the line circuit of the calling subscriber.

In a large office, this is one of up to ten thousand line circuits, each one connected in a unique way to the matrix. Since only one line circuit can have this potential applied to it at any one time, a unique number corresponding to the directory number of the calling line is obtained from the matrix. This number is in the form of a d-c potential on each of four leads, each lead being one of a group of ten. It is then coded into a binary-decimal notation, mixed with appropriate timescale outputs and written on the drum in a section

corresponding to the trunk at which the potential was originally applied. Once this has been done, the potential is removed from this trunk and applied to another. Thus in a similar way the identity of the subscriber calling over this second trunk is found.

Caller Identification

A small, inexpensive transistor oscillator, (Fig. 5), having a stable frequency and placed across the dial contacts of a subscriber's phone identifies the caller on a party line. Ten different types of oscillators, each having its own frequency in the voice band, are used to identify up to ten subscribers on a party line. As a subscriber dials, the dial contacts open, the line voltage appears across the oscillator and the latter then oscillates. The frequency is detected at the central office. The assigned decimal digit corresponding to this detected frequency is added to the digits determined by the line identification equipment and the result, a directory number, is recorded on the drum.

The clock and calendar circuits give dc outputs on a number of

leads such that the time of day and the date appear as binary decimal numbers. These dc potentials are gated with the appropriate time-scale positions to write the information on the drum. The clock and calendar circuits are composed of conventional stepping switches, that are driven by pulses from a 60-cycle synchronous motor such that a pulse occurs every 6 seconds. The switches are interconnected so the first rotates over ten positions in 1 minute, the second steps over 10 positions taking one step per rotation of the first, a third steps once for every rotation of the second and has 6 positions and the fourth steps once for every rotation of the third and has 24 positions.

The calendar switches step each time the fourth clock switch steps, for example, once per day. The switches are so interconnected as to account for the variable number of days in a month and also to automatically insert 29 days in February every four years. Furthermore, all major public holidays are automatically and specially marked, as Sunday rates apply to calls made on such holidays.

Recovering Information

Since a section of a track is permanently allocated to a trunk and within any such section specific elemental positions are allocated to particular items of information, it is necessary to remove the information recorded for one call from the drum when the call is termi-

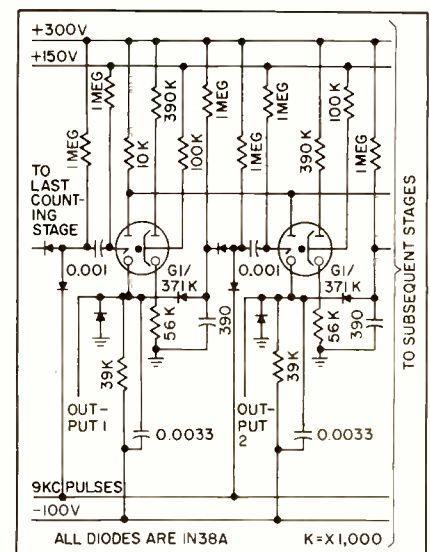

FIG. 3—Single element type counter tubes used in timescale circuit

Optimum electronic focus of television cameras and film chains is effected by scanning bar chart and adjusting focus controls for maximum response of peaks on waveform monitor. Chart also permits rapid determination of system resolution and relative resolving power of different camera lens

By GLEN SOUTHWORTH Moscow, Idaho

Resolution Chart Aids

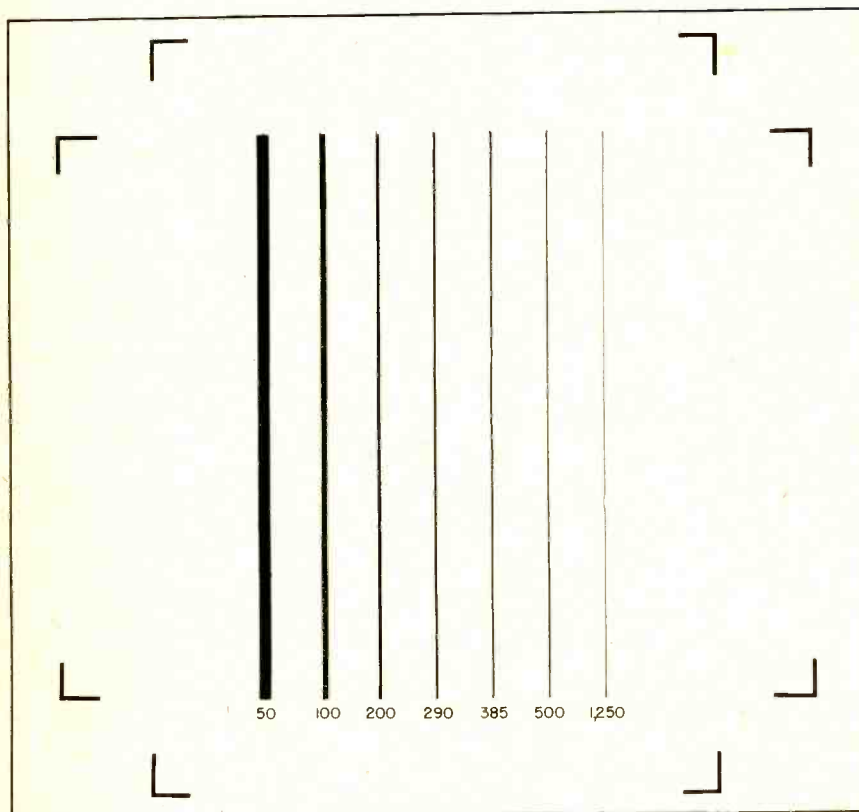

FIG. 1—Focus chart is placed at proper distance from camera so scanned area will fall within corner markings thereby producing correct signals

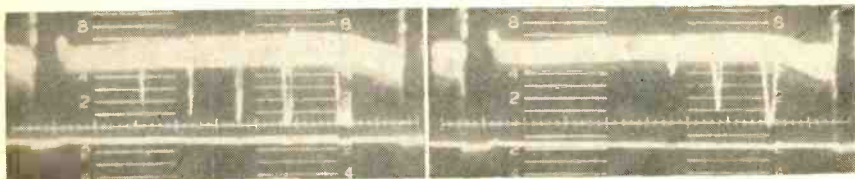

FIG. 2—In-focus (left) and out-of-focus (right) oscilloscope patterns with bars in horizontal position and oscilloscope sweep at field rate



FIG. 3—In-focus (left) and out-of-focus patterns with bars vertical and oscilloscope sweep at line rate

OPTICAL AND ELECTRONIC focusing adjustments in a television system are usually dependent upon the subjective judgments of the operator.

An objective approach to the problem is offered by the chart in Fig. 1. When viewed by a television camera, it provides an oscilloscope pattern that gives a rapid indication of electrical focus adjustments; with nonmobile equipment, such as slide and film chains, the chart also aids optical focusing.

The widest black bar, corresponding to 50-line resolution response, is used as a reference and optical and electronic adjustments are made to produce maximum amplitude of the other traces.

Use of Chart

Initially, the chart is set up with the lines horizontal and the oscilloscope set to the vertical sweep rate of the system. The relatively low video frequencies give an accurate indication of the optical factors involved, as illustrated in Fig. 2. The resulting relative amplitudes may be used as a reference when the chart is placed in a vertical position, with the oscilloscope sweep frequency set to the horizontal scanning rate as in Fig. 3. Under this second condition, the oscilloscope pattern also indicates the high-frequency performance of the video system and the performance of the aperture corrector, if one is used.

This technique is based on the assumption that defocusing of a bar signal will cause the peak-energy level to diminish, at the

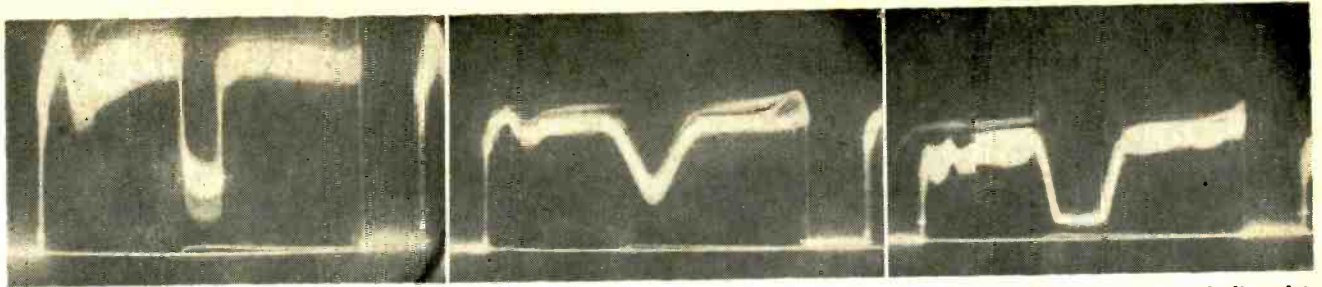

FIG. 4—Pattern of single vertical black bar when in focus (left), out of focus (center) and out of focus but expanded and clipped to simulate in-focus condition (right) as obtained using standard image-orthicon television camera

Tv Camera Focusing

same time spreading the baseline. The effect is most noticeable on thin lines where a pronounced amplitude peak may be noted when passing through the point of optimum focus.

This rule of thumb does not hold completely true for some types of astigmatism, for example image twinning, but for most purposes seems to provide a sensitive and reasonably objective means of determining optimum focus of the camera.

Performance Evaluation

The focus chart provides a simple and rapid indication of overall system performance, as well as the relative resolving ability of different camera tubes. To accomplish this, the focus chart dimensions were chosen so the width of the lines correspond to 50, 100, 200, 290, 385, 500 and 1,250-line characteristics.

Resolution may be recorded in percentage of response at 385 and 500 lines, or higher if desired, and kept for future reference as an indication of possible system deterioration.

Response in older image-orthicon tubes seems to begin to drop off above 200 lines and the amplitude of the 600-line trace may be as low as 10 percent of the 50-line response. This drop in response seems to be the result of the electron optics of the tube, as it occurs with the television test chart situated in both vertical and horizontal positions.

Construction

The line widths were calculated by dividing the vertical dimension of the chart by the number of lines of resolution desired.

A fine trace, corresponding to a approximately 1,250-line response, is included on the chart as an aid

to critical focusing. Though this might appear to be outside of the capabilities of the normal system, a single line of this sort will frequently be reproduced, though broadened and greatly reduced in amplitude.

The chart is also useful in detecting and measuring leading or lagging vertical overshoot due to camera misalignment.

Simulating Sharpness

Apparent sharpness may sometimes be increased by clipping or other forms of amplitude compression. This is illustrated by the series of waveforms in Fig. 4 related to the reproduction of a single black bar.

The photographs of Fig. 5 are shown as examples of some of the differences in apparent sharpness that may be produced by various methods of television camera operation.

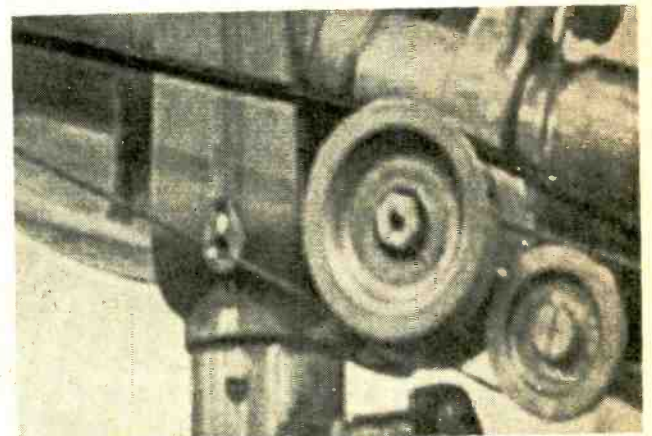
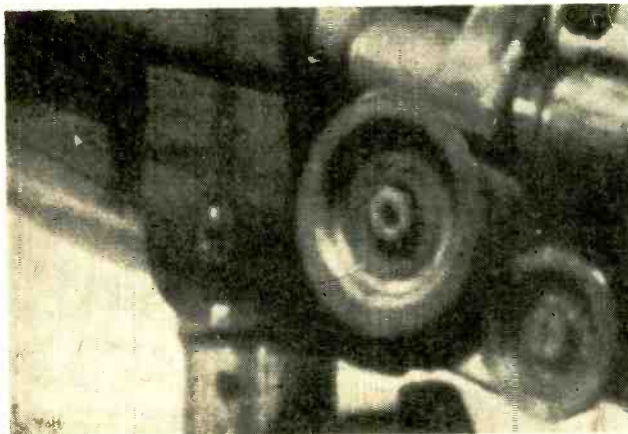

FIG. 5—Image obtained from image-orthicon television camera set up to render normal grey response is improved by tonal compression obtained by opening lens aperture and reducing target voltage

Intruder Alarm Uses

Transistorized burglar alarm has electronically modulated infrared light source and synchronous phase-sensitive demodulator pickup unit. Pulsed light technique overcomes adverse effects of continuous or varying ambient light conditions. Alarm also sounds if power supply or interconnecting lines are tampered with.

By S. BAGNO and J. FASAL Walter Kidde & Company, Inc., Belleville, N. J.

IINTRUDER DETECTION systems must be virtually foolproof, even under the most difficult conditions of operation, and they must also provide safeguards against false alarms or being rendered inoperative by intruders. Furthermore, the system must not respond to a variation of the light intensity and should not be affected, within practical limits, by such climatic conditions as fog, rain or snow.

Because intruders have developed increasingly more ingenious methods of defeating conventional alarm systems, a phase-sensitive system has been developed. An invisible infrared light beam keeps intruders unaware of its exact location. Any tampering with the power supply or any other interruption of lines produces an alarm.

The basic principles of the photoelectric alarm system are illustrated in the block diagram, Fig. 1. A 55-cps transistorized power oscillator powers and modulates the light source and supplies a reference signal to the phase-detector stage of the receiver. Any deviation between the reference-voltage phase and the phase of the modulated light beam deenergizes the relay in the output circuit of the phase detector.

Modulation

The oscillator frequency is made slightly different from the line frequency to eliminate the possibility of synchronization with the 60-cps line which would enable an intruder to paralyze the system by directing a 60-cps stroboscope into

the housing of the phototransistor.

The beam modulation frequency is directly related to the percentage of light modulation. The tungsten-lamp filament reaches its maximum temperature when the collector current of the oscillator transistor goes through its peak value and cools off to its minimum value when its collector current goes through zero. If the time interval between maximum and minimum is small, (frequency is high) the filament does not have time to cool off so much as when the frequency is low. This means that the light modulation with high frequency will be less than with low frequency.

For some applications, it may be necessary to increase the oscillator frequency to detect small and fast-

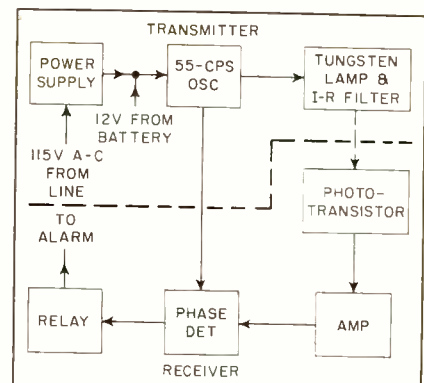
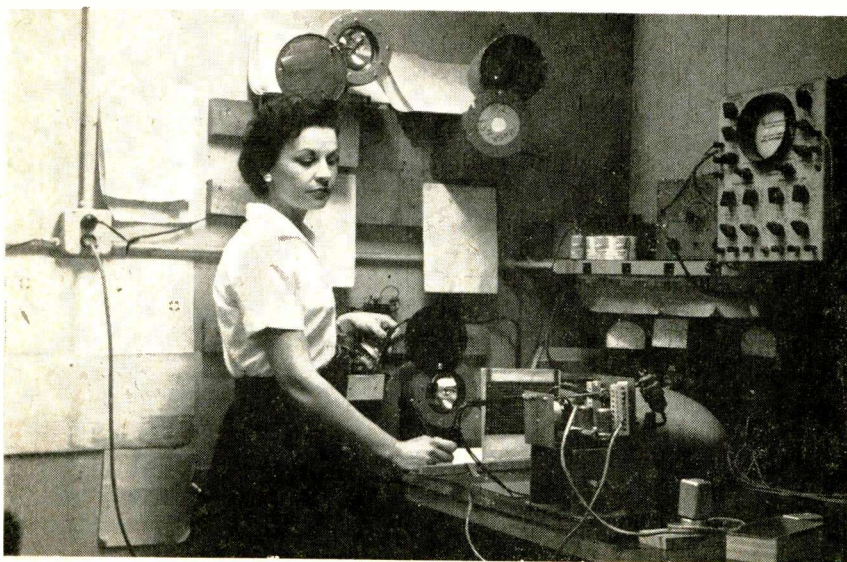

FIG. 1—Basic elements of transmitter and receiver units that make up alarm

Alarm system operation is checked with perforated sheet between receiver and transmitter units

Phase-Sensitive Detector

moving objects, but the price is always the loss of sensitivity, as a result of a lower percentage of light modulation.

Due to the optical characteristics of the phototransistor and the type of glass used, only the portion of the radiated modulation falling above 2 microns is detected, as illustrated in Fig. 2. Since that portion of the spectrum shorter than 2 microns includes most of the energy radiated by high-temperature light and only the portion of the low-temperature light most sensitive to temperature modulations, the phototransistor response indicates that the received modulation percentage is relatively constant and independent of the average filament temperature over a wide range.

A series-emitter resistance can stabilize a phototransistor against ambient variations in collector current.

This effect can be used to make the steady-state d-c response of the phototransistor and its a-c response independent of each other. Thus, for steady-state light, the phototransistor has the low sensitivity of a photodiode, whereas for modulated light it can approach the full sensitivity of a phototransistor—a gain of more than 40 db over the d-c steady-state light response. In that way the phototransistor can operate in bright ambient light without becoming saturated and insensitive to light modulations.

Phase Detection

The basic schematic of the phase detector is shown in Fig. 3 in simplified form.

The amplified signal from the phototransistor drives the base of the phase detector (Fig. 4B).

The emitter-collector voltage of the phase detector is supplied from the 55-cps transistor oscillator through an unfiltered bridge rectifier and through a d-c relay located in the a-c branch of the rectifier bridge. The emitter-collector voltage is therefore a full-wave rectified signal (Fig. 4D) derived from

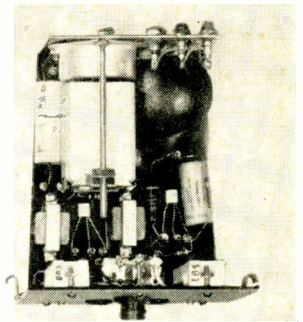
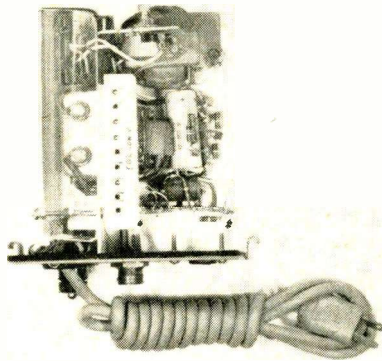

Unhoused transmitter and receiver chassis are shown at left and right respectively

the reference signal in phase with the phototransistor signal (Fig. 4C). The phase shift between phototransistor and reference signals that results from the thermal lag of the filament is corrected in the amplifier.

The resultant collector current (Fig. 4E) of the phase detector depends on the instantaneous voltages on the base and collector and can be considered as the modulation product of both. This current must always be in phase with its driving voltage. Therefore, on the d-c side of the rectifier, where the adjacent half waves are in the same direction, this current will be in the same direction although modified in amplitude by the signal on the base of the transistor.

Similarly, on the a-c side of the rectifier, this current although equally modified in amplitude by the transistor, will have its adjacent half waves alternating in direction in response to the driving alternating potential and be in phase with it (Fig. 4F). This current is therefore a nonsymmetrical alternating current that contains a d-c component by which the relay is energized. The a-c component of the current is bypassed.

There are several cases to consider in the behavior of the phase detector under varying operating conditions.

Suppose first that the phase between the phototransistor signal and reference voltage had been re-

versed (Fig. 4I). This is caused by a reversed primary or secondary winding of one of the coupling transformers.

The considerations leading to the waveform of the collector current and the current through the a-c circuits and through the relay are the same as before. The only difference is that the sequence of the smaller and larger amplitudes of the wave is now reversed. Therefore, the d-c component in the relay circuit or the relay voltage itself has to change its sign as shown in Fig. 4N.

Other Phase Conditions

When no light or nonmodulated light reaches the phototransistor, as shown in Fig. 4O, the phototransistor signal is zero, while the bias reference and full-wave rectified reference signals are the same as before. However, the resultant collector signal will be proportional only to the rectified reference signal because the base signal is the constant bias voltage.

The current through the a-c circuit will be a sinusoidal current without any d-c component so, in this case, the relay is deenergized and drops out.

Another interesting and important condition exists when there is a phase shift of 90 deg between the photo signal and reference signal, as shown in Fig. 4V.

To obtain the resultant collector signal consider adjacent quarter-

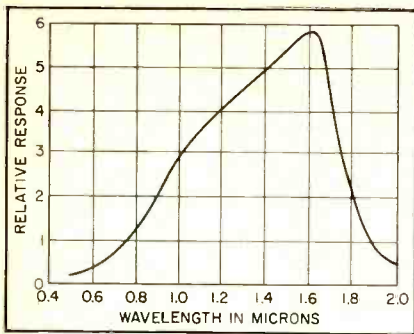

FIG. 2—Typical response of phototransistor to various wave lengths

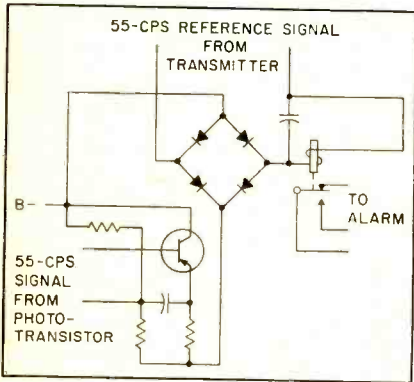

FIG. 3—Simplified representation of basic phase-detector circuit

waves; the first quarter-wave is equal to the fourth, although the mirror image of it. Similarly, the second and third quarter-waves are equal mirror images of each other.

Therefore, the sum of the first and second quarter-waves are equal to the sum of the third and fourth quarter-waves. That they are mirror images of each other does not alter the fact that their areas are equal. Thus, on the a-c side of the rectifier, the positive half-waves will exactly cancel out negative half-waves and give a zero d-c component. The relay is deenergized and the alarm sounds.

Other Cases

For other cases where the phase shift lies between 0 and 90 or 90 and 180 deg, a d-c component will exist in the relay circuit that becomes smaller as the phase shift approaches 90 deg and larger as the phase shift approaches 0 or 180 deg.

From the previous case, it may be seen how the system will behave when the frequencies of the phototransistor signal and reference voltage are slightly different. The two frequencies behave as if the

phase between them were continuously changed. Therefore, within periodically repeating time intervals, the two waves will be in phase, 90 deg or 180 deg out of phase, passing through all possible phase conditions. Consequently, the relay is periodically energized and deenergized and thus triggers an alarm during the unenergized intervals.

As the same detecting device acts on both half-waves that are being compared, any change in the detecting device acts symmetrically and cannot affect the balance.

Phototransistor Properties

There are some properties of the phototransistor that affect the reliability of the whole system.

The collector current of an uncompensated germanium transistor will double for each 8C temperature rise. This can be somewhat obviated with proper temperature stabilization.

Furthermore, a phototransistor, changes continuously and asymp-

totically, the phase between light modulation and photocurrent. Under unfavorable conditions, it may slowly reach a phase shift of more than 15 deg during a day of operation. When the phototransistor is disconnected from its power supply the phase immediately returns to its original position.

This phase shift becomes more important the higher the emitter-collector voltage. The effect is based on the formation of capacitance bounded channels, which are nonuniform diffusion *p* and *n* regions penetrating from the surface of the semiconductor into the base. These channels have a certain capacity to the barriers of the semiconductor which increases with time when the static charge builds up under the action of the internal d-c field.

Since the capacitance of a *p-n* junction is a function of voltage and the voltage in turn is a function of the charge that has been built up through resistance with time, the overall capacitance becomes de-

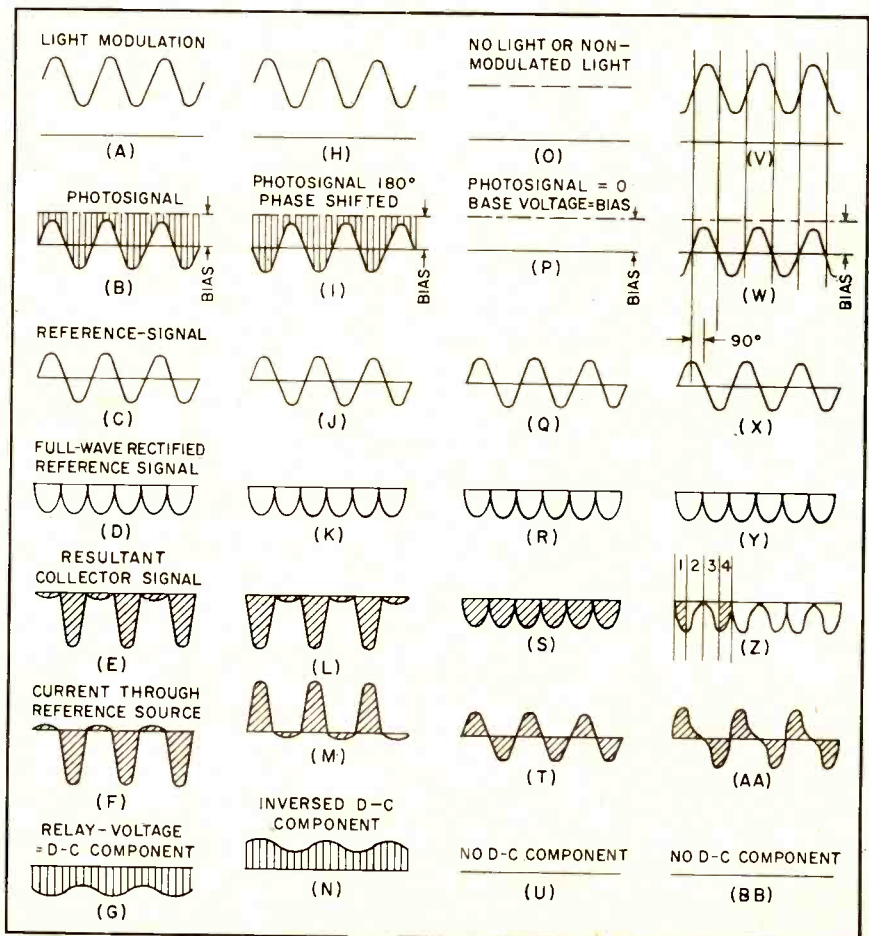

FIG. 4—Typical waveforms in system for different operating conditions

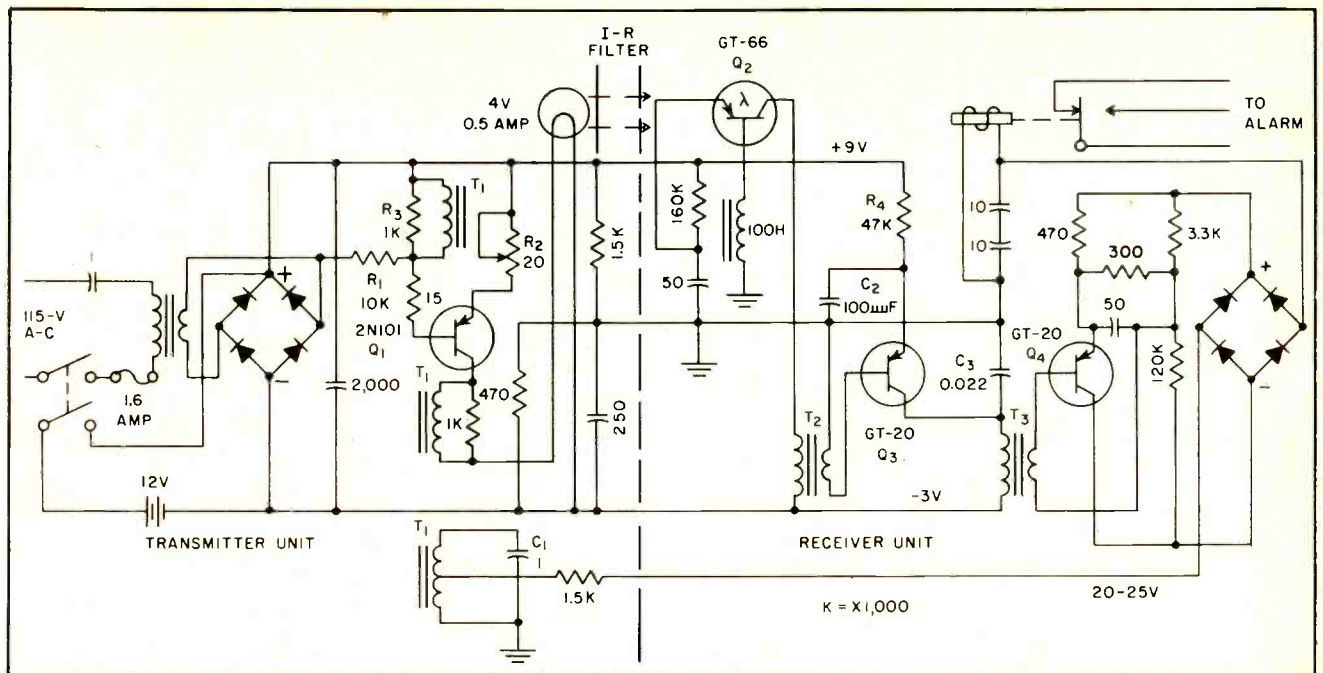

FIG. 5—Complete system normally operates from 115-v a-c power source with storage battery floating; battery takes over load if line supply fails. Capacitor C_1 tunes winding of T_1 to 55 cps, the oscillator frequency

pendent on voltage and time. The entire system corresponds to a rather complicated R-C network in which the capacitance is a function of time and voltage. That time varying network is the origin of the variable phase shift.

Although the network presents large phase shifts to low frequencies (55 cps) the response is hardly affected at higher frequencies.

The phase drift between photo-transistor signal and reference voltage must be eliminated as much as possible. By reducing the emitter-collector voltage, the phase shift can be reduced to a nonmeasurable amount. This also reduces the noise level.

Light Dispersion

An important consideration is the dispersion of the light beam energy so a large portion of the light is lost and does not reach the receiver. The narrower the beam angle the more serious such a situation can become.

In general, the loss in light varies inversely as the area that the transmitter beam would tend to cover in the plane of the receiver. For a given distance between transmitter and receiver, the area of the optical image of the light source would increase inversely as the square of the f -num-

ber of the optical system of the transmitter. Thus, going from an optical speed of $f2.5$ to a speed of $f0.25$, which can be obtained for a condenser system, decreases the sensitivity to lens fogging 100 to 1. For this reason, the highest speed optical system was used; a sealed beam lamp with a parabolic reflector.

Circuit

The schematic of the photoelectric alarm system is shown in Fig. 5.

The primary of the power transformer, which is a saturable type, forms a voltage regulator, in conjunction with the $1\text{-}\mu\text{f}$ capacitor, that maintains a constant d-c supply of approximately 12 v, independent of line voltage variations of + 20 percent but not independent of load.

Where standby power is required, a 12-v battery is connected to the projector unit. In normal operation the battery is trickle charged by the power supply. In the event of a-c power failure, the battery automatically assumes the load.

Resistor R_1 provides proper base current for oscillator Q_1 ; R_2 controls degeneration to vary the a-c voltage on the lamp. The winding of T_1 that is in series with the lamp

and collector of Q_1 provides regenerative feedback to the winding that is connected to the base and emitter; R_3 provides loading to prevent parasitic oscillations.

Capacitor C_1 and its associated winding tune the oscillator to approximately 55 cps. The center tap of this winding supplies an a-c voltage of 20 to 25 v which is relatively independent of lamp intensity setting.

Modulated light falling on the photosensitive junction of Q_2 modulates its collector current. This 55-cycle current is coupled through T_2 to amplifier Q_3 , the emitter of which is biased through decoupling network R_4 , C_2 .

Since the thermal time constant of the lamp produces an inductive phase lag in the transmission of the modulated light, it is necessary to correct the phase of the amplified signal with phasing capacitor C_3 . The corrected signal is coupled through T_3 to the phase-detector stage.

The phase-detector output results in a filtered d-c across the relay, holding it in the energized position.

The normal sensitivity of the system extends to 700 feet, with a four-to-one safety factor for dust and misalignment factors that affect operation at that distance.

Transistorized P-A System

Aircraft passenger-address system uses single preamplifier and up to five power amplifiers and speakers for uniform audio distribution throughout seating area. Differences in ambient noise level in the air and on the ground are compensated by switching. Transistors are used as matching devices to supplant transformers at input and output, and as electronic filter for noise

By J. M. TEWKSBURY

Research Engineer, Bendix Radio Division, Bendix Aviation Corporation, Baltimore, Maryland

SUCCESSFUL DESIGN of aircraft passenger address systems requires flexibility enough to compensate for differences in noise level from one type of aircraft to another, for the changing levels of ambient noise encountered in various positions in any given aircraft, and for differences in the noise patterns aloft and on the ground. Fig. 1 shows how the noise curve changes from the nose to the tail of a typical aircraft. Improved aircraft design has reduced ambient noise levels to a point where the use of the passenger address system for radio programs, frequent routine communications from crew to passengers, tape recordings and

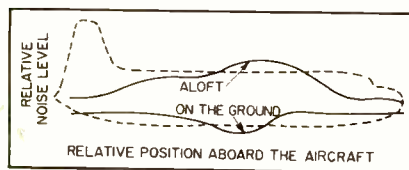

FIG. 1—Noise levels aboard aircraft

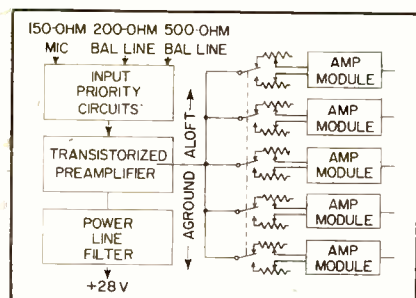

FIG. 2—Functional diagram of 5-station passenger-address system for airliners

other forms of entertainment has become practical.

Transistor Modules

The amplifier to be described is the first-known completely transistorized aircraft p-a system amplifier available to the aviation industry. The key to its flexibility and efficiency is the use of modular construction.

In a passenger address system using this amplifier the seating area is divided into from one to five audio zones, depending on the type of craft. A plug-in amplifier module producing eight watts of audio power is provided for each zone. Individual potentiometers for each amplifier provide independent control of the sound level. To compensate for the difference in audio levels on the ground as opposed to in the air, an air-ground output switch is provided which acts on all amplifiers simultaneously.

The block diagram of Fig. 2 shows the control setup which permits the selective use of audio power. Three input circuits are available which can be adapted to use with carbon microphones, dynamic microphones and tape machines. Order of switching priority is pilot-to-passengers, then stewardess-to-passengers, then the passenger-entertainment circuit.

Transformer Elimination

In push-pull transformer-coupled output circuits there is an auto-

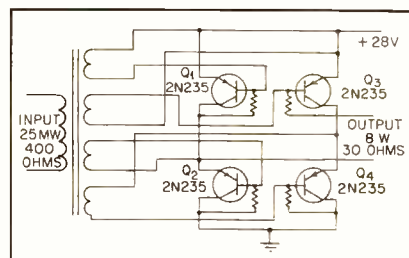

FIG. 3—Power amplifier module schematic

transformer action which places a voltage equal to double the supply potential on the transistors. Hence with a 28-v supply there would be 56 v on the transistors at maximum output. This would necessitate the use of transistors with a high breakdown voltage. But transistors of this type are relatively expensive and their current linearity is generally not satisfactory for this application.

Circuit Details

These difficulties are eliminated by the use of the bridge circuit shown in Fig. 3. Transistors Q₁ and Q₂ are conductive for half a cycle while Q₃ and Q₄ supply the other half-cycle to the load. The maximum peak voltage applied to the load is about 26 v, while the peak current reaches 0.93 amp at 8 w output. Although the 2N235 transistor is capable of 26-w peak output in class B, the 1,200-ohm bias resistors bring about conservative operation in class AB.

One of the inputs required is 200 ohms push-pull at -50 dbm. The

Adjusts to Aircraft Noise

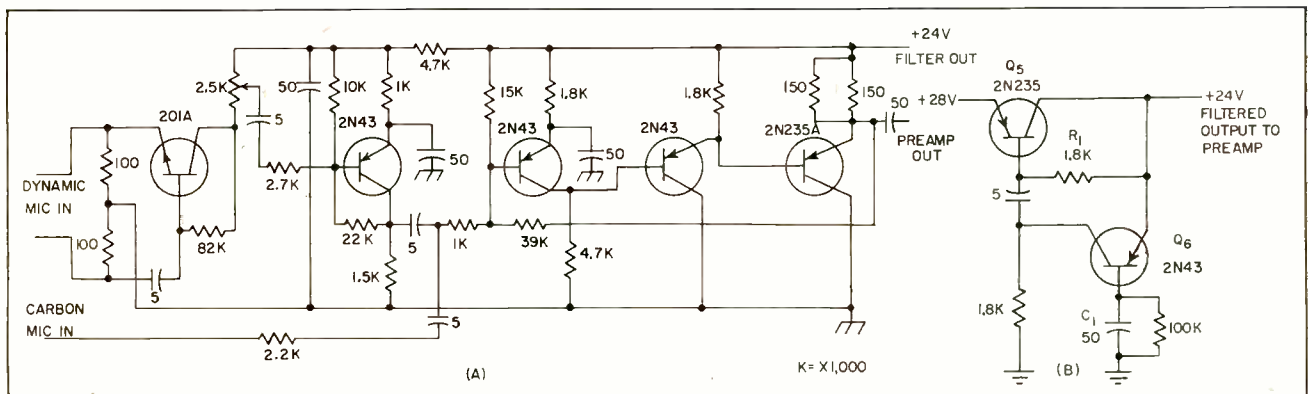

FIG. 4—Schematic of system preamplifier (A). First transistor is coupling device which eliminates push-pull to single-ended transformer. At (B) is electronic filter for d-c line

conventional way to connect such an input is to employ a push-pull to single-ended transformer. An *npn* transistor, however, connected as shown in Fig. 4A is completely equivalent, and this circuit accomplishes the input function with a saving in weight and volume.

Noise Filtering

Another problem to be overcome in the development of p-a amplifiers involves the prevalence of noise components on the 28-v lines of virtually all commercial aircraft. This may be as high as two volts rms on the 28-v bus. This noise must be filtered to prevent it from appearing in the preamplifier stages.

This filtering is accomplished by the special electronic filter shown in

the schematic diagram of Fig. 4B.

Referring to the diagram, R_1 biases Q_5 so that, with the current normally present in the circuit, there is a 24-v output and C_1 charges up to approximately 24 v. Any change in the voltage at the output side of the filter is amplified by Q_6 and applied to Q_5 in such a way as to oppose the change. Experimental results indicate that C_1 is amplified 1,000 times in value, thus having an apparent capacity of 50,000 μ f.

It is not at all necessary to filter the A+ supply to the bridge amplifiers because the collector impedance is extremely high. Consequently little a-c noise is transferred to the low-impedance bridge output load.

The collector current in the am-

plifier is essentially independent of collector voltage. The base current is produced by the signal input voltage. The current which flows in the collector circuit is many times greater than the base current once saturation has been reached. Thus the output load is almost completely isolated from any a-c components on the d-c input line.

Heat Dissipation

Perhaps the most serious limiting factor in the use of transistors in this application is their inability to withstand high temperatures. A study of the heat-dissipation problem resulted in the establishment of certain basic data.

The data shows that the average power dissipated can be calculated by integration and the equation reduced to $P_{av} = 1/2\pi [E (2P/Z)]^{1/2} - (\pi P/2)$, where E is the supply voltage, P is the power output of the bridge and Z is the load impedance.

With a supply of 28 v and a load impedance of 30 ohms it then becomes a simple matter to plot the dissipation of each transistor against the power output of the bridge.

This amplifier is the result of growing demands for lighter, smaller, less complex and more reliable airborne units. It has been made possible largely by the use of transistors and the application of new design techniques which transistors permit.

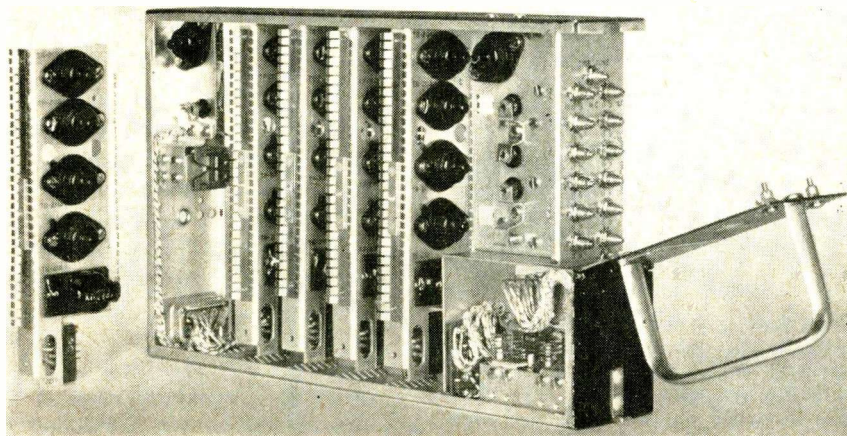

Modular 5-station amplifier. Two sets of potentiometers, one for air and one for ground, permit audio level balance

Print Timer Controls

Electronic timer, used to develop photographic prints of constant quality makes use of phantastron circuit to arrive at the right combination of exposure time and color filter necessary to obtain and repeat the desired exposure values. Timer controls two variables, density and exposure time, to faithfully reproduce the tones of the original scene.

By **JAMES D. WEIR** Assistant Professor of Engineering Research, Ordnance Research Laboratory, Pennsylvania State University, University Park, Pa.

WHEN DEVELOPING photographic prints, both density and contrast must be controlled to obtain a print that faithfully reproduces the tonal variations of the original scene. Density is proportional to the exposure time and the light impinging upon the emulsion. Contrast is determined primarily by the characteristics of the emulsion.

Contrast papers coated with emulsions sensitive to the color of the exposing light, provide the dark-room operator with a simple means of controlling contrast. These papers are coated with two emulsions, one for low contrast, the other for high. The low-contrast emulsion is sensitive to yellow light, the high to blue light. The right contrast is obtained by exposing the print through one of ten color filters that control the relative proportion of yellow and blue light. Even an experienced photographer must exercise considerable skill to arrive at just the right combination of filter and exposure time for a perfect print.

Control by Filters

The process can be performed by using only the two filters at the opposite ends of the range (yellow No. 1 for low contrast; blue No. 10 for high contrast) and controlling the relative exposure time. Even

with this method, there is still much room for operator error.

Operator error is reduced with the electronic timer. Any exposure time between 6 and 60 seconds is set on one dial and any contrast provided by Varigam or similar papers is set on another dial. Exposure time is calibrated accurately and will not vary more than 2 per cent of the set value.

The phantastron control circuit,



Print timer is shown beside the enlarger with the filter-switching motor mounted in place of the red filter normally supplied with the enlarger. The two color filters are mounted on an aluminum plate attached to the motor shaft. Shock mounts prevent jarring of enlarger when switching filters to change contrast

used extensively in radar and fire-control equipment, is shown in Fig. 1. In most applications, plate and grid voltages are clamped to their respective points on the voltage divider by diodes. However, relay contacts are used with the controller to reduce the charge time on C_1 and permit immediate recycling with no loss of accuracy.

Timing Cycle

The timing cycle is initiated by operating K_1 to remove the clamping from plate and grid. When the clamping is removed, the plate voltage immediately drops approximately six volts. This drop coupled through C_1 forces the grid voltage down to a value that reduces the plate current to the few microamperes necessary to establish the plate-to-grid voltage at the initial value e_1 .

From this time to the end of the cycle, the circuit acts as a Miller integrator. An almost constant capacitor-discharge current is maintained and if properly designed, the plate voltage will run down linearly with time within a fraction of one percent.

During plate-voltage run down, the cathode voltage rises a slight amount at a constant rate. Since the plate current is controlled by the suppressor grid, it is eventually cut off as the plate voltage de-

Density And Contrast

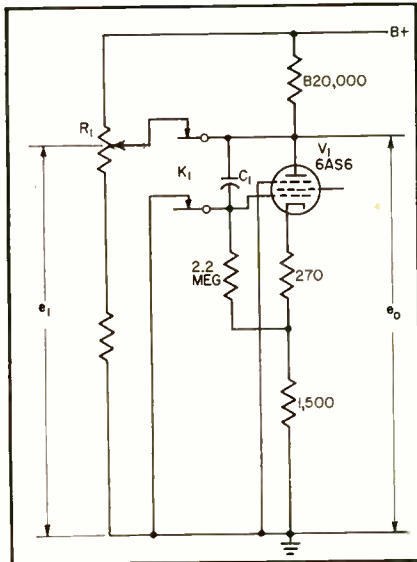

FIG. 1—Phantastron circuit used in radar and fire-control equipment

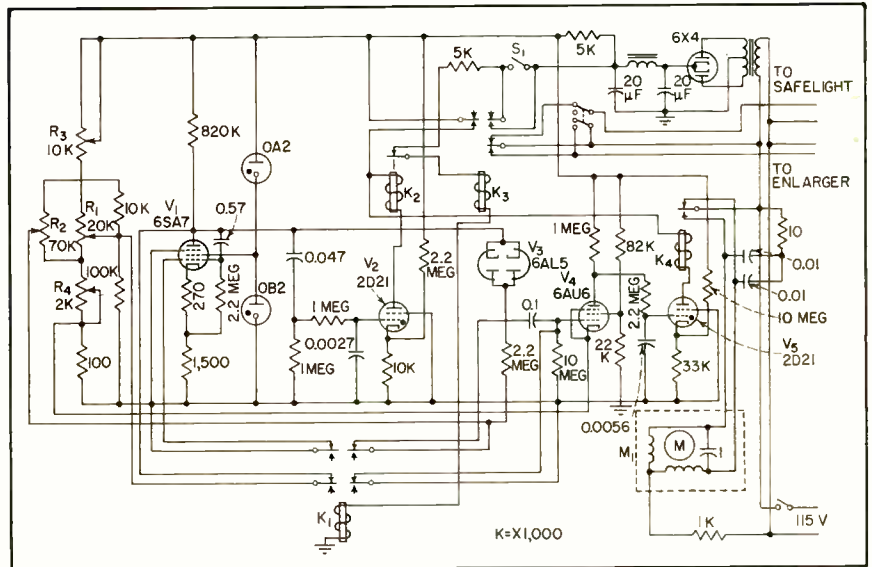

FIG. 2—Electronic timer circuit shows R_1 used to set the exposure time and R_2 to regulate any contrast from high to low

creases and the cathode voltage increases. At this time, the plate voltage suddenly starts to rise and causes the grid and cathode voltages to rise which further increases plate-current cut-off. With the circuit constants shown, the plate-voltage run down is linear with time over the entire cycle.

Circuitry

To operate the timing circuit, Fig. 2, pushbutton switch S_1 operates relays K_1 and K_2 . Contacts on K_2 turn on the enlarger, supply power to the thyatron plates and lock K_2 and K_1 closed. When K_1 operates, the plate-voltage run down on V_1 begins. At the end of the cycle, the sharp rise in plate voltage fires thyatron V_2 to operate relay K_2 . This action interrupts current flow through K_1 and K_2 to reestablish the initial conditions.

Potentiometer R_2 , diode V_3 , d-c amplifier V_4 , thyatron V_5 , relay K_4 , and induction motor M_1 constitute the contrast-control section. Potentiometer R_2 is set to establish the plates of V_3 to any percentage of the plate run-down voltage. Since the cathodes of V_3 are positive with respect to the plates, no

current flows through V_3 until the plate voltage of V_1 drops to a value equal to that set on R_2 . When the voltage does drop to this value, a voltage appears at the grid of V_4 , which, when amplified at the plate, fires V_5 to close relay K_4 . When K_4 closes, M_1 reverses direction.

The small induction motor is mounted on the enlarger so that the filters attached to its shaft rotate close to the enlarger lens. The motor does not run except when switching filters. When K_4 is open M_1 turns to a stop that positions the yellow No. 1 filter under the lens and, when K_4 is closed, a stop positions the blue No. 10 filter under the lens. Switching time is a fraction of a second. Relay K_1 shorts V_3 plate and V_4 grid resistors for rapid recycling.

Calibration

Potentiometers R_2 and R_4 permit the timing cycle to be precisely adjusted at the low and high ends of the range: R_2 to set the maximum time and R_4 to set the minimum time. Since there is some interaction between these adjustments, calibration must be repeated several times to insure accuracy. With

several trials, the accuracy at each end can be set to within one percent. Mid-range accuracy depends on the linearity of R_1 .

Contrast Setting

With the circuit constants shown, any time from 6 to 60 seconds can be set by R_1 and any contrast from low to high can be set by R_2 .

The density of filter No. 10 is normally greater than that of No. 1. Twice the exposure time is required with the No. 10 filter than with the No. 1 to obtain the same reflection density in the print. If this condition were to exist with the controller, the printing time would have to be varied with different filter settings.

A simple solution to this problem is to cement a neutral-density filter (one with approximately 50 percent transmission) over the No. 1 filter. With this arrangement, no printing time compensation is necessary with different contrast settings.

The author thanks C. R. Smitley, W. J. Leiss, C. K. Arnold and R. Swope for their assistance and C. W. Young for photography.

Electronic integrator-amplifier simplifies and speeds grading and matching of magnetic cores. Miller-type integrator measures instantaneous and peak flux in cores at excitation frequencies of 60, 400 and 1,600 cps. Design approaches ideal response throughout 480-kc bandwidth and provides closed loop gain of two at fundamental excitation frequencies. Amplifier increases output to required measurement level and minimizes phase shift

By CHARLES E. GOODELL Hughes Aircraft Company, Culver City, Calif.

Integrator-Amplifier for

FLUX-CURRENT LOOP characteristics of materials used in magnetic cores determine the ability of a core to function adequately in amplifying or switching applications, or as a simple magnetic element. Therefore, by measuring various magnetic properties of the core material beforehand, the user can assure himself that the core selected meets his specific requirements.

The grading and matching of cores and core materials can be accomplished more easily and quickly using the integrator-amplifier described here.

The integrator is of the Miller type and has been designed specifically for measurement of magnetic core characteristics at excitation frequencies of 60, 400 and 1,600 cps. Two important magnetic properties of cores measured by the integrator are magnitude of the instantaneous flux wave developed as a function of excitation voltage

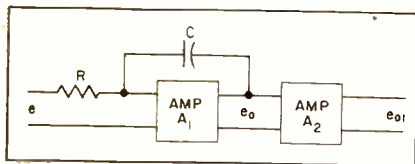

FIG. 1—Block diagram of integrator

and peak flux within the core.

Since the time integral of voltage is a measure of the instantaneous flux existing in the core and since the peak signal from the integrator is proportional to the peak flux, measurement appears simple. The requirements placed upon the integrator, however, are severe. For this reason it is necessary, in practice, to compromise between accuracy of measurement and complexity of design.

Initial Assumptions

To solve the design problem, it is necessary to make certain initial assumptions. As finally conceived, the integrator design assumes: (1) the core is excited by a sine current, (2) the crest factor of the induced voltage wave will not exceed a factor of 50, (3) the minimum rms induced signal, for the smallest core and least number of turns on the pickup coil, will always exceed the equivalent rms input noise of the integrator by a factor of at least 5, (4) the integrator response can be dealt with using superposition of solutions and (5) the induced voltage wave can be simulated by straight-line approximations. Those factors which materially influence integrator op-

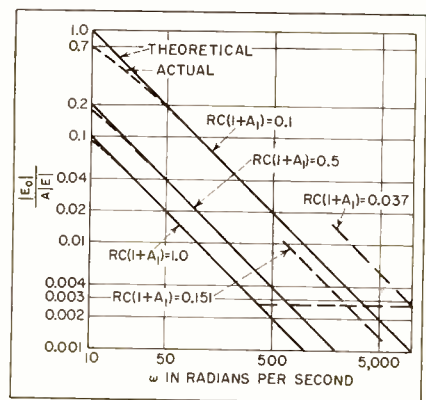

FIG. 2—Output amplitude of first amplifier stage plotted as function of frequency (theoretical and actual)

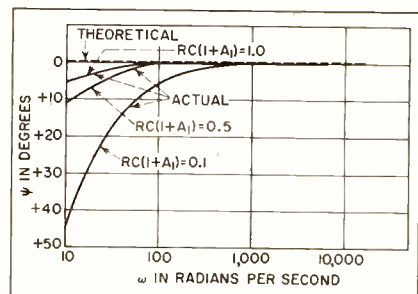

FIG. 3—Output phase angle of first amplifier stage plotted as function of frequency (theoretical and actual)

eration are treated as separate problems. Thus, the effect of each system parameter can be analyzed and its effect on overall system operation predicted.

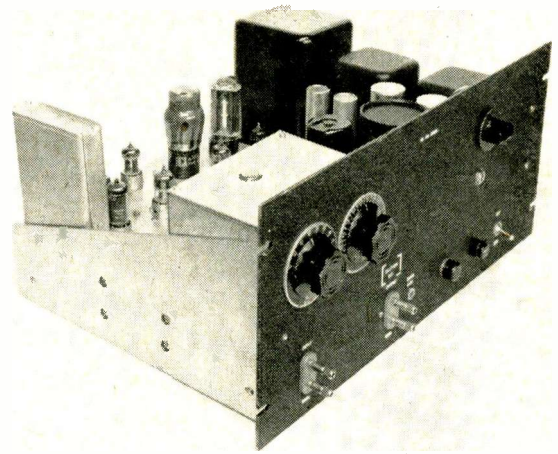
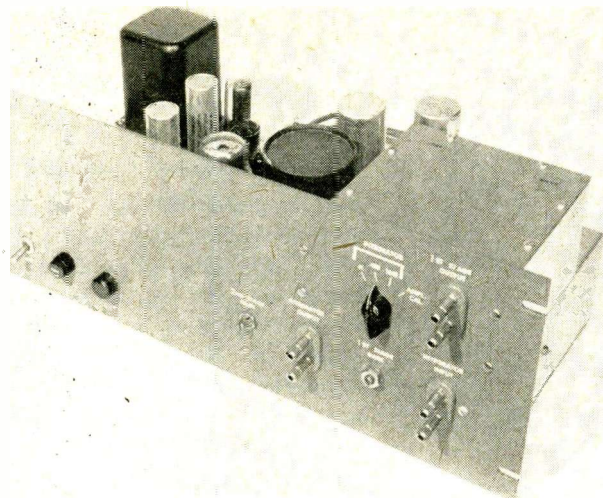

FIG. A—Integrator (left) quantitatively measures magnetic core properties to supply data used for predetermining core performance. Weak integrator output is increased to usable magnitude by amplifier (right)

Core Measurements

Initially, the design of the integrator is analyzed as though amplifiers were perfect devices having constant gain and no phase shift. This approach illustrates the manner in which the product of the R-C feedback network and the magnitude of the first-stage gain influences integration effectiveness.

A block diagram of the integrator is shown in Fig. 1. Steady state integration response of this circuit is expressed as

$$\frac{E_o}{A_1 E} = \frac{1}{\omega RC(1 + A_1)}$$

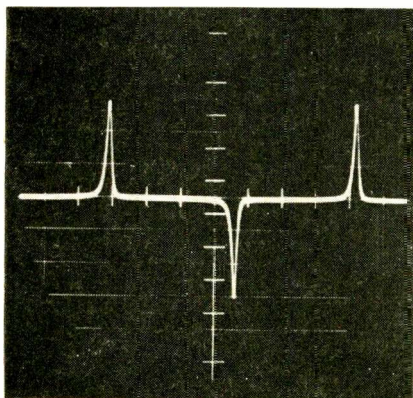

FIG. 4—Induced voltage wave generated by subjecting toroidal core made of 4-79 Molypermalloy to a 400-cps sine current excitation equivalent to 0.5 oersteds at peak. Pick-up loop consisted of two turns closely coupled to core

$$\left\{ \frac{\omega^2}{[RC(1 + A_1)]^2 + \omega^2} \right\} \cos(\omega t + \psi) \quad (1)$$

where E and E_o represent maximum values of the input and output signals respectively, and $\psi = 90^\circ - \tan^{-1} \omega RC(1 + A_1)$.

In deriving Eq. 1, it was assumed that the complex input wave could be represented by a series of sinusoidal terms of the form $e_m = E_m \sin \omega_m t$ and that the gain of the amplifier stage would remain constant and independent of frequency. Plots of the magnitude and phase characteristics of Eq. 1 are shown in Fig. 2 and 3.

An examination of these characteristic curves indicates that relatively large values of the term $RC(1 + A_1)$ are required if the device is to approach the action of a true integrator for all frequencies. Usually it is not difficult to obtain relatively large $RC(1 + A_1)$ products; however, this is not in itself desirable. At any specific frequency f_s , increasingly large values of the $RC(1 + A_1)$ product give rise to diminishing values of the term $E_o/A_1 E$. Although the integration action becomes more nearly perfect, the output signal is diminished in magnitude and may become so small

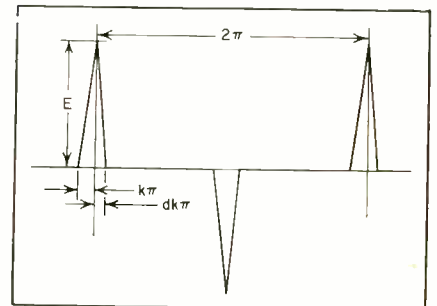

FIG. 5—Straight line approximation of induced voltage wave shown in Fig. 4

as to be unusable or obscured by internally generated system noise.

R-C Combinations

Because of the influence of the term $RC(1 + A_1)$ upon integration effectiveness and upon output signal level, it is generally necessary to provide separate R-C combinations which can be switched into the integrator loop. One combination should be available for each test frequency normally used.

In the construction of the integrator three separate R-C combinations were employed which gave $RC(1 + A_1)$ products of 1 for 60 cps, 0.151 for 400 cps and 0.037 for 1,600 cps. These products were selected so that the term $E_o/A_1 E$ was the same at each test frequency.

Although selection of the value

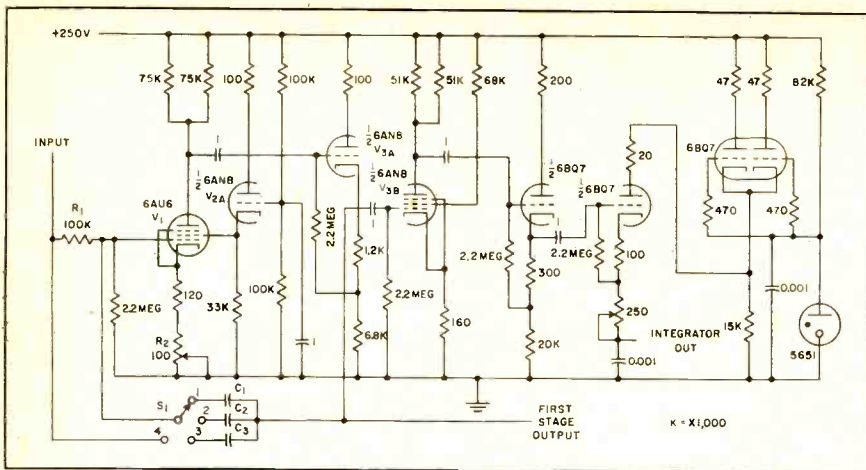

FIG. 6—Schematic diagram of integrator used for core measurement

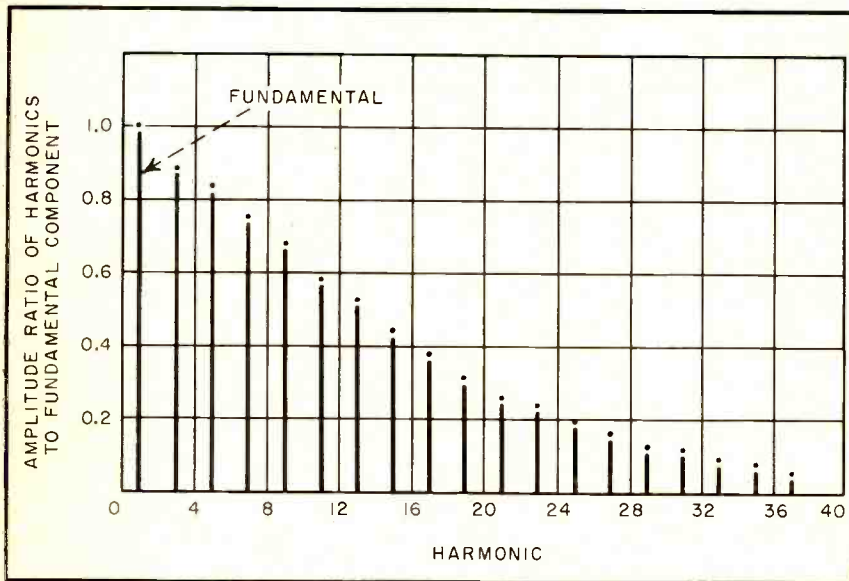

FIG. 7—Harmonic spectrum of induced voltage wave shown in Fig. 4. All even harmonics have zero amplitude for sine current excitation

of the $RC(1+A_1)$ product usually must be compromised, it can be shown that term A_1 should be as large as possible. The larger the stage gain in amplifier A_1 , the larger will be the integrated output signal for any given $RC(1+A_1)$ product. The practical limit of A_1 is determined primarily by the gain-bandwidth requirement for the stage which is a function of the type of tube selected.

The integrator must possess a bandwidth of approximately 0.5 mc for proper operation. By using a receiving tube pentode in the first amplifier stage and assuming that the total stray circuit capacitance can be held between 10 and $15\mu\mu\text{f}$, it is possible to realize gain-bandwidth factors of 45 to 60 mc. This factor, in conjunction with the bandwidth requirements, limits the first stage

gain to a 90-to-120 range.

It has been experimentally determined that the first-stage amplifier can possess a phase shift of approximately $\frac{1}{4}$ of a deg at the fundamental, or excitation, frequency without introducing noticeable error. If the amplifier is considered to be a simple, single-stage, R-C-coupled amplifier with a $\frac{1}{4}$ -deg phase shift, the low-frequency 3-db point ω_c is approximately equal to $\omega/230$ which agrees with a value obtained by Lord.¹ This relationship indicates that the low-frequency response of the amplifier must be extremely good. For example, if the lowest excitation frequency is 60 cps, the low-frequency 3-db point must occur at approximately 0.26 cps. Therefore, the total integrator phase shift at 60 cps and with an $RC(1+A_1)$ product

equal to one is a composite effect resulting from a 0.25-deg phase shift in the amplifier and a 0.15-deg phase shift introduced by the noninfinite $RC(1+A_1)$ integration product.

High-Frequency Requirements

In general, the induced voltage wave is nonsinusoidal and possesses many harmonics of relatively large amplitude. An oscillograph of an actual induced voltage waveform is shown in Fig. 4. An assumed straight-line approximation of this waveform is shown in Fig. 5.

Assume that an induced voltage can be represented satisfactorily by the straight-line values $K = 0.075$ and $d = 0.25$. When inserting these values in the Fourier expansion for the waveform approximation, the amplitude of the thirty-third harmonic is ten percent of the amplitude of the fundamental frequency component. Similarly, signals having higher crest factors possess correspondingly greater spectrums and require greater amplifier bandwidth for faithful reproduction of the impressed signal.

Induced voltages obtained may have crest factors as high as fifty-to-one as demonstrated by Roberts.² To properly reproduce a signal of this type, the high-frequency 3-db point of amplifier A_1 must occur at a frequency approximately 300 times that of the highest fundamental, or excitation frequency employed. Since the integrator is designed to operate at excitation frequencies from 60 to 1,600 cps,

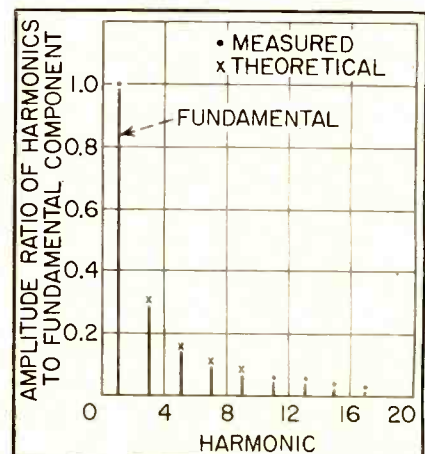

FIG. 8—Integrator output spectrum generated by input driving function shown in Fig. 4. Comparison between measured and theoretical response is also given

the overall frequency response of the first amplifier stage must extend from 0.26 cps to 0.48 mc.

Integrator Design

The integrator, shown schematically in Fig. 6, is designed in accordance with the theoretical criteria. Tubes V_1 , V_{2A} and V_{3A} make up the first amplifier stage A_1 . Because of the extreme low-frequency response required, no attempt was made to by-pass the cathode circuit of V_1 . Resulting current feedback reduces the overall first stage gain from a theoretical value of 100 to a value of 50. At the same time, a certain amount of gain stabilization is produced.

Screen degeneration is reduced to a small value by supplying the screen from cathode-follower stage V_{2A} . The integration R-C loop is made up of the input resistor R_1 and one of the three capacitors C_1 , C_2 and C_3 . First-stage gain can be set precisely to a value of 50 by placing switch S_1 in position 4 to open the integration loop and then adjusting cathode resistor R_c .

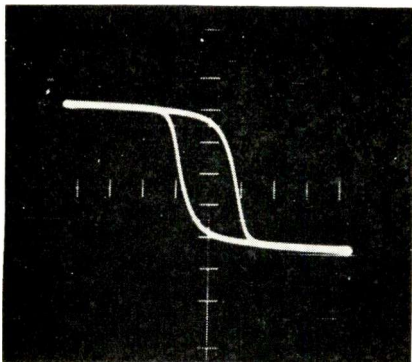

FIG. 9—Flux-current loop out of integrator as seen on cro

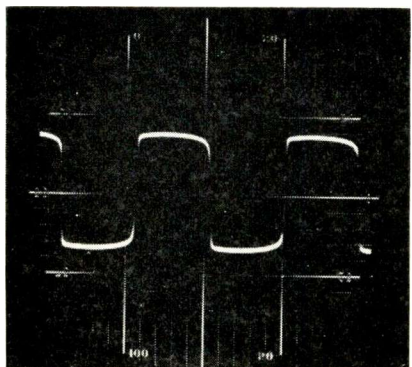

FIG. 10—Integrator output voltage generated from driving function shown in Fig. as seen on cro

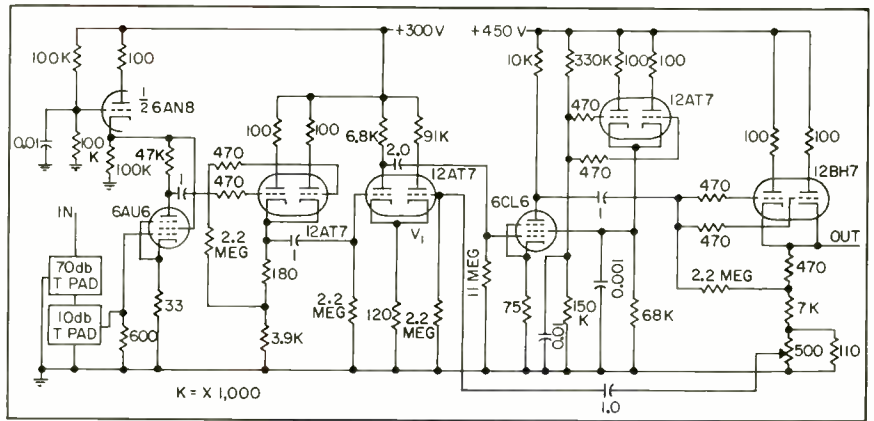

FIG. 11—Amplifier schematic. Special feedback technique minimizes phase shift over 0.3-cps to 650-kc range at the 3 db points. Gain without feedback is 12,500

Remainder of the integrator circuit is made up of a wide-band, moderate-gain amplifier and cathode-follower designed to work into a 600-ohm, resistive T-pad attenuator. Overall open-loop gain of the integrator is adjusted to a value of 740 which, in turn, makes the second stage gain 14.8. With this gain established, open-loop rms noise output with shorted input is 6 mv. Overall closed-loop gain at the fundamental frequency is precisely 2 as can be determined from Fig. 2.

Peak-to-peak output voltage is related to the peak flux in the core by the integration constant of the integrator. This is expressed as

$$\Phi = KE_{eolp-p}$$

where Φ = peak flux and

$$K = \frac{RC(1 + A_1)10^8}{2A_1A_2n}$$

where n is the pick-up coil turns.

Integrator Performance

To evaluate the performance of the integrator, the harmonic spectrum of the induced voltage wave, shown in Fig. 4, was measured using a GR type 736-A wave analyzer. A plot of the spectrum appears in Fig. 7. With this input signal applied, the integrator output signal spectrum was similarly measured and is as in Fig. 8.

Ideally, the integrator response should fall off at a rate of 6 db per octave; therefore, the integrator performance was compared, component by component, with the theoretically determined performance. This has been done and is in the spectrum shown in Fig. 8. Examination of the graph indicates

that the integrator matches the theoretical performance within the accuracy obtainable from the measuring method used. Traces of the flux-current loop signal and output voltage from the integrator are shown in Fig. 9 and 10.

Amplifier Design

Since the closed loop integrator gain is only two at fundamental frequencies, it is usually necessary to provide additional amplification of the output signal for measurement and cro display purposes. To fulfill this need, a wideband amplifier with 80-db gain was designed.

Bandwidth requirements are the same as previously specified for the integrator if the amplifier is to precede the integrator. However, if the amplifier is used following the integrator, the high-frequency response does not need to be as good.

A schematic diagram of the amplifier as actually constructed is shown in Fig. 11. The design is straightforward except for the method of inserting the main feedback signal.

Since the bandwidth is relatively great, 0.3 cps to 650 kc at the 3-db points, it is very important that phase shifts in the feedback loop be minimized over the whole range. Therefore, the feedback signal is applied to one grid of dual-triode amplified V_1 and is combined with the main path signal in the common resistor of the same stage.

REFERENCES

- (1) H. W. Lord, Dynamic Hysteresis Loop Measuring Equipment, *AIEE Trans*, p 269-272, vol LXI, 1942.
- (2) R. W. Roberts, Magnetic Characteristics Pertinent to the Operation of Cores in Self-Saturating Magnetic Amplifiers, *AIEE Trans*, p 682-689, vol LXXIII, part 1, 1954.

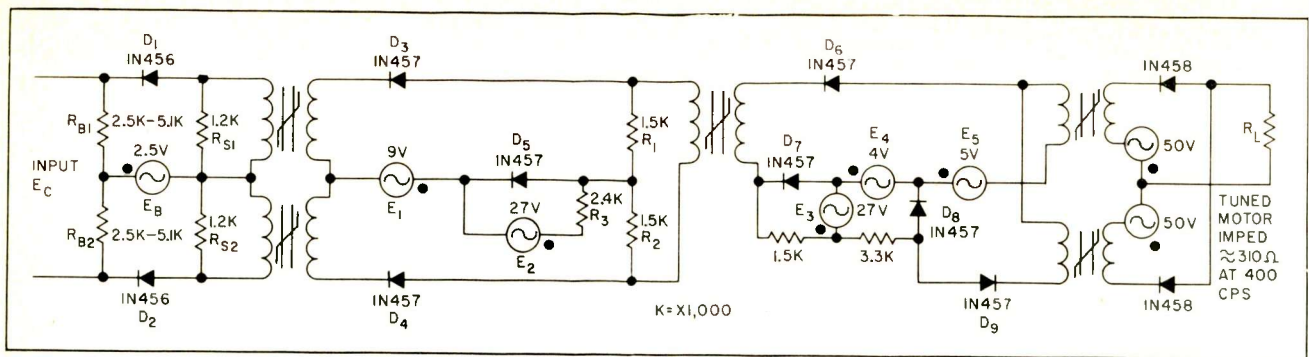

FIG. 1—Basic gyro indicator amplifier has 300 deg per sec follow up rate, ± 0.5 -deg accuracy and ± 0.25 -deg zero drift

Three-stage fast-response magnetic servo amplifier occupies only 22 cubic inches in military airborne gyroscope indicator. Amplifier has balanced two-core input, alternate-firing output stage and synchronous interstage switches to eliminate interaction between stages. Power gain approaches 60 db with less than $\pm \frac{1}{4}$ -deg zero drift

By CLIFFORD C. VOICE Electrical Design Section Head, Lear Incorporated, Grand Rapids, Michigan

Magnetic Amplifier

THERE HAS BEEN considerable activity in recent years toward the application of fast-response magnetic amplifiers in high-performance servo systems. Availability of silicon diodes within the last two years has made the use of magnetic amplifiers attractive for military and airborne applications where extreme environments are encountered. These amplifiers are rugged, yet may still be small and light weight, even to the extent of comparing favorably in size and weight with equivalent transistor circuits in many applications.

One particularly challenging military airborne application required a 3-in. vertical gyro indicator with self-contained servo amplifiers. The amplifiers could not be mounted with the gyro as in other systems, as this aircraft employed a master gyro reference system. Other requirements were for a fast response, a 300 deg per sec follow-up rate and ± 0.5 -deg accuracy.

Accuracy requirements dictated

a required amplifier power gain approaching 60 db, considering the power limitations of the velocity generator output. One watt of control power was required by the servo motor for rated performance.

Half-wave magnetic amplifiers were chosen for their fast response and small size.

Circuit

Since a half-wave amplifier is limited to about 20 db of gain at these low power levels, a three-stage amplifier is required. Only five reactor assemblies are required for the complete amplifier shown in Fig. 1. Supply voltages are shown as voltage generators to simplify the schematic. Many of these voltages can be obtained from a common transformer secondary winding with appropriate taps.

The input stage employs a two-core balanced (differential) configuration with each core biased near the middle of its linear range. The diodes are so arranged that

both cores are reset during the same half-cycle of the supply voltage. Such an arrangement has inherent half-cycle response, eliminating the possibility of induced voltages in the control windings creating a time-constant effect.

Biasing for the first stage is obtained from voltage E_B acting through R_{B1} , D_1 , R_{B2} and D_2 on reset half-cycles. During output half-cycles, E_B blocks D_1 and D_2 preventing current flow through the signal source due to induced voltages. Since the signal is connected to the control winding only during the reset period, it need only supply the incremental current required to increase or decrease the flux reset.

Theoretically the input impedance would be infinite (zero signal current flow) if the usual idealized rectangular hysteresis loops are assumed. Realistically, however, a finite input impedance exists since the flux reset versus half-cycle average current always exhibits a definite slope. The reactors used in this

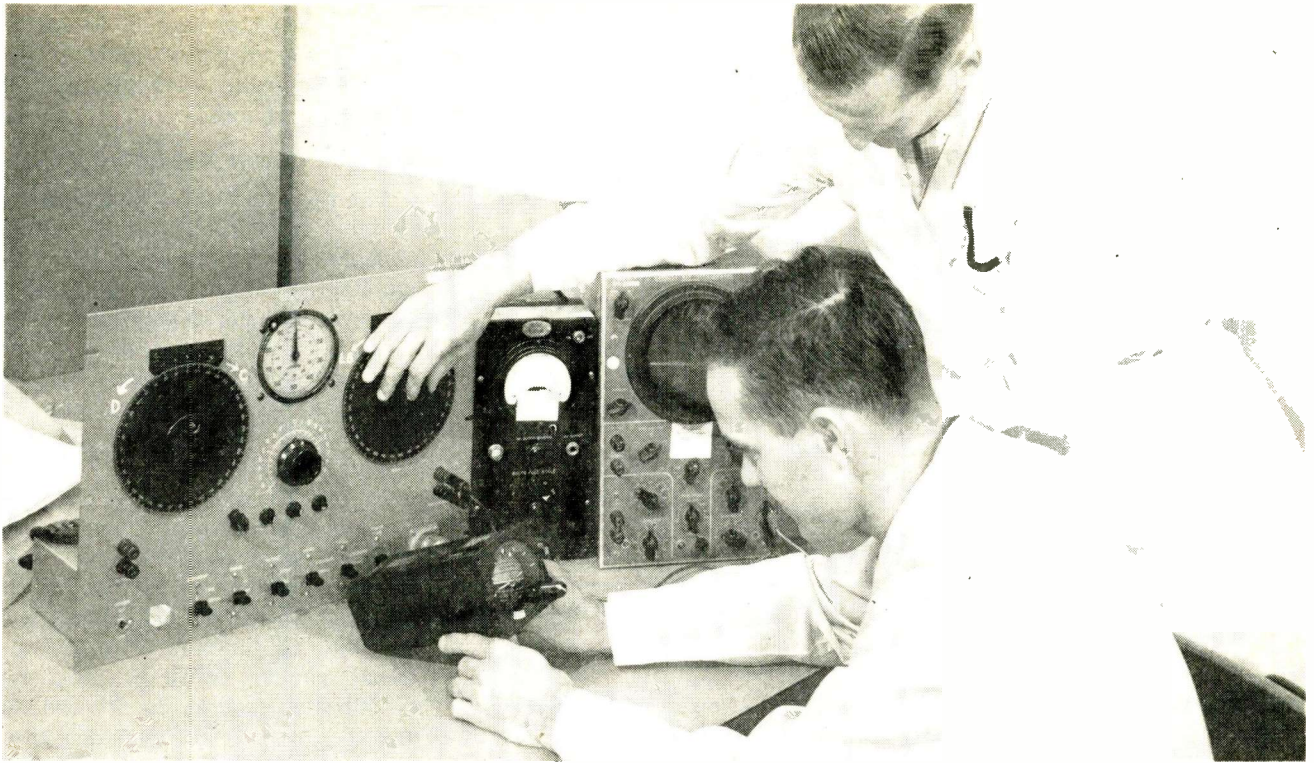

Complete gyroscope-indicator magnetic-servo-amplifier unit is checked out on test bench

Drives Gyro Indicator

design typically exhibit a 5,000-ohm incremental impedance.

Bias Stabilization

Resistors R_{S1} and R_{S2} provide bias stabilization for the input stage by reducing the effective source impedance of the bias network, while permitting E_B to be large enough to cause positive switching of D_1 and D_2 .

Output of the first stage is obtained as the differential voltage across R_1 and R_2 . The synchronous switch circuit comprising E_3 , R_3 , and D_5 connects E_1 to the junction of R_1 and R_2 during output half-cycles. During reset half-cycles, D_5 is blocked, developing a reverse voltage equal to E_2 across it, while D_3 and D_4 are blocked by a voltage equal to $E_1 + E_2$. This produces positive blocking action, preventing any interaction effect between the first two stages. Additionally, it allows the first stage to fully utilize nonsinusoidal input signals such as pulses without saturation effects.

The second stage consists of a single-core amplifier biased for one-half reset (90-deg firing angle in the output) for zero signal. In practice no bias supply is used, but instead the first stage is intentionally biased away from null to produce the required output from the second stage by the proper selection of R_{B1} and R_{B2} . An input signal then advances or retards the second stage output firing angle, depending on the signal polarity.

Synchronous Switching

Synchronous switches are used in the output of the second stage. They operate such that D_6 and D_7 are blocked during the output half-cycle for the second stage. At the same time, D_7 conducts to tie supply voltage $E_1 + E_2$ between the second stage and the control winding of the third stage upper core, which becomes the second stage load.

The third stage lower core is completely isolated by the switching action during this period. During

reset periods for the second stage, D_6 is blocked by a voltage equal to $E_3 + E_4 + E_5$ due to the switching action of D_7 .

The third stage uses two cores in an alternate output firing arrangement.¹ The upper core receives its input from the second stage, whereas the lower core is actually reset by the third stage upper core one half-cycle later.

Each core will have one-half output (90-deg firing) for zero-signal conditions. The firing angle of one is then advanced while the other is retarded as signal is introduced. Null and full output waveforms are shown in Fig. 2. Note that the fundamental a-c component is polarity reversing, although a unidirectional d-c signal is also present.

Core Reset

While the upper core is being reset by the second stage, D_6 and D_7 are blocked, isolating the lower core control winding. On the following half-cycle (the reset period for the

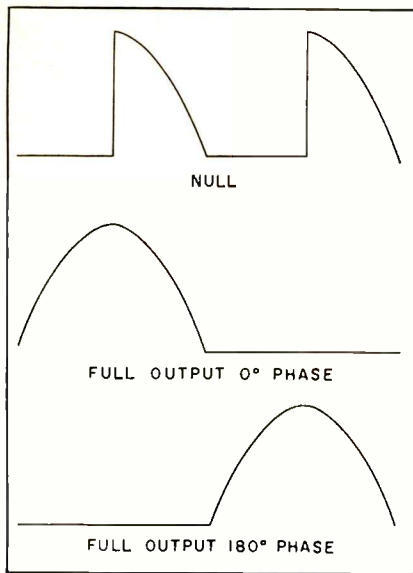

FIG. 2—Output waveforms of amplifier for three different conditions

lower core), D_s conducts due to the action of $E_s + E_i$; D_s also conducts due to E_c which now becomes a bias voltage.

The amplitude of E_s is sufficient to fully reset the lower core, if no other voltages are present. However, acting in series with E_c is the control winding of the upper core which is in its output half-cycle. Until the upper core saturates, it will have an induced voltage present on its control winding which opposes E_s . Since the flux change required to saturate a core is equal to the total flux reset received, this induced voltage is proportional to the last previous reset voltage received by the upper core and so may be used to drive the lower core.

This arrangement causes the reset of the lower core to increase as the reset of the upper core is decreased, producing the desired operation.

The switching is such that the induced voltage in the control wind-

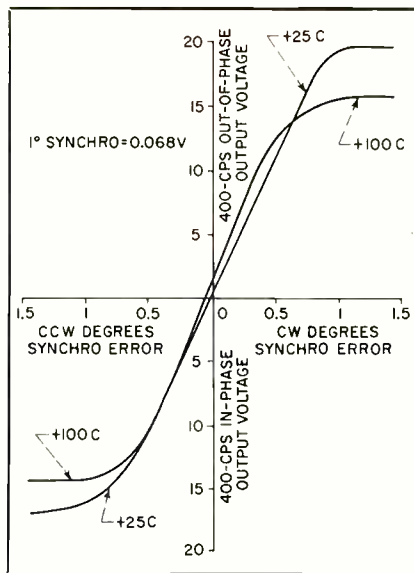

FIG. 3—Amplifier gain curves measured with in-phase voltmeter

ing of the lower core never influences the upper core. Thus the half-cycle response of the upper core is preserved. The lower core is then essentially a slave stage,² producing its output one half-cycle later.

Circuit Advantages

The alternate firing arrangement of the output stage is preferred over any simultaneous firing configurations because of its higher efficiency. This may not be immediately obvious, since both cores are biased for 90-deg firing. However, in simultaneous firing circuits, at null, both cores fire at the same time producing a short-circuiting effect which causes high circulating currents. No such effect occurs when alternate firing is used.

A further advantage of the output configuration is that the output signal is always in phase, either 0 deg or 180 deg, with respect to the supply voltage regardless of output amplitude. The resultant gain

curves, shown in Fig. 3, as measured with an in-phase voltmeter are extremely linear, showing no sign of dishing at null.

Circuit Analysis

The theory of using synchronous switches in magnetic amplifiers has appeared in the literature^{3,4} and is too lengthy to repeat in detail here. However, a brief discussion of the essential features is in order, as it has considerable influence on the individual reactor designs and on the overall performance of the system.

Figure 4A illustrates a test circuit representative of a single core amplifier such as the second stage of the indicator amplifier. Test switch S_1 , when closed, allows the amplifier to function in a conventional manner. With S_1 open, the synchronous switch is allowed to operate. Waveforms for each case are shown in Fig. 4B.

The available blocking voltage for the output rectifier during the reset period is E_i with S_1 closed, whereas it is $E_i + E_c$ with S_1 open. Signal voltage E_s , while resetting the core, will induce a voltage in the output winding which will oppose E_i and E_c .

Should the induced E_c exceed E_i with S_1 closed, the shaded portion of E_c would be lost due to unblocking of the rectifier and the resultant current would load the signal source by transformer action. With S_1 open, the synchronous switch increases the blocking voltage and permits the full use of such non-sinusoidal waveforms.

To reset fully the test circuit of Fig. 4A, the reset volt-seconds must equal the gate circuit supply volt-seconds ($\int_0^\pi E_s dt$). With a synchronous switch, full reset can be achieved with a narrow pulse,

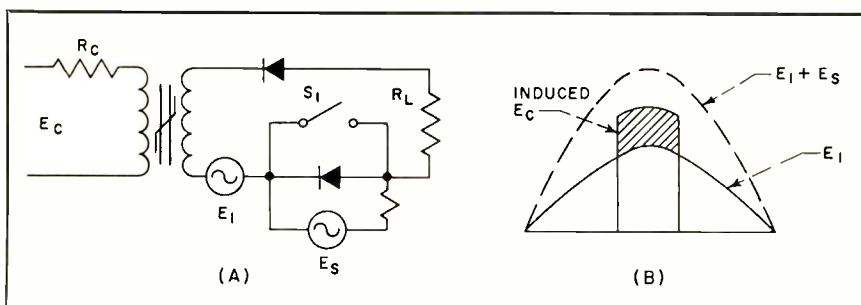

FIG. 4—Single-core test amplifier (A) and output waveforms (B) with S_1 open and closed

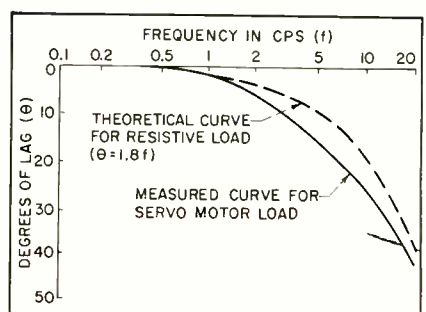

FIG. 5—Open-loop amplifier phase lag

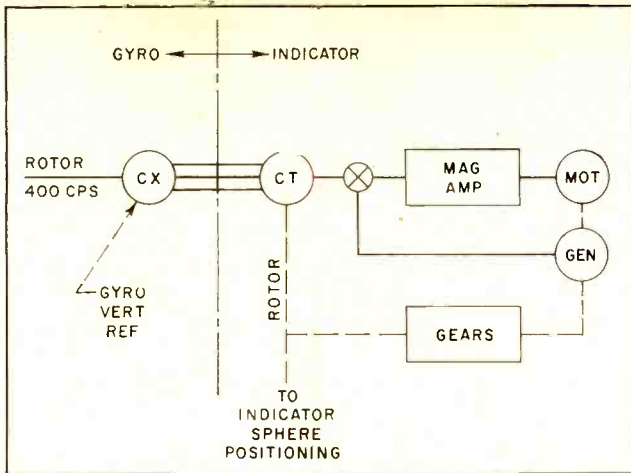
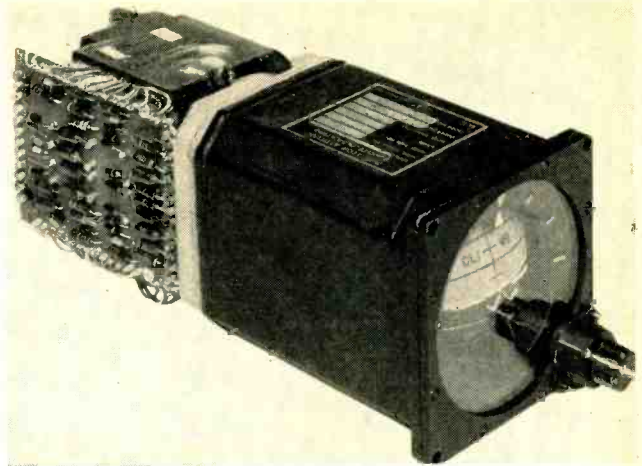

FIG. 6—Block diagram of roll-axis channel. External control for pilot is provided for trimming



Indicator unit with magnetic amplifier at rear gives relative indication of compact packaging achieved

whereas a sine wave or at least a signal voltage equaling or exceeding E_1 throughout 180 deg is required for the conventional circuit. When used, this feature permits E_c to be obtained from a previous magnetic amplifier stage and full control is achieved on the second stage for only a few degrees of firing angle variation on the first stage. Thus firing angle amplification is achieved.

Firing Angle

Firing angle amplification is used between the first and second stages of the indicator amplifier to permit use of a larger and more practical core size in the first stage. The first stage can also operate at its highest gain point, since it is a differential type and is not required to operate over its full useful range.

Additionally, and most important, due to the increased linear range on the first stage, it can integrate larger extraneous signals during the reset interval without saturation effects. This provides an inherent quadrature rejection ability of considerable importance in many applications. Whereas the indicator amplifier produces full output for approximately 0.068 v of in-phase signal, 0.5 v of quadrature will not appreciably alter its in-phase gain.

A disadvantage of using firing angle amplification is that the zero drift problem is increased since the unbalance drift will also be amplified. Shunt resistors R_{81} and R_{82} and/or matched input cores are used as required to minimize this effect.

Typically, a zero drift of less than ± 1 deg has been encountered in this application for varying combinations of temperature (-55 C to $+100$ C), line voltage (± 10 percent) and frequency (± 5 percent).

Performance

Overall performance of the amplifier in the indicator is shown in Figs. 3 and 5. The theoretical phase lag curve of Fig. 5 is predicted with the assumption of a total time delay of 2 cycles (0.005 sec). Net power gain utilized in this application is about 56 db.

Dead zone of the sphere due to friction and other factors is typically less than 0.1 deg. Dynamic lag for the system is about 5 deg at the maximum rated velocity of 300 deg per sec. Excellent damping is achieved, so that no perceptible overshoot is observed as a result of a step-input displacement command.

A prototype indicator employing half-wave magnetic amplifiers is shown in the photographs. The forward

half of the package contains the sphere with its associated motor-generators, gear trains, slip rings and synchros for both the pitch and roll axes. The back half of the package contains all the associated circuits for the two channels, including two three-stage amplifiers, excitation transformers, tuning and phase-splitting capacitors.

Packaging

A printed circuit board mounted on one side of the electronic assembly contains the required resistors, silicon diodes and all tie points. Reactors, capacitors and transformers are cast into an irregularly shaped block to provide maximum utilization of the available space. The complete electronic package has a volume of only 22 cubic inches.

A block diagram of the roll axis system configuration is shown in Fig. 6. The pitch axis is similar, except that a trim potentiometer is added to the synchro control transformer output to allow pilot adjustment for individual aircraft trim requirements. Velocity feedback is used in both axes to obtain maximum performance.

REFERENCES

- (1) W. A. Geygar, A New Type of Magnetic Servo Amplifier, *AIEE Trans*, Part I, p 272, 71, 1952.
- (2) H. W. Lord, Magnetic-Amplifier Circuits with Full-Wave Output and Half-Wave Control Signals, *AIEE Trans*, Part I, p 265, 73, 1954.
- (3) C. C. Voice, Fast Response Multi-Stage Magnetic Amplifiers, *Proc Nat Electr Conf*, p 411, 12, 1956.
- (4) H. W. Patton, The Pulse Stretch Coupling Circuit, *AIEE Trans*, Part I, p 377, 75.

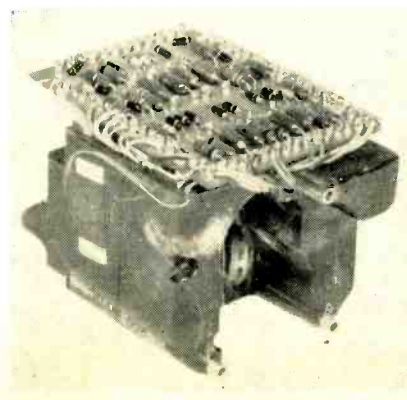

Complete magnetic amplifier assembly

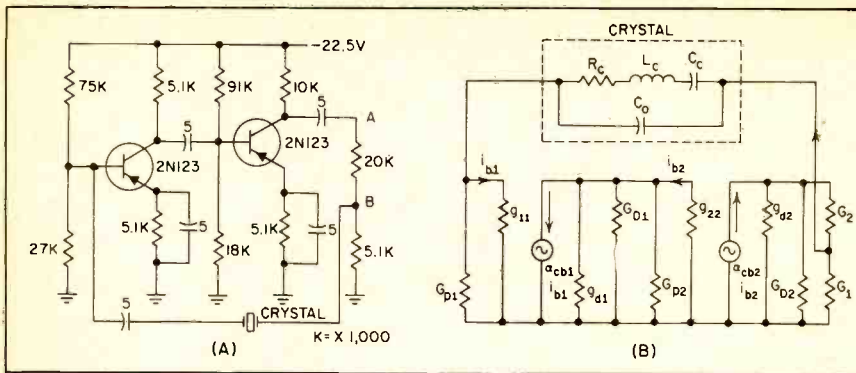

By G. A. GEDNEY

and

G. M. DAVIDSON

Arma Division
American Bosch Arma Corporation
Garden City, New York

FIG. 1—Two-stage amplifier with a crystal load generates stable fixed-frequency oscillations (A); equivalent circuit (B) simplifies loop gain calculation

Crystal Oscillator

Two-stage crystal feedback amplifier operates at 9.1 kc with long-term frequency stability of a few parts per million. Operating frequency can be pulled off resonance by adjustment of trimmer capacitor in series with crystal. Applications include constant-frequency power source for gyroscopic precision integrator and regulated carrier frequency for electrical resolvers, industrial generators and phase computing networks

CONVENIENT CALIBRATION adjustment may be provided in some analog and digital systems by deviating the carrier frequency by a small but accurately known amount. This article describes the design of a fixed-frequency oscillator with long-term frequency stability of a few parts per million and provision for manually varying the output frequency a few cps in calibrated increments.

Design

Requirements of a low frequency of 9.1 kc with high stability necessitated the use of a special high-Q crystal with low variation in nominal frequency over a fairly wide temperature range.

Current degeneration type biasing compensates for the effects of leakage currents flowing from collector to base. The bias stabilization network yields a factor of two to limit the fluctuation in output voltage to less than ± 5 percent over the range of -65 C to $+65$ C.

The basic circuit for fixed-frequency operation is shown in Fig. 1A. From the equivalent circuit of Fig. 1B, when

$$g_{22} \gg g_{d1} + G_{D1} + G_{P2}, \text{ and } g_{11} \gg G_{P1},$$

the loop current gain of the amplifier is

$$K_i \cong \left(\frac{a_{cb1} a_{cb2} G_{L2}}{g_{d2} + G_{D2} + G_{L2}} \right) \left(\frac{G_{crps}}{G_1 + G_{crps}} \right)$$

where G_D = d-c collector load conductance, g_{11} and g_{22} = a-c input conductances of the transistors, g_a = transistor output conductance, G_p = parallel conductance of the biasing network, G_{L2} = total conductance of the attenuation network and G_1 = conductance of one leg of attenuating network.

Current gain of the amplifier varies from 20 to 500 at crystal resonance depending on transistor β .

Output amplitude of the oscillator is limited only by the nonlinearities in the loop. Since the 2N123 has a Zener breakdown of 16 v that varies with age, temperature and

unit, provision must be made to prevent an output rise to 16 v. Also the maximum allowable voltage across the crystal is 1 v. The circuit can be designed to limit the output to any desired value lower than the Zener value by shaping the d-c and a-c-load lines. The relatively high collector supply voltage is needed for bias stabilization.

Crystal Pulled Off Resonance

Oscillation frequency may be varied by inserting a 1 to 100- μ f trimming capacitor, in series with the crystal and adjusting it to the desired frequency. Since the circuit only oscillates when the phase shift around the loop is zero, the crystal acts as an inductance at the new resonant frequency and the loop gain is larger than one.

The effective feedback circuit resistance increases as the square of the change in frequency from resonance thereby increasing the attenuation of the feedback circuit and requiring a larger open-loop gain.

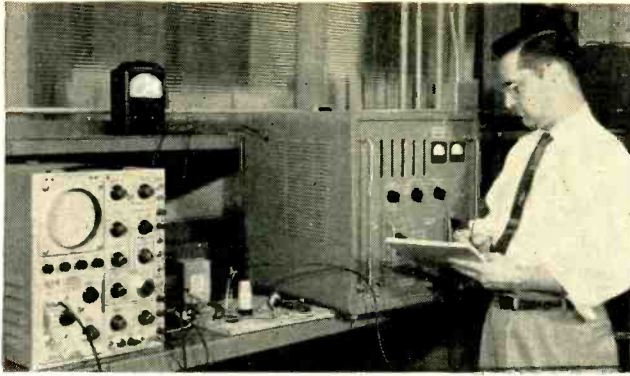

Engineer records observations of 9.1-kc oscillator performance

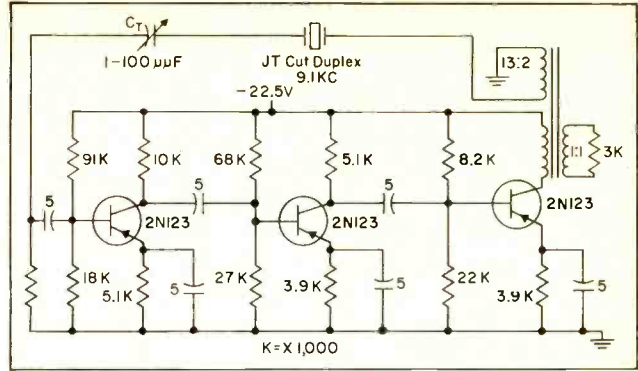

FIG. 3—Three-stage crystal oscillator provides greater power output

Has Variable Frequency

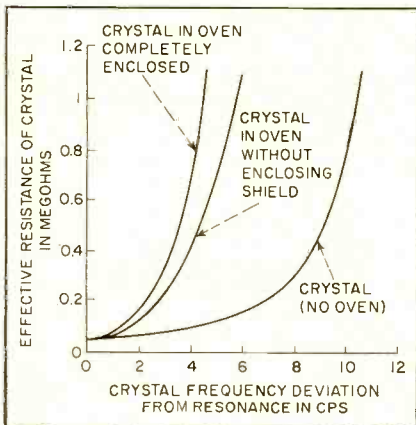

FIG. 2—Crystal resistance as function of deviation from resonant frequency of 9,100.6 cps with crystal partially or entirely enclosed within oven

The effective crystal resistance may be found from R_e where

$$R_e \cong R/[1 - (4\pi L\Delta f/X_{co})^2]$$

and effective reactance from

$$X_e \cong 4\pi L\Delta f/[1 - (4\pi L\Delta f/X_{co})^2]$$

where R , L and X_{co} are crystal constants at series resonance valid when

$$f_{ser} < f_{ser} + \Delta f < f_{antires.}$$

Crystal Parameters

To measure effective resistance R_e and reactance X_e of the crystal as a function of frequency deviation Δf from crystal resonance. A known value of capacitance is inserted in series with the crystal and the oscillator frequency is varied to ob-

tain maximum transfer. Frequency of the oscillator is measured at maximum voltage transfer.

Measurements were performed with the crystal partially and completely oven enclosed for several values of capacitance inserted in series with the crystal. Curve 1 of Fig. 2 shows a rapid increase in feedback circuit resistance as frequency deviates from resonance indicating that the gain of the amplifier must be high to obtain a moderate frequency pull.

When the circuit requires a minimized frequency drift, the crystal should be enclosed in a constant-temperature oven to minimize temperature variation effects. This increases the parallel capacitance across the crystal and also the attenuation of the circuit as a function of frequency deviation. Therefore, for the same gain in the forward loop the crystal cannot be pulled as much. The increased gain required is illustrated in Fig. 3.

Amplifier Requirements

The amplifier must provide sufficient gain to insure a loop transmission of one, under maximum frequency pull off and yield a net phase shift around the loop of 360 deg with the crystal inserted in the circuit. Since the desired circuit frequency is a variable, each amplifier must be trimmed individually. The current flowing into the base of stage 1 is proportional to the output

voltage divided by the crystal impedance. With the output voltage constant the base current swing at resonance is approximately 40 to 60 times the base current swing for a 5-cps pull off resonance.

Though all the amplifier stages tend to saturate, excessive saturation of the first stage is undesirable. The design must allow for this swing or the input current to the first stage must be attenuated by insertion of a trim resistor in series with the crystal. Value of the trim resistor is determined by the required deviation. At resonance where the loop gain is maximum the desired attenuation would be large; zero attenuation is necessary when the circuit is more than 5 cps off resonance.

The circuit of Fig. 1A was developed to yield a maximum pull off resonance of approximately 5 cps.

Impedance the external load must be about 0.3 megohm or more at point A in Fig. 1A. If the load is taken from point B, the combination of load and attenuating resistor should be equal to 5,000 ohms.

Greater Deviation

To obtain a larger frequency deviations off resonance or larger power output, a higher circuit gain is necessary. The circuit of Fig. 3 uses a transformer to obtain a phase reversal and to reflect the desired a-c load line to limit the output swing of the transistor.

Radar System Planning

Pulsed radar system performance is predicted on the basis of selected parameters. Given a hypothetical combination of operating conditions, minimum detectable signal, peak radiated power, maximum free-space range and size of antenna aperture are easily forecast

By CHESTER W. YOUNG

Senior Research Engineer, Advanced Techniques Group, Convair Division of General Dynamics Corp., Pomona, Calif.

SYSTEM ENGINEERING planning often involves compromises dictated by the boundary conditions of the state of the art. The nomograph provides a method of observing quickly the outcome of trial and-error choices in making such compromises in design of radar systems. It is not a substitute for

the design of individual elements of the radar but is rather a method of estimating the magnitude of the system parameters!

Approximations Made

Several assumptions have been made to simplify the nomograph. Signal-to-noise ratio was set at unity. The $\beta\tau$ product was as-

sumed to be one rather than the optimum of 1.2. An illumination factor of 0.65 was assumed. The system losses were forced to bear the weight of all other factors.

To determine S_{MIN} , assuming a visibility factor of 1, draw a line from the value of f_r on scale 1 to the value of θ on scale 2 (example 4

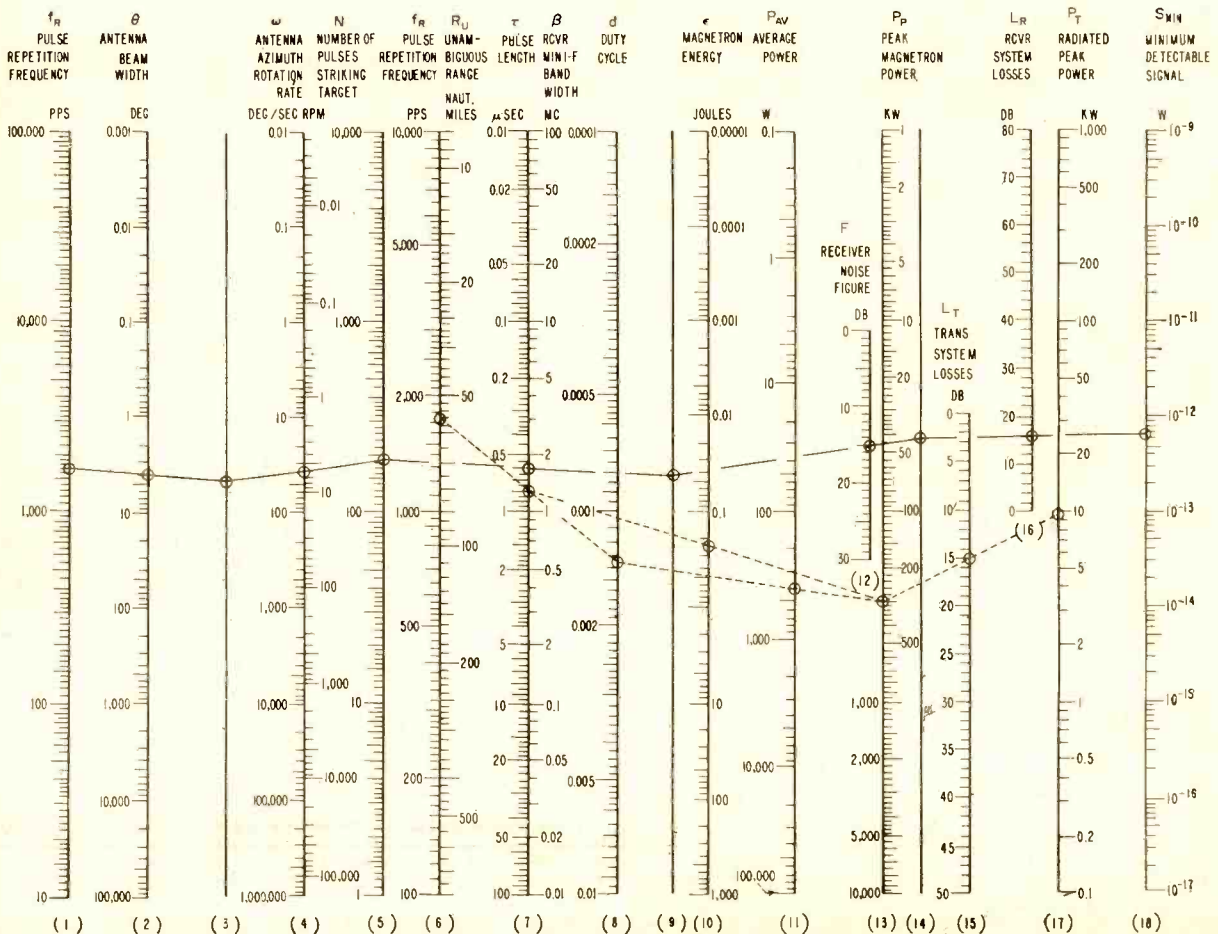

deg) and extend it to turning scale 3. From this point draw a line through ω on scale 4 (example 36 deg/sec or 6 rpm) to scale 5 (example 190 pulses). Draw a line from this point through β on scale 7 (example 1.7 mc) to turning scale 9.

Align this point with F on scale 12 (example 15 db) and extend to turning scale 14. Draw a line from this point through L_R on scale 16 (example 15.5 db) to scale 18 (6.5×10^{-13} w).

Peak Radiated Power

The method of calculating P_T is determined by the information available. If f_R , τ and P_{AV} are known draw a line from f_R on scale 6 (example 1,707 pps) through τ on scale 7 (example 0.8 μ sec) to d on scale 8 (example 0.00137).

From this point align P_{AV} on scale 11 (example 410 w) with

P_p on scale 13 (example 300 kw). If ϵ is known rather than P_{AV} , draw a line from τ on scale 7 (0.8 μ sec) through ϵ on scale 10 (0.24 j) to P_p on scale 13.

Draw a line from this point through L_T on scale 15 (15 db) to P_T on scale 17 (9.5 kw). Conversely if P_p , τ and d are known, then ϵ and P_{AV} can be determined.

Maximum Free-Space Range

To solve for R_{MAX} draw a line joining P_T on scale 17 (9.5 kw) and S_{MIN} on scale 18 (6.5×10^{-13} w) and extend to turning scale 19.

Align this point with either θ or G on scale 20 (example 4 deg or 1,700) and extend the line to scale 21. Draw a line joining this point to the value for either f_c or λ on scale 22 (example 2,900 mc or 10.3 cm) and extend it to RI on scale 23 (example 6.5).

Draw a line from this point

through σ on scale 25 (example 500 sq ft) to R_{MAX} on scale 26 (example 30 naut. miles or 35 stat. miles). If it is desired to apply the visibility factor, the result will be modified by passing a line from the point on scale 26 through V on scale 27 (example 1,707 pps) to R_{MAX} on scale 28 (29.5 naut. or 34 stat. miles).

Any pulse repetition frequency selected must have $f_R \leq 80,000/R_V$. This will prevent second-time-around echoes. Thus the values of R_{MAX} on scales 26 and 28 must always be less than the unambiguous range R_V equivalent to the repetition rate f_R chosen on scale 6.

To find the physical size of the antenna, join the aperture of the antenna, join the value of θ or G on scale 20 (example 4 deg or 1,700) with f_c or λ on scale 22 (example 2,900 mc or 10.3 cm) and extend to D on scale 24 (example 6 ft).

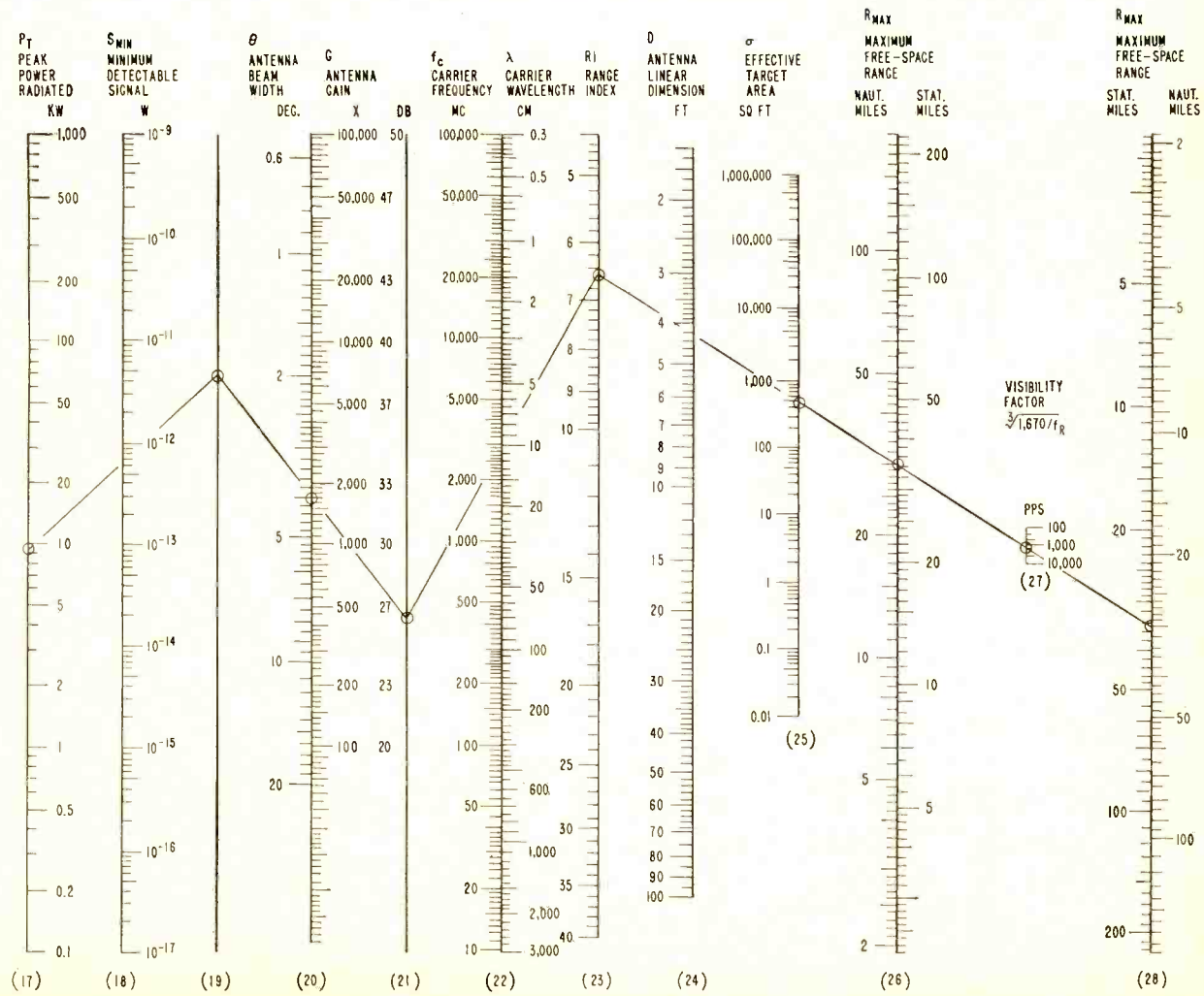

Designing Stability into Transistor Circuits

Chart and nomographs simplify calculation of transistor circuit and cooling-facility parameters necessary for stable operation at elevated junction temperatures. Design information is applicable to both germanium and silicon transistor circuits

By **STANLEY SCHENKERMAN**

Senior Engineer, Missile Development Division, Ford Instrument Company, Long Island City, N. Y.

TO ACHIEVE THERMAL STABILITY of transistorized equipment at elevated junction temperatures, the designer must provide a circuit compatible with its cooling facility. The accompanying graph and nomographs permit the rapid determination of suitable circuit and cooling facility parameters.

Theory

The thermal stability nomograph, Fig. 1, is based upon the criteria for thermal stability¹

$$SV_c I_c \theta < 13 \quad (1A)$$

for germanium and

$$SV_c I_c \theta < 23 \quad (1B)$$

for silicon.

The stability factor² S is the change in quiescent collector current caused by a change in the temperature sensitive component, V_c is collector voltage, I_c is the temperature sensitive component of collector current and cooling-facility characteristic θ is the thermal resistance from collector junction to ambient in deg C per watt. The designer's objective is to obtain compatible values of S and θ .

Temperature sensitive current I_c increases exponentially with temperature, doubling every 9 C for germanium and every 16 C for silicon. The value of I_c at any temperature T may be found

from Fig. 2 if the value of I_{c0} at any temperature T_0 is known; the latter values can be obtained from the manufacturer's data sheet.

Thermal resistance θ consists of the resistance from collector junction to mounting base, θ_{jm} , (specified by the manufacturer) and the resistance from mounting base to ambient, θ_{ma} . The

latter may be determined experimentally from

$$\theta_{ma} = \Delta T / P_d \quad (2)$$

where ΔT is the mounting base temperature rise above ambient in degrees centigrade and P_d is the transistor dissipation in watts. Then

$$\theta = \theta_{ma} + \theta_{jm} \quad (3)$$

The thermal resistance nomo- (continued on page 124)

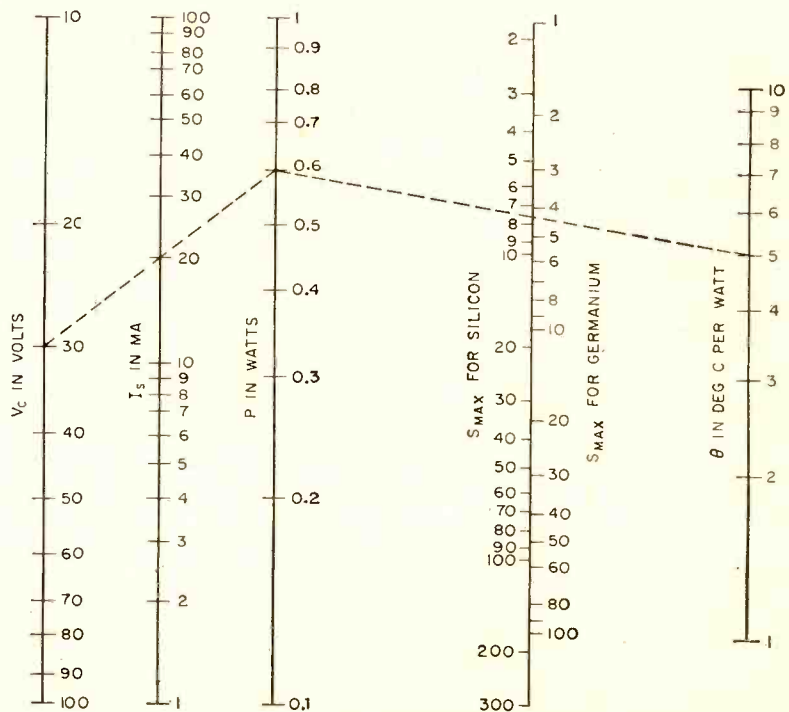
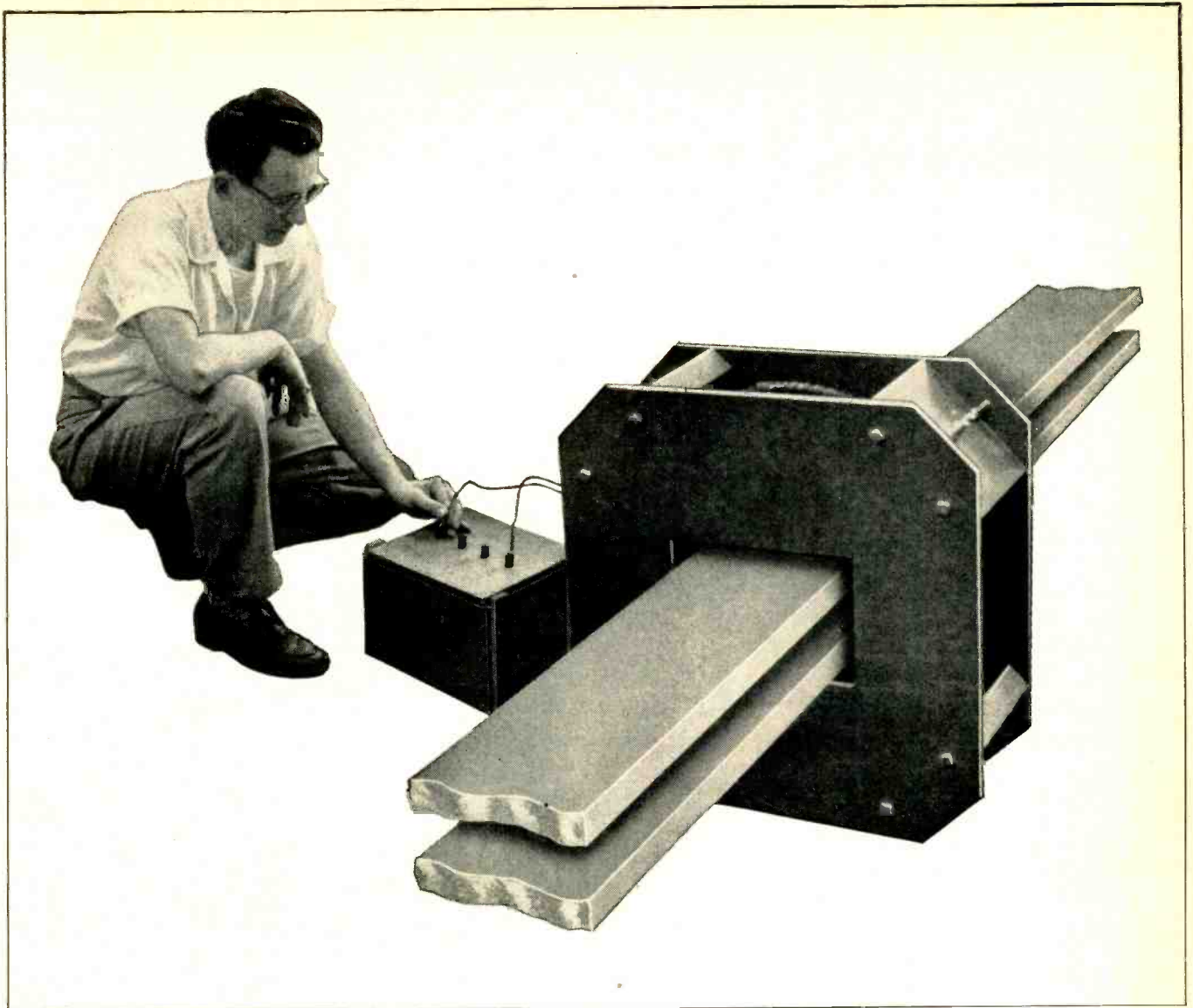

FIG. 1—Range of thermal stability nomograph is extended by powers of 10



Now... measure 200 to 10,000 amperes with isolated meters—CONTROL's Standard Transducers

CONTROL transducers have made obsolete the use of shunts for metering or recording heavy d-c loads. Now, for the first time, a standard line of transducers—nine units ranging from the 200-amp to the 10,000-amp size—make it possible for the systems engineer to measure high bus currents without direct electrical connections into the circuit.

CONTROL transducers are saturable reactors, through which the bus or cable passes. Output is linearly proportional to the bus current, with an accuracy to $\pm 1\%$ of full scale reading. Supply voltage variations of $\pm 10\%$ will not affect this accuracy.

In addition to eliminating the need for breaking into the circuit for connections, the CONTROL transducer has another major advantage over the shunt-millivoltmeter. The transducer will deliver relatively large amounts of power to permit such things as overload relaying and to permit a feedback signal for a magnetic amplifier.

No longer need you be dependent upon "what's available" or a special design. Catalog T-10 gives you a standard range of transducer sizes to meet your every need. For full details... CONTROL, Dept. E-43, Butler, Pa.

Reliability begins with **CONTROL**



A DIVISION OF MAGNETICS, INC.

Designing Stability into Transistor Circuits (continued from page 122)

graph, Fig. 3, facilitates the solution of Eq. 2 and 3.

From measurements, it is determined that at 4 w dissipation, the mounting base temperature of a transistor, when installed in the cooling facility, is 8 C. The resistance from junction to mounting base is specified as 3 C per watt.

Thermal Resistance

Using Fig. 3, connect the point $\Delta T = 8$ C with the point $P_d = 4$ w with a straight line that intersects $\theta_{mb} = 2$ C per watt. Next, connect $\theta_{mb} = 2$ C per watt and $\theta_{jm} = 3$ C per watt with a straight line. This line intersects $\theta = 5$ C per watt which is the total thermal resistance of the cooling facility.

The value of S_{max} may now be found from the thermal stability nomograph of Fig. 1. The circuit S must be less than S_{max} for stability. Conversely, for a given S the maximum permissible θ may be determined.

The transistor of the previous example is a germanium unit with $I_{so} = 0.2$ ma at $T_o = 25$ C. It is desired to operate this unit with $V_c = 30$ v at 85 C in the cooling facility for which $\theta = 5$ C per watt. Since $T - T_o$ is 60 C, I_c/I_{so} is 100 as determined from Fig. 2. Then I_c is 20 ma at 85 C.

On the stability nomograph, Fig. 1, connect $V_c = 30$ and $I_c = 20$ with a straight line that intersects the P scale at 0.6. Now connect this point by a straight line with $\theta = 5$. This line intersects S_{max} for germanium at 4.3. This is the maximum value of S for which the circuit is thermally stable.

REFERENCES

- (1) Specification for H-5, H-6, and H-7 Power Transistors, Transistor Div., Minneapolis Honeywell Regulator Co., p 9, May 1956.
- (2) R. F. Shea, "Principles of Transistor Circuits", John Wiley Sons, Inc., p 97, 1953.

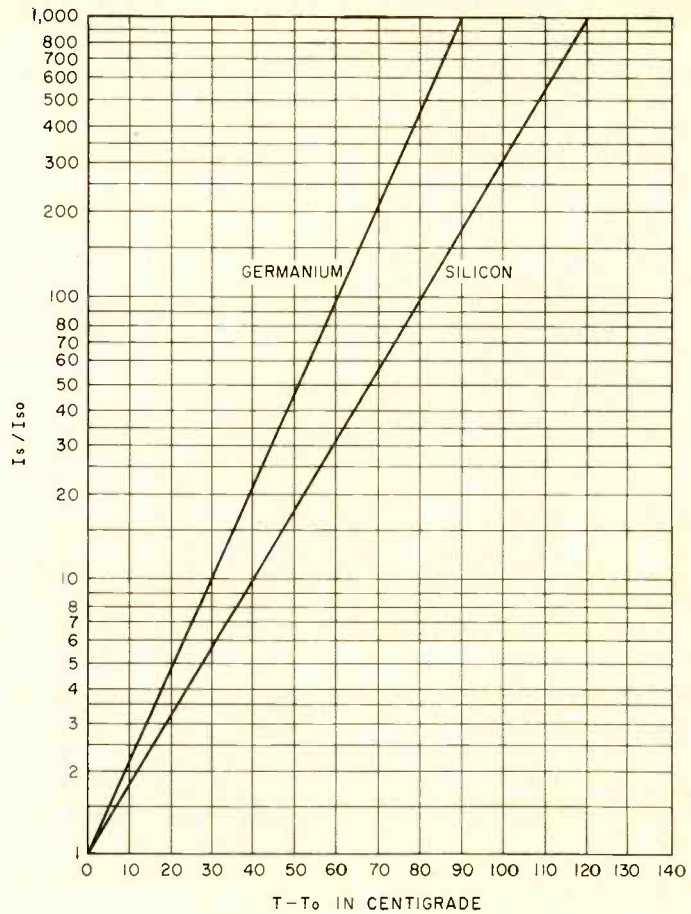

FIG. 2—Curves give normalized temperature-sensitive leakage current as function of temperature change

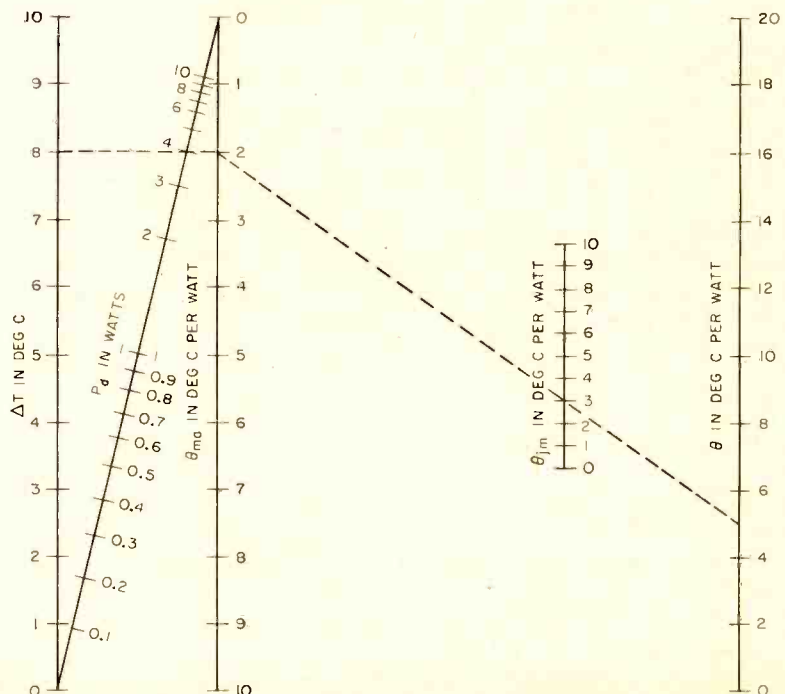

FIG. 3—Range of thermal resistance nomograph is extended by powers of 10

are you **fighting** SPACE ?

No need to suffer from engineering claustrophobia, if you design with **GANNON PLUGS** in mind!



Coaxials.
Screw-type
coupling
Low VSWR.
for 50-, 70-,
93-ohm cable



K miniatures
3 to 50 contacts
13 different
arrangements



DP Type
Rack-Panel-
chassis
style 2 to 57
contacts



MC Sub-
Miniatures
3, 6, 12 contacts
Built for
rugged use



D Sub-Miniatures
9 to 50 contacts
Same space ...
same weight!

Cannon Miniature and Sub-Miniature Plugs are rugged, easy mating, unusually versatile, neat and compact.

When you design with Cannon Miniatures in mind you'll get complete electrical circuit dependability in a very small space. Up to 50 contacts in $\frac{1}{2}$ or $\frac{1}{3}$ the area taken by standard multi-contact connectors!

Rectangular and circular types. Hermetically sealed, vibration and moisture resistant, and general purpose designs. Contacts for 5, 10, 15, 25 amps... and miniature coaxial connectors. Practically all five ampere contacts are gold plated. High dielectric insulation in phenolics, resilient materials, glass seals, Zytel, Diallyl Phthalate and Melamine. Aluminum alloy or steel shells, depending upon application.

Miniature lines include: DPA, DPX, DPM, DPG, K, MM, MR and Diamond MB and SM Coaxial connectors. **Sub-miniatures:** D, MC, and Diamond DIC Coaxial connectors.

Write TODAY for new 32-page 2-color Miniatures Bulletin HMC-2. Also, write for Bulletin SM-1, "Soldering Small Contacts."

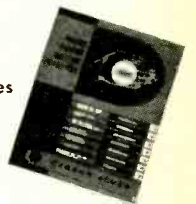

For an interesting discussion of the broad subject of "Reliability," write for Cannon Bulletin R-1.

GANNON PLUGS

WHERE RELIABILITY
IS THE 5TH DIMENSION



Please refer to Dept. 120

CANNON ELECTRIC CO., 3208 Humboldt Street, Los Angeles 31, California. Factories in Los Angeles; Salem, Massachusetts; Toronto, Canada; Melbourne, Australia; London, England. Manufacturing licensees in Paris and Tokyo. Representatives and distributors in all principal cities. See your Telephone Yellow Book.



Built-In Ion Trap Protects Cathode

By William Ross Aiken

Director of Research, West Coast Electronics Laboratory, Kaiser Aircraft & Electronics Corp., Palo Alto, Calif.

Robert E. Heller*

Manager, Product Development, Instrumentation Division, Ampex Corp., Redwood City, Calif.

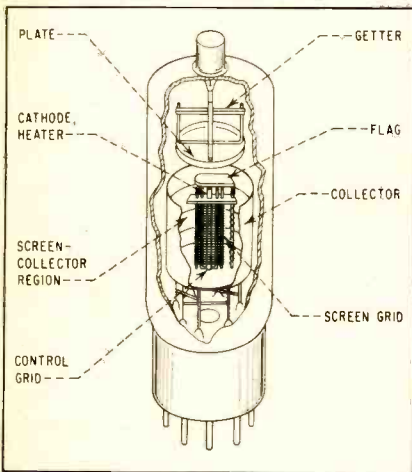

FIG. 1—Collector and flag of new pentode protect oxide-coated cathode from positive ion bombardment

LONGER LIFE for oxide-coated cathodes is made possible by a built-in ion trap. Limited quantities of a high-voltage pentode have been constructed with the ion trap and have life times in excess of 2,000 hours.

The special pentode was developed for a special high-voltage switching operation for use with the Kaiser-developed thin cathode-ray tube. Other applications may be in high-voltage triggering, clamping, mixing and shunt regulation.

Ions, created by collisions between electrons and residual gas molecules, are destructive to oxide-coated cathodes. The problem becomes more acute with higher voltages. In addition, mica supports and other insulators may develop leakage paths as a result of positive ion bombardment.

To minimize the problem, special precautions must be taken in the fabrication of high-voltage tubes with oxide-coated cathodes. For instance, the bake-out, pumping and gettering procedures must be made more thorough.

Alternately, destruction of the cathode at high voltages might be

largely avoided by replacing the oxide-coated cathode with a tungsten or thoriated-tungsten emitter. However, such cathode materials imply the use of much higher filament temperatures and of more complex fabrication procedures.

In the new pentode an ion-trap is provided by which positive ions are prevented from reaching the cathode. An indirectly heated, oxide-coated cathode is surrounded by control and screen grids in the conventional manner as shown in Fig. 1. A cylindrical collector, open at one end, surrounds the screen grid and is connected to it. Thus, in the absence of plate voltage, an essentially field-free region is created in the interspace.

The plate is located opposite the open end of the collector electrode. The electric field of the plate penetrates the space between screen grid and collector, causing the electrons drifting there to be deflected to the anode. Their number is determined by control-grid potential as usual.

Positive ions created in the anode region are deflected downward toward the bottom of the collector, rather than to the screen grid or to the electrodes inside the screen. This is because the positive ions travel with a velocity whose down-

ward component is much larger than any horizontal component.

The only region in which positive ions can reach the cathode itself is at the end of the cathode directly opposite the plate. A small flag electrode, internally connected to the cathode, serves to prevent the entry of positive ions into the cathode region from this direction. The flag also performs the function of a corona shield.

Experimental models of the pentode were operated at 15 kv with a screen and collector voltage of 100 v. Control-grid voltage is -4 v and typical plate current is of the order of 0.6 ma. Maximum plate dissipation is 20 w, screen dissipation is 0.7 w and collector dissipation 5 w. Maximum cathode current is 10 ma.

Mutual conductance is about 600 micromhos and input and output interelectrode capacitances are 7 and 3 micromicrofarads, respectively. Heater voltage and current are 6.3 v and 0.3 amp, respectively.

*Formerly Chief Engineer, West Coast Electronics Laboratory, Kaiser Aircraft & Electronics Corp.

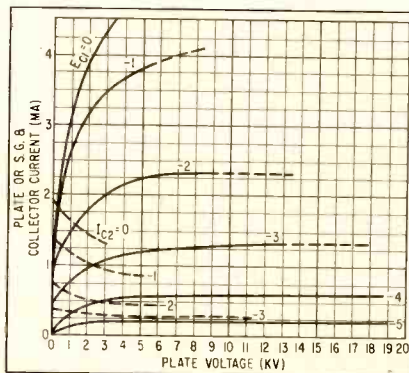

FIG. 2—Transfer characteristics with screen grid and collector at 100 volts and 6.3 volts across the filament

Oscillator Measures Tube Capacitance

By Harvey L. Morgan

Electronic Project Engineer
Phoenix Research Laboratory
Motorola, Inc., Phoenix, Arizona

MEASUREMENT of the variation in interelectrode capacitance in sub-miniature tubes under vibration has been achieved for a critical application. The technique may have value in tube development, as well as in similar applications.

The method involves using the slight variations in interelectrode capacitance to modulate the frequency of an oscillator. A harmonic of the oscillator is detected

*first in
Performance
Reliability
and Quality*



the most complete line
of POWER SUPPLIES

**TRANSISTORIZED
V. R. P. S.***

- REGULATION (for line or load) 0.03% or 0.003 Volts (whichever is greater)
- RIPPLE 1 mv. rms.
- RECOVERY TIME 50 microseconds
- STABILITY (for 8 hours) 0.03% or 0.003 Volts (whichever is greater)
- Tubeless.
- 0.005% resolution with 10 turn voltage control.
- Continuously variably output voltage without switching.
- External overload and short circuit protection included.
- Either positive or negative can be grounded.
- Units can be series connected.
- Suitable for square wave pulsed loading.
- Power requirements: 105-125 volts, 50-65 cycle. 400 cycle units available.
- Terminations on front and rear of unit.
- High efficiency.
- Low heat dissipation.
- Compact, light weight.
- Color: grey hammer tone.
- Suitable for bench or rack use.
- Voltmeter and ammeter provided.

*** VOLTAGE REGULATED POWER SUPPLIES**

Model	Output Volts	Output Amps.	Output Impedance Ohms		Rack Mount		
			DC-1 KC	1 KC-100 KC	W	H	D
SC-32-0.5	0-32	0-0.5	0.02	0.2	19"	3½"	13"
SC-32-1	0-32	0-1	0.01	0.1	19"	3½"	13"
SC-32-1.5	0-32	0-1.5	0.01	0.1	19"	3½"	13"
2SC-32-1.5 DUAL OUTPUT	0-32	0-1.5	0.01	0.1	19"	7"	13"
	0-32	0-1.5	0.01	0.1			
SC-32-2.5	0-32	0-2.5	0.01	0.1	19"	3½"	13"
SC-32-5	0-32	0-5	0.005	0.05	19"	5¼"	13"
SC-32-10	0-32	0-10	0.001	0.01	19"	8¾"	13"
SC-32-15	0-32	0-15	0.001	0.01	19"	10½"	13"
2SC-100-0.2 DUAL OUTPUT	0-100	0-0.2	0.1	1.0	19"	5¼"	13"
	0-100	0-0.2	0.1	1.0			
SC-150-1	0-150	0-1	0.05	0.5	19"	5¼"	13"
SC-300-1	0-300	0-1	0.1	1.0	19"	8¾"	13"



KEPCO
LABORATORIES, INC.
131-38 SANFORD AVENUE • FLUSHING 55, N. Y.
INDEPENDENCE 1-7000

KEPCO OFFERS MORE THAN 120 STANDARD VOLTAGE REGULATED POWER SUPPLIES COVERING A WIDE RANGE OF MAGNETIC, TRANSISTOR AND TUBE TYPES. MOST MODELS AVAILABLE FROM STOCK. SEND FOR BROCHURE B-581

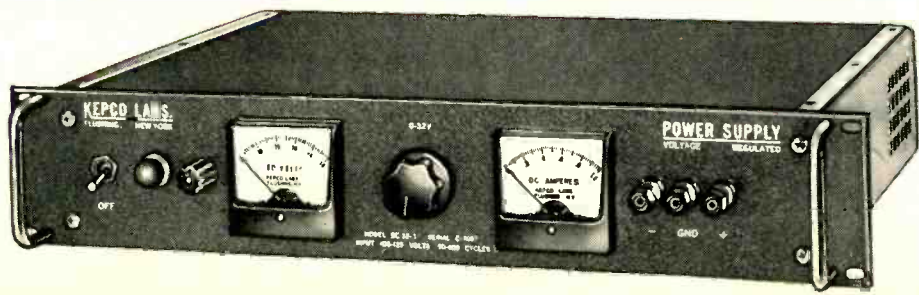

Model
SC-32-0.5
SC-32-1
SC-32-1.5
SC-32-2.5

Visit Our Booths Nos. 2636-2638 I.R.E. Show, Mar. 24-27, N. Y. Coliseum

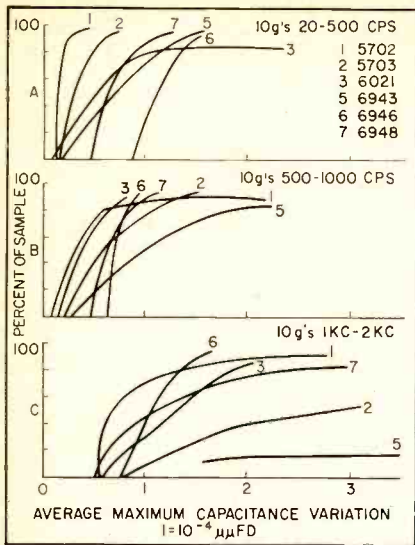

FIG. 1—Average of the maximum capacitance variations between plates and other electrodes

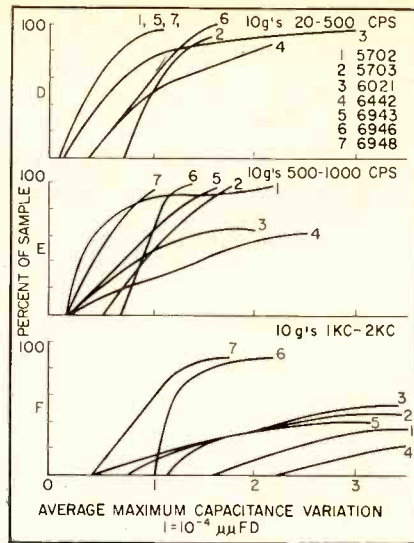

FIG. 2—Average of the maximum capacitance variations between grids and other electrodes

by an f-m receiver with a calibrated discriminator.

In the particular application, variations in capacitance on the order of 10^{-4} micromicrofarads were important. Therefore, it was necessary to be able to measure changes as small as 10^{-5} micromicrofarads.

The frequency of the transistor oscillator is about 33 mc without external loading. With the tube elements connected, the center frequency dropped to as low as 25 mc.

A linear relationship exists between frequency variation and capacitance variation. Going to the higher harmonic frequency increases the frequency change by the order of the harmonic.

In order that the entire assembly can be vibrated, the transistor oscillator is embedded in plastic. It was tested at 10 g's from 20 to 2,000 cps, and no f-m was detected with a system noise level equivalent to 10^{-5} micromicrofarads.

The tube is held in a hollowed-out aluminum block with the oscillator so that the entire assembly does not move with respect to the vibration test jig.

An important requirement for this type test is that the tube being tested, since it is part of the oscillator circuit, must be shielded from external conductors that might be stationary with respect to the moving tube. This requirement was ignored when tests were attempted on a planar grid tube.

The resulting f-m was much greater than that normally resulting from interelectrode capacitance variation.

Measurement was made of the capacitance variation between each electrode and all of the other electrodes tied together except that the cathode and heater were tied together for cathode measurements. The latter technique was necessary because heater-cathode capacitance variation was much larger than any other interelectrode capacitance variation.

At the start of the tests, no heater voltage was used. Then heater-on versus heater-off tests were made. Only the vibration tests with the heaters on were used. There was a significant difference between the two conditions. Usually less interelectrode capacitance variation was observed with the heater on. It appeared that the cathode sleeve expanded sufficiently in the mica holes on heating to reduce cathode vibration.

No appreciable effect of heating on other electrodes was definitely established. By contrast, heater-cathode capacitance variation increased by as much as a factor of 10 when heater voltage was applied. Mechanical vibration resulting when a-c heater voltage is used causes a twice-frequency variation of heater-cathode capacitance of comparatively large proportions. A d-c heater supply was made standard, and a grid bias sufficient for

cut-off was applied to prevent diode action.

Not enough of any one tube type was tested to give statistically satisfactory results (15 was the largest number of one type tested). However, each particular interelectrode capacitance variation measurement for each tube type showed distribution of peak values sufficient for a normal distribution estimate. There were expected variations between various electrode combinations and tube types.

The tube types tested were 5702, 5703, 6021, 6943, 6946, 6947, 6442 and 6BY4. Some tests were made on tubes with folded heaters rather than the more conventional coiled heaters. Only four of the folded-heater type were tested. They were found consistently bad with respect to heater-cathode capacitance variation, but quite good with respect to cathode-grid capacitance variation. Of the coiled-heater tubes the 6BY4 compared favorably to a transistor oscillator; the others were considerable poorer.

The 6943 guided missile tube (a pentode) had more capacitance variation between plate, screen, grid and cathode than other tubes tested. The variation showed up in the form of large resonant peaks

Flexible Light Source



Opaque fabric woven from stainless steel wire becomes flexible light source when coated with phosphors and transparent conductive material. Westinghouse light source is powered by 250 volts at 4,000 cps. Other flexible light sources have been made with a nylon base.

NEW
CTS

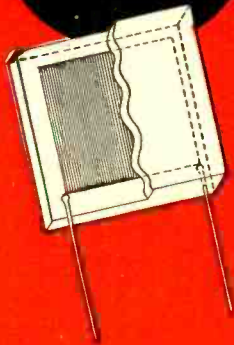

SMALL SPACE FACTOR • MORE STABLE

Bobbinless PRECISION WIRE FIXED Resistors

Featuring Unique CTS "Floating" Element

Another CTS "first". New patented winding process permits resistance elements and contacts to be firmly embedded in epoxy resin, forming a monolithic mass. No bobbin or winding form is used. Wire strain is eliminated.

Burton Browne Advertising

- **Exceptional Stability**—Permanent change in resistance less than 0.2% under most environmental conditions.
- **Guaranteed Close Tolerance**—Resistors guaranteed to be in tolerance under normal conditions of measurement. Tolerances down to $\pm 0.05\%$ available in standard sizes depending upon resistance value. Closer tolerances or matched multiples available on request.
- **Low Inductance and Low Capacitance Characteristics** with reproducible uniform frequency response.
- **Less than 0.2% resistance change with humidity** (MIL-R-93 moisture resistance test).
- **Less than 0.2% resistance change with temperature cycling** (MIL-R-93).
- **Withstands extreme vibration and shock** due to unique construction and encapsulation method.
- **Extremely Stable**—Less than 0.3% resistance change with load life or 100% overload (MIL-R-93).
- **Low Temperature Coefficient Wire** available.

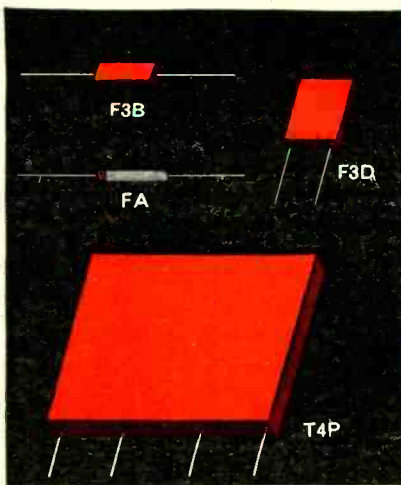

RECTANGULAR			
Wattage	Dimensions (Inches)	Resistance (Ohms)	CTS Type Number
0.25	3/4" x 3/16" x 1/4"	1.0-10,000	F3B
0.25	3/4" x 3/16" x 3/8"	1.0-100,000	F3C
0.25	3/4" x 3/16" x 1/2"	0.5-100,000	F3D
0.25	1" x 3/16" x 1/4"	0.5-100,000	H3B
0.5	1" x 3/16" x 3/8"	0.1-100,000	H3C
0.5	1" x 3/16" x 1/2"	0.1-200,000	H3D
0.75	1" x 3/16" x 3/4"	0.1-300,000	H3F
1.0	1" x 3/16" x 1"	0.1-400,000	H3H
1.5	1-1/2" x 3/16" x 1"	0.1-600,000	L3H
2.0	2" x 3/16" x 1"	0.1-1,000,000	P3H
Special	2-1/2" x 1/4" x 2"	0.1-2,500,000	T4P
TUBULAR			
0.1	3/4" x 1/8"	10-5,000	FA
0.5	1" x 1/4"	0.5-25,000	HB
0.5	1" x 3/8"	0.1-250,000	HC
1.0	1-1/4" x 1/2"	0.1-1,000,000	JD

Special dimensions, tolerances, wattage ratings, etc. can be made to your exact specification. Either axial or radial leads available on all rectangular types.

Write for further details today.



CANADIAN SUBSIDIARY
C. C. Meredith & Co., Ltd.
Streetsville, Ontario
Phone: Taylor 6-1141

EAST COAST OFFICE
5 Haddon Avenue
Haddonfield, New Jersey
Phone: Haddonfield 9-5512
TWX No. Haddonfield 529
Phila. Phone: Market 7-3129

SOUTHWESTERN U. S. A.
(Texas, Oklahoma)
John A. Green Company
137 Parkhouse Street
Dallas 7, Texas
Phone: Riverside 3266

SOUTH AMERICA
Jose Luis Pontet
Buenos Aires, Argentina
Montevideo, Uruguay
Rio de Janeiro, Brazil
Sao Paulo, Brazil

CHICAGO TELEPHONE SUPPLY
Corporation

ELKHART, INDIANA

WEST COAST SUBSIDIARY
Chicago Telephone of
California, Inc.
105 Pasadena Avenue
South Pasadena, California
L. A. Office: Clinton 5-7186
TWX L. A. 1105

KANSAS CITY AREA
(Kansas, Iowa, Nebraska,
Missouri, So. Ill.)
E. B. Schwerin
4210 Main Street
Kansas City, Missouri
Phone: WE 1-7554

OTHER EXPORT
Sylvan Ginsbury
8 West 40th Street
New York 18, New York
Phone: Penn. 6-8239



P&B PROGRESS/

UNIQUE DESIGN IMPROVES WEIGHT, SIZE, PERFORMANCE FACTORS

NEW!

Miniature telephone type relay has superior shock/vibration resistance



NEW

POTTER & BRUMFIELD

MG SERIES RELAY

Unusual for a telephone type relay, the MG Series has excellent stability under high shock and vibration conditions. Tests show this miniature, light weight (only 1.2 oz., open) relay withstands vibration of 10g 55 to 500 cycles per second and will operate under shock to 30g according to Mil-R-5757C.

The superior performance of the MG is due in part to its unique single stack con-

struction and to an exclusive hinge design which provides zero heel gap.

Open, dust covered or hermetically sealed, the MG is available with contact arrangements up to 4 Form C (4PDT). It is rated for ambient temperatures of -55°C to $+85^{\circ}\text{C}$. A high-temperature version with a range of -65°C to $+125^{\circ}\text{C}$ will soon be available. Write or wire today for complete specifications and delivery.

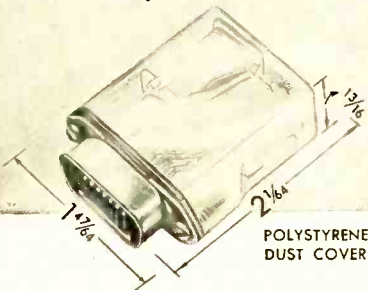
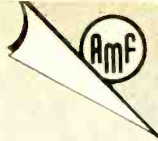
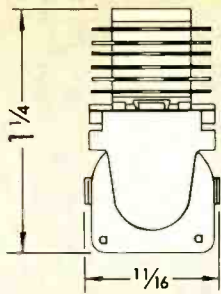
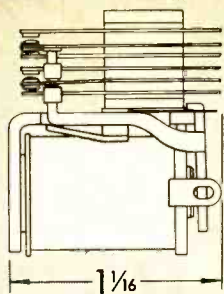

POLYSTYRENE DUST COVER



HERMETICALLY SEALED

MG SERIES

TERMINALS:

Open Relay: Pierced Solder Lugs.

Contacts: Two #18 AWG wires. Coil: Two #20 AWG wires.

Hermetically Sealed:

Miniature plug-in header with 7, 9 or 14 pins. Multiple Solder header with hook end terminals for three #20 AWG wires.

Polystyrene Dust Cover: Micro Ribbon plug-in type.

Mating receptacle: Amphenol #57-20140 or similar.

INSULATION RESISTANCE: 100 megohms min.

VIBRATION: .065" excursion 10-55 cps.

10g 55-500 cps. upon request.

SHOCK: 30g according to Mil-R-5757C upon request.

TEMPERATURE RANGE: -55°C to +85°C.

WEIGHT: 1.2 ozs. (open) 2.0 ozs. (sealed).

PULL-IN SPEED: Approximately 15 ms at nominal voltage.

DROP-OUT SPEED: Approximately 10 ms at nominal voltage.

CONTACTS: 3/32 silver.

CONTACT ARRANGEMENT: 4 pole, double throw (4 Form C).

COIL POWER: 3 watts max. DC @ 25°C. Continuous duty.

P&B STANDARD RELAYS ARE AVAILABLE AT YOUR LOCAL ELECTRONIC, ELECTRICAL AND REFRIGERATION DISTRIBUTORS

See our catalog in Sweet's Product Design File.

Potter & Brumfield, inc.

PRINCETON, INDIANA

SUBSIDIARY OF AMERICAN MACHINE & FOUNDRY COMPANY
Manufacturing Divisions also in Franklin, Ky. and Laconia, N. H.

Mail the coupon below for further engineering data on P&B's MG Relay plus new compact catalog of standard type relays. If you need answers to a specific application problem, write in detail.

Potter & Brumfield, Inc., Princeton, Indiana
Attn: T. B. White, Brig. Gen. USMC (Ret.)
Special Projects Engineer

Please send me complete engineering data on the MG Relay plus the new compact catalog of P&B standard relays.

Name _____
Company _____
Address _____
City _____ Zone _____ State _____



in the 1,200 to 1,400-cps region. It appeared that a cantilever shield in the base of the tube had a resonance in this region, and its capacitive coupling to all other elements in the tube caused large variations for all elements. This effect did not show on normal vibration test data for this type tube.

Missile Antenna Design

By HOWARD ESTEP

Senior Research Engineer Convair
Division of General Dynamics Corporation
San Diego, California

GUIDANCE and telemetry systems require that missile antenna patterns be as nearly omnidirectional as possible so that contact be maintained with the ground stations no matter what attitude the missile assumes. Omnidirectivity is dependent upon the diameter in wavelengths of the missile.

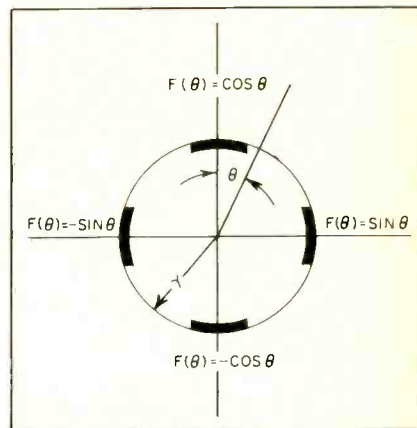

FIG. 1—Layout of omnidirectional missile antenna

Consider an antenna system comprised of 4 slots oriented with the slot perpendicular to the missile axis. In the plane perpendicular to this axis the radiation pattern of a slot may be represented as $\sin \theta$ or $\cos \theta$ (for r sufficiently large) as in Fig. 1.

If the slots are fed in phase with equal amplitudes, total radiation pattern becomes

$$E(\theta) = \cos \theta \sin \left(\frac{2\pi r}{\lambda} \cos \theta \right) + \sin \theta \sin \left(\frac{2\pi r}{\lambda} \sin \theta \right) \quad (1)$$

The mean value \bar{E} of $E(\theta)$ is



Tape Wound Cores

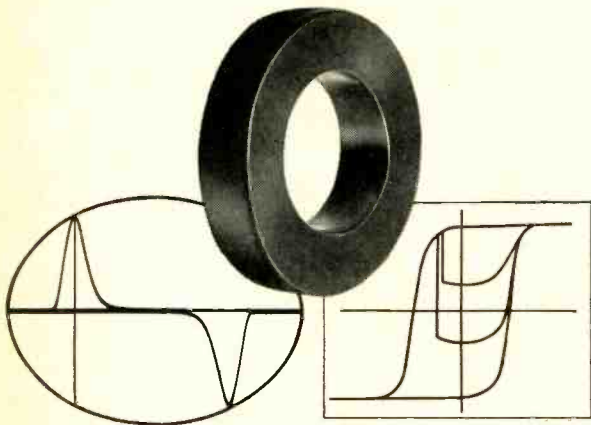

Bobbin Cores

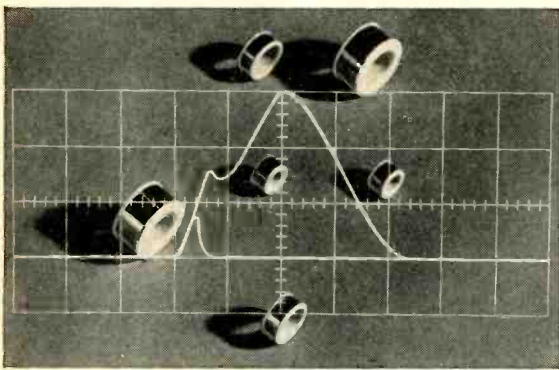

Not only G-L but our customers, too, claim consistent uniformity with every G-L Tape Wound Core and Bobbin Core. This consistent uniformity is the result of: an accuracy of control never before achieved in each and every step of the manufacturing process; the use of the highest quality raw materials and new and exclusive manufacturing technologies.

Prove our claims and the claims of our customers. Write, wire, call or teletype us about your requirements and for our technical bulletins.

G-L ELECTRONICS

2921 ADMIRAL WILSON BOULEVARD
CAMDEN 5, NEW JERSEY

WOODLAWN 6-2780 TWX 761 Camden, N.J.

U N I F O R M I T Y

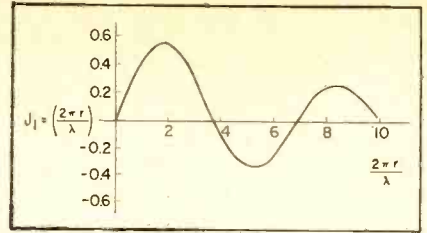

FIG. 2—Bessel function for first order

$$\bar{E} = \frac{1}{2\pi} \int_0^{2\pi} E(\theta) d\theta, \quad (2)$$

by expanding $\sin\left(\frac{2\pi r}{\lambda} \cos \theta\right)$, $\sin\left(\frac{2\pi r}{\lambda} \sin \theta\right)$ into their Bessel identities.

$$\begin{aligned} \sin\left(\frac{2\pi r}{\lambda} \sin \theta\right) &= \\ 2 \sum_{n=1}^{\infty} J_{2n-1}\left(\frac{2\pi r}{\lambda}\right) \sin(2n-1)\theta & \quad (3A) \end{aligned}$$

$$\begin{aligned} \sin\left(\frac{2\pi r}{\lambda} \cos \theta\right) &= \\ 2 \sum_{n=1}^{\infty} (-1)^{n-1} J_{2n-1}\left(\frac{2\pi r}{\lambda}\right) \cos(2n-1)\theta & \quad (3B) \end{aligned}$$

Inserting this into Eq 2 and making use of the orthogonality relationships,

$$\int_0^{2\pi} \sin n\theta \sin m\theta d\theta = \begin{cases} 0 & m \neq n \\ \pi & m = n \end{cases}$$

gives \bar{E} (normalized) as

$$\bar{E} = J_1\left(\frac{2\pi r}{\lambda}\right),$$

as shown in Fig. 2.

Clearly $|E|$ is maximum when $\left|J_1\left(\frac{2\pi r}{\lambda}\right)\right|$ is maximum, or $\frac{2\pi r}{\lambda} = 5.5, 8.5, 10.6$.

Figure 3 is a pattern resulting when $\frac{2\pi r}{\lambda}$ is such that $J_1\left(\frac{2\pi r}{\lambda}\right)$ is zero.

Figure 4 is the pattern obtained when $\frac{2\pi r}{\lambda}$ is such that $\left|J_1\left(\frac{2\pi r}{\lambda}\right)\right|$

is maximum. One should not assume that omnidirectivity is assured for all maxima of J_1 but rather the lobes will be broader under this condition than any other and hence, fewer elements will be required to achieve omnidirectivity. Perhaps the most important feature is that this criteria points out the values of r/λ to be avoided.

Referring to Fig. 1, the above treatment can be generalized by

**FIVE
YOU CAN
COUNT
ON**

**IRC Molded Metal
Film Resistors**
...in 5 sizes

Type MEC 1/2 watt

IRC
MEC1/2

Type MEB 1/4 watt

IRC
MEB1/4

Type MEH 2 watts

IRC
MEH2

Type MEF 1 watt

IRC
MEF1

Type MEA
1/2 watt

IRC
MEA

—and 5 Big Reasons why:

1) IRC Molded Metal Film Resistors are available in 5 wattage ratings, 2) The metallic resistive films they feature are accurately controlled and applied to special high quality ceramic cores, 3) They surpass characteristics A and B of specification MIL-R-10509B, 4) show a low noise level independent of range, and 5) provide a negligible voltage coefficient.

There are other good reasons, too—IRC Molded Metal Film Resistors set new performance standards—they can take full load at 125° C. ambient with linear derating to zero at 175° C. (except 2 watt size which is rated full load at 100° C. ambient) . . . combine stability on load with a low, controlled temperature coefficient never before obtainable in film resistors . . . provide low conductance and shunt capacity . . . show excellent high frequency characteristics.

Even more: IRC Molded Metal Film Resistors are small in size and weight, can replace precision wire wound resistors in numerous applications . . . available in 3 standard and 2 special temperature coefficient spans for maintaining or controlling resistance over

broad temperature ranges. Feature for feature, IRC Molded Metal Film Resistors are just what you want—and need—for high stability under severe load and humidity conditions.

Here's one more tip: Look into IRC Molded Metal Film Resistors for high frequency applications, too.

Find out the complete details about IRC Molded Metal Film Resistors—write today for Bulletin B-3b.



INTERNATIONAL RESISTANCE CO.

Dept. 372, 401 N. Broad St., Philadelphia 7, Pa.
In Canada: International Resistance Co., Ltd., Toronto, Licensee

HYDROFORM JOB SHOP

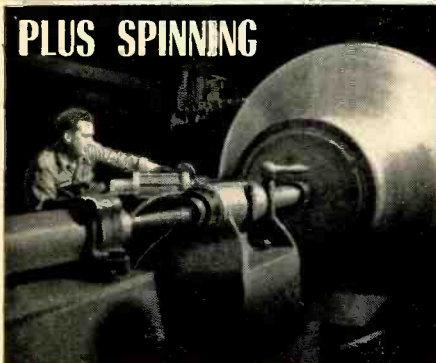
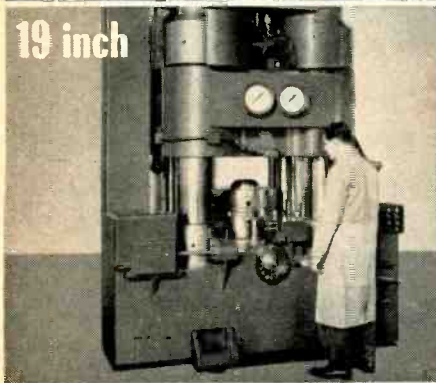
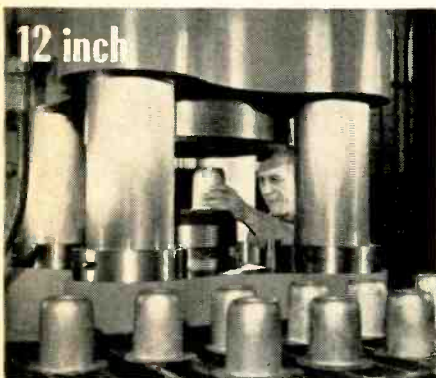

**Parts by Teiner Shipped
by Air — Give You
Fast Service Everywhere**

Modern high speed facilities, unexcelled workmanship and consistent research with new materials and new toolings keep this shop available to the designer, engineer and purchasing agent working with advanced concepts.

ROLAND TEINER

Company, Inc.

DEPT. 4781 TREMONT STREET, EVERETT 49, MASS.
Telephone Everett 7-7800
ENGINEERING REPRESENTATIVES IN PRINCIPAL CITIES
CIRCLE 104 READERS SERVICE CARD

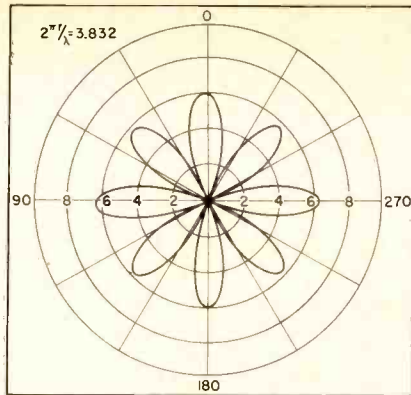

FIG. 3—Radiation pattern for $J_1(2\pi r/\lambda) 0$

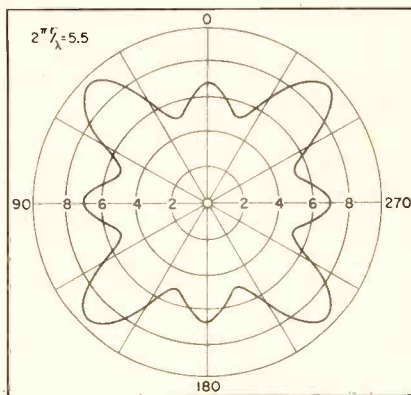

FIG. 4—Radiation pattern for $J_1(2\pi r/\lambda)$ maximum

considering $f_1(\theta)$ as a Fourier series

$$F_1(\theta) = \sum_{n=1}^{\infty} a_n \cos n\theta$$

and $f_2 = f_1(\theta - \pi/2)$. \bar{E} becomes

$$\bar{E} = \frac{1}{2\alpha} \int_0^{2\pi} \sum_{n=1}^{\infty} a_n \cos n\theta$$

$$\sin\left(\frac{2\pi r}{\alpha} \cos \theta\right) d\theta +$$

$$\frac{1}{2\pi} \int_0^{2\pi} \sum_{n=1}^{\infty} a_n \cos n(\theta - \pi/2)$$

$$\sin\left(\frac{2\pi r}{\lambda} \sin \theta\right) d\theta$$

which yields \bar{E} to be an infinite series of Bessel functions. For most antennas having maximum radiation normal to the antenna aperture the predominate term of the Fourier representation will be $\cos \theta$ (or $\sin \theta$, depending upon coordinates), and succeeding terms of the series of Bessel functions can be neglected thus arriving at the original result.

CONTACT YOUR NEAREST

KIN TEL ENGINEERING REPRESENTATIVE

- ALABAMA:** See Ga., Bivins & Caldwell, Inc.
ARIZONA: Neely Enterprises, Phoenix, 641 E. Missouri, CRestwood 4-5431; Tucson, 232 S. Tucson Blvd., MAin 3-2564
ARKANSAS: See Texas, E. Lipscomb Assoc.
CALIFORNIA: Neely Enterprises, N. Hollywood, 3939 Lankershim Blvd., STanley 7-0721; Sacramento: 1317 Fifteenth St., GIlbert 2-8901; San Carlos, 501 Laurel St., LYtell 1-2626; San Diego 6, 1055 Shafter St., ACademy 3-8106
COLORADO: Denver, Lahana & Co., 1886 S. Broadway, PEarl 3-3791
CONNECTICUT: Bridgeport, Yewell Assoc., Inc., 1101 E. Main St., FOrest 6-3456
DELAWARE: See Md., Horman Assoc., Inc.
DIST. OF COLUMBIA: Washington, Horman Assoc., 2017 "S" St., NW, DEcatur 2-5705
FLORIDA: Orlando, Bivins & Caldwell, Inc., 1226 E. Colonial Dr., CHerry 1-1091
GEORGIA: Atlanta 5, Bivins & Caldwell, Inc., 3133 Maple Dr., NE, CEdar 3-7522
IDAHO: See Wash., ARVA
ILLINOIS: Chicago 45, Crossley Assoc., 2711 W. Howard St., SHeldrake 3-3434
INDIANA: Indianapolis, Crossley Assoc., Inc., 5420 N. College Ave., CLifford 1-9255
IOWA: Eastern: See Ill., Crossley Assoc., Inc. Western: See Minn., Crossley Assoc., Inc.
KANSAS: See Mo., Harris-Hanson Co.
KENTUCKY: See N. C., Bivins & Caldwell, Inc.
LOUISIANA: See Texas, E. Lipscomb Assoc.
MAINE: See Mass., Yewell Assoc., Inc.
MARYLAND: Baltimore 10, Horman Assoc., Inc., 635 St. John's Rd., HOPkins 7-2290
MASSACHUSETTS: Burlington, Yewell Assoc., Inc. Middlesex Turnpike, Phone 7-2561
MICHIGAN: Detroit 35, S. Sterling Co., 15310 W. McNichols Rd., BRoadway 3-2900
MINNESOTA: St. Paul, Crossley Assoc., Inc., 842 Raymond Ave., MIdway 6-7881
MISSISSIPPI: See Texas, E. Lipscomb Assoc.
MISSOURI: Kansas City 30, Harris-Hanson Co., 7916 Paseo Ave., HIlland 4-9494
MONTANA: Eastern: See Colo., Lahana & Co. Western: See Wash., ARVA
NEBRASKA: Eastern: See Minn., Crossley Assoc., Inc. Western: See Colo., Lahana & Co.
NEVADA: See Calif., Neely Enterprises
NEW HAMPSHIRE: See Mass., Yewell Assoc., Inc.
NEW JERSEY: Asbury Park, I. E. Robinson Co., 905 Main St., KEIllogg 1-3150 Englewood, RMC Assoc., 391 Grand Ave., DIamond 3-5926
NEW MEXICO: Albuquerque, Neely Enterprises, 107 Washington St., SE, Phone 5-5586 Las Cruces, 126 S. Water St., JACkson 6-2486
NEW YORK: New York 21, RMC Assoc., 236 E. 75th St., TRafalgar 9-2023; Syracuse 2, J. D. Ryerson Assoc., Inc., 412 Genesee East, GRAnite 6-8344
NORTH CAROLINA: High Point, Bivins & Caldwell, Inc., P. O. Box 5187, Phone 3672
NORTH DAKOTA: See Minn., Crossley Assoc., Inc.
OHIO: Cleveland 21, S. Sterling Co., 4311 Mayfield Rd., EVergreen 2-4114 Dayton 19, Crossley Assoc., Inc., 53 Park Ave., AXminster 9-3594
OKLAHOMA: See Texas, E. Lipscomb Assoc.
OREGON: Portland 9, ARVA, 1238 NW Glison St., CApital 7-1281
PENNSYLVANIA: Camp Hill, I. E. Robinson Co., 2120 Market St., REgent 7-6791 Pittsburgh 36, H. E. Ransford Co., 5400 Clairton Blvd., TUxedo 4-3425 Upper Darby, I. E. Robinson Co., 7404 West Chester Pike, Flanders 2-7017
RHODE ISLAND: See Mass., Yewell Assoc., Inc.
SOUTH CAROLINA: See Ga., Bivins & Caldwell, Inc.
SOUTH DAKOTA: See Minn., Crossley Assoc., Inc.
TENNESSEE: See N. C., Bivins & Caldwell, Inc.
TEXAS: Dallas 9, E. Lipscomb Assoc., P. O. Box 7084, FLeetwood 7-1881; El Paso, 720 N. Stanton, Phone 2-7281; Houston 5, 2422 Rice Blvd., JACkson 4-9303
UTAH: See Colo., Lahana & Co.
VERMONT: See Mass., Yewell Assoc., Inc.
VIRGINIA: See N. C., Bivins & Caldwell, Inc.
WASHINGTON: Seattle 99, ARVA, 120 W. Thomas St., MURdoch 7337
WEST VIRGINIA: Northern: See Pa., H. E. Ransford Co. Southern: See N. C., Bivins & Caldwell, Inc.
WISCONSIN: Eastern: See Ill., Crossley Assoc., Inc. Northeastern: See Minn., Crossley Assoc., Inc.
WYOMING: See Colo., Lahana & Co.

CIRCLE 105 READERS SERVICE CARD

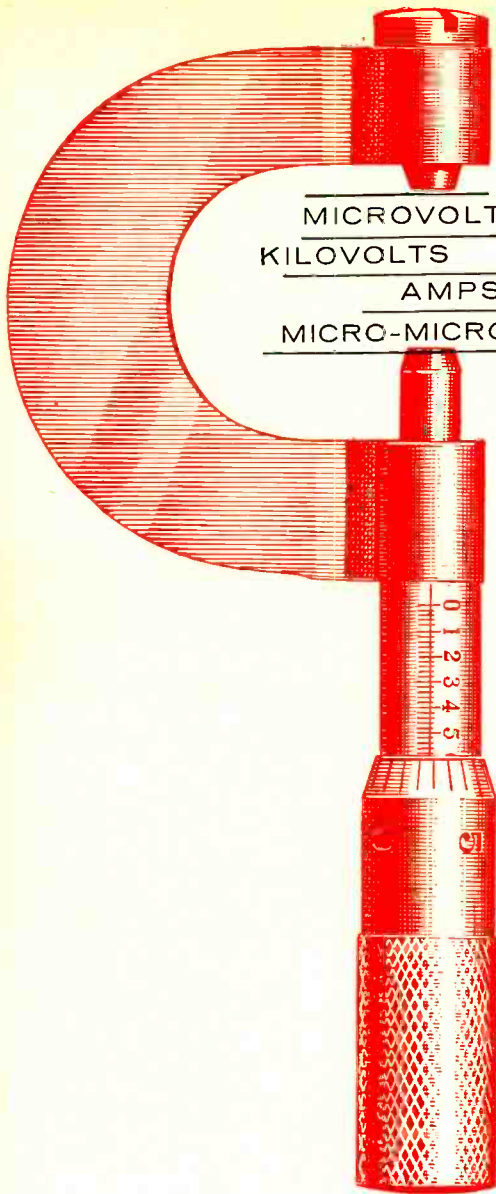

MICROVOLTS
 KILOVOLTS
 AMPS
 MICRO-MICROAMPS

Now! Solve any DC measurement problem—with a proven KIN TEL instrument

MEASURE MICROVOLTS TO KILOVOLTS, MICRO-MICROAMPS TO AMPS WITH STABILITY, ACCURACY, SIMPLICITY!

From research and development to production line testing...one of these versatile DC measuring instruments can meet your most exacting requirements.

All units incorporate KIN TEL's proven chopper-stabilized circuitry for rock-solid measurement of microvolt level DC signals. All have zero center meters for instant polarity indication.

KIN TEL's microvoltmeters feature high input impedance and can be used as stable DC amplifiers. The model 301 both measures and supplies DC from 1 to 501 volts with 0.02% accuracy - provides 20 ma output as a supply.

One of these instruments can solve *your* DC measurement problem. And remember - reliable, accurate performance is assured by KIN TEL's experience in manufacturing more than 10,000 instruments.

Instrument	Model 203	Model 202B	Model 204A	Model 301	Model 203AR
DC Voltage Ranges (Full Scale)	$\pm 100\mu\text{V}$ to $\pm 1000\text{V}$ 15 ranges	$\pm 300\mu\text{V}$ to $\pm 1000\text{V}$ 14 ranges	$\pm 10\mu\text{V}$ to $\pm 10\text{V}$ 7 ranges	1 to 501 volts*	$\pm 100\mu\text{V}$ to $\pm 1000\text{V}$ 15 ranges
DC Current Ranges (Full Scale)	$\pm 100\mu\text{mA}$ to $\pm 100\text{mA}$ 10 ranges	None	$\pm 0.001\mu\text{A}$ to $\pm 1\text{mA}$ 7 ranges	Not Applicable	$\pm 0.001\mu\text{A}$ to 1 amp 19 ranges
Input Impedance	10 megohms below 10mv-30 megohms at 30mv-100 megohms above 30mv	10 megohms below 10mv-30 megohms at 30mv-100 megohms above 30mv	10,000 ohms	Infinite at null	10 megohms at 30mv and below 100 megohms above 30mv
Measurement Accuracy	3%	3%	3% on 2 lower ranges, 4% above	0.02%	3%
Max. Output as Amplifier	1 volt across 1000 ohms	1 volt across 2000 ohms	1 volt across 1000 ohms	Not Applicable	1 volt across 500 ohms
Equiv. Input Drift (Max. Long Time)	$10\mu\text{V}$	$15\mu\text{V}$	$<2\mu\text{V}$	0.01% stability	$10\mu\text{V}$
Price	\$550	\$350	\$325	\$625	\$550

*The 301 utilizes a null voltmeter to indicate difference between voltage being measured and output of its variable DC supply. Its null meter has 4 full scale ranges from ± 0.05 to ± 50 V.

Write for detailed literature - 5725 Kearny Villa Rd., San Diego 11, Calif. Representatives in all major cities.

KINTEL
 A Division of Cohu Electronics Inc.



Model 203. Measure 10 microvolts to 1 kilovolt, $100\mu\text{mA}$ to 100 ma. 25 ranges. This is the ONE universal meter.



Model 202B. Wide range, DC microvoltmeter-amplifier. Zero center meter gives instant polarity indication.



Model 204A. Electronic galvo. Transistorized. Sensitive, rugged DC null detector, amplifier, microvoltmeter, micro-microammeter.



Model 301. Calibrated null voltmeter and DC standard. Instantly measure and supply DC from 1 to 501 volts at 0.02% accuracy.



Model 203AR. Measure $0.001\mu\text{A}$ to 1 amp, 100 μV to 1000 volts. Zero center meter. Compact, 19-inch rack mount design.

Ask for a demonstration today!

Memory Meter Retains Reading

A SIMPLE, reliable means of recording a meter reading which must be taken at a particular instant, but which cannot be noted immediately is provided by the memory meter. Readings may be recorded at any point on the memory meter scale and not necessarily at the maximum reached by the signal. It is ideal for situations which require meter readings in remote areas or simultaneous reading of a group of meters.

The unit, developed by Assembly Products Inc, Chesterland, Ohio is essentially a sensitive panel meter with a rear-mounted solenoid and plunger. The solenoid is normally energized and the plunger retracted. When a reading is desired, the solenoid is de-energized. A nylon-headed plunger pushes

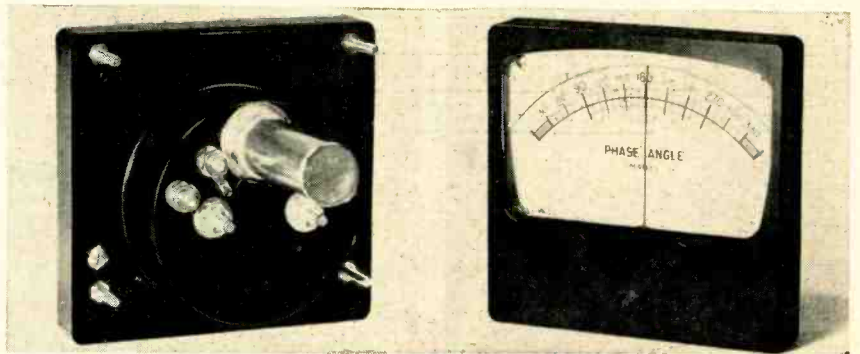

Nylon headed plunger pushes against the back of the face plate and clamps the pointer in position at the reading instant

against the back of the face plate, which is normally held away from the pointer by two small springs at its base. At the reading instant the pointer is held fast between the face plate and a clamping plate mounted over the top arc of the face plate.

The memory meter is available in almost any sensitivity range, from a few μa or mv to 50 amp or 500 v either d-c or a-c. In present models, the solenoid coil operates on 100 d-c and about 30 ma. An external rectifier may be used with a-c current.

High Power Transistor Servo

A DIODE NETWORK which compensates for ambient and junction temperature changes permits transistors to be used in medium and high power servomechanism. Compensating for transistor amplifier drift has been attempted through the use of resistors, but this method simply restricts the operating range of the transistor and the drift current is still present and uncompensated. The transistor amplifiers in the servomechanism use diodes for temperature compensation. Output power up to 140 w is obtained from the amplifier with negligible drift.

The temperature compensating network was designed by Advanced Research Associates Inc, 4128B Howard Ave., Kensington, Md. for use in their model 2-ARA d-c servomechanism. The units have high speed and high torque characteristics and are packaged in a small size currently found only in low power instrument type servos.

The electronic portion of the servo uses transistors with the exception of the input stage. A

vacuum tube is used at the input to convert the signal voltage to a current through transconductance. In this way the component best suited to the job is used. The input signal voltage sees a grid and the output current sees the transistor amplifier. A vacuum tube input also permits use of the servo as a

replacement or complement to larger or less efficient high impedance existing systems.

The transistors are temperature stabilized with a diode connected between the base and emitter. The diode used has several special characteristics and in addition must have the correct thermal connec-



Measuring response characteristics of servo amplifier

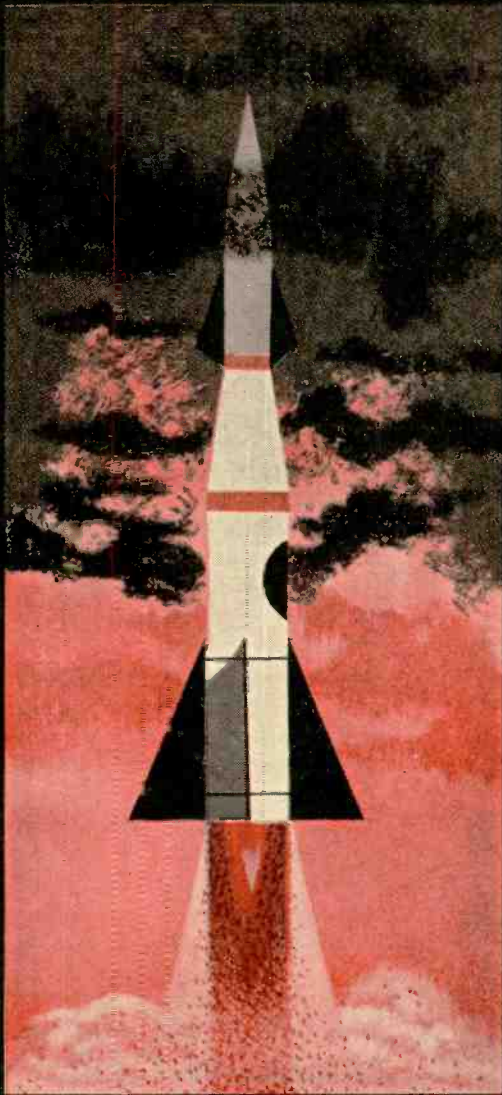

... for inertial guidance systems in guided missiles

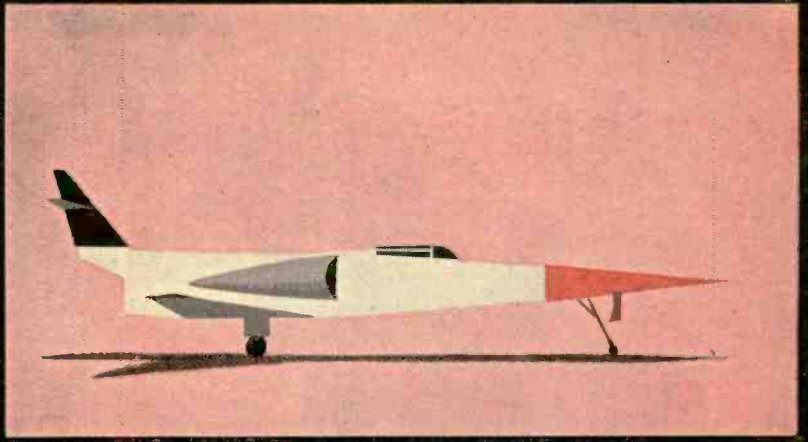

... for inertial navigation systems in military aircraft



... for combination navigation and automatic pilot systems in airlines



See

... for the only precision-built

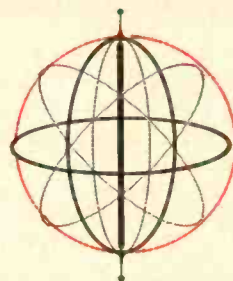

g y r o s c o p e s

now in volume production

The first units of floated rate-integrating, single-degree-of-freedom gyros began coming off the AC production lines in June of 1957. AC gyros are built to such precision standards that they can sense rates of rotation so slight that one revolution would take several years to complete. What's more, AC gyros have withstood as much as 5,000 to 7,000 consecutive hours of operation without significant loss of efficiency. Actual test information is available to qualified manufacturers. Immediate delivery of: 75×10^6 ; 10×10^6 ; 2×10^5 ; 1×10^4 . —If you are an engineer and have an electrical, mechanical or electronic background and might be interested in working with AC in Milwaukee, write Mr. Cecil E. Sundeen, Supervisor of Technical Employment, Dept. A, 1925 E. Kenilworth, Milwaukee 1, Wisconsin, AC . . . the Electronics Division of General Motors.

Afterburner Fuel Controls • Bombing Navigational Computers • Emergency Fuel Controls • Gun-Bomb-Rocket Sights • Gyro-Accelerometers • Gyroscopes
Inertial Guidance Systems • Manifold Air Pressure Regulators • Speed Sensitive Switches • Speed Sensors • Three-Way Selector Valves • Torquemeters

10,000
now in use
throughout
the world



MV-17C
DC-VTVM

Still
\$295

100 microvolts to 1 KV-DC.

For Sensitivity And
Ultimate Reliability Choose
the Millivac MV-17 C DC-VTVM

Millivac established its leadership in the field of sensitive DC VTVM's in 1948 when we introduced the world's first high impedance millivoltmeter for DC, the MV-17 A, forerunner of the present MV-17 C. It had a lowest range of 0-1 mV, at 6 megohms input impedance. Since then we have steadily improved our DC meters. Our latest model, the MV-27 C, is 4 times more sensitive than the original instrument (0-250 uV, 6 meg).

These instruments are available in portable or rack-mounted form, also with or without circuitry to drive recorders, with or without insulated dummy ground as well as for regular 60 cps line operation or for odd line frequencies (50 cps-500 cps, 117V).

Over 10,000 of these meters are now in general use throughout the world. If you are not yet familiar with the MV-17 C or MV-27 C, write for complete literature.

Tomorrow is our yesterday

MILLIVAC Instruments
BOX 997, SCHENECTADY, N. Y.
Division of Cohu Electronics, Inc.

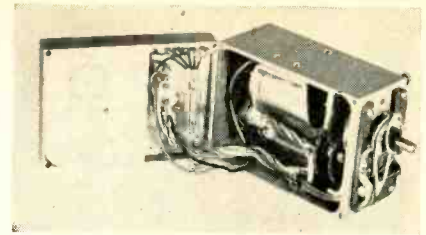

Complete servo mechanism is packaged in a small self-contained unit

tion with the transistor. The linear d-c amplifier is free from balance pots which complicate the system and true Class B amplifier characteristics are obtained without bias voltage dividers. Servo feedback is provided by mounting the wiper of a high resolution, wire-wound potentiometer directly on the output shaft. If alteration is needed the feedback pot can be moved and other mechanical units included in the feedback loop.

The units are adaptable for control of aircraft surfaces, machine tool drives, chemical and nuclear process control, test equipment, or any application where rotary or linear motion is required.

Liquid-Filled Pots Enhance Reliability

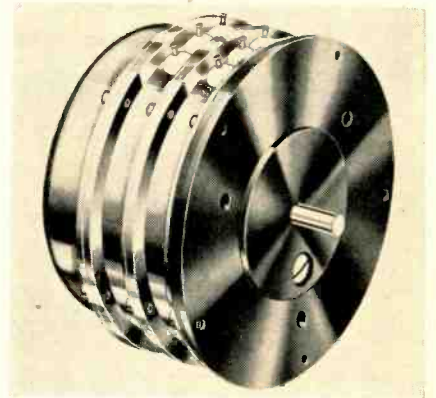

Sealing precision potentiometer in oil bath increases life expectancy 10 times

DETERIORATION and performance problems experienced with precision potentiometers are reduced by a new technique which seals the potentiometer in a bath of oil. Reduced noise, increased dielectric strength, prolonged shelf-life, greater heat dissipation and up to 10 times the life expectancy are the significant advantages

NEW miniature switch...

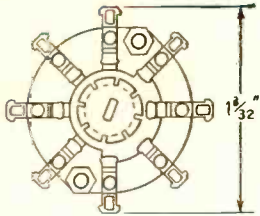

FITS IN 1-3/32" CIRCLE

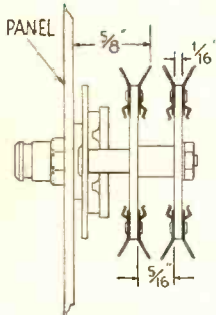

MINIMUM DEPTH BEHIND PANEL—
ONLY 5/8" FOR A
SINGLE-SECTION SWITCH

SWITCH SECTION IS ONLY 1/16" THICK

MINIMUM SPACE BETWEEN SECTIONS—
5/16" WITH CLIPS ON FRONT AND BACK

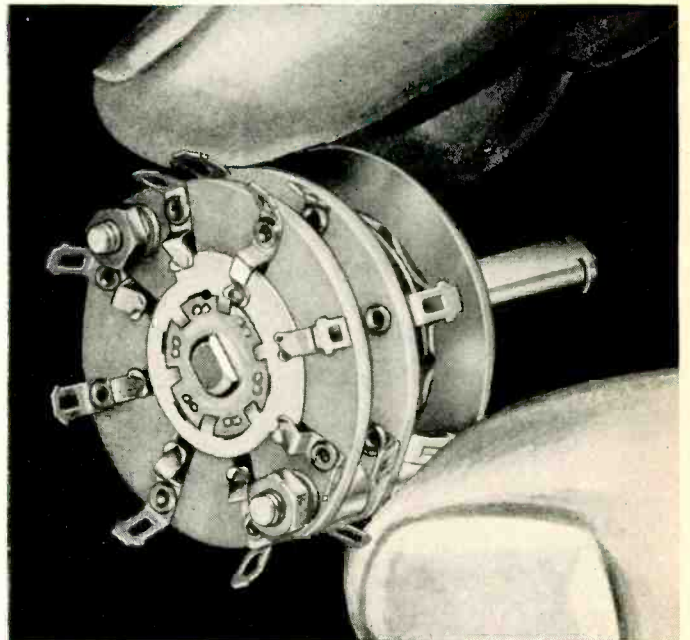

OAK SERIES "A"

LOW-CURRENT ROTARY SWITCH

- ▶ UP TO 18 CONTACTS PER SECTION
- ▶ 1/4" SHAFT, STANDARD
- ▶ LOW CAPACITANCE
- ▶ SAME HIGH QUALITY AND RELIABILITY AS LARGER OAK SWITCHES

Here's new help in the battle of miniaturization. This tiny switch can pare critical space and weight from your designs. The large number of contacts it provides enables you to handle complex circuits, too. The clips on the Series "A" are a miniature version of the famous Oak double-wiping design—long accepted as the standard of the industry for reliability and long life. Oak engineers will be glad to furnish complete information, and work with you in developing the exact variation you need.



Write on Company Letterhead for
a Copy of the Oak Switch Catalog

SPECIFICATIONS

Index—Double ball bearing, hill and valley type with stainless steel spring. Fixed and adjustable stops, and locating key available.

Shafts and Bushings—1/4" shaft with 3/8-32 bushing is standard; 5/32" shaft with 3/8-32 bushing and 1/8" shaft with 1/4-32 bushing can be supplied also. Water seal bushings optional.

Sections—8, 10, or 12-position, stacked in any number up to a total depth of three inches. The 12-position section provides up to 18 insulated contacts—12 on front, 6 on back. No insulating blocks needed on back.

Poles	8-Position (45° throw)	10-Position (36° throw)	12-Position (30° throw)
1 pole	2 to 8	2 to 10	2 to 12
2 poles	2 to 4	2 to 5	2 to 6
3 poles	2 to 3	2 to 4	2 to 5
4 poles	2	2 to 3	2 to 3
5 poles	...	2	2
6 poles	2

Clips—Solid spring-silver alloy or silver-plated spring brass, fastened by solid rivets.

Insulation—Stator is silicone fiber glass, meeting specification MIL-P-997 type GSG; rotor is KEL-F®, known for its excellent mechanical and electrical properties.

Finish—Commercial or 50 and 200-hour salt spray.



1260 Clybourn Avenue, Dept. G, Chicago 10, Illinois
Phone: MOhawk 4-2222

SWITCHES • ROTARY SOLENOIDS • CHOPPERS • SPECIAL ASSEMBLIES • VIBRATORS • TUNERS

Costs Going Up? Production Down?

ESTERLINE-ANGUS OPERATION RECORDERS Will Show You Why

20 Pens in a single recorder will monitor
20 machines or events. Available for

DC: 2-250 Volts

AC: 6-240 Volts

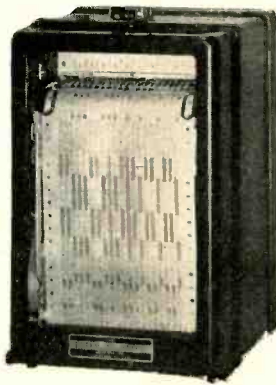

Ask for Catalog Section 50

Product Representatives in Most Principal Cities

The ESTERLINE-ANGUS Company, Inc.

Pioneers in the Manufacture of Graphic Instruments

DEPT. E10, P. O. BOX 596, INDIANAPOLIS 6, INDIANA

CIRCLE 175 READERS SERVICE CARD

STURGES BATTERIES

NON-SPILL IN ANY POSITION!!

The molded plastic cases, in which Sturges batteries are assembled, are completely seamless. The covers are firmly cemented to the cases and a special baffle and non-spill vent prevents all capillary or creeping action of the electrolyte . . . permitting the emission of only dry harmless gas from the cells.

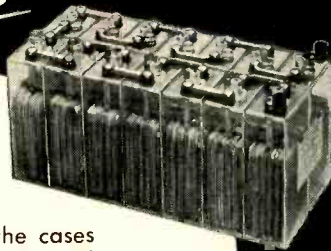

Type "H"
Storage Battery
Amp. Hrs.—15
Voltages from 2 to
28 or as specified
Weight from
1 7/8 lbs. to 26 1/2 lbs.



Type "S" Storage Battery
Amp. Hrs.—6; Voltages from
2 to 28 or as specified;
Weight from 12 oz. to 12 lbs.

FREE

Write for literature on six different sizes of type "S" and type "H" Batteries; including performance curves, size specifications, etc.

CONSULT US ON ALL
YOUR SPECIAL BATTERY
APPLICATION PROBLEMS

STURGES BATTERIES

- ★ Lightweight—Non-Spill (in any position)
- ★ Transparent Molded Plastic Case
- ★ High Output of Watt Hours Per Pound of Battery
- ★ Continuous High Voltage Uniformity While Discharging
- ★ Conforms to Any Amount of Space

manufactured by **ELECTRONIC BATTERIES, INC.**

Bush Terminal Building Number 4 • 28-34 35th Street • Brooklyn 32, New York

claimed over conventional models.

Liquid filled pots were developed by Helipot Corp., New Beach, Calif. to free potentiometer sensitivity from environmental influence. From the very instant of application in a working system—and often before—a potentiometer begins to deteriorate. Wear products, moisture, electrical potential, and heat all contribute to deterioration within the housing of a potentiometer.

Engineers at Helipot reasoned that a potentiometer sealed and running in oil should provide the greatest possible freedom from environmental influence.

Three liquid-filled, multi-turn versions have been introduced as standard models. These are a 10-turn 1 1/8 in. diameter potentiometer for bushing mounting plus 3-turn and 10-turn 2 in. diameter models for servo mounting. Prototypes now in final development include 2 and 3 in. diameter, single-turn potentiometers.

Switch Withstands 7 G's at 1,000 Cps

Developed for use under vibration, shock and acceleration the model RR-30 sub-miniature absolute air pressure switch is accurate to plus or minus 0.5 psi from -85 F to 200 F. Pressure difference between the on and off points is 2 psi. An important design feature is that the switch will not chatter at the operating points.

The sensing mechanism in the RR-30 switch developed by Newark Controls Co., 15 Ward St., Bloomfield, N. J., is a hermetically sealed evacuated bellows. Air pressure being sensed enters through the pressure port. As the pressure

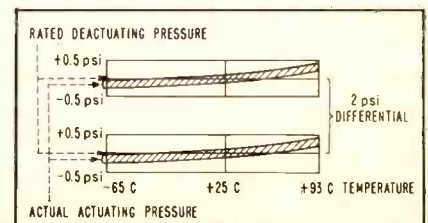

Relative change in operating pressure over -65 C to +93 C temperature range

changes the bellows which is similar to a covered helical spring contracts or expands linearly. The face or end of the bellows works against the actuating pin of the electrical switch turning it *on* and *off* at the pressure settings.

Vibration

The maximum pressure error of the switch due to vibration is 0.3 pounds per square inch. This vibration Error lowers the actuating pressure 0.3 psi and raises the de-actuating pressure 0.3 psi, therefore under the worst vibration conditions the differential between the *on* and *off* pressures is reduced from 2 psi to 1.4 psi.



Miniature pressure switch does not chatter under vibration

The pressure switch is suited for use on aircraft, missiles, parachutes, balloons, wave-guides or vibrating equipment. It comes in nominal pressure settings from 5½ psi to 23½ psi.

SPST, open or close on decreasing pressure or SPDT switches are available.

Overall length is 2½ in. and weight is 2 oz.

Full scale rotation is 56 deg. Resonant frequency is 9 cps and the damping coefficient is 0.4 to 0.6. Input impedance is 1 meg. and power input is 28 v d-c center tapped. Free running speed is 180 deg/sec. and maximum operating temperature 75 C.

Applications

The original design has been adapted to applications requiring much higher load torque capabilities. To date both ten and twenty-five foot/pound units of comparable characteristics have been developed for special applications, with units of several hundred foot/pounds currently in the design stage.

New...from Potter

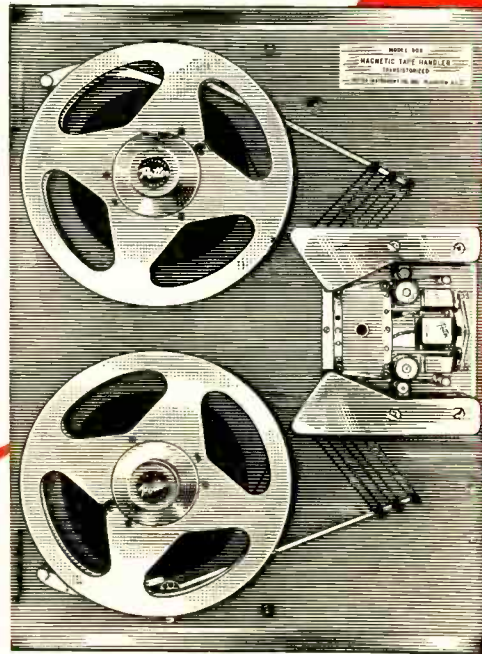

No. 1
source of
peripheral
equipment
for
digital
computers

MODEL
906

Transistorized Digital Magnetic Tape Handler

Replaceable Capstan Panel permits use as Perforated Tape Reader with a remarkable new brake capable of stopping on the stop character at speeds up to 1000 characters per second.

NEW SPEED • VERSATILITY • RELIABILITY

The advanced design of the completely transistorized Potter Model 906 Tape Handler provides improved performance in virtually any tape handling application. Using a small vacuum loop buffer, Model 906 features:

- Complete front accessibility—single panel construction
- Pinch rollers capable of 100 million start-stop operations
- In-line threading, end of tape sensing and tape break protection
- Speeds up to 150 ips
- As many as 4 speeds forward and reverse
- Capable of continuous cycling at any frequency from 0 to 200 cps without flutter
- Rewind or search at 400 ips
- 3 millisecond starts
- 1.5 millisecond stops
- Tape widths to 1-1/4"
- Up to 47 channels
- All functions remotely controllable

The 906 may be supplied with completely transistorized Record-Playback amplifiers featuring electronic switching from record to playback function, with separate module for each channel.

Other Potter products include Transistorized Frequency Time Counters, Magnetic Tape Handlers, Perforated Tape Readers, High Speed Printers, Record-Playback Amplifiers and Record-Playback Heads.



POTTER INSTRUMENT COMPANY, INC.

SUNNYSIDE BOULEVARD, PLAINVIEW, N. Y.

OVERBROOK 1-3200

Transistors Are Made By Photolithography

By J. R. NALL and J. W. LATHROP
Diamond Ordnance Fuze Laboratories
Washington, D. C.

PHOTOLITHOGRAPHIC TECHNIQUES allow great flexibility of miniature transistor design, evaporation of leads and produce a transistor that is an integral part of the printed circuit and able to withstand high shock.

Diffused blanks 0.045 inches by 0.045 inches by 0.010 inches are used. The original material is p-type about 1 ohm-cm into which arsenic is diffused giving rise to an n-type skin about $9\ \mu$ thick. The p-type material becomes the collector of the finished transistor and the n-type skin the base. A layer of photosensitive resist is placed on the germanium surface, masked, exposed and developed leaving a bare rectangular area of germanium.

The aluminum emitter material is evaporated and deposited over the layer of resist. When the underlying resist is chemically stripped away the aluminum remains only on the rectangular area. Resolution equivalent to mechanical masking

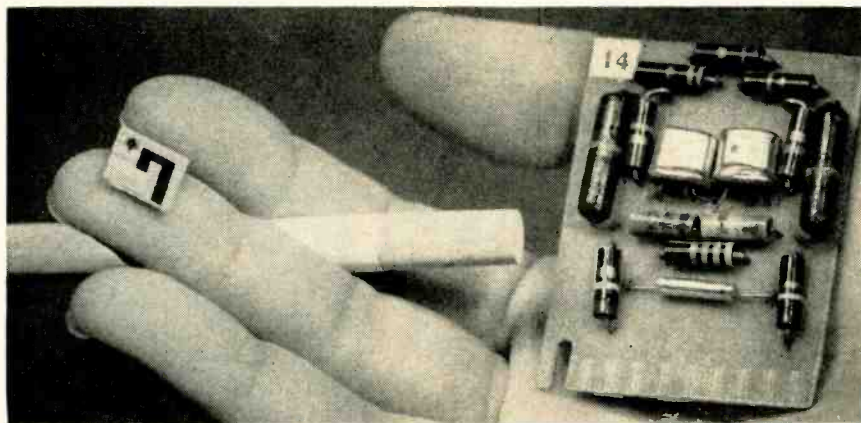

Transistor is dot in upper left corner of fingertip-sized circuit. Entire circuit is no larger than transformer now used in circuit at right

can be achieved by this process. After the aluminum emitter is alloyed to the germanium by heating, a base contact pattern of similar shape is formed next to the emitter by the same photolithographic process. The contact is electrolytically deposited gold with a small percentage of antimony.

The gold is deposited on clean germanium surface and resist is not stripped before alloying. The gold alloys at a lower temperature

than the aluminum, leaving the emitter undisturbed. The collector base junction is defined by etching away the n-type skin except in the vicinity of the emitter and base contacts. Photosensitive lacquer, which is not attacked by the acids commonly used to etch germanium, controls the pedestal geometry during etching. The transistor is soldered to a thin base plate and inserted into a hole in a ceramic printed circuit board. Any

DESIGN TRENDS: Card Programs Function Generator

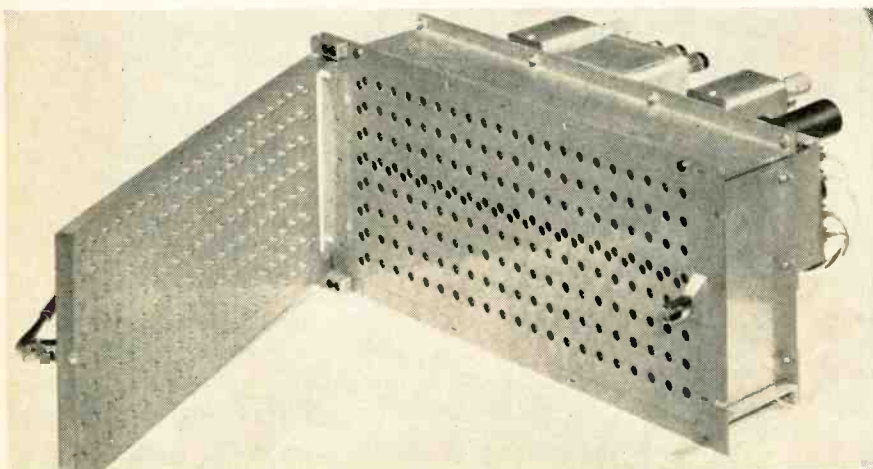

Diode function generator designed by Electrol, Inc., Los Angeles, Calif., for analog computer rack-mounting, employs punched cards. Cards allow pre-programming to reduce setup time, act as function memory or permanent record. Card is placed behind front door. As door closes, spring-loaded plungers in door pass through card holes, actuating sealed switches. Switches, the only moving parts in circuits, set up resistor networks to perform

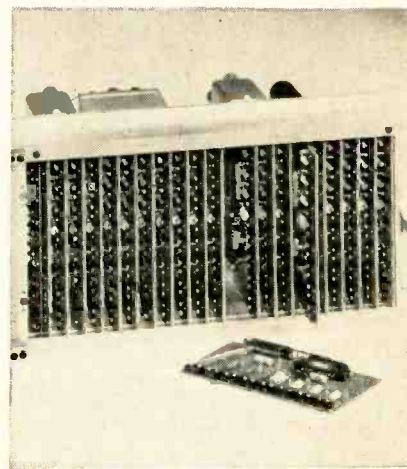

the function. Functions may be composed of 20 contiguous line segments, each with slope values from 0.01 to 10.16 v/v. Zero offset, slope and scale factor are programmed on same card. Plug-in resistor assemblies may be varied to change break points. Accuracy is stated as 0.1 per cent. Photo at left is front with door open to show plungers and plate which backs up card. At right, plate is removed to expose function networks

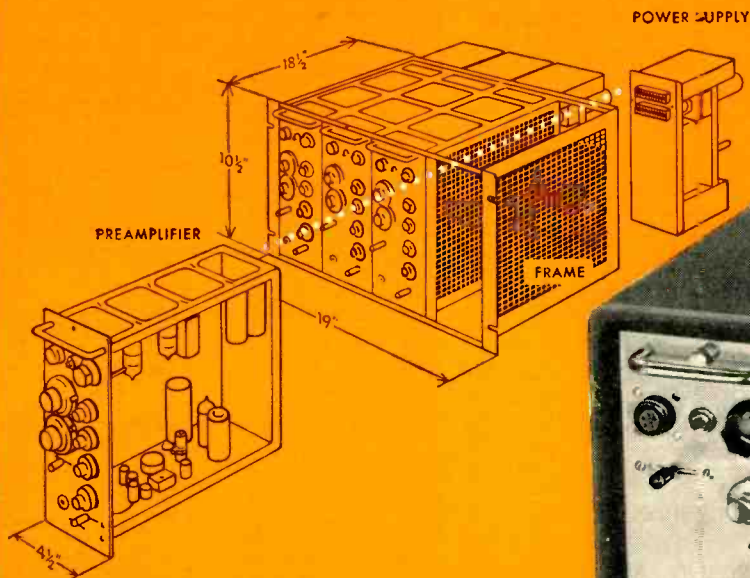

first of the new
SANBORN 450's:
UNIT

PREAMPLIFIERS

with Integral Power Supplies

These new Sanborn Unit Preamplifiers—designed to drive optical recording systems, tape recorders, wide band oscilloscopes, panel meters and other devices—offer you an outstanding combination of performance characteristics, operating versatility and ease, flexibility through interchangeable design, and compactness in either single unit or four-unit rack module packaging. The 1100 Carrier and 1800A True Differential DC types are versatile enough to cover the vast majority of input signal requirements, with practically any type of transducer. (For use with high speed optical galvanometers at frequencies above 500 cps, requiring larger current swings, a transistor output amplifier is built into the 450-1800A and available as optional equipment on other 450's.) Later "450" Unit Preamplifiers will include Servo (demodulator) Monitor, DC Coupling, Logarithmic, Low Level and Dual-Channel DC types. As shown, any "450" can be installed or quickly interchanged in any bay of the four-Preamp module, or in a portable case.

Supplementing the basic specifications, the 450-1100 is a carrier amplifier-demodulator with zero suppression, which provides excitation for and accepts the outputs of various resistance bridge, variable reluctance, differential transformer and other types of transducers. The 450-1800A is a low-noise, low drift, wide band-width, high gain true differential DC amplifier, with front panel controls for smooth gain, position, and internal 2 mv calibration signal. For further data or application information on these new self-contained Unit Preamplifiers, contact your Sanborn Industrial Engineering Representative or write the Industrial Division of Sanborn Company.

SANBORN COMPANY

175 Wyman St., Waltham 54, Mass.

SPECIFICATION SUMMARY

MODEL 450-1800A TRUE DIFFERENTIAL DC PREAMPLIFIER

- Input** — Impedance: 200K differentially between terminals (balanced) or 100K each input lead to gnd. (single-ended)
Common mode rejection: at DC, 100 db; to 60 cps, 94 db; 400 cps, 80 db.
Equiv. input drift: ± 2 uv for 24 hours
Equiv. input noise: 5 uv peak to peak (0-10 cps), 20 uv (0-1000 cps), 50 uv (0-30 kc)
- Output** — Low Power Circuit:
Output appears between two cathodes as true push pull signal.
Common mode level of cathodes ± 2 volts with respect to ground.
Output capability: ± 3 volts into 5000 ohms
 ± 10 volts open circuit
Zero position control not active for this output
Freq. response; 3 db down at 30 kc
Linearity: 0.1%
High Power Circuit:
Output appears between two emitters as true push pull signal.
Common mode level of emitters ± 2.5 volts with respect to ground.
Preferred load: 50 ohms
Output: ± 2.5 volts, ± 50 ma
Freq. response; 3 db down at 15 kc
Linearity: 0.5%
Zero position control is operative for high power output ckt.
- Gain** — Fixed steps 1000, 500, 200, 100, 50, 20
Gain Accuracy 0.5% for D.C.
Smooth gain control covers range between fixed steps
- Power Req.** — 115 volts, 60 cps, approx. 50 watts

MODEL 450-1100 CARRIER PREAMPLIFIER

- Carrier Freq.** — 2400 cps (std.); 600, 1200, 4800 cps optional
- Carrier Exc.** — approx. 4.5-5 volts, depending on transducer imped.
- Transducer Imped.** — 100 ohms min. - 1000 ohms max.
- Input Imped.** — approx. 2500 ohms, incl. zero sup. ckt.
- Sensitivity** — 100 uv rms from transducer (output imped. 1000 ohms or less) gives 1 volt at output under max. output loading
- Output** — preferred circuit: between one active cathode and one reference cathode
alternate circuit: between active cathode and ground
- Output Voltage Capabilities** — (a) ± 3 volts into 2.2K min. load
(b) ± 6 volts into 5K load
(c) ± 7.5 volts open ckt
- Output Linearity** — better than 0.2% for (a) above
- Output Impedance** — approx. 1000 ohms, preferred ckt., 500 ohms alternate output ckt.
- Freq. Response** — 3db at 20% of carrier freq.
- Zero Suppression** — can suppress 0 to 100% of transducer load (either sense via switch)
- Power Req.** — 115 volts, 50-400 cps, approx. 30 watts

WHO IS BORG?

George W. Borg, who founded this corporation, is the "Mr. Clutch" who started with Borg & Beck. He then helped organize the Borg-Warner Corporation of which he became president. Later he served as chairman of the board until he resigned to devote his full attention to The George W. Borg Corporation.

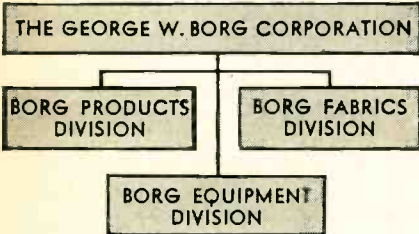

The George W. Borg Corporation is comprised of three divisions

- **Borg Products Division**
Manufactures automotive clocks.
- **Borg Fabrics Division**
Manufactures deep-pile fabrics best known of this line is the fashionable "Borgana" fabric.
- **Borg Equipment Division**
Manufactures Micropots (precision potentiometers), Microdials (precision turn-counting dials), instrument motors, frequency standards, aircraft navigational instruments and components for systems.

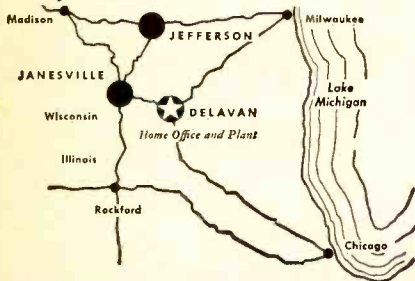

HOW BORG EQUIPMENT DIVISION CAN HELP YOU . . .

Borg's background of experience will save you time and money by helping you solve design and production problems of electronic components. Whether you are faced with a special problem or interested in a standard component, call Borg Equipment Division for an economically sound solution. Write today for catalog BED-A56.



BORG EQUIPMENT DIVISION
THE GEORGE W. BORG CORPORATION
JANESVILLE, WISCONSIN

CIRCLE 65 READERS SERVICE CARD

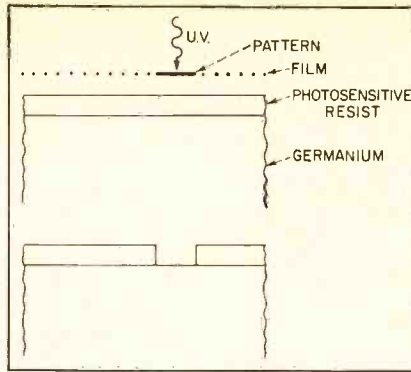

Schematic diagram of exposure process for germanium blanks

gap between the board and the die is filled with insulating cement which serves to firmly attach the transistor. By using relatively crude masking, aluminum leads may now be vacuum deposited for connecting the printed wiring

on the board with the contacts in the pedestal. The leads have a conductivity approximately equivalent to a wire 0.0006" in diameter.

The photo resist insulates the deposited leads from the germanium surface and protects the surface from contamination until the entire circuit or combination of circuits can be hermetically sealed.

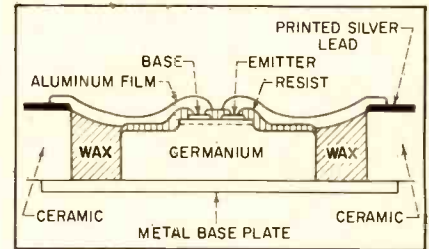

Cross section shows finished transistor fixed in hole in ceramic printed circuit board. Final aluminum film makes leads

Flanges Feed Cutting Coolant

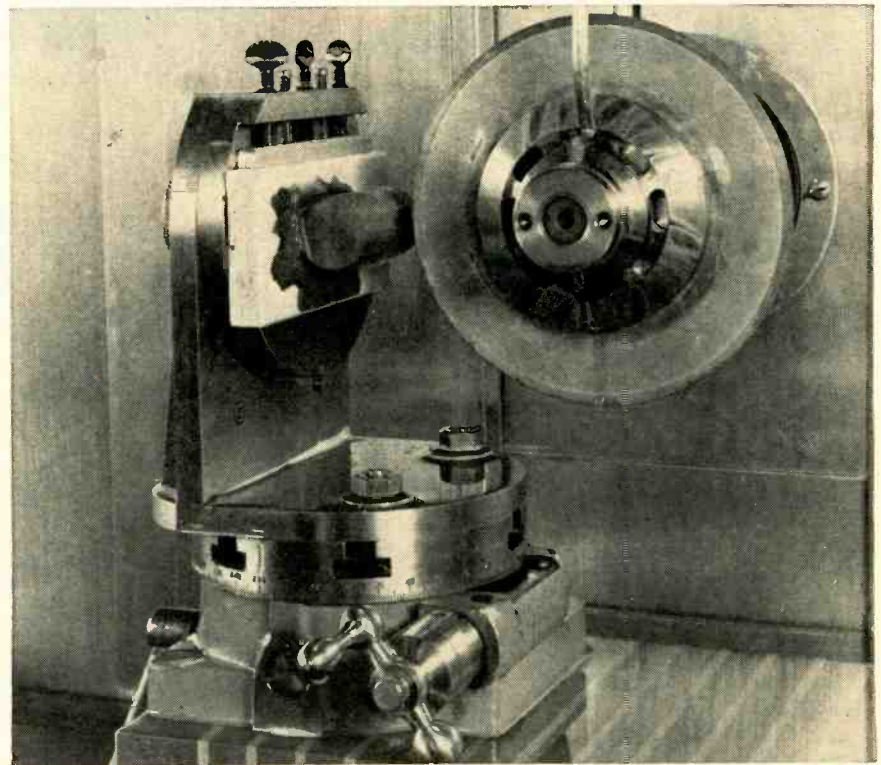

Flanges on 5 inch diamond wheel are slotted to permit coolant to flow into cut by centrifugal force. Crystal holding fixture shown permits cuts along any desired plane

COOLANT FEED flanges are employed in semiconductor wafering machines made by Micromech Mfg. Corp., Union, N. J. The technique helps prolong the life of metal bonded diamond wafering wheels.

The flanges, which impart rigid-

ity to the wheel, are machined so that they also feed coolant along the surface of the wheel into the kerf.

The coolant is fed under pressure through tubes into a radial groove in the flanges. A portion of the cool-

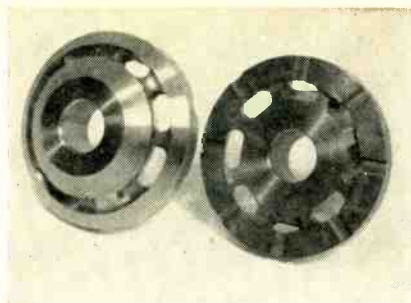

Pair of flanges. Inside is hollowed to accommodate flow of coolant into feeding slots from radial groove on exterior

ant flows through slots to the hollowed inside of the flanges. Centrifugal force carries the liquid out through slots and along the wheel surface.

Flanges are made of 303 stainless steel. They are first roughed turned, faced and the radial groove and hollow undercut made. Then they are drilled and reamed to exact bore, all on a lathe.

The through slots are located in a dividing head and drilled. The flanges, still mounted in the dividing head, are transferred to a vertical milling machine for through slot milling.

The flanges are returned to a lathe, mounted on a mandrel between centers and a finish cut taken all over. Radial runout is held to 0.0005 inch and parallelism of faces, to 0.0001 inch. The diameter of the flange will depend on the depth of cut desired.

Casting Brushes in Continuous Strips

By E. Natkins

Chief Engineer
Gries Reproducer Corp.
New Rochelle, N. Y.

REDESIGN of the five-piece brush assembly for an impulse counter permitted production as one piece by Gries, with resulting improvements in counter assembly time, operation and cost.

IBM uses 18,000 counters of this type yearly in its model 101 statistical machine, model 9600 automatic production recorder and model 528 accumulating reproducer.

Except for bending of brush tips and packaging, automatic machines are used. First, strands of 0.008

These little fellows do a Whale of a job . . .

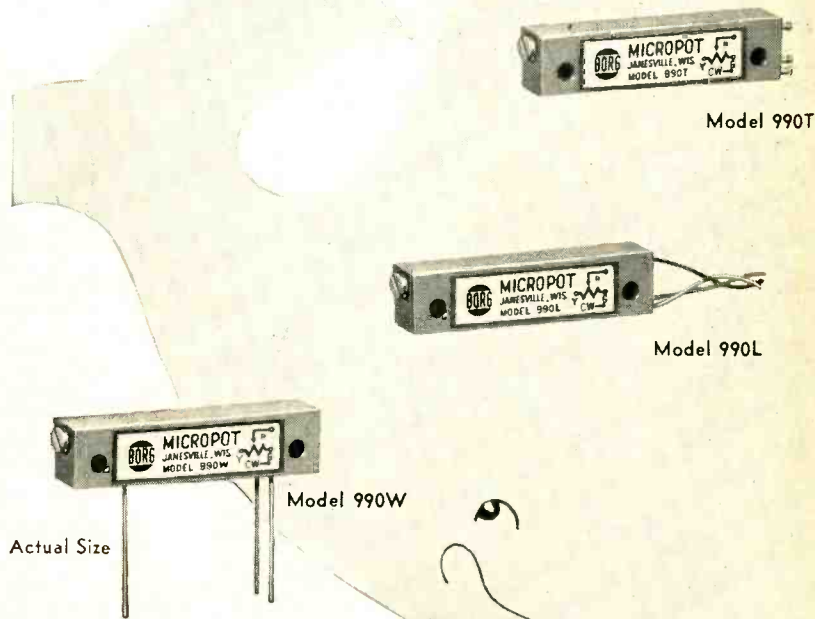

BORG TRIMMING MICROPOTS

Borg 990 Series Trimming Micropots provide accurate voltage adjustments in critical electronic circuits. Extremely small, they fit readily into subminiature circuits. They are wire wound and adjustable. Borg Trimming Micropots are protected against humidity, salt-spray, dust and other adverse environmental conditions. They can be mounted individually or stacked to give the designer the greatest possible latitude. Borg 990 Series Trimming Micropots are available with three types of terminals . . . printed circuit, soldered lug and insulated wire leads.

Write today for the name of your nearest Borg "Tech-Rep." It will pay you to know him.

Write For Complete Information . . .
Bulletin BED-A68

BORG EQUIPMENT DIVISION
THE GEORGE W. BORG CORPORATION
JANESVILLE, WISCONSIN



Built by Borg
MOTORS
MICROPOTS
MICRODIALS

ACEPOT®

SUB-MINIATURE, PRECISION, WIRE-WOUND

LINEAR POTENTIOMETERS



500 Series ACEPOT actual size

Small pot size — Big pot performance

Only 1/2" in diameter, the ACEPOT excels in a combination of all around top performance characteristics comparable to larger units. For example, these precision units feature $\pm 2\%$ resistance tolerance and $\pm 0.3\%$ independent linearity. Every potentiometer is completely sealed against sand, dust and foreign matter to avoid abrasive action between moving parts. All materials and metals are treated for maximum resistance to salt spray, corrosion, humidity and conform to shock and vibration tests. ACEPOTS are designed and assembled MIL-A-8625A, QQ-M-1512, JAN-T-152, MIL-E-5272A, MIL-R-19A, NAS-710 and MIL-R-19518 (ships).

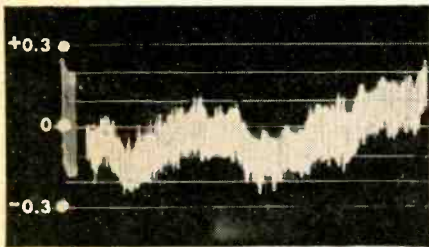

ACEPOT LINEARITY TEST

Plot of voltage ratio error versus rotation illustrates linearity to better than $\pm 0.3\%$.

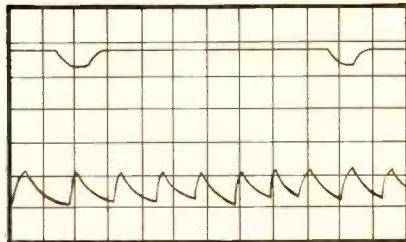

ACEPOT RESOLUTION TEST

Section of oscillograph trace of electrical resolution shows voltage change for each turn of wire.

ACE offers a wide variety of linear and nonlinear precision, wire-wound potentiometers in standard, special and AIA sizes. Custom designs to meet special requirements can be made available on short lead time. Call, write or teletype Dept. F, ACE ELECTRONICS ASSOCIATES, INC., 99 Dover Street, Somerville, Mass., Somerset 6-5130, TWX SMVL-181.

ACEPOT®
ACETRIM®
ACESET®
ACEOHM®

ACE

ELECTRONICS ASSOCIATES, INC.

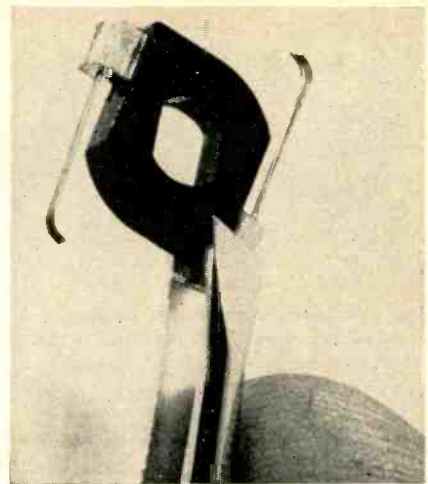

Impulse counter brush assembly using music wire, zinc and nylon emerges in one piece from casting and molding machines

music wire, 3 on a side, are spaced and aligned. Zinc alloy is die-cast around the strands, bridging them at the proper interval and making a continuous chain of cores. The strand and bridge unit becomes the insert for the molding operation, which is handled exactly like an insert casting. Black nylon is molded around the bridge, leaving only a small ear of zinc exposed on each side. The wire may be bent later to center the spring wire strands on the counter contact points. The ends of the strands are cut and bent to specification.

The brush and insert assemblies are die-cast and molded one at a time. Each part is certain to be within tolerance and any variation

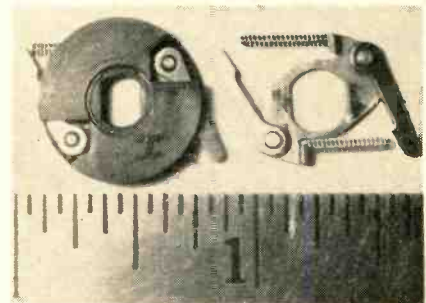

Former design required five hand-assembled parts (right) insulated with phenolic as at left



Cast zinc cores, bare at left and insulated with black nylon at right, are shown before spring wire brushes are cut and bent

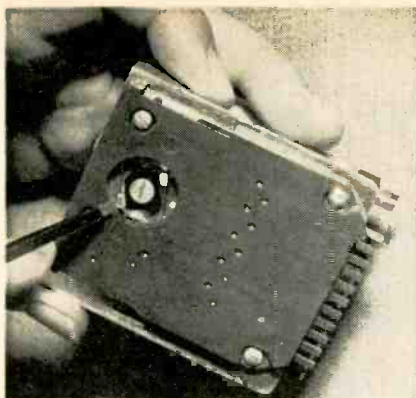

Notched tool bends ears of brush unit to center brushes on contacts in assembled impulse counter

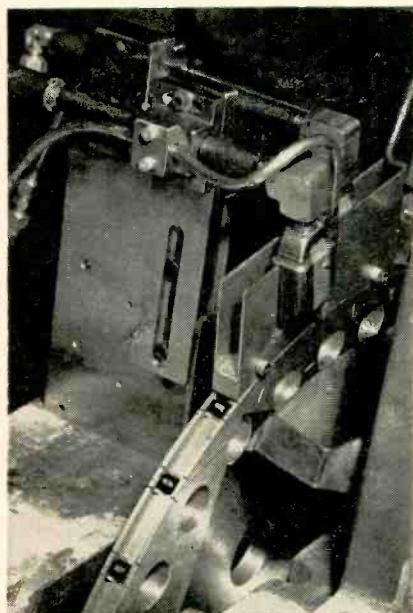

Brush tips are passed under gas flame and air jet (top center) in hardening machine after brushes are loaded into recesses on rim of vertical wheel

within specifications is the same from one part to the next so all parts fit equally well. Die changes may be made quickly.

The ends of the wire are hardened about $\frac{1}{2}$ inch to improve service life. Tips of the completed brushes are passed under a gas flame and quenched by blasts of cold compressed air. The final operation is bending the strands outward to achieve slightly higher spring pressure when inserted into the readout.

The counter is run in for 6 hours at 360 rpm. This is followed by two hours of testing at 48 v, at 20 impulses per minute and 480 rpm, followed by below-normal voltage tests, 30 v at 240 rpm.

Low noise level
Wide frequency response
High input impedance



MODEL 310A
 Price \$235

... with this BALLANTINE Sensitive Electronic Voltmeter

To measure	40 microvolts to 100 volts
from	10 cycles to 2 megacycles
with accuracy ($>100 \mu v$)	3% to 1 mc; 5% above
Shorted input noise	less than 20 microvolts
Input impedance	2 megohms shunted by 19 mmfd below 10 mv; and by 9 mmfd above

Usable as null detector sensitive to $10 \mu v$ from 5 cps to 4 mc

NOTE THE MANY USES OF THIS BALLANTINE VOLTMETER:

- Acoustic measurements
- Low level vibration measurements
- Audio amplifier tests
- Carrier telephone transmission
- Ultrasonic development
- AM broadcast band signal measurements

Write for catalog for more information about this and other BALLANTINE voltmeters, amplifiers, and accessories.

BALLANTINE LABORATORIES, INC. 

100 Fanny Road, Baonton, New Jersey

Microwaves Spur New Parts

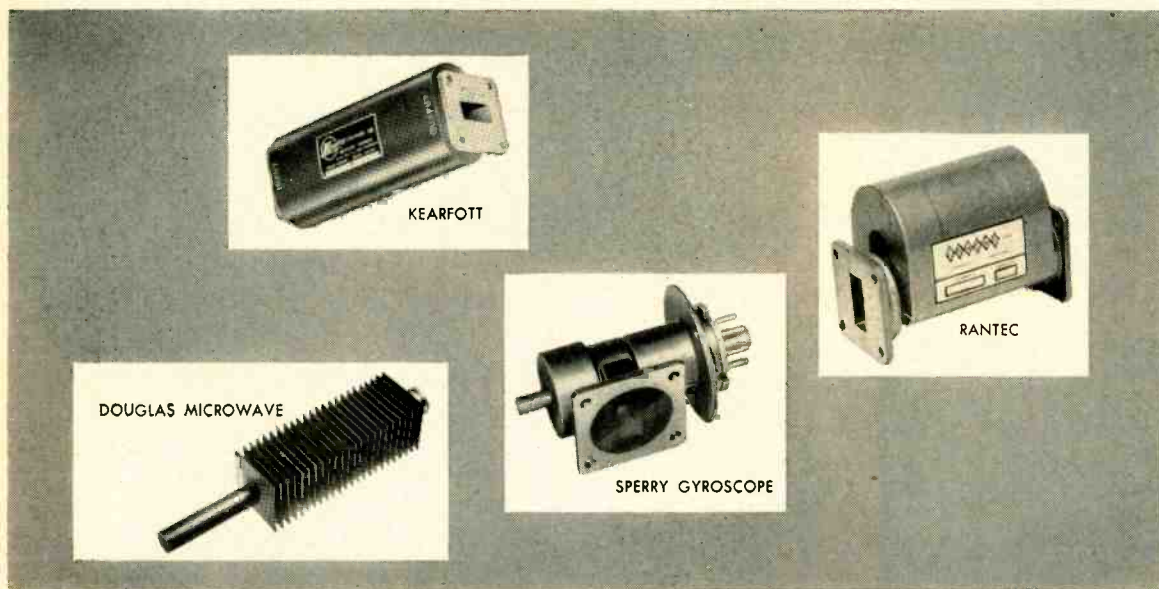

Loads, Isolators Included

Microwave systems continue to be a vital segment of the electronics industry. Versatility of the systems depends largely on equipment used. New equipment designs, in turn, rely on availability of new microwave components.

Kearfott Co., Inc., 14844 Oxnard St., Van Nuys, Calif., (275), has come out with model W177-5C1 transverse field ferrite isolator which operates over the frequency range of 8.2 to 12.4 kmc and is capable of handling an average power of 100 w. Isolation is indicated at 20 db minimum and insertion loss is only 1.3 db maximum over the entire range.

A complete line of very high power loads in both coaxial line and waveguide is announced by **Douglas Microwave Co., Inc.**, 252 E. Third St., Mt. Vernon, N. Y., (276). Recent exhaustive tests reveal these loads will take more than 75 percent of the full power capabilities of the line size used.

Rantec Corp., P. O. Box 18, Calabasas, Calif., (277), has added to its ferrite line the BX8121 load isolator. It utilizes the principle of resonant absorption of microwave energy. The unit is constructed with RG-52/U waveguide and covers the entire useful X-band frequency range from 8.2 to 12.4 kmc. It is 3.5 in. long, light-weight, rugged, and has a typical isolation of 20 db with an insertion loss of 1.0 db.

A new reflex klystron now being offered by **Sperry Gyroscope Co.**, Great Neck, N. Y., (278), features low voltage over the 8.5-10.5 kmc band. Type SRX-92 oscillator is designed for low hysteresis and high thermal stability. Applications include local oscillator in microwave receivers and spectrum analyzers, signal source in radar test sets, and low power oscillator for microwave bench work.

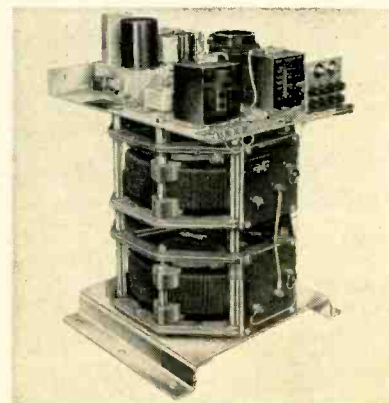

Voltage Regulator extends tube life

THE SUPERIOR ELECTRIC CO., Bristol, Conn. Features of the Stabiline automatic voltage regulator type EM10018 include the extension of life and reliability of high-priced, complex vacuum tubes in sensitive electronic equipment. Operation is fully automatic when used with external contactors and on-off controls. When the equipment is energized, the voltage to the tubes is run-up gradually to minimize the surge strain on the filaments that appreciably shorten tube life. A control circuit auto-

For more information use READER SERVICE CARD

SQUARE

away
your space
problems
with

DU MONT®

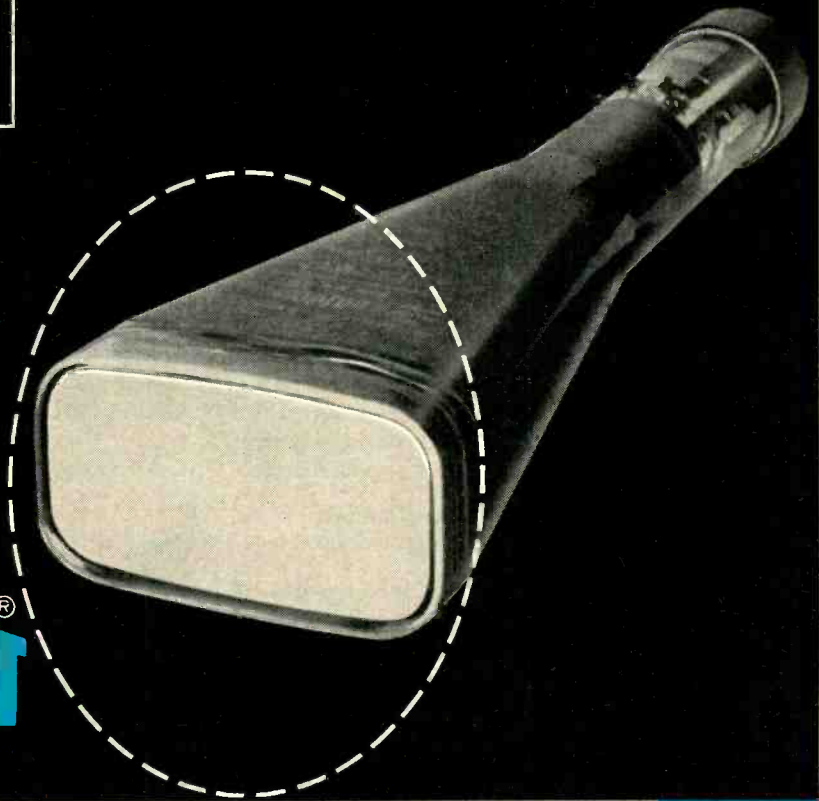

RECTANGULAR

CATHODE-RAY TUBES

Save valuable panel space by using Du Mont Rectangular Cathode-ray Tubes. These tubes permit a larger usable screen area in a given space by elimination of seldom-used segments of the circular screen.

Du Mont Rectangular Cathode-ray Tubes are available in electrostatic or electromagnetic types, in a wide range of screen sizes, shapes and materials. Write for complete technical details . . .



Rectangular screen for display of single, or superimposed patterns.



Square screen for display of two signals on a single time base.

	Tube Type	Screen Size	Focus	Deflection	Max. Anode Voltage	Length
DU MONT RECTANGULAR CATHODE-RAY TUBES	B1204	4" x 2"	Electrostatic	Electrostatic	6 KV	17"
	K1206	3½" x 3½"	Electrostatic	Electrostatic	6 KV	12"
	B1167	6" x 7"	Electrostatic	Electromagnetic	12 KV	10"
	B1194	3" x 1½"	Electrostatic	Electromagnetic	16 KV	10½"
	K1442	6½" x 6½"	Electrostatic	Electromagnetic	35 KV	12¾"

INDUSTRIAL TUBE SALES, ALLEN B. DU MONT LABORATORIES, INC., 2 MAIN AVENUE, PASSAIC, NEW JERSEY

Electro-Pulse presents

the 5100 SERIES PULSE CODE GENERATORS and Magnetic Core Testing Equipment

HIGH CURRENT ...

MEGACYCLE OPERATION

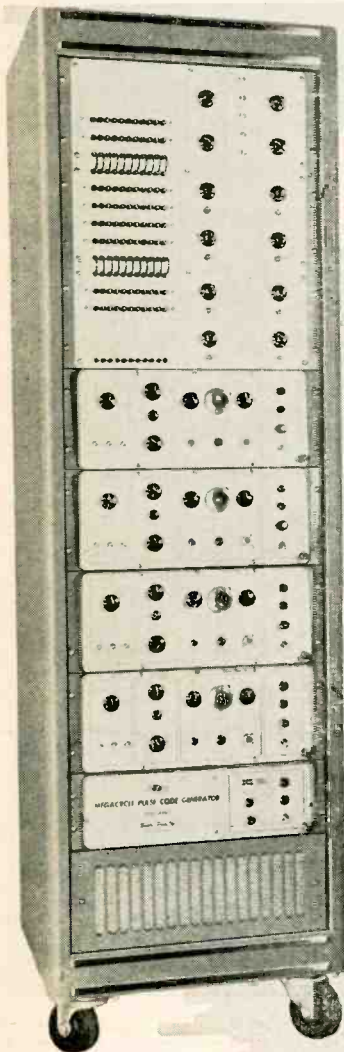

- Ten-Interval Pulse Code
- Five-Interval Controllable Repeat
- Variable Width and Delay Pulses
- Amplitude Variable to 5 Amp. per Channel—500 Mil. Avg. Current
- Independently Coded Channels
- Mixed Output—4 Channels Pos. and Neg.

Model 5100A
Four-Channel Pulse Code Generator

Designed for: Magnetic Memory Core Testing — Switch Core Testing — Magnetic Material Pulse Response Studies — Pulse Code Transmission System Design and Test — Multi-pulse Circuit Development.

The Electro-Pulse 5100 Series Pulse Code Generator has been developed to meet an increasing demand for higher clock rates and higher output currents necessary in data handling and related fields.

The flexible coding system is based on 10 intervals with controllable repeat of five intervals. Each channel Control Unit optionally selects (independently for each interval) a pulse or no pulse.

Four direct channels and two delayed channels feed four output amplifiers to form any required positive or negative code patterns, pulse current amplitudes, or waveforms with variable rise times.

Write for Complete Data: our Bulletin 5100A/E

Model 3450B
MEGACYCLE PULSE GENERATOR

- 2 mc to 200 cps
- Continuously variable pulse width and delay to 100 μ s in 3 ranges
- Simultaneous pos. & neg. pulses

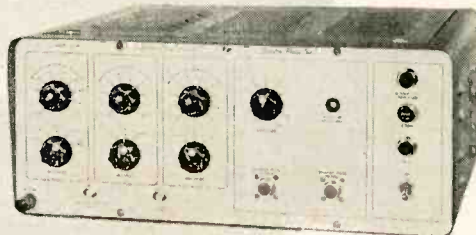

The 5100A Series and the Model 3450B are latest additions to the Electro-Pulse instrumentation line. Others: Precision Pulse Generators, Variable Pulse Generators, Time Delay Generators, Pulse Oscillators, Voltage and Current Calibrators, and Electronic Counters.

See our complete Instrumentation Display
—I.R.E. Show—Booth 3611-13

EP Electro-Pulse, Inc.

11861 TEALE ST., CULVER CITY, CALIF. • Phone: EXmont 8-6764 or TEXas 0-8006

matically actuates at the proper time to maintain a stabilized output voltage level preset to operate the equipment at its peak efficiency.

Input is 208 v \pm 10 percent, single phase, 57-63 cps. Output is 208 v nominal, 0-163 v unregulated, 163-208 v adjustable regulated, 45 amperes at 40 C ambient. Accuracy is \pm 1.0 percent for rated line and load changes.

It meets various MIL specifications including shock, vibration, corrosion, moisture, fungus resistance and utilizes various MIL materials. Circle 279 on Reader Service Card.

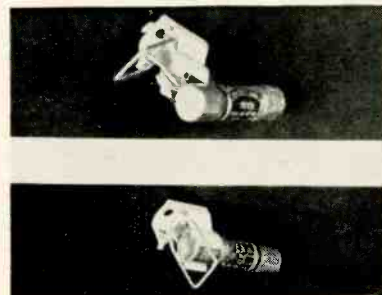

Locking Clips new sizes added

ATLAS E-E CORP., 47 Prospect St., Woburn, Mass., has added new sizes to its line of locking clips. Designed to securely hold ferrule resistors and other cylindrically shaped components under extreme environmental conditions of shock, vibration and heat, they are available in silver, nickel or cadmium plating with or without solder position lug. The clips of phosphor bronze with stainless locking springs are made to BU Ships spec RE28F 121 B. The locking springs are available with a unique device for ejecting the component from the clip.

Clips for the following diameter components are now available: $\frac{1}{8}$ in., $\frac{3}{16}$ in., $\frac{1}{4}$ in., $\frac{5}{16}$ in., $\frac{3}{8}$ in., $\frac{7}{8}$ in., 1 in. and 1- $\frac{1}{8}$ in. Circle 280 on Reader Service Card.

Varicon Connectors are subminiaturized

ELCO CORP., M. St. below Erie Ave., Philadelphia 24, Pa. Series

8000 subminiature Varicon connectors offer a maximum number of contacts in a minimum space. They feature screw-driver actuated locking devices, guide pins, floating mounting holes, and coaxial contact arrangements as optional accessories.

Presently available in 16, 40 and 48 contact units, contact units of 8, 24, 32, 64 and 80 will ultimately be offered—built up of 8 and 16 contact modules.

Insulator materials now available are general purpose or mica filled phenolic, Resinox 3700, and diallyl-phthallate. Other materials may be supplied on request. Excellent contact characteristics with low contact resistance are assured.

Current rating is 5 amperes; contact resistance, 0.002 ohm; and insulation resistance (dry), 25,000 megohms minimum. Circle 281 on Reader Service Card.



V-R Power Supply fully transistorized

KEPCO LABORATORIES, INC., 131-38 Sanford Ave., Flushing 55, N. Y., has released a new dual output completely transistorized voltage regulated power supply, model 28C-32-1.5. Each output of the dual unit delivers 0 to 32 v at 1.5 amperes continuous duty. Regulation for line or load is less than 0.03 percent or 0.003 v, whichever is greater. Ripple is less than 3 mv rms. Recovery time is less than 50 μ sec. Stability for 8 hours is less than 0.03 percent or 0.003 v, whichever is greater. Resolution of 0.005 percent is obtained with a 10-turn voltage control making the output voltage continuously variable without switching. External overload and short circuit protection are included. Either positive

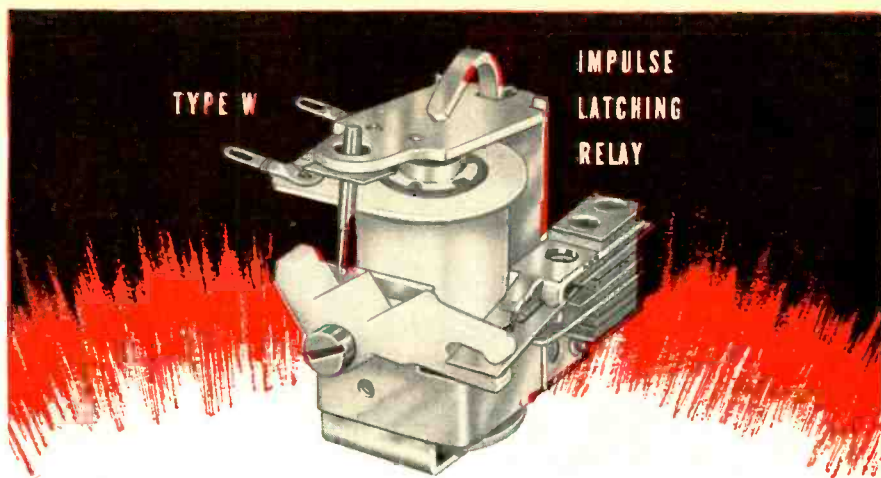

Features an insulated rocker arm activated by a single coil, instead of the usual two. Ideal for machine controls, appliances, positioning devices, remote TV controls and other applications where opposite switching is desired each time circuit is pulsed. Contact combinations up to 4 "C"; rated 7½ amperes @ 115 V. AC resistive.

NEW RELAYS

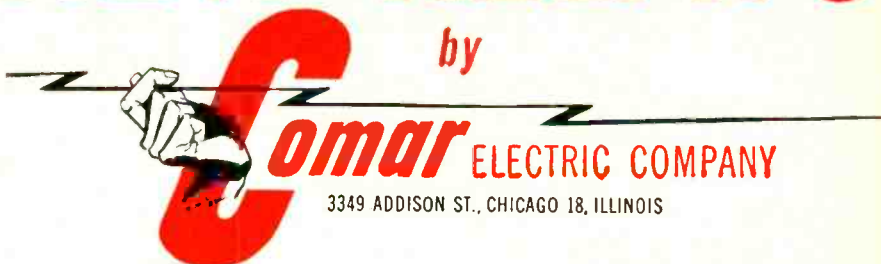

Suitable for use in a wide range of applications. For AC or DC operation. Compact size, lightweight. Shock and vibration resistant. Positive contact pressure. Contact combinations up to 3 "C". Contact rating, 5 amp. resistive with 5/32" dia. (10 amp. with 3/16" dia.). Available open, or in plastic dust covers with plug-in feature, as illustrated. Send For Details

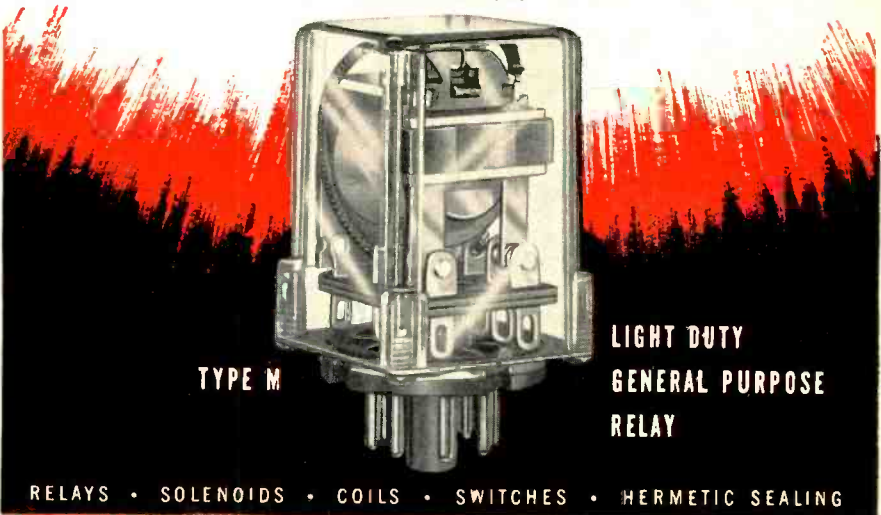

RELAYS • SOLENOIDS • COILS • SWITCHES • HERMETIC SEALING

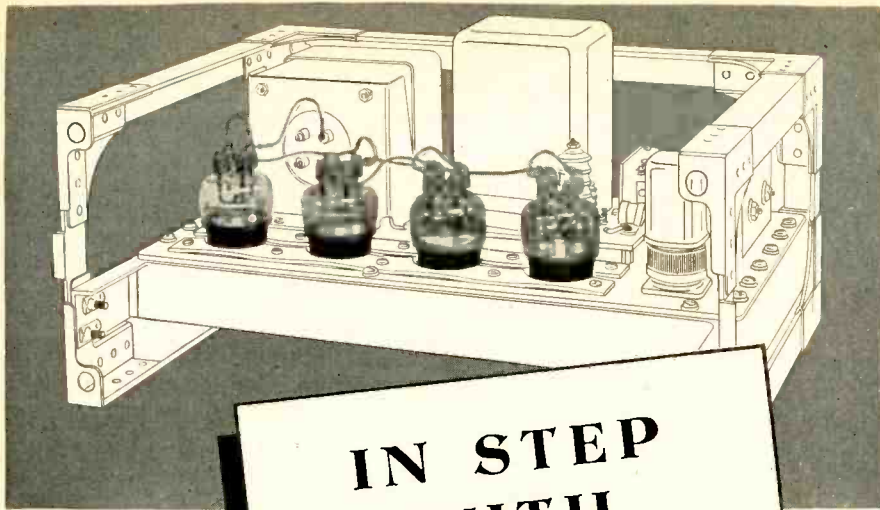

**IN STEP
WITH
PROGRESS**



JENNINGS VACUUM RELAYS

Our Country's missile development program has created demands for relays that must far exceed in performance any previous requirements. Jennings vacuum relays are being used in both the missiles and their checkout and guidance systems for their exceptional reliability under difficult operating conditions.

Four Jennings RE2 vacuum relays are used in part of a missile checkout system manufactured by Jefferson Electronic Products Corporation under contract to Sandia Corporation. In this application it is necessary that the relay reliably switch extremely small "dry circuit" voltages and currents with the entire circuit operating at a high voltage potential with respect to ground.

Jennings RE2 vacuum relay handles these requirements with ease. High vacuum processing permits all parts to be thoroughly degassed and absolutely free of any contaminants that would cause contact resistance to change from one operation to the next. The best electrical grades of borosilicate glass and alumina ceramic are used to minimize leakage by providing over one million megohms insulation resistance in the presence of high voltage. A relatively long external glass path maintains a high resistance to ground in dusty or humid atmospheres.

The R2E relay, rated at 10 kv, 10 amps rms, is also used to switch aircraft antennas and pulse forming networks. All relays are tested during vibration to insure adequate contact pressure and reliable operation.

Jennings manufactures a wide variety of vacuum relays for operation at both high and low voltage levels. Whether they be used in commercial or military equipment, they have been engineered to satisfy requirements that cannot be easily met with conventional relays.

Write for details on the RE2 and other Jennings transfer relays available now in production quantities.



JENNINGS RADIO MANUFACTURING CORPORATION - 970 McLAUGHLIN AVE. P.O. BOX 1278 - SAN JOSE 8, CALIF.

or negative may be grounded. Units can be connected in series.

The power supply is suitable for square wave pulsed loading. Power requirements are 105 to 125 v, 50 to 400 cps. Voltmeter and ammeter are provided. The compact unit is 19 in. wide, 7 in. high and 11 in. deep. Circle 282 on Reader Service Card.



Power Pentode delivers extra-high output

AMPEREX ELECTRONIC CORP., 250 Duffy Ave., Hicksville, L. I., N. Y. Type 6BQ5A tube is a nine-pin, miniature power pentode designed primarily for use as a class B power amplifier in hi-fi audio equipment of over 20 w capabilities.

The 6BQ5A delivers 24 w output with only 4-percent distortion. It incorporates internal construction improvements making for higher power output with less distortion.

Detailed data and applications engineering information are available. Circle 283 on Reader Service Card.

Voltage Standard and null meter

KIN TEL, A Division of Cohn Electronics, Inc., 5725 Kearny Villa Road, Box 623, San Diego 12, Calif. Model 301R is a compact adjustable d-c voltage standard and null voltmeter designed for mounting in standard 19-in. racks. Direct

reading calibrated dials provide instant voltage selection with standard cell accuracy. A chopper stabilized circuit constantly compares the output with an internal standard cell to provide stability, accuracy and excellent dynamic characteristics. Power supply output voltage is 1 to 501 v. It has 4 decades null meter ranges from 50 v to 50 mv full scale. The meter can also be used to read input voltage or the output voltage of the supply.

Model 301R, which has a wide variety of applications, features 0.01 percent stability, 0.02 percent accuracy, 0.002 percent line and load regulations, less than 100 μ V ripple, 0.2 millisecond response time, and less than 0.01 ohm output impedance. Circle 284 on Reader Service Card.



Accelerometer features simple design

CLARK ELECTRONIC LABORATORIES, Box 165, Palm Springs, Calif. A new accelerometer is 0.50 in. in diameter by 2.1 in. long and weighs 38 grams. It operates on the principle of increasing pressure, on a Celab special load cell—simplest design for sensing acceleration. A manual adjustment provides a resistance change between 10 and 1,000 ohms per G and a lock nut for holding this adjustment. As the unit has no moving parts or aging characteristics it is considered of the utmost reliability.

A rating of 1 w provides sufficient power to indicate directly on a meter system without the use of amplifiers. While the unit shown

For 0.035% Accuracy
in your Airborne Data...

...Giannini DATA REPEATERS

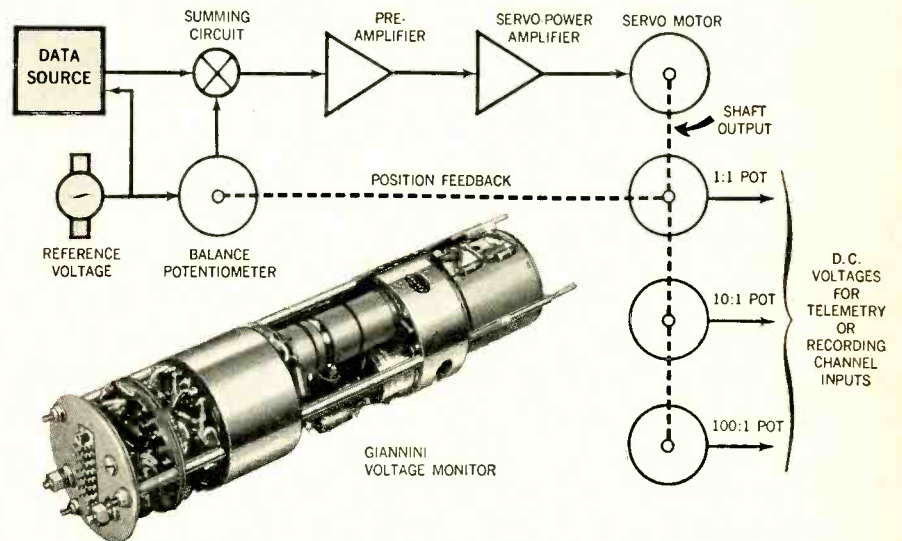

GIANNINI PRECISION VOLTAGE MONITORS are Data Repeaters which utilize the scale multiplying technique. They have an inherent accuracy of 0.035% under all conditions, and repeatability of one part in ten thousand. This is the first time that such accuracy has been possible in a small (2¼" x 9") unit capable of withstanding the extreme environments of airborne operation.

THE PRECISION VOLTAGE MONITOR alters a transducer or control system signal so that data relayed to the telemetering or recording system is less susceptible to system errors. A unit designed for incorporation in the airborne telemetering system of Chance Vought's Regulus II results in telemetered data with approximately 0.04% overall error. This figure is conservative, and includes the effects of all unit error sources such as hysteresis, linearity, temperature effects, and long term drift, as well as telemetering system error.

A VOLTAGE MONITOR CONVERTS AC output signals from an airborne data source into 3 DC voltages, representing the data to three or more significant figures. These three separate units of information are fed into the telemetering or recording system on three separate channels. The result is transmitted information with an accuracy of four or five significant figures.

WITHOUT CHANGING THE CIRCUITRY of the transmitting system in any way, errors incurred in transmittal are restricted to the fourth or higher order significant figures.

Designed to satisfy the extreme environmental demands of aircraft and missile data systems, Giannini Precision Voltage Monitors are also readily adaptable to other airborne or industrial applications requiring precise voltage monitoring, data repeating, or data multiplexing. They are available in voltage ranges from 0.0 to 0.8v to 0.0 to 100.0v, and sizes from 2¼" x 6" to 2¼" x 9".

Giannini measures & controls:

ω	β	θ	ψ	τ	v	ϕ
δ	Ω	α	h	P	ΔP	T
T_s	P_s	Q_c	M	T_o	P_T	TAS

PRECISION
INSTRUMENTS
SYSTEMS & CONTROLS

Giannini

G. M. GIANNINI & CO., INC., 918 EAST GREEN STREET, PASADENA, CALIF.

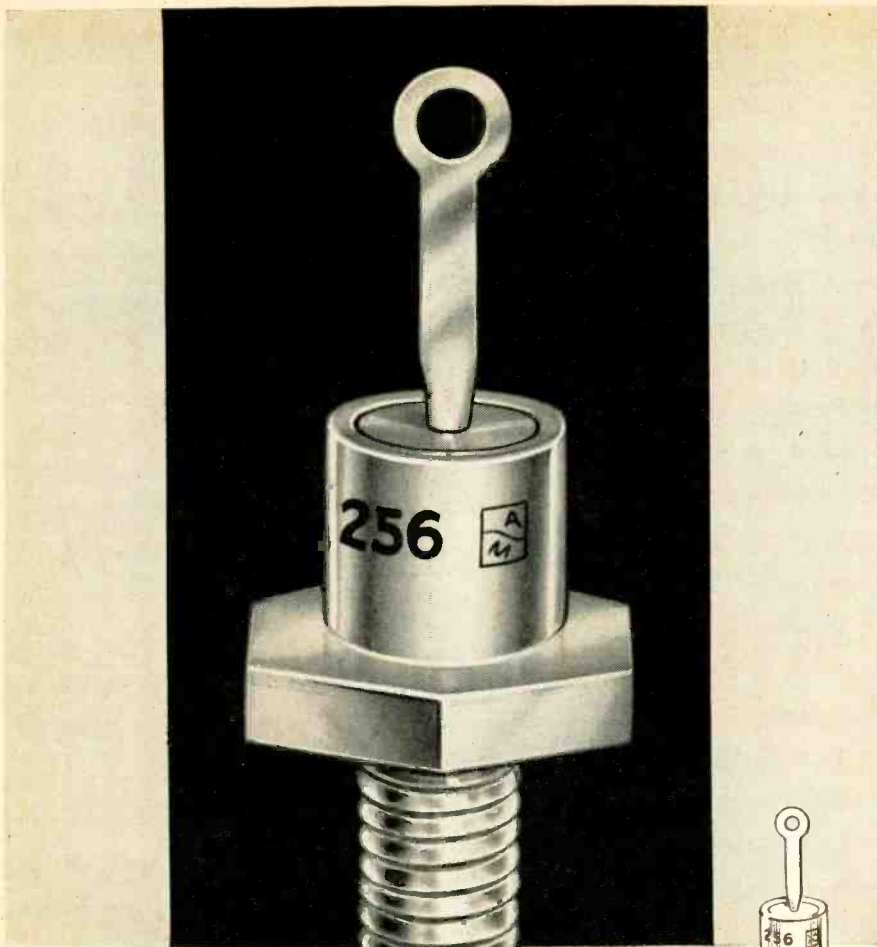

New!

actual size



SILICON POWER RECTIFIERS

53 TYPES including military 1N253, 1N254, 1N255 and 1N256

- 200 ma to 1 amp current capability.
- Voltage ratings from 50 to 1000 vd-c.
- Reliable operation at 150°C.



Send for
bulletin 58R...

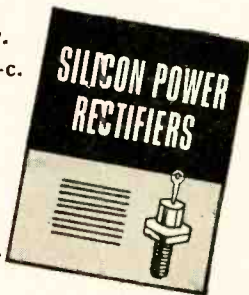

MICROWAVE ASSOCIATES INC.

Burlington, Massachusetts

BRowing 2-3000

weighs 38 grams, it can be further miniaturized by about 5 times if required. Its temperature limit is 500 F, but this is expected to be extended considerably in time. Circle 285 on Reader Service Card.



Telemetry Supply regulated dual output

POWER SOURCES, Inc., Burlington, Mass., has available model PS-1010 regulated dual output telemetry supply. The completely transistorized unit occupies less than 58 cu in. and provides 2 outputs each regulated to within ± 2 percent, 180 v at 0-70 ma and 108 v at 0-85 ma. Ripple on both outputs is below 100 mw.

Regulation will hold over an input of 28 v d-c ± 8 percent and any combination of loads from 0 to full load. The unit is capable of continuous operation under conditions of 100 g shock, 150 zero to 2,000 cps vibration, and sustained accelerations of 100 g. It has an operating temperature range of -55 C to $+85$ C. The unit is designed to operate with a heat sink mounting temperature of 185 C during its final 30 seconds of flight. Circle 286 on Reader Service Card.

Power Pulser no moving parts

TORWICO ELECTRONICS, Inc., 1090 Morris Ave., Union, N. J. A 1-f power interrupter incorporating a specially designed magnetic amplifier involving no thermal or mechanical devices has been added to the Tynmag line.

The magnetic power pulser is extremely rugged since no heaters or moving parts are involved. It will

operate with high reliability and long life with minimum maintenance. The pulser operates on a 60 cps or 400 cps line and is entirely self exciting. It can be provided to pulse a 60-cps line at rates from 1 cycle per minute to 3 cps. On 400 cps it can pulse from 1 cpm to 60 cps. External adjustment can be provided over approximately an 8 to 1 range.

Power output can be provided up to 100 w d-c. Higher power up to 10 kw a-c can be pulsed with the addition of a supplementary saturable reactor. Size is dependent on power rating.

Pulsing is free from steep wavefronts and develops no h-v transients, arcing, or radio interference signals. No biasing, starting mechanisms, or warmup time are required. Ambient temperature range is - 55 C to + 100 C. Circle 287 on Reader Service Card.

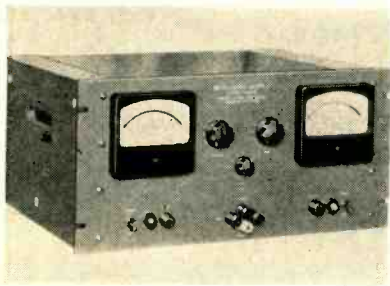

Regulated Supply for transistor circuitry

DRESSEN-BARNES CORP., 250 North Vinedo Ave., Pasadena, Calif., has announced a closely regulated d-c power supply designed for use in transistor research and development, in transistor testing, and original equipment. The unit meets recently-arisen industry demands for heavier-current output, low ripple and low draft in a power supply.

Output is 0 to 60 v d-c, continuously variable, at 300 ma maximum. No derating of output current, or of regulation and ripple specifications, is necessary from 1 to 60 v d-c.

Regulation for 60 v/300 ma load is 20 mv change, no load to full load. For line voltage change of 105 to 125 v a-c (at 60 v/300 ma output), regulation is 20 mv change

4 Ounce Contact Force Gives Relay Reliability

Contact force of 4 ounces per contact on 50 "G" models and 2 ounces per contact on 30 "G" models of "Diamond H" Series R and Series S miniature, hermetically sealed, aircraft type relays is one of the most important factors in their proven high reliability.

Though absolute reliability of any similar device is impossible to guarantee—a bitter fact of life recognized by all electronic engineers—close approach to this goal by the relays manufactured by

The Hart Manufacturing Company is the basic reason they are found today on many of this country's headline-making missiles.

In addition to contact force far beyond that found on other relays, "Diamond H" relays have greater contact cleanliness. Self-contamination is virtually eliminated by a completely inorganic switch mechanism, as well as use of coil materials which will not dust, flake or out-gas.

Finally, the high degree of reliability that is designed into these relays is maintained in their manufacture by high quality workmanship and a stringent inspection policy at every stage.

In addition to missiles, and their ground control systems, Series R and S relays are designed for use in jet engine controls, computers, fire control, radar and similar critical applications.

4PDT units, they offer an extremely broad range of performance characteristics, including temperature ranges from -65° C. to 125° and 200° C.; ratings to 10 A., 120 V., A. C., and 26½ V., D. C., with special ratings to 400 ma. at 350 V., D. C., or down to millivolts and milliamperes. Dry and wet circuits may be safely intermixed.

For more information, write today for Bulletins R250 and S260. For quick facts about "Diamond H" switches, thermostats and other devices, ask also for a copy of the "Diamond H" Check List of Reliable Controls.



THE **HART** MANUFACTURING
COMPANY

202 Bartholomew Ave., Hartford 1, Conn.
Phone JACKSON 5-3491

from Magnet Charger

HEADQUARTERS

MODEL 942

*Recommended
by Leading
Magnet
Makers*

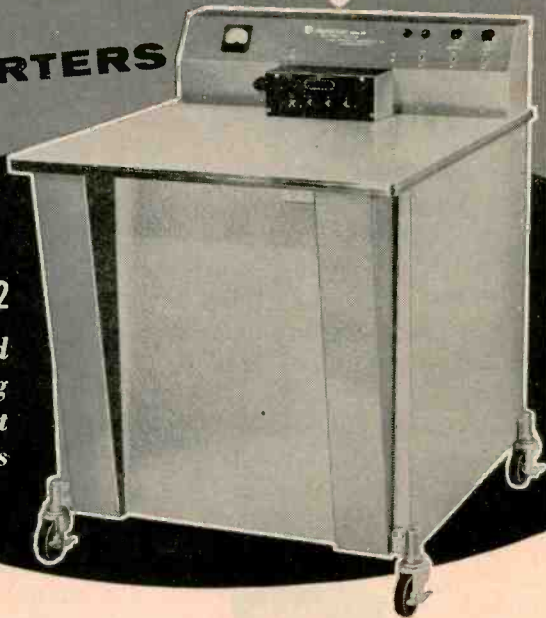

**3
VERSATILE
MODELS**



MODEL 107A

For saturating Alnico magnets weighing up to 34 lbs. and high flux ceramic magnets of any shape or pole configuration. Operates on condenser discharge principle from regular 115-volt, 60-cycle line.

Charging outputs from 100,000 to 200,000 ampere-turns through plug-in transformers, up to 3600 watt-seconds using wire-wound fixtures. Adapters for multi-pole rotors, rod, bar, ring and various other shapes available. Designed for continuous production use with low power consumption. Price of basic unit is less than \$2100.

A basic condenser discharge unit for most medium size magnets, the Model 107A provides ranges of 12,000 and 24,000 ampere-turns. It is capable of saturating most instrument magnets, including the new core type mechanisms, using adapters or wire-wound fixtures. Designed for continuous duty. Operates from 115-volt, 60-cycle line. Price \$530.



MODEL 1221

A low cost, condenser discharge unit employing novel, plug-in wire-wound type charging fixtures, the Model 1221 is designed for the user of small magnets. Its 10,000 ampere-turn output will saturate about 2" of Alnico V. Charging cycle rate is approximately 3 seconds, continuous duty, operates from 115-volt line. Price \$180.

Performance of all models is rigidly guaranteed. Prices are net f.o.b. Boonton, N.J. and subject to change without notice.



12 years' magnet charging experience is yours for the asking—send for illustrated data sheets.



**Radio Frequency
LABORATORIES, INC.**
Boonton, New Jersey, U. S. A.

in output voltage. Ripple and internal noise are below 1.5 mv rms. The unit is designed for very low output impedance and fast recovery time. One-percent meters are provided.

Designated as model .6-300B, the instrument is built to fit in a standard 19 in. relay rack. Circle 288 on Reader Service Card.



Mica Capacitors low price units

GENERAL RADIO Co., 275 Massachusetts Ave., Cambridge 39, Mass. Type 505 mica capacitors are adjusted to ± 0.5 percent and are packaged in a less-expensive case than the company's standard capacitors. They are available in a 1-2-5 series extending from 100 μmf to 0.5 μf . Dissipation factor for the 1,000- μmf and higher sizes does not exceed 0.0003. Capacitors are housed in low-loss molded-phenolic cases and are equipped with both screw- and lug-type terminals and mounting flanges. Circle 289 on Reader Service Card.



Voltage Regulator magnetic amplifier type

PERKIN ENGINEERING CORP., 345 Kansas St., El Segundo, Calif. Model MIR-3000 is a magnetic amplifier regulated 3 kva tubeless a-c line voltage regulator. It con-

tains no moving parts or vibrating contacts, and regulates the rms value. Input voltage range over which the unit operates within specifications is 95-135 v, and the output voltage is 115 v nominal adjustable from 110-120 v.

Regulation accuracy is ± 0.50 percent for any combination of line and load changes and the frequency range is 60 cps ± 10 percent. Wave form distortion is 3 percent maximum, and power factor range is 0.7 lagging to 0.9 leading. Maximum load is 3.0 kva and response time is 0.1 to 0.2 sec. The unit, representing the ultimate in reliability, is ideally suited for laboratory and production testing, and is especially designed for remote unattended installations. Circle 290 on Reader Service Card.

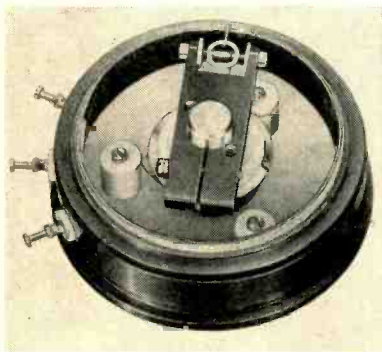

Potentiometer dynamic balance design

CHICAGO AERIAL INDUSTRIES, INC., 1980 Hawthorne Ave., Melrose Park, Ill. The 1000 series pots incorporate dynamic balance which enables mechanical performance to match electronic precision. Standard linearity is 0.1 percent, 0.2 percent for miniatures.

The concept of dynamic balance centers around the contact. The arm is rigidly clamped and dynamically balanced with respect to the shaft. The small, light and rigid contact assembly is mounted in jeweled pivot and is dynamically balanced with respect to the arm. Because of dynamic balance only very light spring pressure is needed to assure constant contact with the winding even under the most severe environmental conditions.

Performance-wise the 1000 series

5 watt capacity - 2 watt size

Centralab ^{CRL} MODEL 4

Miniature Wirewound Radiohms [®]

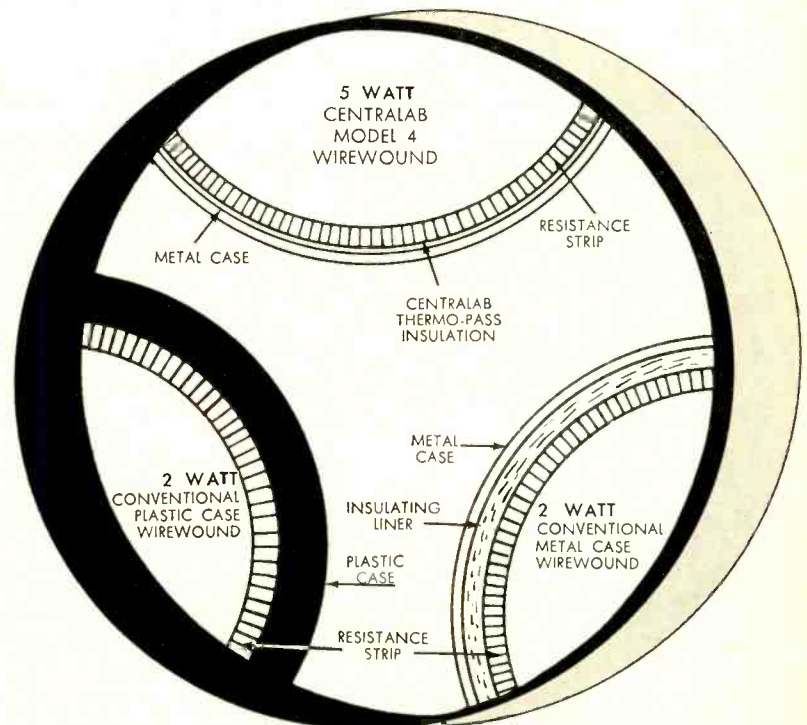

As you know, the rating and size of a variable resistor depends upon the speed with which heat can be transferred from the resistance element to the atmosphere. Centralab "thermo-pass" insulation combines exceptional heat transfer with a dielectric strength of 4500 volts per mil at 25° C. Result: Model 4 Radiohm, a conservatively rated 5 watt wirewound variable resistor smaller than a conventional 2 watt unit.

- Only $1\frac{3}{32}$ " diameter by $\frac{9}{16}$ " deep.
- Resistance range, 1 ohm to 15K ohms; linear taper.
- 295° rotation, stop strength 15 inch pounds.
- Minimum life, 25,000 complete cycles.
- Totally enclosed elements.

For detailed information write for Centralab Engineering Bulletin EP-493 or contact your Centralab sales representative. Ask your local distributor about the many values he carries in stock in the WW and WN series (listed in Catalog 30).

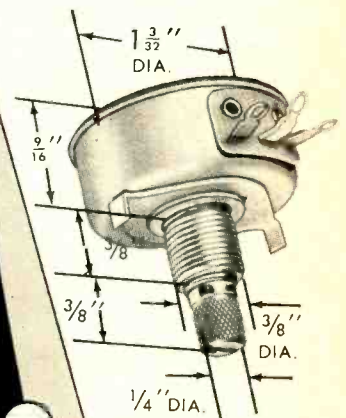

ACTUAL SIZE

Centralab ^{CRL}

B-5810 [®]

A DIVISION OF GLOBE-UNION, INC
9148 E. KEEFE AVE. • MILWAUKEE 1, WIS.
In Canada: 804 Mt. Pleasant Rd. • Toronto, Ontario

VARIABLE RESISTORS • PACKAGED ELECTRONIC CIRCUITS • ELECTRONIC SWITCHES
CERAMIC CAPACITORS • ENGINEERED CERAMICS • SEMI-CONDUCTOR PRODUCTS

The **LARGEST** Selection of the **SMALLEST** **ELECTROLYTICS**

is available from AEROVOX!

...and only from Aerovox can you choose from the widest selection of case styles and constructions in a complete range of low-voltage values. For small space applications... for transistorized assemblies... **ALL** your requirements for miniature electrolytic capacitors are available from Aerovox.

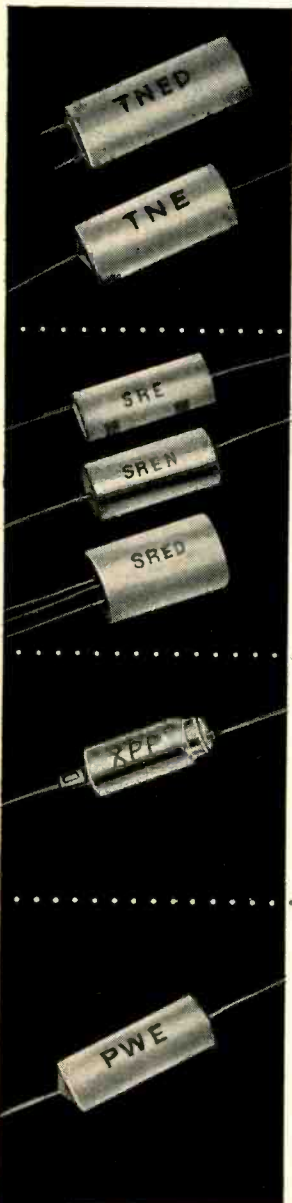

TYPES TNE & TNE

Preferred type subminiature electrolytics where cost, small size and long operating life are of prime importance in transistor assemblies. These tiny, low-impedance, low power factor units are furnished in film-lined glossy tubes with plastic end seals. Available in standard voltage ratings of 3 to 50 vdc with operating temperature range of -30°C to $+65^{\circ}\text{C}$. Leads are firmly imbedded in plastic end seal and will not pull out or work loose under the most severe operating conditions. Color coded end-fill and case marking denotes positive terminal.

TYPES SRE, SREN, AND SRED

Improved electrolytics especially suitable for cathode bypass applications, screen circuit filters and transistorized assemblies. Units tightly sealed in tubular aluminum cases available with external wax-impregnated cardboard insulating tube. Exclusive end-seal provides greater creepage distance and assures positive electrical and mechanical contact. Standard dc voltage ratings from 3 to 150 volts. Operating temperatures from 0°C to 85°C .

TYPE XPP

Miniature, hermetically-sealed, metal-cased tubular aluminum units designed specifically for maximum life where size and weight must be kept to a minimum. Exceptional shelf-life characteristics. Standard voltage ratings of 1 to 5 vdc and standard temperature range from -20°C to $+65^{\circ}\text{C}$. Available with axial leads only.

TYPE PWE

Miniature electrolytics encased in dense steatite tubes with special plastic end fill. Offering high capacitance at low voltages, these units are capable of handling full-size loads in industrial applications. Standard voltages from 1 to 50 vdc and standard operating temperatures from -20°C to $+50^{\circ}\text{C}$.

For detailed technical information write...

AEROVOX CORPORATION

NEW BEDFORD, MASS.

In Canada: AEROVOX CANADA LTD., Hamilton, Ont.
Export: Ad. Aurilma, Inc., 89 Broad St., New York, N. Y. • Cable: Aurilma, N. Y.



meet and surpass NAS-710. A 5,000,000 cycle life, 2,000 cycle vibration at 30 g's, and speeds from 1,000 to 3,425 rpm (depending on size) are standard.

The pots are produced in six sizes from $\frac{5}{8}$ in. to 3 in. Mechanical rotation is 360 deg continuous, but phaseable stops are available. Operation up to 225°C is available and 165°C is standard. Circle 291 on Reader Service Card.

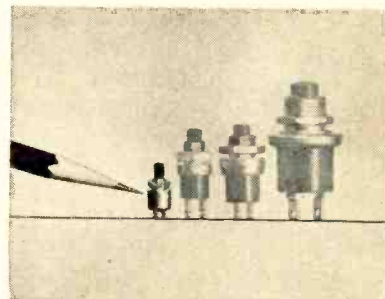

Push-Button Switch ultraminiature type

GRAYHILL, INC., 561 Hillgrove Ave., La Grange, Ill., Series 39-1 ultraminiature push button switch is a spst, momentary contact, normally open model, conservatively rated 1/10 ampere at 115 v a-c resistive. Life expectancy is rated at 200,000 operations minimum at the rated load.

The switch is 0.250 in. diameter, has an overall length of 0.615 in., with 0.315 in. behind the panel, including the soldering terminals. It is designed for use with $\frac{1}{16}$ in. panels and requires a $\frac{3}{16}$ in. hole for mounting. The red push button has approximately $\frac{1}{2}$ in. movement. Circle 292 on Reader Service Card.



Degausser for tape erasure

CINEMA ENGINEERING, DIVISION
AEROVOX CORP., 1100 Chestnut

St., Burbank, Calif., is marketing its No. 9205-A commercial tank-type degausser for erasing program material and residual noise from magnetic tape and film. In two powerful magnetic fields it degausses up to 5,400 ft of ¼ in. tape and 1,000 ft of 35 mm film.

The degausser was designed especially for industrial use with heavy duty double fuse and double pole switch. The copper and iron used in the demagnetizing coils are engineered for heavy industrial usage. Unit is equipped with rubber feet for bench use and operates from standard 115 v, 60 cycle power source.

Model 9205-A has black phenolic top with locating spindle; degaussing being accomplished by rotating reels by hand on top of surface of unit.

Besides the degausser the factory also produces a magnetic erasing pencil, type 8905, for use when a relative limited area of magnetic tape or film must be erased. Circle 293 on Reader Service Card.



Transistor Amplifier wide band, low noise

ELECTRO-VOICE INC., Buchanan, Mich., announces the model 6000 Dec-Amp. Four selected transistors in a highly stable circuit, together with precision components, result in an instrument exhibiting exceptionally low inherent noise. Amplification accuracy is unaffected by normal battery voltage reduction or changes in ambient temperature. The Dec-Amp is powered by a self-contained mercury battery which permits a small, neat portable design. It has numerous applications in laboratory, field or production.

Available gain is either X10 or

From ANY point

...it's HAYDON* for timing devices

If you're looking for a complete product line that includes Timing Devices for every application requirement and, in addition, features the highest quality and most advanced design at the lowest possible cost, HAYDON has it! And all Haydon timing devices incorporate the famous Haydon hysteresis and/or inductor timing motors available for 50, 60, and 400 cycle and DC power supplies.

If you're looking for a complete service to meet all your timing needs, HAYDON offers fully integrated engineering and manufacturing facilities ready to take your timing projects right through from design and development to finished product!

And if you're looking for a complete Field Engineering Service to make all these facilities conveniently available, you'll find there's a HAYDON Timing Specialist in your area, a man fully qualified by training and experience to help fill your Timing Device needs. Why not phone him today and make an appointment to discuss your requirements?

*Trademark Reg. U.S. Patent Office

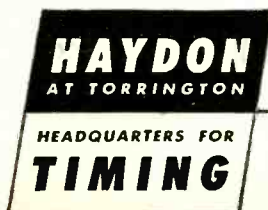

A SUBSIDIARY OF GENERAL TIME CORPORATION

HAYDON Manufacturing Company, Inc.
2426 ELM STREET, TORRINGTON, CONN.

MARCONI

FM/AM SIGNAL GENERATOR

**Model
995A/2**
for both
r.f. and i.f.
testing
with c.w.,
f.m., a.m., or
simultaneous
f.m. and a.m.

The MARCONI Signal Generator Model 995A/2 is an accurate and dependable instrument of broadest applicability. It covers from 1.5 to 220 Mc in five bands and there are facilities for crystal standardization from 13.5 Mc upwards. A precision slow-motion mechanism is employed for the main tuning drive and, for making bandwidth measurements, there is a separate directly-calibrated incremental control. The open-circuit output level is variable, in 1-dB steps, from a minimum of 0.1 microvolt to a maximum of 100 millivolts at 52 ohms and 200 millivolts at 75 ohms. The output may be continuous wave, frequency modulated, amplitude modulated, or simultaneously both frequency and amplitude modulated. The modulation, obtained either from an internal 1000-cps oscillator or from an external source, is variable to maximum frequency deviations ranging from 25 to 600 kc for f.m., and to depths up to 50% for a.m. Send for leaflet B/115B for full details.



Marconi for f.m. test gear

**MARCONI
INSTRUMENTS**

111 CEDAR LANE
ENGLEWOOD
NEW JERSEY

Telephone:
LOwell 7-0607

CANADA: CANADIAN MARCONI COMPANY · 6035 COTE DE LIESSE
MONTREAL 9

MARCONI INSTRUMENTS LTD · ST. ALBANS · HERTFORDSHIRE · ENGLAND

X100 from 10 cps to 1 mc ± 0.2 db. Input impedance is 50,000 ohms shunted by 8 μf , and output impedance is 150 ohms. Maximum noise referred to the input for a 1 mc bandwidth is 50 μv . Maximum output at less than 0.5 percent total harmonic distortion is 1.0 v, rms; battery life, 300-500 hours. Overall size is 3 $\frac{3}{4}$ high by 2 $\frac{1}{2}$ wide by 5 $\frac{1}{2}$ deep. Circle 294 on Reader Service Card.

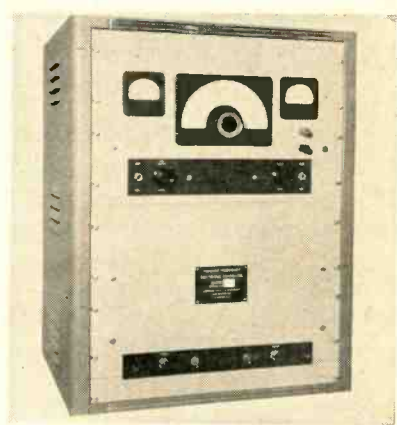

Power Generator ultrasonic type

COMMUNICATION MEASUREMENTS LABORATORY, INC., 350 Leland Ave., Plainfield, N. J. Model 1432-U ultrasonic power generator is of 500 va capacity. It is one of a group of generators in the ultrasonic field which cover a power output range of from 25 va to 2 kva.

All units in this line can be supplied to cover discrete portions of the 5 to 50 kc range with a frequency spread ratio of 3.6 to 1. Common ranges are 10 to 36 kc or 15 to 50 kc. Output voltage regulation is normally within 10 percent from full load to no load, however 3 percent regulation can be supplied on order. Harmonic content of the waveform is low.

Various output impedance ranges are available. Circle 295 on Reader Service Card.

Carrier Equipment five extra channels

BUDELMAN RADIO CORP., 375 Fairfield Ave., Stamford, Conn., is producing their latest improved

TC115

telephone carrier current equipment, type 16B. Designed specifically to provide a low-cost rural telephone carrier expansion of five additional channels (50 new subscribers to an existing wire pair), the type 16B utilizes thoroughly tested double sideband a-m circuits. A complete channel (10 new subscribers) can be installed in as little as four hours on a "connect" and "operate" basis.

A complete channel of carrier consisting of both terminals (central office and subscriber) together with essential accessories, in many cases costs less than poles, wires, labor and supplies for open wire line construction. Without accessories, a complete type 16B channel with selective ringing costs only \$735. Circle 296 on Reader Service Card.



Carrier System features portability

NORTHAM ELECTRONICS, INC., 2420 North Lake Ave., Altadena, Calif., has developed a new single-channel portable 3 kc carrier system, model PCS-1, designed for use with variable reluctance transducers. Weighing only 10 lb the PCS-1 includes a 3 kc oscillator to excite the transducer coils, a full wave transistor switch demodulator and a panel meter to indicate transducer output.

An auxiliary is the model F-1 filter, which may be plugged into the basic carrier unit to provide a suitably filtered output for driving such readout instruments as oscilloscopes, oscillograph, strip-chart and pen recorders. There is an additional output jack available to permit operation of a remote meter as another alternative readout.

Specifications of the PCS-1 call for a regulated excitation voltage from the oscillator of 10 v rms at

Leading rectifier manufacturers select TUFF-TUBE to meet specifications...

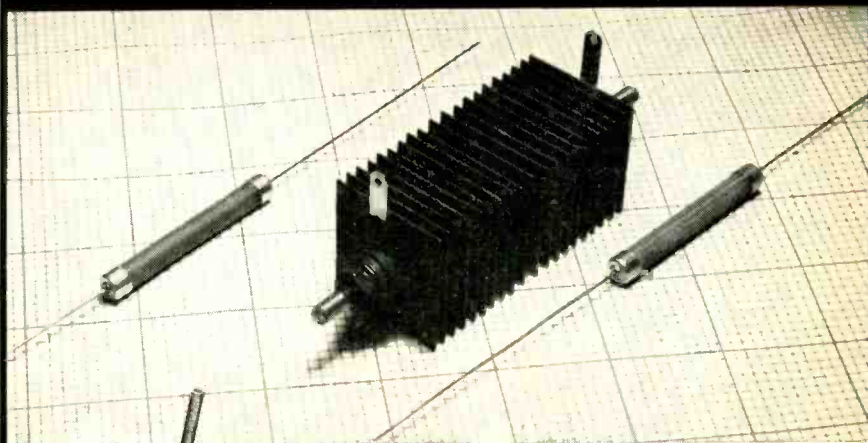

... and cut costs, too!



In high voltage rectifiers for military and commercial applications, the material used for housings and insulating tubes is of critical importance. Latest military specifications are calling for prolonged voltage surges, higher temperatures, severe humidity plus other rigid requirements. Add to these the necessity for high strength, light weight and close mechanical tolerances—the result is a difficult problem in material selection.

Leading rectifier manufacturers are solving this problem with Lamtex TUFF-TUBE, a high quality fiberglass-epoxy laminated tubing. Lamtex's exclusive impregnation and curing process, together with strict quality control, seals in properties that are unmatched for electronic component applications.

* A typical material formerly used for this application was glass-melamine G5. Direct cost comparison proved Lamtex TUFF-TUBE more economical, up to 16% savings in some cases.

Electronic design engineers are using TUFF-TUBE for waveguides, coil forms, spacers, component jackets, antenna housings, brush holders, tuning coils, motor insulation, commutator and printed circuit forms, and many other applications that require any or all of these characteristics:

INSULATION RESISTANCE
DIELECTRIC STRENGTH
HUMIDITY-PROOF

HIGH TEMPERATURES
LIGHT WEIGHT
HIGH STRENGTH

THIN WALLS, FROM .008"
SMALL DIAMETERS, FROM .062"
DIMENSIONAL STABILITY

AVAILABLE IN ALMOST ANY CROSS-SECTION SHAPE

Write for complete info — design features, tech data, application notes.



LAMTEX
INDUSTRIES, INC.
51 STATE STREET • WESTBURY, NEW YORK

the wire problem?

try **CONTINENTAL**
insulated electronic wire

No door is closed to the company that specifies Continental insulated wire or cable. That extra tough problem requiring seemingly impossible performance of wire may have you asking "What wire?" Why not let Continental's engineering help? There's a wide range of wires developed for special applications at Continental everyday.

Maybe the answer that you've been after is even now a standard in the Continental line. It's worth a letter or call today.

ELECTRONIC INSTRUMENT INSULATED WIRE

600-3000 volt service. Sizes: 32 AWG to 6 AWG inclusive. CONSTRUCTION: stranded tinned copper, polyvinyl insulation with or without nylon jacket. Maximum operating temperature: 100°C.

CONFORMS TO: MIL-W-16878B

COLOR CODED: 1, 2, or 3 spiral stripes over polyvinyl insulation.



FACT-FILLED CATALOG
NEW, COMPLETE CATALOG OF CONTINENTAL INSULATED WIRE AND CABLE AVAILABLE ON REQUEST. WRITE TODAY.

Continental

WIRE CORPORATION

WALLINGFORD, CONNECTICUT • YORK, PENNSYLVANIA

3 kc and a demodulator output current linearity of better than 1 percent full scale, providing 1.0 ma into 50 ohms. When the F-1 filter is used, an output signal flat within ± 3 percent from 0 to 250 cps is available to drive either an oscilloscope or a recording oscillograph galvanometer. Circle 297 on Reader Service Card.

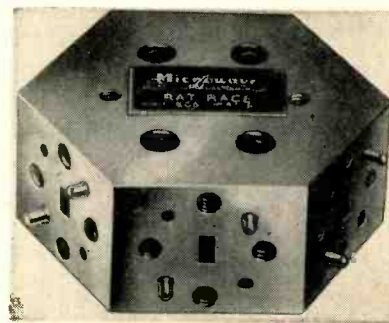

Microwave Hybrid for kmc band

MICROWAVE ASSOCIATES, INC., Burlington, Mass. The MA-606 rat race microwave hybrid for use in the 68-73 kmc band has an isolation in excess of 20 db over the specified bandwidth. The rat race is a precision power divider useful in microwave systems wherever exact power division with negligible cross talk is required. When used in conjunction with two mixer crystals, such as the MA-412, the assembly will perform as a balanced mixer.

MA-606 has a vswr of 1.25 maximum; isolation, 20 db minimum; balance, 1 db. Mating surfaces of the MA-606 connect with flange type UG-385/U used with RG-98/U waveguide. Circle 298 on Reader Service Card.



Dual Power Supply for transistor use

DRESSEN-BARNES CORP., 250 North Vinedo Ave., Pasadena, Calif.

lated d-c power supply for use in transistor circuits. It is equipped with two outputs, each 0 to 60 v d-c continuously variable at 300 ma maximum. Both outputs are electrically separated, and both float above ground—hence either output can be used as a positive or a negative supply, or the two can be connected in series.

No derating of output current or of regulation and ripple specifications is necessary from 1 to 60 v d-c. Regulation for 60 v/300 ma load is 20 mv change, no load to full load. For line voltage changes of 105 to 125 v a-c (at 60 v/300 ma outputs), regulation is 20 mv change in output voltage. Ripple and internal noise are below 1.5 mv rms. Unit is designed for very low output impedance and fast recovery time. One percent meters are provided. Circle 299 on Reader Service Card.

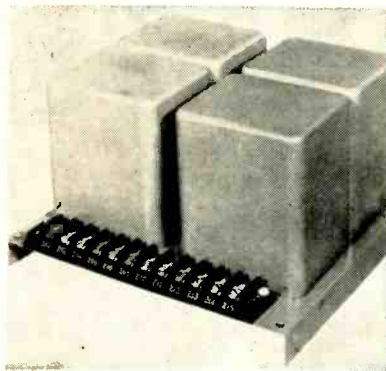

Antirepeat Control with no moving parts

CLARK CONTROLLER Co., Cleveland, Ohio, has announced an antirepeat press control with no moving parts, for use with its type PV protector air valve. Instead of relays, the device utilizes magnetic amplifiers, diodes, a transistor and a pulse transformer. Therefore, it has no moving parts for inspection and maintenance, and is not subject to wear, corrosion, and dust interference.

The new unit provides all the safety performance of the company's antirepeat control using relays. It has external connections essentially like those of conventional controls, and operates on 115-v a-c power. It receives input

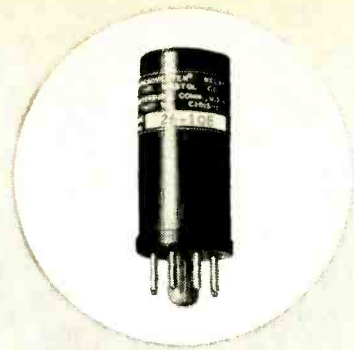

FOURTEEN BRISTOL HIGH SPEED RELAYS IN THIS CONVERTER!

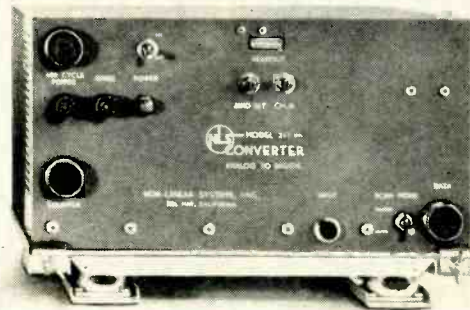

Twelve-and-a-half microvolt resolution at 20 readings per second! That's the outstanding feature of the analogue-to-digital converter, developed by Non-Linear Systems, Inc., Del Mar, California, to "digitalize" the output of low voltage transducers in either ground or airborne service.

It's significant that Non-Linear Systems engineers selected fourteen miniature Bristol Syncoverter* high speed relays (inset, top) for use in the converter scanning circuits. For the Syncoverter was originally designed for use in our own Bristol instruments in extremely critical, low-level, dry-circuit applications. Its rugged non-resonant construction has earned it an enviable reputation for reliability, long life, and immunity to shock and vibration.

Write for complete data. Characteristics below are typical. The Bristol Company, 152 Bristol Road, Waterbury 20, Connecticut.

*T.M. Reg. U.S. Pat. Off.

TYPICAL CHARACTERISTICS

Bristol's Syncoverter High-Speed Relay SPDT or DPDT (covered by patents)

- Temperature range: — 55°C to 100°C
- Operating shock: 30G; 11 milliseconds duration
- Vibration: 10-55 cps (see below, mounting); 10G
- Contact ratings: Up to 35V, 45 microamperes
- Stray contact capacitance: Less than 15 mmf.
- Pull-in time (including bounce): As low as 200 microseconds
- Drop-out time: 300 microseconds
- Life: Over a billion operations under dry-circuit conditions
- Mounting: Octal tube socket; others available, including types for vibration to 2000 cps

BRISTOL FINE PRECISION INSTRUMENTS FOR OVER 68 YEARS

From the AMCI Catalogues

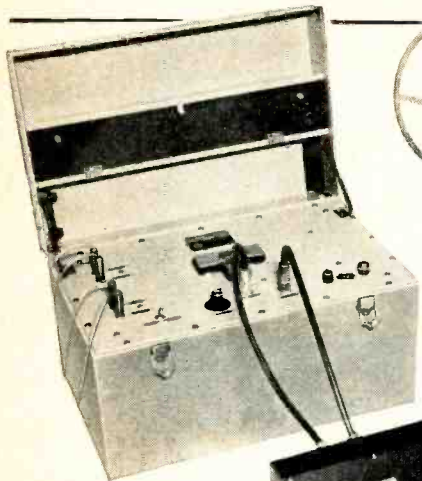

**AUTOMATIC
IMPEDANCE
PLOTTERS**

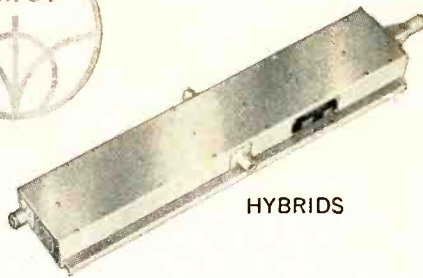

HYBRIDS



LINE STRETCHERS



RF TRANSFORMERS

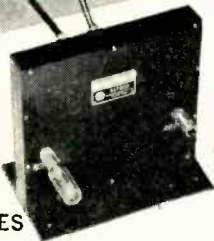

HYBRIDES



SLOTTED LINES



CALIBRATED RF ATTENUATORS



**PRECISION
TAPERED
REDUCERS**



**VOR
ANTENNAS**



**COAXIAL
SWITCHES**

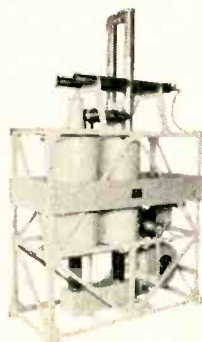

DIPLEXERS



ANTENNAS



**TV BROADCAST
ANTENNAS FOR
VHF AND UHF**

signals from the press "run", "stop", and "inch" buttons and the press limit switches, and delivers its output to the magnet of the type PV air valve.

Essentially a safety device interposed between the operators' control buttons and the press, the Transmag antirepeat control prevents operation of the press unless safe conditions exist. Circle 300 on Reader Service Card.

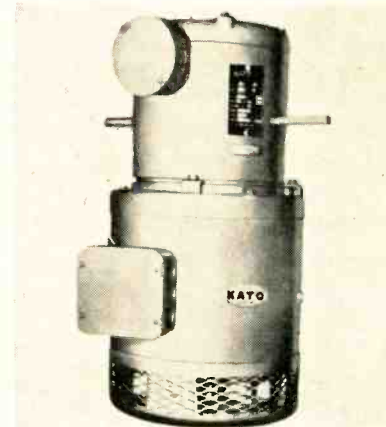

Motor-Generator Set vertical type

KATO ENGINEERING CO., 1415 First Ave., Mankato, Minn. This vertical type motor-generator set has an input frequency of 60 cps and an output frequency of 360 cps. It was developed for use with control equipment. The higher frequency, when placed on normal 60 cycle lines, will interrupt frequency selective circuits, enabling power equipment to be turned on or off remotely.

This machine operates at 1,800 rpm. The motor and generator are on a common shaft. The single phase output of this 360 cycle unit is 500 w. Circle 301 on Reader Service Card.

Sound Spectrograph provides record analyses

KAY ELECTRIC Co., Maple Ave., Pine Brook, N. J. The SonaGraph model recorder is a new sound spectrograph that makes a permanent, storable aural record in addition to three visual analyses of any audio vibrations in the



ANTENNA SYSTEMS - COMPONENTS - AIR NAVIGATION AIDS - INSTRUMENTS

ALFORD Manufacturing Co., Inc.

299 ATLANTIC AVE., BOSTON, MASS.

YOU WILL RECEIVE 53 ISSUES IN 1958

alternate
engineering
and business
editions
plus . . .
the
buyers' guide

electronics  

A MCGRAW-HILL PUBLICATION
330 WEST 42ND STREET, NEW YORK 36, N. Y.

CHART OF PUBLISHING CYCLES

electronics engineering edition		electronics business edition		electronics engineering edition		electronics business edition	
CYCLE A		CYCLE B		CYCLE C		CYCLE D	
JAN.	3	JAN.	10	JAN.	17	JAN.	24
JAN.	31	FEB.	7	FEB.	14	FEB.	21
FEB.	28	MAR.	7	MAR.	14	MAR.	21
MAR.	28	APR.	4	APR.	11	APR.	18
APR.	25	MAY.	2	MAY.	9	MAY.	16
MAY.	23	MAY.	30	JUNE.	6	JUNE.	13
JUNE.	20	JUNE.	27	JULY.	4	JULY.	11
JULY.	18	JULY.	25	AUG.	1	AUG.	8
AUG.	15	AUG.	22	AUG.	29	SEPT.	5
SEPT.	12	SEPT.	19	SEPT.	26	OCT.	3
OCT.	10	OCT.	17	OCT.	24	OCT.	31
NOV.	7	NOV.	14	NOV.	21	NOV.	28
DEC.	5	DEC.	12	DEC.	19	DEC.	26

BUYERS' GUIDE ISSUE — JUNE 15

FIRST CLASS
PERMIT NO. 64
(Sec. 34.9 P.L.&R.)
NEW YORK, N. Y.

BUSINESS REPLY CARD

NO POSTAGE STAMP NECESSARY IF MAILED IN THE UNITED STATES

4¢ Postage Will Be Paid By

ELECTRONICS

Reader Service Dept.
330 West 42nd Street
New York 36, N. Y.

85-12,000 cps range. The display graphs are made in two switched bands, the first from 85 cps to 6 kc, and the second from 6 kc to 12 kc. An added feature is that with only slight loss in output and amplitude the Sona-Graph can be adapted to study such subsonic vibrations as heart and brain waves.

The recording medium is a flexible magnetic disk 12 in. in diameter and approximately 3 mils thick. It can be removed and filed with the visual analyses, or it can be reused as often as desired. The three permanent graphs are 4 in. by 12 in. on 5 $\frac{5}{8}$ in. by 12 $\frac{3}{4}$ in. facsimile paper. Circle 302 on Reader Service Card.



VHF System weighs 22 lb

AIRCRAFT RADIO CORP., Boonton, N. J. Model 210 vhf communications system weighs only 22 lb. It provides a frequency coverage of 118 to 135.95 mc on 360 channels and is suitable for both military and commercial aircraft. Included in the total weight are the transceiver (illustrated), mountings, control panel and power supply. The unit has true 50-kc channel spacing, a 15-w transmitter with a very low, spurious output and a receiver sensitivity of 2 μ v.

By turning a switch on the control panel, the system can be operated either as a single-channel simplex or double-channel simplex with 6-mc operation.

The system is powered by a dynamotor designed to give maximum dependability with the least possible weight. An advanced type of center-of-gravity mount reduces vi-

New PRECISION FREQUENCY

STATIC INVERTER SUPPLY

INPUT 28V D.C. \pm 10%

OUTPUT Nom. 115V \pm 2% 400 CPS \pm 0.01%
1 ϕ (2- or 3-phase output available)

RATINGS: 30VA 50VA 100VA
Higher ratings available.

APPLICATION:

For gyro wheel supplies and where precise 400 cycle voltages are required in aircraft, radar and missile computers.

FEATURES:

PRECISION OUTPUT FREQUENCY
RUGGED
EXCELLENT WAVEFORM
SIMPLICITY OF CIRCUITRY
FAST STARTING TIME
GOOD VOLTAGE REGULATION
throughout an adjustable range
ISOLATED CASE DESIGN
HIGH RELIABILITY
VIBRATION ISOLATED
COMPACT
LIGHTWEIGHT
MILITARY SPECIFICATIONS

(Send for Bulletin S-864)

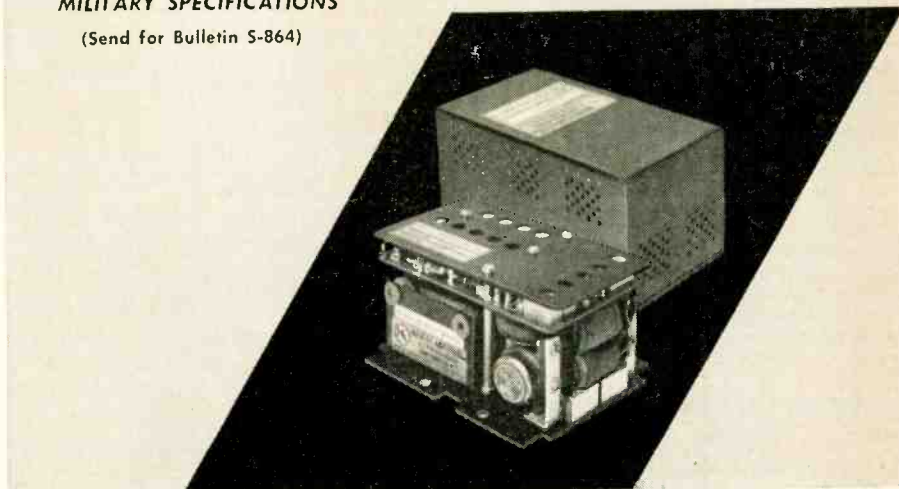

PERFORMANCE SPECIFICATIONS

MODEL NUMBERS	\pm .01% CPS	SIS 40311	SIS 40511	SIS 410011
	\pm .05% CPS	SIS 40315	SIS 40515	SIS 410015
INPUT VOLTAGE	28V DC \pm 10%			
MAX. OUTPUT POWER	30VA	50VA	100VA	
OUTPUT VOLTAGE	115V AC (Adjustable \pm 10%)			
OUTPUT FREQUENCY	400 CPS \pm .01% 400 CPS \pm .05%			
VOLTAGE REGULATION	\pm 1% For Line Variations \pm 2% For Load Variations			
FREQUENCY DISTORTION	3% Maximum At Full Load			
LOAD POWER FACTOR	+ 0.5 to - 0.5 Maximum			
MILITARY SPECS.	MIL-E-5400A & MIL-E-5272A			
AMBIENT TEMPERATURE	- 55°C to + 71°C when mounted to heat sink			
VIBRATION	20G 10 to 2000 CPS			
UNIT DIMENSIONS	15" D 2 7/8" H 2 13/16"	18" D 2 7/8" H 2 13/16"	10" D 4 1/2" H 2 13/16"	
WEIGHT (Approx.)	2 lbs.	3.5 lbs.	5 lbs.	



MAGNETIC AMPLIFIERS INC.

632 TINTON AVENUE • NEW YORK 55, N. Y. • CYPRESS 2-6610

West Coast Division

136 WASHINGTON ST. • EL SEGUNDO, CAL. • OREGON 8-2665

Reliable Electrical Connections

by R. George Roesch

Automatic Wire Processing with Standard Equipment

When standard equipment can be incorporated into a system for automatically stripping, fluxing and tinning coil leads, the cost of such equipment is invariably much less than that of special equipment.

The benefits of mechanizing any operation are (1) uniform quality, (2) fewer rejects and (3) lower inspection costs.

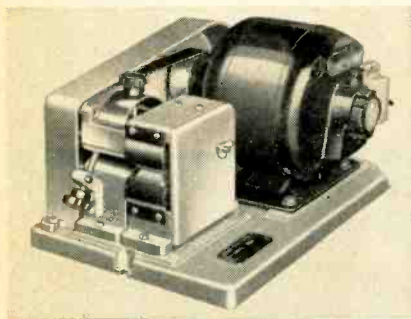

For example, using a standard wire stripper such as illustrated, we have made automatic coil lead straightening, trimming and stripping equipment for Electric Auto-Lite, Ford Motor, General Electric, Westinghouse and others. (Note: Each system was designed and built to meet the individual requirements of the user.)

A COMPLETE PROGRAM generally works out like this:

1. Your Products and Your Present Methods are studied by our engineers, without obligation to you.
2. When we are certain we completely understand your needs and wishes, a Program of Engineering and Experimental Work will be submitted. (NOTE: Nothing will be undertaken until Proven Methods have been experimentally developed.)
3. This Program will tell you (a) How Much Time will be required and (b) The Maximum Cost of Engineering and Experimental Work.
4. If you accept this program, the results must meet your own specifications. Otherwise there will be no charge made by us.
5. Assuming the experiments made prove the job can be done, we will then submit Schematic Drawings and a Quotation for your consideration on all the equipment needed to perform the desired operations.

If you are making Coils in large numbers, we'd like to hear from you.

THE ERASER COMPANY, INC.
1068 S. Clinton St., Syracuse 4, N. Y.

It is said by Tin Research Institute that soldering of silver-plated contacts can be facilitated if the surfaces are first immersed in a cold solution of 8% thiourea in 5% hydrochloric acid.

CIRCLE 122 READERS SERVICE CARD

bration and noise effects far below the levels usually found in this type of equipment. Circle 303 on Reader Service Card.

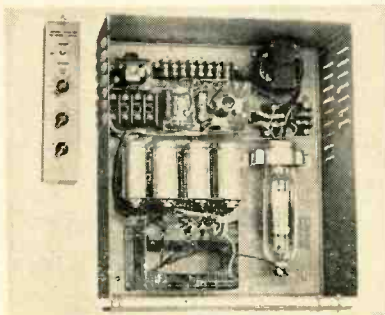

Motor Controller operates 3/4 h-p unit

GERALD K. HELLER CO., 1819 Industrial Road, Las Vegas, Nevada. The C60 electronic motor controller operates a 3/4 h-p shunt wound motor on 220-230 v, 50-60 cycles single phase. Motor speed from 0-2,400 rpm, with full torque from 300 to 2,400 rpm. Controller embodies acceleration control, reverse, coarse and fine speed adjustment. It is mounted in a steel cabinet 14 in. wide by 16 in. high by 6 in. deep. The control station components are mounted in a steel box 2 in. by 2 in. by 9 in., which is connected to the controller with a special 10 conductor vinyl jacketed cable 10 ft long.

Controller price is \$275; 3/4 h-p motor \$125. Circle 304 on Reader Service Card.

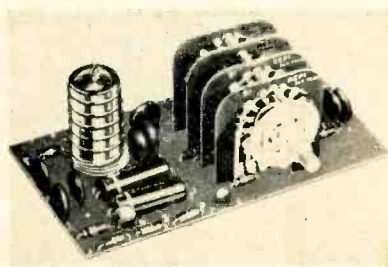

Rotary Switches printed-circuit type

KNIGHT ELECTRONICS CORP., 210 S. Desplains St., Chicago 6, Ill., has developed plug-in printed circuit rotary switches for audio and r-f applications. The new switches

alumina ceramics

for electronic applications

Now you can apply the unique properties of alumina ceramics to special electronic projects:

- Low dielectric losses at all microwave frequencies.
- Extremely high mechanical strength in conjunction with thermal stability and chemical inertness.
- Can be metallized and hermetically sealed to various metals by high temperature brazing.

Frenchtown alumina ceramics are produced in a variety of sizes and geometries, either in prototype or production quantities. Dense shapes of over 200 cubic inches have been manufactured.

To engineers and scientists who wish to learn more about the capabilities and limitations of alumina ceramics, Frenchtown welcomes the opportunity to assist in the selection and proper utilization of these amazing materials. This assistance is directed toward obtaining optimum performance, simplifying complexity, reducing cost and expediting delivery.

Technical literature will be sent upon request.

frenchtown

PORCELAIN COMPANY

FRENCHTOWN, NEW JERSEY

CIRCLE 123 READERS SERVICE CARD

have an important industrial potential in such equipment as computers, test instruments and other electronic circuits requiring multiple switching.

Consisting of a standard rotor and XXXP phenolic wafers, the switches differ from conventional rotary switches in that they eliminate manual wiring and soldering to each individual contact terminal. This saving of time and labor is achieved by using etched foil on the wafers to connect the contacts to terminal prongs on the base of each wafer.

Installing one of the switches is as simple as plugging in a tube, and dip soldering of the printed circuit board establishes all switch connections in one process. Other advantages in their use include the elimination of solder drip on switch contacts, no temper loss in contacts, no torque problem with ganged assemblies, and elimination of wiring errors. Their compactness insures maximum utilization of space. Ganged assemblies require a minimum of only $\frac{1}{4}$ in. between wafers. Circle 305 on Reader Service Card.



Precision Crystals meet exacting standards

REEVES-HOFFMAN DIVISION of Dynamics Corp. of America, Carlisle, Pa. Manufactured to meet exacting military and commercial standards for frequency measurement, the new 5-mc high-precision crystals offer exceptionally long-term frequency stability. Frequency tolerance is held at ± 0.0001 percent and aging is only one part per hundred million parts per week. These

Testing

MAGNETRONS KLYSTRONS CARCINOTRONS

● OTHER MICROWAVE TUBES, COMPONENTS OR SYSTEMS?

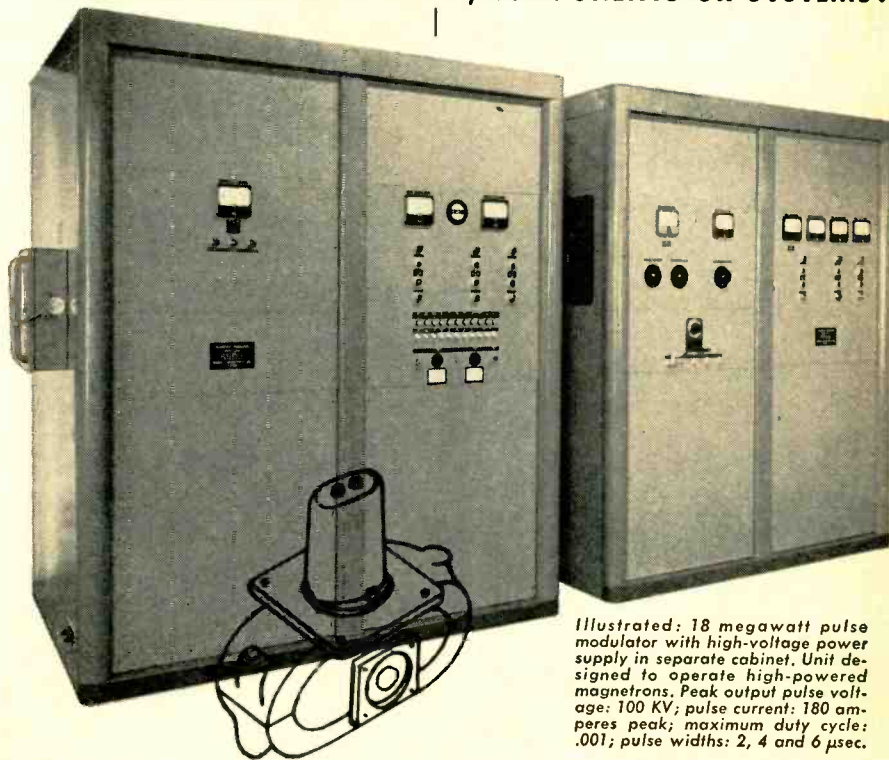

Illustrated: 18 megawatt pulse modulator with high-voltage power supply in separate cabinet. Unit designed to operate high-powered magnetrons. Peak output pulse voltage: 100 KV; pulse current: 180 amperes peak; maximum duty cycle: .001; pulse widths: 2, 4 and 6 μ sec.

Come to Manson for the widest selection of standard *Pulse Modulators* and *High-Voltage Power Supplies* covering all useful power levels. From kilowatts to tens of megawatts, Manson has precision-engineered designs for operation and test of magnetrons, klystrons, traveling wave tubes, backward wave oscillators, lighthouse tubes, pulse transformers, waveguide components and related devices. The wide range of standard models is readily adaptable to meet individual specifications.

HIGH POWER PULSE MODULATORS:

Hard- and soft-tube types from 16 kw. to 30 megawatts peak power output, and higher. Average output powers as high as 60 kilowatts. Typical operating features include: continuously adjustable voltage control; discrete or variable pulse widths; internally- and externally-controllable repetition frequencies; auxiliary synchronized outputs; pulse-shape monitoring circuits; and interlocking and overload protection.

HIGH VOLTAGE POWER SUPPLIES:

High-voltage DC and AC types, single- or multiple-output, regulations and stabilities to 0.01%. Standard and custom designs to satisfy your specific tube testing or production problems: highly-regulated supplies uniquely suited for TWT test and operation; unregulated high-power supplies for systems testing; and complete power sources for controlling all aspects of tube production.

Write today for complete details on our full line of high-power pulse-test equipment and high-voltage power supplies, including applications and performance data.

MANSON



LABORATORIES, INC.

207 GREENWICH AVE.

STAMFORD, CONN.

Manson offers to engineers and technicians a rewarding present and attractive future in Connecticut.

BULOVA

FAMED FOR PRECISION SINCE 1875



NEW ST-73X

"SHOCK MOUNTED" QUARTZ CRYSTAL

The Bulova ST-73X need never be babied. Effective new shock mounting and traditional Bulova manufacturing precision result in a rugged, extremely stable, frequency determining element for missiles, aircraft and other applications involving extreme environmental problems.

Where frequencies must be maintained with ultra-reliable stability under high shock and temperature conditions, you'll find no adequate substitute for Bulova quality.

THE ST-73X FEATURES: Frequency Range from 16 KC through 350 KC, with lower frequencies possible in holders of different configuration; Shock Tests of 100 G; Dynamic vibration tests met per MIL-T-5422, MIL-E-5272 and MIL-E-5400 without adverse results; Storage Temperatures over a range of -65°C. to $+135^{\circ}\text{C.}$ can be coupled with an operation temperature range of -55°C. to $+100^{\circ}\text{C.}$; Low excursions of frequency ($\pm .015\%$) over this range.

Precision Bulova Quartz Crystals are now available in quantity for frequencies from 16 KC and lower to 100 MC and above.



BULOVA

w a t c h c o m p a n y

Electronics Division
Woodside 77, N. Y.

Write Dept. A-738 For
Full Information and
Prices on Quartz Crystals

crystals are available in hermetically sealed glass T5½ enclosures with pigtail leads on a 9-pin Bakelite base as specified. Circle 306 on Reader Service Card.

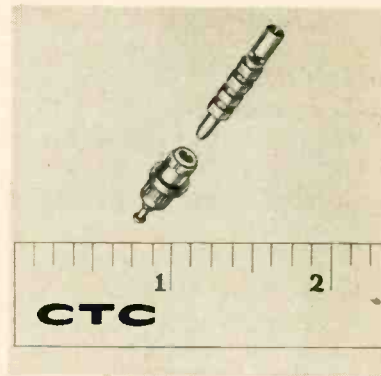

Plug and Jack for panel boards

CAMBRIDGE THERMIONIC CORP., 445 Concord Ave., Cambridge 38, Mass., announces a new plug and jack designed for quick, tight patch work on panel boards.

The new jack (No. 2265) assures perfect electrical connections because its gripping power is maintained by a specially-designed compression spring used with a floating key. The solder terminal is on the under side, and the jack can be obtained in shank lengths for panels varying from $\frac{1}{8}$ in. to $\frac{1}{4}$ in.

The new plug (No. 2225) is available with either a red or black nylon jacket insulation (or uninsulated, No. X2201-2). Pin length is approximately $\frac{1}{8}$ in., body length $\frac{3}{4}$ in. Mechanical connection is simple because the plug will accept up to No. 20 size wire which can be crimped around the insulation to prevent fraying; or for a solder connection, solder can be added through the window provided. Circle 307 on Reader Service Card.

Curing Agent for epoxy resin

LANCASTER CHEMICAL CORP., Broad & 13th St., Carlstadt, N. J. LANCAST-A is a low viscosity room temperature curing agent for epoxy resins. It has a viscosity of 600 centipoises at 80 F and can be

CABLE CLIPS

★
of all Nylon
for severe conditions

★
of Ethyl
Cellulose
for maximum
economy



WECKESSER



molded
Black Nylon
**SCREWS
and NUTS**

★
Acid resistant
★
Need no insulation
★
Can't rust
★
Can't corrode

WECKESSER COMPANY

5701 Northwest Highway • Chicago 30, Ill.

CIRCLE 126 READERS SERVICE CARD

quality ...
uniformity ...
service ...

GLASS for
HERMETIC SEALING
• EPOXY PREFORMS
• PRESSED
CERAMICS

mansol
CERAMICS CO.

138 LITTLE 5th | THORNTON HEATH
BELLEVILLE, NEW JERSEY | SURREY, ENGLAND

CIRCLE 128 READERS SERVICE CARD

ELECTRONICS engineering edition — February 14, 1958

CO-AX



★
ULTRA LOW

capacitance
& attenuation

WE ARE SPECIALLY ORGANIZED
TO HANDLE DIRECT ORDERS OR
ENQUIRIES FROM OVERSEAS

SPOT DELIVERIES FOR U.S.

BILLED IN DOLLARS—
SETTLEMENT BY YOUR CHECK
CABLE OR AIRMAIL TODAY



TYPE	μμ F/ft	IMPED.Ω	O.D.
C1	7.3	150	.36
C11	6.3	173	.36
C2	6.3	171	.44
C22	5.5	184	.44
C3	5.4	197	.64
C33	4.8	220	.64
C4	4.6	229	1.03
C44	4.1	252	1.03

TRANSRADIO LTD, 138A Cromwell Rd, London SW7 ENGLAND

CABLES: TRANSRAD, LONDON

CIRCLE 127 READERS SERVICE CARD

PRECISION POWER OSCILLATORS



PRICE
\$119.00

MODEL 1040

SPECIFICATIONS

Frequencies.....400 or 1000 C.P.S. by selector switch
(other frequencies on request)
Distortion.....Less than 1 %
Hum Level.....Approximately .05 % of rated output
Output Power...3 watts into matched resistive load
Power Supply...115 volts, 60 C.P.S., 40 watts
Dimensions.....5-11/16 x 9 x 6 1/8 inches

OTHER MODELS AVAILABLE

MODEL	DESCRIPTION	POWER OUTPUT
1040A	Sim. to Mod. 1040	8 watts

EXCELLENT ACCURACY AND STABILITY • TRANSFORMER ISOLATED OUTPUT • 3 OUT-
PUT IMPEDANCES • LOW INTERNAL IMPEDANCE • OUTPUT VARIABLE UP TO 120 VOLTS

MODEL 1500

SPECIFICATIONS

FREQUENCY.....400 CPS (Other frequencies
on request)
Distortion.....Less than 1/2 %
Hum Level.....Approximately .02 % of
rated output
Output Power.....15 watts into matched
resistive load
Power Supply.....115 volts, 60 C.P.S.,
120 watts
Dimension.....8 3/4" x 19" rack panel,
8" deep



PRICE
\$299.00

Representatives in Principal Cities

INDUSTRIAL TEST EQUIPMENT CO.
55 EAST 11th STREET • NEW YORK 3, N. Y.

CIRCLE 129 READERS SERVICE CARD

PRECISION ENGINEERED Sub-Miniature Pilot Lights

... facilitate the solution of
miniaturization problems.

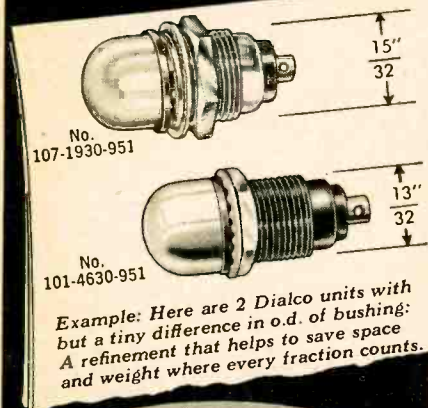

DIALCO

On your next miniaturization project, consult DIALCO for the Pilot Lights. You will quickly find the proper unit for use with either tiny Incandescent bulbs (T-1 $\frac{3}{4}$); or with sub-miniature Neon bulbs (NE-2D).

TWO-TERMINAL units are fully insulated. SINGLE-TERMINAL units are for use on grounded circuits. Also DIMMING or NON-DIMMING sub-miniatures for every requirement. Meet all applicable Military Specifications.

Samples for design purposes on request at once — no charge.

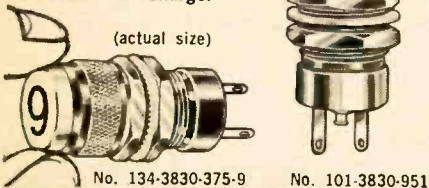

Foremost Manufacturer of Pilot Lights

DIALIGHT CORPORATION

58 STEWART AVE., BROOKLYN 37, N. Y.
HYacinth 7-7600

Dialight Corp., 58 Stewart Ave., Brooklyn 37, N. Y.

- Send brochures on Sub-Min. Pilot Lights
 Brochures on other Dialco Pilot Lights

Name _____
Position _____
Company _____
Address _____

CIRCLE 130 READERS SERVICE CARD

used over a wide range of ratios with all the liquid epoxy resins. The cured epoxies will vary in hardness and flexibility depending on the ratio used.

Because of its properties LAN-CAST-A should find wide use in coatings, adhesives, potting and encapsulating. Circle 308 on Reader Service Card.

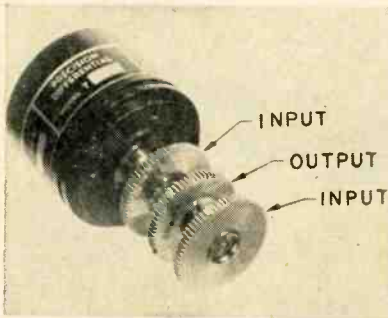

Differential for servo and computer

STERLING PRECISION CORP., 34-17 Lawrence St., Flushing 54, N. Y. A completely enclosed dust-proof differential, model T-750, for high precision servo and computer applications is now available. Instead of the conventional method of having the two inputs at opposite ends of the spider, the output and inputs extend concentrically from one end of a servo mounted case. This permits mounting of this differential similar to standard servo components, thus resulting in a single line gear train. Circle 309 on Reader Service Card.

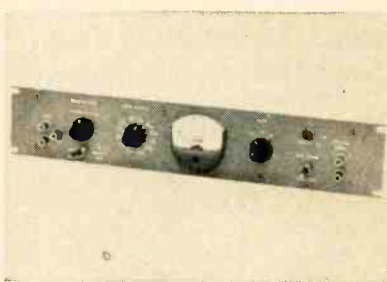

A-C/D-C Voltmeter priced at \$650

ALTO SCIENTIFIC Co., 855 Commercial St., Palo Alto, Calif., has announced a new 3 $\frac{1}{2}$ in. high transistorized voltmeter, measuring either a-c or d-c with full scale

NOW

Increased operational
versatility . . . greater
accuracy in
RF, VHF and UHF
SPECTRUM
ANALYSIS



with the IMPROVED
**PANORAMIC
PANALYZOR**
MODEL **SB-8b**

Check these advanced
engineering features:

NEW Continuously variable scanning rate from 1 thru 60 scans/sec with one control. Three selectable modes . . . free running, line synchronism or external synchronism.

NEW Three selectable types of amplitude displays . . . Square law exponential Linear 20 db, Log 40 db.

NEW Flat face CRT, edge lit calibrated screen and camera mount bezel for photographic records—optional.

NEW Differential markers to show frequency dispersion available in the Type T-10,000.

The Panalyzer Model SB-8b is available in three types, all have continuous variable sweep width and resolution;

Type	Sweep Width Range	Resolution at Reduced Sweep
T-200	0-200 kc	50 cps
T-1000	0-1 mc	200 cps
T-10,000	0-10 mc	9 kc

Write, wire, phone TODAY for detailed specifications and prices.



Send for our new CATALOG DIGEST and ask to be put on our regular mailing list for the PANORAMIC ANALYZER featuring application data.

530 South Fulton Ave., Mt. Vernon, N. Y.
Phone: OWens 9-4600
Cables: Panoramic Mount Vernon, N. Y. State
CIRCLE 131 READERS SERVICE CARD

sensitivity of 1 mv.

Powered by either a 60 cycle a-c source or a built-in rechargeable battery, the model D-31 voltmeter operates on balanced or unbalanced circuits with accuracy of ± 3 percent to ± 5 percent on a-c and ± 3 percent on d-c. Frequency response on unbalanced circuits is flat through the range 10 cps to 1 mc; on balanced circuits response is flat from 10 cps to 100 kc.

The built-in battery can be automatically recharged while the instrument is operating from a 60 cycle a-c power source. Battery life is approximately 8 hr of continuous operation; a-c power consumption is about 5 w. The instrument measures $3\frac{1}{2}$ in. high by $4\frac{3}{4}$ in. deep and is the standard 19 in. width for convenient rack mounting. Circle 310 on Reader Service Card.

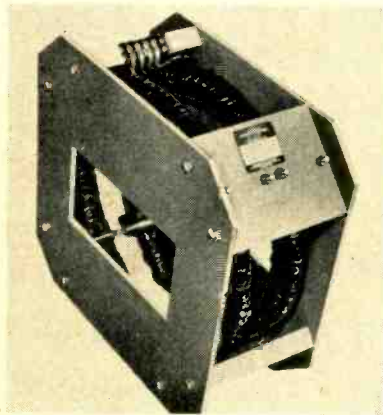

Transducers for industrial control

CONTROL, a division of Magnetics, Inc., Pittsburgh, Pa. The standardized line of transducers recently announced are used in a host of industrial control operations for measurement of large quantities of direct current without electrical connection to the systems in which they are used.

A major value of these transducers (as with the company's power reactors) is the maintenance-free longlife of the units. This results from the use of high permeability magnetic cores—virtually indestructible under normal operation. Orthonol, a nickel-iron tape Toroid registered by the parent company, Magnetics, Inc., has such square

Lapp TUBE SUPPORTS for air-cooled power tubes

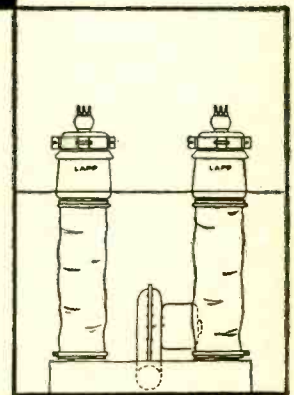

Since forced-air-cooled tubes were first introduced, equipment manufacturers have been designing their own supports, many of which

have been produced by Lapp. To standardize the great variety of tube support designs, Lapp set out to design a complete line which is now available and offers the equipment manufacturer a valuable service by way of more economical production, interchangeability and availability of replacement units. Lapp Tube Supports are compact, efficient and attractive in appearance. Their duty is threefold... they support the tubes, insulate, and furnish an air duct which channels air over tube fins for maximum cooling. Write for Bulletin 301, with complete description and specification data. Lapp Insulator Co., Inc., Radio Specialties Division, 139 Sumner Street, LeRoy, New York.

Lapp

the specs are the proof . . .
 the BEST BUYS are **EICO**[®]
 for COLOR & Monochrome TV servicing



NEW COLOR
 and Monochrome
 DC to 5 MC LAB & TV
 5" OSCILLOSCOPE

= 460
 Factory-wired
 and tested \$129.50
 Also available as kit \$79.95

• Features DC Amplifiers! -

Flat from DC-4.5 mc. usable to 10 mc.
VERT. AMPL.: sens. 25 rms mv/in; input Z 3
 megs; direct-coupled & push-pull thruouts;
 K-follower coupling bet. stages; 4-step freq-
 compensated attenuator up to 1000:1.
SWEEP: perfectly linear 10 cps-100 kc (ext.
 cap. for range to 1 cps); pre-set TV V & H
 positions auto. sync. ampl. & lim. **PLUS:**
 direct or cap. coupling; bal. or unbal. inputs;
 edge-lit engraved lucite graph screen; dim-
 mer; filter; bezel fits std. photo equipt. High
 intensity trace CRT. 0.06 usec rise time. Push-
 pull hor. ampl. flat to 400 kc. sens. 0.6 rms
 mv/in. Built-in volt. calib. Z-axis mod. Saw-
 tooth & 60 cps outputs. Astig. control. Re-
 trace blanking. Phasing control.



NEW TV-FM
SWEEP GENERATOR
 & MARKER

= 368
 Factory-wired
 and tested \$119.95
 Also available \$69.95
 as kit

Entirely electronic sweep circuit (no mech-
 anical devices) with accurately-biased in-
 creductor for excellent linearity. Extremely
 flat RF output; new AGC circuit automati-
 cally adjusts osc. for max. output on each band
 with min. ampl. variations. Exceptional tun-
 ing accuracy; edge-lit hairlines eliminate
 parallax. Swept Osc. Range 3-216 mc in 5
 fund. bands; Variable Marker Range 2-75 mc
 in 3 fund. bands; 60-225 mc on harmonic
 band. 4.5 mc Xtal Marker Osc., xtal supplied.
 Ext. Marker provision. Sweep Width 0-3 mc
 lowest max. deviation to 0-30 mc highest max.
 dev. 2-way blanking. Narrow range phasing.
 Attenuators: Marker Size, RF Fine, RF Coarse
 (4-step decade). Cables: output, scope horiz.,
 scope vertical.

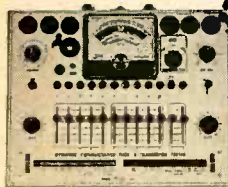

NEW DYNAMIC
CONDUCTANCE
 Tube &
 Transistor Tester

= 666
 Factory-wired
 and tested \$109.95
 Also available \$69.95
 as kit

COMPLETE with steel cover and handle.

**SPEED, ease, unexcelled accuracy & thor-
 oughness. Tests all receiving tubes (and
 picture tubes with adapter). Composite indi-
 cation of Gm, Gp & peak emission. Simulta-
 neous sel of any 1 of 4 combinations of 3 plate
 voltages, 3 screen voltages, 3 ranges of con-
 tinuously variable grid voltage (with 5% ac-
 curate pot). New series-string voltages: for
 600, 450, 300 ma types. Sensitive 200 ua
 meter. 5 ranges meter sensitivity (1% shunts
 & 5% pot.) 10 SIX-position lever switches;
 free point connection of each tube pin. 10
 push-buttons rapid insert of any tube element
 in leakage test circuit & speedy sel. of
 individual sections of multi-section tubes in
 merit tests. Direct-reading of inter-element
 leakage in ohms. New gen.-driven rollochart.
 Checks n-p-n & p-n-p transistors; separate
 meter readings of collector leakage current
 & Beta using internal dc power supply. CRA
 Adapter \$4.50**

See the 50 EICO models IN
 STOCK at your neighbor-
 hood distributor. Write for
 FREE Catalog E-2

Prices 5%
 higher on
 West Coast



33-20 NORTHERN BLVD.,
 LONG ISLAND CITY 1, N. Y.

CIRCLE 133 READERS SERVICE CARD

loop characteristics that accuracy
 of the transducers is within ± 1
 percent of rated output over the
 complete operating range.

The line consists of nine units,
 6 for 120-v and 3 for 240-v rang-
 ing in capacity from 200 to 10,000
 amperes. Accuracy of current meas-
 urement is to within ± 1 percent,
 even with up to ± 10 percent
 voltage variation and significant
 burden additions. Meter reduction
 extends from 2 amperes in the
 largest size to 50 ma in the small-
 est. Circle 311 on Reader Service
 Card.

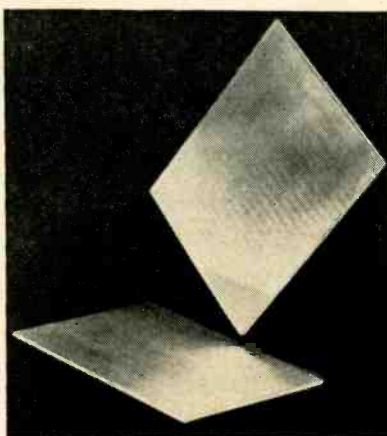

Copper Clad Teflon used in printed circuits

FLUOROCARBON PRODUCTS, INC.,
 Camden 1, N. J., is now marketing
 copper clad Teflon sheet and tape
 for use in printed circuit applica-
 tions.

The new product was designed
 to meet the needs of the electronic
 industry where a printed circuit
 material with a low dielectric con-
 stant, dissipation factor and water
 absorption is required. Besides hav-
 ing all of the properties associated
 with Teflon, this material, under
 duress, assures a uniform dielectric
 constant over a given area and no
 delamination of insulating material
 is possible.

Exhibiting strength and temper-
 ature ranges heretofore not avail-
 able in printed circuits, the new
 material is available in 18 by 36
 in. sheets ranging in thickness from
 $\frac{1}{16}$ to $\frac{1}{8}$ in., with 1 or 2 oz copper
 on both sides. Tapes range from
 12 in. wide to 150 in. in length
 with thicknesses available from

removable dust covers for Class 22 Relays when strip, panel or chassis mounted

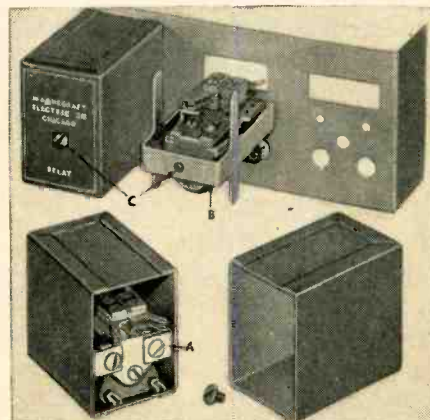

Enclosure No. 45-174

Relay mounting screws (A) attach relay and
 enclosure support frame (B) to strip, panel, or
 chassis. Dust cover fits over frame and is
 secured with screw (C).

Available with Class 22 Relays, AC
 or DC, contact combinations to 6PDT,
 also Class 22 Twin Contact, 22S Time
 Delay, 22R and 22D Power Relays.

when plug-in mounted

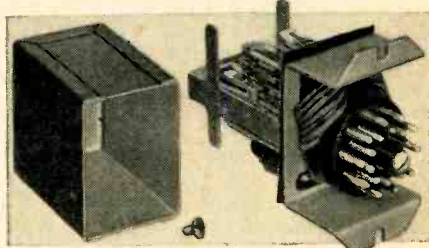

Enclosure 45-176

Enclosure support frame is assembled with
 relay and hold-down bracket. Dust cover fits
 over frame and is secured with screw. Mounts in
 any position — no hold-down clamp required.

Available with 8-, 12-, or 20-pin
 Octal Style phenolic plugs, AC or DC
 Relays; contact combinations to
 6PDT, also Class 22T Twin Contact,
 22S Time Delay, 22R and 22D Power
 Relays. Send for literature.

MAGNECRAFT
 Electric Company

3350B W. Grand, Chicago 51, Ill.

CIRCLE 134 READERS SERVICE CARD

0.005 to 0.060. The tapes can be had with 1, 2 or 3 oz copper on one or two sides. Circle 312 on Reader Service Card.

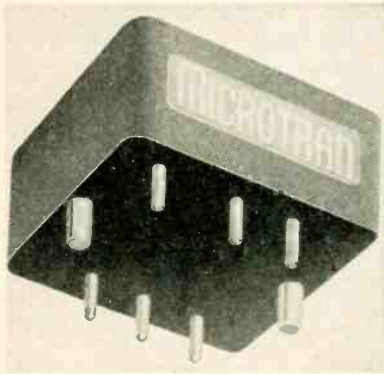

Molded Transformers microminiature

MICROTRAN Co., Inc., 145 E. Mineola Ave., Valley Stream, N. Y. Designed for transistor, audio and servo applications, a new line of microminiature transformers are molded of high temperature epoxy to provide protection against extremes in ambient. Weighing $\frac{1}{2}$ oz, dimensions of the MM-M series is $1\frac{1}{8}$ in. by $\frac{3}{8}$ in. by $\frac{1}{2}$ in. high. Mounting is by means of standard channel ears, threaded studs, or inserts. Terminal pins are arranged for use with dip soldered printed circuitry. Circle 313 on Reader Service Card.

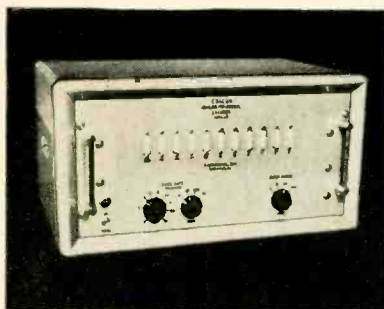

Encoder analog-to-digital

ANDROMEDA, INC., 3742 Howard Ave., Kensington, Md. Analog-to-digital conversion of up to 2,000 codes per sec may be obtained with model 2KB Edacon encoder. The code is binary having 10 bits plus sign. Code accuracy is 1 part in

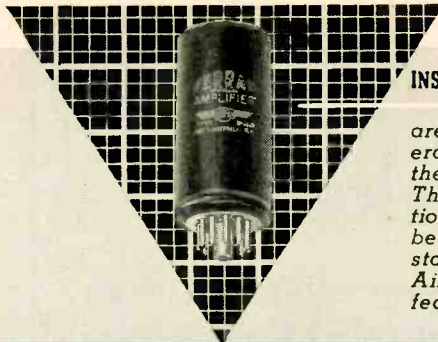

INSTRUMENT-TYPE MAGNETIC AMPLIFIERS

are being held to closer production tolerances than previously so as to make these units even more useful to you. They are used in the computing portions of high-performance instruments because of their unusual linearity and stability. Transfer Characteristics of Airpax Ferrac amplifiers are little affected by supply voltage or frequency.

DC to DC Magnetic Amplifier for Precision Instruments

As with all magnetic amplifiers, Ferrac amplifiers operate directly from the AC generator thereby eliminating the weight of DC power supplies necessary with vacuum tube or transistor amplifiers. The two input control windings are fully insulated from each other, from the power, and from the output. Thus the amplifier can be used with signals that require floating grounds.

Output is Unaffected by Supply Frequency

360 CPS
400 CPS
440 CPS

OUTPUT
7.5 V
5.0 V
2.5 V

INPUT
150 μ A
200 μ A
300 μ A

AMPLIFIER CHARACTERISTICS

INPUT: Two independent control windings. into 1000 ohms.

OUTPUT: Unfiltered DC linear ± 7.5 DC volts

GAINS: Typical full-scale inputs are: 75 μ a, 150 μ a, or 300 μ a.

ENVIRONMENT: Ferrac amplifiers are rated for operation - 55 C to + 85 C, vibrations of 10G at 10 to 2000 CPS, 30G shoke of 11 mspc duration. Units are hermetically sealed.



Airpax Products Company, Seminole Division, Fort Lauderdale, Florida

"We Didn't Know You Make It"

Every now and then someone says to us, "I wish I had known you make it". They know that no other wire or cable is superior to Synkote in quality and performance.

Since 1941 we have made every conventional wire and cable and most of the special constructions in use today.

whether it be



TEFLON-JACKETED
MINIATURE COAXIAL CABLE
or any other Teflon
insulated wire or cable

or

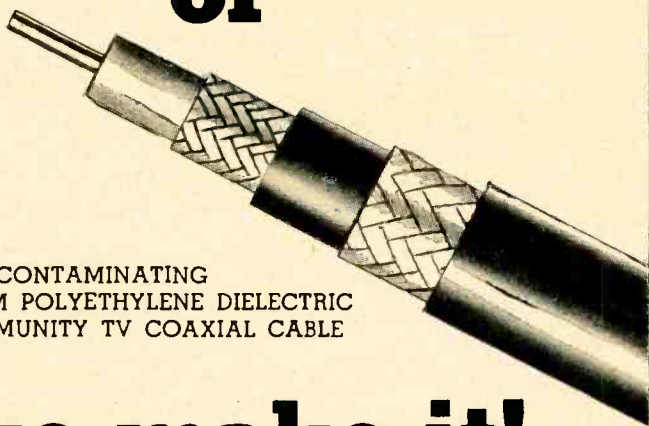

NON-CONTAMINATING
FOAM POLYETHYLENE DIELECTRIC
COMMUNITY TV COAXIAL CABLE

...we make it!

Send for our new 1958 catalog

PLASTOID
Corporation



Plant: HAMBURG, N. J. • Offices: 42-61 24th St., Long Island City 1, N. Y.

2,048 or ± 0.025 percent. Maximum bit rate is 22,000 per sec.

The unit features built-in integral power supplies which include a reference voltage source of ± 0.005 percent stability. Drift of the comparator is less than ± 0.001 percent. Analog input impedance is 1,000 ohms per full scale volt. Input ranges are 1, 10, 100 and 1,000 v. Parallel coded outputs are at 115 v, 10 ma for each of 11 outputs. Coded serial output is at 30 v 10 ma.

Internal and external bit and coding rate control are provided. Dimensions of encoder in cabinet are 21½ in. wide by 11½ in. high by 14½ in. deep. Dimensions for rack mounting are 19 in. wide by 8½ in. high by 14½ in. deep. Power requirements are 117 v ± 10 percent, 60 cps ± 2 cps, 250w. Circle 314 on Reader Service Card.



X-Band Magnetron a one megawatt unit

FERRANTI ELECTRIC, INC., 30 Rockefeller Plaza, New York 20, N. Y. The type VF-10 X-band magnetron is capable of producing 1 megawatt pulse output at mean power levels up to 1,000 w, on frequencies in the range 9,000-9,500 mc. Its overall length is 12.5 in.

The high mean power is made possible by the use of a special cathode with bombardment heating, involving an electron gun operating at 5 kv with 30 ma beam current. Standard tubes can be supplied with ± 20 mc of specified frequency in the range 9,000-9,500 mc, or closer by special arrangement. Circle 315 on Reader Service Card.

MODERN COIL EQUIPMENT

Plus

MODERN COIL HANDLING

Insure perfection in
all DANO COILS

- Encapsulated coils . . . in either polyester or epoxy resins.
- Coils for high temperature applications.
- Bobbins coils.
- Paper interleave coils.
- Cotton interweave coils.
- Form wound coils.

ALSO TRANSFORMERS MADE TO ORDER



THE DANO ELECTRIC CO.
MAIN ST., WINSTED, CONN.

CIRCLE 137 READERS SERVICE CARD

FOR READY ACCESS TO ACCURATE
FREQUENCY CALIBRATION

FULLY TRANSISTORIZED SELF POWERED
FREQUENCY STANDARD

10 KC, 100 KC,
1 MC. Frequency
Stability,
±.002% to
+50° C.



\$12575

- Completely transistorized
- Fundamental outputs at 1 MC, 100 KC and 10 KC
- High accuracy to +70° C
- Self powered by batteries
- Very low power drain
- Extremely portable
- Harmonic content usable beyond 200 MC
- Built-in modulation
- Printed circuit construction
- Multipurpose frame-handle

ELECTRONICS DIVISION
VAN NORMAN INDUSTRIES, INC.
MANCHESTER, NEW HAMPSHIRE

CIRCLE 138 READERS SERVICE CARD

ELECTRONICS engineering edition — February 14, 1958

DIMCO-GRAY

SNAPSLIDE FASTENERS

**PROVIDE VIBRATION-PROOF HOLDING
AND QUICK, FOOL-PROOF RELEASE!**

APPROVED UNDER ARMY-NAVY STANDARDS

Here's a simple, easy means of securely fastening assemblies to withstand shock or vibration, and yet allow quick removal for inspection or repair. Instant snap action engages or releases fastener . . . no tools are required! After installation, fasteners never need adjustment . . . even with repeated use.

Three sizes available for different load requirements. Large and medium sizes are made of corrosion-resistant stainless steel. Small size is made of nickel-plated brass. Stock parts fit various thicknesses of flanges and mounting plates . . . special parts can also be supplied.

WRITE FOR FULL DETAILS TODAY!

DIMCO-GRAY COMPANY

202 E. SIXTH STREET DAYTON, OHIO

CIRCLE 139 READERS SERVICE CARD

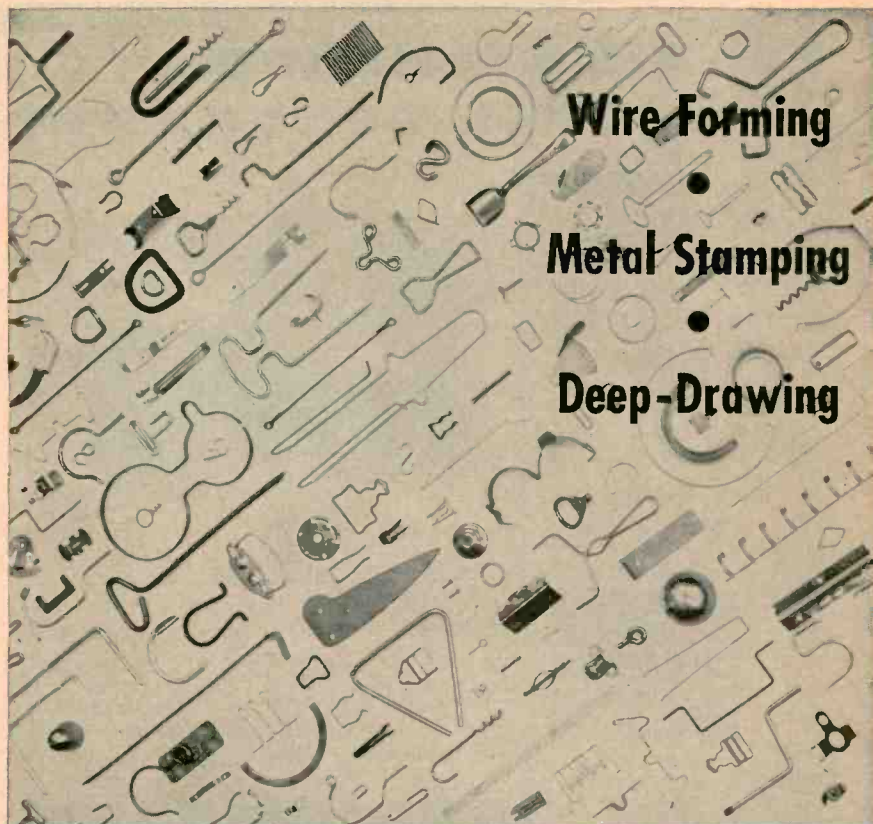
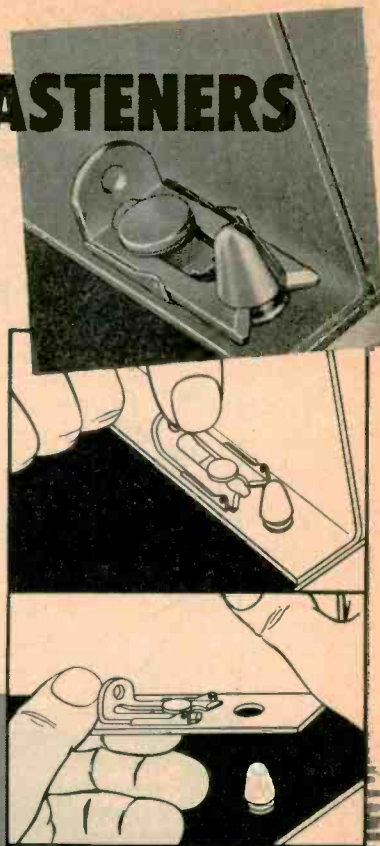

Wire Forming

Metal Stamping

Deep-Drawing

Write for Catalog or to have our representative call.

EASTERN TOOL & MFG. CO. Belleville 9, N. J.

Phones: New York — REctor 2-7875 Belleville — PLYmouth 9-7100

CIRCLE 140 READERS SERVICE CARD

NEW

from the Grayhill Sketch Book



ACTUAL SIZE

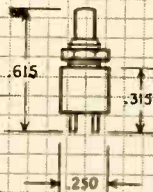

ULTRA-MINIATURE

Series 39-1

PUSH BUTTON SWITCH

- Single pole, single throw, momentary contact, normally open.
- Conservatively rated 1/10 ampere at 115 volts AC, Resistive.
- Life expectancy approximately 1,000,000 operations.
- Maximum panel thickness 1/16" — requires 3/16" dia. hole.

Makes possible heretofore impractical applications of push button switches.

Write for complete details

Telephone
Fleetwood
4-1040



523 Hillgrove Avenue, La Grange, Illinois

CIRCLE 141 READERS SERVICE CARD

New Literature

MATERIALS

Plastics File. Bakelite Co., Division of Union Carbide Corp., 30 E. 42nd St., New York 17, N. Y. The 1958 edition of the "Condensed Reference File" describes in easy, readable terms the major families of plastics produced by the company. The 12-page booklet is profusely illustrated and has thumb-indices to aid in finding data. Circle 351 on Reader Service Card.

COMPONENTS

Constant Voltage Transformers. Sola Electric Co., 4633 W. 16th St., Chicago 50, Ill. CVF-269 is a factual, illustrated four-page folder describing constant voltage transformers for electron tube 6.3 v filament supply. Circle 352 on Reader Service Card.

Magnetic Tapes. Minnesota Mining and Mfg. Co., 900 Bush St., St. Paul 6, Minn. Magnetic tapes for instrumentation recording are covered in an 8-page illustrated booklet. Circle 353 on Reader Service Card.

Microminiature Connectors. DeJur-Amsco Corp., 45-01 Northern Blvd., Long Island City 1, N. Y. A 4-page technical brochure gives specifications, diagrams and general information on an expanded line of microminiature connectors. The units described meet MIL-C-8384 specs and are ruggedized. Circle 354 on Reader Service Card.

Snap-Acting Switches. Hetherington, Inc., Delmar Drive, Folcroft, Pa. Standard definitions for snap-acting switches recently adopted by NEMA are given full illustrated treatment in a new folder. Circle 355 on Reader Service Card.

Switch Catalog. Sargent Electric Corp., 630 Merrick Road, Lynbrook, N. Y. Catalog 100-1 de-

FM-AM STANDARD-SIGNAL GENERATOR

Type **MS27**

0.3—240 Mc/s
in 5 ranges

FM:

Normal: ± 5 , ± 25 , and
 ± 75 kc/s ranges

High: ± 75 , ± 150 , ± 300 ,
and ± 600 kc/s depending
on frequency range.

AM:

0—80%

DISTORTION:

<2% at ± 75 kc/s FM
<5% at 50% AM

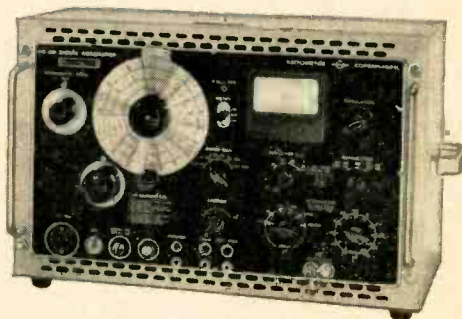

Represented in Canada by
BACH-SIMPSON
London/Ontario

Represented in the United States by
WELWYN INT. INC.
3355 Edgecliff Terrace, Cleveland 11, Ohio

OUTPUT: 0.1 μ V to 0.1 V across 50 or 75 ohms
in 1 dB steps • Crystal calibration of dial •
Direct reading ± 50 kc/s Incremental Frequency
dial • Simultaneous FM and AM •
Rugged militarized construction (NATO
K114 specs.).

RADIOMETER

72 Emdrupvej, Copenhagen NV-1, Denmark

of the Week

scribes a complete line of toggle and trigger switches. Ten types are listed with illustrations, dimensional and electrical rating data. Circle 356 on Reader Service Card.

EQUIPMENT

Magnetic Tape Recorder. Ampex Corp., 934 Charter St., Redwood City, Calif. An 8-page brochure introduces a new magnetic tape recording instrument which puts pictures on tape, retransmits or stores them with complete retention of original fidelity. Called Faxtape, the machine described is used in conjunction with conventional facsimile equipment. Circle 357 on Reader Service Card.

Memory Systems. Daystrom Inc., 5640 LaJolla Blvd., LaJolla, Calif. Technical bulletin 104 covers transistorized magnetic core memory systems. The systems discussed have storage capacities varying anywhere from 500 bits to 40,000 bits, with typical access times of from 10 to 20 μ sec. Circle 358 on Reader Service Card.

Ultrasonic Cleaners. The Narda Ultrasonics Corp., 122 Herricks Road, Mineola, L. I., N. Y., has available a data sheet describing the SonBlaster series 600, a mass-produced line of high capacity, production-size ultrasonic cleaners. Circle 359 on Reader Service Card.

FACILITIES

Printed Circuit Facilities. Electralab, Inc., Industrial Center, Needham Heights 94, Mass. Stressing the role played by research and development, as well as quality control, in the production of printed circuitry, a 4-page brochure outlines the physical and engineering facilities which contribute to the excellence of circuits used in missiles, computers, data processing equipment, radar and quality instruments. Circle 360 on Reader Service Card.

precision
timers by...

STANDARD

TRADEMARK

Industry's preferred "instrument of a thousand uses". Accurate, rugged, versatile STANDARD Elapsed Time Indicators. Synchronous motor drive. Electric clutch controlled by manual or automatic switch or output of electronic tubes. Manual or electric zero reset. Units for flush panel mounting or portable use.

Model	Scale Divisions	Totalizes	Accuracy
S-100	1/5 sec.	6000 sec.	$\pm .1$ sec.
S-60	1/5 sec.	60 min.	$\pm .1$ sec.
SM-60	1/100 min.	60 min.	$\pm .002$ min.
S-10	1/10 sec.	1000 sec.	$\pm .02$ sec.
S-6	1/1000 min.	10 min.	$\pm .0002$ min.
S-1	1/100 sec.	60 sec.	$\pm .01$ sec.
MST	1/1000 sec.	.360 sec.	$\pm .001$ sec.
MST-500	1/1000 sec.	30 sec.	$\pm .002$ sec.

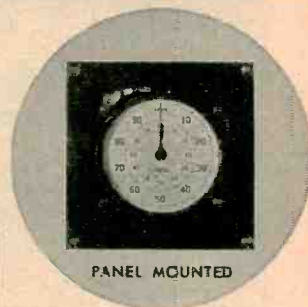

PANEL MOUNTED

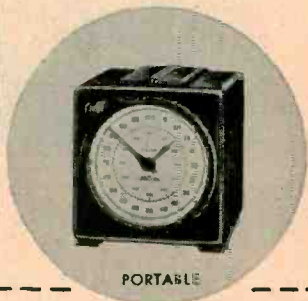

PORTABLE



Request Bulletin No. 198.

THE STANDARD ELECTRIC TIME COMPANY

89 LOGAN STREET • SPRINGFIELD, MASSACHUSETTS

CIRCLE 143 READERS SERVICE CARD

FLUSH

LATCH

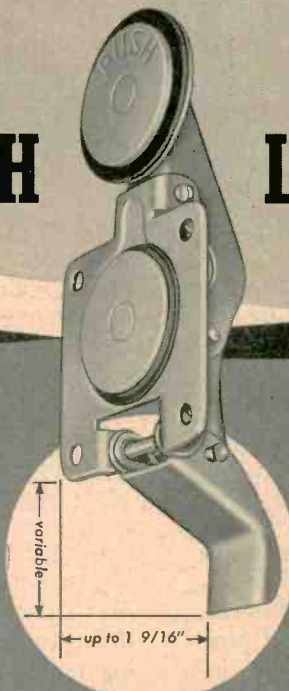

Whether you are designing a cabinet or planning to improve your present one... Missile-Air flush latches are the best in quality, performance, and trouble free in operation.

Ruggedly made of stainless steel, except for aluminum alloy buttons, our flush latches are easy opening positive sealing, light weight, simple to operate and install.

it's the **KEEPER**
that counts!



For further information and literature, contact our Engineering Department.

1108 WEST 135TH STREET, GARDENA, CALIF. • FACULTY 1-3411



SDC Plants Will Serve AF

A \$20 MILLION Air Force contract has just been transferred from the RAND Corporation to the newly organized System Development Corp. (Santa Monica, Calif.), an independent non-profit corporation, as is RAND. Under the contract, SDC will provide professional technical services to the Air Defense Command. The new corporation, using the facilities and personnel of the former System Development Division of RAND, will continue to work closely with RAND. According to RAND's president, F. R. Collbohm, it was found desirable to set up SDC as a separate corporation with the rapid expansion of System Development Division's activities. RAND serves mainly in a scientific advisory capacity on long-range research for the Air Force.

SDC employs more than 1,800 people, including highly-trained specialists from psychologists to computer programmers. Work is being done on two major projects related to Air Defense. One project involves the development, installation, and maintenance of a System Training Program simulating emergency situations, such as enemy raids on U. S. targets, to give the air defense system practice. The program helps the Air Defense Command to develop flexible adaptation to any emergency.

SDC's second big job is programming for SAGE (Semi-Automatic Ground Environment) air defense system computers. SAGE, soon to operate throughout the U.S., uses a network of huge hi-speed electronic digital computers to process data about the 30,000 plane flights taking place daily in the nation. The computers, connected directly to radars, weather stations, etc., sift, display and transmit constant reports on the air traffic picture. Radar detection of aircraft is correlated to all other information by the computer. In the case of "unknown" aircraft, interceptors are accurately guided to the craft with exact information on speed, altitude, and direction. The computers can also serve to launch and guide missiles.

Beside the main location in Santa Monica, SDC has a group at Lexington, Mass., where SAGE originated. SDC representatives are also stationed permanently at major Air Defense Command centers throughout the nation, and traveling teams of programmers set up new programs at the different SAGE computing installations.

Earnings from contracts are used by SDC to further research in the interests of security and public welfare.

In Santa Monica, SDC occupies a new 110,000 sq ft office and

equipment building, plus a 60,000 sq ft structure (right foreground in the picture) housing a modified SAGE computer for developing and checking computer programs before they are taken to SAGE sites. A third office building, 130,000 sq ft, (at left in the aerial view) has just been completed and is being occupied.



AIL Names Chief Engineer

PROMOTION of Lawrence J. Torn (picture) to the position of chief engineer of Airborne Instruments Laboratory, Inc., Mineola, N. Y., is announced. His new work assignment calls for coordination of the company's production design activities in the field of industrial control systems involving automatic machine and process controls and electronic test equipment.

Torn's experiences with AIL have been in the fields of servomechanisms, feedback amplifiers, analog computers and closed-loop radar data processing systems. They include responsibility for engineering development as project engineer of a large-scale radar data processing system that incorporated new concepts of theory and circuitry.

Paragon Plans Consolidation

GROUND has been broken in Two Rivers, Wisc., on a new \$400,000 manufacturing plant for Paragon

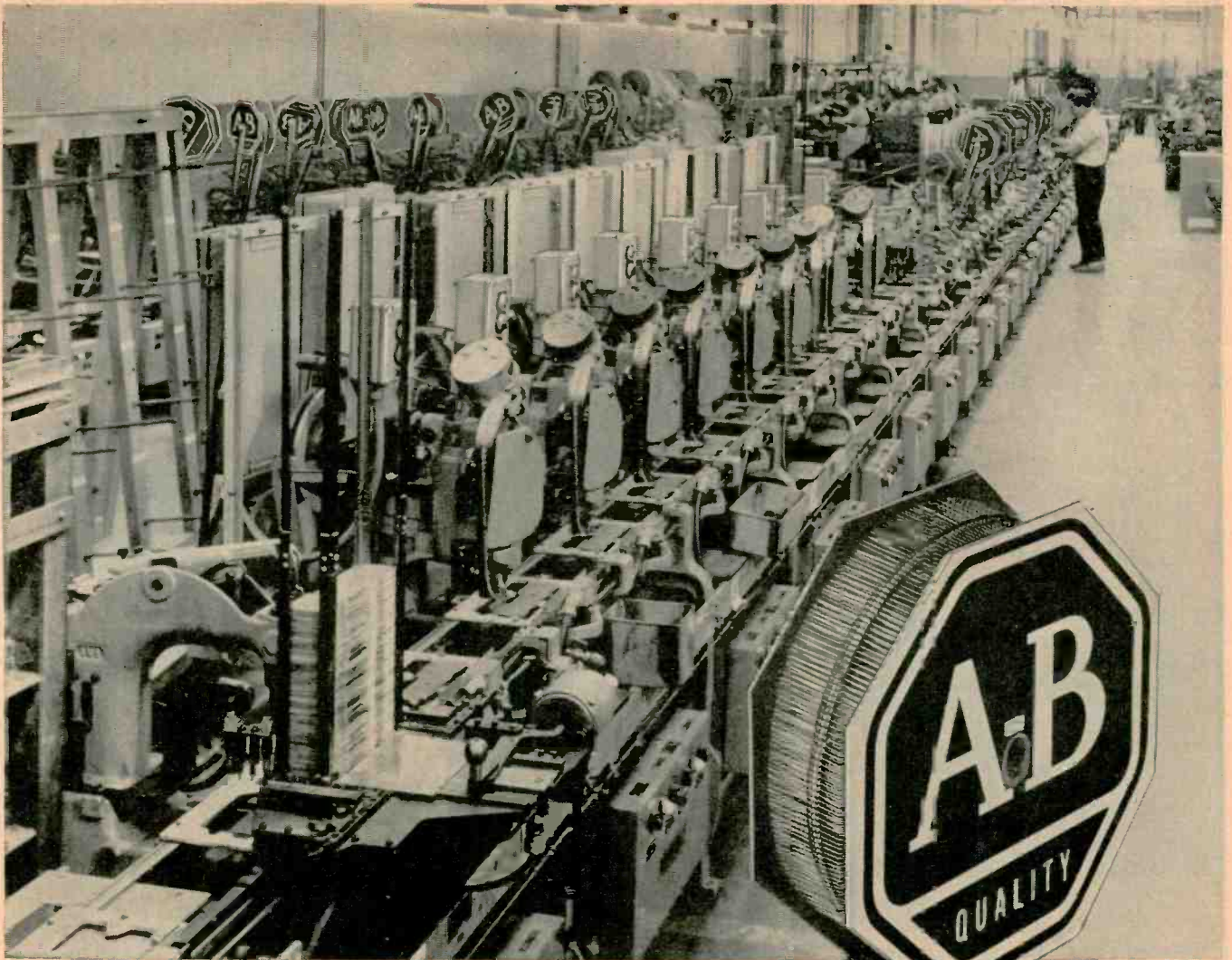

1200 Printed boards assembled per hour... using Allen-Bradley composition resistors. Pressure sensitive tape holds resistors in place on reels for ease in automatic feeding.

Physical uniformity of ALLEN-BRADLEY resistors permits high-speed mechanized assembly

Allen-Bradley's exclusive process used in making its solid molded resistors assures dimensional uniformity that is astounding. Consequently, their use in mechanized assembly virtually eliminates costly shutdowns to clear jammed stations resulting from "off-size" units. The clean, tough surface of A-B molded resistors will withstand mechanized handling without chipping or cracking. Since wax is *not* used to provide moisture resistance, this source of trouble is also eliminated. Differentially tempered leads permit bending without wire breakage.

Electrically, Allen-Bradley resistors are universally recognized for their conservative ratings and stable characteristics. To realize the maximum output from your high-speed assembly process, specify Allen-Bradley *quality* resistors. Write for technical data, today.

Allen-Bradley Co., 110 W. Greenfield Ave., Milwaukee 4, Wis.
In Canada—Allen-Bradley Canada Ltd., Galt, Ont.



A-B fixed resistors are available in 1/10, 1/4, 1/2, 1, and 2-watt sizes in all RETMA values. Also carton packed for manual assembly.

ALLEN-BRADLEY

RADIO, ELECTRONICS, AND TELEVISION COMPONENTS

VITREOSIL®

**FUSED QUARTZ
MEETS YOUR
CRITICAL
REQUIREMENTS**

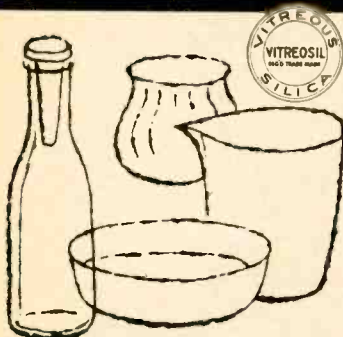

CHECK WHAT VITREOSIL OFFERS:

- ✓ Absolute Chemical Purity
- ✓ Extreme Heat Resistance
- ✓ Thermal Shock Resistance
- ✓ Chemical Inertness
- ✓ Outstanding Electrical Properties
- ✓ Full-Range Radiant Energy Transmission

VITREOSIL fused quartz products can be supplied in an unusually large variety of types and sizes. Also fabricated to specification to meet semi-conductor requirements.

TRANSPARENT VITREOSIL

For ultra-violet applications, metallurgical investigations and processes, chemical research and analysis, photochemistry, spectroscopy and physical, optical and electrical research and production operations. Send specifications for your requirements. Please use coupon below.

See our ad in

Chemical Engineering Catalog

**THERMAL AMERICAN
FUSED QUARTZ CO., INC.**
18-20 Salem Street, Dover, New Jersey

Please send technical data on

Company _____
Name & Title _____
Street _____
City _____ Zone _____ State _____

CIRCLE 145 READERS SERVICE CARD

Electric Co., makers of automatic time controls. The 72,000-sq ft plant will enable the company to consolidate all the manufacturing operations of its five separate plants at a single site.

Consolidation of manufacturing operations and expansion of facilities is expected to result eventually in employment of over 500 people.



Perkin-Elmer Fills Key Post

New general manager of the instrument division, Perkin-Elmer Corp., Norwalk, Conn., is R. Victor Harris (picture). He succeeds Van Zandt Williams, who was recently named executive vice president of the company.

Harris joined Perkin-Elmer in 1949 and became director of production in 1950. When the instrument division was formed in 1956 he became its assistant division manager and held this position until his new appointment.

Prior to Perkin-Elmer, he was associated with Taylor Instrument Co. and MIT. During the war he was a staff research engineer at the MIT Radiation Laboratory where he worked on radar gun directors.

IRE Honors Roberts

FRANK B. ROBERTS, chief engineer for communications receivers and components, National Co., Inc.,

Military reliability in SEMI-CONDUCTOR POWER CONVERTERS



PS-1018 supply for AN.DPN-19 Beacon



PS-3002 28 Volt DC input: 400 cps sine wave output



PS-1004B standard 325 Volt, 200 ma dc-dc converter



PS-4000 115 volt AC input; 300 volt 1.5 ampere regulated DC output supply

Power Sources units are now in production missiles

Complete range of sizes, types and capacities for military and commercial requirements:

★ DC to AC available in any power up to 1500 watts . . . square or sine wave output.

★ AC to DC available with voltages up to 500V, and currents to 3 amps . . . DC Regulation to 0.1% . . . Impedances to .05 ohms . . . Over-all efficiencies 70-75%.

★ DC to DC available in combinations of the DC to AC and AC to DC ratings shown above.

★ Military Reliability is assured by extremely conservative designs and the use of the best, pretested military grade components and advanced semiconductor techniques. Meet MIL-E-5400 and MIL-E-8189.



SEND FOR TECHNICAL DATA

See us at I.R.E. Booth No. 3508

POWER SOURCES, INC.
Burlington, Massachusetts
BRowing 2-3005

CIRCLE 146 READERS SERVICE CARD

Malden, Mass., received an award from the professional group on broadcast and tv receivers of the IRE for contributing the outstanding recent paper in the field of interest of this professional group. The award was made by Harlan A. Bass, Director of Radio & Television Engineering, Avco Mfg. Corp., Cincinnati, Ohio, at the Radio Fall Meeting of the IRE group in Toronto.

Westinghouse Ups Frailey

New operations manager for power and special purpose tubes at Westinghouse electronic tube division is Henry F. Frailey. He will be responsible for the design, development, engineering and manufacturing of these tubes.

Frailey has been with the division since 1951, first as a supervisor of manufacturing engineering and then as superintendent of the CRT department. Prior to joining Westinghouse, he was associated with Sylvania and RCA.



Offers New Service

A PROCUREMENT service organization known as R. G. Expeditors Service has been opened at 220 Fifth Ave., New York, N. Y. Founder is Robert Gueydan (picture), formerly assistant director of purchases, Remington Rand Div., Sperry Rand Corp.; and procurement representative of Convair, a division of General Dynamics Corp., respectively.

The new firm plans to offer a

GE SAVES 80%

with GRC tiny mating parts

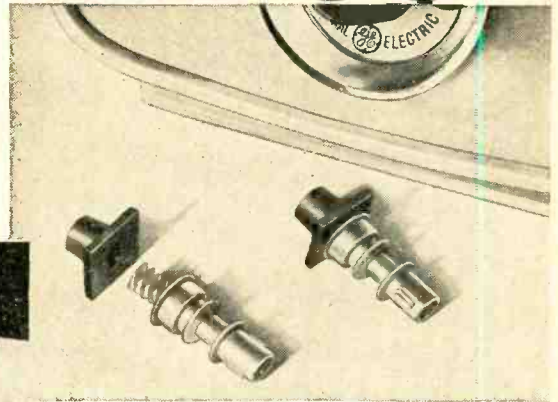

Exclusive Gries techniques actually improved design and performance by die-casting this zinc-alloy threaded shaft and injection-molding the mating Nylon nut. Both units formerly were produced as screw machine parts, at 5 times the present cost. A typical demonstration of GRC's unique talent for doing big things with small parts . . . economically!

Send today for illustrated bulletin

NO MINIMUM SIZE!

MAXIMUM SIZES:

Nylon 1 1/4" long .03 oz.

Zinc Alloy 1 3/4" long 1/2 oz.

Quick deliveries on quantities of 100,000 to many millions

GRIES 

World's foremost
producer of
small die castings

GRIES REPRODUCER CORP.

151 Beechwood Ave., New Rochelle, N. Y. • New Rochelle 3-8600

CIRCLE 147 READERS SERVICE CARD

YOKE

specialists

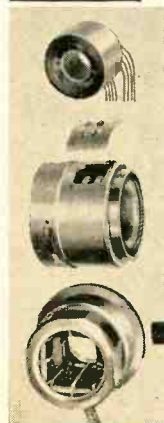

COMPLETE LINE for every Military and Special purpose . . . in PRODUCTION QUANTITIES . . . or CUSTOM DESIGNED to your specific requirement.

syntronic

INSTRUMENTS, INC.

100 Industrial Road, Addison, Ill., Phone Kingswood 3-6444
CIRCLE 148 READERS SERVICE CARD

SWITCHCRAFT INC.

Introduces!

"Custom-Made" MOLDED CABLE ASSEMBLIES

MOLDED-ON PLUGS

Completely
Electrically Shielded

Ask to see these
assemblies and other
new components at the

RADIO ENGINEERING
SHOW

N. Y. Coliseum
Mar. 24 to 27

BOOTH 2228

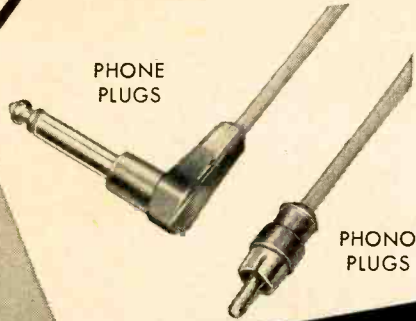

Available in
Innumerable Terminations

EQUIPMENT MANUFACTURERS —

Switchcraft Engineers will help you design an assembly to harmonize and complement the styling of your equipment at possibly a lower cost.

Write for bulletin S-582 or furnish us complete specifications with your inquiry.

SWITCHCRAFT INC.

1336 N. Halsted St.

Chicago 22, Ill.

Canadian Rep: Atlas Radio Corp., Ltd., 50 Wingold Ave., Toronto, Canada.
CIRCLE 149 READERS SERVICE CARD

NOW! GO—NO GO—COMPARATIVE MEASUREMENTS AT A GLANCE

For Quality Control and Production Tests From DC to 250 MC!

NEW HIGH SPEED COAXIAL SWITCH

APPLICATIONS:

Audio — Video — Intermediate — R.F.
Circuitry — Passive Networks — Vacuum
Tubes — Diodes — Transistors — Etc.

Permits Dual Scope Presentations—
Reference and Test

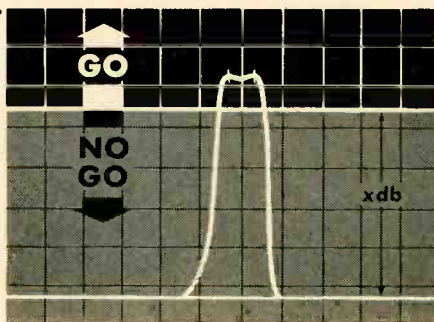

An oscilloscope presentation of a
typical Amplifier in Production Test.



\$250.00
F.O.B. PLANT
Model FD-30*

Frequency range of coaxial circuit is from DC to 250 MC with a VSWR of less than 1.1 at 50 or 75 ohms impedance. Switch contacts "Mercury-Wetted" with an adjustable switch rate of 30, 15 or 10 cps.

For further information on Appli-
cations and Specifications write to:

*Specify 50 ohm or 75 ohm impedance

JERROLD

ELECTRONICS CORPORATION, Dept. TED-6
Philadelphia 3, Pa.

procurement expediting service functioning for purchasing departments everywhere whose suppliers are located in the eastern United States. Gueydan will call on vendors in person, outline problems and circumstances for purchases and make facilities surveys and plant or vendor evaluations in all branches of industry and manufacturing.

According to Gueydan, many companies now find that they have orders that are being processed far too slowly or they find improved delivery dates imperative. Many also require more factual information on the status of their orders and the facilities of their suppliers. He believes this service can serve purchasing departments more economically than they themselves can perform this function with their own personnel.



Dalmo Victor Forms Division

A new electronic systems division has been formed by Dalmo Victor Co., Belmont, Calif. It will be responsible for engineering, manufacturing, and sales of electronic systems, test equipment and sub-assemblies. Present Dalmo Victor work in these fields includes sonar, magnetic detection, communications, countermeasures and infrared.

Glenn A. Walters (picture), formerly vice president in charge of research, will direct the new division as vice president and manager. Walters, who joined Dalmo

Save Money
and Time with

Malco

**SOLDERING LUGS
• TERMINALS •
PRINTED CIRCUIT
HARDWARE**

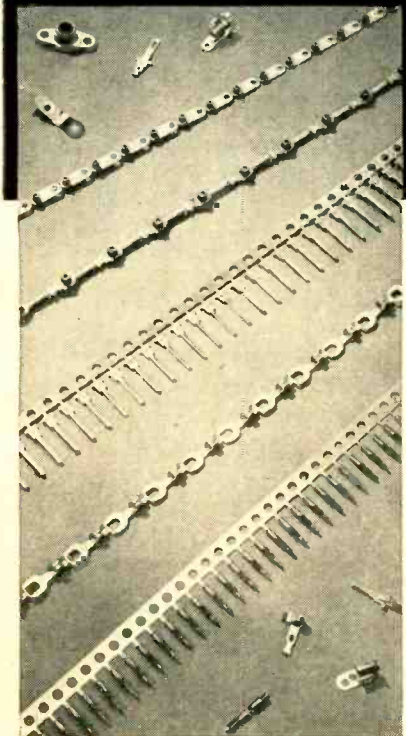

Tell us about your application and production requirements. We'll supply your needs from our complete line—or adapt to your specifications—and show you how to cut costs and speed up production!

- Miniature Tubular Terminals, Wire Wrap Terminals and Contacts for Automated Printed Circuit Applications
- Solderless Crimp-on Terminals
- Line Cord Interlock Terminals
- Automatic terminal inserting, crimping and staking machines

Contact us today. Send blue print or specifications for specific information. Request bulletins for general information.

Malco TOOL and MANUFACTURING CO.

4023 W. LAKE ST. • CHICAGO 24, ILL.

CIRCLE 151 READERS SERVICE CARD

ELECTRONICS engineering edition—February 14, 1958

Victor in 1947 as an electrical design engineer, was appointed director of research in 1950, in which capacity he headed a laboratory staff of 75. In February 1957, he was named a vice president of the firm.

He has pioneered the development of miniaturized electronic packages and circuit simplifications for airborne electronic equipment manufactured by the company.



ESC Hires Peressini

APPOINTMENT of Richard D. Peressini (picture) as project engineer at ESC Corp., Electronic Components Division, Palisades Park, N. J., is announced. He was formerly an associate engineer in the transformer department of Allen B. Du Mont Laboratories.

In his new capacity at ESC, Peressini will be engaged in the design and development of the company's line of custom-built and stock pulse transformers, pulse-forming networks and miniature plug-in encapsulated circuit assemblies.

Plastics Firm To Expand

NORTHWEST Plastics, Inc., St. Paul, Minn., is already planning to double the size of its recently built facility at Gastonia, N. C.

The subsidiary factory, called

This
precision



Potentiometer easily withstands

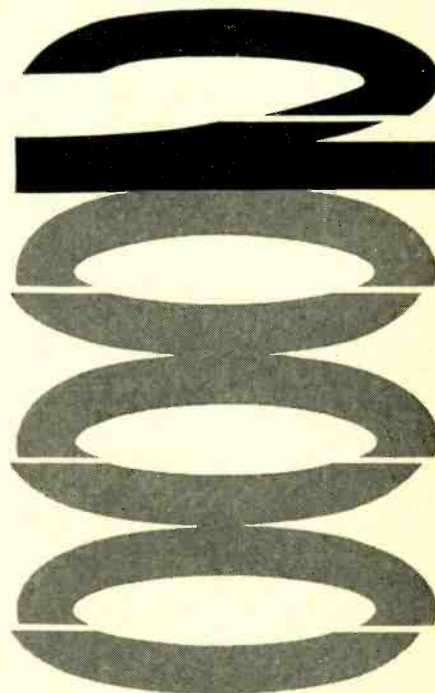

CYCLE VIBRATION!

another result of
"DYNAMIC
BALANCE" *

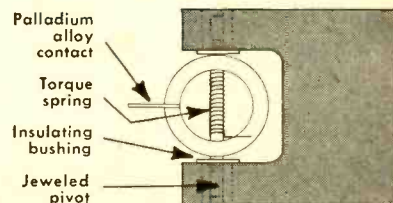

New electromechanical innovation assures potentiometer performance of highest precision . . . electronically *and mechanically!* Arm is dynamically balanced on shaft . . . contact assembly dynamically balanced on arm. The "maximum precision" potentiometer offering wanted performance characteristics:

- Continuous operation at 2000 cycle vibration at 30 g's
- 5,000,000 cycle life
- Up to 3,425 RPM operating speeds

*Patent Pending

Write today for complete information on the 1000 Series

kintronic

Division of
Chicago Aerial
Industries, Inc.

10265 Franklin Avenue Franklin Park, Illinois
CIRCLE 152 READERS SERVICE CARD

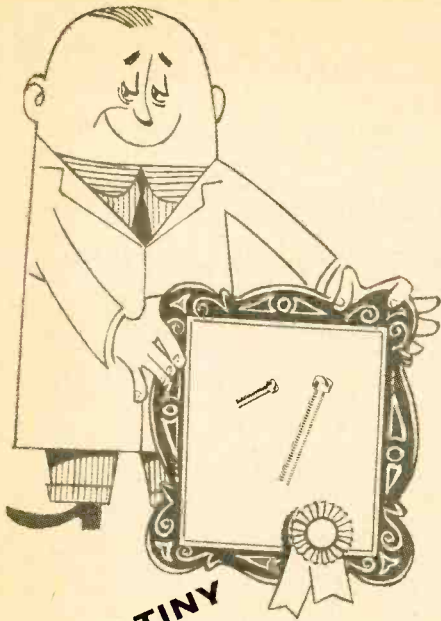

**SO TINY
SO PERFECT**

When Precision Counts...

CIRCON INSTRUMENT SCREWS

- ★ Precision from Head to Thread
Stainless Steel or Brass
- ★ Largest Stock of Miniature Hardware
- ★ Plated Ready for Use
- ★ Immediate Shipment

Check These Dimensions on
Fillister Head Screws

SIZE	Threads Per Inch	Major Diam.	Pitch Diam.	Minor Diam.	Pitch	Depth of Thread
000	120	0.034	0.0286	0.0260	0.00833	0.00400
00	90	0.047	0.0403	0.0326	0.01111	0.00721
0	80	0.060	0.0519	0.438	0.1250	0.00812
1	72	.073	.0640	.0550	.01389	.00902
2	56	.086	.0744	.0628	.01786	.01160
3	48	.099	.0855	.0719	.02083	.01353
4	40	.112	.0958	.0795	.02500	.01624

SIZE	Head Diam.	Height of Head	Depth of Slot	Width of Slot	Tap Drill	Body Drill
000	.056	.031	.014	.012	#71 (.026)	#63 (.037)
00	.068	.038	.014	.023	#65 (.035)	#55 (.052)
0	.090	.050	.022	.025	3/64 (.047)	#51 (.067)
1	.111	.062	.024	.027	#53 (.059)	#47 (.078)
2	.132	.073	.029	.030	#50 (.070)	#42 (.093)
3	.153	.084	.035	.032	#47 (.078)	#37 (.104)
4	.174	.096	.040	.034	#43 (.089)	#31 (.120)

All Tolerances are per AN and MIL Specs. OR BETTER.

We solicit your special and non-standard requirements

Representatives in United States and Canada

CIRCON

COMPONENT CORPORATION

Santa Barbara Municipal Airport
Goleta, California
Telephone: Woodland 7-1113

CIRCLE 153 READERS SERVICE CARD

Northwest Plastics of Carolina, Inc., is operating at near capacity with 50 employees. Plans call for a 10,000 sq ft addition to the Gastonia plant which turns out electrolytic capacitor enclosures.

J. R. Freyeremuth, president of the parent company in St. Paul, looks for ground to be broken in the very near future. The initial \$225,000 factory was so designed on its 11-acre site that it could be enlarged on any of its sides.



Molded Parts Maker Expands

GENERAL PRODUCTS CORP. (picture) of Union Springs, N. Y., manufacturer of terminal boards, cable assemblies and precision molded parts for industrial and government applications, has completed an extensive plant expansion program which increases its floor space over 2½ times the original area.

The new area will house the sales and engineering staff, general offices, additional production areas and a new laboratory. Facilities gained by the plant expansion program allows a much greater range in new product design and development.

Open Testing Lab in West

UNITED ElectroDynamics, Pasadena, Calif., has opened a new facility in Monterey Park, Calif., to be called the United Testing Laboratories. The new facility encompasses 30,000 sq ft of which 7,500 sq ft will be devoted to atmospheric controlled electronic lab-

let Williams
help you apply

FERRIC OXIDES

to the manufacture
of your

FERRITES

You'll be well repaid by getting the facts on a special group of Pure Ferric Oxides, developed by Williams especially for use in the manufacture of ferrites.

Williams Ferric Oxides analyze better than 99% Fe₂O₃. They contain a minimum of impurities. They are available in a broad range of particle sizes and shapes. Among them, we're certain you'll find one that's "just right" for your requirements. The proper application of Ferric Oxides to the manufacture of Ferrites is our specialty.

Tell us your requirements... we'll gladly send samples for test. Chances are good that our Ferric Oxide "Know How" can save you considerable time and money. Address Dept. 25, C. K. Williams & Co., Easton, Pa.

WILLIAMS

COLORS & PIGMENTS

C. K. WILLIAMS & CO.
Easton, Pa. • East St. Louis, Ill.
Emeryville, Cal.

P.S. We also produce IRN Magnetic Iron powders for the Electronic Core Industry, the Magnetic Tape Recording Industry and others. Write for complete technical information.

CIRCLE 154 READERS SERVICE CARD

oratories, and 10,500 sq ft additional floor space to general mechanical and environmental testing area. The spacious site allows for flexibility of indoor as well as hazardous outdoor testing.

Robert D. Fagaly, general manager, and D. L. Roelands, operations manager, head a staff consisting of 60 engineers and technicians, supported by an office staff of 10 persons.

The complete facility is available to industry on either a project performance or a long-term continuing basis.

Midwest Firm Incorporates

In Seymour, Indiana, Condenser Research Corp., a subsidiary of Marathon Electric Mfg. Corp. of Wausau, Wis., was recently incorporated.

James C. Cupp has been appointed vice president and chief engineer, and Arthur B. Mayer, sales manager of the capacitor making firm.



ACF Elects V-P

ELECTION of Henry A. Correa (picture) as vice president for foreign operations of ACF Industries, Inc., is announced. Associated with Bendix Aviation Corp. since 1945, he most recently was aviation sales manager for its International Division.

Correa will coordinate his activi-

2 PL
CLEAR
PLASTIC
2 $\frac{3}{8}$ x 2 $\frac{3}{8}$

LONG KNOWN FOR
THEIR HIGH QUALITY
DURABILITY
ACCURACY AND
ADVANCED DESIGN

BD

BEEDE

for
SMALL POWER-UNIT PANELS,
INDUSTRIAL TEST UNITS,
COMMUNICATION EQUIPMENT.

14
CLEAR PLASTIC 3 $\frac{1}{2}$ x 3

23 CLEAR PLASTIC 4 $\frac{5}{8}$ x 4 $\frac{3}{8}$

BEEDE ELECTRICAL INSTRUMENT CO., INC.
PENACOOK, N. H.
CIRCLE 155 READERS SERVICE CARD

TELEPHONE AND TELEGRAPH EQUIPMENT

Radio Engineering Products is currently producing a number of types of equipment, electrically and mechanically interchangeable with standard Bell System apparatus.

CARRIER-TELEPHONE EQUIPMENT

C5 Carrier-Telephone Terminal (J68756). A kit for adding a fourth toll-grade channel to existing C systems is available. • C1 Carrier-Telephone Repeater (J68757) • 121A C Carrier Line Filter • H Carrier Line Filter (X66217C).

CARRIER-TELEGRAPH EQUIPMENT

40C1 Carrier-Telegraph Channel Terminal (J70047C) • 140A1 Carrier Supply (J70036A1, etc.) • 40AC1 Carrier-Telegraph Terminal.

VOICE-FREQUENCY EQUIPMENT

V1 Telephone Repeater (J68368F) • Power Supply (J68638A1) • V1 Amplifiers (J68635E2 and J68635A2) • V3 Amplifier (J68649A) • V-F Ringers (J68602, etc.) • Four Wire Terminating Set (J68625G1) • IC Volume Limiter (J68736C).

D-C TELEGRAPH EQUIPMENT

16B1 Telegraph Repeater (J70037B) • 10E1 Telegraph Repeater (J70021A) • 128B2 Teletypewriter Subscriber Set (J70027A).

TEST EQUIPMENT

2A Toll Test Unit (X63699A) • 12B, 13A, 30A (J64030A) and 32A (J64032A) Transmission Measuring Sets • 111A2 Relay Test Panel (J66118E) • 118C2 Telegraph Transmission Measuring Set (J70069K) • 163A2 Test Unit (J70045B) • 163C1 Test Unit (J70045D).

COMPONENTS AND ACCESSORIES

255A and 209FG Polar Relays • Repeating and Retard Coils, several types • 184 185, 230A and 230B Jack Mountings.

RADIO ENGINEERING PRODUCTS
1080 UNIVERSITY ST., MONTREAL 3, CANADA
TELEPHONE CABLES
UNiversity 6-6887 RADENPRO, MONTREAL

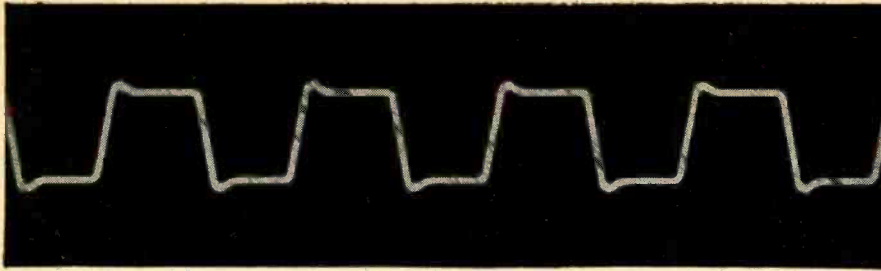

DELAY LINES

standard or specially designed

BY TECHNITROL

These extra-compact delay lines assure a minimum of pulse distortion with maximum stability under ambient temperatures . . . and in a minimum of space. They can be had pencil-thin in plug-in, pig tail or fuse-clip mounting. Available cased or dip-coated in epoxy resin as well as hermetically-sealed units for military application . . . with any desired characteristics of impedance or frequency response. Typical are:

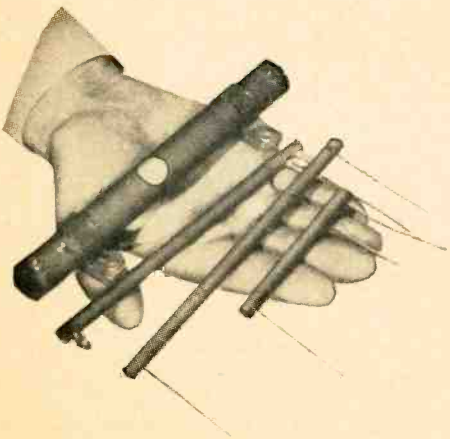

- **Delay:** 0.01 to 6 μ s
- **Characteristic Impedance:** 400 to 5600 ohms
- **Band Pass Characteristics:** Unique windings furnish maximum band width for given delay per inch.

We are prepared to design lumped constant or distributed constant delay lines for your particular circuit applications.



Write today
for Bulletin
E 174.

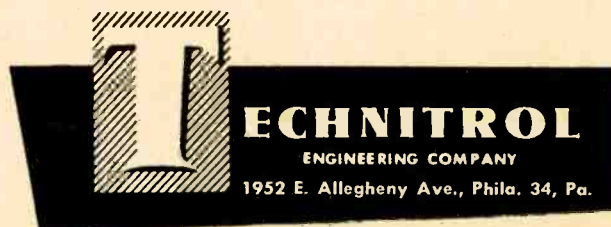

ties with those of the ACF operating divisions in marketing the company's products abroad, including railroad equipment, nuclear reactors, valves, flight simulators, and other training devices, electronic equipment and aircraft and missile parts and components. He will make his headquarters in New York.



Add to Filtors Staff

In Port Washington, N. Y., Filtors, Inc., manufacturer of hermetically sealed subminiature relays, adds Michael Giordano (picture) to its engineering staff.

Prior to joining Filtors, Giordano was associated with The Nagler Helicopter Co. as consulting staff engineer. His background includes an eight year association with the Grumman Aircraft Corp. as missiles design and materials engineer and as test engineer for the engine division of the Fairchild Airplane and Engine Corp.

Clevite Fills New Post

NEWLY created post of production manager at Clevite Transistor Products, Waltham, Mass., is taken over by Albert J. Harcher. The position was created in a move to expand production of recently announced silicon-germanium alloy diodes and

Hundreds of standard
JONES
TERMINAL PANELS
 Complete equipment for
SPECIALS



Send your specifications for prompt quotation

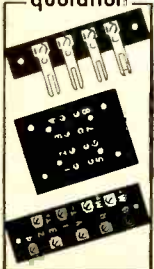

Several pages of Jones Catalog No. 21 illustrate standard and special panels we are constantly producing. Latest special equipment enables us promptly to produce practically any panel required. Send print or description for prices, without obligation. Hundreds of standard terminal strips also listed. Send for Catalog 21 with engineering drawings and data.

JONES MEANS Proven QUALITY



CIRCLE 158 READERS SERVICE CARD

For
Missile Testing

and general use

30 to 300 Amps

- Closely Regulated
- Fast Response
- Underwriters Approved
- Rigid Quality Control

CHRISTIE
SILICON
 POWER
 RECTIFIERS

Available in Industrial and Military types. Military type meets specs MIL-E-4970 and MIL-I-6181. Other stationary and mobile styles available up to 1500 Amps.

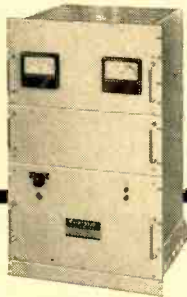

Write for
 Bulletin
 AC-58-A

CHRISTIE ELECTRIC CORP.
 Dept. EL, 3410 W. 67th St., Los Angeles 43
 Over a Quarter Century of Rectifier Manufacturing

CIRCLE 159 READERS SERVICE CARD

IMMEDIATE DELIVERY

(Small Quantity)

PRECISION **C**ARBON **D**EPOSITED **R**ESISTORS

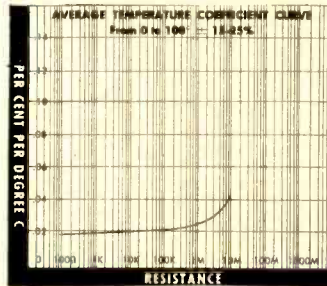

Temperature coefficient characteristics for ALPT-1 watt resistor

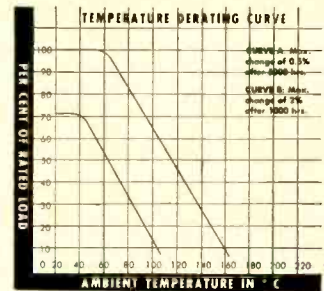

Derating curve for ALPT-1 watt resistor

STANDARD RESISTORS $\pm 1\%$ TOLERANCE IN 10% RMA
 VALUES FROM 10 OHMS TO 2.7 MEGOHMS

APST- $\frac{1}{2}$ WATT, APXT- $\frac{1}{2}$ WATT AND APCT-1 WATT
 SALES OFFICES AND DISTRIBUTORS

Factory Delivery, other than stock values:
 1/10, 1/5, 1/4, 1/2, 1, 2 and 5 Watt

ALLIES' PRODUCTS CORPORATION
 P. O. Box 188, Kendall Branch, Miami, Florida

BROCHURE SUPPLIED UPON REQUEST.

CIRCLE 160 READERS SERVICE CARD

RIBBONS • STRIPS

of
 ★ PURE TUNGSTEN ★ THORIATED TUNGSTEN
 ★ MOLYBDENUM ★ SPECIAL ALLOYS
 and OTHER METALS

IN
ULTRA THIN SIZES

to
TOLERANCES CLOSER THAN COMMERCIAL STANDARDS
 by

OUR SPECIAL ROLLING TECHNIQUE

Note: for highly engineered applications—strips of TUNGSTEN and some other metals can be supplied

ROLLED DOWN TO .0003 THICKNESS

- Finish: Roll Finish—Black or Cleaned
- Ribbons may be supplied in Mg. weights if required

For HIGHLY ENGINEERED APPLICATIONS

DEVELOPED AND MANUFACTURED BY

H. CROSS CO.

15 BEEKMAN ST., N. Y. 38, N. Y.
 TELEPHONE: Worth 2-2044
 Cortlandt 7-0470

CIRCLE 161 READERS SERVICE CARD

**SPACE
IS
Valuable**

... So Use
the **A. W. HAYDON**
company's

**SUB-MINIATURE HERMETIC
ELAPSED TIME INDICATORS.**

You, too, can afford the space to keep track of time! From now on, these really small (1 1/4") Elapsed Time Indicators will keep company with the best of Electronic Miracles.



The illustration shows how the operating time of various sections of an electronic console can be monitored.

The dial type units read up to 2,500 hours in one hour increments, while the digital type units read up to 9999.9 hours in one-tenth hour increments. Designed for military applications, these 4 1/2 ounce units can save valuable panel space in industrial and electronic applications.

The 400 cycle models now in production are described in Bulletin AWH ET 602.



Design and Manufacture of Electro-Mechanical Timing Devices

CIRCLE 162 READERS SERVICE CARD

other diodes and transistors.

Harcher was formerly associated with CBS-Hytron, serving as plant manager of both Newburyport and Kalamazoo tv picture tube operations. Earlier he had served the company as temporary plant manager in Lowell, Mass., and as chief engineer in charge of developing rectangular tv picture tubes.

His professional career started with Westinghouse research laboratories. He also served as a development engineer for RCA, and as chief engineer for Lansdale Tube Co.



**Fite Joins
Burroughs**

RETIRED U. S. Army Colonel, Randolph V. Fite (picture), who set up the Munich relay station for the Voice of America and developed various radar warning and tracking systems for the Army, has joined the Burroughs Corp. Research Center in Paoli, Pa. He will serve in an advisory capacity to the manager of the special products division which is responsible for research and development of secret military equipment and systems.

**Aerophysics Ups
Steinhoff**

NEWLY appointed associate technical director at Aerophysics Development Corp., Santa Barbara, Calif., is Ernst Steinhoff.

With more than 24 years of ad-

**If You Are Having Difficulty
Maintaining Your Mailing Lists...**

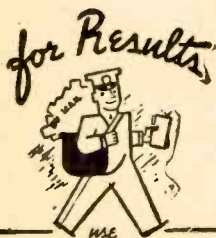

**Mc GRAW-HILL
DIRECT MAIL LIST SERVICE**

Probably no other organization is as well equipped as McGraw-Hill to solve the complicated problem of list maintenance during this period of unparalleled change in industrial personnel.

McGraw-Hill Mailing Lists cover most major industries. They are compiled from exclusive sources, and are based on hundreds of thousands of mail questionnaires and the reports of a nation-wide field staff. All names are guaranteed accurate within 2%.

When planning your direct mail advertising and sales promotion, consider this unique and economical service in relation to your product. Details on request.

McGraw-Hill Publishing Co., Inc.
DIRECT MAIL DIVISION
330 West 42nd Street New York, 36, New York

DE MORNAY-BONARDI

**first in
ultramicrowave
equipment**



A complete line of research instruments covering frequencies up to 90,000 mc... proved in laboratories the country over.



DE MORNAY-BONARDI • 780 SOUTH ARROYO PARKWAY • PASADENA, CALIFORNIA

PRECISION DEFLECTION WITH COSSOR YOKES



Slip Ring Yoke

Two-Axis Fixed Yoke

Component Development Engineering at its BEST!

- ADVANCED ELECTRICAL DESIGN
- PRECISION MECHANICAL DESIGN
- ACCURATE PRODUCTION METHODS

Custom Built to the most
Exacting Specifications
by Cossor Engineers

In Mumetal Cores for Optimum Geometry
In Ferrite Cores for Speed and Sensitivity
In Non-magnetic Cores for Perfection of Response

Any of Cossor's Three Core Types can be
made in single or double axis with single or
push-pull windings, and encapsulated for
fixed or slip ring (rotating) use.

Normal characteristics of yokes for 1-1/2 in.
neck tubes are:

Positional accuracy - the spot position will conform to the yoke current co-ordinates within 0.25% of tube diameter. For deflection angles less than $\pm 25^\circ$ better accuracy can easily be achieved.

Memory - 0.5% max. without over-swing;
0.1% or less with controlled over-swing.

Complete encapsulation in epoxy (stycast) or silicone resins is standard for all Cossor deflection yokes, and is done with special moulding tools ensuring accurate alignment of the yoke axis. When slip rings are added, solid silver rings are mounted in encapsulating resin. The finished slip ring yoke is precision turned to centre bore, and can include bearing mounting surfaces with dimensional tolerances approaching those associated with high quality metal parts.

Settling Time (Micro sec.) =
 $120 \sqrt{\text{Inductance in Henries}}$

Sensitivity degrees/milliampere =
 $0.098 \sqrt{\frac{\text{Inductance} \cdot \text{millihenries}}{\text{Accelerator Voltage} \cdot \text{KV}}}$

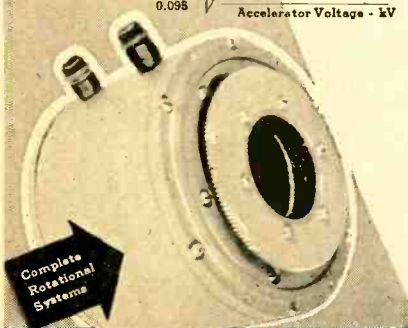

COMPONENTS DIVISION

COSSOR CANADA LIMITED

301 Windsor St., Halifax, N. S.
8230 Mayrand St., Montreal, Que.
648A Yonge St., Toronto, Ont.
Corporation House, 160 Laurier West, Ottawa, Ont.

CIRCLE 164 READERS SERVICE CARD

vanced experience in aeronautical and missile engineering in the U. S. and Europe, Steinhoff has been department manager of Air Force Missile Projects at Aerophysics, a position he will retain.



Form New Firm In California

A NEW electronic systems manufacturing and development company, Moore Associates, Inc., has been founded in Redwood City, Calif. Its president is Albert L. Robinson (pictured at top) who has been a member of the research staff of Bell Telephone Laboratories for the past 21 years.

Vice president of the new firm is James B. Bullock (shown below), formerly with Electrical Communications, Ltd. of San Francisco.

Chief Engineer is Laurence Moore, until recently a project engineer with Levinthal Electronics in Palo Alto.

Moore Associates is specializing



GUDEBROD

GUDEBROD
BRAIDED
NYLON
LACING
TAPES ARE
EASY TO TIE:
WON'T SLIP—
EASY ON
THE HANDS:
WON'T CHAFE—
EASY TO SEE:
COLOR-CODED

Gudebrod flat braided lacing tapes hold harness securely—no bite-through or slip, yet are easy on the hands. Some resist high temperature, some are color-coded . . . and they come wax-coated or wax-free . . . rubber-coated . . . or with special coating. Gudebrod makes many tapes for many purposes, including defense work. Send us your lacing problems or your specifications . . . we can supply the answer to both.

**GUDELACE • GUDE-NYLACE
GUDELACE H • TEFLACE**

GUDEBROD BROS. SILK CO., INC.

ELECTRONICS DIVISION

225 W. 34th St., New York 1, N. Y.

EXECUTIVE OFFICES

12 South 12th St., Philadelphia 7, Pa.

CIRCLE 165 READERS SERVICE CARD

Operate your...

- tape recorder
 - P. A. system
 - portable TV set
 - hand tools
- FROM YOUR CAR, Boat or Plane!

with



INVERTERS

FOR CHANGING YOUR STORAGE BATTERY CURRENT TO

A.C. HOUSEHOLD ELECTRICITY ANYWHERE... in your own CAR, Boat or Plane!

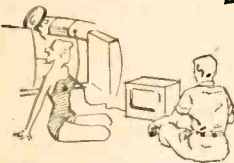

OPERATES PORTABLE TV SET directly from your car!

OPERATES

- TAPE RECORDERS
 - DICTATING MACHINES
 - PUBLIC ADDRESS SYSTEMS
 - ELECTRIC SHAVERS
- directly from your car!



MAKE YOUR CAR, BOAT OR PLANE "A ROLLING OFFICE!"



OPERATES

- RADIOS
 - RECORD PLAYERS
 - MIXMASTERS, ETC.
- directly from your car!



mounted out of sight under dash or in trunk compartment

ATR UNIVERSAL INVERTERS

Especially designed to change 6 or 12 volt D.C. to 110 volt A.C. 60 cycles, for...

- EXECUTIVES
- SALESMEN
- OUTDOOR MEN
- PUBLIC OFFICIALS
- POLICEMEN
- REPORTERS
- FIREMEN

MODELS 6U-RHG (6 volts) 125 to 150 watts. Shipping weight 27 lbs. List price \$89.95

DEALER NET PRICE \$59.97

12U-RHG (12 volts) 150 to 175 watts. Shipping weight 27 lbs. List price \$89.95

DEALER NET PRICE \$59.97

Write for literature on other Sizes and Models of ATR INVERTERS, priced as low as \$9.95 list.

SEE YOUR JOBBER OR WRITE FACTORY

- ✓ NEW MODELS ✓ NEW DESIGNS ✓ NEW LITERATURE
- "A" Battery Eliminators • DC-AC Inverters • Auto Radio Vibrator



AMERICAN TELEVISION & RADIO Co.

Quality Products Since 1931

SAINT PAUL 1, MINNESOTA, U. S. A.

CIRCLE 166 READERS SERVICE CARD

in the manufacture of transistorized telemetering and remote control equipment for rail, petroleum, chemical and utilities industries. The company also anticipates entry into the data reduction field at an early date.

GAC Forms an Affiliate

GENERAL ATRONICS CORP., Bala-Cynwyd, Pa., a consulting, research and development firm, has formed an affiliated company, Atronic Products, Inc.

A typical equipment of Atronic Products is an automatic sequential tester, for checking printed circuit cards at the end of a production line. The prototype of the tester, recently completed by General Atronics, is capable of carrying out as many as 360 electrical tests, within two minutes, on the circuits being tested.



Elect Altec V-P To Top Post

A. A. WARD (picture) executive vice president and director of Altec Companies, Inc., has been elected president of the organization.

He worked four years for the Southwestern Bell Telephone Co. in Houston, Texas, and in 1929, joined Electrical Research Products Inc. to install and service

HOW

precious metal metallurgy works for you!

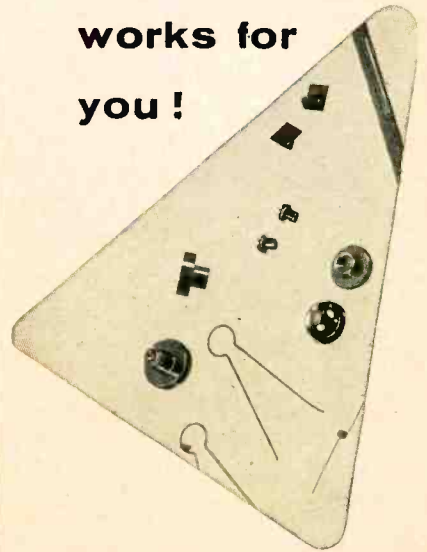

The J. M. Ney Company, with more than 146 years in the highly specialized precious metal business, has gathered a wide background of information for analyzing the properties and uses of precious metal alloys and developing alloys for specific applications.

With facilities for subjecting experimental and standard alloys to a full range of physical, electrical, and metallurgical tests as well as tests simulating actual and accelerated conditions, Ney offers a valuable service to the rapidly growing electronics industry.

Coupled with the development help that Ney offers are extensive manufacturing facilities for the production of materials and small precious metal parts in either standard shapes or to customer specifications. We are also prepared to give engineering advice on general design characteristics and suggest the proper alloy for your use. Our catalog describing our proprietary alloys, line of standard contacts, resistance wires, and engineering services is available on request.

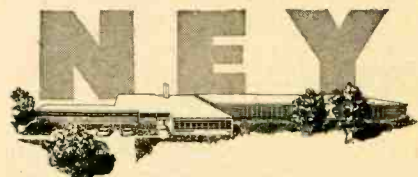

The J. M. Ney Company

P.O. Box 990, Dept. E, Hartford 1, Conn.

CIRCLE 167 READERS SERVICE CARD

theatre sound equipment. In the mid-thirties, Ward was transferred to New York in commercial engineering.

In 1937, Ward became head of specialty engineering with the newly formed Altec Service Co. When Altec Lansing Corp. was formed in 1941, he became general manager and in 1943, was elected vice president and director. In 1945 he was elected executive v-p and also v-p and director of Altec Service Co. In 1956 came the formation of Altec Companies, Inc., parent group for Altec Lansing Corp. and its divisions, with Ward being elected v-p and director. He became executive v-p for the parent company early in 1957.

Ward will maintain offices in the new Altec Lansing Corp. headquarters in Anaheim, Calif., where Altec sound equipment is manufactured.

Mundie Joins Bendix

BENDIX Aviation Corp. has appointed Lloyd G. Mundie head of the infrared department of the Bendix systems division.

Mundie will be in charge of a program devoted to research in infrared physics and the development of devices utilizing infrared radiation in the accomplishment of military and industrial objectives.



GTC Upgrades Cohen

GENERAL TRANSISTOR CORP., Jamaica, N. Y., appoints Bernard

ONE FLICK RESETS this HIGH SPEED Electric COUNTER

Model "YE" by **DURANT**

- Offered in TWO STYLES:
 1. Quick PUSH-BUTTON RESET
 2. Electric REMOTE RESET

First high-speed electrically actuated counters with added advantage of electric reset. Clean-cut, legible 3/16" figures, white on black. Ideal for all high-speed electric counting applications — accurate at high, low or intermediate speeds.

DURANT MANUFACTURING CO.
 1912 N. Buffum St. 12 Thurbers Ave.
 Milwaukee 1, Wis. Providence 5, R. I.
 Representatives in Principal Cities



ALASKA GRAY
AND SEAL BROWN



Compact, with great rigidity — entirely enclosed against dust and moisture. Base or panel mount. Speeds to 1500 C.P.M.

PRODUCTIMETERS
 SINCE 1879 *Count Everything*

CIRCLE 168 READERS SERVICE CARD

A NEW CRYSTAL UNIT WITH EXCEPTIONAL STABILITY AND PRECISION IN RANGE 4 kc TO 3000 kc

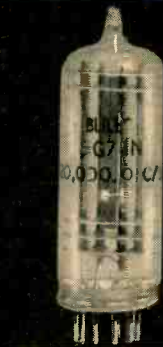

RANGE	A	B
4-85 kc	2"	2 3/8"
85-15C kc	1 7/16"	1 15/16"
150-3000 kc	1 1/8"	1 1/2"

This all-glass vacuum mounted crystal unit provides maximum stability, with low effective series resistance, in the range between 4 kc and 3000 kc.

For example, in the range 800 kc to 3000 kc, stability of 4 parts in 100 million (4×10^{-8}) per day can be obtained when used with temperature control that holds $\pm 0.1^\circ\text{C}$. Under these conditions ageing will not exceed 2 parts in 100 million per day.

Supplied for oven or non-oven operation.

SPECIFY BLILEY BG7 SERIES.

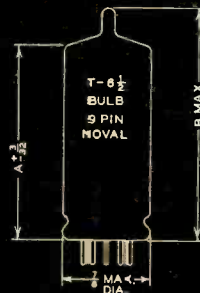

Bliley

BLILEY ELECTRIC CO.
 UNION STATION BUILDING • ERIE, PA.

DIRECTIONAL COUPLERS

VSWR and RF POWER MEASURING EQUIPMENT

New Products included in new Catalog No. 12 create the most extensive line available.



RF POWER and VSWR INSTRUMENTS

Model No.	Frequency Range (mcs.)	Power Range Incident & Reflected (watts)	RF Connectors and Impedance
261**	0.5 - 225	0 - 1000	Type 83-1R 52 ohms
262		0 - 1000 (relative)	Indicator only
263	0.5 - 225	0 - 10; 100; 1000	Type N* 52 ohms
702N	28 - 2000	0 - 4	Type N* 52 ohms
703N	20 - 2000	0 - 12	Type N* 52 ohms
▲705N	20 - 2000	0 - 120	Type N* 52 ohms
▲706N	28 - 2000	0 - 400	Type N* 52 ohms
711N	25 - 1000	0 - 30; 75; 300	N plus 83-1R Adapters
▲722N	1000 - 3000	0 - 4	Type N 52 ohms
▲723N	1000 - 3000	0 - 12	Type N 52 ohms
405B8	28 - 2000	0 - 4000	1 1/2" Flange 51.5 ohms
445A9	28 - 2000	0 - 12,000	3 1/2" Flange 50.0 ohms
445A10	20 - 2000	0 - 40,000	3 1/2" Flange 50.0 ohms

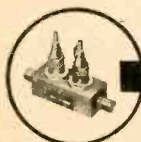

DC OUTPUT DIRECTIONAL COUPLERS

Model No.	Frequency Range (mcs.)	Power Range Incident & Reflected (watts)	RF Connectors and Impedance
576N1	42 - 2000	1.2	Type N* 52 ohms
576N3	20 - 2000	0 - 12	Type N* 52 ohms
▲576N4	46 - 2000	0 - 40	Type N* 52 ohms
576N6	28 - 2000	0 - 400	Type N* 52 ohms
▲592N	1000 - 3000	0 - 4	Type N 52 ohms
▲593N	1000 - 3000	0 - 12	Type N 52 ohms
402B8	28 - 2000	0 - 4,000	1 1/2" Flange 51.5 ohms
442A9	28 - 2000	0 - 12,000	3 1/2" Flange 50.0 ohms
442A10	20 - 2000	0 - 40,000	3 1/2" Flange 50.0 ohms

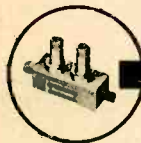

RF OUTPUT DIRECTIONAL COUPLERS

Model No.	Frequency Range (mcs.)	Coupling Attenuation	RF Connectors and Impedance
313N3	300 - 2000	30 db	Type N* 52 ohms
313N4	120 - 2000	40 db	Type N* 52 ohms
313N5	60 - 2000	50 db	Type N* 52 ohms
313N6	30 - 2000	60 db	Type N* 52 ohms
▲442A40	200 - 1000	40 db	3 1/2" Flange 50.0 ohms

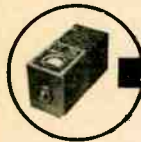

ABSORPTION TYPE RF WATTMETERS

Model No.	Frequency Range (mcs.)	Power Range (watts)	RF Connectors and Impedance
621N	1 to over 1000	0 - 120 milliwatts	Type N* 52 ohms
▲624N	1 to over 1000	0 - 4	Type N* 52 ohms
625C5	50 - 1000	0 - 120	Type C 50 ohms
▲651N	25 - 1000	0 - 25; 100; 500	Type N 52 ohms
▲611A7	50 - 1000	0 - 1200	3 1/2" Flange 50 ohms
612A	44 - 1000	0 - 6000	3 1/2" Flange 50 ohms



RF LOAD RESISTORS

Model No.	Frequency Range (mcs.)	RF Power Dissipation (watts)	RF Connectors and Impedance
633N	3000	50 (air cooled)	Type N* 52 ohms
635N	3000	200 " "	Type N* 52 ohms
636N	3000	600 " "	Type N* 52 ohms
636A	2000	600 " "	3 1/2" Flange 50.0 ohms
638A	2000	6000 (water cooled)	3 1/2" Flange 50.0 ohms

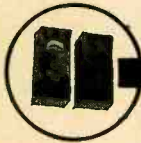

CALORIMETRIC TYPE Primary Standard of RF Power

Model No.	Frequency Range (mcs.)	Power Range (watts)	RF Connectors and Impedance
641N	0 - 3000	0 - 3; 10; 30; 100; 300	Type N 52 ohms

▲New products

*Also available with UHF, C, and HN Connectors.
**Coupler Unit Only for use with 262 Indicator.



M. C. JONES ELECTRONICS CO., Inc.
BRISTOL, CONNECTICUT

Cohen (pictured on p 191) as vice-president and director of the newly expanded engineering division.

Cohen, formerly vice-president and chief engineer, is now responsible for all technical services to the corporation, including manufacturing processes, quality control and equipment design for all four of the company's operating plants in Jamaica, L. I., N. Y.

News of Reps

SYSTEMS control and data handling for the Beckman Systems Division is being handled by LeeMark Associates, engineering reps in Kansas, Missouri and Nebraska. A new Denver office extends technical liaison to the Colorado area.

Metallic rectifier manufacturer, Bradley Laboratories, Inc., New Haven, Conn., gives the nod to John E. Boeing Co., Arlington, Mass., as New England reps.

Thermo Materials, Inc., Menlo Park, Calif., manufacturer of industrial ceramics, names six reps in the west. They include: Cerruti & Hunter Associates, Redwood City, Calif.; Chafin & Champion Associates, Los Angeles, Calif.; Carl G. Chafin Co., San Diego, Calif.; Charles Morrow, Phoenix, Ariz.; Paul Feeger, Denver, Col.; and Ed Brooks, Albuquerque, N. M.

The Gillette Engineering Co. of Phoenix, Ariz., is appointed sales representative in Arizona and New Mexico for Westport Electric, El Segundo, Calif.

George W. Ledbetter and Associates is now the exclusive engineering sales representative for Ryan Industries Division in the states of California and Washington. The division, recently acquired by Lundy from Textron, Inc., makes chaff counter-measures systems and manufactures all the integral parts for this radar jamming device.

New rep firm, Nelson Instrument Co., Evanston, Ill., offers sales and/or service representation in the midwest area covering Illinois, Wisconsin, Indiana and Iowa.

NOT A SUBSTITUTE!

here's the
real thing . . .

The **KURMAN** P255A POLAR RELAY

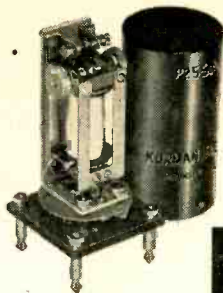

- Unconditionally approved as an equal to the W.E. 255A by both Government and Industry.
- No modifications required for existing field equipment or techniques.
- No adapters necessary—standard connecting blocks available.
- Variations are available including ultra-sensitivity down to 5 micro watts.

IMMEDIATE DELIVERY FROM STOCK!

The complete line of Kurman relays, manufactured to commercial or military specifications, are interchangeable with other leading makes.

Send to Dept. E for complete catalog

KURMAN ELECTRIC CO.

Division of Norbute Corp.

191 Newel St., Brooklyn 22, N. Y., EV 3-8000
Manufacturer of Quality Relays . . . Since 1928

CIRCLE 171 READERS SERVICE CARD



Men on the Move

Now available
in a new edition . . .
with new figures.

This popular booklet points up the important sales problem of personnel turnover in industry. Out of every 1,000 key men (over a 12-month period) 343 new faces appear . . . 65 change titles . . . 157 shift . . . and 435 stay put. These figures are based on average mailing address changes on a list of over a million paid subscribers to McGraw-Hill magazines.

Write us for a free copy

Company Promotion Department
McGraw-Hill Publishing Co., Inc.
330 West 42nd Street,
New York 36, New York

CIRCLE 172 READERS SERVICE CARD

ELECTRONICS engineering edition—February 14, 1958

NOW we can meet the demand for

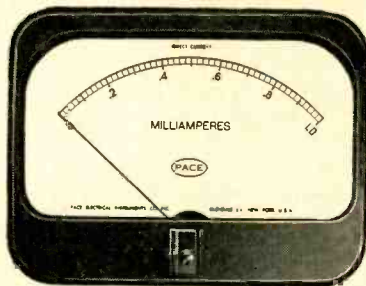

PACE
THE METER OF PRECISION

METERS!
2" TO 7" SIZES

Expanded plant . . . increased staff . . . New, improved automation techniques . . . to meet the demand of electronic equipment manufacturers for custom produced panel meters, in production quantities.

PACE meters are manufactured under rigidly controlled climatic conditions to meet critical specifications as to sensitivity, resistance, damping, response time, illumination, scaleplate design, etc.

Send for latest illustrated catalog, available upon request.
Write, wire or phone for applications engineering, consultation and assistance!

PACE ELECTRICAL INSTRUMENTS CO., INC.

a Division of Precision Apparatus Co., Inc.

70-31 84th Street, Glendale 27, L.I., N.Y.

Export: Morhan Exporting Corp., 458 Broadway, N.Y. 13, N.Y.

CIRCLE 173 READERS SERVICE CARD

► Specialists in the Unusual ◀



Electroplated WIRES

for many different applications

Continuous electroplating methods permit coating of many metals on to wire (or ribbon) in specified thicknesses of plate . . . This very flexible operation makes it possible to designate a desirable base or precious metal with a coating of another metal for its own particular characteristics. In our laboratory Tungsten wire as small as .00015" has been electroplated with Gold. . . . New combinations of plating on wire are being developed by our research staff from time to time. Your inquiry is invited.

Consult us, without obligation, about
your specific wire problems.

Write for
List of
Products



SINCE
1901

SIGMUND COHN MFG. CO., INC.
121 SO. COLUMBUS AVE., MOUNT VERNON, N. Y.



CIRCLE 174 READERS SERVICE CARD

**If it's
TOWERS you
need, check
ROHN
FIRST!**

AMERICA'S FINEST
COMMUNICATIONS
TOWER OF ITS KIND
... WITH EXCLUSIVE
BUILT-IN ECONOMY

✓ **Reduce Costs**

—by getting a tower *specifically* for your job. These towers are suitable for use up to 300 feet guyed—or self supporting to 50-60 ft.! ROHN towers are in daily use for micro-wave, radio and dozens of all type communications requirements throughout the U. S.—at big savings—yet more than do the job! Can be used for a multitude of jobs.

✓ **Proven design**

—get full engineering data to prove superiority. Gleaming, hot-dipped galvanized finish available—stays shiny and new—no painting needed. Design fully tested—proved by thousands of installations. Easily shipped and inexpensively installed. Cross pieces form natural ladder for servicing.

✓ **Special Towers**

—you're invited to submit your requirements. Towers will be built to your specifications if practical. Let us know your needs—ROHN can satisfy them BEST when it comes to towers of this type.

Illustrated here is a micro-wave installation of Rohn No. 40 tower for use by Public Service Company of Colorado for a state-wide communications system—one example of the thousands of ROHN towers now in use.

FREE



Send for new "Specifications & Price" catalog for Rohn Communications Towers. Your inquiry will receive prompt attention. Rohn representatives are coast-to-coast to serve you. Write—phone—wire

ROHN Manufacturing Co.

116 Limestone, Bellevue
Peoria, Illinois

"Pioneer Manufacturers of TV and Communication Towers of All Kinds."

CIRCLE 179 READERS SERVICE CARD

NEW BOOKS

Television Engineering Principles and Practice Vol. II

By S. AMES AND D. BIRKINSHAW
Philosophical Library, New York, 1956, 268 p, \$10.00.

This book is the second to appear in a series of four volumes planned by the British Broadcasting Corporation as engineering training manuals. Volume I, which was published earlier, treats such topics as fundamental television principles, camera tubes, television optics and electron optics. Volume III and IV, which are in preparation will cover waveform generation and a wide range of circuit techniques.

With this background, it is now possible to turn to a detailed consideration of Volume II. Since the book is devoted to video-frequency amplification in general, it will be of use to those engineers who are concerned with wide-band amplification or transmission problems. Further, an extensive mathematical background is not required for an understanding of the book. Simple derivatives are as involved as the mathematics becomes.

Video-Band Characteristics—The first chapters cover a discussion of the amplitude and phase characteristics of the video band and the effects produced by departures from the ideal. The simple R-C coupled circuit, effects on phase shift at high frequencies due to interstage shunt capacity, low-frequency phase shift, envelope-delay and square-wave testing are but a few of the topics discussed.

High-frequency compensation studies are confined to a thorough investigation of the shunt and series-inductance peaking circuits and various forms of cathode compensation.

Gain-Bandwidth product, cascading of stages, and distributed amplification are covered next. After this there is a very complete treatment of the design of passive phase equalizers in the lattice, bridged-T and T forms as well as the active derivative equalizer.

Following this is a treatment of

% STILL
OPERATING

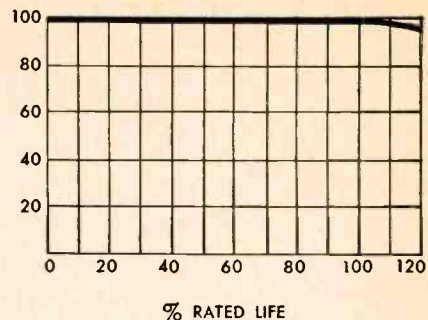

**If you want
reliable transformers**

... don't overlook this old solution

Right now, you demand more from transformers than ever before. You must have high reliability, even at extreme altitudes, and you need smaller lighter units.

Used, and *proved*, for decades, oil-encased transformers should not be forgotten in a search for new methods.

Everyone knows the advantages: effective convection of heat, excellent insulating properties, complete insurance against hidden leaks. Oil-sealed types (with a nitrogen bubble) are good, light, high-altitude transformers. Gas-free oil-filled types (with a bellows to allow for heat expansion) withstand very high voltage stresses. Except in the smallest sizes, they save space, too.

You can place several high voltage units close together in a single oil-filled case, and save case weight. Those connections moved inside the case no longer need large insulators. Even the units themselves can be smaller. This all adds up—particularly in high altitude service—to interesting savings in space and weight.

We make all sorts of transformers and special assemblies for the communication industry: encapsulated, cast in epoxy or foam, and just potted in pitch. But oil transformers still have an important place.

Whatever type you need, we'll be glad to hear from you. Our facilities in design, production, and quality control are at your service. Our experience, too.

CALEDONIA
ELECTRONICS AND TRANSFORMER CORPORATION

Dept. E-2, Caledonia, N.Y.

In Canada: Hackbusch Electronics, Ltd.
23 Primrose Ave., Toronto 4, Ontario

CIRCLE 179 READERS SERVICE CARD

EISLER VERTICAL SPOT WELDERS

MADE IN SIZES 1/2-1-2-3-5 KVA

WITH OR WITHOUT TRANSFORMER OR TIMER

Sent to Any Radio Tube Manufacturer in U.S.A. on a 30 Day Free Trial Basis.

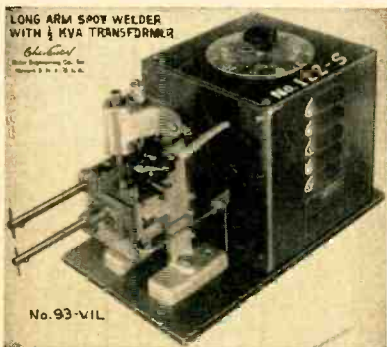
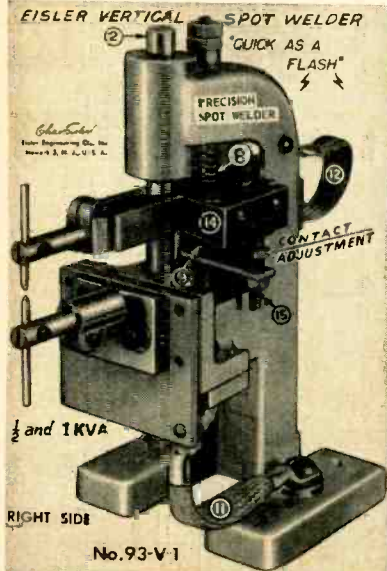

TRANSISTOR MAKING EQUIPMENT

DIODE MACHINERY
 AUTOMATIC OR SEMI-AUTOMATIC

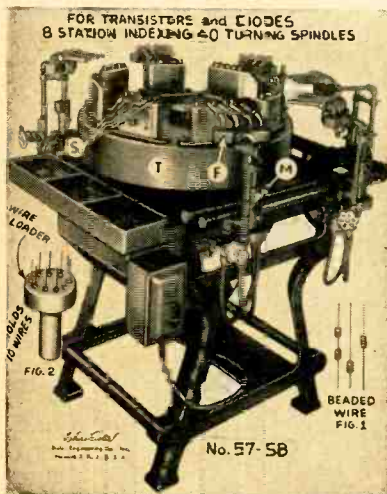

Send for Catalog Dr. Chas. Eisler, M. E. Founder
 CHAS. EISLER, JR., PRES.

EISLER ENGINEERING CO., INC.

751 So. 13th St. NEWARK 3, N. J.

CIRCLE 181 READERS SERVICE CARD

ELECTRONICS engineering edition — February 14, 1958

various interstage coupling and decoupling procedures for low-frequency phase improvement. Included in these sections are uses of current feedback or degeneration for increasing the effective value of the grid resistor, various cathode, screen and plate decoupling circuits and d-c coupling methods.

Feedback—The final chapters concern basic principles of feedback, feedback in a single-stage R-C coupled amplifier and feedback in multistage amplifiers. Aperiodic voltage and current feedback, critical voltage and current feedback, maximal and optimal feedback calculations are some of the topics covered under basic principles. Instability and overloading in multistage feedback amplifiers is also treated.

Two chapters are included on sources of noise in video amplifiers and noise in camera head amplifiers.

The book is well written, has well chosen mathematical symbols and presents the material in a simple, easily understood, elementary fashion.

Two regrettable omissions, which seem quite glaring, are the use of the \sin^2 pulse for transient testing and the shunt-regulated video amplifier. Both of these subjects appear to have been well exploited in England. The \sin^2 pulse with great potential, which is just now beginning to be accepted in this country, has been known and utilized by Dr. Lewis and his associates at the Post Office Research Station for a number of years. In 1951, V. J. Cooper treated the shunt-regulated amplifier in *Wireless Engineer*. It is certainly hoped that Volume IV of this series will include these two topics.—Ralph G. Kennedy, Adj. Assoc. Prof. Physics, Hofstra College, Hempstead, N. Y.

Basic Automatic Control Theory

By GORDON J. MURPHY.
 D. Van Nostrand Co., Inc., New York, 1957, 557 p., \$9.00.

This book is an attempt to provide a teaching text which integrates steady state sinusoidal and transient analyses of cybernetic devices. The author's approach, while not



INDUSTRIAL RETAINING RINGS

cut costs,
 simplify assembly

Precision-engineered INDUSTRIAL Retaining Rings . . . internal, external and open types . . . are available in a wide selection of sizes and finishes. Solve your fastening problems simply and economically with the rings that cut machining and tooling expense, save material, simplify and speed assembly. Series 1000 and 2000 are available *stacked* for quickest application.

Write for free ring samples and catalog.



Originators of
 modern retaining ring
 dispensing

INDUSTRIAL RETAINING RING COMPANY

Dept. E2, 57 Cordier Street
 Irvington 11, New Jersey

CIRCLE 182 READERS SERVICE CARD



GRAY CODE



BINARY



BINARY
CODED DECIMAL

LIBRASCOPE SHAFT POSITION-TO-DIGITAL CONVERTERS

Equipped with ANTI-AMBIGUITY
DOUBLE BRUSH PICKOFFS

Useful in a wide variety of applications, including digital aircraft and missile controls, machine tool controls, digital readout from strip chart recorders, and as the modulator and de-modulator in pulse-code modulated radio links.

GRAY CODE MODEL — Capacity of 8 binary digits (single brush pickoff),

BINARY MODEL — Capacity of 7 to 19 binary digits.

BINARY CODED DECIMAL MODEL
Capacity range from 0-1999 to 0-35,999.

Units for special codes or capacities are built to meet specific requirements.

SHOCK ENDURANCE.....20g
TEMPERATURE RANGE...-50° to 83°C min.
CODE DISCS.....Rhodium plated phenolic
PICKOFFS.....Multiple wire brush.
Two pickoffs/channel
ROTATION.....Continuous, either direction.

RUGGED—NON-MAGNETIC—LONG LIFE
MAY BE READ WHILE IN MOTION

SPECIAL CONVERTERS DESIGNED TO MEET
YOUR INDIVIDUAL PROBLEMS



Send for illustrated brochure

LIBRASCOPE

A SUBSIDIARY OF GENERAL PRECISION EQUIPMENT CORPORATION

808 Western Avenue • Glendale, California
CIRCLE 183 READERS SERVICE CARD

entirely novel, is, in major outline successful. It does represent modern design techniques, and on-the-job advantages can be predicted to accrue from welding mechanical and electrical viewpoints and terminology.

Particularly praiseworthy are the detailed treatment accorded and the excellent exercises which sample the problems involved in incorporating the approach and the field into one's thinking.

Topics—The subject material is restricted to the classically more fundamental topics in the treatment of linear servomechanisms with well-defined input data. There is no discussion of nonlinear techniques, sampled data systems, or statistical design principles as applied to cybernetic devices. Intended, as the author indicates, for undergraduate senior or first year graduate student level these limitations are probably well selected. The book serves well its stated purpose as an introduction to automatic control.

The pedagogic arrangement of the textual material is exemplified in the treatment of carrier type systems. Rather than store the material for separate discussion in one chapter, the author relies upon incremental learning and intersperses this material at appropriate spots of his discussions of components, block diagrams and compensating networks. In a comparable manner, the book discusses proportional, derivative and integral controllers, giving the reader insight into how the stabilizing networks he will meet later in studying Nyquist-Bode plots and root-loci achieve approximations to these ideal control characteristics.

Approach—Typical of the unified approach is the introduction of W-plane or Bode diagrams and Nichol's charts concurrent with discussions of the polar Nyquist plots. This simplifies the study of compensation in the real frequency domain and develops a clearer picture of the inter-relationship between the various stability criteria. In dealing with fundamentals, concepts of analogy are developed between mechanical, thermal, hy

AN INVITATION TO JOIN ORO

Pioneer In Operations Research

Operations Research is a young science, earning recognition rapidly as a significant aid to decision-making. It employs the services of mathematicians, physicists, economists, engineers, political scientists, psychologists, and others working on teams to synthesize all phases of a problem.

At ORO, a civilian and non-governmental organization, you will become one of a team assigned to vital military problems in the area of tactics, strategy, logistics, weapons systems analysis and communications.

No other Operations Research organization has the broad experience of ORO. Founded in 1948 by Dr. Ellis A. Johnson, pioneer of U. S. Opsearch, ORO's research findings have influenced decision-making on the highest military levels.

ORO's professional atmosphere encourages those with initiative and imagination to broaden their scientific capabilities. For example, staff members are taught to "program" their own material for the Univac computer so that they can use its services at any time they so desire.

ORO starting salaries are competitive with those of industry and other private research organizations. Promotions are based solely on merit. The "fringe" benefits offered are ahead of those given by many companies.

The cultural and historical features which attract visitors to Washington, D. C. are but a short drive from the pleasant Chevy Chase suburb in which ORO is located. Attractive homes and apartments are within walking distance and readily available in all price ranges. Schools are excellent.

For further information write:
Professional Appointments

OPERATIONS RESEARCH OFFICE **ORO**

The Johns Hopkins University

7100 CONNECTICUT AVENUE
CHEVY CHASE, MARYLAND

**YOU CAN SAVE
UP TO 50% ON
SMALL PARTS LIKE THESE**

by using
TRADEMARK

BEAD CHAIN Multi-Swage

PRODUCTS

Every year Bead Chain produces billions of tubular metal parts for electronic and mechanical applications. Multi-Swage eliminates costly turning, drilling, stamping and forming—automatically swages from flat stock into strong precision forms with positive, tight seams. If you're a volume user of such parts, in any metal, up to 1/4" diam. x 1 1/2" long, find out how much Multi-Swage can save you. Send sketch or standard parts for prompt estimate. Write for catalog today.

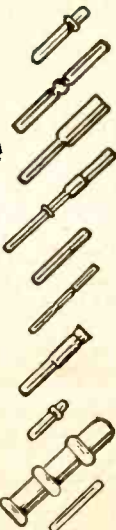

B[®]

THE BEAD CHAIN MANUFACTURING CO.
88 Mountain Grove St., Bridgeport, Conn.

CIRCLE 193 READERS SERVICE CARD

MEASUREMENTS' Standard BARRETTER BRIDGE

2 Mc to 1000 Mc



MODEL 202-C

The Model 202-C provides the most accurate standardization of high-frequency voltage available—checks output voltage of any standard signal generator, and recalibrates such instruments to a high degree of accuracy. Features include:

- 50 ohm impedance with VSWR less than 1.2
- High accuracy—calibrated at d.c.
- True RMS response
- Bolometer element in temperature-controlled oven

Write for Bulletin

Laboratory Standards



MEASUREMENTS
A McGraw-Edison Division
BOONTON, NEW JERSEY

CIRCLE 194 READERS SERVICE CARD

PORTABLE! ONLY 22 1/2 lbs. NUTRON regulated DC POWER SUPPLY

For lab, field or industry. Features continuously variable output, vernier adjustment, sloping front panel, easily-read 2 1/2" meters, rated for full load current over entire voltage range, line cord storage in rear.

SPECIFICATIONS

- AC Input: 105-125 V, 50-60 cps.
- DC Output: 120-300 V, 0-100 ma.
- Regulation: line 0.5% for variations from 105-125 V; load 0.1% for no load to full load.



- Internal Impedance: less than 4 ohms.
- Ripple & Noise: less than 5 mv rms.
- Polarity: either terminal may be grounded.
- Overall size (HWD): 8 3/8" x 6 1/2" x 16 7/8".
- Finish: grey wrinkle.

Model PR-200: same specifications as above except current rating is 0-200 ma.
Price: \$225.00, f.o.b., N.Y.

Write for Bulletin E-214

NUTRON mfg. co. inc.

67 monroe avenue, station island 1, n. y.

CIRCLE 195 READERS SERVICE CARD

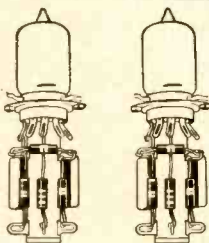

WHY NOT TRY TURRETS?

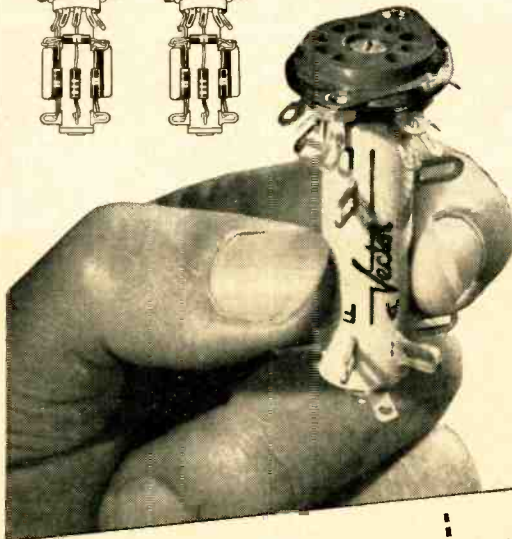

Vector

SOCKET TURRETS

...simplify wiring, cut down assembly time and make up into compact, sturdy structures... Eliminate useless lead length and thus improve performance... Save design time for engineers. Also available in military version.

Vector
STRUCTURES FOR CIRCUITRY

Available in many sizes and types to fit every need:—Post, Deck, Wall and Tinker Turrets; with plugs and cases as required.
— Write for Catalog.

VECTOR ELECTRONIC COMPANY, 3352 San Fernando Road, Los Angeles 65, Calif. • Tel. Cleveland 7-8237
CIRCLE 196 READERS SERVICE CARD

American Beauty

ELECTRIC
SOLDERING IRONS

for the most

RUGGED or
DELICATE
Jobs

Choose from more
than 30 models
 $\frac{1}{16}$ " to $1\frac{1}{8}$ " tips
12 to
550 watts

There's an American Beauty in the right model, the correct tip size, the proper watt input, to do any soldering job quickly, properly, efficiently—whether it's used for a single connection or on 'round-the-clock production.



TEMPERATURE
REGULATING
STAND

For controlling tip temperature of an electric soldering iron while iron is connected to current and not in actual use.

Write for descriptive literature and prices.

**AMERICAN ELECTRICAL
HEATER COMPANY**



DETROIT 2, MICHIGAN

170-H

draulic and electrical systems. These ideas are later applied in the study of stability and transient response.

In all, the book is recommended to the engineer anxious to develop a basic understanding of control systems and is well suited for adoption as a text in a senior undergraduate or first year graduate course in automatic control.—A. E. NASHMAN, Executive Engineer, Guided Missile Laboratory, Federal Telecommunication Lab., Nutley, N. J.

Theorie und Technik der Pulsmodulation

By E. HOLZLER AND H. HOLZWARTH.
Springer Verlag, Berlin, 1957, 505 p, DM 57.

THE introductory chapter to this work compares various types of modulation, amplitude, phase, frequency and pulse, and analyzes the qualitative characteristics of each type. Particular attention is paid to the several types of pulse modulation.

Mathematical Analysis—The second chapter treats the Fourier transform and LaPlace transform theory needed as fundamentals to the pulse modulation technique. The circuit elements for pulse modulation systems are considered in chapter 3 and the characteristics of pulse modulation networks are developed in chapter 4. Effects of noise is treated in chapter 5 and several pulse modulation systems are treated in the last chapter.

A fairly practical level is maintained throughout the book and the circuit engineer should find this work a useful introduction and a guide in the development of pulse modulation circuits and systems.—M. ETTENBERG, Sperry Gyroscope Co. Div. of Sperry Rand Corp., Great Neck, N. Y.

THUMBNAIL REVIEW

Repairing Hi-Fi Systems. By David Fidelman, John F. Rider Pub., Inc., New York, 1957, 212 p, \$3.90. Troubleshooting and repairing audio equipment for technicians and audio enthusiasts.

Senior Engineer Opportunities

in Electronic Packaging and
Printed Circuitry Development

Link Aviation, Inc., offers top opportunities in its expanding Engineering program. If you have an engineering degree with at least five years' engineering experience in electronic component packaging, Link has excellent opportunities for you in its new packaging department.

To fill this position, you should have a good knowledge of electromechanical devices, servos, analog computers, printed circuits, and be familiar with the problems associated with cabling large systems.

Link Aviation offers stimulating associations and a friendly working atmosphere. Located in Binghamton near the heart of upstate New York's recreationland only 180 miles from New York City, Binghamton provides "hometown" comfort with big-city conveniences.

Liberal fringe benefit program ... company-sponsored graduate program. For additional information, or to arrange an interview, submit resume to:

Kenneth T. Viall
Manager of
Engineering
Employment



LINK AVIATION, INC.
BINGHAMTON, NEW YORK

COMMENT

Credit Where Due

I read with interest the article "Crevasse Detector Blazes Glacial Trails" (Jan. 17, p 63), noting particularly the bridged-T transistor oscillator used in the main transmitter.

It is somewhat surprising to me that neither the author, H. P. van Eckhardt, nor your editors saw fit to give credit to the originator of the circuit, P. G. Sulzer of NBS. An article by Mr. Sulzer, containing virtually the same schematic diagram, appeared in *ELECTRONICS* in 1953 ("Low Distortion Transistor Audio Oscillator," Sept. '53, p 171).

An injustice would be done to the more recent author, however, if it were not pointed out that his circuit does contain one improvement upon the original. The capacitors shunting the 10K and 300 ohm collector load resistors accomplish a form of "dominant lag" stabilization against high-frequency oscillation. Such oscillation is otherwise a substantial problem when the circuit is constructed using transistors having better frequency response than those available in 1953.

WILLIAM L. PATERSON
INLAND TESTING LABORATORIES
MORTON GROVE, ILL.

Gravity

Coupla months back thataway, there was quite an argument in the columns of "Backtalk" about gravity. These comments are among the late entries in the argument.

We propose a somewhat more fundamental approach.

Physicists have not only been baffled by the nature of magnetism and gravitation, but also by the bewildering array of "fundamental" particles (32), the astronomers' red shift, and the dual wave-particle nature of light. When a theory starts to get too complicated, it's time to be suspicious of its validity.

The ancients supposed all matter to be composed of a few simple "elements." After the medieval

Now—

NO plate too small— 213B

NO panel too big

NO size limits on engraving

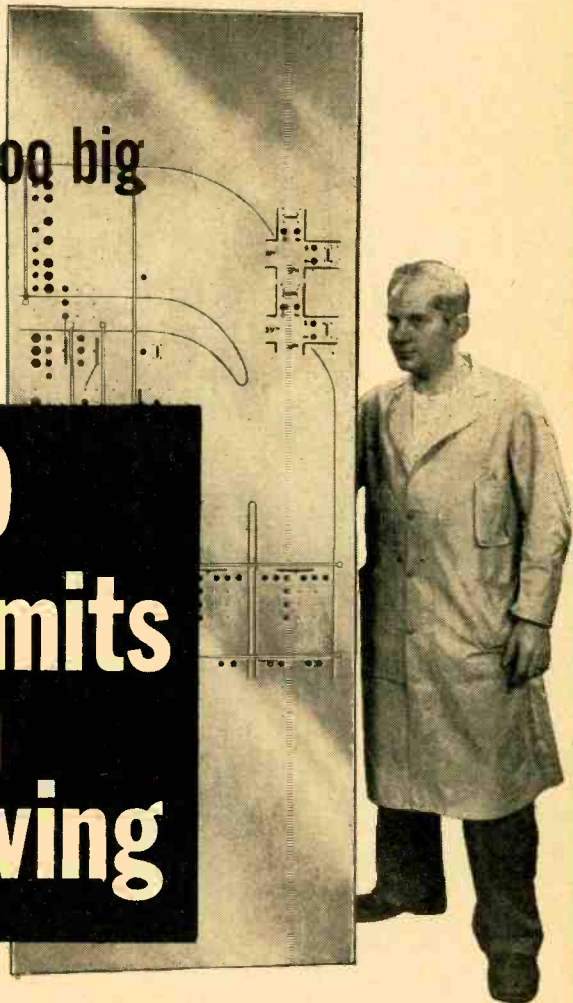

• ENGRAVES 18" x 6" RECTANGLE IN ONE SET-UP

- Takes up only 2 feet of bench space
- Engraving chassis can be detached from base and placed directly on workpiece of any dimension
- Self-centering workholder cuts down set-up time
- Heavy duty cutter spindle

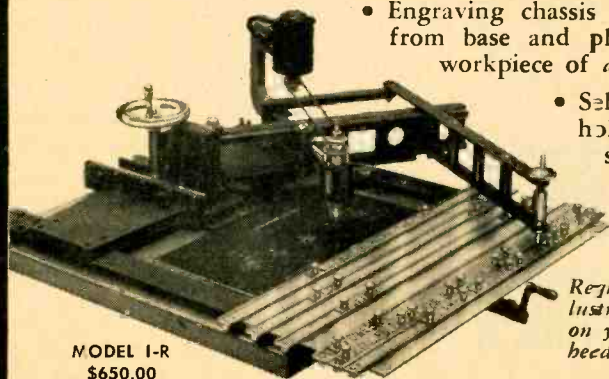

MODEL I-R
\$650.00

Request our 28-page illustrated catalog ZR-2 on your business letterhead.

new hermes ENGRAVING MACHINE CORP.

13-19 University Place, New York 3, N.Y.



SPADE BOLTS

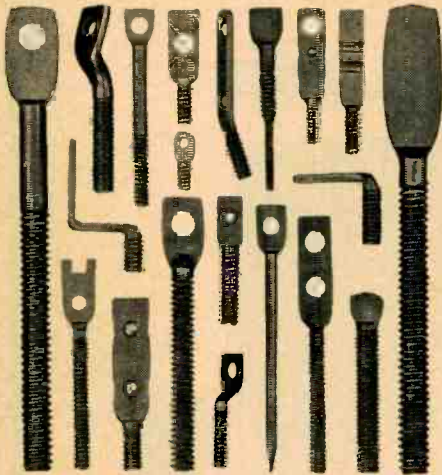

Specialists in designing and manufacturing of all-purpose fasteners and wire forms. Tooling to produce over 1000 styles in any screw size, material, finish, quantity, to your specifications.

Serving Industry for Thirty-Five Years
— OTHER PRODUCTS —

Simplex WIRE STRIPPERS & CUTTERS

• TOOLS • DIES • STAMPINGS
Bulletins on complete line on request

WENCO MANUFACTURING CO.
1133 W. Hubbard St., Chicago 23, Ill., U.S.A.
CIRCLE 187 READERS SERVICE CARD

Earn Extra Income in MOBILE-RADIO MAINTENANCE!



It's now a big business
(650,000 installations) . . .
fast-growing (70% increase
last year) . . . special-
ized . . . and high-paying!

Learn how to turn this opportu-
nity into cash—write today for free
booklet "HOW TO MAKE MONEY

IN MOBILE-RADIO MAINTENANCE!" It's
published as a service to radio engineers
by Lampkin Laboratories, Inc., manufactur-
ers of the well-known 105-B Micrometer
Frequency Meter and 205-A FM Modula-
tion Meter.



105-B



205-A

LAMPKIN LABORATORIES, INC.
Instruments Div., Bradenton, Fla.

At no obligation to me please send "HOW
TO MAKE MONEY IN MOBILE-RADIO MAIN-
TENANCE."

Name _____

Address _____

City _____ State _____

CIRCLE 186 READERS SERVICE CARD

age, chemists began to recognize the chemical elements as the "fundamental" particles of the universe. Then came isotopes and radioactive elements pointing to something even more fundamental. But why 32 of them?

Suppose we assume that corpuscular particles are atomic in structure and some simpler subcorpuscular particles are their building blocks. We could assume the ether to be a subcorpuscular gas. Hence light's dual nature and the maze of corpuscular particles might start to make a less confusing picture. We might then assume that magnetic and electrostatic fields are some sort of standing-wave field in this ether and gravitation a sort of vortex field.

If some physicist could find a way to split the corpuscular particles into pure energy, they might find something that would make the H-bomb look like a firecracker.

TED POWELL

42 NASSAU ROAD
GREAT NECK, L. I., N. Y.

The question is always "How well do you know your physics?"

The essence of gravity has been capably dealt with by the late Albert Einstein. Some of us do not easily understand what Einstein had hold of.

Einstein pointed out that stars can be of a wide assortment in size, but there is a maximum limit. You cannot find a star whose diameter exceeds five light-hours. Masses separated by a distance less than five light-hours attract each other; masses separated by greater distances repel and fly away from each other.

ESTEN MOEN

Box 693
CROOKSTON, MINN.

My congratulations to the original thinker who confessed to "abysmal ignorance" before jumping into this discussion.

To the rest of the hypothesizers I humbly suggest that four or five years studying the works of some of the minor intellects of the past—such as Newton and Einstein—who were also mildly aware of the problem might be in order.

JOHN COONEY

WALDBORO, MAINE

Pulse Notes



Control of Rise Time and Overshoot in Pulse Transformers

A pulse transformer with a turns ratio greater than unity ($n > 1$) can be approximated by the circuit below for the duration of the leading edge of the applied pulse.

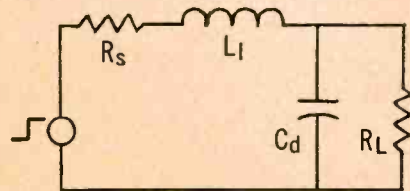

Where R_s is the internal resistance of the pulse source, R_L load resistance, L_l and C_d , leakage inductance and distributed capacitance, respectively. If the transformer is matched ($R_s = n^2 R_L$), this circuit is valid for step-up and step-down transformers.

Optimum step function response (minimum rise time and overshoot) occurs when

$\sqrt{\frac{L_l}{C_d}} = R_L$. Under these conditions overshoot is approximately 4%; rise time from 10% to 90% of pulse height approximately equal to $1.52 \sqrt{L_l C_d}$. If $\sqrt{\frac{L_l}{C_d}}$ is less than R_L , overshoot and ringing occur. Making $\sqrt{\frac{L_l}{C_d}}$

greater than R_L rounds the leading edge and increases rise time. Circuit designers should note that any shunt capacity in the load is effectively added to C_d which causes

$\sqrt{\frac{L_l}{C_d}}$ to be less and overshoot greater than indicated by transformer specifications.

Leakage inductance and distributed capacitance are functions of winding geometry such as insulation pad thickness, wire spacing, and interleaving. These parameters must be accurately controlled during manufacture to meet rise time and overshoot specifications. In the Pulse Engineering Stat-Tran*, a rectangular coil form permits precise control of the winding configuration which contributes to uniform leading edge response.

A new catalog describing the Stat-Tran* and other pulse transformers is yours for the asking. Please address Department _____.

*Registered T.M.

5

Pulse Engineering Inc.



2657 Spring Street
REDWOOD CITY CALIFORNIA

CIRCLE 188 READERS SERVICE CARD

CONTACTS

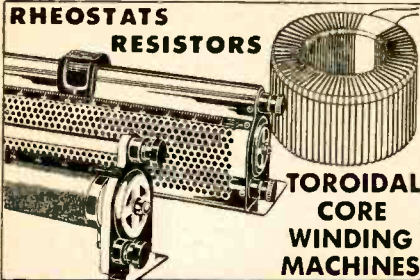

REX RHEOSTAT CO.
BALDWIN, N. Y.

SIMPSON, WESTINGHOUSE AND OTHER

PANEL METERS
AC-DC

Available in Standard and Custom
Ranges
Any Size, with Special Scales
Any Quantity from Large Stock

QUALITY ELECTRIC CO.

3700 S. BROADWAY LOS ANGELES 7, CALIF.
ADams 2-4201



MANUFACTURERS' REPRESENTATIVES

IN THE ELECTRONIC INDUSTRY

As a service to readers, ELECTRONICS presents the advertisements for some of the leading manufacturers' representatives in the electronic industry. These firms are qualified to help the *Manufacturer* with his distribution problems; the *Buyer* with his product needs.

**HORMAN
ASSOCIATES, INC.**
2017 "S" STREET, N.W.
WASHINGTON 9, D. C.
DECATUR 2-5705

SERVING
DELAWARE, MARYLAND
DISTRICT OF COLUMBIA
AND
NORTHERN COUNTIES
IN VIRGINIA AND WEST
VIRGINIA

TELETYPE NO. WA-559

REPRESENTING —

HEWETT-PACKARD CO.
SORENSEN & COMPANY INC.
VARIAN ASSOCIATES
BETA ELECTRIC CORP.
ELECTRO-MEASUREMENTS INC.
GERTSCH PRODUCTS INC.

SENSITIVE RESEARCH INST. CORP.
SANBORN COMPANY
KINTEL (formerly KAY LAB)
JOHN FLUKE MANUFACTURING CO.
BUDD STANLEY COMPANY, INC.
WEINSCHEL ENGINEERING CO.

Complete Recalibration Laboratory

PROFESSIONAL SERVICES

Consulting—Patents—Design—Development—Measurement

in

Radio, Audio, Industrial Electronic Appliances

CROSBY LABORATORIES, INC.

Murray G. Crosby & Staff

Radio - Electronics
Research Development & Manufacturing
Communications, FM & TV
Robbins Lane, Hicksville, N. Y.
WElls 1-3191

ERCO RADIO LABORATORIES, INC.

Radio Communications Equipment

Engineering - Design - Development - Production
Our 27th Year in Air to Ground
Communication and Radio Beacons
Garden City • Long Island • New York

Eugene Mittelman, E. E., Ph. D.

Consulting Engineer, Physicist

INDUSTRIAL ELECTRONICS
RESEARCH DEVELOPMENT
Mathematical Analysis, Instrumentation & Control
High Frequency Heating
549 W. Washington Blvd., Chicago 6, Illinois
Phone: STate 2-3171

DUNLAP ELECTRONICS, INC.

*MANUFACTURING FACILITIES
RESEARCH & DEVELOPMENT*

Specializing in Printed & Etched Circuits
Transistors—Pulse Techniques—Environmental
Test Facilities

3 Day Service on Printed Circuit Samples
764 Ninth Street AT 8-0801 Des Moines, Iowa

McCann Engineering Company

Consulting Mechanical Engineer

Design and Development of Test Equipment
for Synchros, Potentiometers, Gyros, Etc.
Redesign of Products—Trouble Shooting
Production—Automatic Machinery
Special Machines with Sequence, Form
Recognition, Dimension Decision and
Special Environment Features.
9210 So. Vermont Los Angeles 44, Calif.

ALBERT PREISMAN

Consulting Engineer

Television, Pulse Techniques, Video
Amplifiers, Patent technical consultation.
616 St. Andrews Lane, Silver Spring, Maryland

ELECTRONIC RESEARCH ASSOCIATES, INC.

"TRANSISTORIZE" YOUR PRODUCT!
Complete Service in consulting, research, develop-
ment, and production on Transistor circuitry,
products and instrumentation.
67 Factory Place Cedar Grove, N. J.
CEnter 9-3000

MEASUREMENTS CORPORATION

Research & Manufacturing Engineers

Harry W. Houck
Specialist in the Design and
Development of Electronic Test Instruments
Boonton, New Jersey

YARDNEY LABORATORIES

Research-Design-Development

Electro-Chemical Generators of Energy
40-18 Leonard Street WOrth 6-3100
New York 13, N. Y.

ENGINEERS & PHYSICISTS *Electronics*

Information manual
about APL and its
current programs
now available

The Applied Physics Laboratory (APL) of The Johns Hopkins University is unique in that we are neither an industrial nor an academic organization, but rather a composite, having drawn freely from the methodologies of each.

For thirteen years APL has pioneered in guided missiles. Today we are engaged in a broad program of R & D for the Navy; in addition, we are responsible for technical direction of industrial and academic contractors in developing the Terrier, Talos and other major weapons and weapons systems. Our staff members enjoy not only the stimulus of association with their immediate colleagues at APL, but also with those in other organizations of considerable stature.

NEW 30-PAGE PUBLICATION

A few positions for senior engineers and scientists are now open. Information on our accomplishments and goals is available in a new 30-page publication, just off the press.

In it staff leaders representing each of the various disciplines and fields outline the nature of their programs. Information on our new laboratory in Howard County, Md. (equidistant between Baltimore and Washington) is also included, together with facts on the outstanding communities in which our staff members live.

Quantity is somewhat limited. May we suggest you send now to:
Professional Staff Appointments.

The Johns Hopkins University
Applied Physics Laboratory

8609 Georgia Avenue

Silver Spring, Md.

TODAY'S TEMPERATURE:



IN PHOENIX!
*... where Motorola
offers a high degree
of opportunity!*

Phoenix has just 2 seasons: spring and summer. Right now it's spring in Phoenix, with warm, dry, sunny days . . . and crisp, clear nights just cool enough for restful sleep.

Find out more about the outstanding professional opportunity that awaits you in this healthful land of sunshine. Why not work where it's fun to live?



If you are qualified for one of these positions, write, wire or phone Motorola in Phoenix today!

**ELECTRONIC ENGINEERS,
MECHANICAL ENGINEERS, PHYSICISTS**

System Analysis, Design and Test
Radar Communications
Navigation Missile Guidance
Data Processing and Display
Circuit Design, Development and Packaging
Microwave Digital and Analog
R-F and I-F Transistor
Pulse and Video Servos
Technical and Specification Writing
Printed and Etched Circuitry

Write:
Mr. Kel Rowan
Western Military Electronics Center
Motorola, Inc., Dept. A-18
8201 E. McDowell Road
Phoenix, Arizona

Engineering positions also available at Motorola, Inc. in Chicago, Illinois, and Riverside, California.



MOTOROLA, INC.





Electronic Circuit Designer Robert G. Hildenbrandt tells why developing circuits for transistorized airborne computers at IBM Owego offers the professional challenge of a lifetime.

What's it like to be a Creative Engineer at

IBM

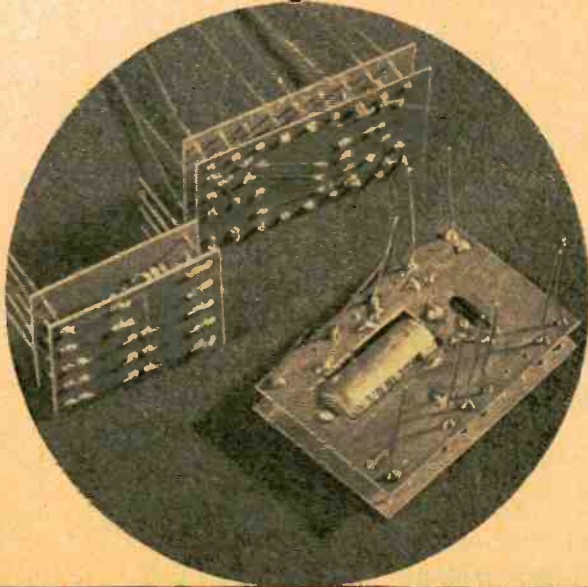

"Since joining IBM Owego in 1952, I've seen some amazing developments in advanced electronic circuitry. I'm now leading a six-man team responsible for all circuits within an airborne computer. Challenge? It's tremendous. We're working not only on present systems but those of the future!"

For those who can qualify, developing circuitry for airborne computers offers one of the most challenging assignments in electronics. At IBM Owego, there are excellent opportunities for creative Electronic Circuit Designers experienced in: Transistor circuits for digital computers; high-frequency power supplies; magnetic amplifiers, regulators, storage devices, cathode ray tube display systems; airborne radar system circuits.

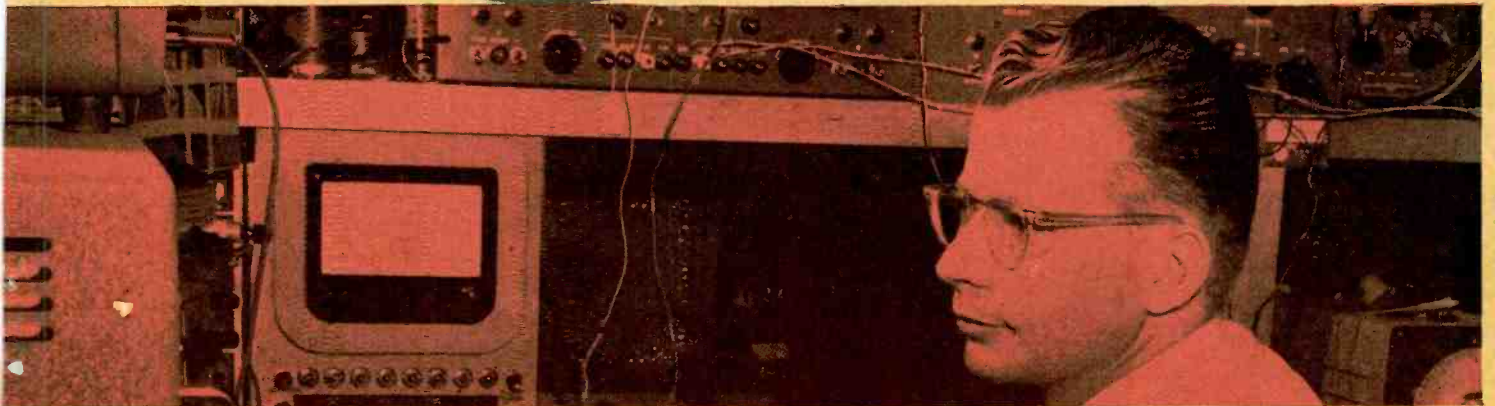

Challenging assignments for well qualified E.E.'s, M.E.'s, Physicists and Mathematicians in:

FOR DETAILS, just write, outlining background and interests, to:

Mr. R. A. Whitehorn, Dept. 554N
Mgr. of Technical Recruitment
International Business Machines Corp.
590 Madison Ave., New York 22, N. Y.

- Digital computer systems and logic
- Radar systems
- Inertial guidance
- Test equipment development
- Electronic circuit design

IBM

MILITARY PRODUCTS

DATA PROCESSING
ELECTRIC TYPEWRITERS
MILITARY PRODUCTS
SPECIAL ENGINEERING PRODUCTS
SUPPLIES
TIME EQUIPMENT

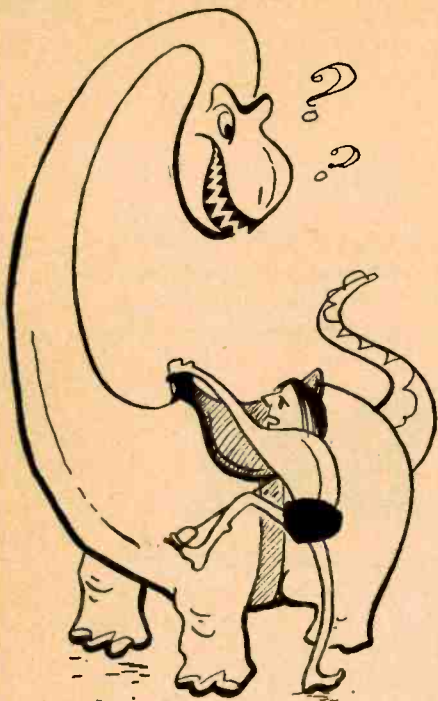

Like to try out original ideas?

MAGNETRON DESIGN ENGINEERS

Progressive research and development programs stimulate your creativity at Microwave Associates. Simplified reports, prompt decisions and informal organization let you do things the way you know they should be done!

Excellent growth potential, based on increasing demand for our improved microwave components, helps insure your steady progress at Microwave Associates. New developments since 1954 have doubled our staff.

Small-company teamwork, provided by 306 co-workers, helps speed the work through design, development and production. Red tape is cut . . . things get done!

Financial stability is built on the support of American Broadcasting-Paramount Theatres, Inc., and Western Union Telegraph Company. You're backed up with up-to-the-minute research and production facilities. Steady company growth and personal security are assured.

Ideal working and living conditions keep you happy at Microwave Associates. Our modern plant near Boston is right next door to educational and recreational advantages no other area can equal.

Interested? If you're experienced in designing magnetrons, write or phone Mr. T. N. Farrell at . . .

MICROWAVE ASSOCIATES INC.
 Burlington, Massachusetts
 BRowing 2-3000

PHOENIX

At the crossroads of opportunity for men with vision in Electronic Engineering

GOODYEAR AIRCRAFT CORPORATION

ELECTRONIC LABORATORY

Arizona Division
 Litchfield Park, Arizona

A Subsidiary of the
GOODYEAR TIRE & RUBBER CO

WE HAVE OPENINGS IN OUR MODERN LABORATORIES FOR ADVANCED ENGINEERS IN ELECTRONIC RESEARCH

Long range research and development projects

University of Arizona graduate studies available under company financed evening courses.

Leisure Living At Its Best "In the Valley of the Sun"

Modern Inexpensive Housing

Send resume to: A. E. Manning

Engineering and Scientific Personnel

GOODYEAR AIRCRAFT

LITCHFIELD PARK PHOENIX, ARIZONA

Similar opportunities available in our Akron, Ohio Laboratory

Chief Components Engineer

To be fully responsible (to Components Division Manager) for conception, design and product engineering of magnetic counters, memories, magnetic storage elements . . . pulse transformers, filters, delay lines . . . and development of modular circuit packages, resistive elements, etc.

Salary, profit-sharing and other incentives commensurate with experience (min. 5 yrs.) . . . will grow as fast as creative, practical and human relations abilities are demonstrated.

Soundly financed, fast-expanding organization with solid reputation for electronic components, which are marketed separately from the company's commercial product such as:

- DATRAC—voltage-digital converters
- ADDAVERTER—analog-digital computer link
- FM TELEMETERING SYSTEMS
- COMPU-CORDER—digital recording unit.

Send resume to Personnel Manager, Epsco, Inc., 588 Commonwealth Ave., Boston 15, Mass.



FIRST in data control

TECHNICAL SALES ELECTRONICS

A high caliber technical salesman with wide acquaintanceship in the electronic equipment and components industries and with a substantial background in electronic products application is needed by a first line Company manufacturing semi-conductor material.

This man must have demonstrated his ability to sell effectively and must possess initiative and drive to sell the output of a small manufacturing division, largely through his own individual effort. Travel necessary.

Salary plus incentives will be provided to make this a lucrative position for the right man in this growth situation.

Send resume with complete personal data, education, sales experience and salary requirements in complete confidence.

SW-7176. Electronics
 Class. Adv. Div., P.O. Box 12, N.Y. 36, N.Y.

LONG RANGE EXPANSION IN NON-MILITARY RESEARCH

Typical Positions:

Electrical Engineer interested in the design and pilot operation of new experimental devices to make and process optical materials.

Electronic Designers interested in photoelectronics and the applications of electronics to optical instrumentation.

Personnel Department
BAUSCH & LOMB OPTICAL CO.
 Rochester 2, New York

TECHNION—ISRAEL INSTITUTE OF TECHNOLOGY, HAIFA

Announces a vacancy for a Senior Lecturer (or Associate Professor) in the field of Servo-Mechanism and Automatic Control.

Candidates, who must have had wide practical and academic experience, will be responsible for advanced courses to post-graduate and fourth year students.

Applications, accompanied by curricula vitae and names and addresses of three references, to be sent to the Secretary for Academic Staff, P.O.B. 4910, Haifa, Israel.

POSITION VACANT

The University of Illinois needs an Electronics Engineer to set up and supervise electronics shop, design and construct research equipment for the Chemistry Department. Permanent, with vacation, sick leave, retirement, and educational benefits. Salary open. Apply 809 S. Wright Street, Champaign, Illinois stating experience and training.

PROJECT ENGINEER

Salary \$13,000
 B.S.E.E. with minimum of 6 years experience including supervisory responsibility. Thorough knowledge of circuitry, transients and transistor application necessary. Must be capable of managing large development projects on communications and frequency standards field. Company client assumes all employment expense.
MONARCH PERSONNEL
 28 E. Jackson Blvd. Chicago 4, Ill.

ENGINEERS

If you have been looking for an Employment Agency that is skilled in the STATE OF THE ART of Technical Recruitment and RELIABILITY OF INFORMATION concerning positions, why not communicate with us at office! ALL POSITIONS FEE PAID.
FIDELITY PERSONNEL SERVICE
 1218 Chestnut St. Phila. 7, Pa.
 Specialist in Aviation, Electronics and Nucleonics

SEARCHLIGHT SECTION

(Continued on pages 201-209)

WANTED

BRITISH MANUFACTURING And/or SELLING RIGHTS

Lion Electronic Developments, Ltd., who have complete United Kingdom Sales coverage, and excellent manufacturing facilities, wish to negotiate for manufacturing and/or selling rights for Electronic Instruments, Industrial, Telecommunications and Automation Products, and Resin Encapsulated Electronic Circuits and Components.

Would interested Organizations please communicate with reference RQM.

Lion Electronic Developments, Ltd.,

Feltham, Middlesex, England

Tel: Feltham 6661

NEED METERS? STANDARD or SPECIALS

ANY QUANTITY—NEW—MILITARY

FOR ELECTRONIC—MILITARY AIRCRAFT—HAMS

ALL MAKES—MODELS RANGES—SIZES

METERS REPAIRED RESCALED RECALIBRATED

WRITE - PHONE - WIRE

A & M INSTRUMENT SERVICE INC.

76-14 Woodside Ave.

Elmhurst 73, N. Y.

CAA No. 4264 Ltd. HA 9-2925



ENGINEERING DEGREES IN E.E.

Option Electronics or Power. May be earned by HOME STUDY or residence work.

(P.I.U. at present operating as a College of Engineering only.)
 5719-G Santa Monica Blvd.
 Hollywood 38, California

RATES

DISPLAYED

The advertising rate is \$24.75 per inch for all Equipment & Business Opportunity advertising appearing on other than a contract basis. Contract rates quoted on request. AN ADVERTISING INCH is measured 1/4 inch vertically on one column, 3 columns—80 inches—to a page.

EQUIPMENT WANTED or FOR SALE ADVERTISEMENTS acceptable only in Displayed Style.

EMPLOYMENT OPPORTUNITIES — \$28.67 per inch, subject to agency commission.

UNDISPLAYED

\$2.40 a line, minimum 3 lines. To figure advance payment count 5 average words as a line.

PROPOSALS, \$2.40 a line an insertion. BOX NUMBERS count as one line additional in undisplayed ads.

DISCOUNT of 10% if full payment is made in advance for four consecutive insertions of undisplayed ads (not including proposals).

if surplus electronics can meet your needs, get it from our new location,

7035 Laurel Canyon, No. Hollywood,

Cal.—the largest, most extensively

stocked electronics warehouse in the

world! Ask for CATALOG 116. It is

loaded with superlative buys!

ARROW SALES, INC.

Box 3007-E No. Hollywood, Calif.

3x.2mf 4000vDCw \$2.15	2x.5mf 600vDCw 40¢
3x.5mf 600vDCw 50¢	Knob-dial 2 inch 9¢
.001mf 5000vDCw \$1.15	N750L 100mmf 7¢
2.5&10mf 400vDCw 95¢	110v to 14v 3A \$1.85
2x6.3v@1A 2x5v@7A 7.5v@24A 115v pri. \$7.45	
shock mounts 3 lb 11¢ Send for List.	
COOPER ELECTRICAL CO., Park Ridge, N. J.	

NOW is the time to SELL!

Turn your equipment into ready cash. We'll PAY MORE for: BC-221; TS-174; TS-175; Frequency Meters; RM-39 Remotes; BC-348 Receivers; BC 610 Transmitters; BD-114 Switchboards GRC-3, 4, 5, 6, 7, 8, 9 components.

ASSOCIATED INDUSTRIES

6855 Tujunga Avenue, North Hollywood, Cal.

a TERRIFIC BARGAIN in a

SOLA CONSTANT-VOLTAGE TRANSFORMER



Ends fluctuating line voltage!

Big Discount Off . . .

the factory price at a 1-input 2,000 VA unit! And here's another bonus! This Air Forces 2,000 VA over-stock, Sol-a Cat. No. 30768, has 4 inputs! 90-125 V., 190-250 V., 60 cy. or 50 cy. Isolated secondary is constant 115.0 V. ± 1% from no-load to full-load at 17.4 amp. So, if you choose, use it as a 220-115 V. step-down. And slash \$97.50 off the factory 1-input price! Brand new in original wood box 4 cu. ft. Ship. wt. 254 lbs. **\$147.50**

F. O. B. Pasco, Wash. Only
THE M. R. COMPANY
 P. O. Box 1220-B Beverly Hills, Calif.

TUBES

★ Brand New! Fresh! Guaranteed!
 ★ Nationally known brands!
 ★ Prices reduced from 5 to 30%

BROADCAST TUBES

2M21	\$25.00	WE305A	\$2.85
2C51	3.00	WE306A	1.75
2E24	1.95	WE310A	1.75
2E22	2.35	WE311A	5.00
3C22	59.95	WE311B	5.75
3C33	5.00	WE313C	2.10
3E29	8.00	WE314A	80.00
3X2500A3	150.00	327A	3.40
4C X300A	30.00	WE328A	3.25
4X150A	18.50	WE331A	7.50
4X150D	20.00	WE337A	5.50
4X250B	38.00	WE348A	4.00
4E27	7.00	WE349A	4.00
4-250	28.50	WE350A	2.25
4-125A	18.50	WE350B	2.00
4-400A	38.50	WE354A	15.00
4-1000A	125.00	WE356B	2.95
5D21	5.00	WE359A	1.45
5D23 RK65	7.00	WE368AS	.75
6C21	13.50	WE371B	2.00
15E	1.20	WE372A	3.00
24G	5.00	WE373A	3.95
HK24	2.50	WE374A	1.75
53A	5.00	381A	5.00
HY65	1.00	WE387A	3.50
1B86	5.00	WE388A	.85
100TH	1.00	WE396A	3.00
C100A	10.00	WE401A	3.95
101D	2.75	WE403A	.90
101F	2.75	WE403B	2.75
104D	2.75	WE404A	14.00
121A	1.50	WE407A	3.75
VT-127	1.00	WE408A	2.25
VT-127A	2.50	WE412A	3.50
V-128A	7.00	WE415A	3.00
FT-158	9.50	WE416A	25.00
HF200	13.00	WE416B	30.00
204A	22.50	WE417A	12.00
WE205F	4.00	WE418A	17.50
211	15.00	WE419A	48.00
WE215A	5.00	WE421A	6.75
220B	55.00	WE422A	7.00
227A	3.75	WE423A	5.00
250TH	23.00	WE426A	2.75
250T1	12.00	WE427A	8.50
WE251A	42.00	WE429A	12.50
WE252A	9.50	WE431A	45.00
WE253A	2.75	WE436A	10.00
WE254A	2.25	WE437A	12.00
261A	7.00	WE441A	7.00
WE262B	2.50	450TH	40.00
WE267B	4.00	471A	190.00
WE272A	6.50	508	190.00
WE274B	.75	HK65A	15.00
WE275A	2.75	750TL	30.00
WE276D	7.00	813	8.50
WE282A	2.50	815	1.25
WE282B	17.50	829B	8.25
WE287A	2.00	837	1.50
WE290A	6.75	922	1.75
WE293A	10.00	1625	.40
304TH	10.00	1625	.40
305A	2.50	ZB3200	60.00

SCOPE TUBES

2AP1	\$2.00	5CP11	\$7.00
3A91	1.50	5CP11A	8.50
3CP1	1.75	5FP7A	2.50
3DP157	12.50	5JP1	8.75
3FP7	1.00	5JP1A	25.00
3GP1	2.00	5NP1	2.00
3WP2P1	50.00	7BP1A	15.00
3EP1	7.00	7CA	2.00
5BP1A	8.50	9LP7	10.00
5BP4	2.25	12DP7	12.00
5CP1	1.75	51UCP11	25.00
5CP1A	7.00	902P1	2.25

MAGNETRONS

2J21A	\$4.75	4J33	\$125.00
2J22	4.50	4J34	25.00
2J26	4.50	4J42	25.00
2J27	4.50	4J50	90.00
2J28	25.00	4J51	75.00
2J29	25.00	4J52	50.00
2J31	12.25	4J58	125.00
2J32	9.50	4J64	40.00
2J33	35.00	5J23	75.00
2J34	10.00	QK60	19.50
2J37	28.50	QK62	19.50
2J38	28.50	QK284	95.00
2J48	24.00	QK366	60.00
2J50	32.50	QK367	65.00
2J51	130.00	70A V-GY	5.00
2J51A	148.00	714AY	50.00
2J55	45.00	720AY/CY	32.00
2J56	38.00	728AY/CY	40.00
2J61	9.95	725A	2.50
2J62	4.00	5657	100.00
4J21	35.00	5780	150.00
4J26	45.00	5780	150.00
4J31	125.00	6177	75.00

QUALITY TUBES!

WRITE FOR QUANTITY PRICES!

100-1B86	1000-6J4	200-313C	250-872A
100-2C46	400-6L6	150-418A	4-889RA
700-2D49	1500-65M7	700-359A	100-922
500-2E29	300-6SK7GY	260-374A	3000-957
100-2G21	350-6SK7W	100-381A	2000-1625
300-3AP1	200-6SK7Y	250-387A	300-5763
50-3C22	600-6Y66	500-407A	300-5559
200-3C45	300-7CP1	300-408A	300-5702WA
700-3FP7	800-12A77WA	250-417A	100-5703WA
500-NS4	1000-12C8	100-703A	2000-5718
500-NS5	100-12M6	400-CK-705	300-571C
100-4X150A	600-125H7	20-714AY	300-5763
300-5C5B	400-14J7	400-715B	5000-5814
700-6AB7	400-HR-24	100-723A/B	500-5886
1000-6AC7	100-15E	1000-815	100-5993
100-6AT6	600-15R	200-726C	200-5015
300-6A U6WA	100-VT-158	800-838W	2000-6045
400-6BA6	400-267B	16-858	200-6211
70-6BM6	200-272A	100-864	1000-9002

5,000 SERIES & UP

5517	\$1.00	5703WA	\$3.85	5932	\$3.00
5633	4.00	5704	1.75	5933	1.50
5635	4.00	5718	1.75	5963	1.25
5636	2.40	5719	1.40	5967	9.50
5637	3.00	5744	1.00	5969	9.50
5639	5.75	5751	2.00	5992	6.75
5641	4.00	5763	.90	5993/TE-10	8.00
5643	3.85	5783	3.75	5995	9.75
5644	5.00	5784	4.00	6000	2.00
5645	4.75	5784WA	6.00	NL710/6011	12.00
5646	3.75	5787	3.75	6021	3.00
5647	3.75	5787WA	4.75	6073	1.50
5651	1.25	5814	.40	6080	3.50
5651WA	3.25	5814A	1.50	6110	4.75
5654/6AK5W	1.25	5829WA	3.50	6112	4.00
5654/6AK5W	1.25	5840	3.00	6130	4.50
5663	2.75	5840A	4.25	6201	2.50
5663	.95	5844	1.40	12A77WA	2.50
5670	1.95	5854	1.30	6211	1.00
5670WA	4.00	5886	3.00	6263	9.50
5691	4.75	5894	17.00	6280/416B	35.00
5692	5.00	5898	3.00	6524	11.00
5696	.75	5899	7.50	8012	1.00
5702WA	3.85	5902	3.25	9002	.45
		5902	4.00	9003	.90

RECTIFIERS & REGULATORS

OB2	\$.50	3B26	\$92.50	371B	\$2.50
OB2WA	2.25	3B28	4.00	575A	10.00
OB3	.90	3B29	4.75	583	5.00
OC3	.50	5R4GY	1.25	676	48.00
OC3W	2.25	5Y3WGT	1.30	705A	.65
OD3	.50	5X3	2.20	836	1.20
OD3W	2.25	249B	2.50	872A	1.00
1V	.90	249C	2.50	876	.75
2C53	9.00	250R	3.95	878	.50
RX-21	4.50	267B	4.95	VXR2700	6.00
3B24W	4.25	313C	2.25	991	.32
3B24WA	7.00	371A	80.00	5931	504WG 4.00
		371A	1.00	8013	3.00

KLYSTRONS

1K015XA/X481	3K30	\$90.00	726A	\$4.75	
B, C, D	540.00	6BL6	24.00	726C, WE	48.00
SRX16	100.00	6BM6	27.50	726 C, RAY	11.50
2K25	10.00	6BM6A	28.50	5611	40.00
2K28	24.00	WL417A	2.00	5981/5650	45.00
2K45	25.00	QK404	4.80	6116	45.00
2K48	15.00	707B	1.75	D1784G1/	
2K54	14.00	707B	1.75	D1784G1/	
2K55	14.00	723A/B	6.50	419A	48.00

IGNITRONS AND THYRATRONS

C1K	\$6.50	FG154	\$9.00	NL1051FC	
1C	1.00	VT-158	8.00	271/5581	550.00
2D21W	.80	FG-271	22.00	NL1052/5552	
3C45	5.00	3238	3.45	FG235A	82.00
4B25	5.00	354A	8.00	2050W	3.50
CSB	1.00	393A	3.35	5559/FG57	8.00
EL5B	5.00	394AWE	3.00	5560/FG-95	17.00
5C22	20.00	KU-627	7.00	5795	7.00
CGM 5528	5.00	5948	1754	100.00	
FG-32	4.00	WL653B	75.00	5966/E36	33.50
FG105	11.00	715C	10.00	6130	4.50

-CAPACITORS-

4 mfd—200 V \$.35

Metalized paper bathtub capacitor. Two 2 mfd sections with 3 side terms. Standard dimensions. The perfect crossover network capacitor. Quality discount.

2 mfd600 V \$.55

CP53 Pyranol bathtub

4 mfd3000 V \$4.95

32 mfd.—600 V \$2.98

1 individual 8 mfd sections. Dim. 4 3/4 x 3 3/4 x 3 1/4. Top Quality Brand.

Mfd Volts Price	Mfd Volts Price	Mfd Volts Price
.001 10KV 5.25	.5 4000 3.25	4 7500 59.50
.001 50KV 24.95	.5 5000 3.05	4 10KV 74.50
.0025 10KV 5.95	.5 7500 3.75	4 15KV PUR
.005 25KV 29.95	.5 25KV 38.50	5 220 1.09
.01 1500 .55	5-5 600 .49	5 330 1.19
.01-01 3000 .40	5-5 9000 8.55	5 600 .95
.012 25KV 12.95		5 1000 1.69
.015 16KV 14.50	5-1 2000 .32	5 5000 27.50
.02 8000 4.75	115VAC .32	
.02 10KV 5.25	1 600V .44	2x5 100 .89
.02 20KV 9.95		2x5 600 1.19
.025 50KV 32.95		6 330 1.29
.03 7500 4.25	1 1000V .69	
.03 17KV 7.95	1 1500V .99	16 600 1.29
.05 2500 4.75	1 2000V 1.45	6 1000 1.55
.05 7500 4.95	1 3000V 2.75	6 1500 2.95
.05 16KV 7.95	1 3600V 2.45	6 2000 1.35
.05-.05 12KV 8.95	1 5000 6.25	7 800 1.55
2x.05 45KV 60.00	1 6000 8.95	8 330VAC 1.50
.08 12.5KV 7.95	1 7500 7.50	8 600 1.29
.1 1500V .45		8 600VAC 2.40
.1 2000V 24.65	1 7500 14.75	8 1000 2.15
.1 2500V .65	1 10KV 25.95	8 1500 3.55
1 3000 .69	1 15KV 38.50	8 2000 6.95
1 4000 1.19	1 16 37.50	8 2500 9.95
1 5000 1.49	1 25KV 69.50	2x8 600 1.89
1 5000 3.25	1 30KV PUR	4x8 600 2.98
1 6000 2.25	2x1.25 7500 20.00	9 10KV PUR
1 7500 .89	1.25 330VAC .49	10 100 .65
1 12KV 6.95	1.5 15KV 49.50	10 600 .98
1 15KV 8.95	1.5 25KV PUR	
1 20KV 9.95	2 200 .55	10 600 1.19
1.25 25KV V 27.50	2 600 .55	10 600 1.49
1.25 27.5KV V 27.50	2 1000 .79	10 1000 3.75
2x.1 6000 2.29	2 1000T1A 1.29	10 1400 2.25
2x.1 10KV 8.35	2 1500 1.15	10 1500 4.25
2 13KV 9.50	2 2000 2.75	12 2000 6.75
2 15KV 12.50	2 2500 3.45	10 2500 10.95
2 50KV 69.50	2 3000 5.25	10 2500* 6.25
25 2000 .89	2 4000 7.10	10 4000 20.95
25 3000 1.45	2 5000 12.50	10 5000 PUR
25 4000 1.98	2 6000 24.50	12 600VAC 4.25
25 6000 .89	3 7500 23.50	12 1000 2.95
25 15KV 15.95	3 16KV	

ELECTRONIC

WAR TERMINATION INVENTORIES

WRITE OR WIRE FOR INFORMATION ON OUR COMPLETE LINE OF SURPLUS ELECTRONIC COMPONENTS. ALL PRICES NET F.O.B. PASADENA, CALIFORNIA

C&H

SALES CO.

2176-E East Colorado St.
Pasadena 8, California
RYan 1-7393

INVERTERS

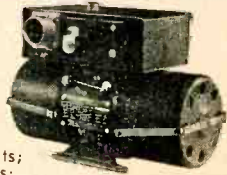

- 10042-1-A Bendix
DC Input 14 volts;
Output: 115 volts;
400 cycles, 1-phase; 50 watt **\$35.00**
- 12116-2-A Bendix
Output: 115 VAC; 400 cyc; single phase; .45 amp. Input: 24 VDC, 5 amps **\$25.00**
- 12117 Bendix
Output: 6 volts; 3 phase; 400 cycles, 6 volt amperes, 1 phase. Input: 24 VDC; 1 amp. **\$15.00**
- 12121 Bendix
Input: 24 volt D.C. 18 amp. 12000 r.p.m.
Output: 115 volts, 400 cycle, 3-phase, 250 volt amp, 7 pf. **\$49.50**
- 12123 Bendix
Output: 115 V; 3 phase; 400 cycle; amps. 5; Input: 24 VDC; 12 amp. **\$49.50**
- 12126-2-A Bendix
Output: 26 volts; 3 phase; 400 cycle; 10 VA; 6 PF. Input: 27.5 volts DC; 1.25 amps. **\$24.50**
- 12142-1-A Bendix
Output: 115 volts, 3 phase, 400 cycle, 250 VA. Input: 27.5 VDC, 22 amps. Voltage and frequency regulated. **\$99.50**
- 12147-1 Pioneer
Output: 115 VAC, 400 cycles; single phase. Input: 24-30 VDC; 8 amps. **\$19.95 each**
- 10285 Leland
Output: 115 volts AC; 750 VA, 3 phase, 400 cycle, .90 pf and 26 volts, 50 VA single phase, 400 cycle, .40 pf. Input: 27.5 VDC, 60 amps. cont. duty, 6000 rpm. Voltage and frequency regulated. **\$59.50**
- 10563 Leland
Output: 115 VAC; 400 cycle; 3-phase; 115 VA; 75 pf. Input: 28.5 VAC; 12 amps. **\$25.00**
- F16 Jack & Heintz
Output: 115 volts, 400 cycle, 1 or 3 phase, 250 VA pf. 9. Input: 27.5 volts, 20 amp. Electronic frequency and voltage regulated. **\$99.50 each**
- PE109 Leland
Output: 115 VAC, 400 cyc.; single phase; 1.53 amp.; 8000 rpm. Input: 13.5 VDC; 29 amp. **\$50.00**
- PE218 Leland
Output: 115 VAC; single phase pf. 90; 380/500 cycle; 1500 VA. Input: 25-28 VDC; 92 amps.; 8000 rpm.; Exc. Volts 27.5 BRAND NEW **\$30.00**
- AN 3499 Eicor, Class "A"
Input: 27.5 volts at 9.2 amps. AC. Output: 115 volts, 400 cycles; 3 phase, 100 voltamp; continuous duty. **Price \$39.50 each**

MINNEAPOLIS-HONEYWELL RATE GYRO (Control Flight)



Part no. JG7005A-11 series 9. 115 volts A.C., 400 cycle, single phase. Potentiometer take off resistance 530 ohms. Speed 21,000 r.p.m. Angular momentum 2 1/2 million, CM²/sec. Weight 2 lbs. Dimensions 4-7/32 x 3-29/32 x 3-31/64. **Price \$22.50 each**

MINNEAPOLIS-HONEYWELL SERVO MOTOR # MG7008A-3



230 volts, 400 cycle, 2 phase, maximum input 50 watts. Total travel 90° in .52 sec., spline shaft, 1900-ohm balancing pot, 1 watt. Torque rating 12" lb. cont.; 20" lb. inter. Cast mag. case 7-3/4" x 7" x 3-1/4". Unit contains A.C. velocity (tach) generator, 115 volts, 400 cycle, output 3 volts at maximum speed. 20 ma. volt null. Approx. weight 5 1/4 lbs. **Price \$50.00 each**

HAYDON D.C. CHRONOMETRIC TIMER #5734



24-30 volts D.C. with an output of 12 r.p.m. Jewelled movements.

1/10 of 1% accuracy, reversible rotation. Round shaft 1/8" dia. x 3/8" long. Mounted by 2 ears with 1/8" dia. holes, 1-7/8" centers. Body 2-1/32" deep x 2-1/2" high x 2-1/8" wide. **Price \$9.75 each**

400 CYCLE GENERATOR

Self-excited, AC/DC, mfgd. by Homelite, Model 18A120-D-28-1. Output 115 volts, 400 cycle, single phase, 39 amps and 28 volts D.C. at 17.9 amps at 4,000 r.p.m. **Price \$100.00 each**

SELSYNS-SYNCHROS



- ICT cont. Trans. 90/55V 60 cy. **\$37.50**
- 1DG Diff. Gen. 90/90V 60 cy. **37.50**
- 1F Syn. Mtr. 115/90V 60 cy. **37.50**
- 1G Gen. 115V 60 cy. **12.50**
- 15F Syn. Mtr. 115/90V 400 cy. **7.50**
- 21JF1 Gen. 115/57.5V 400 cy. **10.00**
- 21JF3 Gen. 115/57.5V 400 cy. **7.50**
- 21JFA1 Gen. 115/57.5V 400 cy. **5.00**
- 21JG1 57.5/57.5V 400 cy. **7.50**
- 21JH1 Diff. Gen. 57.5V 400 cy. **17.50**
- 21SD1 Cont. Trans. 105/55V 60 cy. **17.50**
- 21SF1 Cont. Trans. 105/55V 60 cy. **17.50**
- 21SH1 Gen. 115/105V 60 cy. **17.50**
- 21J5M1 Gen. 115/57.5V 400 cy. **17.50**
- 5CT Cont. Trans. 90/55V 60 cy. **34.50**
- 5D Diff. Mtr. 90/90V 60 cy. **34.50**
- 5ODG Diff. Gen. 90/90V 60 cy. **34.50**
- 5F Syn. Mtr. 115/90VAC 60 cy. **34.50**
- 5G Syn. Gen. 115/90VAC 60 cy. **34.50**
- 5HCT Cont. Trans. 90/55V 60 cy. **42.50**
- 5SDG Diff. Gen. 90/90V 400 cy. **12.50**
- 60G Diff. Gen. 90/90V 60 cy. **25.00**
- 6G Syn. Gen. 115/90VAC 60 cy. **34.50**
- 7G Syn. Gen. 115/90VAC 60 cy. **42.50**
- R110-2A Kearfott Cont. Mtr. 115V 400 cy. **17.50**
- R200-A Kearfott Cont. Trans. 26/11.8V 400 cy. **15.00**
- R210-1-A Kearfott Trans. 26/11.8V 400 cy. **20.00**
- R220-T-A Kearfott Receiver 26/11.8V 400 cy. **20.00**
- R235-1A Kearfott Resolver 26/11.8V 400 cy. **22.50**
- C56701 Type 11-4 Rep. 115V 60 cy. **20.00**
- C69405-2 Type 1-1 Transm. 115V 60 cy. **20.00**
- C69406 Syn. Transm. 115V 60 cy. **20.00**
- C69406-1 Type 11-2 Rep. 115V 60 cy. **20.00**
- C76166 Volt. Rec. 115V 60 cy. **10.00**
- C78248 Syn. Transm. 115V 60 cy. **12.50**
- C78249 Syn. Diff. 115V 60 cy. **5.00**
- C78863 Repeater 115V 60 cy. **7.50**
- C79331 Transm. Type 1-4 115V 60 cy. **20.00**
- 851 Bendix Autosyn Mtr. 22V 60 cy. **7.50**
- 403 Kollsman Autosyn. Mtr. 32V 60 cy. **7.50**
- FPE-25-11 Diehl Servo Mfr. 75/115V 60 cy. **19.50**
- FPE-43-1 Resolver 400 cy. **25.00**
- FJE-43-9 Resolver 115V 400 cy. **19.50**
- 999-0411 Kollsman 26V 400 cy. **15.00**
- 13770410 Kollsman 26V 400 cy. **10.00**
- 15158-0410 Kollsman 26V 400 cy. **20.00**
- 10047-2A Bendix 26V 400 cy. **12.50**
- 2900 Transicoil 115V 400 cy. **15.00**
- 15CX4a Synchro Transmitter MK 22 MOD 1 **15.00 ea.**

INFRA RED SNOOPERSCOPE



High quality now at surplus prices. Eastman Kodak Infra-Red SNOOPERSCOPE Receiver, Type B, 7" long with 5" SCHMIDT ultra-high-speed Objective Lens (approx. f 0.5). Elaborate optical system, many coated lenses. Uses 2 penlight batteries. Govt. cost approx. \$300. Factory-new. Shipping wt. 9 lbs. **Price \$19.95** Waterproof Snooperscope Carrying Case, extra. Shipping wt. 3 lbs. **Price \$3.00**

Dual purpose U.S.N. floodlight throws strong beam of invisible infra-red rays. With infra-red lens, spare sealed beam lamp, batteries. Shipping wt. 23 lbs. **Price \$14.95**

DIFFERENTIAL



Size 2-11/16" long 1-11/16" dia. 1-1 reverse ratio. 1/4" shaft on each end; one shaft 25/32" long, one shaft 15/32" long. Input and output gear 1-23/32" dia. 53 teeth. **\$3.50 ea.**

Stock No. 150

SIMPLE DIFFERENTIAL

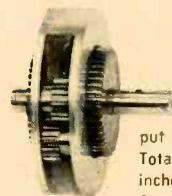

1 to 1 reverse ratio; 48 teeth on input and output gear, 1-1/32 inch diameter. Total outside diameter 1-25/32 inches. Shaft size is 1/4 inch. One shaft is 9/16" long; other shaft is 3/16" long. **\$5.00**

Stock No. 151

BALL DISC INTEGRATOR



Forward & Reverse 2 1/4-0-2 1/4. Input shaft spline gear 12 teeth 9/32" dia. 3/8" long. Output shaft 15/64" dia. x 15/32" long. Control shaft 11/32" x 3/8" long. Cast aluminum constructor. Approx. size 3" x 3" x 2 3/4". **No. 145 \$17.50 ea.**

(All Shafts Ball Bearing Supported)

SMALL DC MOTORS



- (approx. size overall 3/4" x 1 1/4" dia.)
- 5067126 Delco PM, 27 VDC, 125 RPM, Governor Controlled **\$15.00 ea.**
 - 5069600 Delco PM 27.5 VDC 250 rpm **12.50**
 - 5069230 Delco PM 27.5 VDC 145 rpm **15.00**
 - 5068750 Delco 27.5 VDC 160 rpm w. brake **6.50**
 - 5068571 Delco PM 27.5 VDC 10,000 rpm (1x1x2") **5.00**
 - 5069790 Delco PM, 27 VDC, 100 RPM, Governor Control ed **15.00 ea.**
 - 5BA10A118 GE 24 VDC 110 rpm **10.00**
 - 5BA10AJ37 GE 27 VDC 250 rpm reversible **10.00**
 - 5BA10AJ52 27 VDC 145 rpm reversible **12.50**
 - 5BA10AJ50, G.E., 12 VDC, 140 rpm **15.00**
 - 206-1001 PM Planetary Gear Reduced Motor with Magnetic Brake. Mfgd. by Air Equipment 26 volts 600 ma 145 rpm **17.50**
 - 5BA10FJ33, G.E., 12 VDC, 56 rpm reversible **15.00**
 - 806069 Oster series reversible 1/50 h.p. 10,000 rpm. 27.5 VDC 1 5/8" x 3 1/2" **5.00**
 - C-28P-1A 27 VDC 1/100 h.p. 7,000 rpm **3.00**
 - 7100-B-PM Hansen 24 VDC 160 rpm **7.50**
 - SSFD-6-1 Diehl PM 27.5 VDC 10,000 rpm **4.00**
 - 6-volt PM motor mfgd. by Hansen 5,000 rpm 1 1/4" in dia., 2" long overall **4.00**

400 CYCLE GENERATORS & MOTOR GENERATORS

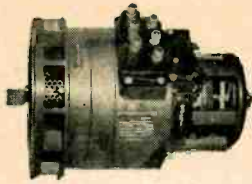

400 cycle, 3 phase 4 wire, 26 KVA 75% PF., 120/208 volt, aircraft alternators, Model A50J201, spline drive, two bearing, 6000 RPM., complete with self contained exciter. Manufactured in 1954 by Westinghouse for the Convair F102 Supersonic Fighter. New in original cases. 52 available. Cost over \$1,600. Our price only \$149.00 each.

400 cycle, 3 phase 4 wire, 115/200 volt, 40 KVA, 30 KW, 75% PF., 6000 RPM. aircraft alternator, Westinghouse type A14A9687-2, gear driven by a Continental 6 cylinder gas engine Model B427, complete with blower for generator air blast cooling, voltmeter, ammeter, frequency meter, voltage regulator, unit is mounted on enclosed trailer with

tires, engine hour meter shows only 340 hours operation but unit is dirty and sheet metal enclosure is damaged in spots. Only \$699.00.

400 cycle, 3 phase 4 wire, 60 KW, 75 KVA, 80% PF. Motor generator set with self contained exciter, Delco Model Y1-4367 dual voltage alternator 120/208-240/416 volt, 1714 RPM., driven by a used G.E. 100 H.P. induction motor, 3 phase 220/440 volt, 60 cycle, F.L. speed 1755 RPM. Model 94E1610, type K1 543, motor and generator direct coupled on steel skid base. Complete with a 220 volt starter and disconnect switch for generator, 400 cycle generator purchased new from Delco in March 1956 and used less than 50 hours. Only \$2,990.00.

400 cycle, 3 phase 4 wire, 37½ KVA 30 KW 80% PF. 1714 RPM gasoline engine driven generator set. Military type with protective housing on a skid base, suitable for outdoor use. Delco alternator with direct connected exciter. 6 cylinder Continental MS-

330 engine, electric starting less batteries, complete with self contained switchboard with all control equipment such as ammeter, voltmeter, frequency meter, wattmeter, voltage regulator, etc. Unit has run 780 hours but looks practically new. Only \$1,699.00.



400 cycle, 3 phase 4 wire, 40 KVA 75% PF, 120/208 volt, aircraft alternator, Model JH-12050-2, single bearing, internal hub drive, 3428 RPM., requires separate 24 volt D.C. for excitation. We believe these were originally direct connected to a Sunstrand hydraulic drive on an aircraft engine. 33 in stock, new in original cases but show signs of extended warehousing. Only \$125.00 each.

INSTRUMENTS & ACCESSORIES CO., INC.

103 Carleton Avenue

Juniper 1-2500

East Islip, L. I., N. Y.

INFRARED SNOOPERSCOPIES!

OPTICS • LAMPS TUBES • PARTS

Former "Top-Secret" Infrared Viewers For Seeing in Total Darkness Without Being Seen. Now Available for Civilian Applications!

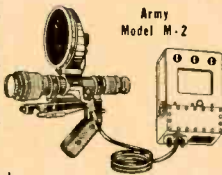

Bell & Howell—uses 1P25-A image tube. Priced from \$50 to \$99.95.

IMAGE TUBE POWER SUPPLY SNOOPERSCOPE PART #1450-A.

Power-pack for 1P25-1P25-A tubes (will also supply CV-147 tubes). Input 6 volts d.c. at only 0.33 ampere. Output 4,250 volts d.c. and additional focusing voltages. Operates from single 6-volt dry cell lantern battery. Size 4½" x 3" x 8". Gov't. cost \$92.00. NEW CONDITION. Complete ready to turn-on. Only \$7.95 ppd.

INFRARED LIGHT SOURCE

SNOOPERSCOPE PART #1364-A. Input 6-volts, 5 amperes. 5% double glass filter. Projects a powerful beam of invisible radiation (free of all visible light) illuminates for infra-red viewing or photography up to distance of 400 feet. STK. #L-5459. BRAND NEW, only \$5.95 ppd.



Terms: Prices include Postage. Cash With Orders. Well Rated Concerns (D & B) Net 10 Days Cash.

Write today for FREE CATALOG

Contains descriptions & price list of other Infrared parts available at our amazing low prices.

McNEAL Electric & Equipment Co.

4736 Olive St., Dept. E-2, St. Louis 8, Mo.

ART-13 APR-4 BC-348

BC-221, BC-342, BC-312, ARC-1, ARC-3, DY-17, Teletype Printers, Boehme Keyers, BC-610E

ALLTRONICS-HOWARD CO.

Box 19, Boston 1, Mass. (Richmond 2-0048)

COMMUNICATIONS EQUIPMENT & TEST EQUIPMENT

SEND US YOUR LIST OF REQUIREMENTS
ALL THE BEST & FINEST AT LOW PRICES

Also Maintenance Manual AN/ARC-27 1953 Revision
MAIL, WIRE OR TELEPHONE FOR QUOTE

MONTGOMERY EQUIPMENT CO.

14315 BESSEMER ST.

VAN NUYS, CALIFORNIA

TEL: SState 6-4657

Telegraph YHV Van Nuys

CONSISTENTLY— HIGH QUALITY ELECTRON TUBES

At SENSIBLE prices!

Write for industrial prices.

AND ON OUR PREMISES:

PRODUCTION
QUANTITIES
AVAILABLE

TUBE TESTING LABORATORY

TEST YOUR TRANSMITTING, RECEIVING, AND
SPECIAL-PURPOSE TUBES TO
JAN. MIL-E-1B AND/OR COMMERCIAL SPECS.
LAB. CERTIFICATES SUPPLIED

We have one of the most complete tube stocks in the country. All tubes are fully guaranteed, standard brands only, & at lowest prices possible consistent with our famous critical standard for high quality. We also stock & manufacture selenium rectifiers & associated transformers and chokes to your own specifications. Fast delivery. Write for prices & details.

Walker 5-7000 - TWX: NY 1-3731

CABLE:
BARRYLECT,
NY

TELEGRAMS:
BARRY, FAX,
NYC

BARRY ELECTRONICS CORP.

512 BROADWAY N.Y. 12, N.Y.

DIRECT SOURCE FOR:
standard brand
SPECIAL PURPOSE
TRANSMITTING
TV & RECEIVING
CRYSTAL DIODES
AND OTHERS

AUTH.
DISTRB'S.
FOR—

PENTA
EIMAC
CETRON
CBS-HYT.
LEWIS & K.
MULLARD
ETC.

Write for
new 1958
Green Sheet
bargains in
Test Gear.
Xmfrs, parts.

INDEX TO ADVERTISERS

AC Electronics Division.....	137
Ace Electronics Associates, Inc.....	146
Accurate Instrument Company, Inc.....	86
Aeromathical Communications Equipment Inc.....	50
Aerovox Corporation.....	158
Airpax Products Co.....	173
Alladin Electronics.....	72
Alford Mfg. Co., Inc.....	164
Allegheny Ludlum Steel Corp.....	34
Allen-Bradley Co.....	179
Allies Products Corp.....	187
American Electrical Heater Company.....	198
American Photocopy Equipment Co. 64A, 64B	
American Television & Radio Co.....	190
American Time Products, Inc.....	70
Applied Science Corp. of Princeton.....	210
Arnold Engineering Co.....	10

Ballantine Laboratories, Inc.....	147
Bead Chain Mfg. Co., The.....	197
Beede Electrical Instrument Co., Inc.....	185
Bendix Aviation Corp. Eclipse-Pioneer Div.....	210
Pacific Division.....	53
Biley Electric Co.....	191
Boonton Radio Corp.....	52
Borg Corp., George W.....	144
Bourns Laboratories, Inc.....	76
Brand and Co., Inc., William.....	29
Bristol Company, The.....	163
Bulova Watch Company.....	168
Burnell & Co., Inc.....	31

C.B.S.-Hytron.....	54
Caledonia Electronics and Transformer Corp.....	194
Cambridge Thermionic Corporation.....	90
Cannon Electric Co.....	125
Centralab, a Division of Globe-Union, Inc.....	167
Chicago Aerial Industries, Inc.....	183
Chicago Telephone Supply Corp.....	129
Christie Electric Corp.....	187
Circon Component Corporation.....	181
Clare & Co., C. P.....	71
Clifton Precision Products Co., Inc.....	85
Cohn Corp., Sigmund.....	193
Comar Electric Company.....	151
Constantin & Co., L. L.....	67
Continental Wire Corporation.....	162
Cossor (Canada) Limited.....	189
Cross Co., II.....	187

Dano Electric Co.....	175
Daystrom Instrument.....	83
Delco Radio Div. of General Motors Corp.	44
DeMornay-Bonardi.....	188
Dialight Corporation.....	170
Dinco-Gray Company.....	175
Dow Corning Corp.....	33
Driver-Harris Company.....	51
Dumont Laboratories Inc., Allen B.....	149
duPont de Nemours & Co. (Inc.) E. I. Polychemicals Dept.....	43
Durant Mfg. Co.....	191

Eastern Industries, Inc.....	35
Eastern Tool & Mfg., Co.....	175
Edison Industries, Thomas A.....	49
Eisler Engineering Co., Inc.....	195
Eitel-McCullough, Inc.....	89
Electrical Industries.....	45
Electro Instruments Inc.....	30
Electro-Pulse, Inc.....	150
Electronic Batteries, Inc.....	140
Electronic Instrument Co., Inc. (EICO).....	172

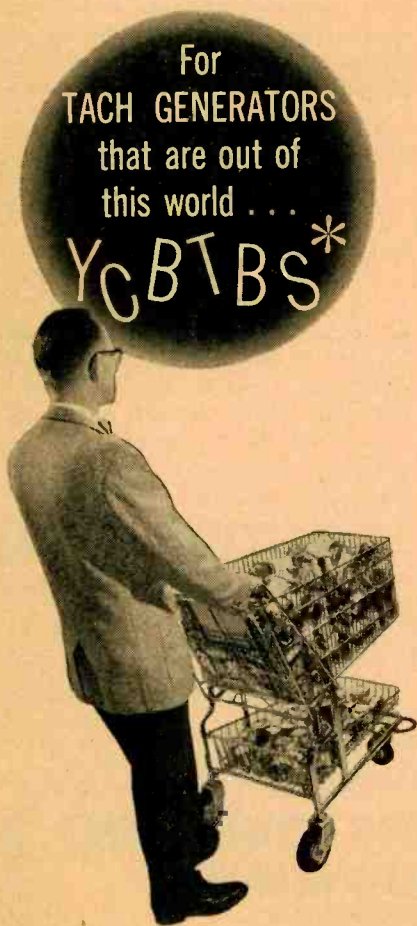

***TRANSLATION: You Can't Beat
The Bendix "Supermarket"**

From our "supermarket" of precision components, we offer you these advantages on temperature-compensated tach generators: *Fast delivery* because of volume production; *Laboratory quality* due to extensive test facilities and high-precision manufacture; *Latest developments*, such as miniaturization, integral motors, wider range of temperature compensation, etc. Our complete line assures you of getting tach generators best suited to your needs.

NOW! FRAME SIZES 10 AND 15 ADDED TO TACH LINE NEW!

Bendix Tach Generators are linear to within 1/10 of 1% over a wide speed range; are available over a temperature range of -55°C to +125°C with output voltage stable to 1/10 of 1%; motor generators also available.

Eclipse-Pioneer Division
Teterboro, N. J.



District Offices: Burbank and San Francisco, Calif., Seattle, Wash.; Dayton, Ohio; Washington, D. C.
Export Sales & Service: Bendix International Division, 205 E. 42nd St., New York 17, N. Y.

CIRCLE 189 READERS SERVICE CARD



SAMPLING SWITCH

BY



The ASCOP Type AS multi-channel rotary sampling switch is designed specifically for airborne telemetering applications where precision high-speed sampling with the utmost reliability is necessary for accurate data. These rugged instruments are engineered to withstand the most severe environmental conditions. Because the switches provide a low generated thermal noise and a low contact resistance, millivolt signals may be fed through and then amplified with minimum error.

SPECIFICATIONS

Pin and Wiper Arrangement: 2 to 6 poles. 30 to 60 pins/pole. In non-shorting applications alternate pins must "float", therefore, 60 pins develop 30 non-shorting channels. 55 to 98% on time with non-shorting channels. 25 to 70% unshorted time with shorting channels. ±5% phasing pole to pole.

Electrical: 20 microvolts generated thermal noise when sampling 40 millivolts signal and feeding into 250,000 ohms. 2 to 30 ohms contact resistance, maximum. 1 to 1000 megohms leakage resistance pin to pin. 12 to 20 microfarads capacitance pin to pin. 2 to 15 watts maximum signal capacity (resistive.) No contact bounce.

Motor: DC, 60 or 400 cps 1 phase or 3 phase. 1/2, 1, 2 1/2, 5, 10 and 30 rps switching speeds.

Environmental: -55°C. to 85°C. ambient temperature range, +125° C. for 1/2 hour. 0-2000 cycles at 20 G's vibration, 1/2 hour sweep in each plane. 150 G's shock bi-directional in each of three planes (non-operative.) 100 G's continuous acceleration. 0-100,000 feet altitude for 1/2 hour.

Life: 300 to 2,000 hours life, depending on speed, severity of environmental conditions, driving source and quality of switching required.

For Further Information, Write:



Electro-Mechanical Division
Applied Science Corporation of Princeton
P.O. Box 44, Princeton, N. J.

CIRCLE 190 READERS SERVICE CARD

Electronics	63
Engelhard Industries, Inc.	73
Esterline-Angus Company, Inc., The....	140
Eraser Company, Inc., The.....	166

Freed Transformer Co., Inc.....	212
Frenchtown Porcelain Company	166

G-I Electronics	132
Garrett Corporation	78
General Electric Co. Apparatus Dept. 23, 60, 61	41
Tube Department	3
General Radio Co.	27
Genisco, Inc.	38
Giannini & Co., Inc., G. M.	153
Grant Pulley & Hardware Corp.....	36
Graybill Inc.	176
Gries Reproducer Corp.	181
Gudebrod Bros. Silk Co., Inc.....	189

Halbamore Electronics Co.	19
Hart Manufacturing Company, The....	155
Haydon Company, A. W.	188
Haydon Mfg. Company, Inc.	159
Heiland, A Div. of Minneapolis- Honeywell	42
Hewlett-Packard Company.... 37, 2nd Cover	201
Horman Associates, Inc.	201
Hughes Products a Div. of Hughes Aircraft Co.	15
Humphrey Inc.	32

Indiana Steel Products Co.	48
Industrial Retabing Ring Company....	195
Industrial Test Equipment Co.	169
Industrial Timer Corp.	4
International Rectifier Corp.	91
International Resistance Co.	133

J.F.D. Electronics Corp.	20
Jennings Radio Mfg. Corp.	152
Jerrold Electronics Corp.	182
Jones Div., Howard B. Clinch Mfg. Co....	187
Jones Electronics Co., Inc., M. C.	192

Kepec Laboratories, Inc.	127
Kintel (Kay Lab)	131, 135
Kleinschmidt Laboratories, Inc.	74
Kurman Electric Co.	193

Lambda Electronics Corp.	9
Lampkin Laboratories, Inc.	200
Lantex Industries, Inc.	161
Lapp Insulator Co., Inc.	171
Librascope	196
Linde Company, Div. of Union Carbide Corp.	40
Link Aviation, Inc.	198

Magnecraft Electric Company	172
Magnetics, Inc.	123
Magnetic Amplifiers, Inc.	165
Malco Tool and Mfg. Co.	183
Mullory and Co., Inc., P. R.	92
Mansol Ceramics Co.	169
Manson Laboratories, Inc.	167
Marconi Instruments Ltd.	160
McCoy Electronics Co.	211
Measurements Corp.	197
Metals and Controls Corp.	56
Microwave Associates Inc.	154
Millivac Instruments	138

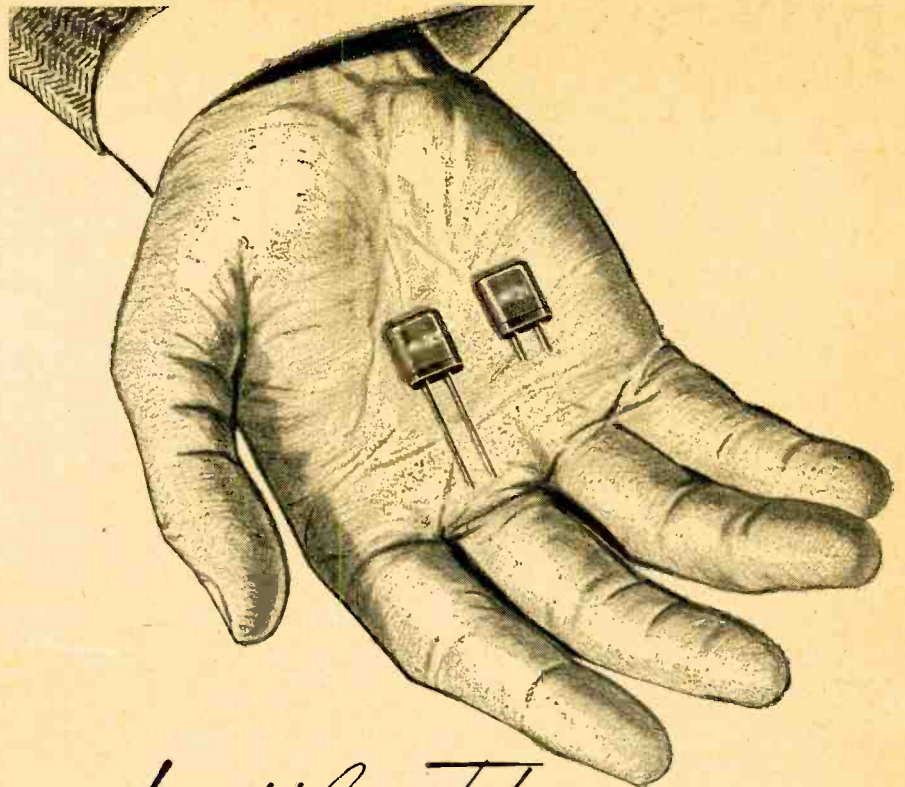

Little Things...

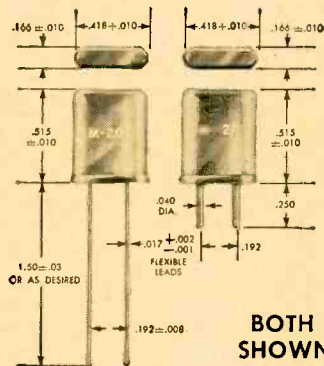

**BOTH
SHOWN
ACTUAL
SIZE**

"Little" things . . . play such a "big" role in the ultimate success or failure of your equipment. Doesn't it, therefore, make sense to insist that the crystals you use are

made by McCoy

— a name synonymous for stability and dependability in crystals—crystals which must operate perfectly even under highly unfavorable conditions yet fulfill exacting requirements for size and weight.

Send for Free Illustrated Catalog describing the McCoy line—produced in frequencies from 2.5 m.c. to 200 m.c. to meet government specifications or made to meet your own particular requirements.



McCoy ELECTRONICS CO.
DEPT. E-2, MT. HOLLY SPRINGS, PENNA.
PHONE 376 - 377

**FOR PRECISION LABORATORY
OR PRODUCTION TESTING**

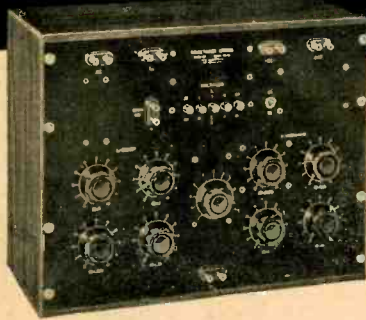

**F R E E D
1110-AB INCREMENTAL
INDUCTANCE BRIDGE**

AND ACCESSORIES

Accurate inductance measurement with or without superimposed D.C., for all types of iron core components.

- INDUCTANCE — 1 Millihenry to 1000 Henry
- FREQUENCY — 20 to 10,000 Cycles
- ACCURACY — 1% to 1000 Cycle, 2% to 10KC
- CONDUCTANCE — 1 Micromho to 1 MHO
- "Q" — 0.5 to 100
- SUPERIMPOSED D.C. — Up to 1 Ampere
- DIRECT READING — For use by unskilled operators.

ACCESSORIES AVAILABLE:

- 1140-A Null Detector
- 1210-A Null Detector - V.T.V.M.
- 1170 D.C. Supply and 1180 A.C. Supply.

**F R E E D
VARIABLE TEST VOLTAGE
MEGOHMMETER NO. 1620**

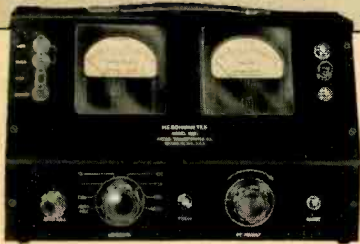

The Freed Type 1620 Megohmmeter is a versatile insulation resistance measurement instrument with a continuously variable DC test potential from 50 to 1000 volts.

Components such as transformers, motors, printed circuits, cables and insulation material can be tested at their rated voltage and above, for safety factor.

- Resistance — 0.1 megohms to 4,000,000 megohms.
- Voltage — variable, 50 - 1000 volts.
- Accurate — plus or minus 5% on all ranges.
- Simple — for use by unskilled operators.
- Safe — high voltage relay controlled.
- Self contained — AC operated.

OTHER MEGOHMMETERS AVAILABLE

Type 1620C MEGOHMMETER — a type 1620 with additional circuitry for testing capacitors.
Type 1020B MEGOHMMETER — a 500 volt fixed test potential. Range 1 megohm to 2 million megohms.
Type 2030 PORTABLE MEGOHMMETER — battery operated 500 volt test potential. Range 1 megohm to 10 million megohms.

Send for NEW 48 page transformer catalog. Also ask for complete laboratory test instrument catalog.

FREED TRANSFORMER CO., INC.
 1722 WEIRFIELD ST., BROOKLYN (RIDGEWOOD) 27, N.Y.
 CIRCLE 192 READERS SERVICE CARD

Minneapolis-Honeywell Regulator Co.	
Davies Laboratories Division	62
Missile-Air	177
Moloney Electric Company	13
Mullard Overseas Ltd.	82

Narda Microwave Corporation	77
New Hermes Engraving Machine Corp.	199
Ney Company, J. M.	190
Nutron Mfg. Co., Inc.	197

Oak Mfg. Co.	139
Ohmite Mfg. Co.	80, 81
Operations Research Office	196

Pace Electrical Instruments Co., Inc.	193
Panoramic Radio Products, Inc.	170
Phelps Dodge Copper Products Corp.	24, 25
Plastoid Corporation	174
Polarad Electronics Corporation	75
Polytechnic Research & Development Co., Inc.	88
Potter & Brumfield, Inc.	130, 131
Potter Instrument Co.	141
Power Sources, Inc.	180
Pulse Engineering Inc.	200

Quality Electric Co.	201
----------------------	-----

Radio Engineering Products	185
Radio Frequency Laboratories, Inc.	156
Radio Corporation of America	4th Cover
Radio Materials Company	46
Radiometer	176
Radio Receptor Co., Inc.	39
Ramo-Wouldridge Corp.	58
Raytheon Mfg. Company	6
Relay Sales, Inc.	47
Rex Rheostat Co.	201
Ribet Desjardins	64
Robinson Aviation, Inc.	11
Rohn Manufacturing Co.	194

Sanborn Company	143
Simpson Electric Company	68, 69
Sola Electric Co.	28
Sorensen & Co., Inc.	5
Sperry Gyroscope Co.	55
Sprague Electric Co.	17
Stackpole Carbon Company	79
Standard Electric Time Co., The	177
Stromberg-Carlson	84
Superior Tube Co.	87
Switchcraft Inc.	182
Sylvania Electric Products Inc.	32A, 32B, 32C, 32D
Sytronic Instruments, Inc.	181

Technitrol Engineering Company	186
Teiner & Co., Inc., Roland	134
Telechrome Inc.	22
Thermal American Fused Quartz Co., Inc.	180
Texas Instruments Incorporated	3rd Cover
Transformers, Incorporated	65
Transradio Ltd.	169
Triplet Electrical Instrument Company	66
Tung-Sol Electric, Inc.	21

Union Switch & Signal Div. of Westinghouse Air Brake Company	26
--	----

Van Norman Industries, Inc.	175
Vector Electronic Co.	197

Valdes Kohinoor, Inc.	59
Wickesser Company	169
Wenco Manufacturing Co.	200

Weston Electrical Instrument Corp.	57
Williams & Co., C. K.	184

Professional Services	201
-----------------------	-----

CLASSIFIED ADVERTISING
 F. J. Eberle, Business Mgr.

EMPLOYMENT OPPORTUNITIES	202-205
--------------------------	---------

BUSINESS OPPORTUNITIES	205
------------------------	-----

EQUIPMENT	
(Used or Surplus New)	
For Sale	205-209

WANTED	
Equipment	205

ADVERTISERS INDEX

Alltronics-Howard Co.	209
Alvaradio Industries	208
American Society for Technion	205
Arrow Sales Inc.	205
Associated Industries	205

Barry Electronics	209
Bausch & Lomb Optical Co.	205

C & H Sales Co.	207
Cooper Electric Co.	205

Epsco Inc.	204
------------	-----

Fidelity Personnel Service	205
----------------------------	-----

Goodyear Aircraft Corp.	204
-------------------------	-----

Instruments & Accessories Co.	209
Instrument Service Inc., A & M.	205
International Business Machines Corp.	203

Johns Hopkins University Applied Physics Lab	202
--	-----

Lion Electronic Development Ltd.	205
----------------------------------	-----

M. R. Co.	205
McNeal Electric & Eqpt. Co.	209
Microwave Associates Inc.	204
Monarch Personnel	205
Monmouth Radio Labs	206
Montgomery Equipment Co.	209
Motorola Inc.	202

Pacific International University	205
----------------------------------	-----

Radalab Inc.	208
Raway Bearing Co.	208

Super Electronics Corp.	208
-------------------------	-----

Universal Relay Corp. (Formerly Universal General Corp.)	208
--	-----

V & H Radio & Electronics	206
---------------------------	-----

This index is published as a service. Every care is taken to make it accurate, but ELECTRONICS assumes no responsibilities for errors or omissions.

NEW TI DIFFUSION TRANSISTORS POWER TO 200°C!

in a small package

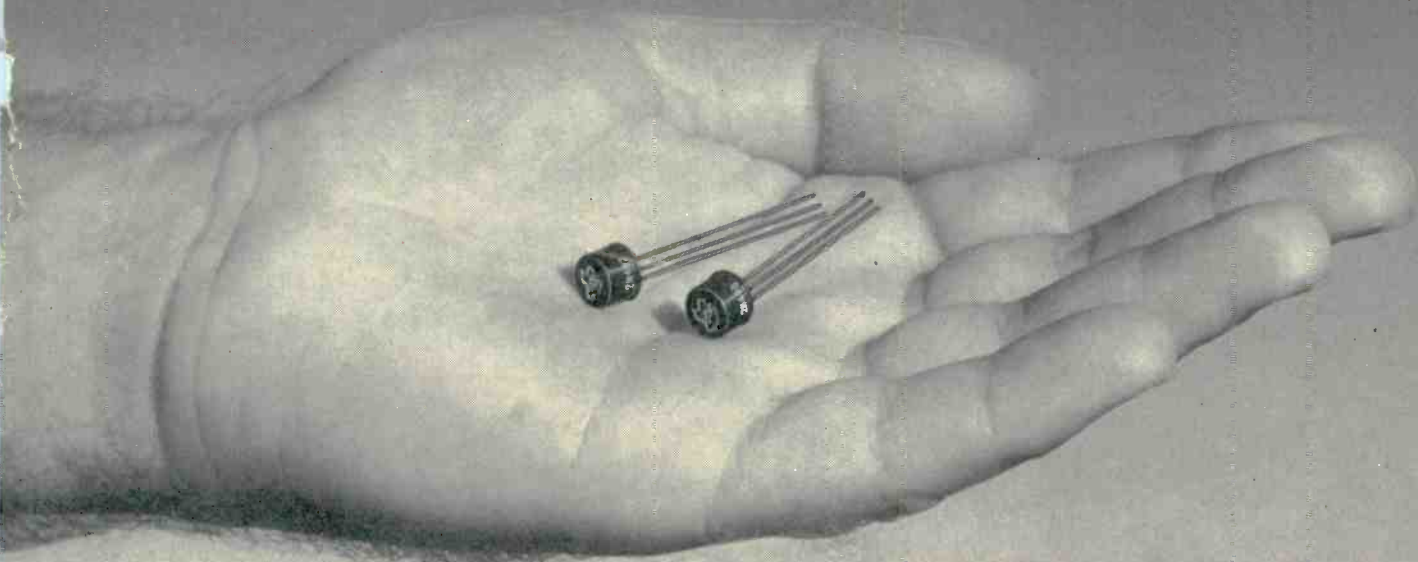

4 W @ 25°C • 1 W @ 150°C
20 OHMS SATURATION (TYP.)
-65 to 200°C OPERATION

YOU get low, low saturation resistance . . . highest dissipation factor yet, at even higher temperatures from these newest TI gaseous diffused silicon units — all stabilized at 215°C! You can control your circuits closely with the 3 to 1 beta spread and exploit the 8 V BV_{EBO} for harder driving switchers in your heavy duty applications.

absolute maximum ratings @ 25°C (case temperature)

	type 2N497	type 2N498	unit
BV_{EBO} ($I_E = 250 \mu A$)	8	8	V
BV_{CEO} ($I_C = 250 \mu A$)	60	100	V
BV_{CBO} ($I_C = 100 \mu A$)	60	100	V

design characteristics @ 25°C (case temperature)

	min.	des. cen.	max.	unit
R_{CS} ($I_B = 40 \text{ mA}$; $I_C = 200 \text{ mA}$)	—	20	40	Ohm
h_{FE} ($V_C = 10 \text{ V}$; $I_C = 200 \text{ mA}$)	12	20	36	—

Just as all TI semiconductors . . . your new 2N497's and 2N498's are fully guaranteed for one year from the date of delivery.

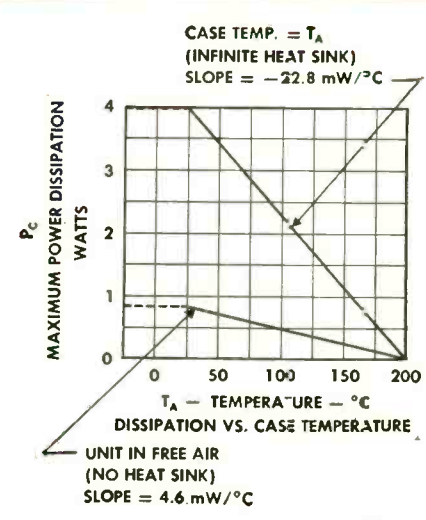
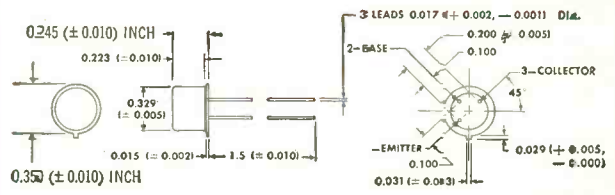

**IMMEDIATELY AVAILABLE IN
PRODUCTION QUANTITIES!**



SEMICONDUCTOR-COMPONENTS DIVISION
TEXAS INSTRUMENTS
 INCORPORATED
 POST OFFICE BOX 312 • DALLAS, TEXAS

Another RCA First...



A 40-Ampere* Thyratron

RCA-7086. Xenon
Thyratron Forced-Air-
Cooled, Negative-
Control Triode Type
(shows 1/2 actual size)

*Anode current averaged over any period of 15 seconds maximum

Again, RCA leads the way in industrial tube development—with a husky thyatron designed for applications in which high peak currents are required or in which high average or rms currents are demanded. Here are just a few of the big jobs the RCA-7086 can do:

- It can deliver a maximum peak anode current of 400 amperes in intermittent service or 160 amperes in continuous service.
- In a typical X-ray tube control circuit, two tubes can control a current of 280 amperes rms through the primary of the power transformer (supplying high voltage to the X-ray tube).
- In welding service utilizing a single-phase inverse-parallel circuit, two tubes can provide a maximum average ac output of 130 kva.
- In inverter equipment, two tubes can deliver up to 15 kva average power.
- In speed control of dc motors, two tubes will control 220-volt dc motors rated up to 20 horsepower.

The 7086 has a high commutation factor, a relatively short dionization time, and a negative-control characteristic that is essentially independent of ambient temperature over the wide range -55° to $+75^{\circ}\text{C}$ because of its xenon gas content.

RCA-7086 DATA

Filament volts 2.5	
Filament Amperes 92	
Air Flow (cfm) 60	
Supply Frequency (cps) 25 to 60	
Peak Anode Volts:	Continuous Service	Intermittent Service
Forward	650 max.	650 max.
Inverse	650 max.	650 max.
Anode Amperes:		
Peak	160 max.	400 max.
Average	40 max.*	7 max.**
*Averaged over any period of 15 sec. max.		
**Averaged over any period of 36 sec. max.		

Your RCA Field Representative will be glad to discuss application of this new thyatron with designers of power-control equipment. For a technical bulletin on the RCA-7086 write RCA Commercial Engineering, Section 819-Q-2, Harrison, New Jersey.



RADIO CORPORATION OF AMERICA
Electron Tube Division
Harrison, N. J.