

# electronics

JUNE • 1951

PRICE 75 CENTS

M c G R A W - H I L L P U B L I C A T I O N



DEEP-FREEZE TEST  
OF NAVY RADAR



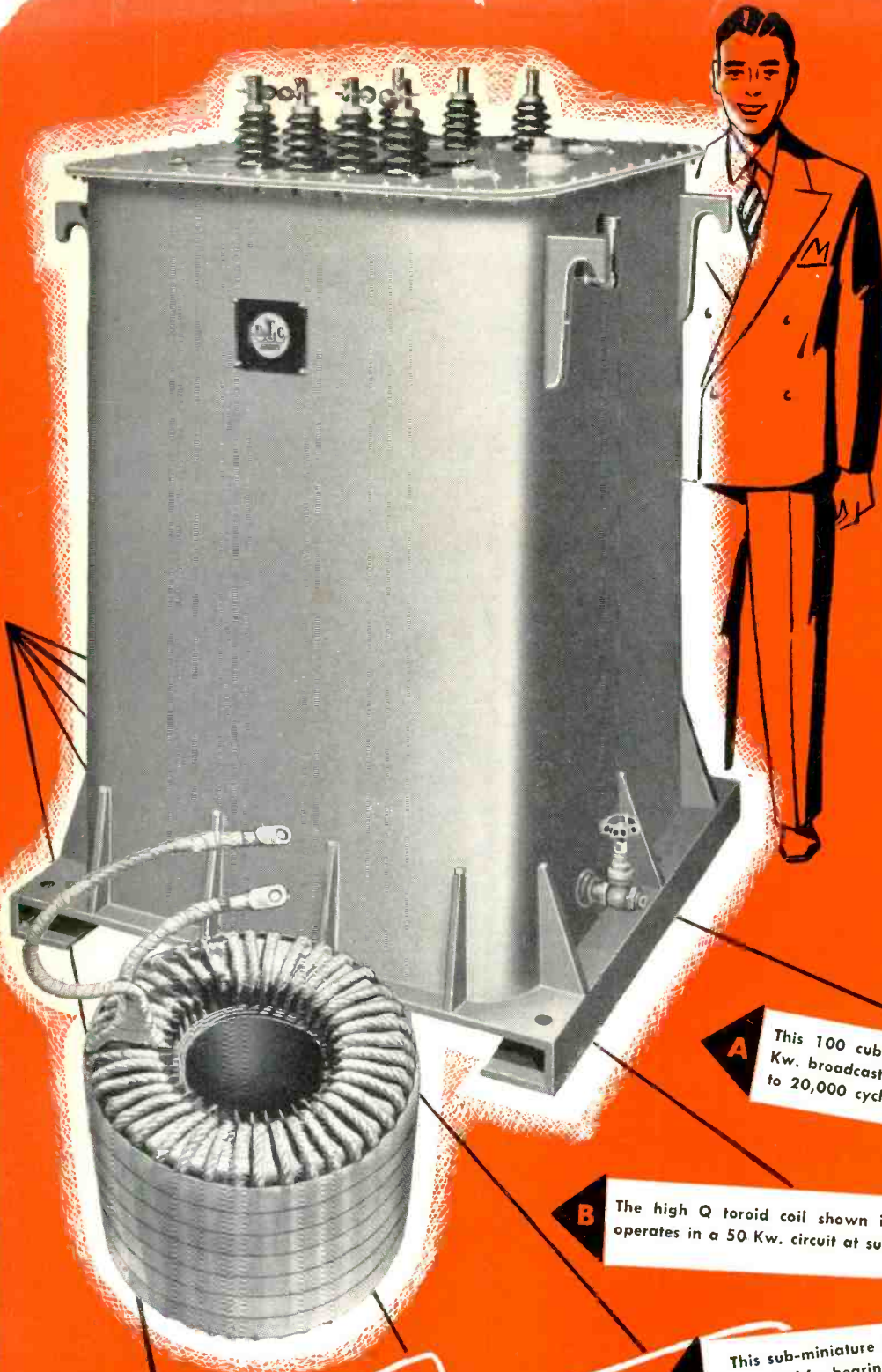

## for every application

While the catalogue line of UTC components covers a wide variety of applications, many people are not familiar with the full range of products produced by UTC. It is impossible to describe the thousands of special UTC designs as they become available. The illustrations below are intended to indicate some of the range in size of these special products.

**A** This 100 cubic foot modulation transformer is for 50 Kw. broadcast service. Frequency response flat from 30 to 20,000 cycles.

**B** The high Q toroid coil shown is 12" in diameter. It operates in a 50 Kw. circuit at supersonic frequency.

**C** This sub-miniature (.18 cubic inch) output transformer is intended for hearing aid and other extreme compact service. While the dimensions are only 7/16" x 9/16" x 3/4", the fidelity is ample for voice frequency requirements.

**D** This sub-miniature (.18 cubic inch) permalloy dust core toroid is available in a wide range of inductances, and for frequencies from 1,000 cycles to 50 Kc.

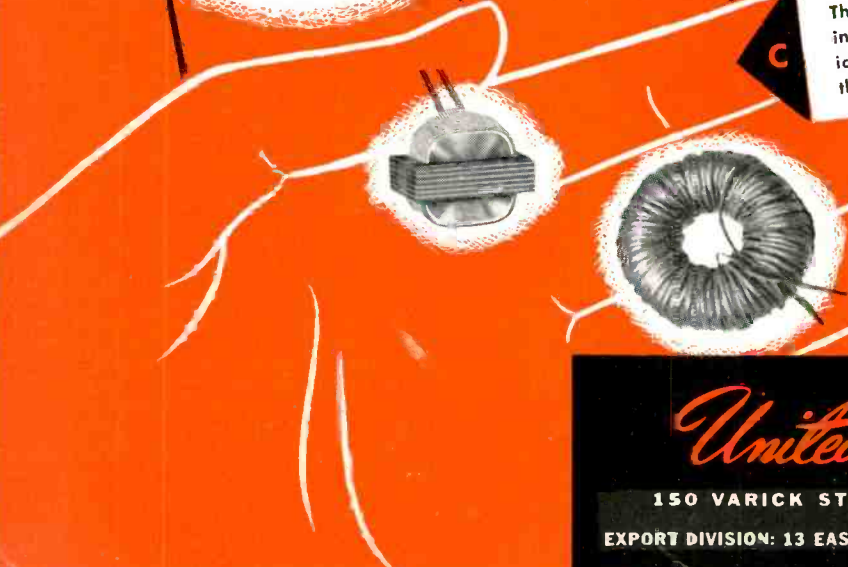

*United Transformer Co.*  
150 VARICK STREET • NEW YORK 13, N. Y.  
EXPORT DIVISION: 13 EAST 40th STREET, NEW YORK 16, N. Y. CABLES: "ARLAB"



# electronics



A MCGRAW-HILL  
PUBLICATION

June • 1951

<b>DEEP-FREEZE TEST OF NAVY RADAR</b> .....	<b>COVER</b>
Ability of remotely-controlled 4-foot parabolic reflector to withstand severe icing is checked in versatile controlled-climate chamber at DuMont's East Paterson, N. J. plant. Unit was rebuilt from Navy SO-1 PT-boat radar (see p 138)	
<b>GOVERNMENT PLANS INDUSTRY SUPPORT</b> , by <b>W. B. Whichard, Jr.</b> .....	<b>82</b>
Assistance will help manufacturers stay in business until military orders are booked	
<b>CHOOSING INDUSTRIAL METAL DETECTORS</b> , by <b>Curtiss R. Schafer</b> .....	<b>84</b>
Factors affecting decision to buy commercial metal detector for a specific industrial inspection application	
<b>SAFEGUARDING PRODUCTION OF MILITARY EQUIPMENT</b> .....	<b>88</b>
Discusses basic elements of plant protection and safeguarding classified information	
<b>ELECTRONIC TORCH</b> , by <b>J. D. Cobine and D. A. Wilbur</b> .....	<b>92</b>
High-power 915-mc discharge at nozzle end of gas-carrying coaxial line provides 3,000 C heat for melting tungsten	
<b>CIVIL DEFENSE COMMUNICATIONS</b> .....	<b>94</b>
Some tangible steps have already been taken at the federal, state and local levels	
<b>ACCURATE TIME FOR BROADCAST STUDIOS</b> , by <b>J. H. Greenwood</b> .....	<b>97</b>
Inexpensive synchronous clocks driven from tuning-fork standard keep correct time within 0.1 second	
<b>HOW TO SET UP AN INSTRUCTION MANUAL DEPARTMENT</b> , by <b>Eugene Anthony</b> .....	<b>100</b>
Optimum organization of staff, personnel qualifications, staff duties, and procedure for meeting contract deadlines	
<b>PULSE-WIDTH DISCRIMINATOR</b> , by <b>A. A. Gerlach and D. S. Schover</b> .....	<b>105</b>
Multiplex telemetering system discriminator operates as channel decoder	
<b>FIVE-KW KLYSTRON UHF TELEVISION TRANSMITTER</b> , by <b>H. M. Crosby</b> .....	<b>108</b>
Output of five kilowatts is obtained from linear klystron amplifier	
<b>LINEAR DISCRIMINATOR FOR F-M TELEMETERING</b> , by <b>G. Slaughter and R. Ellis</b> .....	<b>113</b>
Unbalanced trigger-circuit system provides exceptional stability and linearity	
<b>PREDICTING PERFORMANCE OF UHF AND SHF SYSTEMS</b> , by <b>E. A. Slusser</b> .....	<b>116</b>
Curves and nomograms for evaluating proposed transmitter and receiver sites	
<b>STORING VIDEO INFORMATION</b> , by <b>A. L. Hopper</b> .....	<b>122</b>
Signal amplitude along adjacent picture scanning lines can be compared	
<b>DIELECTRICS MADE TO ORDER</b> , by <b>Arthur von Hippel</b> .....	<b>126</b>
Research into nature of dielectric breakdown provides clues to desirable new materials	
<b>IMPROVED PULSE STRETCHER</b> , by <b>James F. Craib</b> .....	<b>129</b>
Stretcher circuit employs a delay line charged by crystal rectifier	
<b>COAXIAL-STUB FILTER DESIGN (Reference Sheet)</b> , by <b>James A. Craig</b> .....	<b>132</b>
Graphs give rejection and correction stub lengths to attenuate interfering frequency in receiver or transmitter coax	
<b>BUSINESS BRIEFS</b> .....	<b>76</b>
<b>CROSSTALK</b> .....	<b>81</b>
<b>TUBES AT WORK</b> .....	<b>136</b>
<b>ELECTRON ART</b> .....	<b>140</b>
<b>NEW PRODUCTS</b> .....	<b>142</b>
<b>NEWS OF THE INDUSTRY</b> .....	<b>146</b>
<b>NEW BOOKS</b> .....	<b>150</b>
<b>BACKTALK</b> .....	<b>152</b>
<b>INDEX TO ADVERTISERS</b> .....	<b>(Last Page)</b>

**DONALD G. FINK**, Editor; **W. W. MacDONALD**, Managing Editor; John Markus, Vin Zeluff, A. A. McKenzie, Associate Editors; William P. O'Brien, James D. Fahnestock, Ronald K. Jurgen, Assistant Editors; John M. Carroll (on Military Leave), Ann Mastropolo, Marilyn Wood, Editorial Assistants; Gladys T. Montgomery, Washington Editor; Harry Phillips, Art Director; Eleanor Luke, Art Assistant

**KEITH HENNEY**, Consulting Editor

**H. W. MATEER**, Publisher; **WALLACE B. BLOOD**, Manager; **R. S. Quint**, Buyers' Guide Manager; **D. H. Miller**, James Girdwood, New York; **Wm. S. Hodgkinson**, New England; **Warren W. Shew**, Philadelphia; **C. D. Wardner**, Chicago; **J. L. Phillips**, Cleveland; **J. W. Otterson**, San Francisco; **Carl W. Dysinger**, Los Angeles; **Ralph C. Maultsby**, Atlanta; **Bernard H. Butler**, London, England.



June, 1951

ELECTRONICS

Member ABC and ABP

Vol. 24, No. 6



Published monthly with an additional issue in June by McGraw-Hill Publishing Company, Inc., James H. McGraw (1860-1948), Founder. Publication Office, 99-129 North Broadway, Albany 1, N. Y.

Executive, Editorial and Advertising Offices: McGraw-Hill Building, 330 W. 42nd St., New York 18, N. Y. Curtis W. McGraw, President; Willard Chevalier, Executive Vice-President; Joseph A. Gerardi, Vice-President and Treasurer; John J. Cooke, Secretary; Paul Montgomery, Senior Vice-President, Publications Division; Ralph B. Smith, Editorial Director; Nelson Bond, Vice-President and Director of Advertising; J. E. Blackburn, Jr., Vice-President and Director of Circulation.

Subscriptions: Address correspondence to Electronics—Subscription service, 99-129 N. Broadway, Albany 1, N. Y., or 330 W. 42nd St., New York 18, N. Y. Allow ten days for change of address. Please indicate position and company connection on all subscription orders.

Single copies 75¢ for United States and possessions, and Canada; \$1.50 for Latin America; \$2.00 for all other foreign countries. Buyer's Guide \$2.00. Subscription rates—United States and possessions, \$6.00 a year; \$9.00 for two years; \$12.00 for three years. Canada, \$10.00 a year; \$16.00 for two years; \$20.00 for three years. Pan American countries, \$15.00 a year; \$25.00 for two years; \$30.00 for three years. All other countries \$20.00 a year; \$30.00 for two years; \$40.00 for three years. Entered as second class matter August 29, 1936, at the Post Office at Albany, N. Y., under act of Mar. 3, 1879. Printed in U. S. A. Copyright 1951 by McGraw-Hill Publishing Co., Inc.—All Rights Reserved. BRANCH OFFICES: 520 North Michigan Avenue, Chicago 11, Ill.; 68 Post Street, San Francisco 4; Aldwych House, Aldwych, London, W.C. 2; Washington, D. C. 4; Philadelphia 3; Cleveland 15; Detroit 26; St. Louis 8; Boston 16; Atlanta 3, Ga.; 1111 Wilshire Blvd., Los Angeles 17; 738-9 Oliver Building, Pittsburgh 22. ELECTRONICS is indexed regularly in The Engineering Index.



# marion methods

*electrify*

## TWEezer SOLDERING

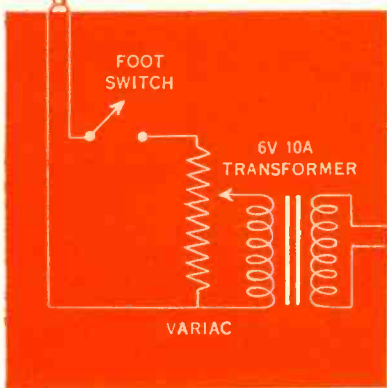

Electrified by Marion, these tweezers now do double duty. They position the work and solder it at the same time. Tripled production and finer fluxless joints result.

FLEXIBLE BRAIDED CONDUCTORS.  
APPROX. EQUIV. #10 B. & S.

SILVER SOLDERED  
TANTALUM-TUNGSTEN TIPS  
SHAPED FOR OPERATION REQUIREMENTS

STANDARD "MM" TWEezer BLADES

INSULATOR

### Help yourself to marion methods

**MARION USES THIS METHOD** of Tweezer Soldering for precise hairspring soldering, positioning small metal parts in thermoplastic cements, and in other fine soldering operations. Resistance heating in the work itself and conducted heat from the tips combine to give greatly increased soldering rates on pretinned components. Because the tweezers develop little heat themselves, adjacent component damage is avoided. These tweezers permit an inexperienced worker to rapidly acquire a high degree of skill. Both positioning and soldering are combined with the handling ease of a fountain pen.

**NOT FOR SALE** — You can make electric soldering tweezers of your own. Those shown here have standard "MM" blades, separated and insulated by bakelite. They are assembled and wired as illustrated. By varying the voltage, the tip cross-section, and the contact area, you can adapt this tool to your specific application.

**OTHER MARION METHODS** — Current demands on industry by the mobilization program accentuate the importance of production methods. Electric tweezer soldering is only one of a number of methods which Marion proposes to present in the hope that some of them can help you as much as they have helped us. Marion Electrical Instrument Company, 401 Canal Street, Manchester, N. H., U. S. A.



MANUFACTURERS OF MARION RUGGEDIZED PANEL INSTRUMENTS

# marion meters



**PUT YOUR NAME ON OUR MAILING LIST**

*for*

# **TECHNIQUE**

**A JOURNAL OF INSTRUMENT ENGINEERING**

**MUIRHEAD  
APPARATUS  
COVERS A WIDE  
RANGE OF REQUIRE-  
MENTS FOR ELECTRICAL  
MEASUREMENTS AND  
TESTING, SERVO AND  
REMOTE CONTROL PURPOSES,  
AND FOR PHOTOTELEGRAPHY.**

**AVAILABLE FREE OF CHARGE**

**TO RESEARCH WORKERS**

**TO TECHNICIANS**

**TO SCIENTISTS**

**TO ENGINEERS**

*and others who are interested in scientific and  
electronic instruments and their applications*

**POST  
COUPON  
TODAY**

MUIRHEAD & CO., LTD.  
BECKENHAM · KENT · ENGLAND

NAME \_\_\_\_\_  
MAILING ADDRESS \_\_\_\_\_  
COMPANY \_\_\_\_\_  
POSITION \_\_\_\_\_

**MUIRHEAD & Co LTD**

**PRECISION ELECTRICAL INSTRUMENT MAKERS**

**BECKENHAM · KENT · ENGLAND**

Telegrams & Cables MUIRHEAD ELMERS-END

PRECISION  
**MUIRHEAD**  
ELECTRICAL INSTRUMENTS



# Uniformity is

for  
resistors  
too!

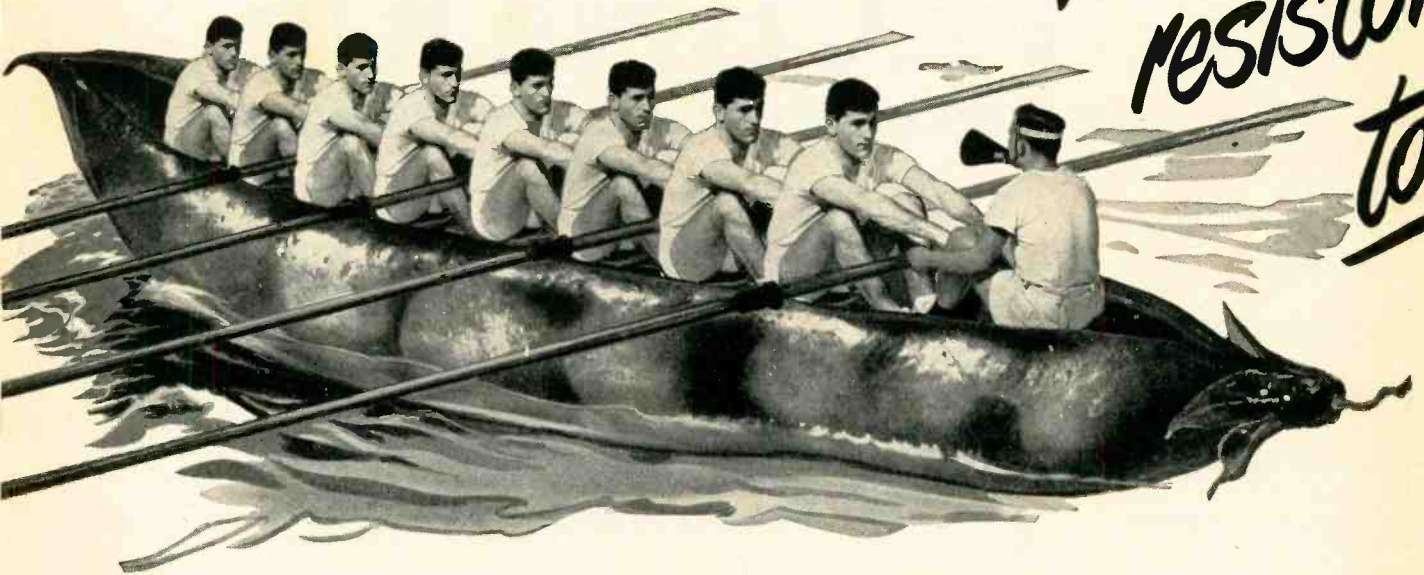

It isn't hard to make a resistor with specific characteristics.

The trick is to make resistors by the million, fast and at low cost, and *still retain uniformity* in those characteristics. Specializing in resistors, IRC achieves this uniformity through mechanization of production, plus continuous inspection and rigid quality control.

Result:—IRC customers are assured of identical resistance units—within prescribed limits—regardless of quantities or time of purchase.

Uniformity of IRC Advanced BT Resistors—which meet JAN-R-11 specifications—is the result of combining IRC's filament-type resistance elements with exclusive construction features. Resistance material is permanently cured and bonded to special glass. Leads extend into filament for rapid heat dissipation. Molded bakelite seals element against moisture and prevents grounding. In standard RMA Resistance Ranges, Advanced BT's possess extremely low operating temperature and excellent power dissipation at  $\frac{1}{8}$ ,  $\frac{1}{2}$ , 1 and 2 watts.

Full details of these compact, light-weight, fully insulated units are contained in 12-page technical data Bulletin B-1. Use coupon to send for your free copy.



Meet and beat JAN-R-11 Specifications.

Low noise level and temperature coefficient.

$\frac{1}{8}$ ,  $\frac{1}{2}$ , 1 and 2 watts—Available in  $\pm 5\%$ ,  $\pm 10\%$ , and  $\pm 20\%$  tolerance.

Easily meets rigorous TV requirements.



**INTERNATIONAL  
RESISTANCE COMPANY**

401 N. Broad Street, Philadelphia 8, Pa.



# important

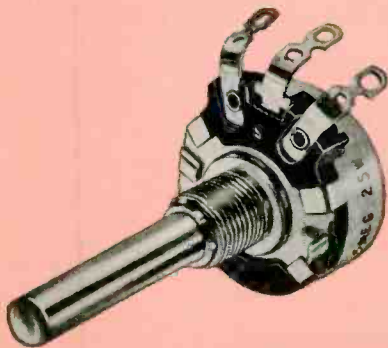

Meticulous engineering and elimination of hand manufacturing operations assures maximum uniformity in these small 1 1/4" Type Q Controls. Resistance element is the best IRC has ever manufactured. Increased arc of rotation permits same resistance ratios proved successful in previous larger IRC controls. Electrical rotation is the same with or without new IRC Type "76" switch. Catalog data Bulletin A-4 gives complete information.

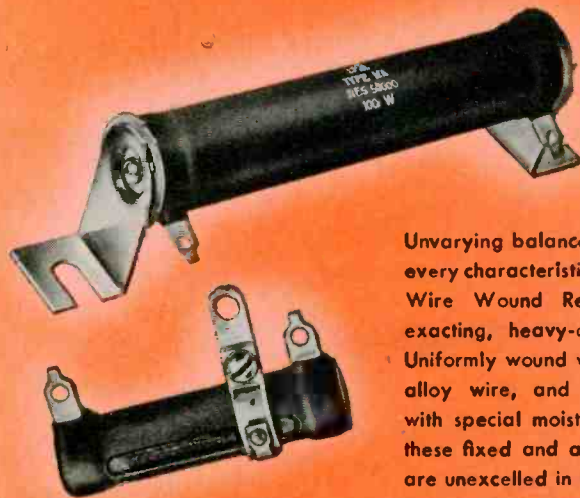

Unvarying balanced performance in every characteristic makes IRC Power Wire Wound Resistors ideal for exacting, heavy-duty applications. Uniformly wound with highest-grade alloy wire, and precisely coated with special moisture-proof cement, these fixed and adjustable resistors are unexcelled in essential electrical and mechanical characteristics. Leading industrial, aircraft, broadcast, maritime and commercial users have specified them for over 14 years. Catalog data Bulletin C-2 contains full details.

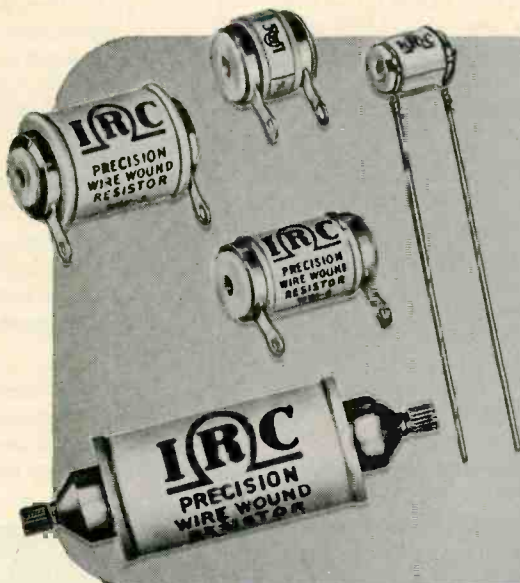
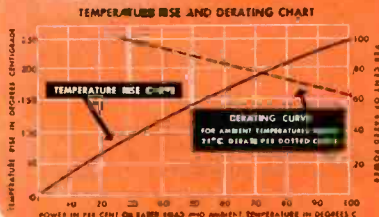

Uniformly accurate and dependable, IRC Precision Wire Wounds excel in every significant characteristic. Leading instrument makers use them extensively for close tolerance applications. Winding forms are non-hygroscopic ceramic with high insulation qualities, high mechanical strength, low coefficient of expansion. Special humidity-proof enamelled-wire windings receive particular attention to avoid strain or breakdown in insulation. Standard 1.0% tolerance. 1/2, 1/4 and 1/10% are available. Full details in catalog data Bulletin D-1.

Power Resistors • Voltmeter Multipliers • Insulated Composition Resistors • Low Wattage Wire Wounds • Volume Controls • Voltage Dividers • Precision Wire Wounds • Deposited Carbon Precistors • Ultra-HF and High Voltage Resistors • Insulated Chokes

*Wherever the Circuit Says*

For prompt delivery of uniformly dependable standard resistors, in experimental or maintenance quantities, simply phone your local IRC Distributor. IRC's Industrial Service Plan keeps him fully stocked with the most wanted types and ranges—permits him to give you fast, round-the-corner delivery of small order requirements. We'll be glad to send you his name and address.



## INTERNATIONAL RESISTANCE COMPANY

403 N. BROAD ST., PHILADELPHIA 8, PA.

Please send me complete information on the items checked below:—

- Advanced BT Resistors (B-1)
- Type Q Control (A-4)
- Precision Wire Wounds (D-1)
- Power Wire Wounds (C-2)
- Name and Address of Nearest IRC Distributor

NAME \_\_\_\_\_

TITLE \_\_\_\_\_

COMPANY \_\_\_\_\_

ADDRESS \_\_\_\_\_

CITY \_\_\_\_\_ ZONE \_\_\_\_\_ STATE \_\_\_\_\_



**MITCHELL-RAND** announces....

**3738**

## DIP-COATING and POTTING COMPOUND

ANOTHER SIGNIFICANT DEVELOPMENT OF  
MITCHELL-RAND LABORATORY RESEARCH

3738 is a special hot-melt, black thermoplastic moisture-proofing, insulating compound with unusual low-pouring, high cold-flow characteristics. This relatively low-cost compound also has flexible toughness at room temperature and a low rate of moisture vapor transmission.

### 3738 Applications

- FLASH DIP-COATING coils and small transformers to furnish moisture resistance and electrical insulation.
- POTTING JOBS which require its distinctive properties.
- SEALING SOCKETS AND SCREW HOLES for which a filling composition with good adhesion and high cold-flow temperature are specified.

### 3738 Features

- HIGH COLD-FLOW TEMPERATURE COUPLED WITH LOW-POURING TEMPERATURE facilitates potting high operating temperature units which contain delicate parts that would be damaged by compounds poured at high temperatures. The low pouring viscosity of 3738 recommends its application to potted units in which minimum clearances of small filling holes require a free flowing composition.  
The combination of viscosity and cold-flow, in 3738, permits rapid application of dip-coatings to resist sagging and sweating at temperatures above 105°C.
- GOOD FLEXIBILITY AND ADHESION permit good moisture seals around leads and physical shock-resistance on both dip-coated and potted units.
- RAPID RATE OF SET speeds production when used for dip-coating, potting or sealing.
- NON-TACKY SURFACE reduces the possibility of accumulating surface contamination or sticking on the production line or in storage.

### Methods of Application

- POTTING AND SEALING: The viscosities of 3738 differ appreciably between the upper and lower limits of the suggested pouring temperature range. To obtain higher or lower pouring viscosities, temperatures below or above this range can be employed.

Best adhesion, without surface priming, is obtained by pouring at temperatures in the upper portion of the suggested range or by preheating the unit.

Although 3738 has a low-pouring viscosity, preheating is recommended when filling close tolerance areas where a quick chill may be caused by cold parts. Preheating is suggested since 3738 sets at relatively high temperatures.

DIP-COATING: The thickness of 3738 on a single dip can be varied considerably. Generally higher bath temperatures and shorter periods of immersion will control thickness or thinness of coating.

### 3738 Specifications

Cold Flow (M-R).....248/253 F	Softening Point (B&R) .....254/259 F
Penetrations	Pouring Temperature....340/390 F
32/200/60 .....1-2	Specific Gravity .....1.03
77/100/5 .....7-8	Flash Point .....480 F
115/50/5 .....10-12	
Color .....Black	

Write for your laboratory test samples  
... free upon request.



## MITCHELL-RAND INSULATION CO., INC.

51 MURRAY STREET

CORLAND 7-9264

NEW YORK 7, N. Y.

A PARTIAL LIST OF M-R PRODUCTS: FIBERGLAS VARNISHED TUBING, TAPE AND CLOTH • INSULATING PAPERS AND TWINES • CABLE FILLING AND POTHEAD COMPOUNDS • FRICTION TAPE AND SPLICE • TRANSFORMER COMPOUNDS • FIBERGLAS SATURATED SLEEVING • ASBESTOS SLEEVING AND TAPE • VARNISHED CAMBRIC CLOTH AND TAPE • MICA PLATE, TAPE, PAPER, CLOTH, TUBING • FIBERGLAS BRAIDED SLEEVING • COTTON TAPES, WEBBINGS AND SLEEVINGS • IMPREGNATED VARNISH TUBING • INSULATED VARNISHES OF ALL TYPES • EXTRUDED PLASTIC TUBING



*Sh-h-h!*

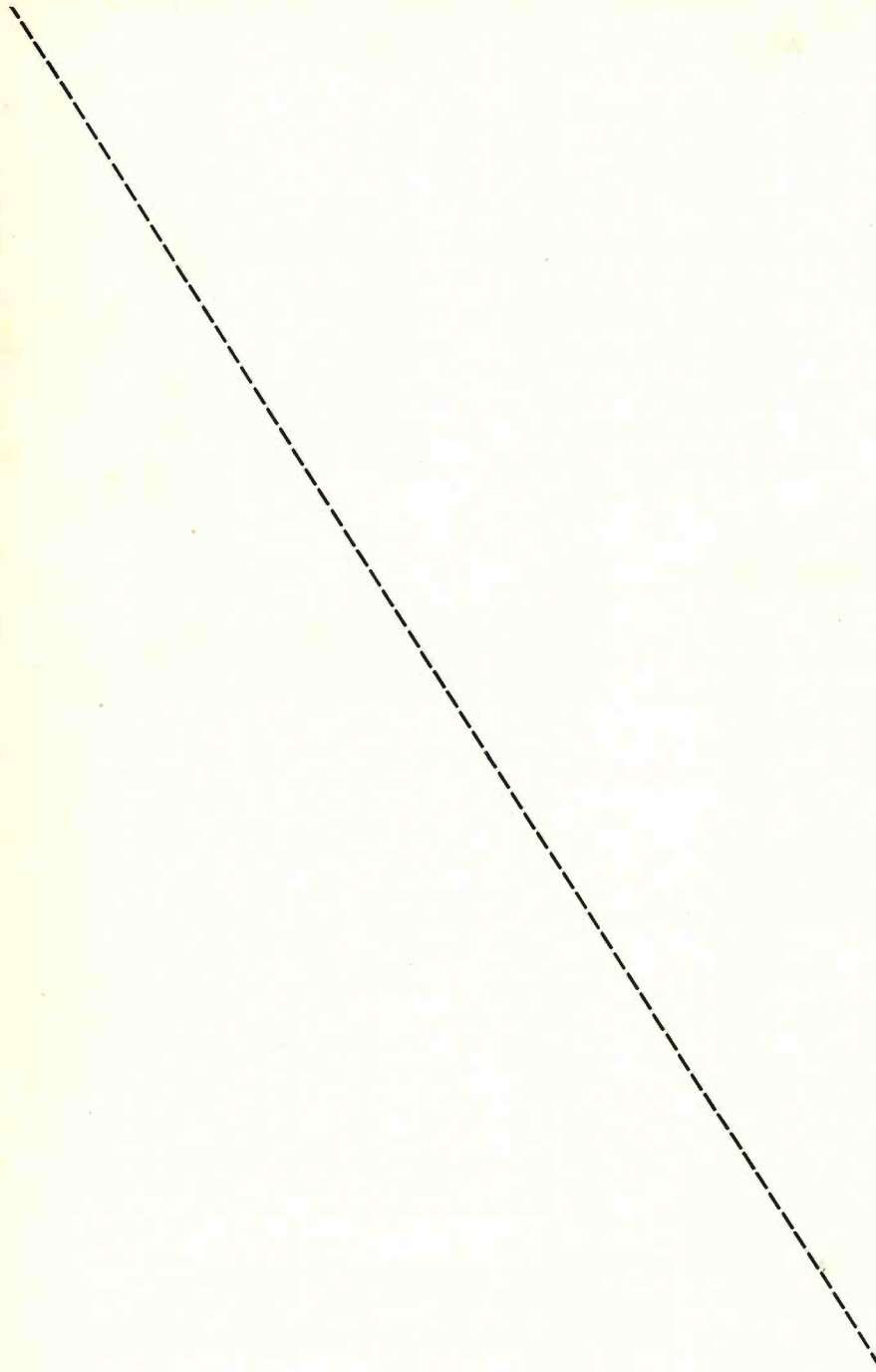

**Don't spread it around —**

We're in full-scale production in our new, larger plant.

(Our previous factory was destroyed by fire on January 10, 1951.)

With our expanded facilities, we can promise you good delivery on Glassmikes, Plasticon Capacitors, Hi-Volt Power Supplies and Pulse Forming Networks . . . if you promise to give us realistic delivery requirements.

**MANUFACTURERS**  
Glassmike Capacitors  
Plasticon Capacitors  
Hi-Volt Power Supplies  
Pulse Forming Networks

All Phones: AMBassador 2-3727

**C**ondenser **P**roducts Company



7517 North Clark Street • Chicago 26, Illinois

# A COMPLETE APPROACH TO SINGLE TRANSIENTS and PULSES of low-repetition rate

For visual observation of pulses and single transients, the Type 294-A Cathode-ray Oscillograph provides high light-output and wide-band response. For careful study and permanent reference of these signals the Type 295 Oscillograph-record Camera records writing rates as high as 35 inches per microsecond.

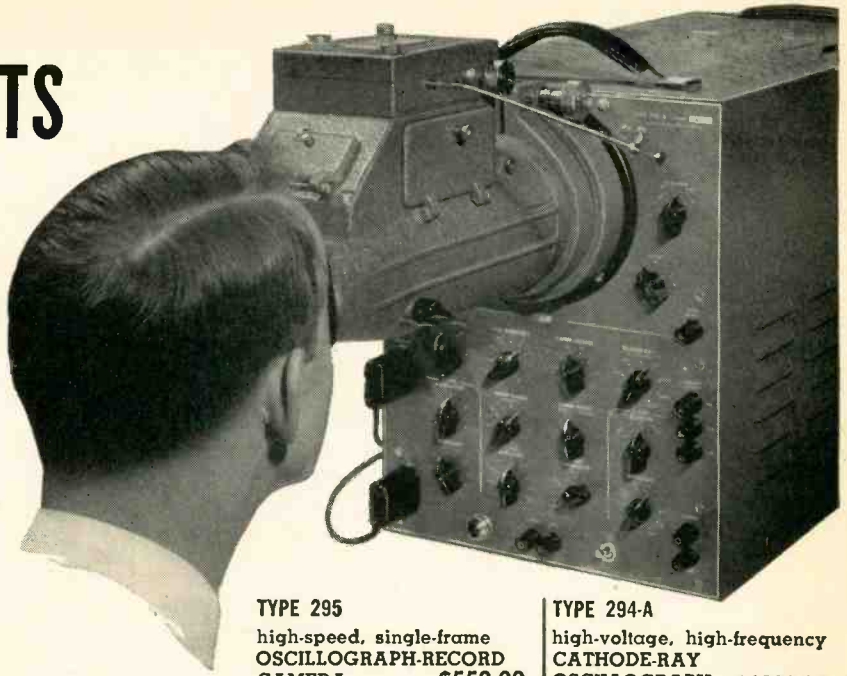

**TYPE 295**  
high-speed, single-frame  
OSCILLOGRAPH-RECORD  
CAMERA \$550.00

**TYPE 294-A**  
high-voltage, high-frequency  
CATHODE-RAY  
OSCILLOGRAPH \$1320.00

## PULSE RESPONSE FREQUENCY RESPONSE SENSITIVITY

This oscillogram illustrates the double exposure technique. Binocular viewing in the Type 295 facilitates proper positioning for close comparison.

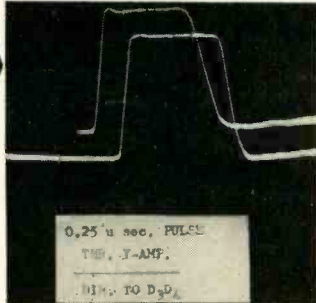

The pulses in the oscillogram at left are identical pulses of 0.25 microsecond width. The first pulse was applied through the Y-axis amplifier of the Type 294-A, and the second, directly to the vertical deflection plates. A comparison of their waveforms illustrates the excellent transient response of the Y-axis of the Type 294-A.

Response of the Y-axis amplifier to a rise time of 0.01 microsecond or less is 0.03 microsecond max. Notice that a minimum of overshoot (less than 2%) is introduced by the amplifier.

For the study of sinusoidal frequencies, the response of the Type 294-A extends from 10 cps. to 12 megacycles (down 30%). Sensitivity of the Y-axis, through the amplifier, is 0.42 peak-to-peak volts per inch.

## AVAILABLE DEFLECTION LIGHT OUTPUT SIGNAL DELAY

"Time" and "Bulb" exposures may be taken with the Type 295. And provision is made so that equipment may be triggered simultaneously with shutter opening. With appropriate accelerating potentials, the Type 295 is capable of recording single transients in excess of 280 inches per microsecond.

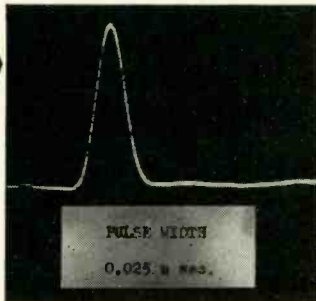

The Type 294-A provides undistorted vertical deflection of 1.3 inches or more for both positive and negative pulses; and 2.75 inches for symmetrical signals. The high light-output of the Type 294-A increases the value of the large, vertical deflection provided by the Y-axis amplifier. This is illustrated by the high visibility of the rise and decay of the pulse shown at left. Here, the Type 5XP- Cathode-ray Tube of the Type 294-A was operated at 12 kv. However, where maximum light output is not required, the accelerating potential may be lowered to 7 kv by means of a switch. At this level of operation, of course, the available undistorted deflection is increased.

To insure the complete display of fast pulses such as those at left, the Y-axis includes a 0.25 microsecond signal-delay line.

## SWEEP SPEEDS TIME CALIBRATION

The built-in illuminated data-card of the Type 295 will prove invaluable when making time measurements. A film take-up cassette is arranged so that exposed frames of film may be separated from unexposed film and taken to the darkroom for immediate developing.



Complementing the Y-axis performance of the Type 294-A, sweep durations are continuously variable from 0.1 second to 3 microseconds. By increasing the length of the sweep, speeds greater than 0.25 microsecond per inch may be obtained, thus providing more detail to facilitate the study of short-duration pulses.

Calibration of the sweeps of the Type 294-A is accomplished with vertical marks occurring at intervals of 100, 10, 1, or 0.1 microseconds. In the oscillogram at left, the 0.1 microsecond markers appear mixed with the signal on the vertical axis. Time measurements may also be made by double exposure of first, the signal, and second, the timing markers.

Send requests for information to

**ALLEN B. DUMONT LABORATORIES, INC.**

Instrument Division

1000 Main Avenue, Clifton, N. J.

# DUMONT

*for Oscillography*





# Master Pieces of Hermetic Sealing — Proven to Eliminate Rejects!

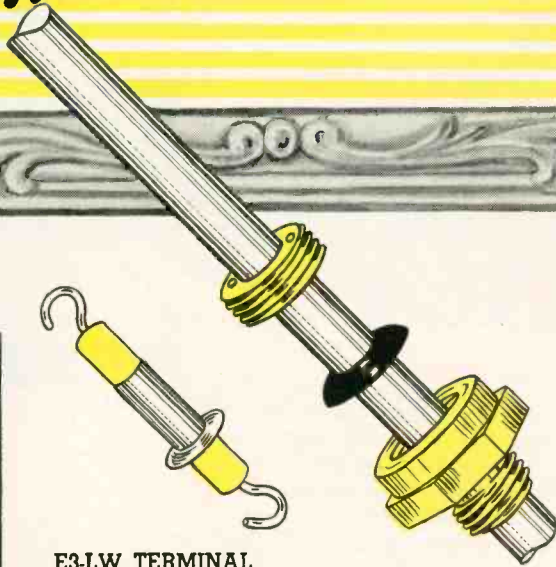

**E3-LW TERMINAL**

"E-Series terminals are applicable on MIL requirements and will withstand thermal shock, vibrations, mechanical strains, and excessive pressures with no impairment of the seal or other functional characteristics. E-3LW terminals are now being used at 1000 psi static oil pressure and undergo 5000 psi tests."

**1/4" SHAFT**

**WATERSEAL BUSHING**

"Rotary Waterseal Panel Assemblies, with GRAF-SIL Packing Glands, have an excellent five year customer history on gas filled pressurized components. They are available for 1/4" shafts and for potentiometers and switch bushings."

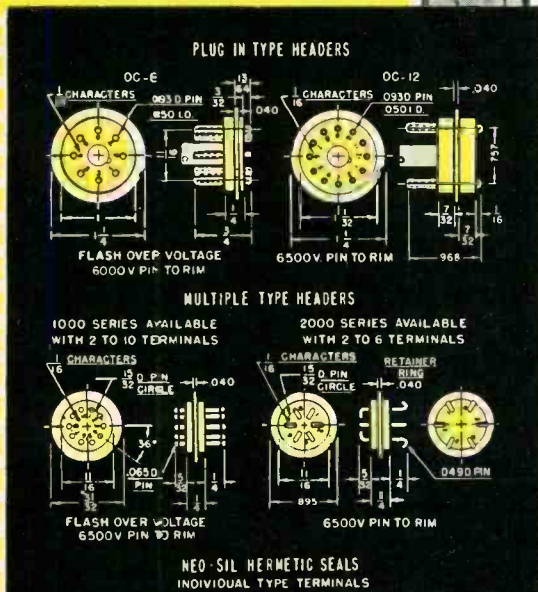

**TEST DATA**

The result of the Electrical Testing Laboratories Inc., Report #330655, dated March 18, 1949, on this material shows the following:

Volume Resistivity at 800 Volts d-c  
Room Temperature 25°C R.H. 30 percent  
Megohm-inches  $1.4 \times 10^6$  ohm-centimeters  $3.5 \times 10^5$

Dielectric Constant	Dissipation Factor	Loss Factor
9.22 @ 60 cycles per second	.058	5.32
6.17 @ 1 megacycle per second	.0455	.28
5.35 @ 50 megacycles per second	0.20	1.1

Dielectric Strength at 60 cycles  
Volts per mil — 370

Durometer — Average — 80 ± 5  
Temperature — Rated as a Class A material conservatively — 105° to —70° centigrade.

The Flashover Voltages indicated were taken at a temperature of 68° Fahrenheit, and 47% Relative Humidity.

"NEO-SIL's proven Hermetic sealing components will eliminate rejects resulting from breakage, strains, cracks, etc. Each NEO-SIL component is pressure checked at 25 psi — to meet military requirements and as applied to our units, NEO-SIL rubber will resist abusive temperature cycling, salt water, most acids and alkalis, and withstand high pressures and vacuums."

"In addition to the items illustrated above, NEO-SIL offers many other components, such as Hermetically Sealed Fuse Holders, Octal Type Plug In Headers, Multiple Pin Headers, Hermetically Sealed Cables, Hermetically Sealed Line Cords With Plugs For European use, Meter Gaskets, Panel Gaskets, Adapters (U.S. to Continental), Coil Forms, Crystal Contacts and other molded bakelite and NEO-SIL rubber units."

"Hermetically Sealed Fuse Holders are available for 3-AG and 4-AG fuses. These units are completely sealed from moisture with or without the cap or fuse inserted and are applicable for use on vacuum or gas filled units."

Your special problems are solicited.



26 CORNELISON AVE., JERSEY CITY 4, N. J.



# For low-level d-c measurements use these new, L&N triple-purpose Amplifiers

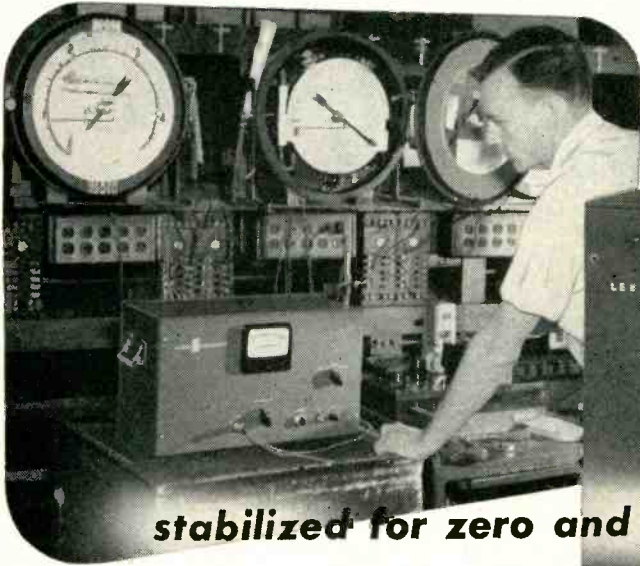

High precision checking and calibrating under factory conditions using D-C Indicating Amplifier as null detector for accurate bridge and potentiometer circuits. Through combination of a-c amplification and balanced feedback network, zero and gain stability are designed right into instrument. Trimmer controls are eliminated.

*can be used as . . .*

- ✓ **DIRECT-READING MICROVOLT METER OR MICRO-MICROAMMETER**
- ✓ **RECORDER PREAMPLIFIER**
- ✓ **NULL DETECTOR**

## SPECIFICATIONS

**MICROVOLT UNIT**  
No. 9835

**MICRO-MICRO-AMPERE UNIT**  
No. 9836

**FULL SCALE RANGES WITH BUILT-IN 4" METERS**  
0 to 50 or -25 to +25 Microvolts; scale multipliers: 1, 2, 4, 10, 20, 40

0 to 1000 or -500 to +500 Micro - Microamps; scale multipliers: 1, 2, 5, 10, 20, 50, 100, 200, 500, 1000, 2000

### ACCURACY

Of amplifier:  $\pm 0.4\%$   
Of reading; Of meter:  $\pm 1\%$

Of amplifier:  $\pm 0.5$   
0.8%\* of reading;  
Of meter:  $\pm 1\%$

### ZERO OFFSET

Max. offset:  $\pm 0.5$   
Microvolt

Max. offset:  $\pm 2\%$  of  
scale

### \*SOURCE RESISTANCE

Up to 10,000 ohms.

0.1 megohm or more.

### RESPONSE TIME

2 to 3\* sec.

2 to 3\* sec.

### OUTPUT

For full scale input on any range: 10 millivolts at output impedance of 500 ohms for null recorder; 1 volt for 20,000-ohm external meter.

**Front panel fits standard 19" relay rack.**

\*Accuracy and Response Time depend on Source Resistance.

THESE new D-C Indicating Amplifiers are the answer for all your low-level measurements with thermocouples, strain gages, bolometers—bridge and potentiometer circuits—ionization, leakage, and phototube currents—almost any measurement of extremely small direct current or voltage.

Actually 3 instruments in 1, Amplifiers can be used as:

✓ Direct-reading instruments—Scale multiplier knob lets you select the range in which you want to work.

✓ Recorder preamplifiers—with broad flexibility. One or two degrees temperature difference can be spread right across a 10" Speedomax recorder chart.

✓ Null detectors—more sensitive than most reflecting galvanometers, yet with full scale response time of only 2 to 3 seconds. Leveling is unnecessary; the instrument is not affected by vibration. At the turn of a range knob, you have available a wide choice of sensitivities. And when using non-linear response, not only does the instrument stay on scale at extreme unbalance; sensitivity increases automatically as the null point is approached.

For details, send for Folder EM9-51(1). Write our nearest office, or 4979 Stenton Ave., Phila. 44, Pa.



MEASURING INSTRUMENTS • TELEMETERS • AUTOMATIC CONTROLS • HEAT-TREATING FURNACES

**LEEDS & NORTHRUP CO.**



# PROVED

by reports of satisfied users...  
that you can depend on higher  
speed, fewer rejects, less expense  
on the assembly line using  
Ersin Multicore of even lower  
tin content than other solders.  
Specify Multicore, the original  
3 core solder with extra-active,  
non-corrosive Ersin Flux and  
Thin-Wall Triple Core  
construction.

# APPROVED

Pound by pound,  
Ersin Multicore meets all  
requirements of Federal  
Specification QQ-S-571-b.  
Made of virgin metals only —  
Tin: 99.75% pure  
Lead: 99.97% pure  
The World's Finest Solder!

**ERSIN**

# Multicore



**3-CORE  
SOLDER**

New Edition! FREE —  
valuable booklet "Modern  
Solders" and testing samples  
available on request.



Address U. S. A. and Canadian inquiries to  
**MULTICORE SALES CORP.**  
164 Duane Street • New York 13, N. Y.  
Inquiries regarding other territories to  
**MULTICORE SOLDERS LTD.**  
Mellier House, Albemarle Street • London, W. 1, England



# ELECTRICAL and MECHANICAL ENGINEERS

## METALLURGISTS, PHYSICISTS and CHEMISTS

You're on the main line to the top  
when you work at Westinghouse

UNLIMITED OPPORTUNITIES  
IN DESIGN, RESEARCH, APPLICATION, DEVELOPMENT

## INVESTIGATE IMMEDIATELY!

\*Engineers fill 16 of the 29 top executive spots in Westinghouse. Hundreds of engineers hold high-level staff and supervisory positions. Your opportunity to advance is practically unlimited at Westinghouse.

\*Right now Westinghouse is building seven new plants. These are not temporary jobs. Nearly all of the engineers and scientists who joined us in World War II are still with us, and in the past 10 years our total employment has almost doubled.

\*At Westinghouse you will participate in the nation's defense effort. In 1951 a large part of all Westinghouse production will be to satisfy the nation's military needs.

**THIS MAY BE YOUR OPPORTUNITY TO MOVE AHEAD IN THE CAREER OF YOUR CHOICE . . . MANY SUPERVISORY POSTS IN NEW PLANTS AND DIVISIONS WILL BE FILLED FROM OUR ENGINEERING STAFF! INVESTIGATE!**

**Minimum Experience Required**—2 years . . . but some of these openings call for top-flight men with more experience.

**Salaries**—Determined individually on the basis of the experience and ability of the applicant.

**Location**—There are openings for engineers, metallurgists, physicists, and chemists at most of Westinghouse's 36 plants. For example: You'll find opportunities to do jet engine work at Kansas City, Missouri and South Philadelphia, Pa. . . in Ordnance manufacturing at Sunnyvale, California and Sharon, Pa. . . on atomic power projects in Pittsburgh, Pa. . . in radar and electronics at Baltimore, Md. . . in aircraft equipment and fractional horsepower motors at Lima, Ohio . . . and in commercial and airport lighting at Cleveland, Ohio . . . and in power producing equipment to speed the production lines of America. And all of these activities have a definite and established peacetime application.

### WESTINGHOUSE OFFERS YOU IN ADDITION TO GOOD PAY

- Help in finding suitable housing
- Low cost life, sickness and accident insurance with hospital and surgical benefits.
- Modern pension plan
- Opportunity to acquire Westinghouse stock at favorable prices
- Privilege of buying Westinghouse appliances at employe discount

Investigate Westinghouse today . . . Write Mr. R. P. Meily,  
Westinghouse Electric Corporation, Box 2182  
306 Fourth Ave., Pittsburgh 30, Pa.



# NEW MINIATURE SWITCHES BY CENTRALAB

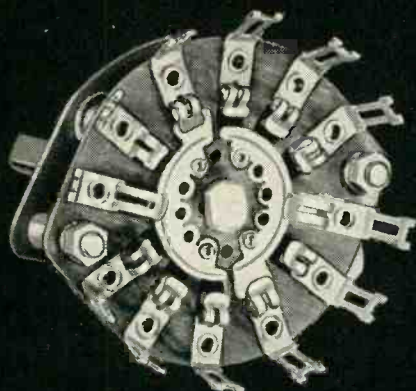

STANDARD SIZE

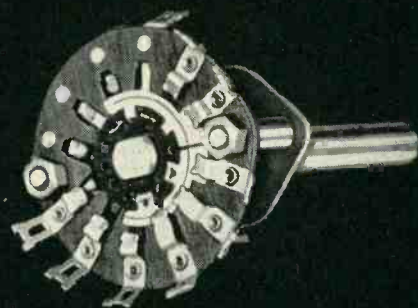

NEW MINIATURE SIZE

*Now, Centralab, the first name in Electronic Components, offers new design possibilities in an entirely new line of truly miniature, top-quality, rotary switches for radio, TV and similar high-frequency, low-power applications.*

**WANT MORE INFORMATION?**

**SEE NEXT 2 PAGES** ➔

# CENTRALAB ANNOUNCES A COMPLETE

FOR COMMERCIAL OR

## New Centralab Miniature Switches Give You Top-Quality Construction & Performance

You'll find these new Centralab miniature rotary switches have every quality-construction feature — every quality-performance characteristic as previously built into larger size Centralab switches. Switch sections are high-quality, laminated phenolic or Centralab's own Grade L5 Steatite. Clips and contacts are self-cleaning, spring brass with heavy silver plating or coin silver. All other metal parts are adequately plated to meet commercial or government specifications. Switches have positive 30° indexing. What's more, these miniature Centralab switches offer identical opportunity with the larger size units for having multiple sections on a single shaft. Switches are available with 2 to 11 positions with stops, or 12 position continuous rotation. Of particular interest for AM-FM-TV designers — these miniature switches may be furnished with dual concentric shafts coupled with regular line switches and Centralab's famous Model 2 Radiohm variable resistors. (See illustrations at right.)





# NEW LINE OF MINIATURE SWITCHES

## MILITARY APPLICATIONS

Now Centralab offers a completely new, unusually small rotary switch line — available in a variety of multi-pole, multi-position, multi-section models and in combination with line switches and variable resistors.

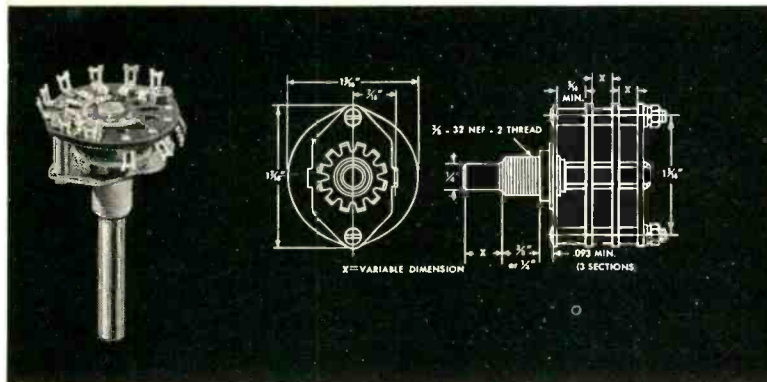

New Centralab Series 20, miniature, single section, phenolic switch. Available in 2 to 11 positions with stops, or 12 position continuous rotation — and with multiple sections.

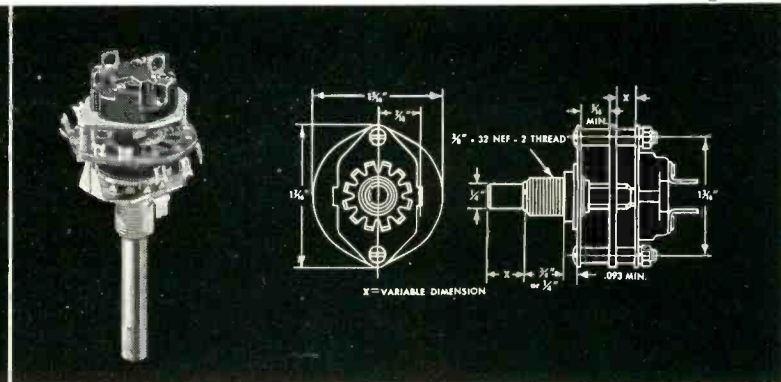

Here's standard Series 20 miniature switch with standard shaft and phenolic section with conventional off-on switch added. Also available with multiple sections.

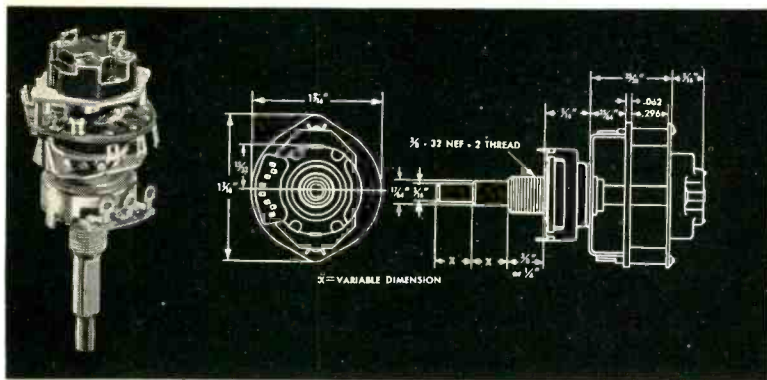

Combination Series 30 miniature switch unit with dual concentric shaft — permits independent operation of miniature switch including off-on switch, and Model 2 variable resistor.

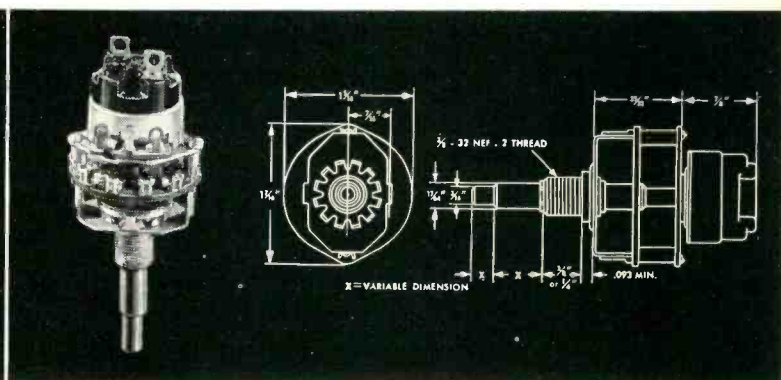

Same combination Series 30 unit as shown at left, except that Model 2 variable resistor is mounted at rear of miniature switch. Position of resistor provides convenience of wiring.

If you need a truly small size, long-life switch, Centralab's new miniature Series 20 and Series 30 switches are the answer. They have been specifically designed to meet the modern trend toward greatly reduced size in electronic equipment for high-frequency, low-current applications. Extremely compact design and small size, plus availability of separate sections and index assemblies provide an adaptability that is invaluable to design engineers and manufacturers. For complete specification information on the new Centralab Miniature Series 20 and Series 30 Switch line, mail the coupon today. *Manufacturer's samples promptly.*

# Centralab

Division of GLOBE-UNION INC • Milwaukee

CENTRALAB Division of Globe-Union Inc.  
914 East Keefe Avenue, Milwaukee 1, Wisconsin

Please send me complete specification information on Centralab's new Series 20 and Series 30 Miniature Switch line.

Name .....

Address .....

City ..... Zone ..... State .....



*Have you a Military Job  
for this Special Counting Mechanism?  
...then you will find out  
what we mean when we say...*

# Everyone Can Count on **VEEDER-ROOT**

You're looking at a new *and patented* development...featuring the Veeder-Root "Geneva Transfer"...designed for higher speeds and easier readability from a distance.

Here's another vitally important Veeder-Root "first," for use in military equipment. And within the understood limitations of the present-day rule of "first things first" . . . what can we *figure out* for you?

VEEDER-ROOT INC.  
HARTFORD 2, CONN. • GREENVILLE, S. C.  
Montreal, Canada      Dundee, Scotland  
*Offices and agents in principal cities*

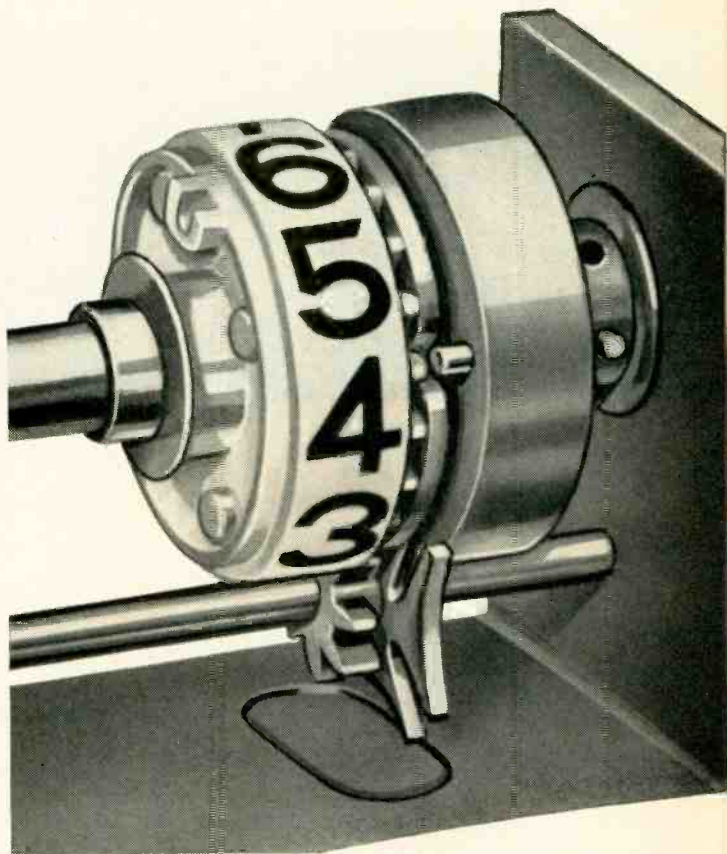

**VEEDER-ROOT**

**COUNTERS**

*"Count Everything on Earth"*





# NEW! VHF COMMUNICATIONS ANTENNA FOR AIRCRAFT

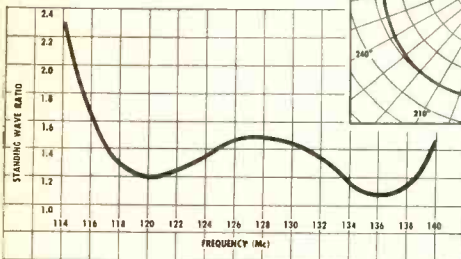
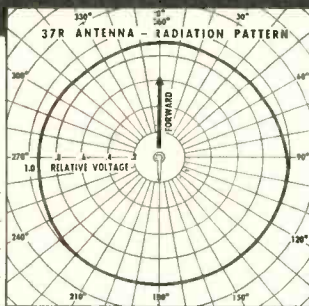

This is a portrait of the new Collins 37R-1 antenna, made expressly for use with the Collins 51R-17L two-way VHF communications system. It is designed for the most efficient radiation and reception of vertically polarized communications signals in the frequency range of 118 to 136 megacycles. Note the excellent radiation pattern and standing wave ratio graphed on this page.

The 37R-1 mounts externally on the skin of the aircraft. Its mounting base, identical with the Collins type 37J-2 omni antenna, greatly simplifies installation especially on pressurized aircraft. Only the r-f connector protrudes through the skin of the ship.

We invite inquiries and investigation of this highly specialized and effective development.

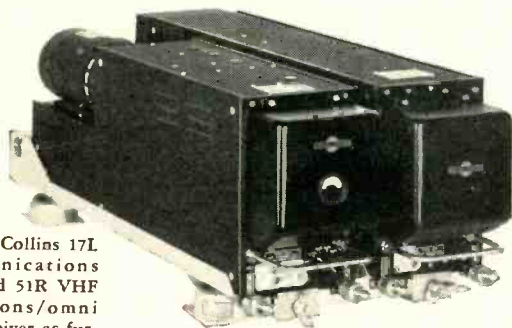

Left to right: Collins 17L VHF communications transmitter and 51R VHF communications/omni navigation receiver as furnished in specially designed dual shockmount.

In aviation communications, it's . . .



**COLLINS RADIO COMPANY, Cedar Rapids, Iowa**

11 West 42nd Street, NEW YORK 18

2700 West Olive Avenue, BURBANK

# Nothing can touch them!

these tiny Class "S" Relays from

## Automatic Electric

are HERMETICALLY SEALED

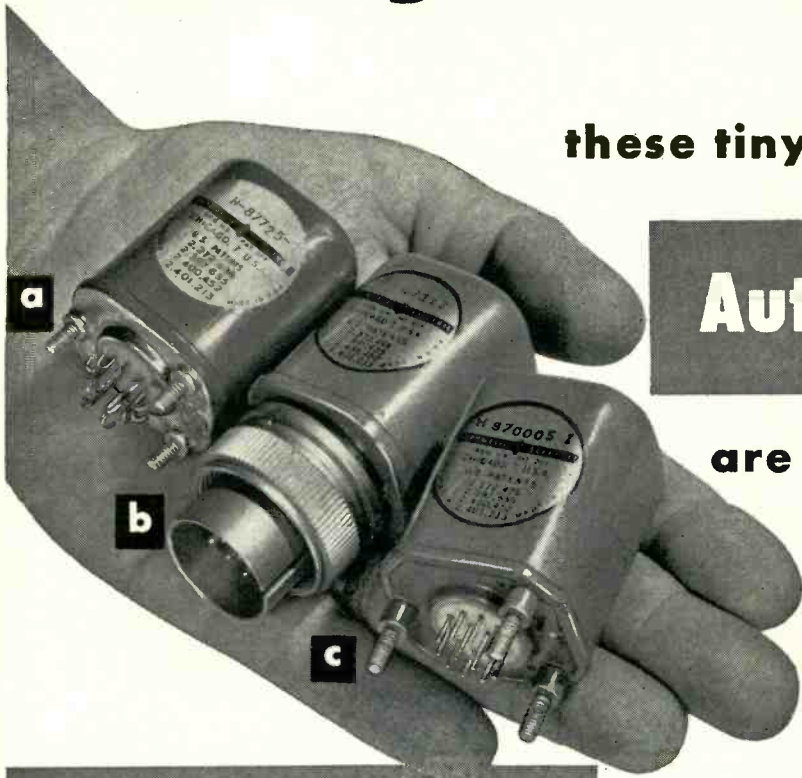

To give your product high performance standards, use relays that meet *aviation's* highest standards. These Automatic Electric Class "S" Relays meet them all!

**small, light-weight**—mount in any position in a restricted space...save valuable room, hold down weight.

**resist shock and vibration**—contact operation is dependable at vibration up to 10.5 G's.

**protected from harmful conditions**—operate in "ideal" atmosphere of dry nitrogen, sealed against dust, corrosion, atmospheric pressure changes and tampering.

**versatile in application**—as shown at left, Class "S" Relays are available with solder-or socket-type terminals...and with the contact arrangements *you* specify.

Other telephone-type relays can also be supplied, with or without hermetically sealed enclosures. Write for circulars. Address: AUTOMATIC ELECTRIC SALES CORPORATION, 1033 West Van Buren St., Chicago 7, Ill. In Canada: Automatic Electric (Canada) Ltd., Toronto. *Offices in principal cities.*

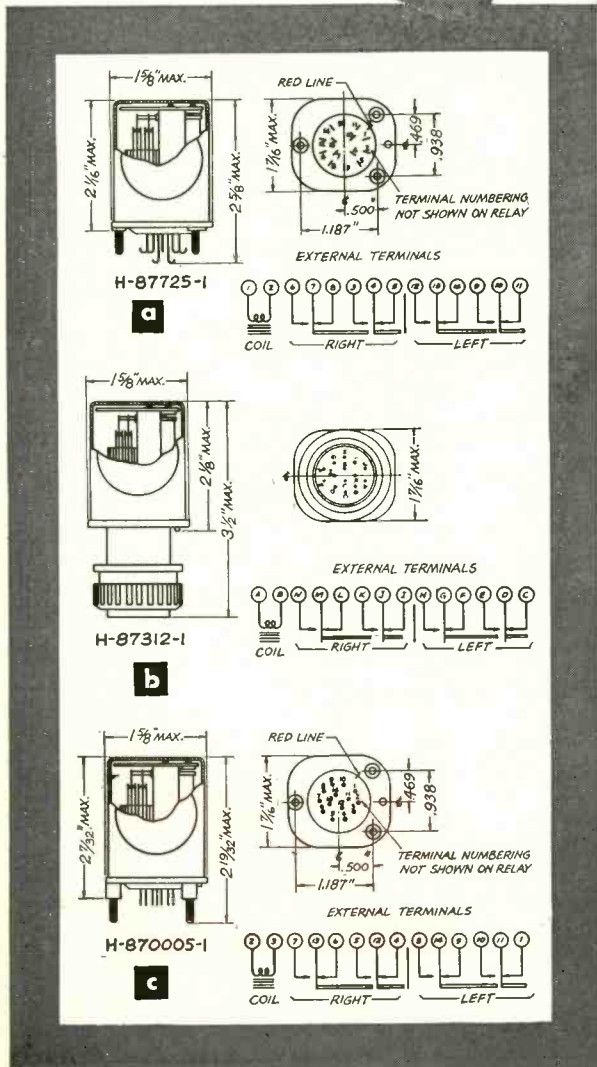

**RELAYS SWITCHES**  
**AUTOMATIC ELECTRIC**  
**CHICAGO**



# Burnell **NOW** BIGGER THAN EVER IN THE PRODUCTION OF TOROIDS AND FILTERS

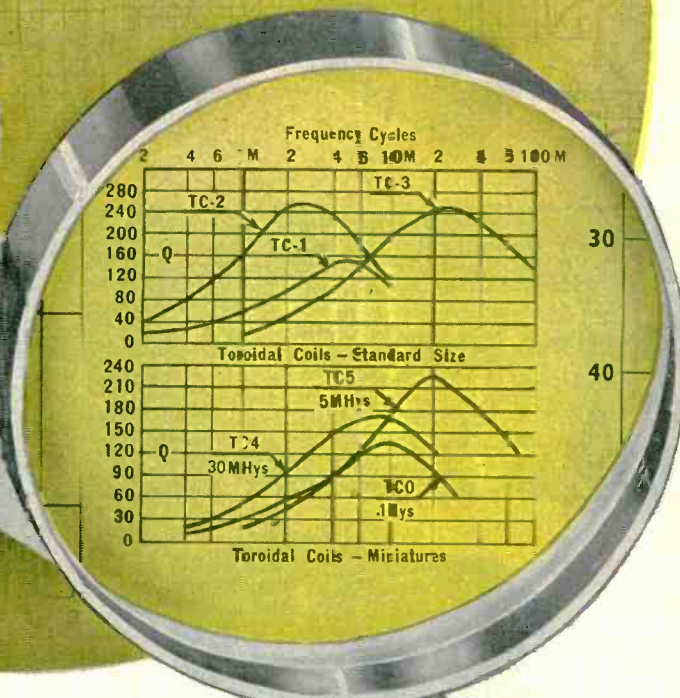
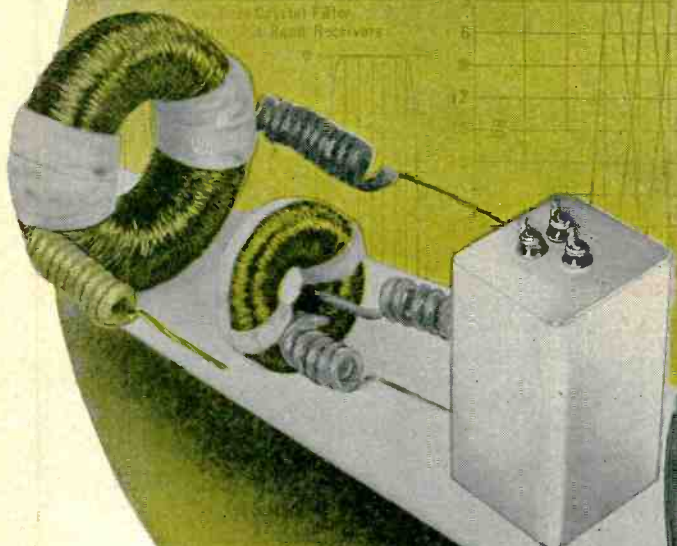

## TYPICAL "Q" CHARACTERISTICS OF BURNELL TOROIDS WOUND ON MOLYBDENUM PERMALLOY CORES

Several years ago we began to specialize in the design and manufacture of toroidal coils and audio filter networks. At that time too few electronic engineers were aware of the full value of toroids (particularly those wound on molybdenum permalloy dust cores) as very little publicity had ever been devoted to a product that was fast becoming one of the most vital in the development of modern communications and control equipment.

We believe that since then through our technical service and advertising methods we have helped thousands of engineers to understand and appreciate the toroid as an essential in network applications.

The resulting popularity and industry acceptance of our toroidal coils and filters have necessitated an expansion of our production facilities to ten times what they were five years ago and we are proud to point to this growth as an expression from our customers of their satisfaction in the quality of our product and our service.

STANDARD SIZES	
TC-1	1 3/8" O.D. x 3/8"
TC-2	2 1/4" O.D. x 7/8"
TC-3	1 1/2" O.D. x 9/16"
MINIATURE SIZES	
TC-0	7/8" O.D. x 3/8"
TC-4	1-3/16" O.D. x 9/16"
TC-5	1-3/16" O.D. x 9/16"
MAXIMUM INDUCTANCE	
TC-1	Ind.-Up to 10 Hys.
TC-2	Ind.-Up to 100 Hys.
TC-3	Ind. MHY-Up to 750
TC-0	Ind.-Up to 2 Hys.
TC-4	Ind.-Up to 10 Hys.
TC-5	Ind. MHY-Up to 750



**Burnell & Company**  
YONKERS 2 NEW YORK  
CABLE ADDRESS "BURNELL"

EXCLUSIVE MANUFACTURERS OF COMMUNICATIONS NETWORK COMPONENTS



**CUTS REJECTS 70%.** High voltage capacitors made by Centralab for use in television sets are subjected to a high voltage breakdown test. Rejections were cut 70% when Centralab switched to Plaskon Alkyd.

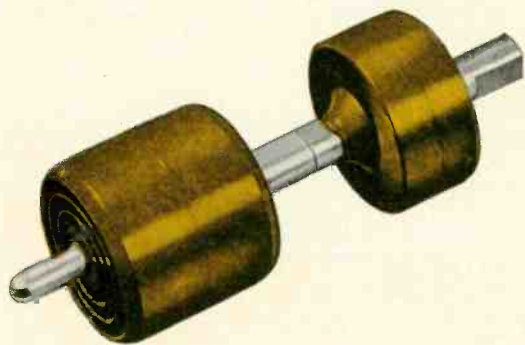

**REDUCTION IN SIZE.** Exhaustive arc resistance tests faithfully reproducing actual service conditions convinced Arrow, Hart & Hegeman engineers of the unexcelled arc resistance of molded Plaskon Alkyd. This benefit enabled them to redesign and reduce the overall size of their complete line of magnetic starters.

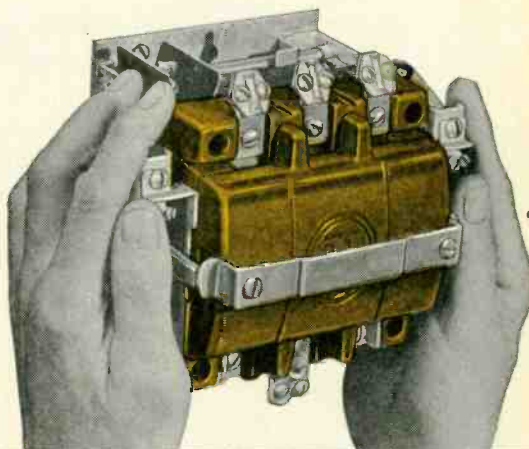

## more evidence of savings with PLASKON ALKYD

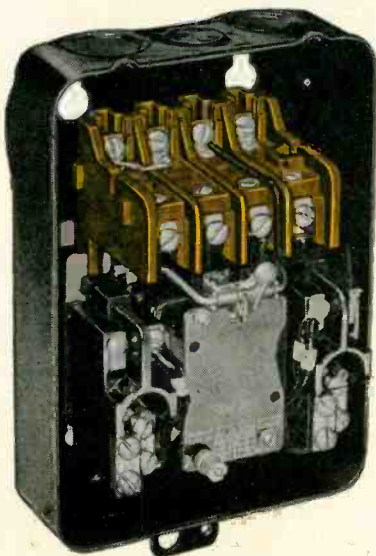

**TIME SAVING 50%; MONEY SAVING 25%.** Furnas Electric Company found that the fast molding characteristic of Plaskon Alkyd cut production time 50%. A cost saving of 25% has been realized on the cost of the finished product.

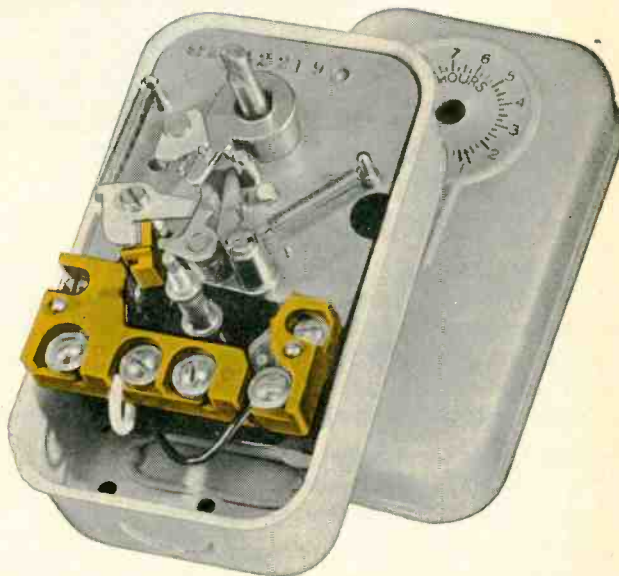

**PRODUCTION INCREASED 392%.** Switching to Plaskon Alkyd enabled Sangamo Electric Company to produce plastic parts for their time switch nearly 4 times as fast as was possible with a competing material.



# HOW

**you can produce for less . . .  
TO SELL MORE PROFITABLY**

Leading producers of electrical and electronic parts have found Plaskon Alkyd a real helper in producing better parts, faster...often for less.

Plaskon Alkyd is an ultra high-speed, thermosetting plastic molding compound with excellent electrical properties. It can be molded three to four times faster than conventional thermosetting materials... assuring greater production from molding equipment.

Loss from profit-robbing rejects is reduced because Plaskon Alkyd just doesn't require a lot of fussy, kid-glove care to mold. It's much less sensitive to variations in pressure, temperatures and time than other thermosetting materials.

And you can save some real money on tooling costs with Plaskon Alkyd. Simple, less expensive dies are required to mold it. Plaskon Alkyd's high-speed molding characteristics assure greater production from each mold cavity. And fewer cavities are needed to maintain your production schedules.

Plan to use Plaskon Alkyd to produce for less...  
to sell more profitably!

***... mold it better and faster with***

**PLASKON<sup>®</sup>**  
ALKYD

**PLASKON DIVISION • LIBBEY • OWENS • FORD GLASS CO.**

2136 Sylvan Avenue • Toledo 6, Ohio

*In Canada: Canadian Industries, Ltd., Montreal, P. Q.*

*Branch Offices: Boston, Chicago, New York, Los Angeles, Rochester*

*Manufacturers of Molding Compounds, Resin Glues, Coating Resins*

BROWN  
INSTRUMENTS  
ACCELERATE  
RESEARCH

# For Accurate Records Of Rapidly Changing Variables



Internal view with chassis swung out . . . showing amplifier and damping circuit components.

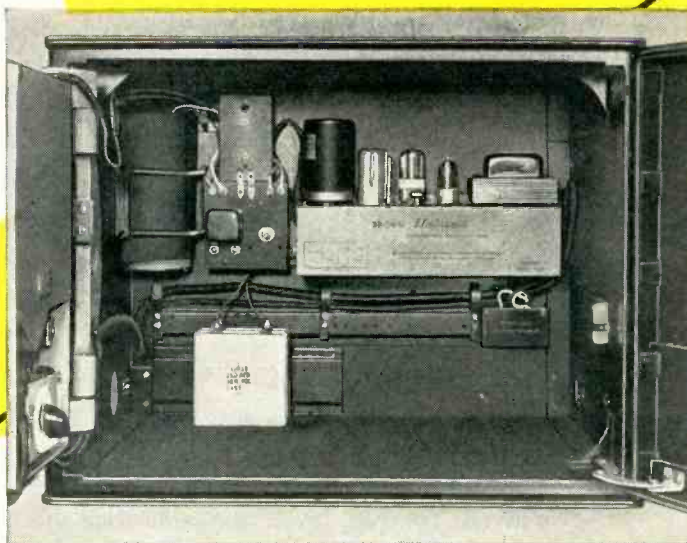

## ... the NEW HIGH SPEED *Elektronik* RECORDER

### OPERATING CHARACTERISTICS

- **ACCURACY**—0.25 per cent of span (spans over 12 mv.); 0.030 mv. (span under 12 mv.)
- **DEAD ZONE**—0.06 per cent of span (over 12 mv.); 0.007 mv. (under 12 mv.)
- **NOMINAL SPEED**—Full scale in one second, maximum.
- **CHART SPEEDS**—1, 2, 3 and 4 inches per second (change gears provided) or any standard chart speed.
- **STANDARDIZATION**—Push-button.
- **POWER SUPPLY**—115 volts, 60 cycles.

Now you can accurately record on a null-balance instrument full scale signals which vary as rapidly as 20 cycles per minute. Signals with a peak to peak amplitude of 10% of scale, can be reproduced at variations up to 3 cycles per second.

The new *Elektronik* High Speed Recorder is especially designed to measure rapidly changing variables in laboratory and test applications. The instrument develops a pen speed that traverses its eleven inch graduated chart in one second! It has chart speeds up to 4" per second—20 feet per minute. It incorporates an adjustable damping circuit... and has a motor driven reroll mechanism to main-

tain constant tension on the chart.

Adaptable to the measurement of practically any d-c signal, the *Elektronik* High Speed Recorder can be employed in conjunction with thermocouples, Radiamatic pyrometers, pressure and force transducers . . . plus a host of other devices capable of resolving variables to d-c signals.

For detailed information write for Data Sheet No. 10.0-7.

MINNEAPOLIS-HONEYWELL REGULATOR CO., Industrial Division, 4428 Wayne Ave., Philadelphia 44, Pa. Offices in more than 80 principal cities of the United States, Canada and throughout the world.

MINNEAPOLIS  
**Honeywell**

BROWN INSTRUMENTS



## Something New

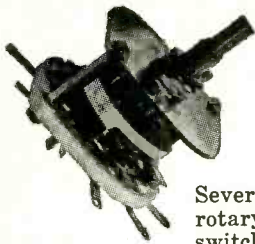

### NEW OVAL SELECTOR SWITCHES

Several new oval rotary selector switches are described in Bulletin L13 just issued by the Shallcross Manufacturing Co., Collingdale, Pa. Six basic plates and three rotor types produce switches having from one to three poles per deck or gang and with other desired mechanical and electrical details. As many as 18, 9 or 6 positions may be obtained in single-, double-, or triple-pole types respectively. These may be single-, double-, or triple-pole decks exclusively or a combination of different types.

### VERTICAL STYLE PRECISION RESISTORS FOR JAN USES

Improved vertical style precision wire-wound resistors for use where mounting requirements make it desirable to have both terminals at the same end of the resistor have been introduced by the Shallcross Manufacturing Co., Collingdale, Pa. These units provide a longer leakage path from the mounting screws to the terminals. Known as Shallcross Types BX120, BX140, and BX160, they are designed to meet JAN requirements for styles RB 40 B, RB41B and RB42B respectively. For commercial uses, the resistors carry somewhat higher ratings than for JAN applications. Wire leads instead of terminals can be furnished if desired. Complete details will gladly be sent on request to the manufacturer.



### FLAT, METAL-ENCASED WIRE-WOUND RESISTORS

Flat, metal-encased, Type 265A wire-wound power resistors introduced by the Shallcross Manufacturing Company, Collingdale, Penna. are space wound, have mica insulation, and are encased in aluminum for mounting flat against a metal chassis. At 175° C. continuous use they are conservatively rated for 7½ watts in still air and 15 watts when mounted on a metal chassis. Write for Bulletin 122. ADV

FOR QUICK, ACCURATE

# Bond Tests

( BETWEEN 2 AND 800,000 MICRO-OHMS )

## ...AND TESTS OF OTHER LOW RESISTANCES



### 670 Series Portable Low-Resistance Test Set

6 ranges from 1,000 to 500,000 micro-ohms full scale. Weighs only 10 lbs.—operates from dry cells. Ideal for production line or portable use.

These Shallcross linear micro-ohmmeters permit quick, accurate "go—no go" tests of low resistances between 2 and 800,000 micro-ohms. They are widely used for testing electrical bonds and welds in the aviation, railway and other fields as well as for production testing of a variety of products ranging from heavy current switch and relay contacts, to armatures and light bulb filaments. Resistance is directly indicated on meter. Write for Shallcross Engineering Data Bulletin L-12.



### 668 Series Low-Resistance Test Set

8 ranges from 200 to 800,000 micro-ohms full scale. Weighs 30 lbs. and operates from 115 V. 60-cycle current. A convenient instrument for research, laboratory or production line low resistance tests.

# SHALLCROSS

SHALLCROSS MANUFACTURING COMPANY

Collingdale, Pa.

Precision Resistors • D-C Bridges • Decade resistances • High-voltage measuring equipment • Galvanometers • Rotary Selector Switches • Attenuators • Capacitor Analyzers • Transmission Test Sets . . . and custom-built electronic specialties

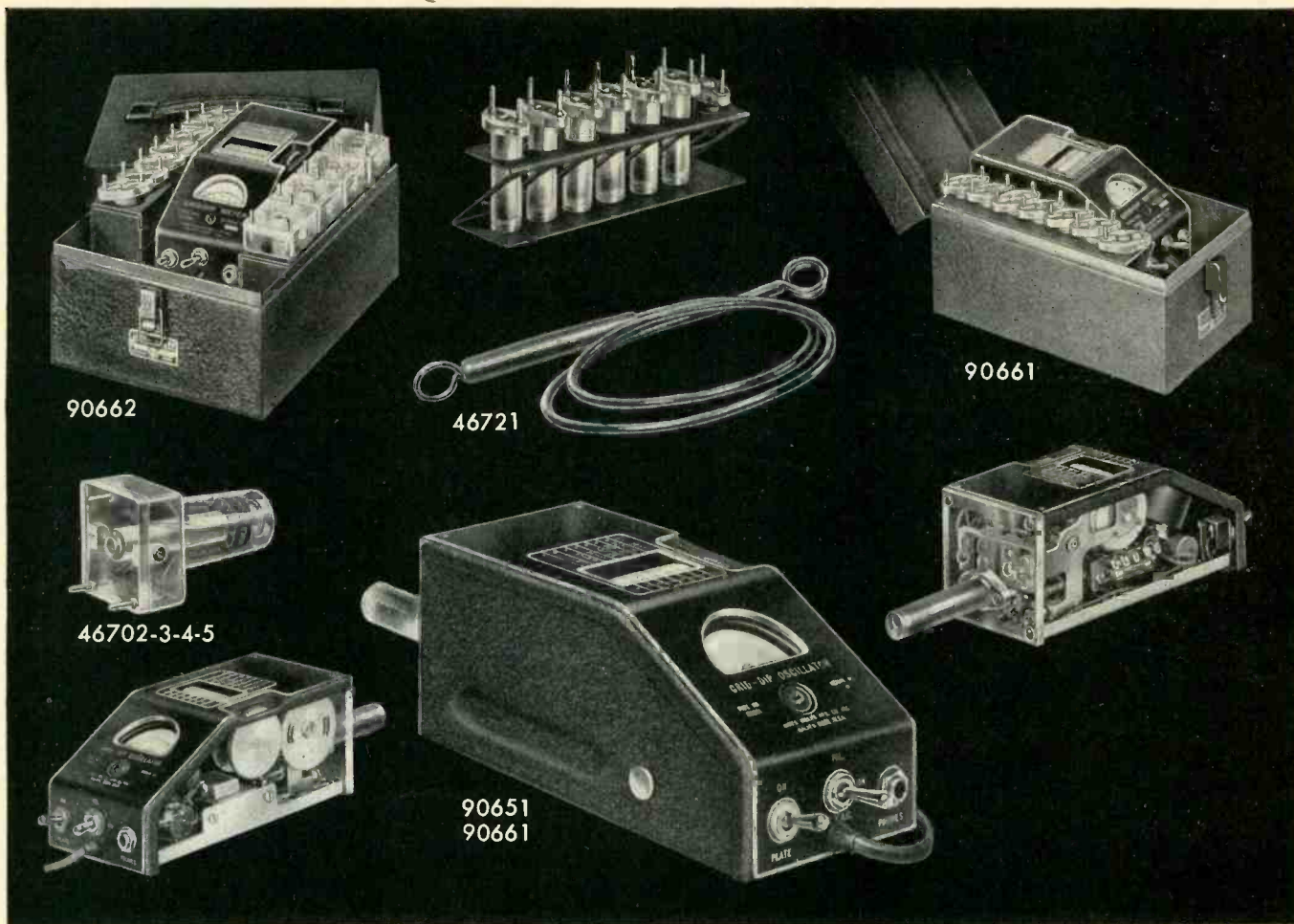

## Designed for Application

### Grid Dip Meters

Millen Grid Dip Meters are available to meet all various laboratory and servicing requirements.

The 90662 Industrial Grid Dip Meter completely calibrated for laboratory use with a range from 225 kc. to 300 mc. incorporates features desired for both industrial and laboratory application, including three wire grounding type power cord and suitable carrying case.

The 90661 Industrial Grid Dip Meter is similar to the 90662 except for a reduced range of 1.7 to 300 mc. It likewise incorporates the three wire grounding type cord and metal carrying case.

The 90651 Standard Grid Dip Meter is a somewhat less expensive version of the grid dip meter. The calibration while adequate for general usage is not as complete as in the case of the industrial model. It is supplied without grounding lead and without carrying case. The range is 1.7 to 300 mc. Extra inductors available extends range to 220 kc.

The Millen Grid Dip Meter is a calibrated stable RF oscillator unit with a meter to read grid current. The frequency determining coil is plugged into the unit so that it may be used as a probe.

These instruments are complete with a built-in transformer type A.C. power supply and interterminal terminal board to provide connections for battery operation where it is desirable to use the unit on antenna measurements and other usages where A.C. power is not available. Compactness

has been achieved without loss of performance or convenience of usage. The incorporation of the power supply, oscillator and probe into a single unit provides a convenient device for checking all types of circuits. The indicating instrument is a standard 2 inch General Electric instrument with an easy to read scale. The calibrated dial is a large 270° drum dial which provides seven direct reading scales, plus an additional universal scale, all with the same length and readability. Each range has its individual plug-in probe completely enclosed in a contour fitting polystyrene case for assurance of permanence of calibration as well as to prevent any possibility of mechanical damage or of unintentional contact with the components of the circuit being tested.

*The Grid Dip Meters may be used as:*

1. A Grid Dip Oscillator
2. An Oscillating Detector
3. A Signal Generator
4. An Indicating Absorption Wavemeter

The most common usage of the Grid Dip Meter is as an oscillating frequency meter to determine the resonant frequencies of de-energized tuned circuits.

Size of Grid Dip Meter only (less probe): 7 in. x 3 $\frac{3}{8}$  in. x 3 $\frac{3}{8}$  in.

JAMES MILLEN



MFG. CO., INC.

MAIN OFFICE

AND FACTORY

MALDEN, MASSACHUSETTS, U. S. A.



EXTRA-  
DEPENDABLE

LONG-  
LIVED

WON'T  
SHORT

WITHSTAND  
HIGH  
HEATER-  
CYCLING

SHOCK-  
RESISTANT

# G-E 5-STAR ARINC TUBES ARE 5 WAYS BETTER!

Take your design cue from airmen who praise the superiority of ARINC types!

"Records kept by our company show replacement of ARINC tubes to be only 2% as compared with an average of 49% replacement for 13 types of regular tubes over the same period."

W. W. LYNCH, *System Communications Superintendent, Pan American World Airways System.*

"Our company is using ARINC reliable tubes wherever possible. Experience has shown that equipment using these tubes seldom causes delays from tube failure."

J. H. CARMICHAEL, *President, Capital Airlines.*

"The effect of using ARINC tubes in our equipment became immediately apparent. Off-schedule removals of airborne equipment due to tube failures have been materially reduced."

J. R. CUNNINGHAM, *Director of Communications, United Air Lines.*

"During a six months' carefully controlled comparison service test, ARINC tubes required only 1/4 as many replacements as first quality standard brand tubes."

FRANK R. WAGNER, *Supervisor of Radio, Electrical and Instrument Engineering, TWA*

"We have four VHF Navigation Receivers which have been in service for more than 1,000 hours each. Of the 104 ARINC tubes used, we have not had a single failure."

J. LANE WARE, *Supervisor of Communications Engineering, National Airlines.*



GL-5654



GL-5670

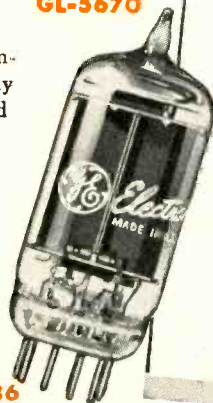

GL-5686

★ ★ ★ A pioneer in manufacturing ARINC tubes, G.E. offers nine 5-star types which set new standards of dependability and long life. Specify these tubes in electronic circuits now on your boards, to increase safety factor . . . reduce upkeep costs . . . build reputation for your equipment!

G-E 5-star ARINC tubes are a joint achievement of Aeronautical Radio, Inc., and General Electric Co. Built with exacting care—individually tested—they accent the reliability of altimeters, radio compasses, h-f receivers, other apparatus that guides air passengers safely to their destinations.

Learn more about G-E 5-star tubes! Write for Bulletin ET-B29A, which tells the story of their design, manufacture, and testing . . . describes and rates the various 5-star types . . . shows how you, as equipment builder or designer, can profit from their superior performance! *General Electric Company, Electronics Department, Schenectady 5, New York.*

- GL-5654—Sharp-cutoff r-f pentode
- GL-5670—H-f twin triode
- GL-5686—Power-amplifier pentode
- GL-5725—Semi-remote-cutoff r-f pentode
- GL-5726—Twin diode
- GL-5749—Remote-cutoff r-f pentode
- GL-5750—Pentagrid converter
- GL-5751—High-mu twin triode
- GL-5814—Medium-mu twin triode



# GENERAL ELECTRIC

185-K4



## YOU'LL FIND ALL 3 IN CHASE SHEET BRASS

Chase brass sheet is uniform in gauge, temper and surface. It is quality metal with accurate widths, straight, smooth edges and clean, flat surfaces. Remember, too, that the same degree of close supervision and critical inspection goes into every bit of Chase copper or bronze alloys in strips or rolls.

For information on all forms of brass and copper—sheet, rod, wire, tube—write on business letterhead for 124 page book, "Commercially Important Wrought Copper Alloys." Gives composition, forms available, uses, properties of over 50 copper alloys, weights, tolerances and other data.

# Chase BRASS & COPPER

WATERBURY 20, CONNECTICUT • SUBSIDIARY OF KENNECOTT COPPER CORPORATION

• The Nation's Headquarters for Brass & Copper

Albany†	Cleveland	Kansas City, Mo.	New York	San Francisco
Atlanta	Dallas	Los Angeles	Philadelphia	Seattle
Baltimore	Denver†	Milwaukee	Pittsburgh	Waterbury
Boston	Detroit	Minneapolis	Providence	
Chicago	Houston†	Newark	Rochester†	(Tables office only)
Cincinnati	Indianapolis	New Orleans	St. Louis	





Control Room WGEM, Quincy, Illinois  
Affiliated with GATES

## HOW MANY ARMS

## should your engineer have?



If you're talking about arms in sleeves, we'll concede that the usual pair is ample — if, however, you're talking about those on turntables, well, that's a different story!

Station managers are finding it good business, indeed, to own more than the usual two turntables. There are many reasons, among them the increasing trend toward more and more transcribed commercials that must go in split second sequence without a "hitch" — often during station breaks. Engineers often find it impossible to "set up" the minimum two turntables for best results.

With an extra turntable or two, station breaks and spots are aired with precision — studio dramatic productions "live" with well timed sound effects. Extra turn-

tables mean extra flexibility — smoother station operation.

Then, too, your salesmen will tell you it's profitable to have a turntable available for client audition, without having to make the customer wait 'til the show is "off the air"!

Actually, from the standpoint of investment, the cost of an extra turntable or two is small when proper consideration is given the many advantages they offer in better employee and customer relations, in smoother productions and in dependable "on-the-air" insurance!

The unquestioned quality of GATES transcription equipment will make it your first choice in bringing your station up to modern standards.

*Write today for your copy of GATES complete Transcription Turntable Catalog.*

### GATES CB-10, MASTER TRANSCRIPTION TURNTABLE . . .



Provides complete transcription facilities independent of control room equipment. Incorporates GATES CB-11 Chassis for all speeds with built-in three-stage pre-amplifier, power supply and pick-up of your choice. Mixing control, broadcast-cue switch and filter control conveniently located on sloping front panel. Attractive two-tone gray cabinet.

### GATES CB-14 TRANSCRIPTION TURNTABLE



Probably the most popular transcription turntable in use today. Transcription chassis is GATES CB-11, providing operation at all speeds. Variable filter is on the chassis proper and a mercury starting switch is conveniently located on the side. Available with or without self-contained pre-amplifiers. All GATES Transcription Turntables are available with the pick-up of your choice.

**GATES RADIO COMPANY • MANUFACTURING ENGINEERS • QUINCY, ILLINOIS, U. S. A.**  
2700 Polk Avenue, Houston, Texas • Warner Building, Washington, D. C. • International Division, 13 E. 40th St., New York City  
Canadian Marconi Company, Montreal, Quebec

*specify  
Sorensen*

# RANGERS

(FULL-RANGE-VARIABLE DC SUPPLYS)

This versatile supply is a combination of the widely used Sorensen NOBATRON and a filter-variable output circuit.

The result gives a continuously variable output voltage regulated against line and load changes through the full range of the instrument.

Look at the specifications tabulated below — check them against your requirements. Where range of output, adaptability to diverse applications is essential, the Sorensen RANGER may well be your instrument of choice.

## ELECTRICAL SPECIFICATIONS

Model No.	SR-10	SR-30	SR-50
Output range	3 - 135 VDC	3 - 30 VDC	3 - 13 VDC
Current range	1 - 10 amps	3 - 30 amps	5 - 50 amps
Input voltage	95 - 130 VAC, 50 - 60 cycles, single phase		
Regulation accuracy	± 0.25 percent at any voltage setting from 3 VDC to top rating		
Ripple	RMS max. 1% of output setting		

Meters — standard. Coarse and fine adjustment.

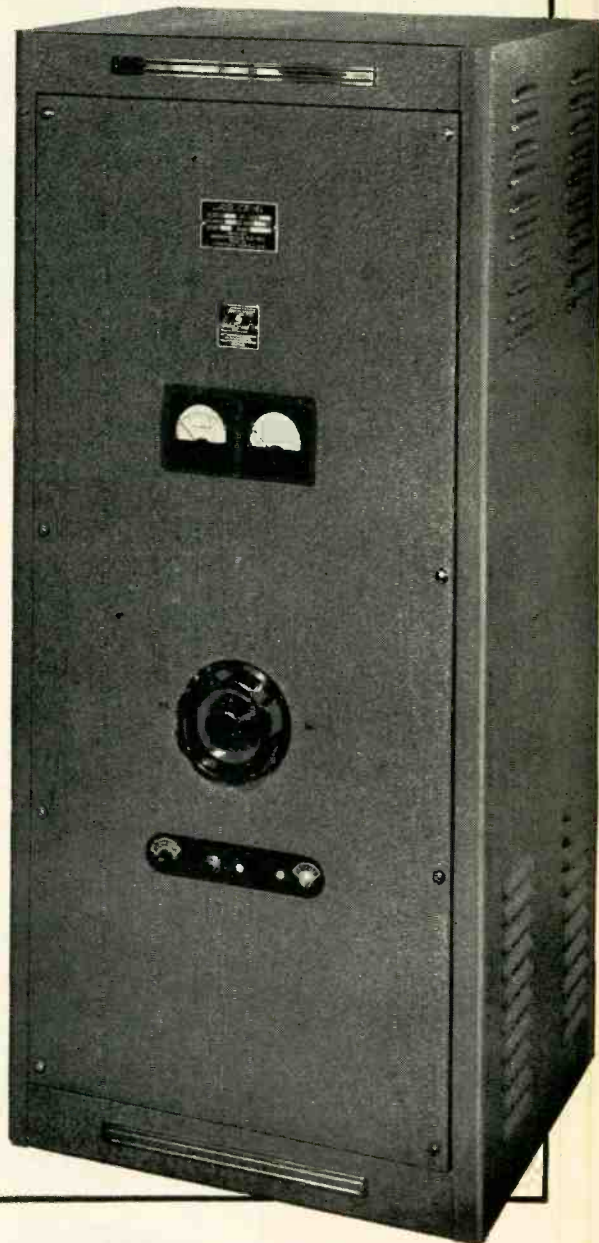

*Write for complete information.*

For other regulated DC supplys, investigate Sorensen's line of NOBATRONS (low voltage) and B-NOBATRONS (high voltage).

**POWER**  
controlled converted

*Sorensen*

**and company, inc.**  
375 FAIRFIELD AVE. • STAMFORD, CONN.



# When you need a FUSE—think of BUSS

## THE MOST COMPLETE LINE OF FUSES FOR THE *Electronic Industries*

- RADIO
- TELEVISION
- RADAR
- INSTRUMENTS
- CONTROLS
- AVIONICS

Whatever your needs in electrical protection there's a Buss fuse made to fit.

Send for Bulletin SFB—showing full line of fuses and fuse mountings.

### SPECIAL FUSES, FUSE CLIPS, FUSE BLOCKS and FUSE HOLDERS

Sometimes a special fuse or fuse mounting is required. In such cases we welcome your requests either to quote—or to help in designing or selecting the special type of fuse or fuse mounting best suited to your particular conditions.

Submit description or sketch, showing type of fuse to be used, number of circuits, type of terminal, etc. If your protection problem is still in the engineering state, tell us current, voltage, load characteristics, etc.

At any time our staff of fuse engineers is at your service to help solve your problems in electrical protection.

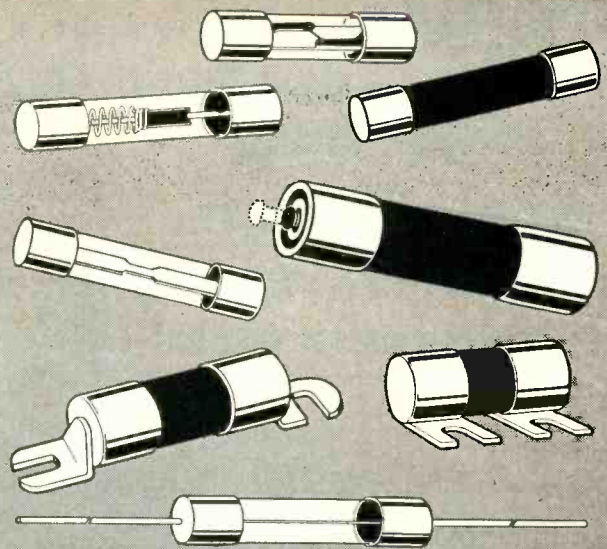

A complete line of fuses made to dimensions smaller than National Electrical Code fuses.

These fuses are SPACE SAVERS.

They are particularly well suited to the protection of instruments, radios, television and electronic equipment of all kinds, aircraft, automobiles, coin-operated devices and any apparatus where space for the protective device is at a premium.

Fuses of the Dual-Element, Renewable and One-Time type are available.

Companion lines for FUSETRON and BUSS small dimension fuses are BUSS Fuse Clips, Blocks and Fuse Holders. They are made in many types and sizes to make it easy to select the fuse and fuse-mounting needed to give the required protection.

For full information ask for the BUSS Bulletin on Small Dimension Fuses and Fuse Holders — Form SFB.

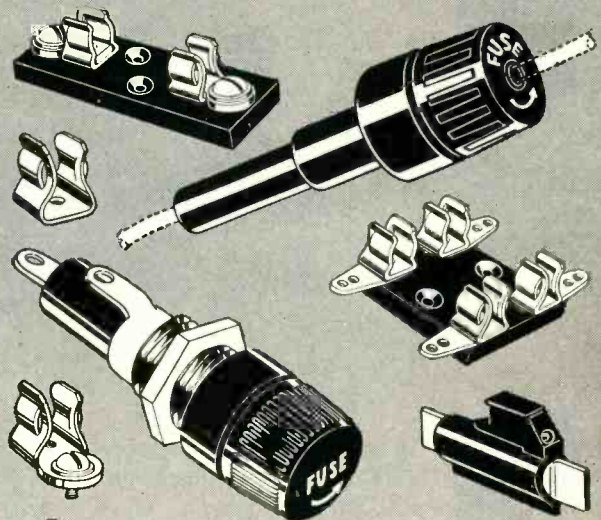

### USE THIS COUPON — *Get all the facts*

Bussmann Mfg. Co., University at Jefferson  
St. Louis 7, Mo. (Division McGraw Electric Co.)

Please send me Bulletin SFB containing complete facts on Buss Small Dimension Fuses.

Name \_\_\_\_\_

Title \_\_\_\_\_

Company \_\_\_\_\_

Address \_\_\_\_\_

City \_\_\_\_\_ State \_\_\_\_\_

ELRC-650

## PROBLEM:

# How to Get Better Electrical Conductivity in a Switch Spring

## GENERAL PLATE:

# Provided the Solution with "BRONCO", a Composite Metal

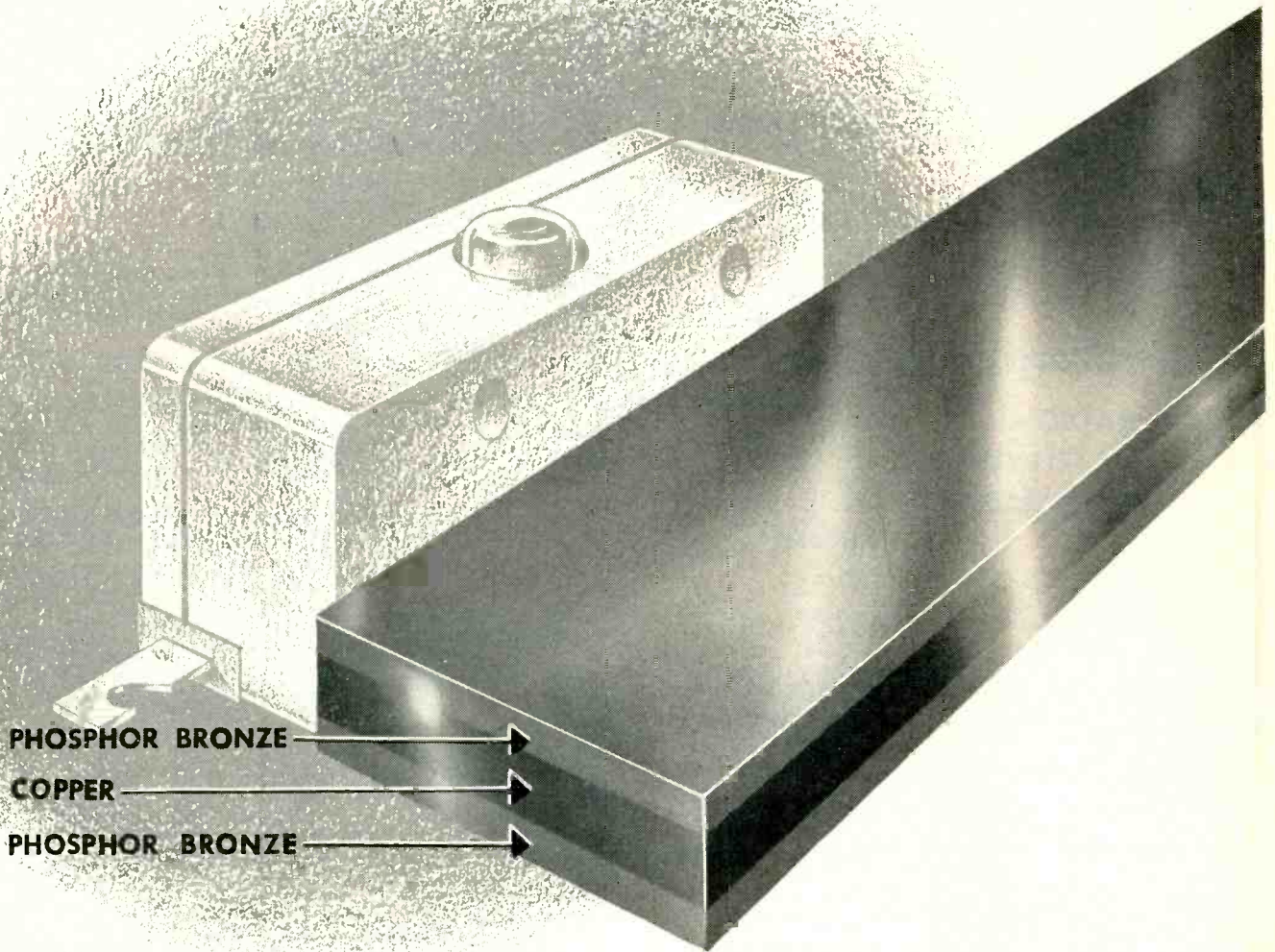

A well-known manufacturer of small switches needed high electrical conductivity in a spring. Solid phosphor bronze would be too thick or would heat up too much.

The problem was presented to General Plate engineers who quickly provided the solution with "BRONCO" strip, a double clad metal — phosphor bronze on copper. The desired electrical conductivity was obtained, the spring size was maintained.

No matter what your metal problem, it will pay you to consult with General Plate. Their vast experience in cladding precious to base metals or base to base metals can overcome your problems . . . often reduce costs.

General Plate Products include . . . Precious metals clad to base metals, Base metals clad to base metals, Alcuplate (copper and aluminum), Silver Solders, Composite contacts, buttons and rivets, Platinum fabrication and refining, Age-hardenable #720 Manganese Alloy. Write for information.

*Have You a Composite Metal Problem?  
General Plate can solve it for you*

## **GENERAL PLATE**

Division of Metals & Controls Corporation  
306 FOREST STREET, ATTLEBORO, MASS.

50 Church St., New York, N. Y. • 4326 N. Elston Ave., Chicago, Ill. • 757 W. Third St., Mansfield, Ohio • Detroit, Mich. • Los Angeles, Calif.



With the help of **ADLAKE RELAYS**—

**ADLAKE RELAYS AT WORK**  
—One of a series of advertisements  
on specific ADLAKE applications.

You can count your chickens  
**Before** they hatch!

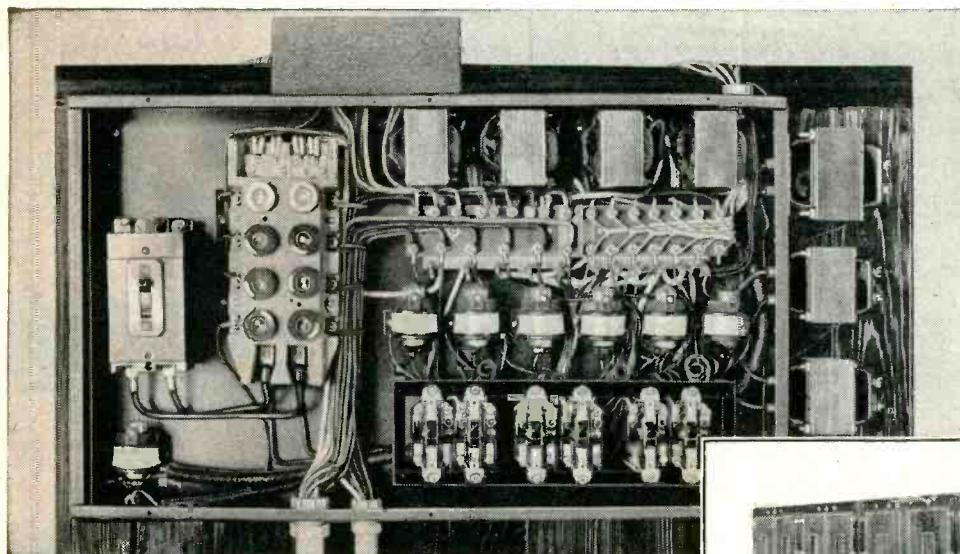

The master control panel of a Robbins Incubator, showing the seven ADLAKE Relays that are an essential part of the over-all control circuit.

**Dependable  
Robbins Incubators  
use  
ADLAKE RELAYS  
in Essential  
Control Circuits**

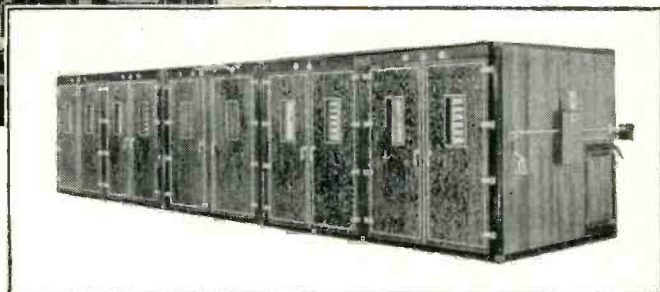

**Control relays** have a tricky job to do in incubators. As Mr. B. L. Rosenberg, Vice-President of the Robbins Incubator Company of Denver, wrote in a recent letter, "The exacting and precise control required in our specifications makes it essential that the control relays we employ be highly sensitive and dependable. The latest modifications have made ADLAKE Relays better than ever before, and we are entirely satisfied with them."

**ADLAKE Relays** are designed and built to meet the most exacting needs of industry. Their mercury-to-mercury contact prevents burning, pitting and sticking, and their sturdy construction armors them against outside vibration or impact.

Most important of all, *they require no maintenance*, for they are hermetically sealed against dust, dirt and moisture.

**For the full story** on the part ADLAKE Relays can play in *your* business, just drop a card to The Adams & Westlake Company, 1107 N. Michigan, Elkhart, Indiana. No obligation, of course.

**Every ADLAKE Relay Gives You  
These Advantages:**

- HERMETICALLY SEALED — dust, dirt, moisture, oxidation and temperature changes can't interfere with operation.
- SILENT AND CHATTERLESS
- REQUIRES NO MAINTENANCE
- ABSOLUTELY SAFE

**THE  
Adams & Westlake  
COMPANY**

Established 1857 • ELKHART, INDIANA • New York • Chicago  
Manufacturers of Hermetically Sealed Mercury Relays for Timing,  
Load and Control Circuits



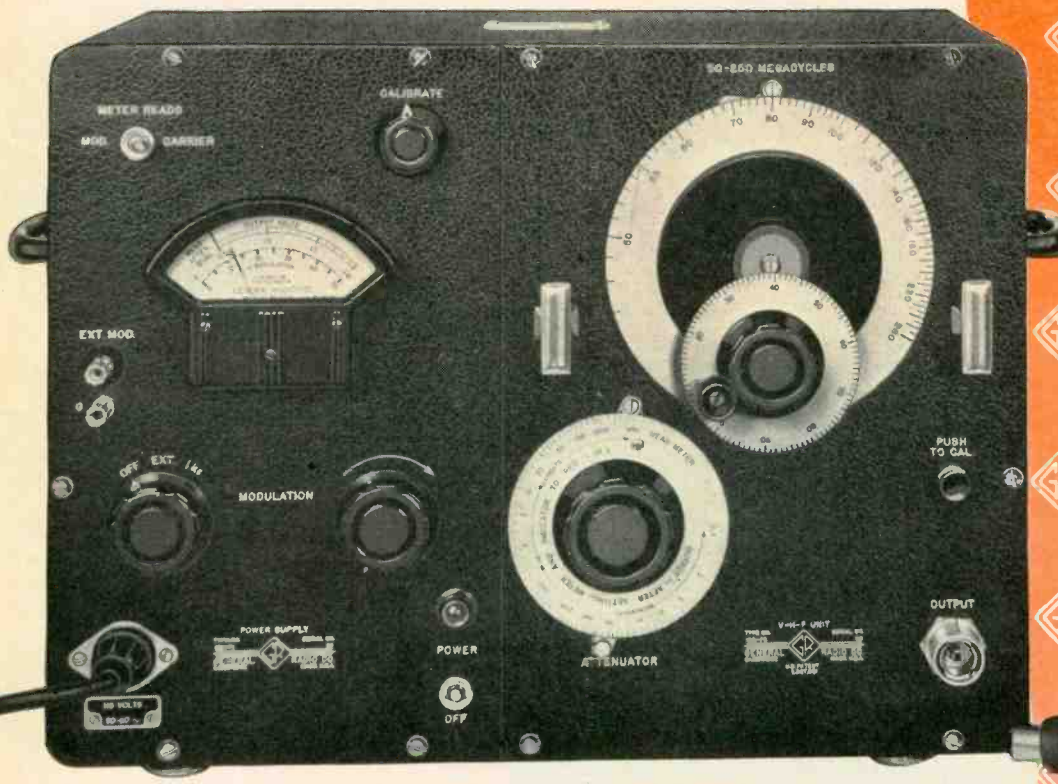

Butterfly Tuning Circuit no sliding contacts . . . no noise . . . perfectly smooth tuning . . . rugged design with good stability and very low drift . . .

Regulated Power Supply assures good heterodyne beat note.

Output 0.5 Microvolt to 1 Volt over-all accuracy better than  $\pm 20\%$ .

Internal Output Impedance 50 ohms.

Leakage and Residual Output Voltage below sensitivity of most receivers.

Internal 1000-Cycle and External Amplitude Modulation over audio range, adjustable from 0 to 50%. Incidental fm under 100 parts per million over most ranges.

# Standard Signal Generator

for Television, V-H-F Video, and U-H-F Channels

50 to 920 Mc.

The General Radio Type 1021-A Standard-Signal Generator operates at frequencies between 50 and 920 Mc with the same convenience and reliability found in other G-R generators in the broadcast frequencies.

Its main use is the determination of radio receiver and circuit characteristics. With an inexpensive diode modulator, television picture modulation can be produced for overall testing of television receivers.

It is a convenient and well-shielded source of power for measurements with bridges, imped-

ance comparators, and slotted lines. For these uses internal modulation is provided.

With the G-R Type 874 line of Coaxial Elements, this generator provides a very complete and flexible system for measurements of voltage, power and standing-wave ratio from 50 to 920 Mc.

Two separate oscillators are available. They are mechanically and electrically interchangeable and are sold as separate units to convert the range of one standard signal generator to that of the other.

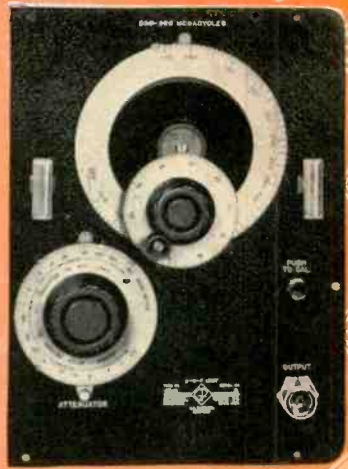

To cover the complete range of 50 to 920 Mc., the following units are required:  
 Type 1021-P1 Power Supply, Type 1021-P2 U-H-F Oscillator (250-920) Mc and  
 Type 1021-P3 V-H-F Oscillator (50-250 Mc.) — Total Price . . . **\$1015.00**  
 Type 1021-AV V-H-F Standard-Signal Generator (50-250 Mc) . . . \$595.00  
 Type 1021-AU U-H-F Standard-Signal Generator (250-920 Mc) . . . \$615.00

Type 1021-P1 Power Supply and 1000 cycle modulation source . . . \$195.00  
 Type 1021-P2 U-H-F Oscillator Unit only (250-920 Mc.) . . . \$420.00  
 Type 1021-P3 V-H-F Oscillator Unit only (50-250 Mc.) . . . \$400.00



# GENERAL RADIO Company

275 Massachusetts Avenue, Cambridge 39, Mass.



## for Bridge and Slotted Line Measurements

High output voltage of one volt across 50 ohms makes possible measurements over high noise levels. Filter characteristics may be taken over wider frequency ranges for given noise level.

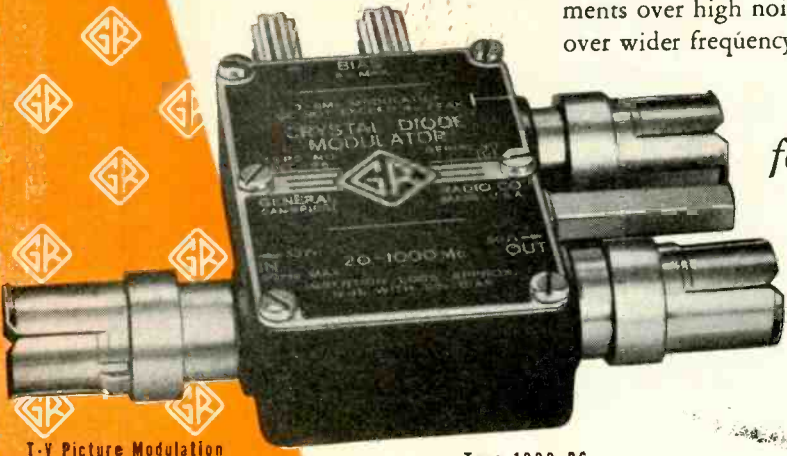

## for Pulse Modulation

and for T-V picture modulation, the Type 1000-P6 Crystal Diode Modulator provides the means to obtain it with *no* accompanying frequency modulation. Plugs into Signal Generator output externally. Video or pulse modulation is applied from any convenient source. Note these characteristics in charts below.

T-V Picture Modulation on all Channels

Type 1000-P6 Crystal Diode Modulator — \$35.00

from 50 to 920 Mc with *no* incidental FM, when Type 1000-P-6 Crystal-Diode Modulator and source of video signals are used. The power requirements for modulation are so low, video output from a standard T-V receiver can be used.

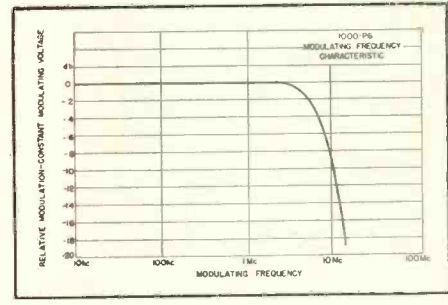

above Typical Modulation Characteristic at 300 Mc. Up to 30% modulation there is no significant difference in characteristic from 20 to 1000 Mc.

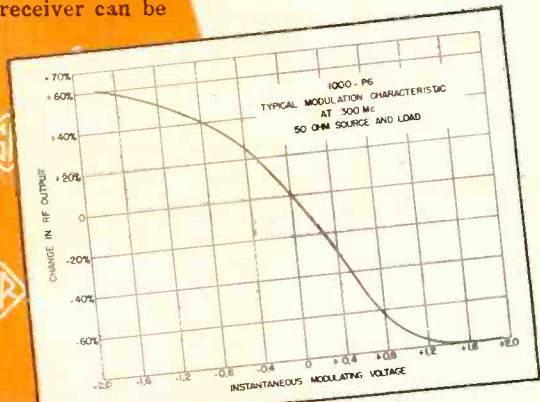

at left Frequency Characteristic of Type 1000-P6 Diode Modulator.

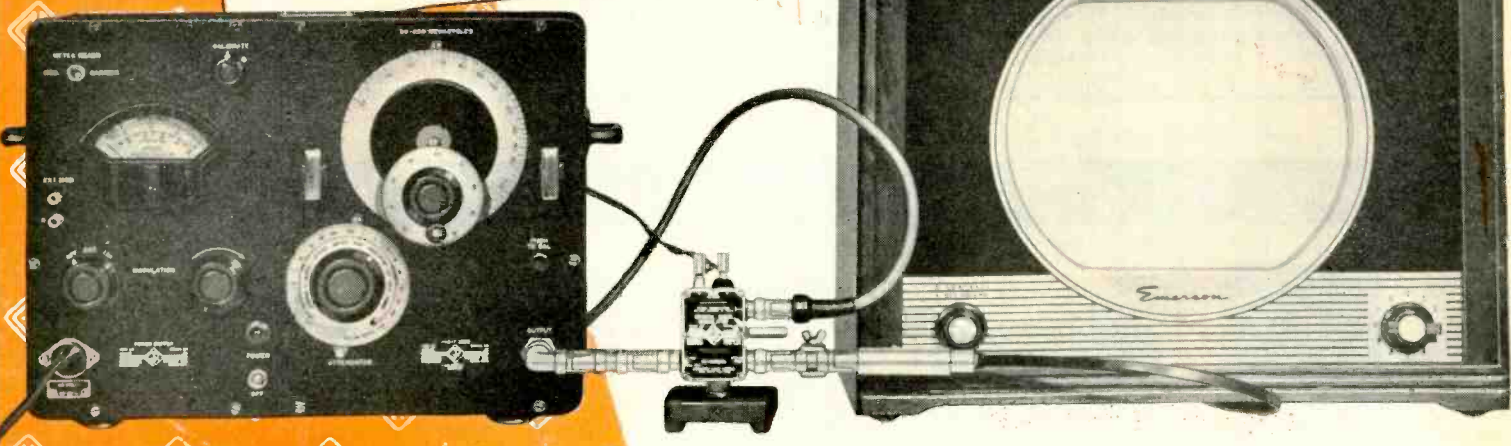

Type 1021-AV V-H-F Standard-Signal generator with Type 1000-P6 Crystal Diode Modulator, set up for tests on a television receiver.

90 West Street NEW YORK  
920 S. Michigan Ave. CHICAGO  
1000 N. Seward St. LOS ANGELES

Since 1915 — Designers and Manufacturers of Electronic Test Equipment  
STROBOSCOPES • VARIACS • SOUND-LEVEL METERS • VIBRATION METERS

IMPEDANCE BRIDGES • SIGNAL GENERATORS • OSCILLATORS • WAVE ANALYZERS • DISTORTION METERS • IMPEDANCE STANDARDS • VACUUM-TUBE VOLTMETERS • FREQUENCY STANDARDS • BROADCAST MONITORS • PARTS AND ACCESSORIES



# Dependable Synchronous Motor Driven INSTANTANEOUS RESET TIMERS

For Process Control  
in Industrial Applications



Here, incorporated into a single, compact unit, you obtain all the features that spell *performance, dependability, and long life.*

*Quality designing* has assured exceptional accuracy—plus simplicity that means trouble-free operation.

*Quality engineering* has built in dependability and strength—produced a precision instrument that stands up under hard industrial usage day in and day out.

**TIME SETTING**—The long pointer of the timer is simply turned to the dial calibration corresponding to the time cycle required. (The red actuating arm automatically takes the same position.)

When the timer is hooked up to a power source, its motor runs continuously. Upon pushing the starter button, a magnetically engaged clutch operates—causing the red actuating arm to start traveling immediately.

**RESET**—the instant the red actuating arm completes the time cycle, the clutch is disengaged, and the arm is returned to its reset position by spring action in a fraction of a second. Thus reset is *automatic and instantaneous.*

You will find this Industrial Timer—product of our long experience and close association with innumerable practical applications—*unsurpassed* for process control in industrial applications where precision timing and absolute dependability are essential.

Write us today for complete details—or, if you would like to send us specifications, we shall be glad to make recommendations based on your particular needs.

#### SERIES PAB INDUSTRIAL TIMERS

The simple clutch mechanism makes it possible to offer this type timer in a number of models, ranging from PAB-5S to the PAB-3H, as follows:

MODEL	TIMING RANGE	DIAL CALIBRATION
PAB-5S	5 cycles to 5 seconds	5 cycles
PAB-15S	1/4 second to 15 seconds	1/4 second
PAB-30S	1/2 second to 30 seconds	1/2 second
PAB-60S	1 second to 60 seconds	1 second
PAB-3M	2 seconds to 3 minutes	2 seconds
PAB-5M	5 seconds to 5 minutes	5 seconds
PAB-15M	15 seconds to 15 minutes	15 seconds
PAB-30M	30 seconds to 30 minutes	30 seconds
PAB-60M	60 seconds to 60 minutes	60 seconds
PAB-3H	2 minutes to 3 hours	2 minutes

Manufacturers of These and Other Timers and Controls for Industry



Time Delay  
Timers

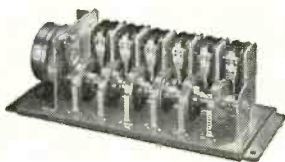

Multi-cam  
Recycling Timers



Manual  
Set Timers

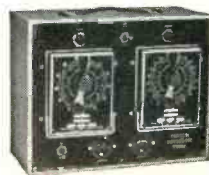

Tandem Automatic  
Recycling Timers



Running  
Time Meters

Timers that Control  
the Pulse Beat of Industry



**INDUSTRIAL TIMER CORPORATION**

115 EDISON PLACE, NEWARK 5, N. J.



# 12 TRUARC RINGS SAVE 25% MATERIAL ...50% LABOR COSTS...50% ASSEMBLY TIME

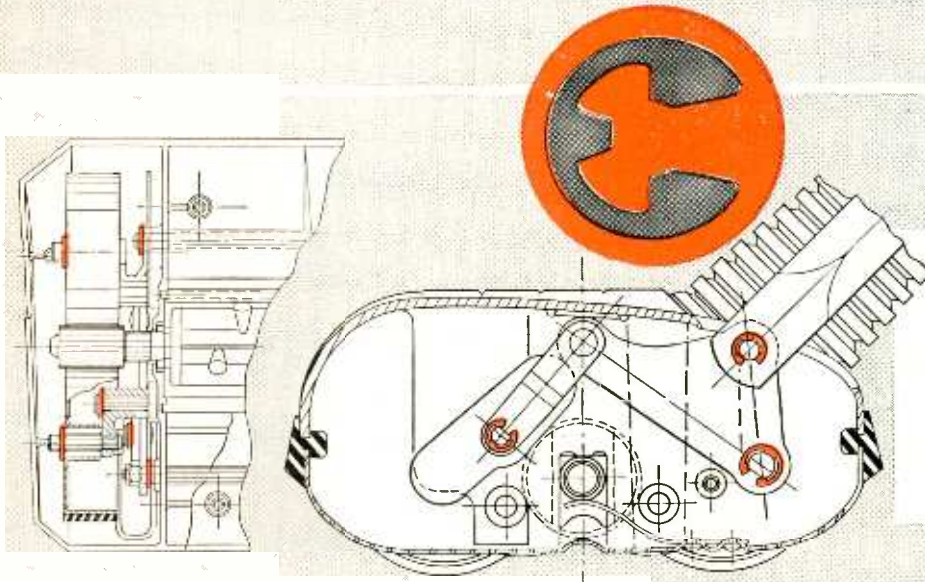

With Waldes Truarc Retaining Rings, assembly in hard-to-reach places is easier, since there are no washers and bulky lock nuts. Smaller shafts can be used. Unit is smaller, lighter, more efficient!

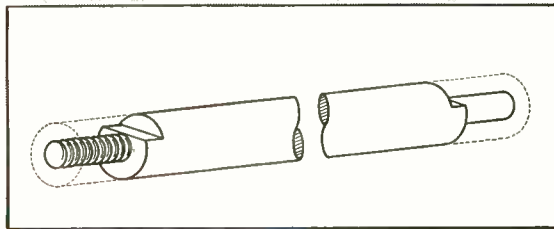

**CONVENTIONAL WAY:** 2 round rods were required, milled down to D-shape. 4 threading operations to accommodate lock nuts.

Using 12 Waldes Truarc E Retaining Rings in their new "101" Vacuum Cleaner nozzle brought the Lewyt Corporation, Brooklyn, N. Y. tremendous material and labor savings... eliminated 2 milling and 12 threading operations... made possible the use of stock extruded D-shaped rods... simplified maintenance. And with Waldes Truarc Rings unit is 15% lighter... 10% smaller overall!

Redesign with Truarc Rings and you too will cut costs. Wherever you use machined shoulders, bolts,

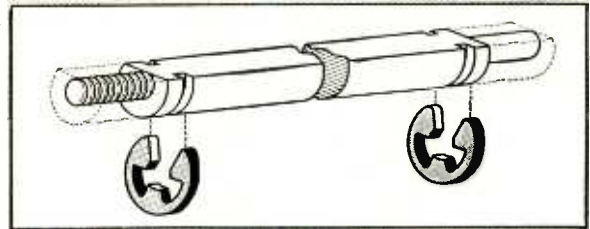

**TRUARC WAY:** Truarc Rings allowed Lewyt Corporation to use 2 stock D-shape rods. No milling... no threading—just 2 grooves!

snap rings, cotter pins, there's a Waldes Truarc Retaining Ring designed to do a better job of holding parts together.

Waldes Truarc Rings are precision-engineered... quick and easy to assemble and disassemble. Always circular to give a never-failing grip. They can be used over and over again.

Find out what Truarc Rings can do for you. Send your blueprints to Waldes Truarc engineers for individual attention, without obligation.

Waldes Truarc Retaining Rings are available for immediate delivery from stock, from leading ball bearing distributors throughout the country

SEND FOR NEW BULLETINS →

**WALDES**  
**TRUARC**

REG. U. S. PAT. OFF.

**RETAINING RINGS**

WALDES KOHINOOR, INC., LONG ISLAND CITY 1, NEW YORK

WALDES TRUARC RETAINING RINGS ARE PROTECTED BY THE FOLLOWING PATENT NUMBERS:  
U. S. PAT. 2,382,949; 2,420,921; 2,411,761; 2,487,803; 2,487,802; 2,491,306 AND OTHER PATS. PEND.



Waldes Kohinoor, Inc., 47-16 Austel Place E063  
Long Island City 1, N. Y.

Please send Bulletins 6, 7 and 8—giving engineering specifications for all types of Waldes Truarc Rings.

Name \_\_\_\_\_

Title \_\_\_\_\_

Company \_\_\_\_\_

Business Address \_\_\_\_\_

City \_\_\_\_\_ Zone \_\_\_\_\_ State \_\_\_\_\_

678



## **LOOK TO** *The* **RICHARDSON COMPANY** **FOR HELP ON PLASTICS** **FOR YOUR DEFENSE ORDERS**

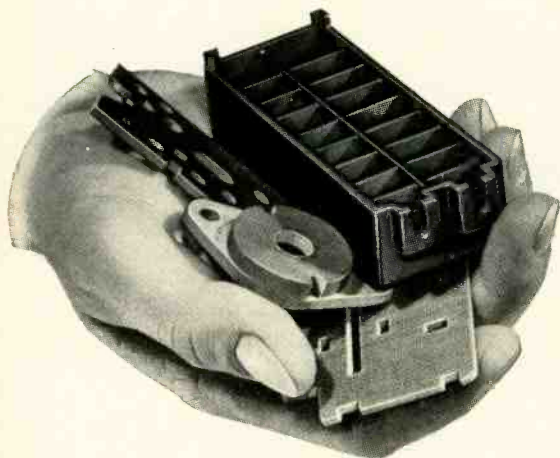

● If you have a puzzling plastics problem, consult The Richardson Company. The extensive services of its research, design, and engineering departments are offered you without cost or obligation.

Richardson engineers have a broad background in the plastics industry. For many years they have been co-operating with manufacturers in the selection or development of the correct plastics materials, choice of the proper manufacturing process, and actual production of the plastics part. Richardson's molding, laminating, and fabricating experience assure you a thorough handling of your plastics problem from beginning to end.

### **1 MATERIALS TO MEET GOVERNMENT REQUIREMENTS**

The Richardson Company has extensive experience in the volume production of materials made to meet government requirements. In addition, Richardson develops new materials for special applications.

### **2 FACILITIES FOR MOLDING AND LAMINATING**

Richardson is one of the few companies that have the engineering experience and production facilities to do both molding and laminating, and to produce molded laminates and post-formed laminates.

### **3 SIX PLANT LOCATIONS**

The Richardson Company operates large, modern plants at 6 widely separated locations: Melrose Park, Ill.; Indianapolis, Ind.; Newnan, Ga.; New Brunswick, N. J.; Tyler, Tex.; and Ogden, Utah.

## *The* **RICHARDSON COMPANY**

FOUNDED 1858 — LOCKLAND, OHIO

2797 Lake St., Melrose Park, Illinois (Chicago District)

**INSUROK**®  
Laminated and Molded Plastics

SALES OFFICES: Cleveland • Detroit • Indianapolis • Lockland, Ohio • Los Angeles  
Milwaukee • New Brunswick, (N. J.) • New York • Philadelphia • Rochester • St. Louis





# SWIFT, SURE FREQUENCY COMPARISON

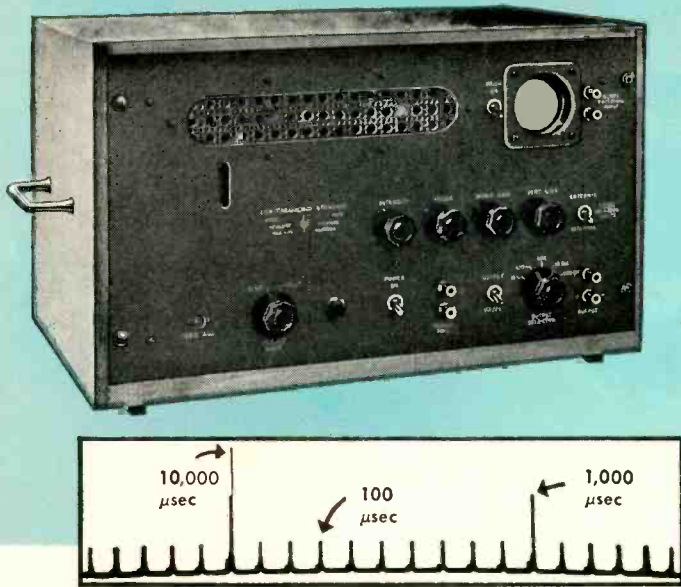

FIG. 1. Timing Comb, -hp- Model 100D

## NEW **hp** SECONDARY FREQUENCY STANDARDS

### MODELS 100C AND 100D

- Sine or rectangular waves
- 100  $\mu$ sec time markers
- Built-in oscilloscope
- Stability 1/1,000,000
- Low output impedance
- New, improved circuits
- Audio, supersonic, rf measurements

## SPECIFICATIONS

### -hp- 100D Secondary Frequency Standard

- Accuracy:**  
About 2 parts per million per week, normal room temperature.
- Stability:**  
About 1 part per million over short intervals.
- Output:**  
Controlled frequencies: 100 kc, 10 kc, 1 kc, 100 cps, 10 cps. Sine or rectangular waves; marker pips. Internal impedance approx. 200 ohms.
- Wave Shape:**  
Sine wave: less than 4% distortion into 5,000 ohms or higher load.
- Marker Pips:**  
10,000, 1,000 and 100  $\mu$ sec intervals.
- Oscilloscope:**  
Integral with circuit. Establishes 10:1 Lissajous figures to show division ratio. May be used independently of standard.

### -hp- 100C Secondary Frequency Standard

- Accuracy:**  
Within  $\pm .001\%$  normal room temperature.
- Output:**  
Controlled frequencies of 100 kc, 10 kc, 1 kc, and 100 cps. Internal impedance approx. 200 ohms.
- Wave Shape:**  
Sinusoidal only. 4% distortion into 5,000 ohm load.
- Power Supply:**  
(100C and 100D) 115 v, 50/60 cps, regulated to minimize line voltage fluctuations. Power drawn approx. 150 watts.
- Mounting:**  
(100C and 100D) Cabinet or relay rack. Panel 19" x 10 $\frac{1}{2}$ " x 12" deep.

Data Subject to Change Without Notice

The new -hp- 100C and 100D Secondary Frequency Standards incorporate all the features of the time-tested -hp- models 100A and 100B, plus important new advantages including rectangular wave output, timing pips, and an internal oscilloscope for convenient frequency comparison. The -hp- 100D may be conveniently standardized against station WWV with a minimum of external equipment, and thus provide most of the advantages of an expensive primary standard.

### Crystal Controlled Frequencies

The new -hp- Models 100D and 100C employ a crystal-controlled oscillator and divider circuits offering a new high in stability and simplicity of operation. Standard frequencies are available through a panel selector switch, and may be employed simultaneously. Internal impedance is low (about 200 ohms), so that standard frequencies can be delivered at some distance from the instrument.

The -hp- 100D Secondary Frequency Standard offers sine waves at 5

frequencies and rectangular waves at 4 frequencies, plus a built-in oscilloscope. The instrument also provides a timing comb with markers 100, 1,000 and 10,000 microsecond intervals. Rectangular wave output has a rise time of approximately 5 microseconds. Accuracy is 2 parts per million.

### 5 v. at all Frequencies

The more moderately priced -hp- 100C Standard offers sinusoidal frequencies at 4 crystal-controlled frequencies and, like the -hp- 100D, provides 5 volts of output at all frequencies. Accuracy .001%.

Both models operate from a 115 v. ac power supply, and power is regulated to minimize power line voltage fluctuations.

Get full details... see your  
-hp- representative or write  
direct... today!

### HEWLETT-PACKARD CO.

1977A Page Mill Road • Palo Alto, Calif.  
Export: FRAZAR & HANSEN, LTD.  
301 Clay Street, San Francisco, Calif., U. S. A.  
Offices: New York, N. Y.; Los Angeles, Calif.

**hp** laboratory instruments  
FOR SPEED AND ACCURACY

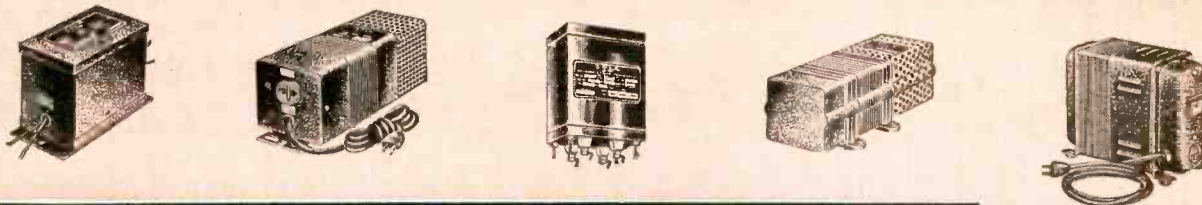

# SOLA voltage regulation

## for Military Components

TYPICAL EXAMPLES

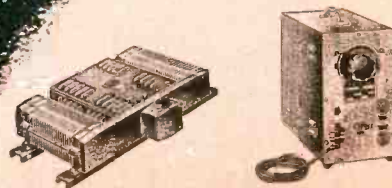

OF THE MANY REGULATING

Unfailing voltage control is vital to the performance of today's complex, sensitive electrical and electronic military devices. The manufacturer of such a device can insure its continuous optimum performance by "building in" a SOLA Constant Voltage Transformer to insure the proper input voltage required.

SOLA regulators are ideal for military use. They are rugged . . . completely automatic . . . instantaneous in response . . . have no moving or expandable parts . . . require no manual adjustment or maintenance . . . and are self-protecting against short circuit. The standard units will regulate secondary voltage output within  $\pm 1\%$  regardless of continuous line voltage fluctuations as great as 30%.

In addition to line voltage regulation for 115 and 230 volt service, SOLA regulators are available in many special types such as: harmonic-neutralized units for commercial sine wave output; regulated plate and filament power supply transformers; adjustable, regulated A.C. voltage supplies; low voltage, high current filament transformers for oscillators and other large tubes.

The engineering skill and production facilities of the SOLA ELECTRIC CO., the world's largest manufacturer of constant voltage transformers, are available for defense production. SOLA regulators were purchased during World War II directly by the Signal Corps, Air Force and Navy as well as primary military contractors.

We invite your inquiries about standard and custom designed regulators, or the use of SOLA engineering and production facilities as a sub-contractor. Your request will be promptly answered.

TRANSFORMER TYPES

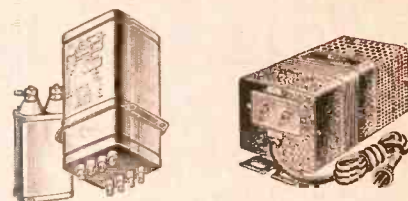

PRODUCED BY THE



SOLA ELECTRIC CO.

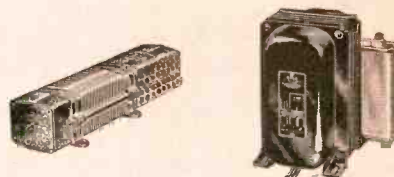

# SOLA *Constant Voltage* TRANSFORMERS

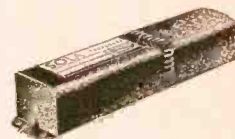

Transformers for: Constant Voltage • Fluorescent Lighting • Cold Cathode Lighting • Airport Lighting • Series Lighting • Luminous Tube Signs • Oil Burner Ignition • X-Ray • Power • Controls • Signal Systems • etc. • SOLA ELECTRIC CO., 4633 W. 16th Street, Chicago 50, Illinois





# TONE ARMS— STYLI



Type UPX-006

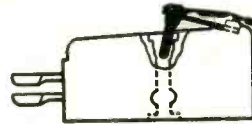

Type RPX-041

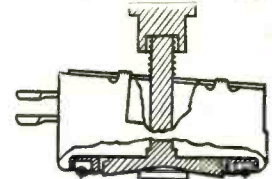

Type RPX-050 (Triple Play)

**...still available**  
**...still tops**

### HERE'S PLUS BUSINESS!

Use G-E phono Preamplifiers to sell *modernization* to your customers. Self-contained for easy installation, these units are ready to operate when connected to a power source. They provide sufficient amplification to enable the Variable Reluctance Cartridge to be used with any standard phonograph.

**P**RODUCT shortages? Sure. But there's *never* a letdown in the *quality* of G-E phono-accessories . . . and the items shown above are still available to manufacturers, jobbers, dealers and servicemen.

The G-E tone arm is built to accommodate the famous G-E Triple Play Cartridge (also in stock). It's equipped with ball bearings for smooth lateral movement . . . special light weight alloy keeps the arm mass to a minimum . . . stylus pressure is *constant at 6-8 grams for all three speeds* to reduce record wear. Plainly marked selector knob projects through the top of the arm—a single twist

places either stylus in playing position.

General Electric's high compliance Baton Stylus with diamond or sapphire tip is unsurpassed in its field. Stock it in quantity—give your customers listening quality that lasts.

**MANUFACTURERS:** Your production requirements of General Electric phono-accessories can still be filled. General Electric application engineers have suggestions that will help you design a better product. Call or wire us today for details. *General Electric Company, Parts Section, Electronics Park, Syracuse, New York.*

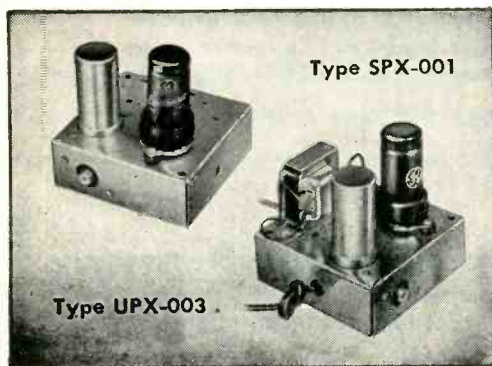

Type SPX-001

Type UPX-003

General Electric Company, Section 461  
Electronics Park—Syracuse, N. Y.

Please forward information on the G-E phono accessories checked:

- Variable Reluctance Cartridges     Replacement Styli     Phono Preamplifiers     Tone Arms

NAME \_\_\_\_\_

ADDRESS \_\_\_\_\_

CITY \_\_\_\_\_ STATE \_\_\_\_\_

**GENERAL ELECTRIC**



# MYCALEX

## low loss miniature **TUBE SOCKETS**

**OFFER ALL THESE ADVANTAGES:**

- ..... CLOSER TOLERANCES
- ..... LOWER DIELECTRIC LOSS
- ..... HIGH ARC RESISTANCE
- ..... HIGH DIELECTRIC STRENGTH
- ..... GREAT DIMENSIONAL STABILITY
- ..... IMMUNITY TO HUMIDITY
- ..... HIGH SAFE OPERATING TEMPERATURE

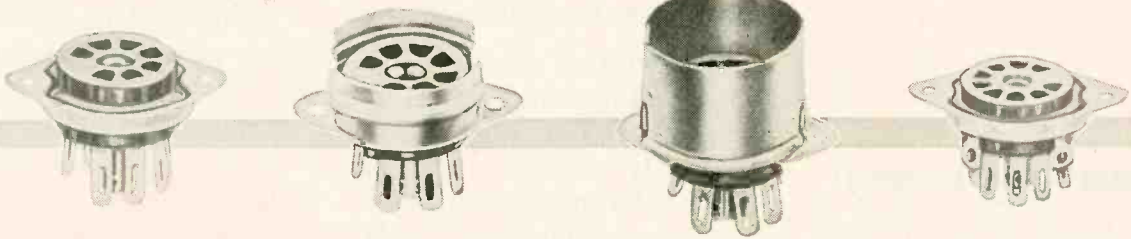

- cost no more than

### **PHENOLIC TYPES**

These glass-bonded mica sockets are produced by an exclusive MYCALEX process that reduces their cost to the level of phenolic sockets. Electrical characteristics are far superior to phenolics while dimensional accuracy and uniformity exceed that of ceramic types.

MYCALEX miniature tube sockets, available in 7-pin and 9-pin types, are injection molded with great precision and fully meet RTMA standards. They are produced in two grades,

described as follows, to meet diversified requirements.

MYCALEX 410 is priced comparable to mica-filled phenolics. Loss factor is only .015 at 1 mc., insulation resistance 10,000 megohms. Conforms fully to Grade L-4B under N.M.E.S. JAN - 1 - 10 "Insulating Materials Ceramic, Radio, Class L".

MYCALEX 410X is low in cost but insulating properties greatly exceed those of ordinary materials. Loss factor is only one-fourth that of phenolics (.083 at 1 mc.) but cost is the same. Insulation resistance 10,000 megohms.

#### **MYCALEX TUBE SOCKET CORPORATION**

Under Exclusive License of  
MYCALEX CORPORATION OF AMERICA  
30 ROCKEFELLER PLAZA, NEW YORK 20, N. Y.



### **CORPORATION OF AMERICA**

"Owners of 'MYCALEX' Patents"  
Executive Offices: 30 Rockefeller Plaza, New York 20 • Plant and General Offices: Clifton, New Jersey



# *Federated* ROSIN CORE SOLDER

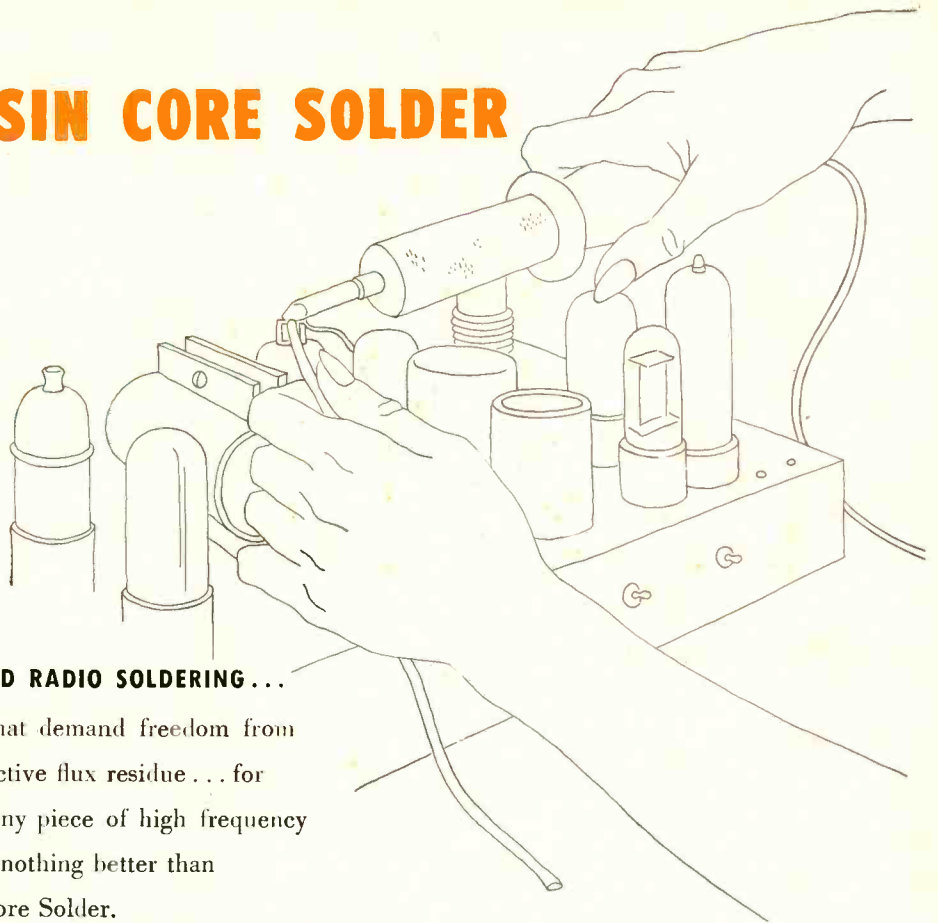

## *for* TELEVISION AND RADIO SOLDERING...

for operations that demand freedom from corrosion and conductive flux residue... for soldering on any piece of high frequency equipment... there is nothing better than Federated Rosin Core Solder.

Each Rosin Core Solder composition is a precise alloy of tin and lead with a pure turpentine distillate flux that is effective but not corrosive.

This means that current leakage at radio frequencies is prevented.

Federated Rosin Core Solder is unequalled for consistency and ease of working... for the permanence of the bond it produces. Look for it on the familiar orange and black metal spool. 1, 5, and 20-pound sizes.



# *Federated Metals Division*



AMERICAN SMELTING AND REFINING COMPANY • 120 BROADWAY, NEW YORK 5, N. Y.

*Home entertainment has changed*



**... and in producing better and better TV**  
**MODERN ELECTRONICS LOOK TO HI-Q\***  
 Capacitors • Trimmers • Choke Coils • Wire Wound Resistors

The fast development of the television industry since World War II has been matched, stride for stride, by **HI-Q**. For TV producers were quick to recognize this organization as their most dependable source for the ceramic components they needed in such profusion. They quickly learned that **HI-Q** engineers were competent and resourceful in developing new components to meet new needs as they arose.

Now, though **HI-Q** output has reached several million capacitors, trimmers, choke coils and wire wound resistors each month, never once have the original precision standards or strict adherence to specifications and tolerances been shaded — or the rigid system of inspection of each individual unit at each stage of production been relaxed. The **HI-Q** engineering staff is just as ready as ever to cooperate with your engineers in the production of special components for special requirements.

JOBBERS—ADDRESS: 740 Belleville Ave., New Bedford, Mass.

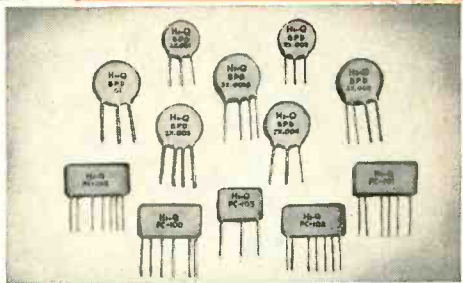

**HI-Q DISKS AND PLATES**

High dielectric by-pass, blocking or coupling capacitors for use where their geometrical shape makes them more adaptable than tubular components. Essentially similar, other than shape, except that in multiple units, **HI-Q** Plates do NOT have to have a common ground, as is the case with the Disk type.

**BETTER 4 WAYS**

- ✓ PRECISION
- ✓ UNIFORMITY
- ✓ DEPENDABILITY
- ✓ MINIATURIZATION

*\*Trade Mark Registered, U. S. Patent Office*



**Electrical Reactance Corp.**  
 OLEAN, N. Y.

SALES OFFICES: New York, Philadelphia, Detroit, Chicago, Los Angeles

PLANTS: Olean, N. Y., Franklinville, N. Y. Jessup, Pa., Myrtle Beach, S. C.





## Where did this car come from?

Most of us think that new cars come from big auto-making cities.

But the fact is, new automobiles are assembled in these cities—but their hundreds of parts come from every state in the union!

Bringing in these parts involves plenty of expert timing. A few missing pieces

can slow up production seriously. A few missing doorhandles can stop an assembly line!

But the auto makers never let that line stop. They keep their cars rolling by using the speed of planes. They bring in needed parts by Air Express!

Today, with increased production for defense, Air Express speed helps keep the tanks and planes rolling, too. Whatever your business, here are the unique advantages you can enjoy with regular use of Air Express:

**IT'S FASTEST** — Air Express gives the fastest, most complete door-to-door pick up and delivery service in all cities and principal towns, *at no extra cost.*

**IT'S MORE CONVENIENT** — One call to Air Express Division of the Railway Express Agency arranges everything.

**IT'S DEPENDABLE** — Air Express provides one-carrier responsibility all the way and gets a receipt upon delivery.

**IT'S PROFITABLE** — Air Express expands profit-making opportunities in distribution and merchandising.

For more facts call Air Express Division of Railway Express Agency.



**AIR EXPRESS**  
**GETS THERE FIRST**

IN BUSINESS



SINCE 1904

# Wire for Defense Projects!

**HOOK-UP WIRES and CABLES  
for COMMUNICATIONS EQUIPMENT  
and ELECTRONIC INSTRUMENTS**

**F**OR almost a half century Lenz has been producing insulated Wires and Cables for the Communications Industries, wires that are engineered and designed under high quality standards.

Now, Lenz is prepared to furnish hook-up wire and cables for defense projects, conforming to Government specification JAN-C-76 TYPES WL, SRIR and SRHV. These Thermo-Plastic Insulated Wires, with or without Lacquered Braids, and the cables constructed of same, are available for use in Communications Equipment and Electronic Instruments.

For a dependable source for your wire and cable requirements, consult Lenz.

CONFORMING TO  
**JAN-C-76**  
TYPES WL, SRIR and SRHV

IN THE AIR



ON LAND



ON THE SEA

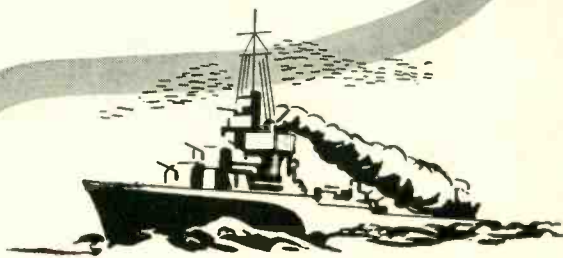

**LENZ ELECTRIC MANUFACTURING CO.**

1751 No. Western Ave. • Chicago 47, Illinois





A detailed black and white illustration showing various office tasks. In the top left, hands are seen writing on a document. In the top right, hands are handling a stack of envelopes, one of which is addressed to 'SOMECOT CO. INC. CHICAGO, ILL.'. In the middle left, hands are working with a clipboard and a pen. In the bottom left, hands are using a tool to cut a piece of material. In the bottom right, hands are holding a large, framed document or certificate. The central text is set against a white background.

## SERVICE . . . .

From mail desk to shipping platform every order for Republic Aluminum Foil is constantly in capable hands — hands guided by minds that recognize every individual's responsibility of filling orders accurately and quickly with a product of flawless quality.

### REPUBLIC FOIL & METAL MILLS INCORPORATED

SALES OFFICES: 209 W. Jackson Blvd., Chicago 6, Ill.  
666 Mission St., San Francisco 5, Cal.

DANBURY

CONNECTICUT

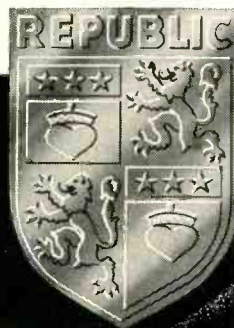



*Best for Your  
Essential Production*

**...INDIANA  
High-Energy  
PERMANENT MAGNETS**

Need permanent magnets?

Call in INDIANA, world's *largest* producer!

INDIANA makes nothing but permanent magnets . . .

all materials, all types, all sizes . . .

and renders *completely unified service*

from magnet design to delivery.

At INDIANA, permanent magnets get full-time attention

from a staff of highly qualified specialists.

**SAVE TIME AND MONEY**

Whether you want reliable "use" information or a dependable source of supply, you'll find the *whole organization* ready and willing to help speed defense and essential production.

The industry's greatest diversification and broadest experience are yours without cost

when you call in INDIANA, sole makers of Hyflux Alnico V . . .

*highest energy product* of any magnet material.

*Write or Phone Today!*

**INDIANA  
PERMANENT  
MAGNETS**

**THE INDIANA STEEL PRODUCTS COMPANY**

VALPARAISO, INDIANA • • • Sales Offices Coast to Coast

SPECIALISTS IN "PACKAGED ENERGY" SINCE 1908

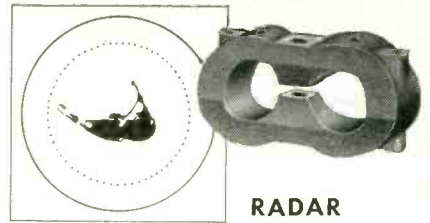

**RADAR**

Stability, inherent in permanent magnets, makes magnetron tubes practical.

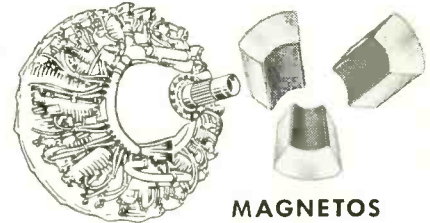

**MAGNETOS**

Reliability of permanent magnets makes magnetos the most dependable form of ignition.

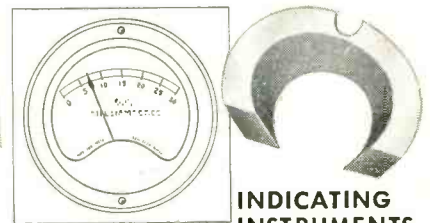

**INDICATING INSTRUMENTS**

Permanent magnets are essential to hundreds of types of instruments.

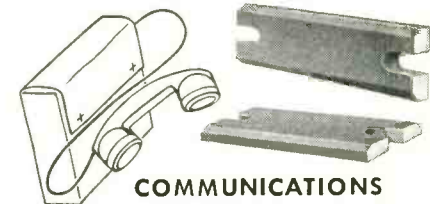

**COMMUNICATIONS**

Trouble-free permanent magnets permit unattended operation indefinitely.

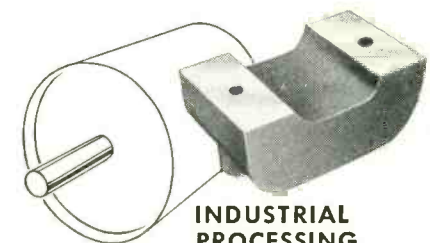

**INDUSTRIAL PROCESSING**

Versatility of permanent magnets is continually improving processing. Illustrated: separator pulley for removing tramp iron from bulk material.

Many types and sizes of permanent magnets are available at once for your experimentations.



**Only General Industries  
provides a Complete line of**

**TURNTABLE  
MOTORS**  
Three Speed  
Dual Speed  
Single Speed

**RECORD-CHANGER  
MOTORS**  
Three Speed  
Dual Speed  
Single Speed

**PLUS** the popular,  
profitable

**MODEL 250**  
Tape-Disc

**RECORDER ASSEMBLY**

It's the famous General Industries *Smooth Power* line, backed by years of proved dependability in America's leading radio-phonographs and other sound reproduction units.

Write today for complete information, including specifications, design features and dimensions. Quantity price quotations available on request.



**The GENERAL INDUSTRIES Co.**

DEPARTMENT B • ELYRIA, OHIO



# it's magic!

and that magical word in  
today's lower-cost  
higher-quality  
tv-radio specs  
is



Sheer magic! This Croloy Radio Rod with suitable winding, replaces usual loop in today's advanced radios.

"Q" is of the order of 250 and up, as against 80 for average small loop mounted inside receiver. The Croloy Radio Rod fits anywhere — only 8" long by 1/2" diameter, or smaller. Pivoted and rotated for additional selectivity, or mounted vertically for omnidirectional reception. On the production line, the magnetic antenna can be mounted on chassis for complete assembly and test, before placement in cabinet.

Molded in widest ranges of shapes and sizes, Croloy provides other magical touches. Croloy deflection yokes expand TV-tube deflection angles without corresponding voltage increases. Croloy cores slash TV transformer bulk and cost. Croloy slug tuners and I. F. coils reduce cost and raise gain. Croloy components cut TV cabinet sizes and prices. Try Croloy: it's magic!

Let us collaborate  
on your TV, radio or electronic  
problems and needs.  
Samples, engineering service,  
and quotations.

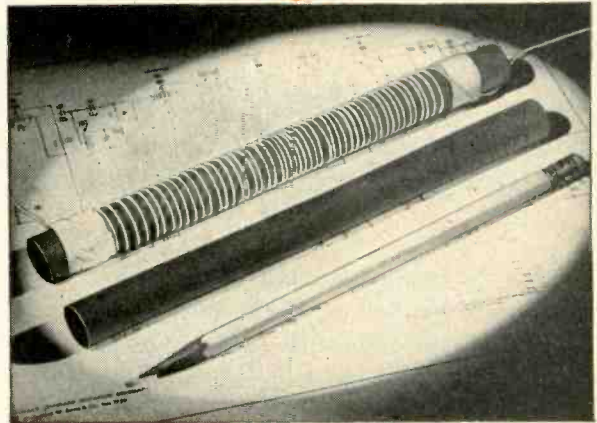

**HENRY L. CROWLEY & COMPANY, INC.**  
Pioneering POWERED-IRON and STEATITE products  
1 Central Avenue  
West Orange, N. J.



## **We Mobilize for Freedom**

# **WHY Controls are Necessary**

One of the encouraging characteristics of the American people is their dislike for government controls. This augurs well for the future of their economic and political freedom.

**But for the next few years we must not only tolerate but also help to make effective a whole battery of emergency government controls over our economic life.** If we fail to do this now the future of that freedom we cherish will be imperilled. It is the purpose of this editorial—the third in a special series—to explain in simple terms why this is so.

After our military victory in World War II, we rushed through a demobilization which cut our military strength to about one-tenth of its wartime peak. Our allies did much the same thing. But the Russians maintained much of their wartime military strength and built up that of their satellites. With prodigious speed we switched from military to civilian production and went on to enjoy a rousing postwar boom—the greatest in our history.

This boom was in vigorous progress when, on June 25 last year, the Russian-sponsored North Korean army attacked South Korea. Our industrial production was rolling along at almost twice its prewar level. We had labor shortages in many key industrial areas. Under the impact of heavy buying all along the line, prices were climbing.

When the North Koreans smashed into

South Korea they smashed into our national consciousness this fact: if we want a fair chance to save our national freedom from destruction by Communist aggression, we must race to restore some of the military power we had so speedily written off after World War II. And we must do it with our resources already very fully occupied with a boom in civilian business.

### **Program Small Compared to World War II**

Compared with our military effort in World War II, the mobilization on which we are now embarked is small. At its peak, under present schedules, it will absorb no more than one-fifth of the total national production. During World War II we reached a point when nearly half of our total production went for war-making.

Moreover, our economy now is much bigger and stronger than it was in World War II. During the last decade there has been an increase of about 15 percent in our labor force. Our workers have had the training advantage of steady employment. The capacity of our industrial establishment is two-thirds again as great as it was ten years ago. Since the war no less than \$70 billion has been spent to expand and modernize it.

Given time, the industrial giant we have created could pick up in its stride the added load of production for defense that now is con-

templated. But speed is of the very essence. There is little dissent from the proposition that if we are to stand off Russian aggression successfully we have, at the outside, two years in which to get ready.

### **Controls Needed to Prevent Chaos**

These two facts — (1) the necessity for speed in our rearmament program and (2) an economy already stretched taut by a record civilian boom—create the general necessity for government controls. If we simply pile the billions of added defense expenditures authorized since last June on top of the civilian boom, and let it go at that, two destructive developments would follow. There would be a scramble for scarce materials, notably metals, which would create chaos in those markets. And prices would go through the roof.

**Our situation during this mobilization is radically different from what it was when we rushed to get ready for World War II.** Then we started with an economy that was coming out of a long depression. There was plenty of slack. Even in mid-1941 we still had over 6 million unemployed. Thus it was possible for us to expand war production greatly and also increase civilian living standards before the limits of our productive capacity made extensive controls necessary. But as we begin this new mobilization we find our economy already operating virtually at capacity. This fact is of key importance in understanding why this relatively small defense program so quickly requires the imposition of controls.

**The selection and administration of controls thus far has been badly bungled.** The threat of price controls, for example, was broadcast so vigorously and for so long that our people were virtually asked to raise prices and thereby do much to defeat the controls. Adequate taxation directed so as to attack inflation at the source and thus give direct price control a chance to operate has not yet been provided.

Indeed, we could readily assemble a long and devastating catalog of the deficiencies of

the government's control program. But that would not dispose of the necessity for controls—by priority, by allocation, and, as a stop-gap, by direct prescription of selling prices—if we are to carry out our mobilization successfully. That is the only means by which a clear right of way for defense production can be cut through the highways of trade and commerce now jammed with civilian boom business.

### **Hope In The Wilson Plan**

Since he became Director of Mobilization, Charles E. Wilson has added a new element of order and hopefulness to the mobilization program. He has laid out a plan which, if we are spared all-out war, would do three things by 1953. First, it would produce the weapons needed by our army and our allies to meet an immediate threat. Second, it would create the capacity that would enable us to move at high speed into weapons production for all-out war—if necessary. Third, it would create the additional production capacity that would restore by that date our ability to resume the climb of the American civilian standard of living.

**In technical and industrial terms the Wilson Plan seems to be feasible. If it is successfully carried out, we should be able to begin getting rid of controls rapidly by 1953.** But to carry out the program successfully, it must now have vigorous support from everyone. That does not mean mere agreement that it is a good plan. It means that we must conform to the controls that are necessary to make the plan work. In developing this support, the business community is in position to exercise crucially important leadership.

As has often happened in our national history, we are confronted by a paradox. We must accept emergency controls for the time being to insure survival of the freedom that they infringe. But, as we do this, we may find some comfort in the reflection that while controls from Washington are hateful, controls from Moscow would be infinitely worse.

**McGraw-Hill Publishing Company, Inc.**





*versatile*

Multi-channel --  
telegraph A1 or  
telephone A3.

FROM GROUND TO AIR OR POINT TO POINT

**STABLE**

High stability (.003%) under  
normal operating  
conditions.

**RUGGED**

**Components  
conservatively  
rated. Completely  
tropicalized.**

*Model 446 transmitter operates on 4 crystal-controlled frequencies (plus 2 closely spaced frequencies) in the band 2.5-13.5 Mcs (1.6-2.5 Mcs available). Operates on one frequency at a time; channeling time 2 seconds. Carrier power 350 watts, A1 or A3 AM. Stability .003% using CR-7 (or HC-6U) crystals. Operates in ambient 0° to -45° C using mercury rectifiers; 35° to -45° C using gas filled rectifiers. Power supply, 200-250 volts, 50/60 cycles, single phase. Conservatively rated, sturdily constructed. Complete technical data on request.*

**Here's the ideal general-purpose high-frequency transmitter! Model 446 ... 4-channel, 6-frequency, medium power, high stability. Suitable for point-to-point or ground-to-air communication. Can be remotely located from operating position. Co-axial fitting to accept frequency shift signals.**



3090 DOUGLAS ROAD

MIAMI 33, FLA.

Reg. U.S.

Pat. Off.

**Consultants, designers and manufacturers of standard or special electronic, meteorological and communications equipment.**

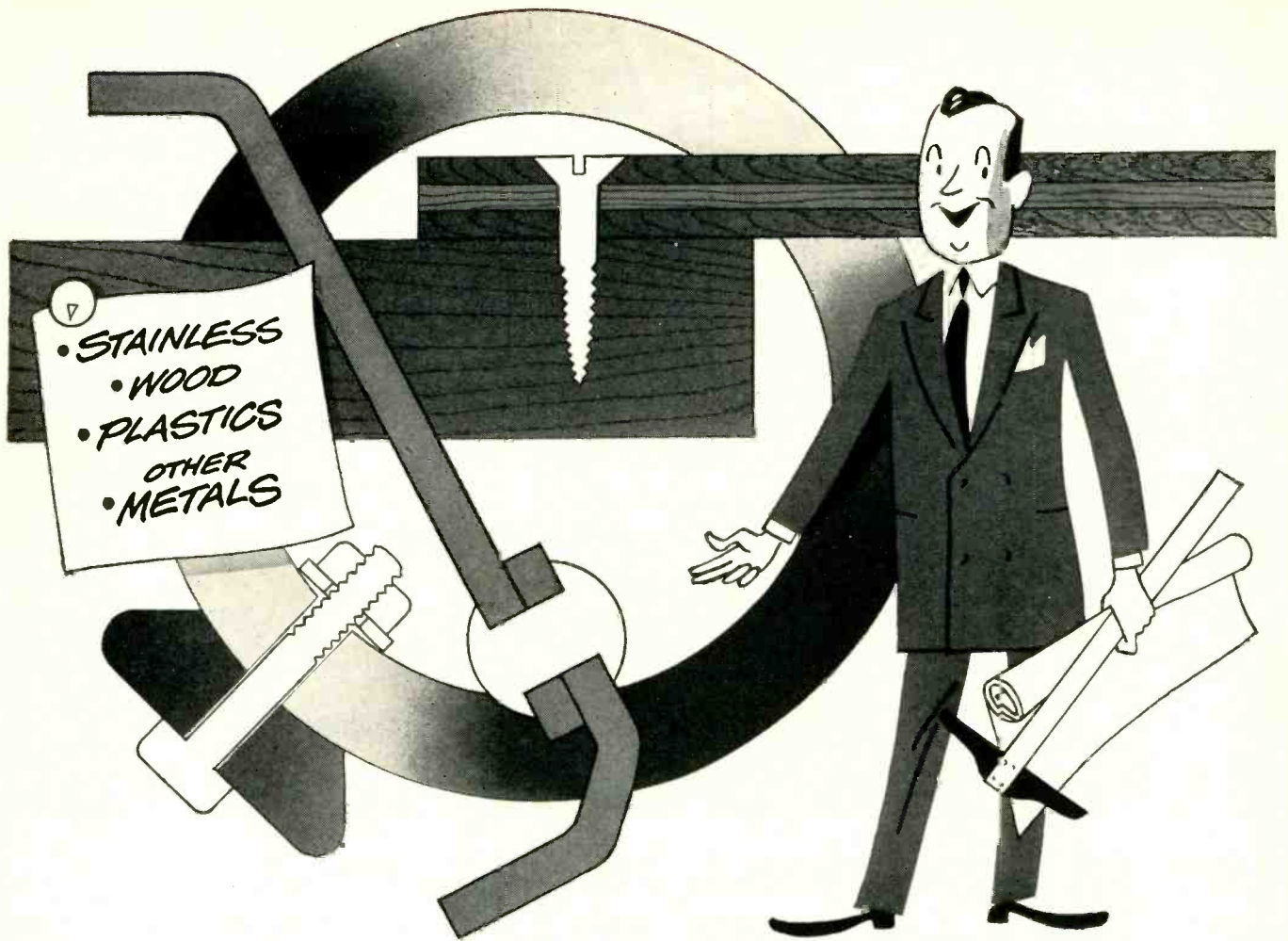

# Fasten it with **STAINLESS STEEL** for Better Looks - Longer Life

## LEADING PRODUCERS OF FASTENERS USE ALLEGHENY METAL

A complete line of stainless steel fasteners—all types and sizes of bolts and nuts, rivets, wood and machine screws, cotter pins, washers, etc.—are made of Allegheny Metal by the leading manufacturers in this field. Get in touch with them for catalogs and prices, or write us direct.

ADDRESS DEPT. E-18

Allegheny Metal fasteners are non-rusting, non-staining. They will last as long as, or longer than, the materials they join. You can count on them to stand up through the years—both in strength and in bright good looks.

Best of all, stainless steel fasteners can be used anywhere. It isn't necessary that the materials to be joined are stainless—these corrosion-proof fasteners are the perfect answer for joining other metals, woods, or plastics.

Fasteners made of Allegheny Metal are produced in complete variety—every type and size that your job requires.

For improving quality and reliability wherever they're used—and for the economy of lifetime service—specify fasteners made of the time-tested stainless steel, *Allegheny Metal*. ● For any technical data or engineering help in the use of stainless steel, address *Allegheny Ludlum Steel Corporation, Henry W. Oliver Bldg., Pittsburgh 22, Pa.*

You can make it **BETTER** with  
**Allegheny Metal**



W&D 3590



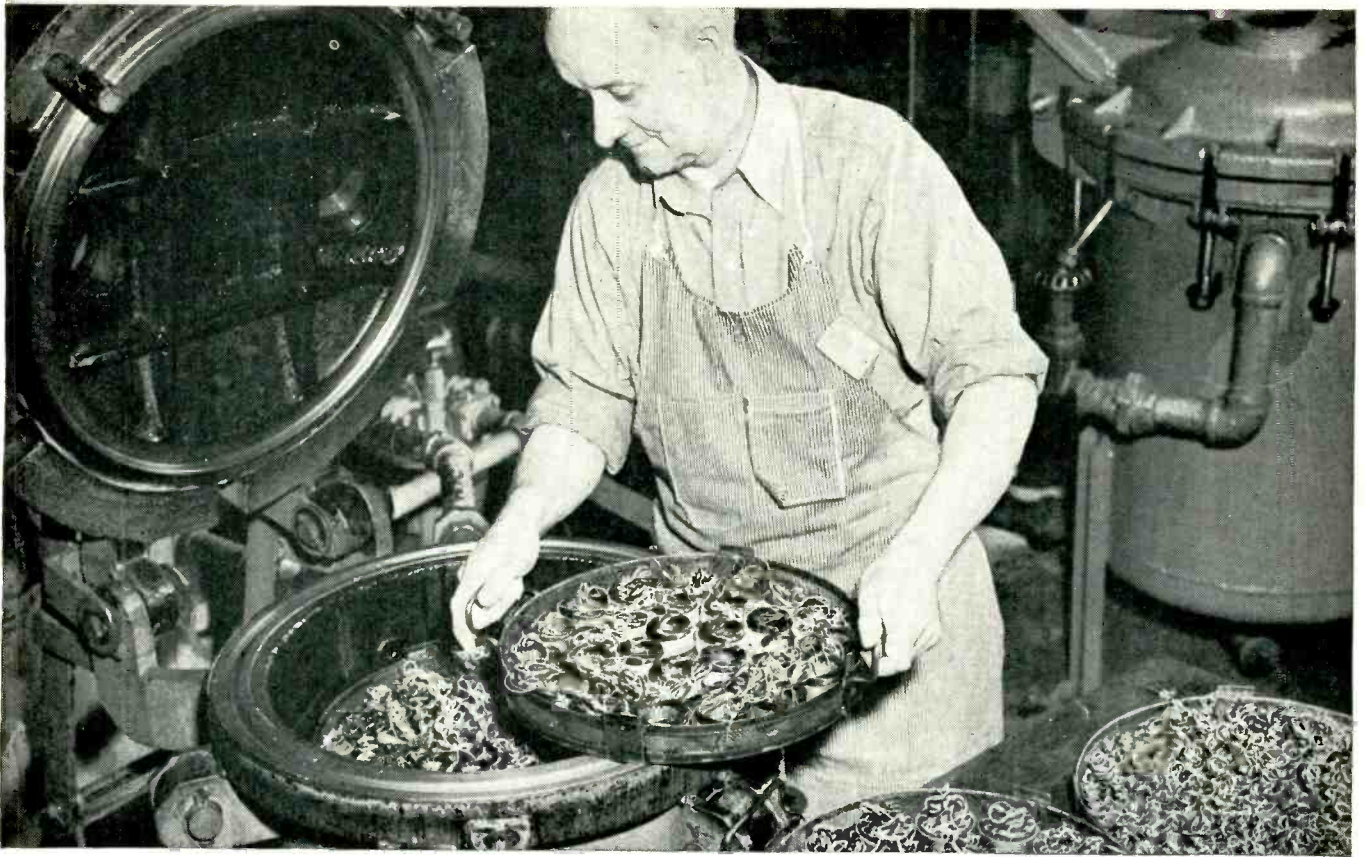

## For *lasting* insulation strength, Sperry counts on **HARVEL 912-C**

For more than 10 years, Sperry Gyroscope Company has been insulating coils and other components with Harvel Internal Curing Varnishes, because of their excellent mechanical and electrical properties. Sperry . . . world famous for the quality and performance of its instruments . . . reports these specific advantages from the use of Harvel 912-C, electrical insulating varnish:

1. *High mechanical strength.* Conductors rigidly bonded into a compact mass. No soft, tacky varnish interiors to allow movement of conductors.
2. *High dielectric strength . . .* 2200 vpm. Electrical properties retained at high temperatures—unaffected by oil.
3. *Fast baking time.* 912-C cuts baking schedules as much as 50%—materially reduces production costs.

Sperry also turns to Irvington for Class "H" flexible insulations when space and weight are at a premium. Running safely at temperatures as high as 500°F, these insulations permit using smaller conductors, and thus open the way to lighter, more compact designs. It will pay you to investigate these Irvington products—mail coupon today for the full story.

Look to

**IRVINGTON**

for insulation leadership

INSULATING VARNISHES

VARNISHED CAMBRIC

VARNISHED PAPER

VARNISHED FIBERGLAS

INSULATING TUBING

CLASS "H" INSULATION



EL-6/51

Send this convenient coupon now

# Irvington

VARNISH & INSULATOR COMPANY

Irvington 11, New Jersey

Irvington Varnish & Insulator Co.  
6E Argyle Terrace, Irvington 11, N. J.

Gentlemen:

Please send me technical literature on:

Harvel 912-C Varnish  Class "H" Insulation

Name.....

Company.....

Street.....

City..... Zone..... State.....



Westinghouse Switchboard Instruments are used as "standards" on this Universal Tube Test Station manufactured by Radio Corporation of America.

Westinghouse Switchboard Instruments are available in circular or conventional scale types for any switchboard application.



# Where instrument accuracy is a "Must" . . .

## ← specify Westinghouse

The use of Westinghouse instruments as "standards" on RCA's Master Tube Test Stations demonstrates how they measure up to *your* need for accurate measurement of any electrical quantity.

In order to reliably measure the quality of all types of electronic tubes the instruments have to consistently maintain precise accuracy. Westinghouse Switchboard Instruments not only fulfill this requirement but provide important plus benefits as well: Easier readability—to simplify the operator's job . . . and co-ordinated space-saving design—to contribute to the functional compactness of the unit.

Here's further assurance of quality: all Westinghouse switchboard panel, portable and recording instruments are built to meet the rigid performance requirements of the American Standards Association. Moreover, you can select from . . .

### The most complete line in the industry!

You get a wider selection for every need whether it be a-c or d-c current and voltage, single or polyphase circuits, watts or vars, frequency, power factor, synchrosopes, temperature indicators, ground detectors or synchrotie (position indicators). And you get . . .

### Competent application assistance!

Westinghouse Instrument Application Engineers are available to consult with and serve you in selecting and applying the proper instruments for your application. Simply call your nearest Westinghouse office.

For complete information about Westinghouse Instruments write for Booklet B-4696. Address: Westinghouse Electric Corporation, P.O. Box No. 868, Pittsburgh 30, Pennsylvania.

J-40400

YOU CAN BE **SURE**.. IF IT'S  
**Westinghouse**

**INSTRUMENTS**



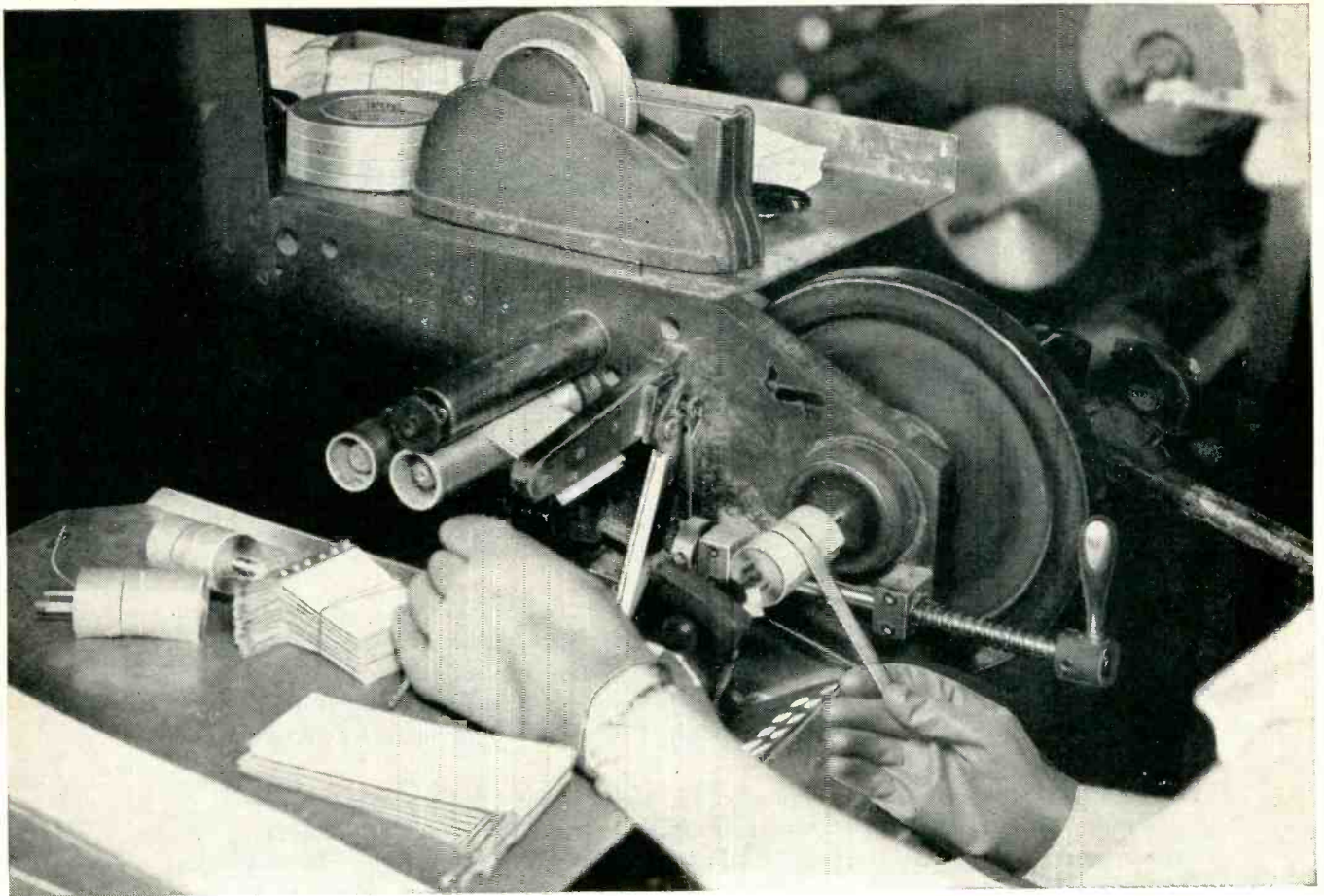

ELECTROLYTIC CONDENSERS at The Magnavox Co., Fort Wayne, Ind., are wrapped for dipping with the new high purity "SCOTCH" Electrical Tape No. 42.

## WHAT'S NEW IN TAPE?

**New high purity tape,  
3 years in development,  
cuts condenser breakdowns**

At last, after three years of research, a condenser wrap that doesn't cause corrosion and break-

downs! It's the 3M Company's new "SCOTCH" Electrical Tape No. 42—a tape with extremely low chloride content, designed specifically for condenser construction.

Usual methods of wrapping condenser rolls for dipping caused frequent failures. Now this new low chloride content tape won't bring on electrolyte contamination or electrolytic corrosion. Tensile strength: 20 pounds per inch of width. Adhesion strength: 45 ounces per inch of width.

"SCOTCH" Electrical Tape No. 42 is only one of a big family of "SCOTCH" Electrical Tapes that can crack tough problems for you. Write to Dept. ES-651 for full information.

### Quick facts about "SCOTCH" Electrical Tape No. 42

- **NON-CORROSIVE**—low chloride content, won't cause breakdowns.
- **TENSILE STRENGTH**—20 pounds per inch of width.
- **ADHESION STRENGTH**—45 ounces per inch of width.
- **THIN CALIPER**—holds condenser roll snugly in place.



Made in U. S. A. by **MINNESOTA MINING & MFG. CO.**, St. Paul 6, Minn.

also makers of other "Scotch" Brand Pressure-Sensitive Tapes, "Scotch" Sound Recording Tape, "Underseal" Rubberized Coating, "Scotchlite" Reflective Sheeting, "Safety-Walk" Non-Slip Surfacing, "3M" Abrasives, "3M" Adhesives.

General Export: Minn. Mining & Mfg. Co., International Division, 270 Park Avenue, New York 17, N. Y.



# A New Concept in Precision Potentiometers . . .

## THE MODEL J Helipot

Precise Mechanical Concentricity

High Electrical Accuracy

Ball Bearing Construction

Independent Phasing

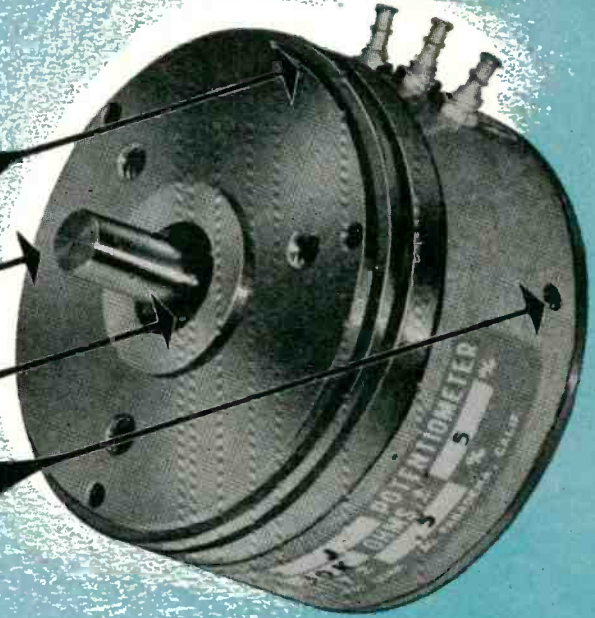

*. . . combined with mass-production economies!*



TYPICAL 6 GANG  
MULTIPLE ASSEMBLY

### If it's a tough potentiometer problem, bring it to Helipot

—for Helipot has facilities and know-how unequalled in the industry for mass-producing precision potentiometers with advanced operating and electrical features.

This recently-developed 'Model J' Helipot, for example, combines several revolutionary advancements never before available in the potentiometer field . . .

#### Precise Mechanical Concentricity

Modern servo mechanisms and computer hook-ups require high mechanical precision to insure uniform accuracy when connected to servo motors through close-tolerance gears and couplings.

In the "Model J," close concentricity between mounting surface and shaft is assured by a unique mounting arrangement. The unit can be aligned on either of two wide-base flange registers and secured with three screws from the front of the panel . . . or it can be secured with adjustable clamps from the rear of the panel to permit angular phasing. Or if preferred, it can be equipped with the conventional single-hole bushing type of mounting.

In addition to accurate mounting alignment, exact rotational alignment is assured by the long-life, precision-type ball bearings upon which the shaft rotates. Precise initial alignment coupled with negligible wear mean high sustained accuracy.

#### High Electrical Accuracy

Helipot products have long been noted for their unusually high electrical accuracy and the "Model J" embodies the latest advancements of Helipot engineering in this field.

For example, tap connections are made by a new Helipot welding technique whereby

the tap is connected to only ONE turn of the resistance winding. This unique process eliminates "shorted section" problems!

High linearity is also assured by Helipot's advanced production methods. Standard "Model J" linearity accuracies are guaranteed within  $\pm 0.5\%$ . On special order, accuracies to  $\pm 0.15\%$  (capacities of 5000 ohms and up) have been obtained.

#### Ball Bearing Construction

The shaft of each "Model J" is carefully mounted on precision-type ball bearings that not only assure sustained rotational accuracy, but also provide the constant low-torque operation so essential for servo and computer applications. Starting torque is only  $\frac{3}{4}$  of an inch-ounce ( $\pm .25$  in.-oz.)—running torque, of course, is even less.

#### Independent Phasing

When using the "Model J" in ganged multiple assemblies, each section can be independently phased electrically or mechanically—even after installation on the panel—by means of hidden internal clamps controlled from outside the housing. Phasing is simple, quick, accurate!

#### Mass-Production Economies

In addition to its many other unique features, Helipot engineers have developed unusual techniques that permit mass-production economies in manufacturing the "Model J". Actual price depends upon the number of taps required, special features, etc. . . . but with all its unique features, you will find the "Model J" very moderate in cost.\*

#### Wide Choice of Designs

The "Model J" Helipot is available in a wide selection of standard resistance ranges—50, 100, 1,000, 5,000, 10,000, 20,000, 30,000 and 50,000 ohms . . . in single- or double-shaft designs . . . with choice of many special features to meet virtually any requirement within its operating field.

\*Write for Bulletin 107 which gives complete data and price information on the versatile "Model J" Helipot!

# THE Helipot CORPORATION

South Pasadena 2, California

Field Offices: Boston, New York, Philadelphia, Rochester, Cleveland, Detroit, Chicago, St. Louis, Los Angeles and Fort Myers, Florida. Export Agents: Fratham Co., New York 18, New York.

# Potter & Brumfield's Super Midget Relays

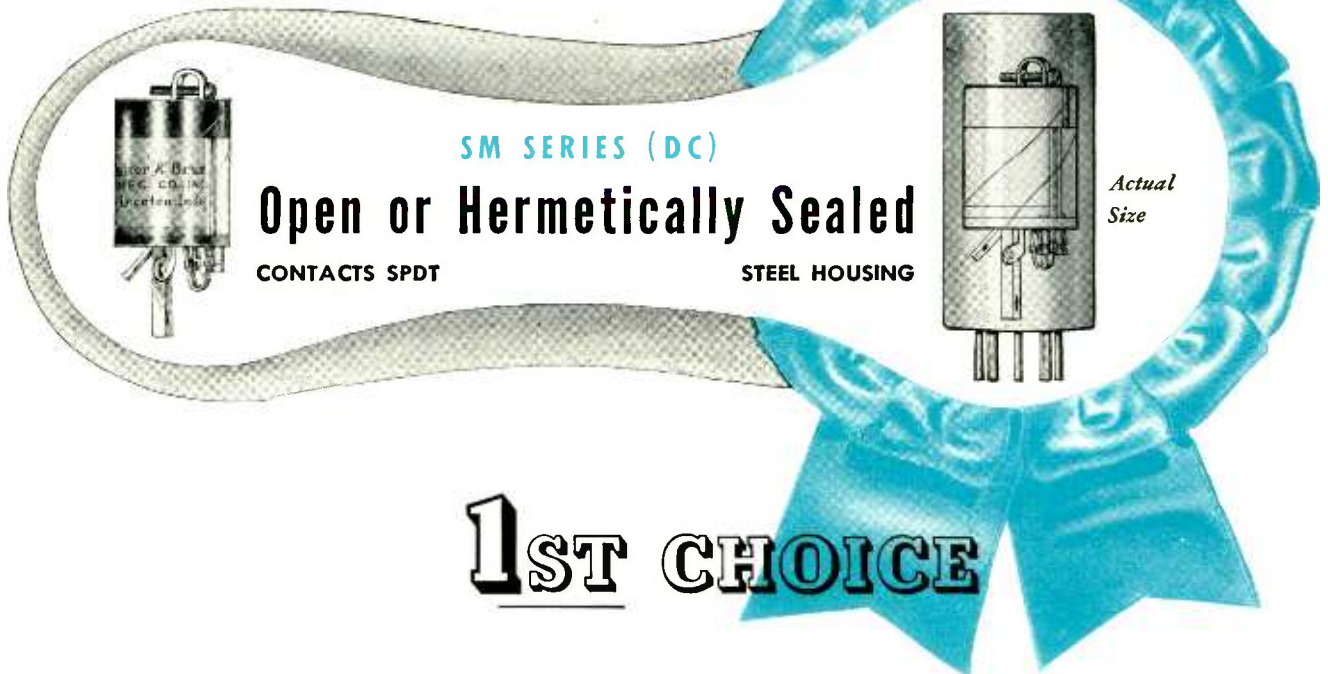

SM SERIES (DC)

**Open or Hermetically Sealed**

CONTACTS SPDT

STEEL HOUSING

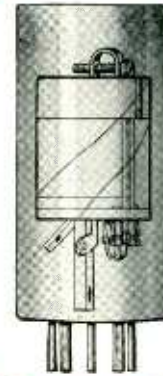

*Actual Size*

## 1ST CHOICE

**... when Product Performance Requires:**

### Sensitivity

**Operates on only 75 MW.**

In spite of its small size this unique relay is capable of remarkable sensitivity. With maximum coil resistance of 10,000 ohms it will operate on only 2.75 ma while with minimum resistance of 0.15 ohm only 0.7 amp. is required. Relays for voltage operation are provided with 1/2 watt coils up to 60 volts; 1.2 watt at 115 volts. Maximum coil power permissible is 1.75 watt. Practically any combination for voltage or current operation can be provided within the limits given above. Voltage-operated relays pull in at 75% or less of nominal value; drop-out is approximately 50% of the pull-in value.

### Vibration Resistance

**Meets 10-G Air Force Tests**

An unbelievable degree of vibration resistance has been engineered into this relay by the use of an extremely light movable element. Any type will stand 10-G test with 1/4 watt in coil and the sealed relay mounted in socket with shield will pass this test with only 0.1 watt. Also meets 25-G shock test and will stand 50-G test non-operating without damage.

### Compactness

**1/2 Ounce — 1/2 Cubic inch**

—for the unsealed relay. Sealed in drawn steel case, this relay is same size as miniature tube and fits into standard 7-pin socket. Weight of sealed relay is only 3/4 ounce!

Hermetically sealed type SM relays may be used in sockets fitted with standard miniature tube shields. Such shields will provide adequate "hold-down" as required by military applications.

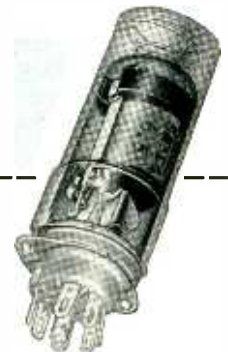

# Potter & Brumfield

PRINCETON, INDIANA  
EXPORT: 13 E. 40th St., NEW YORK, N. Y.

Your Electronic Parts Distributor Stocks Standard P&B Relays. Sales offices in principal cities.

Potter & Brumfield Super Midget relays have proven themselves in guided missile and related control applications. Numerous "tough" assignments have been successfully fulfilled by this rugged sub-miniature component under rigid government specifications. Samples and quotations will be supplied upon receipt of your specifications.



**TOM JACOBS, Owner**  
**Apex Radio Shop**  
**Detroit, Michigan**

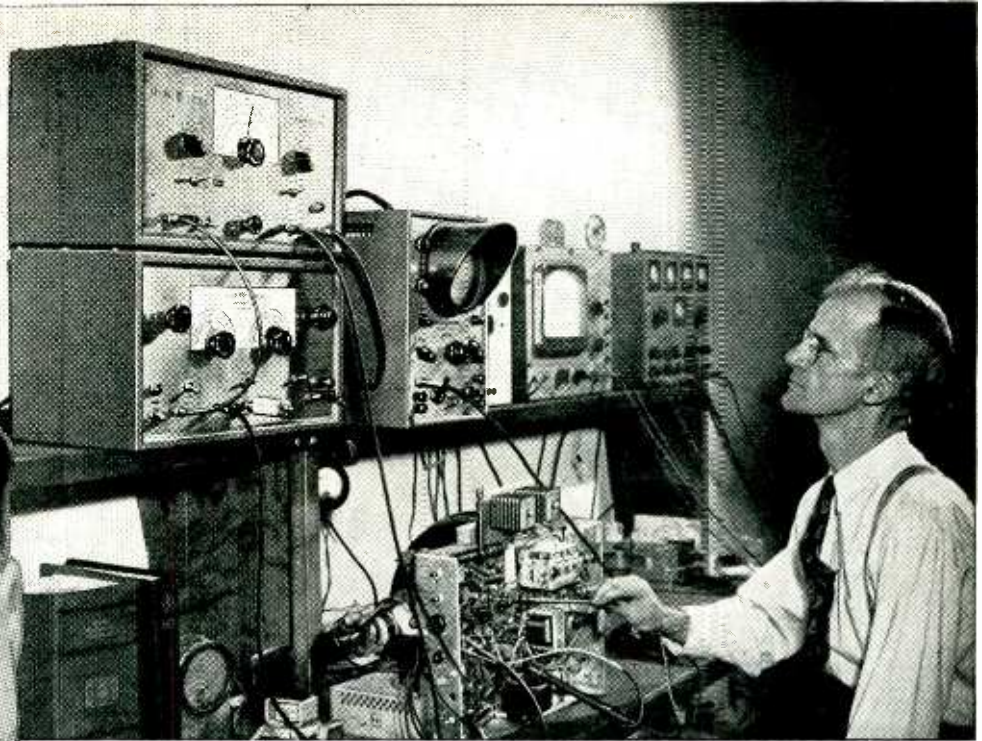

***“200% MORE TV BUSINESS  
 --NO INCREASE IN OVERHEAD!”***



“With no increase in trained personnel, we tripled our TV service business in 6 months. The answer lies in our G-E Test Equipment.

“The *Scope* is the best trouble-shooter on the market . . . it holds a steady trace—it’s stable—you can overload it and it recovers instantly. The *Variable Permeability Sweep* is extremely simple to operate, and with the crystal-controlled

*Marker Generator* we always get accurate and reliable results. While keeping profits up, the G-E Test Package has cut our service time in half!”

Hundreds of TV dealers and servicemen use G-E Test Equipment to turn out clean, accurate jobs that keep customers satisfied and put money in the till. Call your G-E distributor or mail coupon today for full information.



General Electric Company, Section 461  
 Electronics Park, Syracuse, New York  
 Rush me latest bulletins plus price information on  
 General Electric test equipment.

NAME.....  
 ADDRESS.....  
 CITY.....STATE.....

*You can put your confidence in—*

**GENERAL  ELECTRIC**



# High Accuracy **AT LOW ENERGY LEVELS**



**WESTON**  
*Model 622*

## High sensitivity • PORTABLE • Instruments

Combining extreme sensitivity with high accuracy and a 6.1 inch scale, Weston Model 622 instruments are ideally suited for precise measurements of potential and current at the very low energy levels encountered in nuclear physics, electronics and electro-chemical research or in general test work. Hand calibrated, double pivoted, electrostatically and magnetically shielded.

These instruments are available as d-c voltmeters, millivoltmeters, milliammeters and microammeters; electrolysis volt-millivoltmeters and high resistance voltmeters. They are also made as thermocouple ammeters, milliammeters, and voltmeters; and as a-c rectifier type instruments. For technical data consult your Weston Representative, or write Weston Electrical Instrument Corporation, 595 Frelinghuysen Avenue, Newark 5, New Jersey . . . manufacturers of Weston and TAGliabue instruments.

---

# WESTON *Instruments*



# 215

SQUARE INCHES OF FINEST  
PICTORIAL REPRODUCTION...

*Yours with the*

*new Bent-Gun for  
edge-to-edge sharpness,  
gray filter face plate,  
"Standard" neck length of 7 $\frac{3}{16}$ "*



\*trade-mark

*Our commercial  
engineering department  
invites all design inquiries*

ALLEN B. DU MONT LABORATORIES INC., TUBE DIVISION, CLIFTON, N. J.

*New!*

## LAPP TUBE SUPPORTS

### for mounting forced-air-cooled tubes

Now available as a standardized line, these Lapp insulated supports for mounting forced-air-cooled tubes facilitate design of transmitter and other high-power circuits. They are simple, compact and efficient. For high frequency tubes they are available either in Lapp porcelain or Lapp steatite; for standard broadcast frequencies in Lapp porcelain.

WRITE for specification sheets. Radio Specialties Division, Lapp Insulator Co., Inc., Le Roy, N.Y.

# Lapp





**ERIE STYLES  
325 and 326  
STAND-OFF  
CERAMICONS®**

**The Most  
Efficient  
Stand-Off  
Units for  
VHF and UHF  
Applications**

**HERMETICALLY SEALED  
... RUGGED**

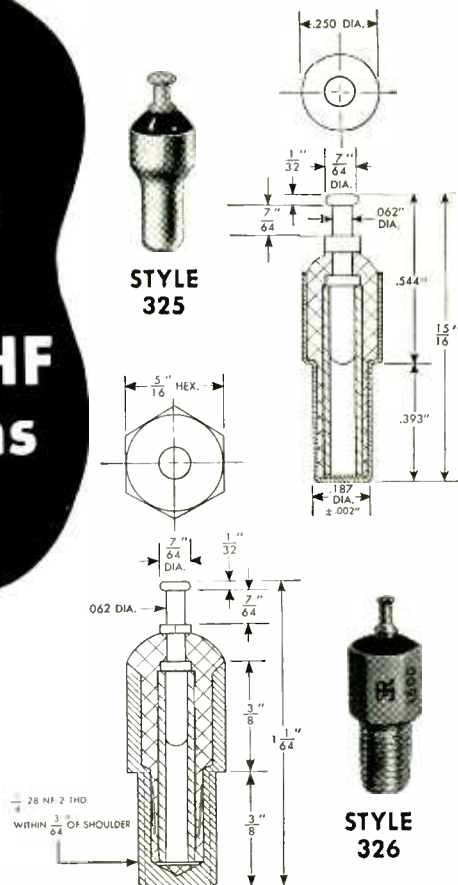

**B**BETTER by-passing is one solution to control of regeneration in high frequency receivers. The Erie Styles 325 and 326 Stand-off Ceramicons offer outstanding features for extremely efficient by-passing. Style 325 is designed for push-on clip mounting to chassis; Style 326 is for threaded mounting installation.

This basic design provides, in a hermetically sealed case, a by-pass-to-ground through the shortest possible path. Full advantage is taken of the concentric electrode configuration in maintaining this short path by making connection to the outer electrode at the plane of the chassis. The result is an extremely low and uniform series inductance. In assembly operations both location and length of leads are accurately fixed, resulting in better mechanical uniformity. This feature has been demonstrated to be of particular importance in good VHF and UHF design.

### OUTSTANDING FEATURES

- 1 Tubular ceramic capacitor is completely sealed.
- 2 Very low and uniform inductance path to ground.
- 3 Electrical shielding is provided by means of the grounded metal case.
- 4 Post terminal provides a sturdy tie point for several connections, and is made essentially to match tube socket terminal height in the interest of maintaining uniform short leads.

### SPECIFICATIONS

Standard available capacitance values in MMF: 10, 33, 47, 68, 82, 100, 680, 1,000, 1,500. Voltage Rating, 500 VDC.



*Electronics Division*  
**ERIE RESISTOR CORP., ERIE, PA.**  
LONDON, ENGLAND...TORONTO, CANADA

# New

## 16 PAGES OF VALUABLE RECTIFIER DATA...AND YOURS FOR THE ASKING!

### INFORMATION-PACKED SELETRON SELENIUM RECTIFIER

# Catalog

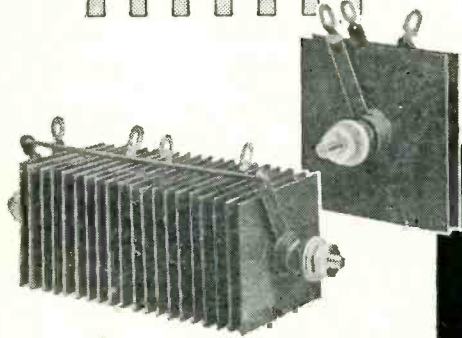
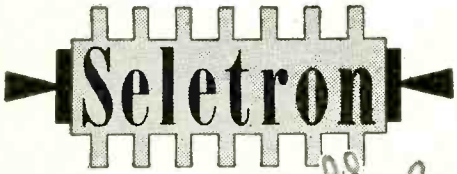
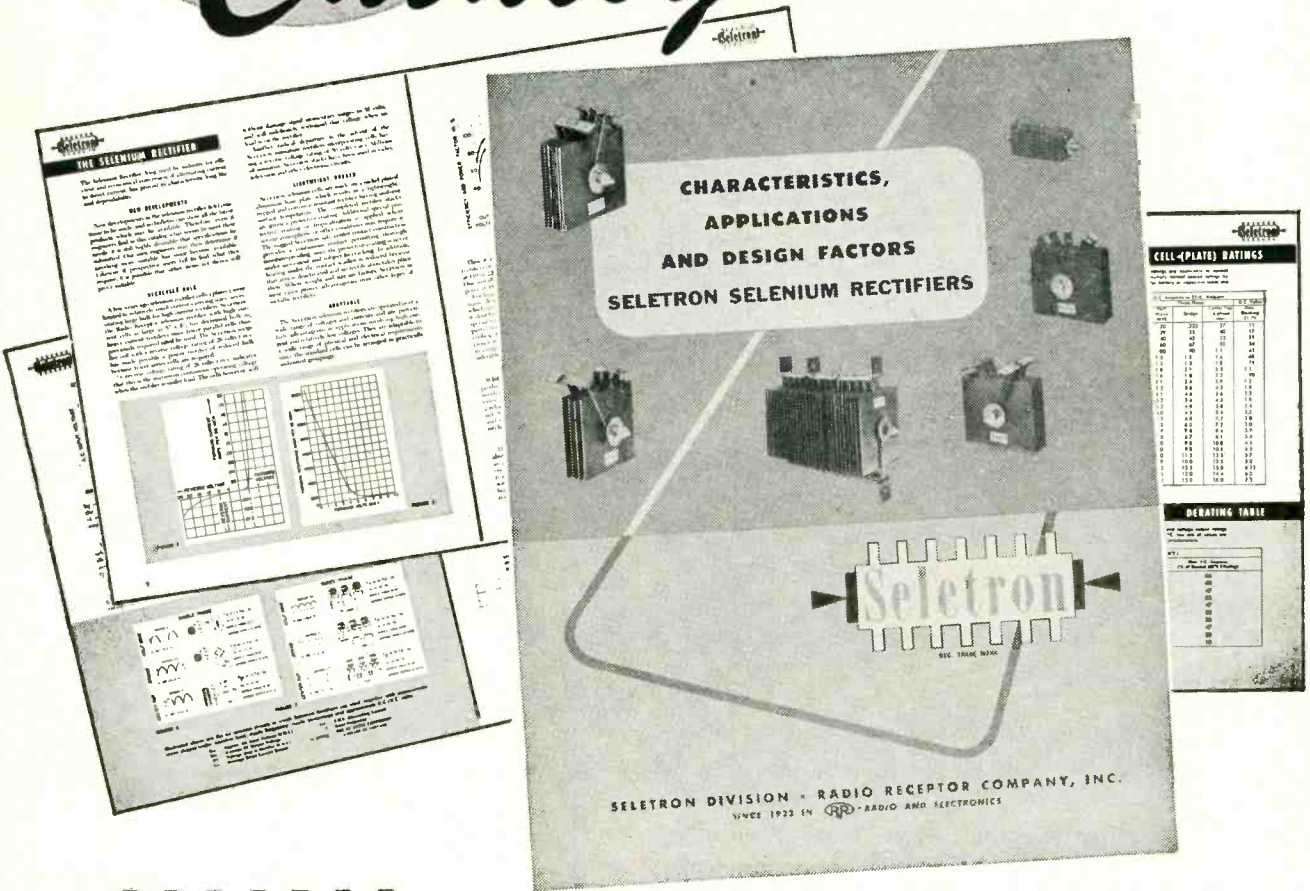

THIS NEW two-color, fully illustrated catalog just off the press belongs on your desk for handy reference. Includes comprehensive listings of dimensions and ratings for miniature SELETRON selenium rectifiers, as well as a large selected group of power stacks. Also contains complete background material on these versatile rectifiers and illustrates many of their uses.

Request your copy today — It's FREE, of course. When ordering, ask for new catalog No. 104-D-6.

**SELETRON DIVISION**

**RADIO RECEPTOR COMPANY, Inc.**  
*Since 1922 in Radio and Electronics*

**Sales Department: 251 West 19th St., New York 11, N. Y.**  
**Factory: 84 North 9th St., Brooklyn 11, N. Y.**





## THEY'RE BOTH IN THE KARP PICTURE

# Beauty AND Utility

### IN ENCLOSURES

Hand in hand they go, briskly pacing each project in our streamlined plant ... symbols of the handsome *styling* and *utility* that engineers demand in modern "packaging" of electrical and mechanical equipment.

Under our big roof there lives a proud tradition: industry holds the name Karp synonymous with sheet metal fabrication of the highest order ... in every category from simple to intricate.

This reputation we prize highly as a challenge that draws out our best efforts for every customer we serve, large or small. May we prove to you, too, that superior craftsmanship really costs less in terms of value received? Write for data book.

**ANY METAL      ANY GAUGE      ANY SIZE**  
**ANY QUANTITY      ANY FINISH**

\* Trademark Registered

## KARP METAL PRODUCTS CO., INC.

215 63rd STREET, BROOKLYN 20, NEW YORK

*Specialists in Fabricating Sheet Metal for Industry*

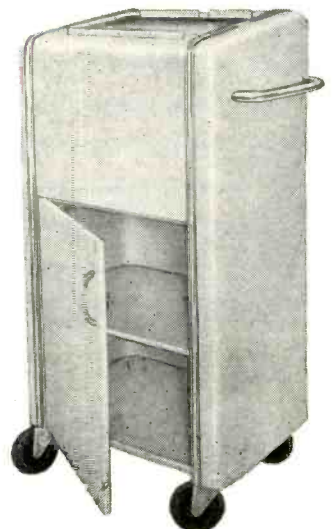

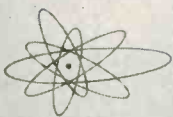

# Designers

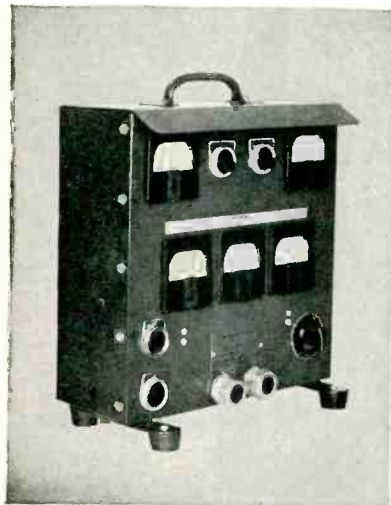

Operator's Control Unit

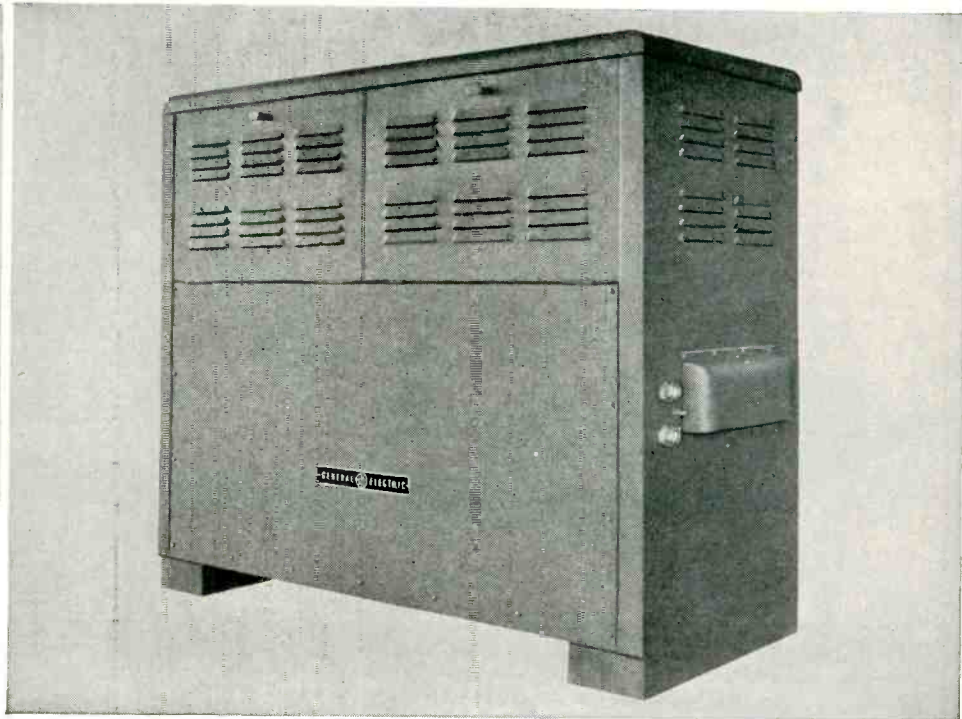

Motor-Generator-Type  
Frequency  
Changer

## PACKAGED FREQUENCY CHANGERS

### 400-Cycle Ground Power Supply for Aircraft Radar Units

Here's a low-cost, high-performance, 400-cycle ground power supply with a regulated output voltage adjustable from 187 to 229 volts. It's rugged enough for permanent installation, yet compact enough to be moved on a fork truck. A 30-kva output rating is more than sufficient for virtually all radar, radio, or general load applications.

**Voltage regulation:**  $\pm 2$  per cent variation under all conditions of balanced load, power factor, and heating, within normal operating range.

**Voltage recovery:** To within 5 per cent of steady-state value in 0.1 second.

**Voltage adjustment:** 187-229 volts in increments of 0.5 volts or less.

**Wave shape:** Low harmonic content.

**Radio interference:** Adequate suppression for most rigid applications.

**Enclosure:** Dripproof cabinet houses motor, generator, and controls. A separate operator's panel contains "start-stop" push buttons, adjusting potentiometer, selector switches and meters.

For further data on these G-E frequency changers see Bulletin GEA-5589.

# GENERAL ELECTRIC



# Digest

## TIMELY HIGHLIGHTS ON G-E COMPONENTS

### Husky Relays Mount 3 Ways Make or Break up to 45 Amps

For those heavy control-circuit applications, here's a versatile relay that can be front-connected, back-connected, or plug-in-connected, and is supplied in open or enclosed models. Circuits: spst, dpst, or dpdt.

Heavy, long-lasting silver contacts carry 10 amps continuous. Normally open forms make or break 45 amps; normally closed forms make or break 20 amps. Coils are supplied for 12-, 24-, 115-, or 230-volt, 60-cycle a-c; for 6, 12, 24, 32, 125 or 250 volts d-c. Dimensions for enclosed model: 6 x 6 x 5 inches. Complete details are available in Bulletin GEC-257.

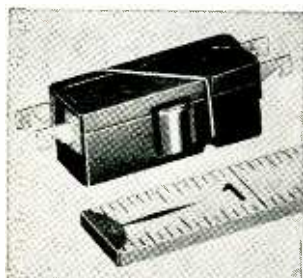
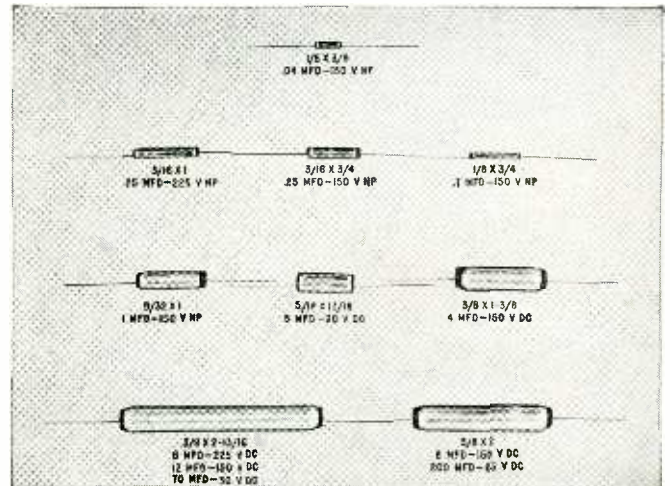

### G-E Switchette Handles High Current in Crowded Quarters

Though small and lightweight, the G-E switchette does the same work as many bulkier switches. Available in a wide variety of forms and circuits, this snap-action unit is approximately 1 1/4 x 1/2 x 1/2 inches, weighs only 9 grams, and operates dependably from sea level to 50,000 feet altitude.

Contact arrangements available are single-circuit, normally open; single-circuit, normally closed; and two-circuit, one normally open and one normally closed. Rated 1/2 hp at 115 and 230 volts a-c, the switch is designed for ambient temperatures from -70F to +200F and meets the 50-hr salt-spray test for Specification AN-QQ-S-91. For full details, ask for Bulletin GEA-4888.

### Cast-Glass Bushings Permit Hermetically Sealed Apparatus

Embedded nickel-steel hardware eliminates the need for gaskets and makes possible the soldering, brazing, or welding of G-E cast-glass bushings directly to apparatus. This assures gas-tight, oil-tight, or vacuum-tight construction. Extraordinary resistance to vibration and weather means the small, compact bushings are especially suited to aircraft applications or where high humidity occurs. They will not puncture or shatter under excess potentials. For full details ask for Bulletin GEA-5093A.

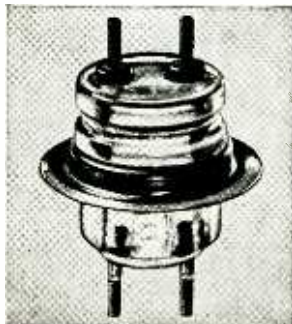

## Tantalum + New Electrolyte = More Performance, Less Space New G-E Tantalitic D-C Capacitors Feature

- Size and weight about the same as conventional electrolytics
- Over-all life as good as paper dielectrics
- Low-temperature properties and shock resistance better than either

By combining tantalum in foil form and a newly developed non-corrosive electrolyte, General Electric has designed a capacitor that packs superior performance into amazingly small space. Good stability, unusually low leakage currents, and hermetic sealing are additional advantages. Operating range is from -55C to +85C. Ratings presently available range from 0.02 muf to 12 muf at 150 volts d-c. Capacitors shown in illustration are representative. For additional information, furnish requirements such as temperature range, leakage resistance values, and operating voltage in writing to *Capacitor Sales Division, 42-304, General Electric Company, Pittsfield, Mass.*

General Electric Company, Section D667-15  
Schenectady 5, N. Y.

Please send me the following bulletins:

- |                                       |                                   |                            |
|---------------------------------------|-----------------------------------|----------------------------|
| (V) Indicate for reference only       | <input type="checkbox"/> GEC-257A | General-Purpose Relay      |
|                                       | <input type="checkbox"/> GEA-4888 | Size 1 Switchette          |
| (X) For planning an immediate project | <input type="checkbox"/> GEA-5093 | Cast-Glass Bushings        |
|                                       | <input type="checkbox"/> GEA-5589 | Packaged Frequency Changer |

Name \_\_\_\_\_  
Company \_\_\_\_\_  
Address \_\_\_\_\_  
City \_\_\_\_\_ State \_\_\_\_\_





## REASON for CONFIDENCE

### ... in Peace or War



... that's what the trademarks and brand names of American producers establish. For never has a country accumulated such wealth of designing and engineering talent, such monumental means for producing both the necessities and luxuries of the day, or such massive potential for meeting the needs of tomorrow—however vast and varied they may be.

Accordingly, we take particular pride in our personal emblem. Representing a wide range of alloys for the electrical, electronic and heat-treating industries, it is the very symbol of quality and dependability to a host of manufacturers thruout the nation. We are well aware of our obligation to uphold its reputation—in peace or war.

So if your products demand electrical resistance material of outstanding uniformity, high stability, and long life . . . or if you require radio alloys for elec-

tronic uses . . . or high heat-resistant equipment . . . consult with us. Our fifty years' experience is at your disposal.

As recipient of the highest Armed Services Award in 1918, and of no less than five Army-Navy "E" Awards in World War II, it is logical that the resources of this firm should be engaged to an unprecedented extent in meeting the demands of the present emergency. However, we stand ready to make recommendations based upon your specific requirements, and shall be glad to serve you to the best of our ability.

One thing is sure: Your use of a D-H product will prove a source of confidence—confidence not only in Driver-Harris products per se, but, in a wider sense, confidence in the capacity of creative America to meet any situation, *come what may*.

*Manufacturers of world-famous Nichrome®  
and over 80 other alloys for the electrical,  
electronic, and heat-treating fields.*

## Driver-Harris Company

HARRISON, NEW JERSEY

BRANCHES: Chicago, Detroit, Cleveland, Los Angeles, San Francisco  
In Canada: The B. GREENING WIRE COMPANY, LTD., Hamilton, Ontario, Canada



®T.M. REG. U. S. PAT. OFF.



Putting the **HUSH**  
on radio background noises...

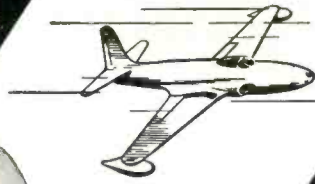

# AEROVOX "INTER- FERENCE" FILTERS



● That "radio quiet," so vital to satisfactory communications, radar and allied radio-electronic functions on land and sea and in the air, is now simplified with AEROVOX INTERFERENCE FILTERS. These latest filter units provide maximum attenuation from 150 KC well up into the UHF range. And they are extra-rugged, extra-compact, extra-efficient, by any comparison with previous filters.

Primary applications are in r.f. noise suppression work in military or commercial aircraft and for vehicular low-voltage d.c. applications. Also, for special applications such as battery or low-voltage d.c. filters, for shield room applications, and for critical equipment.

Available in seven standard types meeting a wide variety of applications. For extraordinary requirements, special filters can be developed and built to your order.

● Write on your letterhead for latest literature. Consult AEROVOX on your noise-suppression problems, as well as capacitor requirements in general.

Remarkably small sizes and minimized weights.

Cases and terminals based on time-and-service-proven AEROVOX hermetically-sealed containers and terminals.

Cases of non-magnetic material suitably protected to withstand military service requirements for humidity, immersion, vibration, etc.

Advanced pi type construction for highest efficiency.

Capacitor sections utilize AEROLITE\* metallized-paper dielectric, assuring maximum reliability and life including "fault isolation" characteristics for protection against extreme surge voltages above rated voltages.

Filter chokes of newest design, embodying high impedance to r.f. currents and low d.c. resistance, assuring low voltage drop and minimum heating.

\*trade-mark

AEROVOX INTERFERENCE FILTERS			
Aerovox Type	Amps.	VDC	Size (l. x w. x h.)
IN 148	2.0	150	1 3/4" x 1" x 7/8"
IN 150	3.0	150	1 13/16" x 1" x 1"
IN 151	5.0	150	1 13/16" x 1 1/4" x 1"
IN 152	10.0	150	2 1/16" x 1 1/4" x 1"
IN 153	25.0	150	2" x 2" x 1 3/16"
IN 156	40.0	150	5 1/16" x 1 13/32" x 1 1/16"
IN 154	100.0	150	3 1/16" x 2 1/8" x 2 7/8"



THE HOME OF CAPACITOR CRAFTSMANSHIP

AEROVOX CORPORATION, NEW BEDFORD, MASS., U. S. A.

Export: 41 East 42nd Street, New York 17, N. Y. • Cable: AEROCAP, N. Y. • In Canada: AEROVOX CANADA LTD., Hamilton, Ont.

SALES OFFICES IN ALL PRINCIPAL CITIES

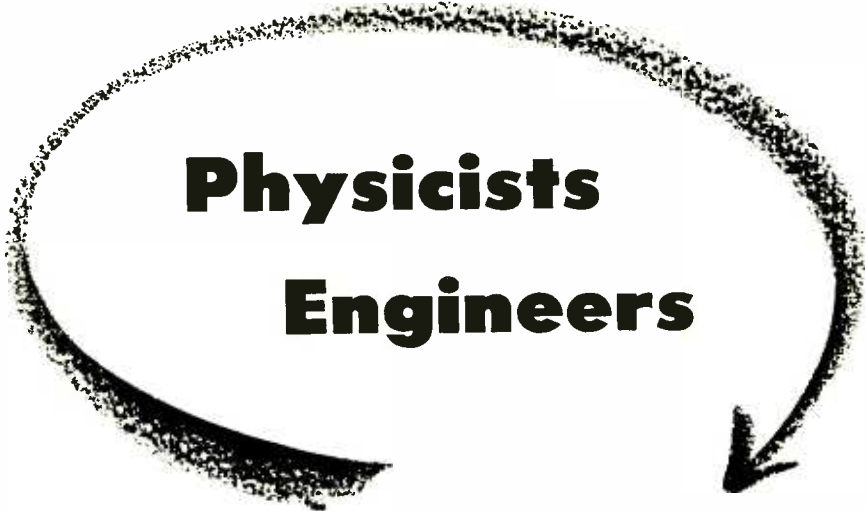

# Physicists Engineers

The Boeing Airplane Company has exceptional openings at Seattle for outstanding physicists and engineers. Are you one of them?

The work is in Boeing's expanded Physical Research Unit—on some of the nation's most vital projects: research and development on

- Weapon systems**
- Electronic and microwave circuits**
- Flush antennas**
- Servomechanisms and computers**
- Radar systems and components**
- Instruments and gyros**

These positions offer challenging work and a stimulating professional environment. You'll live in the Pacific Northwest with its equable climate and unparalleled recreational possibilities.

Opportunity for advancement is essentially unlimited in the rapidly expanding fields of guided missiles, airplane control and industrial machine and process control. Salaries are based on semi-annual performance review.

To qualify, you must already have demonstrated outstanding experimental or analytical abilities. Or you must have recently received the M.S. or Ph.D. degree in Electrical Engineering, Physics, or Applied Mathematics.

If you qualify, write today for application. . . .

JOHN C. SANDERS, Staff Engineer—Personnel  
Boeing Airplane Company  
7762 East Marginal Way, Seattle 14, Washington

## **SPECIAL OPENINGS FOR ENGINEERS**

Boeing's Engineering Division needs experienced and junior engineers in the following and allied engineering fields: mechanical, aeronautical, electrical, electronic, civil, acoustical, and structural. Write today for application forms to address indicated above, right.

# **BOEING**



why  
**FIBERGLAS\*** *Yarns* HERE...

## IN RADIO AND TELEVISION WIRE?

*Because*

- Fiberglas yarn braid won't burn, resists soldering heat
- Fiberglas yarns are tough even in small diameters . . . that means thinner, easier to handle wire
- Fiberglas yarns won't rot . . . even in tropical climates
- Competitive in price with conventional wire braiding!

*Specify*

Fiberglas Yarn braid when you order Radio and Television wiring.

Send for your **FREE** copy of the booklet,  
 "Specify Fiberglas Yarns in Wire or Cable," today!



OWENS-CORNING  
**FIBERGLAS**  
TRADE-MARK

*Yarns*

\*Fiberglas is the trade-mark (Reg. U. S. Pat. Off.) of Owens-Corning Fiberglas Corporation for a variety of products made of or with glass fibers

**FIBERGLAS IS IN YOUR LIFE . . . FOR GOOD!**

Owens-Corning Fiberglas Corporation  
 Electrical Sales Division, Dept. 860  
 16 E. 56th Street, New York 22, N. Y.

Please send me the booklet "Specify Fiberglas Yarns in Wire or Cable."

Name: .....

Title: .....

Company: .....

Street: .....

City: ..... Zone ..... State .....

# If You Need Coils Like These . . .

you need UNIVERSAL Coil Winders



**Lattice-type coils** for television and radio. Wind one to four coils at once on the Universal No. 84 Coil Winder, with (in most cases) a single operator for two machines.

Speeds are from 400 to 950 rpm, and a counter control provides instant automatic stop upon completion of coil.

Quickly-adjustable "gainer" mechanism, which accurately positions wire turns, and strap-type tensions help you get accurate, uniform winding. In-built calibration facilitates change-over.

Write for Bulletin 84-LM.

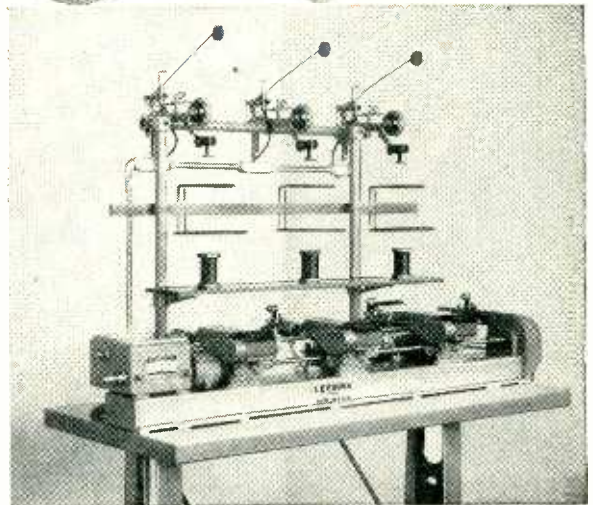
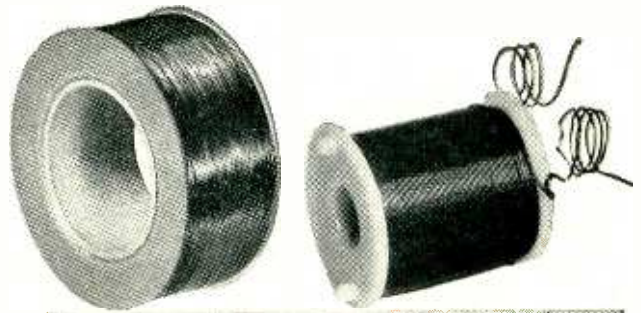

**Non-insulated spool-wound coils.** Wind coils on several heads at once, using the new Universal 102 High Speed Coil Winder, and synchronize output on the basis of handling time per coil.

Each head is individually operated, and you can so schedule the winding that certain heads will be producing while manual operations are performed on other heads.

With a maximum speed of 5000 rpm, the High-Speed 102 is efficient for coils having up to 15,000 turns. Oil seals make the machine *oil-tight*.

Write for Bulletin 102-LM.

## UNIVERSAL WINDING COMPANY

P. O. Box 1605 Providence 1, R. I.

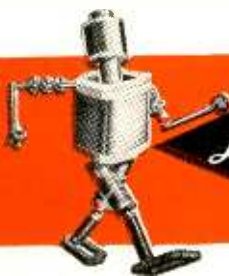

FOR WINDING COILS IN QUANTITY  
ACCURATELY . . . AUTOMATICALLY  
USE UNIVERSAL WINDING MACHINES



# THE INCOMPARABLE

*Eimac*

**3X2500A3**  
POWER TRIODE



Outstanding in performance, outstanding in life, and outstandingly low in cost . . . the Eimac 3X2500A3 triode is today the prime component in many of the newest noteworthy electronic equipments.

The excellent characteristics of the 3X2500A3 in CW, Modulator or Pulse service, over a wide frequency range, account for the diversity of applications in which it is employed.



## Medium Frequencies

**AM broadcast, police and aircraft communications, navigational aids, etc.**



## High Frequencies

**Short wave broadcast, commercial communications and teletype service, r-f heating applications, etc.**



## Very High Frequencies

**Television broadcast, FM broadcast, communications, r-f heating, etc.**

*Complete data on the 3X2500A3 and other outstanding Eimac Tubes for CW, Modulator, and Pulse Service are available in a new catalogue . . . Write today.*

### TYPICAL OPERATION Eimac 3X2500A3\*

#### CLASS-B AUDIO AMPLIFIER (2 tubes)

D-C Plate Voltage	- 5000 volts
D-C Grid Voltage	- -190 volts
D-C Plate Current	- - .5 amps
Plate Load	- - - 5000 ohms
Driving Power	- - - 59 watts
Power Output	- - - 8000 watts

#### CLASS-C R-F AMPLIFIER - 40 Mc.

D-C Plate Voltage	- 6000 volts
D-C Grid Voltage	- -500 volts
D-C Plate Current	- 2.08 amps
Driving Power	- - 136 watts
Power Output	- - - 10,000 watts

#### CLASS-C FM TELEPHONY - 110 Mc. (grounded grid)

D-C Plate Voltage	- 4000 volts
D-C Grid Voltage	- -500 volts
D-C Plate Current	- 1.85 amps
D-C Grid Current	- 190 ma.
Driving Power	- - 1900 watts
Useful Power Output	- 7500 watts

#### MAXIMUM PULSE RATINGS

	Maximum Plate Voltage
RF Service (plate pulsed)	- 15 kv.
RF Service (grid pulsed)	- 10 kv.
Modulator Service	- - - 25 kv.

\*Below 30 Mc. type 3X2500F3 (flexible grid and cathode leads) may be used.

**EITEL-McCULLOUGH, Inc.**  
**San Bruno, California**

Export Agents: Frazer & Hansen, 301 Clay St., San Francisco, California

Follow the Leaders to

*Eimac*  
TUBES

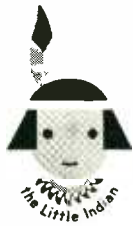

THE LITTLE INDIAN SAYS.

# "Tiny-but Mighty!"



## SANGAMO MINIATURE SILVERED MICA CAPACITORS

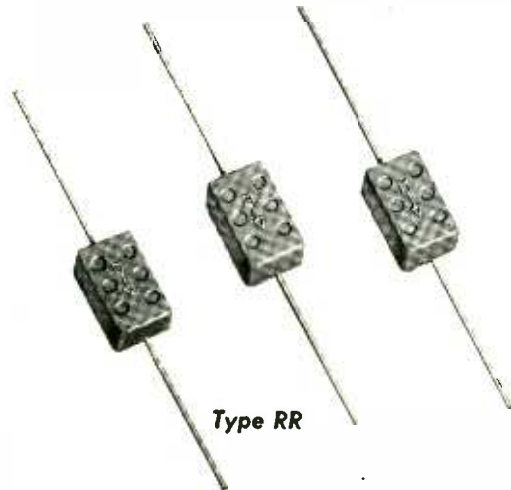

Type RR

## Do a "Heap Big" job in a minimum of space

Exceptionally small, easy-to-install capacitors that can do a *big* job in *minimum* space are a helpful factor in speeding production.

Where space limitations exist, the tiny—but mighty Sangamo "Shawnee," Type RR Miniature Silvered Mica Capacitor will solve your problem without sacrificing stability or high quality. These capacitors are designed and constructed to meet the Tentative Joint Army and Navy Specification JAN-C-5A for the CM-15 case size. Whether you require Sangamo RR miniature, or standard size types KR and CR silvered mica capacitors, you can safely specify any of them for use in all types of military, or commercial radio and electronic equipment. These and many other types of Sangamo Mica Capacitors are fully described in Catalog No. 800. Write for your copy.

## SANGAMO STANDARD SIZE SILVERED MICA CAPACITORS

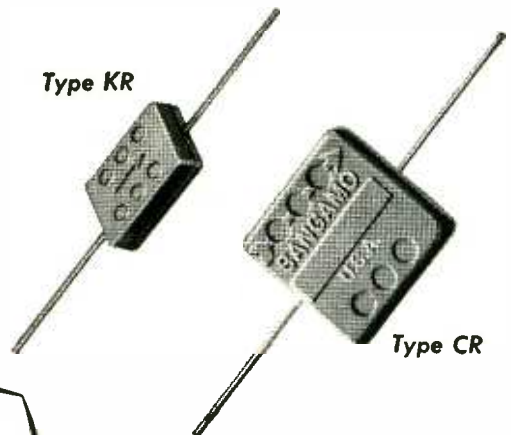

Type KR

Type CR

Your Assurance of



Dependable Performance

## SANGAMO ELECTRIC COMPANY SPRINGFIELD, ILLINOIS

IN CANADA: SANGAMO COMPANY LIMITED, LEASIDE, ONTARIO

8C51-6



# it's PRESTO around-the-clock at Nola Recording Studios



Studio Manager  
Tom Nola impressed  
with Presto's quality  
performance under  
heavy schedule

Fifteen years ago the now famous Nola Recording Studios opened for business with a hope, a prayer... and one early model Presto recorder. Today the New York studios occupy 40,000 feet of space including an entire floor in one of Broadway's good size office buildings and a branch studio in Steinway Hall. From nine in the morning until after midnight the outstanding stars of show business parade through the studios and record their talents on a battery of Presto machines.

wherever you go  
there's **PRESTO**



The basic equipment used includes Presto 14-B disc machines, Presto 92-A recording amplifiers and Presto 41-A limiting amplifiers. For playback purposes and re-recording, Presto 64-A transcription turntables are employed, while Presto "Green Label" discs are standard equipment also. Says Manager Nola, "The faultless performance of all our Presto equipment which is in use almost continuously has been a big factor in our growth and success. That's why we're a Presto studio."



**PRESTO** RECORDING CORPORATION

PARAMUS, NEW JERSEY MAILING ADDRESS: BOX 500, HACKENSACK, N. J.

IN CANADA: Walter P. Downs, Ltd., Dominion Sq. Bldg., Montreal, Quebec OVERSEAS: M. Simons & Son Co., Inc., 25 Warren Street, New York, N. Y.



# ENJOY MULTIPLE SAVINGS

*IN TIME, SPACE and MONEY*

WITH A



# Varicell

**STABILIZED — REGULATED  
VARIABLE D-C VOLTAGE  
FROM AN A-C SOURCE**

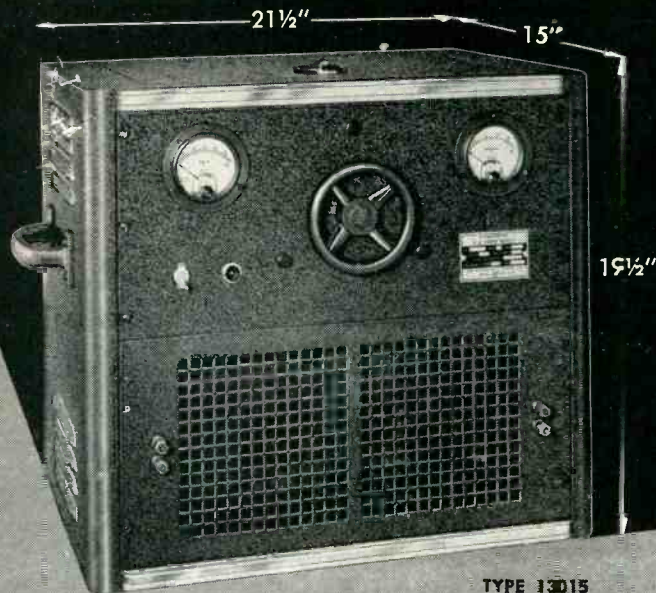

TYPE 13015

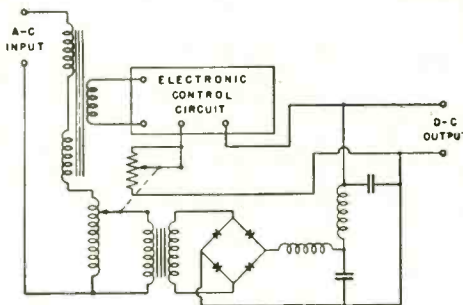

In keeping with rapid advancements of the electronic and nuclear fields, The Superior Electric Co. has developed the VARICELL D-C power supply. It provides a multiple range of regulated and stabilized low D-C voltages operating from an A-C source. You buy one compact unit — no need for several purchases, no need for accessories or special parts — to handle 6, 12 and 28 volts output. Control is centralized, space is conserved and engineers, technicians and test men welcome the convenient dependable performance.

VARICELL type 13015, illustrated above, is rated 95-135 volts, 60 cycles, 1 phase, A-C input; and 0-30 volts, 15 amperes D-C output. Stabilization and regulation is  $\pm 0.25$  volts and R.M.S. ripple voltage never exceeds 0.1 volt for the output range of 6 to 30 volts. Any output voltage setting is not affected by line voltage changes or load current variations. For more detailed information fill in handy coupon and mail.

**WRITE FOR  
VARICELL  
BULLETIN  
TODAY**

**THE SUPERIOR ELECTRIC CO.**  
BRISTOL, CONNECTICUT



**THE SUPERIOR ELECTRIC CO.**

406 Church Street, Bristol, Connecticut

Please send me more information on \_\_\_\_\_

Please have a SECO Voltage Control Engineer call

Name \_\_\_\_\_

Company \_\_\_\_\_

Co. Address \_\_\_\_\_

City \_\_\_\_\_ Zone \_\_\_\_\_ State \_\_\_\_\_

**MANUFACTURERS OF VOLTAGE CONTROL EQUIPMENT**

POWERSTAT VARIABLE TRANSFORMERS  
STABILINE VOLTAGE REGULATORS  
VOLTBOX A-C POWER SUPPLIES  
VARICELL D-C POWER SUPPLIES  
5-WAY BINDING POSTS  
LIGHT DIMMING EQUIPMENT



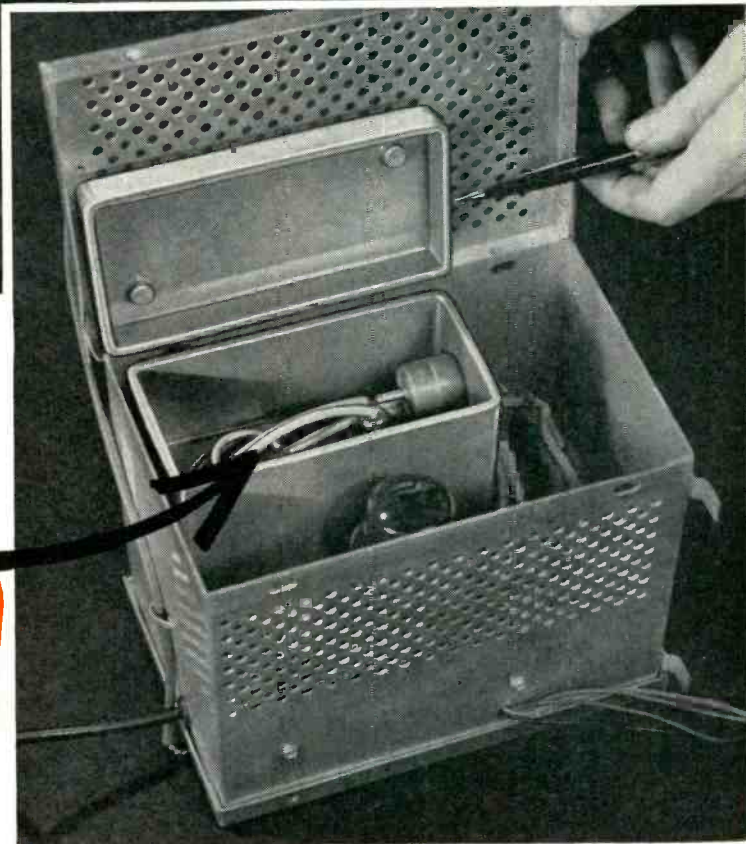

# Low Cost Housing for 25,000 Volts!

Two amplifier tubes and a transformer, putting out a walloping 25,000 volts—are contained far more safely and economically in this 7¾-inch-high housing, molded from **BAKELITE Low-Loss Phenolic Plastics BM-17748\***. The power unit was originally designed by North American Philips Co., Inc., as part of the Norelco Protelgram projection television system, and is now being adapted to military applications where space, weight and efficiency are major design requirements.

Originally these high-voltage drivers were vacuum impregnated, oil-filled, and hermetically sealed in metal cans. Today, with the use of **BAKELITE Low-Loss Phenolic**

Plastics, neither oil impregnation of high-voltage components nor vacuum sealing is required, because of the superior dielectric qualities of the material. Tube replacement and other services are easily handled in the field. Flammability worries are greatly reduced. Production is speeded up and simplified. Costs are pared to the bone.

BM-17748 is one of a group of **BAKELITE Low-Loss Phenolic Plastics** specially formulated for high-frequency electrical insulation wherever low power factor, low loss factor, high resistivity, dimensional stability, and low water absorption are required. It is available for such exacting services as capacitor casings and frames, condensers, and coil

forms. It is recommended to molders and manufacturers desiring approval under MIL-P-14A.

Bakelite's engineers will be glad to consult with you, and provide detailed data on electrical, mechanical, and other properties of low-loss phenolics. Write Dept. BX-47.

\*Molded by Chicago Molded Plastics Corporation

**BAKELITE**  
TRADE-MARK  
**Phenolic  
PLASTICS**

TRADE MARK  
**BAKELITE COMPANY**

A Division of  
**Union Carbide and Carbon Corporation**  
30 East 42nd Street, New York 17, N.Y.

# BUSINESS BRIEFS

By W. W. MacDONALD

# new!



## PYRAMID TINY TYPE 85LPT TUBULAR PAPER CAPACITORS

**Fit anywhere!**

**Suitable for  
85°C. operation!**

**CAPACITANCE RANGE:**  
.0001 TO .5 MFD.

**VOLTAGE RANGE:**  
200 TO 600 V., INCLUSIVE

**Sturdily built in phenolic-  
impregnated tubes. Ends  
are plastic-sealed.**

**WRITE FOR COMPLETE LITERATURE**  
Representatives and Distributors  
Throughout the U.S.A. and Canada



## PYRAMID

**PYRAMID ELECTRIC COMPANY**

1445 Hudson Boulevard

North Bergen, N. J., U. S. A.

TELEGRAMS: WUX North Bergen, N. J.  
CABLE ADDRESS: Pyramidusa

Engineering Manpower is, as predicted (p 76, April) rapidly becoming the most critical factor in the mobilization program. Here are a few straws that show the way the wind blows:

Weston has appealed to readers of its widely mailed *Engineering Notes* for six electrical engineers, four mechanical engineers and five industrial engineers. Westinghouse has listed its detailed requirements for 563 electrical engineers, mechanical engineers, metallurgists, chemists and physicists in *Sales Record*. Philco has made a mailing for men to amateur radio station licensees.

New York's Department of Labor says firms advertising in the area for radar and other technical personnel are finding recent respondents inferior in qualifications compared with those recruited two months ago, says one company rejected 38 out of 42 men interviewed, says further that "two months from now they may regret this."

FCC field offices have been authorized to relax temporarily the requirements for a-m and f-m broadcast station operators if, after consultation with stations needing operators, it is apparent that radiotelephone-first-class operators cannot be found.

**Certificates Of Necessity** for fast amortization of taxes on new plant facilities have been awarded to 17 firms in the field of electronics, the dollar value of the facilities covered totalling \$25,000,000 and 75 percent of the cost being written off in five years.

All industry, including electronics, has received 493 such certificates, covering \$3,045,700,000 worth of facilities.

**Replacement Parts Shortage** will be minimized as the mobilization program progresses if television receiver makers observe the following RTMA-Better Business Bureau recommendations:

*Supply present set owners with*

*replacement parts and tubes on a quota basis related to new set production.*

*Expand the use of noncritical materials.*

*Continue to improve quality and inspection controls so as to obviate consumer complaints.*

*Minimize circuit changes with due consideration to availability of replacement parts.*

*Furnish substitution data to the trade for tubes and parts.*

*Develop more equitable distribution of components for repair and replacement purposes through closer cooperation within the industry.*

*Refrain from shipping sets without complete complements of tubes.*

*Increase the standardization of tubes and parts.*

*Continue to improve specifications for better service and longer life of component parts.*

**Speaking Of Parts**, we've checked into a reported holdup of orders which the Signal Corps has for some time been quietly placing as part of an Industrial Preparedness Study (IPS). Washington and Philadelphia offices tell us that these pilot runs are being held in abeyance to make way for components needed immediately in military operations and that they will soon be resumed.

**Mobilization Order** attributed to Haile Selassie:

"The country is now mobilized. All men and boys able to carry a spear will report for active duty. Married men will bring their wives to do the cooking; men who are not married will bring any women they can find. The very young, the very old, and women with very young children need not report for active duty. Anybody else found at home after the issuance of this order will be hanged."

How simple war was in those days.

**We're Bearing Down** editorially on mobilization problems, as promised (p 81, April).

The April issue itself contained five feature articles designed to help management in these abnormal times . . . . *Washington Report*, *Conservation of Critical Materials*,





Guided missiles...  
*100 MILES UP*

and in the ground receiving system...

*29 SYLVANIA CRYSTAL DIODES*

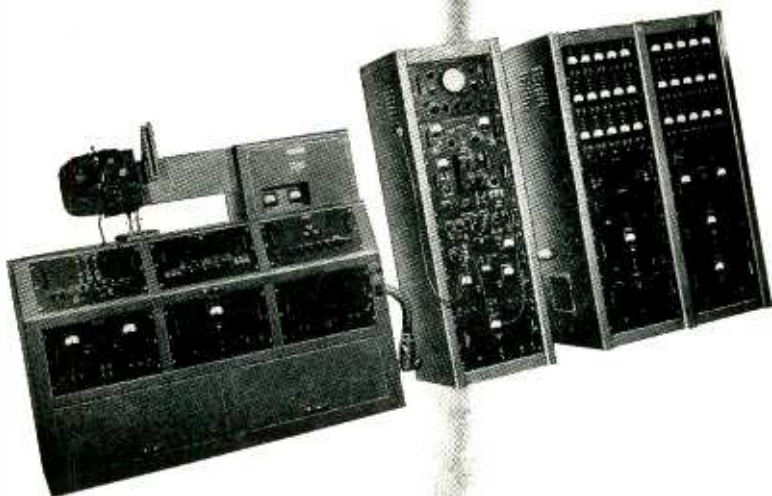

**I**N the Air Material Command's guided missile research at Alamogordo, N. M., transmitters in the airborne units, operating on a pulse system modulated with reference to time, send out pertinent data on temperature, air pressure, speed and structural strains. The signals are received by the ground telemetering system shown at the left.

This ground system uses a total of 29 Sylvania Crystal Diodes—25 1N34's and one 1N38 (Germanium); 3 1N21B's (Silicon). Major reasons for the selection of the Sylvania Diodes are their reliability and accuracy—outstanding advantages of these components *wherever* they are used, but *particularly* important in operation under desert conditions.

Sylvania Crystal Diodes may improve the performance standards of *your* equipment—or permit more compact designs. Get the facts!

*Mail coupon for literature*

Sylvania Electric Products Inc.  
Electronics Division, Dept. E-1006  
1740 Broadway, New York 19, N. Y.

Gentlemen:

*Please send literature on your Germanium and Silicon Diodes.*

Name \_\_\_\_\_

Position \_\_\_\_\_

Company \_\_\_\_\_

Street Address \_\_\_\_\_

City \_\_\_\_\_ State \_\_\_\_\_

**SYLVANIA  
ELECTRIC**

*Electronics Division, 1740 Broadway, New York 19, N. Y.*

ELECTRONIC DEVICES; RADIO TUBES; TELEVISION PICTURE TUBES; ELECTRONIC TEST EQUIPMENT;  
FLUORESCENT TUBES, FIXTURES, SIGN TUBING, WIRING DEVICES; LIGHT BULBS; PHOTOLAMPS;  
TELEVISION SETS

# SHOCK and VIBRATION NEWS

BUSINESS BRIEFS

(continued)

*Growing Quartz Crystals for Military Needs, Military Requirements for Subminiature Tubes and Material-Saving Picture Tube.*

May contained three special articles . . . . *Electronic Research in the Emergency Program, Washington Adopts Automatic C-D Warning System and Army Walkie-Talkie in Mass Production.*

In this current issue, June, there are four . . . . *Government Plans Industry Support (p 82), Safeguarding Production of Military Equipment (p 88), Civilian Defense Communications (p 94) and How to Set Up an Instruction Manual Department (p 100).*

In the words of the late Al Jolson, "you ain't seen nothin' yet!"

**Quote** from a speech before NEMA by our own McGraw-Hill executive vice-president Col. Willard Chevalier:

"This time our military requirements are heavily concentrated in electronic control equipment, vehicles and airplanes—the sort of equipment calculated to multiply our limited manpower by giving it the best of modern equipment and a great deal of it.

"I am reliably informed that the electronic equipment on a medium bomber now costs as much as the entire plane cost in World War II. And, believe it or not, the same thing seems to be true of a medium tank. The electronic equipment costs as much as the whole tank did in World War II."

**Television Shipments by RTMA** members totalled 7,068,000 in 1950. Here's the breakdown:

Alabama	23,487
Arizona	8,823
California	658,233
Connecticut	126,453
Delaware	23,479
District of Columbia	95,756
Florida	36,332
Georgia	60,807
Illinois	508,239
Indiana	98,876
Iowa	26,227
Kansas	10,856
Kentucky	55,557
Louisiana	33,214
Maryland	131,989
Massachusetts	397,082
Michigan	352,160
Minnesota	85,264
Missouri	167,783
Nebraska	29,963
New Jersey	363,403
New Mexico	4,896
New York	1,129,801
North Carolina	26,749
Ohio	496,802
Oklahoma	25,689
Oregon	2
Pennsylvania	635,926
Rhode Island	60,426

BARRYMOUNTS FOR ASSURED CONTROL OF SHOCK AND VIBRATION

## NEW ALL-METL BARRYMOUNTS for Unusual Airborne Applications

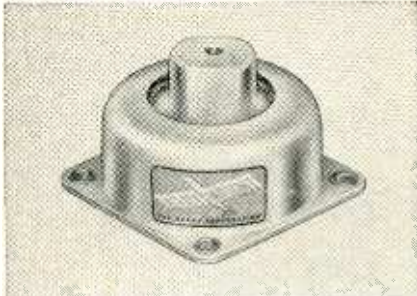

These new Barrymounts provide the aircraft and electronic engineer with a vibration isolator designed to meet the unusual temperature and environmental conditions encountered in high-altitude, high-speed flight. Employing no organic materials, these mountings are not subject to temperature influences that may affect the performance of other mountings.

ALL-METL Barrymounts offer a wide load range with uniform performance. They have a natural frequency of about 7½ cycles per second, with low horizontal stiffness for maximum isolation of horizontal vibration. Transmissibility at resonance is only 4½. There is no snubber contact nor resonance carry-over when ALL-METL Barrymounts are vibrated at government-specified amplitudes.

These mountings are designed especially for unusual military conditions. They meet the vibration requirement of JAN-C-172A, MIL-E-5272 (USAF), and MIL-T-5422 (BuAer). For details of sizes, ranges, and construction of unit mounts and bases using ALL-METL Barrymounts, see catalog 509.

### FREE CATALOGS

- 502 — Air-damped Barrymounts for aircraft service; also mounting bases and instrument mountings.
- 509 — ALL-METL Barrymounts and mounting bases for unusual airborne applications.
- 504 — Shock mounts and vibration isolators for marine, mobile, and industrial uses.
- 607 — How to cut maintenance costs by using Barrymounts with punch presses.

## STANDARD MOUNTINGS ISOLATE VIBRATION Available for Aircraft, Marine, Mobile, Instrument, and Industrial uses.



Standard bases built to meet government specifications can be furnished by Barry; special bases can be supplied in sizes and load ratings to fit customers' exact requirements, including miniaturized bases. See catalog 502 and data sheets 605 and 606.

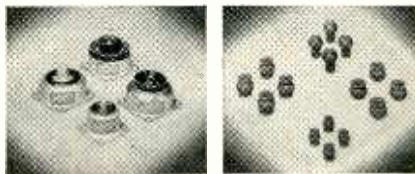

Aircraft vibration isolators designed to meet Army, Navy, and CAA requirements are available in ¼-pound to 45-pound unit ratings; also miniature mounts to 0.1 lb. See catalogs 502 and 509 and bulletins 605-6.

Instrument mountings are furnished for electronic components, tiny, fractional-HP motors, record changers, dictating machines, and other light-weight apparatus. See catalogs 502 and 504.



Shock mountings for mobile, railroad, and shipboard service also give vibration isolation at frequencies above 2000 c.p.m.; useful for general sound isolation. See catalog 504.

Industrial mountings isolate vibration from fans, motor-generator sets, transformers, punch presses, and other heavy industrial equipment. Bulletin 607 tells how to cut maintenance costs with Barrymounts.

THE **BARRY** CORP.

707 PLEASANT ST., WATERTOWN 72, MASSACHUSETTS

SALES REPRESENTATIVES IN

New York Rochester Philadelphia Washington Cleveland Dayton Detroit  
Chicago Minneapolis St. Louis Seattle Los Angeles Dallas Toronto



South Carolina .....	1,258
Tennessee .....	47,095
Texas .....	129,421
Utah .....	21,195
Virginia .....	59,671
Washington .....	31,685
West Virginia .....	12,512
Wisconsin .....	83,111
Areas unlisted .....	1,006,778

TV Broadcasters took in \$105,-800,000 during 1950, more than triple the \$34,300,000 revenue of 1949, and more than half the 107 stations on the air made a profit. A-m and f-m broadcast station revenue amounted to \$447,700,000, the highest on record. Thus the combined visual and aural services passed the half-billion mark for the first time.

Back in January (p 60) we published an item relative to interest in British television cameras at UN Headquarters. B. G. H. Rowley now tells us that three Marconi Wireless camera chains have been purchased, along with full ancillary equipment.

Receiving Tube Exports are reported as follows by the U. S. Department of Commerce:

Country	1949	1950
Belgium .....	\$307,702	\$243,507
France .....	129,946	212,069
Germany .....	4,902	32,824
Greece .....	119,377	64,679
India .....	202,641	116,113
Indonesia .....	45,643	4,806
Iran .....	24,692	47,219
Ireland .....	19,073	5,930
Israel .....	37,111	24,403
Italy .....	106,521	164,107
Lebanon .....	26,030	9,166
Netherlands .....	60,921	9,653
Norway .....	51,544	11,971
Pakistan .....	39,190	56,235
Philippines .....	122,673	98,113
Portugal .....	25,993	21,324
Spain .....	36,177	17,482
Sweden .....	132,518	84,472
Switzerland .....	185,792	132,827
Tangier .....	45,410	67,121
Thailand .....	32,795	24,432
Union of South Africa .....	142,655	81,382
United Kingdom .....	37,522	26,965
	\$1,936,828	\$1,556,800

Export license applications for the first quarter of 1951 totalled \$1,567,000, more than total shipments for the year 1950.

Secondary Supply Sources (p 83, April) are still being sought by government procurement people. To them we recommend close perusal of the 1951 ELECTRONICS Buyers Guide, due out about June 15.

Shot Effect is a well-known phenomenon. Not so well known is "big-shot effect," the phenomenon that causes electronic equipment not to work when first demonstrated before an admiral or a general.



SERIES 4

SPDT GENERAL PURPOSE SENSITIVE D.C.

RELAY. Inexpensive balanced armature for vibration resistance on aircraft at 50 milliwatt adjustment. Sensitive enough for V-T operated relay circuits; can be set to operate down to 10 milliwatts. Precision adjustments for pull-on and drop-out. 2 amp. nominal contact rating. Coil resistance up to 14,000 ohms.

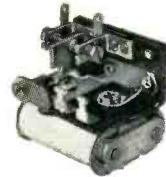

SERIES 5

SPDT VERY SENSITIVE D.C. RELAY. Balanced

armature and magnetic efficiency resist aircraft vibration on inputs as low as 5 milliwatts. Withstands 500g shock without damage. Precision adjustments. 2 amp. nominal contact rating. Coil resistance up to 16,000 ohms. Special adaptations: Built-in rectifier, two-coil differential operation, constant voltage temperature compensation.



SERIES 41

SPDT SENSITIVE RELAY

A.C.-D.C. — KEYING. Unusual characteristics at low

cost. Same D. C. sensitivity as Series 4 but less flexibility of adjustment. Available with long life and bounce-free contacts, it is suited to high speed counting and keying. Mechanical life exceeds 10<sup>9</sup> operations. Good for plate circuits needing moderate precision and vibration immunity. Contact ratings up to 5 amps. Coil resistance to 14,000 ohms. A. C. sensitivity exceeds 0.1 V. A. at 60 cps. Serviceable on frequencies from 16-400 cps.

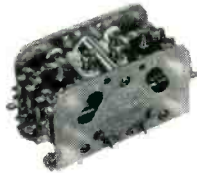

SERIES 6

MULTICIRCUIT POLARIZED SENSITIVE RELAY. Single or double (differential) windings. Resistance up to 25,000 ohms total. Contacts up to 4PDT, 5 amp. nominal rating. Balanced armature for strong vibration resistance. FORM X — Three Position or Null Seeking. For automatic positioning or 2-Way process control. Sensitivity (depending on contact complexity) from 10 to 100 milliwatts. FORM Y — Biased (Spring Return). Use as an ordinary sensitive relay if a complex contact combination is needed. Responds only to one polarity. Combines function of pilot relay and contactor. Sensitivity same as Form X. FORM Z — Latching (permanent magnetic). Replaces mechanical latch electrical reset relays, where longer life and greater vibration resistance is required. Sensitivity from 100 to 250 milliwatts.



SERIES 7

SPDT SENSITIVE HIGH SPEED

POLARIZED RELAY. Single or multiple windings up to 14,000

ohms (single). Balanced armature. Nominal contact rating 2 amps. For repeating telegraphic signals at speeds up to 250 WPM. Small in size and weight. Hermetically sealed. Mechanical life exceeds 10<sup>9</sup> operations. FORMS X, Y and Z (see Type 6 above) available in Series 7. Sensitivities from less than 1 to 10 milliwatts depending on form and requirements. Form X is useful as the detecting element in positioning bridge circuits.

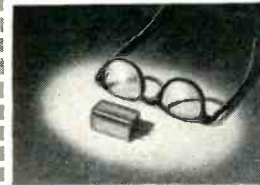

SERIES 22

Miniaturized double-pole double-throw Direct Current Sensitive (45 milliwatt) relay. 2-amp contact rating, coils up to 12,000 ohms. Hermetic seal enclosure only, 1 inch square mounting space. Specially designed for highly stable and precise operating adjustments, extreme immunity to vibration and to thermal and mechanical shock. Will operate under 50 g's sustained acceleration if operating and releasing margins are increased.

VARIETY OF ENCLOSURES

In addition to the open styles shown, SIGMA Relays are available with dust-proof or hermetically-sealed enclosures. Most types are available for either plug-in or permanent solder-lug connections.

Write for fully descriptive catalog.

SIGMA Sensitive Relays

SIGMA INSTRUMENTS, INC., 62 CEYLON STREET, BOSTON, MASS.

**Result  
Beyond  
Expectation!**

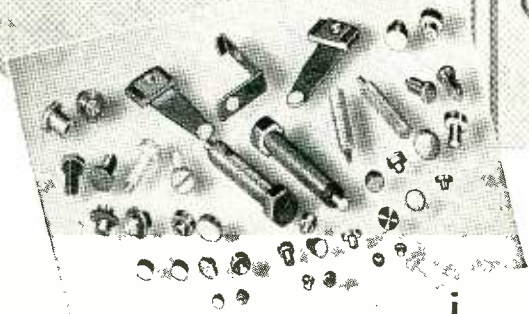
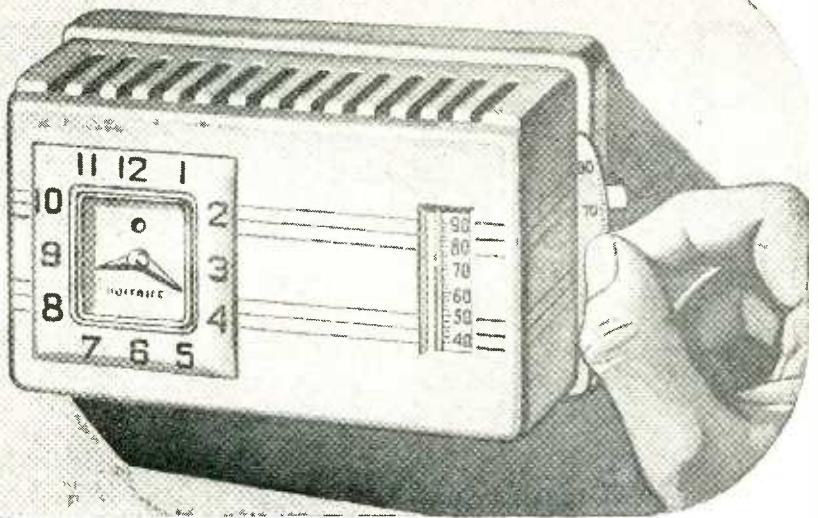

## Mallory Creative Research *Develops Low-Cost Technique For Platinum-Tipped Contact*

### MALLORY

#### PLATINUM CONTACTS

Platinum is ideal for electrical contacts where low resistance must be maintained for long periods of time. However, pure platinum lacks hardness. Mallory platinum alloys overcome this by the use of such hardening agents as iridium, ruthenium and palladium. Mallory is fully qualified to recommend the best contact material for your design. Write today.

New time and money saving methods for meeting customer contact specifications result from continuing research and development by Mallory.

Typical is the application of Mallory metallurgical and welding experience to the problem of attaching and forming the platinum tip on a contact screw used in home thermostats. Mallory tackled the problem of reducing the high cost involved . . . and came up with a new weldable material for the screw, a way to weld the tip in place more securely, and a method for forming the tip to proper contour. Savings on machining and waste platinum were immediately passed on to the customer.

*That's result beyond expectation!*

Mallory contact know-how is at your disposal. What Mallory has done for others can be done for you.

*In Canada, made and sold by Johnson Matthey and Mallory, Ltd., 110 Industry St., Toronto 15, Ontario*

## Electrical Contacts and Contact Assemblies

**P. R. MALLORY & CO., Inc.**  
**MALLORY**

P. R. MALLORY & CO., Inc., INDIANAPOLIS 6, INDIANA

### SERVING INDUSTRY WITH

Electromechanical Products  
Resistors                      Switches  
TV Tuners                      Vibrators

Electrochemical Products  
Capacitors                      Rectifiers  
Mercury Dry Batteries

Metallurgical Products  
Contacts                      Special Metals  
Welding Materials





# CROSS TALK

► **PIPES** • • • Fresh back from the IRE Southwestern Conference in Dallas, we are mightily impressed with the future of microwave systems for communication, control and supervision of oil and gas pipelines. The largest single order for industrial electronic equipment in history, over a million dollars worth of microwave gear, was placed last year in this field. At least five big companies are contesting for future business they estimate at 10 million dollars by the end of 1951, 100 million by the end of the next decade.

These figures are justified by the extraordinary development of pipeline transportation in recent years, but more particularly by the enormous value of the product transported in relation to the costs of controlling and supervising the pipeline system. The readiness with which the pipeline business has embraced electronic methods stands in strange contrast to the attitude of their competitors in the maritime field, down whose throats radio and radar have had to be forced at every stage.

► **UPGRADE** • • • If our post-convention conversations with engineering managers mean anything, and we think they do, the hottest subject at the late IRE clambake was not technical. It was the salaries being offered to young engineers in the recruiting drives of several companies, largely in the aircraft field, engaged in govern-

ment cost-plus contracts. We heard repeated reports of salary offers of a straight 50 percent over the recruit's present salary. This kind of inducement is hard to resist, and as a result a great many families are now moving across the continent, and a great deal of resentment has been stirred up among the managements of old-line companies. We think this situation deserves comment and a bit of gratuitous advice.

The comment: the fact that government contracting officers will approve engineering costs in these cost-plus contracts which run 50 percent or more above the going rate is not wholly explained by expediency and the urgency of our military preparations. It is, we believe, partly explained by the fact that engineering costs in our field are low compared with many other fields, low compared with the true value of the engineering service rendered.

The gratuitous advice, to the young-man-going-west: be sure the new job offers more than mere money upgrading. If you can learn a new field, put more arrows in the quiver, fine. But if you find yourself standing still, in every respect except the bank balance, beware. To the managements of old-line companies: to hold your men against the blandishments of the pirates, how about reconsidering the true value of the services listed under engineering costs? The cost-plus boys may be

closer to the proper level than you think.

► **INDEX** • • • We are happy to announce that a cumulative index of *ELECTRONICS* covering the first decade of publication, from April 1930 to December 1939, has been compiled and will be printed in the 1951 Mid-June Buyers Guide Issue. Every article published in that period, full-length feature articles as well as shorter departmental items, has been listed alphabetically by author, by title and by subject matter.

The compilation turned out to be a monumental job. It fills 36 pages of fine type, and its production took 1,200 man-hours of staff time. Indexing methods of other publications were studied, technical librarians were consulted, the bound volumes were meticulously scanned by our technical staff to collate hundreds of different subject categories into a consistent and rational listing. Every listing, whether by author, title or subject, contains the issue date and page, so no cross-checking is necessary.

We think it's one of the most complete and easiest-to-use technical jobs of its kind yet published. While hoping our readers agree, we ask for criticism which will prove helpful in our continuing effort to provide where-to-find-it information on electronic techniques. A similar index covering the second decade, 1940-1949, is in preparation and will be printed in the 1952 Buyers Guide Issue.

# GOVERNMENT PLANS

Washington takes initial steps to insure that manufacturers stay healthy against emergency needs. Critical materials allotted to tube makers facing shutdown, and plant expansion permitted companies having government contracts. Controlled materials plan effective July 1 will afford further relief, may even leave adequate materials for civilian goods

---

By **W. B. WHICHARD, JR.**

*McGraw-Hill Washington Bureau*

---

**T**HE GOVERNMENT is going to see to it that the electronics industry stays healthy so that it will be ready when the time comes to meet military needs.

Mobilization officials will see that key segments of the industry obtain sufficient materials to stay in operation, and encourage expansion of production facilities that will be needed later to meet military needs for electronic equipment.

Two basic problems have complicated such planning by both the mobilizers and the industry.

First, other defense production has steadily cut deeper into the supply of raw materials vitally needed to keep the industry in business. The shortages of such metals as cobalt, nickel, tungsten and copper are going to get worse before they ease.

## **Shutdown Threatened**

Second, military orders for electronic equipment—which, of course, are backed by government assistance to the producer in obtaining raw materials—are not being placed in anywhere near the volume necessary to offset any major reduction in output of civilian equipment. A substantial flow of military orders to the industry is not expected before the last quarter of 1951, and will reach a peak even later. In the interim, the mobilizers have decided, something must be done to prevent other defense programs from choking off the industry's sup-

ply of critical materials.

Impact of materials shortages on the industry came in for Washington attention early in April when eight manufacturers of receiving tubes warned mobilization officials that they would be forced to halt production before June 1 unless they received relief. The National Production Authority passed the problem up to the Defense Production Administration, top policy agency for industrial phases of the mobilization program.

A check with the Armed Forces developed potent arguments for keeping the tube makers, in particular, and at least part of the industry, in general, in business.

More and more new weapons are controlled by electronic equipment. Though the arms build-up has not yet reached the phase where these devices are needed in quantity, it is nearing that stage. There will be a military demand for tubes and other components very similar to those now going into civilian products, so the services want to keep these items in production.

Even more important, some electronic controls for future weapons are still to be perfected and adopted to special uses. That will take engineering and the work of other technicians now employed by the industry. To keep these people on the job until the armed services get their orders out, there will have to be a high level of activity throughout the industry in the interim.

Finally, electronic equipment has become vital to a broad range of industrial operations that rate second only to military production in Washington planning. Among these are transportation, communications and other utility services, to name a few.

How much of the industry should be supported by assistance in obtaining materials and aid in expanding plant has not been worked out yet. Components makers will get substantial help, to prepare for anticipated military orders, and to maintain equipment already in use. Certificates of necessity for five-year tax amortization already have been issued for new plants to turn out military equipment.

## **Program Planning**

A batch of certificates approved late in April indicates the type of plant Washington wants built. For example, Electronics Products Co. obtained certificates covering 75 to 85 percent of the \$1,003,965 cost of new facilities to produce coils, tubes, and tube production equipment. Weston Electrical Instrument Corp. was certified for 80 percent of \$1,500,000 in a new aircraft equipment plant. Resistance Products Co. won a certificate covering 80 percent of a new plant to turn out resistors.

Even more significant, however, was the establishment in April of an Electronics Production Board within DPA. It was set up to de-



# INDUSTRY SUPPORT



termine requirements for electronic products, to steer distribution of such products into essential programs, to break production bottlenecks on vital equipment, to encourage needed expansion — in short, to make policy for mobilization operations of the industry. Material requirements and day-to-day operating problems of the industry are still assigned to the National Production Authority.

The Electronics Production Board is headed by Edmund T. Morris, Jr., on leave from Westinghouse Electric Co. Other members are Captain F. R. Furth, Director, Naval Research Laboratory; Harry A. Ehle, International Resistance Corp; John G. Daley, Chief, NPA Electronics Division; M. W. Boyer, General Manager, Atomic Energy Commission, and Don G. Mitchell, Sylvania Electric Products Inc.

## Allotted Materials

First tangible result of the decision to assist the industry was an allotment of cobalt, tungsten and nickel to the tube makers faced with shutting down plants. The allotments were in the form of directives from NPA to suppliers of these materials, covering a portion of the tube manufacturers' requirements for April, May and June.

There is little question but that similar allotments will follow in July for tube production, at least. Makers of tubes, industrial communications equipment, and many

other electronic devices were instructed to fill out during May NPA forms reporting their requirements during the third quarter for copper, steel and aluminum. The implication was that these producers would receive allocations of the latter metals under the controlled materials plan going into effect July 1.

## Hope for '51

Manufacturers of home radio and television sets, on the other hand, were told not to fill out the forms. But this did not mean they would get no steel, copper or aluminum after July 1. There will be no allocations of metal to such producers under CMP. That is, radio and tv manufacturers will have to compete against other unallocated producers for the steel, copper and aluminum left over after military programs and other allocated production take their bite. Mobilizers were, however, guessing that as much as 60 to 70 percent of total output of steel, copper and aluminum would be unallocated under CMP this year.

To prevent a mad scramble for unallocated metals, Washington will cut down their use in production in other than the allocated programs by conservation orders. These almost certainly will slow output of home radio and television receivers. But such production would be cut back, anyhow, by the lack of nickel, cobalt and other critically short materials.

Cutbacks will be gradual. Mobilization officials see this year's radio and tv production approaching the record levels of 1950. The limitations on use of metals will become more severe, but are likely to be eased in 1952, barring a new military crisis.

Before that time, however, there will be tough sledding for segments of the industry. Assemblers of radio and tv receivers now appear likely to be the hardest hit. Since they are not producing essential components or, in most cases, maintaining large engineering and research staffs, they can expect little help from Washington in the way of materials allotments. Their components suppliers are likely to shift from civilian to military production as fast as they can get contracts from the Armed Forces.

Some components makers are likely to be hurt, too, unless they can shift into turning out items of a military or essential-civilian nature. The mobilization agencies hope to keep some production of most civilian goods, but materials shortages already are hitting the electronics industry all along the line.

First port of call for industry people in trouble of this sort is NPA. John Daley's Electronics Division, and the Communications Equipment Division headed by Luther W. Hill, are being staffed to help with supply, production and distribution problems.

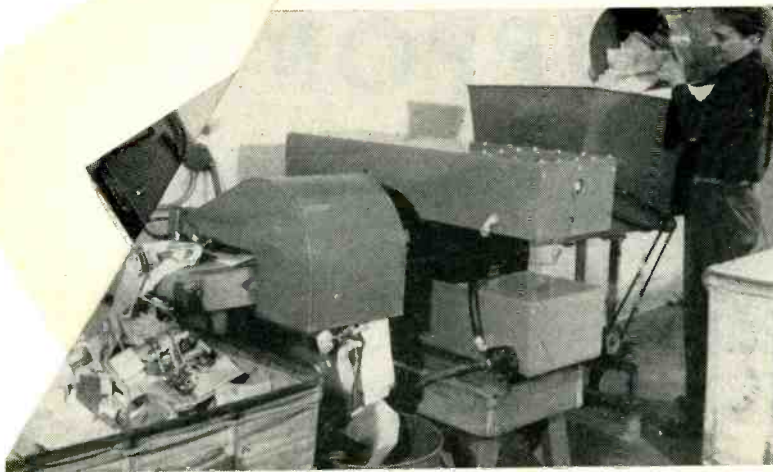

Use of RCA metal detector to inspect contents of wastebaskets for coins overlooked by mail sorters. Air jet blows coin-bearing material into can

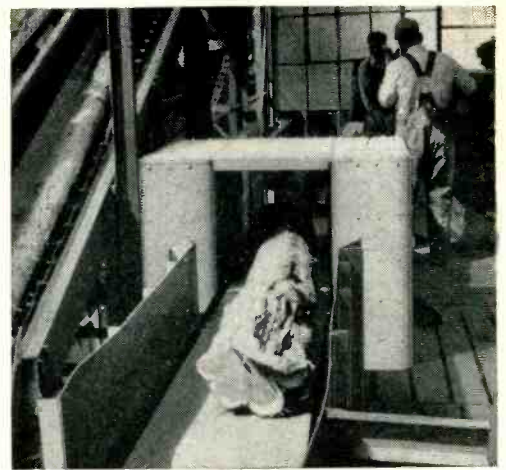

Installation of RCA detector at The Lane Co. in Altavista, Va. for inspection of cedar logs

# CHOOSING INDUSTRIAL

Practical survey analyzing factors affecting decision to buy or not buy a commercial metal detector for a particular industrial inspection application. Covers reliability, stability, effects of moisture and nearby metal, minimum detectable particle size for various coil apertures, fail-safe requirements and methods of testing performance

**D**URING the past three decades, the status of the metal detector has evolved from that of a laboratory experiment to a practical means of locating land and underwater mines, and within the last three years it has become a highly desirable way of detecting unwanted metallic fragments in many raw materials and manufactured products.

Perhaps the first industrial use of the metal detector was to warn a sawmill operator of the presence of spikes, horseshoes and unexploded artillery shells in the logs he was about to rip into boards and lath. Now, metal detectors are widely and successfully used in many fields, from detecting counterfeit Bank of England notes to finding machete blades in loads of sugar cane.

Two companies in the United States, RCA and Allis-Chalmers, are making identical models of a general-purpose detector. Eriez

By  
**CURTISS R. SCHAFER**

*Ridgefield, Conn.*

Manufacturing Co. has developed a metal detector which is specifically designed for conveyor belt applications. The General Electric Co., which in the past has produced tailor-made detectors for specific applications, is now developing a new version of their type YE-6, which was first made for the lumber industry.

## Commercial Models

The RCA, Allis-Chalmers, and GE models are built around some form of mutual-inductance bridge employing a symmetrical coil arrangement which is fed by a suitable oscillator. The presence of a metallic particle in the a-c electromagnetic field which links the coils disturbs the original field pattern

for which the bridge was balanced. The resulting bridge unbalance current is amplified and made to operate a warning or rejection device. The Felici mutual-inductance balance is ideal for this purpose, and its action is illustrated in Fig. 1. The RCA and Allis-Chalmers detectors use a slight modification which is shown in Fig. 2.

If the two pairs of coils are of identical electrical and mechanical construction, this system is inherently free from variations due to ambient temperature and humidity, line voltage (within certain limits) and oscillator frequency. Variations in temperature and humidity affect both pairs of coils alike, and hence result in no change in mutual inductance. A shift in oscillator frequency or amplitude will change the sensitivity somewhat, but will not produce an erroneous indication.

The Eriez detector, as well as one developed by Furzehill Laboratories



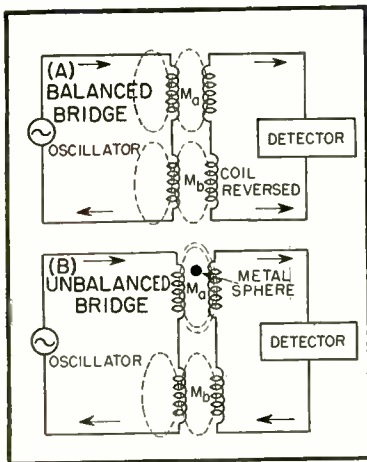

FIG. 1—Mutual-inductance bridge used in many metal detectors

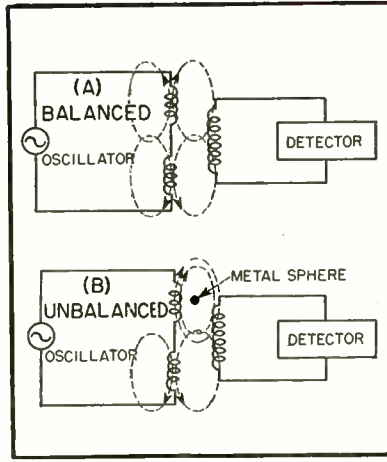

FIG. 2—Three-coil metal-detecting arrangement

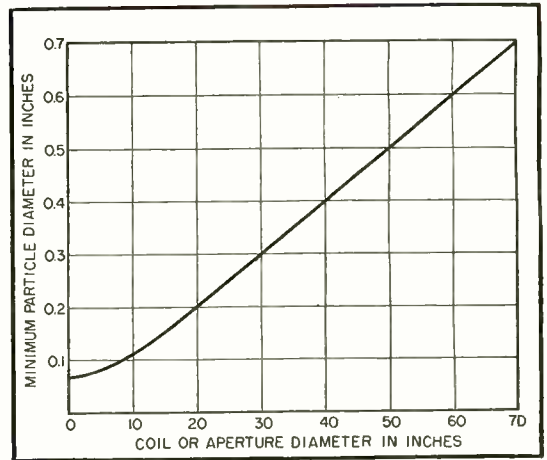

FIG. 3—Sensitivity of commercial metal detectors using mutual-inductance bridge

# METAL DETECTORS

in England during the war, operate by virtue of the change in the output current of an oscillator due to hysteresis and power-factor changes in the tank circuit in the presence of metal. The sensitivity of this system can be made very high, with a corresponding loss of stability; all voltages must be very carefully regulated, as a slight change in any of the voltages applied to the oscillator tube will give a change in the output of the oscillator similar to that produced by the presence of metal.

## Before-Buying Questions

The production man who is interested in the possible application of metal detector techniques to his own industry should evaluate the answers to these questions:

- (1) What may be accomplished by the use of a metal detector?
- (2) What advantages will an electronic metal detector have over older methods of inspection?
- (3) What are the capabilities and limitations of the commercial models of electronic detectors?
- (4) What shall we look for when buying a metal detector?

The proper use of a metal detector will accomplish several things. First, it will insure an uncontaminated product. This is im-

portant, for steel slivers found in flour, processed meats and candy will not only lose the goodwill of consumers of these products, but will often form a valid basis for expensive and embarrassing lawsuits. Bits of broken machinery have been found in flour; lead shot and steel slivers have been found in soups; a broken shredder blade was found in a cigarette; hairpins and pieces of bearings got into packaged cereals. To the consumer, these are logical reasons for changing to another brand.

Second, a metal detector will protect personnel and machinery. When a tooth is broken out of a circular saw by a spike which is completely embedded in a log, when a bit of metal in an explosives mill or a plastics mill strikes a spark, or when a large calender is used to process plastics which may contain metallic particles, both personnel and equipment are unnecessarily endangered.

Third, a metal detector will increase production rates. This is a direct result of protecting the machinery of production. In addition, it is a result of increasing the rate of inspection over that obtainable with visual and x-ray methods, even where such methods are possible.

Visual inspection methods are

seldom feasible, for metallic particles are either imbedded in the product, as in the case of logs and candy, or are covered or mixed in with the product, as in the case of canned foods and packaged cereals.

## Safety Aspects

X-ray inspection will endanger personnel exposed to these rays. This danger is particularly deceptive because the effects are cumulative and may not be evident for some time after exposure. Elaborate safety measures must be used which will not only provide shielding and space factors, but which will call for periodic exposure tests and measurements of the intensity of radiation to which the personnel is exposed. These safety measures are not required with electronic metal detection. All commercial models of electronic detectors are so constructed that the operator cannot touch any part that carries any voltage. The electromagnetic field around the coils is of such low intensity that no injurious effects are possible from exposure to this field.

## Metal Detector Limitations

There are several things that an electronic metal detector will not do. It is well to know the limitations of the equipment at the start,

in order to avoid later disappointment. First, the presence of much moisture, say in excess of 10 per cent by weight, will reduce the normal sensitivity greatly and even render the detector useless. Most commercial models react to the presence of water just as they would to the presence of a nonferrous metal. The higher the operating frequency used, the greater the sensitivity of the equipment to moisture.

Second, the sensitivity will be impaired if large sheets or masses of metal are near the coil system of the detector, even if these masses are fixed and never moved around. This means that conveyor belts, chutes or rollers of metal cannot be run through the metal detector. Even a canvas or leather belt with metal rivets cannot be used, if normal sensitivity is required.

Third, most commercial models will not fail safe; if the oscillator stops, the presence of metal will cause no indication whatever. Various other component failures in the detector and amplifier section will likewise cause the metal detector to fail to indicate. A common cause of failure is a defective tube, for most commercial models use regular radio receiver tubes. Miniature and subminiature tubes are now readily available with a rated minimum life of 5,000 hours, and some special industrial types have been

available for several years that have a rated life of 10,000 hours. These types should be used in industrial metal detectors where reliability and continuous operation are desired.

In view of the possibility of failure of the detector, its operation should be checked at least every eight hours with the special steel and brass spheres that are provided for this purpose. Most metal detectors require a slight adjustment of the balancing controls at least once a day, and this procedure is in itself a check on whether or not the detector is functioning correctly.

Fourth, no commercial model will operate satisfactorily if it is subject to much vibration, as this will cause slight dimensional changes in the coils and their relation to each other. This, in turn, will require frequent adjustment of the rebalancing control. In addition, the tubes used in most commercial models are not of the ruggedized industrial types, and hence vibration will cause shorts and intermittent operation.

#### Buying a Metal Detector

There are several factors which should be considered when buying a metal detector. The first of these is sensitivity; will it be adequate to detect the smallest metallic particle that may cause damage to other machinery or consumer goodwill?

Particle size is directly related to coil size and aperture size, which determine the maximum dimensions of the material that may be inspected. For instance, a nail one-sixteenth inch in diameter will easily be located in a three-inch diameter log by a detector that will accommodate only a three-inch log, but it is not feasible, at this stage in the art, to locate the same size nail in a 36-inch diameter log. Table I gives the sensitivity obtainable for various metals with three different detection apertures.

#### Sensitivity and Stability

Sensitivity is also indirectly related to stability; the higher the required sensitivity, the more frequently the rebalancing controls will have to be adjusted.

Stability is the second feature to be considered when selecting a metal detector. Good stability is achieved by good mechanical layout and construction, a symmetrical coil system, adequate ventilation to prevent overheating of the electronic components, a mounting base (which is usually built by the user) that will effectively isolate the detector from vibration, and electrical and electronic circuit design which is inherently free from line voltage variations. This latter is most readily achieved by the use of a symmetrical mutual inductance bridge and an amplifier stabilized

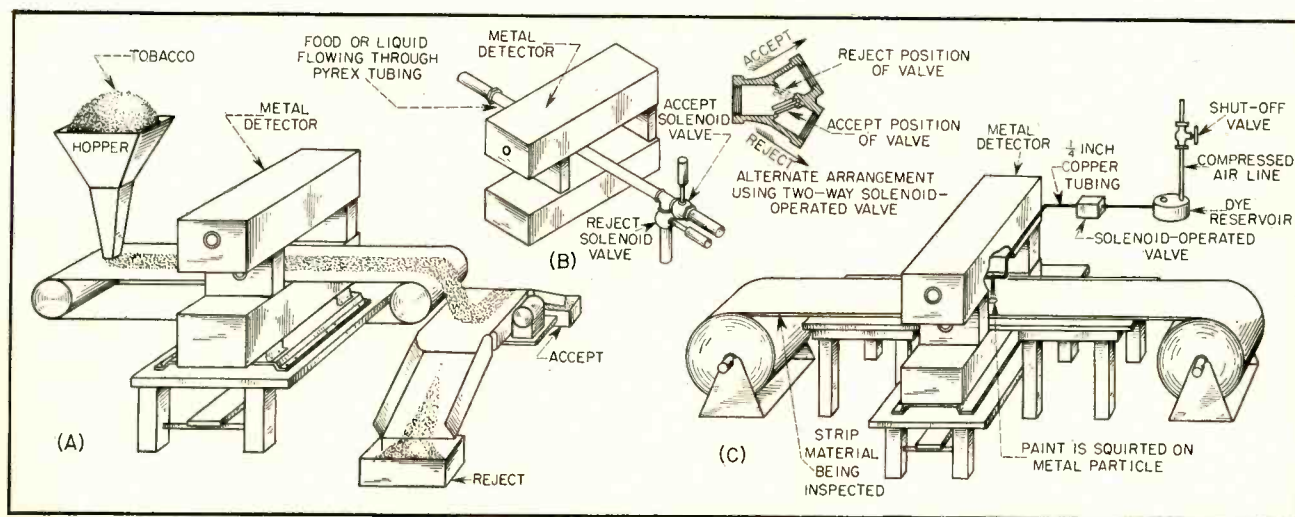

FIG. 4—Examples of metal detector applications in three different industries. Conveyor belt arrangement at (A) works well with many other granular materials besides tobacco. For any material that can be sent through a glass pipe, the arrangement at (B) is ideal. Strip material such as sheet plastic (C) can be inspected for extremely small particles because it requires minimum aperture



by a high percentage of inverse feedback. Otherwise, either line voltage regulators, plate supply regulators, or both, must be used.

The fact that voltage regulators must be used is not evidence of unsound design; it is pointed out here to emphasize that if the model selected is affected by line voltage variations, the user must be sure that voltage regulators are provided as part of the installation.

The third important buying factor is the speed of response. The electronic circuits and the necessary relays all have definite time lags, which determine the maximum speed at which the conveyor belt may be run. Most commercial models permit operation at speeds up to 600 feet per minute. Some models, particularly those using the change in the output of an oscillator, will not detect metal that moves through too slowly, so this limitation should be kept in mind where conveyor speeds are very low.

The fourth point to consider is the probable moisture content of the material to be inspected. Several metal detectors are just as sensitive to water as they are to nonferrous metals. If the materials to be inspected are not reasonably dry, the sensitivity of the detector will have to be reduced to the point where only relatively large masses of metal will give any indication at all.

Fifth, the detector should be made of materials which will not be affected by high humidity, corrosive fumes, chemicals, dust, water splash or other factors which are a part of the environment in which it will be used. If it is to be used in a grain elevator, flour mill or explosives mill, it should be adequately sealed against dust; if it will be used in a sawmill or ore crusher, the coil system should be protected from the impact of logs or large pieces of ore.

### Conveyor Installations

Installations generally fall into one of three groups:

(1) *Manual.* Here the material is fed or guided through the coil aperture by an operator; the detector signals the presence of metal, and the same operator removes the contaminated piece.

**Table I—Minimum Spherical Particle Weights and Diameters Detectable With RCA Metal Detectors**

Metal	4-inch aperture		7-inch aperture		12-inch aperture	
	Mass grams	Diam inches	Mass grams	Diam inches	Mass grams	Diam inches
Iron or steel.....	0.035	0.080	0.049	0.090	0.460	0.190
Brass.....	0.124	0.120	0.196	0.140	1.130	0.250
Copper.....	0.130	0.120	0.208	0.140	1.180	0.250
Aluminum.....	0.040	0.120	0.063	0.140	0.356	0.250
Lead.....	0.222	0.130	0.327	0.150	2.600	0.290
Magnesium.....	0.080	0.140	0.100	0.150	1.000	0.340
Stainless steel (non-magnetic).....	0.184	0.140	0.220	0.142	3.000	0.340

(2) *Semiautomatic.* The material passes through the coil aperture on a conveyor; a bell or light signals the presence of metal, and an operator removes the contaminated material.

(3) *Automatic.* The material passes through the coil aperture on a conveyor; the detector operates a solenoid which is mechanically coupled to a reject vane, an arm which pushes the package off the line, a dye-marking gun operated by compressed air, or an air valve in a compressed air line which blows the contaminated material off.

Figure 3 shows what generally may be expected in commercial detectors with regard to the smallest particle size of steel or iron that may be detected with a coil aperture of a given diameter.

### Applications

A portable metal detector unit is quite convenient in a small plant. It may be moved around to inspect raw materials, to control contamination of the product during the various stages of manufacture, and for final inspection of the packaged product before it is shipped. The portable unit is also advisable in certain factories where a metal detector has not been used before, and hence where its most desirable location in a processing line is doubtful.

Applications of a metal detector to three specific industries are illustrated in Fig. 4. Figure 4A shows the automatic inspection of tobacco, which is conveyed through the detector on a continuously moving belt, and then dumped on a second conveyor which is instantaneously

reversible by means of a rejection signal from the electronic circuits of the detector.

Figure 4B shows the inspection of liquids and liquid foods prior to canning. Plastic or glass piping is used to conduct the liquid through the metal detector. Two rejection methods are illustrated, both employing the same principle of operation. When metal is detected, the accept solenoid is de-energized and the reject solenoid is energized, thus diverting the flow from the canning machines. After a preset time interval, the accept solenoid is again energized (and the reject solenoid de-energized), but only if the metal detector indicates no further contamination.

Figure 4C illustrates the inspection of plastic sheeting. Operation is completely automatic, and speeds up to 600 feet per minute may be used with full sensitivity. When the electronic circuits of the detector indicate metallic contamination, a solenoid is energized which squirts a dye upon the area that is contaminated. The flow of dye continues as long as the presence of metal is indicated.

### BIBLIOGRAPHY

- H. G. Doll, M. Lebourg and G. K. Miller, Vehicular-Mounted Mine Detector, *ELECTRONICS*, p 105, Jan. 1946.
- Finding Shells in Lumber, *ELECTRONICS*, p 150, Jan. 1948.
- C. R. Schafer, Metal Detector for the Lumber Industry, *ELECTRONICS*, p 100, Sept. 1949.
- K. Urbach, Metal Detector for Conveyors, *ELECTRONICS*, p 80, July 1949.
- P. A. Greenmeyer, Electronic Inspection, *Modern Packaging Magazine*, Sept. 1947.
- P. A. Greenmeyer, Metal Detection for Better Plastic Products, *Modern Plastics*, April 1947.
- P. A. Greenmeyer, Improving Candy Inspection Methods, *The Manufacturing Confectioner*, April 1947.
- Electronic Metal Detector (*Instruction Manual*), Radio Corporation of America, Camden, N. J.

# Safeguarding Production

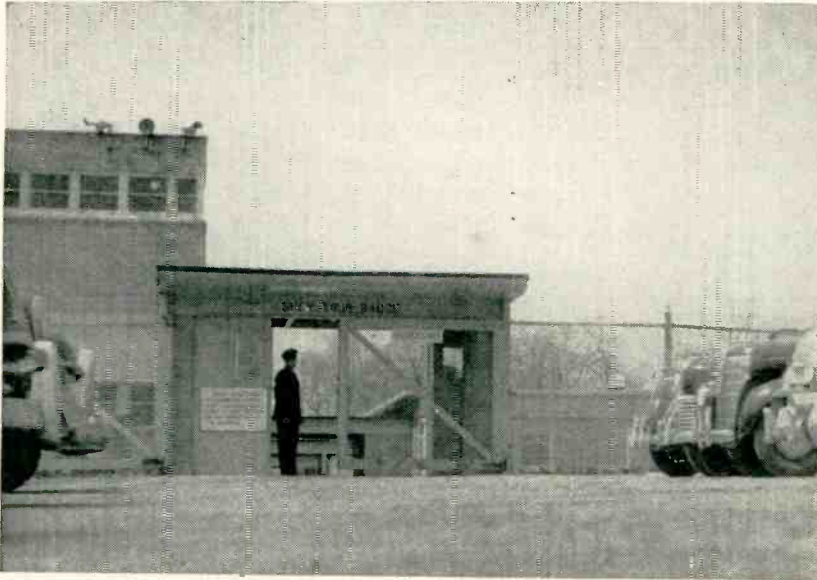

Physical barriers of the type shown are the most effective means for preventing sabotage by keeping space between classified projects and espionage agents



Rigid enforcement of seemingly insignificant details is important



Classified equipment that must necessarily be electrically "in the clear" may be hidden from public view by tarpaper and wood structures

**M**ILITARY strength depends on the continuous flow of essential equipment. Any interruption in production, whether premeditated or accidental, can seriously cripple striking power of a nation and its ability to ward off enemy attack.

The problems involved in protecting the electronics industry are, for the most part, similar to those necessary for safeguarding any kind of production. Electronic equipment is, however, particularly susceptible to sabotage, because of the delicacy of measuring and calibrating instruments, the dependence of over-all equipments on each of hundreds of basic components, and the extremes in speed and physical dimensions involved.

In World War II, the enemy was fairly well defined. He was a citizen of a country, rather than a member of an international party; and his activities could, for the most part, be watched. Today the problem is different, and consequently, different methods for combating sabotage must be used. The danger of mass enemy-inspired destruction timed to coincide with a surprise air attack is within the realm of possibility. Isolation is no longer a valid military advantage,



# of Military Equipment

Much of today's defense dollar goes toward the purchase of electronic equipment. The result has been an increased awareness of the industry's vulnerability to possible enemy action. Basic aspects of the problem of plant protection and internal security are discussed

because in the present state of affairs it no longer exists.

### Three Dangers

Protection from the three basic dangers, attack, espionage, and sabotage, come under different responsibility headings. Naturally, a great deal of overlapping exists. Protection from enemy attack is primarily a federal and military function, but it is the function of the community and local plant management to provide means for protecting employees from such attack and for facilitating rapid return to production after an attack.

Safeguarding classified information such as circuit diagrams, parts specifications, operating frequencies, or even business-office orders, is likewise a joint problem. The development of policies, standards and procedures is the responsibility of the Munitions Board and the military department for whom the classified work is being done. It is the responsibility of the particular military department to see that adequate security measures are invoked and to take appropriate remedial action in cases involving a breach of security. Management's part is to see that directives and set procedures are complied with.

In the actual protection of plant facilities, management has the prime responsibility. The military departments furnish advice and assistance, but it is management's job to set up and maintain sufficient security measures to protect its own and the country's investment. It is relatively simple for plant managers to pin-point possible weak points, while an outside agency might have to spend countless hours finding them and recommending appropriate security measures.

In planning a program for protecting electronics plants from enemy action, a great deal of ingenuity and resourcefulness is required. The usual scheme is for the management to appoint some person who is gifted with these essentials, and then to endow him with all the authority and assistance he requires.

The success or failure of a security system is hard to measure—some steps taken during the last

war now seem to have been unnecessary, but there is no way of measuring the damage that *might* have been done, had these steps not been taken. Thus planning for defense of production facilities becomes a typical engineering problem; the most severe conditions must be anticipated and generous safety factors must be employed.

Plant protection measures taken during World War II will in most cases form the nucleus for an ade-



Specific regulations have been set up for safeguarding classified information. It is management's duty to enforce these regulations

quate system for the present time. In many cases, more than adequate steps were taken, and with a very few changes, those steps can be utilized now.

One of the most effective aids, though often the most expensive, is space. It is axiomatic that, under usual circumstances, the saboteur cannot harm what he cannot reach, and the foreign agent cannot report what he cannot see. Restricted areas, along with fences, guards, photoelectric detection devices, charged wires, and so on, are all based on the principle of keeping a distance between classified equipment and information and personnel not authorized to have access to it.

The guards at the gate, and indeed the gate itself, have practically become a permanent fixture on the site of the electronics plant—with the exception of facilities engaged only in nonmilitary proj-

ects. Where the expense is justified, some plants employ electronic detection devices to prevent employees from carrying off pieces of equipment that might be essential to the smooth flow of products. Electronics also plays an important part in keeping a constant vigil on the boundaries of restricted areas—a number of plants are protected by photoelectric systems, usually operated in parallel as a safety measure, that signal the presence of intruders.

Photoelectric devices are also widely used to detect the presence of saboteurs who enter the plant under the guise of employees and conceal themselves during working hours with the idea of committing an act of sabotage when regular plant personnel have left for the night. The motivating impulse may not come from the foreign government—a disgruntled employee can cause just as much damage as an

enemy agent, and a technician who conducts a servicing business on his own time can interrupt production to a great extent if he replenishes his tube supply at the cost of his employer and the taxpayer.

So the job of physical protective devices is to keep the right people in the right places and at the right times. No system is foolproof, but the nearer a system comes to fulfilling this basic requirement, the better the chances for uninterrupted production.

### **Safeguarding Classified Information**

Requirements for safeguarding classified information are set by the federal government, and one function of the government is to see that appropriate precautions are taken so that such information does not fall into enemy hands. However, when a company receives a contract from the Army, Navy or Air Force that involves classified information, responsibility for safeguarding that information is placed squarely on the shoulders of management. The contract-issuing agency will issue security regulations that must be complied with in full.

Here again imagination and ingenuity must be applied. Persons having access to classified information must anticipate attempts to steal, copy or even see such information. And again, no system can be made perfect, but any system that makes obtaining information extremely difficult and reduces the odds of an agent's succeeding will also reduce the chances of his attempting the act in the first place.

Safe combinations and keys should be issued to a minimum number of persons. Safe combinations should be changed frequently and when employees knowing the combination leave the firm. Control of the number of copies of correspondence containing information of value must be exercised to assure that extra copies are not made and delivered to outside agents. Carbons and scrap paper may provide information and must be destroyed if of possible value to the enemy. Janitors and charwomen have an opportunity to obtain uninterrupted access to information of

#### **GOVERNMENT PUBLICATIONS . . .**

##### **Principles of Plant Protection**

Obtainable from the Munitions Board, U. S. Department of Defense, Washington, D. C.

##### **Industrial Security Manual for Safeguarding Classified Matter**

Obtainable from the Munitions Board, U. S. Department of Defense, Washington, D. C.

##### **National Security Factors in Plant Location**

A National Security Resources Board publication obtainable from the Superintendent of Documents, U. S. Government Printing Office, Washington, D. C., price 15 cents.

##### **The Effect of Atomic Weapons**

Obtainable from the Superintendent of Documents, U. S. Government Printing Office, Washington, D. C., \$1.25.

##### **Fire Effects of Bombing Attacks**

Obtainable from the Superintendent of Documents, U. S. Government Printing Office, Washington, D. C., price 15 cents.

##### **Damage from Atomic Explosion and Design of Protective Structures**

A National Security Resources Board publication obtainable from the Superintendent of Documents, U. S. Government Printing Office, Washington, D. C., price 15 cents.

##### **Survival Under Atomic Attack**

Obtainable from the Superintendent of Documents, U. S. Government Printing Office, Washington, D. C., price 10 cents.

##### **Health Services and Special Defense Weapons**

Obtainable from the Superintendent of Documents, U. S. Government Printing Office, Washington, D. C., price 60 cents.

#### **OTHER REFERENCES . . .**

##### **Disaster Control**

An article in the American Machinist magazine, November 13, 1950, McGraw-Hill Publishing Company, New York.

##### **Employee Organization for Fire Safety**

Published by the National Fire Protection Association, Boston, price 25 cents.

##### **Industrial Fire Brigade Training Manual**

Published by the National Fire Protection Association, Boston, price 25 cents.



general and possibly specific value.

A complete discussion of the rules and regulations governing the handling of classified information is beyond the scope of this article. Detailed treatment of the subject is contained in the second government manual listed in the accompanying editorial box.

### Personnel

Clearance of plant personnel engaging in classified work comes under the jurisdiction of both the contract assigning agency and the plant management. The important thing is, of course, to eliminate subversive characters and to prevent their committing any act detrimental to smooth-flowing production. As before, the federal government's jurisdiction is limited, and to provide the comforting safety factor additional initiatives must be taken by the firms themselves.

The Federal Bureau of Investigation cannot look into the background and political affiliations of every person employed by a plant engaged in defense work. Where a particular employee is actually suspected of subversive activities, the FBI steps in at the request of management. But the routine screening of employees must be undertaken by management itself.

Many large cities and some states have files of people suspected or proved to be subversive. In most instances, these files are available to manufacturers. The old-fashioned fingerprint card still ranks high on the list of screening aids. These cards are available from the Superintendent of Documents at a price of \$1.50 a hundred; and while it is true that a set of fingerprints is of limited value in some cases, the psychological effect cannot be overemphasized.

Security clearances of facilities and personnel are considered by the military departments only in connection with work involving classified military information. Inquiries concerning security clearances are made directly to the local procuring agency involved, and not to Washington.

Local agencies have at their disposal the Central Security Index File in Washington which saves



Personnel employed for work on classified matter must be cleared through local military contracting agencies involved

much of the needless double checking that went on during World War II. Once a facility or a person is cleared for one classified job, a permanent file saves further investigations when the same facility or person is being considered for handling another job of similar classification.

Another recent innovation is the Security Requirements Check List, which further reduces the number of clearances necessary. These lists break complex equipments down into parts some of which are classified, and others of which are not. For example, a radio receiver may have a secret front-end that must be made by cleared personnel, while the rest of it can be subcontracted to uncleared facilities without fear of classified information falling into enemy hands.

Aliens *can* be cleared to work on classified matter but the process is slightly more involved. According to the law, no aliens employed by a contractor for furnishing or constructing aircraft, aircraft parts, or aeronautical accessories for the government shall be permitted to have access to *unclassified* plans or specifications or the work under construction or to participate in the contract trials without written consent beforehand of the Secretary of the military department concerned. Special forms are available for clearing citizens and aliens. All clearing procedures start between the contracting firm and the local

issuing office. In the case of subcontractors, clearance of their personnel is handled through the prime contractor.

Many special cases come up in the course of fulfilling contracts for classified matter. Oftentimes banks must be consulted for financial assistance, and the bank officers righteously insist on being informed about the contents of the contract before they will grant loans that will enable the contractor to start work on the project. In this case, the bank personnel must also be cleared through the borrowing firm, the prime contractors (if any) and the contract issuing office.

### Defense Department Activities

The Department of Defense maintains an active staff of internal security experts, whose job it is to recommend and prescribe effective means for safeguarding production facilities. Among other things, these specialists make visits to selected defense plants, and from the results of their investigations, they make recommendations to assist industry in developing better security systems.

A study of the surveys made by these teams shows that industry security systems in general can stand improvement. Many plans are yet on paper, but most plants have programs under way. The general thinking, in contrast to ten years ago, is that *it can happen here*. —J.D.F.

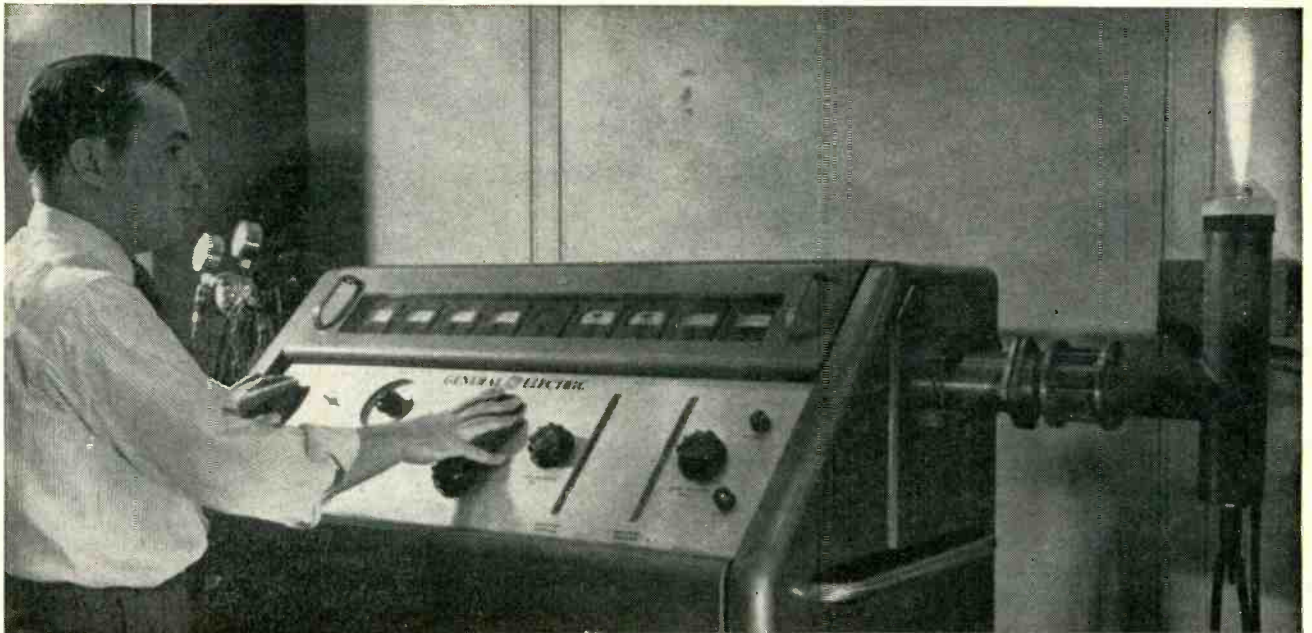

Electronic torch attached to output of GE magnetron electronic heater which serves as power supply

# ELECTRONIC TORCH

By **J. D. COBINE** and **D. A. WILBUR**

*General Electric Research Laboratory  
Schenectady, N. Y.*

**D**ESIGN of a torch suitable for use with a 5-kw microwave power unit at 915 mc is shown in Fig. 1.

The torch unit has a short-circuited quarter-wave section to permit the introduction of cooling water to the inner conductor. A perforated teflon washer is placed between the conductors to produce a more uniform flow of gas, which ensures a steady flame. The gas flow at the nozzle is at a velocity of from 50 to 200 feet a minute. A number of nozzles were developed, two of which are shown in Fig. 1.

The discharge is established at the tip of the inner conductor by touching the tip with an insulated carbon rod or a short piece of wire. Once started in this way, the discharge is stable when the r-f system is tuned to match its impedance. The tuning is accomplished

by means of a triple-stub tuner in the power unit.

Two general types of flame are observed in the electronic torch. When polyatomic gases such as air, nitrogen, carbon dioxide and oxygen are used, the flame develops a considerable amount of heat and is capable of melting refractory materials. The other type of flame occurs when monatomic gases such as argon and helium are used, and develops little heat.

The flame usually has a bright core surrounded by a relatively dark space, which is in turn surrounded by a luminous shell of lower intensity than the core. The nitrogen flame has melted firebrick (1,800-2,000 C), and small tungsten rods (mp-3,370 C). Fernico parts have been welded together with this flame.

It seems probable that most of

the heat developed at surfaces inserted in the flame is due to the heat of association of molecules dissociated by the electronic discharge. This action is comparable to the operation of the atomic-hydrogen torch described by Langmuir in 1926. The energy absorbed by the gas, both as ionized atoms and dissociated molecules, comes from the electromagnetic field through the collision processes of free electrons oscillating in the field. The central core also acts somewhat as a radiator of microwave energy which is largely lost. In many cases, the active length of the flame is about one-quarter wavelength. The buoyance of the flame in nitrogen indicates an average gas temperature of the order of 3,000 K for the polyatomic gases.

When monatomic gases are used, very little heat is developed by the flame and only a small power output can be established from the magnetron. A piece of paper could be held with this flame impinging





# CIVIL DEFENSE

It is hard enough to stimulate production of military gear when the immediate need overseas is limited, and still harder to prepare people on the home front for possible attack. Planning is nevertheless well along and some tangible steps have already been taken

**F**EDERAL civil defense communications planning is currently hampered by lack of three things . . . money, Money and MONEY.

The Federal Civil Defense Administration (FCDA) is at this writing operating on emergency funds from the President's budget. The appropriation under which it will eventually function is not yet known. The agency is nevertheless ambitiously opening 13 regional offices in

ATLANTA (Alabama, Florida, Georgia, Mississippi, South Carolina, Tennessee)  
BOSTON (Connecticut, Maine, Massachusetts, New Hampshire, Rhode Island, Vermont)  
CHICAGO (Illinois, Indiana, Wisconsin)  
CLEVELAND (Kentucky, Michigan, Ohio)  
DALLAS (Arkansas, Louisiana, Oklahoma, Texas)  
DENVER (Colorado, New Mexico, Utah, Wyoming)  
KANSAS CITY (Iowa, Kansas, Missouri, Nebraska)  
MINNEAPOLIS (Minnesota, Montana, North Dakota, South Dakota)  
NEW YORK (New York, New Jersey)  
PHILADELPHIA (Delaware, Pennsylvania)  
RICHMOND (Maryland, North Carolina, Virginia, West Virginia)  
SAN FRANCISCO (Arizona, California, Nevada)  
SEATTLE (Idaho, Oregon, Washington)

Contact between Washington headquarters and the 13 regional offices will be maintained initially by land wire, with teletype as an important adjunct. Wire service will ultimately be backed up by a network of 13 government-owned and operated high-frequency radio transmitters. The existing Military Amateur Radio Service (MARS) network may be used to back up the government-owned network, operating at the federal level.

Three major questions currently asked by state and local civilian defense officials can be partially answered:

(1) To what extent will the federal government support the purchase of civil defense communications equipment? *FCDA is in no position to give more than moral support and advice at this time. It would like to say it with dollars but*

*we are not too sanguine about even its future ability to do so.*

(2) What frequencies can states obtain for the operation of radio networks devoted specifically to civil defense communications? *This is still under discussion between FCDA and the Federal Communications Commission (FCC), with the military also involved. It may be some time before the question is resolved. FCC may eventually allocate a block of frequencies for such use, FCDA determining specific frequencies within this block for use by various states. Meanwhile, amateur networks can be set up on frequencies already allocated (p 148, March) for this purpose. Radio Amateur Civil Emergency Service (RACES) licenses are under consideration for use at the state and local level.*

(3) How can radio broadcast and television stations be fitted into the defense communications picture? *It now seems certain that radio stations will be so fitted in, and operators are right now studying a proposal which would permit them to function without presenting homing signals on a silver platter to potential enemy bombers. Details of the proposal are, at this writing, classified.*

## The State Picture

Arizona's police communications network fits the state's civil defense plan almost to perfection. Back in 1940 the highway patrol and various county sheriffs agreed to cooperate in the building up of a network, with all base stations and mobile units operating on a common frequency. All counties, and several town and city police departments, will be covered by the end of 1951. Should any base station become inoperative, a mobile unit will be used for temporary headquarters operation and, if neces-

sary, a number of mobile units spaced several miles apart will provide relay points between communities.

At present the highway patrol has 96 mobile units and the counties have 126. Four other state departments . . . the Department of Liquor License and Control, the State Penitentiary, the State Game and Fish Commission, and the State Highway Department . . . have 54 mobile units, including an airplane. There are, in addition, three mountain-top base and repeater stations. If present plans materialize there will eventually be a total of eight such stations, all interconnected by microwave and with a terminal station at each county seat. This will allow intercommunication without utilization of a common communications frequency.

The 276 mobile units and 25 base stations now operating on a common frequency might indicate chaos to the uninitiated. However, the state covers an area of 113,810 square miles, so there is only one base station for each 4,552 square miles and one mobile unit for each 412 square miles. Additional base stations and mobile units can still be added without difficulty.

Plans call for a secondary network of amateur stations operating on frequencies set up for the purpose, with each control center connected by direct telephone to the nearest police department, county sheriff or highway patrol station. In addition, there will be groups equipped with walkie-talkies, pack sets, mobile equipment and portable stations. Organization of the secondary setup is nearly complete.

The state of Arkansas has not yet made funds available for the establishment of a civil defense communications system. Until such time as money is forthcoming officials are making use of the extensive net-



# COMMUNICATIONS

## CIVIL DEFENSE PERSONNEL

STATE	DIRECTOR	COMMUNICATIONS	STATE	DIRECTOR	COMMUNICATIONS
ALABAMA	Col. James Garrett State Capitol Montgomery	—	NEVADA	Brig. Gen. James May Adjutant General Carson City	Merrill Inch Reno Newspapers, Inc. Gazette Bldg., Reno
ARIZONA	Maj. Gen. A. Tuthill Adjutant General Phoenix	G. O. Hathaway Arizona Highway Patrol 1701 W. Jackson Phoenix	NEW HAMPSHIRE	Rear Ad. Miles R. Brown- ing, State Capitol Concord	Capt. Basil Cutting New Hampshire State Police, Concord
ARKANSAS	Carl C. Martin State House Little Rock	Vernon L. Kimball State Capitol Bldg. Little Rock	NEW JERSEY	Leonard Dreyfuss State House Trenton	J. R. Poppele WOR, 1440 Broadway New York City
CALIFORNIA	Maj. Gen. W. M. Robert- son, P. O. Box 110 Sacramento 1	T. J. Kelly P. O. Box 110 Sacramento 1	NEW MEXICO	Brig. Gen. Charles G. Sage Adjutant General Santa Fe	—
COLORADO	Lt. Gen. Henry L. Larsen 300 Logan St. Denver 9	Byron Jackson Mountain States Tel. & Tel. Co., Denver	NEW YORK	Lawrence Wilkinson 124 E. 28th St. New York 16	Ford Bond Ford Bond Radio Ad- visors, 810 RCA Bldg. West New York 20
CONNECTICUT	General William Hesketh State Capitol Hartford 1	Col. Wesley L. Rogerson 92 Farmington Ave., Hartford	NORTH CAROLINA	E. Z. Jones 807 Capital Club Bldg. Raleigh	Paul Dillon 807 Capital Club Bldg. Raleigh
DELAWARE	D. Preston Lee Adjutant General's Office, Wilmington	Lt. Samuel H. T. Standt State Police Station Dover	NORTH DAKOTA	Brig. Gen. H. L. Edwards Fraire Barracks Bismarck	—
FLORIDA	Col. R. G. Howie 575 Riverside Ave. Jacksonville	M. L. Barre Southern Bell Tel. Co. 325 W. Adams St.	OHIO	Maj. Gen. Leo M. Kreber Adjutant General Columbus 16	H. G. Rice Fort Hayes Barracks Columbus
GEORGIA	Maj. Gen. Ernest Vandiver, Jr., 410 State Office Bldg., Atlanta 3	—	OKLAHOMA	Brig. Gen. Roy W. Kenny Adjutant General's Office, Oklahoma City	—
IDAHO	Col. Philip Doddridge State House Boise	—	OREGON	Louis E. Starr 1022 S. W. 11th Ave. Portland 5	I. B. McKinney 1022 S. W. 11th Ave. Portland 5
ILLINOIS	Lenox R. Lohr 57th & Lake Shore Drive, Chicago 37	M. W. Casad 57th & Lake Shore Drive, Chicago 37	PENNSYLVANIA	Alton C. Miller 201 South Office Bldg. Harrisburg	Lt. Donald E. Wagner Pennsylvania State Police, 350 Main Capitol Bldg., Harrisburg
INDIANA	Arthur M. Thurston 777 North Meridian St. Indianapolis	Zellon Audritsh Indiana State Police Stout Field, Indian- apolis 21	RHODE ISLAND	Brig. Gen. James A. Murphy, 1051 North Main St., Providence	Col. John B. Gegan 234 Washington St. Providence
IOWA	Rodney Q. Selby Central National Bldg. Des Moines 9	Alex M. Miller 716 Equitable Bldg. Des Moines	SOUTH CAROLINA	Maj. Gen. James C. Dozier 105 Wade Hampton State Off. Bldg. Columbia	Ralph King State Highway Dept. 908 1/2 South Main St., Columbia 1
KANSAS	Standish Hall National Bank of Topeka Bldg., Topeka	Col. H. F. Edwards Kansas Highway Patrol Masonic Temple Bldg., Topeka	SOUTH DAKOTA	R. P. Harmon State Capitol Pierre	Sam Fantle Midcontinent Broadcasting Co., Sioux Falls
KENTUCKY	Roscoe L. Murray Adjutant General Frankfort	Capt. E. B. Jones Dept. of State Police Frankfort	TENNESSEE	Brig. Gen. Claude M. Adams Adjutant General Nashville 3	Comm. Sam K. Neal Department of Safety State Office Bldg. Nashville 3
LOUISIANA	William J. Dodd State Capitol Bldg. Baton Rouge	James A. Noe KNOE Monroe	TEXAS	William L. McGill Executive Department Austin 11	Col. Homer Ganison, Jr. Dept. of Public Safety Austin
MAINE	Co. Spaulding Bisbee State House Augusta	Harold L. Gerrish State House Augusta	UTAH	Brig. Gen. J. Wallace West 207 South Main Salt Lake City	Joseph W. Dudler State Highway Patrol State Capitol Salt Lake City
MARYLAND	David G. McIntosh, III Pikesville 8	Col. J. P. Cooper, Jr. Chesapeake & Potomac Tel. Co., 320 St. Paul Pl., Baltimore 2	VERMONT	Meritt A. Edson Dept. of Public Safety Montpelier	—
MASSACHUSETTS	John F. Stokes State House Boston	Daniel I. Murphy Dept. of Public Safety 1010 Commonwealth	VIRGINIA	Joseph H. Wyse The Capitol Richmond	Guthrie S. Kennard C. & P. Telephone Co. 701 E. Grace St. Richmond
MICHIGAN	Lester J. Maitland Prudden Bldg. Lansing	—	WASHINGTON	Philip Batson Legislative Bldg. Olympia	Capt. Richard Quantz Washington State Patrol 901 Dexter Ave. Seattle
MINNESOTA	Col. E. B. Miller 1003-4 Commerce Bldg. St. Paul	—	WEST VIRGINIA	Brig. Gen. Charles R. Fox Adjutant General Charleston 5	E. L. Haines 215 Hale St. Charleston
MISSISSIPPI	Walter Spiva Executive Department Jackson	—	WISCONSIN	Maj. Gen. Ralph J. Olson State Capitol Madison	—
MISSOURI	Ralph W. Hammond 401 Madison St. Jefferson City	Charles E. Dewey, Jr. 401 Madison St. Jefferson City	WYOMING	R. L. Esmay Adjutant General Cheyenne	C. K. Faught P. O. Box 395 Cheyenne
MONTANA	Col. E. K. Cheadle P. O. Box 1157 Helena	Arthur Zion State Highway Com- mission, Helena			
NEBRASKA	Edward Gillette State House Lincoln	Leonard O. Arstad Northwestern Bell Tel. Co., 118 S. 19 St., Omaha 2			

works of the Game and Fish Commission, the Forestry Service and the State Police.

In *Illinois* an ambitious program for communications and control has been proposed. It involves use of telephone, telegraph and teletype facilities, commercial radio and television stations, local, county and state police networks, amateurs, mobile highway telephone services, civil air patrol gear and private radio equipment operated by taxicab companies, transportation firms and utilities. Details of the proposal have been distributed in mimeographed form to local officials for further action at that level.

*Indiana* has appropriated \$150,000 to support a full-time state civil defense department for two years, and set up a \$350,000 contingency fund for use in the event of actual emergency. Because of the limited budget, immediate plans revolve primarily around the use of existing communications facilities such as those operated by various commercial and public mobile services and amateurs.

The state of *Maine* has set up a telephone network similar to one used during World War II. The state police network is used as an auxiliary, and the Civil Air Patrol has a considerable amount of equipment, including walkie-talkies, which can be quickly transported to disaster areas. Amateurs are organized, and have a good supply of portable equipment for use in the 80-meter band. There have been several statewide tests of the amateur network, all reported as satisfactory.

In *Maryland* plans are still under development. The air-raid warning system will utilize a wire network operating outdoor and indoor signals controlled by keys located in a Baltimore-area warning center. Communications in the event of a disaster will be by telephone where possible. As an alternate means, a fairly high-powered radio net is contemplated to interconnect seven Baltimore-zone headquarters and the headquarters of five counties surrounding the city. Use will also be made of commercial and amateur mobile services to communicate from zone headquarters to field units. Much remains to be done, in

obtaining funds, organizing, and in making detailed arrangements, but tangible progress has already been made.

The civil defense communications plan of *Massachusetts* utilizes the state police radio network for the alerting of local communities. The plan calls for the installation in each community, at police headquarters, fire headquarters or other central points designated by defense directors, of radio receivers tuned to the police frequency. Emergency 500-watt, 120-volt, 60-cps gasoline-driven generators are mandatory. Selective calling attachments are optional. An auxiliary amateur radio network is also being set up.

*Missouri* has no definite plans for the procurement of radio equipment. Existing communications facilities such as those of the highway patrol are being utilized.

*New Jersey* is organizing communications in four districts, each of which contains from two to four subdivision areas. The committee roster lists men from the broadcasting field, telephone and telegraph companies, the state police and amateur radio.

In *New York* telephone lines form the primary communications network at the present time, with police radio networks contemplated as an auxiliary service and amateur equipment and personnel being enlisted as rapidly as possible for use as a third line of defense. A separate radio network for defense work has been suggested as a means of avoiding shutdowns which might occur in the event of a disaster taking out telephone lines, often used for the remote operation of police transmitters, but financing and other details have not yet been worked out.

*Ohio* is taking inventory of existing state communications facilities and has placed a printed bulletin outlining general communications needs in the hands of local defense officials. The state has also distributed an annex to the bulletin, listing 47 amateur radio coordinators, giving their addresses and station call letters.

At the moment, emergency work in *South Carolina* is confined to the wire services. The highway patrol's

radio facilities consisting of 280 mobile units and 11 base stations have, however, been made available for auxiliary use. Means for cross-band communications with the highway patrols of North Carolina and Georgia are available. The highway patrol's message center has been designated as key state outlet. County-level notification is by telegraph.

Final plans in the state of *Washington* are dependent upon what appropriations the legislature allows. Officials contemplate using telephone facilities insofar as they remain in operation and within their traffic capabilities. They would also provide each local control center and alternate centers with portable or semiportable vhf or hf stations equipped with auxiliary power units. Several large aircraft would, ideally, be equipped with transmitters and receivers. These aircraft would be strategically located throughout the state. If the situation warranted, they would be airborne and sent to an altitude sufficient to provide solid communications or relaying to any control center or area. This would make the proposed communications system entirely independent of land wire and power facilities, extremely flexible and mobile, and overtaking of existing facilities would be avoided.

Some thought is also being given to the use of microwaves for general cross-state official communications. Should this prove feasible, several channels will be multiplexed for use by civil defense. Each control center would be equipped to feed either the microwave link or aircraft.

### **Typical Local Organization**

Several major cities are well along with their planning for civil defense communications. Most of these have organizations set up and functioning, and some are already installing equipment.

At this writing it appears that we will be able to describe a model local setup in these columns next month, omitting only those details concerning precise control-center locations, operating schedules and frequencies which might be of value to a potential enemy.—W.MACD.



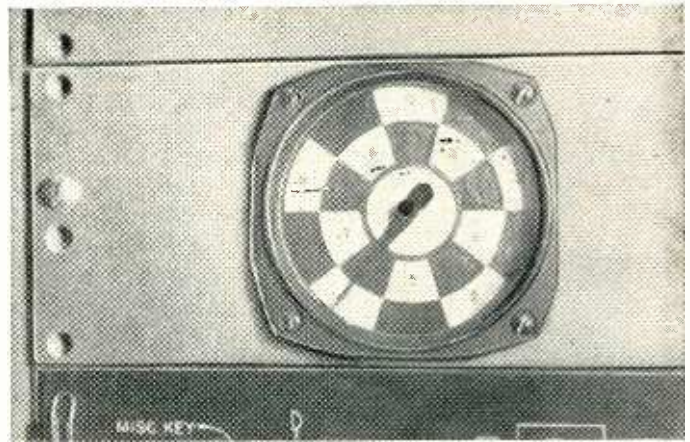
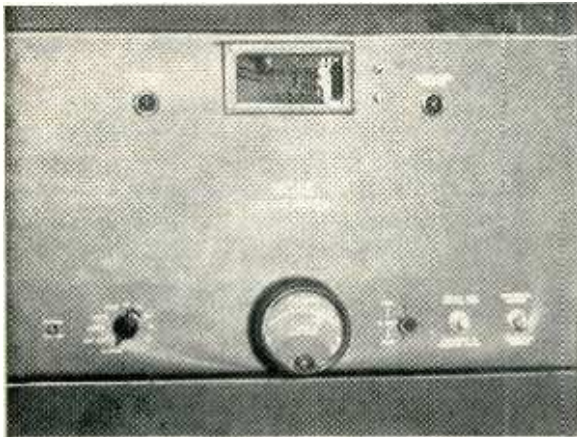

Complete rack-mounted time standard at left shows condition of system at a glance. Special 1-rps monitor clock (right) allows checking system to 0.1 sec from WWV standard time signals at any live-minute interval

# ACCURATE TIME for Broadcast Studios

Inexpensive synchronous clocks keep time within 0.1 sec when driven through an audio amplifier at exactly 60-cps from a tuning-fork controlled multivibrator. They can be set when the multivibrator runs free at 55 or 70 cps

**A**CCURATE time is necessary in every broadcast studio to comply with FCC program-log requirements as well as for coordination of local and network programming. For these purposes, an accuracy of  $\pm 1$  second is adequate.

Anyone who has investigated the various means for telling time has found an almost endless variety. The exactness that may be obtained is limited only by the complexity and cost that can be tolerated. Every application has its own special requirements. The system to be described was designed to meet the needs of a radio broadcasting station in which various sizes and models of clocks were required for the different studios, control room, announce booths and recording room.

Many radio stations subscribe to a commercial time service that provides a special clock or clocks,

By **JAMES H. GREENWOOD**

*Chief Engineer  
WCAB, Inc.  
Pittsburgh, Pa.*

which are corrected by a timing impulse sent out each hour. The system to be described comprises a 60-cps multivibrator controlled by a 240-cps tuning fork. Any reasonable number of inexpensive self-starting synchronous clocks can be operated from the 50-watt audio amplifier driven by the time standard. Means are provided for speeding up or slowing down the standard. The system can be checked to an accuracy of 0.1 second at any five-minute interval using the standard-time broadcasts of WWV.

Ten clocks are in use at present, although this is not the limit of the equipment. The larger clocks re-

quire about 4 volt-amperes, but less than 3 watts. Each clock has been adjusted for maximum power factor by connecting a capacitor across the motor winding, the capacitor being mounted within the clock case. The adjustment is not critical and only two values of capacitors are used,  $0.5 \mu\text{f}$  for one type of clock and  $0.75 \mu\text{f}$  for another. Over-correction of some clocks is offset by undercorrection in others.

### **P-F Correction**

Power-factor correction could also be accomplished for the system as a whole with all clocks connected. This alternative is less satisfactory because correction is not automatic with the addition or subtraction of clock units. Removal of the entire clock load from a tuned-output amplifier might result in damage to the output transformer.

Adjusting the clock's power

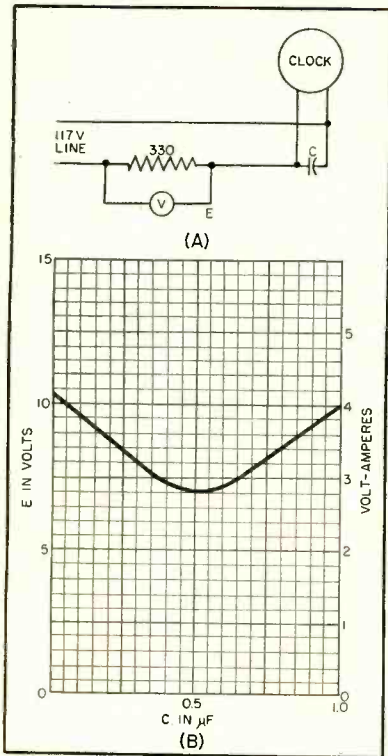

FIG. 1—Circuit (A) for determining clock power factor. Various capacitors are tried and the results plotted at (B). Correct compensation is secured with capacitance giving minimum volt-amperes

factor to unity is the same as tuning the clock to resonance. The method is simple as shown in Fig. 1. Various capacitances are tried for each type of clock used and the voltage across the resistor recorded for each value. When the parameters for a type are plotted as shown in Fig. 1B and joined by a smooth curve, the capacitance resulting in minimum voltage provides maximum power factor.

All of the available clocks were found to have backlash in the gears between the second and minute hands so that they would not track together. If adjusted to agree at 15 minutes before the hour, the minute hand would lead the second hand at 15 minutes past the hour, sometimes by  $\frac{1}{4}$  minute, which would then be read as a full minute.

Drags have been installed on all clocks so that the minute hand is being pushed at all positions. The design of the drag differs for different sizes and styles of clocks, but usually consists of a thin phosphor-bronze spring pressing against the intermediate gear that transfers

motion from the minute to the hour hand. It is readily accessible and a drag at this point takes up play in all the gear train ahead of it.

Counterbalances were also installed on the minute hands of the larger clocks to reduce the amount of friction required in the drag. Clocks so modified can be used indiscriminately on either 60-cycle power lines or from the time standard.

### Setting the Clocks

The time standard is a type 2001-1 fork unit followed by a multivibrator that can be locked in at 60 cycles, at which the output is tuned. The entire assembly was purchased as a package from American Time Products, Inc. It is followed by a commercial audio amplifier designed to operate on about 1 milliwatt input power at high impedance. Additional amplifiers can be bridged across the same 60-cycle source if needed to operate another set of clocks. Although the nominal output power is 50 watts, only about 40 watts is available at the operating frequency.

Necessary flexibility in a clock system requires that there be a means of advancing or retarding the movement in order to set it. Although there are a number of systems possible, such as selsyns operating from a three-phase power line, there is always the danger of correcting so rapidly that the instantaneous frequency of the supply falls beyond the capacity of the clock to follow synchronously. Besides, life of a clock run at high speed (such as 120 cps) is seriously reduced. Slowing the system by simply shutting off power is not feasible because some clocks coast more than others.

A good solution is modification of the multivibrator to permit operation slightly above and below 60 cps, as shown in the circuit of Fig. 2. When switch  $S_1$  is in the center position, normal operation occurs at 60 cps. In the upper position the clocks run fast and in the lower they run slow. Because the multivibrator output is tuned for 60 cps, operation at a higher frequency results in reduced output. Accordingly, resistor  $R_2$  is automatically switched in to reduce the 60-

cps output but is disconnected during operation at higher or lower frequencies.

Contacts on the upper portion of the switch,  $S_{1A}$ , in the cathode circuit of the 12AU7 tube, should be of the shorting type (make-before-break) so that there will be no interruption of the multivibrator as the switch is operated. The switch should disconnect the tuning-fork drive before it has changed the speed of operation of the multivibrator to either fast or slow speed. This action eliminates beat notes between the tuning fork and the detuned multivibrator and also assists in maintaining uniform output voltage. A switch having suitable characteristics can be assembled from one switch deck with non-shortening contacts (disconnecting the input) and one switch deck with shortening contacts (controlling the speed of the multivibrator).

### Frequency Limits

The resistor and capacitor values shown in Fig. 2 result in setting frequencies of about 70 and 55 cps. Frequencies of 66 cps and 54 cps would be somewhat preferable since the change in each case would then be 1 second in 10, simplifying the daily setting against WWV signals.

The variable 3,000-ohm resistor  $R_1$  in the multivibrator cathode circuit should be initially adjusted to the center of the range over which the tuning fork maintains control. An oscilloscope is handy at this time. One pair of plates is connected to the amplifier output and the other pair to the 60-cps power

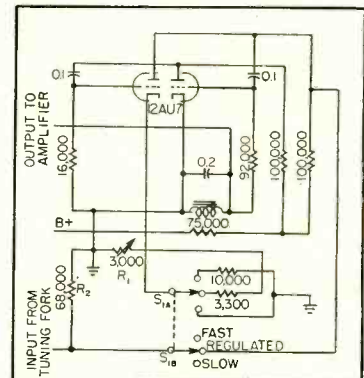

FIG. 2—Multivibrator circuit ordinarily tuned to 60 cps and driven by tuning-fork. In free-running positions of switch  $S_1$  it can be used to speed up or slow down clock system for setting



line. If the clock-amplifier and the power-line frequencies are the same, the pattern on the scope will be stationary. When the multivibrator is detuned so far that the fork loses control, the pattern will rotate several times a second. The condition becomes immediately apparent with an oscilloscope, whereas several minutes would have to elapse before a change in the speed of the clock system could be detected. The exact speed of the fast and slow positions can be determined in the same manner if a calibrated audio oscillator is used instead of the power line on one pair of plates.

It will be noticed that the wave-

below 90 volts. At the same time, power is removed from the amplifier, tuning fork and multivibrator and a warning light goes on at master control. As shown in Fig. 3, power is available from two separate trunks. Commercial power for the emergency operation of the clocks is obtained from the trunk other than that used for the amplifier. A plug-and-socket system allows rearrangement of power inputs.

The undervoltage relay used to transfer the clocks from one system to the other is a standard 5-pole double-throw type designed for 115 volts 60 cps. A resistor  $R_1$  can be added to cause the relay to drop out

periodically. This is accomplished by means of the dpdt switch  $S_1$  in the COMMERCIAL SOURCE position. It applies power to the amplifier without disconnecting the clocks from the commercial system. A 40-watt lamp load is connected to the output of the amplifier at the same time.

After the amplifier has been adjusted for normal output, pushbutton  $S_2$  (Fig. 3) is held down, maintaining an uninterrupted supply of power to the amplifier while the dpdt switch  $S_1$  is returned to the REGULATED SOURCE position.

To facilitate maintenance, a plate-current metering system is used, with appropriate resistors connected in the plate or cathode circuit of each tube. A rotary triple-pole switch connects a 1-milliampere meter across the resistors in sequence. For a-c measurements on the output voltage from the amplifier and that of the power lines, a copper-oxide rectifier is switched into the circuit. The meter and selector switch are illustrated.

### Clock Outlets

Special outlets are installed in the clock wiring system so that it is impossible to plug in other devices. The outlets are Hubbell 6822 or equivalent two-wire polarized. Alternatively, a standard double-T slot, single, plastic receptacle can be modified by cementing Bakelite plugs in the arms of one of the T's. Each clock is equipped with a 6918 polarized plug cap. This cap can be used in any receptacle having double-T slots, allowing the clocks to be tested on commercial power.

### Standardizing the System

In order to compare the system with the standard time signals from WWV the special clock (illustrated) was assembled. It comprises a B3 Telechron motor operating at 1 rps, mounted with a suitable face plate, cover glass and indicating hand. The dial is divided into ten portions as shown. The hour, minute and second are determined from a standard clock, while tenths of a second are clearly indicated by the position of the hand at the start of the tick from standard-frequency station WWV.

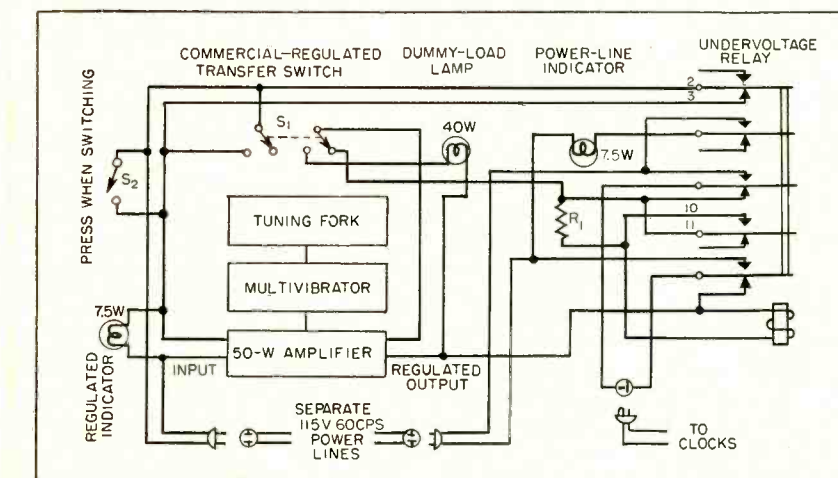

FIG. 3—Automatic switching circuits to transfer clock system from regulated 60-cps source to commercial power. Amplifier and associated circuits can be checked without interfering with clocks. Two power mains insure continuity of service

form of the time standard is not perfectly sinusoidal. Few commercial 50-watt amplifiers are designed for full undistorted power output at frequencies as low as 60 cps. Usually most of the distortion occurs in the output transformer. However, it is almost impossible to produce sufficient overload distortion to disturb the operation of the clocks.

### Auxiliary Power

It was not considered necessary to provide a spare amplifier or tuning fork. Instead, provision is made to switch the clock system automatically onto commercial power if the regulated supply falls

with 90 volts across the coil and resistor in series. In the unoperated position of the relay, this resistor is shorted out in order that the voltage at which the relay characteristically closes will not be essentially altered by this addition. The contacts should be adjusted so that as the voltage across the relay is reduced contacts 2 and 3 open before contacts 10 and 11 close. This arrangement will prevent any tendency towards chattering in normal operation. Since the relay is connected across the amplifier output, its power factor should be compensated as was that of the clocks.

Maintenance practice demands that the amplifier system be checked

# How to set up an INSTRUCTION

Over-all analysis of the problem of producing the manuals required under practically all military electronic equipment contracts, optimum staff organization for producing manuals efficiently to meet deadlines, personnel qualifications, and breakdown of staff duties

By **EUGENE ANTHONY**

*Product Service Manager  
General Electric Supply Corp.,  
New York, N. Y.*

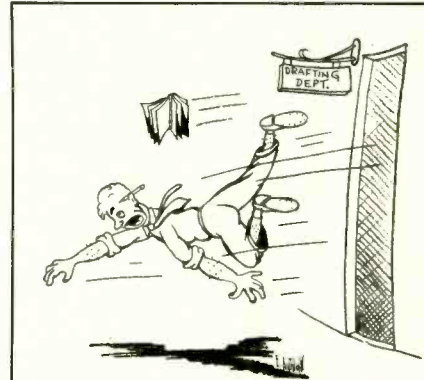

**DO** make certain that the technical manual writer and the supervisor of drafting can meet on equal terms.

**U**NCLE SAM needs a lot of electronic equipment today and many concerns are designing and building it for him. Some are new in the field; others are working with new personnel; still others are using essentially the same organization they had during World War II.

All of these groups can use help in making plans for the preparation of technical manuals. The last group particularly needs attention, for it includes many concerns whose facilities proved inadequate before. Poor planning was rather common because the technical manual was often treated as just an extra gimmick—something of secondary importance in the contract.

It is expected by the military that the manual you supply will include

## **AUTHOR**

THE AUTHOR, during World War II, was in the Technical Manual Section of the General Electric Co., Electronics Department, Bridgeport, Connecticut, as one of three men specifically assigned the responsibility of producing manuals. During the war he completed approximately 20 manuals on electronic equipment ranging from small and simple units to large and complex military electronic systems

all needed technical data. Completeness is more than a theoretical need, as the manual may have to serve in the field in the absence of any supplementary information.

The technical manual is the only permanent link between the brains that conceived and built the equipment and the men who are called upon to put it together, use it and keep it running. Because of its importance, the technical manual demands organized and responsible planning for its preparation.

## **Department Manager**

The block diagram (p 103) shows the operations and facilities which enter into the production of a technical manual. The block marked Mr. X shows the common force through which all others are coordinated. The force is a man—the man who is specifically charged with the responsibility of producing the manual.

What kind of a man is he? What are his qualifications?

The best bet is to get a man who is first an engineer and second a writer. He must be fully acquainted with and intensely interested in electronics. He will have to do most of the heavy writing before he is through.

Don't expect your project engi-

neers to do the major portion of the writing. That's the tough way of doing the job and the results won't be good. A good manual is a full-time job and requires the kind of devotion your project engineers can't afford. Anyway, it's a bad idea to rely on them for the writing because they will be needed for engineering. Besides that, you may have several projects in the mill at one time and each one will represent a major educational job to get the manual idea over to new groups of engineers. In the long run, the manual department man will probably have to kick in full time to make sense out of the material initially prepared by the project engineers. It's a much better idea to start with the right man and plan on his doing the job from scratch.

Mr. X is the right man to do the heavy writing for still another reason; the manual requires literally hundreds of different kinds of information, all of which must be combined into a well-organized outline. These things can't be put together like so much patchwork. Some manuals have well over 500 printed pages. The man who does it must be a professional—he must know all of the requirements and precisely how they are to be filled.



# MANUAL DEPARTMENT

## DO'S AND DON'TS

**DO** assign the responsibility for producing the manual to a single individual who has professional abilities in this work.

**DO** provide the writer with full-time engineering-writing assistance.

**DO** provide some full-time ink tracers in your drafting section exclusively for manual work.

**DO** impress your engineering department with the importance of manuals so that their willing cooperation is obtained.

**DON'T** expect project engineers to do the heavy writing.

**DON'T** subject your technical manual section to indirect, impersonal drafting service.

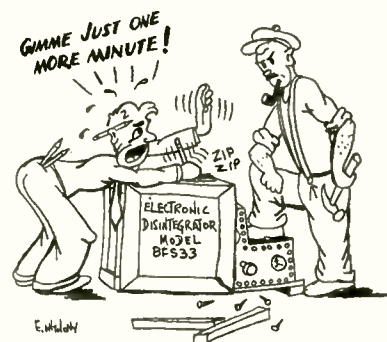

**DON'T** wait for the final design freeze before starting serious work on the manual.

Mr. X won't be able to do the job alone; he will require the services and assistance of many people before he is through. This leads to another very important requirement of the man. He must have the ability to supervise people properly and, of course, must be recognized as a supervisor. He must have a plan of action and be able to carry it out.

In that connection it is well to take into account the kind of philosophy Mr. X must have with respect to his approach to the task. He must not become a victim of the most common human failing which occurs in this kind of work. That failing is to take too seriously the fact that the engineering is not yet completed, that extensive changes are anticipated, and that the existing material is inadequate to prepare a final and correct manuscript. Those are the bugaboos of technical manual preparation, and they lead to hectic, heart-breaking pressure when deadlines are approached. More disturbing is the fact that this pressure occurs when the heat is on in engineering and production, with the result that there is little time or talent available for technical assistance from those departments. That's not a comfortable position for anyone.

There's not much that can be done, as a general rule, to freeze design months or even weeks before the production deadline. That's a situation Mr. X will have to live with. But there are ways of distributing the load quite evenly so that, when the pressure is on, he has enough cushion to absorb the shock. How does he do it?

He must be practical enough to accept the equipment as it exists when he starts the manual and to dismiss, temporarily, the probability of future changes. He must also keep his assistants working and thinking along those same lines.

Consider the photograph problem, as an example. Mr. X knows that his only available model is an experimental engineering sample, dirty perhaps, and with only a rough resemblance to the final product. He also knows that his best bet for his final book is the first actual production model, which will not be available until very near to deadline time. Rather than postpone all photo work until that time, however, he proceeds to take all pictures called for in the specifications. He treats them as finals, even to the extent of having the rough art work done (such as lettering and balloons).

The result of this policy is that

his thinking is done early in the game. The only remaining job is to bring the photos up to date at the last possible moment. With the early pictures as guides, people with virtually no experience or talent can follow through to get new photos made up, "just like these samples only of the latest model". Similarly, the finished art work simply represents copying something already done, with a few corrections here and there that can be done with a minimum of experienced direction. Direction is much more costly than the reworking of the photos.

If Mr. X has that kind of approach to the problem he'll turn out better books quicker and with the least amount of wear and tear on personnel. When deadline time approaches he'll have the simpler problem of bringing an existing manual up to date, rather than the problem of *producing a manual*.

### His Assistant

The diagram shows what Mr. X needs to get his job done in commercial time (a couple of months or in time to join the completed equipment at the end of the assembly line).

Referring again to the block diagram, note that branch 1 represents

a technical person (or persons) who works directly under Mr. X. He must be good but can be a man with less experience. Generally, an engineer directly out of school is good here. We will call him the assistant technical writer. He is absolutely necessary, as he relieves Mr. X of the hundreds of detailed tasks which go into the completion of the manual, leaving him free to do the heavy writing and supply the continuity.

The assistant technical writer must gather statistical data relative to the equipment. This includes such things as weights, dimensions, test voltages and drawing references. He must follow through the preparation of stock drawings such as outline drawings, socket-voltage diagrams, tube-layout diagrams, installation drawings, panel drawings, coil data and others as required by government specification. He must gather spare-parts information if not actually make up the lists. He must supervise photography of the equipment, not only to fill government specifications but also to obtain a good comprehensive collection of reproducible photographs. He must also write some of the procedures and tables that are self-sufficient within themselves.

The assistant can also be of invaluable aid in recording drawing and photo titles and their reference numbers as they are filed away upon completion, so that they are easily gathered when needed. He is most helpful toward the end of the project when the manual work enters its final correction stages. He can withdraw the illustrations one by one, check them for validity and supervise their correction or replacement. This is frequently done while Mr. X is deeply engaged in galley proof work and is approaching the point where the final illustrations will be needed by the printer.

### **Office Personnel**

Branch 2 in the diagram represents general office personnel directly under Mr. X. The most obvious duty here is the typing of both the rough and finished manuscripts. That, in itself, is a major operation and calls for a typist who can type rapidly and who enjoys doing it.

One good typist can usually handle the work for two or three Mr. X's and their assistants.

In addition there is a good deal of stenographic work related to, but not part of, the manual. There is constant communication with the interested government agencies as well as other persons.

Some form of file system must be maintained of manuscripts, general data, blueprints, photographs and negatives of completed manuals. One manual may involve hundreds or even several thousand blueprints.

In addition to the above, it is often necessary to prepare manuals in quick stop-gap form. This requires the typing of stencils, running off the required number of copies and collation of the individual pages.

Clerical helpers also come in handy in delivering finished drawings to engineers for their on-the-spot approval, for example, after Mr. X has made those arrangements by means of a telephone call. This can save many precious hours for him near deadline, when his time is at a premium and hundreds of drawings have to be carried back and forth as they are completed. If your engineering department is on another floor or in an adjoining building you can see the advantage of this help.

### **Drafting**

Branch 3 represents the drafting section of your organization. It is imperative that Mr. X be placed on an equal footing with the supervisor of drafting so that he can obtain top priority from that department when necessary in keeping with the importance of the associated project. It is a sorry situation when Mr. X finds himself just one among many who call upon drafting for services. The requirements of manual preparation call for so large a number of drafting services, in keeping with a strict schedule, that Mr. X cannot afford to be subject to the drafting supervisor's whims. Make certain that those two men can meet and discuss problems on equal grounds.

The drafting department is called upon to produce large numbers of ink drawings for the manual. Generally, the assistant technical writer

will supervise these. The drawings do not require the most experienced draftsmen and can usually be done by inexperienced girls who have artistic talent. Government specifications call for machine lettering which is easily mastered with little practice.

A good way to handle the drawing problem is to have the assistant writer look up an existing pencil drawing which approximates what he wants, then to mark up a print with colored pencil. He can do this in stages, requiring that just so much be done, after which he is provided with a print which he marks up further. In this way, the most experienced draftsmen are available to engineering for the greatest part of the time. Some of the more complicated drawings may require top-grade draftsmen, of course, but such drawings are the exception and are usually done only in pencil. The ink job is given to less-experienced tracers.

If the assistant writer has had some drafting education or experience, there are many drawings which he can produce in rough form to speed things up.

The drafting department is also called upon to provide prints of existing drawings as needed by the technical writer. These drawings usually run into the hundreds and cover such items as chassis layouts, schematics, coil data, parts lists and component specifications.

The drafting department includes storage facilities for original tracings where they can be held for safekeeping. They are surrendered upon demand to the technical manual section as they are needed. Ordinarily that section works with prints only up to the time that the manual is ready for the printer. At that time, the original tracings are needed to make the cuts or negatives.

The drafting department may also provide art service for the technical manuals. This would include technical illustrations in the form of line drawings. It may also include the addition of balloons, callouts or other types of line and lettering work on stiff-back photographs.

One remaining function of the drafting department which is im-



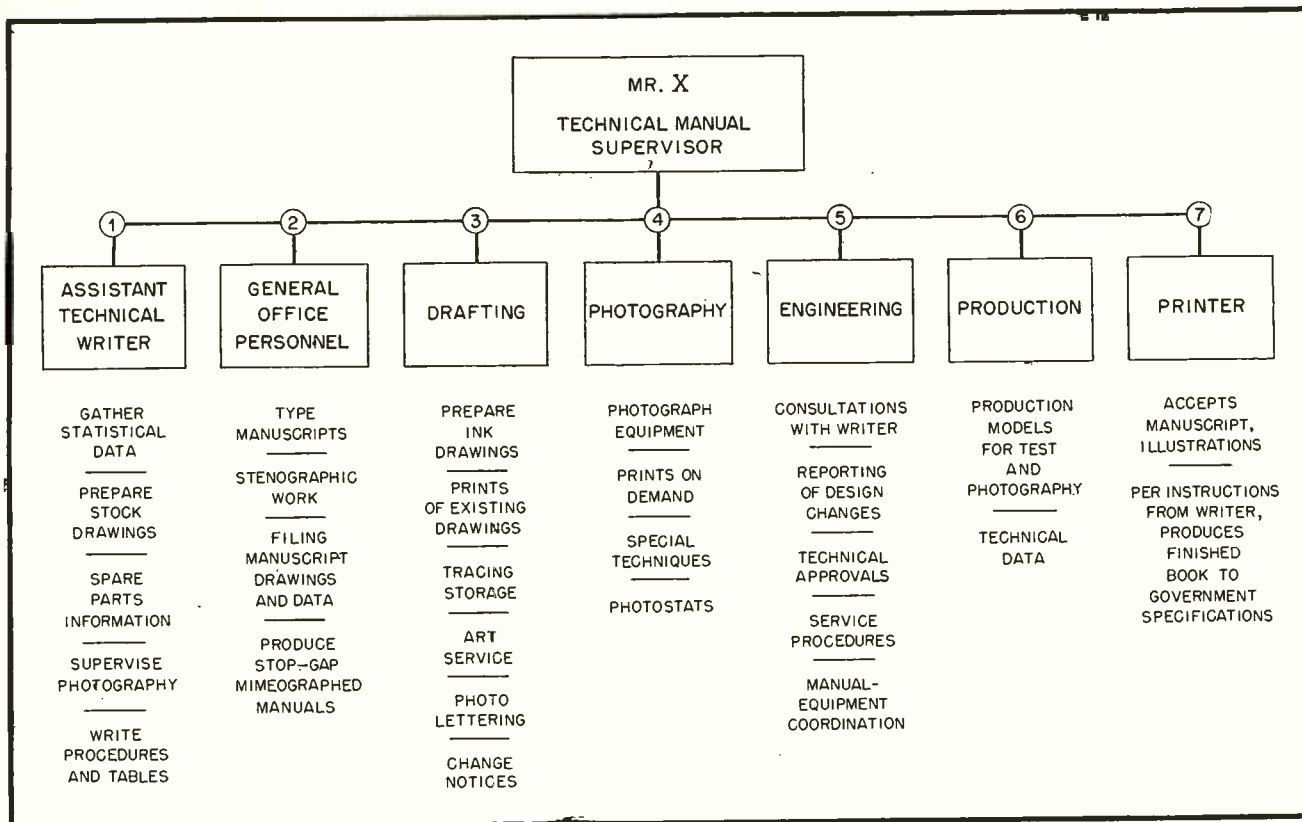

Block diagram of departments and operations for producing technical manuals

portant to technical manual production is the automatic daily reporting of drawing changes associated with the project. This is usually done by means of an engineering notice or drafting bulletin which is distributed through internal mail service to all interested persons. It describes drawing changes and permits these persons to keep up-to-date with a project.

The technical manual section must be kept posted on such changes, otherwise serious errors can creep into the manual. The notices also serve as an excellent check reference when final corrections are made in the drawings just prior to printing the manual. That kind of follow-through is necessary when the engineering department changes only its own pencil drawings and leaves the ink drawings to the technical manual section. In some instances, a project engineer may take it upon himself to direct the change in a technical manual drawing (in good faith), and this correction may not be considered neat enough to satisfy the requirements of the manual. The notices flag these changes, making it possible

to locate and check them when convenient.

### Photography

Branch 4, the photographic section, may be a formal department in your organization or it may be a group in your drafting or advertising section. It may also be specifically organized as a part of your technical manual section or it may be an outside organization which is called as needed. In any event, it will be required to take the various photographs which are needed and provide the prints on demand. A good deal of this work is special in that it may require opaueing on the negative and special mounting and printing techniques to permit further art work. The art work is generally done by other persons. Balloons and call-outs, for example, may be done by draftsmen.

The assistant technical writer will ordinarily do the rough work on prints. In the case of parts identification, the project engineer may do the very rough work on one print after which the assistant technical writer may transfer the information in a more desirable layout

on another print so that an inexperienced draftsman can then do a finished job on a mounted print.

The photography section will also be called upon to provide photostats or other "hard" copies of line drawings. A highly detailed piece of art work, for example, cannot withstand too much handling without damage; it is good practice to photograph such drawings immediately upon completion, store the original, and to do lettering on a photographic print.

In view of the preceding requirements, it is highly desirable to have Mr. X so related to the photography section that he can deal with it personally and directly.

### Engineering Cooperation

Branch 5 is perhaps the most important of all. It involves the engineering section and, more specifically, the project engineers themselves.

It is most important that the engineering section appreciate fully the importance of the technical manual. They must understand in advance that a portion of their time must be spent working with Mr. X

and that this is part of their expected routine. It is rather common for the engineering section to regard the manual as a nuisance, with the result that Mr. X finds himself in a difficult position to meet schedules and produce an acceptable product.

The engineering section will be called upon for the following services:

*Consultation:* During the early phases of a project, Mr. X will require many hours of the project engineers' time. They will have to sit down together and review the complete project. Mr. X will have to learn the general purpose of the equipment, its required functions and the manner in which it performs these functions. He will need copies of the existing specifications and he will have to know what the equipment looks like by inspection of existing models.

*Progress Reporting:* The engineering section should understand that any significant progress or modifications must be called to the attention of the technical manual section. It is sometimes difficult for the manual writer to recognize modifications without the interested participation of the project engineers.

*Technical Approvals:* As manuscript is prepared, it will have to be studied carefully by the project engineers. They should be ready to provide responsible approval together with corrections and constructive suggestions. This frequently leads to further consultation.

*Service Procedures:* The project engineers will be called upon to suggest specific service procedures in such a form that they will require only editing to make them suitable. As an example of this, the equipment may include a receiver of some sort, and the alignment procedure must be supplied by the project engineers.

*Manual-Equipment Coordination:* There are a great many requirements set forth in the specifications for the technical manual. These requirements cannot be properly filled without the active cooperation of engineering. For example, the technical manual may require drawings on which test points are

clearly located and identified by symbols or numbers. The specifications may require further that those same symbols appear on the equipment itself. Mr. X cannot directly make design changes and additions to the equipment. This must be done by the project engineer.

The preceding example is a minor case. There are some which are appreciably more important and more involved. In any event, the writer of the technical manual is sometimes the only individual who recognizes the need for design changes or modifications and he must be able to pursue this point with the project engineer.

*Production Cooperation:* Branch 6 in the diagram represents the equipment production department. Certain requirements of the technical manual section can best be fulfilled through the production department. This relationship must be clearly established so that Mr. X has a solid contact in the production department as well as with the project design engineer.

The most common function of the production department is to make available production samples from which artists can work in preparing line drawings and for verification of test procedures. The production department can also be of great assistance in providing the technical manual section with other technical data.

*Printing:* Branch 7 is perhaps the most obvious of all. It represents the printing of the finished manual. Mr. X will have to work closely with the printer so that schedules can be worked out which are mutually satisfactory. The technical manual section will have to submit complete drawings and photographs and manuscript. It will have to schedule time for the galley-proof and paste-up work. When final page proof is submitted, schedules should be made with engineering for final approval by that department.

Along about this time, incidentally, Mr. X will be busy buttoning up his work. Part of that job is getting the project engineers to sign copies of the manuscript and drawings as a recorded indication of their approval. Last, and most certainly not least, will be his job

of "selling" the manual to the military inspector or other officers assigned to the acceptance of the manual.

### Summary

The preparation of the technical manual is a matter of prime importance to the military. It is a highly specialized endeavor and requires careful and responsible organization. Because of these factors, it requires a capable manager or supervisor, and the section should be a unit independent of engineering or production.

The assistance and services required by the technical manual section are of such magnitude that they cannot be permitted to resolve themselves through cut-and-try methods. They must be authoritatively recognized and accepted by the various department heads involved. Only in this way can the technical manual supervisor be given the opportunity to assemble the necessary data and compile a manual which fills the needs (and demands) of the military. The job is highly technical and requires a great deal of personal devotion to duty, but despite this, is frequently overlooked to some degree in overall organizational planning.

The precise size of the instruction manual department is difficult to estimate here, because of the wide variance in types of electronic equipment and numbers of types in production. A very broad approximation however, will be attempted.

One Mr. X with two assistant technical writers and one good typist-clerk can produce a manual in about 15 to 20 weeks, assuming that the equipment involved is a single rack affair of only moderate complexity. This assumes, further, that the departmental assistance mentioned above is available upon demand. In this very broad example, the drafting services of about four people for the duration of the job will probably fill the bill.

The above guess is made with some apprehension because of the variables involved. It is offered only to illustrate what proved to be true in at least one case. Once you have selected your specific Mr. X, he will be in a better position to provide a more correct estimate.



# PULSE-WIDTH DISCRIMINATOR

Designed specifically for use as a channel decoder in a multiplex communications system, this discriminator handles input pulses 20 to 100 microseconds wide. Also useful for measuring width of rectangular and other waveforms

By A. A. GERLACH and D. S. SCHOVER

*Armour Research Foundation of Illinois Institute of Technology  
Technology Center, Chicago, Ill.*

**A** MAJOR PROBLEM exists in the method of multiplexing or mixing information channels together at the sending end of a telemetering system and identifying these channels at the receiving end, whether the transmission of information is accomplished by wire or radio link.

Many methods are now employed successfully in telemetering systems of varying complexity and factors involved in the choice of a particular mode of multiplexing are usually dictated by the nature of the intelligence to be transmitted and the degree of equipment complexity that is to be tolerated.

## Multiplexing Methods

One widely used method is the subcarrier system where a separate carrier signal, usually in the super-sonic or low r-f range of frequencies, is assigned to each information channel. The channel information is superimposed on the carrier signal by amplitude or frequency modulation and all carrier signals are transmitted through a common transmission medium to the receiving station where the individual channels are separated by means of selective band-pass filters.

Many systems of pulse-coding multiplexing have been used to good

advantage such as pulse-sequence coding. Here the intelligence of each channel is embodied in the amplitude or width of a pulse and the channel is identified with the time position of the pulse. This is an electronic elaboration of the simple mechanical commutation

method which is still in use.

The pulse-width discriminator to be described is employed in still another pulse-coding method of multiplexing which utilizes pulse width as a mode of channel identification. The telemetering system for which the equipment was de-

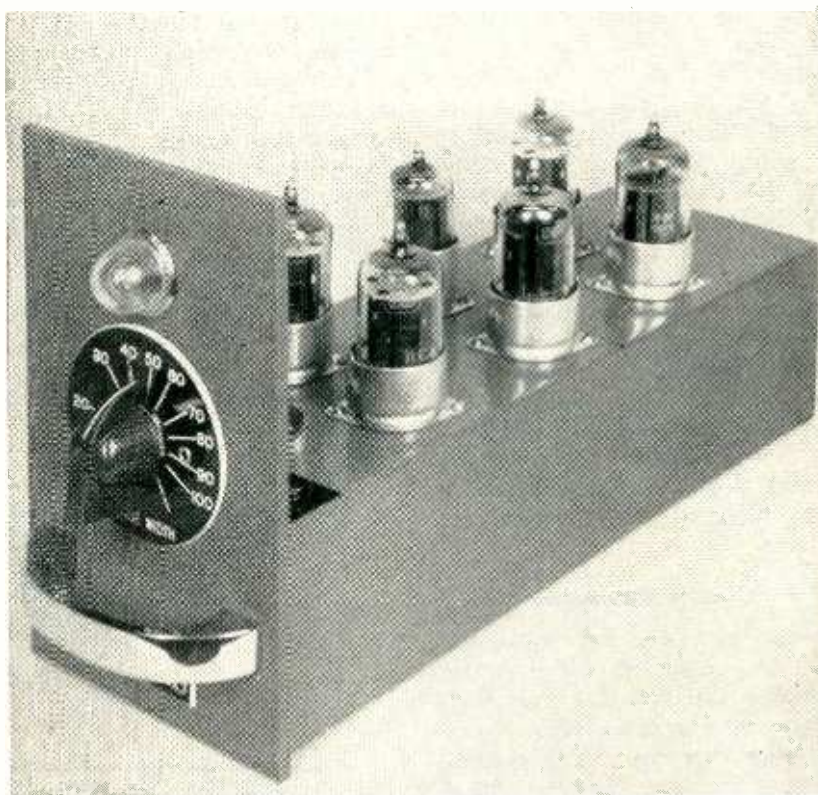

Pulse-width discriminator chassis. Predetermined pulse-width is selected by calibrated dial. Neon lamp lights when coincidence is achieved

This work was performed under contract with the United States Department of the Air Force.

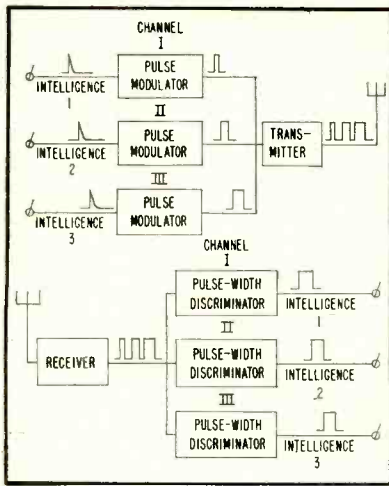

FIG. 1—Block diagram of three-channel telemetering system using pulse-width channel coding

veloped required that three channels of information be relayed by a vhf radio link and that all three channels contain information which originally appeared as pulses. The desired information would be the pulse frequency. Since the pulse-repetition rate of each channel was an independent function, pulse-position coding methods were ruled out and a pulse-width coding system was used. A block diagram of the system is shown in Fig. 1.

The function of the pulse-width discriminator in the system is to separate the information channel for which the discriminator is set from all other signals appearing at its input. Therefore, the output from each pulse-width discriminator is one channel of information. Requirements of the pulse-width discriminator are to respond to and reproduce a pulse of a predetermined width and to be unresponsive to pulses of all other widths. The equipment has been designed to perform properly under conditions of rather severe random noise as might be experienced in the output of a high-gain receiver.

### Circuit Operation

Referring to Fig. 2 the input signals (1) are fed to a slicer which separates the spurious variations such as receiver noise from the intelligence signals. The output pulses of the slicer (2) have various widths corresponding to the inform-

ation channels transmitted. This output is fed to two different circuits, one with a differentiator input stage and the other with an inverter-clipper input stage. The positive output of the differentiator (4) is used to trigger a one-shot multivibrator which provides a gating pulse of predetermined width (9) to the coincidence tube. This gating pulse is delayed for a period of time after the start of the input pulse equal to the width of the input pulse.

The output of the slicer is also inverted (3), differentiated (5) and used to initiate a delay multivibrator whose width is a controllable parameter of the discriminator unit. The output of this multivibrator (6) is differentiated and appears as a negative pip (7) at the trailing edge of the delay multivibrator used to trigger a second gate multivibrator.

The output from the second gate multivibrator (8) is delayed for a period of time after the start of the input pulse equal to the width of the delay multivibrator pulse. Outputs of the two gate multivibrators (8) and (9) are fed to a coincidence tube which conducts only during the coincidence time of the two gate pulses. The coincidence tube will therefore trigger the output multivibrator only for a given input pulse width and this width is a controllable adjustment of the discriminator unit.

Figure 3 illustrates the sequence of operations on the input intelligence shown in proper time orientation. The various numbered waveforms are related to the number

points in the block diagram, Fig. 2. Three different pulse inputs are shown—one to which the discriminator is set to respond, one shorter and one longer than the properly selected pulse width. Waveforms 8 and 9 of Fig. 3 illustrate the proper and improper gating conditions for coincidence.

### Circuit Details

The details of the circuitry involved in accomplishing the desired objectives are illustrated in Fig. 4. Slicing of the input signals is obtained by biasing the grid of the first half of a 12AX7,  $V_{1A}$ , about 14v below cutoff. This allows for slicing of the center three volts out of a 30-v input; the rectifier action of the tube suppresses the top half of the pulse. For other input voltages the bias may also be adjusted to allow selection of the center three volts of the input pulse. The positive input pulses appear at the plate of  $V_{1A}$  inverted and cleaned of any receiver noise.

The inverted pulses are fed simultaneously to the grid of  $V_{1B}$ , inverted again and then differentiated by the 50- $\mu$ mf capacitor and 51,000-ohm resistor. The resulting positive pip triggers the gate multivibrator consisting of both halves of  $V_{2A}$ .

The output at the plate of  $V_{1B}$  is differentiated by the R-C network and the positive pip triggers the delay multivibrator consisting of both halves of  $V_{2B}$ . The negative pip at the grid of  $V_{2A}$  is suppressed by a germanium crystal so as not to influence the width of the delay multivibrator pulse. The width of

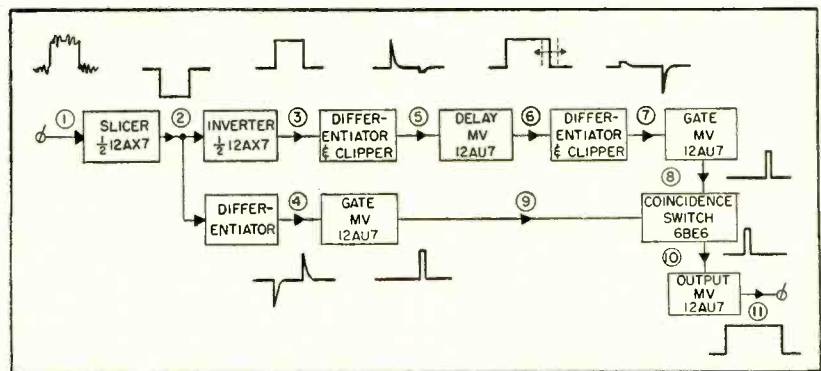

FIG. 2—Block diagram of pulse-width discriminator showing waveforms at successive stages



this delay pulse is controlled by an adjustment of the grid resistor of  $V_{2B}$  which determines the time constant of the multivibrator.

The output of  $V_{2B}$  is again differentiated through an R-C network and this time the resulting negative pip is fed to the plate of  $V_{3A}$  to trigger the gate multivibrator consisting of both sections of  $V_3$ . The positive pip at this point is suppressed by the germanium crystal connected between the plates of  $V_{2B}$  and  $V_{3A}$ . The width of this gate pulse is internally controllable in order to provide a sensitivity control for the discriminator.

The coincidence tube,  $V_4$ , is a pentagrid converter with inputs at the first and third grids. The first grid is biased at about 23v negative and the third grid is biased at about 56v negative. Either bias alone is sufficient to cut the tube off but when the outputs of the two gate multivibrators occur simultaneously at the grids of  $V_4$ , the tube conducts, supplying a trigger impulse to the output multivibrator consisting of both sections of  $V_6$ . A neon lamp is incorporated in the output circuit to indicate when coincidence at  $V_4$  is achieved.

The power-supply requirements

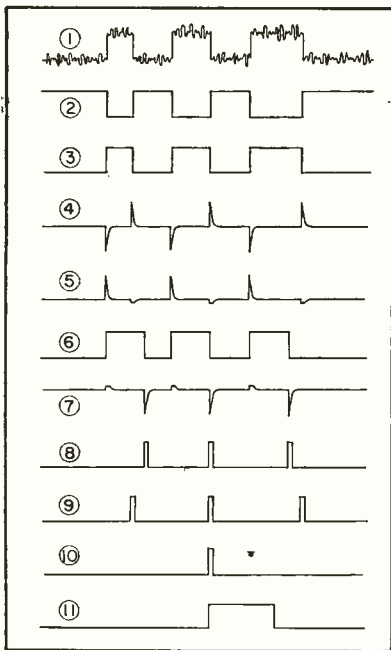

FIG. 3—Waveform relations in pulse-width discriminator. Waveforms (8) and (9) show the proper and improper gating conditions for coincidence

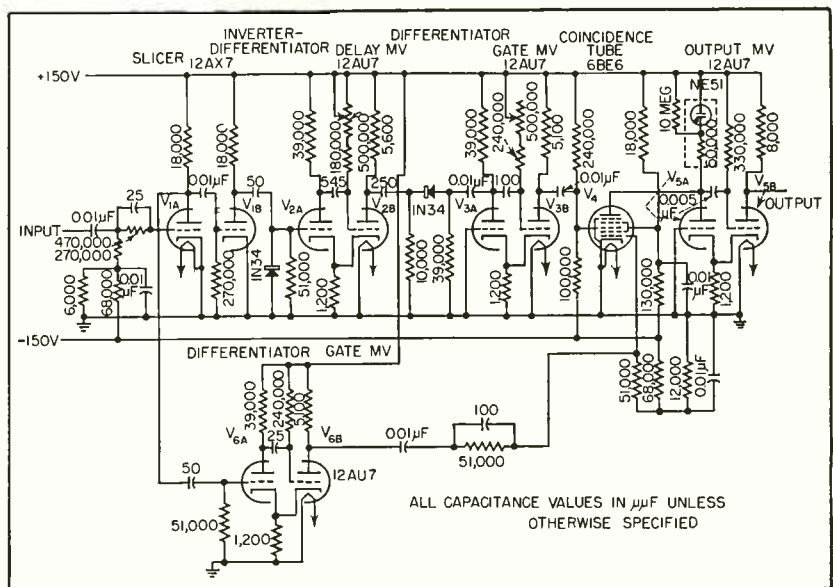

FIG. 4—Schematic diagram of the pulse-width discriminator

for the discriminator consist of a positive and a negative 150-v supply and a 6.3-v filament supply. The positive 150-v supply drain is 48 ma and the negative supply drain is 7 ma. The filament current is 1.7 amp.

The circuit illustrated in Fig. 4 has been constructed and tested with both a direct video input and a modulated r-f signal which was detected by a receiver and fed to the pulse-width discriminator. In either case the circuit performed very satisfactorily and exhibited excellent stability over a prolonged period of operation.

In the circuit shown, the delay multivibrator is adjustable in width over a range of from 20 to 100  $\mu\text{sec}$  by a calibrated front-panel adjustment. The width of the gating pulses may be varied by an internal adjustment over a range of from 2 to 12  $\mu\text{sec}$ . For a 3-channel multiplexing system employing pulse widths of 30, 60, and 90  $\mu\text{sec}$  it was found that a sensitivity range of  $\pm$  five  $\mu\text{sec}$  was very satisfactory. This allows for instabilities due to slight pulse-width and pulse-amplitude variations and yet provides ample guard bands between channels.

The pulse-width discriminators were constructed as small compact plug-in units which may be removed and replaced in a minimum of time.

Miniature tubes are employed throughout as well as turret-type sockets to make the units light and compact.

### Conclusions

The pulse-width discriminator described exhibits both a high degree of stability and simplicity of operation. It has the ability to discriminate the intelligence pulses from the random noise background occurring in high-gain receivers. Although the unit was designed to handle pulses in the range of 20 to 100  $\mu\text{sec}$  wide, modification of the network components will allow the range to be extended.

The units discussed were intended for intelligence channel decoders in a multiplex communication system; however, their use may be extended to the field of instrumentation and measurement. The unit has been used to measure the width of rectangular pulses, and, due to the clipping action of the input circuit, it may be employed to measure the pulse width of other waveforms. This circuit has, in general, turned out to be a very useful addition to the laboratory pulse equipment used by the authors. For this measurement application it is recommended that a more accurate vernier-type control be employed in place of the simple dial arrangement shown.

# Five-KW Klystron UHF

Single-ended output of five kilowatts from 475 to 890 megacycles is achieved with newly developed high-power klystron. Operating as a linear amplifier, its use avoids parallel operation of low-power tubes and other expedients suggested for these frequencies

**F**OR SEVERAL YEARS, government, manufacturing and operating organizations have been actively engaged in tube and circuit development, as well as propagation surveys, to determine the best means for utilizing the proposed uhf band for television.

Reports from some of the propagation investigations have been quite optimistic; others rather discouraging. Certainly much work remains to be done in this field. It

A summary of this article was presented at the fifth annual NARTB Broadcast Engineering Conference, April 1951, in Chicago.

is generally conceded, however, that high-power transmission is especially desirable for uhf television service. At the same time, all agree that the problems involved in generating high power at uhf are extremely difficult, in some cases seemingly impossible of solution.

Conventional tubes and circuits usually fail to operate even at the low end of the proposed frequency band. Commercially available tubes, when used in carefully designed and very special circuits, will provide power in the order of 100 watts. By paralleled arrangement of several small tubes, outputs up

to one kilowatt have been obtained.

To avoid paralleling of several small tubes, our tube and circuit development was directed toward obtaining high power of at least five kilowatts in a single-tube output stage. It was planned to build this up to an effective radiated power of 100 kw by means of a high-gain antenna system. This power level has now been successfully reached, using tubes, circuits and techniques which we believe are entirely practical for commercial television service.

In a study of conventional single or multiple-grid electron tube design for high-power uhf television, a serious conflict arises. The extremely high frequency demands a compact tube with very close spacing of elements to minimize the electron transit time and to shorten r-f circuits. At the same time, increased circuit losses due to high-frequency current and increased dissipation caused by transit time require large high-emission cathodes and large heat-dissipating surfaces. A compromise must be accepted if one is to consider any form of negative-grid tube. The

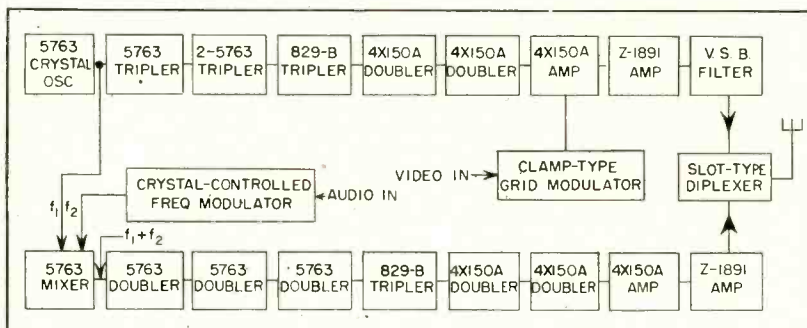

FIG. 1—Block diagram of the video and audio channels of the transmitter. For output from 475 to 890 mc, crystal frequencies from 4.4 to 8.2 kc are used

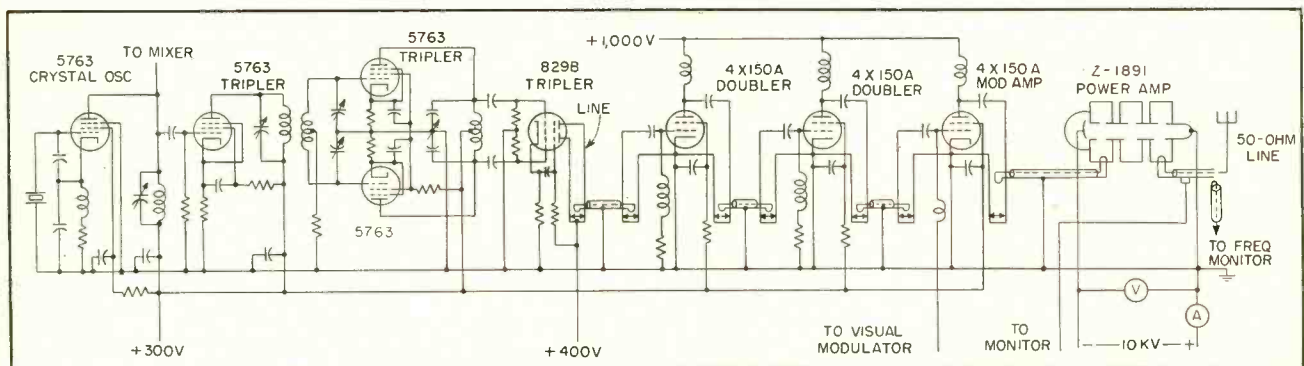

FIG. 2—Stages of the visual carrier channel. Cavities are used in the 4X150A stages and the units drawn as plate r-f chokes are not actually chokes but consist of the separation provided by the shielding between inner and outer surfaces of the cavities. The 829B tripler output tank is an open-type transmission line coupled by coaxial cable to the input cavity of the first doubler



# Television Transmitter

By **H. M. CROSBY**

*Development Engineer  
Electronics Department  
General Electric Company  
Syracuse, New York*

result is almost certain to end in high initial cost, short tube life and, in most cases, failure to reach the desired power output.

## **High-Power Klystron**

Since unavoidable transit time has such disastrous effect on the performance of the conventional high-frequency tube, it seemed logical to consider a type of tube which used such effect to advantage. General Electric did considerable development work prior to World War II on velocity-modulated tubes at outputs of a few hundred watts in the higher uhf ranges. Several types of receiver tubes and low-power transmitter tubes of this kind were employed successfully during the war.

Of the several tubes in this class, the klystron seemed to offer the most desirable characteristics. In this tube, the cathode can be placed relatively far from and outside the r-f field. Hence, the problem of designing a suitable high-emission cathode is at once simplified. The r-f circuits, which form a part of the tube, take on the dimensions of the wavelength to be used; therefore, the microscopic spacings and difficult alignments involved in conventional tube manufacture are eliminated.

Up to the time of this development, uhf klystrons providing continuous outputs as high as 5 kw had never been made, to our knowledge. Varian Associates were approached with the idea of developing for General Electric a klystron capable of at least 5-kw output and suitable for broadband amplification of uhf television signals.

The first developmental 5-kw klystron was completed and tested prior to 1950. An improved version of the tube was placed in operation



Adjustments are made by the author to the 5-kw klystron mounted in the cubicle of a developmental transmitter. The tube cooling system requires six gallons per minute of water and approximately 200 cu ft of air, practically at atmospheric pressure

during the summer of 1950. Numerous tests have been made and a great deal of operating data shows that this tube is entirely practical and reliable for high-power uhf television transmission.

Simultaneously with the high-power tube development, a uhf television exciter was being developed at General Electric, suitable for driving the klystron amplifier. In parallel with this, an extensive program was under way to develop a new type of high-gain antenna.

## **Line-up of Stages**

The block diagram, Fig. 1, shows the tube complement and circuit functions of the complete transmitter, with power supplies omitted for

clarity. The exciter-driver unit developed for use in this equipment is really a complete 100-watt television transmitter in itself. As shown in Fig. 2, the crystal-oscillator output is multiplied in the conventional manner by means of miniature tubes and normal circuits to one-fourth of the visual carrier frequency. The frequency is then doubled twice in cavity-type circuits using type 4X150A tetrodes which, in turn, excite the driver amplifier at the output frequency. Up to this point, all stages are adjusted for ordinary narrow-band operation since no modulation has taken place.

The driver amplifier, also a 4X150A tetrode in a cavity-type cir-

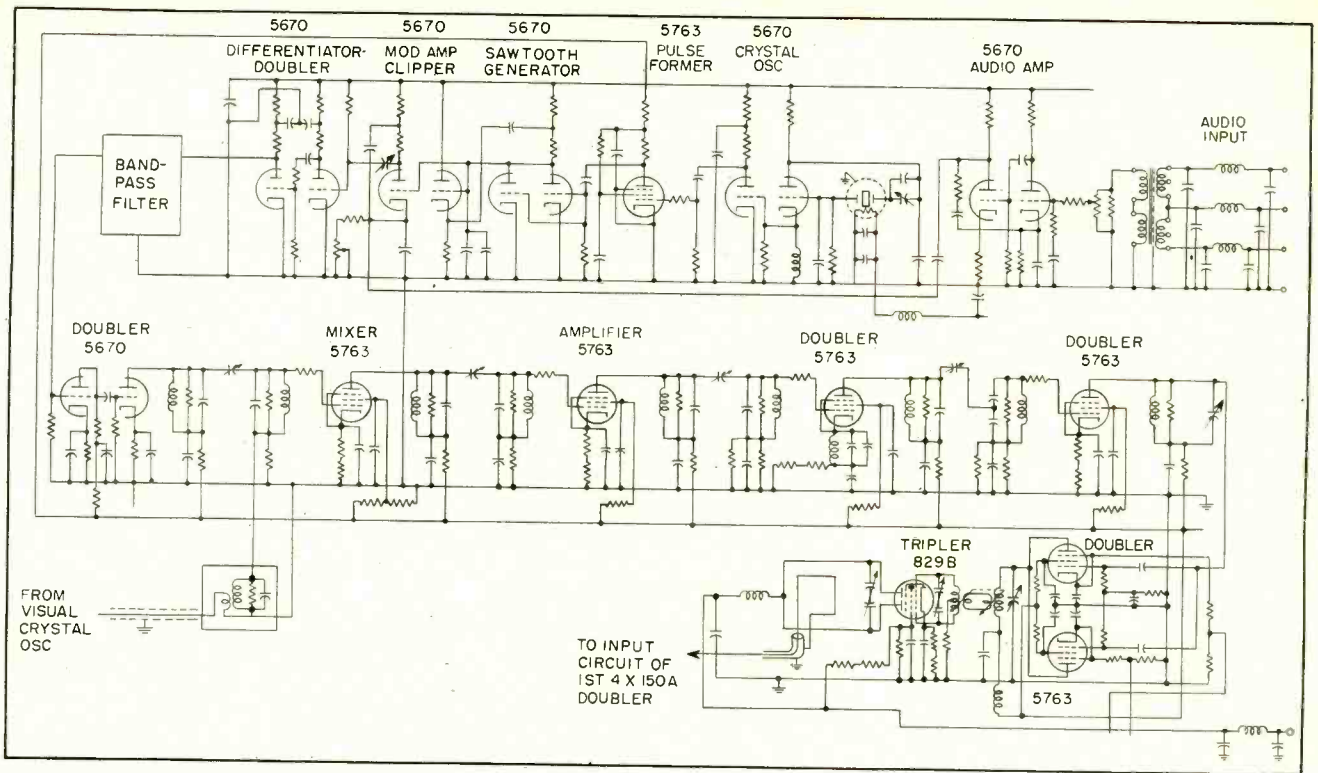

FIG. 3—Circuits of phase modulator, mixer and frequency multipliers

cuit, is grid-modulated by the visual signal through a clamp-type visual modulator. The video-modulated r-f signal from the driver is fed to the output circuit of the klystron power amplifier through a coaxial cable.

### Single Crystal

The r-f frequency control of the exciter-driver unit is of novel design in that only one crystal oscillator is used to control both the visual and aural carriers. Consequently, these two carriers are essentially locked together with a fixed separation of 4.5 megacycles. Any frequency drift due to the crystal results in each of the carriers drifting in the same direction, while the two remain 4.5 megacycles apart.

The advantage of this system over the customary use of separate frequency controls for visual and aural transmitters, is obvious. It is especially desirable for receivers using the intercarrier method of aural reception. A better understanding of how this single-frequency control is achieved may be obtained by a description of the aural portion of the transmitter.

The frequency-modulated aural

signal is generated by a direct crystal-controlled phase modulator employing conventional tubes and having exceptionally low noise and distortion.

The schematic diagram of Fig. 3 shows the principal circuits of the phase-modulator, mixer and conventional frequency multipliers. The plate current pulses of the crystal oscillator are transformed to narrow square-wave pulses by the pulse-former stage.

The sawtooth generator transforms these crystal-controlled square pulses into a sawtooth wave having a very linear slope. The modulating amplifier-clipper stage clips off the top of the sawtooth at varying heights depending on the instantaneous values of the audio input voltage, and produces a square wave whose trailing edge varies along the time axis in proportion to the varying slope length of the clipped sawtooth.

A differentiator stage generates from the phase modulated trailing edge a narrow pip which is then doubled in frequency and passed through a band-pass filter. The band-pass filter converts the phase-modulated narrow pip into a pure sine wave which is again amplified

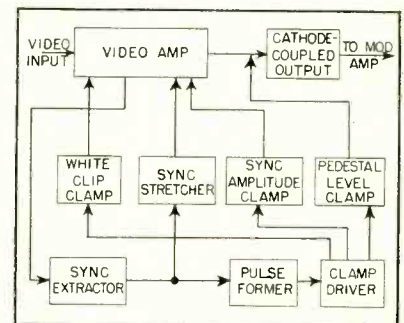

FIG. 4—Stages of the video modulator

and doubled in frequency. This frequency-modulated r-f signal, very much lower in center frequency than that of the visual channel carrier control crystal, is then added to the latter signal in a mixer stage. The resulting sum signal becomes the controlling source of the aural carrier. This frequency-modulated signal is then multiplied by conventional multiplier stages to one-fourth of the aural carrier frequency.

The signal is next doubled twice and amplified in cavity-type circuits identical to those used in the visual channel. It is then fed to the aural power amplifier through a coaxial cable. The result is a fre-



quency-modulated aural carrier whose center frequency is 4.5 megacycles higher than the visual carrier, and essentially controlled by the visual carrier crystal.

### Video Modulator

The visual modulator used in this transmitter is designed to accept a standard composite video signal, and, after processing and amplifying, to apply this signal to the grid of the r-f driver amplifier. The several functions of this modulator may be more clearly understood by reference to the block diagram of Fig. 4. The composite video signal, in passing through the video amplifier, is also applied to a sync extractor circuit, followed by a sync-stretcher which increases the percentage of synchronizing signal contained in the original composite input.

A pulse-former circuit generates a narrow pulse immediately following the trailing edge of all synchronizing signals. This narrow pulse, through the clamp driver circuit, keys the white-clip clamp, the sync-amplitude clamp and the pedestal-level clamp. These three clamp circuits then apply the clamp-type d-c insertion to the proper stages

of the video amplifier to maintain the video signal at the correct pedestal level.

The white-clip clamp may be adjusted to the desired level to prevent over-modulation in the white region, thus ensuring satisfactory operation of intercarrier-type receivers. The sync amplitude clamp provides a means for maintaining the correct percentage of sync in the transmitter output signal. The pedestal level clamp may be adjusted to provide the desired pedestal power. The cathode-coupled output stage presents a low-impedance source of composite video signal to the modulated r-f driver.

### Linear Klystron Amplifier

Possibly the most unusual and novel portions of this transmitter are the visual and aural power amplifier stages. Yet these are perhaps the least complicated parts from the standpoint of circuitry and operation. These two stages employ multi-cavity klystrons developed especially for uhf television, G. E. development type Z-1891.

Figure 5 is a schematic representation of the internal structure of the tube. The stream of electrons leaving the hot cathode flows through the drift space toward the anode or catcher because of the difference in potential. Divergence of this electron beam is prevented by an external magnetic field, thus forcing nearly all of the electrons to pass through the three cavities to the collector. When an r-f input signal excites the resonant input cavity, the electrons are bunched or velocity-modulated so that they travel in concentrations or groups. The bunches, in passing through the succeeding resonant cavities, transfer part of their energy to these circuits.

A load may be coupled to the collector cavity to extract useful power. The operating conditions are such that the power transferred to the output cavity is much greater than that used to modulate the beam at the input resonator. Therefore, the tube is an amplifier, the energy being supplied by the beam current and accelerating or collector voltage.

Pure electron coupling exists in this tube, resulting in complete iso-



One of four sections of the side-fire helical antenna that provides a gain of 20 on the uhf television frequencies

lation of input and output circuits. Consequently, very high gain can be realized with no need for neutralization. The three-cavity klystron operates like two cascaded stages, resulting in high gain in a single tube.

### Operating Characteristics

As a linear r-f amplifier, the klystron operates somewhat as a conventional tube in that output voltage across a constant load is approximately proportional to input voltage up to a certain level. Beyond this point, with a conventional tube, the output increases more slowly as excitation is increased and finally reaches a saturation point where it levels off to a constant value.

In the case of the klystron, the output current follows a Bessel function of first order and first kind. Consequently, the output voltage across the load first increases to a maximum and then reduces as excitation is increased, finally reaching zero output. Further increase in excitation causes a second

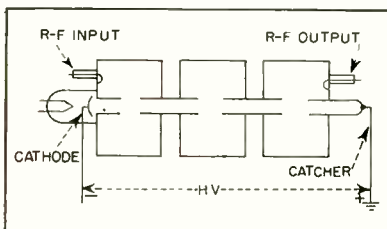

FIG. 5—Internal structure of the new klystron

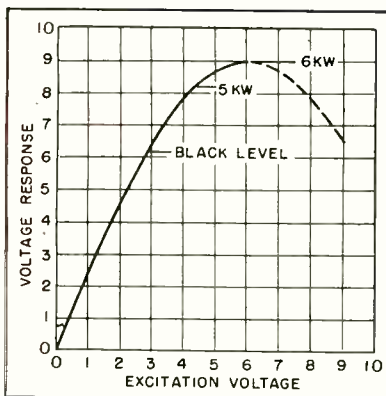

FIG. 6—Response curve of klystron power amplifier

rise in output. For linear amplifier operation in a television transmitter, we are interested in only the first part of the characteristic.

Figure 6 shows a typical voltage response curve of the Z-1891 klystron under operating conditions suitable for a 5-kw television transmitter. The output is quite linear up to the 3-kw or black-level point, which includes the picture portion of a television signal. The synchronizing signal occupies the remaining part of the output curve up to 5 kw. Considerable limiting of the synchronizing signal is permissible, and is standard practice in tv transmitters for reasons of economy. Sync stretching is normally provided in the video circuits of commercial transmitters to compensate for this compression.

With exception of the cathode structure and the r-f output seal, the tube is of metal construction. Cooling is accomplished by means of circulating water and forced air. The cathode structure, that part of any tube which usually limits its life, is designed for exceptionally long performance. The fact that

in a klystron the cathode is removed from the r-f part of the tube permits the use of sufficiently large emissive surfaces operated at relatively low temperatures to achieve long life. It is expected that the useful life of this tube will exceed that of more conventional high-frequency tubes by several times. In addition to long-life expectancy, another unusual feature contributing to low operating cost is the type of construction whereby this tube may be easily repaired at the factory.

The klystron serving as the visual power amplifier operates as a broadband linear stage. Power gains in excess of 50 are easily realizable in this stage when adjusted for an output response flat within 1 db over a frequency band of 5 megacycles. Noise and distortion compare favorably with that obtained from the best conventional low-frequency high-power tubes.

A typical frequency response curve taken on the visual power amplifier stage is shown in Fig. 7. Here the stage has been adjusted so as to have a total variation in response not exceeding 1 db over a range of 5 megacycles.

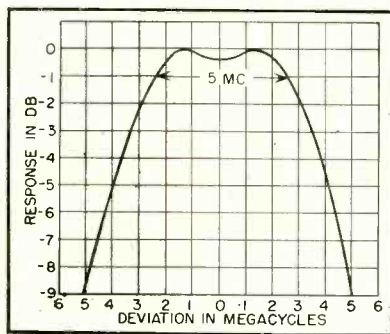

FIG. 7—Frequency response of visual power amplifier tube

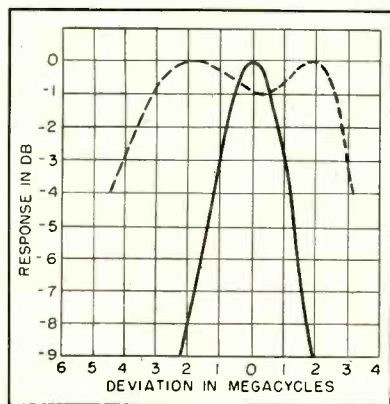

FIG. 8—Narrow-band and broad-band performance of the klystron

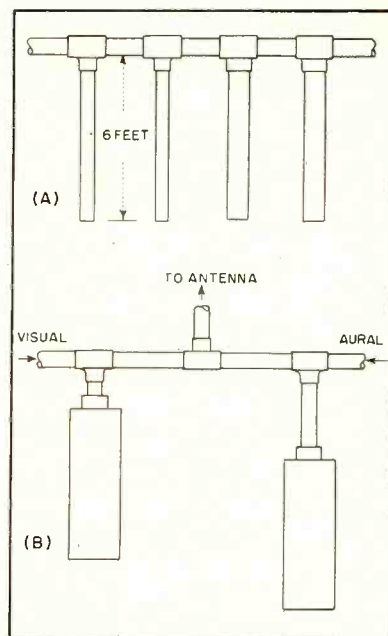

FIG. 9—The vestigial sideband filter is shown at A and the diplexer at B

### Narrow-Band Operation

The klystron used as the aural power amplifier is identical with that used in the visual channel, but need not be adjusted for broad-band response. Therefore, if desired, the power gain may be made extremely high. Power gains of over 5,000 times have been obtained under narrow-band operating conditions from this tube, with no evidence of instability. Figure 8 shows a typical voltage response curve for narrow-band operation, along with a broad-band response for the same tube by way of comparison.

One advantage inherent in television transmitters using low-level modulation is that considerable attenuation of the lower sideband may be accomplished in the linear amplifiers following the video-modulated stage. As a result, little additional filtering is necessary to meet the standards for vestigial sideband transmission. In this uhf transmitter some of this advantage is retained, even though only two-broad-band linear stages are used, thus making the filtering process

somewhat easier than it might otherwise be. A vestigial sideband filter is included to completely meet the required standards. This is a reflective-type band-rejection filter consisting of four coaxial stub sections approximately six feet in length, and containing internal slope-sharpening transformer sections to provide the desired characteristics. Figure 9A illustrates the physical arrangement.

As in the case of vhf television transmitters, a diplexer is used to isolate the visual and aural outputs of this uhf transmitter. In this case, a so-called slot-type diplexer gives the necessary isolation while feeding both aural and visual outputs into a single coaxial line to the antenna. As shown in Fig. 9B, the diplexer consists of two special coaxial cavity sections connected one-quarter wave either side of the common connection to the outgoing transmission line.

A transmitter of the general type just described has been placed in operation at Electronics Park in Syracuse on an experimental basis using a newly developed antenna having a power gain of 20 times. From an effective radiated power of 100 kw, we expect to obtain some new and valuable data to supplement that already available on uhf television propagation.



# Linear Discriminator For F-M Telemetering

Unbalanced trigger-circuit system provides exceptional stability and linearity and operates over a wide range of frequencies throughout audio and ultrasonic spectrum. System developed for study of experimental aircraft performance during test flights

By **GORDON S. SLOUGHTER** and **RICHARD T. ELLIS**

*Senior Research Engineer  
Electro-Mechanical Research, Inc.  
Ridgefield, Connecticut*

*Telemetering Project Engineer  
Applied Physics Laboratory  
The Johns Hopkins University  
Baltimore, Md.*

**F**LIGHT CHARACTERISTICS of developmental aircraft are usually recorded on the ground by means of frequency-division telemetering equipment. In the plane, a series of oscillators operating on different frequencies throughout the audio and ultrasonic spectrum modulate a subminiature f-m transmitter in accordance with the intelligence to be conveyed. The transmitter operates on a center frequency of either 217.55 or 219.45 mc, the two channels allocated for such telemetering services.

The receiving equipment consists of a series of subcarrier discriminators, low-pass filters and a magnetic oscillograph to record the intelligence. The accuracy of the system is a function of the stability and linearity of the discriminator unit. Linearity is desirable for ease of calibration, and stability is essential to maintain calibration during flight.

The Foster-Seeley and cycle-counter circuits have been among the discriminator circuits used in the past for detection. These discriminators are most linear for very small frequency deviations and do not readily provide the combination of linearity with frequency stability and high output voltage to the degree required by

the latest transmitting equipment. Amplitude modulation also causes occasional trouble with these types of discriminators.

### **Unbalanced Trigger Circuit**

The unbalanced trigger circuit type of discriminator described here offers many marked advantages over former types. The specifications met by the development include: input impedance of 0.5 megohm, input level 10 mv to 10 volts, subcarrier frequency range of 400 cps to 70 kc with intelligence frequency ranges from d-c to 8 cps on lowest bands and from d-c to

7,500 cps on highest bands. Output is  $\pm 10$  ma for  $\pm 7.5$ -percent deviation. Deviations as high as  $\pm 20$  percent are sometimes used on the higher frequency channels. Drift is less than  $\pm 2$  percent of bandwidth for temperature variations from 50 to 100 F and line changes from 105 to 125 volts.

The essential stages of the unit are shown by the block diagram of Fig. 1A. The discriminator circuit generates a rectangular pulse of constant length  $t_1$  each time it is triggered. The center frequency  $f_0$  is the frequency produced when the square wave is symmetrical, or

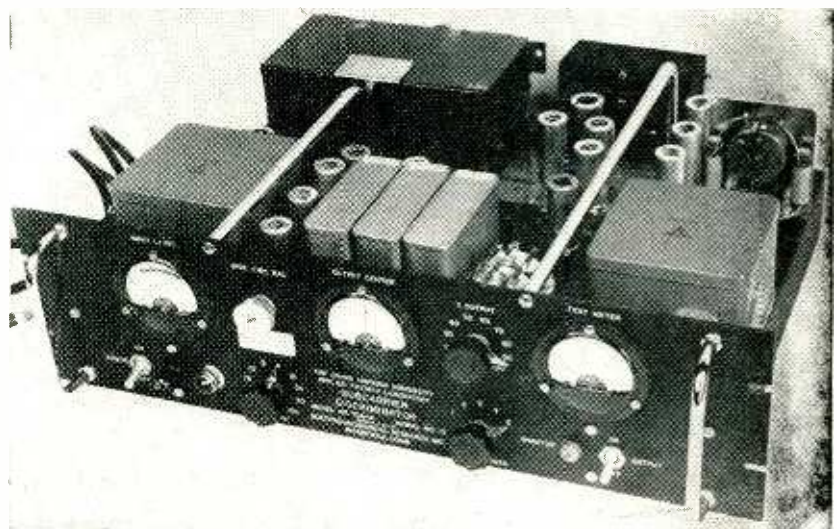

Photograph showing small panel space required for subcarrier discriminator circuit

The work described in this paper was done for the United States Navy Bureau of Ordnance.

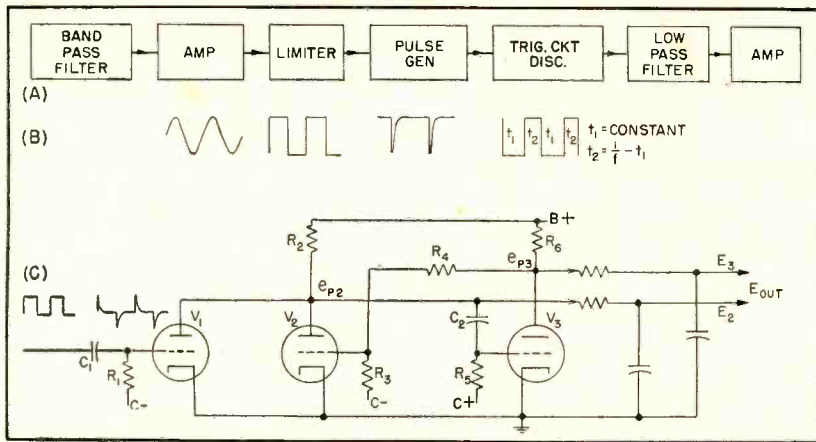

FIG. 1—Block and basic diagrams show effect of varying frequency on output waveshape

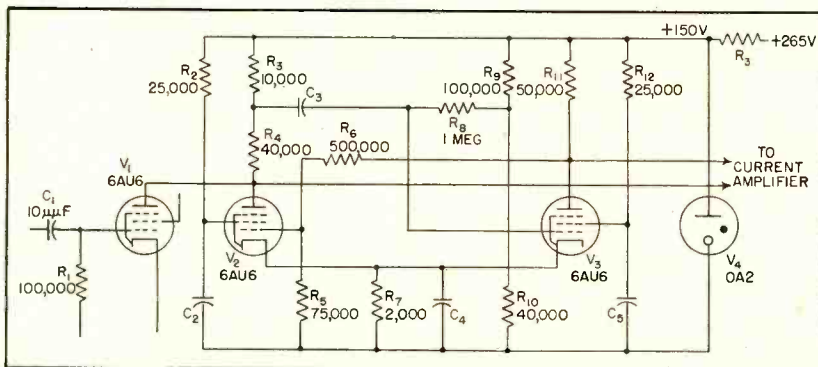

FIG. 2—Pulses from differentiated input signal trigger unstable flip-flop circuit

when  $t_1$  is equal to  $t_2$  as shown in Fig. 1B. When  $t_2$  is shorter than  $t_1$  the frequency is increased, and when  $t_2$  is longer than  $t_1$  the frequency is decreased. This system permits the use of d-c output in a push-pull arrangement in which the difference voltage is zero for the center frequency.

### Basic Circuit

The basic circuit of Fig. 1C provides this type of operation. The subcarrier signal emerges from the limiter as a square wave which is

differentiated by  $R_1C_1$  and applied to the grid circuit of the pulse generator  $V_1$ . The grid circuit is biased beyond cutoff, so that only positive pulses cause  $V_1$  to conduct.

In the absence of pulses from  $V_1$ , the discriminator circuit is inoperative, with  $V_2$  cut off and  $V_3$  conducting by virtue of their respective grid-return voltages. The discriminator passes through one cycle of operation each time the plate of  $V_2$  is triggered by  $V_1$ . The trigger pulse also appears on the grid of  $V_3$ . With  $V_3$  cut off, its plate

voltage rises to B+, applying positive bias to the grid of  $V_2$  through  $R_3$  and  $R_4$ . Thus  $V_2$  remains saturated and  $V_3$  cut off for a specific time  $t_1$  until  $C_2$  discharges through  $R_5$  sufficiently to start conduction of  $V_3$ . The circuit then returns abruptly to the initial condition, where it awaits the next pulse.

The time spent in the steady state condition ( $V_2$  cut off) is later referred to as  $t_2$ , so that the total time between pulses is  $t_1 + t_2$ , and this total must equal  $1/f$ . During continuous operation of the discriminator, the instantaneous plate voltages of  $V_2$  and  $V_3$  are complementary rectangular waves, as is true in an ordinary multivibrator circuit.

Within the limits of operation the output is a perfectly linear function of input frequency. The amplitude of the output voltage for a given frequency deviation depends on the cutoff value of plate voltage (which is essentially equal to the B+ voltage) and the plate voltage while the tube is saturated. The latter value is determined by the circuit constants and the tube characteristics. To avoid excessive drift, steps must be taken to minimize the instability of certain components and the circuit constants must be so chosen as to minimize the effect of tube variations.

### Linearity of Basic Circuit

The most obvious source of non-linearity arises from the fact that  $t_1$  cannot be maintained perfectly constant. Although  $t_1$  depends primarily on  $C_2$ ,  $R_5$  and  $e_{p2}$  for moderate deviations from the center frequency, as  $f$  approaches  $2f_0$ , increasingly less time is allowed for

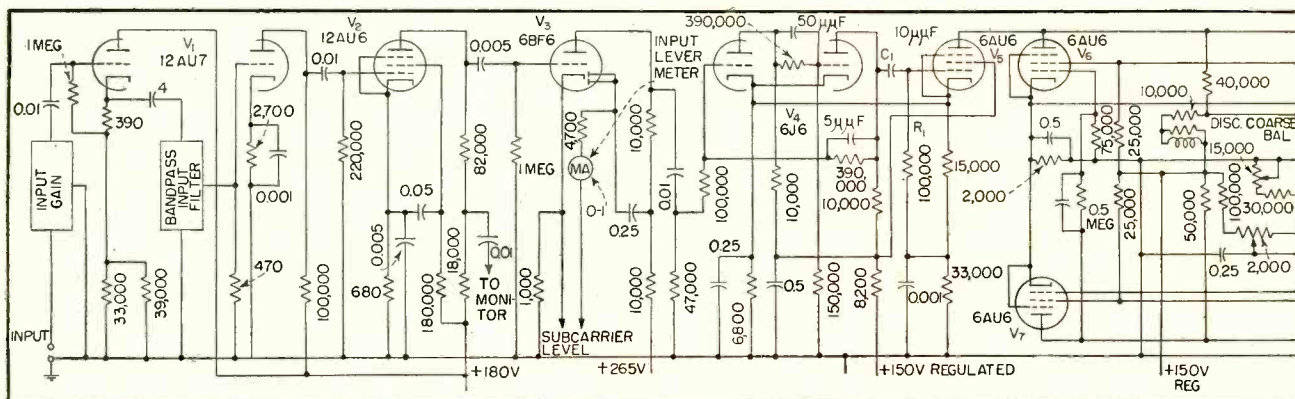

FIG. 3—Complete circuit of discriminator with input voltage amplifier and output



$C_2$  to charge through  $R_3$ ,  $R_5$  and the grid of  $V_3$ . The potential across  $C_2$  at the instant the circuit is triggered will, therefore, be less. It follows that the time  $t_1$  required after triggering for  $C_2$  to discharge through  $R_5$  to the point at which the circuit returns to the steady state will be correspondingly decreased. Accordingly, it becomes highly desirable to discharge  $C_2$  through a much greater impedance than that through which it is charged.

A second source of nonlinearity becomes troublesome at higher frequencies of operation when the rise time for  $e_p$  is an appreciable portion of  $t_1$  and  $t_2$ . Rounded leading edges may be produced by stray capacitance when operating in the high center frequencies. While such a departure from square-wave operation might be expected to introduce nonlinearity, it may be seen to be quite small until the rise time approaches  $t_1$  and  $t_2$  in magnitude. As the average d-c output is proportional to the area under the plate-voltage curve, if equal frequency deviations produce equal changes in area, the output is linear. Provided the top of the curve is flat, and the curve is otherwise constant in shape, this condition for linearity is satisfied. As the wave is not entirely symmetrical, when  $t_1$  is adjusted so that  $E_1 = E_2$  for the center frequency,  $t_1$  will not be exactly equal to  $t_2$ . However, this condition reduces slightly the slope of the output-vs-frequency curve, without affecting linearity.

### Practical Circuit

Sharp-cutoff pentodes are used in the trigger circuit to provide a very high plate impedance ratio for

positive to negative grid swing. The circuit is shown in Fig. 2. Stability is enhanced by stabilizing the B + voltage and by the use of precision wire-wound resistors throughout. Since  $C_3$  is in the component that determines  $t_1$ , it should also have as low a temperature coefficient as practicable. Resistor  $R_5$  is returned to a positive voltage with respect to the cathodes, so that the circuit will restore to the steady state while  $C_3$  is discharging rapidly, providing further stability of  $t_1$ .

The circuit is inherently linear with frequency so long as  $C_3$  is fully charged prior to each trigger pulse. Thus, the upper limit of linearity with frequency is determined by the speed with which  $C_3$  may be charged during the second portion of each cycle. To this end,  $R_3$  is made small as compared to  $R_5$  so that the charging time becomes largely a function of the grid-cathode impedance of  $V_3$ .

This circuit has consistently operated from 7.5 percent below to 7.5 percent above the center frequency with less than 1-percent nonlinearity, the nonlinearity occurring at the high-frequency end, as expected. Even better linearity may be obtained by operating the trigger circuit off center, so as to provide more time for  $C_3$  to charge, but this has only been done in those channels where the frequency deviation is greater than  $\pm 7.5$  percent as voltage output is otherwise sacrificed. Experience has shown that the same order of linearity may be obtained at larger frequency deviations, provided that the output is reduced to that obtained for  $\pm 7.5$  percent deviation by means of off-

center operation of the trigger circuit. Compensation for the slight droop at the high-frequency end may also be accomplished by introducing a closely controlled nonlinearity in the output circuit.

### Complete Subcarrier Channel

The entire circuit diagram, minus power supplies and galvanometer-protecting circuits, is shown in Fig. 3. As sixteen channels may be connected to the receiver simultaneously, the input impedance must be high, and a cathode-follower circuit is employed to reduce the impedance presented to the band-pass filter. Tubes  $V_1$ ,  $V_2$  and  $V_3$  amplify the channel signal,  $V_4$  provides square-wave output to the pulse forming stage  $V_6$ , which then triggers the discriminator at the plate of  $V_6$ . For carrier deviations of  $\pm 7.5$  percent, the output is 10 ma across a load of 330 ohms.

Considerable care must be taken to trigger the discriminator circuit in a manner which will not influence the output linearity. This condition is satisfied by providing plenty of grid drive to  $V_6$ , short pulse duration (determined by  $C_1$  and  $R_1$ ), and cathode bias somewhat above that of  $V_6$  and  $V_7$ . The pulse duration is approximately 2  $\mu$ sec. Of course,  $V_6$  must be biased well beyond cutoff, so that the plate will have no effect on the discriminator except during positive excursions of the control grid.

All circuits past the discriminator are direct-coupled, so that d-c intelligence may be transmitted. The zero drift during normal operation has been found to be less than  $\pm 2$  percent of full-scale one hour after a 15-minute warm-up.

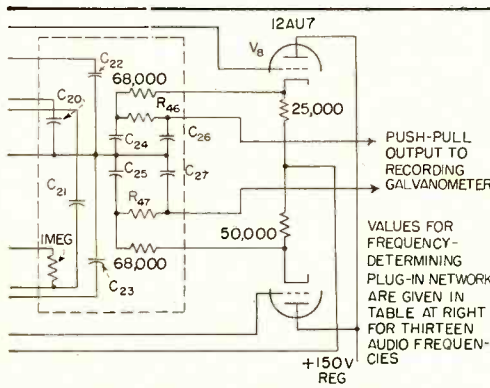

CARRIER CPS	MODULATION CPS	$C_{20}$	$C_{21}$	$C_{22,23}$	$C_{24,25}$	$C_{26,27}$	$R_{46,47}$ MEG
560	0-8.5	6.0	0.0015	1.0	0.05	0.005	0.560
730	0-11	6.0	0.001	0.5	0.03	0.005	0.470
960	0-14.5	6.0	0.0008	0.5	0.02	0.005	0.390
1,300	0-20	6.0	0.0006	0.25	0.02	0.002	0.560
1,700	0-26	1.0	0.00045	0.25	0.016	0.002	0.470
2,300	0-35	0.5	0.00035	0.25	0.01	0.001	0.680
3,000	0-45	0.5	0.00025	0.1	0.008	0.001	0.470
3,900	0-60	0.5	0.0002	0.1	0.007	0.00043	0.680
5,400	0-81		0.00015	0.1	0.005	0.00043	0.560
7,350	0-110		0.0001	0.05	0.003	0.00043	0.390
10,500	0-160		0.00008	0.1	0.002	0.0001	0.680
12,500	0-180		0.00006	0.05	0.002	0.0001	0.560
14,500	0-220		0.00005	0.02	0.00143	0.0001	0.470

cathode followers. Power supplies and galvanometer protection circuits not shown

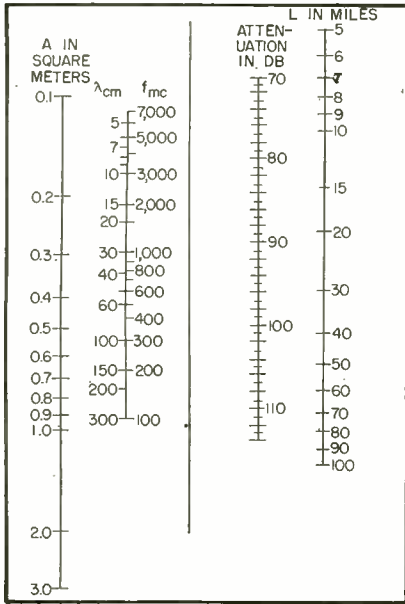

FIG. 1—Free-space attenuation between two identical antennas in terms of effective areas

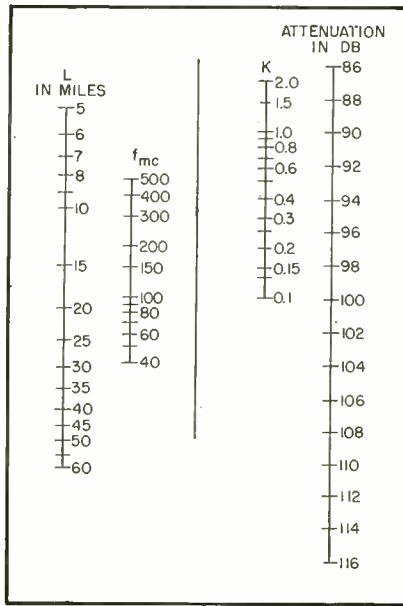

FIG. 2—Free-space attenuation in terms of effective antenna areas when the effective areas are expressed as  $K\lambda^2$

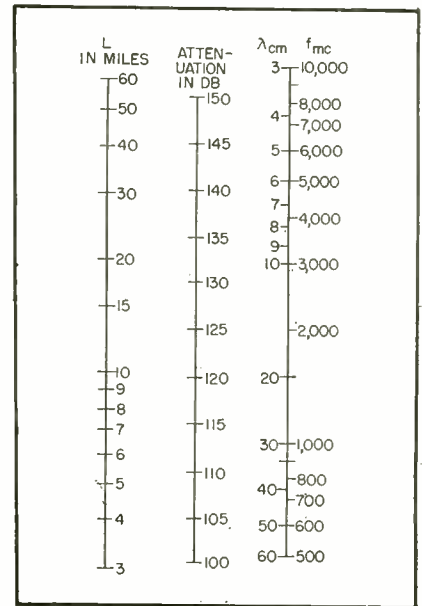

FIG. 3—Attenuation between two isotropic antennas separated by a distance of  $L$  miles

# Predicting Performance

Graphic method determines suitability of a location for use as a transmitter or receiver site for uhf and shf transmissions. Takes into consideration such factors as free-space attenuation, topographic and atmospheric conditions, and absorption

**I**N SELECTING transmitter sites, the propagation conditions at a proposed location must be considered. This can be done by means of mathematical formulas and nomograms. For the uhf and shf regions a number of required nomograms are contained herein, as well as the procedure to be followed in making a calculation.

Four items must be considered in determining space attenuation. These are: the attenuation that would exist in free-space, the topographical conditions, the atmospheric conditions, and absorption.

In making actual estimates for proposed sites, locations are chosen on the basis of topographical characteristics, assuming the effects of absorption to be negligible and allowing a safety margin for atmos-

By **E. A. SLUSSER\***

*Airborne Instruments Laboratory  
Mineola, New York*

pheric changes. The following discusses the four factors that affect attenuation, with particular emphasis on the free-space and topographic factors, which are the most important.

## Free-Space Factor

Free-space propagation is defined as the propagation which occurs in a homogeneous medium which is both unbounded and non-dissipative. In actual practice, a criterion which determines free-space propagation is to have no objects project into the first Fresnel zone. This first zone is bounded by points for which the transmission path from the transmitter to re-

ceiver is greater than the direct path by one-half wavelength.

The attenuation that occurs in free space can be expressed in terms of different variables and, for a particular case, one formula may be more advantageous than another.

The free-space attenuation in terms of effective antenna areas between two identical antennas is:

$$10 \log \frac{P_t}{P_r} = 10 \log \frac{2.33 L^2}{f^2 A^2} \times 10^{11} \\ = 113.7 + 20 \log L - 20 \log fA \quad (1)$$

where  $f$  is expressed in mc,  $L$  in miles, and  $A$  in sq meters ( $A$  is the effective antenna area  $K\lambda^2$ ). The above equation is shown solved by the nomogram in Fig. 1.

For use in Eq. 1, the effective area of the antennas must be calculated. In general, the effective

\* Formerly with General Telephone Service Corporation.



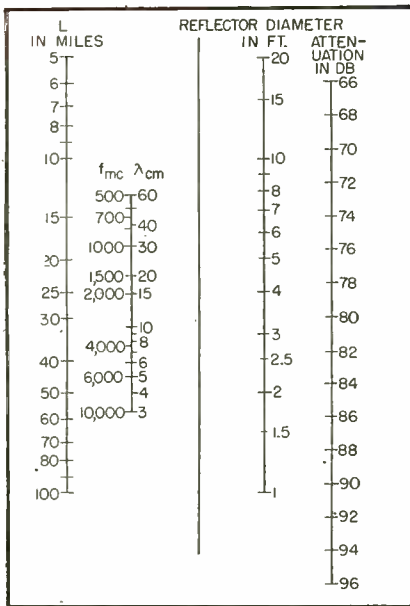

FIG. 4—Attenuation between two parabolic antennas in terms of reflector diameter in feet

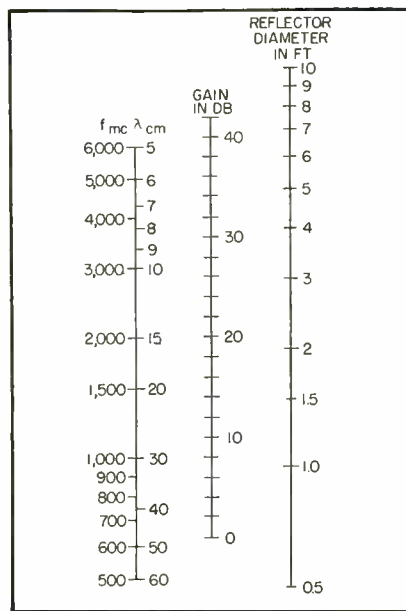

FIG. 5—Apparent power gain of a parabolic antenna in terms of reflector diameter in feet

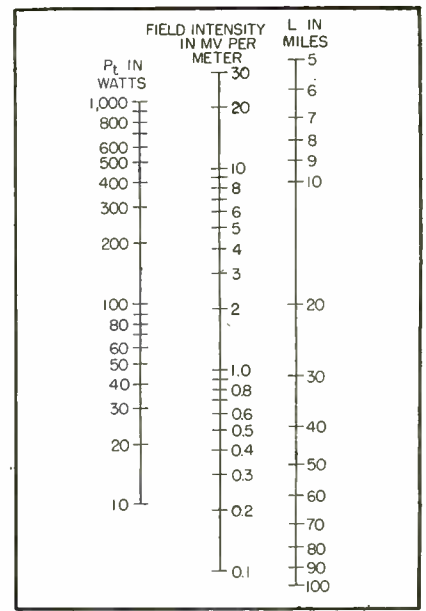

FIG. 6—Field intensity in millivolts per meter for a half-wave dipole at a distance of  $L$  miles

# of UHF and SHF Systems

area of an antenna is  $1.64G\lambda^2/4\pi$  where  $G$  is the gain over a dipole radiator. Some specific examples are included in Table I.

Frequently the effective area of an antenna is expressed as  $K\lambda^2$ . When this is the case, the path attenuation can be expressed as:

$$\begin{aligned} 10 \log \frac{P_t}{P_r} &= 10 \log \frac{28.8 L^2 f^2}{K^2} \\ &= 14.6 + 20 \log Lf - \\ &= 20 \log K \end{aligned} \quad (2)$$

where  $L$  is in miles and  $f$  in mc. Figure 2 is a nomogram for the solution of Eq. 2.

The path attenuation between two isotropic antennas expressed in terms of power ratio is:

$$\begin{aligned} \frac{P_t}{P_r} &= 4.55 \times 10^3 f^2 L^2 \\ 10 \log \frac{P_t}{P_r} &= 36.6 + 20 \log Lf \end{aligned} \quad (3)$$

where  $L$  is in miles and  $f$  in mc. Figure 3 is a nomogram for the solution of Eq. 3.

In the case of actual antennas having gains of  $G_t$  and  $G_r$ , the path attenuation becomes:

$$\frac{P_t}{P_r} = \left( \frac{P_t}{P_r} \right)_{isotropic} \times G_t G_r \quad (4)$$

The gains of a few typical antennas are included in Table I for use in Eq. 4.

For identical parabolas, we find that:

$$\begin{aligned} 10 \log \frac{P_t}{P_r} &= 20 \log 345 \frac{L\lambda}{D^2} \\ &= 50.76 + 20 \log L\lambda - \\ &= 40 \log D \end{aligned} \quad (5)$$

where  $L$  is in miles,  $D$  (parabola diameter) is in feet, and  $\lambda$  in cm. This formula is solved in the nomogram given in Fig. 4. The apparent power gain of a parabola is given by the nomogram in Fig. 5.

The maximum field intensity from a half-wave dipole in free space is given by the expression:

$$E_o = \frac{60 \pi l I}{\lambda L}$$

where  $E_o$  = field intensity at a distance  $L$  in volts per meter,  $l$  = effective length of the antenna in meters,  $I$  = antenna current in amps, and  $\lambda$  = wavelength in meters. Any other consistent system

Table I—Approximate Gains of Various Antennas

Antenna	K	Gain In Db Referred to Isotropic	Gain in Db Referred to Half-Wave Dipole
Isotropic	0.08	—	- 2
Half-Wave Dipole	0.13	+ 2	—
2-Element Parasitic	0.40	+ 7	+ 5
3-Element Parasitic	0.88	+10	+ 8
4-Element Parasitic	1.30	+12	+10
5-Element Parasitic	1.64	+13	+11
Dipole-Fed Parabola	—	Use Fig. 5	Subtract 2 db from values obtained from Fig. 5

of units may be used also.

For a half-wave dipole, the effective length is  $\lambda/\pi$ , and the radiation resistance is 73 ohms so, when  $L$  is in miles,  $E_o$  in millivolts per meter, and  $P_t$  in watts, the field intensity is:

$$E_o = \frac{4.35 \sqrt{P_t}}{L} \quad (6)$$

This expression is solved in the nomogram given in Fig. 6.

For a properly terminated one-half wave dipole of length  $d$ , the voltage in microvolts appearing across its terminals for a given field intensity is:

$$V = \frac{d E_o}{\pi} = \frac{\lambda E_o}{2\pi} \quad (7)$$

Figure 7 is a nomogram for the solution of Eq. 7. Thus, when  $L$  is in miles and  $\lambda$  in cm, the free-space attenuation between two dipoles is:

$$10 \log \frac{P_t}{P_r} = 20 \log \frac{1.23 L \times 10^6}{\lambda} = 121.8 + 20 \log L - 20 \log \lambda \quad (8)$$

This is solved by the nomogram given in Fig. 8.

### Topographical Considerations

The free-space formula does not hold over the surface of the earth due to the fact that the earth acts as a reflector and the received energy is the vector sum of the direct and reflected energy. The direct energy travels the distance  $L$  and the reflected energy the distance  $S$ . The difference between the horizontal and vertical polarization characteristic depends upon the nature of the reflection, the earth, and the angle of incidence  $\beta$ . Thus the phase and magnitude of the direct and reflected energy depends upon the separation distance  $L$ , the antenna heights  $h_i$  and  $h_r$ , and the reflection coefficient of the earth.

It can be shown that the field intensity at the receiving position in the above illustration is:

$$E_i = 0.0105 \frac{h_i h_r f \sqrt{P_t}}{L^2} \quad (9)$$

where  $h_i$  and  $h_r$  are the antenna heights in feet,  $L$  is in miles,  $f$  in mc, and  $E_i$  is in  $\mu$ volts per meter.

From the above, we can develop a formula for direct transmission between two dipoles in terms of dis-

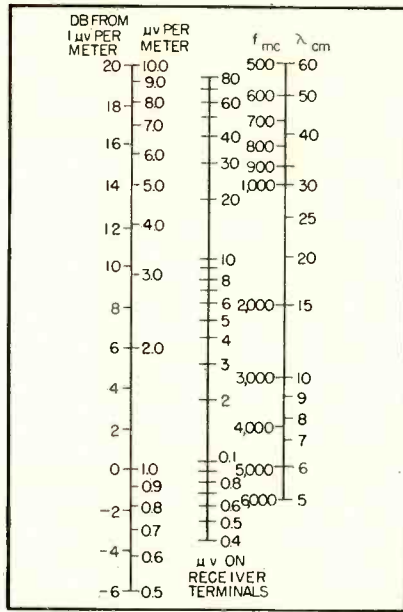

FIG. 7—Field intensity in terms of microvolts on half-wave antenna

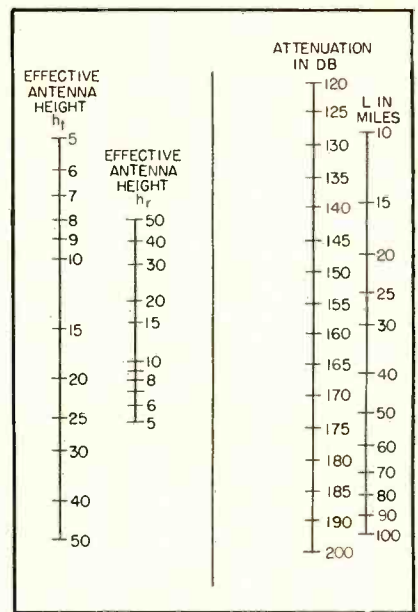

FIG. 9—Attenuation between two dipoles assuming ground reflections

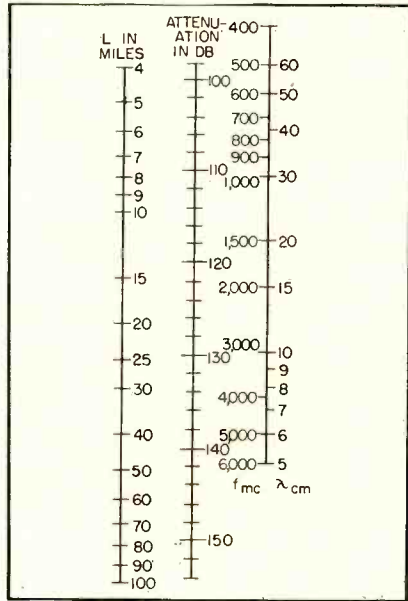

FIG. 8—Free-space attenuation between two dipoles

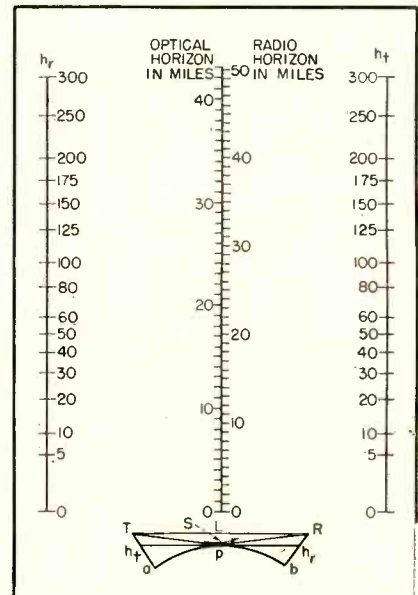

FIG. 10—Radio line-of-sight nomograph. Insert illustrates conditions

tance and antenna heights:

$$10 \log \frac{P_t}{P_r} = 20 \log \frac{1.71 \times 10^4 L^2}{h_i h_r} = 144.6 + 40 \log L - 20 \log h_i h_r \quad (10)$$

where  $h_i$  and  $h_r$  are in feet and  $L$  in miles. Figure 9 is a nomogram for solution of Eq. 10.

In order that Eq. 9 and 10 be valid,  $\beta$  must be small for horizontal polarization at uhf (less than 10 degrees); for vertical polarization over earth or fresh water  $\beta$  must be less than 1 degree; and over sea water less than 0.15 degree. The antennas must be elevated at least

$1\frac{1}{2} \lambda$  above the earth plane, and  $h_i$  and  $h_r$  must be the effective heights of the antennas. Effective antenna height is explained in the discussion of radio horizons. Furthermore, the phase angle arising from the path difference between the direct and reflected waves must be less than about 30 degrees. This latter condition is satisfied if  $h_i h_r / L \lambda < 7$  where  $h_i$  and  $h_r$  are in feet,  $L$  in miles, and  $\lambda$  in cm.

### Optical and Radio Horizons

Two factors account for reception beyond the optical horizon;



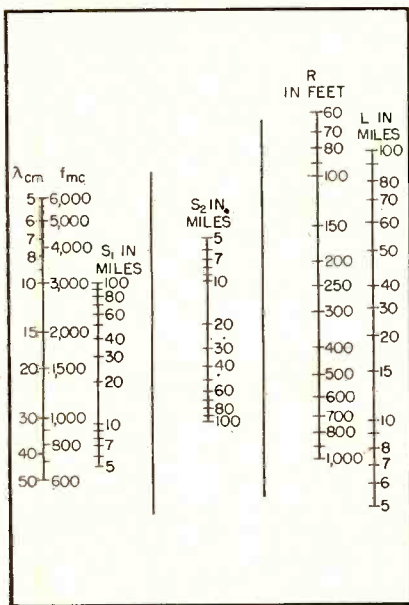

FIG. 11—Nomogram for determining Fresnel zone radius

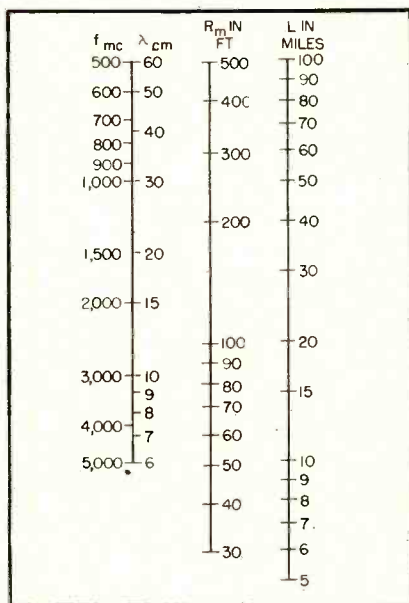

FIG. 12—Maximum radius of Fresnel zone

namely, refraction and diffraction. At uhf and shf, the effect of refraction predominates within the horizon.

For ranges just within and beyond the horizon, the effect of diffraction becomes of increasing importance. (Hence, for ranges near the horizon, somewhat inconsistent results may be obtained between Eq. 10 and 14 since the first considers only reflection or refraction while the latter equation considers mainly diffraction and average refraction.)

Refraction results in bending of

the energy and is caused by the earth's atmosphere. This bending is equivalent to increasing the earth's diameter by about 33½ percent of average conditions. Over smooth earth a transmitter antenna at height  $h_t$  and a receiver antenna at height  $h_r$  are therefore, in radio line of sight provided the spacing in miles is less than

$$\sqrt{2h_t} + \sqrt{2h_r}$$

Both optical and radio line-of-sight distances can be determined for given antenna heights from the nomogram given in Fig. 10.

Let us consider the effect of refraction on the radio horizon as used in Eq. 10, thus taking into account both the curvature of the earth and the average refraction.

The conditions that exist are shown in Fig. 10. The intersection of a tangent plane through a point  $P$  and the antenna supports determines the effective heights ( $h_t$  and  $h_r$ ) of the antennas. The values of  $a$  and  $b$  can be determined by means of the line-of-sight nomogram (Fig. 10). A line is drawn on the nomogram between the total tower heights on the antenna height scales. Parallel to this line another line is drawn so as to intersect the radio line-of-sight scale, at a value equal to the actual distance  $L$ . The values of  $a$  and  $b$  are read at the points where this line intersects the antenna height scales. The value of  $h_t$  and  $h_r$  are then found by subtracting  $a$  or  $b$  from the respective total tower heights.

It is these effective antenna heights that should be used in Eq. 9 and 10.

#### Fresnel Zone Clearance

To have free-space propagation, the first Fresnel zone must clear all obstacles in the transmission path.

The first Fresnel zone is bound by points for which the transmission from the transmitter to the receiver is greater than the direct path by one-half wave length. These points generate an ellipsoid. The radius  $R$  of the first zone at any point in the transmission path located at distance  $S_1$  from the transmitter and  $S_2$  from the receiver is given by the formula:  $R^2 = S_1 S_2 / \lambda$  where all quantities are expressed

in the same units. When  $R$  is in ft;  $\lambda$  in cm;  $S_1$ ,  $S_2$ , and  $L$  in miles:

$$R = 13.2 \sqrt{\frac{\lambda S_1 S_2}{L}} \quad (11)$$

A nomogram for solution of this expression is given in Fig. 11. Radius  $R$  is a maximum when  $S_1 = S_2$ , and this is given by the formula  $R_m = 1,140 \sqrt{L/f}$ . (12)

In actual use  $R_m$  is usually computed and a line is drawn a distance  $R_m$  below the direct line-of-sight path between antennas on a profile to determine if this line clears all obstacles. This method is easier than construction of an ellipse. If there is an obstacle protruding over the  $R_m$  line, it can be investigated on the basis of the first Fresnel ellipsoid using the nomogram in Fig. 11.

#### Shadow Losses

Equation 9 indicates that the field intensity varies directly as the frequency so that for a given distance and antenna height, as the frequency is increased, less radiated power is required for a given field intensity. Beyond the horizon this is not the case, as it has been found that the frequency varies inversely as some exponential power of the distance, the latter increasing rapidly with frequency. In fact, the exponent increases so rapidly with frequency that transmission into shadow areas in the uhf and shf regions is impractical. It has been found empirically that the following expression can be used for calculating field intensity near or beyond the horizon:

$$E_o = \frac{0.0105 \sqrt{P_t h_t h_r f L_H^{N-2}}}{L^N} \quad (13)$$

where:  $E_o$  = field intensity in mi-

Table II—Approximate Noise Figures for Receivers

Frequency	Good Receiver 10 log F	Average Receiver 10 log F
<200 mc	5 db	10 db
200- 1,000 mc	8 db	13 db
1,000- 5,000 mc	14 db	19 db
5,000-10,000 mc	17 db	22 db

crovolts per meter,  $P_t$  = power transmitted in watts,  $h_t$  and  $h_r$  = actual antenna heights in feet,  $L_H$  = distance to the optical horizon in miles,  $L$  = total distance in miles, and  $f$  = frequency in mc.

The factor  $N$  is taken from Fig. 13. This curve takes into consideration both diffraction and average refraction. Within the horizon the exponent  $N$  is equal to two regardless of the frequency so that  $L_H^{N-2}$  equals unity. Distance  $L_H$  can be obtained from the nomogram of Fig. 10. From Eq. 13 the attenuation in this case is found to be:

$$10 \log \frac{P_t}{P_r} = 144.6 + N 20 \log L - 20 (N - 2) \log L_H - 20 \log h_t/h_r \quad (14)$$

### Atmospheric Considerations

The normal refraction produced by the atmosphere has been previously discussed. We know that the energy under normal conditions is not refracted sufficiently to follow the curvature of the earth, but rather follows a path whose curvature is equivalent to an earth of diameter  $\frac{1}{3}$  larger than the actual earth.

The normal refraction is the refraction with which we are most concerned. However, there are some cases when the normal refractive index is exceeded and the index gradient reaches the requisite strength (5 parts in  $10^8$  feet) such that the energy may follow the earth's curvature. This is termed superrefraction.

The most prevalent cause of superrefraction is the presence of water vapor in the air. Over the surface of the ocean the air in near contact with the water is nearly saturated with water vapor. Frequently, this brings about a condition where the refractive index gradient becomes negative and exceeds the critical value. This forms a duct which has its top at the level where the gradient reaches the critical value. At this level the energy will just follow the curvature of the earth. It should be noted that ducts have no observable effect on the propagation of low frequencies and generally speaking, their effects are confined to frequen-

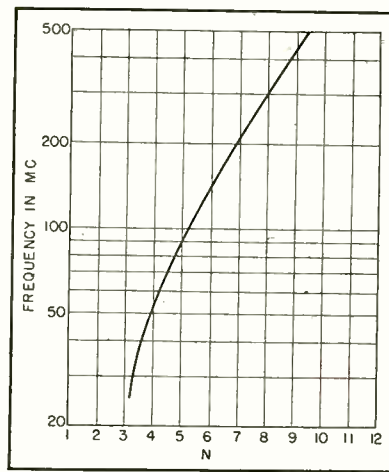

FIG. 13—Factor  $N$  is used in predicting field intensities near or beyond horizon

cies in the 1,000-mc range and above.

Superrefraction may occur over land. In this case it occurs during a radiation fog. The latter is caused by the cooling of land at night by radiation, causing a thin layer of cold air to be formed just above the surface of the ground, resulting in an abnormally large index of refraction in the lower layers of air.

The effect of duct formations between two microwave stations whose antennas are directed on the basis of the normal radio line-of-sight path might be to decrease slightly the signal intensity at one of the stations, but the observed effect is usually negligible.

### Absorption

For all practical purposes, the absorption of energy by the atmosphere in the uhf region can be considered negligible. It does increase, however, in the shf region. The chief cause of absorption is the presence of water in some form. Curves are included in Fig. 14 to show the effect of rain and fog or clouds. It can be seen from these that the absorption increases quite rapidly with frequency, but that even a heavy rain gives little effect on any of the presently used communication frequencies.

Variations in the atmosphere result in changes in the atmospheric and absorption factors and are the chief cause of fading. Information on the amount of fading experienced under various conditions is far from complete. However, measurements

made over an extended period of time at several locations indicate that for distances under 45 miles and with temperate weather conditions, fades of 20 db or greater occur only about 0.1 percent of the time on the vhf and shf frequencies. For longer distances, fades of 20 db or greater occur a larger percentage of the time. As a practical system design figure, a margin of 20 to 25 db should be allowed to provide for fading.

### Overall System Calculations

The foregoing sections have developed various nomograms for predicting uhf and shf propagation. It remains to tie this data together in a form such that it may be used to predict whether or not a proposed path can be satisfactorily covered by a given uhf or shf system.

In general, the difference between the overall system gain  $G_s$  and the path attenuation  $\alpha_p$  gives a safety margin that is used to improve the signal-to-noise ratio  $S/N$  of the output signal and to provide a safety factor  $S_f$  to protect against fading. Thus:

$$S/N + S_f = G_s - \alpha_p \quad (15)$$

where all of the quantities are expressed in db. (The following neglects any noise improvement factor  $nif$  that is obtained by use of some modulation systems and hence, is somewhat pessimistic.) The overall system gain  $G_s$ ,

$$G_s = G_e + G_t + G_r \quad (16)$$

where  $G_e$  is the equipment gain,  $G_t$  the gain of the transmitting antenna, and  $G_r$  the gain of the receiving antenna.

Any properly designed receiver for these frequencies should have sufficient gain to operate on signals comparable in amplitude to the receiver noise output referred to the receiver input, and it can be shown that

$$G_s = 10 \log P_t - 10 \log K T \Delta f - 10 \log f$$

Hence, the margin to provide for a desired output signal-to-noise ratio plus a safety factor to protect against fading is:

$$S/N + S_f = 10 \log P_t - 10 \log f - 10 \log K T \Delta f - (\alpha_p - G_t - G_r) \quad (18)$$



where the various terms in this equation are all expressed in db.

From Eq. 18 the following method is obtained for determining whether or not a point-to-point path will be reliably spanned using a particular equipment:

(1) From the available transmitter output power  $P_t$ , calculate  $10 \log P_t$ .

(2) Estimate the term  $10 \log F$  for the receiver noise figure using the approximate values given in Table II.

(3) Calculate  $KT\Delta f$ . (Since  $K = 1.38 \times 10^{-23}$  joules per deg K and a normal value for  $T$  is 290 K, this becomes approximately  $4 \times 10^{-21} \Delta f$  where  $\Delta f$  is the receiver bandwidth in cps).

(4) Determine whether or not free-space propagation conditions exist. This can be done by plotting a profile of the proposed path and checking for adequate first Fresnel zone clearance of the nearest obstacle by means of the nomograms of Figs. 12 or 13.

(5) Calculate the term  $(\alpha_p - G_t - G_r)$  by one of the following methods:

**Free-space propagation.** If free-space propagation conditions exist, this can be calculated equally well in three different manners. These are:

(a) Use Fig. 1 to determine the attenuation. The effective antenna area required by this nomogram may be taken from the figures given in Table I.

(b) Use Fig. 3 to determine the attenuation between two isotropic antennas. Then subtract from this the gains of the antenna arrays actually used and, hence, determine  $(\alpha_p - G_t - G_r)$ . The gains for various arrays referred to an isotropic antenna may be obtained from Table I.

(c) Use Fig. 8 to determine the attenuation between two dipoles. Then subtract from this the gains of the antenna arrays actually used and, hence, determine  $(\alpha_p - G_t - G_r)$ . The gains for various an-

tennas referred to a dipole antenna may be obtained from Table I.

**Line-of-sight conditions.** If free-space propagation conditions do not exist, but radio line-of-sight conditions still prevail, Fig. 9 should be used to find the attenuation between two dipoles. Then the gains of the antenna arrays actually used should be subtracted to determine  $(\alpha_p - G_t - G_r)$ . The gains of various arrays referred to a dipole can again be obtained from Table I.

**Shadow conditions.** If radio-line-of-sight conditions do not exist, Eq. 14 can be used to obtain the attenuation between two dipoles. Then the gains of the antenna arrays actually used should be subtracted to determine the value of  $(\alpha_p - G_t - G_r)$ . The gain of various arrays referred to a dipole are given in Table I.

Attempts to check values obtained by either Fig. 9 or Eq. 10, with values obtained from Eq. 14 for ranges close to the distance to the horizon, will lead to inconsistent results since the nomogram of Fig. 9 (or Eq. 10) considers only refraction and ground reflection while Eq. 14 mainly considers diffraction. Within the horizon Fig. 9 is to be used and beyond it Eq. 14, but in the crossover region encompassing ranges near the horizon both effects exist and, hence, it must be left up to individual judgment as to which method applies.

(6) From the foregoing and Eq. 18 find  $S/N + S_f$ . From this subtract a value of  $S_f$ , equal to 20 or 25 db, since this is a reasonable system design figure to use to provide for fading. The value of  $S/N$  then found gives the worst signal-to-noise ratio that should normally be obtained over a path served by this radio equipment; that is, it is the value that will exist under conditions of maximum fade. Experience will have to determine what is permissible here. Offhand, a value of 35 db should be quite satisfactory.

(7) If f-m is used, the above  $S/N$  will be improved by an amount equal to  $10 \log 3m^2$  where  $m$  is the deviation ratio.

The author wishes to acknowledge the assistance of Edward Daskam in the preparation of the original manuscript.

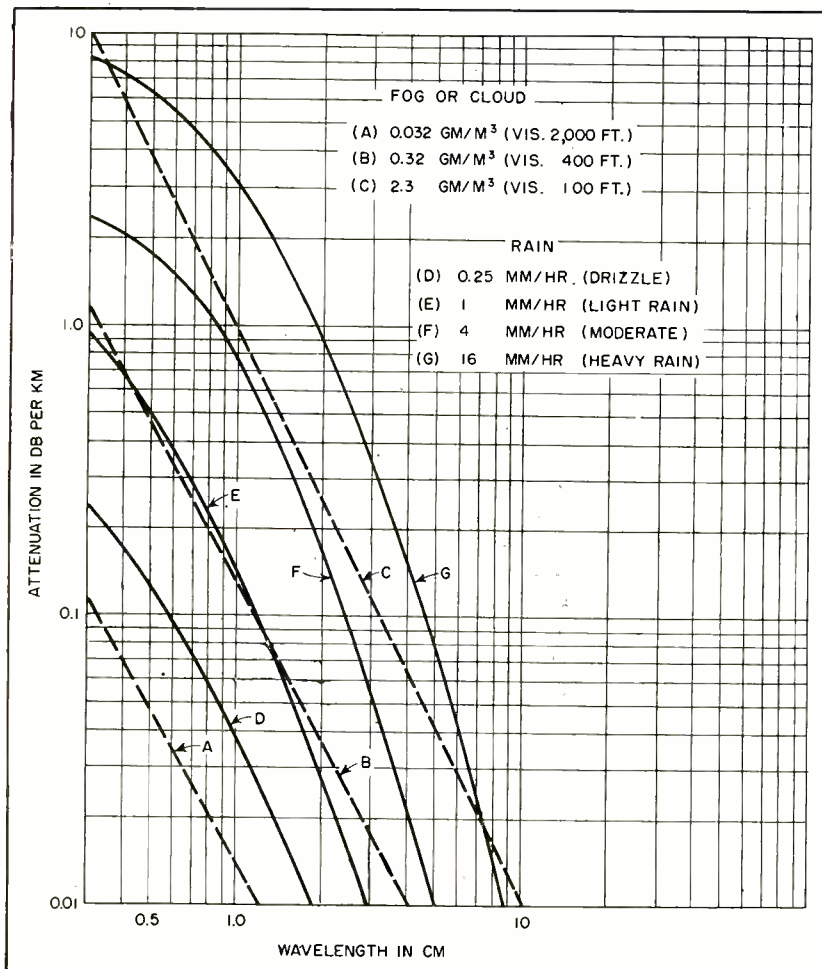
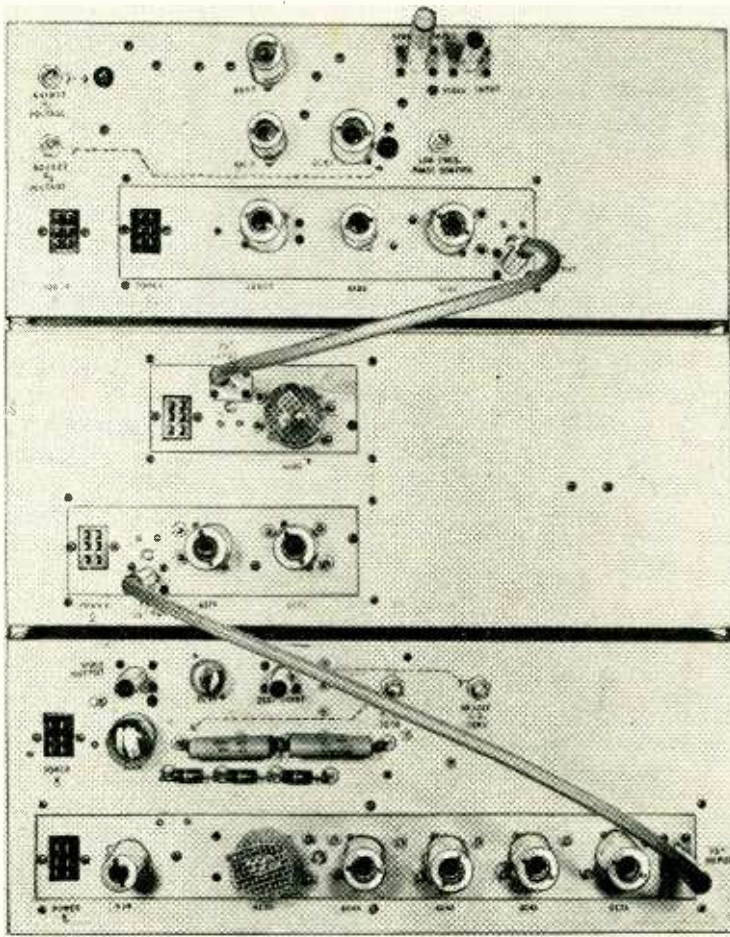

FIG. 14—Curves illustrate effect of rain and fog on shf absorption

# Storing



Panel view shows the arrangement of tubes and chassis assemblies for the circuits shown in the block diagram of Fig. 1, below

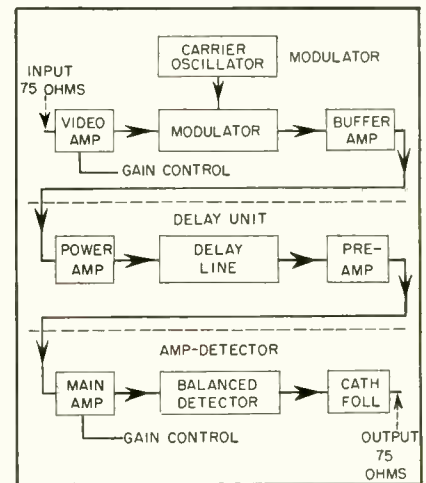

FIG. 1—Stages of the three units comprising the delay equipment

ULTRASONIC solid delay lines represent a practical means for obtaining broadband delays up to several hundreds of micro-seconds.

This paper describes an experimental delay equipment whose over-all video characteristic is essentially flat in amplitude up to 5 megacycles and is down 3 db at 7 megacycles. The delay is 63.5 micro-seconds. This permits comparison of signal amplitudes along one television scanning line with those along the preceding line. For this purpose impairments due to non-linearity, noise and band limiting must be minimized for correct evaluation of the test data. Nonlinear distortion in this equipment is about one percent when the peak-to-peak signal to rms noise ratio is 58 db.

Delay lines recently developed for wideband transmission usually

employ a solid transmitting medium and operate at carrier frequencies between 15 and 60 mc.<sup>1,2</sup> These lines often exhibit spurious responses due to reverberations. For this application spurious responses should be no more than one percent of the main signal. To meet this requirement, H. J. McSkimin of these Laboratories designed a fused silica bar utilizing shear wave transmission. The electromechanical transducers are quartz crystals approximately 0.004 inch thick with a fundamental resonance at 18 mc. If the carrier were located at this frequency the filtering between upper video and lower sideband frequencies might prove difficult, hence the line was designed to operate at the third harmonic of the quartz crystal transducer, 54 mc.

Considered as a purely electrical circuit element, the delay line is analogous to a pentode having high

input and output resistances and parallel input and output capacitances of around 30  $\mu\mu\text{f}$ . To attain the desired bandwidth at 54 mc, it is therefore necessary to provide resistive loading. For high gain-bandwidth product and high signal-to-noise ratio, double-tuned circuits are used with loading concentrated at the delay-line terminals.

Load resistors of 180 ohms resulted in a bandwidth of 7.5 mc at the 3-db points. Unfortunately, the use of lower values of resistance does not increase the bandwidth in proportion. For example, halving the resistor values would increase the loss 6 db but might increase the bandwidth by only 10 percent. This is due to small electromechanical coupling in the transducers. The electrical Q looking into the crystal terminals, with mechanical loading only, is approximately 100 which corresponds to an internal



# Video Information

Comparison of signal amplitudes along adjacent television scanning lines can be made by storing the video information of one line for 63.5 microseconds. Storage is done in an ultrasonic delay line employing a fused silica bar with quartz transducers

By **A. L. HOPPER**

*Bell Telephone Laboratories, Inc.  
Murray Hill, New Jersey*

resistance greater than 10,000 ohms.

The loss associated with the delay line may be specified in terms of the voltage ratio between input and output with the proper terminating resistor. If this resistor is 180 ohms the voltage ratio for this particular line is about 500 to 1. In computing gains at 54 mc, the line may be likened to a pentode having very low transconductance as follows:

$$\frac{\Delta E_{out}}{\Delta E_{in}} = \frac{1}{500}$$

$$g_m = \frac{\Delta I_{out}}{\Delta E_{in}} = 11.1 \text{ micromhos}$$

The power gain available from such a pentode with 180-ohm resistors at both input and output may be determined as follows:<sup>3</sup>

$$G = \frac{g_m^2 R_1 R_2}{4} = -60 \text{ db}$$

If the advantage of mismatching (removing the input resistor) is 6 db, the loss is reduced to 54 db. This is the same as 20 times the log of the voltage ratio between input and output shown above.

In practice it was found convenient to adjust the band characteristic of the transformers at either end of the line by temporarily bypassing the line with a 1,800-ohm resistance. This maintains sufficient attenuation to avoid serious interaction between the input and output circuits yet allows the delay line transmission to be effectively overridden.

The velocity of transverse waves in fused silica varies with temperature by +70 parts per million per degree centigrade. This causes the delay to decrease by 0.045 micro-

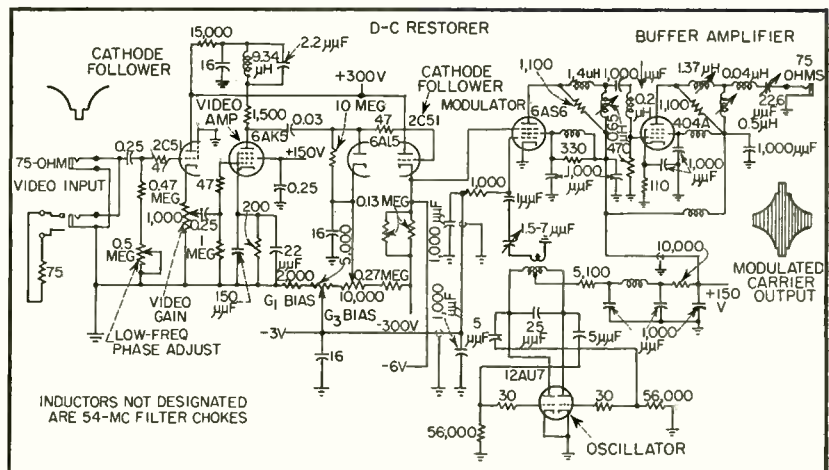

The video signal input feeds this modulator circuit

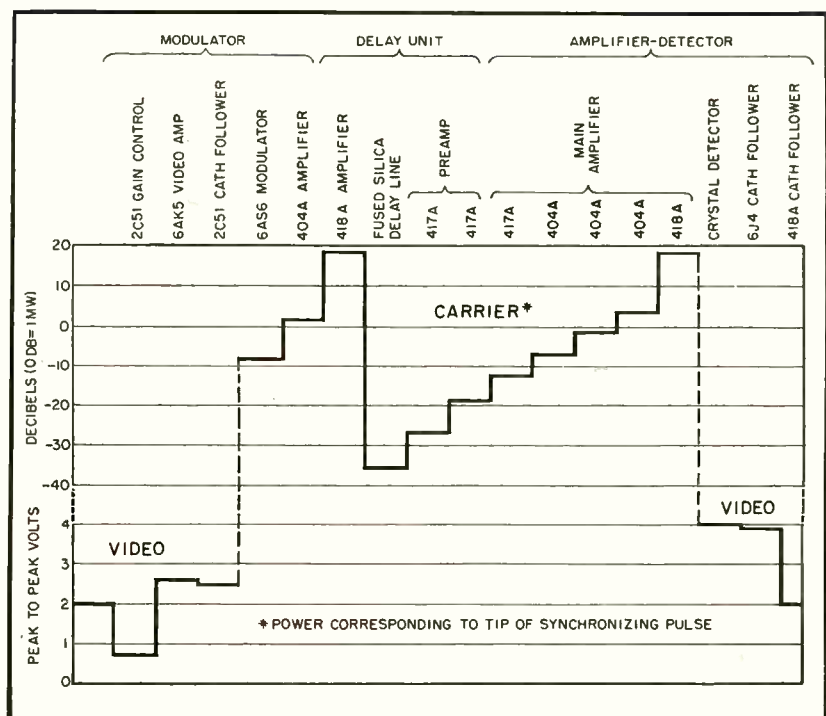

FIG. 2—Power and voltage levels throughout the three units





interelectrode capacitance and low forward resistance at high driving levels.

The detector feeds a small (6J4) cathode follower to minimize loading effects. This stage in turn feeds a large (418A) cathode follower which is capable of delivering 2 volts peak-to-peak to a 75-ohm line. The amplifier-detector linearity is shown in Fig. 4.

A detector load resistance of 1,200 ohms is high enough to give good efficiency and low enough to avoid appreciable distortion due to a-c shunting. The detector efficiency is about 33 percent; therefore, to provide 6 volts of rectified output, which is on the linear portion of Fig. 4, the power delivered to a single load resistor by the 418A tube is as follows:

$$\text{Efficiency} = \frac{E_{d-c}}{E_{peak}} \cong 0.33$$

$$\therefore E_{peak} = 18v \quad E_{rms} = 12.7v \quad P = 135 \text{ mw}$$

### Soaker Circuit

In general, the 54-mc amplifier stages are coupled by matched double-tuned circuits for good gain and absence of criticalness.<sup>3</sup> Since the delay line has a single-peaked band pass characteristic as shown in Fig. 5A, a "soaker" circuit interstage is used to broaden and flatten this band. It consists of a low-Q shunt-resonant circuit in parallel with a higher-Q series-resonant circuit (see Fig. 5B). The latter circuit soaks out energy near the center of the pass band, hence the name "soaker" or "sucker" circuit.

The Q of the shunt-resonant circuit is made as low as possible consistent with the required gain. The soaker Q is then made equal to the effective Q of the delay line,

$$Q = \frac{f_m}{\Delta f} = 7.2$$

Both circuits are separately tuned to midband. After connecting them together, adjustment of the soaker circuit Q permits flattening the band as shown in Fig. 5C. Detuning the soaker circuit in either direction causes a corresponding tilting of the band characteristic.

A triple-tuned circuit is used in the interstage following the soaker circuit. The basis of this design is two double-tuned transformers in tandem to permit attaining a large

step down ratio (nearly 5 to 1). The first transformer is reduced to an equivalent L and the second to an equivalent  $\pi$ . By combining elements, a two-mesh configuration having five adjustable elements is obtained. In practice, this facilitates the compensation of amplitude irregularities which invariably accumulate when a number of stages are cascaded.

A cascode preamplifier with W.E. 417A triodes is used to attain the best possible noise figure at 54 mc.<sup>4</sup> Including the main amplifier, a 3-db overall bandwidth of 24 mc is obtained with an overall noise figure of 2.1 db minimum and 2.3 db average.

For 417A triodes operating with a noise bandwidth of 25 mc in the vicinity of 60 mc, it appears that the cascode arrangement is about one db better than the grounded-grid circuit.

The measured overall video transmission characteristic is shown in Fig. 6. By careful design the overall bandwidth is greater than that of the delay line alone. On a video basis the delay line is less than 4 mc wide at the 3-db points, yet the overall is 7 mc wide.

The signal-to-noise ratio may be estimated as follows:

Power at delay line input	+20 dbm
Gain in delay line (loss)	-54 db
Input signal	-34 dbm
Noise power in 14-mc band	-102+dbm
Noise figure	2+
Input noise	-100 dbm

S/N versus percent modulation	S/N
100-percent modulation	100-34 = 66 db
50-percent modulation	66-6 = 60 db
25-percent modulation	60-6 = 54 db

Excellent power supplies are needed to minimize low-frequency noise and some selection of modulator and amplifier tubes may be required to minimize noise and microphonics.

The author wishes to acknowledge the assistance of J. L. Wenger who constructed and tested this apparatus.

### REFERENCES

- (1) David L. Arenberg, Ultrasonic Solid Delay Lines, *Jour. Acous. Soc. Am.*, Jan. 1948.
- (2) A. G. Emslie and R. A. McConnell, Moving Target Indication, "Radar Systems Engineering," McGraw-Hill Book Co., New York.
- (3) V. C. Rideout, Parallel Tuned Transformer Design, *BSTJ*, Jan. 1948.
- (4) Wallman, Macnee and Gadsden, Low Noise Amplifier, *Proc. IRE*, June 1948.

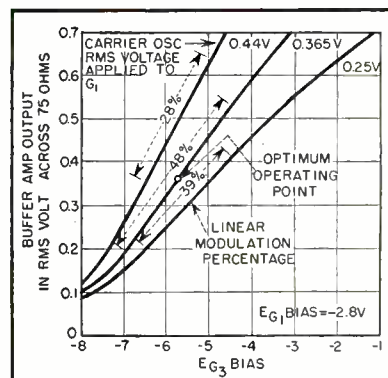

FIG. 3—Characteristics of the 6AS6 tube as modulator

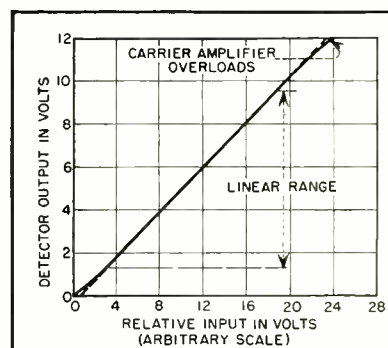

FIG. 4—Amplifier-detector linearity

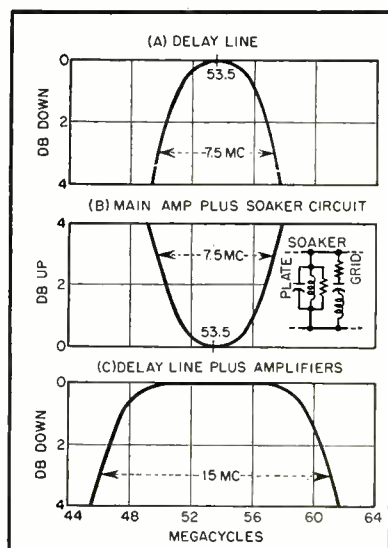

FIG. 5—Band-pass transmission characteristics

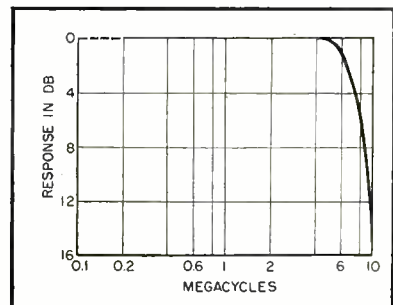

FIG. 6—Overall video transmission

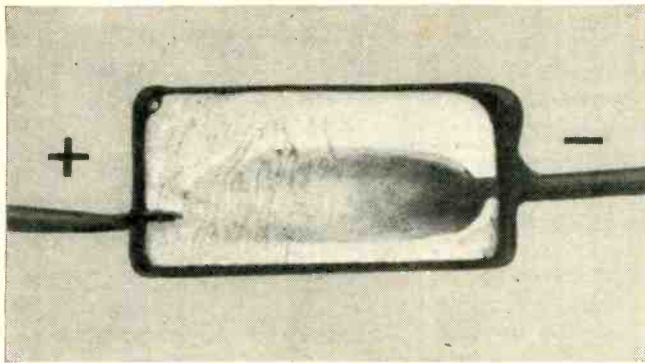

FIG. 1—First of four steps in breakdown of rock salt crystal dielectric is electron emission from cathode in clouds

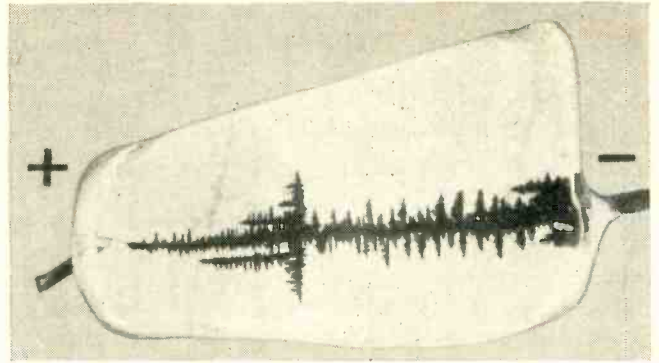

FIG. 2—Second step in breakdown is Christmas-tree growth of sodium dendrite from cathode, forming metallic bridge

# DIELECTRICS

**T**HE RELATIVELY INEFFICIENT use of materials in electrical engineering today stems from the still prevailing idea that dielectrics have unalterable properties and are bestowed on us either by nature (as oil, mica and shellac) or by industry as the more or less accidental by-products of a manufacture directed toward other goals (plastics, paper and ceramics).

These premises have to be revised. The properties of materials can be changed within wide limits, and our goal should be to tailor them to order by combining the proper atoms and molecules in the fitting patterns.

On this postulate the Laboratory for Insulation Research was founded at MIT twelve years ago. It carries on an extensive fundamental research program, now sponsored jointly by the Navy Department, the Army Signal Corps, and the Air Force under ONR Contract. It is aimed at acquiring the basic knowledge for a synthesis of materials with prescribed electric and magnetic properties.

For this type of approach, the old definition of a dielectric as a nonconductor of electricity has lost its meaning. Any material may show conduction to a varying degree, depending on the conditions and the pretreatment chosen.

A slab of rock salt, for example, may at room temperature be an excellent insulator with approximately  $10^{17}$  ohm-cm resistivity. If used, however, at 450C in a field of about

1,000 volts per cm it will fail dramatically. For a few minutes the only indication of trouble may be a slowly climbing ammeter needle, indicating that the resistivity is falling to about  $10^7$  ohm-cm. Then suddenly, like an erupting volcano, the cathode begins to eject cherry-red clouds which drift rapidly through the clear crystal toward the counter-electrode (Fig. 1); the current simultaneously rises steeply. The clouds are formed by electrons issuing from the cathode and migrating to the anode. Reversal of the voltage may still pull them back and save the dielectric.

Behind this smoke screen of electron clouds, however, other events occur which damage the crystal beyond repair. From the cathode a structure like a Christmas tree begins to grow—a dendrite of sodium deposited by discharging cations, which rapidly throws a metallic bridge across the electrode gap as in Fig. 2. To replace these ions, the copper anode releases invisible copper ions into the rock salt. As the electron clouds of Fig. 1 approach this anodic region, they begin to act like a developer; each copper ion traps an electron to neutralize its charge, and a brilliant red copper colloid appears, circling the anode like a halo as in Fig. 3. Then an electric spark bursts forth from the anode in zig-zag patterns similar to lightning and, striking the dendrite, completes the destruction in the grand finale of Fig. 4.

A casual observer, not aware of

By  
**ARTHUR R. von HIPPEL**

*Director,  
Laboratory for Insulation Research  
Massachusetts Institute of Technology  
Cambridge, Mass.*

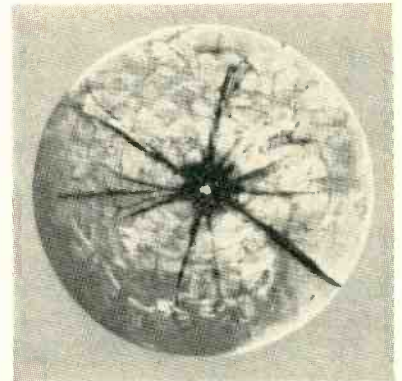

FIG. 5—Cross-section of rock salt crystal, showing breakdown hole in center due to spark discharge

these turbulent events, will notice a hole in the crystal (Fig. 5) and comment in casual complaint that the insulation broke down. Yet this outcome, like the climax in any good murder story, might have been prevented if the influences at work had been properly appraised and controlled.

We should learn how to contain the electrons in the cathode and how to release them at will; we should understand the laws of migration of electrons and ions and know how to interfere with their motions when necessary. This, then, is one of our long-range problems.

There are other problems of



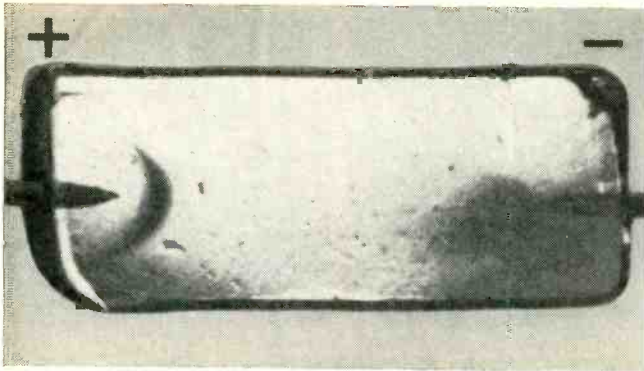

FIG. 3—Third step, occurring as electron clouds approach anodic region, is halo of brilliant red copper colloid

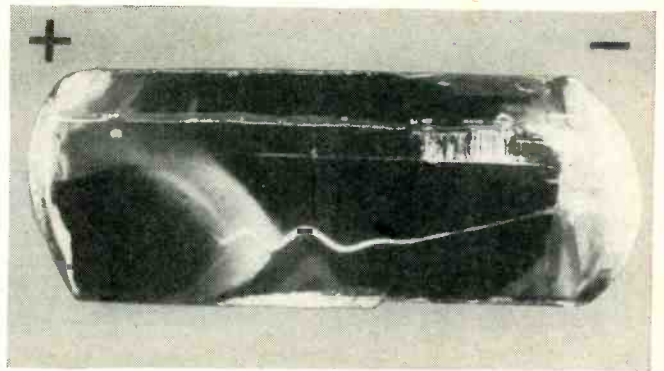

FIG. 4—Final step is destruction of dendrite and hence crystal itself by electric spark zig-zagging out of anode

# MADE TO ORDER

Properties of many old and new dielectric materials can be altered at will by combining the proper atoms and molecules in particular patterns. Research into the nature of dielectric breakdown, described here, has provided clues to desirable new dielectrics

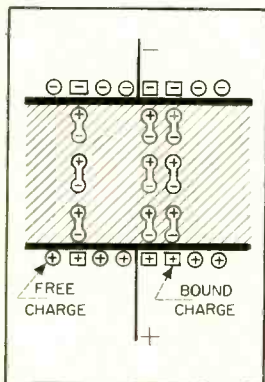

FIG. 6—Dipole chains in dielectric produce polarization in electric field

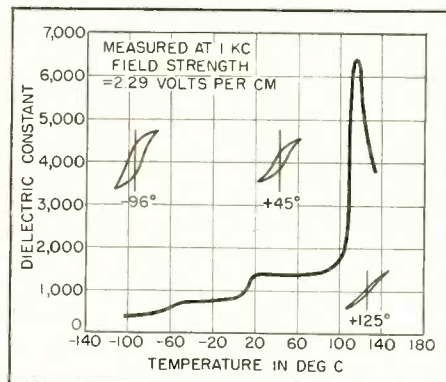

FIG. 7—Effect of temperature on dielectric constant of barium titanate ceramic, and hysteresis loops for three temperature values

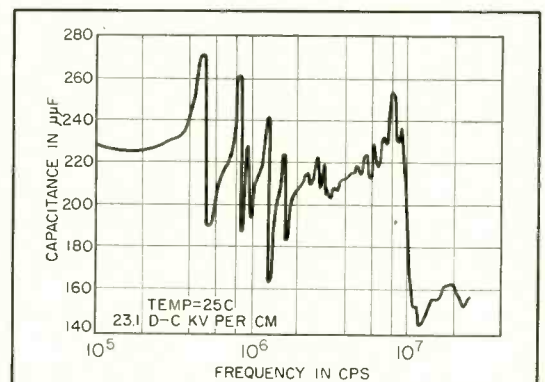

FIG. 8—Piezoelectric resonances of barium titanate ceramic. This characteristic permits use of titanates in microphones, pickups and ultrasonic generators

equal importance. Materials serve for a concentration and storage of electric and magnetic energy. It is a well-known fact that a capacitor can store more charge per unit voltage if the interspace between its internal electrodes is filled by a dielectric instead of vacuum. How much more it can store is expressed by the dielectric constant (permissivity) of the filling medium. Normally one has to be satisfied with constants ranging from 2 to 5, but recently materials have become available which may increase the storage capacity a thousand to ten-thousand-fold for special applications. These materials are called

ferroelectrics, and our Laboratory has spent much research effort in developing one of the important prototypes, barium titanate.

### Dipole Formation

A dielectric material increases the storage capacitance of a capacitor because it polarizes in the applied electric field. Schematically speaking, chains of electric dipoles form in the medium and the charged ends of these electric dumbbell chains bind countercharges at the electrodes as in Fig. 6. These dipoles may form under the influence of the applied voltage because the positive charges of the

atoms and molecules move slightly toward the cathode and their negative counterparts toward the anode.

On the other hand, the dielectric may already contain preformed dipoles which tend to turn under the influence of an electric field like magnetic needles in the earth's magnetic field. The effect will normally be small and the dielectric constant low because the applied field is very small in comparison to the strong fields binding the atoms and molecules and tending to destroy the orientation of the permanent dipoles by thermal agitation.

In special materials, however, below a critical or Curie temperature

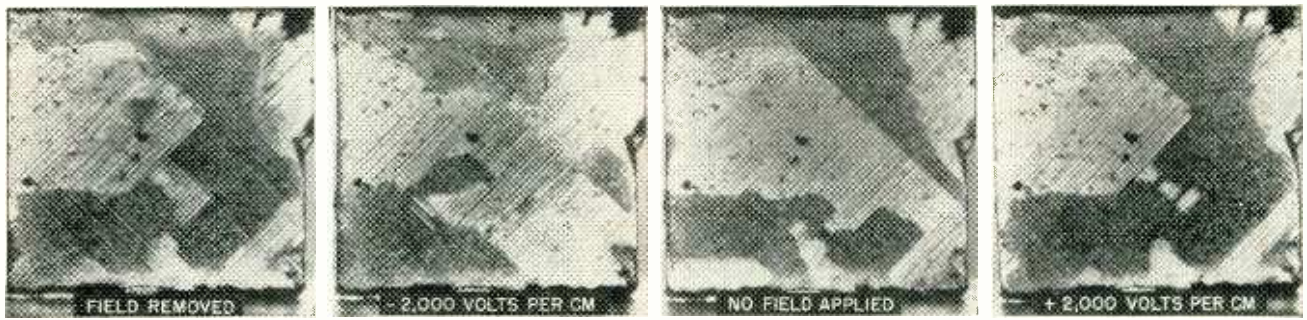

FIG. 9—Effect of high-voltage electric field on domain structure of barium titanate

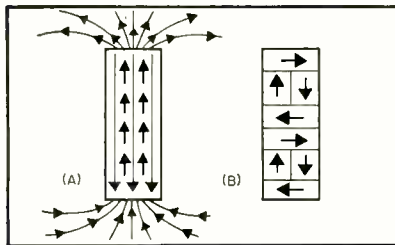

FIG. 10—Magnetic field surrounding a permanent magnet (A) and its removal (B) by domain structure involving mutual compensation of magnetic dipoles

FIG. 11—Square-net domain pattern of single barium titanate crystal, visible because crystal is transparent



the dipoles sometimes align their moments spontaneously in parallel orientation by mutual interaction. If this happens to magnetic dipoles, ferromagnetism results, as in iron, nickel, or cobalt; in the case of electric dipoles, ferroelectricity is obtained—for example, in rochelle salt or barium titanate.

Figure 7 illustrates the situation for a piece of barium titanate ceramic. As the sample is cooled through the critical temperature region near 120C, the dielectric constant shoots up and traverses a peak reaching a value of about 7,000. Simultaneously it is not a constant any more but becomes a function of the applied field strength; that is, the polarization describes hysteresis loops like the magnetization in ferromagnetic metals. This makes the material not only useful for storage of energy but also as a nonlinear device in amplifiers and modulators and as tuning elements in electric circuits.

We found, furthermore, that these ceramics, once polarized, are piezoelectric resonators; they respond to electric fields by mechanical deformations (Fig. 8) and generate electric voltages under mechanical distortion. Thus ultrasonic generators, pickups, microphones, accelerometers, delay lines and many other devices can be based on these materials, a develop-

ment carried forward after our findings by a number of industrial laboratories.

Studies on single crystals are required instead of the measurements on the multicrystalline ceramics if one wants really to understand the mechanism of ferroelectricity. We therefore learned to grow single crystals and discovered that such crystals below the critical temperature contain a variety of shaded areas (Fig. 9). In an electric field these areas were seen to expand or contract, sections of new shading suddenly emerged, and disconnecting of the voltage left a remanent state which required a countervoltage for its removal. Viewed in alternating fields under stroboscopic illumination, the whole crystal appeared in violent agitation, and in polarized light the flickering of the transmitted birefringence colors gave the impression of Broadway at night.

#### Magnetic Analogy

The implications of this spectacular phenomenon become clear when one turns to a ferromagnetic analog and considers the difference between a permanent magnet and a piece of soft iron. In a steel magnet a strong magnetic field originates from the free north poles of the dipole chains and terminates in the free south poles of the opposite end. A part of this field closes

directly through the bar and tends to turn the dipoles in the opposite direction.

In magnetically hard materials the dipole groups are firmly clamped in place and resist this suicidal tendency, but in magnetically soft ferromagnetics the array breaks up into microblocks or domains which eliminate the external field by mutual compensation (Fig. 10). Since the metals are opaque, their domain structure can only be derived indirectly. Our ferroelectric crystals are transparent, and the domain pattern therefore lies visible before our eyes. Such patterns may have a beautiful geometrical regularity, as Fig. 11 demonstrates.

Detailed investigations have clarified the ferroelectric mechanism operating in barium titanate, and the material is beginning to play an important role in electrical engineering devices. Other studies may lead to ferromagnetic insulators or organic metals, to photocells of higher sensitivity or rectifiers of improved characteristics, and to new cables for high-voltage transmission or microwave uses. We do not know yet what will be realized, nor consider it a matter of primary concern at present. Fundamental research thrives best in a detached and unhurried atmosphere, with full freedom to follow targets of opportunity.



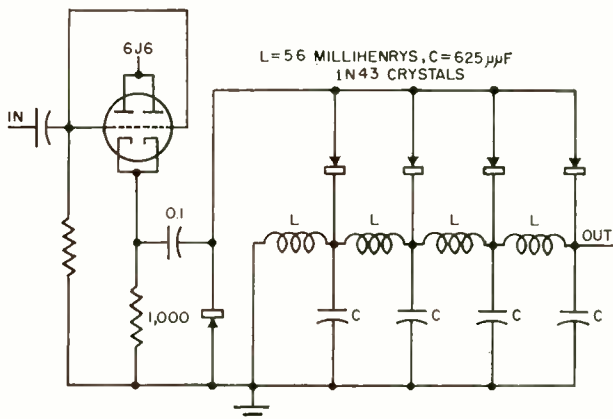

Circuit for increasing pulse duration from 1 to 15  $\mu$ sec with no change in pulse amplitude

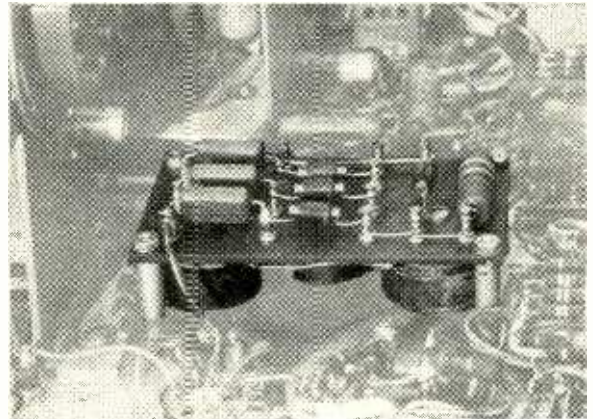

Complete setup of physical components of pulse stretcher in an actual circuit application

# Improved Pulse Stretcher

Duration of pulses is increased as much as 25 times, with output amplitude remaining proportional to input. Flat-topped output is provided by a delay line charged by crystal rectifiers driven by a cathode follower. Sample design equations are given

By **JAMES F. GRAIB**

*Airborne Instruments Laboratory, Inc.  
Mineola, New York*

**I**NCREASED DURATION of pulses in a series without change in their relative amplitudes is often desirable in design of pulse circuits. Pulse stretching, as distinguished from multivibrator action, retains information in the relative amplitudes of successive pulses.

One common method of stretching pulses is shown in Fig. 1A. For a positive-pulse input at terminal 1, the rectifier conducts only for the pulse duration. The capacitor charges to nearly peak pulse voltage during the pulse duration and slowly discharges through the high resistance during the interval between pulses.

In this type of stretching, the output pulse can never have a flat top because the stretched portion of the pulse is fundamentally the exponential discharge of the R-C circuit.

The exponential nature of the discharge results in a residual signal lasting much longer than the duration of the useful output. The trailing end of one pulse may overlap the beginning of the next pulse and reduce its effective amplitude. In an extreme case this phenomenon is the basis for power-supply filter operation.

A new type of stretcher is shown in Fig. 1B. Output pulses from this

circuit are flat-topped with amplitudes proportional to input-pulse amplitudes. However, output-pulse duration may be as much as 25 times the original pulse length.

## **Pulse-Stretcher Circuit**

The circuit consists of a multi-section repetitive network of series inductors and shunt capacitors forming a delay line. Sections of this line are parallel charged by crystal rectifiers which permit an incoming pulse to be applied to all shunt capacitors simultaneously and charge them to nearly the amplitude of the incoming pulse. With no pulse input, the rectifiers become

high resistances and the line is left with all capacitors charged equally.

When the line discharges through a short circuit at its end, a negative step of voltage (from line potential to zero) progresses down the line discharging each capacitor in turn. The output pulse, which has been at maximum since the line was charged, is terminated when the discharging action reaches the open end of the line.

Input and output waveforms are shown superimposed in Fig. 1C. The output pulse rises as rapidly as the capacitors are charged and nearly as fast as the input-pulse rise time. When the discharge step reaches the open end of the line, it tends to appear at double amplitude, shown dotted in Fig. 1C. However, the rectifiers prevent a negative excursion and the pulse ends abruptly at the base line.

The end of the pulse is more rounded than the beginning because of distortion of the step wave as it travels down the line. This distortion is usually permissible

but with less distortion a line would have a wider passband and introduce less delay per section. To obtain the same delay more sections would be required. The trailing edge of the pulse may be as round as possible to save size, weight and cost of components.

### Choice of Impedance Levels

Flatness of the pulse top is affected by any leakage that may discharge the capacitors before the discharge wave reaches them. Back resistance of the crystals is one source of leakage and line impedance should be limited to about one-tenth the back resistance or about 10,000 ohms for 1N43 crystals.

Another source of leakage is the output circuit fed by the line. The stretcher is usually connected directly to a vacuum-tube grid without a blocking capacitor but if such a capacitor is used, the grid resistor must be as large as possible. Low line impedance will reduce relative leakage through the grid resistor but will increase the cur-

rent necessary to charge the line.

The stretcher is usually driven by a cathode follower whose cathode impedance, in series with the forward resistance of the rectifiers, varies from 50 to 200 ohms. The time constant formed by the cathode impedance and the parallel combination of line capacitors should be short enough so that the capacitors charge within the duration of the incoming pulse. The driving tube must be capable of delivering the peak current that will flow during the charging period.

These considerations are not easily subject to analytical prediction because cathode impedance and rectifier forward resistance change with current during the charging period. A good design provides for the necessary grid drive at the instant the pulse is applied to the grid, as the capacitors are then uncharged. Cathode impedance may then be assumed to be some average value and the charging time constant calculated for this value.

With stretched-pulse durations of one to twenty  $\mu\text{sec}$ , it is practical to use a 6J6 cathode follower with both halves in parallel and a line impedance between 5,000 and 20,000 ohms. To properly swing the crystals between low forward resistance and high back resistance it is necessary to operate with pulse amplitudes of at least two volts. Values lower than this give stretched pulses whose tops are not flat because of line discharge by the crystals.

Pulses of the order of ten volts are about the maximum that can be handled by a 6J6 cathode follower with these circuit values. Higher-amplitude pulses may have rise times rapid enough to drive the cathode follower into its grid-current region. This is permissible only if a low-impedance grid circuit or satisfactory d-c restoration is provided.

Stretching may be increased by operating several stages in cascade. However, a cathode follower is then needed between stages to provide power gain and impedance matching.

### Superposition of Pulses

When a second pulse, equal in amplitude to the first pulse, is ap-

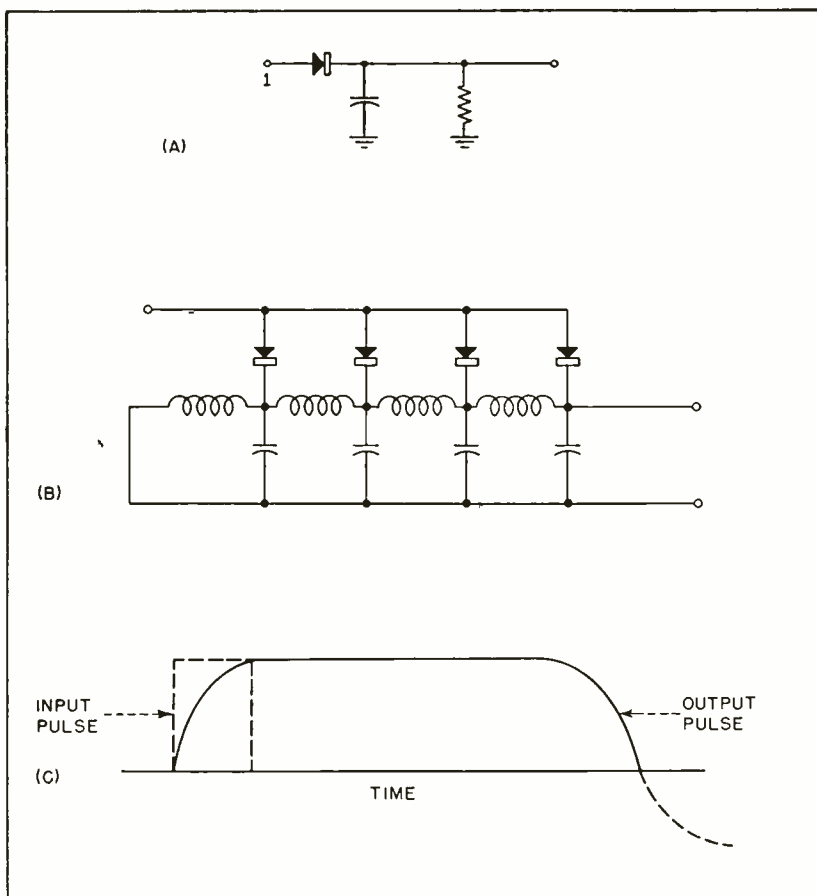

FIG. 1—Usual form of R-C pulse stretcher (A), improved type utilizing a delay line (B) and input and output waveforms for improved circuit (C) showing the sharpening of the end of the output pulse by rectifier damping



plied to the stretcher before the first pulse has completely passed through the circuit, the output amplitude will remain constant during the total stretching interval.

If the second pulse is either larger or smaller in amplitude than the first, the output amplitude will be that of the first pulse until the second is applied when it will change to the amplitude of the second and remain there for the rest of the total stretching interval. These actions are shown in Fig. 2.

Many designs for a circuit which generates pulses of special shapes are possible through the use of unequal charging voltages on successive stages and by charging the line with a series of pulses of various amplitudes.

If the input pulse is of constant amplitude and duration, series resistors may be used to vary the charging potential of various sections of the line. For varying pulse amplitude and duration, it is necessary to obtain rapid charging by the use of separate cathode followers.

When the pulse is accompanied by a background of noise, the noise pulses are stretched so that a constant d-c level is established. In most circuits this level is discarded by coupling capacitors so that the apparent signal-to-noise ratio is improved.

As the noise level approaches the signal level the signal may be degraded by short noise pulses whose amplitudes are nearly the same as the signal. These pulses may reduce crystal back resistance momentarily, permitting the capacitors to discharge. As a result, the signal is degraded into a sawtooth and becomes lost in noise. The signal-to-noise ratio at small values is not improved by the stretcher and may even be reduced slightly.

### Design Equations

In the design equations of a pulse stretcher the following terms will be used:  $T_s$ , stretching interval;  $T_p$ , input pulse duration;  $R_k$ , impedance of a driven source (usually the cathode impedance of a cathode follower);  $L$ , inductance per section of network;  $C$ , capacitance per section of network; and  $n$ , number of sections of network.

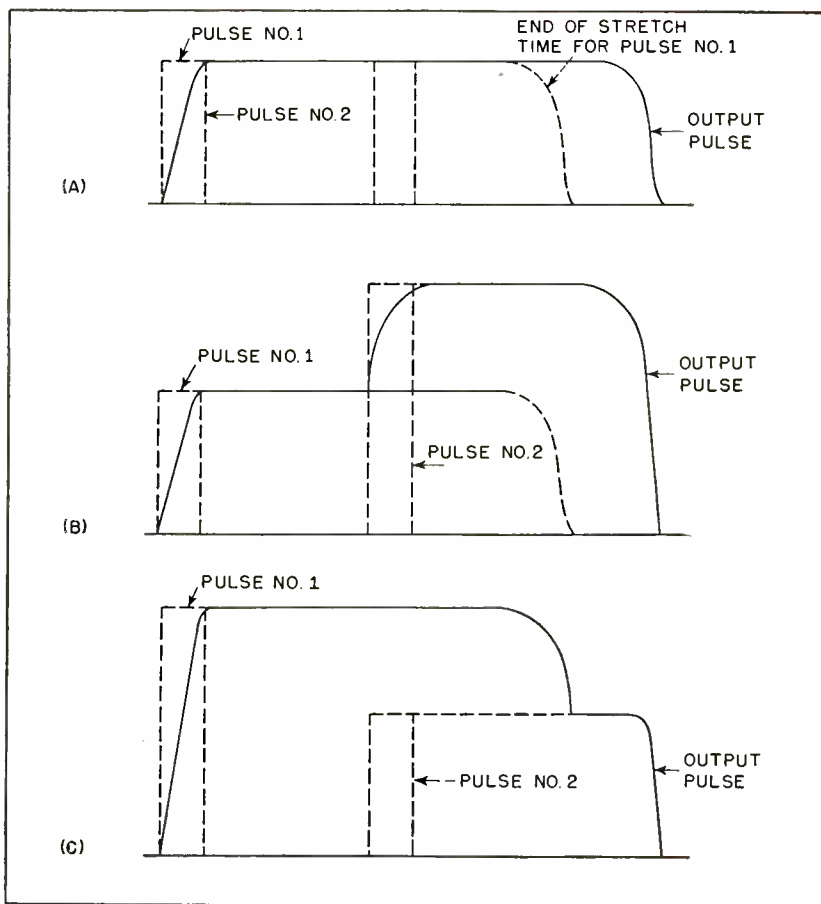

FIG. 2—Outputs for a pair of pulses spaced by less than the stretching interval. Pulses of equal amplitude (A), second pulse of greater amplitude than first (B) and second pulse of less amplitude than first (C) are shown

The input pulse duration should be at least four time constants to insure adequate charging of the capacitors

$$T_p = 4 R_k n C$$

The stretching interval will be the delay of the network or approximately

$$T_s = n \sqrt{LC}$$

Solving these two equations for line constants gives

$$C = \frac{T_p}{4 n R_k}$$

$$L = \frac{T_s^2}{16 n^2 C}$$

In practice, the number of line sections is determined by the required output-pulse squareness and in most cases about four sections have proved satisfactory. The type of driver determines the value of  $R_k$ . For both halves of a high- $g_m$  double triode such as the 6J6 or 12AT7 the cathode impedance should be about 100 ohms.

A line impedance of about 10,000 ohms is as high as practical with germanium crystals. A practical

limit to the stretching ratio then is

$$\frac{T_s}{T_p} = \frac{n \sqrt{LC}}{4 n R_k C} = \frac{\sqrt{L/C}}{4 R_k} =$$

$$\frac{Z_o}{4 R_k} \cong \frac{10,000}{4 \times 100} = 25$$

Circuit constants for a pulse stretcher with a 1- $\mu$ sec input pulse and 15- $\mu$ sec output pulse with both halves of a 6J6 in parallel as driver can be calculated as follows

$$C = \frac{T_p}{4 n R_k} = \frac{1 \times 10^{-6}}{4 \times 4 \times 100} = 625 \times 10^{-12} \text{ farads}$$

$$L = \frac{T_s^2}{4 n^2 C} = \frac{(15 \times 10^{-6})^2}{4 \times 4^2 \times 625 \times 10^{-12}} = 5.6 \times 10^{-3} \text{ henrys}$$

In this case, rounding of the trailing edge that accompanies a four-section line is permissible.

The final circuit uses a 0.1- $\mu$ f coupling capacitor which tends to become charged by the rectifiers. However, the negative charge is drained off by an extra crystal diode connected so that a positive-going pulse may exist but a negative bias may not.

# COAXIAL-STUB FILTER

Undesired signals in a coaxial transmission line can be attenuated up to 30 db by connecting two stubs to the line, one for rejection and the other to correct the line impedance. Graphs give approximate stub lengths for any interfering frequency in range from 20 to 200 mc

**C**OAXIAL LINE stubs often can be effectively used in transmitter or receiver coaxial transmission lines to reduce or trap out specific spurious radiations or interfering signals. Stubs are well worth trying, since they are relatively inexpensive and can be depended upon to furnish up to 30-db additional attenuation to an undesired signal. Two stubs are used, one for rejection and one for correction, as shown in Fig. 1.

Receiver stubs are most easily fabricated from RG-58/U solid dielectric cable. Where stubs are to be used to suppress transmitter spurious radiations, a solid-dielectric cable should be used having the same power-handling capacity as is used between the transmitter and its antenna. The approximate length of the rejector stub for the undesired frequency can be determined from Fig. 2. A piece of

By **JAMES A. CRAIG**

*Systems Engineer  
Link Radio Corporation  
New York, N. Y.*

cable several inches longer than that called for should be connected into the transmission line as in Fig. 1, as close as practical to the transmitter or receiver. Use a pick or other sharp-pointed instrument to short-circuit the outer shield to the inner conductor at various points, starting from the outer end of the stub and working inward. Note at which point the short-circuit produces the greatest attenuation of the undesired signal and permanently short-circuit the cable there. Cut off the excess cable. This short-circuit may be best accomplished by collapsing the outer shield around the center conductor and soldering all around.

As Fig. 3 shows, the rejection

stub alone produces a certain amount of attenuation to the undesired signal. This is because it has been tuned to be a shorted half-wave section of line at the undesired frequency. As such, it presents close to zero impedance to this frequency at its point of connection to the main transmission line. However, at the desired frequency, the rejection stub will not be a shorted half-wave section of line and will therefore present either capacitive or inductive reactance to the line and thereby cause some degree of attenuation to the desired frequency. This effect can be overcome by adding a second stub called a correction stub, as shown in Fig. 1.

For various desired versus undesired frequency conditions, the length of the correction stub may vary from almost zero to one-half wavelength. The length of

(Continued on p 134)

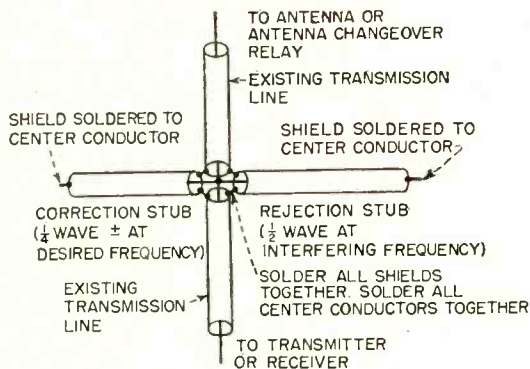

FIG. 1—Method of connecting stubs is same for both transmitting and receiving lines. Put stubs as close as possible to transmitter or receiver

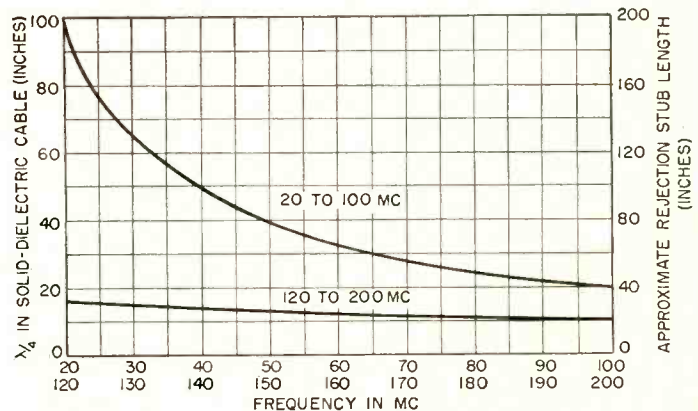

FIG. 2—Correction and rejection stub lengths. Use left-hand scale in connection with Fig. 4 to determine correction stub length, since this is longer or shorter than a quarter-wavelength at some frequencies



# Cinch

## ELECTRONIC COMPONENTS

Photographs are one-half size, one fourth area of original terminal boards.



### TERMINAL BOARDS

... Something of the scope of the Cinch operation in the design and production of electronic components is indicated by these photographs of terminal boards fabricated to meet exacting Armed Forces requirements.

Twenty years ago Cinch Engineers developed an idea . . . that gave the Radio Industry its first terminal strips for practical production.

And so established Cinch strips and boards as standard over the years.

In Cinch components the user gets the utmost in quality, of insulation, tooling, fabrication, plating and printing, vacuum waxing, lug types, materials and workmanship. Cinch facilities and engineering experience and ability, assure the satisfactory fulfillment of any assignment for a terminal board or electronic component. Consult Cinch!



**Cinch**  
ELECTRONIC  
COMPONENTS

## CINCH MANUFACTURING CORPORATION

1026 South Homan Ave., Chicago 24, Illinois

Subsidiary of United-Carr Fastener Corporation, Cambridge, Mass.



Cinch Electronic Components are available at leading jobbers—everywhere.

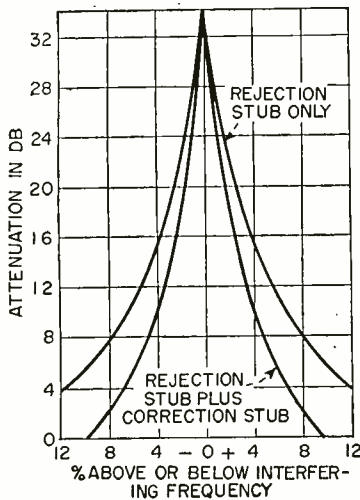

FIG. 3—Attenuation characteristics of stubs

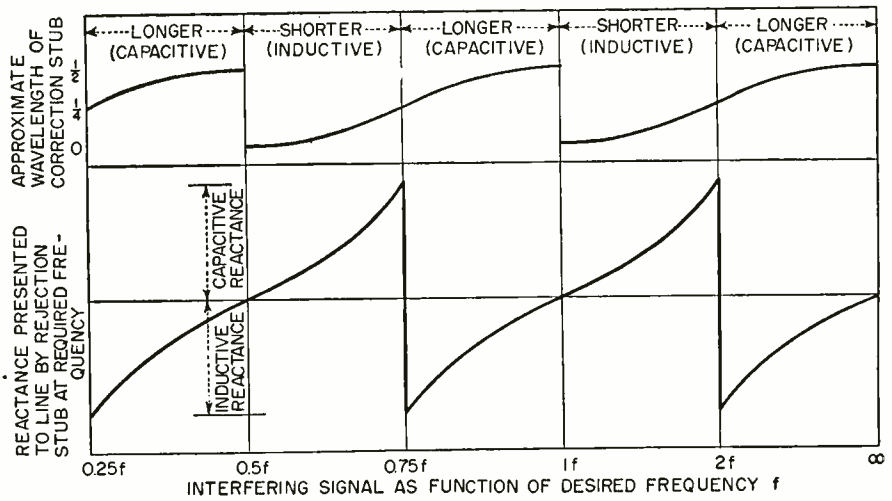

FIG. 4—Curves showing line characteristics with stubs in place, as function of ratio of interfering signal to desired signal

one-quarter wave in solid dielectric cable is also plotted in Fig. 2, to show that the correction stub will be some value between zero and a definite upper limit. In this case, the desired frequency should be used in determining the length of the correction stub. This stub is tuned and is permanently short-circuited as in the case of the rejection stub, except that the tuning is done to produce the least attenuation of the desired signal.

If the correction stub were to be made exactly one-quarter wave long at the desired frequency, it would present infinite impedance (neither capacitive or inductive) to the desired signal. While being made shorter than a quarter wave it presents progressively less inductive reactance. While being made somewhat longer than a quarter wave it presents progressively less capacitive reactance to the line.

The amount of reactance in either case depends upon how much longer or shorter than a quarter wave the correction stub is made. This length is automatically arrived at in the tuning procedure given above.

Figure 4 shows whether the correction stub will be longer or shorter than the quarter-wavelength shown in Fig. 2. To use Fig. 4, determine what relation-

ship the interfering frequency bears to the desired frequency. As an example, if the desired frequency  $f$  is 40 mc and the interfering signal is 25 mc, the interfering frequency would be between  $0.5f$  and  $0.75f$ . The lower curve shows that in this range the reactance presented to the line by the rejection stub is capacitive, and the upper curve shows that the correction stub should present inductive reactance and hence be shorter than a quarter wave, or shorter than the value called for on Fig. 2. The correction stub is thus utilized to balance out the reactance presented to the line by the rejection stub at the desired frequency.

#### Correction Stub Details

It is not necessary or desirable to show how many inches shorter or longer than a quarter wave the correction stub should be in chart form, since the precise length will be automatically arrived at as the stub is short-circuited in the tuning process. However, the upper curves in Fig. 4 do give the approximate length of the correction stub in terms of wavelength. In the example given above, these curves show that the corrector stub will be less than  $\frac{1}{2}$  wave long. In this case, it is advisable to start with

a quarter-wave length of cable and short it at various points in the vicinity of an eighth wave to find the exact point.

Had Fig. 4 indicated the need for a capacitive correction stub (greater than a quarter wave and less than a half wave), it would be advisable to start with a half-wavelength of cable and probe through the predicted point. Figure 4 is to be used chiefly as an aid in predicting the length of the correction stub and to help in visualizing the line conditions with the stubs in place.

A word of caution is advisable in a few specific cases. If the interfering frequency is approximately  $\frac{1}{2}$ ,  $\frac{1}{4}$  or  $\frac{1}{3}$  of the desired frequency, stubs cannot be used. In these cases, the rejection stub will prove to be a full wavelength or multiple of a full wavelength at the desired frequency and will therefore present high attenuation to the desired frequency as well as to the interfering frequency. On the other hand, if the interfering frequency is exactly twice the desired frequency a correction stub will not be necessary since the one-half wave rejection stub will be an exact quarter wave at the desired frequency and will present infinite impedance to the desired frequency.



**Value  
Beyond  
Expectation!**

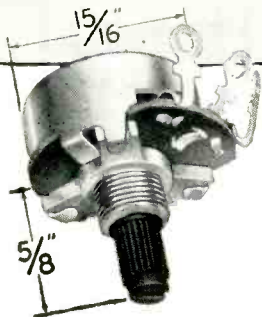
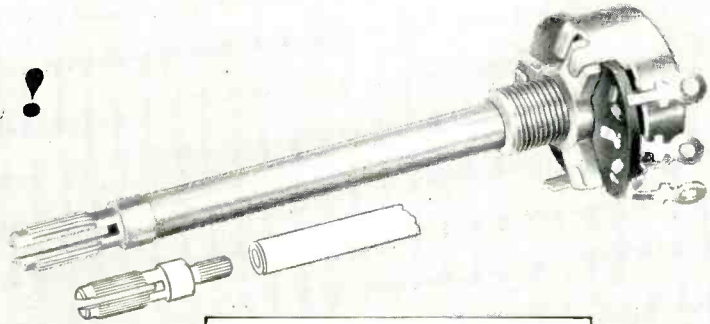

*Improved*

**Mallory Midgetrol\***  
*permits fast and economical  
delivery of short orders!*

**15/16" MALLORY MIDGETROL  
WITH PHENOLIC SHAFT**

Insulated shafts are knurled and slotted for ease in adjustment. Current-carrying parts provide 1,500 volt insulation . . . 15/16" diameter saves space . . . phenolic material eliminates mechanical noise. Precision-controlled carbon element provides smooth tapers, quiet operation, accurate resistance values, less drift in television applications.

*\*Trade Mark*

A new and particularly important feature has been added to the Mallory Midgetrol . . . the carbon control with electrical characteristics specially suited to critical applications in television, radio and other electronic circuits.

The incorporation of a universal, tubular shaft permits easy adapting of the standard unit to the specific needs of a wide range of applications. As a result, short orders can be filled practically overnight . . . for production emergencies, for service replacement stocks. The Mallory Midgetrol is available in resistance values from 1,000 ohms up to ten megohms, for loads up to 1/2 watt . . . and can now be supplied with shafts to meet your specifications to fill your hurry-up orders for less than normal production quantities and at low cost.

*That's value beyond expectation!*

Mallory's electronic know-how is at your disposal. What Mallory has done for others can be done for you!

Television Tuners, Special Switches, Controls and Resistors

**P. R. MALLORY & CO. Inc.**  
**MALLORY**

**P. R. MALLORY & CO., Inc., INDIANAPOLIS 6, INDIANA**

**SERVING INDUSTRY WITH**

Electromechanical Products  
Resistors                      Switches  
TV Tuners                      Vibrators

Electrochemical Products  
Capacitors                      Rectifiers  
Mercury Dry Batteries

Metallurgical Products  
Contacts                      Special Metals  
Welding Materials

# TUBES AT WORK

Including INDUSTRIAL CONTROL

Edited by RONALD K. JURGEN

Electronic Knitting-Machine Drive.....	136
The Front Cover.....	138
Increased Safety for Safes.....	138
Submarine Telephone Cable with Submerged Repeaters.....	164
Filament Protection Circuit.....	198
Emergency Broadcast Pickup Head.....	200
An Improved Telephone Set.....	204

## Electronic Knitting-Machine Drive

HIGH PRODUCTIVITY of modern machinery is to a large degree the result of the evolution of electric motor drives. Once purely a power unit to cause rotation of a drive shaft, today, the motor with its associated control is an electrical transmission that assumes the functions and duties of such mechanical transmissions as clutches, belts, gears and brakes.

Contributing heavily in this development of electrical transmis-

sions are recently introduced electronic devices which have already proved their value in the textile and knitting industries. Full-fashioned knitting machines, such as built by Karl Lieberknecht, Inc., in Reading, Pa., are typical of modern machines in which the evolution of motor drives to electrical transmissions incorporating industrial electronics has contributed heavily in establishing new production records.

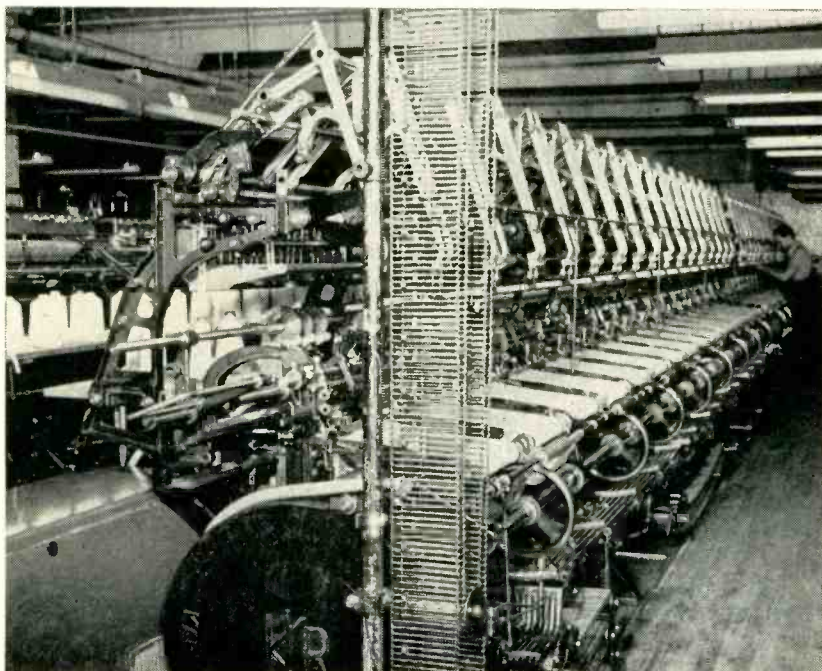

Full-fashioned knitting machine powered by an electronic drive. The control unit is partially visible at the lower left corner

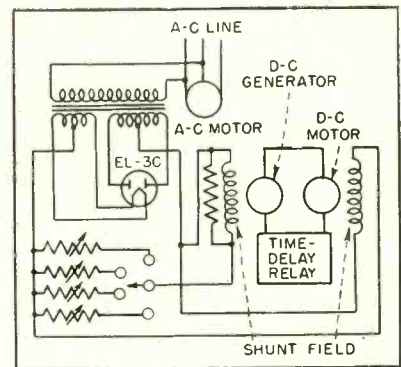

FIG. 1—Schematic diagram of the adjustable-speed control system

The Reliable V-S Drive as furnished with the machine consists of an adjustable-speed motor with shunt characteristics (the speed tends to remain constant for all loads) and a power unit with electronic excitation. The combination provides a voltage control system whereby adjustable speed is obtained from an a-c power supply. Figure 1 is a schematic diagram of the system.

The speed change on the part of the adjustable-speed motor results from varying the voltage impressed across the terminals of the motor. The generator voltage which is applied to the motor terminals is controlled by adjusting the generator field current. This current is supplied by an electronic exciter consisting of an anode transformer and a full-wave rectifier tube plus the necessary control parts and circuits.

Figure 2 is the front view of the electronic units combined with the power unit in the packaged control.

The EL-3C tube is a full-wave uncontrolled rectifier tube which furnishes unidirectional current for both the generator and motor fields. Since sufficient speed variation is obtained by varying the armature voltage, the motor field needs only a fixed, definite direct current. The motor field is connected directly to the transformer as shown in Fig. 1.

The generator field current must be varied in order to obtain variable voltage as explained previously. This variable current is obtained by inserting resistance in series with the generator field. There are four variable resistors plus a fixed resistance, any one of which may be





*The finest solder made  
for all television and radio work  
... Everything Electrical*

# Kester Solder

# Uniform

# Efficient

Kester Plastic Rosin-Core and Kester "Resin-Five" Core Solders are recognized by the trade as outstanding for the finest type of radio, television and electrical work.

These two Solders, which are available in the usual single-core type, can now also be had in a 3-core form.

Only highly skilled craftsmen are employed by the Kester Solder Company. Flux formulas and specifications are rigidly adhered to for perfect uniformity.

Making Kester Solder is an exact science from the raw material to the finished product. Everyone knows and prefers Kester because it can be relied upon to do the job right every time, even under the most difficult soldering conditions.

WRITE FOR FREE COPY "SOLDER AND SOLDERING TECHNIQUE"



Be sure to get your free copy of Kester's Technical Manual filled with valuable information regarding the most advanced and efficient industrial solders and fluxes.

Kester...Standard for the TV and Radio Fields

**KESTER SOLDER COMPANY**

4204 Wrightwood Avenue, Chicago 39, Illinois  
Newark, N. J. • Brantford, Canada



EASIER TO USE

MADE FROM VIRGIN METALS

FASTER

ELIMINATES REJECTS

DEPENDABLE

SAVES TIME



put into the circuit by means of switches on the machine. This permits the use of five preset, adjustable speeds by the knitting machine.

For best tube life the filament voltage of all tubes must be maintained to  $\pm 5$  percent of rated voltage. Since conventional a-c power systems vary more than this amount, the tap switch should be set to the voltage as indicated on the wiring diagrams.

Since all high-circuit rectifier tubes must have their filaments heated before the load is applied, a time-delay relay is provided. This consists of a small synchronous motor operating, through a reduction gear, an actuator arm which closes the switch after a 30-second delay. Until this time has elapsed, after closing the circuit breaker, the d-c motor or the control cannot be operated. The relay switch is held closed by the motor during all operations. When the a-c power is shut off, by tripping the circuit breaker, the spring returns the actuator arm and opens the switch, thus recycling the relay.

A pair of fuses in the rectifier plate circuits protect the tubes against short circuits or faulty operation.

For the knitting machine described, there are control stations to provide start, stop and creep operation.

The three speed-selecting switches are of the spdt type and are mounted on the upper automatic shaft of the knitting machine. The three switches are the welt-turner, splicing and narrowing switches.

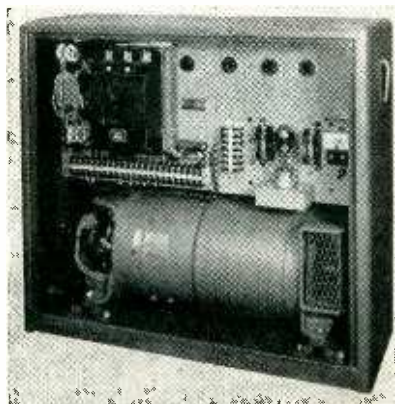

FIG. 2—Packaged control unit for the electronic drive

## THE FRONT COVER



**T**HE FOUR-FOOT parabolic reflector and pedestal shown in the cover photograph and the accompanying picture are part of a Navy SO-1 radar equipment formerly in use on a Navy PT boat.

The controlled climate chamber in which the equipment is

shown being tested has a controlled temperature range of  $-25$  C to  $+70$  C. Relative humidity can be controlled throughout a range of 20 to 90 percent. Both temperature and humidity are controlled with an absolute accuracy of  $\pm 1.0$  percent.

The equipment was adapted for tv broadcast field work by adding vertical tilt to the original mechanism so that the dish can be rotated or tilted in either the horizontal or vertical plane. The dish may be remotely controlled through use of electrical circuits and a position-indicating system employing selsyn motors.

It is possible to search for remotes in the field with the equipment by positioning the dish until maximum signal amplitude is observed. The unit was built for this purpose for use at station WABD, Du Mont station in New York City.

## Increased Safety for Safes

BY ESTHER H. FORBES  
New York, N. Y.

AN ELECTRONIC MECHANISM for controlling a combination lock has been designed from standard servo components of Servomechanisms, Inc. Operating the lock electronically from a remote position, the device can make any vault almost completely impregnable.

Present combination vault locks have three principal shortcomings which make them vulnerable to burglars. In the first place, the dial is manipulated manually, so that a person with sensitive fingers or sensitive ears can detect when the tumblers fall in place and thus discover the combination. With modern equipment it is also possible to rig up an electronic device to detect the combination with even greater precision.

In the second place, the dial is

connected to the lock by means of a shaft which cuts through the wall of the vault. When such a mechanical connection is used, the lock is usually directly on the other side of the wall from the dial. Therefore, a burglar has a good indication of where he can drill through the wall to get at the lock mechanism.

Lastly, the person who knows the combination and can open the lock is stationed directly at the vault. This means that a hold-up man can force him to open the vault before he can register an alarm of any sort.

Substitution of electronic for mechanical operation of the lock eliminates all three hazards. This is possible with existing compon-

(continued on page 156)



# THE RIGHT R-F NOISE FILTER FOR THE JOB



Tailored to fit!

That's the way Sprague likes to make radio interference filters for aircraft electrical and electronic equipment. Sprague filter engineers have a wealth of experience in designing ingenious mounting arrangements and case shapes to fit in cramped quarters. Moreover, the filters they design to meet these tough mechanical requirements have excellent insertion loss characteristics and are designed to withstand aircraft operating temperatures, vibration and shock beyond the stiffest specification limits.

Write today for help in solving your radio noise filter problems!

# SPRAGUE

PIONEERS IN

FILTER DIVISION  
**SPRAGUE ELECTRIC COMPANY**  
NORTH ADAMS, MASSACHUSETTS

ELECTRIC AND ELECTRONIC DEVELOPMENT

# THE ELECTRON ART

Edited by JAMES D. FAHNESTOCK

Mobile Ionosphere Station .....	140
Modified Wallman Circuit with Voltage Feedback .....	208
Electronic Analysis of Walking .....	212
Instantaneous Peak Voltmeter .....	216
Additional "Trons" .....	218
Differential Analyzer Uses Plug-In Units .....	222
Radio-Frequency Micropotentiometer .....	230

## Mobile Ionosphere Station

IN AN EFFORT to obtain more comprehensive data on the ionosphere, the National Bureau of Standards has incorporated a mobile ionospheric research unit into the existing chain of 60 world-wide ionosphere stations—approximately 15 of which are maintained by the Bureau. With this new unit, ionospheric soundings will be made from points midway between two permanent transmitting-receiving stations. This information will be used in studies of ionospheric effects on radio waves directly above the mobile transmitter-receiver; and it will also aid in analyzing the behavior of radio waves propagated from transmitters to distant receivers.

The equipment includes two gasoline-powered motor-generators which will provide 10 kw each. One of the trailers has been converted into living quarters for the two-

man operating crew for use in regions where living accommodations cannot be obtained.

The caravan's first recording stop, 30 miles east of Cincinnati, Ohio, is a point midway between the station at Sterling, Virginia, and a leased station operated by Washington University, St. Louis, Missouri.

During the past twenty years the technique of vertical-incidence ionosphere soundings by the use of pulse transmitters scanning over a wide frequency range has been adopted internationally for recording the virtual height and degree of ionization for each of the ionosphere layers. Although vertical incidence reflection principles are basic to the understanding of radio propagation, they are rarely encountered in practical radio communication. The wave received at a distance from the transmitter im-

pinges on the ionosphere obliquely in its journey from the transmitter to the receiver. However, theory indicates that much information about oblique incidence propagation can be inferred from data obtained at vertical incidence. Experiments with the mobile unit are designed to record simultaneously both vertical and oblique incidence data, and from an analysis of the information the relation between oblique and vertical incidence reflectors will be more exactly deduced.

In the first experiment, the Sterling and St. Louis stations will simultaneously transmit pulses of radio energy directed to strike the ionosphere obliquely. Each station will receive the other's signals. Because the pulses must pass all the way up to the ionosphere at the midpoint of the path and then be



Interior of National Bureau of Standards mobile ionosphere station

reflected down again, the travel times will be greater than if the signals traveled directly along the earth's surface. The heights of reflection will be calculated from time delays. During the transmission, the frequencies used at both ends of the paths will be slowly but simultaneously varied. At the higher frequencies the time delays will be greater because these waves travel to greater altitudes before they are reflected. Meanwhile the mobile station located at the critical point of the propagation path, will transmit signals vertically upward and receive its own echoes. By recording the heights and degree of ionization of the several layers, the heights at which, according to

(continued on page 208)

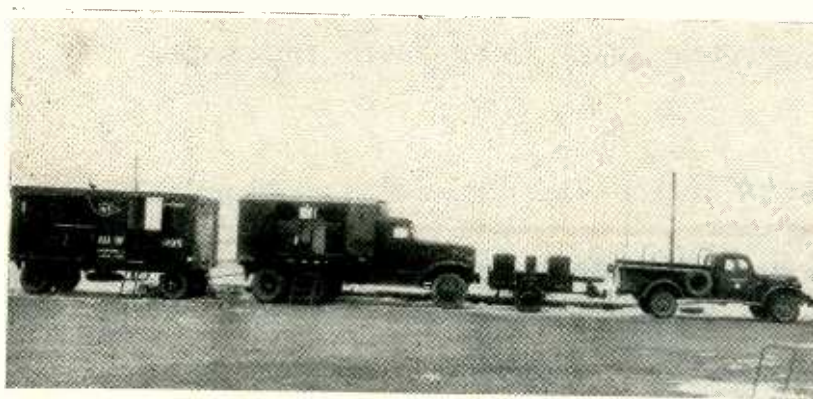

Mobile ionosphere station will permit simultaneous study of oblique and vertical incidence propagation



# Wide Band UNIVERTER

for complete frequency coverage

when used with the

FM-AM SIGNAL GENERATOR TYPE 202-B

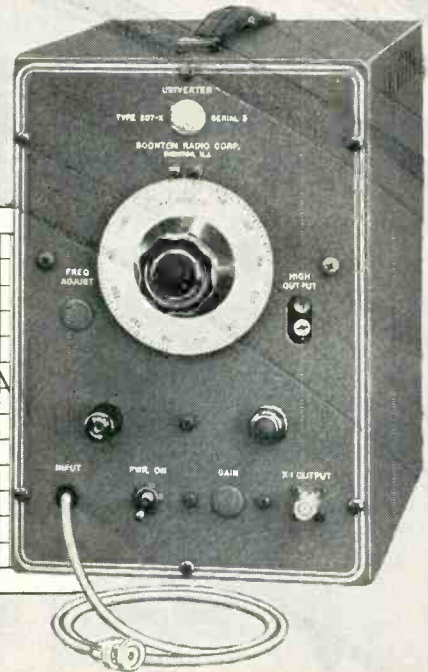
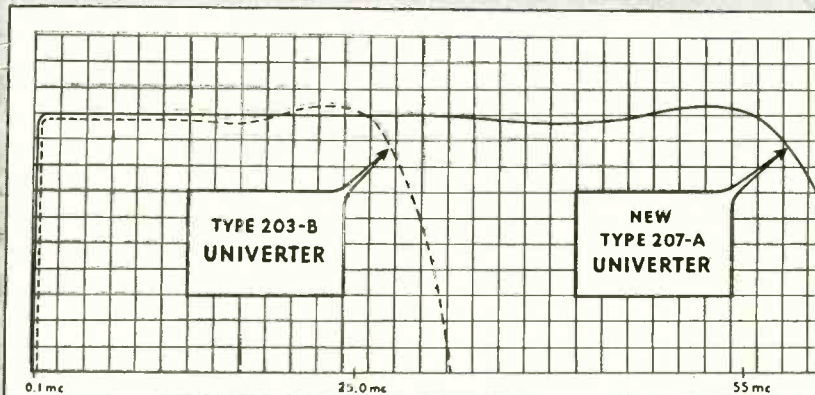

## UNIVERTER TYPE 207-A

The Univertor Type 207-A provides a continuous extension of the frequency range of the 202-B FM-AM Signal Generator down to 0.1 mc. The two instruments may be used over a continuous frequency range of 0.1 mc. to 216 mc. The Univertor Type 207-A subtracts 150 mc. from a signal obtained from the 202-B and provides outputs between 0.1 mc. and 55 mc. without change of signal level. Negligible spurious signals are introduced and modulation of the signal is unaffected. Small incremental changes can be made in frequency to allow the study of band pass characteristics of very narrow band receivers. A regulated power supply prevents change of gain or frequency with line voltage.

### SPECIFICATIONS (When used with 202-B)

- FREQUENCY RANGE:** 0.1 mc. to 55 mc. (0.3 mc. to 55 mc. with 200 kc. carrier deviation).
- FREQUENCY INCREMENT DIAL:** Plus or minus 300 kc. calibrated in 5 kc. increments.
- FREQUENCY RESPONSE:** Flat within  $\pm 1$  db over frequency range.
- FREQUENCY ADJUST:** Front panel control allows calibration with 202-B output.
- OUTPUT:** Continuously variable, at X1 jack from 0.1 microvolt to 0.1 volt across 53 ohms by use of 202-B attenuator.
- HIGH OUTPUT:** Uncalibrated approximately 1.5 volts from 330 ohms into open circuit.
- DISTORTION:** No appreciable FM distortion at any level.  
No appreciable AM distortion at carrier levels below 0.05 volt and modulation of 50%.
- SPURIOUS RF OUTPUT:** At least 30 db down at input levels less than 0.05 volts.

Write for complete information

(In Canada, direct inquiries to R.C.A. Victor Co., Ltd., Montreal)

## FM-AM SIGNAL GENERATOR

TYPE 202-B

- The standard signal source for the FM and TV industry.
- Univertor 207-A extends frequency range down to 0.1 mc. without change in signal level or modulation characteristics below.

### SPECIFICATIONS:

**RF RANGES:** 54-108, 108-216 mc.  
**FREQUENCY DEVIATION:** 0-24 kc., 0-80 kc., 0-240 kc.  
**FM DISTORTION:** Less than 2% at 75 kc. deviation  
**AMPLITUDE MODULATION:** Continuously variable 0-50%  
**RF OUTPUT VOLTAGE:** 0.1 microvolt to 0.2 volt.

**BOONTON RADIO**  
 Corporation

BOONTON, N. J.



# NEW PRODUCTS

Edited by WILLIAM P. O'BRIEN

## Plate Circuit Relays

POTTER & BRUMFIELD, Princeton, Ind. The LM series relays are of the long coil construction giving a powerful magnetic circuit that with

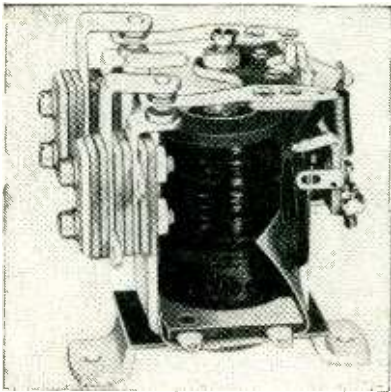

10,000-ohm winding permits adjustment to pull in as low as 1 ma with contact pressure sufficient to carry 5 amperes. Nominal operating power is 0.1 watt. The design includes an adjustable armature return spring that allows easy adjustment when installing to meet unusual or variable current or voltage conditions. The armature is equipped with an adjustable residual screw that controls the ratio between pull-in and drop-out current. The relays are stocked in 2,500, 5,000 and 10,000-ohm windings and all contact combinations up to dpdt.

## Electronic Standard Cell

HASTINGS INSTRUMENT CO., INC., Super Highway at Pine Ave., Hampton 8, Va., has produced a new electronic standard cell for industrial and laboratory use. The unit provides a d-c reference voltage stable to 0.25 percent. Output ripple on



the low-current models is less than 0.01 percent. It contains JAN-type components, is immune to damage by momentary short circuits and is unaffected by temperature changes. The unit is for use with self-balancing potentiometers, wire strain gages, recording oscillographs, resistance thermometers and other applications that require a stable d-c source. It operates from an a-c source; 90 to 130 v, 50 to 500 cycles.

## Disk Capacitors

SPRAGUE ELECTRIC Co., North Adams, Mass. Cera-mite disk capacitors with voltage ratings as

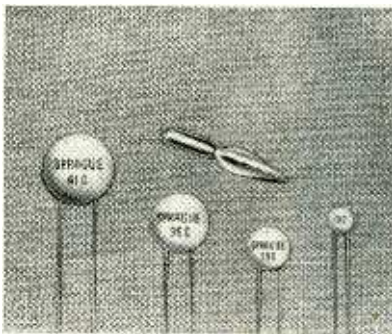

high as 1,500 v are among the complete line of ceramic capacitors including temperature-compensating, general application and high-k types now available. Some 90 different standard ratings together with complete performance characteristics are included in engineering bulletin 601B, available on letterhead request.

## F-M Communications Tuner

GON-SET Co., 72 E. Tujanga Ave., Burbank, Calif., has announced a new f-m communications tuner designed for uhf reception. The 5-tube tuner is ideally suited for reception of police, fire, taxicabs, aircraft, civilian defense and other

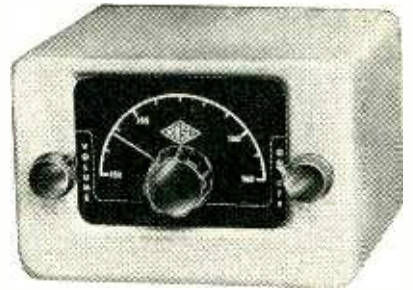

such services. Frequency ranges available are 30 to 40 mc, 40 to 50 mc, 88 to 108 mc and 152 to 162 mc. Price is \$59.50 net.

## Studio Picture Monitor

POLARAD ELECTRONICS CORP., 100 Metropolitan Ave., Brooklyn 11, N. Y. Model M-104 studio picture monitor is a high-impedance device and may be connected across a video transmission line without affecting the terminal impedance of the line. It features a resolution in excess of 500 lines, 16-in. kinescope, excellent vertical and horizontal linearity, light weight and minimum of maintenance. Input impedance is 470,000 ohms. Video amplifier is flat to 5.0 mc  $\pm 1\frac{1}{2}$  db.

## Mobile Radiotelephone

KAAR ENGINEERING Co., Middlefield Road, Palo Alto, Calif., has announced the Radiopak, a single unit transmitter-receiver for mobile communication in the 152 to 174-mc band. Power output is 10 to 12 watts, while battery drain is 6.5 amperes during standby periods and 15 amperes transmitting. The equipment will operate satisfactor-

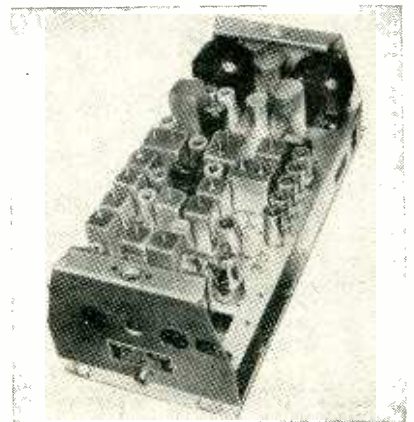



RAYTHEON SUBMINIATURE TUBES...

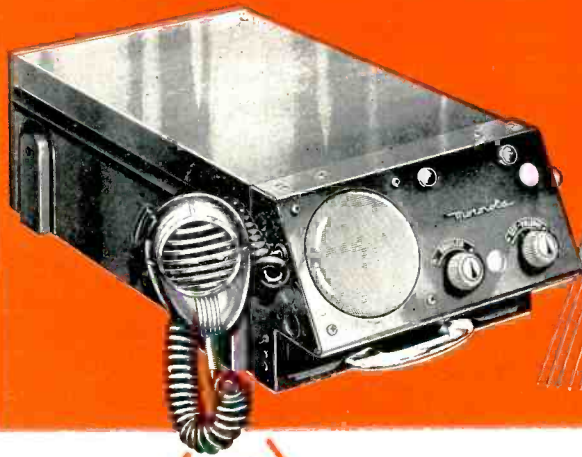

2-WAYS BETTER  
for  
2-WAY RADIO

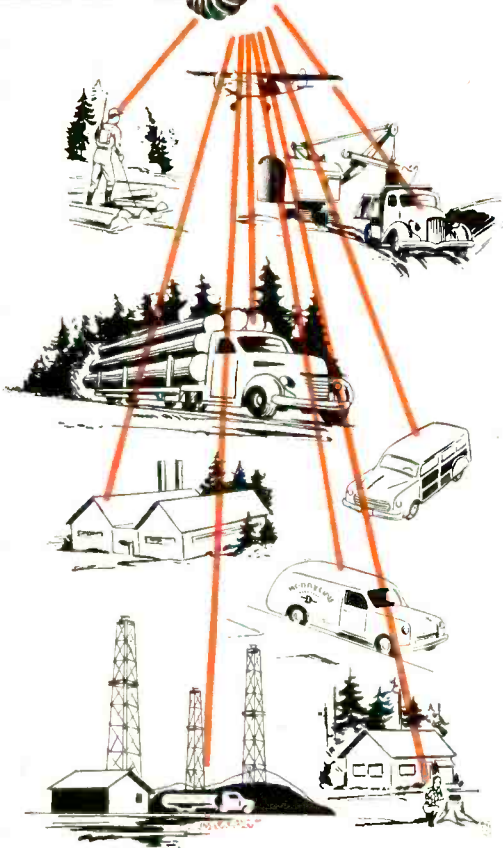

### HOW RAYTHEON SUBMINIATURE CATHODE TYPE TUBES CONTRIBUTE

1. GREATER CONVENIENCE AND UTILITY
2. LONGER, MORE DEPENDABLE SERVICE

to the new *Motorola Uni-Channel Sensicon Dispatcher*

Raytheon Filamentary Subminiature Tubes are used in the transmitter section and receiver section of this sturdy, practical, multi-purpose unit (1) because they take up minimum space and help make it a marvel of compactness, and (2) because their lower heater power assures minimum drain, maximum service.

Motorola is one of many equipment manufacturers that have standardized on Raytheon Subminiatures, having found them even more rugged, long lasting, dependable and efficient than large tubes for the same service.

Raytheon Subminiatures fit standard sockets or can be soldered or welded into the circuit.

Raytheon Subminiatures are standard the world over — *more are used than all other makes combined.*



Motorola Handie-Talkie<sup>®</sup>, portable 2-way radio, and Pack Sets employ as many as twenty-one Raytheon Subminiature Tubes to help them achieve minimum size and weight as well as high sensitivity.

\*TRADEMARK OF MOTOROLA, INC.



*Excellence in Electronics*

**RAYTHEON MANUFACTURING COMPANY**

SPECIAL TUBE SECTION • Newton 58, Massachusetts

SUBMINIATURE TUBES • GERMANIUM DIODES and TRIODES • RADAR TUBE COUNTER TUBES • RUGGED, LONG LIFE TUBES

ily from the regular 6-volt, electrical system of any vehicle. Overall measurements are: 6½ in. high × 8 in. wide × 18½ in. long; weight is 24 pounds.

### Stroboscopic Tachometer

ELECTRONIC MEASUREMENTS Co., Red Bank, N. J., is producing model 351A stroboscopic tachometer that measures a wide range of speeds without physical connection to the rotating equipment. Fundamental range of flashing speed is 600 to 14,400 rpm. Accuracy is ±1 percent of the dial reading above 900

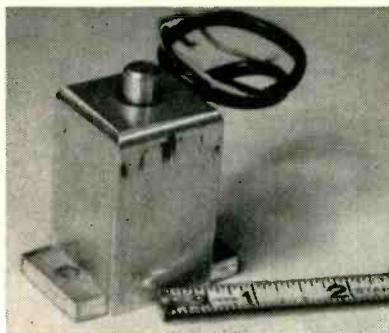

of 15 in. per second and higher. Output pulse is double ended and symmetrical, allowing synchronization on the positive or negative polarity.



rpm when the Strobotac is standardized in terms of a frequency controlled power line. The unit operates on 105 to 125 volts, 50 or 60 cycles, and consumes approximately 35 watts.

### Synchronization Pickup

THE STERLING INSTRUMENTS Co., 13331 Linwood Ave., Detroit 6, Mich. The type 140 synchronization pickup was designed to be used in conjunction with the c-r oscillograph for studying pressure, stress and displacement. It consists of a 20,000-turn coil wound around a highly magnetized pole piece that protrudes a half-inch through the mounting case. A pulse to trigger the sweep of the c-r oscillograph is formed when a small piece of steel is moved past the face of the pole piece. It can trigger an oscillograph from rotary speeds of 70 rpm and up, and from linear speeds

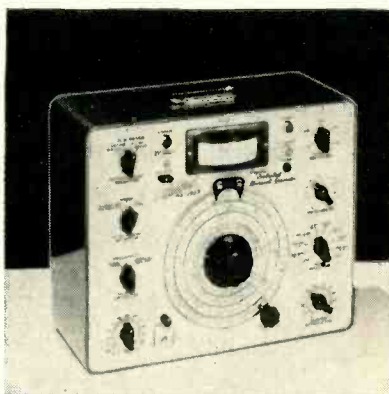

accurately controlled modulated and unmodulated output from 0.2 to 100,000 μv through a 10 to 1 cast aluminum attenuator. It may also be externally modulated from 15 to 10,000 cps. The a-f output is 0 to 2 volts at 400 cycles.

### Automatic Voltage Regulator

THORDARSON-MEISSNER MFG. DIV., Maguire Industries, 500 West Huron St., Chicago 10, Ill., has announced the Power-Guard low-cost

automatic voltage regulator designed to provide sure protection to electric motors or other electrical appliances from damage resulting from excessive fluctuations of line voltage. Rated at 750 va, the unit utilizes a power transformer with tapped windings and electrically adjusted to keep the output voltage within certain prescribed limits. One popular model adds 25 volts to



the output when line input drops to 95 volts. It also will automatically step-down 25 volts if line surge exceeds 130 volts. The relay in the Power-Guard is chatter-proof and the unit itself is filtered to prevent interference to radio or tv.

### Synchronous-Motor Timer

GENERAL CONTROL Co., 1200 Soldiers Field Rd., Boston 34, Mass., has designed a new synchronous-motor timer for accurate control of a wide variety of timed operations. The type SY Promatic timer can be used for all time periods between ½ second and 24 hours. It actuates five spdt load contacts independent of the timer-control circuits. There are two separate solenoids—one operates the clutch and timing mechanism, the other actuates the load

(Continued on page 236)





*Announcing*

**GLASSEAL**

REG. TRADE MARK



ACTUAL  
SIZE

**HERMETICALLY-  
SEALED**

*Miniature*

**TUBULAR PAPER CAPACITORS by**

**PYRAMID**

Pyramid Type PG "GLASSEAL" miniature paper capacitors are assembled in metal tubes with glass-metal terminals. They will fully meet the most exacting demands of high vacuum, high pressure, temperature cycling, immersion cycling and corrosion tests.

**TEMPERATURE  
RANGES:  $-55^{\circ}$  to  $+125^{\circ}\text{C}$ .**

CAPACITANCE  
RANGE: .001 mfd. to 1.0 mfd.  
VOLTAGE RANGE: 100 to 600  
v.d.c. operating

*Your inquiries are invited*



**PYRAMID Electric Company**

GENERAL OFFICES and PLANT NO. 1  
1445 HUDSON BLVD. • NORTH BERGEN, N. J.

PLANT NO. 2  
155 OXFORD ST. • PATERSON, N. J.

# NEWS OF THE INDUSTRY

Edited by WILLIAM P. O'BRIEN

## Mobile Radio Unit Enters Military Service

THE MOBILE radio broadcasting company, part of the Army's Organized Reserve, which has been sponsored by the National Broadcasting Co. through the Dept. of the Army's Industrial Affiliation Program, entered active military service on May 1, 1951. Its activities heretofore had been supervised by Major General G. L. Van Deusen (Retired), president of RCA Institutes.

The unit is composed chiefly of personnel from NBC and from RCA Institutes. The bulk of the men are specialists in some phase of broadcast communications or programming.

Primary mission of the unit will be mobile radio broadcasting for psychological warfare purposes. The men in the unit will be performing essentially the same type of work they did in civilian life, which will be the operation of broadcasting studio facilities and high-power transmitters.

The NBC-sponsored group is commanded by W. B. Buschgen, Captain, Signal Corps—USAR, and was organized originally in November, 1948. The regular biweekly meetings and technical lectures have been held in NBC's Radio City studios, and other engineering facilities of the network were made available to the unit.

Initial training for the group will be given in Fort Riley, Kansas.

## Research Fellowships Offered

RESEARCH fellowships in electrical engineering will be awarded by the Institute of Industrial Research, University of Denver. The stipend is \$3,300 for 21 months starting Sept. 1, 1951.

Recipients will work approximately 25 hours per week in the Institute of Industrial Research on industrial research projects leading

to the fulfillment of the thesis requirement, while engaged in graduate study leading to the M.S. degree in electrical engineering.

Interested applicants should send a transcript of college record, personal data, and names of three persons acquainted with their work, to the Director, Institute of Industrial Research, University of Denver, Denver 10, Colorado.

## Washington Award

E. H. ARMSTRONG, professor of electrical engineering, Columbia University, has received the Washington Award for 1951 "for outstanding inventions basic to radio transmission and reception and notable service to his country". Administered by the Western Society of Engineers, this engineering honor was founded in 1916. There have



E. H. Armstrong

been 28 recipients, the first being Herbert Hoover in 1919. This is the first time the award has been made in the field of radio.

## Autoradiography Course Available

A COURSE in the theory and techniques of autoradiography will be held this summer by the Special Training Division of the Oak Ridge Institute of Nuclear Studies. George A. Boyd will direct the course, which will begin on July 2 and continue for from three to four weeks.

Subjects to be covered in lectures and laboratory sessions will in-

## "WHAT ABOUT COLOR, MR. COMMISSIONER?"



Off-air photo of FCC Commissioner George Sterling (left), Don Fink of *Electronics* and Earl Cullum, consulting engineer, during interview over WFAA-TV, Dallas on occasion of Southwestern IRE Conference. Mr. Sterling indicated that if a new color television system is perfected, dual standards are "always a possibility"



# G.U.4 THREE SPEED PHONOGRAPH UNIT



78·45·33 $\frac{1}{3}$  R.P.M.

This is the G.U.4 Phonograph, incorporating the B.S.R. 'Rotocam' instantaneous speed change . . . 78, 45 and 33 $\frac{1}{3}$  R.P.M. at the turn of a switch.

- Plays without 'wow' on all speeds.
- High fidelity pick-up complete with two permanent sapphire stylii.
- Auto-stop operates on all types of records, irrespective of run-off groove diameter.

The G.U.4 is precision built and does not employ rubber drive belts, thus assuring years of trouble-free operation.

*Further details available on application.*



The M.U. 14 Three Speed Turntable satisfies the demand where auto-stop and pick-up are not required.



*U.S. and Canadian Warehouse and Offices.*  
**SAMCO PRODUCTS COMPANY**  
1 Spruce Street, New York 7. N.Y.  
*Telephone: Worth 4-0152.*

Made by Birmingham Sound Reproducers Ltd., Old Hill, Staffs. England Grams: 'Electronic Old Hill, Cradley Heath.'

clude: theory of the photographic process; reaction of ionizing particles with photographic emulsions and the interpretation of results; and techniques of making gross and microscopic autoradiograms, including special histological procedures, such as freeze-drying, carbowax embedding and smearing of cell suspensions on emulsion surfaces.

The course is intended for professional research workers who will direct research employing autoradiographic techniques. Applicants must have completed the basic radioisotope techniques course given by the Institute or possess equivalent experience in the use of radioisotopes in medical or biological research. Twenty individuals from the medical and biological sciences will be accepted for the course.

Lecturers and laboratory leaders will include: Julian Webb and John Spence of Eastman Kodak Co.; Robert Dudley of MIT; Margaret Holt of New England Deaconess Hospital; C. P. Leblond and Rita Bogorach of McGill University; L. F. Belanger of University of Ottawa; S. R. Pelc of Hammer-smith Hospital, London; Agnes Williams of University of New

Mexico; and Harvey Blank of University of Pennsylvania.

Registration for the course will be \$25.00. Additional information and application forms will be available at a later date from Ralph T. Overman, Chairman, Special Training Division, Oak Ridge Institute

## MEETINGS

JUNE 4-7: 1951 RTMA Convention, Stevens Hotel, Chicago.

JUNE 18-22: ASTM Annual Meeting, Hotel Chalfonte-Haddon Hall, Atlantic City.

JUNE 20-22: IRE 7th Region Conference, U. of Washington, Seattle, Wash.

JUNE 25-29: AIEE Summer General Meeting, Royal York Hotel, Toronto, Canada.

AUG. 15-18: 1951 APCO Conference, Everglades Hotel, Miami, Florida.

AUG. 20-23: AIEE Pacific General Meeting, Multnomah Hotel, Portland, Oregon.

AUG. 22-24: Seventh Annual Pacific Electronic Exhibit and West Coast Annual IRE Convention, San Francisco Civic Auditorium, San Francisco, Calif.

AUG. 28-SEPT. 8: Eighteenth British National Radio Show, Earls Court, London, England.

SEPT 10-14: Sixth National Instrument Conference and Exhibit, sponsored by Instrument Society of America, Sam Houston Coliseum, Houston, Texas.

OCT. 8-10: AIEE Conference on Aircraft Equipment, Hollywood Roosevelt Hotel, Los Angeles, Calif.

OCT. 22-24: 1951 National Electronics Conference, Edgewater Beach Hotel, Chicago, Ill.

OCT. 22-26: AIEE Fall General Meeting, Hotel Cleveland, Cleveland, Ohio.

Nov. 12-15: NEMA Convention, Haddon Hall, Atlantic City, N. J.

of Nuclear Studies, P. O. Box 117, Oak Ridge, Tenn.

## FORECASTER OF MAGNETIC STORMS



John H. Nelson, radiowave analyst of RCA Communications, Inc., has discovered evidence of a direct relationship between magnetic storms on earth and the position of planets with respect to each other and the sun. From this observatory atop an RCA building at 25 Beaver St., in the heart of New York's financial district, the scientist has applied this new approach in predicting radio weather months and years ahead

## Defense Contract News

### Navy:

An \$8,500,000 contract for the production of radar equipment for the Navy has been awarded to the Westinghouse Electric Corp., Springfield, Mass. The contract is for search-type radar sets recently designed by Westinghouse electronics engineers at Baltimore, Md., who worked in cooperation with Navy experts.

Several hundred employees are expected to work on the project when it is fully underway, but present plans call for them to be assigned from other departments in the plant. More than half of the radar contract funds will be spent on materials and parts to be furnished by subcontractors and other suppliers.

### Air Forces:

A \$3,000,000 order for high-precision instruments to be used by the Air Forces has been received by the General Electric X-Ray Corp., Milwaukee, Wisc. Production of the special devices will require the hiring of 200 more employees with-

(continued on p 274)



**These famous names in  
the sky...have a famous  
friend in SYLVANIA**

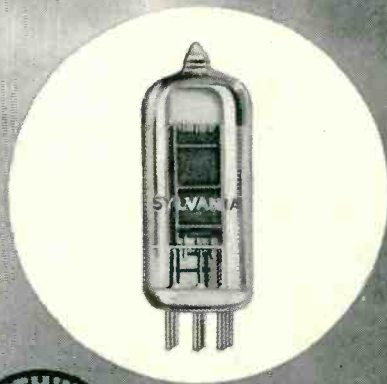

Wherever these famous airliners fly, a trusted group of friendly guides goes with them, in the form of Sylvania Radio Tubes.

For, the dependability, long life, and splendid performance of Sylvania Tubes have won them top preference with radio and electronics engineers throughout this country, as well as abroad.

Sylvania's ruggedized tubes are typical examples of the alert engineering which is responsible for the

increasing demand for all Sylvania quality products.

**What is your problem?**

Let Sylvania radio research and advanced engineering work for you. If you have problems—as widely varied as the designing of more compact sets, and the overcoming of shock and vibration—put them up to Sylvania. Address your letters to Radio Tube Division, Dept. R-1106 Emporium, Pa.

**SYLVANIA  ELECTRIC**

RADIO TUBES; TELEVISION PICTURE TUBES; ELECTRONIC PRODUCTS; ELECTRONIC TEST EQUIPMENT; FLUORESCENT LAMPS, FIXTURES, SIGN TUBING, WIRING DEVICES; LIGHT BULBS; PHOTOLAMPS; TELEVISION SETS  
ELECTRONICS — June, 1951

The **ONLY** Book That Offers Complete Coverage of the Oscilloscope As a Laboratory Facility!



**ENCYCLOPEDIA ON CATHODE-RAY OSCILLOSCOPES AND THEIR USES**

by John F. Rider and Seymour D. Uslan

A cross-section of knowledge on cathode-ray oscilloscopes, theory and applications, embracing all fields of activity. It is the **ONLY** book that so clearly and fully describes the oscilloscope . . . WHAT is it . . . what it can DO . . . and how to use it PROPERLY.

**An Outstanding Feature!**

An outstanding feature is a comprehensive compilation of 1600 complex waveform patterns listing the harmonics and exact phase and amplitude of each. MORE THAN 70 different types of oscilloscopes (all models produced in the past 10 years) are clearly described, with specifications and schematic wiring diagrams, APPENDIXES on the characteristics cathode-ray tubes, RMA cathode-ray tube basing charts and cathode-ray photography are included. For engineers, geophysicists, technicians, manufacturers, teachers, libraries, Armed Forces, schools, laboratories, research laboratories. 992 pages. 3000 illustrations. 22 chapters. 8½" x 11". Only \$9.00.

**Partial List of Contents:**

Principles of Electrostatic Deflection and Focusing—Mechanical Characteristics—The Electron Gun—Screens—The Basic Oscilloscope and Its Modification—Phase and Frequency Measurements—Auxiliary Equipment—Waveform Observation in TV Receivers—AM-FM-TV Transmitter Testing—Electrical Measurements—Special Purpose Cathode-Ray Tubes.

Revised, Enlarged and Up-to-Date Edition!

**VACUUM-TUBE VOLTMETERS**

by John F. Rider



**All The Facts . . .**

. . . on the many types of vacuum-tube voltmeters are presented here under one cover. This instrument is recognized as one of the MOST VALUABLE aids in the field of electronics . . . the most useful r-f, a-f,

d-c voltage measuring device for the engineer, laboratory technician, maintenance man, teacher and student.

**The New, 1951 Revised Edition . . .**

. . . brings the text up to date in its coverage of all types of voltmeters—diode, triode, rectifier-amplifier, tuned, amplifier-rectifier and slide-back. This is the **ONLY** book of its kind. All the different voltmeter types are described and presented in complete form. A comparison tabulation of operating characteristics is a special feature of this book. A bibliography of more than 200 listings is included. The section on applications includes step-by-step procedures for applying the vacuum-tube voltmeter for basic measurements of various circuits and networks.

Completely Indexed and Generously Illustrated. Review questions at the end of each chapter provide a helpful check on the reader's grasp of the material. This is a practical rather than a theoretical book, with emphasis on actual working conditions. 432 pages, 5½ x 8½ inches 215 illustrations. ONLY \$4.50.

**Partial List of Contents**

Fundamentals of Vacuum-Tube Voltmeters—Diode and Triode Vacuum-Tube Voltmeters—Rectifier-Amplifier and Amplifier-Rectifier Types—Tuned Vacuum-Tube Voltmeters—Slide-Back Vacuum-Tube Voltmeters—Vacuum-Tube Voltmeters for DC Voltage, Current and Resistance Measurements—Design and Construction of Vacuum-Tube Voltmeters—Applications—Maintenance.

Order From Your Jobber, or Direct From Us

**JOHN F. RIDER PUBLISHER, Inc.**  
480 Canal Street • New York 13, N. Y.

**NEW BOOKS**

**Micro-Wave Measurements**

By H. M. BARLOW AND A. L. CULLEN.  
The Macmillan Company, New York, 1950, 399 pages, \$6.00.

THE material described in this volume is concerned with measurement techniques developed during the past ten years in the field of microwaves. The presentation is clear, concise, and logical, the rationalized mks system of units being used throughout.

The first two chapters are devoted to the fundamentals of guided waves and the transmission line impedance concept. Basic principles of microwave measurements are presented with a minimum of mathematical derivations and a maxi-

**RELEASED THIS MONTH**

Electromagnetic Problems of Microwave Theory; H. Motz; Wiley; \$2.00.

Time Bases; O. S. Puckle; 2nd Edition; Wiley; \$5.00.

Transformers; F. C. Connelly; Pitman; \$7.50.

num of physical reasoning. Various graphical representations are thoroughly discussed and practical examples of transmission line calculations are illustrated.

The third chapter stresses the characteristics of cylindrical cavity resonators as tuned circuits and methods for coupling into and out of such resonators.

The next six chapters are engaged in the development of various methods for the microwave measurement of impedance, wavelength, frequency, standing waves, power, attenuation, Q-factor and electrical properties of materials. These methods are suitable to coaxial, waveguide and cavity systems.

The measurement of receiver bandwidth, noise factors, modulation envelope of transmitters, and radiation patterns, gains, impedance and bandwidth of microwave antennas, are discussed in the last

(continued on page 282)

**Examine FREE**



**Prentice-Hall ELECTRONICS & UHF LIBRARY**

Edited by W. L. EVERITT

5 VOLUMES 1662 ILLUSTRATIONS

Pay Easy Installments If You Keep the Set

Turn to this new, up-to-date Library with complete confidence, for dependable facts on any phase of modern electronic theory and practice. These volumes, by outstanding authorities, give you thorough guidance—clearly written, logically arranged, profusely illustrated.

**Electronic Fundamentals and Applications**  
By Prof. John D. Ryder, Univ. of Illinois

Complete, logical, easy-to-follow treatment of (a) physical principles underlying electron tubes, (b) characteristics of vacuum tubes, (c) all basic tube circuits. Includes: Electron Ballistics—Cathode-Ray Tubes. Emission of Electrons. Space Charge in Vacuum Tubes. Diode Rectifiers. Triodes. Multi-Element Tubes. Small-Signal Amplifier Circuits. Audio-Frequency Amplifiers. Radio-Frequency Amplifiers. Oscillator Circuits. Modulation Systems. Wave-Shaping Circuits. Gaseous Conduction. Gas Diodes. Gas Control Tubes and Circuits. Photoelectric Cells. Solid-State Electronics.

**Electromagnetic Waves and Radiating Systems**  
By Prof. Edward C. Jordan, Univ. of Illinois

Covers entire field of electromagnetic engineering. Includes propagation as well as radiation and transmission. Full treatment of UHF transmission lines, wave guides, antennas, slot antennas radiation and diffraction, ground-wave and sky-wave propagation.

**Ultra High Frequency Engineering**  
By Thomas L. Martin, Univ. of New Mexico

Theory and technique of ALL the new fields of electronic engineering: Radar, Telemetering, Electronic computing, Facsimile, Television, Blind landing systems, Pulse-time modulation, Ionosphere measurements . . . and the others.

**Networks, Lines and Fields**  
By Prof. John D. Ryder, Univ. of Illinois

Network transformations and theorems. Resonance. Impedance transformation and coupled circuits. Filters. General transmission line. High-frequency line. Equations of the electromagnetic field. Radiation. Transmission and reflection of plane waves at boundaries. Guided waves between parallel planes. Wave guides.

**Elements of Television Systems**  
By George E. Anner, New York University

Complete basic theory, plus current practice, covering: Closed TV Systems. Commercial Teletexting Systems. Color TV Systems. Gives clear exposition of all phases of picture transmission, including the new technique of dot interlace.

**SEND NO MONEY — EXAMINE FREE**

Just mail coupon below to get complete 5-Volume Set on 10 DAYS' FREE TRIAL. If not complete satisfactory, return in ten days and owe nothing. Or keep the set and pay only \$5.35 down and \$8 a month for five months until full price of \$45.35 is paid. Decide for yourself — without risk or obligation — just mail coupon to examine Library ten days free.

Prentice-Hall, Inc., Dept. M-E-651  
70 Fifth Avenue, New York 11, N. Y.

Send me the Prentice-Hall, ELECTRONICS & UHF LIBRARY (5 Volumes) for ten days' free examination. If fully satisfied in ten days I will send you \$5.35 plus few cents postage and then \$8 a month for five months until full price of \$45.35 is paid. Or I will return the Library in ten days and owe nothing.

Name.....

Address.....

City and State.....





you specify the properties...in **Lamicoid®**

- High Dielectric Strength
- Low Power Factor
- Heat Resistance
- Low Moisture Absorption
- High Impact Resistance
- Dimensional Stability
- Light Weight
- Tensile Strength
- Resistance to Abrasion

Essential characteristics are "built-into" LAMICOID to meet the needs of *your* application—mechanical, structural and/or insulating. Because LAMICOID—a thermo-setting plastic laminate—is made with fillers such as glass, nylon, fabric, paper, etc. with a variety of resins, many combinations of properties are possible.

LAMICOID is used for tube socket supports, coil forms, dials, name-plates, panels, antenna parts and many other applications. For example, in combination with synthetic rubber it is used for end seals of electrolytic capac-

itors to keep out moisture and provide a non-corrosive seal.

Take advantage of LAMICOID's versatility to give *your* product peak efficiency. LAMICOID can be supplied in standard sheets, rods and tubes or fabricated into parts to your specification. We will be glad to apply the knowledge gained through 58 years of experience in developing and producing electrical insulating materials to your problem. Send your blueprint and specification today for a prompt quotation.



**MICA Insulator COMPANY**

Schenectady 1, New York

Offices in Principal Cities

## simplified electronic synthesis

a *mecha*\* concept



Servomechanisms Inc. pioneered in the production of packaged plug-in electronic and mechanical functional units. Each is a convenient component for control-device synthesis. A system composed of several packages fulfills the urgent need for

- Spatial Adaptability
- Instant Maintainability
- Training Simplicity
- Ease of Manufacture

### SPATIAL ADAPTABILITY

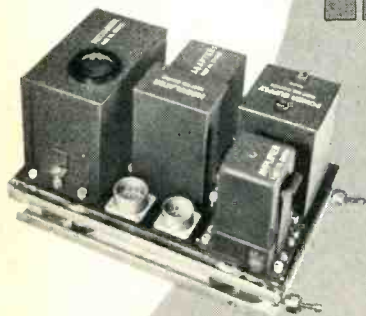
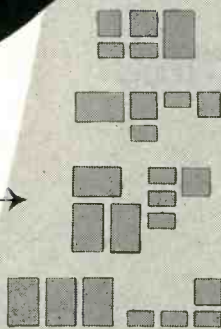

SYNTHESIS of a complete Servomechanisms Inc. unit using packaged functions.

**MECHATRONICS\*** The functional packaging of a functional unit so that it has an interchangeable use in one or more electronic syntheses.

\*Trademark

**SERVOMECHANISMS**  
\*INC.

POST & STEWART AVENUES, WESTBURY, N.Y.  
Ft. Lauderdale, Fla. • El Segundo, Cal.

## Backtalk

This department is operated as an open forum where our readers may discuss problems of the electronics industry or comment upon articles which **ELECTRONICS** has published.

### Bombs Away

DEAR SIRs:

I HAVE JUST come to the conclusion, after a recent visit to the Windy City (Chicago to you), that what this country needs most is an AN/DJC-(Pilotless Carrier Pigeon, Countermeasures). There is a good project for some genius to work on.

I would still like to see a good article on hi-fi amplifier construction. Surely **ELECTRONICS** can outdo some of the amateur mags. Most engineers that I know are classical music addicts, and I believe that an authoritative article on a good amplifier would be well received. Incidentally, the Rural Radio Network in New York state has nothing on us. We are a station in the Wisconsin State Broadcasting Service, Non-Commercial, Educational. Two 5-kw a-m stations, six 10-kw f-m stations and two more in construction are all state owned and operated, with nothing but good music and classroom lectures from the University.

F. C. HERVEY  
WHKW  
Chilton, Wisconsin

### Rho Phi Epsilon

Mr. D. G. Fink

**ELECTRONICS**  
330 West 42nd Street  
New York 18, N. Y.

DEAR DON:

IN A GENTLY chiding way, you were so good as to call the attention of all and sundry to a regrettable sin of commission in the *Proceedings of the IRE* in relation to the fortunately nonexistent demise of

(Continued on page 290)

# Spincraft

SKILL WILL DO IT®

## provides a low cost source for the Production of Electronic Parts

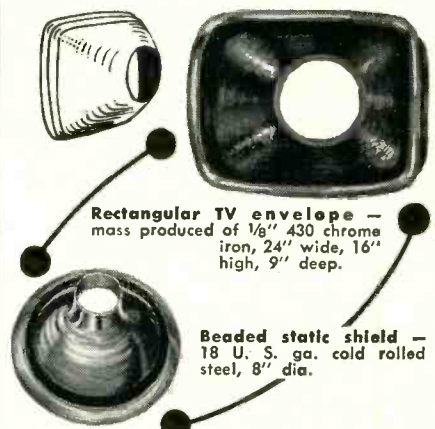
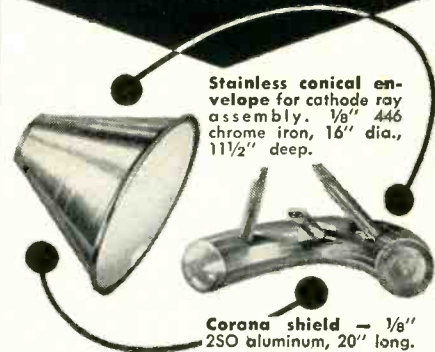

**STUDY** these illustrations of Spincraft "engineering" — interesting examples of a high order of ability to "work" metal by spinning and fabricating. Best of all, these methods pay off in time gained — and substantially lower costs, both on large and small runs.

Progressive new Spincraft techniques may help simplify your production problem in any metal — just as they have helped others in the electronics industry. Your inquiry is welcome — and you are invited to send for the new Spincraft Data Book, a stimulating source of ideas for engineers, designers and plant production men. Write today.



4143 W. State St. Milwaukee 8, Wis.  
Heretofore known as  
Milwaukee Metal Spinning Co.

June, 1951 — **ELECTRONICS**





Use **“dag”**  
Colloidal Graphite for  
CRT Exterior Wall Coating

**“Dag”** Exterior Wall Coating is a specially processed dispersion of electric-furnace graphite in a lacquer-base vehicle.

It is easily applied to CRT surfaces by spraying . . . dries very rapidly, enabling tubes to be handled in 2 or 3 minutes. Maximum adhesion is obtained by drying at room temperature for twenty-four hours. If faster action is desired, infra-red drying at 100° C. for ½ hour can be used.

The smooth, uniform, conductive black coating obtained adheres tenaciously to all types of glass. Its adhesive properties are so good that it resists scratching and cannot be readily loosened in water.

An interesting brochure describing the uses of **“dag”** colloidal graphite in the electronics and electrical industries is yours for the asking. Write today for your free copy of Bulletin #433-5F.



**Acheson Colloids Corporation** Port Huron, Mich.  
... also Acheson Colloids Limited, London, England

# bringing YOUR INSULATION

▶ ▶ to market ▶ ▶

## is a full time job for . . . electronics

The basis of electronics is circuitry. It is sensitive current circuits, composed of tubes, capacitors, resistors, relays and other components, that put the electrons through their paces and produce the electronic devices for communications, home, broadcasting, industrial and military use that make up the two billion dollar market of electronics.



But without insulation there could be no circuitry. Without insulation the electrons couldn't be kept in the circuit channels. They'd short cut out.

The illustrations show some applications of insulation in electronics. But they are just a beginning. There are many insulating compounds, insulating materials, insulation parts and insulators . . . all used extensively in electronics. There are asphalts, coil dopes, enamels, varnishes and lacquers, plastics, pitch and resins, silicone compounds, varnished cambric coatings, and waxes. There's asbestos, ceramics, fabrics and fibres, glass and mica, woven glass laminates and glass bonded mica, nylon, paper and rubber; and conductive rubber, a new semi-insulator developed for use in electronics. There's insulating cord, foil, sleeves, rods and sheets, bead insulation, capacitor boxes and films, stampings and punchings of all kinds of insulating materials into all kinds of insulation parts. There are antenna, feeder spreader, fused quartz, high dielectric paper, and mast guy insulators. There are passthrough and bushing, standoff and cone, strain and test clip insulators; tower insulators, and insulators called thermocouples. There is insulation everywhere in electronics.

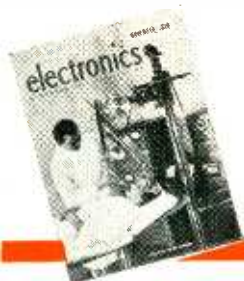

# electronics



**12 REGULAR ISSUES**  
supplying latest technical information, design and product news

A McGraw-Hill Publication • 330 West 42nd St., New York 18, N. Y.

**ANNUAL BUYERS' GUIDE**  
supplying all basic product source and technical specifying data



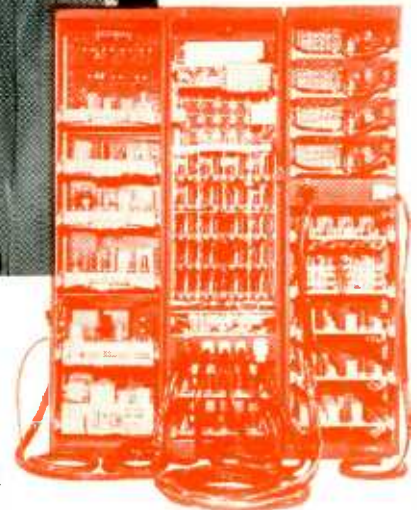

### HOW BIG IS THE ELECTRONICS INSULATION MARKET?

The insulation manufacturers who supplied the illustrations used here answer that by saying they can't imagine an electronic component that uses none of their products and they claim that some of their products can be found in every piece of packaged electronic equipment no matter what its use.

### HOW BIG IS THE MARKET IN VOLUME AND IN DOLLARS?

On those questions the same company is silent. They don't know, although they know it's big in both. They have installed electronic punch-card accounting machines to find out how big. They feel sure that the results will point directly to electronics for increased sales and increased profits. Recently they discovered that one product for which they believed the only market was the petroleum industry is going in quantity to electronic equipment manufacturers.

The important question for you, however, is how to get YOUR insulation products used in electronics. The answer is: Get them designed-in by selling the design engineers on YOUR products' advantages.

Exactly like all other components, materials and al-

lied products used in electronics, every insulation part, material, compound and insulator is designed-in, specified and bought by the electronic design engineers who are, almost without exception, subscribers to, or readers of **ELECTRONICS**... for whom **ELECTRONICS** is the chief, often the only source of electronic engineering information on insulation products.

Beyond a doubt, **ELECTRONICS** is the best way to take your insulation products to market in electronics. Many individual advertising sales success stories attest to that. Of the 249 known manufacturers of insulation, more than one third (87) are selling insulation to the electronics market through the sales pages of **ELECTRONICS**.

**THE DIRECT ROUTE TO — — — — — A \$2,000,000,000 MARKET PLACE**

AN approved (3303-1)



# R-B-M

## ELECTRONIC AND COMMUNICATION RELAYS

*Now Hermetically Sealed*

**H**UNDREDS of thousands of R-B-M telephone type relays saw Government service in World War II. Now most of these relays are available in hermetically sealed enclosures designed to meet AN specifications.

R-B-M hermetically sealed telephone type relays are available in contact forms up to and including 4-pole, double throw, 3 ampere, 28 Volts D. C. construction. Also 10 ampere rating up to and including 2-pole double throw at 28 Volts D.C. All relays available with approved AN plug connector, or with solder connections.

**Engineers!** What is YOUR hermetically sealed relay requirement? R-B-M is developing new and smaller relays to meet Armed Services requirements. Perhaps one of these will solve your problems. Write giving complete relay specifications, application, quantity and AN specifications applying. Address Dept. F-6.



AN approved (3304-1)

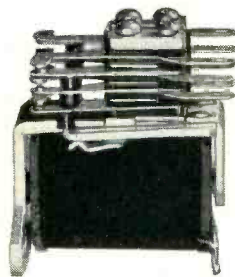

R-B-M Production and Engineering facilities in two plants, located in different states, (over a quarter million square feet), can assist you in the development and production of special electro-magnetic devices for Armed Services application.

### TUBES AT WORK

(continued from page 138)

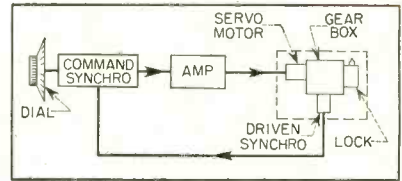

FIG. 1—Diagram of the servo loop used with the vault lock control. The command synchro dial may be remotely located from the safe itself

ents so that cost can be kept to a minimum.

In the arrangement, the shaft on the lock is not connected mechanically to a dial in any way. Instead it receives all information concerning the position of the dial electrically. A servo-type motor provides the energy to turn the shaft in the same direction and at the same rate as the dial, so that at any given time the shaft is in the same position as if it were being rotated manually.

With mechanical connections between the dial and the lock eliminated, it is impossible to sense when the tumblers fall by moving the dial. Moreover, the dial no longer need be placed in front of the vault but instead may be located remotely at any safe convenient point. When the dial is thus removed from the vault, there is no outward indication on the vault to suggest to a burglar where the lock mechanism is located.

The information concerning the position of the dial is supplied to the lock shaft by an electrical system using two synchros, see Fig. 1. The dial is coupled to one synchro, which turns once for each revolution of the dial. Similarly, the lock shaft is coupled to another synchro, also on a 1-to-1 gear ratio. The two synchros are then connected with each other electrically by three wires, so that they can act as references for each other in detecting shaft position. When the two shafts are in the same angular position, the system is in balance and the currents flowing through the connecting lines are balanced and equal. However, if one of the shafts is turned so that the rotors are no longer in alignment, the currents become unbalanced, inducing a volt-



**R-B-M DIVISION  
ESSEX WIRE CORP.**  
*Logansport, Indiana*

MANUAL AND MAGNETIC ELECTRIC CONTROLS  
— FOR AUTOMOTIVE, INDUSTRIAL, COMMUNICATION AND ELECTRONIC USE



# ALLIED CONTROL RELAYS

*built with*

# Cleveland PHENOLIC TUBES

ensure

- ★ DEPENDABILITY
- ★ PRECISION PERFORMANCE
- ★ LONG LIFE
- ★ ECONOMY



The Allied Control Co. has built a long and enviable record as a quality supplier of control relays to both private industry and governmental services.

Their S K Relay shown above, is typical of the various Allied Relays in which CLEVELAND CONTAINER tubing provides excellent service.

It is likewise the answer for hundreds of other problems of manufacturers in the electrical industry.

Write today for our new descriptive brochure. Also ask for quotations and samples to meet your exact specifications.

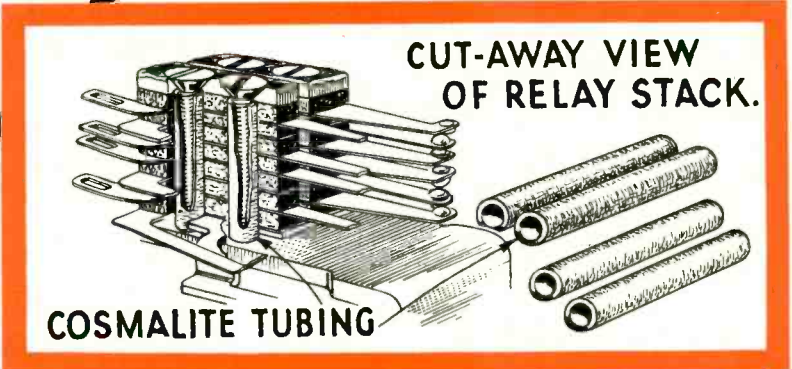

## CLEVELITE\* and COSMALITE\* *Laminated Phenolic Tubing*

combines electrical and physical properties to meet the most exacting requirements.

CLEVELITE is produced in six grades . . .  
COSMALITE in four grades . . .

A grade for EVERY need.

Cleveland Container's large production facilities further ensure minimum production costs as well as dependable deliveries.

Why pay more? . . .  
for the BEST call CLEVELAND

\* Trade Marks

*The* **CLEVELAND CONTAINER Co.**  
6201 BARBERTON AVE. CLEVELAND 2, OHIO

PLANTS AND SALES OFFICES at Plymouth, Wisc., Chicago, Detroit, Ogdensburg, N.Y., Jamesburg, N.J.  
ABRASIVE DIVISION at Cleveland, Ohio

CANADIAN PLANT: The Cleveland Container, Canada, Ltd., Prescott, Ontario

### REPRESENTATIVES

NEW YORK AREA R. T. MURRAY, 604 CENTRAL AVE., EAST ORANGE, N. J.

NEW ENGLAND R. S. PETTIGREW & CO., 10 N. MAIN ST., WEST HARTFORD, CONN.

CHICAGO AREA PLASTIC TUBING SALES, 5215 N. RAVENSWOOD AVE., CHICAGO



# GRC CUTS COST AND TIME!



## TINY INJECTION MOULDED PRECISION PLASTIC PARTS

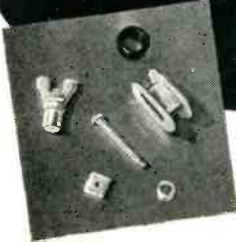

**INDIVIDUAL PARTS**  
No limit on smallness.  
Intricacy and precision  
—our unique feature.

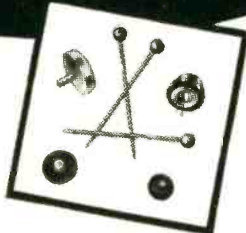

**INDIVIDUAL INSERTS**  
Automatic insert feed  
permits wide variety  
of product possibilities.



**CONTINUOUS INSERTS**  
Small members accurately  
spaced on tape,  
cord, wire, chain, etc.

Completely automatic parts delivered trimmed, ready for use, in one operation, with GRC's speedy, specialized production facilities.  
**NYLON A SPECIALTY.**



Maximum Size:  
.025 oz.—1¼" long.  
**NO MINIMUM!**



**LOW MOLD COSTS**  
**WRITE TODAY FOR**  
**SAMPLES and PRICES**

**GRIES REPRODUCER CORP.**

100 Willow Ave., New York 54 • MO 9-2476

Where the  
Requirements  
are Extreme...

Use  
**SILVER  
GRAPHALLOY**

For extraordinary  
electrical performance



**THE SUPREME BRUSH  
AND CONTACT MATERIAL**

for **BRUSHES**

- for high current density
- minimum wear
- low contact drop
- low electrical noise
- self-lubrication

for **CONTACTS**

- for low resistance
- non-welding character

Graphalloy is a special  
silver-impregnated graphite

Accumulated design experience counts —  
call on us!

**GRAPHITE METALLIZING  
CORPORATION**

1055 NEPPERHAN AVENUE, YONKERS 3, NEW YORK

**GRANT Electronic EQUIPMENT**

# SLIDES

for Consoles • Chassis • Racks

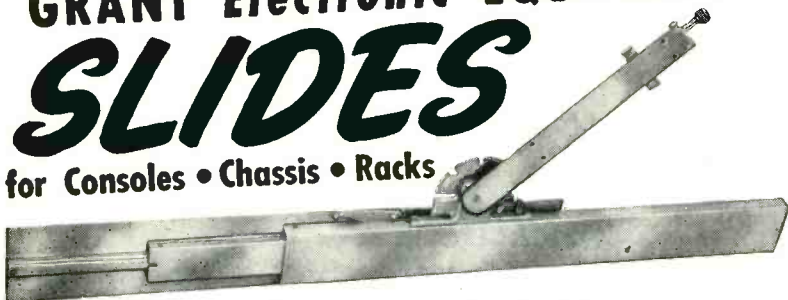

GRANT manufactures standard slides to carry from 25 pounds to 2000 pounds for your every requirement.

GRANT No. 392 Electronic Equipment Slide—Three section, progressive action type slide which locks in open position. Slide includes mechanism for unlocking from outside of chassis and for tilting to 90° angle. Mechanisms vary to suit the individual installation. This slide has been adapted to the standard 19" rack. Load capacity: 100 lbs. per pair depending on length of slide and travel.

Other outstanding advantages:

- Continuous ball bearing action
- Closely fitted sides eliminate chassis rattle

GRANT also manufactures:

- Single or double acting slides
- Side or undercarriage mounting types
- Slides with locking and pivoting devices

Consult with our engineering department on any slide problem.  
Write Dept. E2 for complete illustrated information.

**GRANT PULLEY & HARDWARE CO.**

31-87 Whitestone Parkway, Flushing, L. I., N. Y.



*The foremost name in Sliding Devices*



**General  
Electric  
can build  
and test  
JAN-C-25  
CAPACITORS  
in mass  
production  
quantities**

*Apparatus Department,  
General Electric Company,  
Schenectady 5, New York*

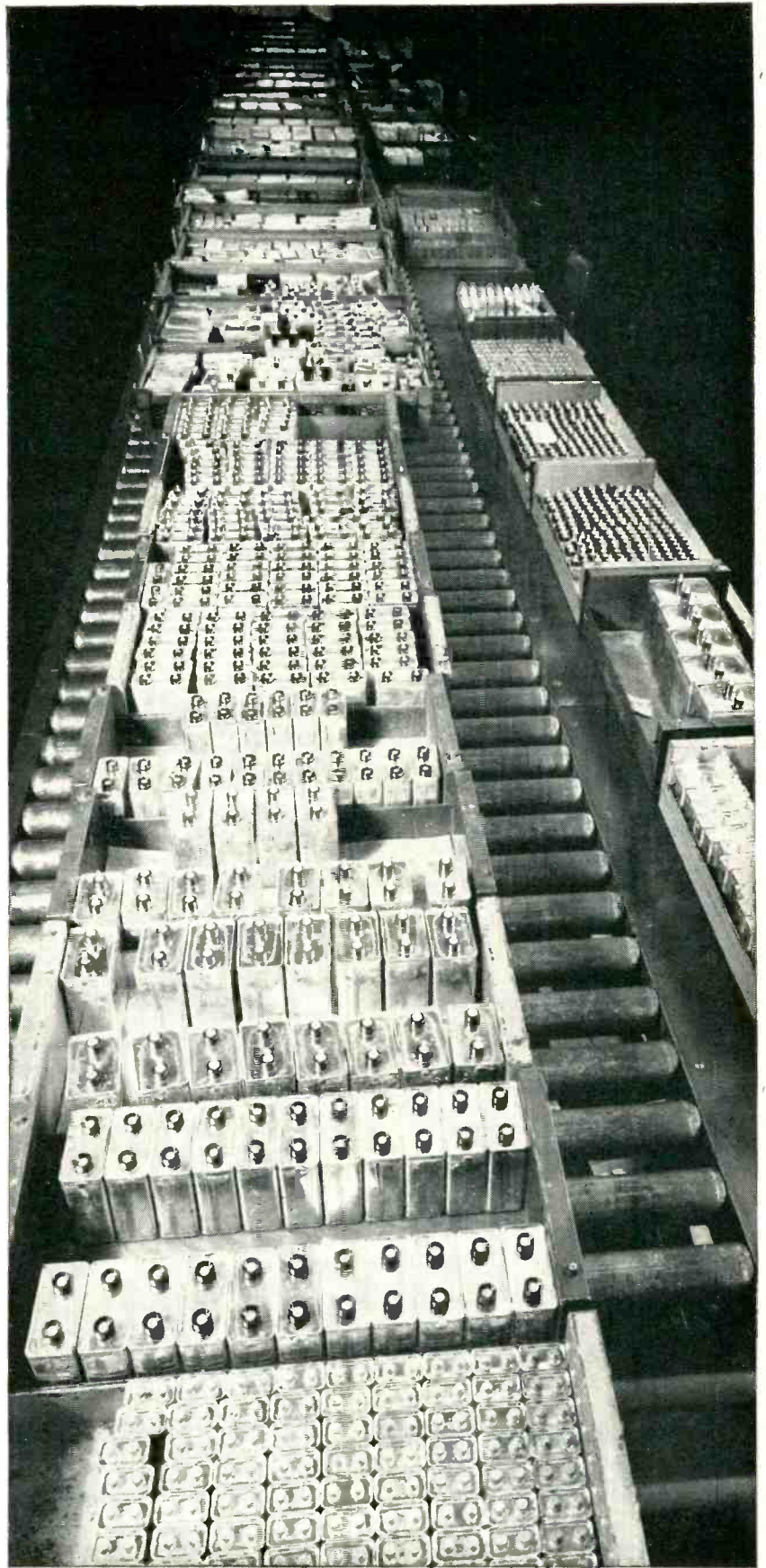

**GENERAL**  **ELECTRIC**

407-301

**It's Powered Right . . .  
When It's Powered with  
TAYLOR TUBES**

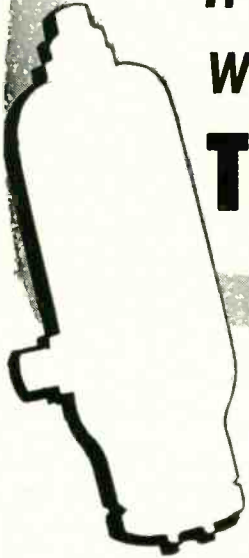

**These Taylor Tubes  
Representatives are  
at Your Service!**

Perry Saffler Associates, Inc.  
53 Park Place  
New York 7, New York

Harold A. Chamberlin  
31 Milk Street  
Boston 9, Massachusetts

Ray T. Schottenberg  
152 Merion Avenue  
Haddonfield, New Jersey

Tanner & Covert  
600 Grant Street  
Pittsburgh 19, Pennsylvania

Fred J. Stevens  
15324 Mack Avenue  
Detroit 24, Michigan

Southern Sales Company  
1135 Lincoln Tower  
Fort Wayne 2, Indiana

J. M. Cartwright & Son  
1336 Madison Avenue  
Memphis 4, Tennessee

J. M. Cartwright & Son  
1145 Peachtree St., N. E.  
Atlanta 5, Georgia

F. C. Somers & Company  
18th and Grand Avenue  
Kansas City 8, Missouri

J. Y. Schoonmaker Company  
2011 Cedar Springs  
Dallas 1, Texas

W. Bert Knight Co., Inc.  
10373 W. Pico Boulevard  
Los Angeles 64, California

Dale G. Weber  
234 Sherlock Building  
Portland 4, Oregon

J. Fred Whitehead  
5403 Massachusetts Ave., N. W.  
Washington 16, D. C.

**CANADIAN FACTORY DISTRIBUTOR**

Atlas Radio Corporation, Ltd.  
560 King Street, West  
Toronto 2-B, Canada  
Cable: ATRADCO

**EXPORT**

Royal National Company, Inc.  
75 West Street  
New York 6, New York  
Cable: NATVARNCO, N. Y.

★ **TRANSMITTING**

★ **INDUSTRIAL**

★ **RECTIFIER**

★ **ELECTRONIC**

*As always, Taylor is producing tubes of superior quality and outstanding performance. The Taylor Representative nearest you is ready and willing to discuss your particular requirements. Call on him for information any time.*

**Taylor** HEAVY **CUSTOM BUILT** DUTY **Tubes**

**TAYLOR TUBES INC., 2312-18 WABANSIA AVE., CHICAGO 47, ILL.**

age in the rotor of one of the synchros. The polarity of the voltage indicates the direction the shaft has been turned, and the amount of voltage is in direct proportion to the difference in position between the two shafts.

A servo system provides the necessary power to turn the lock shaft. The induced voltage is amplified then used to control the motor on the vault lock, making it run in the correct direction and the correct amount to wipe out the difference between the position of the lock shaft and that of the dial shaft.

The servo system makes it possible to turn the lock shaft accurately to within a fraction of one percent by moving the dial with ex-

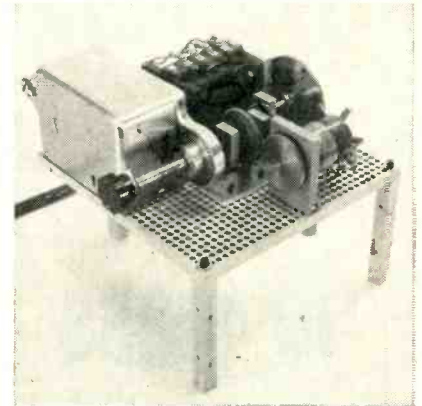

Experimental chassis for safe lock mechanism. Enclosed metal box at left is the lock mechanism. Servo motor to operate lock is at center and driven synchro is at right

tremely small forces. When the last number of the combination is dialed, the servo motor provides the energy to unlock the bolt and pull it back.

The dial can be set up at almost any desired distance from the vault and be placed at any convenient inconspicuous spot. A direct telephone system can then be installed between the man controlling the dial and the person stationed at the vault entrance, and prearranged signals worked out to indicate trouble.

If the man at the vault were held up, he would be unable to open the lock himself, even at the point of a gun, and would have to ask the person in the control room to dial



a product of imagination . . .

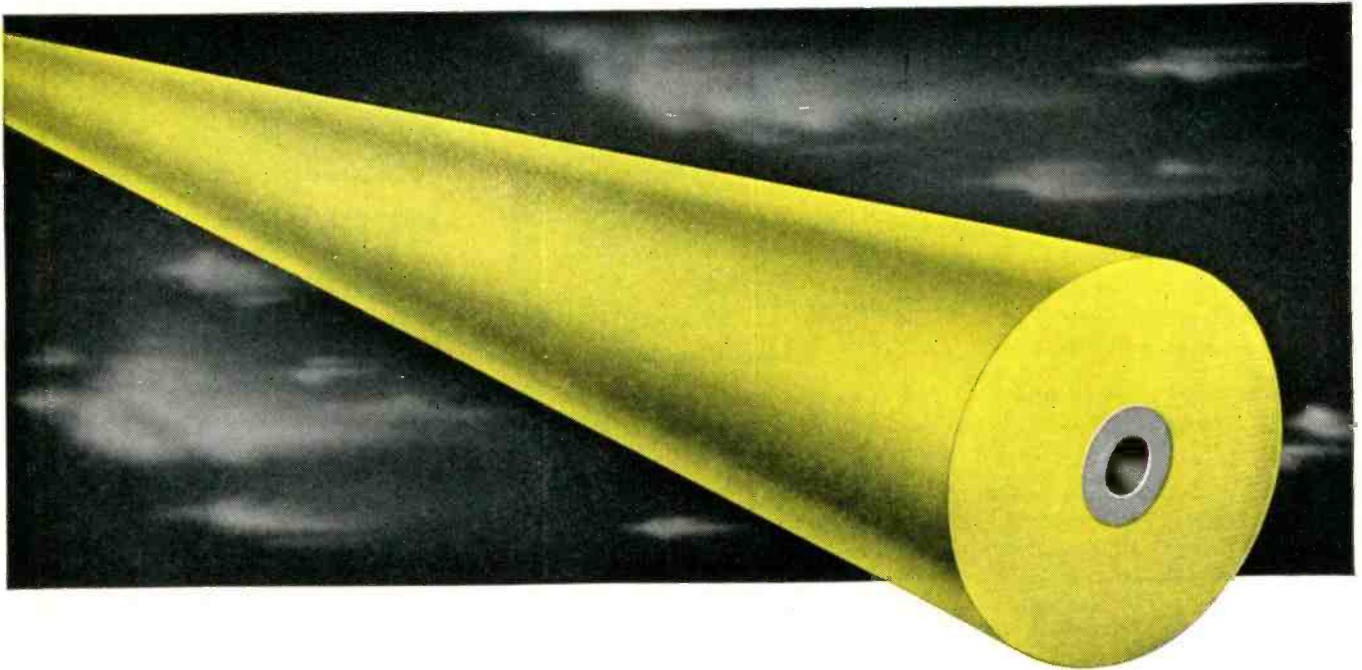

... with an ideal combination of electrical and mechanical properties

By working alongside folks like yourself—at design desks, workbenches, and in laboratories—we've acquired a good idea of the time, care, and imagination you pour into the engineering and production of your products. The thick-skinned insulation tube for an expulsion fuse shown here is a good example. The manufacturer wanted moisture resistance, high strength, weather resistance *plus* excellent arc resistance—all wrapped up in a material that was easy to machine. Working with him, and using a little imagination, C-D engineers came up with *two* different plastics: Laminated Dilecto Tubing for the wall, and Vulcanized Fibre for the core.

It's another example of how you, too, can depend upon C-D to engineer the right laminated plastic for your needs. For C-D has no "axe to grind." We can recommend from five basic plastics subdivided into a remarkably wide range of grades and combinations of grades to supply almost *any combination* of mechanical, electrical, and chemical characteristics. For *this* kind of help and imagination, call your nearest C-D office, any time.



Your success in producing better products

**CELORON** (Molded High-Strength Plastic)  
**MICABOND** (Bonded Mica Splittings)  
**DIAMOND FIBRE** (Vulcanized Fibre)  
**VULCOID** (Resin Impregnated Fibre)  
**DILECTO** (Laminated Thermosetting Plastic)

DE-4-50

BRANCH OFFICES: NEW YORK 17 • CLEVELAND 14 • CHICAGO 11 • SPARTANBURG, S. C. • SALES OFFICES IN PRINCIPAL CITIES.  
WEST COAST REPRESENTATIVE: MARWOOD LTD., SAN FRANCISCO 3 • IN CANADA: DIAMOND STATE FIBRE CO. OF CANADA, LTD., TORONTO 8

**Continental = Diamond** FIBRE COMPANY

Established 1895.. Manufacturers of Laminated Plastics since 1911—NEWARK 16 • DELAWARE

# FM RECEIVER TESTER TF 913/1

## Solves your FM Problems

Comprising fm/am signal generator, audio output power meter and crystal calibrator, this compact portable tester is ideal for shop or field use.



- 22 - 176 mc, crystal 0.02%
- 1 $\mu$ V - 31.6 mV and force output
- 0 - 100 kc deviation, 50 - 15,000 cps.
- 30% am at 1,000 cps.
- 10 mW - 1W audio power

Other Marconi fm instruments include:

FM/AM SIGNAL GENERATOR TF 948 — fm standard signal generator.  
 FM/AM SIGNAL GENERATOR TF 995 — Wide range general purpose unit.  
 FM DEVIATION METER TF 934 — Direct reading monitor, 0 - 75 kc.

## MARCONI INSTRUMENTS

23-25 BEAVER STREET · NEW YORK 4

CANADA: Canadian Marconi Co., Marconi Building, 2442 Trenton Avenue, Montreal  
 ENGLAND: Marconi Instruments Limited, St. Albans, Herts.

*Unless the Dry Battery You Need  
 Is Listed in This Free Manual...*



**BURGESS ENGINEERS WILL  
 DESIGN A NEW BATTERY TO  
 MEET YOUR SPECIFICATIONS**

It's all part of the Burgess Service! This complete Engineering Manual lists *hundreds* of battery types developed by Burgess Engineers to meet new requirements. If the specific battery you need is not among them, the complete Burgess facilities, design, production, and engineering will be placed at your disposal to build the battery you need in any quantity —large or small!

**Write for ENGINEERING MANUAL and CHECK SHEET**

No obligation. By return mail you will receive the FREE Engineering Manual listing the complete line of Burgess Batteries together with specifications; also the Burgess "Check Sheet" on which you may outline your requirements in the event that the battery you need has not already been developed. Address:

**BURGESS BATTERY COMPANY**  
 (DEPT. E-6) FREEPORT, ILLINOIS

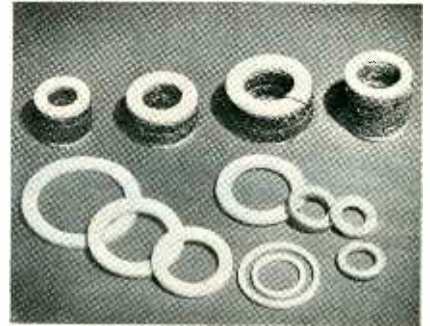

## "TEFLON" A PLASTIC HAS OUTSTANDING ELECTRICAL PROPERTIES

• It's power factor is less than 0.05% over the entire spectrum measured to date, 60 cycles to 30,000 megacycles. Its volume resistivity is greater than  $10^{15}$  ohm-cm. even after prolonged soaking in water. The surface resistivity of the plastic is quite high and drops to only  $10^{13}$  ohms at 100% relative humidity. "Teflon" also shows good arc resistance. On exposure to an arc, the material is decomposed to a vapor which leaves no carbonized path regardless of time of exposure to the arc. Short time dielectric strengths are high. These values range from 1000 to 2000 volts per mil., depending on thickness. "Teflon" is almost as good in this respect at 200°C (392°F) as at room temperature.

We have complete manufacturing facilities to mold "Teflon" for your application in the following shapes:

- Tapes
- Special Molded Shapes
- Tubes
- Sheets
- Packing Sets
- Gaskets Plain and Envelope
- Rods

SEND FOR CATALOGUE 711

*John L. Dore Inc.*  
**MOLDERS OF "TEFLON" SHAPES**

P. O. BOX 6002

5406 Schuler, St. Houston 6, Texas





# BE SURE YOU'RE RIGHT!

“

His simple creed for word or deed

True as the bullet sped—

And rung the target straight:

'Be sure you're right, then go ahead.'

James Jeffery Roche



Production Sample  
**GRACOIL**  
Input Transformer

Quality of Product—Efficiency in Service  
More Functional Methods

One good Turn—or a Million

FILAMENT  
AUDIO  
TRANSFORMERS  
•  
FILTER REACTORS  
•  
ISOLATION-STEP-UP  
STEP-DOWN  
TRANSFORMERS  
•  
WINDINGS

# GRAMER

## TRANSFORMER

C O R P O R A T I O N

2734 N. PULASKI ROAD • CHICAGO 39, ILLINOIS

SEND YOUR  
B/P  
SPECIFICATIONS

To: **PRIME CONTRACTORS**  
and **SUBCONTRACTORS**  
on **GOVERNMENT WORK**..

★ It's a promise! Your first test of a Gracoil Transformer in your electrical equipment will be a satisfying discovery. For we offer our product on a "prove it first" basis. No guesswork. Simply arrange for a *production sample* Gracoil transformer built to your b/p specifications. Test it under actual operating conditions. Then order production quantities with absolute assurance of physical and electrical correctness, uniformity for easy assembly, substantial savings on profit-tight contracts.

*James M. Blackledge*  
PRESIDENT



**FIXED RESISTORS**  
( $\frac{1}{2}$ -, 1- and 2-watts)



**VARIABLE RESISTORS**



**IRON CORES**



**CERAMAG® (FERRITE) CORES**



**LINE AND SLIDE SWITCHES**



**CHOKE FORMS**



**GA CAPACITORS**

## WRITE FOR NEW CATALOG



Your request (on company stationery) will bring you this new 42-page catalog containing latest data on the complete line of standard Stackpole electronic components plus helpful engineering data. Ask for Catalog RC-8.

# STACKPOLE

Electronic Components Division  
**STACKPOLE CARBON COMPANY**  
St. Marys, Pa.

the combination. In making the request he could say the code word or phrase to indicate a holdup. In order to protect the man at the vault, the control man could unlock the vault but at the same time signal for the police.

A typical use of such a system might be in a bank. The dial could be secreted in the office of the president or other designated officer. From this one spot, the officer would be able to control any number of vaults either in the same building or in branch banks miles away through the use of refined telemetering techniques. Both wire and wireless telemetering are available for remote control.

On installations in which the control dial is only a few hundred feet from the vault, the problem of interconnecting the wires is simple. Precautions should be taken to protect the wiring.

Cutting the connecting wires will not affect the operation of the lock mechanism, unlike a burglar-alarm system, which cannot work when the wires are cut. In order to profit from cutting the wires of the electronic lock control, a burglar would have to have a duplicate synchro and connect it to the three cut wires in the proper order and he would still have to know the combination of the lock and open it by remote control.

### Submarine Telephone Cable With Submerged Repeaters

BY J. J. GILBERT  
*Bell Telephone Laboratories, Inc.*  
New York, N. Y.

A NEW type submarine telephone cable system was installed between Key West, Florida, and Havana, Cuba, in April of 1950, comprising cables No. 5 and 6 of the Cuban-American Telephone and Telegraph Company.

Included within the armor of the new submarine cables are electron-tube repeaters designed to pass through the cable-laying machinery during normal laying procedure. The repeaters are designed so that they should not require servicing for the purpose of changing defective



1. Designed for stable, accurate amplification that is simple in operation and low in cost, the Microsen D.C. Amplifier can help you solve your d.c. amplification problems. Covering an exceptionally wide range of applications, the versatility of this instrument makes possible new approaches in engineering research and process development.

**It All Adds Up To Stable, Accurate Amplification...**

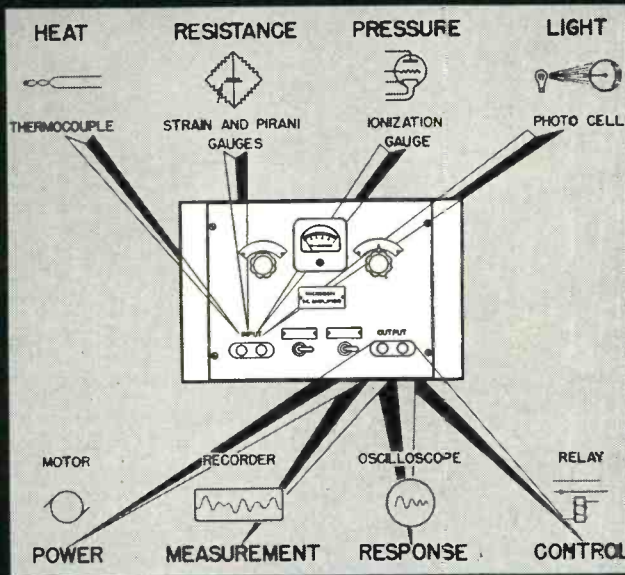

**Simple In Operation Low In Cost**

2. The Microsen D.C. Amplifier is compact to provide both easy portability and convenient general use. It is designed with three different ranges within a single model. Readily available types include Voltage, Current, and Potentiometer Amplifiers, Direct Current Converters, Direct Current Transformers and engineered designs to meet special requirements.

3. Typical applications in the field of measurement include:  
**ELECTRONICS** in tube development, vacuum gauging, wave guide studies.  
**ELECTRICAL BRIDGES** in resistor inspection, moisture detection, transient stresses, conductivity measurements, vacuum gauging.  
**ELECTROLYSIS** in electrolytic plating, production control, electrolytic process.  
**GAS ANALYSIS** in mixture control, efficiency of filters,

detection of explosive mixtures.  
**PHOTOMETRY** in fluid flow and turbulence, polarimetry, physiology of blood and density.  
**THERMOMETRY** in combustion research, gas turbine development, meteorology, distillation processes, thermocouple inspection.  
 Inquiries for modification within the scope of the Microsen D.C. Amplifiers are invited. If possible, please send complete application specifications.



**MICROSEN**

ELECTRICAL INSTRUMENTS

A Product of

**MANNING, MAXWELL & MOORE, INC.**  
 STRATFORD • CONNECTICUT

Makers of 'Microsen' Electrical and 'American' Industrial Instruments, 'Hancock' Valves, 'Ashcroft' Gauges, 'Consolidated' Safety and Relief Valves. Builders of 'Shaw-Box' Cranes, 'Budgit' and 'Load Lifter' Hoists and other lifting specialties.



Manning, Maxwell & Moore, Inc.  
 250 East Main Street  
 Stratford, Conn.

We are interested in the Microsen D. C. Amplifier. Application specifications and/or specific queries attached   
 Please send bulletin describing the instrument

Name \_\_\_\_\_  
 Position \_\_\_\_\_  
 Company \_\_\_\_\_  
 Street Address \_\_\_\_\_  
 City and State \_\_\_\_\_



# TUNG-SOL ELECTRON TUBES

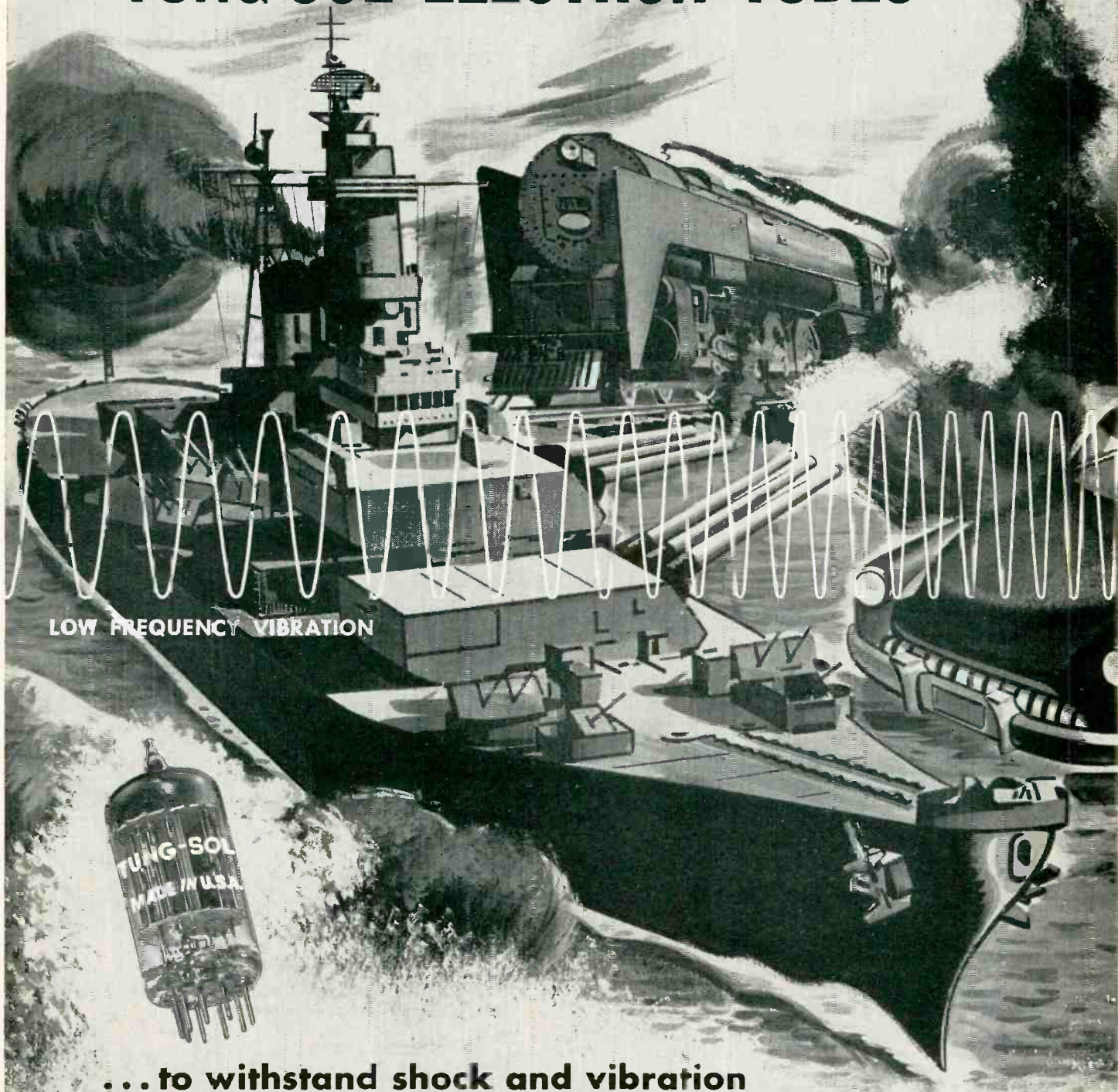

LOW FREQUENCY VIBRATION

## ... to withstand shock and vibration

Shock! Vibration! Both are major problems in military and industrial applications of electron tubes.

Yet, electron tubes *are* built which withstand the thunderous shock of battleship gunfire, the vibration fatigue of a jet plane, or the violent acceleration of a guided missile.

However, the engineering solutions to these problems are not necessarily the same.

TUNG-SOL produces such tubes—ruggedized and vibration-tested to give top performance in military and industrial service. TUNG-SOL's statistical quality control methods in manufacturing make uniformity and dependability



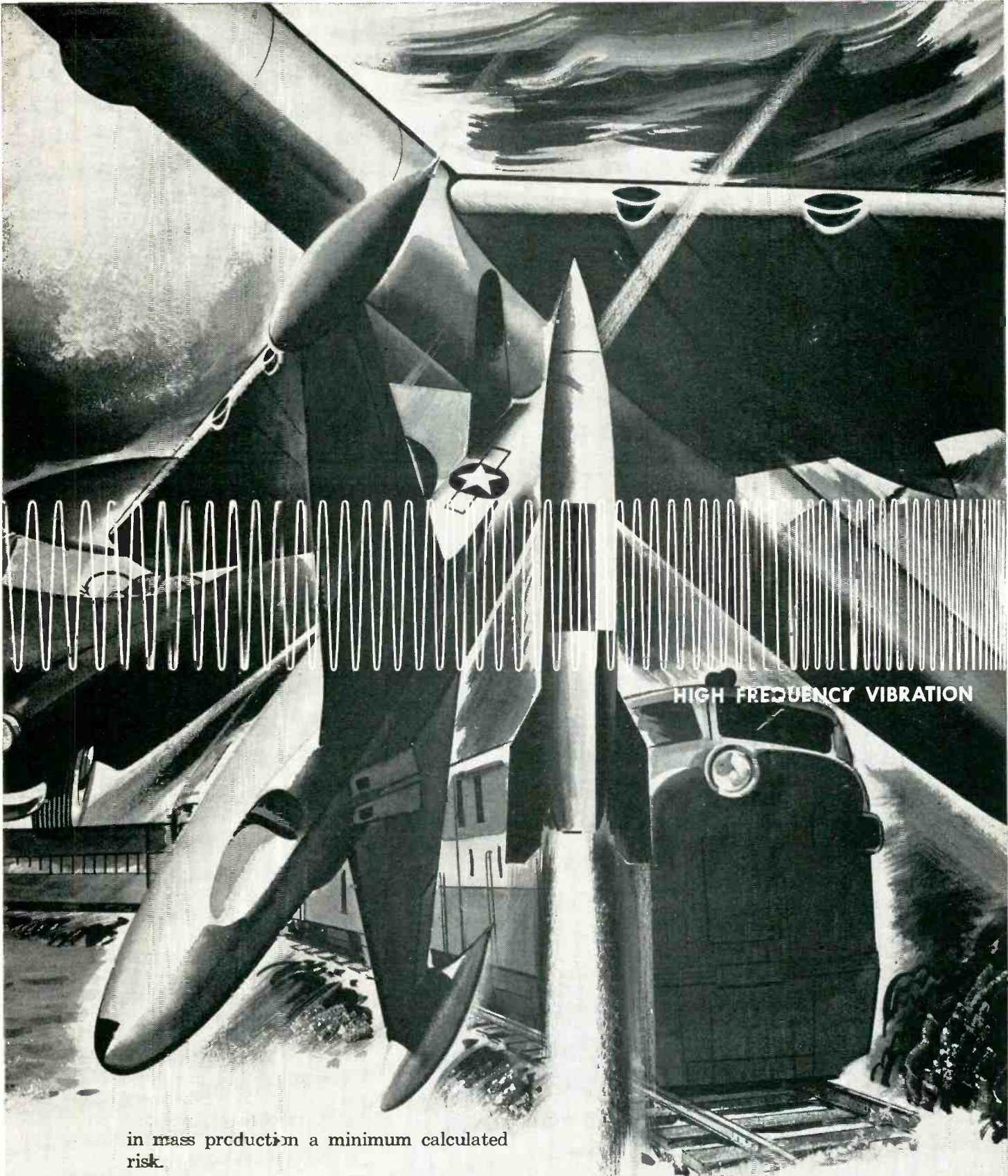

HIGH FREQUENCY VIBRATION

in mass production a minimum calculated risk.

Whether you build a guided missile or a jeep, TUNG-SOL has the technical know-how to design and manufacture electron tubes to meet your requirements with every assurance of complete satisfaction.

## TUNG-SOL LAMP WORKS INC.

95 Eighth Avenue • Newark 4, N. J.

SALES OFFICES:

Atlanta • Chicago • Dallas • Detroit • Los Angeles • Newark



Improve Your  
Product through  
Sound Research



WITH

Magnecorder  
High Fidelity Tape Recorders for Industry

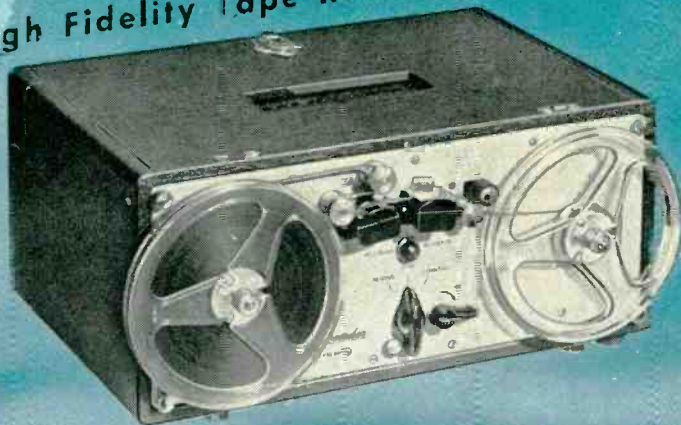

Telemetry of guided missiles demands the finest precision tape recording . . . precision that has made Magnecord outstanding in the field of industrial and defense research. Whatever your recording problem, Magnecorders offer greater flexibility, fidelity. Available for subsonic audio or supersonic research, Magnecord can fill your most exacting requirements.

Write for complete specifications

**Magnecord, INC.**

360 N. Michigan Ave., Dept. EA-6  
Chicago 1, Illinois

- NOISE ANALYSIS
- PROCESS CONTROL
- VIBRATION TESTS
- TELEMETERING



FIG. 1—Submarine cable repeater being taken off cable ship after laying tests

circuit elements or electron tubes over a period of about 20 years.

The repeater appears as a bulge in the cable about three inches in diameter and tapers off in both directions to the cable diameter of a little over an inch. Total length of the expanded cable diameter is about 35 feet. The repeater was designed to be flexible enough in the cable so that it can follow the curvature of the brake drum and the sheaves in the laying gear on the cable ship. Figure 1 shows a repeater with stub cables.

The first three submarine cables between Key West and Havana were laid in 1921<sup>1</sup> and, in 1930, cable No. 4 was installed<sup>2</sup>. After World War II, when demand for circuits to Havana continued to grow, it was decided to use the submerged repeater in cables No. 5 and 6.

#### Repeater Requirements

Because the stretch of water between Florida and Cuba reaches a depth of 6,000 feet in some places, the first major requirement of a submerged repeater is that it must be able to withstand the high hydrostatic pressures encountered in waters of this depth.

A second important requirement is that the operation of getting the repeater overboard from the cable ship should not slow up the functioning of the laying process. As previously mentioned, this requirement was met by making the repeater structure flexible, within practical limits, and as small as possible in diameter so that it could pass around the drum and sheaves of the laying gear like any ordinary length of cable.

From operating and commercial points of view, a third requirement



Description:

1. In order to compare the output wave form of three different line voltage regulators, a DuMont Type 304-H oscillograph was connected to the output of each in turn. Regulators A and B were loaded with 250 watts while Regulator C was loaded by an additional 550 watts, since it is rated for much greater loads.
2. Each of the wave forms was recorded with an oscillograph record camera.
3. The RC filters of Figure 1 were connected between the regulator outputs and the CRO Y input and the wave forms were again recorded for comparison.

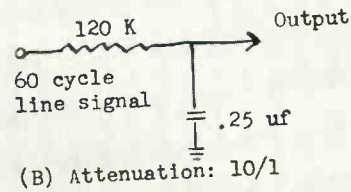
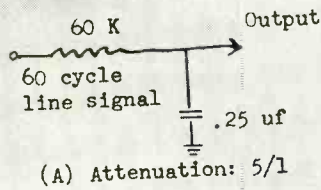
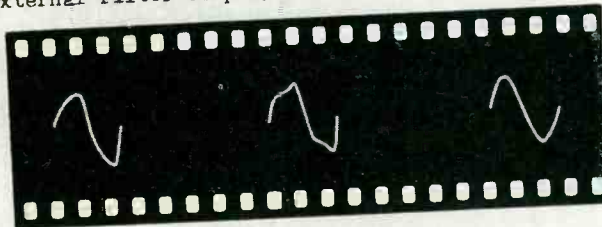

Figure 1

Results:

Fig. 2 shows the signal waveform of output of three different line regulators without external filter displayed on a DuMont Type 304-H.



Voltage Regulator A    Voltage Regulator B    Voltage Regulator C

Fig. 3. Improvement of output wave form of Regulator B using filters of Fig. 1.

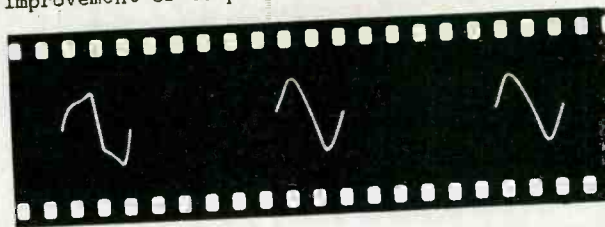

No External Filter    Filter A    Filter B

## Photography makes a sine wave's signature indelible

The oscillograph traces analyzed in this report leave no doubt as to results. Every detail of wave form is captured by photography for quick, accurate reference. A similar test need never be set up again because of inaccurate drawings or faulty memory.

Team your oscillograph with photography and you make it a recording device that gives you clear, sharp, incontrovertible records. It saves time and money, and makes your work much easier. Eastman Kodak Company, Industrial Photographic Division, Rochester 4, N. Y.

**PHOTORECORDING . . . an important function of photography**







# meets JAN-R-19

## VARIABLE WIRE WOUND RESISTORS TO ALL SPECIFICATIONS IN JAN-R-19

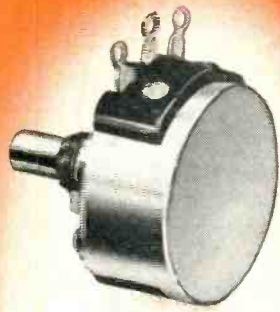

JAN Type RA 20A  
2 Watt (CTS Type 252)

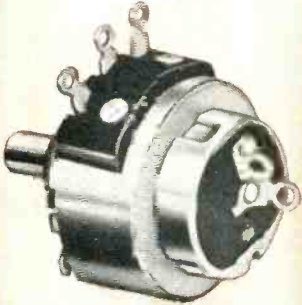

JAN Type RA 20B  
2 Watt (CTS Type GC-252)

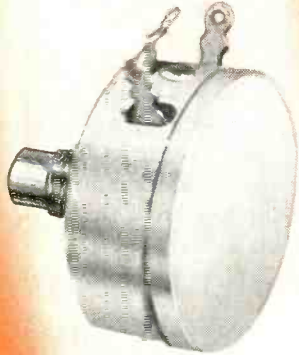

JAN Type RA 25A  
3 Watt (CTS Type 25)

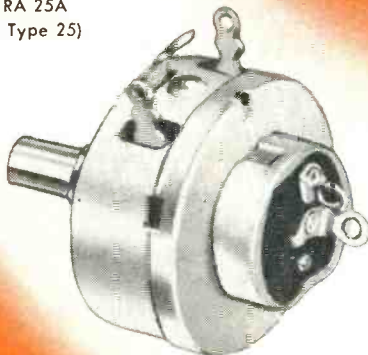

JAN Type RA 25B  
3 Watt (CTS Type GC-25)

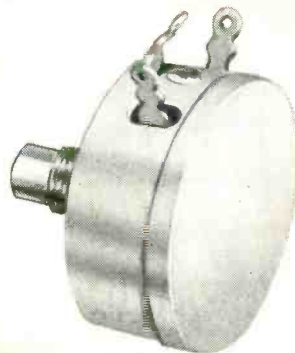

JAN Type RA 30A  
4 Watt (CTS Type 25)

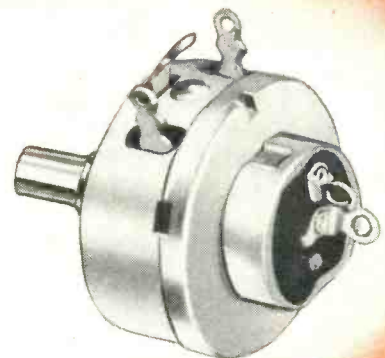

JAN Type RA 30B  
4 Watt (CTS Type GC-25)

### TYPES NOW AVAILABLE

JAN TYPE	CTS TYPE	WATT RATING
RA 20A	252 (without switch)	2
RA 20B	GC-252 (with switch)	2
RA 25A	25 (without switch)	3
RA 25B	GC-25 (with switch)	3
RA 30A	25 (without switch)	4
RA 30B	GC-25 (with switch)	4

Exceptionally good delivery cycle due to tremendous precision mass production facilities.

Please give complete details on your requirements when writing or phoning for further information.

ILLUSTRATIONS ARE ACTUAL SIZE.



### CHICAGO TELEPHONE SUPPLY Corporation

ELKHART + INDIANA

#### REPRESENTATIVES

S. J. Hutchinson, Jr.  
401 North Broad Street  
Philadelphia 8, Pennsylvania  
Phone: Walnut 2-5369

W. S. Harmon Company  
1638 South La Cienega Blvd.  
Los Angeles, California  
Phone: Axminster 3-6219

#### IN CANADA

C. C. Meredith & Co.  
Streetsville, Ontario

#### SOUTH AMERICA

Jose Luis Pombal  
Buenos Aires, Argentina  
Montevideo, Uruguay  
Rio de Janeiro, Brazil  
Sao Paulo, Brazil

#### OTHER EXPORT

Sylvan Ginsbury  
8 West 40th Street  
New York 18, N. Y.

A COMPLETE LINE OF VARIABLE RESISTORS (COMPOSITION AND WIRE WOUND) FOR MILITARY APPLICATIONS:

*Specialists in Precision Mass Production of Variable Resistors*

FOUNDED 1896



Another  
**BALLANTINE**

achievement in  
**SENSITIVE ELECTRONIC VOLTMETERS**

... **THE MODEL 310A**, a Super-Sensitive Electronic Voltmeter, measuring 100 microvolts to 100 volts from 10 cycles up to 1 MC with 3% accuracy (and up to 2 MC with 5% accuracy) at any point on the single logarithmic voltage scale.

- Input Impedance is 2 megohms shunted by 15 mmfds on the 0.001 and the 0.01 ranges and by 8 mmfds on the other ranges.
- Generous use of negative feedback provides customary Ballantine stability.
- Null Detector Switch enables instrument to be used as a null balance detector in bridge measurement work down to 20 microvolts.
- Six decade range switch permits entire voltage range to be read on a single voltage scale. Linear DB Scale.
- Illuminated and hand-calibrated meter scale.
- Amplifier section may be separately used as a 60, 40 or 20 DB pre-amplifier flat within  $\frac{1}{2}$  DB up to 2 MC.
- Available multipliers increase the voltage range to 1,000 or 10,000 volts.
- Available precision shunt resistors permit the measurement of AC currents from 1 ampere down to one-tenth of a microampere.



**MODEL 310A**  
Price: \$235.

For further information on this Voltmeter and the Ballantine Model 300 Voltmeter, Battery Operated Voltmeters, Wide Band Voltmeters, Peak to Peak Voltmeters, Decade Amplifiers, Multipliers and Precision Shunt Resistors, write for catalog.

**BALLANTINE LABORATORIES, INC.**

100 FANNY ROAD, BOONTON, NEW JERSEY



is necessary, that the circuit elements of the repeater should be designed for long life under operating conditions to assure freedom from trouble or replacement of parts over a period of 20 years or more. This considerable period of trouble-free operation is desirable because of the expense of a cable-repair operation. Long life of the circuit elements presents an especially difficult problem when the space available for the elements must be minimized in order to keep the repeater diameter small.

Still another requirement relating to circuit elements is one of ruggedness. When laying cables in deep waters, the cable is often under a tension of several thousand pounds and the delicate elements of the repeater may be subjected to dangerous shocks.

Lastly, the armor unlays somewhat as a consequence of the cable tension and, as a result, twist and elongation are imposed on the interior structure, either coaxial circuit or repeater housing. The repeater housing is much more susceptible to damage from this cause than the cable circuit.

#### Repeater Housing

Design of the repeater housing and of the end seals, the means by which the cable enters and leaves the housing, was influenced largely by the requirements of flexibility and watertightness under ocean-bottom pressures.

The housing consists of a long tube of soft copper,  $1\frac{3}{4}$  inches in diameter and 0.03 inch thick, internally supported against collapse under pressure by an assemblage of abutting steel rings, each  $\frac{3}{4}$ -inch wide. The housing is made rigid by means of thinner steel rings of the same width overlaying and staggered relative to the thicker rings.

The housing can be bent to a radius as small as three feet without undue distortion to the copper envelope. When sealed at the ends, the structure is capable of withstanding pressures as high as 10,000 psi.

The insulated conductor of the cable is fed into each end of the housing by means of a series of seals. The glass-metal-type inner or



# A NEW CLARE RELAY...

## the Type "R"

combines extremely small size with unusual sensitivity and long life

CLARE Type "R" RELAY



Approximately Actual Size

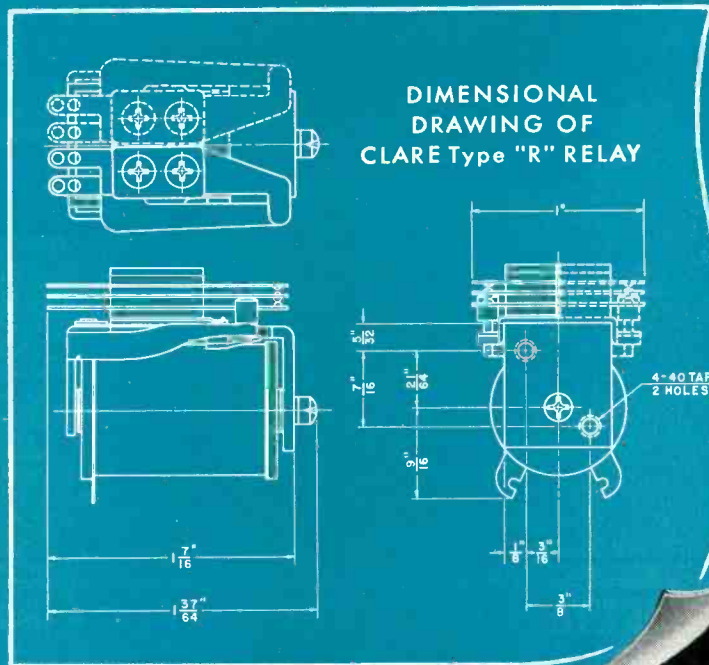

### SPECIFICATIONS

#### SIZE

Length:  $1\frac{7}{16}$ "—Height:  $1\frac{37}{64}$ "—  
Width: 1"

#### WEIGHT

Approximately 2 ounces

#### COIL

Single or double-wound

#### OPERATING VOLTAGE

Up to 230 volts d-c

#### ARMATURE

Single or double arm

#### CONTACT ASSEMBLY

Form A to C. Maximum of 10  
springs in each pileup.

#### MOUNTING

Two #4-40 tapped holes in end of  
heelpiece

● This new CLARE Type "R" d-c Relay embodies many features of the famous CLARE Type "K" Relay, which was the first to combine the advantages of a telephone-type relay with the small size, light weight and resistance to vibration required to meet the rigid demands of aircraft service.

In appearance, the Type "R" resembles the Type "K", but, through hardly noticeable structural differences, CLARE has given the new Type "R" even greater sensitivity and operating range. Both relays use the same contact springs, but the Type "R" coil is longer and of larger diameter, to provide greater winding space. Life expectancy of the new relay has been not only increased but multiplied.

The CLARE Type "R" Relay retains in an improved form the reed armature suspension which discerning engineers have come to recognize as one of the subtler reasons for the superior performance of CLARE Type "K" Relays over other relays of comparable size and somewhat similar appearance.

The Type "R" is available as either an open or hermetically sealed relay. Clare sales engineers are located in principal cities to give you firsthand information on this new relay and to cooperate with you on any complex relay problem. Call them or write to C. P. Clare & Co., 4719 West Sunnyside Avenue, Chicago 30, Illinois. In Canada: Canadian Line Materials Ltd., Toronto 13. Cable Address: CLARELAY.

Write for CLARE Bulletin No. 115

# CLARE RELAYS

First in the Industrial Field

# 5 Big Reasons WHY AIRPAX CHOPPERS ARE AN ESTABLISHED STANDARD FOR THE INDUSTRY!

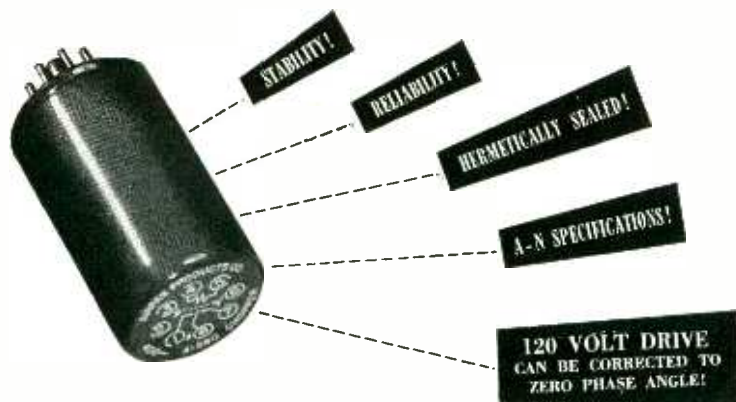

## AIRPAX A580 400 CYCLE CHOPPERS

Modulating minute DC potentials, this chopper combines rugged action with sensitivity and precision for delicate servo applications.



# ENGINEERS DESIGNERS PHYSICISTS

THE Aerophysics & Atomic Energy Research Division of North American Aviation, Inc. offers unparalleled opportunities in Research, Development, Design and Test work in the fields of Long Range Guided Missiles, Automatic Flight and Fire Control Equipment and Atomic Energy. Well-qualified engineers, designers and physicists urgently needed for all phases of work in

- Supersonic Aerodynamics,
- Preliminary Design & Analysis,
- Electronics,
- Electro-Mechanical Devices,
- Instrumentation,
- Flight Test,
- Navigation Equipment,
- Controls,
- Servos,
- Rocket Motors,
- Propulsion Systems,
- Thermodynamics,
- Airframe Design,
- Stress & Structures.

Salaries Commensurate with training & experience.  
Excellent working conditions.  
Finest facilities and equipment.  
Outstanding opportunities for advancement.

Write now — Give complete resume of education, background and experience

PERSONNEL DEPT.  
AEROPHYSICS & ATOMIC ENERGY  
RESEARCH DIVISION  
NORTH AMERICAN AVIATION  
INC.  
12214 LAKEWOOD BLVD.  
DOWNEY, CALIFORNIA

## CABINETS • CHASSIS • PANELS • RACKS

### Planning ELECTRONIC EQUIPMENT? Investigate the ECONOMIES of PAR-METAL HOUSINGS!

We manufacture Metal Housings for every purpose — from a small receiver to a deluxe broadcast transmitter. And the cost is low!

Because we specialize in the Electronics field, Par-Metal Products excel in functional streamlined design, rugged construction, beautiful finish, and economy.

Remember, Par-Metal equipment is made by electronic specialists, not just a sheet metal shop.



# PAR-METAL

PRODUCTS CORPORATION  
32-62 — 49th ST., LONG ISLAND CITY 3, N. Y.  
Export Dept.: Rocke International Corp.,  
13 East 40 Street, New York 16, N. Y.



WRITE FOR CATALOG!



40.109  
240.65  
1174.6  
20000.  
— OR ANY OTHER

**precision**

**FREQUENCY**

**FROM 40 TO 20,000 CYCLES**

CONSERVATIVE ACCURACY UNDER USUAL CONDITIONS  
1 PART IN 100,000—(.001%)

Have you a need for any specific number of cycles in precision frequencies?

Can a source of such frequency solve your design problem or increase its factor of safety?

Have you a system that requires great accuracy, stability and dependability?

The frequencies shown at the top of the page are but a few among hundreds furnished for precision application in industries, laboratories and Government departments.

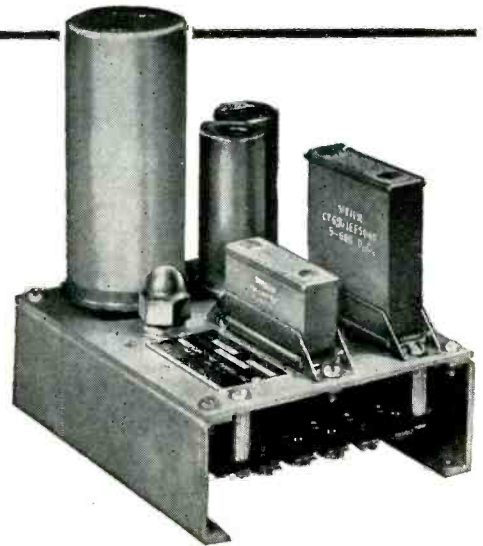

CALIBRATED AGAINST A STANDARD  
ACCURATE TO 1 PART IN 10-MILLION

*The basic unit of this frequency standard is an electronically driven fork,—temperature compensated and hermetically sealed against changes of humidity and barometric pressure. Through its use, any frequency or multi-frequencies between 40 and 20,000, fractional or otherwise, are obtainable.*

**OUR ENGINEERS  
ARE AVAILABLE  
TO COOPERATE  
ON ANY PROBLEM**

**American Time Products, Inc.**

**580 Fifth Avenue**

**New York 19, N. Y.**

MANUFACTURING UNDER PATENTS OF WESTERN ELECTRIC CO.



AMERICA'S  
LEADING INDUSTRIAL PLANTS

RELY ON

**MILO**

FOR URGENTLY-NEEDED  
ELECTRONIC PARTS

FROM coast-to-coast, Industrial Organizations everywhere have come to realize that MILO SERVICE is one that is unsurpassed!

*The Secret?*

— MILO TEAMWORK!

Every order or inquiry, whether large or small, receives highly personalized attention from a CO-ORDINATED TEAM of EXPERTS!

THERE'S no haphazardness at MILO. We pride ourselves on the high speed efficiency of our great staff, every man and woman of which is highly trained and experienced, with broad technical knowledge, working with precision accuracy—aiming to give customer satisfaction.

THAT'S just one of the reasons why thousands of America's leading industrial giants continue to look to MILO for their every electronic need.



**FREE!** 1053 PAGE  
MILO CATALOG

*Purchasing Agents!*

Write today on your company letterhead for this gigantic, ready-reference buying guide and directory, listing latest electronic equipment, complete with technical specifications, illustrations and prices. (Necessarily limited to responsible purchasing officials only.) Address Dept. EL.

**MILO** stocks practically **EVERYTHING** for all electronic applications in scores of industries—radio, television, broadcasting, gas, oil refining, public utilities, power and light, mining, chemicals, plastics, ceramics, electro-plating, aviation, textiles, coal and iron, railroading, transportation, construction, signaling, telephone and telegraphic communications—as well as being suppliers to schools, colleges, research laboratories, police, fire and marine departments of municipal, city, state and U. S. Government agencies, including the Signal Corps, Army, Navy, Air Force and foreign government agencies.

OUR huge warehouse stocks permit us to offer instant shipment on thousands of nationally-advertised, standard brand electronic products—and, if by chance not in stock (we are human, too), due to our close relations with our many factory suppliers, we can get it for you with unbelievable speed.

**LET US HELP SOLVE YOUR  
MATERIAL PROBLEMS, TOO!**

for  
**FASTER**  
service  
**TELETYPE**  
Your Orders  
and Inquiries  
—  
OUR NUMBER IS  
**NY1-1839**

*Leading Brands*

— IN STOCK!

ADVANCE ELECTRIC  
AEROVOX • ALPHA WIRE  
AMPHENOL • ATR  
BELDEN • BLILEY  
BOGEN • BUD • BURGESS  
BUSSMAN • CINCH-JONES  
CLAROSTAT  
CORNELL-DUBILIER  
DEJUR-AMSCO • DIALCO  
DRAKE • EITEL-McCULLOUGH  
ERIE • GENERAL CEMENT  
GENERAL ELECTRIC  
GUARDIAN ELECTRIC  
HAMMARLUND  
HICKOK • HYTRON • ICA  
IRC • E. F. JOHNSON  
KESTER • KINGS ELECTRONICS  
LITTELFUSE  
MALLORY • MEISSNER  
JAMES MILLEN • NATIONAL CO.  
OHMITE  
PAR-METAL  
POTTER & BROMFIELD  
PRECISION APPARATUS  
PREMAX  
SANGAMO • SHALLCROSS  
SHURE BROS.  
SIMPSON ELECTRIC  
SOLA ELECTRIC  
SPRAGUE  
STANDARD TRANSFORMER  
SUPERIOR ELECTRIC  
SYLVANIA  
TUNG-SOL  
TRIPLETT • UNGAR ELEC.  
UNITED TRANSFORMER  
WARD LEONARD  
WESTON  
and many, many others!

**One Call—Gets Them All!**

WRITE — WIRE — PHONE  
— or TELETYPE, TODAY!

**MILO RADIO**

**& ELECTRONICS CORP.**

200 GREENWICH STREET, NEW YORK 7, N. Y. • Tel. BEekman 3-2980  
Cable Address: MILOLECTRO • The ONE Source for ALL your electronic needs.

vapor seal is capable of withstanding hydrostatic pressures. The next seal is made of a central brass tube and an external brass member, both vulcanized to rubber, which joins the insulating material of the cable.

The seals are coaxial in form with the outer member brazed to the housing or an extension of it. A close-fitting tube of copper extends over the cable insulation for a distance of about seven feet and is brazed to an extension of the copper envelope of the housing. The tube is filled with vistac and sealed at the distant end with a neoprene sleeve which joins firmly to the cable insulation and the core tube.

Corrosion protection layers and a bedding for the armor wires, built up in the form of a taper, are provided for the repeater housing and core tube. The armor consists of a continuation of the cable armor wires with additional wires interspersed because of the larger diameter of the repeater.

A second layer of wires with a direction of lay opposite to that of the main armor is employed to prevent twisting of the container due to the unlaying of the armor wires under tension. The repeater may be armored either as part of the cable or separately, with a stub on each end, and spliced into the cable.

#### *Repeater Circuit*

The main problem in designing the repeater circuit was to package the elements involved in a high-gain electron-tube amplifier in the restricted space available. The complete amplifier is made up of an assembly of composite lucite cylinders, each about five inches long, with successive units joined together by a spring assembly. Each lucite cylinder contains the related electrical elements of one particular part of the repeater circuit.

Groups of smaller elements are rigidly mounted in a lucite form which slides into an insulating envelope made up of two close-fitting lucite shells held in place by end pieces of lucite. Electrical interconnection of the various parts is made possible by eight copper tapes laid in axial slots between the shells and extending over several sections



they

may

look

alike,

but:

there

is

only

one

**C-D**

# THE STANDARD IN THE FIELD OF HIGH POWER OSCILLATORS



type 50 series

## C-D HIGH POWER MICA TRANSMITTER CAPACITORS

Typical of the many C-D firsts are the type 50 mica capacitors. Only C-D micas can point to a record of dependable service of over forty years. Here's why:

**Series mica stack**—C-D first to use and patent this construction. Affords uniform voltage gradient!

**India-ruby mica**—Sheets individually tested for uniform thickness and dielectric strength!

**Special exclusive high melting point low loss filler**—Reduces stray field losses; protects against humidity!

**Vacuum impregnated assembly**—Assures high insulation resistance; low losses; eliminates air voids!

**High pressure maintained on stacks**—Results in high Q; good capacity stability.

**Cast-aluminum end caps**—Low-resistance, wide-

path, positive-contact terminals for series, parallel or series-parallel connection. Speedy, space-conserving installations!

**Every unit tested under long, continuous overload**—Assures maximum reliable service.

Type 50 capacitors are available in all commercial capacity and voltage ratings. For complete description of these and Faradon type transmitter capacitors, write for catalog, CORNELL-DUBILIER ELECTRIC CORPORATION, Dept. K-61 South Plainfield, New Jersey. Other plants in New Bedford, Brookline and Worcester, Mass.; Providence, R. I.; Indianapolis, Ind., and subsidiary, The Radiart Corp., Cleveland, Ohio.

*C-D Best by Field Test!*



CONSISTENTLY DEPENDABLE

**CORNELL-DUBILIER**

CAPACITORS • VIBRATORS • ANTENNAS • CONVERTERS



# BRITISH RADIO INVITES YOU!



Do you realise that the Radio Show in London this year will be the biggest show of Radio, Television, Telecommunications and Electronics the world has ever seen. In addition to the wide range of exhibits which will be on show, visits to actual installations can be arranged for interested visitors. Special arrangements have been made to welcome a record number of overseas visitors. Will *you* be coming? There is a heavy demand for accommodation in England this year, so it is advisable to book your travel and hotel accommodation early.

## British National Radio Show

EARLS COURT • LONDON

August 28 — September 8

Information brochures may be obtained from THE RADIO INDUSTRY COUNCIL  
59 RUSSELL SQUARE • LONDON WC1 • ENGLAND  
Telegrams: Oidarion, Westcent, London



# NATIONAL

- **P**roven
- **D**ependable
- **Q**uality



## NEW IMPROVED DESIGN MINIATURE TUBE CLAMPS

- Easy to assemble—just two pieces—a spring clip and a base of stainless steel.
- Base mounts in same holes, using same screws or rivets, as sockets.
- Easy to remove tube, simply snap off spring clip.
- Made to government specifications.
- Types available for all standard miniature tubes.

TYPE NO.	TUBE BODY LENGTH	TYPE SOCKET
TC-1	1 1/8"	7-pin
TC-2	1 1/2"	7-pin
TC-3	2 1/2"	7-pin
TC-4	1 1/8"	9-pin
TC-5	1 9/16"	9-pin
TC-6	2"	9-pin

Write for Drawings.

EXPORT DIV.—DEP'T E 651



## SPECIALTY OFFERS

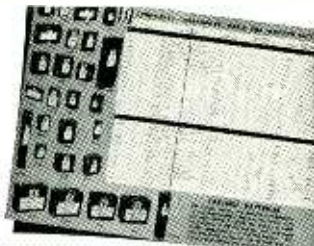

## LAB-BILT DRY BATTERIES Standard or Custom-made



INDUSTRY

LABORATORY



RADIO AND  
IGNITION



### Write for FREE CATALOG

This catalog gives complete specifications of 78 Lab-Bilt Batteries of industrial and hard-to-get types.

### CUSTOM-MADE BATTERIES

Battery Specification Sheet illustrated in catalog enables you to get any type dry battery designed and made to your individual specifications — even in small quantities!

### SUPER SERVICE

Specialty Battery Company is specially equipped to make all Lab-Bilt Batteries FRESH for each order and ship immediately. Give your customers this valuable service. Write for a new catalog today.

## SPECIALTY BATTERY COMPANY

A Subsidiary of the **RAY-O-VAC** Ray-O-Vac Company

MADISON 10, WISCONSIN



# NEW Minipower Relay

TYPE  
ME  
RELAY

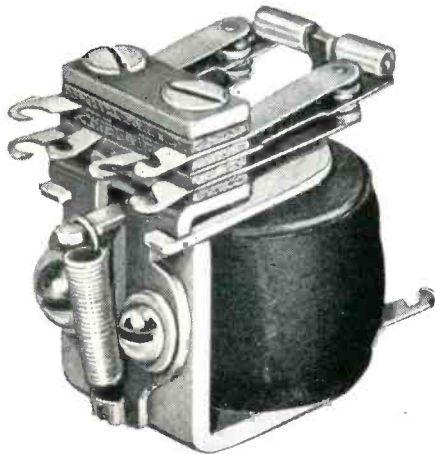

## HERE ARE THE FACTS AND FIGURES

- DIMENSIONS:** 1-3/16 x 13/16 x 1-3/8
- CONTACTS:** 5 amp. standard. 28 volts D.C., 115 volts A.C. Up to 4 P.D.T. D.C. and up to D.P.D.T. A.C.
- SENSITIVITY:** D.C. 0.7 watts D.P.D.T. (0.1 watt in special applications)  
A.C. 3 volt-amperes (operating range: 80% to 110% of nominal voltage)
- COIL:** Available for A.C. or D.C.
- HEAT RISE**  
D.C. 50°C Rise—2 watts  
85°C Rise—3.5 watts  
A.C. 45°C at nominal voltage  
65°C at 10% overvoltage
- MOUNTING:** One-screw mounting with locating pin.
- HERMETICALLY SEALED DATA**
- DIMENSIONS OF CAN:** Base: 1" x 1-1/8"  
Height above chassis: 1-11/16"  
Lugs: 3/8"
- Available with solder terminals or special miniature plug-in base.



## VERSATILE — FROM SIGNAL TO 5 AMP. POWER

This latest addition to Allied's line of quality relays will meet the vibration, shock and environmental requirements for air, marine and ground applications.

## BULLETIN ME GIVES COMPLETE DETAILS. SEND FOR YOUR COPY TODAY

Also, be sure to send for your copy of Allied's Relay Guide. It gives engineering data for 27 Allied relays in a concise tabular form for easy reference.



**ALLIED CONTROL COMPANY, INC., 2 EAST END AVE., NEW YORK 21, N.Y.**



## Keeps Size Down

### by keeping one jump ahead in design

The smaller the equipment—the more trouble from high inrush currents . . .

This portable telecast equipment first used a single pole supply line relay—but the high inrush currents the instant after closing, sometimes welded the contacts. Solution appeared to be to use a larger relay or to alter the equipment, increasing its size.

Then: Ward Leonard suggested a *heavy-duty midget* parallel contact relay—no larger than before—with poles paralleled and with silver-to-carbon contacts on one pole making contact before the silver-to-silver contacts close on the other pole.

Investigate Ward Leonard facilities for *variations* of standard designs to simplify your control.

WARD LEONARD ELECTRIC CO., 31 South Street, Mount Vernon, N. Y. Offices in principal cities of U. S. and Canada.

**WARD LEONARD  
ELECTRIC COMPANY**

**Result-Engineered Controls**

RESISTORS • RHEOSTATS • RELAYS • CONTROL DEVICES



FIG. 2—One of the typical sections of the cable repeater

where necessary. A representative assembly is shown in Fig. 2. The complete assemblage is 84 inches long and contains 15 sections.

#### *Circuit Elements*

As far back as 1933, work was begun on an electron tube suitable for use in a submerged repeater. Early models of the tube, a suppressor-grid pentode with indirectly-heated cathode, had been operated on continuous life test for as long as ten years.

Spacings between electrodes in the tube are relatively large in order for the tube to be able to withstand the shocks of cable laying. Unusual care was taken in manufacture to be certain of solid welds and to avoid the presence of loose particles. Rigorous inspections were made on all tubes during the various stages of assembly.

Selection of tubes for use in the cable was based on a comprehensive examination of all details in the history of each tube as well as the group of tubes in which the individual tube was manufactured. All tubes were aged several thousand hours before the preliminary selection. Other tubes from the same production group were life tested several thousand hours more to establish the quality of the group.

It was decided at the beginning to power the repeaters by direct current fed from land over the cable conductor. Plate and grid potentials would be furnished by the tube heaters connected in series. These factors were important in setting the nominal power requirements for the tube, about  $\frac{1}{4}$  amp at 20 volts for the heater supply and 40 to 60 volts for plate potentials.

Attention had to be given to life of other circuit elements, even though the electron tube is usually



# Do You Know?

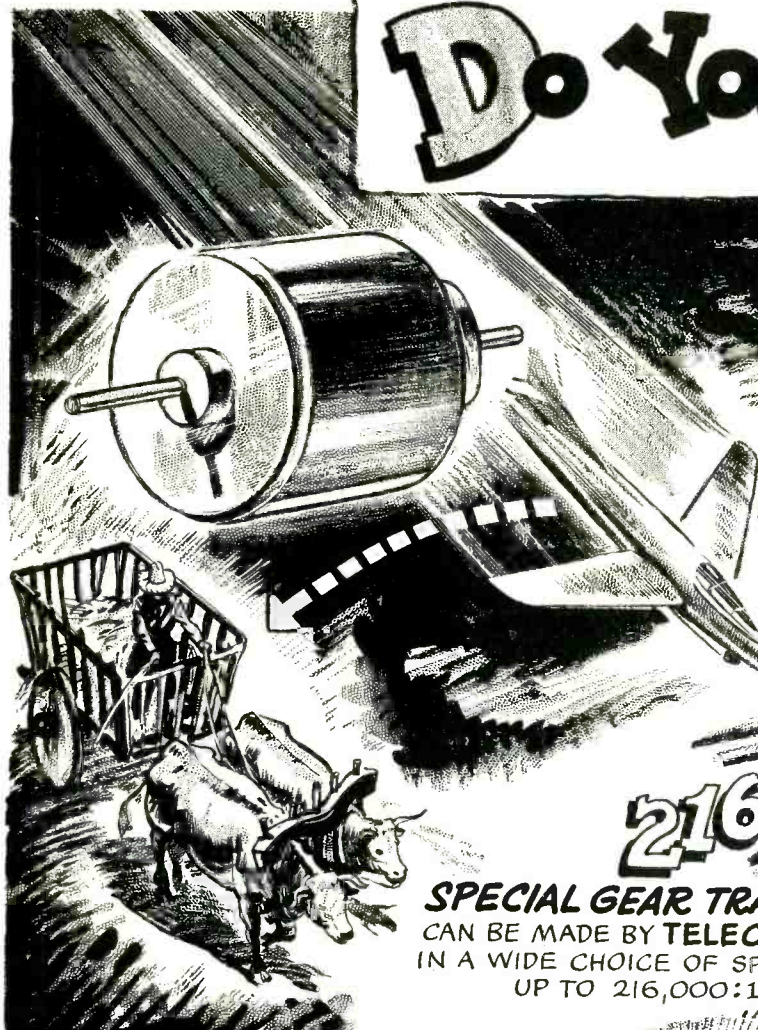

## YOU CAN CHANGE SPEEDS

IN A RATIO OF 7200:1 IN A SPACE OF ABOUT 2 CU. IN. WITH A TELECHRON SEALED, SELF-OILING GEAR TRAIN... IF YOUR OUTPUT SHAFT LOAD DOES NOT EXCEED .375 POUND INCHES?

# 216,000 TO 1

**SPECIAL GEAR TRAINS** CAN BE MADE BY TELECHRON INC. IN A WIDE CHOICE OF SPEED RATIOS UP TO 216,000:1?

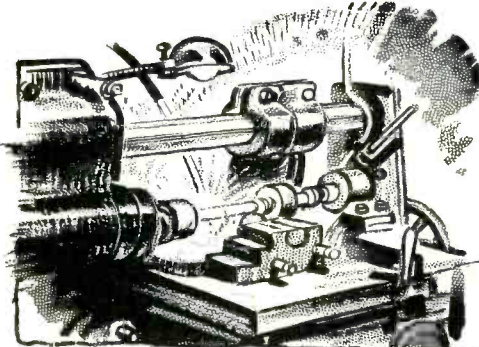
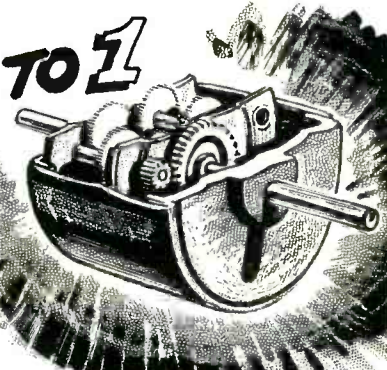

**ALL TELECHRON SPUR GEARS ARE HOBBED...** NOT STAMPED... FOR TRUER, QUIETER OPERATION AND LONGER LIFE?



## YOU CAN BREAK BOTTLENECKS

ON YOUR DEFENSE CONTRACTS BY CALLING IN TELECHRON INC. NEW BROCHURE "PRECISION ON THE PRODUCTION LINE" GIVES A QUICK PICTURE OF PERSONNEL CAPABILITIES AND MASS PRODUCTION FACILITIES. WRITE FOR YOUR COPY TODAY.

## BY RETURN MAIL,

YOU CAN GET DATA AND ESTIMATED QUANTITY PRICES ON TELECHRON GEAR TRAINS IN STANDARD SPEED-CHANGE RATIOS RANGING FROM 7200:1 TO 25:1. WRITE FOR THE FACTS TODAY. TELECHRON INC. 46 UNION STREET, ASHLAND, MASS. A GENERAL ELECTRIC AFFILIATE.



# Telechron

ALL TELECHRON TIMING MOTORS ARE

INSTANTLY...CONSTANTLY SYNCHRONOUS



# ZOPHAR

WAXES  
COMPOUNDS

Anti-Corona high heat-resistant compounds for Fly Back Transformers.

Waxes and compounds from 100° F to 285° F Melting Points for electrical, radio, television, and electronic components of all types.

Pioneers in fungus-resistant waxes.

Our efficient and experienced laboratory staff is at your service.



**ZOPHAR MILLS, INC.**  
112-130 26th Street,  
Brooklyn 32, N. Y.

# Pacing the Field

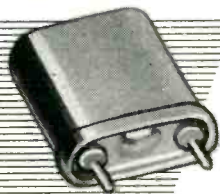

The electronic industry is progressing with seven league strides. Probably no segment of this industry has made greater progress than that accomplished in the design and manufacture of crystals.

Stabilized, metal plated and wire mounted crystals of today are far superior in stability and precision.

Take advantage of these advances by designing your equipment to use modern crystals — such as the H-17. Compare the specifications and features of the H-17 with the old-fashioned units of 5 years ago!

**H-17 SPECIFICATIONS** — Frequency range 200 kc to 100 mc. Hermetically sealed metal holders. Wired mounted, silver plated crystals. Two type H-17 holders fit loctal socket. H-17 is military type HC6/U, CAATC #3R1-3.



CRYSTALS

**THE JAMES KNIGHTS CO.**  
SANDWICH, ILLINOIS

Announcing new  
**MULTICHANNEL  
RECORDING  
COMPONENTS**

BY *Brush*

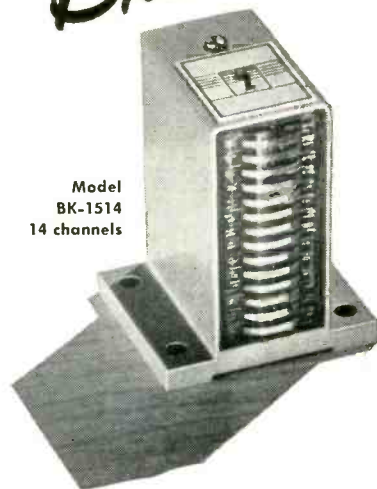

Model  
BK-1514  
14 channels

- All gaps in exact alignment
- Cast in a block of synthetic resin
- Magnetic shielding between channels
- Nonmicrophonic
- Adaptable to many widely different applications including sound and pulse recording
- Channels available up to 14

*Brush also introduces:*

Magnetic Recording Rubber (Synthetic)  
Watch for new announcements.

For information about these and other Brush  
Magnetic Recording Components in stock or  
for special purposes, write



**THE BRUSH  
DEVELOPMENT  
COMPANY**

3405 PERKINS AVENUE  
CLEVELAND 14, OHIO

*"Our business is the future"*



# FREED

## TRANSFORMERS & INSTRUMENTS

"PRODUCTS OF EXTENSIVE RESEARCH"



NO. 1060 VACUUM  
TUBE VOLTMETER  
1-INPUT IMPEDANCE  
50 MEGOHMS

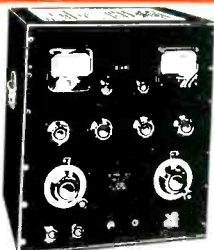

NO. 1030 LOW  
FREQUENCY "Q"  
INDICATOR

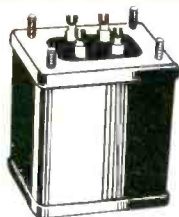

HIGH FIDELITY  
TRANSFORMERS  
1/2 DB 20 CPS TO 30 KC

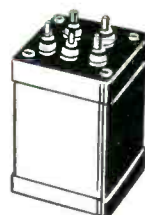

DISCRIMINATORS  
10 CPS TO 1 MC

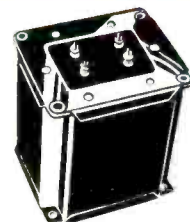

COMMERCIAL  
COMPONENTS  
QUALITY —  
DEPENDABILITY — PRICE



NO. 1140 NULL  
DETECTOR  
COMPLETE WITH  
SELECTIVE CIRCUITS



NO. 1020 MEGOHMMETER  
2,000,000 MEGOHMS  
DIRECT READING



HERMETICALLY  
SEALED COMPONENTS  
TO MEET MIL-T-27 SPECS.

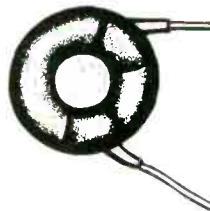

TOROIDAL INDUCTORS  
60 CPS TO 1 MC



MINIATURE INDUCTORS  
1000 CPS TO 100 KC



NO. 1210 NULL  
DETECTOR & VACUUM  
TUBE VOLTMETER



DECADE INDUCTORS  
30 CPS TO 300 KC



SUB MINIATURE  
HERMETICALLY SEALED  
TOROIDAL INDUCTORS



SUB MINIATURE  
HERMETICALLY SEALED  
COMMUNICATION  
COMPONENTS



SLUG TUNED  
COMPONENTS  
1000 CPS TO 1 MC



NO. 1150 UNIVERSAL  
BRIDGE  
5 A.C. BRIDGES IN ONE  
UNIT



NO. 1010 COMPARISON  
BRIDGE  
FAST, ACCURATE,  
RELIABLE

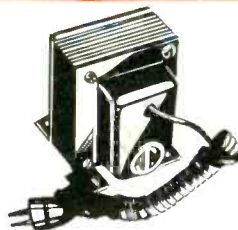

STEPDOWN  
TRANSFORMERS  
50 WATTS TO 3 KW



PULSE TRANSFORMERS  
FROM WATTS TO  
MEGAWATTS



POWER  
TRANSFORMERS  
RUGGED, DEPENDABLE,  
INEXPENSIVE.



1170 D.C. SUPPLY  
DIRECT CURRENT UP TO  
500 MA.



NO. 1110 A INCREMENTAL  
INDUCTANCE BRIDGE  
A NECESSITY FOR EVERY LAB



PRECISION FILTERS  
10 CPS. TO 1 MC.



CHANNEL MOUNTING  
INEXPENSIVE—RELIABLE

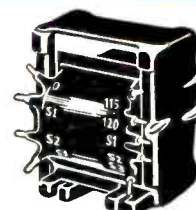

FREEDSEAL TREATMENT  
ANE-19 SPECS.

SEND FOR LATEST CATALOG!

# FREED TRANSFORMER CO., INC.

DEPT. JE 1718-36 WEIRFIELD ST., (RIDGEWOOD) BROOKLYN 27, NEW YORK

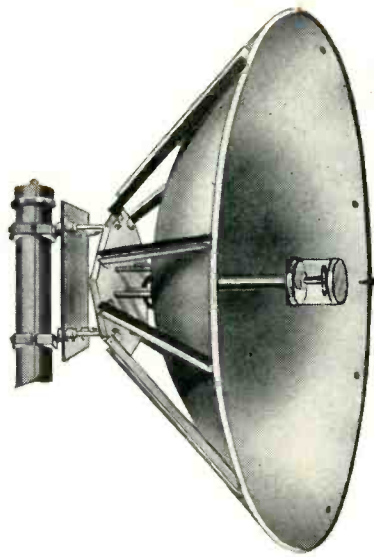

# WHAT ARE *Your* REQUIREMENTS IN PARABOLIC ANTENNAS ?

For microwave systems . . . check these advantages of ANDREW Parabolic Antennas:

- DEPENDABILITY**—An actual record of 100% dependability. There has never been a single mechanical or electrical failure on an ANDREW Parabolic Antenna . . . anywhere in the world.
- COST**—Exceptionally low; made possible by high production.
- LIGHT WEIGHT—HIGH STRENGTH**—Achieved by spun aluminum reflectors braced by formed steel struts.
- ADJUSTABLE MOUNTING**—Through  $\pm 10$  degrees in azimuth and elevation.
- DEICING KITS**—Thermostatically controlled, available where required.
- CABLE**— $\frac{7}{8}$ " air dielectric Teflon insulated cable. Radiator is pressure tight. Fittings for solid dielectric cables also available.

## SPECIFICATIONS

Frequency Range	... 890-960 MCS ...				... 1750-2110 MCS ...			
	1002	1004	1006	1010	2002	2004	2006	2010
Type Number	1002	1004	1006	1010	2002	2004	2006	2010
Diameter of Parabola feet	2	4	6	10	2	4	6	10
Gain Over Half Wave Dipole Decibels	10	15	20	25	15	20	25	29
Beam Width, Half Power Points, Degrees	36°	22°	16°	11°	18°	10°	7°	5°
Net Weight, Pounds	10	64	150	380	10	65	150	380
Thrust Due to Wind Loading at 30 Pounds/FT Pounds	127	509	1145	3200	127	509	1145	3200

**Andrew**  
CORPORATION  
363 EAST 75th STREET • CHICAGO 19

Your antenna problems can best be solved by ANDREW—the largest firm of antenna equipment specialists in the world. Write today.

**ANDREW**

WORLD'S LARGEST ANTENNA EQUIPMENT SPECIALISTS

TRANSMISSION LINES FOR AM-FM-TV • ANTENNAS • DIRECTIONAL ANTENNA EQUIPMENT  
ANTENNA TUNING UNITS • TOWER LIGHTING EQUIPMENT

the most vulnerable. It was felt that the best assurance of dependability in the case of capacitors, resistors and coils could be obtained by conservative design and by paying special attention to cleanliness during manufacture.

An air-conditioned area was provided for this purpose at the Murray Hill Laboratory. Precautions were taken against the entrance of dirt by any possible means and the humidity of the air was carefully controlled to prevent contamination from perspiration during handling of parts. A view of one of the assembly operations is given in Fig. 3.

### Field Trials

Over a period of years, many simulated laying tests were conducted in the laboratory, including

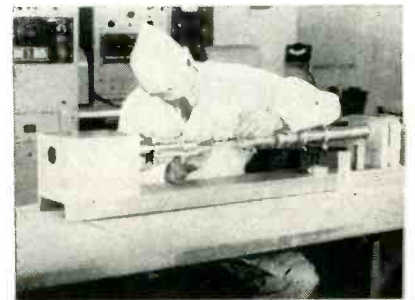

FIG. 3—Repeater assembly operation in the laboratory

as far as possible all aspects of the laying operation. Tests were made to determine the effect, if any, of the laying operation upon electrical transmission characteristics of the cable. Other tests were made to determine whether any unexpected effects would be encountered because of immersion of the cable in water.

A deep-water test of the repeater cable was made in the Bahamas in 1948 using the cable ship Lord Kelvin. Cable lengths up to 15 nautical miles with repeaters were laid in depths of water up to two nautical miles. Several repeaters were laid, measured while on the ocean bottom and then hauled back up again, involving much more severe treatment than a mere laying operation. Results indicated that the repeaters as well as the cable could



# TAYLOR COAST-TO-COAST SERVICE...

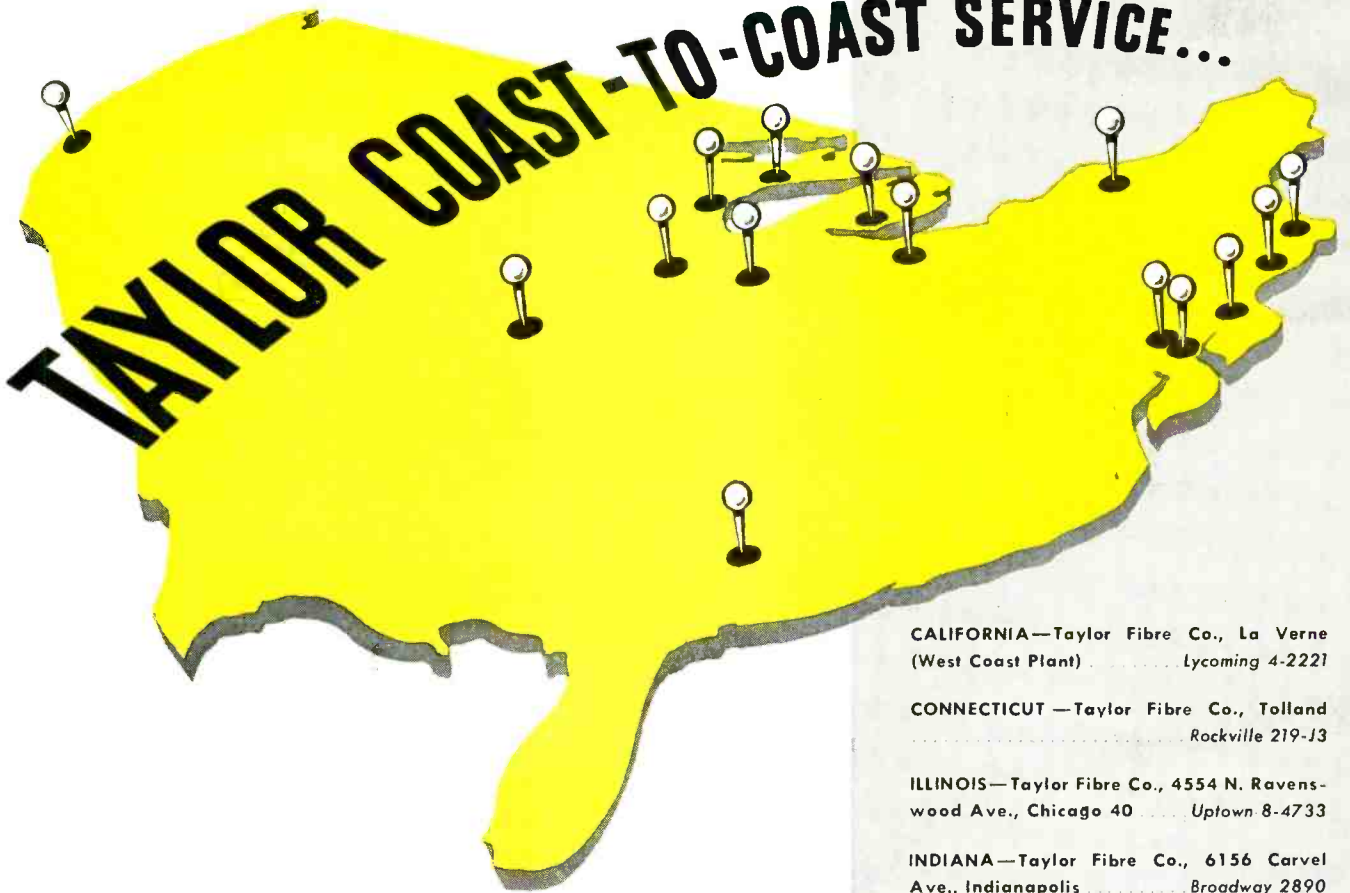

Wherever your plant may be located, there's a Taylor Sales Engineer ready to serve you. Call on him when you want the *best* in Vulcanized Fibre, Phenol Fibre, Special Glass Melamine and Silicone Laminates. Ask him, too, about the complete Taylor Fabricating Service—designed to help you save time, trouble and money on your machining operations.



*This new 1951 Taylor Catalog contains complete specifications and description of Taylor Laminated Plastics. See for yourself how these versatile materials can help you produce your product or part better, faster and at lower cost. Write today for Catalog E6.*



**TAYLOR FIBRE CO.**  
 NORRISTOWN, PENNSYLVANIA  
 WEST COAST FACTORY: LA VERNE, CALIF.

**CALIFORNIA**—Taylor Fibre Co., La Verne (West Coast Plant) ..... Lycoming 4-2221

**CONNECTICUT**—Taylor Fibre Co., Tolland ..... Rockville 219-13

**ILLINOIS**—Taylor Fibre Co., 4554 N. Ravenswood Ave., Chicago 40 ..... Uptown 8-4733

**INDIANA**—Taylor Fibre Co., 6156 Carvel Ave., Indianapolis ..... Broadway 2890

**MASSACHUSETTS**—Taylor Fibre Co., Rm. 316 United Bldg., 43 Leon St., Boston 15 ..... Highland 2-8170

**MICHIGAN**—Taylor Fibre Co., 801 Stephenson Bldg., 6560 Cass Ave., Detroit 2 ..... Trinity 3-1593

**MISSOURI**—Taylor Fibre Co., 3435 Chouteau Ave., St. Louis ..... Sidney 6405

**NEW JERSEY**—Taylor Fibre Co., 26 Journal Square, Jersey City ..... Journal Square 3-5440

**NEW YORK**—Taylor Fibre Co., 214 Cutler Bldg., 42 East Ave., Rochester 4 ..... Baker 3767  
 Taylor Fibre Co., 26 Journal Square, Jersey City, N. J. .... Digby 9-4367

**OHIO**—Taylor Fibre Co., Euclid 71st Bldg., 7016 Euclid Ave., Cleveland 3 Endicott 1-2287  
 Taylor Fibre Co., 238 Lofayette St., Dayton 2 ..... Michigan 3711

**PENNSYLVANIA**—Taylor Fibre Co., Norristown (Main Plant and Executive Offices) ..... Valley Forge 9-2811  
 Taylor Fibre Co., 401 N. Broad St., Philadelphia 8 ..... Walnut 2-6030

**SOUTH CAROLINA**—Taylor Fibre Co., 1013 Woodside Bldg., Greenville. Greenville 2-3051

**WISCONSIN**—Taylor Fibre Co., 2400 W. Clybourn St., Milwaukee 3 ..... Division 2-8100

# FOR YOUR PANEL

A NOVEL and UNIQUE CIRCUIT INDICATOR

DESIGNED FOR NE-5T NEON LAMP

For 110 or 220 volt circuits

The required resistor is an integral part of this assembly — "built-in."

**RUGGED • DEPENDABLE  
LOW IN COST**



PATENTED: No. 2,421,321  
Cat. No. 521308-997

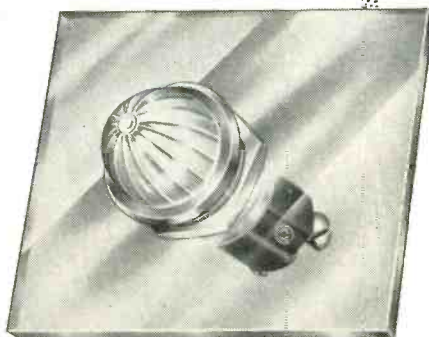

## WILL YOU TRY A SAMPLE?

Write on your company letterhead. We will act at once.  
No charge, of course.

**SEND FOR THE 192 PAGE HANDBOOK OF PILOT LIGHTS**

Among our thousands of Pilot Light Assemblies there is one which will fit your special conditions. Many are especially made and approved for military use. We pride ourselves on prompt deliveries—any quantity.

**ASK FOR OUR APPLICATION ENGINEERING SERVICE**

Foremost Manufacturer of Pilot Lights

**The DIAL LIGHT COMPANY of AMERICA**

900 BROADWAY, NEW YORK 3, N. Y.      SPRING 7-1300

**SEND  
FOR IT!**

## 1951 ALLIED CATALOG

**free!**  
212-Page  
Buying  
Guide

World's Largest Stocks  
**ELECTRONIC SUPPLIES**  
for **INDUSTRY** and  
**BROADCAST STATIONS**



### One Complete Dependable Source for Everything in Electronics

Simplify your purchasing—send your consolidated orders to ALLIED—the single, complete source for all Electronic Supplies. Depend on ALLIED for the world's largest stocks of special tubes, parts, test instruments, audio equipment, accessories—complete quality lines of electronic supplies. Our expert Industrial supply service saves you time, effort and money. Send today for your FREE copy of the 1951 ALLIED Catalog—the only complete, up-to-date guide to Electronic Supplies for Industrial and Broadcast use.

**ALLIED RADIO CORP.**

833 W. Jackson Blvd., Dept. 11-F-1, Chicago 7, Illinois

We Specialize in Electronic  
Equipment for Research,  
Development, Maintenance  
and Production Operations

**SEND FOR  
FREE 1951  
ALLIED CATALOG**

ULANET RUGGEDLY DESIGNED

# Miniature THERMAL TIMERS

Provide timing ranges of  
2 seconds to 3 minutes

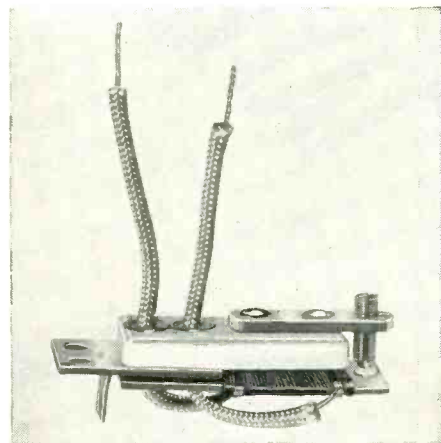

★ These miniature units actually require a space less than 1 3/8" x 3/8" x 1/2", yet the sturdy design contributes to long life.

A Steatite base provides dimensional stability while mounting is accomplished thru a Bakelite bracket which furnishes complete insulation as well as elimination of pressure on the ceramic member. Electrolytic silver contacts insure best conductivity and longer operation. Stable adjustment is provided for by the clinch-type bracket which holds the adjustment screw. Contact rating is 100 watts 115-230 volts ac.

Of course the Ulanet line includes many other Timing and Thermostat units. Why not investigate the vast line of miniature and sub-miniature designs available. State application or requirements when writing.

## GEORGE ULANET COMPANY

417 MARKET STREET  
NEWARK 5, NEW JERSEY

If your problem is *Heat Control*  
your solution is *Ulanet*—  
Precision Thermostats & Thermal Timers  
Exclusively Since 1931





# Superior Tubular Parts

## ... mean Superior Electronic Performance

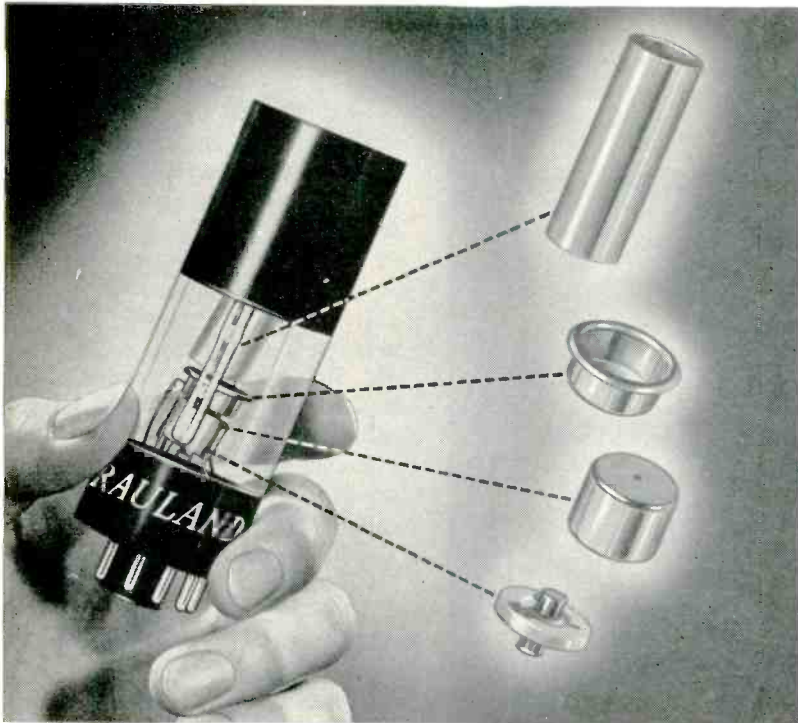

Superior supplies disc cathodes, cups and anodes for the famous *Rauland* "Tilted Offset" Electron Gun used in peak-performance picture tubes. This new development of *Rauland* permits the use of a single Ion Trap magnet, bends the electron beam only once and gives the sharpest possible beam focus. The new Indicator Ion Trap reduces adjustment time to a matter of seconds, eliminates the need for mirrors or guesswork in Ion Trap adjustment. This "Double Feature" gun is a triumph of *Rauland* research.

But no electronic device can be better than the components of its assembly. That's why *Rauland* and so many other electronics manufacturers specify Superior tubular parts.

Here at Superior we combine production know-how, research facilities and engineering experience to produce tubular parts, in many forms and metals, each designed to do tough electronics jobs better. We have specialty equipment for the high speed production of anodes, cups, cathodes, grid cylinders and many other parts for television and cathode ray gun structures. If you are not now a customer of Superior it will pay you to check on the many ways in which we can serve you. Write for information — no obligation of course. Superior Tube Company, 2500 Germantown Ave., Norristown, Pennsylvania.

### Which Is The Better For Your Product . . .

**SEAMLESS . . . ?** The finest tubes that can be made. Standard production is .010" to .121" O.D. inclusive, with wall thicknesses of .0015" to .005". Cathodes with larger diameters and heavier walls will be produced to customer specification.

**Or LOCKSEAM\* . . . ?** Produced directly from thin nickel alloy strip stock, .040" to .100" O.D. in standard length range of 11.5 mm to 42 mm. Round, rectangular or oval, cut to specified lengths, beaded or plain.



Part of Inspection Procedure on Lockseam Nickel Cathodes as they come off the production machine. Each cathode must undergo many rigid tests before being approved.



Engineering . . . laboratory equipment for all kinds of testing, including emission characteristics of nickel cathode materials.

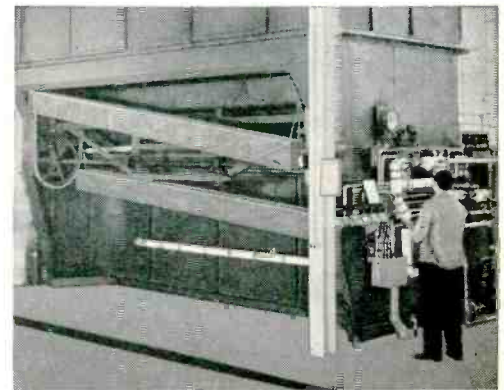

To Guard Against contamination by processing lubricants, Superior tubing is thoroughly degreased before each annealing operation.

**Superior**  
THE BIG NAME IN SMALL TUBING

All analyses .010" to 3/8" O.D.  
Certain analyses (.035" max. wall) Up to 1 1/4" O.D.

\*MFD. UNDER U. S. PATS. SUPERIOR TUBE COMPANY • Electronic Products for export through Driver-Harris Company, Harrison, New Jersey • Harrison 6-4800

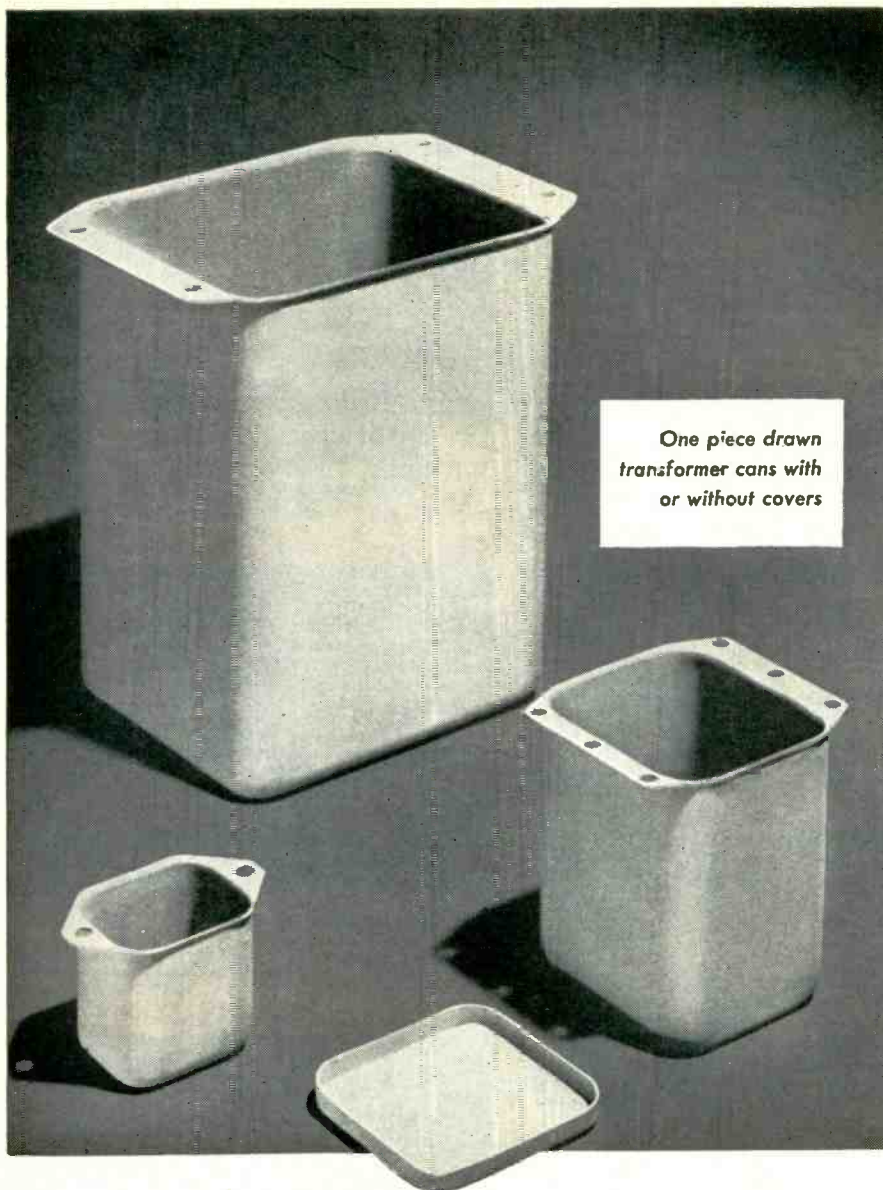

One piece drawn  
transformer cans with  
or without covers

## TRANSFORMER CANS STOCKED IN STANDARD SIZES

We can save you die costs on all stock size transformer cans, and will make IMMEDIATE DELIVERY. A full range of sizes are available with or without covers. List of stock sizes and prints furnished on request.

### SPECIAL SHAPES AND SIZES

We are also equipped to fabricate special sizes and shapes (round, square and rectangular) to your own specifications. Tell us your transformer can requirements and we will be glad to submit estimates.

Craft Transformer Cans are  
drawn in one piece.



*Craft*

**MANUFACTURING CO.**  
3949 W. Schubert Ave., Chicago 47

*Stainless Steel Specialists*

withstand the laying operation with a comfortable margin of safety.

### Transmission System

The electrical circuit of the repeater was designed to get the most out of the long-life electron tube in the way of stability of repeater gain and low modulation while obtaining as much gain as the system would permit. Consequently a unidirectional repeater design was decided upon to obtain the most efficient use of tubes and to simplify the structure.

The circuit employed, shown in Fig. 4, has three stages with negative feedback, giving a gain-versus-frequency characteristic as shown in Fig. 5. The transmission band is from 12 to 120 kc with insertion gain at 108 kc, the top frequency employed in traffic, equal to 65 db. The repeater gain equalizes the loss in about 36 nautical miles of cable.

Each of the two cables transmits in only one direction. The No. 5 cable, which transmits south, is 114.55 nautical miles long. The No. 6 cable, which transmits north, is 124.97 nautical miles long. Each cable has three repeaters spaced about 36 nautical miles apart. Of the six repeaters, two are in a depth of about 0.35 nautical miles and

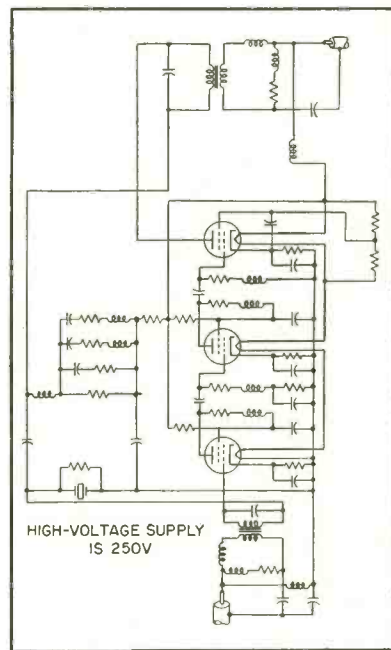

FIG. 4—Circuit diagram of the submarine cable repeater



# Motorola microwave

Multiply your present communication facilities, realize new economies, and make sure of the greatest possibilities for future expansion, by insisting on a MOTOROLA, superior-engineered Microwave System.

With the most *private-owned* microwave mileage now in operation, Motorola offers you the benefit of EXPERIENCE, *plus* many immediate and practical advantages.

Operating in the proven 6000 Mc. frequency band, Motorola Microwave provides maximum effective power gain. The superior frequency-division multiplexing system provides optimum reliability. All your electronic equipment is at ground level for fast, precision maintenance.

## One Microwave System Does This . . . and More



teletype



supervisory control



voice channels



telemeter

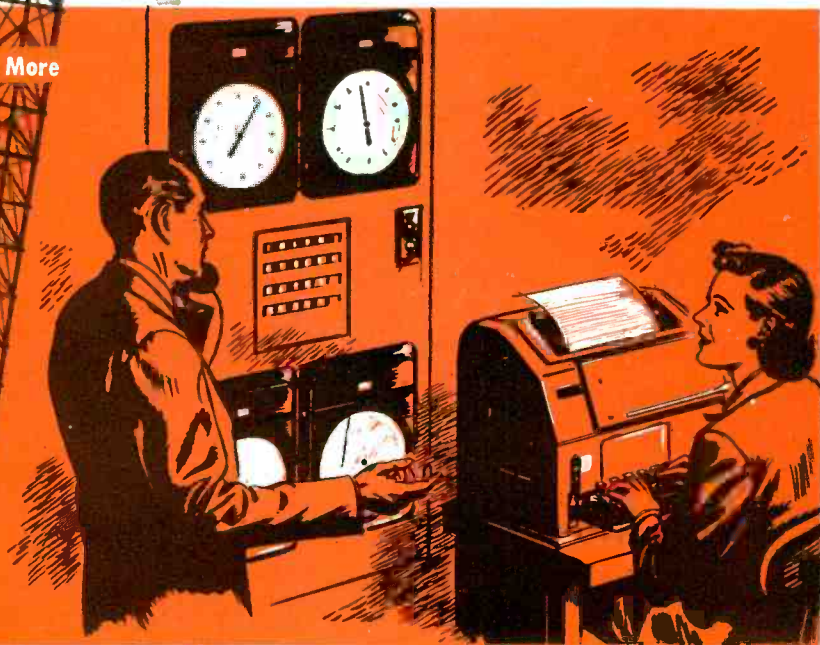

## Installations

Aeronautical Radio Incorporated  
State of California  
Pan American Pipeline Co.  
Shell Pipeline  
Panhandle Eastern Pipeline Co.  
Texas Illinois Natural Gas Pipeline Co.  
Mid-Valley Pipeline Co.  
Brazos River Electric Transmission  
Cooperative  
City of Dayton, Ohio  
Michigan State Police

Motorola Microwave is the super communication "pack horse" of complete round-the-clock reliability. Cross-town or cross-country, office to plant—to branch—to mobile crews, it provides multi-channel facilities for voice circuits, supervisory control networks, teletype, and 2-way radio tie-in, with innumerable additional combinations for automatically and simultaneously operating your entire system. Motorola Microwave means efficient, economical point-to-point communication.

# Motorola

COMMUNICATIONS AND  
ELECTRONICS DIVISION

4545 Augusta Blvd., Chicago 51, Illinois

World leaders in FM 2-way radio communications • 2-way mobile • portable • microwave • carrier and control • supervisory control equipment



*Now Terminals Can Be  
ATTACHED & SOLDERED  
in ONE Automatic Operation!*

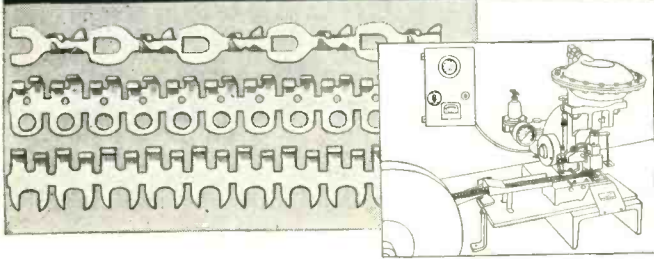

**New Terminal Attaching Machine—**

attaches and solders various sizes and types of pre-soldered tandem terminals (supplied on reels) at rates up to 1200 per hour. Machine cuts off, clinches and solders terminals in one instantaneous operation. Eliminates handling of loose terminals, solder and flux to increase production and lower costs on long runs. Standard types available. Strong, perfectly soldered joints are assured, as absolute control of heat is maintained. Send for detailed information, enclose sample of wire and terminal now used. Address Dept. E.

*For ordinary runs in moderate quantity we continue to produce*  
**SEPARATE TERMINALS for ELECTRIC WIRES**

We also make **SMALL METAL STAMPINGS**, exact to Customer's Prints. Modern Plant, Equipment and Methods. Precision Work. Moderate Die Charges. Prompt, Dependable Service.

**PATTON-MacGUYER COMPANY**  
17 Virginia Avenue, Providence, R.I.

**2 PURPOSE TELEDAPTER**

- TELEVISION WAVE FORM OBSERVATION
- RADAR PULSE

LOW \$  
PRICED  
AT **195** F.O.B.  
PLANT

- Converts a DuMont 208 or 304 Scope for use with TV and Radar pulse type signals. Response 3 db down at 5 M.C.
- Completely self-contained including power supply. No modifications to the 208 or 304 Scope required.
- Size matches both Type 208 and 304 scopes and tie plates are furnished to fasten both instruments together.

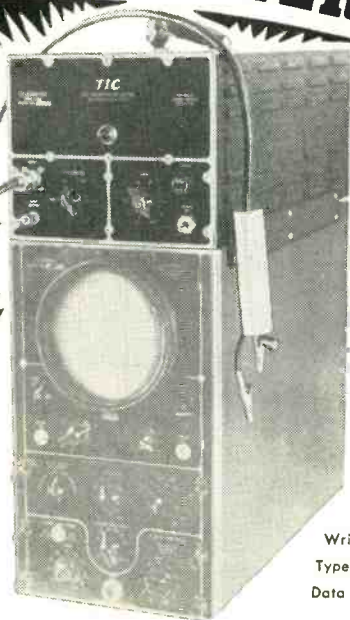

Write for  
Type 1000  
Data Sheet

Convert your Type 208 and 304 Scopes for TV and Radar testing, for only \$195.00

**TIC** Manufacturers of a complete line of TV and Radar Test Equipment  
**Tel-Instrument Co. Inc.**  
50 PATERSON AVENUE • EAST RUTHERFORD, N. J.

**LEDEX**

**RELAYS and  
CIRCUIT  
SELECTORS  
ROTARY SOLENOID  
OPERATED**



- REMOTE CONTROL
- SELF-STEPPING OR EXTERNAL IMPULSING
- POSITIVE DETENT ACTION

**for REMOTE CONTROL  
of MULTIPLE  
COMPLEX CIRCUITS**

Many versatile designs of stepping, counting, adding and subtracting, latching, and *circuit selecting* relays are made possible by the combination of the LEXED Rotary Solenoid and wafer type rotary switches. Self-stepped or externally impulsed, the device is immediately adaptable to many remote control applications. A choice of wire sizes permits a wide range of operating voltages and power requirements. Various types of mountings further increase its adaptability. In addition to its positive control of multiple, complex circuits, a reserve of mechanical power is available for the performance of duties other than switching operations.

We supply to quantity users and solicit the opportunity to be of assistance in solving multiple circuit relay problems.

WRITE DIRECT TO

*G. H. Leland* INC.

118 WEBSTER STREET

DAYTON 2, OHIO





## “... a screw driver for breakfast”

Nine A.M. on a glorious Sunday morning. What a day for the links. John is all set for a quick breakfast—with plenty of crisp golden toast. Suddenly a flash . . . toaster out of commission. John doesn't know it yet, but there goes that golf game. As a good little fixer-upper he's tops in his own mind. But that's not the Mrs.' opinion—nor that of the local service store where tomorrow John will take the “picces” for a professional repair job. And wait until he discovers that the manufacturer saved a few cents on insulation to meet a price. John won't like it . . . and when he buys a new toaster it will be another make.

**N**ow there is a sleeving that withstands temperatures up to 1200° F., which is unsaturated yet non-fraying.

BH Special Treated Fiberglas Sleeving is a remarkable electrical insulation combining these properties:

Permanently non-raveling—elim-

nates the extra operation of securing the ends;

Permanently rounded—all corrosive volatile materials are removed and the material is permanently rounded, with crossing strands crimped to provide the non-raveling feature;

Permanently flexible—unaffected by heat or aging.

BH Special Treated is one of a family of BH insulations, each designed to meet particular conditions in service. Whether your problem is heat, cold, flexibility, abrasion, high voltage, or resistance to chemicals, there is a BH insulation to help you. Give us a few facts about your requirements—products, temperatures, voltages. We will furnish production samples for testing.

Address Dept. E-6

Bentley, Harris Manufacturing Co.  
Conshohocken, Pa.

# BH *Fiberglas*\* SLEEVINGS

\*BE Non-Fraying Fiberglas Sleeveings are made by an exclusive Bentley, Harris process (U. S. Pat. No. 2393530). “Fiberglas” is Reg. TM of Owens-Corning Fiberglas Corp.

precision built...

powerful...

highly efficient...

# Cramer

## timing motors

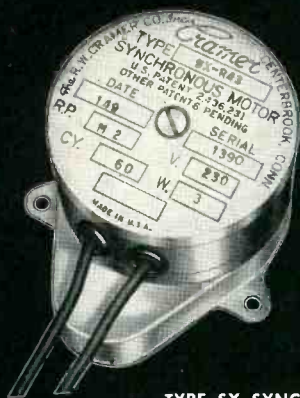

TYPE SX SYNCHRONOUS MOTOR

A permanent magnet type motor producing an exceptionally high torque, the Cramer Type SX Synchronous Motor is widely used with timing devices, recording instruments, communications equipment ... and for many other applications throughout the instrument and control fields requiring a constant speed at a given frequency. Self-starting ... operates at synchronous speed only. Compact ... precision-built ... available with output speeds from 60 RPM to 1/24 RPH.



TYPES SCS & SCR CLUTCH MOTORS

Designed to meet the needs of many timing, recording, indicating, and switching applications where an accurate reset operation is essential, Cramer Clutch Motors combine the Type SX Motor and a differential gear drive. Two basic types ... Type SCS equipped with direct-acting clutch ... Type SCR with reverse-acting clutch ... each available in a wide range of speeds.

Cramer motors are also available as Reversible and Chart Drive Types. Write for complete information.

# THE R. W. CRAMER CO., INC.

BOX 3, CENTERBROOK, CONN.

Builders of dependable timing devices for more than 25 years.

INTERVAL TIMERS • TIME DELAY RELAYS • RESET TIMERS • CYCLE TIMERS  
PULSE TIMERS • RUNNING TIME METERS • PERCENTAGE TIMERS

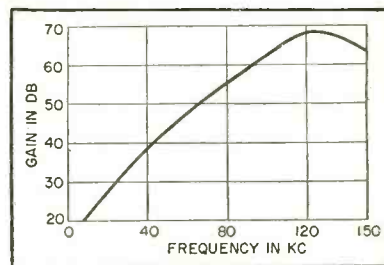

FIG. 5—Gain-frequency characteristic of repeater

two in about 0.9 nautical miles.

The final repeater in each cable is located as close to deep water as possible so that the signal will be strengthened before it enters shallow water and land sections of cable where crosstalk and static noise might be picked up.

The cables are spliced directly to underground cables at manholes near the shore at both ends. The underground cables run in ducts to the terminal equipment at the offices, a distance of one mile at Key West and three miles at Havana. The same coaxial circuit is used for the underground cables as for the submarine cables but the underground cables are provided with electrical protection of helical steel tapes, layers of paper and an overall lead sheath.

There are 24 channels in each cable, with each channel occupying a band of 4 kc. The signal-to-noise ratio for the 24 channels is about the same as for the same length of high-grade carrier frequency circuit on land.

### The Cable

As in the case of earlier installations, the cable has a copper return. New features are polyethylene insulation as well as design principles that make the cable circuit less subject to change of electrical characteristics due to laying stresses. The latter feature is important in the case of submerged repeaters because after the cable has been laid it is impossible to adjust the repeater to compensate for changes in cable attenuation during laying. In ordinary cables, this compensation can be taken care of by adjusting the equipment on shore.

Special precautions were taken



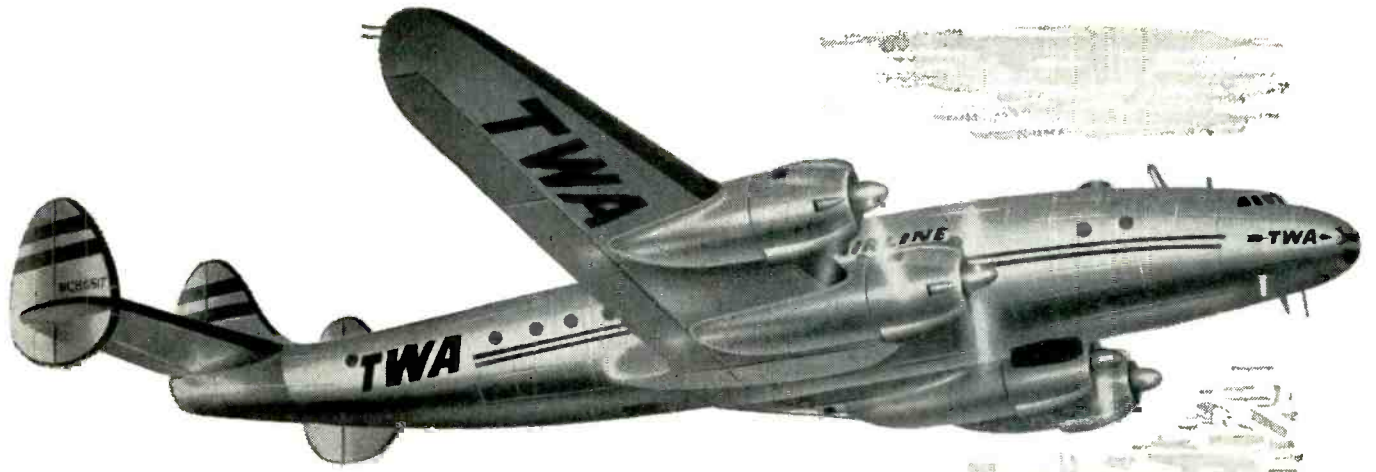

# WILCOX...

## CHOICE OF **TWA**

**WILCOX TYPE 96D TRANSMITTERS  
CHOSEN FOR TWA'S GROUND  
STATION INSTALLATION**

### **AT ROME**

TWA's far-flung empire requires the finest communications network that research and precision manufacturing can produce. TWA has long been a user of Wilcox equipment, and Wilcox is proud to be chosen again as TWA expands and improves its world-wide services. The Wilcox Type 96D 2500 watt transmitter covers the 2-26 mc. range.

#### **UNIT CONSTRUCTION OFFERS OPERATING FLEXIBILITY**

Either simultaneous transmission on several frequencies or the selection of an individual frequency best suited to your particular problem.

#### **JAN COMPONENT STANDARDS FOR DEPENDABILITY**

All components meet the latest JAN specifications. This means maximum resistance to wear, corrosion, humidity, fungus, temperature, and time.

*Write Today* for complete information and specifications on the Wilcox 96D Transmitting Station.

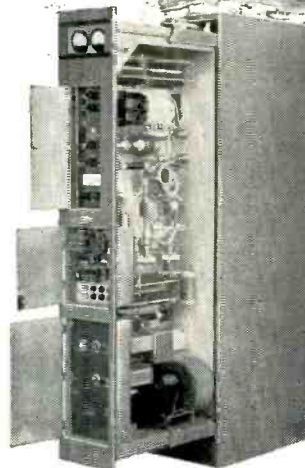
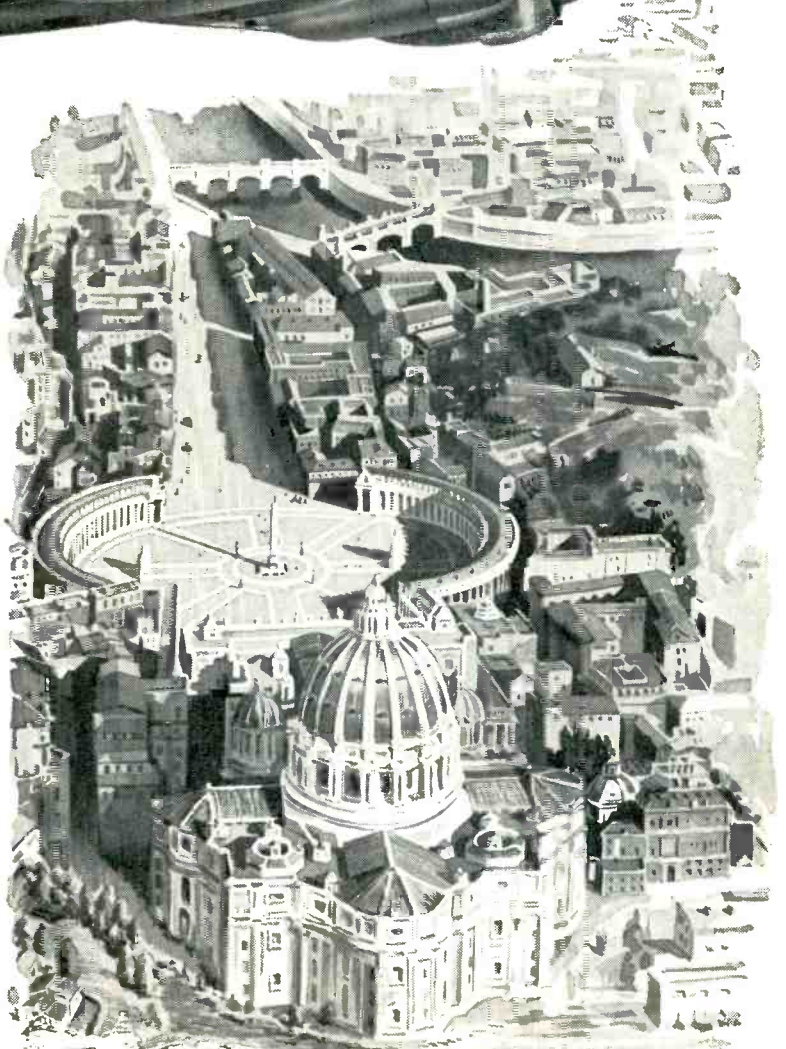

# **WILCOX**

## **ELECTRIC COMPANY**

Fourteenth & Chestnut  
KANSAS CITY 1, MISSOURI, U.S.A.



**NEW SYSTEM** Accurately measures  
**VSWR from 1.02 to 100/1**

**DOUBLE  
 PROBE  
 SYSTEM**

**ROLLIN**

**REFERENCE  
 LABORATORY  
 STANDARD**

**PRECISION  
 SLOTTED LINE  
 & VSWR INDICATOR**

MEASURES  
**IMPEDANCE • VSWR  
 RELATIVE POWER  
 100 MC TO ABOVE 1000 MC**

NEGLIGIBLE  
 REFLECTIONS  
 —  
 PIN POINT  
 TYPE PROBE  
 —  
 "HARDWAYS"  
 PRECISION  
 HANDWORKED  
 SURFACE

SWR INDICATOR —  
 STABLE SENSITIVE  
 1000 CYCLE NEGATIVE  
 FEED BACK AMPLIFIER  
 FLAT TOP SELECTIVITY.

**MODEL  
 62**

MIN. GENERATOR RF. POWER  
 REQ. 2-20 MILLIWATTS

- Full scale VSWR ranges: 1.1/1 - 4.0/1 - 10./1 and to 100/1 using included calibrated probe depth attenuators.
- Differential probe system for accurate measurement of low VSWR.
- Useable electrical probe travel 150 centimeters (1/2 wave at 100 mc/s).
- Removable end tapers exhibit negligible impedance transformation — under 1%.
- Residual VSWR under 1% — voltage uniformity  $\pm 0.5\%$  or better — mechanical tolerances held to 0.2%.
- Machine engraved centimeter scale and vernier (Starrett) measures probe travel to 0.1 millimeter accurate to 0.01mm.
- Continuously adjustable probe depth 0—.500" calibrated in .001" steps. Permits measurements of relative power and maintenance of square law crystal characteristic.

**ROLLIN**

**THE ROLLIN COMPANY**  
 2070 N. FAIR OAKS AVE. • PASADENA 3, CALIFORNIA

during manufacture of the cable to avoid undesirable irregularities in transmission characteristics. Because of the wide transmission band, previous schemes used to reduce the effect of variation of impedance among the core lengths would have called for core lengths so short as to seriously increase the number of joints.

Irregularities were minimized by careful control of conductor and insulation diameters and by continuously insulated lengths of the order of 12 nautical miles. These lengths were cut only as was necessary for handling. The shorter lengths were reassembled in insulating order, as far as possible, to assure random addition of reflections due to impedance irregularities.

Structure of the deep sea, or type D, cable is shown in Fig. 6 and 7. The central conductor consists of a solid wire 0.131 inch in diameter on which are laid three copper surround tapes, each 0.0145 inch thick and 0.148 inch wide, closely conforming to the solid wire. The interstices of the conductor are filled with polyethylene.

The return conductor made up of six copper tapes is laid directly on the polyethylene insulation. Each type is approximately 0.016 inch thick by 0.241 inch wide, preshaped so that when in place they conform to the surface of the insulation.

Over the return conductor is wound a teredo tape approximately 0.003 inch thick with overlap. Cutched jute, the armor and the outer jute are applied over all. Four types of armor are employed in the cable for use in various depths of water or for special shore conditions.

The cable was manufactured by the Simplex Wire and Cable Com-

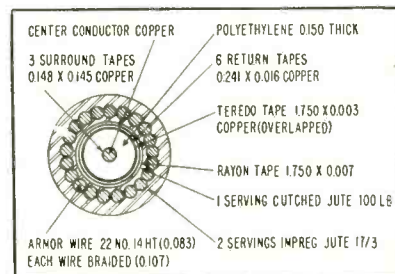
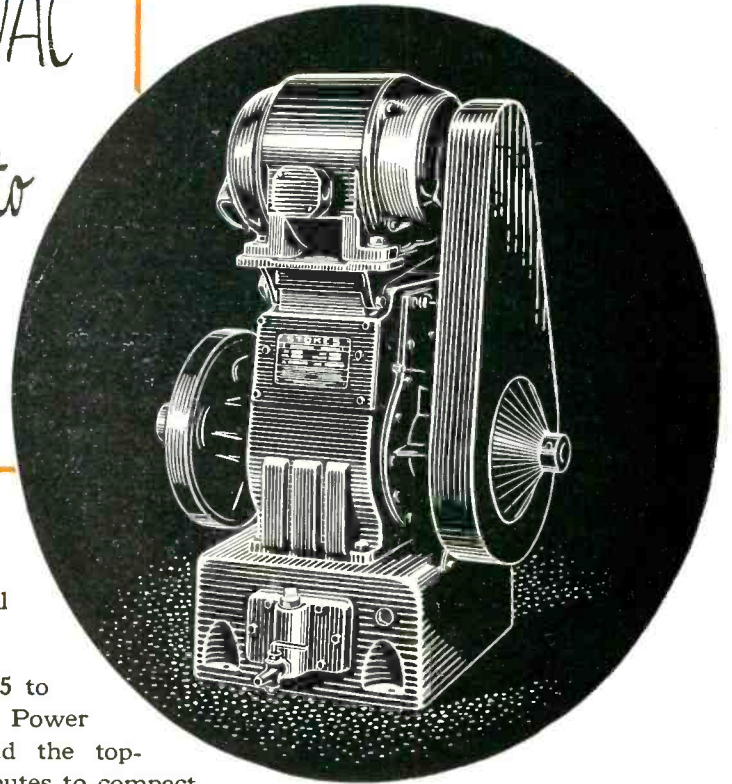

FIG. 6—Structure of the deep-sea, type D, armored cable



# STOKES MICROVAC PUMPS...are basic to Vacuum Processing



High volumetric and mechanical efficiency make these famous pumps economical and reliable units in any vacuum system.

Capacities of Stokes Microvac Pumps run from 15 to 500 cfm . . . pressures to 10 microns absolute. Power consumption is low and the top-mounted motor contributes to compact design requiring minimum floor space.

Send for FREE Stokes Vacuum Calculator. This slide rule determines needed pump capacity for any job... shows Centigrade to Fahrenheit conversion. Other useful conversion tables and scales on reverse of rule.

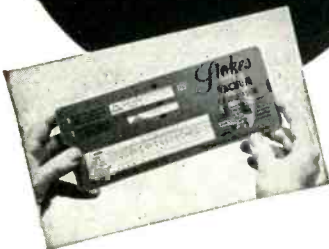

Lubrication of the four moving parts (including the exhaust valve of corrosion-resistant Teflon) is fully automatic. There are no stuffing-boxes or grease fittings, and no packing.

Parts are precision-finished, standard and interchangeable. Freedom from wear assures years of trouble-proof service.

Stokes is the only manufacturer of equipment for complete vacuum systems, including Microvac mechanical pumps, oil diffusion pumps, McLeod Gages and Vacuum Valves.

Consult with Stokes on the application of vacuum to rotary exhaust machines, house vacuum systems, vacuum impregnation, vacuum furnaces, vacuum metallizing, and to other applications in which vacuum deserves exploration.

#### STOKES MAKES

Plastics Molding Presses,  
Industrial Tableting  
and Powder Metal Presses,  
Pharmaceutical Equipment,  
Vacuum Processing Equipment,  
High Vacuum Pumps and Gages,  
Special Machinery

# STOKES

F. J. STOKES MACHINE COMPANY, 6046 TAVOR ROAD, PHILADELPHIA 20, PA.

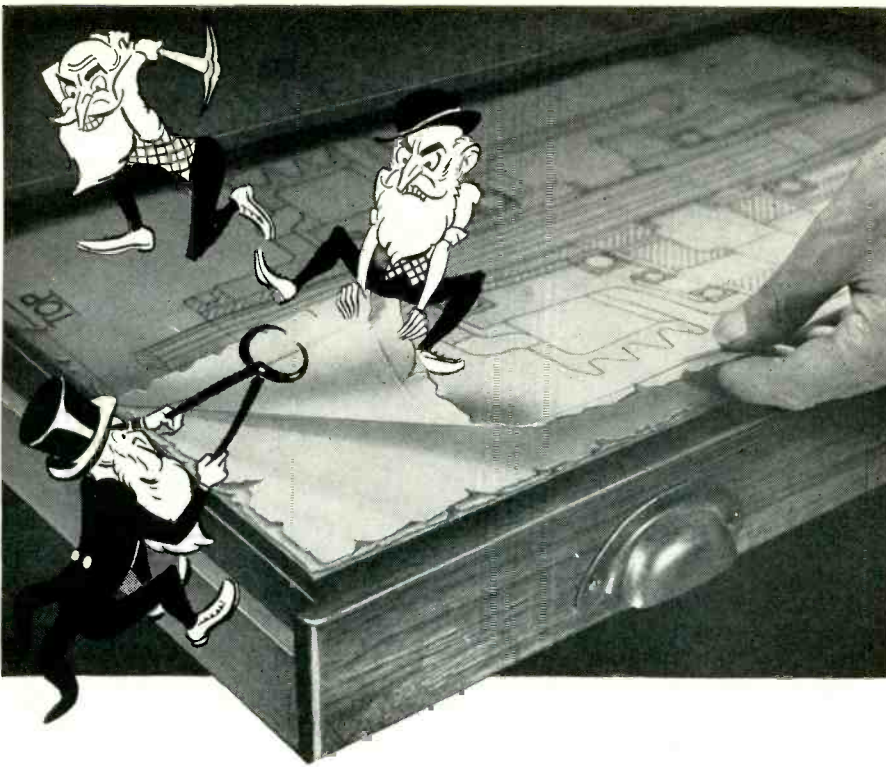

## For Drawings That Won't Get 'EDGY' With Age...

Specify Arkwright Tracing Cloth! Then you can be sure that no matter how often a master drawing is yanked out of the cabinet, it will never become ripped, or paper-frayed around the edges to spoil your work.

Arkwright Tracing Cloth is the best insurance you can get that your drawings will never go brittle, discolor or become opaque with age. Best insurance, too, that original drawings are always sharp, clean and ghost-free. Erasures on Arkwright cloth re-ink without feathering. And every roll is carefully inspected for pinholes, thick threads or imperfections of any kind.

All good reasons for you to remember: if a drawing is worth saving, put it on Arkwright Tracing Cloth. Would you like a sample? Write Arkwright Finishing Company, Providence, R. I.

**ARKWRIGHT**  
*Tracing Cloths*

AMERICA'S STANDARD FOR OVER 25 YEARS



pany of Cambridge, Mass., and incorporated the results of a cooperative development program conducted by that company and the Bell Telephone Laboratories.

### *Terminal Equipment*

The transmission apparatus at Key West and Havana is mostly standard equipment as employed in land-line carrier systems. The operations involved in combining the 24 voice circuits into one band and then separating them again are also largely conventional.

Special equalizers, power separation filters and an auxiliary amplifier were designed and the standard transmitting amplifier used in the J system was modified to accommodate the lower frequency band.

Each repeater contains a sharply tuned circuit for increasing the gain of the repeater above normal at a distinctive frequency outside the transmission band of the repeater. The gain with reduced feedback of the individual repeaters can be measured with the aid of a loop circuit at Havana by scanning the test frequency region with an oscillator and detector at Key West. This measurement procedure gives an indication of incipient decay of gain of any repeater.

Power for the repeaters is supplied over the cable conductor from Key West. A positive potential of about 250 volts is applied to one cable and -250 volts to the other with a loop connection between the two cables at Havana to complete the d-c circuit. This neutral point is connected to ground. Current in the cable conductors is maintained at 0.23 ampere.

### *Laying the Cables*

Laying of the cables was completed without undue incident by the cable ship Lord Kelvin after modifications were made in the cable-laying gear in order to obtain an additional margin of safety for the repeaters.

The courses laid out for the two cables kept a five-mile separation between the two cables and also a five-mile separation from the nearest of the cables comprising the



# A Good Example of MODERN ENGINEERING\*

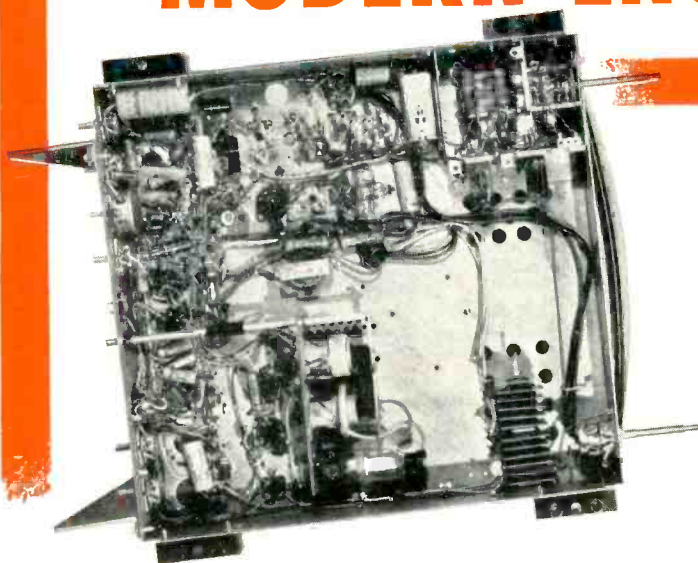

## MOTOROLA'S NEW TS-196 TELEVISION CHASSIS

A total of 27 RMC By-pass and Temperature Compensating "DISCAPS" are incorporated in this new Motorola TV chassis. Motorola engineers specified them in place of tubular ceramic and mica condensers because of their outstanding performance and cost savings as well as their availability in these trying times.

## RMC DISCAPS

Used in this New Motorola Chassis

BY-PASS TYPES	TEMPERATURE COMPENSATING TYPES
7 - .005 MFD	1 - 150 MMF ± 20% N-750
7 - .001 MFD	2 - 30 MMF ± 10% N-150
4 - .0015 MFD	1 - 68 MMF ± 10% N-470
2 - 2 × .008 MFD	1 - 180 MMF ± 20% 3000 volt

Engineering costs out of a TV or radio chassis without sacrificing quality or performance is a mighty important job today. You, too, will find an important cost savings by specifying RMC By-pass and Temperature Compensating "DISCAPS."

If you will advise us of the types of tubular ceramic and mica condensers which you are now using, we will send samples of RMC "DISCAPS" with prices. The savings will be very apparent.

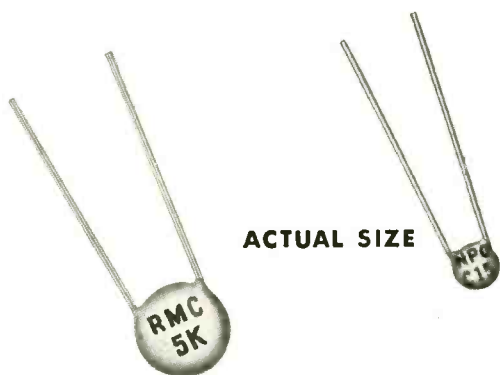

ACTUAL SIZE

**RMC "DISCAPS"**  
THE RIGHT WAY TO SAY  
CERAMIC CAPACITORS

\*Engineering with an Eye to Quality  
and Cost Savings

DISCAP  
CERAMIC  
CONDENSERS

**RMC**

**RADIO MATERIALS CORPORATION**

GENERAL OFFICE: 1708 Belmont Ave., Chicago 13, Ill.

FACTORIES AT CHICAGO, ILL. AND ATTICA, IND.

Two RMC Plants Devoted Exclusively to Ceramic Condensers

# MORE GEO. STEVENS COIL WINDING EQUIPMENT IS IN USE THAN ALL OTHER MAKES COMBINED!

- **MORE OUTPUT . . . LOWER COSTS . . .** from EXCLUSIVE SPEED FEATURE. Universal motors permit variable speeds without changing belts and pulleys. Coil design permitting, speeds as high as 7500 RPM are not uncommon.
- **PORTABILITY.** Conveniently carried from place to place. Machines come mounted on bases to constitute one complete unit.
- **MUCH LOWER ORIGINAL COST.** The same investment buys more GEO. STEVENS machines than any other coil winding machines.
- **LONG LIFE.** Most of the original

GEO. STEVENS machines bought 14 years ago are still operating daily at full capacity.

- **MUCH FASTER CHANGING OF SET-UPS** than any other general purpose coil winding machine. Quickly changed gears and cams save time between jobs.
- **VERY LOW MAINTENANCE.** Replacement parts are inexpensive, can be replaced in minutes, and are stocked for "same day" shipment, thus saving valuable production time.
- **EASIEST TO OPERATE.** In one hour, any girl can learn to operate a GEO. STEVENS machine.

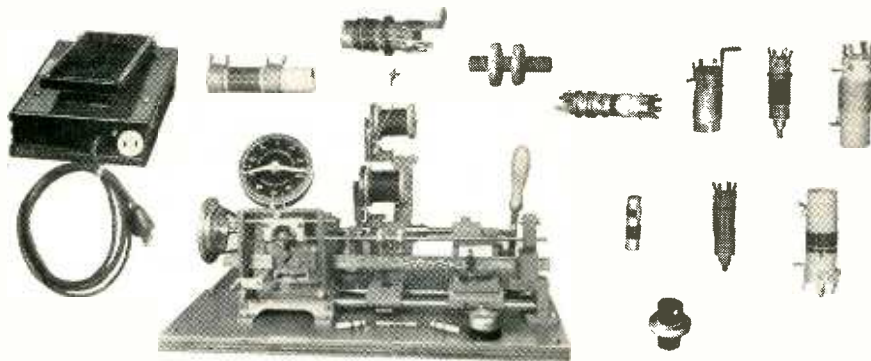

Progressive universal winding machine, Model 125, handles space wound coils and solenoids up to 8" in length, progressive universal coils up to 4" in length and 3" in diameter, universal coils up to 3/4" in width, and I.F. coils. Wire sizes are from 20x44 gauge. Cams are stocked from 1/16" to 3/4" in decrements of 1/64". Sizes larger than 3/4" or less than 1/64" decrements are made upon request. Head to tailstock is over 8"; base 22".

Change gears and idler forming the pattern are enclosed in front. Traverse rack is driven by change gears and idler enclosed in back of the head. The traverse rack has a mandrel return crank and a stop to insure return to identical starting position. Large ball bearings on head stock spindle give long life and easy running. Ball bearing tailstock with spring tension lever permits quick change of coil forms.

Motor equipment:—1/4 H.P. Universal motor, V belt driven, double spool carrier tension device with oilite bearings, and adjustable tension friction brake for changing winding tension of the wire.

Dial Counter (Model 50 or 51) with 6" full vision clock dial, accurately registers all turns.

There is a GEO. STEVENS machine for every coil winding need. Machines that wind ANY kind of coil are available for laboratory or production line. . . . Send in a sample of your coil or a print to determine which model best fits your needs. Special designs can be made for special applications. Write for further information today.

World's Largest Manufacturer  
of Coil Winding Machines

#### REPRESENTATIVES

Frank Tatro  
6022 No. Rogers Ave., Chicago 30, Illinois  
Ralph K. Reid  
1911 W. 9th St., Los Angeles 6, California  
R. A. Staff & Co.  
1213 W. 3rd St., Cleveland 13, Ohio

## GEO. STEVENS

MFG. CO., INC.

Pulaski Road at Peterson  
Chicago 30, Illinois

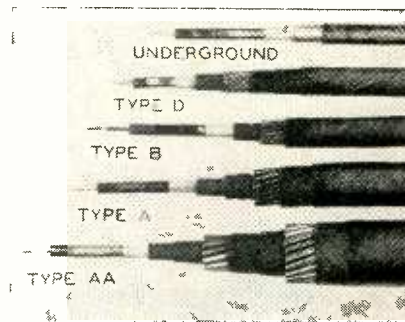

FIG. 7—Cutaway view of construction of deep-sea type cable

Key West-Havana network.

Material in this article has been abstracted from *The Bell System Technical Journal*, January, 1951, page 65.

#### REFERENCES

- (1) W. H. Martin, G. A. Anderegg and B. W. Kendall, Key West-Havana Submarine Telephone Cable System, *AIEE Trans.*, 41, p 1, Feb. 1922.
- (2) H. A. Affel, W. S. Gorton, and R. W. Chesnut, New Key West-Havana Carrier Telephone Cable, *BSTJ*, 11, p 197, April 1932.

## Filament Protection Circuit

BY JOSEPH F. SWINGLE, JR.  
*Bartol Research Foundation  
The Franklin Institute  
Swarthmore, Pa.*

THE USE of a vacuum gage tube as a vacuum indicator in a Van de Graaf electrostatic generator necessitates a protection circuit to remove the filament voltage from the tube in the event of vacuum failure. A circuit to do this is shown in Fig. 1.

A standard difference amplifier reads pressure by measuring voltage drop across the grid resistor of a 6SN7. The filament voltage should be removed when the pressure exceeds approximately  $5 \times 10^{-3}$  mm of mercury, corresponding roughly to a current of 50  $\mu$ a or a potential of 50 v across a 1-megohm grid resistor.

It was decided to use a control circuit which would remove filament voltage at various pressures (voltages). The circuit of Fig. 1 incorporates the previously mentioned features and operates the filament cutout relay at any desired voltage from 0 to +50 v.

The setting of  $R_1$  determines the relay triggering voltage. The total range of control voltages may be



**Snyder**  
PHILADELPHIA

**ANTENNA SPECIALISTS**

**COMPLETE PRODUCTION  
FACILITIES**

*Under One Roof*

**FOR**

**MILITARY**

**PRODUCTION**

ENGINEERING  
FABRICATING  
ASSEMBLY  
FINISHING  
ELECTRO-PLATING  
EXPORT PACKING

**BROCHURE  
ON  
REQUEST**



**SNYDER MFG. CO.**

**ANTENNA-ENGINEERS®  
PHILADELPHIA 40**

# Leach RELAYS

**TROUBLE-FREE  
PERFORMANCE**

*"as specified"*

Because all *Leach* Relays are *quality engineered* for dependable duty... they are specified *first* by leading manufacturers of industrial equipment of all types. If your equipment demands relays that are first and foremost, more dependable and longer lasting, specify *Leach* Relays... they're more dependable... *performance proves it*. Whatever your relay control problem... it's a challenge to *Leach*. Illustrated are but a few of the wide selection *Leach* provides industry, as standard equipment.

RELAYS SHOWN ABOVE CAN BE SUPPLIED WITH VARIOUS CONTACT ARRANGEMENTS. WRITE FOR DETAILS.

**BETTER CONTROLS THROUGH BETTER RELAYS**

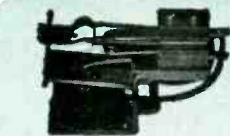

✓ MOTOR STARTING RELAY

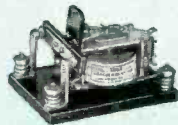

✓ OVERLOAD TRIP LIGHT DUTY



✓ HERMETICALLY SEALED



✓ MIDGET LATCHING RELAY



✓ RADIO AND HIGH VOLTAGE

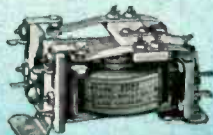

✓ ANTENNA TRANSFER



✓ MULTIPOLE RELAY



✓ MIDGET RELAY



✓ CIRCUIT CONTROL

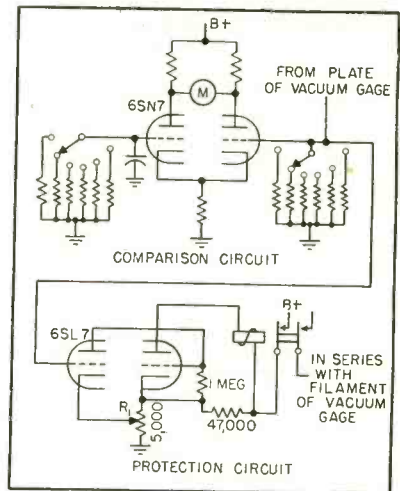

FIG. 1—Schematic diagram of filament protection circuit and comparison circuit. Plate supply may be 100 to 250 v

increased or decreased by changing the value of  $R_1$ .

The circuit should have many applications where it is desired to trigger a relay, counter or other device at predetermined input voltages using a minimum of parts.

## Emergency Broadcast Pickup Head

BY ANTONIO VACCARO  
Chief Engineer, WHEB  
Portsmouth, N. H.

STUDIOS of most small broadcasting stations are located at some remote point from the transmitter and the engineering staff. The situation at station WHEB is one in which the announcers or a nonlicensed man run the controls and turntables at the studio and the engineers are located out of town.

Whenever trouble occurs on any of the pickup heads, the table is out of order until one of the engineers can get to the studio and make the necessary repairs. Repairs may be delayed for an hour or more during which time the control man has only one table at his disposal.

The pickup head and arm to be described can be placed into operation by the control man or announcer in a matter of seconds after trouble occurs on any pickup head.

A pickup arm was made from an old aluminum based transcription disk according to the design shown in Fig. 1. The pattern was cut out with shears, scored and then bent

**LEACH RELAY CO.**

5915 AVALON BOULEVARD, LOS ANGELES 3, CALIFORNIA  
Representatives in Principal Cities of U. S. and Canada



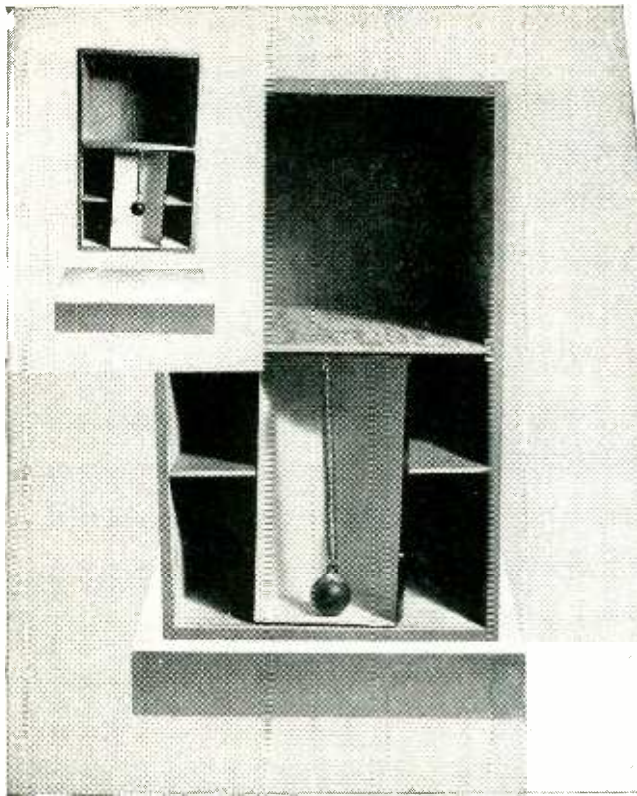

Photograph shows how the "g's", generated by a 6 inch uncushioned drop, forced the spring suspended ball clear to the bottom of its container. It's "g's" that tear the heart out of a delicate instrument...with a bang. Inset shows position of ball just before the drop.

Shown at right is the same container cushioned in Texlite. The "g's" of the 6 inch drop were dissipated by the gentle deceleration of Texlite. Note that there was no noticeable downward movement of the ball.

**g's**...  
they ruin  
your product

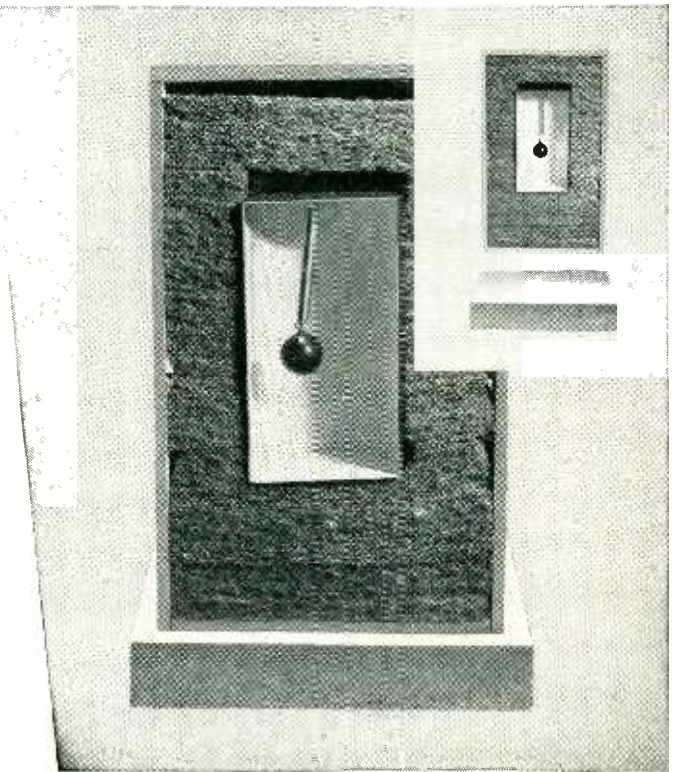

### Protect your instruments from bangs

with  
**TEXLITE®**  
rubberized curled hair

Texlite is your best assurance that delicate equipment will arrive anywhere — undamaged and ready to work. It combines high deflection with low density — weight ranges from 1 to 8 lbs. per cu. ft. Unaffected by changing moisture and temperature conditions, Texlite is fungus resistant and dust free. Possessing excellent resistance to aging, Texlite may be reused for back and forth shipments.

Also available for protective packaging are **SPONGEX®** cellular rubber, **SPONGEX CELL-TITE®** with almost zero water absorption and 0.28-0.30 K factor, and **TEXFOAM®** latex foam rubber.

If you have a protective packaging problem, consult our packaging division. Let our laboratory analyze, and prescribe, the protective requirements for your products for safe shipment anywhere — by land, sea or air.

*The World's Largest Specialists in Cellular Rubber*

**THE SPONGE RUBBER PRODUCTS COMPANY**

469 Derby Place, Shelton, Connecticut

# first again with TEFLON

7-pin Miniature Tube Sockets, ideal wherever high or low ambient temperatures or frequency stability are problems.

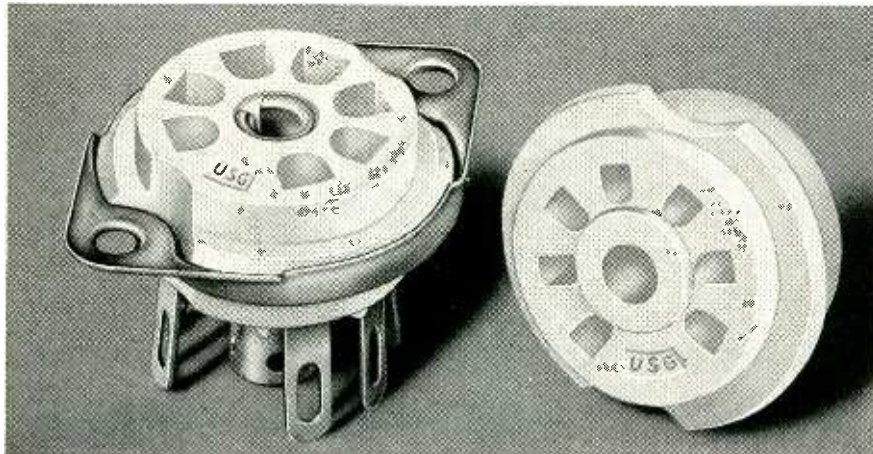

## CHEMELEC HIGH PERFORMANCE TUBE SOCKETS

- Surface resistivity  $3.5 \times 10^{13}$  ohms.
- Loss factor less than 0.0005.
- Dielectric constant 2.0 (60 cycles to 30,000 megacycles).
- Serviceable at  $-150^{\circ}\text{F}$  to  $+575^{\circ}\text{F}$  with negligible change in critical electrical characteristics.
- Won't carbonize under arcing.
- 0.0% water absorption (ASTM Test).
- Unaffected by extreme humidity, corrosive atmosphere or fungus.
- Non flammable.
- Chemically inert—unaffected by oils, organic or inorganic acid, alkali or solvent.
- Allocation limits supply to projects with National Production Authority sanction.
- Write for catalog No. SO-428.



**TEFLON PRODUCTS DIVISION**

**UNITED STATES GASKET CO.**  
600 North 10th Street, Camden, New Jersey

TUBES AT WORK

(continued)

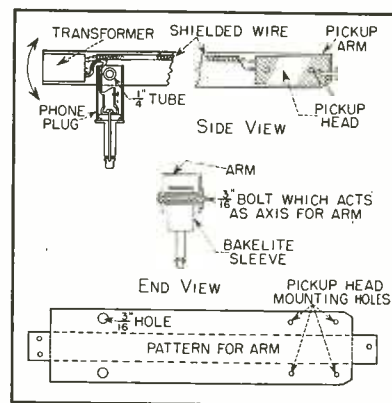

FIG. 1—Mechanical details of the emergency broadcast pickup arm

with the aid of angle irons. The arm was designed to fit around a fairly good crystal pickup head although a magnetic head could be used just as well with a few changes in design.

The only additional parts needed for construction are a UTC model 0-11 ounce transformer, a phone plug and a jack. The transformer serves the dual purpose of matching the high impedance of the crystal head to the low impedance of the turntable input of the console and also serves as a counter weight for the pickup arm.

On the finished arm, the phone plug may be mounted approximately  $1\frac{1}{2}$  to 2 in. from the tail end of the arm depending upon how much counter weight is desired. The plug is so mounted that it serves as the supporting mount for the arm and, at the same time, allows the head to be raised from or lowered onto the recording.

The head is wired to the high-impedance primary of the transformer and the secondary is wired to the tip and sleeve of the phone plug leaving just enough slack wire to allow the head to be raised and lowered. Whenever trouble occurs with one of the pickup heads, the announcer just has to plug the emergency head into jacks on the turntable.

A closed circuit jack was used which automatically cuts out the regular head from the circuit and places the emergency head into operation. In this way, no mismatch of impedance occurs because of two heads being across the turntable input circuit at the same time.

Some of the construction details





*Leading the Quality Field for more than 25 Years*

# **KENYON** **TRANSFORMERS**

**for all ARMY-NAVY specifications**

- built for durability
- engineered for trouble-free operation
- designed for standard and special applications

**use KENYON TRANSFORMERS for**  
**RADAR • BROADCAST • SPECIAL MACHINERY**  
**JAN APPLICATIONS • ATOMIC ENERGY**  
**EQUIPMENT • AUTOMATIC CONTROLS**  
**EXPERIMENTAL WORK**

*Write for details*

**KENYON TRANSFORMER CO., Inc.**  
**840 BARRY STREET • NEW YORK 59, N. Y.**

# It's time we got working mad!

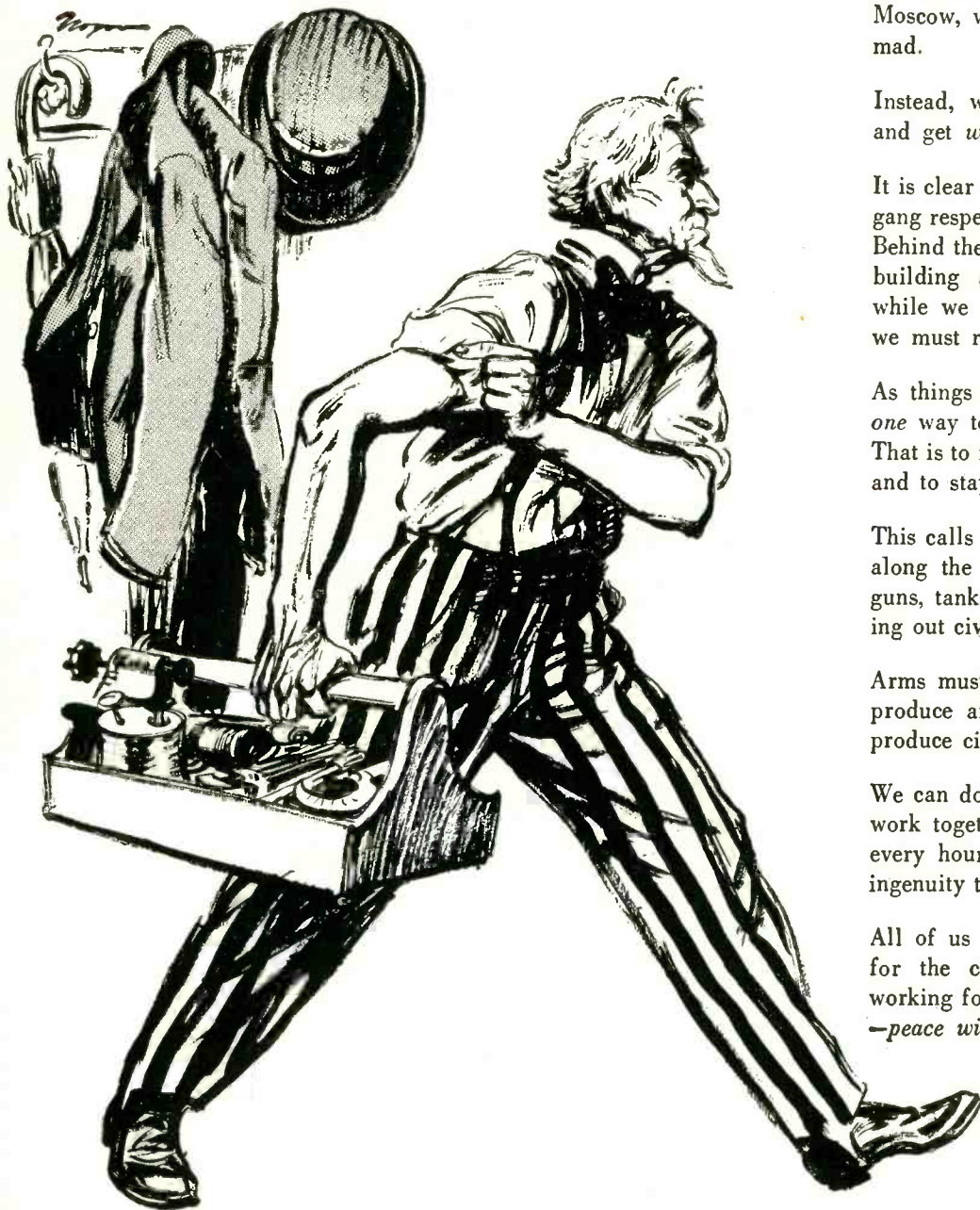

As we listen to the latest insults from Moscow, we're likely to get fighting mad.

Instead, we'd better use our heads and get *working* mad.

It is clear by now that Stalin and his gang respect just one thing—strength. Behind the Iron Curtain they've been building a huge fighting machine while we were reducing ours. Now we must rebuild our defenses—*fast*.

As things stand today, there is just *one* way to prevent World War III. That is to re-arm—to become strong—and to stay that way!

This calls for better productivity all along the line. Not just in making guns, tanks and planes, but in turning out civilian goods, too.

Arms must come first. But we must produce arms *at the same time* we produce civilian goods.

We can do this double job if we all work together to turn out more for every hour we work—if we use our ingenuity to step up productivity.

All of us must now make sacrifices for the common good. But we're working for the biggest reward of all—*peace with freedom!*

## THE BETTER WE PRODUCE THE STRONGER WE GROW

### FOR A FREE COPY OF "THE MIRACLE OF AMERICA"

MAIL THE COUPON to Public Policy Committee, The Advertising Council, Inc., Dept. B.P., 25 West 45th Street, New York 19, N. Y.

Name.....

Address.....

.....



**McGRAW-HILL PUBLISHING COMPANY**



are as follows: About  $\frac{3}{8}$  in. down from the top of the Bakelite sleeve of the phone plug a  $\frac{1}{4}$ -in. hole is drilled and then reamed out to be just slightly larger than  $\frac{1}{4}$  in. A piece of copper tubing is cut off to a length which fits snugly between the inside surfaces of the pickup arm. The tubing is pushed through the reamed out holes which were drilled horizontally through the Bakelite sleeve of the phone plug. The tube should fit loosely enough so that the arm can be raised or lowered with ease. Next the copper tube is aligned with the  $\frac{3}{16}$ -in. holes on the side of the pickup arm and a  $\frac{3}{16}$ -in. bolt is passed through the entire unit and a nut is affixed tightly. The arm is then complete and the only job remaining is to mount and wire a jack on each table. The jack serves as contact for arm, support and horizontal pivot of arm.

### An Improved Telephone Set

A NEW and improved common battery telephone set has been developed by the Bell System. It incorporates technical advances as well as a more functional design making the handset smaller and 25 percent lighter than the existing type. One of the new features is a manually adjustable volume control for the ringer which allows the subscriber to change the loudness over a wide range.

A schematic diagram of the new 500-set is shown in Fig. 1. The main design objective was to obtain acceptable performance over greater distances from the central office or with finer gage cable conductors and, at the same time, use



External view of the handset

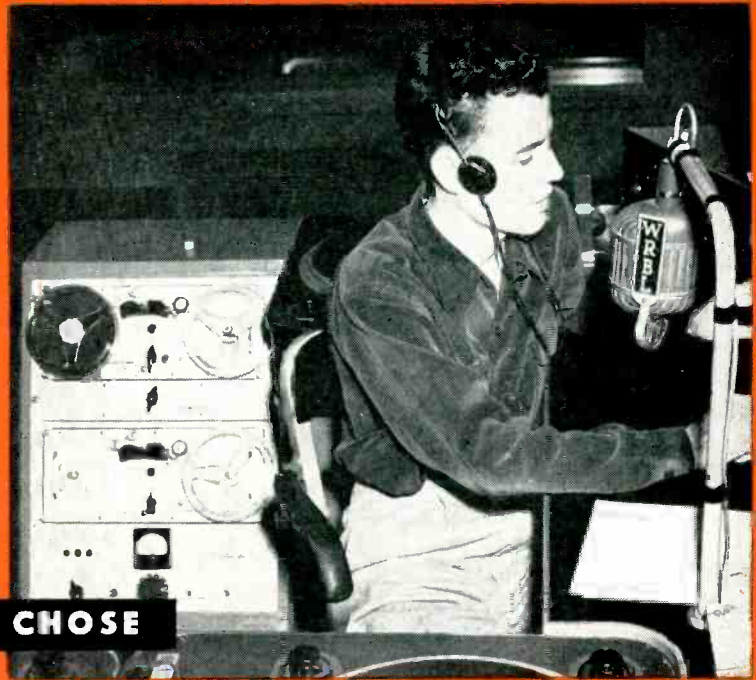

WE CHOSE

# Magne recorder

THE FIRST CHOICE OF RADIO ENGINEERS



### FLEXIBILITY

In rack or console, or in its really portable cases, the Magne recorder will suit every purpose. PT6 Series shown is the most widely used professional tape recorder in the world, and is available with 3 speeds ( $3\frac{3}{4}$ ,  $7\frac{1}{2}$ ,  $15$ ) if preferred.

### FIDELITY

Lifelike tone quality, low distortion meet N.A.B. standards — and at a moderate price! PT63 Series shown in rack mount also offers three heads to erase, record, and play back to monitor from the tape while recording.

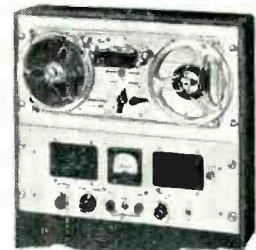

### FEATURES

PT7 accommodates  $10\frac{1}{2}$ " reels and offers 3 heads, positive timing and pushbutton control. PT7 Series shown in complete console model is also available for portable or rack mount. For outstanding recording equipment, see the complete Magne recorder line — PT6, PT63 and PT7.



### WRITE FOR NEW CATALOG

Magne recorder, Inc., Dept. EB-6  
360 N. Michigan Ave., Chicago 1, Ill.  
Send me latest catalog of Magne recorder Equipment.

Name.....

Address.....

City..... Zone..... State.....

## Magne recorder, INC.

360 NORTH MICHIGAN AVENUE  
CHICAGO 1, ILLINOIS

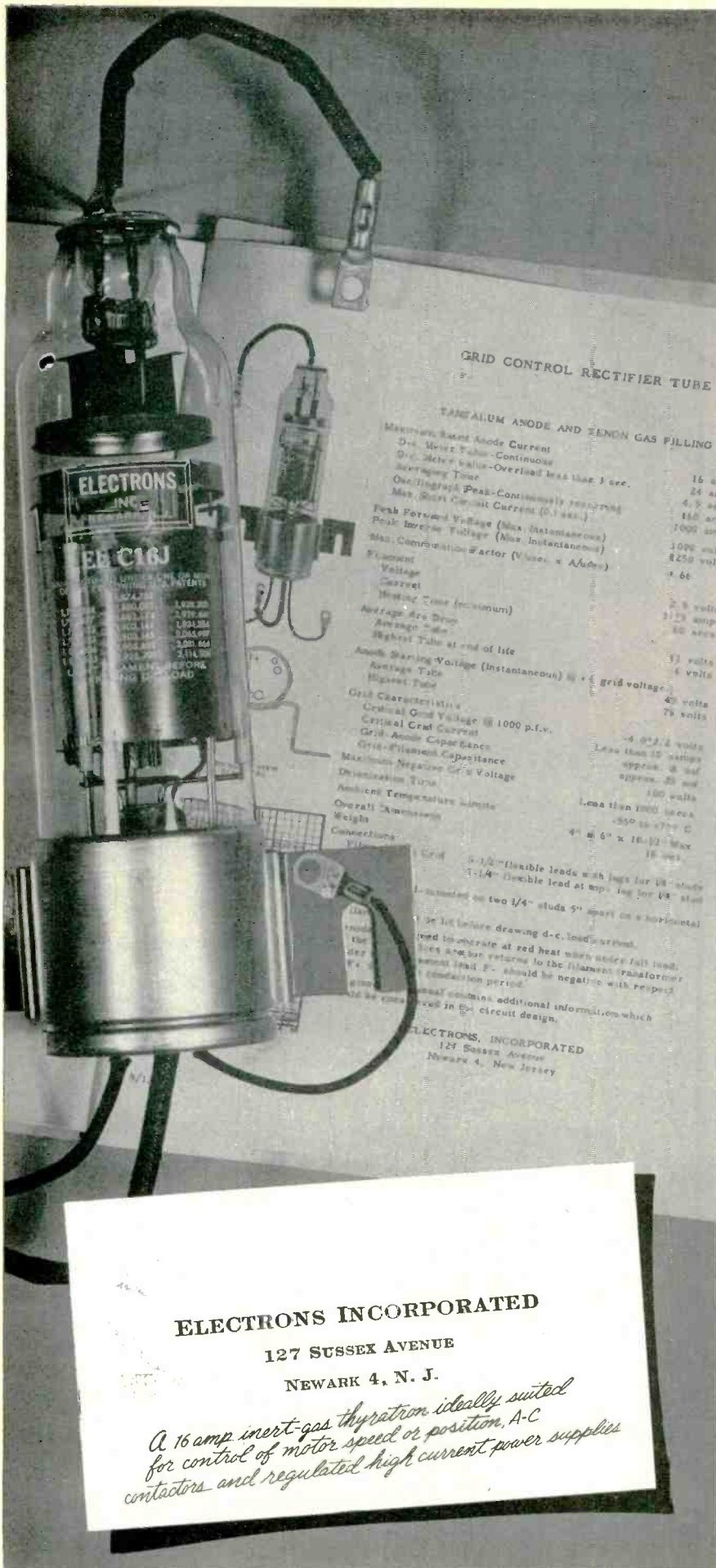

**ELECTRONS INCORPORATED**

127 SUSSEX AVENUE  
NEWARK 4, N. J.

*A 16 amp inert-gas thyratron ideally suited for control of motor speed or position, A-C contactors and regulated high current power supplies*

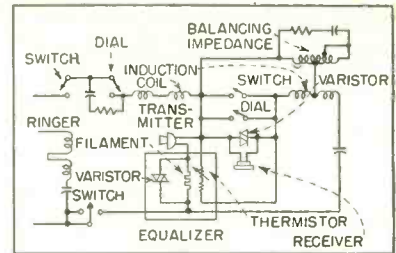

FIG. 1—Schematic diagram of the new 500-set

existing central office facilities.

A second goal was a reduction in variations in transmission between individual users and between stations with wide variations in distance from the central office.

Automatic change in performance to obtain the maximum usable increase in transmitting and receiving volume on long loops has been achieved by the use of an automatic transmission equalizer. The inserted loss characteristics of the equalizer are adjusted by the magnitude of the d-c line current through the set.

The initial design has a tungsten ballast filament in series with the transmitter so that the effect of transmitting on long loops is small. On short-loop transmission, however, with high values of d-c, the combined battery supply and a-c circuit loss inserted is about 5 db.

New transmitter and receiver designs were required because of the increased transmission gain. The receiver design utilizes a ring armature structure.<sup>1</sup> The structure is 5 db more efficient than the present model receiver and allows the upper frequency range to be extended by about 500 cycles.

In the transmitter design, modulation of the carbon was increased, smaller parts were used and the transmitter located more advantageously with respect to the mouth to increase the effective working acoustic pressures.

This material was abstracted from an article entitled "An Improved Telephone Set" by A. H. Inglis and W. L. Tuffnell which appeared on page 239 in the *Bell System Technical Journal* for April 1951.

REFERENCE

(1) E. E. Mott and R. C. Miner, The Ring Armature Telephone Receiver, *BSTJ*, 30, p 110, Jan. 1951.





# Why Corning **ALL GLASS** Television Bulbs?

Few materials are more ideally suited to electronic tube enclosures than glass. For television bulb applications, Corning has been able to select from over 50,000 glass formulae a glass that meets every requirement—high dielectric strength, high physical shock resistance, optimum light transmission. Lead-free, this glass is light in weight. Easy to work, it is readily adaptable to production on high speed automatic machinery. Add to this the fact that glass is a low cost, *readily available material* and you can see why many tube manufacturers prefer Corning all-glass television bulbs.



**CORNING GLASS WORKS, CORNING, N. Y.**

*Corning means research in Glass*

**ELECTRONIC SALES DEPARTMENT — ELECTRICAL PRODUCTS DIVISION**

1851 · 100 YEARS OF MAKING GLASS BETTER AND MORE USEFUL · 1951

# ANTENNAS

*from P to K*

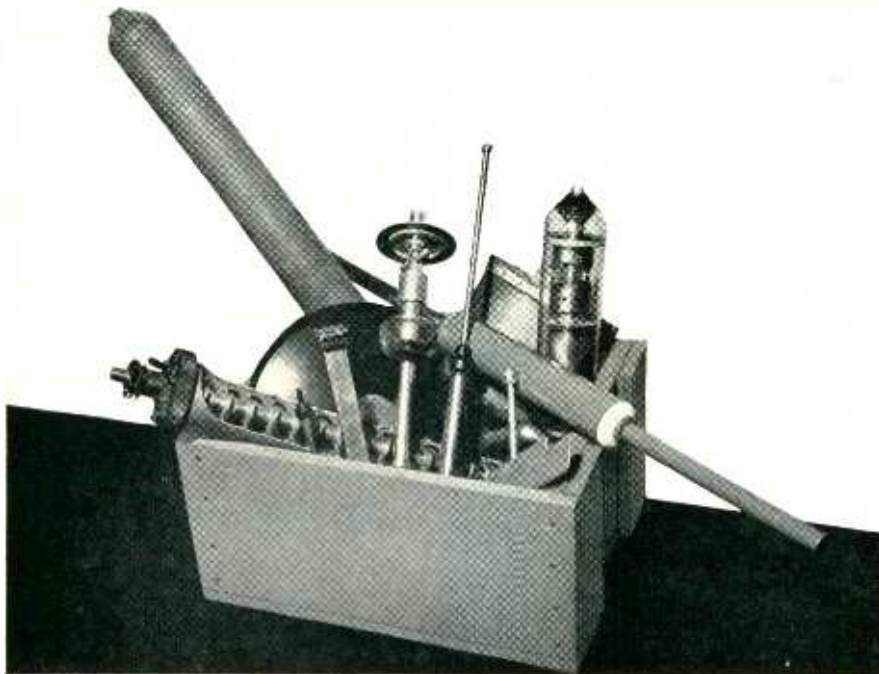

*A*s a matter of fact, Workshop high-frequency antennas start below the P band at 30 mc. and continue throughout the spectrum to 33000 mc. The twelve models haphazardly placed in the box (above) may give you an idea of the infinite variety of antenna problems presented to Workshop engineers in their everyday work. With research, test, and production facilities unmatched in the industry, coupled to an experienced staff, the Workshop can meet the most exacting military and commercial requirements. If you have an antenna problem—write, or phone Needham 3-0005. No obligation.



**The WORKSHOP ASSOCIATES,**  
INCORPORATED

*Specialists in High Frequency Antennas*

135 Crescent Road, Needham Heights 94, Massachusetts

## THE ELECTRON ART

(continued from p 140)

simple theory, the oblique incidence signals should be reflected can be calculated.

All three transmitting-receiving stations will use the model C-3 automatic ionosphere recorder developed by the Bureau. Its transmitted power is 20 kw and it is capable of scanning a frequency range of 1 to 25 mc in 7.5 seconds. Signals will be transmitted, received and recorded on film strips at a 24-hour-per day-basis.

The proposed experiment involves comparatively short distances. However, it is known that the discrepancies between theory and practice increase in magnitude as the distance between transmitter and receiver becomes greater. To investigate this effect, the mobile unit will be placed at the midpoint of much more widely spaced permanent installations. The next stop may be between the Sterling station and one in the Hawaiian Islands, Alaska, San Francisco, Puerto Rico, or Panama. Before the program is completed, the mobile unit will have been placed at the midpoint of the path to most of the Bureau's ionosphere stations in the western hemisphere.

The Bureau will analyze the film-strip records from each tri-station experiment. The analysis will shed more light on the causes of fading and explain the complete loss of a signal between the transmitter and the receiver. Thus, at the end of this unusual series of experiments, the Bureau will be in a position to supply all the users of long-range communications with more accurate information for selecting the proper frequency to transmit intelligence over a certain path at any particular time of the day and year.

## Modified Wallman Circuit With Voltage Feedback

BY SHIGEO SHIMIZU

*Tokyo Shibaura Electric Co.  
Kawasaki City, Japan*

THIS is a report of a new low-noise amplifier circuit. The second stage of the Wallman circuit, which is a current-feedback amplifier, can be replaced by a voltage-feedback amplifier, to form a more convenient



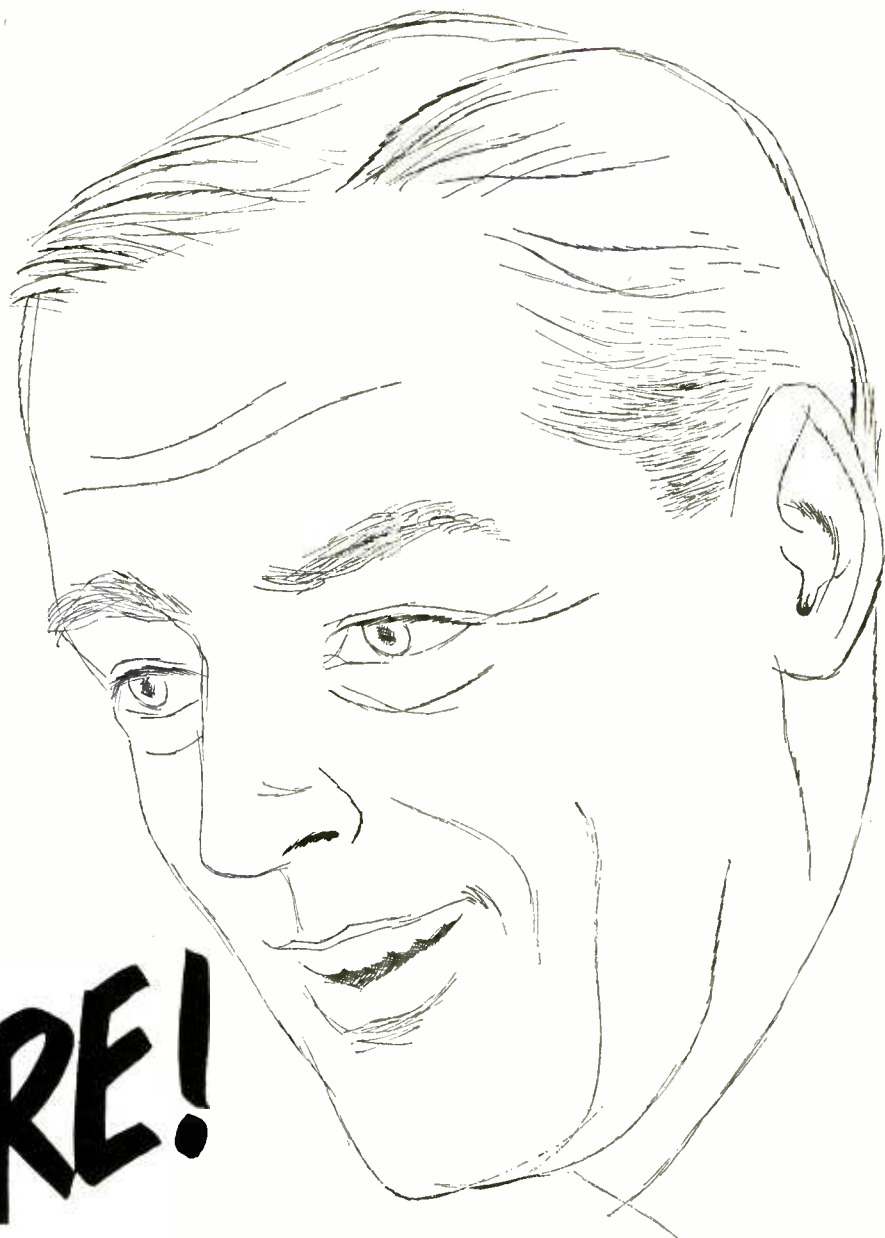

**SURE!**

**BUY SPEER  
WHEN YOU BUY RESISTORS**

*...for consistent high stability  
in operation*

Complete your circuits with R. F. coils...chokes...tubular and disc capacitors...high voltage condensers...capristors by

JEFFERS ELECTRONICS, INC.  
DU BOIS, PA.

Another Speer Carbon Co. Subsidiary

**SPEER**  
*Resistor* **CORP.**

A SPEER CARBON COMPANY SUBSIDIARY

ST. MARYS, PENNSYLVANIA

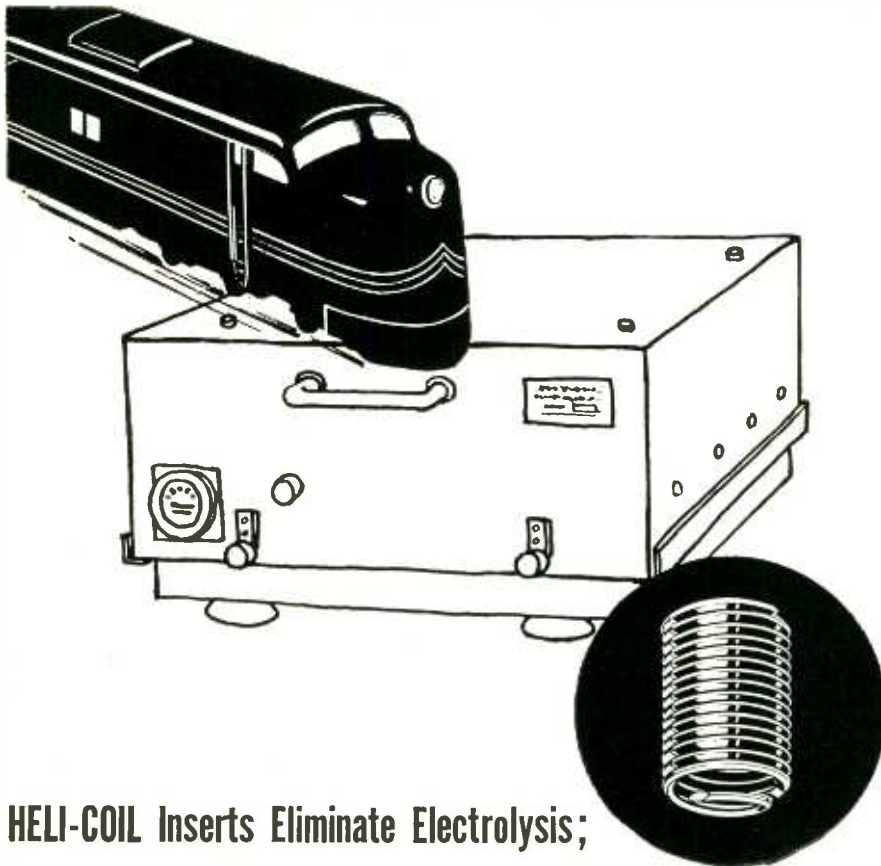

## HELI-COIL Inserts Eliminate Electrolysis; Provide Easy Assembly and Disassembly

Heli-Coil Inserts, precision-formed of stainless steel or phosphor bronze wire, permit freer use of aluminum and magnesium without risk of electrolysis... outlast the product. They strengthen assemblies without use of heavy bushings... are completely free from vibration wear. Lighter assemblies and more compact designs are possible when Heli-Coil Inserts are used... and they never strip, gall, seize, or corrode.

In cover plates, connectors, radar pick-up screens, stroboscopic and X-ray equipment—wherever light metals are used in communications and electronic equipment—Heli-Coil Inserts allow wide use of light metals with assurance of permanent, non-wearing threads. Assembly and disassembly are quick and easy, however frequently needed. No inventory of oversize bolts, studs, and nuts is required when Heli-Coil Inserts are used... salvage, repair, and maintenance are simplified.

Heli-Coil Screw Thread Inserts guarantee permanent freedom from tapped thread troubles. Made in National Coarse and Fine Thread Series, Unified Thread Series, and pipe thread sizes... meet all industrial, military, and aircraft specifications. Class 3 fits are standard; tools and inserts available to suit pitch and major diameter for Class 2 and 2B fits.

### HELI-COIL



Protecting Screw Threads for Industry

## CORPORATION

Heli-Coil  
is a Registered  
U. S. Tradename

HELI-COIL CORPORATION  
47-243 Thirty-Fifth Street,  
Long Island City 1, N. Y.

Please send me  
 Bulletin 650-R on Design Data  
 Bulletin 349 on Salvage and Service

NAME \_\_\_\_\_

FIRM \_\_\_\_\_

STREET \_\_\_\_\_

CITY \_\_\_\_\_ ZONE \_\_\_\_\_ STATE \_\_\_\_\_

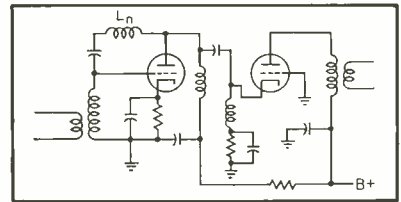

FIG. 1—Normal Wallman circuit with current feedback in second stage

circuit. This circuit was developed during a study of a low-noise i-f amplifier of a microwave receiver.

For this purpose, the Wallman circuit (Fig. 1) was generally used for its superiority in terms of noise-figure; but it has some disadvantages, such as difficulty of adjustment, and inconvenience due to the floating cathode of the second stage tube.

The operating expression of the second stage of the Wallman circuit is as follows:

$$i_{p2} = g_{m2} (e_{k2} + i_{p2} Z_{k2})$$

$$i_{p2} (1 - g_{m2} Z_{k2}) = g_{m2} e_{k2}$$

$$i_{p2} = \frac{g_{m2} e_{k2}}{1 - g_{m2} Z_{k2}} \approx \frac{e_{k2}}{Z_{k2}} = \frac{(Z_{k2} g_{m1} e_{p1}) + E_{n2}}{Z_{k2}}$$

$$\therefore e_{p2} = Z_{p2} i_{p2} = Z_{p2} g_{m1} e_{p1} + \frac{Z_{p2} E_{n2}}{Z_{k2}}$$

From these equations the facts are clear that, the second stage of the Wallman circuit is a current feedback amplifier and this stage has lower noise input impedance and lower noise output than a normal grounded-cathode amplifier. It was decided to try voltage feedback in the second stage to achieve the same benefits that are obtained in the Wallman circuit through the use of current feedback. The resulting circuit (Fig. 2) has the advantage of a grounded cathode in the second stage and easier adjustment due to the use of a pentode. The operating expressions are as follows:

(1) Without feedback

$$e_{p1} = Z_{p1} g_{m1} (E_s + E_{n1})$$

$$e_{p2} = Z_{p2} g_{m2} (e_{p1} + E_{n2})$$

$$= Z_{p2} g_{m2} [Z_{p1} g_{m1} (E_s + E_{n1}) + E_{n2}]$$

(2) With feedback

$$e_{p1}' = e_{p1} / Z_{p1} g_{m1} = (E_s + E_{n1})$$

$$e_{p2}' = e_{p2} / Z_{p1} g_{m1} = Z_{p2} g_{m2} \left[ (E_s + E_{n1}) + \frac{E_{n2}}{Z_{p1} g_{m1}} \right]$$

where the mean square of  $E_{n2}$





it's the "Steps  
between"

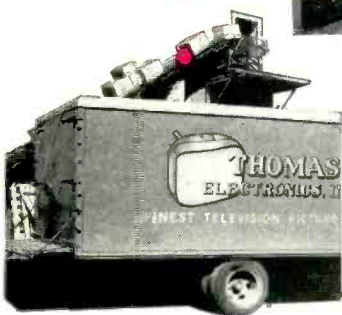
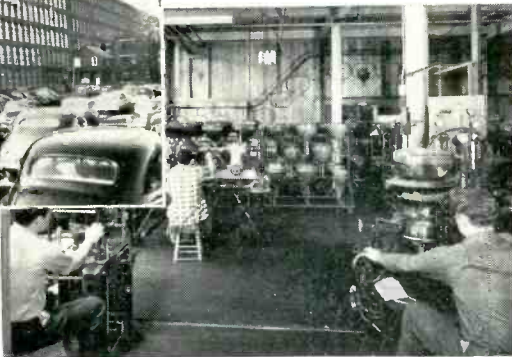

that make

**Thomas**  
**Photo-tron**  
PICTURE TUBES

**Superior!**

EVERY STEP in the making of a Thomas picture tube is followed through with the foresight, intelligent planning, sound engineering, continuous research and attention to detail by Thomas designers, engineers and technicians whose experience goes back to the beginning of electronic tube history. From drafting board to shipping platform, only the highest quality production control is evident. Little wonder then that Thomas Photo-tron picture tubes are used by so many major TV set makers. See list of 20 at right of this page.

**Thomas Photo-tron**  
Picture tubes are exact original equipment with all these TV set makers:

*Admiral*  
*Kaye-Halbert*  
*Bendix Television*  
*Olympic*  
*Meck*  
*Packard Bell*  
**PILOT**  
*Magnavox*  
*Starrett*  
*Colbest*

*hallicrafters*  
*Tele-tone*  
**CROSLEY**  
*Lyon & Healy*  
*Tele King*  
*Motorola*  
**Hoffman**  
*Westinghouse*  
**Imperial**  
**SCOTT**

**Thomas** ELECTRONICS, Inc.  
PASSAIC, N.J.





It's only natural  
that the largest  
**PRODUCER\*** of  
switch-type tuners  
should produce  
the **BEST!**

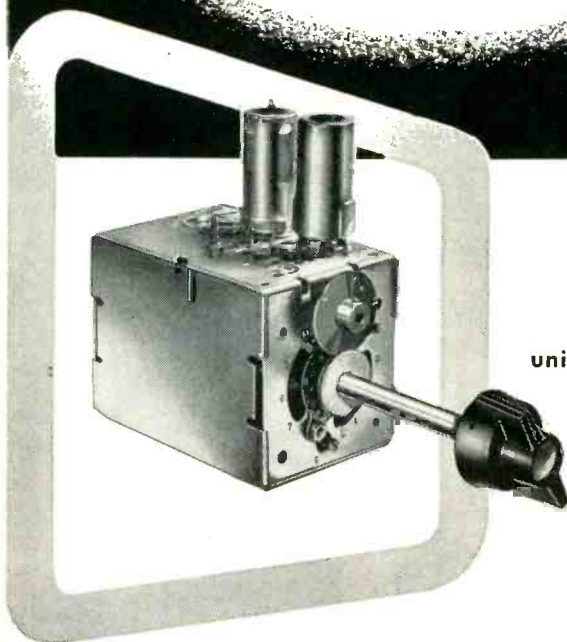

No other commercial  
unit possesses all of the  
Desirable Features  
found in the

**Tarzian  
Tuner!**



**SARKES TARZIAN, INC.**  
TUNER DIVISION  
Bloomington, Indiana

**OTHER TARZIAN-MADE PRODUCTS**



Centre-Kooled  
Selenium Rectifiers



Air Trimmers



Cathode-Ray  
Tubes

**STATIONS WTTT (5000 WATTS) AND WTTV (CHANNEL 10)  
OWNED AND OPERATED BY SARKES TARZIAN IN BLOOMINGTON**

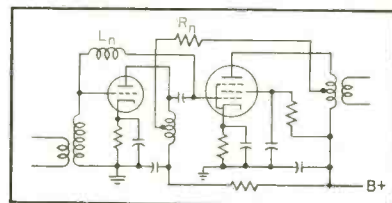

FIG. 2—Modified Wallman circuit permits grounding of second-stage cathode and offers several other advantages

$$E_{n2}^2 = 4 k T \beta \left[ R_{v2} + R_{p1} + \left( \frac{R_{p1} R_{g2}}{R_{p1} + R_{g2}} \right)^2 \frac{5}{R_{g2}} \right]$$

For the conditions studied—center frequency 50 mc, and a 6AK5 tube connected as pentode

$$E_{n2}^2 = 4 k T \beta (4,300)$$

The converted value of this to the first tube grid is

$$\frac{E_{n2}^2}{(Z_{p1} g_{m1})^2} = 4 k T \beta (43)$$

By comparison of these expressions and expressions of normal Wallman circuit, it is evident that this circuit has an equal noise figure for the case where

$$R_{p1} \gg \left[ R_{v2} + \left( \frac{R_{p1} R_{g2}}{R_{p1} + R_{g2}} \right)^2 \frac{5}{R_{g2}} \right]$$

and in addition to that, this circuit provides easier adjustment.

*Result of the Experiment*

In experimenting with this circuit for examination of the foregoing theory, it was found that this circuit (with a center frequency of 52 mc, bandwidth of 10 mc, and employing a 6AK5 tube) had a noise figure of 1.9, as compared to 2.04 for the normal Wallman circuit.

**Electronic Analysis of Walking**

THE ELIMINATION of the hazards imposed by slippery walkway surfaces—responsible each year for a large number of serious injuries and accidental deaths—is the principal objective of a research project at the National Bureau of Standards. To obtain basic quantitative data on some of the factors involved in the slipperiness of walkways, the Bureau has devised an electronic stepmeter which measures the three components of force produced between the foot and the floor in normal walking.

The electronic stepmeter consists



YOU CAN BE **SURE**.. IF IT'S  
**Westinghouse**

## Transformer Space-saving problem

**SOLVED**

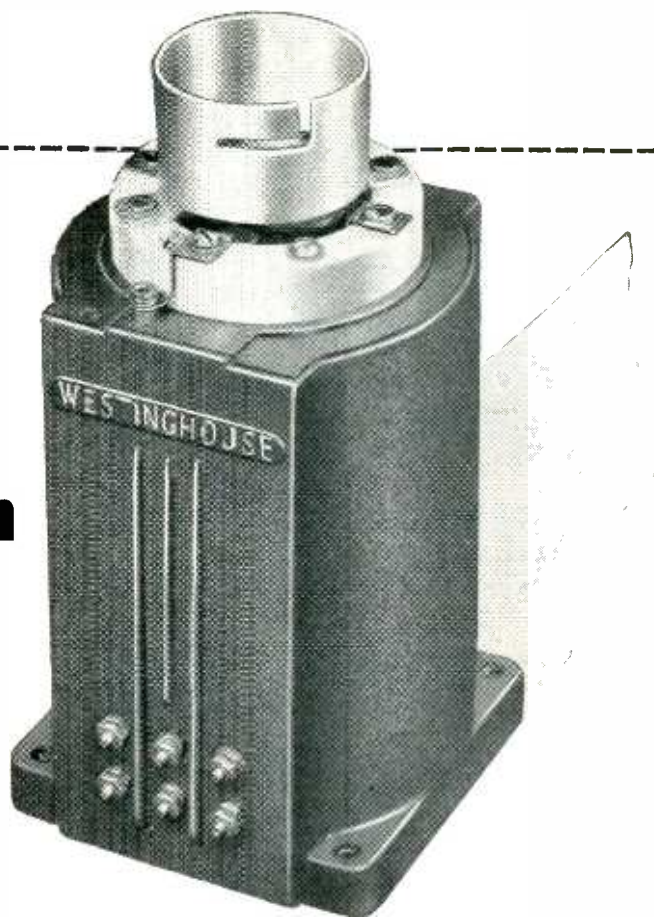

Here's a space-saving problem . . . and another example of how Westinghouse applies engineering experience to handle all types of transformer problems.

**The problem:** To build a more compact filament transformer for use with Phanotron rectifier tubes.

First, the transformer case, core and coils had to be made smaller.

Second, the large standoff insulator between the transformer case and tube socket had to be eliminated. Because the previous case was metal, a large standoff insulator had been used to keep the tube socket, mounted on top of the transformer case, 11,000 volts from ground.

**The Westinghouse solution:** MOLDARTA and Type C HIPERSIL cores, two Westinghouse engineered products.

Westinghouse Type C HIPERSIL cores,  $\frac{1}{3}$  smaller

than ordinary cores, easily fit the smaller MOLDARTA transformer case.

MOLDARTA, a low power factor, low loss material, also served as the perfect insulator. Thus the large standoff insulator was eliminated . . . the desired compactness was attained . . . and a difficult space-saving problem was solved.

*If you have a tough transformer problem, take advantage of the facilities of Westinghouse for quick, practical solutions. Transformers specially designed for all types of electrical and electronic circuits, as well as a wide selection of standardized designs . . . produced in quantity . . . with quality. Call your nearby Westinghouse representative, or write Westinghouse Electric Corporation, P. O. Box 868, Pittsburgh 30, Pennsylvania. J-70569*



**Westinghouse**

SPECIALTY  
TRANSFORMERS

On the line . . .  
or in the lab . . .

**Clippard  
Instruments**

**... speed, simplify  
and assure  
accurate work**



PC-4 CAPACITANCE COMPARATOR

Any type of condenser can be checked, graded or sorted on this instrument. Unskilled operators can process up to 17 capacitors per minute with absolute accuracy. Ask for Catalog Sheet.



PR-5 RESISTANCE COMPARATOR

Accuracy of better than  $\pm 1\%$  through range of 100 ohms to 100 megohms. Some fast, easy operation as companion instrument, PC-4 above. Ask for Catalog Sheet.



ELECTRONIC VOLT-OHMMETER

Measures AC and DC voltages 0-1000 volts; Ohms; 0 ohms to 1000 megohms on seven overlapping ranges; DB: -20 to +51 DB; Full scale sensitivity for AC, DC, -DC, AF, IF, RF and UHF potentials with maximum accuracy and stability. Ask for Catalog Sheet.

In production, alignment, testing or quality control, Clippard Capacitance and Resistance Comparators and Electronic Volt-Ohmmeters save time and cost in all types of electronic manufacture. Used by radio, electrical, resistor and condenser manufacturers and large parts jobbers, the instruments illustrated provide unerring accuracy in both laboratory and production work.

**Clippard**

INSTRUMENT LABORATORY INC.

1125-6E Bank St., Cincinnati 14, O.

MANUFACTURERS OF R. F. COILS AND ELECTRONIC EQUIPMENT

primarily of a two-foot square platform mounted on ball bearings attached to four J-shaped springs. The four sides of the platform bear against ball bearings attached to L-shaped springs which are kept under slight tension so that all will follow the horizontal motion of the platform. Electromechanical pick-ups are mounted adjacent to the appropriate springs. Deflections of the springs due to forces exerted against them produce output voltages in the pick-ups proportional to the forces in each of three directions—vertical, longitudinal, and transverse. Walkways on a level with the platform of the stepmeter are used so that walking on a level



Electronic stepmeter measures the vertical and horizontal components of the forces exerted by the leg on a walkway surface during a step

surface can be simulated. The output voltages are amplified, and are recorded with respect to time by an oscillograph.

Oscillographic recordings of the vertical and horizontal components of the force exerted by the leg on the platform of the stepmeter during a step have been analyzed for 7 men and 5 women. Curves for the vertical forces show two maxima during each step, usually greater than body weight, and a minimum, between the two maxima, usually less than body weight. The two maxima occur when the body is being accelerated upward.

Curves for the horizontal forces in the longitudinal direction frequently show a slight backward thrust when the foot first contacts the platform, indicating that the body is being accelerated forward;





## New Packard antenna design employs two Du Pont plastics

*Nylon plastic and "Alathon" polythene resin meet mechanical and electrical requirements for automotive antenna*

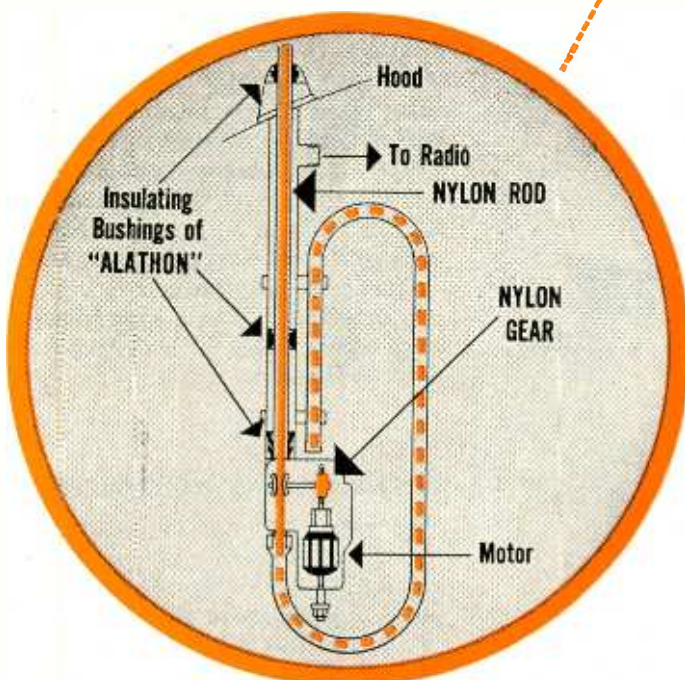

When driver pushes button, motor-driven worm gear turns nylon gears, which turn spring-loaded pulleys. Nylon rod is driven up by pulleys, forcing "live" members upward. Rod coils into trombone-like shape (dotted line) when antenna is lowered. (Automatic antenna used on 1951 Packards made by Casco Products Corp., Bridgeport, Conn.)

Two Du Pont plastics materials—nylon and "Alathon"\* polythene resin—are playing key roles in the success of this new motor-driven antenna used on Packard automobiles. A 4½-foot flexible rod which raises and lowers the "live" members is made of nylon, as are the two gears that transmit power from the motor to pulleys which drive the rod upward and downward. Insulating bushings, which must have very low moisture-absorption and excellent dielectric properties at radio frequencies, are molded of "Alathon."

The rod must have an unusual combination of properties. Most important of these: it must be rigid enough to force the antenna up and down, yet flexible enough to fold into a trombone-like position when the antenna is down; and it must also have good dielectric properties. Only nylon was found to meet the mechanical requirements, while at the same time maintaining a high "Q" and low capacity. The nylon rod and gears have been subjected to as many as 80,000 cycles—many more times than they could possibly be called on to withstand during the life of any car. Neither shows any sign of wear.

Both nylon and "Alathon" are finding a number of uses in molded parts for electrical equipment, in addition to their many well-known applications in wire and cable. Nylon is used in such items as coil forms, insulator bushings, grommets, motor slot liners, switch components . . . "Alathon" in radio and television parts, potting compounds, etc.

Demand for both nylon and "Alathon" currently exceeds supply. However, we suggest that you evaluate these materials for future application. We will gladly discuss the availability of quantities for development work. For additional information, write:

\*TRADE-MARK

E. I. du Pont de Nemours & Co. (Inc.),  
 Polychemicals Dept., District Offices:  
 350 Fifth Avenue, New York 1, New York  
 7 S. Dearborn St., Chicago 3, Illinois  
 845 E. 60th St., Los Angeles 1, California



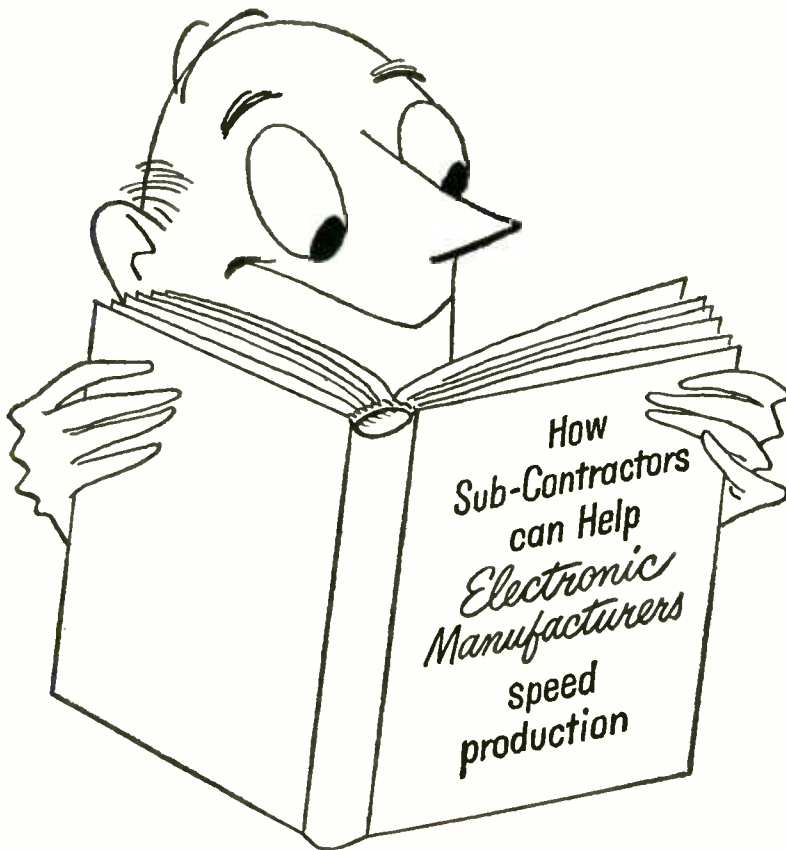

## It's an Old Story with US!

During World War II, we supplied cabinets, control assemblies, chassis and similar equipment to many of the nation's major war production manufacturers. And we're doing it again today.

If you need a dependable supply of components of this type—built to your specifications—you'll find this sub-contracting experience of ours extremely valuable. We know the importance of precision quality, carefully inspected work, on-time deliveries, and the ability to meet your particular contract requirements with the minimum of attention on your part. Complete information on our facilities and capacity is yours for the asking.



**CALL, WRITE OR WIRE US TODAY!**

**CORRY-JAMESTOWN MFG. CORP.**

CORRY, PENNSYLVANIA

*Makers of famous Steel Age office furniture.*

this backward thrust is of very short duration and occurs at about the same time the curve for the vertical force shows a sudden deflection or reversal in direction.

The longitudinal forces reach a maximum in the forward direction shortly after the heel contacts the platform, thus retarding forward movement of the body. They reach a maximum in the backward direction as the ball of the foot prepares to leave the platform, thus accelerating the body in the direction of progression.

The transverse forces were relatively small. For the most part, their direction is outward from the body and depends upon which leg is involved. The transverse forces, however, would likely be materially increased when the direction of progress is abruptly changed.

In general, the results showed that during the retarding phase of a step, a minimum coefficient of friction of around 0.2 is essential if slipping is to be avoided. When walking is entirely automatic and subject to sudden changes in velocity and direction, a higher coefficient would likely be necessary to prevent slipping.

### Instantaneous Peak Voltmeter

THE CIRCUIT shown in Fig. 1 is capable of measuring the height of an individual voltage or current pulse, regardless of the amplitude of the preceding pulse. This sort of operation is desirable in certain biological applications.

The grids of  $V_2$  are biased so that in the absence of a pulse no current flows in that tube, regardless of the charge on capacitor  $C$ . The amplitude control potentiometer adjusts the voltage at the grid of  $V_1$  to be less than that appearing at the grids of  $V_2$ . The latter tube acts as a switch—it conducts current in either direction during a pulse and acts as a high-impedance in the absence of a pulse.

If the height of a pulse appearing at the cathode of  $V_1$  is greater than the voltage on  $C$ ,  $V_{2a}$  will conduct, and  $C$  will charge to the new voltage with a time constant  $R_oC$ , where  $R_o$  is the series resistance of the output of cathode-follower  $V_1$ .



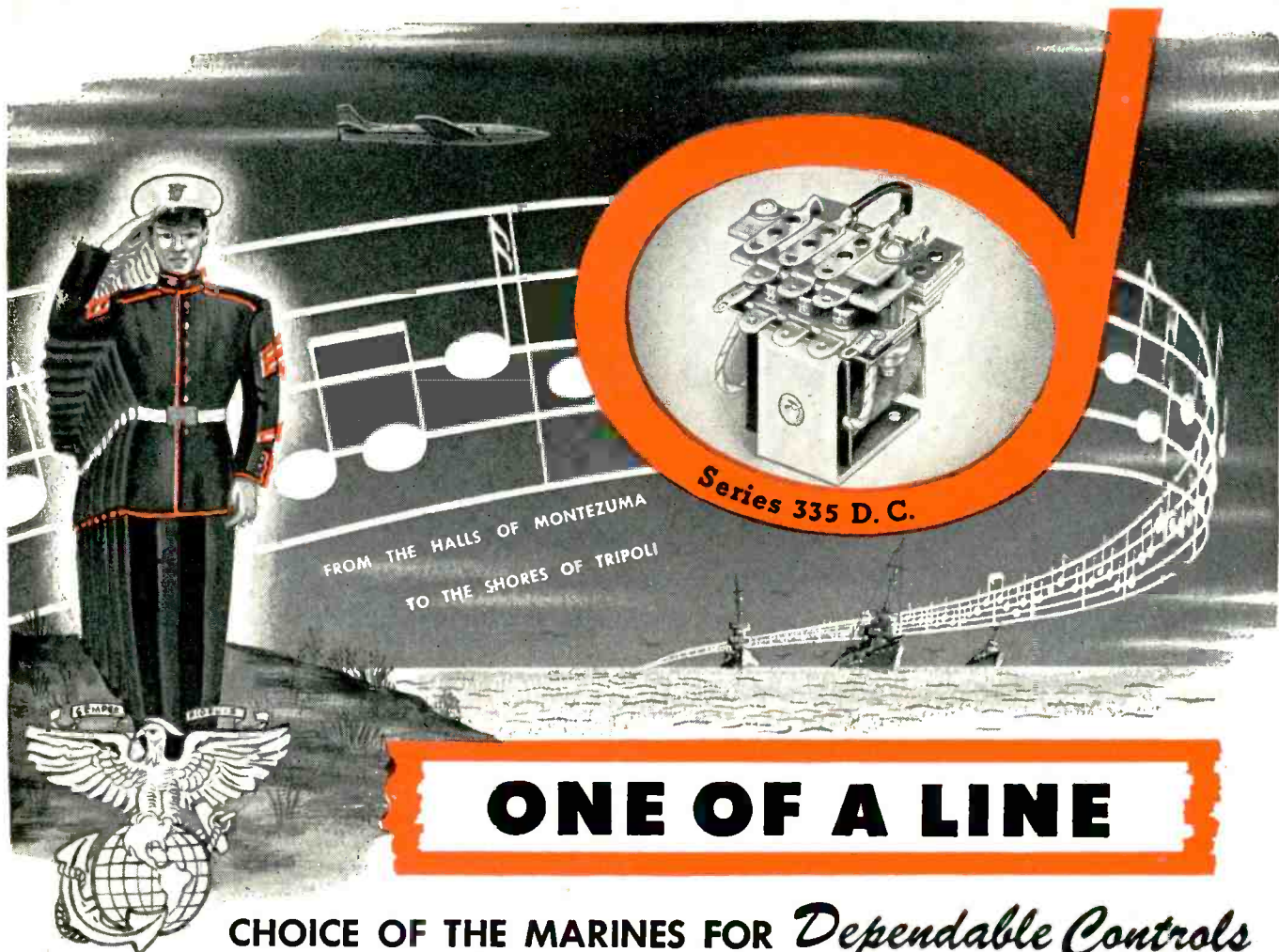

# ONE OF A LINE

CHOICE OF THE MARINES FOR *Dependable Controls*

## GUARDIAN RELAYS

**NEW CATALOG** on Hermetically Sealed Guardian Relays with various containers is yours for the asking, cost-free.

“From the halls of Montezuma” to marine testing laboratories—technicians are singing the praise of Guardian Relays. The Series 335 D.C. Relay shown above is but one of a most comprehensive line of Guardian Relays *approved* by the Marine Corps and all branches of the Armed Forces. Available with open-type construction or *hermetically sealed*—Guardian’s Series 335 D.C. Relay or any Government Approved Guardian control unit used singly, in combination, or in completely packaged controls, will serve you faithfully and well.

*The Series 335 D.C. Guardian Relay shown above is available with the A.N. Connector Plug, Octal Plug and Lug Header hermetic seal containers. Packs loads of power over a wide operating range, withstands the rigors of dust, moisture, salt air, temperature changes, vibration and impact.*



A.N. CONNECTOR PLUG  
HERMETIC SEALED  
CONTAINER

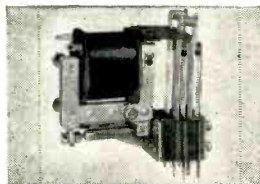

Series 30 A.C.

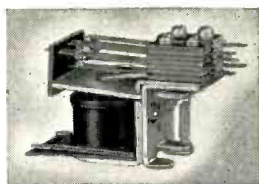

Series 210 A.C.—215 D.C.

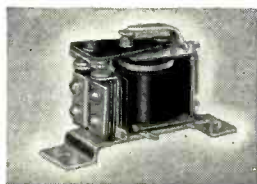

Series 220 A.C.



Series 595 D.C.



Series 610 A.C.—615 D.C.

**WRITE OR WIRE ... FREE CATALOG, SPECIFIC RECOMMENDATIONS, NO OBLIGATION.**

**GUARDIAN  ELECTRIC**  
1625-G W. WALNUT STREET CHICAGO 12, ILLINOIS

A COMPLETE LINE OF RELAYS SERVING AMERICAN INDUSTRY

# MOSINEE

*"More than Paper"*



If you have a fabricating or processing problem involving paper . . . if you require definite technical characteristics and, above all, *dependable uniformity*, it may be worthwhile for you and MOSINEE technicians to get together. MOSINEE is not interested so much in terms of volume production as in our ability to render helpful service to manufacturers in the field of electronics and in the electrical goods industry. Our "paperologists" are at your service for consultation.



MOSINEE PAPER MILLS COMPANY • MOSINEE, WIS.  
*Essential Paper Manufacturers*

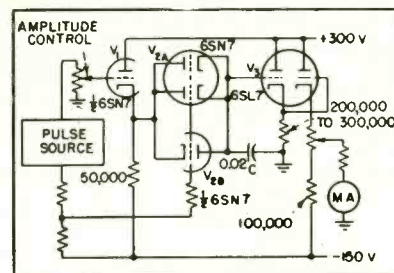

FIG. 1—Schematic diagram of instantaneous peak voltmeter

and the forward saturation resistance of  $V_{2A}$ . If the incoming pulse is less than the voltage on  $C$ ,  $V_{2B}$  will conduct, and  $C$  will discharge to the new voltage with the same time constant. The trailing edge of the pulse cuts off both sections of  $V_2$  and in the interval between pulses  $C$  discharges with time constant  $R_m C$ , where  $R_m$  is the parallel resistance of the input resistance of  $V_3$ , the parallel resistance of the two sections of  $V_2$ , and the leakage resistance of  $C$ .

With the components shown, according to Tobin, Grundfest and Schoenfeld, who describe this development in detail in the March 1951 issue of *The Review of Scientific Instruments*, a 0.1- $\mu$ sec pulse of maximum amplitude and minimum frequency ( $T = 5$  sec) shows a decay of less than 2 percent of the interval between pulses. At frequencies of 1 cps or higher there is no observable decay on the meter between pulses.

### Additional "Trons"

By W. C. WHITE  
Research Laboratory  
General Electric Co.  
Schenectady, N. Y.

- SINCE publication of a list of words ending in the suffix *tron* in the May, 1950, issue of **ELECTRONICS**, these additional words and meanings have been brought to our attention.
- Additron**—A Canadian special-purpose computer tube.
  - Airlectron**—Name of a firm making electronic equipment.
  - \***Alphatron**—Trade name for a form of blow gun.
  - Anticyclotron**—A form of traveling-wave tube.
  - Bio-tron**—Trade name for a pharmaceutical product.
  - Circlatron**—Trade name for prod-



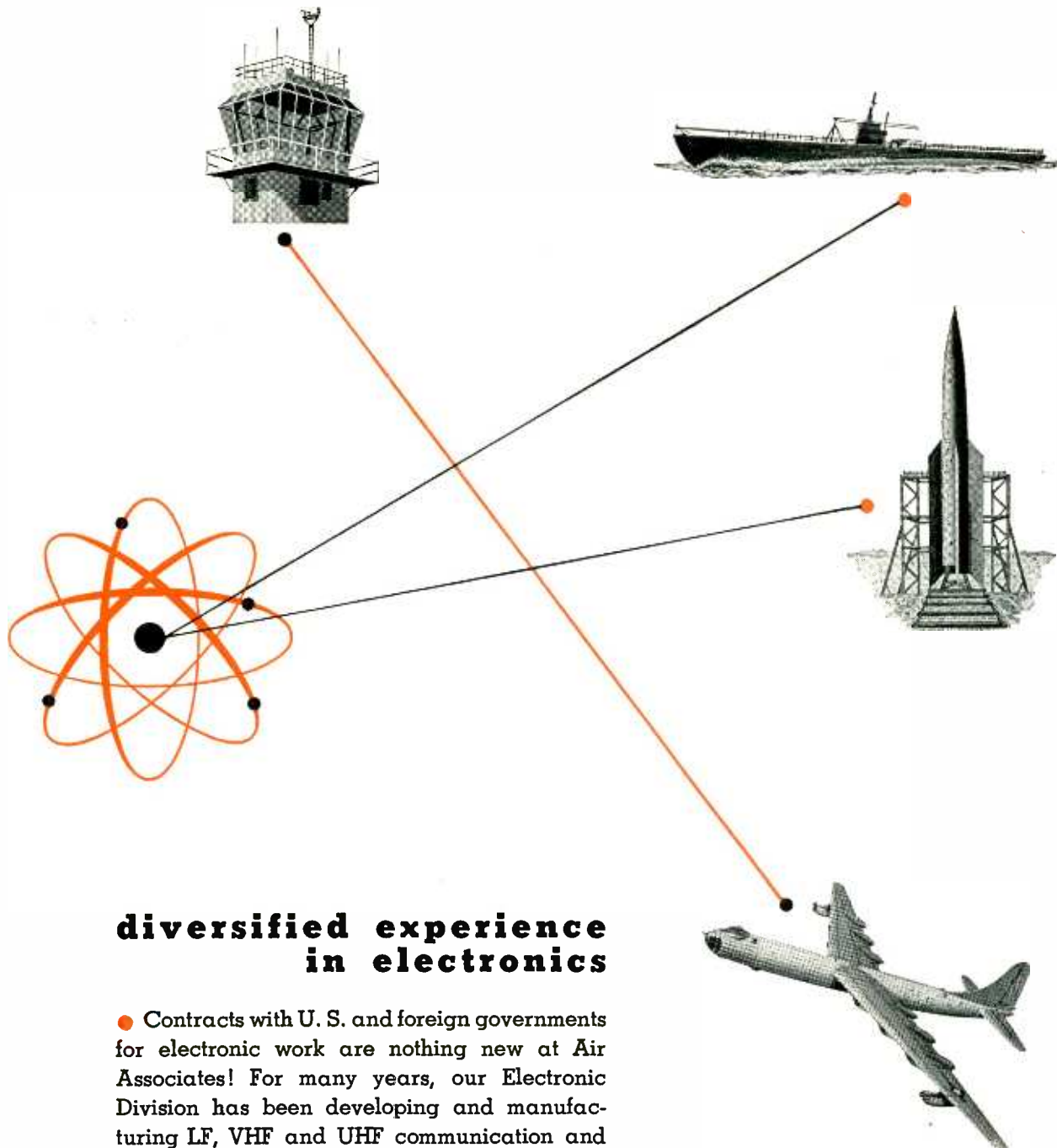

## **diversified experience in electronics**

● Contracts with U. S. and foreign governments for electronic work are nothing new at Air Associates! For many years, our Electronic Division has been developing and manufacturing LF, VHF and UHF communication and navigation systems, landing systems, firing error indicator systems, echo ranging systems (including sonar) and special miniaturized electronic devices. Our wide experience and expanded facilities for airborne, marine and ground electronics equipment are available to help solve your design and production problems. Your inquiry to Teterboro will receive prompt attention.

*Air Associates*  
INCORPORATED  
TETERBORO, NEW JERSEY



**SERVING THE NATION IN AVIATION**

# ECLIPSE-PIONEER

Announces the New Line of

## PYGMY SYNCHROS

Size of pygmy as compared to AY-200 series outline

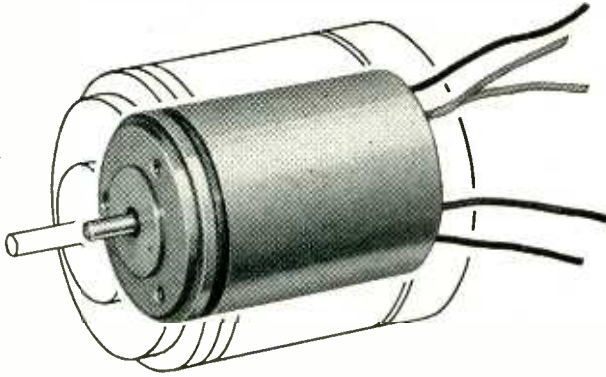

Eclipse-Pioneer has added a tiny new member to its great family of famous Autosyn\* synchros. It's the new AY-500 series, a precision-built pygmy weighing only 1¾ oz. while scaling only 1.278" long and .937" in diameter (the same diameter, incidentally, as a twenty-five cent piece). Its accuracy and dependability are assured, thanks to Eclipse-Pioneer's 17 years of experience and leadership in the development of high precision synchros for aircraft, marine and industrial applications. For more detailed information on the AY-500 and other E-P Autosyns, such as the remarkably accurate AY-200 series (guaranteed accuracy to within 15 minutes on all production units), please write direct to Eclipse-Pioneer, Teterboro, N. J.

\*REG. TRADE MARK BENDIX AVIATION CORPORATION

LOOK FOR THE PIONEER MARK OF QUALITY  
REG. U.S. PAT. OFF.

### Typical Performance Characteristics

	One AY-201-3 Driving		One AY-500-3 Driving
	One AY-500-3 Control Transformer	Two AY-500-3 Control Transformer	One AY-500-3 Control Transformer
<b>INPUT</b>			
Voltage	26-volts, single-phase	26-volts, single-phase	26-volts, single-phase
Frequency	400 cycles	400 cycles	400 cycles
Current	88 milliamperes	110 milliamperes	55 milliamperes
Power	0.8 watts	1.2 watts	0.9 watts
Impedance	105+j280 ohms	100+j220 ohms	290+j370 ohms
<b>OUTPUT</b>			
Voltage Max. (rotor output)	17.9 volts	16.2 volts	14.1 volts
Voltage at null	40 millivolts	40 millivolts	40 millivolts
Sensitivity	310 millivolts/degree	280 millivolts/degree	245 millivolts/degree
Voltage phase shift	23 degrees	26 degrees	44 degrees
System accuracy (max. possible spread)	0.6 degrees	0.6 degrees	0.75 degrees

Other E-P precision components for servo mechanism and computing equipment:

Servo motors and systems • rate generators • gyros • stabilization equipment • turbine power supplies • remote indicating-transmitting systems and special purpose electron tubes.

For detailed information, write to Dept. C

**ECLIPSE-PIONEER DIVISION of**

TETERBORO, NEW JERSEY

Export Sales: Bendix International Division, 72 Fifth Avenue, New York 11, N. Y.



wave spectrum analyzer.

\*Vidotron—Trade name for a cathode-ray tube.

\*Vitron—Trade name for a glass fiber insulation.

Vocatron—Trade name of equipment for an intercommunication system.

\*These names appeared also in the list published in the May, 1950, ELECTRONICS, but were applied to different devices or business firms.

### Differential Analyzer Uses Plug-In Units

By C. D. MORRILL

Goodyear Aircraft Corp.  
Akron, Ohio

GEDA (Goodyear Electronic Differential Analyzer) comprises equipment designed to analyze the performance of dynamic systems under the influence of initial and boundary conditions and driving forces by simulating the mathematical operators of the integro-differential equations which represent them. The solution of a rather wide and complex range of engineering problems with acceptable precision is thus made feasible. Such problems extend into the varied fields of aircraft design and control, vibration analysis, indus-

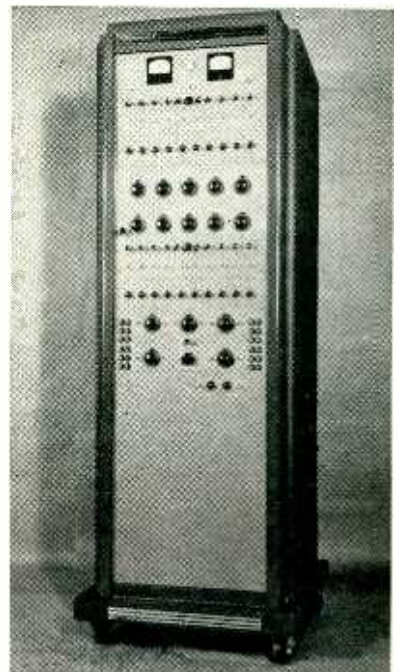

FIG. 1—GEDA linear computer





# LAMINATES News

News of General Electric Plastics Laminates that can be of importance to your business.

## G-E PLASTICS LAMINATES Give You EXTRA QUALITY AT LOW COST!

The engineering and manufacturing experience gained through many years in both the production and use of plastics laminates by General Electric is your assurance of extra quality at low cost.

For example, General Electric is one of the world's largest producers of naval and industrial control panels for both electrical and electronics applications. Through extensive work with this equipment, G.E. has developed a complete, high-quality line of laminated sheets for a wide variety of industrial and military applications.

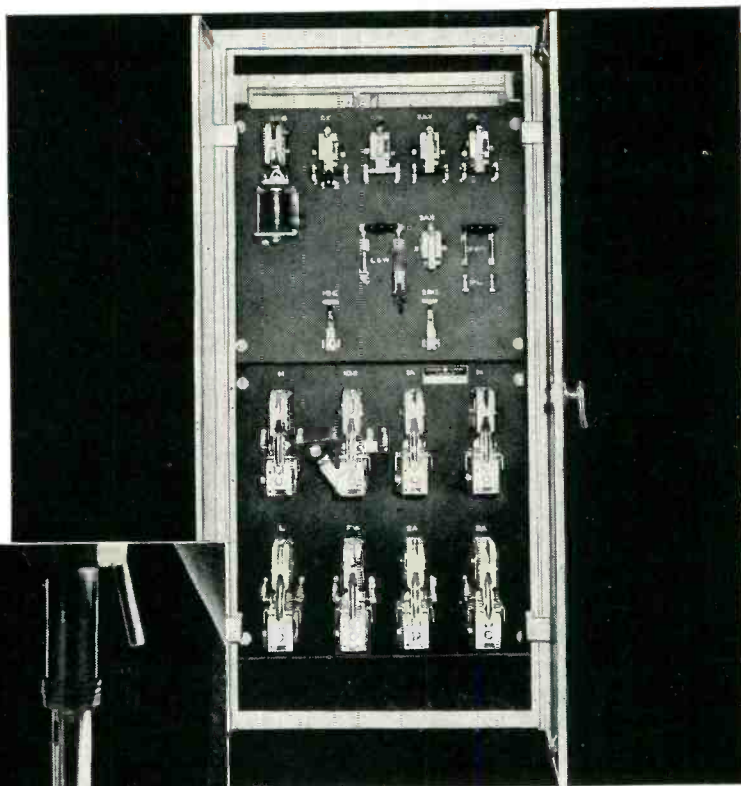

### FAST WORK!

With G-E Laminates, most high-speed machining operations are easily performed on standard wood and metal-working tools. Intricate shapes and fine cross sections can be machined to close tolerances with a minimum of rejects. Work can usually be performed dry, for easier handling of finished pieces.

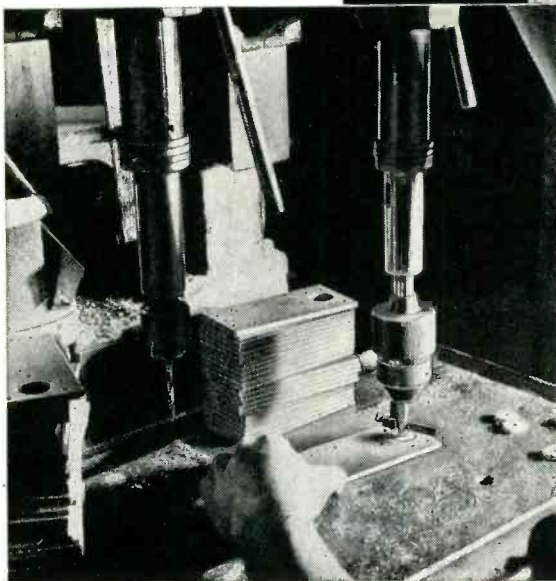

### NEW! LAMINATES COMPARATOR

Send ten cents for the new G-E Laminates Comparator—a quick, easy reference to different grades, characteristics and uses of laminated materials. Write Section Y-3, Chemical Department, General Electric Co., Pittsfield, Mass. Also, ask for information on the complete line of G-E Plastics Laminates.

**COMPLETE LINE OF LAMINATES**—General Electric produces a complete line of plastics laminates—either molded or in the forms of sheets, tubes and rods with cloth, paper, glass fabric, or special bases for a wide variety of applications.

**ALSO**—Look to General Electric for silicone insulation, insulating varnishes, sealing and filling compounds, mica insulation, varnished cloth and tape.

You can put your confidence in

**GENERAL  ELECTRIC**

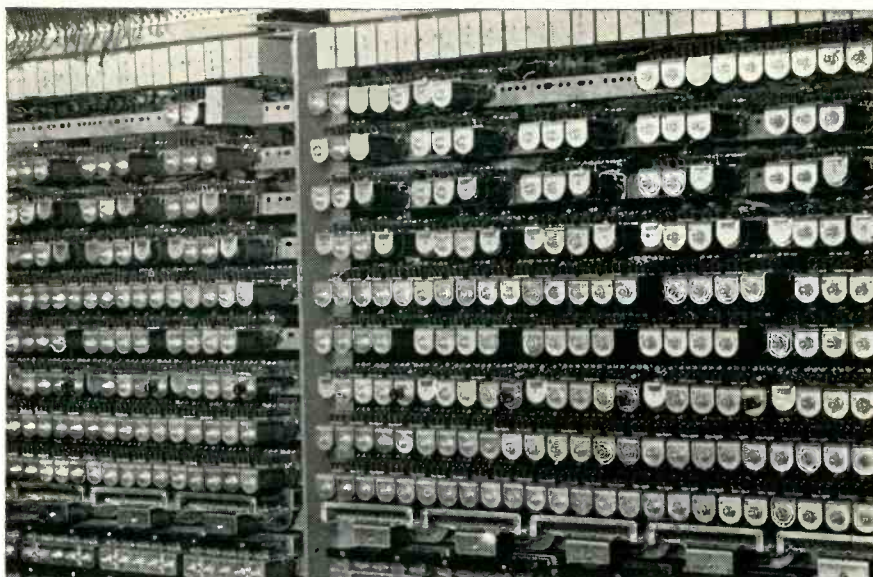

**...by the company they keep**



**S**ELECTING relays for dependable remote control is a lot like choosing friends. It's easy to go wrong, and the best measurement is the background from which they spring. That's why we pictured above several types of North Relays used in automatic telephone switching, a specialty of this company for sixty years.

*There is no higher quality relay than those designed for telephone service. The experience and know-how with which North meets these specifications goes into every type of relay bearing the North name. You can get North Relays to meet every requirement in high-speed sensitive control; from Midgets to Multiples; from low power transfers to switching 5 amp loads at 250 V; from single make-breaks to the control of 32 circuits with one impulse through a single pair at low voltage.*

Protect the integrity of *your* remote control circuit design by specifying North Relays.

## NORTH "All purpose" RELAYS

Ask for the new informative North Relay Catalog

**THE NORTH ELECTRIC  
MANUFACTURING COMPANY**

Originators of ALL RELAY  
Systems of Automatic Switching

1438T, South Market Street, Galion, Ohio, U.S.A.

trial control analysis, structures, turbines and reciprocating engines and other dynamic electrical and mechanical systems.

Essentially, the GEDA equipment comprises three compact computing elements which can be combined to form an analog computing system. The first of these three elements (see Fig. 1) solves linear differential equations with constant coefficients up to the tenth order. The time scale can be varied over a wide range including actual time.

The second element (Fig. 2) extends the field of utility of the first element into the range of linear differential equations with variable coefficients and nonlinear differential equations. The third element comprises a six-channel recorder-amplifier assembly which records six of the variables appearing in the computing system as functions of time.

In the first or linear computing element of the GEDA system, simulation is accomplished by means of passive network components and direct-coupled amplifiers. Twenty plug-in d-c amplifiers comprise the operational components. These amplifiers perform complex linear operations dependent upon the combination of input and feedback impedances. Problems are set up by

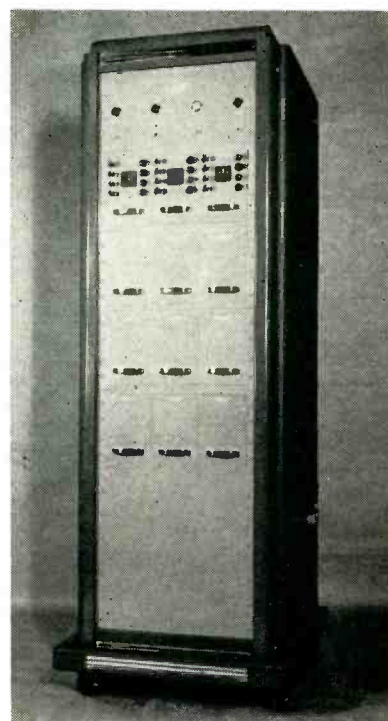
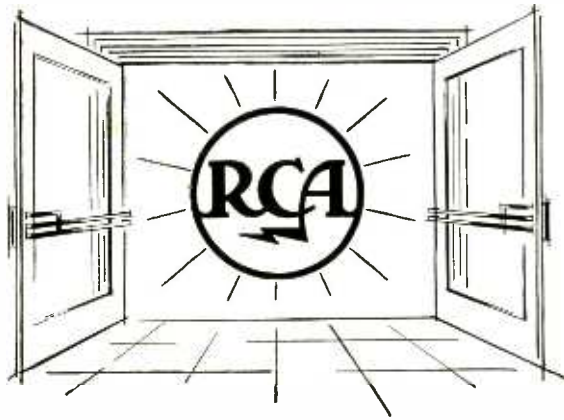



FIG. 2—GEDA nonlinear computer





# THE OPEN DOOR

## to career opportunities for QUALIFIED ENGINEERS

 Career opportunities for experienced **ELECTRONIC, ELECTRICAL and MECHANICAL ENGINEERS . . . PHYSICISTS . . . METALLURGISTS . . . CHEMICAL and CERAMIC ENGINEERS** are now open at RCA, pioneer in many of the world's greatest developments in virtually every field of radio-electronics.

The opportunities are in research, development, design and application, also in technical sales—on commercial projects as well as the nation's defense program.

 These are not temporary positions. Many of RCA's activities today are designed to satisfy the nation's military needs. RCA, however, has always been (even in peacetime years) an "arsenal" from which the military forces have been equipped with the finest radio-electronic apparatus. RCA also is working on many commercial long-range projects.

They call for expanding electronic research and development in a diversified line of products.



These openings offer life-long career opportunities. Unlike "feast or famine" businesses, RCA has forged ahead regardless of wars or depression.

At RCA, you enjoy professional status, recognition for accomplishments . . . unexcelled research facilities for creative work . . . opportunities for advancement in position and income . . . pleasant surroundings in which to work. You and your families participate in Company-paid hospitalization, accident and life insurance. Modern retirement program. Good suburban or country residential and recreational conditions. Opportunities for graduate study.



### POSITIONS OPEN IN THE FOLLOWING FIELDS:

**TELEVISION DEVELOPMENT**—Receivers, Transmitters and Studio Equipment

**ELECTRON TUBE DEVELOPMENT**—Receiving, Transmitting, Cathode-Ray, Phototubes and Magnetrons

**TRANSFORMER and COIL DESIGN**

**COMMUNICATIONS**—Microwave, Mobile, Aviation, Specialized Military Systems

**RADAR**—Circuitry, Antenna Design, Computer, Servo-Systems, Information Display Systems

**NAVIGATIONAL AIDS**

**TECHNICAL SALES**

★ \_\_\_\_\_ ★  
If you qualify for any of the positions listed here, by all means write us for a personal interview—include your resumé. Write to: *Mr. Robert McQuiston, Specialized Employment Division, Dept. R-36, Radio Corporation of America, 30 Rockefeller Plaza, New York 20, N. Y.*  
★ \_\_\_\_\_ ★



Whatever your plans for the future—you will find the booklet "The Place of the Engineer in RCA" interesting reading. Mail the coupon for your *free* copy.

Mr. Robert McQuiston |  
Specialized Employment Division, Dept. R-36.  
Radio Corporation of America  
30 Rockefeller Plaza, New York 20, N. Y.

Please send me copy of booklet "The Place of the Engineer in RCA."

Name \_\_\_\_\_

Address \_\_\_\_\_

City \_\_\_\_\_ State \_\_\_\_\_

List degree or degrees \_\_\_\_\_



**RADIO CORPORATION of AMERICA**

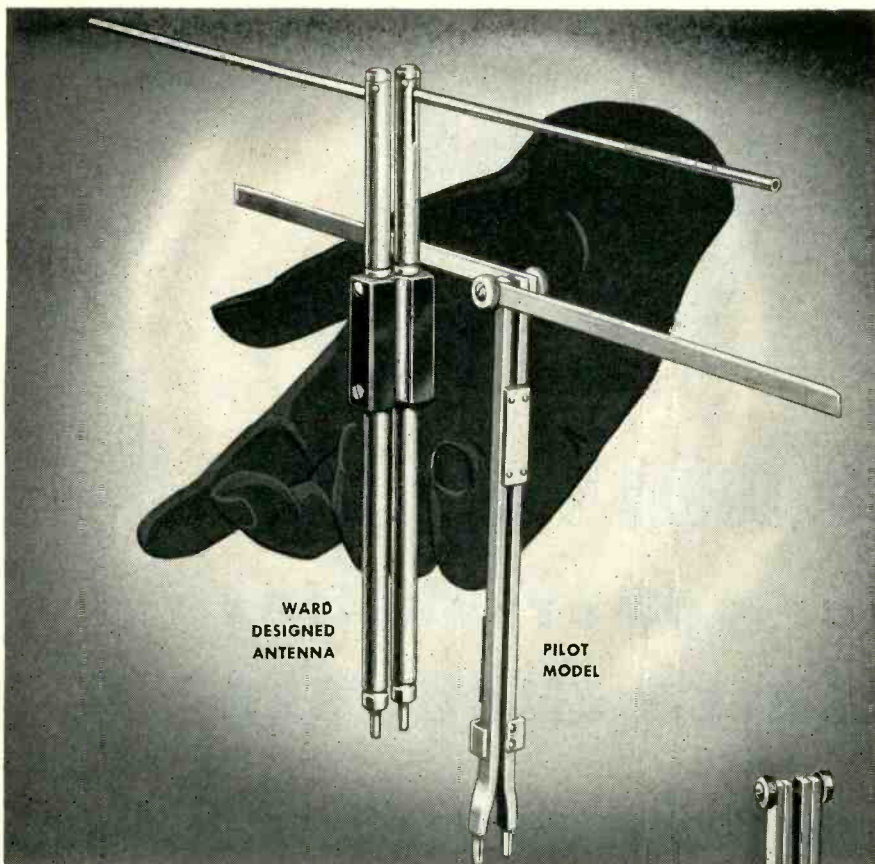

## a flick of the finger and broadcast begins

Designing an aerial for citizens radio offers a number of challenging problems. From the pilot model Ward engineered the production unit.

Sturdy mechanical design, light weight, high electrical efficiency are all combined with extreme simplicity of operation. A flick of the finger opens the antenna from its closed position, ready for operation.

Would you like the complete story of how Ward engineering can be applied to your problem? Whether you require one or thousands of special antennas, Ward's complete engineering facilities are at your service. Just 'phone or write.

**THE WARD PRODUCTS CORP.**

Division of The Gabriel Co.

1523 EAST 45TH STREET  
CLEVELAND 3, OHIO

only **WARD** OFFERS  
ONE SOURCE FOR  
SPECIAL COMMUNICATION  
TV-FM-AM and AUTOMOTIVE  
**ANTENNAS**

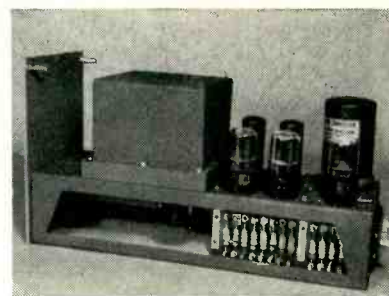

FIG. 3—Servo-multiplier unit for obtaining products

patching together the various amplifiers, resistors, capacitors, voltage sources and the like to simulate the dynamic system in question. Solutions are obtained in the form of time-varying voltages representing the different problem variables.

The second computing element, which is designed as an adjunct to the first, employs up to 12 servo-multiplier units of various types. These units permit the application of the equipment to nonlinear and transcendental integro-differential equations. Two different types of plug-in multiplier units are employed. As illustrated, one type (Fig. 3) is used to generate products only. The other (similar in size and appearance to Fig. 3) generates products and, in addition, develops certain classes of empirical or analytical functions. A third type of unit, a sign changer, makes possible the multiplication of two variables in all four quadrants.

As all of the multiplier units are of the plug-in type, it is a relatively simple matter to select an arrangement of components to meet a given set of conditions. The positive and negative voltage references required for multiplier use are supplied by a reference power supply regulator. Inter-connecting cabling permits interwiring the nonlinear element with the associated linear equipment. A jackboard for this purpose is contained in the linear computer.

Typical operation of a position servomechanism multiplier unit is shown diagrammatically in Fig. 4. Referring to the drawing, *S* represents the servo amplifier and actuator. The first potentiometer acts as a feedback unit and turns through an angle proportional to



# It's a fact that

✓ Very few customers object to our suggestions on redesign. For those who object, we make their designs exactly as they want them. Most customers appreciate the close cooperation given and gladly use our fifty years of specialized experience.

Here are the reasons:

1. Makes best use of favorable ceramic characteristics, avoids misapplication.
2. Designs are kept within practical manufacturing limits.
3. Subsequent assembly operations frequently are speeded.
4. Several components can sometimes be combined into one.
5. Maximum economy.

Redesigned

60% LOWER COST  
BETTER PERFORMANCE

**ALSiMAG<sup>®</sup>**

=



Diversified equipment which is far beyond the reach of the average ceramic manufacturer permits us to use the best production method for the job.

Illustrated is a redesign which saved about 60% in original price, saved assembly time, and gave improved performance. Our engineers and production men will make recommendations on request. Send blue prints or samples with data on operating conditions and tolerance requirements. By working together we can serve you better.

**AMERICAN LAVA CORPORATION**

50TH YEAR OF CERAMIC LEADERSHIP

CHATTANOOGA 5, TENNESSEE

OFFICES: METROPOLITAN AREA, 671 Broad St., Newark, N. J., Mitchell 2-8159 • CHICAGO, 228 North LaSalle St., Central 6-1721  
PHILADELPHIA, 1649 North Broad St., Stevenson 4-2823 • LOS ANGELES, 232 South Hill St., Mutual 9076  
NEW ENGLAND, 38-B Brattle St., Cambridge, Mass., Kirkland 7-4498 • ST. LOUIS, 1123 Washington Ave., Garfield 4959

# 2 BIG ADVANTAGES

... over any other Switch Timer



**SESSIONS**  
Switch Timer,  
as used in  
**PHILHARMONIC**  
Clock Radios

1. Lowest cost with absolute dependability
2. Most distinctive beauty

Designers with a keen eye for extra value in radio or TV switch timers, as well as new product beauty that helps sales, find a welcome answer in Sessions Switch Timers.

Sessions movements feature a compact, demountable, self-starting motor which operates at low, subsynchronous speed... has fewer moving parts. The result is lower cost, plus longer, more accurate service, without annoying buzz of high speed gears. Distinctive styling to your specifications gives your product greater beauty. You can select the hand and dial styling you prefer from a variety of stock

models, or Sessions engineers will work with you to develop special styling for your own application. Quiet-acting switch, rated at 10-15 amps. (UL approved) turns on silently and positively. All movements tested and guaranteed for one year.

Discover for yourself, as many leading manufacturers have already done, that with Sessions Switch Timers, you can increase your product's value and cut manufacturing cost at the same time. Write for complete details. The Sessions Clock Company, Timer Div., Dept. 4, Forestville, Connecticut.

**Sessions**  
SWITCH TIMERS

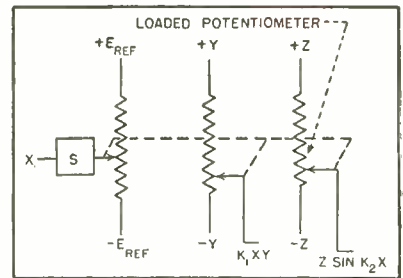

FIG. 4—Schematic diagram showing operation of multiplier unit

the variable input  $X$ . The second and third potentiometers are ganged to the first and must therefore turn through the same angle. As a result, the output of the second potentiometer is  $k_1XY$  volts, where  $k_1$  is an appropriately chosen constant. The third potentiometer is shown loaded to generate  $\sin X$  and its output is  $Z \sin k_2X$  where  $k_2$  has the dimensions of radians per volt. The multiplicands are  $Y$  and  $Z$ .

By means of these ganged linear potentiometers, driven by highly responsive servo actuators to produce products and/or functions, it is feasible to produce a number of linear and nonlinear mathematical results. It is possible to produce the products of functions of the independent variable—as in the coefficients of linear differential equations—or products of functions of the independent and the dependent variables—as in nonlinear differential equations. If the potentiometers be made nonlinear by suitable loading, the multiplier can be employed to generate functions of a variable.

#### Conversion of Error Signal

Operation of the computing potentiometers is based upon the conversion of d-c error signals in a conventional modulator circuit to a 60-cycle square wave. For this purpose, a conventional Brown 60-cycle converter is employed. Electronically, Brown converters operating as circuit components of conventional modulators, convert d-c error signals. In addition, each error signal has a plus or minus 90-degree phase relationship to the line voltage depending upon the sign or polarity of the d-c error signal.

The output of each converter is amplified sufficiently to drive an



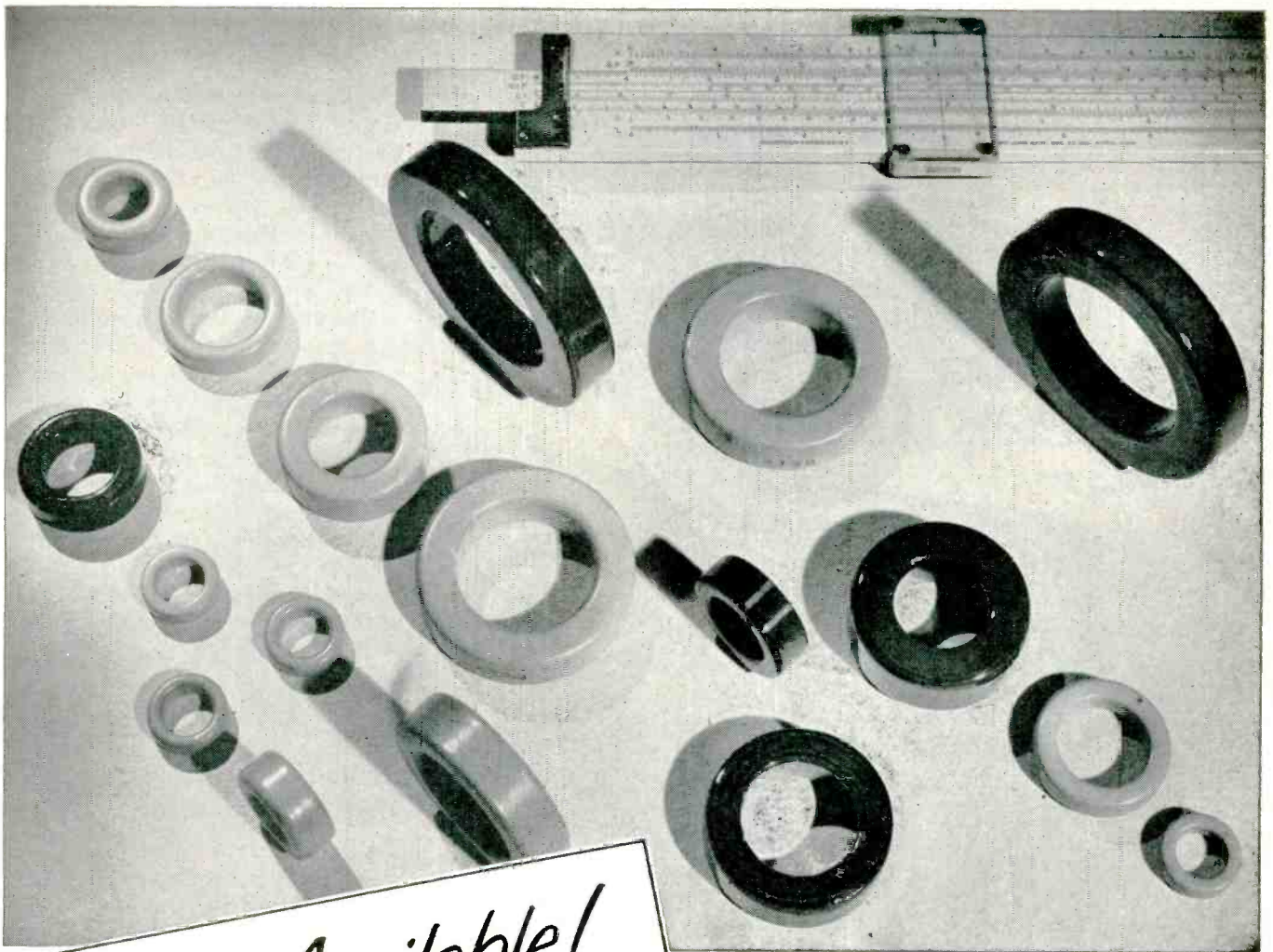

*Now Available!*  
**MOLYBDENUM PERMALLOY  
 POWDER CORES\***

**HIGH Q TOROIDS** for use in Loading Coils, Filters, Broadband Carrier Systems and Networks— for frequencies up to 200 K C

**COMPLETE LINE OF CORES  
 TO MEET YOUR NEEDS**

- ★ Furnished in four standard permeabilities—125, 60, 26 and 14.
- ★ Available in a wide range of sizes to obtain nominal inductances as high as 281 mh/1000 turns.
- ★ These toroidal cores are given various types of enamel and varnish finishes, some of which permit winding with heavy Formex insulated wire without supplementary insulation over the core.

For high Q in a small volume, characterized by low eddy current and hysteresis losses, ARNOLD Moly Permalloy Powder Toroidal Cores are commercially available to meet high standards of physical and electrical requirements. They provide constant permeability over a wide range of flux density. The 125 Mu cores are recommended for use up to 15 kc, 60 Mu at 10 to 50 kc, 26 Mu at 30 to 75 kc, and 14 Mu at 50 to 200 kc. Many of these cores may be furnished stabilized to provide constant permeability ( $\pm 0.1\%$ ) over a specific temperature range.

\* Manufactured under licensing arrangements with Western Electric Company.

W&D 2930

**THE ARNOLD ENGINEERING COMPANY**



SUBSIDIARY OF ALLEGHENY LUDLUM STEEL CORPORATION

General Office & Plant: Marengo, Illinois

Here's why those in the know

-demand

# CANNON PLUGS

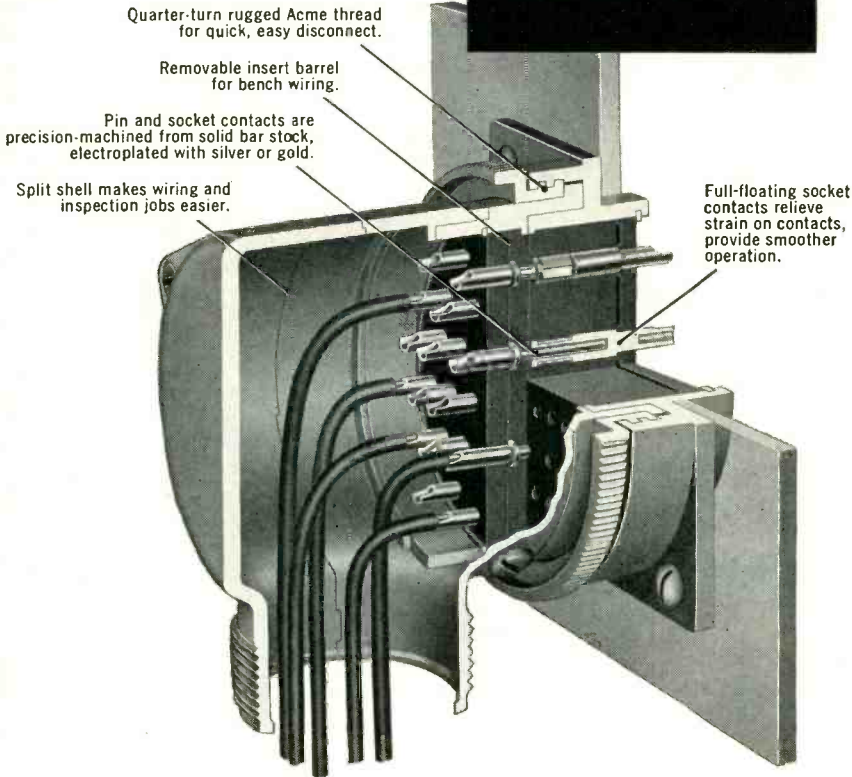

Quarter-turn rugged Acme thread for quick, easy disconnect.

Removable insert barrel for bench wiring.

Pin and socket contacts are precision-machined from solid bar stock, electroplated with silver or gold.

Split shell makes wiring and inspection jobs easier.

Full-floating socket contacts relieve strain on contacts, provide smoother operation.

Recognition of Cannon's 36 years of sound engineering and fine, uncompromising construction has built the demand for Cannon Plugs. Here we take an inside look at the lightweight Type "K" 90° connector, forerunner of the Army-Navy Series. More features of the "K" were incorporated into the "AN" design than any other connector.

Constantly improved over the years, Type "K" is now used for numerous applications such as aircraft, radio, television, sound, phone recorders, motion pictures, geophysi-

cal research and widely used throughout the electro-mechanical and electronic instrument fields.

The design and construction details in the Cannon "K" Series are typical of the care Cannon takes in producing more than 18,000 precision, multi-contact connectors to serve the exacting needs of industry.

We will gladly send you engineering bulletins describing each of the many basic types of Cannon Plugs if you will briefly describe your applications.

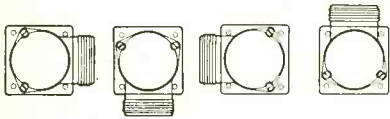

Diagram at left shows how the four positions of cable entry on the large 90° "K" endbell make the wiring job easier. Smaller Type "K" connectors have three positions.

## CANNON ELECTRIC

Since 1915

Cannon Electric Company  
Los Angeles 31  
California

Factories in Los Angeles, Toronto, New Haven. Representatives in principal cities. Address inquiries to Cannon Electric Company, Department F-120, P. O. Box 75, Lincoln Heights Station, Los Angeles 31, California



Type "K" and "RK" connectors are available in 7 shell types having 8 diameters. Inserts have more than 190 contact arrangements. Some of these have Coax, Twinax or Thermocouple contacts as standard. Integral cable clamps available in all "K" plug types.

associated servo motor. Each servo motor is mechanically coupled to the computing potentiometers incorporated in the respective multiplier units. To reduce the dependence of multiplier performance on the characteristics of the servo motor, each amplifier circuit includes an equalizing network.

A maximum of 12 servo multiplier and/or sign changing units can be accommodated. The design arrangement is such that three units can be installed on each of the four shelves. All of the units are of the plug-in type and are mechanically interchangeable. This flexibility permits the selection of component combinations best suited to the type of problems for which the computer is to be used.

### Radio-Frequency Micropotentiometer

TWO EXTREMELY simple devices which produce r-f voltages at a very low impedance and at a wide range of frequencies have been conceived and developed at the National Bureau of Standards. They provide accurate voltages from 1 to  $10^6$  microvolts without the use of attenuators at frequencies up to 300 megacycles and above. Thus, convenient standards of low voltages are made available which should greatly reduce equipment and shielding problems encountered in calibration of present-day commercial voltage generators, attenuators, voltmeters, and other radio-frequency equipment.

The micropotentiometers are especially useful in measurements of radio receiver sensitivity. The large disagreement between various

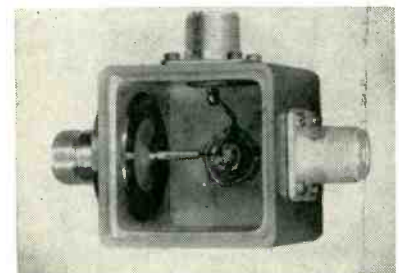

FIG. 1—Photograph shows interior of NBS r-f micropotentiometer



# You Can Depend on

# DAVEN

for

# Accuracy in Attenuators

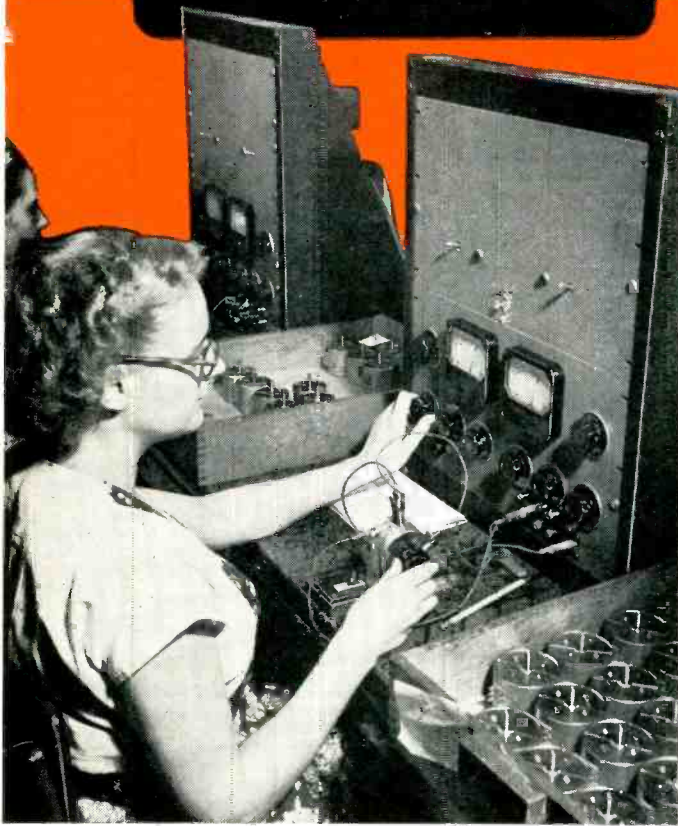

**7** or many years Daven has been known for the quality of its attenuators. And, although Daven production has grown to include a wide variety of instruments for the electronics industry, the development of its attenuators has grown apace. Much of the testing equipment used by Daven to guide them in the manufacturing of attenuators has been developed by Daven's own engineering specialists. As a result, Daven attenuators have become the standard of the industry, by which all other similar equipment is measured. Shown and described here are two of the newest units that are typical of the vast Daven line of attenuators. Your inquiry for specific information to apply to your own particular problems is invited. Let Daven furnish you with completely detailed catalog data.

## RF Attenuation Network



This equipment is an exclusive Daven development. It is a moderately priced attenuator incorporated in an RF Attenuation Box to insert accurate losses from D.C. to 225 MC. The unit has many applications where attenuation of UHF is desired, since it can be utilized as an all-purpose laboratory and test instrument.

### SPECIFICATIONS:

ZERO INSERTION LOSS OVER ENTIRE FREQUENCY RANGE.  
FREQUENCY RANGE: Zero to 225 MC.  
IMPEDANCE ACCURACY: Within  $\pm 5\%$  over frequency range.  
ATTENUATION ACCURACY:  $\pm 5\%$  over frequency range.  
CONNECTORS: Receptacles are supplied. Cable plugs, if required, will be supplied at a slight additional cost. When ordering, specify which type connector is desired—either Series "BNC" (UG-185/U) or Series "N" (UG-58/U).  
CIRCUIT: Constant input and output impedance (unbalanced). Zero initial loss.  
RESISTOR ACCURACY:  $\pm 2\%$  at D.C.

## Carrier Frequency Decade Attenuator



This equipment is particularly applicable to extremely accurate measurements from D.C. to 200 kc. and can be used up to the lower radio frequencies. The Decade type switches make the box convenient to use. In addition, there are switch stops which prevent return from full to zero attenuation when making adjustments. A total of 110 Db. is available in 1.0 Db. steps, or 111 Db. is available in 0.1 Db. steps. Both of these types may be obtained in either a balanced H or an unbalanced T network.

### SPECIFICATIONS:

ACCURACY: Each individual resistor is adjusted within  $\pm 0.25\%$  of its correct value. The error in attenuation is less than  $\pm 1\%$  of the indicated value, provided the output is matched by a pure resistance.  
FREQUENCY ERROR: At frequencies below 200 kc., the total error in attenuation will not be greater than  $\pm 1\%$  of the indicated value.

THE **DAVEN** CO.

191 CENTRAL AVENUE  
NEWARK 4, N. J.



when you need a  
**QUALITY OSCILLATOR**

**SIE**

**Model M-2 Oscillator  
 Is Your Answer**

The unique SIE oscillator circuit which has no lower limit to its possible frequency of oscillation is responsible for the excellent low frequency performance of the Model M-2 and other SIE oscillators.

**SPECIFICATIONS**

**Range:** 1 cps to 120,000 cps

**Calibration:** within 1½% plus 1/10 cycle

**Output circuits:** 20 volts or 20 millamps and 1 volt at 300 ohms constant impedance

**Amplitude stability:** Plus or minus ½ db  
**UNDESIRED VOLTAGES**

**Power Supply Noise:** Less than 1/100% of output signal

**Power Line Surge:** Less than 1/10% of output signal

**Harmonic Distortion:** Less than 2/10% from 20 cps to 15,000 cps. Less than 1% at all other frequencies

**Microphonic Noise:** Less than 1/100% of output signal

**SOUTHWESTERN INDUSTRIAL  
 ELECTRONICS CO.**

2831 POST OAK ROAD  
 HOUSTON 19, TEXAS

434 SEVENTH AVE. EAST — CALGARY, ALBERTA, CANADA

standard voltage generators at high frequencies and low voltage levels has been due to three major causes. First, generator output impedance and receiver input impedance are not ordinarily known as functions of changing frequencies. Second, extreme care is necessary in using precision voltage-dropping attenuators. Finally, the long-time calibration stability of vacuum-tube voltmeters is uncertain. For these reasons, manufacturers of voltage generators have been unable to guarantee the accuracy of their equipment at all frequencies. Development of the micropotentiometers now appears to have removed most of the obstacles to standardization of receiver sensitivity.

The new instruments consist essentially of appropriately housed and mounted current-carrying elements together with means for monitoring the currents they carry. Their electrical constants are simply determined by using known d-c voltages and currents. The current-carrying elements are annular membranes, either metallic or nonmetallic, of various radii, thicknesses, and electrical resistivities. Monitoring may be accomplished by means of thermocouples, thermoelements, bolometers, stable vacuum-tube voltmeters, or other devices whose indications are independent of frequency. Thermoelements have been used in measurements of 1 to 100,000 microvolts at frequencies from zero to 300 mc and also for 100,000-microvolt measurements in the region of 1,000 mc.

By means of known voltage ra-



FIG. 2—Micropotentiometer is shown in set-up for calibrating millivoltmeter



*Announcing*

**the First Basically New  
Cathode in Over 25 Years**

Providing High Emission Density  
with Long Life

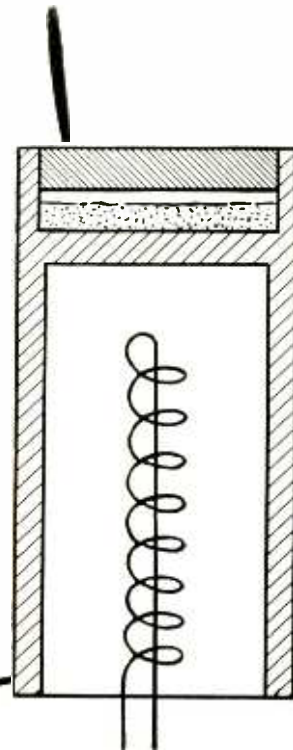

# PHILIPS L-CATHODE

Illustrated above is the first basically new cathode in over 25 years—the new PHILIPS L-CATHODE. It offers these practical advantages to users of klystrons, disc seal triodes, iconoscopes, magnetrons, special cathode-ray tubes and other types where a high degree of reliability is essential:

1. *High emission current density with long life*
2. *Can be made in great variety of shapes and to close tolerances*
3. *Not damaged by high electrostatic forces*
4. *Reactivates after arcing*
5. *Can be reactivated after exposure to air*
6. *Withstands severe ionic and electronic bombardment*

7. *Maintains uniform emission characteristics during its life*

The PHILIPS L-CATHODE originated in the Philips Research Laboratories in Holland, and was further developed by Philips Laboratories, Inc., here. It was first described in the June 1950 *Philips Technical Review*. Leading electronic research laboratories have already used development types of various shapes with outstanding results.

Samples of PHILIPS L-CATHODES for experimental use can be supplied in limited quantities to those interested in producing greatly improved tubes of high emission density with longer life.

## PHILIPS LABORATORIES, INC.

Dept. E6, Irvington-on-Hudson, New York

# "NOFLAME-COR"

the TELEVISION hookup wire

fits perfectly  
into this  
picture

Meets government  
specification  
AN-J-C-48a

- FLAME RESISTANT
- HEAT RESISTANT
- HIGH INSULATION RESISTANCE
- EASY STRIPPING
- HIGH DIELECTRIC
- FACILITATES POSITIVE SOLDERING

Also  
is not affected by the  
heat of impregnation . . .  
making it an ideal wire  
for use in connection  
with coil and trans-  
former leads

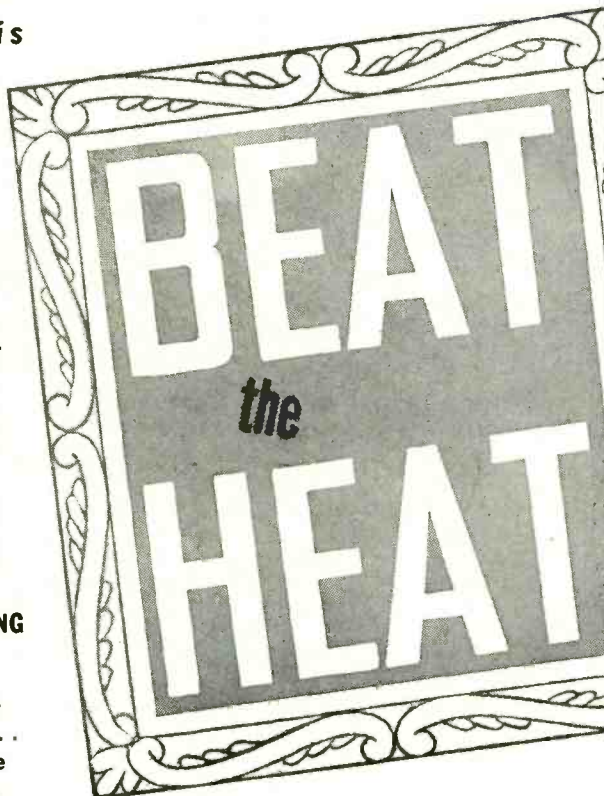

No "Nicking" problem in using this proven wire. Not being an extruded plastic, its diameter uniformity can be absolutely guaranteed. This eliminates nicking of conductors and constant re-setting of blades in the cutting process. Available in all sizes, solid and stranded, in over 200 color combinations . . . "NOFLAME-COR" assures maximum output and minimum rejects.



"made by  
engineers  
for engineers"

No "blobbing" of insulations under soldering heat, because "NOFLAME-COR" is NOT an extruded plastic. Production executives specify it as the most efficient heat-resistant wire yet developed. Save time, money and assembling headaches. Investigate!

**CORNISH WIRE COMPANY, Inc.**  
50 Church Street, New York 7, N. Y.

Branch Offices

- PHILADELPHIA
- BRIDGEPORT
- CLEVELAND
- CINCINNATI
- CHICAGO
- DETROIT
- MINNEAPOLIS
- ST. LOUIS
- ATLANTA
- DALLAS
- DENVER
- LOS ANGELES
- SAN FRANCISCO
- SEATTLE

MANUFACTURERS OF QUALITY WIRES AND CABLES FOR THE ELECTRICAL AND ELECTRONIC INDUSTRIES

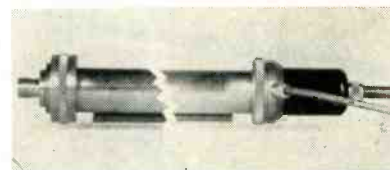

FIG. 3—Coaxial-line model of NBS r-f micropotentiometer

tios, the micropotentiometers may be used to extend the range for checking attenuators up to 120 db or higher. Simplicity of operation, trouble-free circuitry, flexibility, and absence of serious shielding problems make these instruments particularly adaptable to use by personnel of limited training.

In comparing the micropotentiometers with other sources, such as a voltage-measuring thermistor bridge<sup>1</sup>, absolute reproducibility and agreement have been limited only by the relative complexity of the standards of comparison. Verification of the exact frequency and voltage ranges of the micropotentiometers in terms of other independent standards is still in progress at the Bureau, along with other phases of design and application. Probably the greatest single difficulty encountered in this work has been the lack of stable sensitive receivers which can indicate one microvolt (or lower voltages) at 100 mc and higher frequencies with accuracies of 10 percent or better.

Figure 1 shows one of the r-f micropotentiometers. This particular unit provides voltages in the microvolt range without the use of attenuators, at frequencies up to 1,000 mc and with source impedances of the order of milliohms. The thermoelement is shown in its housing. The cylindrical section within the right side wall of the unit incorporates silver-deposited annular membranes (the current-carrying elements of the micropotentiometer). Similar elements of different resistivities and materials may be interchanged to attain other ranges.

Figure 2 shows the unit of Fig. 1 in use as part of a setup for calibrating a millivoltmeter (left). Figure 3 shows a coaxial-line model.

REFERENCE

(1) M. C. Selby and Lewis F. Behrent, J. Res. NBS 44, No. 1, p 15, 1950.





## What's wrong with telephone WU 2-1186?

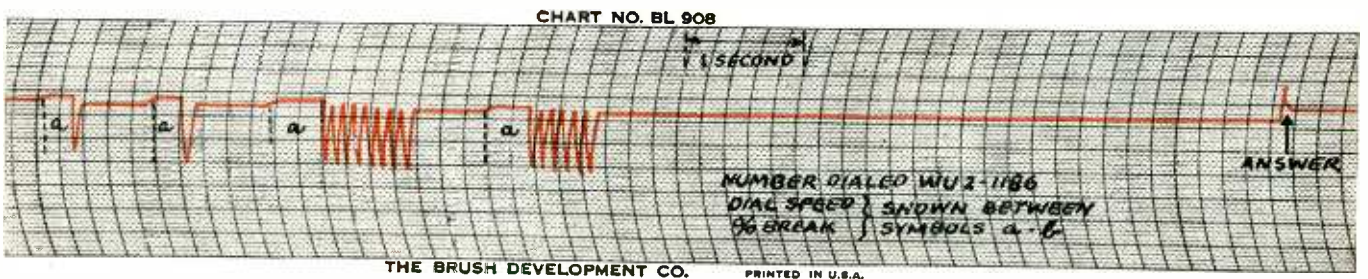
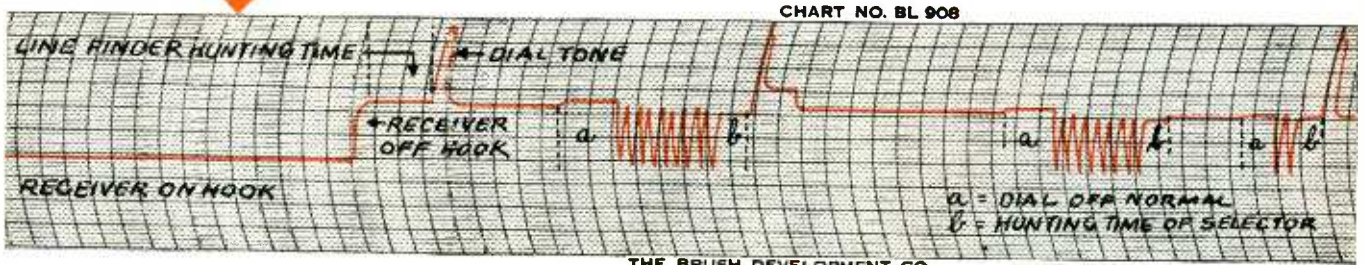

## Fast relays checked by BRUSH Analyzer

A Brush Analyzer drew the graph above when one of the subscribers of an eastern telephone company picked up his phone and dialed WU 2-1186.

This record—drawn automatically in the time it took to dial the number—shows the timing and magnitude of every electrical impulse involved in the complex operation. Such records of impulses from the dials of both subscribers and operators provide the tip-off on equipments which require adjustment or repair.

This check on fast relay operation is but one of hundreds of investigations of electrical and mechanical phenomena which are being made speedily with Brush Analyzers. They record instantaneously. They simplify the study of strains, displacements, pressures, light intensities, temperatures, d-c or a-c voltages or currents.

Write for time-saving help stating your problems. The Brush Development Company, Dept. K-6, 3405 Perkins Avenue, Cleveland 14, Ohio, U. S. A. *Canadian Representatives:* A. C. Wickman (Canada) Limited, P. O. Box 9, Station N, Toronto 14, Ontario.

*Put it in writing with a*  
**BRUSH RECORDING ANALYZER**

THE  
**Brush**  
DEVELOPMENT COMPANY



PIEZOELECTRIC CRYSTALS AND CERAMICS • MAGNETIC RECORDING  
ELECTROACOUSTICS • ULTRASONICS • INDUSTRIAL & RESEARCH INSTRUMENTS



# The SAFETY

OF ALLEN HEAD SCREWS  
SAVES YOUR TIME

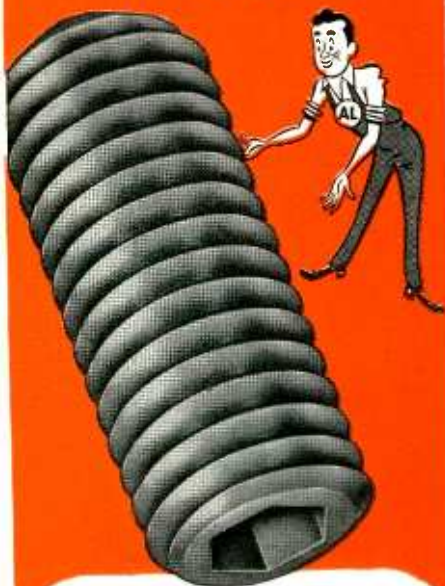

There's safety in positive, non-slip driving, weld-like grip under vibration and stress and absence of protruding heads. These features protect your own employees, the product you make and the people who use it. Allen Head screws and keys help keep both men and machines on the job.



THE **ALLEN**  
MANUFACTURING COMPANY  
Hartford 2, Connecticut, U. S. A.

## NEW PRODUCTS

(continued from page 144)

contacts. The timer automatically resets for each new cycle. It is available for either 115 or 230 volts a-c.

### Space-Saving Oscilloscope

SIMPSON ELECTRIC Co., 5200 W. Kinzie, Chicago, Ill. Model 476 Mirroroscope, designed to save space on the testing bench, has its 5-in. c-r tube mounted in a vertical position. Bench area required is only 9 in. × 8 in. The c-r image is reflected



from a mirror mounted in the adjustable cover at the top of the cabinet; thus the viewing surface is brought near the eye level when the unit is used on benches of normal height. Height is 16½ in. and width, 9½ in. Weight is 24 lb; price, \$179.50.

### Multicircuit Electrical Connector

L. J. KAMM Co., 40 W. 96th St., New York 25, N. Y. A new multicircuit electrical connector is available in sizes from ten to several hundred conductors in a single unit. It is engineered for cable connection, plug-in chassis, subassembly mounting and connection including miniaturized assemblies. Contact ratings



## HERE'S AN *Oster* SPECIALTY

GUARANTEED QUALITY  
COMPACT  
RUGGED  
PRECISION BUILT  
FRACTIONAL H. P.  
ELECTRIC MOTORS  
1/1000 H. P. to 1/4 H. P.

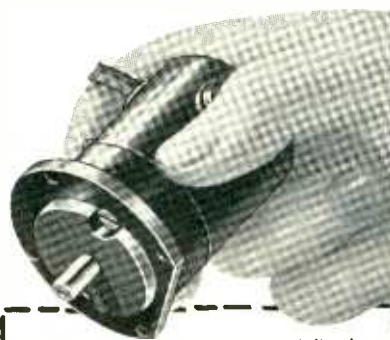

For 25 years, OSTER has specialized in building fractional H.P. motors to meet specific requirements. OSTER is unsurpassed in engineering, tooling, and assembly of electric motors up to 6" maximum O.D. of the following types:

- Direct current—6 volts to 220 volts
- Universal motors—6 volts to 220 volts
- Induction motors—conventional voltages
- Shaded pole motors—conventional voltages
- 400 cycle motors of the smaller sizes

Also precision electro mechanical assemblies

In several fields of fractional H.P. motor use, OSTER is the world's largest producer—electric barber clippers and massage instruments, for example. OSTER electric housewares, including food mixers, knife sharpeners, and hair dryers, because of their outstanding design and efficiency, are currently national best sellers.

All this OSTER experience and precision workmanship, plus the considerable volume of fractional H.P. electric motor production, assures you a reliable source for motors of dependable performance. For full information as to how OSTER can serve your special motor needs, write, wire or telephone . . .



**JOHN OSTER**  
MANUFACTURING CO.  
RACINE, WISCONSIN



**We challenge comparison: a powerhouse of economy backed with proven field performance.**

*The Du Mont*  
**5 KW OAK**

**TELEVISION TRANSMITTER**

*designed to grow with you!*

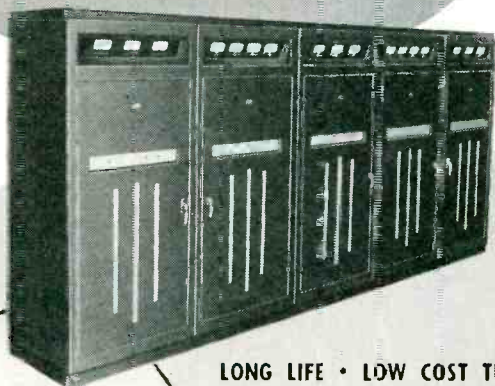

A model of efficiency and low cost. This 5 KW Oak Transmitter in commercial use for nearly two years with no final amplifier tube replacement expense. **COMPARE!**

**LONG LIFE • LOW COST TUBES**

In an actual operation report, the Eimac Final Amplifier Tube is still going strong after 6000 hours. Costs only \$198.00.

TOTAL TUBE COST FOR 5 KW results in a greater overall saving. **COMPARE!**

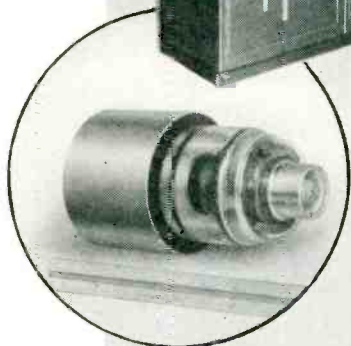

**AIR COOLED**

Air cooled throughout. Built-in fans. Completely eliminates water cooling apparatus with its maintenance, overhead and tube changing difficulties. **COMPARE!**

★ **ACCESSIBILITY**

Simplicity of construction, inherent lightness results in open construction. Basic units are rack mounted. All components easily accessible. **COMPARE!**

★ **TROUBLE-SHOOTING SYSTEM**

Overloads are indicated on the exclusive Du Mont Memory Circuit which acts as a comprehensive protective and fault indicator system. **COMPARE!**

**LOWER SIDE-BAND ATTENUATION**

The majority of side-band attenuation is obtained from each broad-band circuit. Additional attenuation is accomplished with a simple, non-dissipative notching filter in the visual amplifier. **COMPARE!**

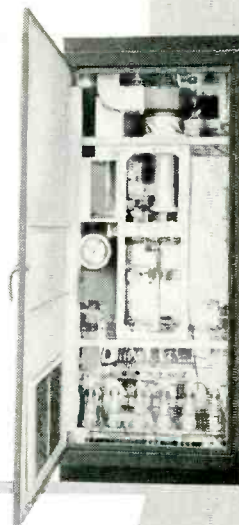

**FOR COMPLETE DETAILS, SEND FOR BULLETINS TTD-T101, TTD-T102**

*First Compare - Then Buy Du Mont... First with the Finest in Television*

**START SMALL . . . GROW BIGGER**



Many new stations are investing in the Du Mont Acorn Transmitter. Containing the most advanced thinking in television transmitters, the Acorn (500 Watt), is geared to equip you at the very start of your television career. It is designed to grow with you! It can readily be expanded to 5 kilowatts comprising the Oak Series, or to maximum power required at a later date.



**TELEVISION TRANSMITTER DIVISION**

**ALLEN B. DU MONT LABORATORIES, INC.**  
 Clifton, New Jersey

# CHICAGO

hermetically-sealed TRANSFORMERS  
and Filter Reactors meet the  
full requirements of **MIL-T-27**

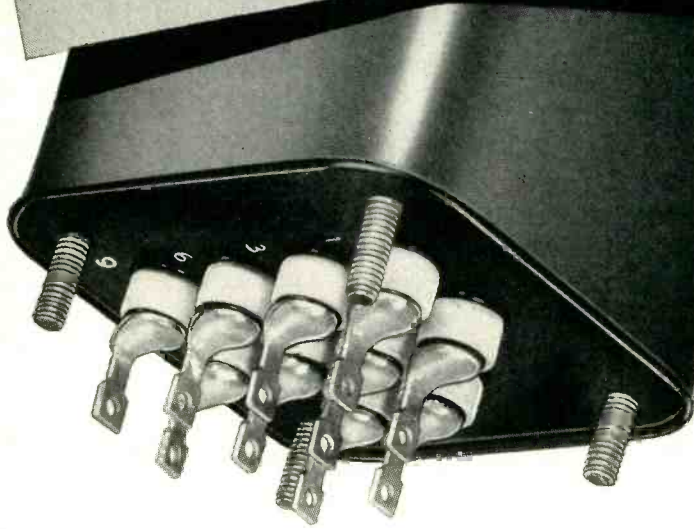

## the Complete Transformer line that Meets Military Specifications

If you require fully approved MIL-T-27 Transformers and Filter Reactors for prototype models, pilot runs or special applications, and need them in a hurry—call your electronic parts distributor for *quick service* on CHICAGO Hermetically-Sealed units. Chances are he'll have them in stock—and you'll save valuable time and effort. There's a *complete* range of CHICAGO MIL-T-27 Transformers available: *Power, Bias, Filament, Filter, Audio.*

CHICAGO Hermetically-Sealed Transformers are the world's toughest units, preferred by engineers for those rugged applications. These stock transformers may be incorporated in your equipment with full assurance that they meet *complete* MIL-T-27 specifications.



### SEND FOR "NEW EQUIPMENT" TRANSFORMER CATALOG

Have the full details at your fingertips on CHICAGO'S New Equipment Line—covering all MIL-T-27 units as well as famous Sealed-in-Steel transformers engineered for every application and geared to today's circuit requirements. Write for your free copy of this important catalog today, or get it from your distributor.

## CHICAGO TRANSFORMER

DIVISION OF ESSEX WIRE CORPORATION

3501 ADDISON STREET • CHICAGO 18, ILLINOIS



NEW PRODUCTS

(continued)

are 5 and 25 amperes, 150, 500 and 1,000 volts. Special contacts can be had in iron, constantan or gold plated. Dustproof, pressurized or true hermetically sealed connectors are available for military, naval and air operating conditions. It is engaged with substantially zero friction and then a lever or knob is turned to apply contact pressure. For wiring, the connector disassembles into twenty point strips with easily accessible terminals.

### Small pH Meter and Probe

ANALYTICAL MEASUREMENTS INC., 585 Main St., Chatham, N. J., has available a pocket-size portable pH meter and companion probe unit. Total weight is 3 lb. The meter is scaled from 2 to 12 pH for easy reading, and a simple adjustment gives readings from 0 to 14. Accuracy of 0.1 pH is obtainable.



Hearing-aid type batteries provide up to 1,300 hours of operation. The electrometer tube, switch and input connector are sealed in a single unit to ensure freedom from high-humidity difficulties. The unit features one-knob control, continuous reading and a completely shielded instrument and electrode.

### Servo Amplifier

SERVOMECHANISMS, INC., Old Country and Glen Cove Roads, Mineola, N. Y., is producing the SA-203 compact 60-cycle servo amplifier. It is designed as a small plug-in unit in which all the electronic elements required for one function in the control system are packaged together. Already proven in use on Government equipment, and now released for industrial use, it is available for



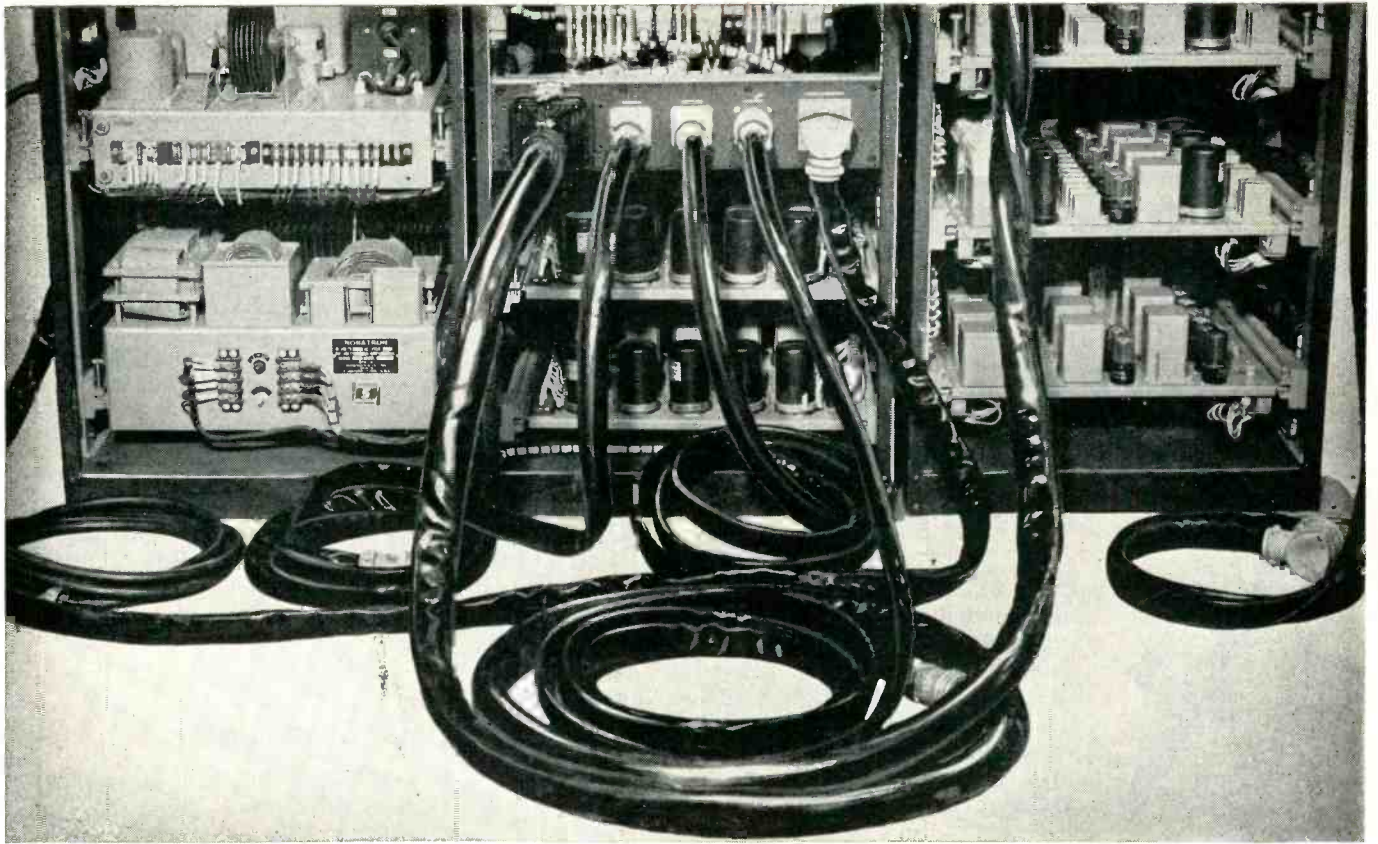

## Reeves saves space in its Electronic Brain... with **IRV-O-LITE** Tubing

The Reeves Electronic Analog Computer (REAC)\* saves plenty of man-hours in performing complex calculations. And in this Electronic Brain's complicated wiring system, shielding and terminal labeling are done exclusively with IRV-O-LITE XTE-30 Plastic Tubing—saving plenty of space.

XTE-30's high dielectric strength of 1,000 vpm (dry) frequently permits the use of *thinner-walled* tubing. Where space is at a premium, follow the example of Reeves and hundreds of other manufacturers—use XTE-30!

You get these *other* advantages, too, with XTE-30 Plastic Tubing: high mechanical strength; lasting flexibility; excellent chemical and moisture resistance.

XTE-30 comes in a standard range of sizes from .022" to 2" ID and even larger for special applications. Six contrasting colors simplify identification of leads and speed up complex wiring jobs. See for *yourself* what XTE-30 will do for you—just mail the coupon for free Technical Data Sheet.

*\*Manufactured by Reeves Instrument Corp. of N. Y., one of the outstanding producers of high precision electronic and electro-mechanical computing equipment.*

Look to

**IRVINGTON**

for insulation leadership

INSULATING VARNISHES

VARNISHED CAMBRIC

VARNISHED PAPER

VARNISHED FIBERGLAS

INSULATING TUBING

CLASS "N" INSULATION



Send this convenient coupon now

**Irvington**  
VARNISH & INSULATOR COMPANY

Irvington 11, New Jersey

Irvington Varnish & Insulator Company  
6E Argyle Terrace Irvington 11, N. J.

Gentlemen:

Please send me your Technical Data Sheet on IRV-O-LITE XTE-30 tubing.

Name.....Title.....

Company.....

Address.....

City.....State.....

# NOW!

## 3 new ceramic components from C.T.C.



**LS-8 SLUG TUNED COIL FORM.** Features silver-plated phosphor bronze clip terminals which cannot loosen. Height,  $23/32$ " Maximum diameter,  $1/2$ ". Mounts in "D" punched hole or in  $1/4$ " round hole. Coil form is of grade L-5 silicone impregnated ceramic. Slug is provided with a spring lock. All metallic parts except clips are cadmium plated. Supplied complete with slug and all mounting hardware.

### X1986 CERAMIC TERMINAL BOARD.

Grade L-5 silicone impregnated ceramic.  $35/64$ " O.A. mounted height including terminals.  $1/4$ " length,  $7/8$ " width. Assembly has 8 C.T.C. Type X1558 terminals in 2 rows (4 per row)  $9/16$ " apart, plus two 4-40 tapped standoffs  $3/16$ " high on  $5/8$ " centers. A center ground strap is provided to which standoffs are riveted and soldered for good grounding at R.F. frequencies. All metal parts are non-ferrous, heavily plated.

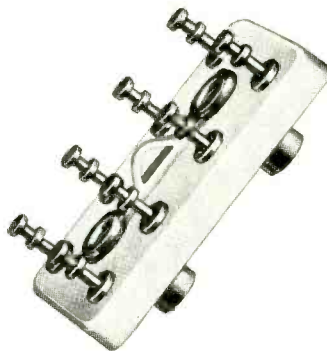

### X1990 CERAMIC FEED-THROUGH INSULATOR.

Grade L-5 silicone impregnated ceramic.  $7/8$ " O.A. length including through terminal.  $3/8$ " hex bushing threaded for  $1/4$ " hole mounting. Voltage breakdown 4800 volts R.M.S. @ 60 cycles AC.

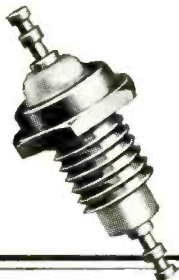

### SPECIAL CONSULTING SERVICE

A staff of thoroughly experienced C.T.C. component engineers is at your service . . . at no cost to you . . . to help you secure exactly the *right* components for your requirements. They will design special units for you when standard parts are not suitable, working closely with you for economical, satisfactory results.

Feel free to call upon the C.T.C. Consulting Service at any time. Just write direct to Cambridge Thermionic Corporation, 437 Concord Avenue, Cambridge 38, Massachusetts.

custom or standard . . . the guaranteed components

**C.T.C.**

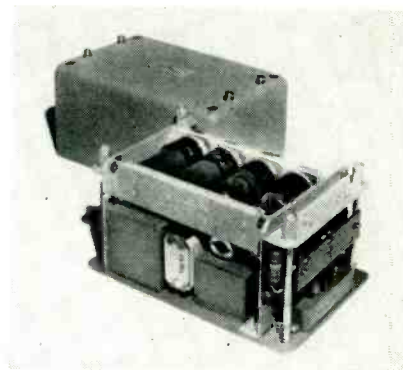

application in such equipments as analog computing devices, laboratory measuring instruments, and industrial process controls. It measures 5 in. in width  $\times$  8 in. in length  $\times$   $4\frac{3}{8}$  in. in height and weighs  $5\frac{1}{2}$  pounds.

### V-T Electrometer

KEITHLEY INSTRUMENTS, 1507 Warrensville Center Road, Cleveland 21, Ohio. Model 200 vacuum-tube electrometer is a self-contained d-c voltmeter that has an extremely high input impedance. It measures voltages on two ranges, 2 volts and 20 volts full scale, and has an input



grid drift current of less than  $5 \times 10^{-14}$  and  $5 \times 10^{-13}$  ampere for the two scales respectively. Input resistance is greater than  $10^{11}$  ohms and capacitance is approximately  $6 \mu\text{mf}$ . Accuracy is within two percent of the full scale value.

### Microphone Preamplifier

CINEMA ENGINEERING CO., 1510 W. Verdugo Ave., Burbank, Calif. The 101-BX microphone preamplifier is designed for use in the tv field or wherever extremely low micro-



It tells your  
**"RINGER"**  
 when not to ring!

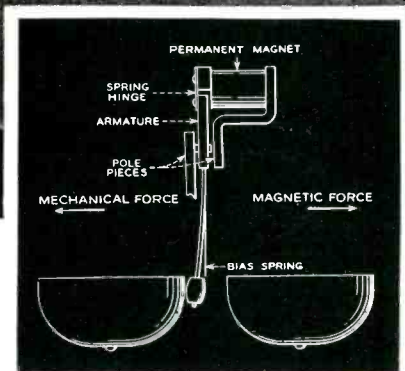
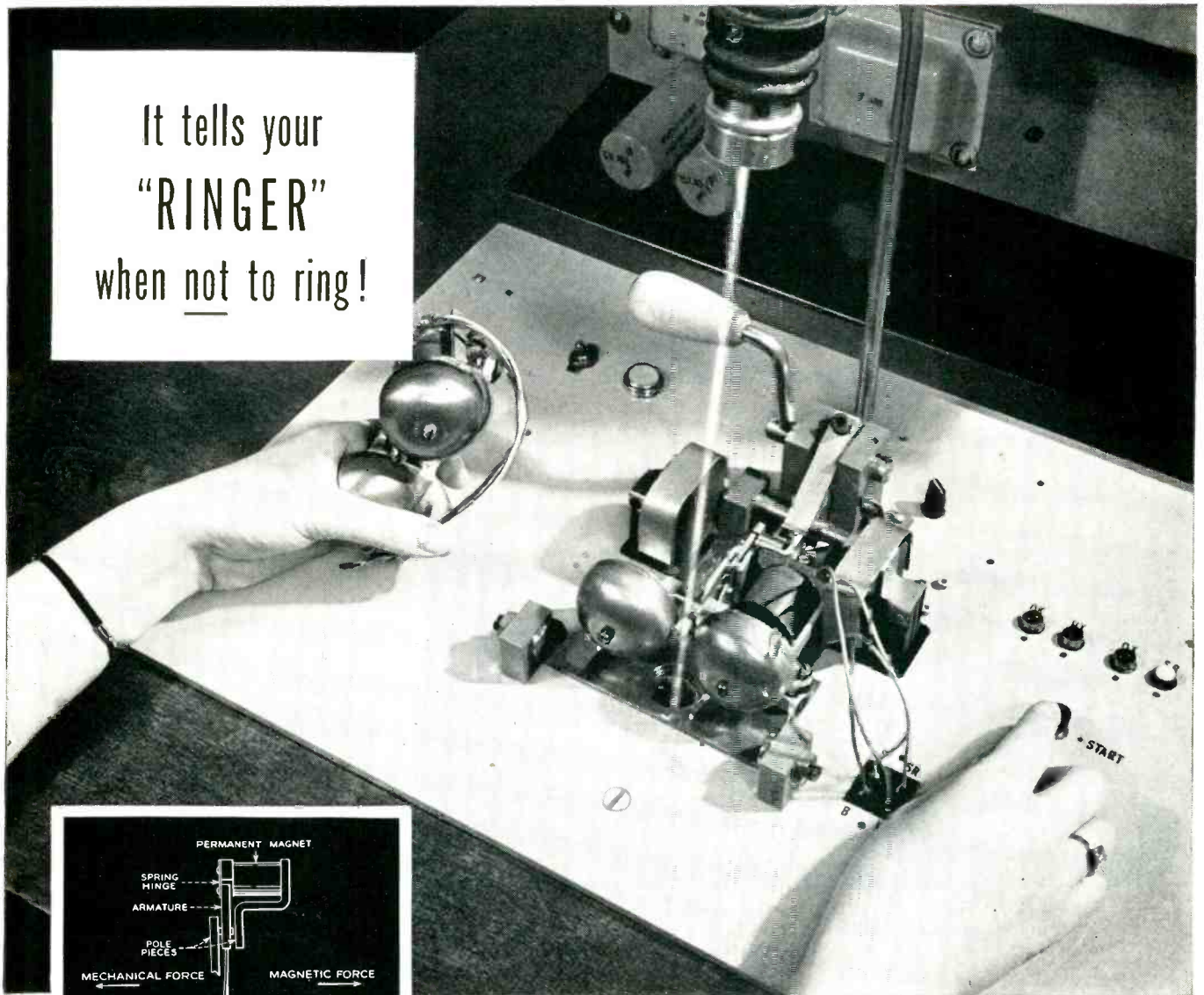

The Bell System's new automatic method of adjusting telephone ringers uses a beam of light passing between the gongs to a photoelectric cell. When test currents are applied to the ringer the machine decides whether to change the spring tension or the magnetic pull. After each change it tests again until the ringer is in perfect adjustment—and the whole procedure takes only 30 seconds.

To YOU, it's your familiar telephone bell. To telephone engineers, it's a "ringer." And it has two jobs to do. It must ring, of course, when someone calls you. And it must overlook the numerous electrical impulses which do not concern it, such as those sent out by your dial.

Ability to respond to some impulses, to ignore others, requires exact adjustment between the pull of a magnet and the tension of a spring. If they are out of balance your telephone might tinkle when it oughtn't, or keep silent when it should ring.

In the past, adjustment was made by hand, little by little until the proper setting was reached. It took time. But now Bell Laboratories engineers have developed a machine which adjusts new ringers perfectly, before they leave the Western Electric Company plants where they are made. And the operation takes just 30 seconds.

This is another example of how the Laboratories work constantly to improve every phase of telephony — keeping the costs low while the quality of service grows higher and higher.

# BELL TELEPHONE LABORATORIES

WORKING CONTINUALLY TO KEEP YOUR TELEPHONE SERVICE ONE OF TODAY'S GREATEST VALUES



# Facts-

## YOU SHOULD KNOW ABOUT

### GENERAL ELECTRIC STABILIZING AMPLIFIER TYPE TV-16-B



**Input and Output** — No other stabilizing amplifier gives you a choice of matching or bridging input with an input gain for both. This unit provides *two* standard RTMA outputs. One of these can be used for monitoring—with as much as 37 db of isolation between monitor output and picture output.

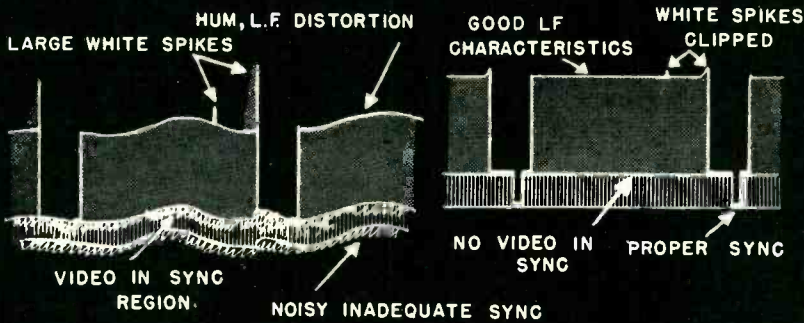

**Vertical Wave Form** — Output level control can be adjusted while maintaining critical circuits at a constant signal level. This effectively increases the range of input variation over which the amplifier will maintain stability.

**White Clipper**—A unique General Electric feature that guards against overloads due to “whites”. It may also be used as a guard against buzz in inter-carrier type receivers.

**Automatic Correction** of the sync and blanking portion of the television signal, adjustable sync percentage, and improved LF characteristics are the important benefits available with G.E.'s new Stabilizing Amplifier.

**FREE**— Handy leatherette folder containing specification bulletins of all General Electric TV Station equipment will be forwarded on request to television station managers and engineers. Write: *General Electric Company, Section 461 Electronics Park, Syracuse, New York.*



# GENERAL ELECTRIC



phone levels are encountered, such as when the performer is 6 to 10 feet from the microphone. It makes use of high-gain multishielded transformers, and increases the signal-to-noise ratio 10.5 db over the conventional preamplifiers. The unit uses a single 12AY7 tube, providing two stages of amplification. It is built on a plug-in chassis and weighs 4½ lb.

### Adjustable Treble Filter

BERKELEY CUSTOM ELECTRONICS, 2216½ Grant St., Berkeley 3, Calif. Annoying surface noise and disagreeable distortion products in the upper-frequency ranges, commonly heard when imperfect recordings or radio programs are reproduced through wide-range reproduction systems, can now be virtually eliminated with minimum loss of use-



ful-treble frequencies, by means of the new OA-1 adjustable 5-range treble filter. The filter operates from the outputs of typical a-m/f-m tuners or phone preamplifiers and into usual amplifier or tuner input circuits. No power is required. Price is \$32.50 net.

### Variable Capacitors

THE JFD MFG. Co., INC., 6101 Sixteenth Ave., Brooklyn 4, N. Y., has announced a new piston-type variable trimmer capacitor. Tubular in



Looking for ways to make old things **BETTER?**  
 Looking for ways to make new things **POSSIBLE?**

**Look into KINNEY  
 VACUUM PUMPS**

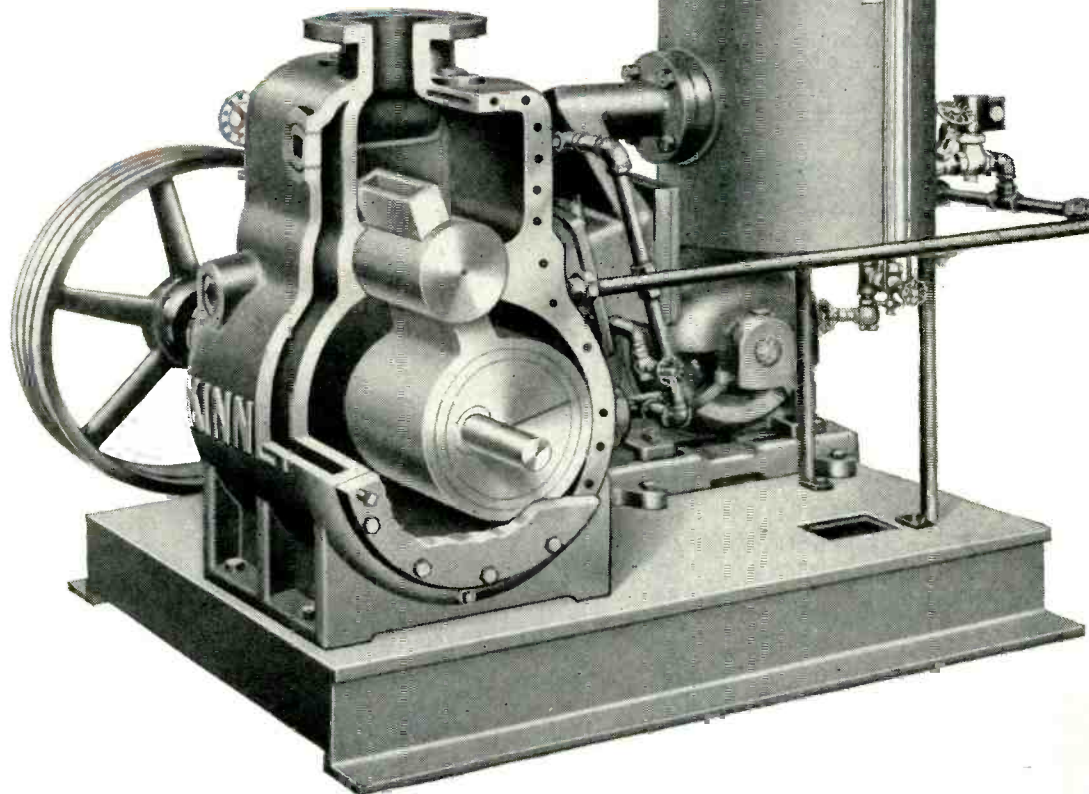

More vacuum processes depend on this "vacuum powerhouse" than on any other type or make of pump. More new developments — new products, new improvements in old products — are made possible and practical by this pump. Every day, more and more engineers use this pump to make their vacuum dreams come true — in the laboratory, the pilot plant, the production line.

Have you looked into Kinney Vacuum Pumps? Do it today — just fill out and mail the coupon. KINNEY

MANUFACTURING CO., Boston 30, Mass. Representatives in New York, Chicago, Cleveland, Houston, New Orleans, Philadelphia, Los Angeles, San Francisco, Seattle.

**FOREIGN REPRESENTATIVES:** General Engineering Co. (Radcliffe) Ltd., Station Works, Bury Road, Radcliffe, Lancashire, England • Horrocks, Roxburgh Pty., Ltd., Melbourne, C. I. Australia • W. S. Thomas & Taylor Pty., Ltd., Johannesburg, Union of South Africa • Novelectric, Ltd., Zurich, Switzerland • C.I.R.E., Piazza Cavour 25, Rome, Italy.

SEND COUPON TODAY FOR COMPLETE INFORMATION



**KINNEY MANUFACTURING CO.**  
 3565 WASHINGTON ST., BOSTON 30, MASS.

Gentlemen:  
 Please send illustrated Bulletin V45. We are interested in:

- Vacuum exhausting     Vacuum distillation  
 Vacuum coating       Vacuum metallurgy  
 Vacuum dehydration

Name.....  
 Company.....  
 Address.....  
 City..... State.....



## PRECISION ELECTRONIC SYSTEMS

### RADIO

- Direction Finders  
Electronic Goniometer
- Signal Generators  
Crystal Control  
1 kc to 150 mc.
- Spectrum Generator  
Marker Pulses  
.5 to 50mc.

### CONTROLS

- Servoscope
- Servoboard
- System Synthesis
- Reluctance  
Amplifiers
- 60  $\checkmark$  Servo  
Amplifier
- Plug-in  
Component  
Assemblies

### RADIATION

- Servotherm  
Bolometers
- Bolometer  
Preamplifiers
- Thermistor  
Power Supply
- Servotherm  
Pyrometers

Write today for  
complete information

**SERVO**  
CORPORATION  
OF AMERICA  
NEW HYDE PARK, N. Y.

# MEN! ENGINEERS PHYSICISTS

BASE YOUR  
*FUTURE*  
ON  
*FACTS*

★ ★ ★ ★ ★  
THIS GROWTH

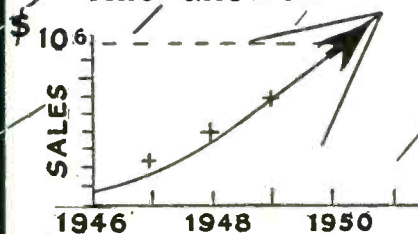

CREATED THESE  
**PRIORITY PRODUCTS**

FOR  
**INDUSTRY**  
IN

**PEACE OR WAR**  
AND THESE NEW  
**STAFF POSITIONS**

- Applied Physicist  
Semi-conductors
- Electronic Seniors  
1—R. F. Systems  
1—Infrared Systems  
1—Servo Systems
- Design Engineer  
Mechanical Instruments
- Jr. Engineers  
ME, Physics, Electronic

SEE  
INDUSTRY in the  
MAKING  
A SMALL COMPANY  
WITH A **BIG**  
FUTURE!

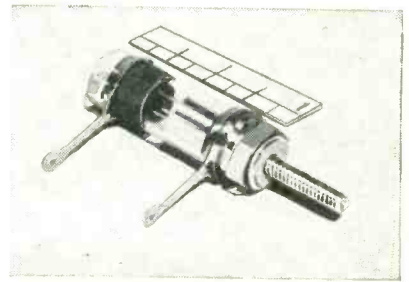

design, it delivers continually uniform change of capacitance in relation to rotation. Smooth, precise settings without backlash or disturbance from severe vibrations are made and maintained. Other features include: approximately zero temperature coefficient; Q rating of over 1,000 at 1 mc; 55 C to 100 C operating temperature; 10,000 megohms insulation resistance. The units offer the low capacitances needed especially in the operation of commercial and government land and marine communications and microwave equipment.

### TV Antennas

CHANNEL MASTER CORP., Napanoch Road, Ellenville, N. Y. A new, complete line of Yagi antennas, the 500 series, is designed to extend tv reception areas beyond present limits. Available for channels 2 through 13, the antennas combine high gain with high directivity and have an actual gain of 8 db that may be substantially increased by stacking. They have a high front-to-back ratio of 26 db to reduce rear and side pickup and match both 72 and 300-ohm line. Construction features include aluminum elements and cross-arm, high-impedance step-up dipoles of seam-

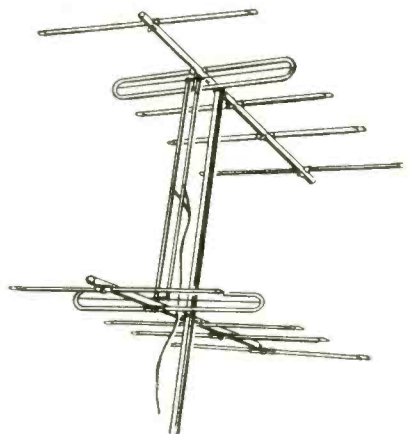



# Where "Photographic Memory"

*Counts!*

When you're comparing waveshapes it takes the "photographic memory" of a camera to give you the whole story in accurate, permanent form.

Until recently, photographic oscilloscope recording called for considerable trouble in setting up equipment and a long time period for developing the results. But today, with the Fairchild-Polaroid Oscilloscope Camera, it's an easy job to record as many traces as are needed.

Take a look at the prints below. They provided the engineer with valuable but inexpensive records for immediate evaluation. All were removed from the camera *one minute* after the final exposure was made.

## The stories of 3 "One Minute" Oscillograms

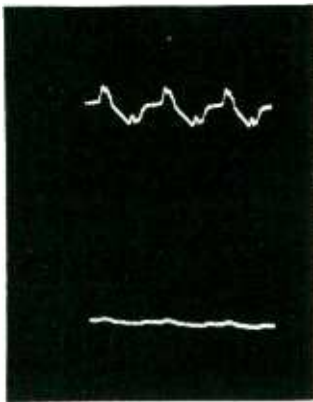

**1. BEFORE AND AFTER.** A visual comparison of "before and after" conditions is an easy job for the "one step" camera. Here, the upper trace shows the output of a full wave rectified power supply with insufficient filtering. The lower trace shows the effectiveness of the addition of a filtering condenser. The camera is easily adjusted to two positions (upper and lower) for two exposures; traces are exactly one half scope size.

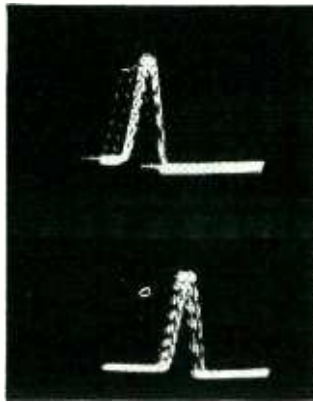

**2. SUPERIMPOSING FOR COMPARISON.** The problem—determine the maximum time-interval variation between successive camera shutter openings and flash circuit closings. Instead of carefully measuring successive scope traces, the engineer superimposed several exposures for easy comparison. The length of the trace before the shutter opened is a measure of the time between the electrical contact closing and camera shutter opening.

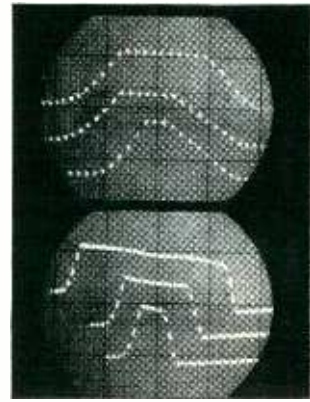

**3. MULTIPLE EXPOSURE PRE-SOLARIZATION.** Here, by making 3 successive exposures on each half of the print, the engineer was able to record performance of a camera shutter at its 1/100, 1/200, 1/400 second (upper) and 1/25, 1/50, and 1/100 second settings (lower). "Pre-solarizing," the process of pre-exposing the print with the trace off the screen, made it possible to record the high writing speeds involved.

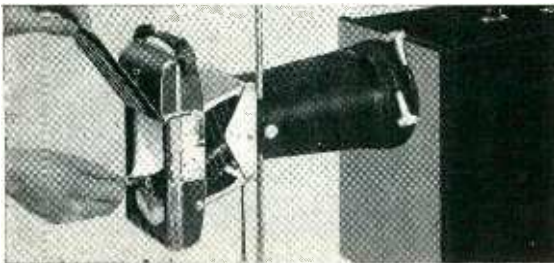

A minute after you've pulled the tab a finished print is ready for evaluation.

for still or continuous-motion  
oscilloscope recording on 35-mm film or paper

— THE FAIRCHILD  
OSCILLO-RECORD CAMERA



The Fairchild Oscillo-Record Camera is the first unit specifically designed for the purpose of recording cathode-ray tube images. Features: records still or continuous motion on standard 35-mm film or paper, film frontage indicator, electronic speed control—1 to 3600 in./min., film capacity—100, 400 or 1000 feet.

### SPECIFICATIONS

- Lens and Shutter**—Choice of 75mm f2.8 Wollensak Oscillo-Anastigmat with  $\pm 2$  Alphax shutter having speeds of 1/25 sec. to 1/100 sec., "time" and "bulb"; or, 75mm f1.9 Wollensak Oscillo-Anastigmat with  $\pm 3$  Alphax shutter having speeds of 1 sec. to 1/100 sec., "time" and "bulb".
- Picture Size**— $3\frac{1}{4} \times 4\frac{1}{4}$  in. (2 or more images per print; 16 exposures per roll of film.)
- Image Size**—One-half reduction of scope image.
- Writing Speed**—With f2.8 lens, up to 1 in./ $\mu$ sec at only 3000V accelerating potential; higher speeds at higher voltages. With f1.9 lens these values are approximately doubled.
- Dimensions**—Camera,  $10\frac{1}{2} \times 5\frac{1}{4} \times 6\frac{1}{4}$  in.; hood, 11 in. length,  $7\frac{1}{2}$  in. dia; adapter, 2 in. width,  $6\frac{5}{8}$  in. max. dia.
- Weight**—Complete,  $7\frac{3}{4}$  lb.

Fairchild-Polaroid Oscilloscope Camera Kits include camera, carrying case and film. Write today for complete data on the Fairchild-Polaroid and Fairchild Oscillo-Record Cameras. Fairchild Camera and Instrument Corp., 88-06 Van Wyck Blvd., Jamaica 1, N. Y. Dept. 120-15A.

**FAIRCHILD**  
OSCILLOSCOPE RECORDING CAMERAS

# RCA ELECTRONIC COMPONENTS



*Typical RCA hermetically sealed and fungus-proofed power transformer for military use.*

## For military requirements . . . built to military specifications

BECAUSE of its experience, engineering skill, and vast production facilities, RCA is singularly well equipped to manufacture in quantity, special transformers, chokes, filters and coils, rigidly designed to military specifications.

As one of the major suppliers of specialized electronic and television components, RCA is geared to handle your individual requirements without delay.

RCA Application Engineers are at your service—and will be pleased to confer with you on your specific military component designs. For further information, write or phone RCA, Commercial Engineering, Section 42FS, Harrison, N. J., or your nearest RCA field office.

FIELD OFFICES: (EAST) Harrison 6-8000, 415 S. 5th St., Harrison, N. J. (MIDWEST) Whitehall 4-2900, 589 E. Illinois St., Chicago, Ill. (WEST) Trinity 5641, 420 S. San Pedro St., Los Angeles, California.

less tubing, and reflectors and directors of  $\frac{3}{8}$ -in. butted tubing with  $\frac{1}{2}$ -in. external sleeves.

### Miniature Paper Tubular

PYRAMID ELECTRIC Co., 1445 Hudson Boulevard, North Bergen, N. J. Type 65PTR hearing aid tubular paper capacitor is rated for 65 C, 150-v d-c applications. Designed

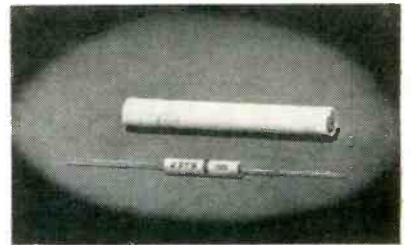

for continuous operation at d-c voltage rating, it will withstand a 5-second test of 300 v d-c and will meet the standard RTMA humidity test.

### Resistors and Rheostats

OHMITE MFG. Co., 4981 Flournoy St., Chicago 44, Ill., has available 11 models of rheostats, each meeting the requirements of specification JAN-R-22. These models include both standard and enclosed types, in sizes ranging from 25 to



750 watts. Also available is a complete line of wire-wound resistors that meet all the tests prescribed in specification JAN-R-26A, including 5-hour vibration tests and air and water tests for thermal shock.

### C-R Scope

SYLVANIA ELECTRIC PRODUCTS INC., 1740 Broadway, New York 19, N. Y. Type 132Z is a 7-in. c-r oscilloscope that has been specially designed for general use in radio and tv receiver testing and in laboratory and pro-



**RADIO CORPORATION of AMERICA**  
ELECTRONIC COMPONENTS HARRISON, N. J.





BRIDGEPORT BRASS COMPANY

# COPPER ALLOY BULLETIN



MILLS IN BRIDGEPORT, CONN. AND INDIANAPOLIS, IND.—IN CANADA: NORANDA COPPER AND BRASS LIMITED, MONTREAL

## Season Cracking Can Be Avoided By Cutting Down Internal Stresses

The fine art of drawing brass has been built up through many years of experience. Brass, while one of the easiest and most satisfactory metals to work with, is not without certain problems. These problems, fortunately, are avoidable by proper controls.

When drawing cups and shells, the percentage of reduction of both the outside diameter and the wall thickness should be carefully calculated: 1. in order to obtain the maximum reduction per operation, and 2. to prevent the introduction of dangerous internal stresses especially in the finished shell, stresses which may lead to season cracking when the article is kept in storage or during service use.

### Proper Drawing Practice to Prevent Severe Internal Stresses

To avoid danger of internal stresses, the general practice in the brass industry is to use fairly severe wall reductions on every operation, along with gradually decreasing reductions on the outside diameter. It is very important that the finish draw should be sure to include a substantial wall reduction in order to keep internal stresses to a minimum. If the final draw calls for a wall reduction of .002" or .003", care should be taken to make sure that die wear is not excessive. Otherwise, insufficient pinching of the wall will occur after long runs. The "Selection Chart for Deep-Drawing Dies", reproduced in the reprint of the Feb., 1950 issue of the Copper Alloy Bulletin, will be mailed on request.

### Relief Anneal Helpful

If the final drawing of the shell without reducing the wall cannot be avoided and dangerous internal stresses are developed, the article should promptly be subjected to a relief anneal to reduce the stresses. Otherwise, it may fail in storage or when it is put to service. A relief annealing operation calls for

heating the article at a temperature sufficiently high to reduce the stresses to a safe point, yet without bringing about softening of the hard drawn metal.

### Mercurous Nitrate Test

The usual method of determining the presence of internal stresses is the mercurous nitrate test. Here the article is immersed in a solution of mercurous nitrate for a period of 15 minutes. If no cracking occurs, it is assumed that no severe internal stresses are present. However, cracking within that period of immersion indicates the presence of internal stresses.

Strange to say, the dangerous internal stresses are not the result of excessive reduction of the metal. They are brought about by reducing the outside diameter without simultaneously thinning the wall. This operation is known as "sinking" when applied to tube drawing and actually thickens the wall.



Both tubes were "sunk" or drawn without a plug to induce stresses. Tube (left) was then annealed at the base only and tube (right) was annealed its entire length. After testing in mercurous nitrate solution, cracking revealed the presence of severe internal stresses that were present in the unannealed portion of the tube.

Often material which cracks in mercurous nitrate does not season crack after long years of service either because it is resistant to season cracking or because favorable atmospheric

conditions exist. It must be remembered that when season cracking in service does take place, it is due to the combined action of ammonia, air and moisture on stressed material.

### Ammonia Prime Cause of Season Cracking

In recent years, the ammonia test is also used to determine the presence of dangerous stresses in hard worked brasses. However, ammonia tests are rather awkward to handle and much slower. The results must be interpreted with considerable caution. Consequently the ammonia test is not used as a standard method of control.



Micrograph illustrates cracking of stressed tubing after testing with ammonia, moisture and air.

It is often asked whether a nickel and chromium plate on a highly stressed shell is effective in preventing season cracking. There is no doubt that such a plate affords distinct protection. However, even the best plate shows some porosity and experience has shown that some stressed shells, even heavily nickel plated, have been subject to season cracking.

Yellow brass (66% copper, 34% zinc) is less resistant to season cracking than the higher copper alloys such as red brass (85% copper, 15% zinc) and commercial bronze (90% copper, 10% zinc). (6743)



**It's easy to  
satisfy both conditions with  
S. S. White flexible shafts**

You want optimum circuit efficiency and you want maximum tuning convenience in electronic equipment.

You can get both without compromise when you use S.S. White flexible shafts to couple variable elements to their control knobs. By doing this, you are free to locate both the elements and their knobs to satisfy all requirements.

S.S. White flexible shafts include types engineered and built specifically for remote control service. They give smooth, jump-free, sensitive tuning. And they're about as easy to install as electric wiring.

**WRITE FOR NEW BULLETIN 5008**



*It contains the latest information and data on flexible shafts and their application. Write for a copy today.*



**THE S.S. White INDUSTRIAL DIVISION  
DENTAL MFG. CO.**



Dept. E, 10 East 40th St.  
NEW YORK 16, N. Y.



duction applications. It incorporates a multivibrator sweep circuit for linear internal sweep from 10 to 30,000 cycles which may be synchronized to 60 cycles, an external signal or signal applied to its vertical input terminal. Balanced, non-astigmatic sweep is assured by push-pull deflection. Terminals are provided for direct connection to horizontal and vertical deflection plates and to the control grid of the c-r tube for intensity modulation.

#### Junction Block

CORNISH WIRE Co., Rutland, Vt., has designed and produced an all-moulded-rubber junction block to reduce wire assembly costs and to simplify and improve product and installation wiring. The unit,

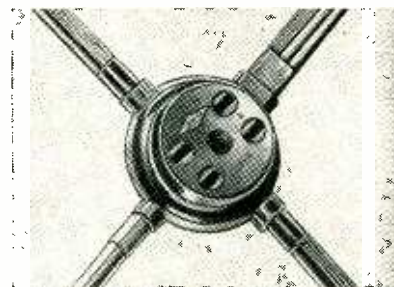

which handles two cord connectors or plugs, facilitates internal wiring to any circuit arrangement or specification. The one-hole screw fastener is fully insulated and wire entrances are flexible as regards position or sizes of conductors. The unit is sealed against moisture and corrosion.

#### Tube Tester

THE TRIPLETT ELECTRICAL INSTRUMENT Co., Bluffton, Ohio. Model 3413-A tube tester with improved



# Now! the first and only electronics distributor COAST TO COAST!

*Federated Purchaser announces  
the opening of its newest Electronics Center in...*

- to cut your production costs
- speed your service, and
- assure you a smooth flow of supplies

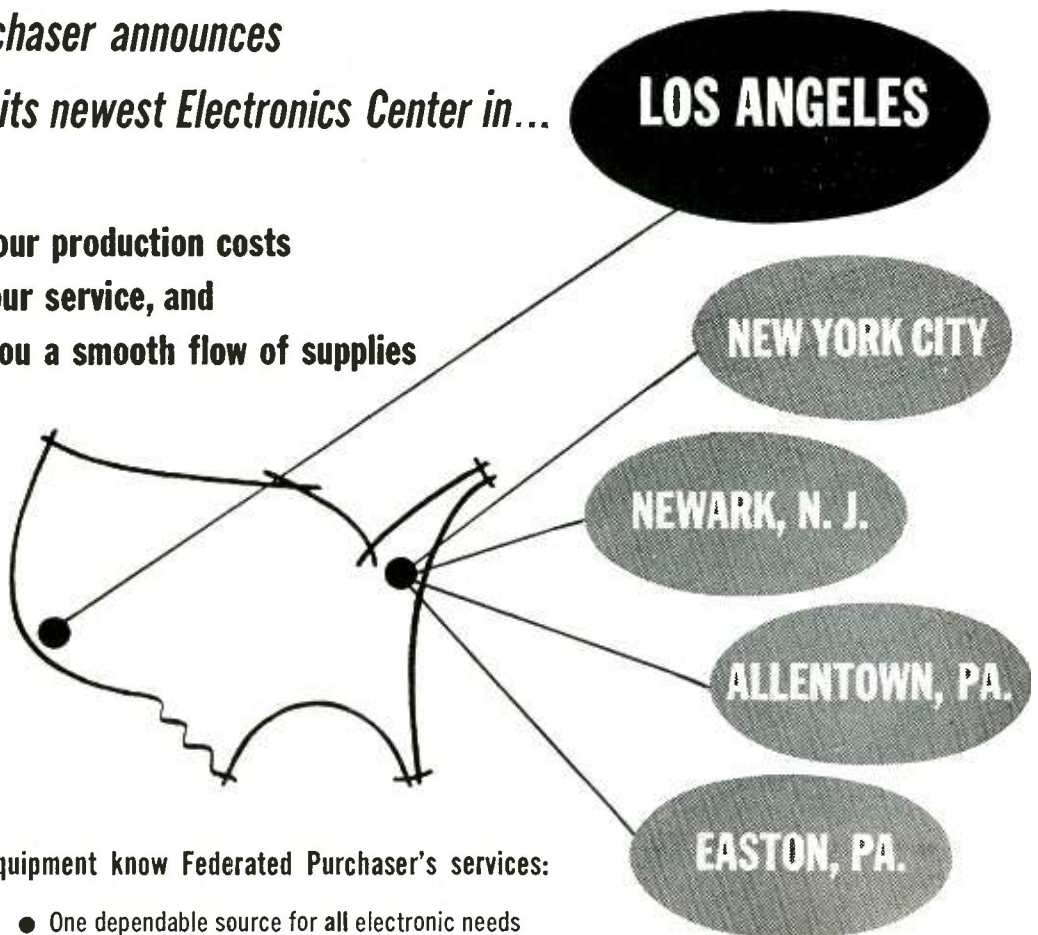

Buyers of electronic equipment know Federated Purchaser's services:

- One dependable source for all electronic needs
- Quick delivery...now more important than ever
- The always-friendly "Mr. Fed" service
- Most modern and complete electronic centers in strategic locations

Purchasing Agents! Engineers! Take advantage of F-A-R R-E-A-C-H-I-N-G Federated Purchasing Power

**Federated Purchaser**  
INCORPORATED  
CABLE: FEDERPURCH  
THE ONLY COAST TO COAST ELECTRONICS DISTRIBUTOR

New York City  
66 Dey St.  
Digby 9-3050

Los Angeles  
911 S. Grand Ave.  
TRinity 7311

Newark, N. J.  
114 Hudson St.  
Market 3-4005

Allentown, Pa.  
1115 Hamilton St.  
Phone 3-7441

Easton, Pa.  
701 Northampton St.  
Phone 4259

"Mr. Fed" says:  
Get it faster—the **FP** way!

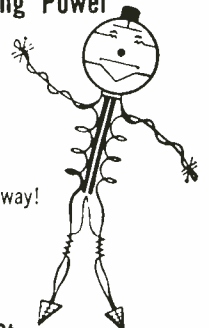

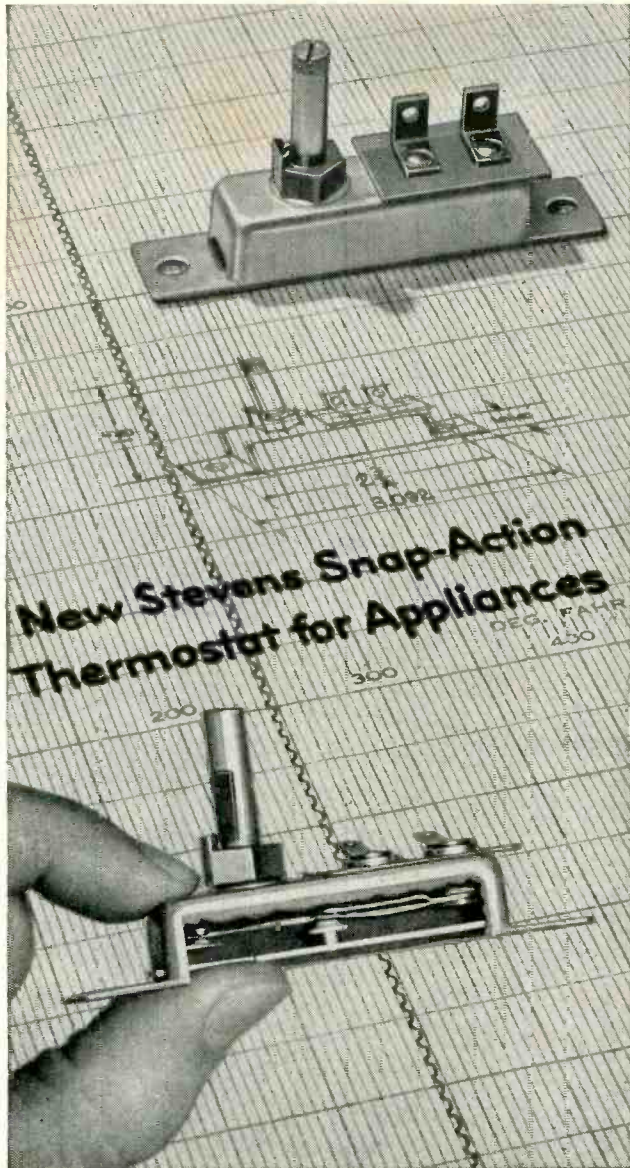

- fixed differentials as close as 5° F
- highly responsive
- non-radio-interfering
- longer contact life

■ New Stevens Type W Snap-Action Thermostats are specially engineered for appliances requiring sensitive, precise control of high-wattage heater loads.

Featuring an electrically independent bimetal that effectively eliminates artificial cycling and "jitters," Type W thermostats closely follow temperature of controlled device ... respond rapidly to temperature changes. Spring pressure remains positive until actual instant contacts snap open, thus assuring longer contact life and non-interference with radio reception.

Stevens Type W Snap-Action Thermostats are now available in adjustable or non-adjustable styles, with various terminal designs and arrangements, and for operation within a 400° F temperature range. Specify Stevens thermostats on your next order—they insure the performance and long, trouble-free life of your product.

A-9969

**STEVENS** manufacturing company, inc.  
MANSFIELD, OHIO



testing flexibility permits checking any type radio receiving tube, miniature hearing-aid tubes, pilot lamps, flashlight bulbs and tv picture tubes. It has flexible 3-position lever switches for complete coverage of present and future tube connections. The RTMA pin numbering of tube element levers makes for quick reference of tube base connections. Line voltage indication on the center of the meter dial permits observation and adjustment for line fluctuations. Filament voltage is 0.63 v to 110 v in 14 steps.

### H-V Electrostatic Focusing Control

CHICAGO TELEPHONE SUPPLY CORP., Elkhart, Ind., has developed the type 85 high-voltage control for

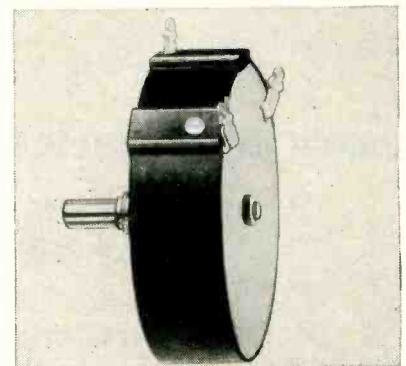

electrostatic focusing that is made chiefly of materials using a minimum amount of Alnico V magnets and copper wire.

### Variable Scale

THE GERBER SCIENTIFIC INSTRUMENT CO., 89 Spruce St., Hartford 1, Conn. The variable scale illustrated is a new, unique instrument designed to be used on a multitude



# THE TOWER OF STRENGTH

IDEAL FOR  
COMMUNICATIONS  
MICROWAVE  
TELEVISION  
LIGHTING

Superior construction features give **LOW COST Vee-D-X sectional towers** the highest safety factor of any tower in its price class.

If you have an elevated installation problem, absolute permanency of your installation is assured when you use a **VEE-D-X sectional tower**. Strength is a major factor. Don't take chances with structural failure. Be sure with **VEE-D-X!**

- *Rugged, all-welded construction diagonally laced with angle iron for maximum rigidity.*
- *Can be erected on ground or on flat or peaked roof.*
- *Patented plate spaced at two foot intervals prevents twisting and affords rigidity found in no other tower.*
- *Safe and easy to climb.*
- *Completely galvanized, light weight tubular steel . . . 20 ft. section 72 lbs.*

## PRE-ASSEMBLED for fast, inexpensive installation

VEE-D-X towers are designed for use at any height from 10 to 140 feet. They are self-supporting up to 20 feet and, where space is limited, *semi-guyed\** type installations may be used at 30, 40, and 50 foot heights. Sketch at right shows the basic parts and necessary accessories for a complete installation. Three types of top mount are available. VEE-D-X towers may be ordered in separate units or as a complete package for a specific height. (Either guyed or semi-guyed.) Write the LaPointe-Plascomold Corporation of Windsor Locks, Conn. for complete information.

\*Semi-guyed towers employ one set of guy cables attached at a height of 10 ft. up the tower and anchored at a 6 ft. radius from the base.

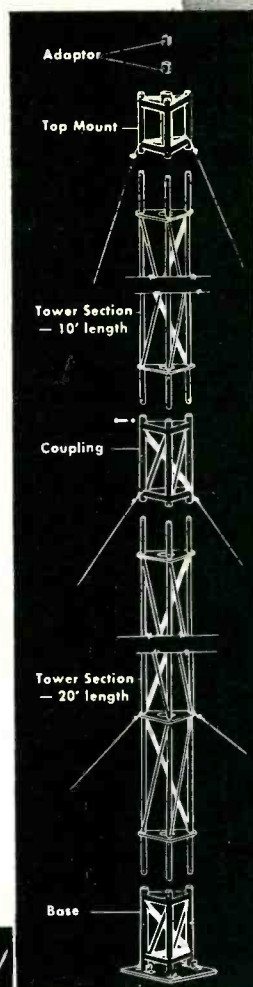

# VEE-D-X

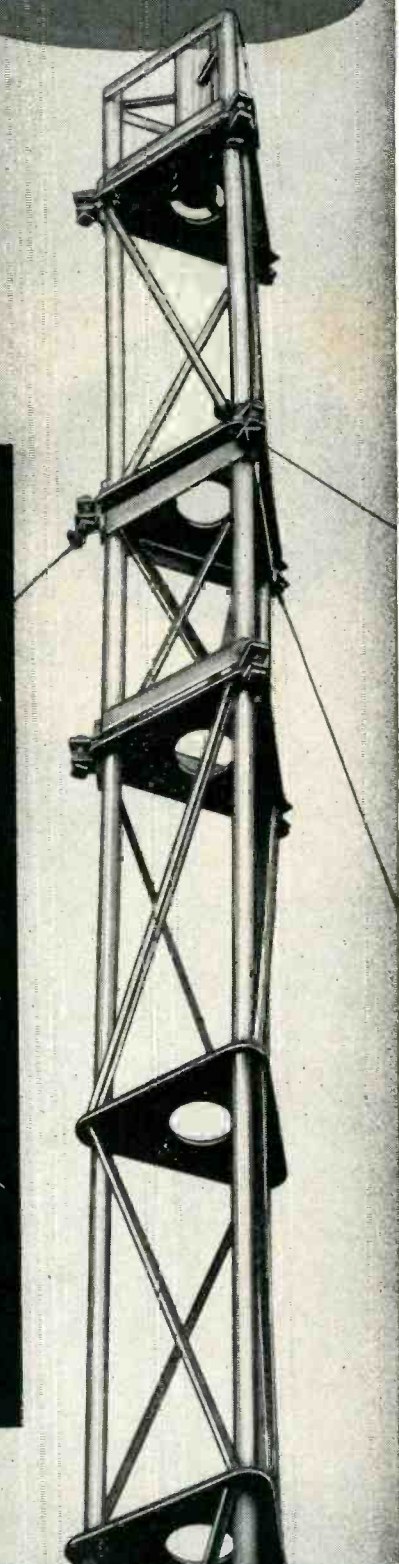
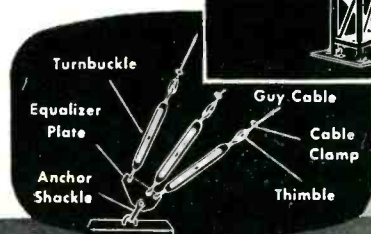

**BUILDERS OF THE WORLD'S MOST POWERFUL ANTENNAS**

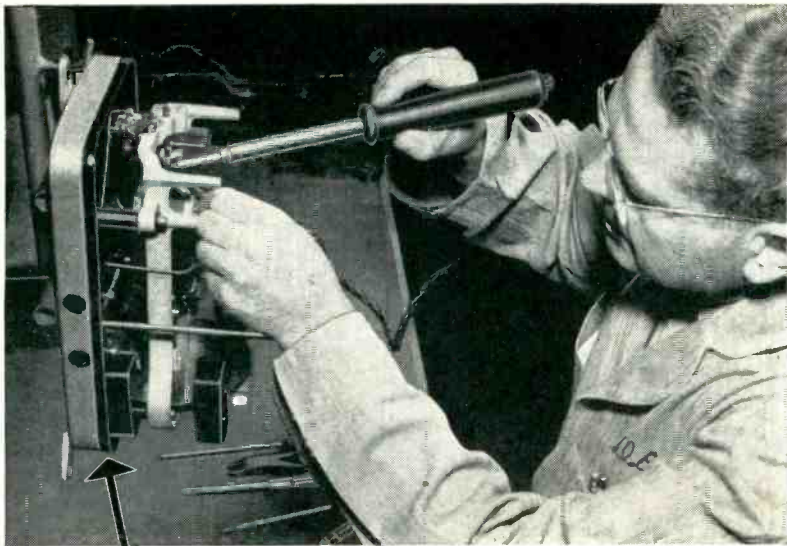

from  
**INSTRUMENTS**  
to  
**ARMATURES**

# American Beauty

**SOLDERING IRONS**  
for **PRODUCTION JOBS**  
**LARGE or SMALL!**

For descriptive catalog pages write Dept. S-2



**DEPENDABLE • DURABLE • EFFICIENT • SINCE 1894**

**AMERICAN ELECTRICAL HEATER CO.**  
DETROIT 2, MICH.

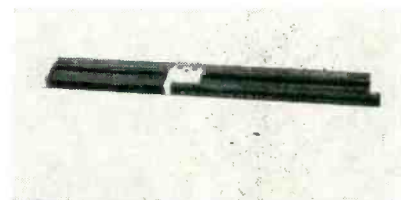

of technical and nontechnical problems involving spacing, scaling, plotting and the like. The heart of the device is an extremely accurate calibrated triangular spring fastened at one end to the aluminum base and at the other end to a slide by means of brass end connections, screws and nuts. The slide is held in position by means of an adjustable pressure friction plug and always remains centered because of a dovetail fit between slide and base. An adjustable indicator fastened to the slide correlates the reciprocal and linear scales to the spring.

## Half-Octave Filter

GERTSCH PRODUCTS, 11846 Mississippi Ave., Los Angeles 25, Calif. The BP-1 half-octave filter has been designed to meet a requirement where extreme attenuation outside the pass band and sharp cutoff are

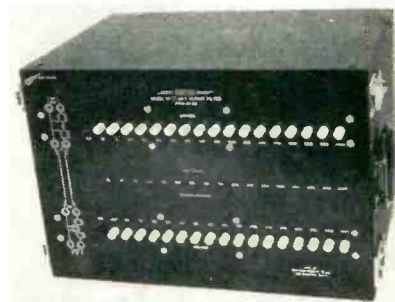

required. Frequency range is from 37.5 to 13,600 cycles in half-octave steps; attenuation rate, 80 db per half-octave. Input and output are 600 ohms with one side common. Maximum input is +10 db referred to 1 mw.

## Connecting Lead

ASSOCIATED ENGINEERING CORP. OF BOSTON, 38 Euston Road, Brighton 35, Mass., has introduced the Addaplug connecting lead. Completely molded with vinyl plastic,



# TV and RADIO MANUFACTURERS ARE MAKING BIG SAVINGS

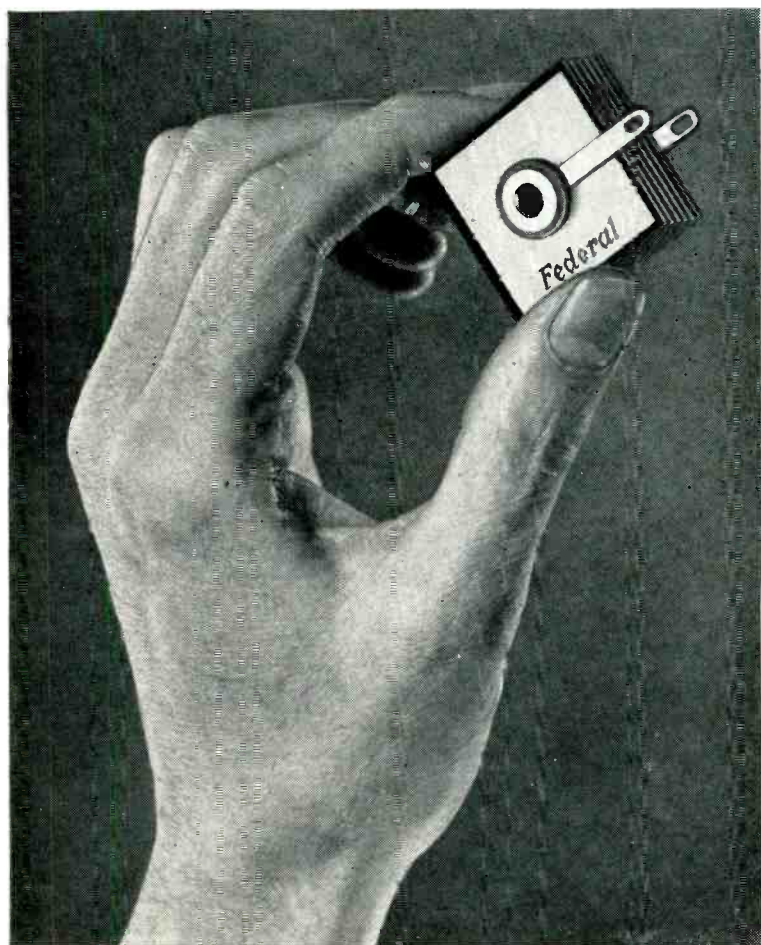

- ➔ **In COMPONENTS**
- ➔ **In MATERIALS**
- ➔ **In SPACE**
- ➔ **In WEIGHT**
- ➔ **In LABOR**

## with *Federal* **SELENIUM RECTIFIERS**

**Y**OU'VE got to hand it to Federal Selenium Rectifiers for the *vital* job they are doing for America's leading television and radio receiver manufacturers!

Power transformers, rectifier tubes and filter chokes are being *eliminated* . . . heavy percentages of copper and steel are being conserved . . . receivers are more compact and efficient . . . space and weight are saved in production, shipping and warehousing . . . assembly time is saved . . . costs are cut up and down the line and production facilities are kept on the move.

Product-design engineers with power conversion problems that can be solved with Selenium Rectifiers are urged to get in touch with Federal—the *originator* of the Miniature Selenium Rectifier. Federal—and only Federal—has the most complete information available today on this outstandingly versatile unit. Send your requirements to Dept. F-413 for a quick reply!

### **Federal "PREFERRED TYPES" Handle 90% of Today's TV-Radio Replacements:**

**FTR 1004** Used for Replacing 50-100 MA, 130 Volts

**FTR 1010** Used for Replacing 150-250 MA, 130 Volts

**FTR 1023** Used for Replacing 300-350 MA, 130 Volts

**FTR 1021** Used for Replacing 450 MA, 130 Volts

America's Oldest and Largest Manufacturer of Selenium Rectifiers



## *Federal Telephone and Radio Corporation*



SELENIUM-INTELIN DIVISION, 100 Kingsland Road, Clifton, N. J.  
In Canada: Federal Electric Manufacturing Company, Ltd., Montreal, P. Q.  
Export Distributors: International Standard Electric Corp., 67 Broad St., N. Y.

# Hermetically Sealed

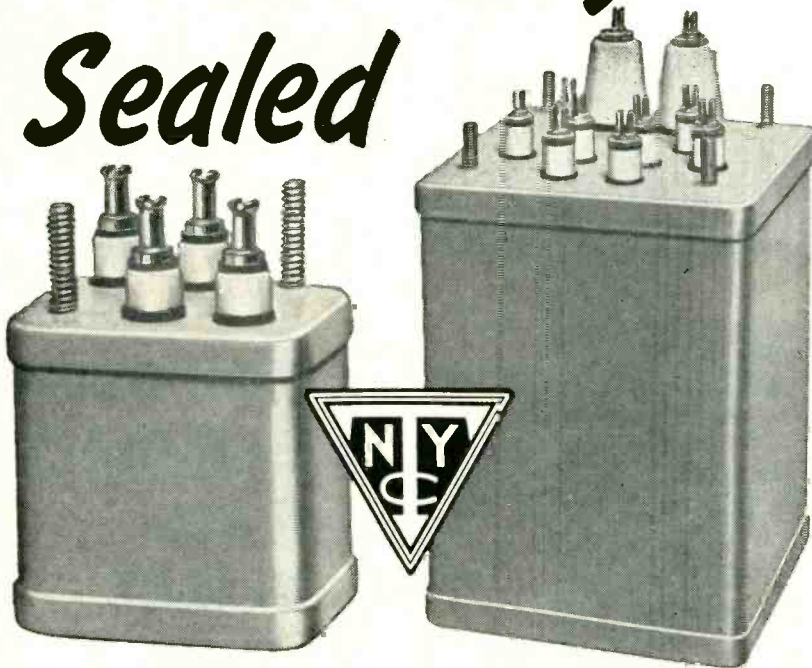

Power—Audio—Plate

## TRANSFORMERS

FULL RANGE  
of  
STANDARD

**MIL-T-27**  
CASES

**Prompt  
Delivery**

of  
Pre-production samples  
to your specifications

**NEW YORK  
TRANSFORMER CO., INC.**  
ALPHA, NEW JERSEY

NEW PRODUCTS

(continued)

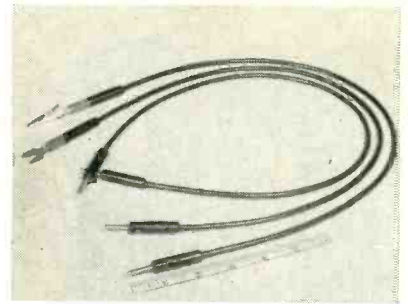

the lead consists of an insulated low-resistance wire, terminated by Addaplug connectors that feature a durable plug with a spring-loaded knife edge for firm low-resistance connections. The Addaplugs, which have plug holes in each for multiple connections fit into alligator clips, spade lugs and terminals of standard equipment. The lead will withstand 5,000 volts and has a current capacity of 15 amperes. Leads are available in various lengths and in red or black.

### Flying-Spot C-R Tube

RADIO CORP. OF AMERICA, Harrison, N. J., has announced the 5ZP16, a 5-in. c-r tube for use as the flying-spot scanner in a video-signal generator. Resolution capability is better than 1,000 lines at the center of the reproduced picture. Featured is a metal-backed phosphor that has not only extremely short persistence to provide a good signal-to-noise ratio but also a stable decay characteristic for which equalization can be easily supplied. Other features include a high-resolution of the electrostatic-focus type and a 40-deg deflection angle to mini-





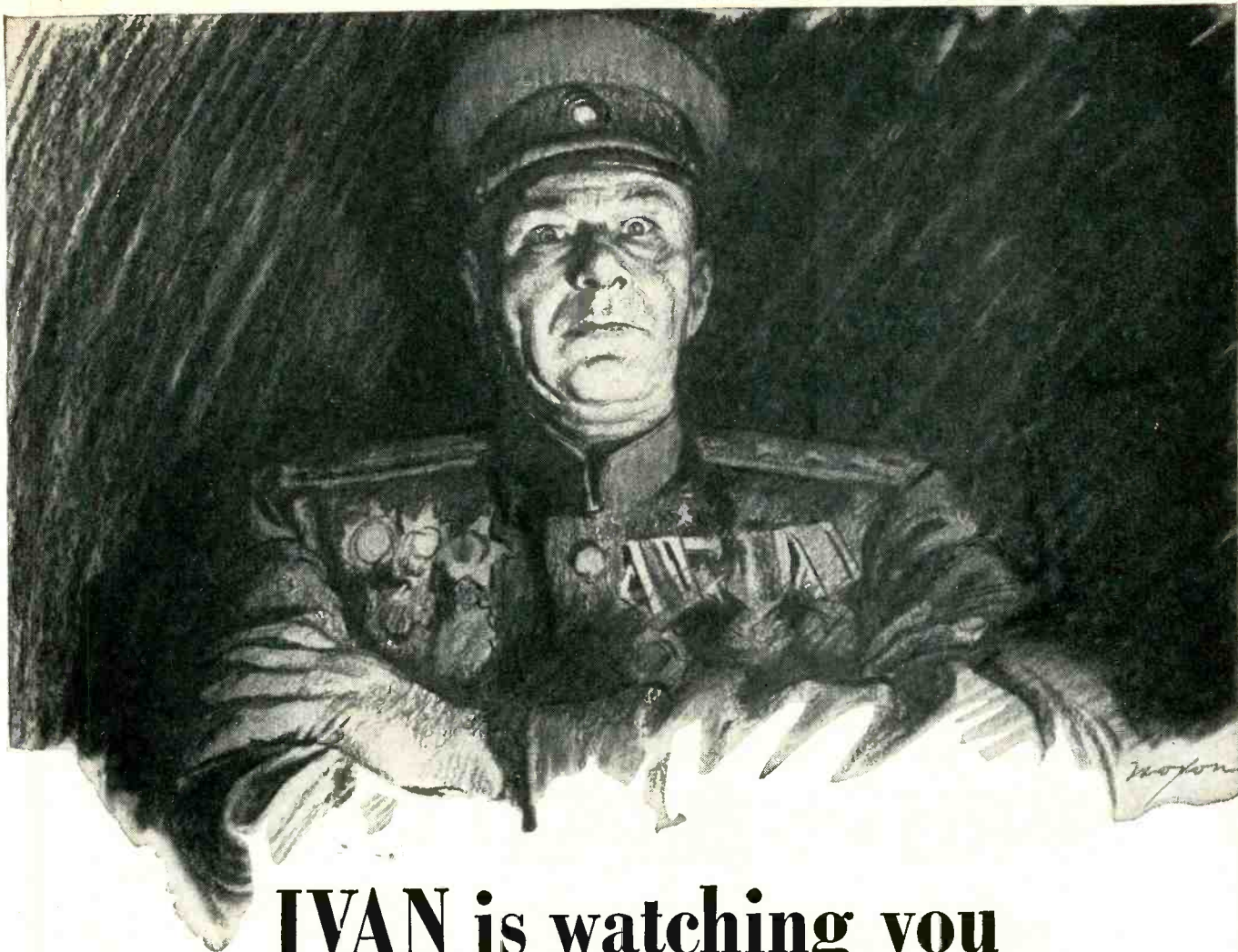

# IVAN is watching you

**I**VAN is a dyed-in-the-wool Communist. There are only 6 million party members like him in all Russia, yet these Communist brass-hats enforce the iron dictatorship of the Kremlin over 200 million Russians.

He's sold to the hilt on Red ideas. Which means he's out to get you. He believes it's either you or him . . . that the world is too small for both.

Ivan is working hard to beat you down. He has a big head start.

Right now he's got you in a bad spot.

Ivan is afraid of only one thing.

He fears your ability to out-produce him in guns, tanks, planes.

Frankly, he doesn't think you value your free system enough to do it . . . to make willingly the sacrifices he has squeezed out of the Russians.

But he's wrong!

Because you and all of us have set out

to build more and better weapons—to do it faster all the time.

We must use every bit of know-how and inventive skill we have to improve our machines and methods—to turn out more and more for every hour we work. Only in this way can we become militarily strong.

But we've got to supply essential civilian

needs as well. We can't allow needless shortages to take prices skyrocketing and lower the value of our dollar.

Sure, that means sacrifices for everybody. But doing this double job well is the only sure way to stop Ivan in his tracks—and to save the freedoms which are ours and which he has never known.

**FREE . . . this important booklet tells you how our American System Grew Great**



How Americans developed better machines, power and skills to build a great nation . . . Why we have been able to produce constantly more per hour . . . How this has given us the world's highest living standard.

*How we can meet today's challenge*—Why we must expand our productive capacity . . . supply arms and essential civilian needs, too. Read how this dynamic process works in free booklet, "The Miracle of America," endorsed by representatives of management and labor. Send for your free copy today!

**MAIL THE COUPON—**  
The Advertising Council, Inc., 25 West 45th St., Dept. B. P., New York 19, N. Y.

Name \_\_\_\_\_  
Address \_\_\_\_\_  
Occupation \_\_\_\_\_

*This advertisement, approved by representatives of management, labor and the public, is published in the national interest*

**McGRAW-HILL PUBLISHING COMPANY**



**THE BETTER WE PRODUCE  
THE STRONGER WE GROW**



This photograph shows a Jennings Type UXC Variable, High Voltage Vacuum Capacitor which makes possible for the first time, in large transmitters, continuous motor tuning from 4 to 26 megacycles in a Collins 50 KW transmitter.

**Jennings**  
-RADIO-  
VACUUM ELECTRONIC COMPONENTS

#### Another Capacitor Problem Solved—

**T**he Jennings Variable Capacitors with wide ranges of capacity change make possible continuous tuning of this 50 KW transmitter, giving high efficiency operation on any frequency from four to twenty-six megacycles without switching. These 205E-1 transmitters were designed by Collins Radio Company of Cedar Rapids, Iowa.

All power amplifier tank and output circuits in these transmitters use Jennings all-copper vacuum variable capacitors, especially the type UXC, as shown, which has a capacity change of 20 to 1 (25 to 500 mmfd.). Other vacuum fixed and vacuum variable units are used throughout the transmitter. Such flexible capacitors make possible circuit tuning over bands much wider than heretofore considered practical. These Jennings vacuum units give trouble-free service throughout the life of the transmitter and are unaffected by elevation, dirt, temperature and humidity. They are small physically for effective high frequency operation.

May we help you solve your Capacitor problems?

JENNINGS  
TYPE UXC  
VARIABLE  
HIGH  
VOLTAGE  
CAPACITOR

JENNINGS RADIO MANUFACTURING CO. • 970 McLAUGHLIN AVE. • P. O. BOX 1278 • SAN JOSE 12, CAL.

mize deflection defocusing and provide high corner resolution.

### Volt-Ohm-Mil-Ammeter

THE TRIPLETT ELECTRICAL INSTRUMENT CO., Bluffton, Ohio. Model 666RL is a new handy size, compact volt-ohm-mil-ammeter that answers a need for portability and quick-testing usage. Its a-c/d-c voltage ranges from 0 to 5,000, at 1,000 ohms per volt; direct current to 10 amperes. Resistance is 0 to 3,000 to 300,000 ohms, 3 megohms. Only

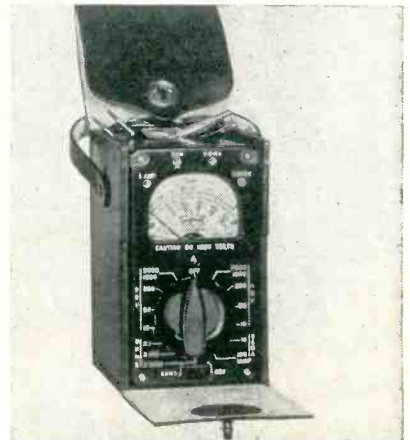

one selector switch retains contact alignment permanently. Direct connections, with no cabling, eliminate chance for shorts. The unit features a precalibrated rectifier.

### Tape Recording Head

SHURE BROTHERS, INC., 225 W. Huron St., Chicago 10, Ill. The tape recording head illustrated provides record and playback in one compact unit. Model TR6 series is designed for use in equipment where a separate a-c erase or a d-c erase may be involved. The structure insures production control of gap dimensions and alignment. Another feature is the fact that it em-





## THEORY and APPLICATION OF INDUSTRIAL ELECTRONICS

*Just Published!*

1. Thoroughly treats the entire field of industrial electronics. Breaks the field down to its basic principles, showing many practical applications of electronic circuits and devices outside the field of communications. Covers electronic instrumentation of both electrical and non-electrical quantities, electronic control, and electronic power including induction heating and dielectric heating. By John M. Cage, Prof. of Elec. Engin., Purdue U.; with the assistance of C. F. Bashe, Research Eng'r. I.B.M. Corp. 290 pages, 248 illus., \$4.75



## THEORY AND DESIGN OF TELEVISION RECEIVERS

*Just Published!*

2. Gives physical explanations and mathematical theory for the behavior of various television circuits from the engineering viewpoint, as well as discussing their practical design. Covers standards governing television transmission, the theory of circuits and systems, and various receiver servicing techniques. Presents numerous tables, graphs, and schematic drawings that save time and effort. By Sid Deutsch, Polytechnic Research and Development Co., New York. 536 pages, 386 illus., \$6.50

## HIGH FREQUENCY MEASUREMENTS

*Just Published!*

3. Here is up-to-date reference material for experiments being carried on in radio as well as electronics. Discusses many procedures for measuring practical units such as amps, watts, volts, m<sup>2</sup>, etc. to enable you to decide which procedure to use for a specific problem. Describes measurements for short-waves, lines and antennas, and for a-m, p-m, and f-m. By August Hund, Scientific and Tech. Radio Consultant. 676 pages, 417 illus., \$10.00

## RADIO ENGINEERING HANDBOOK



4. Provides quick answers to routine and special assignments in communications, broadcasting, aircraft radio, television, and related fields. Reflecting modern developments in the field, this handbook gives a complete coverage of every aspect of radio engineering—from inductance, power-supply systems, and electron tubes . . . to receiving systems, and code reception—all arranged in concise, quick-reference form. By Keith Henney, Editor-in-Chief. 4th Ed. 1197 pages, 1038 illus., \$10.00

See them 10 days free

McGRAW-HILL BOOK CO.,  
330 W. 42nd St., N. Y. C. 18, N. Y.

Send me book(s) corresponding to numbers encircled below for 10 days' examination on approval. In 10 days I will remit for book(s) I keep, plus few cents for delivery, and return unwanted book(s) postpaid. (We pay for delivery if you remit with this coupon; same return privilege.)

1      2      3      4  
(Print)  
Name.....  
Address.....  
City.....Zone.....State.....  
Company.....  
Position.....L-6-51  
This offer applies to U. S. only

## WINCHESTER ELECTRONICS, INCORPORATED

# WHEN SIZE AND WEIGHT ARE LIMITED

WE SUGGEST

## Miniature Rectangular (MRE) or Sub-Miniature Rectangular (SMRE) CIRCUIT CONNECTORS

*They embody the usual high quality features that distinguish WINCHESTER ELECTRONICS connectors:*

- 1 MONOBLOC\* construction to reduce length of creepage paths and to eliminate dust and moisture pockets.
- 2 MOLDED MELAMINE body parts for high dielectric and mechanical strength.
- 3 PRECISION MACHINED contacts, gold plated over silver for consistent electrical conductivity, prevention of corrosion and ease in soldering.

\*Trade Mark

See our advertisement in **ELECTRONICS BUYERS' GUIDE**

Receptacle  
SMRE14S



Plug  
SMRE14P



Actual Size

The SMRE14 (14 contact) connector above follows the general design of the miniature rectangular (MRE) series but has been reduced to almost one-half size to meet recent requests for a smaller multi-contact connector for aircraft electronic applications.

Please write or telephone for additional information on our SMRE or other types of connectors.

# Winchester Electronics

INCORPORATED  
GLENBROOK, CONNECTICUT, U.S.A.

# Cut Your Costs, Too, With POWRARM WORK POSITIONERS

HERE'S HOW  
OTHERS DO IT

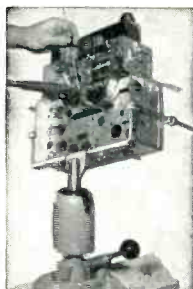

POWRARM cuts costs by increasing every worker's productivity. It gives the worker a powerful *third hand* to hold work while two hands produce. That's why POWRARM works on the most efficient assembly lines in America today, and *belongs on yours*. Write us about your production "head-ache" . . . we'll show you how POWRARM can cure it.

Write For Catalog 101E  
32 informative pages, FREE



Holds work at any angle in Horizontal, Vertical or Co-axial Plane,

Three sizes of Powrarm—24 to 150 lbs. capacity.



# WILTON TOOL MFG. CO.

Precision Built Bench Vises, "C" Clamps and Work Positioners

925-T Wrightwood Avenue • Chicago 14, Illinois

# KINGS

## Microwave Equipment

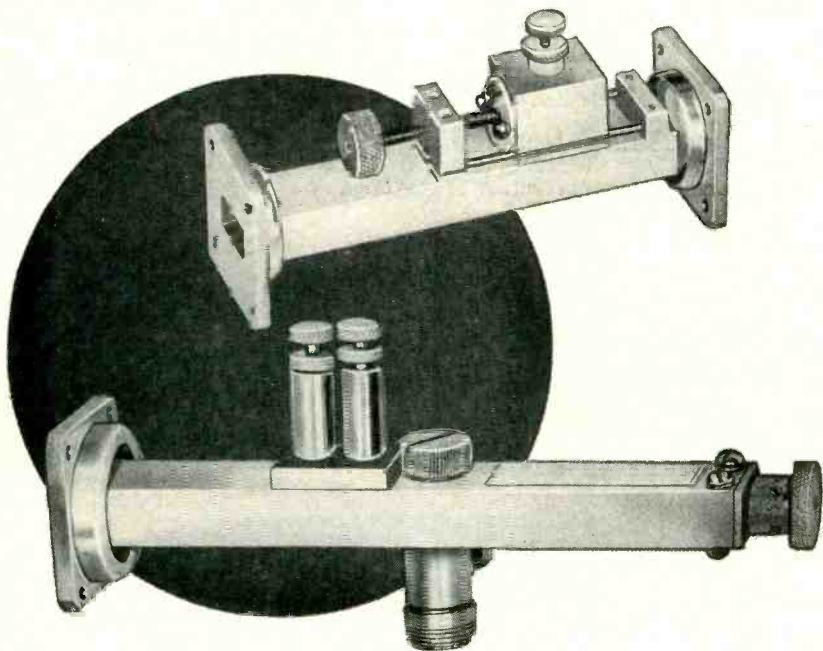

**KINGS** proudly intraduces a new and complete line of microwave equipment. Many improvements in design and construction are your assurance of the finest in precision instrumentation. Our engineering department is ready to cooperate on your most exacting microwave and research problems. Inquiries are invited.

**KINGS MICROWAVE CO., INC.**

**50 Marbledale Road, Tuckahoe 7, N. Y.**  
an affiliate of Kings Electronics Company, Inc.

NEW PRODUCTS

(continued)

plows an effective deep-drawn, mu-metal shield for optimum hum reduction. Record and playback coil impedance is 1,650 ohms at 1,000 cps; output level, 1 mv at 1,000 cps; and bias frequency, 25 kc.

### Coaxial Line

PRODUCT DEVELOPMENT CO., INC., Arlington, N. J. Series 800 reflectionless r-f air-dielectric coaxial lines are now available in standard twenty-ft. assemblies in sizes up to 3½-in. diameter with a unique Air-

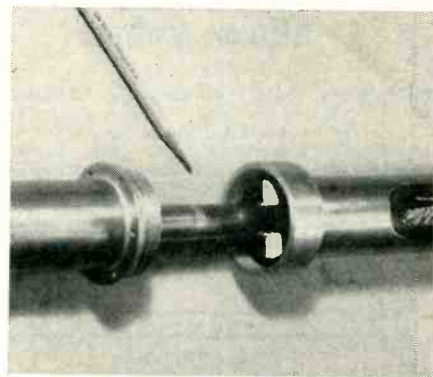

tite coupling designed for use in broadband transmission service. A new Prodelin compensated insulator structure supports the center conductor without projecting through the surface of the outer conductor. The line has been serving in commercial and military systems handling higher powers and providing lower vswr values in applications up to 3,500 mc for tv, telephone, navigation, radar and other critical transmission systems.

### Miniature Motors

SERVO-TEK PRODUCTS Co., Paterson, N. J., has begun production of a line of miniature permanent magnet field type d-c motors, measuring 1½ in. in diameter by 1½ in. long and weighing approximately 2½ ounces. Motor voltage ratings from 6 to 28 volts are available for varied service applications ranging from fan or blower uses to telemetering sequence switch drives. A cylindrical, or ring type, Alnico V field magnet is used in conjunction with a 14 commutator segment armature. Long brush life and excellent commutation characteristics are





achieved. All units employ precision ball bearings and are available with high-altitude brushes for aircraft and allied services.

**Wide-Range Bridge Oscillator**

GENERAL RADIO Co., 275 Massachusetts Ave., Cambridge 39, Mass. Type 1330-A bridge oscillator is a compact, stable, variable-frequency source of moderate power output. Three audio frequencies (power line, 400 and 1,000 cycles) and a wide continuous range of r-f from 5 kc to 50 mc, either modulated or unmodulated, are provided. Out-

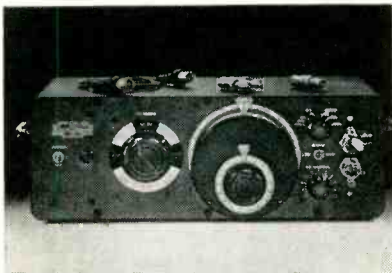

put voltage is of the order of 10 v, and more than one watt can be delivered into a 50-ohm load over most of the frequency range. Two levels of internal modulation at either 400 or 1,000 cycles are available over the range from 15 kc to 50 mc.

**Electronic Relay**

FARMER ELECTRIC Co., 21 Mossfield Rd., Waban 68, Mass. Positive operation on pulses as low as 0.5 millisecond, even with a total resistance as high as 500,000 ohms in the initiating circuit, is provided by the type CK electronic relay. The control relay operates approximately 10 milliseconds after contact, and normally remains energized for a time, adjustable by

**KINGS**  
COAXIAL CONNECTORS

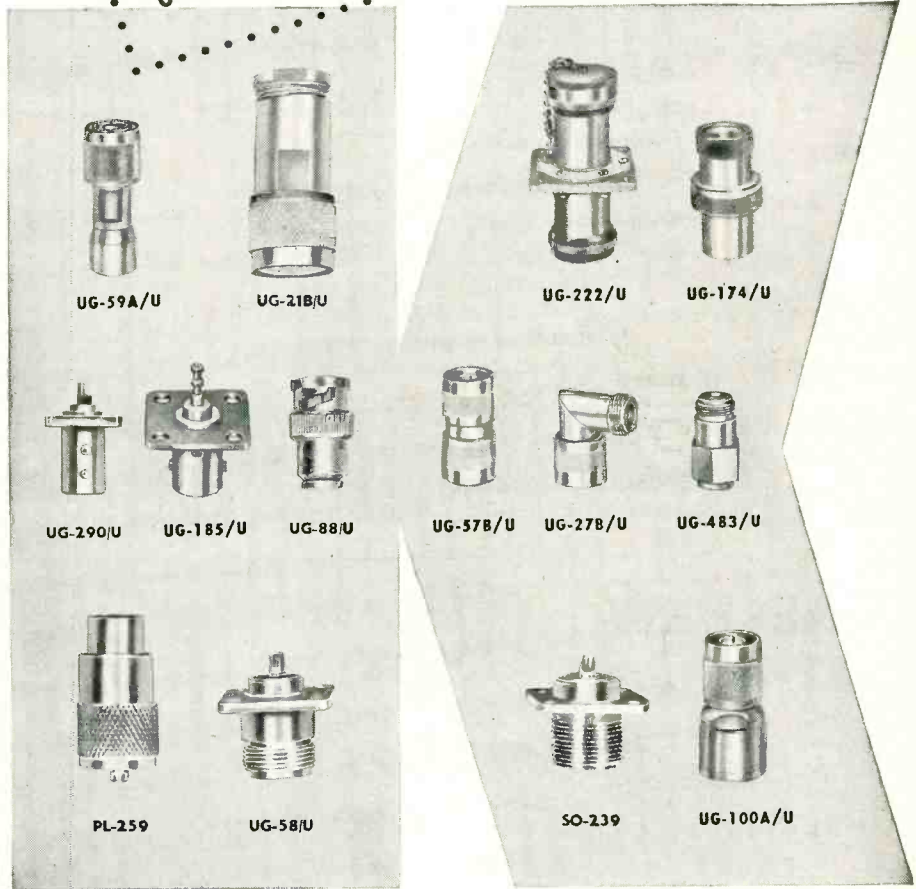

preferred by engineers everywhere

From coast-to-coast, engineers in all fields look to Kings Electronics for the finest coaxial connectors.

Special problems in design and fabrication receive the wholehearted cooperation of Kings own engineering department.

For precision-made, pressurized R. F. Connectors call on Kings — the leader. Quotations on request.



40 MARBLEDALE ROAD, TUCKAHOE 7, N. Y.

In Canada: Atlas Radio Corp., Toronto

## SURE SOURCE FOR SPECIAL LAMINATION SHAPES

Special shapes are often the *only* way to meet rigid specifications . . . the *only* way to reduce *weight*, to save *space*.

Whether your problem is a transformer, a rotating device, a choke or a saturable reactor, check with Thomas & Skinner. With their quarter century of experience, they can offer you a solution that will incorporate all the latest advances in technology and design.

For peak performance to rigid specifications, make Thomas & Skinner your *sure source for special laminations*.

**THOMAS & SKINNER**  
Specialists in magnetics—permanent magnets and laminated cores.



**THOMAS & SKINNER**  
STEEL PRODUCTS COMPANY

1122 East 23rd Street • Indianapolis, Indiana

## THE NEW 6T-4



PRECISION STROBOSCOPIC  
FREQUENCY METER

MEASURES FREQUENCIES  
**INSTANTLY**  
BY PURELY VISUAL MEANS!



## ACCURATE TO 0.05%



**FILL IN AND MAIL TODAY  
for FREE Literature**

C. G. CONN Ltd.  
Electronics Division, Elkhart, Ind.  
Department 612

Send me descriptive literature on  
NEW 6T-4 STROBOCONN.

Name \_\_\_\_\_

Street \_\_\_\_\_

City \_\_\_\_\_ State \_\_\_\_\_

Measures transient vibrations. Finds precise speed of rotating mechanical parts. Calibrates or checks precision tachometers, oscillators, other pulse generators. Used in place of bridge methods in measuring inductance and capacitance. Many other uses.

**MAIL COUPON FOR COMPLETE  
INFORMATION . . . SEE HOW  
STROBOCONN CAN HELP YOU!**

## PHYSICISTS

And

## SENIOR RESEARCH ENGINEERS

• • •

## POSITIONS NOW OPEN

• • •

Senior Engineers and Physicists having outstanding academic background and experience in the fields of:

- Microwave Techniques
- Moving Target Indication
- Servomechanisms
- Applied Physics
- Gyroscopic Equipment
- Optical Equipment
- Computers
- Pulse Techniques
- Radar
- Fire Control
- Circuit Analysis
- Autopilot Design
- Applied Mathematics
- Electronic Subminiaturization
- Instrument Design
- Automatic Production Equipment
- Test Equipment
- Electronic Design
- Flight Test Instrumentation

are offered excellent working conditions and opportunities for advancement in our Aerophysics Laboratory. Salaries are commensurate with ability, experience and background. Send information as to age, education, experience and work preference to:

**NORTH AMERICAN AVIATION, INC.**

*Aerophysics Laboratory*

Box No. K-4, 12214 S. Lakewood Blvd.

DOWNEY, CALIFORNIA



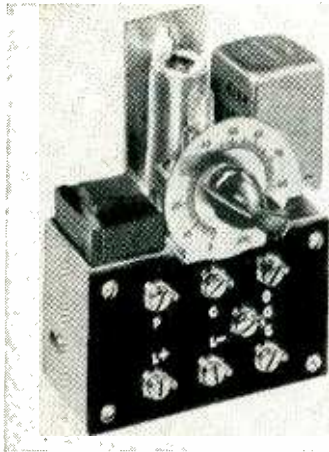

means of a delay potentiometer, between 0.25 and 1.5 seconds. The relay is adaptable to use as an on-off timer for life-testing and laboratory applications. The spdt relay contacts are rated at 2 amperes, 115 v a-c, noninductive.

### TV Signal Booster

I.D.E.A., 55 North New Jersey, Indianapolis, Ind. Model DB410 Regency tv signal booster has contra-wound bifilar coils with push-pull triode to give a balanced circuit. Internal impedance matching



an input and output accommodates either 300-ohm parallel-line or 73-ohm coaxial cable. The wide bandwidth assures satisfactory video-audio reception on all twelve channels.

### Literature

Flexible Shafts. Kupfrian Mfg. Co., 218 Prospect Ave., Binghamton, N. Y. Bulletin 5194 describes

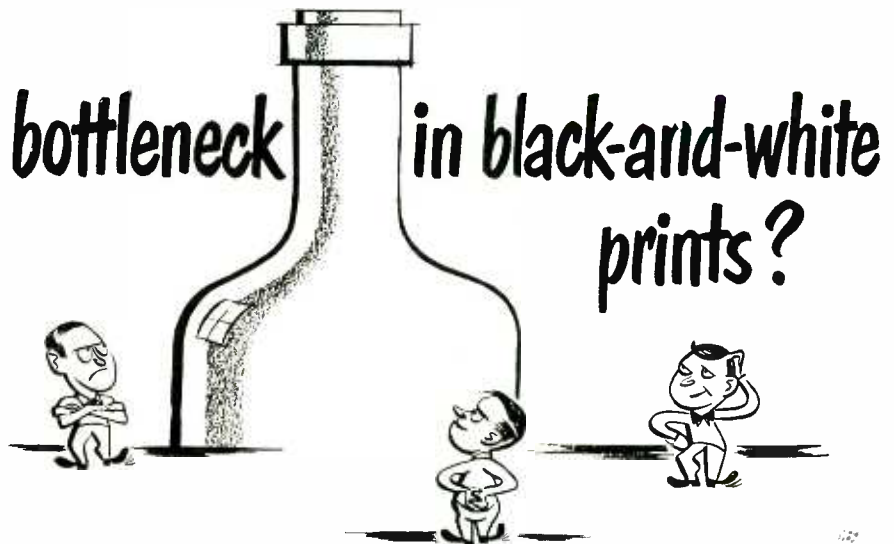

### A modern Bruning BW machine will print up to 105 square feet per minute

The Bruning Model 93 BW machine makes prints up to 46 inches wide at speeds up to 30 feet a minute. Prints are fully developed, regardless of speed. They come out flat, dry, odorless, and ready for immediate use.

With such speed, it is possible to break bottlenecks in black-and-white prints, and still have capacity for other types of work.

- Duplicate tracings can be made on BW sensitized cloth or film—and changes or additions then made as desired with BW Eradicator Fluid and pen or pencil.
- Reports, records, correspondence and other paperwork can be copied in seconds and for pennies.
- Twenty different color combinations are available, and copies can be made on an unrivalled selection of card stocks, acetates, films and cloths as well as on papers of different weights and speeds.

Bruning BW machines do *not* use a vapor developer, hence emit no fumes, need no exhaust vents, no plumbing connections. They do not require a specially trained operator; *anyone* can easily operate a BW machine.

See for yourself what a Bruning BW copying machine will do for you. The coupon will provide you with a demonstration or with an explanatory booklet. No obligation. Send it today.



The Bruning Model 93, the finest black-and-white print machine made.

## BRUNING

Specialists in copying since 1897

CHARLES BRUNING COMPANY, INC.

Dept. Z-61 100 Reade St. New York 13, N. Y.

Please send me your free booklet A-1053A.

I would like to see a Bruning BW machine demonstrated.

Name \_\_\_\_\_ Title \_\_\_\_\_

Company \_\_\_\_\_

Street \_\_\_\_\_

City \_\_\_\_\_ Zone \_\_\_\_\_ State \_\_\_\_\_

# Important SAVINGS

to VOLUME users of small parts

..like these

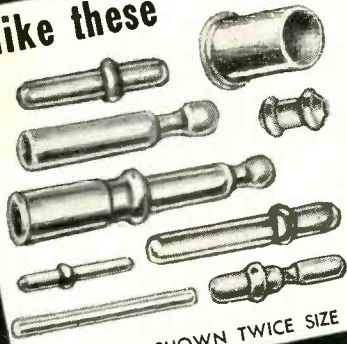

SHOWN TWICE SIZE

thanks to **MULTI-SWAGE**

If you need small tubular metal parts like these in large VOLUME, Bead Chain's MULTI-SWAGE Process can mean important savings to you.

### Much Cheaper Than Solid Pins

Many prominent users of solid pins for electronic and mechanical purposes have cut costs by switching to Multi-Swaged tubular pins . . . without sacrificing strength or accuracy.

### Typical Applications—

As terminals, contacts, bearing pins, stop pins, male-female connections, etc., in a wide variety of products such as Business Machines, Ventilator Louvres, Toys, Radio and Television Apparatus, Terminal-boards, Electric Shavers, Phonograph Pickups, etc.

Send part (up to 1/4" dia. and to 1 1/2" length) and your specs for a quotation or write for DATA BULLETIN.



**THE BEAD CHAIN® MFG. CO.**

88 Mountain Grove St., Bridgeport 5, Conn.

Manufacturers of BEAD CHAIN—the kinkless chain of a thousand uses, for pull and retaining chains and other industrial uses; plumbing, electrical, jewelry, fishing tackle and novelty products.



Patents Regd Trade Mark

### THE LOWEST EVER CAPACITANCE OR ATTENUATION

We are specially organized to handle direct enquiries from overseas and can give

**IMMEDIATE DELIVERIES FOR U.S.A.**

Billed in Dollars Settlement by your check.

Transaction as simple as any local buy.

## TRANSRADIO LTD

CONTRACTORS TO H.M. GOVERNMENT  
138A CROMWELL ROAD·LONDON SW7 ENGLAND  
CABLES: TRANSRAD. LONDON.

LOW ATTEN TYPES	IMPED OHMS	ATTEN db/100ft	LOADING $K_w$ of 100 Mcs.	O.D."
A 1	74	1.7	0.11	0.36
A 2	74	1.3	0.24	0.44
A 34	73	0.6	1.5	0.88
LOW CAPAC TYPES	CAPAC mmf/ft.	IMPED OHMS	ATTEN db/100ft/100Mcs.	O.D."
C 1	7.3	150	2.5	0.36
PC 1	10.2	132	3.1	0.36
C 11	6.3	173	3.2	0.36
C 2	6.3	171	2.15	0.44
C 22	5.5	184	2.8	0.44
C 3	5.4	197	1.9	0.64
C 33	4.8	220	2.4	0.64
C 44	4.1	252	2.1	1.03

HIGH POWER FLEXIBLE

PHOTOCELL CABLE

V.L.C. ★

★ Very Low Capacitance cable.

### Little thought-of facts about capacitors

The short time breakdown voltage of a well-made D.C. capacitor is not less than 5 to 6 times the actual working voltage at 20°—

$$E = 5 \times e \text{ min}$$

E = Breakdown voltage

e = Rated d.c. working voltage

INDUSTRIAL CAPACITORS are unvaryingly held to this formula.

Designed for maximum safety and the smallest possible volume, INDUSTRIAL CAPACITORS are the most widely used capacitor in industrial applications.

WRITE TODAY FOR DETAILED CATALOG

## INDUSTRIAL CONDENSER CORP.



Watch this space for other capacitor facts that will help you.

Sales Offices in All Principal Cities  
3243 N. California Ave.  
Chicago 18, Illinois

An Accredited Technical Institute  
Pioneer in Radio Engineering  
Instruction Since 1927 . . . . .

# CAPITOL RADIO ENGINEERING INSTITUTE

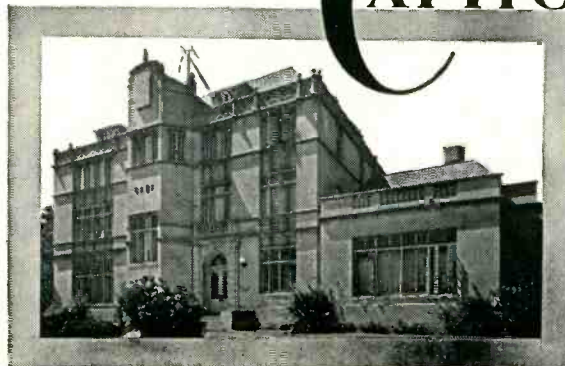

● Advanced Home Study and Residence Courses in Practical Radio-Electronics and Television Engineering.

Residence Courses approved for Veteran Training

● Request your free home study or residence school catalog by writing to Dept. 286C.

16th & Park Road, N.W., Washington 10, D.C.



various typical flexible shafts and their properties, illustrates a number of standard fittings and also describes various casings that may be employed. Applications of the shafts treated are found in electronic and other instruments, servo devices, radio transmitters and receivers and remote controls for aircraft.

**Preformed Contact Finger Stock.** Eitel-McCullough, Inc., San Bruno, Calif., has available a catalog sheet giving an illustrated description of its preformed contact finger stock that is especially suitable for making connections to coaxially constructed tubes and those of external-anode design. The sheet also points out that the strip is an excellent means of providing good circuit continuity through adjustable components or to moving parts such as long-line and cavity-type circuits and also is very useful in acting as an electrical weather-strip around access doors of equipment cabinets.

**Antenna Data.** Technical Appliance Corp., Sherburne, N. Y. Bulletin No. 65 covers the application of the special twin-driven Yagi antenna in overcoming the problem of cochannel interference. Complete technical information as to gain and directivity is given in curves and graphs, while other electrical characteristics are written up in the accompanying copy.

**Selenium Rectifiers.** Seletron Division of Radio Receptor Co., Inc., 251 West 19th St., New York 11, N. Y., has prepared a comprehensive new 16-page catalog on selenium rectifiers. In two colors and fully illustrated, it includes listings of dimensions and ratings for all miniature selenium rectifiers, as well as a large selected group of power stacks. It also contains complete background material on the versatile rectifiers and illustrates many of their uses.

**Wire-Wound Resistors.** Wirt Co. 5221-27 Greene St., Germantown, Philadelphia 44, Pa. Complete information and specifications on an extensive line of standard wire-wound resistors available in fixed,

# Standard RADIO INTERFERENCE and FIELD INTENSITY Measuring Equipment

Complete Frequency Coverage - 14 kc to 1000 mc!



**VLF!**

**NM - 10A**

14kc to 250kc

Commercial Equivalent of AN/URM-6.

Very low frequencies.



**HF!**

**NM - 20A 150kc to 25mc**

Commercial Equivalent of AN/PRM-1. Self-contained batteries. A.C. supply optional. Includes standard broadcast band, radio range, WWV, and communications frequencies.

**VHF!**

**NMA - 5**

15mc to 400mc

Commercial Equivalent of TS-587/U.

Frequency range includes FM and TV Bands.



**UHF!**

375mc to 1000mc **NM - 50A**

Commercial Equivalent of AN/URM-17.

Frequency range includes Citizens Band and UHF color TV Band.



These instruments comply with test equipment requirements of such radio interference specifications as JAN-I-225, ASA C63.2, 16E4(SHIPS), AN-I-24a, AN-I-42, AN-I-27a, AN-I-40 and others.

**STODDART AIRCRAFT RADIO CO.**

6644-A SANTA MONICA BLVD., HOLLYWOOD 38, CALIFORNIA  
Hillside 9294

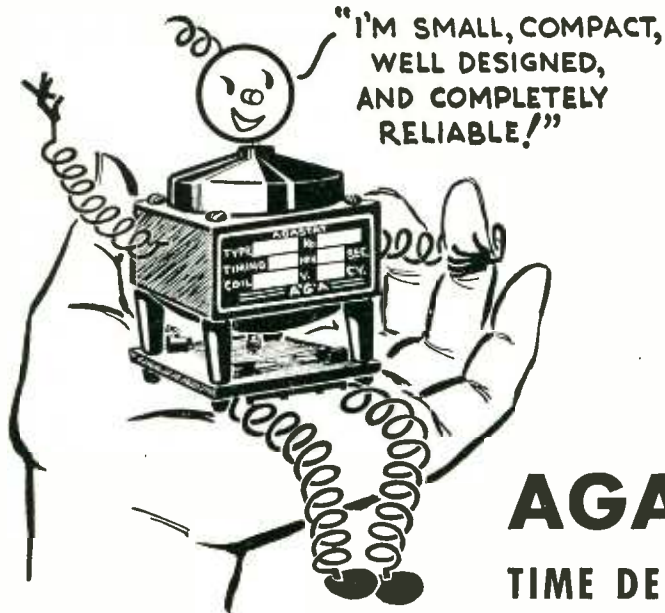

## AGASTAT TIME DELAY RELAY

Solenoid actuated — pneumatically timed. For AC and DC service. A special diaphragm and cap encase the head, providing an enclosed, dustproof timing chamber in which the air used for timing is recirculated. Low cost with dependability.



AMERICAN GAS ACCUMULATOR COMPANY  
1027 NEWARK AVENUE • ELIZABETH 3, N. J.

## PERFORMANCE TESTED TRANSFORMERS DESIGNED FOR YOUR NEEDS

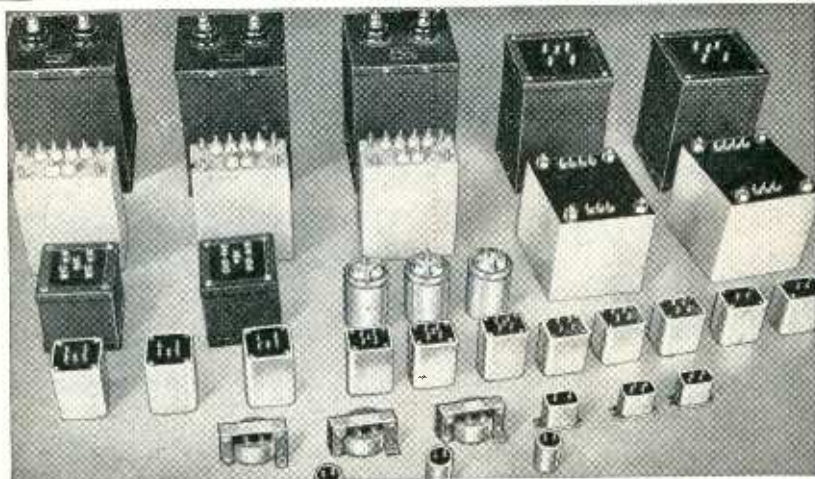

QUALITY PRODUCTS PRODUCED IN QUANTITY  
**ACME ELECTRIC CORPORATION**  
316 WATER STREET CUBA, N. Y.

**Acme**  **Electric**  
TRANSFORMERS

ONLY  
SPECIFIC COILS  
CAN DO  
THIS JOB-



The components of high altitude airborne radar installations must be extremely accurate because a given voltage jumps a longer distance in the stratosphere where the atmospheric pressure is lower. The focus coil, shown below, goes around the neck of the Cathode Ray Tube and focuses the beam. The nature of its use demands that it meet the most exacting electrical and physical specifications.



*Builds Them!*

When you need electrical coils, why not take advantage of 34 years of experience, engineering competence, and modern production facilities. Coto coils are built for you, to your specifications.

**COTO-COIL CO., inc.**   
COIL SPECIALISTS SINCE 1917  
65 PAVILION AVE  
PROVIDENCE 5, R.I.



ferrule and adjustable styles are found in bulletin 176. Arranged for easy reference, a specification table lists catalog number and core dimensions with maximum wattages and resistances for Phenocoted units which are rated for maximum rise of 130 C above ambient temperatures; vitreous enamel and Infernocoted units for a maximum rise of 250 C.

**Civilian Defense Pamphlet.** Tracerlab, Inc., 130 High St., Boston 10, Mass. A new pamphlet entitled "How Safe," contains a discussion of the dangers of the radiation resulting from an atomic explosion and recommendations for instruments to be used for the protection of all personnel. The publication is of interest to all industrial safety directors and state, municipal and local civilian defense officials.

**Booster Data.** Industrial Television, Inc., 359 Lexington Ave., Clifton, N. J., has announced publication of application notes for its Autoboooster and Multiboooster. The notes described detailed methods of increasing gain by means of peaking, impedance matching and cascade operation. Also described are methods of eliminating several kinds of interference.

**Tube Catalog.** Eitel-McCullough, Inc., San Bruno, Calif. A new comprehensive catalog summarizes the basic characteristics of all the vacuum tubes manufactured by the company. In addition to data on vacuum tubes the publication contains pertinent information on other products presently being manufactured.

**TV Transmitting Equipment.** Allen B. DuMont Laboratories, Inc., Television Transmitter Div., 1000 Main Ave., Clifton, N. J. Several new equipment bulletins are available to anyone interested in telecasting operations or plans. They describe in detail the latest products of the division, including operational features, engineering data, illustrations and diagrams of interest to the station manager, engineer and planning personnel. Among the topics covered are: the universal color scanner, master

# NEW Alden Basic Chassis

Alden Products Company announces a new basic chassis design in which circuit elements can be laid out and easily fabricated as unit sub-assemblies . . . . Equipment manufacture proceeds at an efficient high velocity level, and in operation, the accessible plug-in construction simplifies maintenance and service. Bringing the work out into the open is the keynote. Here's how.

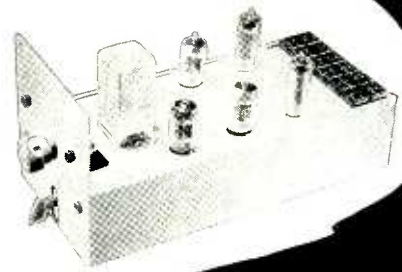

## Components for Plug-in Unit Construction

### WORK OUT INTO THE OPEN

The first step—components and circuit elements are laid out and mounted on Alden Terminal Cards. These cards come with terminal holes pre-punched, allowing the engineer to select optimum component layout. Miniaturized Alden Terminals are staked into the layout. Components snap or push into terminals and are held for soldering without pliers or twisting. The Alden Terminal Mounting System speeds design and simplifies production.

### CABLING IS NEAT UNIT PACKAGE

At the same time unit cabling is made as a sub-assembly—no mess or fuss—connectors and leads are a neat package. Again, because the work is out in the open and is easily accessible, connections are made to the terminal mounting board with speed and facility. Unit cabling allows instant continuity checks, rapid replacement in the field and eliminates many problems of malfunctions and excessive production costs.

### SUB-ASSEMBLIES MADE INDEPENDENTLY

While the component sub-assemblies are being processed, back connectors, sockets, switches, etc., can all be mounted on the basic chassis, ready for joining to the sub-assemblies. The front panel is detachable so it can also proceed as a sub-assembly—Switches, dial lights, meters, etc. can be mounted to facilitate production. Joined to the chassis, the panel is hinged and opens forward for clear inspection and service in the field. The completely pre-wired terminal cards are quickly and easily mounted on the open-sided chassis and wired to the unit cable and Alden color-coded back connectors.

### COMPLETED ASSEMBLY NEAT AND EFFICIENT

The finished assembly is an efficient, plug-in, slide-in unit. Mounted in cabinet or panel rack in horizontal or vertical succession or in an individual unit housing for portable operation, chassis elements are always instantly accessible for check service, or replacement. A simple twist of the handle and the Serve-A-Unit Lock backs the chassis off with fingertip ease. For re-assembly, chassis is slid in and piloted into locked position with the same facility.

### QUICK SERVICE TO YOU

The Alden Basic Chassis Design makes possible a wonderfully simple method of construction so that orders—large or small—can be started and with a minimum of stocking or storing, proceed rapidly to completion. Fabrication parallels the operation of a progressive die. The work proceeds as a flat piece as it is sheared and blanked and moves to plating or painting and assembly with little or no lost effort or waste material.

This manufacture as a straight-line operation gives speed and economy to completing the chassis and allows us to move into volume production fast.

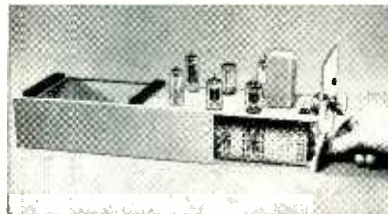
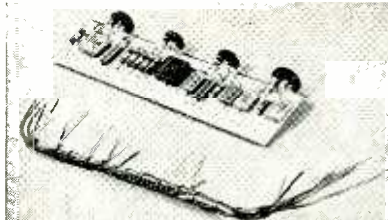
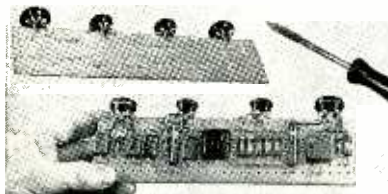

Write Department E for catalogue "Components for Plug-in Unit Construction."



## ALDEN PRODUCTS COMPANY

117 N. MAIN STREET, BROCKTON 64, MASSACHUSETTS





*Sensitive* **Rugged**  
**Dependable**

**HEILAND GALVANOMETERS**  
of high current and voltage sensitivity are the heart of Heiland recorders.  
Heiland galvanometers are available in natural frequencies ranging from 32 cycles per second to 4700 cycles per second. All galvanometers are electromagnetically damped with exception of those having natural frequencies above 450 cycles per second; these are fluid damped. Permanent magnet assemblies are available for mounting 2, 6, and 12 Heiland galvanometers.

dependable instruments  
**Heiland**  
DENVER

For further information on Heiland Galvanometers, Multi-Channel Oscillograph Recorders or Associate equipment, write or wire...

**HEILAND RESEARCH CORPORATION** 130 East 5th Ave. DENVER, COLO.

**THREE DECADES OF RADIO-TELEVISION "KNOW-HOW"**

an **insuline** cabinet or chassis for every need



ICA is the leading manufacturer of metal goods. Our line consists of hundreds of styles and sizes for racks, transmitters, amplifiers, speakers, meters, etc. . . . many with decorative chrome trim.

Prompt delivery of all sizes of standard chassis bases and bottom plates (steel and aluminum) plus all necessary accessories and hardware.

Equipped to produce custom built metal goods for domestic or government requirements—any quantity, style or material.

Write Dept. E-6 for latest catalog.

**insuline** CORPORATION OF AMERICA  
INSULINE BUILDING • 36-02 35th AVENUE • LONG ISLAND CITY, N. Y.  
West Coast Branch and Warehouse: 1335 South Flower Street, Los Angeles, Calif.  
Exclusive Canadian Sales Agents: CANADIAN MARCONI COMPANY, Montreal



**THE MOST VERSATILE LEVER SWITCH**



solves complex switching problems

Patent 241086



This simple mechanism gives positive control of these seven useful lever actions.

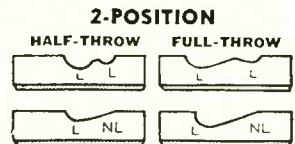

**THESE FEATURES**

- are the key to the exceptional versatility of the Type MCM lever switch.
- Interchangeable stainless-steel camtracks as shown above are shaped to give your choice of seven different lever actions.
- Lever arm can have full throw in non-lock as well as in locking action.
- Detachable mounting block, carrying all contact assemblies, is held to frame with a single bolt; easily dismantled to speed wiring.
- Alternate actuating methods include waterproof handle for marine use, rotary knob actuator, and lever arm for use with switch mounted parallel to panel.
- Single-hole mounting; available with positioning pin if specified.
- Compact design — switch extends only 2 3/4 inches back of panel and weighs but 3 1/2 ounces complete with 12 springs.
- High load rating — contacts will handle 10 amperes at 115 VAC, depending on load characteristics; insulation-tested at 2500 VAC to ground.
- Ask for Catalog Sheet and B/P 351510 giving details of contact arrangements, lever actions, dimensions and prices.



**GENERAL CONTROL COMPANY**

1202 SOLDIERS FIELD ROAD  
BOSTON 34, MASSACHUSETTS



control switch unit and master control mixer amplifier, universal console and linearity bar generator.

**Electronic Student Aids.** Sylvania Electric Products Inc., Emporium, Pa. A profusely illustrated bulletin listing: wall charts; notebook-size lesson folders; technical tube manuals; color code cards; radio symbol charts; tv servicing booklets; tube complement and characteristics bulletins for tv picture, radio receiving, radio transmitting and subminiature electron tubes; and eight precision instruments for school and college electronics laboratories, was recently published.

**Transmitter Accessories and Parts.** Gates Radio Co., Quincy, Ill., has available a new transmitter accessories and parts catalog. The publication covers open wire transmission line equipment, meter switches, relays, sockets, meters, remote metering equipment, coaxial cable, radio frequency inductors, sampling loops, isolation coils and power lighting chokes. Much application information is illustrated and described.

**Positive-Ion Accelerators.** High Voltage Engineering Corp., 7 University Road, Cambridge, 38, Mass. Bulletin H deals with Van de Graaff electrostatic accelerators for positive ions. The 5.5-million-volt unit that makes available a new energy range for precision research is described in addition to the 4-million-volt horizontal apparatus and the compact, 2-million-volt unit. Photographs giving external and internal views of the accelerators, and drawings that show the manner of installing the apparatus are included.

**Precision Stampings.** John Volkert Metal Stampings, Inc., 222-34 96th Ave., Queens Village 8, New York, N. Y., has published a 16-page word and picture tour of a precision stamping plant that serves the electronics, television and radio industries. A typical engineering-tooling-stamping problem of a radio tube manufacturer is described in detail. Another interesting feature of the booklet is the series of photographs of five progressive dies

# SAVE TIME

## cut costs



## PRINT YOUR CIRCUITS WITH DU PONT CONDUCTIVE COATINGS

### HERE ARE SOME TYPICAL USES OF DU PONT CONDUCTIVE COATINGS

#### FOR PRINTED CIRCUITS IN:

Television receivers  
Radar equipment  
Aircraft communication equipment  
Audio frequency amplifiers  
Hearing aids  
Switchboards and panels  
Industrial electronic controls  
Recording equipment  
Radios  
Meters

**ALSO FOR USE IN** high- and low-voltage ceramic and mica capacitors (on TV receivers), static shieldings, resistors, and solder seals (for hermetically sealed coils, transformers, etc.)

Use them in place of conventional wiring and solder connections. These highly conductive, low-resistance coatings are easily and rapidly applied by spray, brush, dip or stencil to metals and non-conductive surfaces.

Look at these advantages:

1. High conductivity (low resistance).
2. Flexible application — composition may be formulated in suitable vehicles for desired methods.
3. Fired-on types unaffected by contaminating atmospheres.
4. Foolproof connections.
5. Easy application with simple, economical equipment.
6. High-speed production.
7. Economy — one troy ounce covers about three sq. ft.

Two types of Du Pont Conductive Coatings are available:

Type "F," fired-on, specifically designed for use on ceramic bases.

Type "A," air-dried, for use on plastic, paper, and wood bases.

For additional information  
call our nearest office of Electrochemicals Department,  
E. I. du Pont de Nemours & Co. (Inc.)

#### DISTRICT OFFICES

Baltimore 2	321 Falls way	PLaza 2862	Kansas City 1*	Guinotte & Mich. Avs.	Victor 6240
Boston 10	140 Federal Street	HAncock 6-1714	Los Angeles	P. O. Box 70,	
Charlotte 2, N. C.	427 W. 4th Street	CHarlotte 5-5561		El Monte, Calif.	CUMberland 3-2761
Chicago 3	7 S. Dearborn Street	ANdover 3-7000	New York 1	350 Fifth Avenue	LONgacre 3-6440
Cincinnati 2	2412 Carew Tower	PARKway 5253	Philadelphia 3	1616 Walnut Street	KINGSley 5-1900
Cleveland 4	1226 National City Bank Bldg.	CHerry 1-6078	Pittsburgh 22	517 Park Bldg.	GRant 1-2960
Detroit 26	966 Penobscot Bldg.	WOODward 2-7360	San Francisco 6	111 Sutter Street	EXbrook 2-6230

\*Barada & Page, Inc.

Clip coupon for  
your free bulletin  
on Du Pont  
Conductive Coatings



BETTER THINGS FOR BETTER LIVING . . . THROUGH CHEMISTRY

E. I. du Pont de Nemours & Co. (Inc.)  
Electrochemicals Dept., Wilmington 98, Del.  
Please send me Conductive Coatings  
Bulletin CP 2-150

Name \_\_\_\_\_  
Address \_\_\_\_\_  
City \_\_\_\_\_ State \_\_\_\_\_

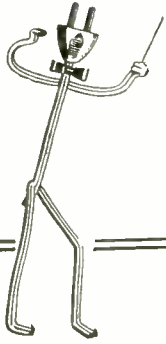

# DEPEND ON ME

(Current's Favorite Conductor!)

## For All Your Electronic Wire Requirements

### APPLICATIONS

72-Ohm cable for use with receiving antennas—high frequency.

100-Ohm cable for use with receiving antenna, link connection, matching transformer. Also for experimental use at high frequency.

150-Ohm cable for use with receiving antenna, matching transformer and high frequency experimental applications.

300-Ohm for use with FM and Television receiving antenna.

300-Ohm heavy-duty cable. Same applications as above and also for low power transmitting antenna.

300-Ohm shielded cable, FM and Television lead adaptable to noisy locations.

3, 4 & f Conductor Antenna rotator control cable.

75-Ohm cable for use with doublet receiving antenna—low frequencies.

Same as above with added shield to reduce noise pick-up.

72-Ohm coaxial cable for television antenna.

52-Ohm cable for pulse and radio frequency transmission, television.

75-Ohm coaxial low loss.

For extension speakers, control circuits and low frequency doublet receiving antenna.



Ask for the new PHALO catalog.

# PHALO

Plastics Corporation

WORCESTER, MASS.

Manufacturers of Thermoplastic insulated wire, cables, cord sets and tubing

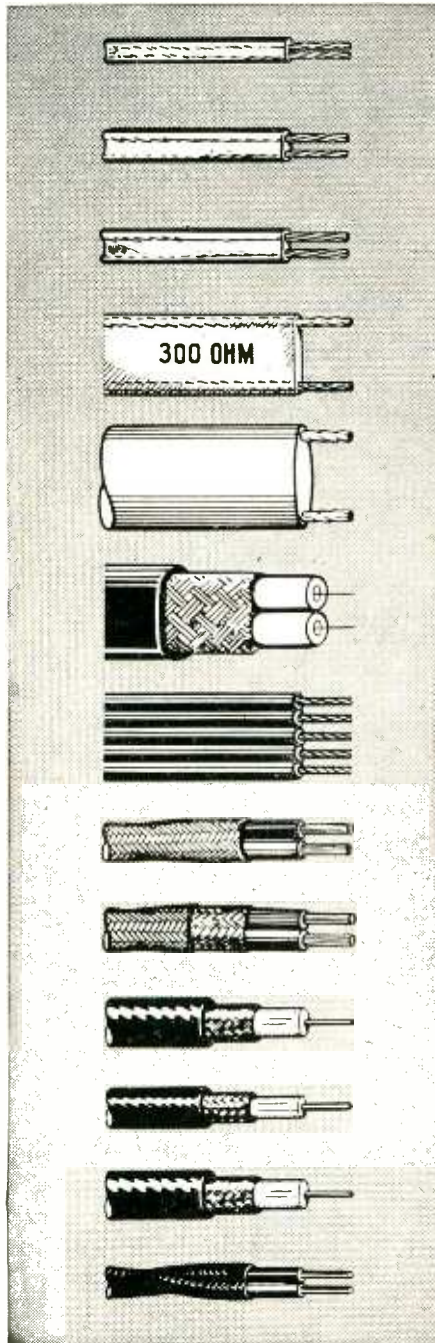

for producing complex stampings in high-production quantities.

**Atomic Energy Development.** The Kellogg Corp., 233 Broadway, New York 7, N. Y. An 18-page booklet, "Engineering New Fields," contains information on the company's staff, facilities and present program. It includes a general story on the status of the U. S. atomic energy development and outlines the company's work for the AEC and the Armed Services.

**Electronic Air Cleaner.** Westinghouse Electric Corp., 200 Readville St., Hyde Park, Boston 36, Mass. Booklet SA-6691 describes in non-technical language the Precipitron air cleaner for factories, stores and offices. The 8-page leaflet explains how it operates, why it cleans air so efficiently, where it can be used to advantage, how it is constructed and the kind of unit to select for a given job of air cleaning.

**Marine Radio Service.** Radiomarine Corp. of America, 75 Varick St., New York 13, N. Y. Details concerning world-wide marine radio and electronic service facilities are described in a 12-page illustrated reference booklet. The booklet shows the various types of systematic service plans available and illustrates the varied assignments covered by the company's technicians. The assignments referred to range from refinishing chassis and repairing broadcast receivers to overhauling shipboard radar sets and surveying damage claims, and include free consultation service on FCC regulatory matters.

**Antenna Bulletin.** Andrew Corp., 363 E. 75th St., Chicago 19, Ill. Bulletin 64 covers a line of bidirectional and cardioid antennas. Radiation patterns, specifications, transmission line requirements and illustrations are included.

**Germanium Diode Applications.** Sylvania Electric Products Inc., Emporium, Pa. A new booklet describes 24 applications of germanium crystal diodes. It contains circuits for an interval timer; polarity checker; polarity reversal



**"CALL A  
MERIT  
DISTRIBUTOR  
FOR STOCK TRANSFORMERS!"**



*Merit has been  
making the best  
for over a quarter  
of a century!*

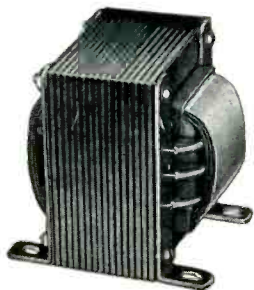

You can rely on dependable fast service from MERIT distributors.

Merit top quality transformers will improve your production, reduce your inventory and step-up your deliveries.

Call your Merit distributor today or write for the new Merit catalog #5111.

**TAPE-MARKED TO HELP YOU!**  
Handy tape marking on every Merit Transformer shows permanent hook-up data for quick reference. ORIGINATED BY MERIT.

**MERIT**  
FINE RADIO PARTS  
**TRANSFORMER CORP.**  
4416 NORTH CLARK ST., CHICAGO 40, ILL.

# Polarad

*Portable*  
**TV WAVE FORM  
MONITOR**

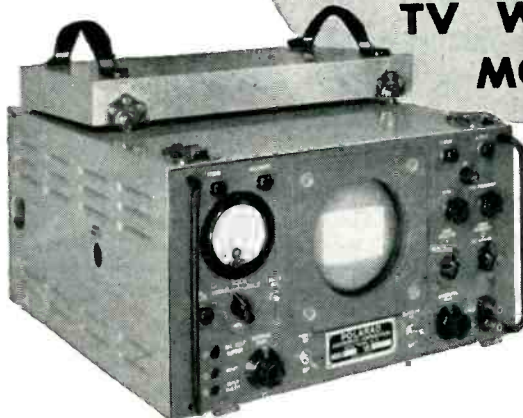

### Features

- Sweep expansion of 25 tube diameters.
- Voltage calibration accuracy to 2%.
- Input signal level 0.25 to 5 volts peak to peak.
- Rack mounting and portable.
- Excellent synchronizing capabilities.

Specifically designed for precision waveform analysis and amplitude measurement of video signals in television circuits. Also ideally suited as a

general purpose instrument in many applications due to its wide frequency response, high sensitivity, and excellent synchronizing capabilities.

Write Dept. E-6 for details.

**Polarad**  
Electronics Corporation

100 Metropolitan Ave.  
Brooklyn 11, N. Y.

Engineers and  
Consultants to  
the Nation's  
Great TV Stations

# AMPERITE

Thermostatic Metal Type

*Delay Relays*

**PROVIDE DELAYS RANGING  
FROM 1 TO 120 SECONDS**



**FEATURES:** — Compensated for ambient temperature changes from  $-40^{\circ}$  to  $110^{\circ}$  F . . . Hermetically sealed; not affected by altitude, moisture or other climate changes . . . Explosion-proof . . . Octal radio base . . . Compact, light, rugged, inexpensive . . . Circuits available: SPST Normally Open; SPST Normally Closed.

PROBLEM? Send for "Special Problem Sheet"

*Regulators*

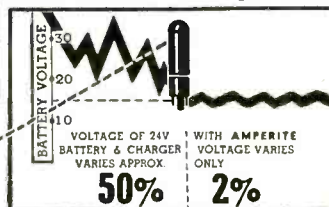

Amperite REGULATORS are the simplest, lightest, cheapest, and most compact method of obtaining current or voltage regulation . . . For currents of .060 to 6 Amps. . . Hermetically sealed; not affected by altitude, ambient temperature, humidity.

Write for 4-page Illustrated Bulletin.

**AMPERITE CO., Inc.**, 561 Broadway, New York 12, N. Y.

In Canada: Atlas Radio Corp., Ltd., 560 King St., W. Toronto

# A Better WAY...

for **LABORATORY OR PRODUCTION LINE!**



## EPUT\* for

- ELECTRONIC TACHOMETRY
- FREQUENCY MEASUREMENTS
- HIGH SPEED COUNTING

**THE BERKELEY EVENTS-PER-UNIT TIME\*** Meter will automatically count and display the number of events that occur during a precise one second interval at rates up to 100,000 per second. Accuracy is  $\pm$  one event. These events may be any mechanical, electrical, or optical occurrences regularly or randomly spaced that can be converted into changing voltages. Thus the EPUT becomes an extremely flexible tool which may be used as a precision electronic tachometer, a secondary frequency standard, a device for rapid determination of unknown frequencies or simply a multi-purpose general laboratory instrument.

**AUTOMATIC:** This unit will count for a precise one second interval, display the

results in direct reading form for a period variable from one to five seconds, and then automatically recycle. On "Manual" operation the instrument will count for one second and display the result indefinitely until the "reset-count" button is again depressed.

**MODIFICATIONS:** Standard modifications available: a selectable 0.1, 1, and 10 second time base; addition of mechanical register for extended range; addition of panel switch to permit use as straight counter; scanning feature to provide a time base in any multiple of 10 seconds. Special modification including accessories such as tachometer pickups and photocell arrangements can be supplied to meet specific requirements.



## TIM\* for

- TIME INTERVAL MEASUREMENTS
- PRECISE LOW-FREQUENCY MEASUREMENTS
- HIGH SPEED COUNTING

**THE BERKELEY TIME INTERVAL METER\***, Model 510, provides a direct reading of elapsed time between any two events in the range of 0.000010 to 1.0000 seconds. Accuracy of measurement is  $\pm$  10 u/secs. Any occurrences that can be translated into changing voltages may be timed. Timing may be started and stopped by independent voltages. The polarity of these control voltages may be selected by means of toggle switches so that the unit may be started and stopped by either positive or negative pulses. A sensitivity control permits selection of the amplitude of the start or stop voltages at optimum level for elimination of interference.

**DIRECT READING:** The only truly direct reading equipment of its kind, presenting results in decimal form on an illuminated panel. No interpolation, no lights to add. A convenience in the laboratory; a necessity in production.

**OPERATION:** By use of photocell attachments the interval between two separate light flashes may be timed. Similarly by use of an added photochannel and a single photocell duration of a light period or a dark period may be determined.

**MODIFICATIONS:** Standard modifications available: addition of a photocell channel; the addition of a mechanical register to extend range to 10 seconds; threshold control to permit selection of precise amplitude of input pulse so unit may be made to operate at any desired position on sine wave; panel switch to permit use as straight counter.

**COMPACT:** The Models 554 and 510 are standard 19" single rack units mounted in Berkeley cabinets 20 $\frac{3}{4}$ " wide x 10 $\frac{1}{2}$ " high x 15" deep. Weight per unit, approximately 60 pounds.

For complete information, write for Data Sheets IRE-510 and IRE-554

# Berkeley Scientific Corporation

2200 WRIGHT AVE. • RICHMOND, CALIF.

A NATIONAL ORGANIZATION

Berkeley Scientific Representatives: DALLAS, TEX. — John A. Green Co. • VANCOUVER, B. C. — Hugh M. Birch-Jones Co. • CLEVELAND — J. R. Dannemiller • MONTREAL, QUEBEC — Electrodesign • CHICAGO — KANSAS CITY — Everett Associates • NEW YORK CITY (Export) — Frathom Co. • NEWARK — WASHINGTON, D. C. — PHILADELPHIA — Gawler-Knoop Co. • MINNEAPOLIS, MINN. — Graybar Electric PORTLAND, OREGON — Hawthorne Electronics • DENVER — SALT LAKE CITY — Mine & Smelter Supply ATLANTA — Murphy & Cota • ROCHESTER, N. Y. — E. A. Ossman • LOS ANGELES — V. T. Rupp Co. DETROIT — S. Sterling Co.

alarm; spark quenchers; charger for small dry batteries; low current relay circuit; door chime "pepper"; photoelectric relay; crystal radio receiver; wired radio control transmitter and receiver; and other applications. Price is 25 cents a copy, postpaid.

**Q Control.** International Resistance Co., 401 N. Broad St., Philadelphia 8, Pa. Comprehensive data on characteristics and specifications of a new type Q control are found in catalog bulletin A-4. Advanced performance standards are completely given for Q control with "76" switch, insulated shaft, split bushing, Q control plain dual, concentric dual, plain triple and with taps. Detailed charts and graphs are shown.

**Nonfiring Paints.** Micro-Circuits Co., New Buffalo, Mich. A recent data sheet describes the SCT-series of silver Micropaints that have considerably higher conductivity, high-temperature durability and adhesion than has been obtained so far in similar preparations. A few uses of the paints described are in conductors, tube shields, circuit shielding and printed-circuit wiring.

**Connector Bulletin.** Waltham Horological Corp., 899 Main St., Waltham 54, Mass. A recent 6-page bulletin covers a line of r-f connectors and adapters, pulse connectors, telephone plugs and terminal boards. Tabular data, illustrations and dimensional diagrams are included.

**Vibration-Isolating Mounts.** The Barry Corp., 700 Pleasant St., Watertown, Mass. Assurance of accuracy and portability of machine tools, flexibility of plant operation, as well as reduction of building and machinery maintenance costs are described in bulletin 607. Included is a convenient table from which the proper Barrymount can be quickly selected in terms of machine-weight and strokes-per-minute.

**Strain and Vibration Study.** Baldwin-Lima-Hamilton Corp., Philadelphia 42, Pa. Bulletin 331 gives a 2-page description of the H-42A



## TERMINAL BLOCKS

now available for industrial use...

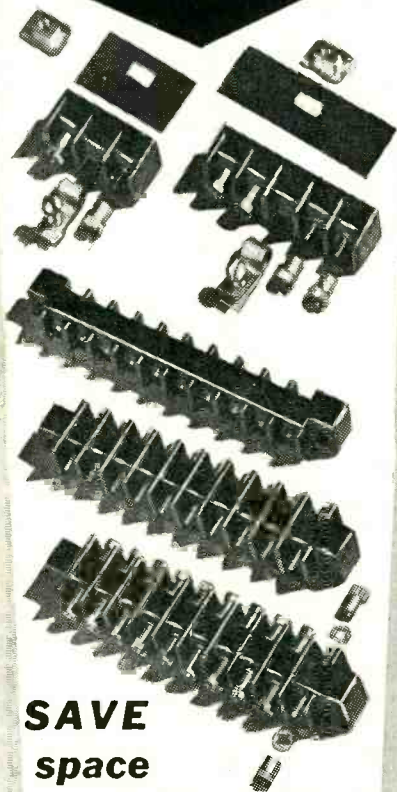

**SAVE space servicing costs installation time**

Shaw developed these terminals to highest standards for the Navy. They're designed to eliminate non-functional material and take advantage of minimum space. Their maximum strength, high voltage insulation, and quick easy installation make them ideally suited for industry. Send for complete information today.



MOLDERS  
SINCE 1892

**SHAW INSULATOR CO.**  
160 COIT ST., IRVINGTON 11, N. J.



## The new S.S. WHITE 80X HIGH VOLTAGE RESISTOR

(1/2 Actual Size)

**4 watts • 100 to 100,000 megohms**

Developed for use as potential dividers in high voltage electrostatic generators, S.S. White 80X Resistors have many characteristics—particularly negative temperature and voltage coefficients—which make them suitable for other high voltage applications.

They are constructed of a mixture of conducting material and

binder made by a process which assures adequate mechanical strength and durability. This material is non-hygroscopic and, therefore, moisture-resistant. The resistors are also coated with General Electric Dri-film which further protects them against humidity and also stabilizes the resistors.

### WRITE FOR BULLETIN 4906

It gives complete information on S.S. White resistors. A free copy and price list will be sent on request.



**THE S.S. White INDUSTRIAL DIVISION**  
**DENTAL MFG. CO.**



Dept. R, 10 East 40th St.  
NEW YORK 16, N. Y.



## ...for MAXIMUM RADIO INTERFERENCE SUPPRESSION

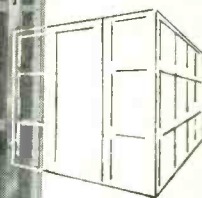
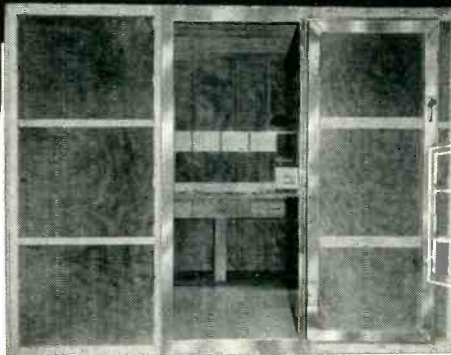

- ✓ "Cell-type" panel construction
- ✓ Ready built
- ✓ Ready to assemble
- ✓ Easy to disassemble and relocate
- ✓ Easy to enlarge
- ✓ Many standard sizes
- ✓ Special filter entry
- ✓ Unique door construction
- ✓ Built to last

**Attenuation of 100 db. from 0.15 to 10,000 mc. obtainable**

(HIGHER ATTENUATION WITH SPECIAL DESIGN)

Scientifically designed and constructed for maximum radio interference suppression, ACE pre-built screen rooms assure real accuracy for:

**Radio inspection and quality control... R-F calibration, susceptibility, spurious radiation and other tests.**

and complete, low-cost shielding for:

**Medical instruments sensitive to minute voltages, diathermy, induction heating and similar equipment that must meet FCC interference regulations,**

Write, wire, or phone for details.

**ACE ENGINEERING and MACHINE CO., INC.**

3644 N. Lawrence St.

Philadelphia 40, Pa.

Telephone:  
REgent 9-1019



LET **Mack**  
FIGURE IT IN PLASTICS—



RCA-Victor  
Television  
Picture Tube  
Mask...

MOLDED BY MACK FOR THE  
NEW RCA-VICTOR 16-INCH  
TELEVISION RECEIVERS  
POLYSTYRENE SOLVES THE  
HIGH VOLTAGE PROBLEMS

Write today for the 12-page Mack Molding  
Data Book—yours without obligation. Address  
inquiries to Department H on your company  
letterhead, please.

*3 plants* completely  
equipped to serve you!



DESIGN

- WAYNE, NEW JERSEY
- ARLINGTON, VERMONT
- WATERLOO, P.Q., CANADA



MOLD MAKING



MOLDING

Figured any way you look at it, letting MACK figure on your plastic molding jobs makes good sense. In the business since the early days of the industry, MACK has the experience and the facilities to do the job right. Choice of materials, design and mold making, finishing and delivery are *all* carefully followed through to insure the *best* results for you. That's why many MACK customers have been with us for a quarter of a century. Inquiries are invited — address Mack Molding Co., Inc., Main Street, Wayne, N. J.

THREE  
PLANTS

WAYNE,  
NEW JERSEY

ARLINGTON,  
VERMONT

WATERLOO,  
P.Q., CANADA

**Mack**  
MOLDED  
EXCELLENCE

Strainalyzer, an instrument used in conjunction with SR-4 resistance wire strain gages and designed for dynamic strain and vibration studies from 0 to 50,000 cps. Possibility of simultaneous observation and recording of four strains is shown.

**Adjacent Channel Interference.** Westinghouse Electric Corp., 2519 Wilkins Ave., Baltimore 3, Md. A new 10-page railroad radio booklet (SA-6736) presents a relatively simple graphical method of evaluating the adaptability of f-m radio equipment for adjacent channel use. The graphical method described uses a plot of receiver attenuation vs frequency off-resonance for both type FE railroad radio equipment and a hypothetical receiver, both meeting AAR specification points, and both with their squelch circuits adjusted to open on an assigned channel signal of 0.5  $\mu$ v.

**Function Plotter.** Minneapolis-Honeywell Regulator Co., 4428 Wayne Ave., Philadelphia 44, Pa. Outstanding advantages, applications and detailed information on the ElectroniK function plotter are found in data sheet 10.0-5. With the instrument described it is possible to record automatically a precise and continuous curve representing the relation of any two variables that can be reduced to a d-c voltage.

**Equipment Catalog.** Milo Radio & Electronics Corp., 200 Greenwich St., New York 7, N. Y., is offering free to industrial purchasing agents a copy of its gigantic 1,053-page catalog. The lavishly illustrated book lists the products of the major radio-electronic equipment manufacturers, complete with prices and discounts, and will serve as a valuable ready-reference buying guide.

**General Export List.** Hellesens Enke & V. Ludvigsen Ltd., Copenhagen, Denmark, has available a booklet made up of catalog sheets covering a line of electrolytic capacitors, paper capacitors and high-frequency iron dust cores. Complete descriptions and a full export price list are included.



*"Sound"* INVESTMENT  
IN FINE MUSIC . . . .



50 WATTS (Peak: 100)  
50W-2 . . . \$249.50

# McIntosh

WORLD'S FINEST  
AUDIO AMPLIFIER

## 50 WATT AMPLIFIER

20 WATTS  
(peak: 40)  
20W-2  
\$149.50

Unequaled for quality reproduction of any sound source, the McIntosh is the most advanced amplifier of the day. Its unique, compact design offers: HIGHEST EFFICIENCY — over 65%; LESS THAN 1% DISTORTION AT PEAK POWER; DYNAMIC RANGE: OVER 70 db; FREQUENCY RESPONSE: 20-20,000 cps.



AE-2 Amplifier  
Equalizer - \$74.50



SEND FOR *Free* CATALOG Dept. B

McINTOSH Engineering Laboratories, Inc.  
320 Water Street, Binghamton, N. Y.

# Special TRANSFORMERS by NOTHELPER

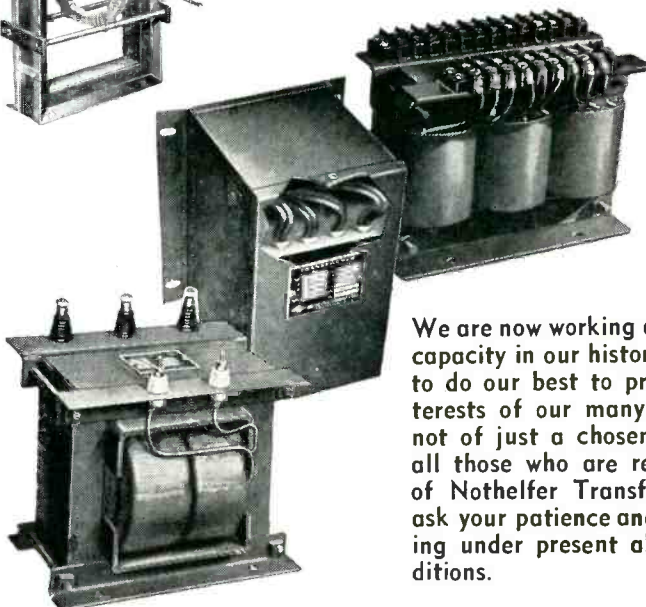
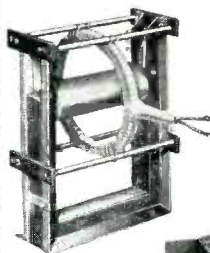

Proven by  
Past  
Performance

We are now working at the highest capacity in our history. We intend to do our best to protect the interests of our many customers—not of just a chosen few, but of all those who are regular buyers of Nothelfer Transformers. We ask your patience and understanding under present abnormal conditions.



## NOTHELPER

WINDING LABORATORIES

9 ALBEMARLE AVE., TRENTON 3, N. J.



Over 85% of the torque wrenches used in industry are

# STURTEVANT

## TORQUE WRENCHES

Read by Sight, Sound or Feel.

- Permanently Accurate
- Practically Indestructible
- Faster—Easier to use
- Automatic Release
- All Capacities

in inch ounces . . . inch pounds . . . foot pounds  
(All Sizes from 0-6000 ft. lbs.)

Every manufacturer, design and production man should have this valuable data. Sent upon request.

STURTEVANT TORQUE MANUAL

PA **STURTEVANT CO**  
ADDISON [QUALITY] ILLINOIS

# PRECISION PAPER TUBES

are best for COILS . . .

- ANY SIZE
- ANY SHAPE
- ANY LENGTH

Round  
Oval  
Square  
Rectangular

- No coil forming after winding
- Wire saved by closer engineering of coil
- Automatic stacking
- No side bow

Precision gives you plus quality at no extra cost. Coil bases are formed under heat and pressure . . . result, a coil base weighing less . . . greater strength . . . more thorough insulation . . . more effective resistance to moisture and heat. All at minimum cost. Any coil is a better coil if it has a Precision base. Precision Di-formed Paper Tubes made to your special specifications of finest dielectric kraft, fish paper, cellulose acetate or combinations.

Write For Free Sample and Complete Mandrel List of Over 1,000 Sizes, Today!

# PRECISION PAPER TUBE CO.

2041 W. Charleston St.  
Chicago 47, Ill.  
Plant No. Two, 79 Chapel St., Hartford, Conn.



# Rx for HARMONIC TROUBLES

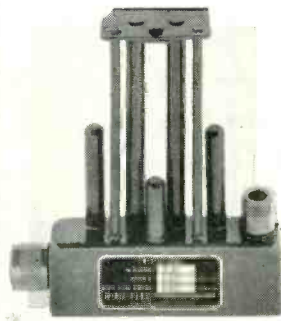
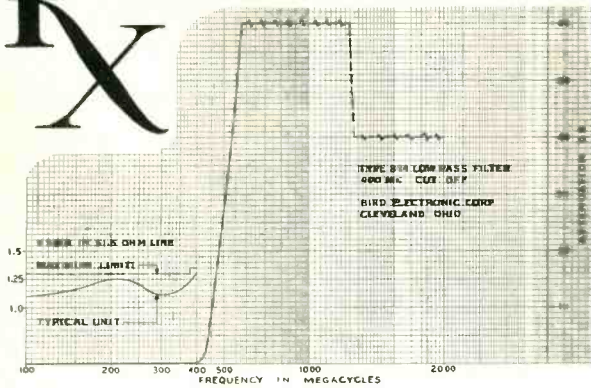

**Model 844**  
**Low Pass Filter**

• Suppression of low-order harmonics in transmitters operating below 400 mc is the prime function of Model 844 Low Pass Filter. 40 db or more attenuation of 2nd to 5th harmonics of transmitters operating between 225-400 mc is afforded. Insertion loss and VSWR are very low thruout the pass band. Teflon insulation and rugged construction thruout assures reliability.

**FREQUENCY RANGE**—pass band 0-400 mc. Stop band 500-2000 mc.

**POWER RANGE**—150 watts maximum.

**IMPEDANCE**—50 ohms. VSWR better than 1.35 thru pass band.

**CONNECTORS**—Type N. One male and one female. Filter is reversible with equal results.

**ATTENUATION**—pass band .3db or less below 400 mc. Stop band 40db or more 500 to 2000 mc.

**PHYSICAL DIMENSIONS**—5 1/8" H x 5" W x 1". Weight—12 oz.

**BIRD ELECTRONIC CORP.**  
*Terminal Coaxial Line Instruments*  
1800 East 38<sup>th</sup> Street • Cleveland 14, Ohio  
West Coast Representative • NEELY ENTERPRISES • Hollywood 46, Calif.

## NEWS OF THE INDUSTRY

(continued from page 148)

in the next few months.

Together with a number of other military orders received earlier this year, the new order brings the company's war contract total over the \$5,000,000 mark.

No specific information concerning the product to be manufactured could be revealed except that it is mechanical-electrical in nature and requires close tolerances and high-quality manufacturing processes. The military orders will not curtail civilian operation.

## Air Force Aids Radio Reception Studies

OFFICIALS at Air Materiel Command, Wright-Patterson AFB, Dayton, Ohio, recently announced a three-way cooperative venture, involving the Air Force, State Department and the Crosley Broadcasting company. The plan is expected to assure the continuance of undistorted radio reception in a radius of 150 to 200 miles from Cincinnati.

Because new antennas being installed for the Voice of America broadcasts may interfere with the radio waves from station WLW and thus modify its coverage characteristics and cause distortion in receiving sets, studies are being made of the existing intensity patterns of the standard broadcast station with a view toward determining the extent of reradiation of waves from the new antennas and the seriousness of the possible interference.

An Air Force helicopter, equipped with standard field intensity measuring equipment and two types of antennas mounted on a pole extending from the front of the aircraft, flies for several hours a day over check points around WLW's transmitting tower. Intensity readings are taken at various altitudes up to 5,000 feet and in eight directions from the tower. When all readings have been taken, engineers will analyze their findings and will augment them with similar readings taken after the new antenna system is constructed, six months to a year from now.

An analysis of the readings is expected to show that the reradiation of the new antenna system will

**MICRODIMENSIONAL WIRE**

*Custom-Enameled*

TO YOUR SPECIFICATIONS

The enamel-~~ms~~u-~~ation~~ of our microdimensional wire meets the high standards of quality set by all our products. The enamel is uniform, tough, flexible and has high dielectric strength... Send us your specifications or ~~square~~ for further details.

Since 1901

**SIGMUND COHN CORP.** 44 GOLD ST., NEW YORK 7



ENGRAVING

ROUTING

PROFILING

MODELING

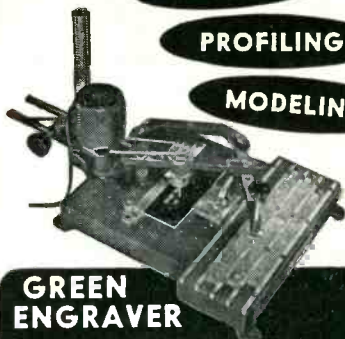

**GREEN ENGRAVER**

Proved Profitable —

Machine Tool, Radio, Electrical and Instrument Mtrs., Sales Promotion and Advertising.

Fast, rugged, convenient—and inexpensive. The Green Engraver is tops for low-cost performance—rips out precision work on metal, plastics or wood . . . cuts four lines of letters from 3/64" to 1" on curved or flat surfaces . . . operates by tracing . . . makes anyone an expert . . . engraves panels, name plates, scales, dials, molds, lenses and instruments. (Also widely used for routing, profiling and three dimensional modeling.) Electric etching attachment available.

Special attachments and engineering service available for production work.

FREE—Fact-packed folder. Send for yours, today

**GREEN INSTRUMENT COMPANY**

363 PUTNAM AVENUE  
CAMBRIDGE, MASS.



**The Ideal Quality Relay for . . .**

**MULTIPLE CIRCUITS  
IN  
SMALL SPACE!**

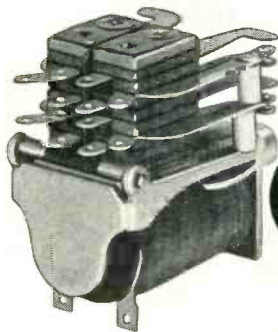

**AMRECON**

**TYPE: TKL**

D. C. Operation

A MINIATURE TELEPHONE-TYPE UNIT FOR DEPENDABLE CONTROL OF SMALL CURRENTS. HAS HIGH RESISTANCE TO SHOCK AND VIBRATION.

Use the dependable little AMRECON Type TKL relay, wherever multiple circuit control must be packed into small space! This miniature telephone-type relay is designed to resist shock and vibration, and was first used in aircraft control applications. Coils are normally rated at 1.25 watts d.c., for voltages up to 115 volts d.c. Maximum standard contact combination: 4-pole, double-throw—others on request. Contact rating: 1 amp—at 115 volts a.c. or 32 volts d.c. (non-inductive loads.) Weight 1 3/4 oz. Size: 1-17/32" high (normal), 61/64" wide, 1-19/32" long.



WRITE FOR COMPLETE INFORMATION  
**American Relay & Controls, Inc.**

4911 W. Flournoy St., Chicago 44, Ill.

**ELECTRONICALLY REGULATED  
LABORATORY  
POWER SUPPLIES**



**BENCH MODEL 25**

- STABLE
- DEPENDABLE
- MODERATELY PRICED

- **INPUT:** 105 to 125 VAC, 50-60 cy
- **OUTPUT #1:** 200 to 325 Volts DC at 100 ma regulated
- **OUTPUT #2:** 6.3 Volts AC CT at 3A unregulated
- **RIPPLE OUTPUT:** Less than 10 millivolts rms

WIDTH 14"  
DEPTH 6"  
HEIGHT 8"  
WT: 17 LBS.

For complete information write for Bulletin E



**LAMBDA ELECTRONICS CORPORATION**  
CORONA NEW YORK

**the right combination**

AiResearch Rate of Change Control

**FOR THE RIGHT CABIN PRESSURE**



The AiResearch Rate of Change Control regulates the rate at which pressure in the airplane's cabin changes. An A. W. Haydon Motor was chosen to drive the instrument because of its proved performance record in scores of important aircraft applications. Other functions for which similar A. W. Haydon Motors are used include controls for wing and propeller de-icing, propeller feathering, camera intervalometer, hydraulic bypass, fuel tank purging as well as recorder chart drives, trim control, telemetering and destructor control, etc.

Send for complete catalog.

A. W. Haydon  
Standard D.C. Timing Motor No. 5301



The **A.W. HAYDON COMPANY**  
235 NORTH ELM STREET  
WATERBURY 20, CONNECTICUT  
Design and Manufacture of Electrical Timing Devices

# CHICAGO OIL IMPREGNATED VACUUM FILLED CAPACITORS



BATHTUB TYPE  
RADIO  
INTERFERENCE  
MOTORS  
ELECTRONIC  
SPECIAL TIMING  
HERMETICALLY SEALED  
TESTED AT THREE-TIMES VOLTAGE



INDUSTRIAL  
TRANSMITTING  
MOTOR CAPACITORS  
POWER FACTOR CORRECTION  
SIGNAL INSTRUMENTS  
HERMETICALLY SEALED  
TESTED AT TWICE-RATED VOLTAGE

Your Inquires Invited And Will Receive  
Our Immediate Attention

# CHICAGO CONDENSER CORPORATION

General Offices and Factory  
3255 W. ARMITAGE AVE.  
CHICAGO 47, ILLINOIS

be so low that it will not interfere with the standard broadcast. Should its intensity be high enough to cause distortion, however, the engineers can either detune the new antennas or trap the interfering signals. Either or both methods are expected to eliminate reradiation by the antennas.

## NPA Appoints NEDA Members

THE Industry Advisory Committees of NPA have appointed six members of National Electronic Distributors Association to serve as members of the Electronic Parts and Components Distributors Industry Advisory Committee.

Those named to serve on the committee are Arthur C. Stallman of Ithaca, N. Y.; Dahl W. Mack of Scranton, Pa.; W. D. Jenkins of Richmond, Va.; George Wedemeyer of Ann Arbor, Mich.; Hoyt C. Crabtree of Dallas, Texas; and Lealis L. Hale of Monroe, La.

The first meeting of the committee was held on March 5, 1951 in Washington, D. C. Agenda include critical materials, supply situation, inventory problems, conservation, repair parts program and equitable distribution.

## BUSINESS NEWS

WESTINGHOUSE ELECTRIC CORP. will construct a new manufacturing plant on a 70-acre site in Bath, N. Y., to produce electronic tubes for the Armed Services and for essential industries.

LONG ISLAND RADIO Co., formerly of Flushing, N. Y., has moved to a new address at P. O. Box 474, Montrose, Pa.

PHILCO CORP., Philadelphia, Pa., has established a separate Government and Industrial Operating Division with full divisional status, to handle increased output of government and industrial products.

GLOBE-UNION INC. has purchased a 650-ft building at 3410-3450 W. Hopkins St., Milwaukee, Wisc., to be used by the company's Centralab electronics division. Facilities in

## ELECTRO TEC MINIATURE SLIP RING ASSEMBLIES & COMMUTATORS

— for Gyros, Computers,  
Resolvers, Instruments,  
Selsyns, Motors

ACTUAL SIZE

- DIAMETERS FROM .05 TO 24.0 INCHES
- ABSOLUTE MINIMUM TORQUE FRICTION
- MINIMUM 1000 V.A.C. HI-POT BETWEEN CIRCUITS
- PALLADIUM AND RHODIUM FINISH TO PREVENT TARNISH, MINIMIZE FRICTION



ELECTRO TEC supplies virtually any type of Precision Miniature Slip Ring Assembly or Commutator to rigid mechanical and electrical specification. An exclusive manufacturing technique—hard silver plated to a precision machined plastic base and wire—forms a rigid assembly that easily withstands up to 12,000 rpm. Concentricity and dielectric strength are superior to any other method of construction. Although Electro Tec products provide improved performance and extra dependability, prices are strictly competitive. Write today for details.

Patents Pending

## ELECTRO TEC CORPORATION



50. HACKENSACK, NEW JERSEY



Here it is! The

# NEOMATIC

A TRULY RUGGED  
SUBMINIATURIZED

Anti-vibration

Anti-acceleration

## RELAY

High and Medium  
Sensitivity

Small in size! Big in performance!

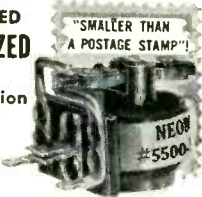

Actual  
Size

The latest development in subminiaturized relays! NEOMATIC Relays are extra small, feather-light, yet are rated higher than much larger conventional relays. NEOMATICS are extremely rugged, yet are exceptionally sensitive. Special anti-vibration, anti-acceleration design assures positive functioning under severe operating conditions. Ideal where space is strictly limited.

Over 500,000 current interruptions with no evidence of wear! NEOMATICS are solving daily the really tough relay problems in aircraft, guided missiles, rockets, radar, radio and telemetering devices. For fast solution to your subminiature relay problems—call on NEOMATIC engineers. They are always glad to help.

RAPID DELIVERY

### SPECIFICATIONS —

Model 5500 — Standard

Vibration Resistance . . . . . 20 g's  
Acceleration Resistance . . . . . Over 50 g's  
Contacts . . . . . SPDT, 1 amp (non-ind.)  
Coil Voltages . . . . . 3-72 V. D.C.  
Coil Resistances . . . . . 8-5000 ohms  
Coil Power Consumption . . . . . 1 watt  
Weight . . . . . 0.462 oz.  
Size . . . . . less than 0.5 cubic inch

Other models also available

Hermetically sealed No. 5610, special alloy contact No. 5530 for heavy loads, and dual SPDT No. 5580 for motor control.

## NEOMATIC, INC.

879 Wellesley Avenue • Los Angeles 49, Calif.  
ARizona 3-4897

# Square Wave Generator



## MODEL 71

### SPECIFICATIONS

FREQUENCY RANGE: 5 to 100,000 cycles.

WAVE SHAPE: Rise time less than 0.2 microseconds with negligible overshoot.

OUTPUT VOLTAGE: Step attenuator giving 75, 50, 25, 15, 10, 5 peak volts fixed and 0 to 2.5 volts continuously variable.

SYNCHRONIZING OUTPUT: 25 volts peak.

R. F. MODULATOR: 5 volts maximum carrier input. Trans-lation gain is approximately unity—Output impedance is 600 ohms.

POWER SUPPLY: 117 volts, 50-60 cycles.

DIMENSIONS: 7" high x 15" wide x 7½" deep, overall.

MANUFACTURERS OF  
Standard Signal Generators  
Pulse Generators  
FM Signal Generators  
Square Wave Generators  
Vacuum Tube Voltmeters  
UHF Radio Noise & Field  
Strength Meters  
Capacity Bridges  
Megohm Meters  
Phase Sequence Indicators  
Television and FM Test  
Equipment

## MEASUREMENTS CORPORATION

BOONTON NEW JERSEY

Ideal for  
ANTENNA CONNECTIONS  
PHOTO-CELL WORK  
MICROPHONE CONNECTIONS

## JONES SHIELDED TYPE PLUGS & SOCKETS

LOW LOSS PLUGS AND  
SOCKETS FOR HIGH  
FREQUENCY CONNECTIONS.  
SUPPLIED IN 1 AND 2  
CONTACT TYPES:

101 Series can be fur-  
nished with ¼", .290",  
5/16", ¾" or ½" fer-  
rule for cable entrance.  
Knurled nut securely  
fastens unit together.  
Plugs have ceramic in-  
sulation and sockets have  
bakelite. Quality con-  
struction. Fine finish.  
Assembly meets Navy  
specifications.

For full details and en-  
gineering data ask for  
Jones Catalog  
No. CS-18.

JONES MEANS  
Proven QUALITY



S-101

Jones  
HOWARD B. JONES DIVISION  
CINCH MANUFACTURING CORPORATION  
CHICAGO 24, ILLINOIS  
SUBSIDIARY OF UNITED-CARR FASTENER CORP.

All you need . . .

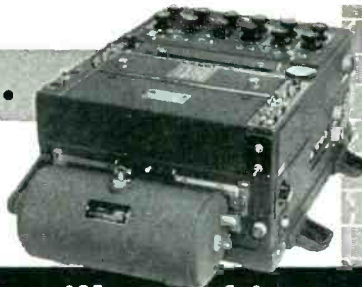

for complete oscillographic recording

The 5-8 Oscillograph, long the standard of oscillographic recording, has been improved to meet the expanding demands of modern research. The NEW Type 5-8 Oscillograph has all the inherent capabilities you need to record rapidly changing phenomena such as vibration and dynamic strain.

### A few of the newest features are:

QUICK-CHANGE TRANSMISSION—16 record speeds over range of 120:1  
FULL RESILIENT MOUNTING makes possible use of super-sensitive galva-  
nometers

CHART TRAVEL INDICATOR provides continuous indication of chart motion  
NEW GALVANOMETER STAGE takes all Hathaway galvanometers for  
recording milliamperes, microamperes, and watts.

NEW RECORD-LENGTH CONTROL and NUMBERING SYSTEM for long,  
trouble-free service

All the other valuable features characteristic of the 5-8 are retained.  
Investigate the NEW Type 5-8 and its 170 types of galvanometers.

Write for Technical Bulletin 2B-1A-G.

Hathaway  
INSTRUMENT COMPANY.

1315 SO. CLARKSON STREET • DENVER 10, COLORADO

Try Remler for Service-Tested  
"Hard-to-Get" Components



*Custom Components*  
Metal-plastic components designed and manufactured to order. Write for quotations specifying electrical and mechanical characteristics. Describe application. No obligation.

**REMLER  
TUBE SOCKETS**

● STANDARD FOR 30 YEARS...  
THE BEST IN THE INDUSTRY

Heavy duty phenolic sockets with high current wiping action contacts... for industrial, transmitter and test applications. Rugged. Years of tube insertions and withdrawals do not impair contact effectiveness. Black phenolic is standard, low loss phenolic or alkyd on order.

Remler Company Ltd. 2101 Bryant St. San Francisco 10, Calif.

*Since 1918* **Remler**  
PIONEERS IN ELECTRONICS AND PLASTICS

distributors for 30 years  
of radio and electronic  
components for all your needs

**RADIO WIRE TELEVISION**  
INCORPORATED

**NEW YORK 13, N.Y.**

100 Sixth Avenue  
WAlker 5-8883

**NEWARK 2, N. J.**

24 Central Avenue  
MArket 2-1661

**BOSTON 10, MASS.**

110 Federal Street  
HUBbard 2-7850



Have you your copy? If not, we'll send you this 1250 page book for only \$1.50. Write: Radio Wire Television, Incorporated, 100 Sixth Ave., New York 13, Dept. E.

the 158,000 sq ft of space will be devoted entirely to production of a defense item in the classified category.

REX RHEOSTAT Co., Baldwin, L. I., N. Y., has sold to P. R. Mallory & Co., Inc., Indianapolis, Ind., its equipment for manufacturing vitreous-enamelled, round power rheostats for 50 to 500 watts. In addition, the Mallory Co. has acquired the exclusive patent and manufacturing rights.

I.D.E.A., INC., Indianapolis, Ind., tv signal booster manufacturer, has expanded its production facilities by the addition of 25,000 sq ft of floor space.

BERGEN-PASSAIC ELECTRONICS, INC., Bogota, N. J. is broadening its activities to include consulting engineering on electronic equipment maintenance and service problems, with emphasis on consultation in early design stages to minimize need for special test equipment and simplify servicing requirements.

ACME ELECTRONICS, INC., has moved from Los Angeles to larger quarters at 300 N. Lake Ave., Pasadena, Calif. The company designs and manufactures precision wave filters, sonar and radar delay lines, coils and similar devices.

**PERSONNEL**

ANDREW KALITINSKY, former chief engineer of the Nuclear Energy for Propulsion of Aircraft Project, has been appointed manager of the M. W. Kellogg Co. Special Projects Department.

JOHN S. BOYERS, formerly chief engineer and assistant treasurer of the corporation since 1946, has been elected president of Magne-cord, Inc., manufacturer of high-fidelity magnetic tape recorders for the broadcast, industrial and educational markets.

MARTIN V. KIEBERT, JR., formerly with Raymond Rosen Engineering products, Inc., as manager and director of research of the company's telemetering division, was recently



# EISLER Television Tube MACHINERY

- ECONOMICAL
- MODERN DESIGN
- PRODUCTION ENHANCING

Machines for Manufacturing Incandescent Lamps, Radio and Electronic Tubes

TV Sealing Machine

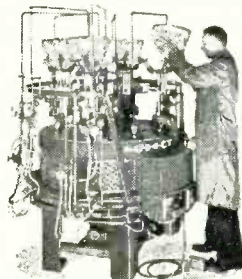

From 5" to huge 24" Television Tube

RESISTANCE WELDERS  
1/4 to 300 KVA



EISLER'S Electronic Equipment is especially Designed and Built to your exact requirements.

EISLER TRANSFORMERS  
STANDARD • SPECIAL

WE INVITE YOUR INQUIRIES Sizes From 1/4 to 500 KVA



EISLER ENGINEERING CO., Inc.  
751 So. 13th St. Newark 3, N. J.

# CUT WIRING COSTS

with

# PRINTED CIRCUITS

Appreciable reductions in wiring and assembly costs, circuit reproducibility and miniaturization are a few of the advantages of "Photocircuit-Printed Circuits."

Etched foil circuit patterns of copper, aluminum, silver and brass on a variety of rigid and flexible plastic bases are

used in electronic and allied equipment.

Applications extend to radiant heaters and complex wiping contact switches. Greatly improved miniaturization and ruggedness are insured.

Let our engineering facilities and experience help you solve your design and application problems.



## PHOTOCIRCUITS Corporation

Dept. EL 6, GLEN COVE, NEW YORK

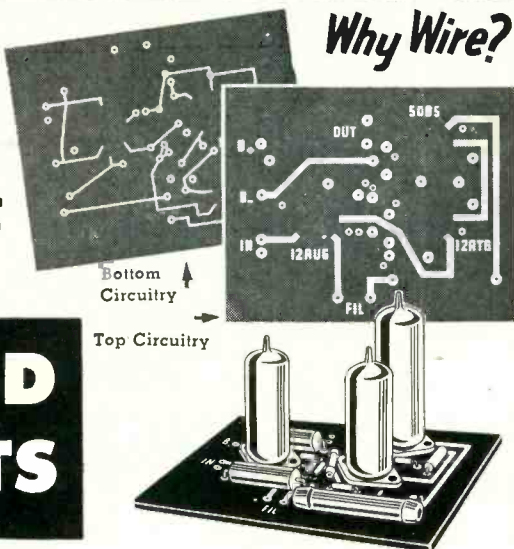

Why Wire?

*Linde*  
Trade-Mark

M. S. C.

(Mass Spectrometer Checked)

RARE GASES

HELIUM • NEON

ARGON • KRYPTON • XENON

LINDE Rare Gases are mass spectrometer checked to assure you gases of known purity and uniformly high quality. Available in commercial-size cylinders and glass bulbs.

LINDE, the world's largest producer of gases derived from the atmosphere, can meet your individual needs of purity...volume...mixture...containers...

LINDE AIR PRODUCTS COMPANY  
A DIVISION OF UNION CARBIDE  
AND CARBON CORPORATION

30 East 42nd Street  New York 17, N. Y.

In Canada:  
Dominion Oxygen Company, Limited, Toronto

The term "Linde" is a registered trade-mark of Union Carbide and Carbon Corporation

# FOR POSITIVE AND INEXPENSIVE SHIELDING

— use Metex "Electronic Weather Strips"

Because they combine exceptional *resiliency* with good *conductivity*, Metex Electronic Products made of knitted wire mesh offer an unusually effective means of sealing and shielding a wide variety of types of electronic equipment.

As closures for sheet metal cabinets, for instance, the resiliency of "Metex" assures positive conductive contact at every point between cover and cabinet — eliminating costly machining for close tolerances. Metex Gaskets also assure resilient metal-to-metal contact between flanges, and can be combined with rubber com-

pounds to function both as a shield and as a seal.

Applications in which "Electronic Weather Strips" have already proved their effectiveness include pulse modulator shields, wave-guide choke-flange gaskets, replacement of beryllium-copper fingers and springs on TR and ATR tubes.

We will be glad to put our experience at your disposal. A letter to Mr. R. L. Hartwell, outlining your problem, will receive immediate study.

For preliminary information, write for bulletin "Metex 'Electronic Weather Strips.'"



## METAL TEXTILE CORPORATION

641 EAST FIRST AVENUE, ROSELLE, N. J.

# FOR COMPLETE TESTING



## WALK-IN ROOMS

by **BOWSER  
TECHNICAL  
REFRIGERATION**

Bowser Walk-In Rooms have a temperature range from +180°F. to -100°F. and relative humidity simulation from 20% to 95%. Because of sectionalized panel construction any size or shape room can be manufactured for final assembly in the field. Smaller sizes are preassembled at the factory. Extended ranges of temperature, humidity and provision for altitude simulation can be provided. Special accessories and instrumentation also available.

*Standard Environmental  
Simulation Chambers —  
Wide range of sizes  
and performance ratings.  
Meet all Govt. test specs.*

**BOWSER TECH. REFRIG., Terryville, Conn.**

Send me more information on the following:

- |                         |                          |                         |                          |
|-------------------------|--------------------------|-------------------------|--------------------------|
| Walk-in Chambers        | <input type="checkbox"/> | High Altitude Tests     | <input type="checkbox"/> |
| High Temp. Tests        | <input type="checkbox"/> | Mildew Resistance Tests | <input type="checkbox"/> |
| Low Temp. Tests         | <input type="checkbox"/> | Sand & Dust Tests       | <input type="checkbox"/> |
| Fungus & Humidity Tests | <input type="checkbox"/> | Explosion Proof Tests   | <input type="checkbox"/> |

Name \_\_\_\_\_ Pos. \_\_\_\_\_

Company \_\_\_\_\_

Street \_\_\_\_\_

City \_\_\_\_\_ Zone \_\_\_\_\_ State \_\_\_\_\_

**BOWSER**  
**TECHNICAL REFRIGERATION**  
DIVISION BOWSER INC.  
TERRYVILLE • CONN.

appointed business manager of the Research Laboratories of Bendix Aviation Corp., Baltimore, Md.

EDWARD G. HALL, for several years general transmission engineer for the Indiana Associated Telephone Corp., Lafayette, Ind., had been appointed engineering representative for the sales and engineering service department of The Lenkurt Electric Co., San Carlos, Calif.



E. G. Hall



H. S. Bamford

HENRY S. BAMFORD, vice-president and chief engineer of the company since 1942, was recently elected president of Electronic Tube Corp., Philadelphia, Pa., manufacturers of electronic instruments and c-r tubes.

WALTER J. BONAZZA, formerly associated with Hazeltine Electronics Corp., is now chief engineer of Aerocoil Inc., Union City, N. J.

## WALKIE-SEEIE DEMONSTRATED



Jack Dille and model demonstrate 53-pound newly developed portable television transmitter before IRE in New York City last March. Trial model, developed under direction of Vladimir K. Zworykin at RCA Laboratories, Princeton, N. J., sends both voice and video signals for a distance of a mile

To Aircraft Electrical and  
Radio Designers:

*Lockheed has  
a great future  
...make it yours!*

There's a great future waiting for you in California—in Lockheed's long-range production program.

For Lockheed is building planes for defense, planes for the world's airlines. The backlog of orders is vast—for both military aircraft and the world-famed Constellation.

Lockheed offers you increased salary rates; fine, modern working conditions; a chance to live in Southern California—in an area where living conditions are beyond compare. Generous travel allowances are also offered.

Requirements are: design experience in aircraft electrical installation, circuit layout and systems analysis; experience in radio and radar circuit design and installations, as applied to aircraft.

Send today for free, illustrated brochure describing life and work at Lockheed in Southern California. Use handy coupon below.

MR. M. V. MATTSON  
Employment Mgr., Dept. 6, Plant B-1

**LOCKHEED**  
**AIRCRAFT CORPORATION**  
**BURBANK, CALIFORNIA**

Please send me your free illustrated booklet describing the better living and working conditions at Lockheed.

My Name \_\_\_\_\_

My Street Address \_\_\_\_\_

City and State \_\_\_\_\_



## Wizardry in WIRE FORMS

Small diameter wire formed  
in any shape you need!

### IMMEDIATE CAPACITY FOR DEFENSE SUB-CONTRACTS

#### STRAIGHTENING & CUTTING

Perfect straight lengths to 12 ft.  
.0015 to .125 diameter

#### WIRE FORMS

.0015 to .080 diameter

#### SMALL METAL STAMPINGS

.0025 to .035 thickness  
.062 to 3 inches wide

★

Specializing in Production of Parts  
for Electronic and Cathode Ray Tubes

Write for Illustrated Folder  
Send Blueprints or Samples for Estimate

**ART WIRE & STAMPING CO.**  
227 High Street Newark 2, N. J.

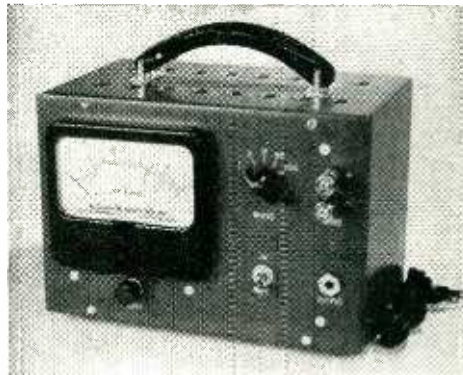

## ELECTRONIC MICROAMMETER Type 100

The instrument features a **MAGNETIC AMPLIFIER** whereby low input impedance and high **CURRENT SENSITIVITY** are obtained. It is designed to replace delicate galvanometers in many applications and to allow **DIRECT RECORDER OUTPUT**. It may be overloaded to the current carrying capacity of the Toroidal transformer windings ( $\frac{1}{4}$  ampere) without damage and from use of a one milliamper meter, is much more rugged than galvanometers of microampere sensitivity.

While intended as a versatile laboratory instrument, it is particularly suited for use in balancing resistance bridges, measuring crystal rectifier output, photo-cell, strain-gage, thermocouple, and lead sulphide cell circuits, and in related fields.

#### SENSITIVITY:

1 microampere full scale  
50 microvolts full scale

#### RANGES:

1—100 microamperes

#### ACCURACY:

$\pm 3\%$  full scale

#### TIME CONSTANT:

3-6 seconds

#### INPUT IMPEDANCE:

50-0.5 ohms.

A descriptive bulletin is available upon request.

**W. S. MACDONALD CO., INC.**

University Road • Cambridge • Massachusetts

no other  
tape recorder  
like..!

**AMPEX**  
STANDARD OF THE GREAT RADIO SHOWS

to 40,000 cps at 30 inches  
per second tape speed

to 15,000 cps half-track at  
7 1/2 inches per second tape  
speed

**AMPEX ELECTRIC CORPORATION**  
San Carlos, California

**SOLD BY...**  
BING CROSBY ENTERPRISES, INC., Hollywood  
AUDIO-VIDEO PRODUCTS CORP., New York City  
GRAYBAR ELECTRIC CO., All Principal Cities  
TERMINAL RADIO CORP., New York City  
RADIO SHACK CORPORATION, Boston  
NEWARK ELECTRIC CO., Chicago  
WESTREX CORP. (Export), New York City

AX-34

## New BIRTCHER TUBE CLAMP FOR MINIATURE TUBES

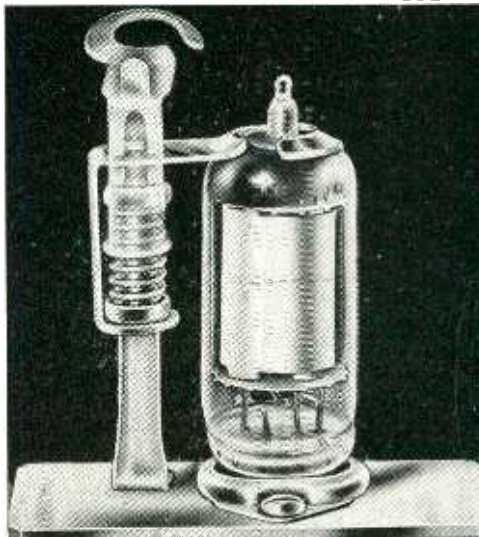

### POSITIVE PROTECTION AGAINST LATERAL AND VERTICAL SHOCK!

The *New* Birtcher Type 2 Tube Clamp holds miniature tubes in their sockets under the most demanding conditions of vibration, impact and climate. Made of stainless steel and weighing less than  $\frac{1}{2}$  ounce, this *New* clamp for miniature tubes is easy to apply, sure in effect. The base is keyed to the chassis by a single machine screw or rivet...saving time in assembly and preventing rotation. There are no separate parts to drop or lose during assembly or during use. Birtcher Tube Clamp Type 2 is all one piece and requires no welding, brazing or soldering at any point.

If you use miniature tubes, protect them against lateral and vertical shock with the Birtcher Tube Clamp (Type 2). Write for sample and literature.

Builder of millions of stainless steel Locking Type Tube Clamps for hundreds of electronic manufacturers.

The **BIRTCHER** Corporation

5087 HUNTINGTON DRIVE • LOS ANGELES 32



# TEKTRONIX SQUARE WAVE GENERATOR

Continuously Variable, 25 CPS-1 MC  
Rise Time, .02 Microseconds  
Direct Reading Frequency Meter  
Versatile Output Circuit

Square wave testing techniques come into wider use as the need for good transient response in wide band amplifiers becomes increasingly important. In order to test the high frequency response it is necessary to have a signal which has a rise and fall at least equal to and preferably faster than the risetime of the amplifier being tested. In addition to a sharp rise and fall, the test signal should be free of over-shoot and other spurious responses. For examination of the low frequency response a square wave signal having flat horizontal portions is needed.

The TEKTRONIX Type 105 Square Wave Generator provides a suitable signal for both of the above tests. Its frequency range, extending continuously from 25 cycles to 1 mc., combined with its risetime of .02 microseconds, makes it possible to quickly and accurately test amplifiers, filters, etc., having pass bands from a few cycles to 20 mc.

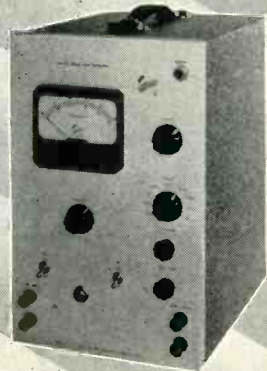

TEKTRONIX Type 105  
Square Wave Generator  
Price \$395.00 f.o.b.  
Portland, Oregon



Cable, TEKTRONIX

712 S. E. HAWTHORNE BLVD. PORTLAND 14, OREGON

Write Today for Detailed Specifications of  
Type 105 and Other Tektronix Instruments

## NEW BOOKS

(Continued from page 150)

three chapters of the book.

The text is ideally suited for personnel with formal training in microwave theory. It is an excellent companion to Professor Barlow's book, "Micro-Waves and Wave Guides," published by Dover. This book should prove to be most valuable as a reference manual for graduate courses in microwave laboratory techniques even though details of equipment design and methods for determining equivalent circuits of multiterminal structures are not elaborated upon. Each chapter is documented with an adequate bibliography, which is in the main British.—ANTHONY B. GIORDANO, Polytechnic Institute of Brooklyn

## Short Wave Wireless Communication

By A. W. LADNER AND C. R. STONE, both former affiliates of Marconi's Wireless Telegraph Co. Ltd., of London. John Wiley and Sons Inc., New York, 1950, 5th edition, 716 pages, \$8.00.

A COMMON complaint about books on the subject of communications is that they are usually too technical and too theoretical. As an example, in most books the chapters on tuned circuits are of limited value when one is actually confronted with the problem of choosing a wire size for winding a coil for a specific purpose.

This new fifth edition of a widely-accepted British book comes just about as close as possible to tying theory and practice together in an understandable way. For instance the effects of different values of Q in power amplifiers are fairly well known among practical engineers, but most of us can remember what a mystic thing this Q was when we first came across it in college. To orient the reader on this subject, the authors of Short Wave Wireless Communication have listed the various effects of low Q and high Q. The reader finishes the chapter on power amplifiers with a complete picture.

The illustrations are plentiful, but somewhat inferior in quality. By American standards, they are oldfashioned—indeed, some of the photographs appear to have aged



**STARTLINGLY SMALL  
AMAZINGLY LIGHT WEIGHT  
UTMOST RELIABILITY**

# "METALITE"

**METALLIZED PAPER CAPACITORS**

Type MQ



Type MR



Type ML



**QUALITY MINIATURES—**  
the space-saving solution  
to size reduction problems — save  
50% to 75% in capacitor space—self-healing  
properties eliminate capacitor service problems  
— excellent RF characteristics — the "last word" in ultra-  
compact, miniature capacitor design—available in standard,  
JAN and special case styles.



METALITE  
AS1016



METALITE  
METR-11-5M



METALITE  
AS1034



METALITE  
METR 4-6M

ASTRON RF Interference  
filters with "METALITE"—  
is the answer to your  
RF Interference  
suppression problems

## ASTRON CORPORATION

255 Grant Avenue East Newark, New Jersey

Manufacturers

WRITE FOR CATALOG AC-2

HIGH QUALITY FIXED CAPACITORS AND FILTERS



THIS FEATHERWEIGHT WILL  
**LICK  
SOLDERING  
FATIGUE!**



THE NEW  
**HEXACON  
BANTAM  
MODEL 30H**

Weight—5½ Ounces • Watts—  
40 or 60 • Tip Dia.—Both ⅛" and ¼" Tips  
Furnished with Each Iron • Price—\$550

So light its weight is hardly noticeable. Out-  
performs any iron of equal size. Hatchet de-  
sign makes it more comfortable and practical  
to use than a pencil iron. No transformer re-  
quired. Write for complete catalog.



**HEXACON ELECTRIC CO.**  
130 WEST CLAY AVE., ROSELLE PARK, N. J.

# "Just tell them they CAN'T AFFORD TO USE ANYTHING ELSE . . ."

That's Joe Gibbons speaking. We were talking about how to make people realize what a terrific thing this new

## JELLIFF ALLOY 1000 RESISTANCE WIRE

really is, and that's the way he summed it up. And even when you make allowances for a salesman's natural enthusiasm, he's pretty near right. Just look at some of the important data:



Resistivity 1000 ohms/cmft  
Tensile strength 165,000 psi—  
TC of Resistance 20 ppm—  
Coefficient of Expansion 13.9  
ppm—  
Corrosion Resistance equal to the  
best nickel-chromiums—  
Winds fast and solders easily—  
Lots more ohms in lots less space.

See what we mean? For the whole story,  
write for Bulletin-17.



*Hermetically Sealed*

### DELAY LINE

Acme has engineered many different types of delay lines to customers' requirements. Among them is this hermetically sealed unit for a radar system, tapped for various delays up to 4 micro seconds. We will be glad to discuss your problems.

**Acme**  
ELECTRONICS, INC.

300 No. Lake Ave., Pasadena 4, Calif.  
Formerly Acme Metal Die, Inc.

Wave Filters • Delay Lines • Magnetic Amplifiers • Special Trans-  
formers & Chokes • Toroidal, Universal & Solenoid Wound Inductors



## Rate Measuring GYROSCOPES

for

Control  
Stabilization  
Flight Testing  
Rate Computation

For the accurate measurement of absolute rates of angular rotation, the Doelcam Model K Rate Measuring Gyroscope offers the following features:

1. Accuracy: 0.5%
2. Resolution: 0.1%
3. Maximum uncertainty: 0.2%
4. Hermetically sealed
5. Shock and vibration resistant
6. Microsyn pickoff: 60 — 5,000 cps
7. Thermostatically controlled damping ratio
8. Small size: 3 inches diameter x 5.82 inches
9. Lightweight: 3 5/8 lbs.

The design of the Model K Gyroscope affords wide latitude in the adjustment of parameters and permits design to any particular specifications.

For complete details write for Bulletin K

**DOELCAM CORPORATION** 56 Elmwood Street  
Newton 58, Massachusetts

GYROSCOPIC FLIGHT TEST AND CONTROL INSTRUMENTATION  
SYNCHROS • SERVOMECHANISMS • MICROSYNS • ELECTRONIC INVERTERS



**VIBRATORS!**  
By every test  
**ATR**  
is Best!

**ATR**  
AUTO RADIO  
VIBRATORS  
have Ceramic Stack Spacers



**A COMPLETE LINE OF VIBRATORS . . .**  
Designed for Use in Standard Vibrator-Operated Auto Radio Receivers. Built with Precision Construction, featuring Ceramic Stack Spacers for Longer Lasting Life. Backed by more than 19 years of experience in Vibrator Design, Development, and Manufacturing.

**ATR PIONEERED IN THE  
VIBRATOR FIELD.**

NEW MODELS NEW DESIGNS  
NEW LITERATURE

"A" Battery Eliminator, DC-AC Inverters  
Auto Radio Vibrators  
See your jobber or write factory



**AMERICAN TELEVISION & RADIO CO.**  
Quality Products Since 1931  
SAINT PAUL 1, MINNESOTA—U.S.A.

**NEW BOOKS**

(continued)

with the book since its first publication in 1932. The writing is definitely British, but since circuits and theory explanations are of a general nature and not confined to specific tube types, this fact should not detract from the book's value to American readers. Practical examples and problems are included.

The book is recommended as supplemental reading for anyone engaged in studying communications who feels that the gap between the textbook formulas and the bread-board or chassis is too great. Some would resent the absence of mathematical treatment, but many will appreciate this omission.—J.D.F.

**Television Receiving  
Equipment**

By W. T. COCKING. Published for Wireless World by Iliffe and Sons Ltd., Dorset House, Stamford St., London, S.E. 1, England, 1950, 375 pages, 19 shillings plus 8d. postage.

As GLOBAL distances become more and more insignificant, technical differences in ways and means of different countries become more and more evident. The engineers of various countries seem to consider their pet technical systems just as sacred as their flags and standards.

In this book, W. T. Cocking presents the British side of television reception. The material presented, however, should be of value to both British and American engineers. To the British, it represents a well-organized compilation of current circuits and techniques in which they find themselves involved from day to day. To American engineers it fulfills the need for a to-the-point synopsis of what the other guy is doing.

The book assumes a fairly complete previous knowledge of radio, but the coverage of television is complete and thorough. The material has been carefully organized, reflecting the editor's experience in both the technical side of his subject and journalism. Although two chapters are devoted to servicing and finding and remedying faults, the book is not recommended as an aid to the serviceman, as such. It will of course furnish background

**NEW CIRCUIT ELEMENT  
THE  
SIGNATRON**

*A High Q Electro-Mechanical Resonator  
Of Small Size And Great Stability*

**SERVES YOU 4 WAYS**



**A TRANSDUCER**

*of pressure, temperature,  
acceleration, displacement,  
strain, etc. for FM tele-  
metering systems.*



**AN OSCILLATOR**

*of near crystal stability  
with a wide tuning range.*



**A DISCRIMINATOR**

*to convert FM signals to  
amplitude variations.*



**A FILTER**

*with a Q range from 300  
to 2500.*

For Information Write To:

**RAHM**  
INSTRUMENTS, INC.

12 WEST BROADWAY, NEW YORK 7, N. Y.

Manufacturers of  
Direct Recording Oscillographs  
And Telemetering Systems



# The New STAVER MINI-SPRING

TRADE MARK REG. AND PAT. PEND.

Available!  
Special  
Improved  
Types for  
Military  
Apparatus



Gives support two ways—Keeps pressure downward and gives sideway support. The spring action is constant and resilient permanently. Send for catalog sheet.



91 PEARL ST. • BROOKLYN 1, N. Y.  
ULSTER 5-6303

MODEL PFR

## POLINEAR RECORDER

FOR AUTOMATICALLY PLOTTING  
both ANGULAR and STRAIGHT  
LINE functions on either  
POLAR or RECTILINEAR  
coordinates in any  
COMBINATION . . .

- Records both AC and DC voltage levels
- Designed for STANDARD 8½ x 11 chart sheet
- POLAR and LINEAR turntable movement
- TURNTABLE instantly set to any chart position
- Auxiliary Electrical linkage for synchronizing to turntable motion:
 

Oscillators	Rotational Devices
Test Turntables	Analyzers
- Interchangeable range potentiometers
- Dependable and service free operation

Typical applications:

- Beam Pattern Plotting of antennas, microphones, loudspeakers, lighting fixtures, ultrasonic devices;
- Frequency Response Records of microphones, loudspeakers, amplifiers, Filters, Radio and television circuits;
- Rectilinear Curves on vacuum tubes, potentiometers, amplifiers, counting and computing devices.

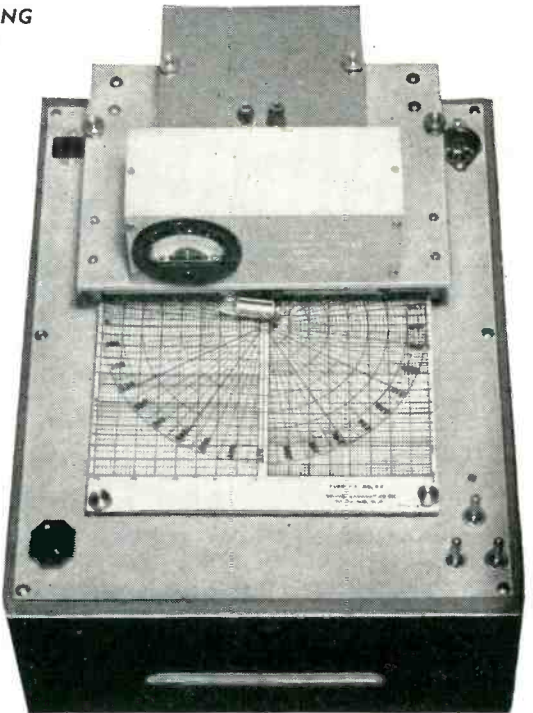

Descriptive literature mailed upon request

Designers and Manufacturers of Graphic Recorders

### SOUND APPARATUS COMPANY

STIRLING, N. J.  
Instruments Engineered for Individual Requirements

# Runzel WIRE, CORD and CABLE

In almost endless variety of sizes, insulation and colors to your specifications, Runzel products are available to assist you in your wiring problems.

Shielded wire and cords . . . popular hook-up and lead-in wire . . . speaker cords and all types of insulated wire products.

Precision made RUNZEL products are the finest. Write for samples.



**RUNZEL** CORD & WIRE CO.  
4723 Montrose Avenue  
Chicago 41, Illinois

Your FREE copy  
of the latest  
**IN-RES-CO**  
CATALOGS  
will be sent  
promptly on request

contains complete  
data including  
**ELECTRICAL**  
AND  
**MECHANICAL**  
Specifications

of  
the  
complete  
line  
of



**IN-RES-CO**  
RESISTORS

Please write  
on company  
letterhead

## IN-RES-CO RESISTORS

meet all instrumentation needs

TOLERANCE TO  $\pm 0.1\%$

.01 OHM TO 1.0 MEGOHM

HIGH OR LOW WATTAGE

HERMETIC SEALED TYPES

ALL TYPES OF MOUNTING

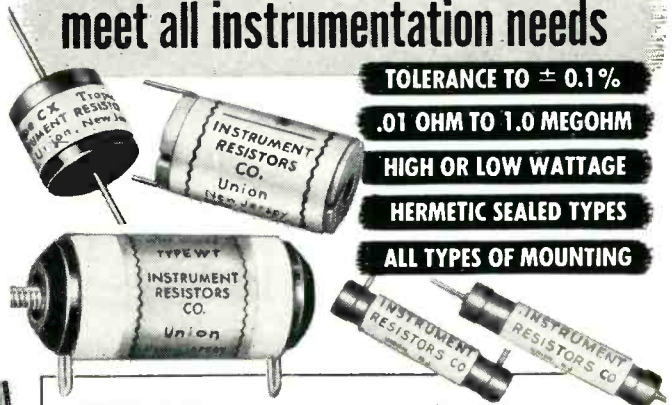

INRESICO Resistors are a product of high-speed winding techniques that introduce a new measure of economy in precision wire wound resistors.

They are available for IMMEDIATE DELIVERY, in diversified types that meet practically every circuit requirement of load, ohmic value, size, and shape.

When planning a new circuit design, investigate the advantage of INRESICO resistors for economy, dependability and permanently fixed characteristics. For complete details, call or write today for catalog.

Manufacturers and designers of wire wound resistors—exclusively. Estimates on custom built resistors furnished without obligation; inquiries are invited.



**INSTRUMENT RESISTORS COMPANY**  
1036 COMMERCE AVENUE, UNION, NEW JERSEY

# New! diacro BOX FINGER BRAKE

Four models 6" 12" 18" 24"  
Capacity—16 Gauge Steel

## 3 TOOLS IN ONE

1. BOX and PAN BRAKE
2. STANDARD BRAKE
3. BAR FOLDER

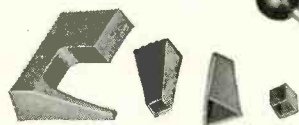

### OPEN END FINGER

for forming triangular, square and rectangular tubes.

**Versatility from the word GO!!** One box or 10,000—can be economically produced with the new Di-Acro Box Finger Brake. The complete box finger bar also serves perfectly for all standard brake operations. An Acute Angle Bar—quickly mounted—converts the brake to a bar folder for locks, seams, hems and sharp angles. The unique Di-Acro Open End Finger forms square or triangular tubes and other similar parts difficult to make. Real machine tool construction, with hardened and precision ground box fingers, assures permanent accuracy in producing duplicated parts. The Box Finger Bar can be easily mounted on all standard Di-Acro Brakes.

Di-Acro is pronounced "DIE-ACK-RO"



**O'NEIL-IRWIN MFG. CO.**

321 EIGHTH AVENUE, LAKE CITY, MINN.

Send for

### 40 PAGE CATALOG

describing  
DI-ACRO Shears,  
Punches, Benders,  
Brakes, Notchers  
and Rod Parters,—  
also Power Shears  
and Benders.



for the serviceman, but the actual discussion of dollars-and-cents troubleshooting is very limited and somewhat sketchy.—J.D.F.

## The Electronic Musical Instrument Manual

BY ALAN DOUGLAS. *Pitman Pub. Corp., 2 West 45, New York, 1949, 142 pages, \$3.50.*

This British-authored book discloses design details of American as well as British commercial instruments, including many circuit diagrams on which values of component parts are commendably indicated as an aid to understanding circuit operation. Four opening chapters on underlying theory deal with the nature of sound, the nature of music and noise produced by strings and by wind instruments, the construction of conventional pianos and organs, and the production and mixing of electrical oscillations. Next comes a highly practical chapter on the amplifiers, tone controls and loudspeakers required with all electronic musical instruments, and the remainder of the book deals with the instruments themselves.

Apparently U. S. firms are well advanced in this particular field, because well over ninety percent of the book deals with or is applicable to their products. The book is well written, and highly recommended both for background reading and for engineering reference by anyone interested in the music of vacuum tubes, electromechanical tone generators and photoelectric tone generators.—J.M.

## THUMBNAIL REVIEWS

**RADIO AND TV INDUSTRY RED BOOK.** Howard W. Sams & Co., Inc., Indianapolis, Ind., 2nd Edition, 1950, 623 pages, \$3.95. New edition contains 8 sections: I—component replacement listings for 1938-1948 radios and amplifiers, including correct replacement data for tubes, dial lights, electrolytic capacitors, transformers, chokes, phono cartridges, i-f coils, speakers and controls; II—same for 1948-1950 sets; III—postwar television receiver replacement listings, covering tubes, dial lights, electrolytics, iron-core transformers, phono cartridges, coils, speakers and controls; IV—vibrator replacements for 1938-1950 sets; V—battery replacements for 1938-1950 sets; VI—selenium rectifier re-

# IF you use SILVER laminated to non-precious base metals in your products

... you will welcome the fast and efficient service of this 53-year old organization and find it a dependable source for the finest of materials ... in sheet, wire or tubing.

Owner-management cuts red tape ... speeds production ... assures you of interested attention and complete satisfaction.

*Your inquiries will be appreciated and replied to ... promptly.*



**The Home of IMPROVED Service**

**The IMPROVED SEAMLESS WIRE COMPANY**

INCORPORATED 1898

775 Eddy Street, Providence 5, Rhode Island



# PICKERING



# SOLENOIDS

For DC Circuits

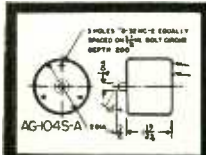

Pickering engineering service is available for special applications where Pickering standard Solenoids do not apply.

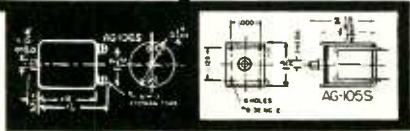

For details and literature address Department N  
**PICKERING & CO., INC.**  
 Manufacturers of world-famous electro-magnetic phonograph cartridges and audio equipment.  
 Oceanside, L. I., New York

AVOID SHUT-DOWNS WHERE CONTINUOUS OPERATION IS ESSENTIAL SPECIFY GRAYHILL "PLUG-IN" RELAYS FOR YOUR CUSTOMER'S BENEFIT. NO SOLDERING OR SCREW TERMINAL CONNECTIONS. SIMPLY PULL OUT THE OLD AND PLUG IN A REPLACEMENT. RANGES ARE FROM 6 TO 230 VOLTS, A. C. OR D. C. SILVER CONTACTS RATED AT 10 AMPS. PER POLE, RESISTIVE LOAD.

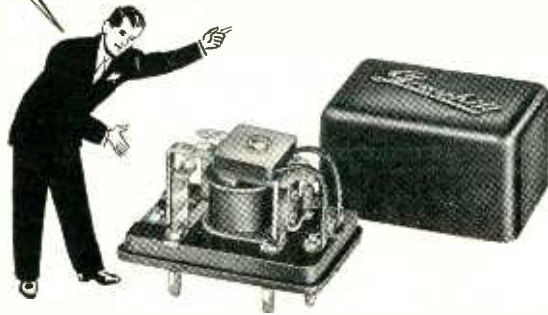

## Grayhill

4522 West Madison Street

GET DETAILS—  
 Write for the  
 Grayhill Catalog  
 now

Chicago 24, Ill.

**CAA** approved  
**instrument**  
 repair station NO. 2783

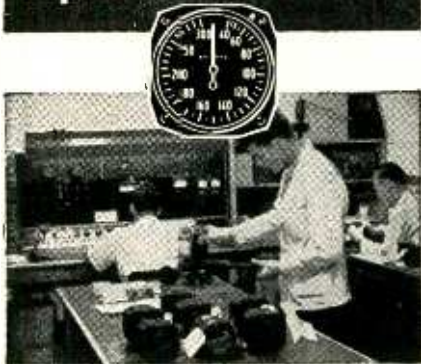

Instruments and accessories reconditioned and standardized in our modern, fully equipped and technically staffed laboratory.

**inquiries invited**

from foreign or domestic airlines and base operators

**Standard Products Inc.**

650 East Gilbert • Wichita, Kansas

# PRECISION POTENTIOMETERS

The linear Type RL-275 illustrated is one of a series ranging from 1 1/4" to 5" in diameter, with resistance ranges of 80 ohms to 500,000 ohms.

GAMEWELL Potentiometers are precision instruments in every respect. They feature extremely close limits in electrical characteristics and mechanical construction, low electrical noise, low torque, and long life—far in excess of 1,000,000 cycles of operation.

All types will operate within specified limits of performance at temperatures -55° C. to +55° C., 95% relative humidity at altitudes up to 50,000 feet. Corrosion resistant materials are used throughout and all insulating parts are fungicided. Our potentiometers meet AN-E-19 specifications.

We invite your inquiries and will gladly study and quote on special requirements.

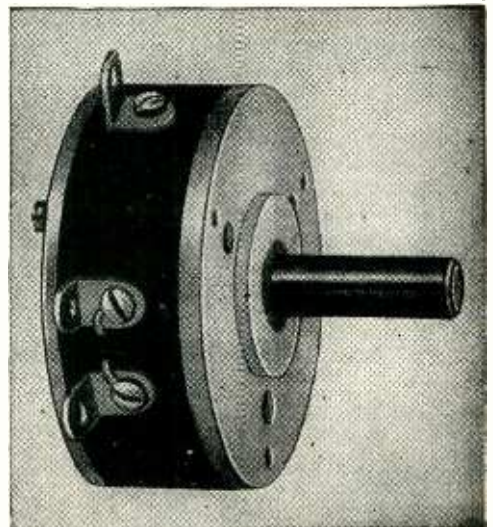

Write for Bulletin F-68.

**THE GAMEWELL COMPANY**

Newton Upper Falls 64, Massachusetts





The ONLY Soldering  
Tool You Need for

light

or **HEAVY**  
Work!

Switch instantly from light to heavy work—or vice versa—with the 250-watt Weller Soldering Gun. Controlled dual heat makes the Weller Gun the only soldering tool you need for all types of work. 5-second heating saves time and current on every job, too. Your Weller Gun pays for itself in a few months!

## 250-Watt WELLER SOLDERING GUN



### • TRIGGER-SWITCH CONTROL

Governs heat and saves power because no need to unplug gun between jobs. Heat goes off when you release trigger.

• **5-SECOND HEATING**—No waiting, no wasted current. Saves hours and dollars each month.

• **SOLDERLITE**—Spotlights the work. Lets you see what you're doing at all times, even in dark corners.

• **LONGER REACH**—Lets you get at any job with ease. Slides between wiring, into the tightest spots.

• **STREAMLINED**—Compact and comfortable to hold. Pistol-balanced for fast precision soldering.

• **WELLERTIP**—Rigid and chisel-shaped with more area for faster heat transfer. Over/under terminals brace tip, give greater visibility.

• **DUAL HEAT**—Single heat 200 watts; dual heat 200/250 watts; 120 volts; 60 cycles.

See the all-purpose Weller Soldering Gun today at your distributor—or write for bulletin direct.

**SOLDERING GUIDE**—Get your new copy of **SOLDERING TIPS**—revised, up-to-date and fully illustrated 20-page booklet of practical soldering suggestions. Price 10c at your distributor, or order direct.

**WELLER**  
ELECTRIC CORP.

806 Packer Street, Easton, Pa.



NEW BOOKS

(continued)

placements for postwar equipment; VII—volume control replacement data for very popular 1931-1938 radios; VIII—installation notes.

**HANDBOOK OF HUMAN ENGINEERING DATA FOR DESIGN ENGINEERS.** Tufts College Institute for Applied Experimental Psychology, Technical Report No. SDC 199-1-1, produced under contract with Special Devices Center of ONR; approximately 350 pages loose-leaf, \$5.00 from Tufts College Bookstore, Medford, Mass. Report on investigation into all aspects of increasing the effectiveness of a man-machine system, with emphasis on data pertaining specifically to fighting machines. Essentially a condensed compilation of literature on the subject, organized for convenient reference. Subjects covered include minimum and maximum space requirements for functional use of human body, factors affecting visual acuity, light sensitivity, depth perception and color vision; factors affecting efficiency of hearing; human response to various cues; effect of amount of sleep, temperature, humidity, ventilation, drugs, alcohol, tobacco, caffeine and benzedrine on higher mental processes, motor processes, sensory processes and physiological functions.

**AUTOMATIC RECORD CHANGER SERVICE MANUAL.** Volume 3 (1949-1950). Howard W. Sams & Co., Inc., Indianapolis, Ind., 286 pages, \$3.00. Servicing information and exploded views of mechanisms of 30 record changers, wire recorders and tape recorders, based on analysis of actual equipment, with cumulative index covering models in first two volumes as well.

**MODEL CONTROL BY RADIO.** By Edward L. Safford, Jr.; No. 43 of the Gernsback Library, published by Radcraft Publications, Inc., 25 West Broadway, New York, paper cover, 112 pages, \$1.00. The author, who is instructor in Guided Missile Electronics at Fort Bliss, Texas, has carefully selected portions of the literature that are of value to the person applying radio control to model ships, airplanes and cars. The book presents complete systems, separate sections on fundamentals of receiver and transmitter design, and discussions of various types of tubes, batteries, controls, servos, antennas, coders and decoders and power circuits. All component values for circuit diagrams are given, even coil dimensions.

**BIBLIOGRAPHY AND ABSTRACTS ON ELECTRICAL CONTACTS,** 1949 Supplement, American Society for Testing Materials, Philadelphia, 28 pages, paper-covered, \$0.75.

**APPLIED ELECTRONICS ANNUAL 1951.** British-Continental Trade Press Ltd., 222, Strand, London, W.C. 2. 264 pages, \$8.00. Available also from J. D. Griffiths, 2 Clarke Court, Rutherford, N. J. Collection of articles on various aspects of broadcasting, communication, radar, radioactivity and industrial electronics; addresses and officers of electronic associations throughout the world; addresses of electronic manufacturers throughout the world, arranged by countries; buyers' guide listing firms making various electronic components and equipments.

**INDUSTRIAL RESEARCH LABORATORIES OF THE UNITED STATES.** Published by National Research Council, National Academy of Sciences, Washington, D. C., Ninth Edition, 1950, 444 pages. For each of 2,845 different research laboratories, gives address of lab, names of executives, size of research staff, nature of research activities, whether consulting services are available, and size of library. Appendices give similar data for government labs and for universities and colleges offering research services to industry. One index gives geographical distribution of laboratories, and the other is a subject index to research activities. For electronics, 189 labs are listed; for microwave equipment 13; antennas 16; radar 22; radio 69; television 43.

# DUMONT

NEW  
IMPROVED  
TINYMITE

SMALLEST  
PRACTICAL MINIATURE  
PAPER CAPACITORS

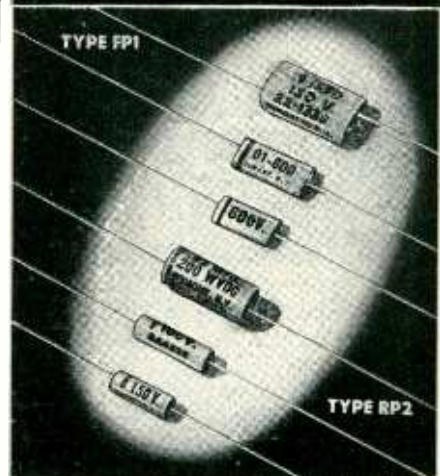

## FEATURES

1. 125°C. CONTINUOUS WORKING.
2. FULLY MOISTURE PROOF
3. SMALL • COMPACT LIGHTWEIGHT
4. UNIT ENTIRELY MOULDED.
5. FPI • FLAT SHAPE
6. RP2 • ROUND SHAPE

SEND FOR  
SAMPLES  
AND  
LITERATURE

FOR DEPENDABILITY ALWAYS  
SPECIFY DUMONT

**DUMONT**  
ELECTRIC CORP.

MEM'S OF  
CAPACITORS FOR EVERY REQUIREMENT  
308 DYCKMAN ST., NEW YORK, N. Y.



# STAY ON THE AIR WHEN POWER FAILS...with an ONAN Electric Plant



**AUTOMATIC  
START & STOP**

Model 10EL, 10KW A.C.

When storms, floods, or fires interrupt electricity and force you off the air, you lose listeners and income. Guard against loss, assure vital public service during emergencies by installing an Onan Electric Plant. Onan Standby Electric plants serve many network and private stations. Automatic models to 35,000 watts.

### PORTABLE ELECTRIC PLANTS FOR MOBILE RADIO USES

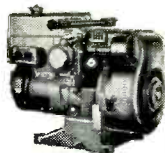

Supply A.C. power for broadcasting at scene of events. Can be carried by hand or in trunk of car. Weigh as little as 80 pounds. A.C. models 350 to 35,000 watts.

Write for **FREE Folder**



**D. W. ONAN & SONS INC.**  
7023 University S. E.  
Minneapolis 4, Minnesota

# Lavite STEATITE GERAMIC

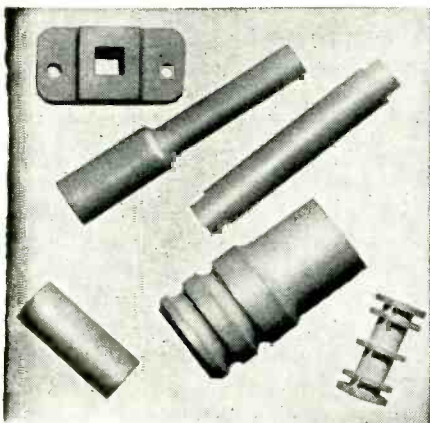

Design engineers and manufacturers in the radio, electrical and electronic fields are finding in LAVITE the precise qualities called for in their specifications . . . high compressive and dielectric strength, low moisture absorption and resistance to rot, fumes, acids, and high heat. The exceedingly low loss-factor of LAVITE plus its excellent workability makes it ideal for all high frequency applications.

Complete details on request

## D. M. STEWARD MFG. COMPANY

Main Office & Works: Chattanooga, Tenn.  
Needham, Mass. • Chicago • Los Angeles  
New York • Philadelphia

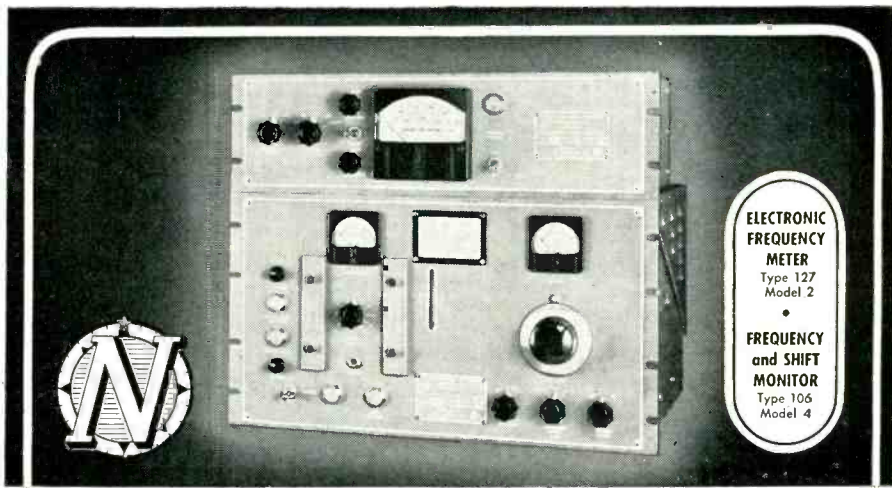

**ELECTRONIC  
FREQUENCY  
METER**  
Type 127  
Model 2

**FREQUENCY  
and SHIFT  
MONITOR**  
Type 106  
Model 4

## LABORATORY PRECISION for Communications Monitoring

Speed, sensitivity, widest usefulness, greatest ease of operation, and accuracy and stability—these are the features that make the Northern Radio MONITOR and FREQUENCY METER the most popular monitoring combination in communications. It measures carrier frequency and shift — during initial setup and while keying.

The Monitor's stability is better than 2 cycles per megacycle over an ambient temperature range of 0-50° C—using crystals having a temperature coefficient of only 3 parts/million/degree C. Range is 2.5-30 mc with 10 crystal-controlled frequencies (separate panel trimmers for each); use of external oscillator also provided for. Frequency Shift range is 10-10,000 cps. Less than 100 millivolts RF input needed for 2 volts audio output.

The Frequency Meter is specially designed with selectable normal and fast-acting damping factors, permitting frequency measurements of signals while keying. Its accuracy is 1% for the ranges 0-200, 500, 2000, 5000; 2% for 20,000 cps range.

See the specifications on this outstanding combination in the Electronics Buyers' Guide. For full data on the complete precision-built Northern Radio line, write today for your free latest Catalog E-6

**NORTHERN RADIO COMPANY, inc.** : 143-145 West 22nd Street  
: New York 11, N. Y.

Pace-Setters in Quality Communication Equipment

# Coil-Proved

LARGE OR SMALL  
SQUARE, ROUND OR RECTANGULAR

**PARAMOUNT**  
Spiral-Wound  
**PAPER TUBES**

Lengths from 1/2" to 30"  
Inside Perimeters, .450" to 25"

PARAMOUNT Paper Tubes facilitate coil winding—insure coil accuracy and stability. Proved by use, they have become standard with leading manufacturers of electrical, radio and electronic products. Here you are sure to obtain the exact size and shape you need for coil forms and other uses . . . from stock arbors, or specially engineered to your specifications. *Hi-Dielectric. Hi-Strength. Kraft, Fish Paper, Red Rope, or any combination, wound on automatic machines. Tolerances plus or minus .002" • Also Shellac Bonded Kraft Paper Tubes for absolute moisture resistance.*

WRITE ON COMPANY  
LETTERHEAD FOR  
STOCK ARBOR LIST  
OF OVER 1000 SIZES

## PARAMOUNT PAPER TUBE CORP.

616 LAFAYETTE ST., FORT WAYNE, IND.

Manufacturers of Paper Tubing for the Electrical Industry



# Kahle

specialists in custom-built, ultra-precision

## ELECTRON TUBE MACHINERY

KAHLE CUSTOM-BUILDS machines to make the exact tubes you require—from big 20-inchers to tiny sub-miniature—from laboratory types to those for high-speed production. Kahle puts each unit through exhaustive trial runs in our plant to assure trouble-free operation in yours.

### #1375 12-HEAD SEALING MACHINE

Also for hearing aid tubes. Kahle Standard Dual motor drive. Indexing by barrel cam and rollers. Heads have self-centering bulb holders.

Consultations invited  
Send for our new catalog

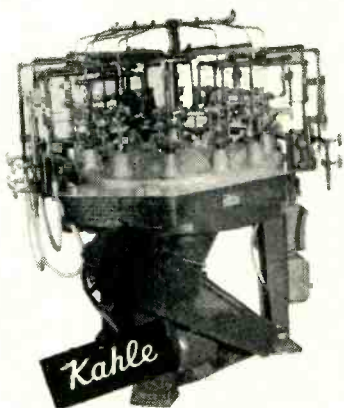

Production-boosting, labor-saving equipment for complete manufacture of cathode ray tubes, standard, miniature and sub-miniature radio tubes, sub-miniature tubes, fluorescent lamps, photocells, x-ray tubes, glass products.

# Kahle ENGINEERING CO.

1309 Seventh Street, North Bergen, New Jersey

## BACKTALK

(continued from page 152)

our eminent and revered friend, Dr. V. K. Zworykin (ELECTRONICS, March, 1951, page 81).

However, there are also sins of editorial omission, often quite as serious as those of commission. May I accordingly welcome you also to Rho Phi Epsilon, the fraternity of Red-Faced Editors. Please consider yourself elected, "tapped," initiated, and a member in as good standing as the rest of us.

I refer particularly to a beautiful but mangled composition which appeared in the March, 1951 issue of ELECTRONICS, namely, Dr. A. C. Schroeder's letter on "Simultaneous Systems". His letter started sedately, and with promise, on page 154 of your journal, under the general heading of "Backtalk". It ended after about one paragraph without any indication of the page on which it would resume its thoughtful way. In other words, the reader could only guess how far "back" the "talk" would be continued. Still sadder, the final sentence on page 154 was both cryptic and challenging, namely, "Since sampling multiplies the". This left the reader dangling, supported by an uncomfortable noose. What was multiplied by sampling, he asks himself. Could it be trouble, joy, dot visibility, circuit components, or something else?

On the following page 155, the reader finds only a pleasing advertisement. Pages 156 and 157 bring him no more than the startling news that 1,862,000,000 fasteners were used in television set assembly in 1950—and ELECTRONICS helped get them there. Surely these billions of fasteners could not have been multiplied by sampling. Page 158 brings another advertisement and also a continuation, stated to be from page 138, of "Tubes at Work". Hopefully the reader scans the first few phrases. But they do not fit into the "Backtalk" jigsaw puzzle.

Rather desperately the reader continues on his way, grimly determined to find what sampling multiplies. Like fluttering calendar sheets in a movie, the individually and carefully scanned pages fly past; 162, 170, 180, 200, 220, 240, 260, 280 and 300. Pausing for

## NEW! FREQUENCY AND TIME MEASUREMENTS ACCURATELY . . . CONVENIENTLY!

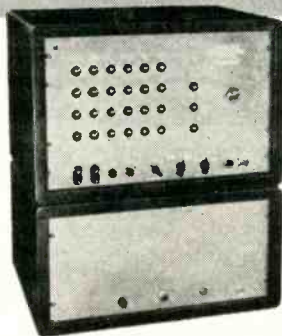

-using  $f = \frac{N}{t}$

ANY FACTOR  
MAY BE  
MEASURED  
FOR FIXED  
VALUE OF  
THE OTHER

### Universal 6-in-One MEGACYCLE FREQUENCY-TIME COUNTER

Model 801  
by **Potter**

Now, the Potter Instrument Company offers all in one equipment, the features heretofore available only in separate counting systems. Two complete counting channels, a 100 kc crystal oscillator time base and unique gating circuits are combined to provide the new FREQUENCY-TIME COUNTER.

FREQUENCY MEASUREMENTS	0 to 1 mc range by counting cycles per pre-selected time or by measuring time per pre-selected count. Accuracy 0.001% minimum.
TIME INTERVAL MEASUREMENTS	0 to 10 seconds ± 10 micro-seconds.
FREQUENCY RATIO MEASUREMENTS	Ratio of two external frequencies can be measured.
SECONDARY FREQUENCY	100 kc crystal oscillator with divided frequencies available at 10, 1 kc and 100, 10, 1 cps.
TOTALIZING COUNTER	Six decades, pulses 0 to 1 mc, sine wave 10 cps to 1 mc.
DIRECT RPM READING TACHOMETER	Through the use of an external 60 count per revolution photoelectric disc generator an accuracy of ± 1 rpm is obtained.

Please address inquiries to Dept. 6A



**POTTER INSTRUMENT COMPANY**  
INCORPORATED  
115 CUTTER MILL RD., GREAT NECK, NEW YORK





# G AIR

## FOLDING CARTONS

*Sell on Sight!*

Smartly designed and brilliant multicolor Folding Cartons by G AIR are solving packaging problems for many manufacturers who are as meticulous about their packaging as they are about their famous products.

Sales, profits and prestige are increased with the SELL-ON-SIGHT magic of G AIR MULTI-COLOR CARTONS.

WRITE TODAY for samples and technical information.



• REG. U. S. PAT. OFF.

### ROBERT G AIR COMPANY, INC.

155 EAST 44TH STREET, NEW YORK • TORONTO  
PAPERBOARD • FOLDING CARTONS • SHIPPING CONTAINERS

## CIRCUITS AND MICROWAVE ENGINEERS

*Permanent Positions for Men with Several Years of Experience*

A rapidly expanding organization with long range programs for commercial and government developments offers excellent opportunities in the field of general instrumentation including VHF, UHF, and microwave test equipment.

Our modern, well equipped laboratories are conveniently located in downtown Brooklyn and offer a stimulating and pleasant working atmosphere.

Men with Master's or Ph.D. degrees are preferred.



RESEARCH and DEVELOPMENT CO • Inc.

202 TILLARY STREET, BROOKLYN 1, N. Y.

## WASHERS—ALL KINDS

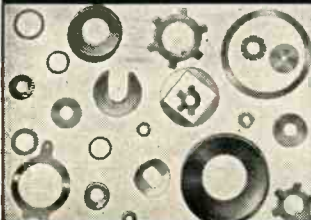

WASHER SPECIALISTS for nearly half-a-century. Dies in stock will produce most sizes. Big runs made with automatic presses. An economical, accurate, and highly reliable source for washers. also all kinds of metal stampings. HAVE WHITE-HEAD'S CATALOG ON FILE; write for it.

BEVELED CUP  
D-HOLE  
RETAINER  
LOCK  
SPACERS  
SPRING TENSION  
SQUARE HOLE  
STAR LOCK  
THRUST  
TONGUE



EST. 1903

WHITEHEAD STAMPING COMPANY

1691 W. LAFAYETTE

DETROIT 16, MICH.

## THE HI-GAIN Industrial POCKETSCOPE

BY WATERMAN

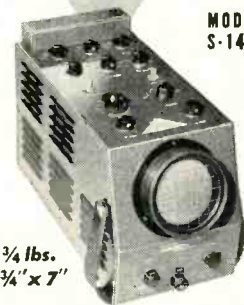

MODEL S-14-A

Wt. 12 3/4 lbs.  
12" x 5 3/4" x 7"

Another Waterman POCKETSCOPE providing the optimum in oscilloscope flexibility for analyses of low-level electrical impulses. Identified by its hi-sensitivity and incredible portability, S-14-A POCKETSCOPE now permits "on-the-spot" control, calibration and investigation of industrial electronic, medical and communications equipment. Direct coupling without peaking, used in the identical vertical and horizontal amplifiers, eliminates undesirable phase shifting. Designed for the engineer and constructed for rough handling, the HI-GAIN POCKETSCOPE serves as an invaluable precision tool for its owner.

Vertical and horizontal channels: 10mv rms/inch, with response within —2DB from DC to 200KC and pulse rise of 1.8µs. Non-frequency discriminating attenuators and gain controls with internal calibration of trace amplitude. Repetitive or trigger time base, with linearization from 1/2cps to 50KC with ± sync. or trigger. Trace expansion. Filter graph screen. Mu metal shield. And a host of other features.

### WATERMAN PRODUCTS CO., INC.

PHILADELPHIA 25, PA.  
CABLE ADDRESS: POKETSCOPE

WATERMAN PRODUCTS INCLUDE:

- S-10-B GENERAL POCKETSCOPE
- S-11-A INDUSTRIAL POCKETSCOPE
- S-14-B WIDE-BAND POCKETSCOPE
- S-15-A TWIN TUBE POCKETSCOPE
- S-21-A LINEAR TIME BASE

Also RAKSCOPES, LINEAR AMPLIFIERS, RAYONIC® TUBES and other equipment



# MICROPOT

PRECISION TEN-TURN POTENTIOMETER

1. You get permanent accuracy because the resistance wire is locked in place. It is precision positioned and moulded integrally with the housing.
2. You get permanently accurate settings, smooth action and low uniform torque provided by the stainless steel, precision ground, double thread lead screw guiding the moving contact.
3. You get precise positioning of the moving contact because of the two bearings supporting the rotor assembly.
4. You get good rigid terminals because they are moulded integrally with the housing.
5. Terminals soldered to ends of resistance element before moulding. Entire resistance circuit is an integral part of the housing.
6. You get accurate setting and re-setting due to anti-backlash spring in contact guide.
7. You get a fine resolution because of the  $43\frac{1}{2}$ " length of resistance wire in the spiral element.
8. You get a resistance output directly proportional to shaft rotation within  $\pm 0.1\%$  of the total resistance. Every potentiometer is automatically machine tested for linearity at 101 points.

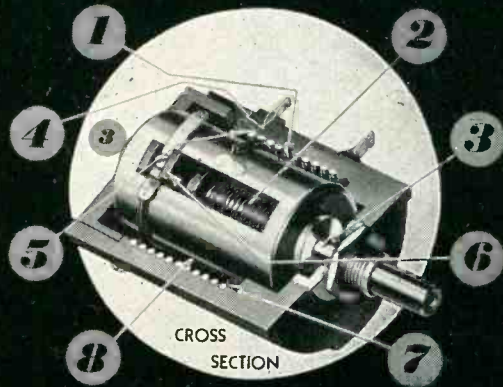

**LINEARITY  
ACCURACY  $\pm 0.1\%$**

Units for immediate shipment:  
1,000 to 30,000 ohm range.  
Special resistance values made to order.

WRITE TODAY FOR  
ENGINEERING INFORMATION



BORG EQUIPMENT DIVISION  
**THE GEORGE W. BORG CORPORATION**  
DELANA • WISCONSIN

breath and renewed vigor, the reader decides to fight out this battle even if it takes all summer. After all, eventually the Editor of ELECTRONICS will have to break down and tell what sampling multiplies. So he plods on, somewhat like Kipling's "boots" over Africa.

And then, Eureka! On page 318, and without any indication of authorship by Dr. Schroeder or the page from which it stems, Dr. Schroeder's letter is resumed. It is a bit of an anti-climax to find that what is multiplied by sampling is a mathematical function. But why quibble after so great a triumph as finding an unannounced continuation of an important analysis only 164 pages further on.

From this point, the sailing is comparatively smooth. Sandwiched here and there, a paragraph or two to a page, the reader picks his way through the letter on pages 320, 322, 324, and 326. Thus he triumphantly finds the remainder of Schroeder's "Unfinished Symphony".

Evidently our editorial slips are showing. And as one not without sin I have not hesitated to throw the second stone.

With sincere regards,

Whimsically yours,

ALFRED N. GOLDSMITH

*Editor  
Proceedings of the Institute of  
Radio Engineers*

Editor's Note: Doctor Goldsmith's observations are, unfortunately, quite correct. We were, however, somewhat relieved to find that our distinguished critic's careful eye overlooked a similar omission in the *New Books* department for the same month. We should have had continued lines routing book review readers to page 306. We hope our standing in Rho Phi Epsilon will not be jeopardized if we promise it will never happen again.

## Electronics Quiz

THIS month's quiz puzzler was furnished by A. T. Colbeck of Talgarth, Breck, Wales. For his contribution, Colbeck will receive our check for five dollars, as will all

# E-HERMETIC SEALING COMPONENTS

*Now Available!*

An extended range of types and sizes in the popular

## 90-G SERIES MULTIPLE HEADERS

The 90-G Series is now supplied in a wider range of types than ever before. These include 5 and 10 amp lead sizes with from 2 to 14 terminals as well as plug-in bases for miniature 7, noval 9, and special 14-prong sockets. Voltage ratings are 1600 peak.

Write for These Descriptive Bulletins:

- 849 — Hermetically Sealed Terminals
- 850 — Hermetically Sealed Headers
- 851 — Gasket Type Bushings



90 G/40-HS-8

90 G/40-HS-14



90 G/P-7  
(Miniature)

90 G/P-9  
(Noval)

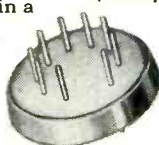

90 G/P-14



90 G/60-NS-12



**ELECTRICAL INDUSTRIES  
INCORPORATED**  
44 SUMMER AVENUE • NEWARK 4, N. J.





## Ungar's little Angels

### DO A HEAVENLY SOLDERING JOB

Pick any job and you'll find a pip of a tip to use with the trim, slim Ungar Pencil. Any of the 8 Ungar Angels interchange in the No. 776 Handle to make a honey of a tool that does work faster and better than larger, heavier irons. Whatever your problem, you'll bless the day you discovered these saintly soldering cherubs!

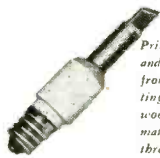

No. 540 COMBINATION KNIFE

Primarily recommended for cutting and stripping vinyl plastic insulation from specialty wire. Also ideal for cutting and marking various plastics and wood, cutting and sealing woven plastic materials. Consists of Part No. 122 which threads onto Heating Unit No. 267.

Write for Catalog No. 600

**Ungar** ELECTRIC TOOLS, INC., Los Angeles 54, Calif

# MICRODIAL

## TEN TURN-COUNTING DIAL

Microdial is composed of two concentrically mounted dials... one for counting increments of each turn and the other for counting turns. The incremental dial has 100 equal divisions and is attached rigidly to the shaft so there is no backlash. Thus the contact position is indicated to an indexed accuracy of 1 part in 1,000. Rotation is continuous in either direction. There are no stops on the Microdial assembly.

**COMPACT...** Microdial has same O.D. as Micropot... requires no more panel space.

**CLEAR READING...** Forced fast-reading tests showed only 1/20th as many errors with Microdial open window as with next most legible dial. Turn counter distinguishes between 0 and 10 turn readings, and accelerates to avoid confusion on readings near integral turns. Precise readings are made from larger dial with maximum separation of graduations and wide angle visibility.

**CONVENIENT...** delivered completely assembled with dials synchronized. Easily mounted in a few seconds. All dials may be locked.

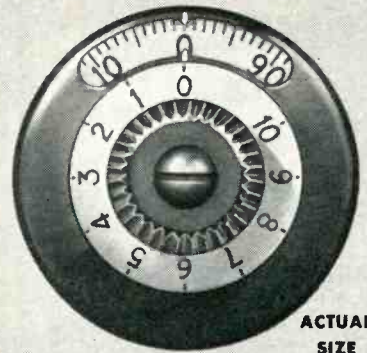

ACTUAL SIZE

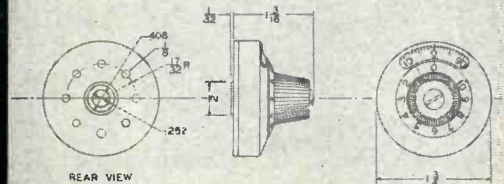

Microdial... turn-counting dial, primarily designed for use on Micropot ten turn linear potentiometers... use it on any multiturn device having ten turns or less.



BORG EQUIPMENT DIVISION  
**THE GEORGE W. BORG CORPORATION**  
DELANA • WISCONSIN

## STATHAM ANGULAR ACCELEROMETERS



A new series of unbonded strain gage angular accelerometers is available to detect and measure angular acceleration in ranges from  $\pm 3$  to  $\pm 400$  radians/sec/sec. The design of these instruments permits close balance against linear acceleration effects and excellent resolution while providing greatly increased resistance to destruction by linear acceleration. In these instruments, the suspended mass weighs but a few grams.

In corresponding, may we suggest that you be as specific as possible in outlining range and frequency requirements so that we may offer detailed recommendations in our reply.

**SL**  
STATHAM  
LABORATORIES SCIENTIFIC  
INSTRUMENTS

12401 WEST OLYMPIC BLVD.  
LOS ANGELES 64, CALIF.

STANDARDIZE ON Standard • STANDARDIZE ON Standard • STANDARDIZE ON Standard

## Standard CRYSTALS Stand UP!

That's not just "sales talk" either. Years of research and experience in crystal manufacture are behind the special process we use to make STANDARD products stand up under shock and extreme temperature variations. Their range?—200 to 1200 kc. CT and DT cut. Hermetically sealed and dry nitrogen filled. Of course, they meet all Government Specifications.

Write—wire—call for specific information or request Catalog E for complete details.

# Standard Piezo COMPANY

CARLISLE, PENNSYLVANIA

STANDARDIZE ON Standard • STANDARDIZE ON Standard • STANDARDIZE ON Standard

## 2 KW VACUUM TUBE BOMBARDER OR INDUCTION HEATING UNIT



For Only \$650.

Never before a value like this new 2-KW bench model "Bombardeer" or high frequency induction heater . . . for saving time and money in surface hardening, brazing, soldering, annealing and many other heat treating operations.

Simple . . . Easy to Operate . . .  
Economical Standardization of  
Unit Makes This New Low Price  
Possible.

This compact induction heater saves space, yet performs with high efficiency. Operates from 220-volt line. Complete with foot switch and one heating coil made to customer's requirements. Send samples of work wanted. We will advise time cycle required for your particular job. Cost, complete, only \$650. Immediate delivery from stock.

Scientific Electric Electronic Heaters are made in the following ranges of Power: 1-2-3½-5-7½-10-12½-15-18-25-40-60-80-100-250KW.

*Scientific  
Electric*

Division of

"S" CORRUGATED QUENCHED GAP CO.

107 Monroe St., Garfield, N. J.

BACKTALK

(continued)

of the other contributors whose problems are published in this department.

### *This Month's Problem*

A bridge of resistors is formed as follows: C to A = 100,000 ohms; A to D = 200,000 ohms; D to B = 50,000 ohms; and B to C = 100,000 ohms. Points C and D are connected across a zero-impedance source of 300 volts d-c, and a 10- $\mu$ f capacitor is placed between points A and B.

What will be the initial current flowing into the capacitor at the instant the voltage is applied? Also, what is the time constant of the circuit? (By time constant is meant the time taken for the potential difference across the capacitor to rise to  $(1 - 1/e)$  of its final value.)

The answer to this problem will be published in this column next month.

### *Last Month's Problem*

Last month's problem was as follows.

Assume a superheterodyne receiver with a signal input to the converter of frequency  $f$ , and a local oscillator input of frequency  $(5/4)f$ . Then, in accordance with established principles of converter action, its output will contain the two input frequencies  $f$  and  $(5/4)f$ , and the sum and difference frequencies  $(9/4)f$  and  $1/4f$ . The intermediate frequency amplifier is, as usual, tuned to pass only the difference frequency.

Now suppose that, instead of the local oscillator, we substitute a modulator. This modulator accepts the signal input of frequency  $f$  and modulates it with a voltage of frequency  $1/4f$ , taken from a point at or near the output of the intermediate frequency amplifier. In accordance with principles of modulator action, its output will contain the two input frequencies  $f$  and  $1/4f$ , two side-band frequencies  $(3/4)f$  and  $(5/4)f$ ,

## REK-O-KUT

Turntables are now being specified on Gov't. Contracts for this particular type of equipment!

We particularly call your attention to the new

## REK-O-KUT

Continuously Variable-Speed Turntable Model CVS-12



MODEL-CVS 12  
Chassis, Motor and  
Turntable Assembly  
Plays all records  
from 6 to 16  
inches.

\$84.95 net

Plays at any speed from 25 to 100 R.P.M. without wow. Meets the following Government Specifications for operation and power requirements!

POWER	VOLTAGE	FREQUENCY
Nominal	115 V.	60 Cycles
Upper Limit	122 V.	65 Cycles
Lower Limit	108 V.	55 Cycles

### Specifications on Equipment:

Equipment shall rotate records at 78, 45 and 33 $\frac{1}{3}$  and shall be arranged so that those speeds can be established and maintained on the specified power supply, and any slow rate variations, and also within the limit specified as above.

The new REK-O-KUT CVS-12 is the ONLY 12 inch Turntable to our knowledge which will meet these Government Specifications.

Operates on 50 or 60 cycles . . . no pulleys to add or idlers to change. The only Turntable to use in areas of fluctuating voltage, frequency, or with portable power plants.

### SPECIFICATIONS

Speed Changes: Continuously Variable  
(a) 110V-60 Cycles, Range: 25 to 100 R.P.M.  
(b) 110V-50 Cycles, Range: 20 to 85 R.P.M.  
Turntable-12" cast aluminum, hardened and ground shaft.  
Motor-constant speed, 4 pole.  
Drive-exclusive Rek-O-Kut VARI-CON\* self-seating rim drive.  
Noise Level-30db maximum below recording level.  
Dimensions-16" L., 12" W., 5" below chassis.  
Available at your regular parts distributor. Manufacturer's discounts on request.

## REK-O-KUT CO.

38-23 Queens Boulevard  
Long Island City 1, N. Y.





**GET YOUR COPY NOW!**

—Of "Standard's" **UNBRAKO Standards**  
Write on your business letterhead, today.

SOCKET **UNBRAKO** SCREWS

**-SPS STANDARD PRESSED STEEL CO.**  
JENKINTOWN 10, PENNSYLVANIA

## HOBSON PRECISION COMPONENTS

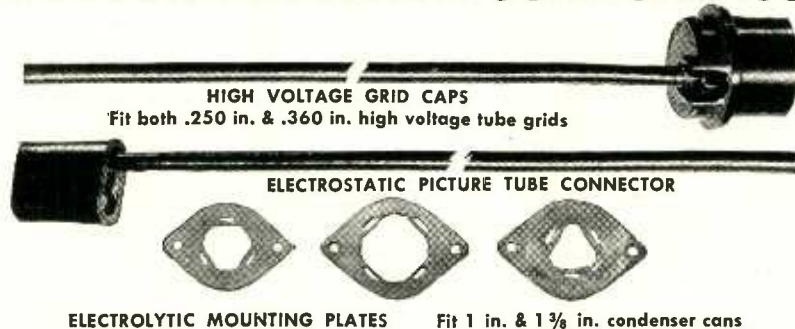

**HIGH VOLTAGE GRID CAPS**  
Fit both .250 in. & .360 in. high voltage tube grids

**ELECTROSTATIC PICTURE TUBE CONNECTOR**

**ELECTROLYTIC MOUNTING PLATES** Fit 1 in. & 1 1/2 in. condenser cans

**HOBSON BROS. • 4049 W. Fullerton St. • CHICAGO 39, ILL.**

## DANO COILS STAR IN ANY LEAGUE



- Form Wound
- Paper Section
- Acetate Bobbin
- Bakelite Bobbin
- Cotton Interweave
- Coils for High Temperature Applications

ALSO,  
**TRANSFORMERS  
MADE TO ORDER**

Whether you need a simple coil winding or specially treated coils deeply impregnated with wax or varnish in vacuum impregnation tanks and cured in heat controlled ovens—get on the winning team with **DANO COILS**.



**THE DANO ELECTRIC CO.**  
MAIN ST., WINSTED, CONN.

## RELIABLE INSTRUMENT PERFORMANCE

—is predicated on

- Understanding the end use
- Electronic "know how"
- Design technique
- Dependable components

for better  
instrumentation

### Subminiature vacuum tubes



5799	Diode
5800	Electrometer tetrode
5803	Electrometer triode
5828	Triode, medium mu
5841	Corona Regulator, 900 V
5950	Corona Regulator, 700 V
VXR-130	Regulator, 130 V
VX-10	Switch

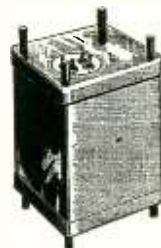

### Vibrator power supply

The Model 517 vibrator type power supply provides regulated high and plate voltages for counter tubes, photomultipliers and associated circuit from 4 1/2 V of battery.

High conversion efficiency

Low weight and size

### Hi-megohm resistors

Vacuum sealed in glass in a range of values from 100 megohms to 10,000,000 megohms. A quality resistor for today's precision instrumentation.



**THE VICTOREEN INSTRUMENT CO.**  
5806 HOUGH AVENUE  
CLEVELAND 3 OHIO

# SERVOTHERM PRODUCTS

## BOLOMETER AND PREAMPLIFIER

Thermistor bolometers are FAST, sensitive INFRARED and HEAT detectors. Especially RUGGED for industrial, scientific, and military applications. PREAMPLIFIER provides NOISE-FREE initial amplification and mount.



## THERMISTOR POWER SUPPLY

Provides voltages required by BOLOMETER bridge and PREAMPLIFIER. Regulated and filtered permitting THEORETICAL NOISE LIMITS of amplification, while operating from 60 CYCLE line.



**SERVO CORPORATION OF AMERICA**

DEPT. E-6

NEW HYDE PARK, N.Y.

and higher harmonics which may be bypassed and neglected. Note that the side-band frequency  $(5/4)f$  is the same as the local oscillator frequency in the original receiver. The other side-band frequency  $(3/4)f$ , entering the converter would produce beat frequencies with the signal frequency, of which only the difference frequency  $1/4f$  would be accepted by the intermediate frequency amplifier.

### General Case

Extending the reasoning now to the general case for any ratio  $n$  of signal frequency to intermediate frequency, the output of the modulator contains the frequencies

$$f + \frac{f}{n} \text{ and } f - \frac{f}{n}$$

Considering the first of these two terms in the converter action, we obtain the following expressions for the sum and difference frequencies in its output:

$$(1) \left(f + \frac{f}{n}\right) + f = 2f + \frac{f}{n}$$

(rejected by i-f amplifier)

$$(2) \left(f + \frac{f}{n}\right) - f = \frac{f}{n}$$

(passed by i-f amplifier)

Considering the other modulator output frequency, we obtain for the sum and difference frequencies in the converter output:

$$(3) f + \left(f - \frac{f}{n}\right) = 2f - \frac{f}{n}$$

(rejected by i-f amplifier)

$$(4) f - \left(f - \frac{f}{n}\right) = \frac{f}{n}$$

(passed by i-f amplifier)

Thus it would appear that we can construct a super-heterodyne receiver with a modulator operating as described instead of a local oscillator. The modulator would automatically provide the correct relationship of frequencies to make best use of the intermediate frequency amplifier characteristic and thereby do away with the tracking

STANDARD OF THE WORLD FOR QUALITY HEADSETS



# LISTENING COMFORT

HEARING AT ITS BEST!

Modern, lightweight, durable—Telex Quality Headsets are easy on the ears . . . No uncomfortable ear pressure . . . Easily adjustable and built for hard usage . . . Telex Headsets effectively block out background noises . . . 5 ft. standard cord or special cord with built-in volume control . . .



### TWINSET \*

Nothing Touches the Ear  
Weighs only 1.6 oz.

### MONOSET \*

Direct Signal for Both Ears  
Weighs only 1.2 oz.



WRITE FOR FREE FOLDER—OR SEE YOUR PARTS JOBBER.

\*TRADEMARK

**ELECTRO-ACOUSTIC DIVISION • DEPT. H-15 TELEX PARK ST. PAUL 1, MINN. In Canada, Atlas Radio Corporation, Toronto**



**SECON** development  
and production  
**METALLURGISTS**

Base, Rare and Precious Metals  
and Alloys.

Small Units

Small Sizes

Close Tolerances

Nickel alloy, filament wire and  
ribbon: flat, grooved, crowned.

Grid wire electroplated.

Alloys for special requirements,  
bare or enamelled.

*Further details upon  
request.*



**METALS CORPORATION**  
228 East 45th Street, New York 17, N. Y.  
MUrray Hill 7-1594

*Simplify Your Wiring With*  
**KULKA TERMINAL BLOCKS**

*Eliminate Splicing • Stop Leaks and  
Shorts • Increase Insulation*



Blocks of high tensile strength Baka-  
lite (or other plastics to gov't spec.)  
and come in 4 sizes—with 1 to 23  
terminals. Screws and solder lugs  
of nicked brass. Lugs in several  
styles, also eyeletted to block.  
Marker strips come plain or printed,  
or blocks can be engraved.



Write Dept. E for Catalogue

**KULKA** ELECTRIC  
MFG. CO. INC.  
Mt. Vernon, N. Y.

# “Wow-Meter”



Improved direct-reading instrument sim-  
plifies measurements of wow and flutter in  
speed of phonograph turntables, wire re-  
corders, motion picture projectors and  
similar recording or reproducing mecha-  
nisms. It is the only meter in existence  
giving direct steady indication of meter  
pointer on scale.

The Furst Model 115-R “Wow-Meter” is  
suitable for both laboratory and produc-  
tion application and eliminates complex  
test set-ups.

A switch on the front of the panel permits  
selection of low frequency cut-off and  
corresponding meter damping for use on  
slow speed turntables.

*Inquiries Invited on our line of Regulated Power Supplies*  
Frequency Response: 1/2 to 120 cycles or 10 to 120 cycles  
Sensitivity: 0.2, 0.5, and 2.0% Wow Full Scale



## FURST ELECTRONICS

10 S. Jefferson St., Chicago 6, Ill.

### RECOGNIZED . . . FOR SERVICE TO THE INDUSTRY



A Complete  
Line of  
Radio and  
Television  
KNOBS

Ceramic  
Stand-off, Feed Thru,  
and Tie Terminals  
Army-Navy Approved



Designers • Engineers

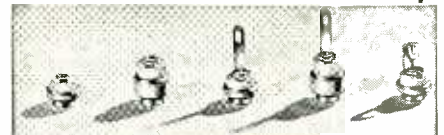

•KNOBS • PLASTIC EMBOSSED • TERMINALS  
4739 MONTROSE AVE. CHICAGO 41, ILL.

## MIL-T-27 CANS ARE STOCK ITEMS

AT *Heldor*



We can supply all standard sizes of MIL-T-27 cans  
with or without brackets, weld studs, centrifugal  
hot tinned, blind inserts, compression type hermetic  
seal bushings on 3/8"–1/2"–5/8"–3/4" centers, and  
stamped ratings. Custom sizes can also be supplied.  
Our other services include complete hermetic seal  
assemblies. Write for specifications and price list.

**HELDOR MANUFACTURING CO.**

A Division of **Heldor Bushing and Terminal Co., Inc.**

Note Our New Address: 225 Belleville Ave., Bloomfield, N. J.

# Attention: ELECTRONIC ENGINEERS

Are You Looking For A Material To Completely Impregnate, Mold, and Encapsulate Electrical Components?

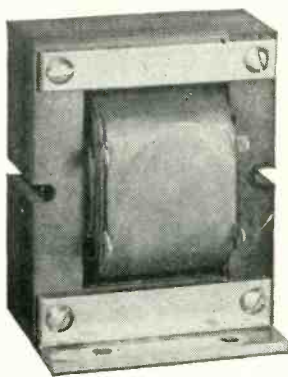

Before

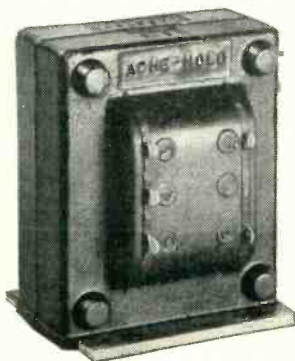

After

Acme Star Compound withstands rugged humidity and thermal cycling, as well as salt spray tests.

Millions of ACME-MOLD coils are in service and now Acme offers Star Compound for your use.

Write today for further details

**Acme**

THE ACME WIRE CO.

INSULATING VARNISHES  
ACME-MOLD COILS



**Wire**

NEW HAVEN, CONN.

MAGNET WIRE  
VARNISHED INSULATION

BACKTALK

(continued)

problems inherent in the tuning of an adjustable type of local oscillator.

What is the fallacy in this reasoning?

*Answer:* The reasoning is not fallacious per se. It is actually possible to construct a receiver operating on this principle, although the feedback involved makes stabilization of the circuits extremely difficult. Furthermore, the circuit would accept all signal frequencies equally well, and hence such a receiver would have no better selectivity than that of the preselector ahead of the converter.

## Feedback

DEAR SIRS:

ROBERT TANNER of Stanford, California (Stanford University) did an excellent detailed theoretical analysis of a loudspeaker coupled to an amplifier in his article entitled "Improving Loudspeaker Response with Motional Feedback" in *Electron Art*, March, 1951.

I am enclosing letters to show that I had the same idea; in fact, with my good friend Russell Warren I made a stab at getting a patent on the idea in 1939. We conducted laboratory experiments on both RCA and Jensen speakers by winding an

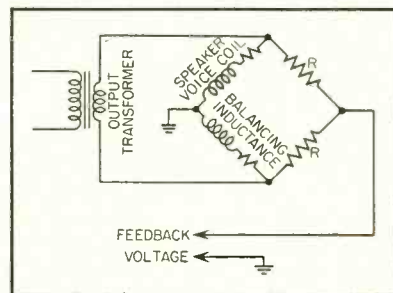

extra coil on the voice coil form for feedback. The results were very pleasing.

Now there is another way of accomplishing similar results which does not necessitate any work on the speaker itself. By using the voice coil as one arm of a bridge and balancing the coil with an equal inductance, the counter emf of the voice coil may be separated from the driving voltage. The counter emf is just as good for equalizing as the voltage from a separate coil.

ROBERT B. MCGREGOR  
WHAS-TV  
Louisville, Kentucky

when

# MAXIMUM

## SIGNAL RESOLUTION

### IS A "MUST"...SO ARE

## PANORAMIC PANALYZOR SB-8 AND PANADAPTOR SA-8

These instruments enable spectrum analysis of signals so close in frequency that their corresponding indications would normally mask one another.

**FEATURES**—Continuously variable resolutions • Continuously variable scanning width • Long persistence cathode-ray tube . . . 5" Screen • Intensity grid modulation for pulse analysis • Synchronous and non-synchronous scanning • Variable scanning rates • Linear and log amplitude scales.

Let a Panoramic specialist advise you on your individual problems.

Write for fully detailed bulletin.

10 SOUTH SECOND AVENUE, MOUNT VERNON, N. Y.

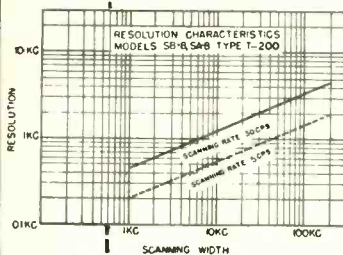



# PROFESSIONAL SERVICES

## AMERICAN SPEEDLIGHT CORP.

(AFFILIATED WITH J. G. SALTZMAN, INC.)  
HARRY L. PARKER, PRESIDENT and  
CHIEF ENGINEER  
Specialist in Flash and Electronic Equipment  
for Photography.  
Consultation—Development—Design and  
Manufacture  
480 Lexington Avenue New York 17, N. Y.

## CROSBY LABORATORIES, INC.

*Murray G. Crosby & Staff*  
Radio-Electronic Engineering,  
Research & Development  
FM, Communications, TV  
Test Equipment  
Offices, Laboratory & Model Shop at:  
126 Herricks Rd., Mineola, N. Y.  
Garden City 7-0284

## DUBROW DEVELOPMENT CO.

*Design — Development — Mfr.*

Quality Electronic Equipment  
347 High St. Burlington, N. J.  
Burlington 3-0446

## EDGERTON, GERMESHAUSEN & GRIER, INC.

*Consulting Engineer*

Research Development and Manufacture  
of Electronics and Stroboscope Equipment  
Specialists in High-Speed Photography  
160 Brookline Avenue, Boston 15, Mass.

## ELECTRONIC ENGINEERING CO. of CALIFORNIA

Radio and Electronic Consulting and  
Designing.

180 S. Alvarado Los Angeles  
DUnkirk 2-7353 California

## ERCO RADIO LABORATORIES, INC.

*Radio Communications Equipment*

Engineering - Design - Development - Production  
Pioneers in Frequency Shift Telegraph  
Garden City • Long Island • New York

## GEORGE H. FATHAUER

Development and Design

of FM, TV, VHF Communications Equipment  
Complete Laboratory and Model Shop Facilities  
4005 E. Michigan St. Telephone  
Indianapolis 1, Indiana BLackstone 1330

## EDWARD A. GAUGLER, Ph.D.

*Consulting Physicist*

Magnetic Materials and their Applications  
#19 Shepherd St. Chevy Chase, Md.  
Wisconsin 6106

## HERMAN LEWIS GORDON

*Registered Patent Attorney*

Patent Investigations and Opinions  
Warner Building, Washington 4, D. C.  
National 2497

## WHEN TIME IS

### SHORT . . . .

put the solution of your problems up  
to a specialized Consultant whose pro-  
fessional card appears on this page.  
His broad experience may save you  
months of costly experimentation.

## ELECTRONICS

330 West 42nd St., New York 18, N. Y.

## HANSON-GORRILL-BRIAN INC.

*Products & Mfg. Development*

ELECTRICAL - ELECTRONIC  
HYDRAULIC - MECHANICAL  
One Continental Hill Glen Cove, N. Y.  
Glen Cove 4-1922

## R. W. HODGSON

PATENT-INVENTION RESEARCH & DEVEL-  
OPMENT ENGINEER SPECIALIZING  
IN ELECTRONICS

Gadget-of-the-Month Club Bldg.  
8600 Lexington Ave., Hollywood 38, Calif.  
All mail to Box 874, Sherman Oaks, Calif.  
GLadstone 9680 HUdson 2-2311 STate 4-9318

## HOGAN LABORATORIES, INC.

John V. L. Hogan, Pres.

*Applied Research, Development, Engineering*  
Est. 1929. Exceptionally competent staff.  
Electronics, Optics, Mechanisms, Facsimile  
Communication, Electro-sensitive record-  
ing media, instrumentation.  
155 Perry Street, New York 14 CHelsea 2-7855

## MEASUREMENTS CORPORATION

*Research & Manufacturing Engineers*

Harry W. Houck Jerry B. Minter  
John M. van Beuren  
Specialists in the Design and  
Development of Electronic Test Instruments  
Boonton, N. J.

## A. JOHN MICHEL

*Registered Patent Attorney*

SPECIALIZING IN ELECTRONICS  
15 Park Row, New York 38, N. Y. Tel. CO 7-9034

## Eugene Mittelman, E.E., Ph.D.

*Consulting Engineer & Physicist*

High Frequency Heating—Industrial Electronics  
Applied Physics and Mathematics  
549 W. Washington Blvd. Chicago 6, Ill.  
State 2-8021

## NIAGARA ELECTRON LABORATORIES

CONSULTATION - DESIGN - CONSTRUCTION  
MFG. THE THERMOCAP RELAY

Specializing in solution of problems of electronic  
and electro-physical instrumentation for the re-  
search or analytical laboratory. Industrial plant  
problems also invited.  
Andover, New York Cable Address: NIATRONLAB

## PHYSICAL RESEARCH ASSOCIATES

*Consulting Physicists & Engineers*

Arthur M. Vigilante, Director  
Research, Development, Design and Manufacture  
of Detection and Recording Systems. Industrial  
and Analytical electro-physical instrumentation.  
Dynamic Condenser Electrometers.  
#1 Azurelee Drive Malibu, Calif.  
Malibu 8444

## PICKARD AND BURNS, INC.

*Consulting Electronic Engineers*

Analysis and Evaluation  
of Radio Systems  
Research, Development & Design  
of Special Electronic Equipment  
240 Highland Ave., Needham 94, Mass.

## ALBERT PREISMAN

*Consulting Engineer*

Television, Pulse Techniques, Video  
Amplifiers, Phasing Networks,  
Industrial Appliances  
Affiliated with  
MANAGEMENT-TRAINING ASSOCIATES  
#308-14th St., N.W. Washington 10, D. C.

## SKINNER, HARLAN AND IRELAND, INC.

*Consulting Engineers*

Specializing in Magnetic Materials and  
Their Application  
Office and Laboratory Indianapolis 7, Indiana

## The Robert H. Streeter Co.

*Electronic Design Specialists*

Engineering Consultants  
Representing Manufacturers  
of Electronic Equipment  
in Southern United States  
Specialists in the design and construction of spe-  
cialized pieces of equipment for specific applications  
Tel. 97 Greenwood, Miss.

## THE TECHNICAL MATERIEL CORPORATION

*Communications Consultants*

Systems Engineering  
General Offices and Laboratory  
121 Spencer Place, Mamaroneck, N. Y.

## TELECHROME, INC.

*Electronic Design Specialists*

COLOR TELEVISION EQUIPMENT  
Flying Spot Scanners, Color Synthesizers, Keyers,  
Monitors, Oscilloscopes and Related Apparatus  
J. R. Popkin-Curman, Pres. & Ch. Engr.  
88 Merrick Rd. Amityville, L. I., N. Y.

## WHEELER LABORATORIES, INC.

Radio and Electronics

Consulting—Research—Development  
R-F Circuits—Lines—Antennas  
Microwave Components—Test Equipment  
Harold A. Wheeler and Engineering Staff  
Great Neck, N. Y. Great Neck 2-7806

## YARDNEY LABORATORIES, INC.

*Research - Design - Development*

Electro-Chemical Generators of Energy  
105 Chambers Street WORTH-2-3534, 35, 36  
New York 7, N. Y.

# CONTACTS

FOR THE FIELD OF ELECTRONICS

## SEARCHLIGHT SECTION

(CLASSIFIED ADVERTISING)

REPLIES (Box No.): Address to office nearest you  
 NEW YORK: 330 W. 42nd St. (13)  
 CHICAGO: 320 N. Michigan Ave. (11)  
 SAN FRANCISCO: 68 Post St. (4)

### EMPLOYMENT SERVICES

SALARIED PERSONNEL, \$3,000-\$25,000. This confidential service, established 1927, is geared to needs of high grade men who seek a change of connection under conditions assuring, if employed, full protection to present position. Send name and address only for details. Personal consultation invited. Jira Thayer Jennings, Dept. L, 241 Orange St., New Haven, Conn.

SCIENTISTS' & ENGINEERS' Ass'n.-Specializes in confidential placement of qualified personnel U. S. & overseas. Write Radio Engineering & Communications Dept. Mgr., Mrs. R. M. Fish, Woodbine Rd., Stamford, Conn.

### POSITION WANTED

GRADUATE E. E. with heavy technical and administrative experience in radio and electronic engineering seeks position as chief engineer of small or medium-sized company or assistant chief of larger. Will also consider position as technical group leader. Within commuting distance of Paterson, N. J. PW-9730, Electronics.

### SELLING OPPORTUNITY WANTED

WASHINGTON REPRESENTATIVE: Available to established electronic or electrical production or development organization. Thoroughly experienced in government procurement procedures and all phases of government relations. RA-9512, Electronics.

### PATENTS

Consult: Z. H. Polachek.  
 Reg. Patent Attorney, 1234 Broadway, New York 1, N. Y.

## CHICAGO SALES REPRESENTATIVE AVAILABLE

Thoroughly experienced in selling electrical and electronic components and supplies to radio, television and electrical manufacturers. Commission basis only. Can furnish excellent references and sales record.

RA-9608, Electronics  
 520 No. Michigan Ave., Chicago 11, Ill.

### PACIFIC COAST

Sales Engineering Specialists accept representation of Eastern or Midwestern manufacturer in Electrical and Electronic Field.

Engineering Service with Wide Sales Coverage  
 Assembly and Warehouse Facilities Available

Reply RA-9457, Electronics  
 330 W. 42 St., New York 18, N. Y.

### WANTED FACILITIES & PERSONNEL

Old established electrical manufacturing concern is interested in acquiring facilities and technical personnel in the Selenium Rectifier field.

M-9313, Electronics  
 330 W. 42 St., New York 18, N. Y.

The nonmelting **SILICONE** insulating and waterproofing compound, stable at temperatures from -70°F. to +400°F.



### MEETS ALL REQUIREMENTS OF AN-C-128a

More water repellent than paraffin, Dow Corning 4 Compound is highly resistant to oxygen, ozone and to deterioration caused by corona discharge.

POWER FACTOR up to 10 megacycles... 0.001  
 VOLUME RESISTIVITY ohm centimeters... 10"  
 DIELECTRIC STRENGTH volts/mil... 500

Write Today!

for your copy of our new booklet on Dow Corning 4 Compound, Address Dept. J

DOW CORNING CORPORATION, Midland, Michigan



for switches and contacts in the POWER INDUSTRY



for ELECTRONIC EQUIPMENT



### ALUMINUM Sheets—Circles 25/35/525

Mill Certification for Defense Orders from warehouse stock

HENRY B. LUST  
 310 West 85th St. New York 24, N. Y.  
 Telephone: TRafalgar 7-6329

### Shorted Turn Indicator

MODEL 101C BULLETIN 42  
 HUNTINGTON BEACH, CALIF.

## KARTRON

### EISLER Manufactures Complete Equipment for:

SPOT WELDERS, Electric, for 1/4 to 250 KVA.  
 TELEVISION TUBE GLASS WORKING EQUIPMENT.  
 TRANSFORMERS, Special and Standard Types.  
 INCANDESCENT LAMP Manufacturing Equipment.  
 FLUORESCENT TUBE Manufacturing Equipment.  
 NEON SIGN MAKERS' EQUIPMENT.  
 ELECTRONIC EQUIPMENT, Vacuum Pumps, etc.  
 WET GLASS SLICING and Cutting machines for Laboratory use.  
 EISLER ENGINEERING CO., Inc. 751 So. 13th St., Newark 3, N. J.

### EL-TRONICS, INC.

Research, development, and manufacture of electronic equipment—a single model to large quantities.

Write Today for Free Resume of Our Plant Facilities  
 Specialists in Geiger-Muller equipment  
 2647-67 N. Howard St.—Phila. 33, Pa.—GARfield 5-2026

### NEED PAPER CAPACITORS?

Range .005 — 1.00 MFD  
 Voltage 100 — 600 V  
 New Firm setting up machinery. Will be in operation around June 1st. Would like to contact customers with D.O. order, requiring quick delivery.

FS-9320, Electronics  
 330 W. 42 St., New York City

### ELECTRICAL COILS

TO MEET YOUR EXACT REQUIREMENTS  
 D. O. & MILITARY SPECIFICATIONS

Any type construction, materials, leads, taps, wire, or finish. For ignition, solenoid, relay, voice, choke, transformer, clock, motor, switch, television, or communications.

Send your specifications for quotations.



THE FIVE STAR CO.  
 110 MIXVILLE ROAD  
 WEST CHESHIRE, CONN.

### Make it a HABIT . . . to check this page—EACH ISSUE

THIS CONTACTS SECTION supplements other advertising in this issue with these additional announcements of products and services essential to efficient and economical operation in the field of

ELECTRONICS



6751 BRYN MAWR AVE.



# SEARCHLIGHT SECTION

EMPLOYMENT • BUSINESS • OPPORTUNITIES • EQUIPMENT—USED or RESALE

## UNDISPLAYED RATE

\$1.50 a line, minimum 3 lines. To figure advance payment count 5 average words as a line. **EMPLOYMENT WANTED & INDIVIDUAL SELLING OPPORTUNITY** undisplayed advertising rate is one-half of above rate, payable in advance.

PROPOSALS \$1.20 a line an insertion.

## INFORMATION:

BOX NUMBERS count 1 line additional in undisplayed ads.

DISCOUNT 10% if full payment is made in advance for four consecutive insertions of undisplayed ads (not including proposals).

EQUIPMENT WANTED OR FOR SALE Advertisements acceptable only in Displayed Style.

## DISPLAYED—RATE PER INCH

The advertising rate is \$12.00 per inch for all advertising appearing on other than a contract basis. Contract rates quoted on request.

AN ADVERTISING INCH is measured 7/8 inch vertically on one column, 3 columns—30 inches—to a page.

ELECT.

NEW ADVERTISEMENTS received at the N. Y. Office, 330 W. 42 St., N. Y. 18, by June 1st will appear in the July issue, subject to limitation of space available. The publisher cannot accept advertising in the Searchlight Section which lists the names of the manufacturers of resistors, capacitors, rheostats, and potentiometers or other names designed to describe such products.

## WANTED

Research and Development Engineers and Physicists with educational background in mechanical, electrical or electronic engineering, physics or engineering physics for openings in plant and laboratory instrumentation, physical measurements, geophysics, and industrial electronics. Prefer persons with two to four years experience in experimental research design and development of instruments, intricate mechanisms, electronic apparatus, optical equipment, servo-mechanisms or allied fields. Positions are of immediate and permanent importance to our operations.

Write Personnel Director

Research and Development Department

PHILLIPS PETROLEUM COMPANY  
Bartlesville, Oklahoma



## RESEARCH - DEVELOPMENT - DESIGN

### ENGINEERING WITH A FUTURE

The steady growth of several established research and development projects has created a number of exceptional engineering opportunities with a future.

### PHYSICISTS—ENGINEERS

Positions are now available in our organization for qualified physicists and engineers with backgrounds in circuit analysis, microwaves, servomechanisms, analog computers, etc. Openings exist at several levels with salaries dependent on education, ability, and experience.

If you are qualified and interested in a position which combines stability and unusual opportunity, write, giving full details to Mr. C. G. Jones, Manager, Salary Personnel.

GOOD YEAR  
AIRCRAFT CORPORATION

Akron 15, Ohio

WANTED

## Engineers

ELECTRONIC • ELECTRICAL • MECHANICAL

LAB TECHNICIANS: For Design and Development of Magnetic Tape Recorders used for Audio Work and Instrumentation. Creative ability essential.

ALSO: Electrical Draftsmen, Mechanical Draftsmen and Designers.

PERSONNEL for Purchasing, Expediting, and Production Control.

Please send complete information concerning education and experience.

Ampex

ELECTRIC CORPORATION

SAN CARLOS, CALIFORNIA • Telephone LYte# 3-3128

Do you need

## EQUITY FINANCING?

Inquiries invited from new or established industrial concerns having potentials for sound future growth.

Situations involving \$250,000 and over preferred

GRAHAM, ROSS & CO., INC.

INVESTMENT SECURITIES

82 Beaver Street

New York 5, N. Y. C.

For Special Service-Book Advertising see page 337

# OPPORTUNITIES IN RESEARCH AND DEVELOPMENT

IN  
 BASIC AND APPLIED  
 PHYSICS  
 ELECTRONICS  
 MATHEMATICS  
 MECHANICAL ENGINEERING  
 AERONAUTICAL SCIENCES AND ENGINEERING

PERMANENT POSITIONS FOR QUALIFIED PERSONNEL  
 EXPERIENCED DESIRABLE BUT NOT ESSENTIAL  
 WORK VITAL TO NATIONAL DEFENSE

THE LABORATORY OFFERS THE ADVANTAGES OF  
 UNIVERSITY ATMOSPHERE AND CONTACTS, EXCEL-  
 LENT RESEARCH FACILITIES, AND SALARIES COM-  
 PARABLE WITH INDUSTRY. GRADUATE STUDY  
 ENCOURAGED WHILE EMPLOYED.

## CORNELL AERONAUTICAL LABORATORY, INC.

A Non-Profit Research Corporation, Wholly Owned by Cornell University  
 P.O. BOX 235, BUFFALO 21, NEW YORK  
 INQUIRIES CONFIDENTIAL

# RADAR, COMMUNICATIONS and SONAR TECHNICIANS WANTED

For Overseas Assignments

### Technical Qualifications:

1. At least 3 years' practical experience in installation and maintenance.
2. Navy veterans ETM 1/c or higher.
3. Army veterans TECH/SGT or higher.

### Personal Qualifications:

1. Age, over 22—must pass physical examination.
2. Ability to assume responsibility.
3. Must stand thorough character investigation.
4. Willing to go overseas for 1 year. Base pay, bonus, living allowance, vacation add up to \$7,000.00 per year. Permanent connection with company possible.

Apply by Writing to  
 A-1, P. O. Box 3414  
 Philadelphia 22, Pa.

Men qualified in RADAR, COMMUNICATIONS or SONAR give complete history. Interview will be arranged for successful applicants.

### ELECTRONIC ENGINEER

At least three (3) years post-college experience in development, DC amplifier, digital computers, pulse and servo design. Established Company, New York City.

P-9418, Electronics  
 330 W. 42 St., New York 18, N. Y.

### ELECTRONIC ENGINEERS

A few permanent staff positions available for energetic young engineers with E.E. degree and circuit experience. 40-hour week. Attractive salaries. Submit resume, including background and references to

P-9745, Electronics  
 330 W. 42 St., New York 18, N. Y.

### SENIOR ELECTRONIC ENGINEER

Progressive instrument manufacturer in Rocky Mountain region needs engineer to take charge of electronics laboratory. Must have at least five years industrial electronics experience and be completely familiar with resistance strain-gage amplifiers of all types. Interviews will be arranged for successful applicants.

Write Chief Engineer  
 P. O. Box 360 Denver, Colorado

### PHYSICIST

Design, Develop, Geiger Counters, Voltage Regulators, and other Gas Discharge Tubes . . . Degree Plus 4-5 Years' Experience Required

### DEVELOPMENT ENGINEER

Vibrators, Small Transformers, Electric Circuits . . . Degree Plus 4-5 Years Experience Required

Apply By Letter or in Person To  
 JOSEPH B. STICKNEY  
 VICTOREEN INSTRUMENT CO.  
 5806 HOUGH AVE. . . CLEVELAND 3, O.

## NATIONAL UNION RESEARCH DIVISION

The Research Laboratories of one of the nation's larger electron tube manufacturers have vacancies for electronic engineers and engineering physicists qualified in the following fields:

- Vacuum tube development
- Electronic circuit design
- Electronic equipment

This organization can offer excellent prospects for security and personal advancement due to our continued growth. Our location is in the New York metropolitan area.

Whether you have a background of electron tube or circuit design, or are a recent graduate and interested in our field, we would like to hear from you. Send your resume to:

Personnel Department  
 National Union Research Division  
 350 Scotland Rd. Orange, N. J.



## BENDIX RADIO DIVISION



**ELECTRONICS ENGINEERS**—At all salary and experience levels.

**RESEARCH ON:** Antennae, Servo-mechanisms, Microwave ccts. and other phases of communications and navigation equipment.

**PRODUCTION DESIGN OF:** Military and commercial communications and navigation equipment.

**FIELD ENGINEERS** — Supervise installation and maintenance of radio and radar equipment. Factory training will be given. Base salaries from \$4200 to \$6900 per year. 25% bonus for time spent overseas. Traveling and living expenses paid by Bendix. Insurance plan.

**TEST AND INSPECTION ENGINEERS** —Practical knowledge of radio, radar, or TV manufacturing processes. Good knowledge of radio fundamentals essential. Base salaries from \$3900 to \$5880.

**TECHNICAL WRITERS** — Knowledge of radar fundamentals or radio required. Work closely with engineers to gather material for instruction and maintenance manuals. Base salaries from \$3400 to \$4300.

**LABORATORY TECHNICIANS** — Require knowledge of radio fundamentals and skill in use of measuring instruments and laboratory equipment. Previous industrial experience essential. Salaries from \$262 to \$321 per month.

**BASE SALARIES FOR ALL POSITIONS LISTED ABOVE ARE SUPPLEMENTED BY UP TO 30% FOR REGULARLY SCHEDULED 48 HOUR WEEK.**

Housing is no problem in Baltimore.

Excellent group insurance and family hospitalization plan.

Attractive retirement plan for professional personnel.

Write for application:  
Department "E"

Engineering Personnel Supervisor  
**BENDIX RADIO DIVISION** of  
Bendix Aviation Corporation  
Baltimore 4, Maryland  
TOWSON 2200

# ATOMIC ENERGY INSTALLATION NEEDS ELECTRONICS ENGINEERS

Two to ten years' experience in research, design, development or test. Patent history desirable but not necessary. A variety of positions open for men, with Bachelor's or advanced degree, qualified in one or more of the following fields:

- RELAYS
- PULSE CIRCUITS
- SERVO-MECHANISMS
- LOW POWER APPLICATION
- TELEMETERING
- UHF TECHNICIANS
- INSTRUMENTATION
- QUALITY CONTROL

TEST EQUIPMENT RELATING TO THE ABOVE

## CAREER DRAFTSMEN

EXPERIENCED CAREER  
DRAFTSMEN WITH NO  
COLLEGE DEGREE.

These are PERMANENT POSITIONS with Sandia Corporation in Albuquerque, New Mexico. Sandia Laboratory is operated by Sandia Corporation, a subsidiary of Western Electric Company, under contract with the ATOMIC ENERGY COMMISSION. This laboratory offers good working conditions and liberal employee benefits, including paid vacations, sick leave, and a retirement plan.

*Albuquerque, center of a metropolitan area of 150,000, is located in the Rio Grande Valley, one mile above sea level. The "Heart of the Land of Enchantment." Albuquerque lies at the foot of the Sandia Mountains, which rise to 11,000 feet. Climate is sunny, mild and dry the year 'round.*

Make Application to:

## PROFESSIONAL EMPLOYMENT DIV.

# SANDIA CORPORATION

SANDIA BASE

ALBUQUERQUE, NEW MEXICO

## ELECTRONIC ENGINEERS

SENIOR ENGINEERS or PHYSICISTS  
Degree and experience in Radar,  
Pulse Circuits, Digital or Analogue  
Computers, or Servomechanisms  
JUNIOR ENGINEERS and recent  
graduate in EE or Physics.

### ELECTRONIC ENGINEERING COMPANY OF CALIFORNIA

180 S. Alvarado St. Los Angeles 4, Calif.

## WANTED ENGINEERS

With power and transmitting tube design  
experience. State draft status and experi-  
ence.

Write Direct To:

**TAYLOR TUBES, INC.**  
2312 W. Wabansia Ave. Chicago 47, Ill.

## Electronics Engineers Electromechanical Engineers Engineering Physicists

Several senior and junior engineers are required immediately for the direction of important research and design work by an organization specializing in all types of advanced armament development. This is an opportunity to participate in the growth of an exceptionally active group in a highly technical field. Direct inquiries to:

R. W. Sanford  
**AIRCRAFT ARMAMENTS, INC.**  
4415 Reisterstown Rd.  
Baltimore 15, Md.

# EXPERIENCED electronic engineers and physicists

Organization established in 1942. Electronic research, development, and production must expand to meet long-term, pre-Korea commitments. Openings in all branches of electronics, including

RECEIVERS      TRANSMITTERS  
ANTENNAS      RADARS  
RELATED EQUIPMENT

Positions available for men with at least 5 yrs experience

Write or telephone Howard J. Gresens at

*Airborne Instruments Laboratory*  
INCORPORATED

160 Old Country Road, Mineola

Long Island, N. Y.

## SCIENTISTS AND ENGINEERS

for

challenging research and advanced development in fields of

RADAR  
GYROSCOPES  
SERVOMECHANISMS  
MECHANICAL SYSTEMS  
ELECTRONICS CIRCUITS  
APPLIED PHYSICS AND MATH  
PRECISION MECHANICAL DEVICES  
ELECTRICAL SYSTEM DESIGN  
GENERAL ELECTRONICS  
INSTRUMENTATION  
MICROWAVES  
COMPUTERS  
AUTOPILOTS

*Scientific or engineering degree, and extensive technical experience required.*

Write:

Manager, Engineering Personnel  
**BELL AIRCRAFT CORPORATION**  
P.O. Box 1, Buffalo 5, N. Y.

## Electrical ENGINEERS or PHYSICISTS

### Microwave . . .

- to develop test sets and methods on long-distance radio relay equipment.
- Experienced in performance of amplifiers, modulators, filters and cavities at microwave frequencies.

### Filters and Networks . . .

- to develop manufacturing facilities and methods of manufacture.

### Test . . .

- to develop test facilities for the manufacture of communication and television transmission. Basic knowledge of transmission theory required.

Minimum Qualification B.S. Degree or Equivalent

Write Dept. E giving details of qualifications, experience and salary expected, or

Apply in Person  
Employment Department  
Monday through Saturday,  
8:30 AM to 3:30 PM

Applicants must furnish proof of citizenship and social security number. Veterans must present discharge papers.

## WESTERN ELECTRIC CO.

- 100 Central Ave., Kearny, N. J.
- SUPPLY UNIT of the BELL SYSTEM

Engineers . . .  
Physicists . . . .  
Chemists . . . . .  
Metallurgists . . . .

## A Reminder from GENERAL ELECTRIC

Tremendous material resources . . . the stimulation of highly creative work . . . long-range security and professional recognition . . . these are but a few of the assets General Electric offers you in unusual positions now available in:

Advanced Development, Design, Field Service and Technical Writing.

If you have a Bachelor's or Advanced Degree in Electrical or Mechanical Engineering, Physics, Metallurgy or Physical Chemistry and experience in the Electronics Industry, you can expand your training and experience to the fullest in openings in connection with:

- .. MILITARY RADIO & RADAR
- .. MOBILE COMMUNICATION
- .. MULTIPLEX MICROWAVE COMMUNICATIONS
- .. ELECTRONIC COMPONENTS
- .. TELEVISION, TUBES and ANTENNAS.

Please send resume to:  
TECHNICAL PERSONNEL  
ELECTRONICS PARK

**GENERAL  ELECTRIC**  
Syracuse, New York

## PHILADELPHIA AREA Aircraft Industry ELECTRONIC ENGINEERS

—All Grades—

Men whose education and interest or experience qualifies them for the development or design of airborne or ground radio, radar, or other electronic equipment can work under ideal conditions. We have openings in our small, efficient group (under 20 people) where the work is personalized and individual ability can be recognized and rewarded.

Write or telephone  
Chief Engineer

Kellett Aircraft Corporation  
Central Airport, Camden 11, N. J.  
Merchantville. 8-4800  
Founded 1929

EMPLOYMENT . . . EQUIPMENT . . .  
BUSINESS

**OPPORTUNITIES**  
*Whatever your need—  
think "SEARCHLIGHT" FIRST*



# ENGINEERS WANTED

*For PERMANENT Positions*

Design and Development  
of Electro-mechanical and Electronic Devices

*with* **IBM**  
TRADE MARK

Endicott, N. Y. and Poughkeepsie, N. Y.

Finest working conditions in modern laboratories and plants. Good salaries . . . opportunities for advancement . . . and exceptional employee benefits.

*Advanced degree or experience required in*

<b>GYROS</b>	<b>HYDRAULICS</b>	<b>OPTICS</b>
<b>SERVOS</b>	<b>ELECTRONICS</b>	<b>RADAR</b>
<b>MECHANICS</b>	<b>ELECTRICITY</b>	

A FINE OPPORTUNITY TO DO INTERESTING, CREATIVE, *LASTING* WORK . . . TO SETTLE IN A PLEASANT, CONGENIAL COMMUNITY. Write, giving full details including education and experience, to:

Mr. R. H. Austin  
International Business Machines  
1723 North Street  
Endicott, N. Y.

**INTERVIEWS ARRANGED IN YOUR CITY**

**PROJECT ENGINEERS  
DESIGN &  
DEVELOPMENT ENGINEERS  
TECHNICAL WRITERS**

**AERODYNAMICISTS**  
Some stability experience desirable

**ELECTRONIC DRAFTSMEN**  
For  
Cabling & Wiring Design  
Layout and Packaging

**MECHANICAL DRAFTSMEN**  
For  
Checking and Layout

**ESSENTIAL INDUSTRIAL &  
GOVERNMENT PROJECTS**

Challenging research, development and production programs are in process in the fields of flight simulation, television, radar, servo-mechanisms, aeronautics, computers, advanced armaments, and specialized machinery.

**FAVORABLE  
WORKING CONDITIONS**

Top Pay  
Excellent opportunity for  
advancement on merit.

This Washington suburb has direct access to all the cultural, social, educational, recreational, and industrial facilities of our Nation's Capitol. Housing is adequate in the Washington Area.

**ENGINEERING &  
RESEARCH CORP.**

Riverdale, Md.  
Warfield 4444 Ext. 80  
Interviews 8:30-3:00 Mon.-Sat.



*Wanted*  
**ENGINEERS  
AND  
SCIENTISTS**

Unusual opportunities for outstanding and experienced men.

These top positions involve preliminary and production design in advanced military aircraft and special weapons, including guided missiles.

Immediate positions include:

Electronic project engineers  
Electronic instrumentation engineers  
Radar engineers  
Flight test engineers  
Stress engineers  
Aero- and thermodynamicists  
Servo-mechanists  
Power plant installation designers  
Structural designers  
Electro-mechanical designers  
Electrical installation designers  
*Excellent location in Southern California. Generous allowance for travel expenses.*

Write today for complete information on these essential, long-term positions. Please include resume of your experience & training. Address inquiry to Director of Engineering,

**NORTHROP AIRCRAFT, INC.**  
1009 E. Broadway  
Hawthorne (Los Angeles County) California

**AC SPARK PLUG  
DIVISION**  
*of*  
**GENERAL MOTORS  
CORPORATION**

**PRECISION INSTRUMENT PLANT**

Positions now available for highest caliber personnel in the field of airborne automatic electro-mechanical control equipment.

**MECHANICAL DESIGN ENGINEERS  
ELECTRONIC ENGINEERS  
SERVO ENGINEERS  
JUNIOR ENGINEERS**

New and expanding division of an established firm with 20 years of successful experience in the instrument field. Work involved deals with the manufacture and development of highly complex equipment of the most advanced type.

*Write or Apply*

**AC Spark Plug Division  
GENERAL MOTORS CORPORATION**

1925 E. Kenilworth Place  
Milwaukee 2, Wisconsin

# ELECTRONICS ENGINEER

to work in

**SYLVANIA'S**  
Product Development  
Laboratories

AT KEW GARDENS, L. I.

## CIRCUITS ENGINEERS (2)

Design circuits for testing experimental high-frequency subminiature tubes. Evaluate tube features, study theory of operation, match tube and circuit performance, recommend tube design changes. BS in EE—communications major. One or more years of circuit experience in 100 to 1000 mc range desirable.

## MICROWAVE ENGINEER

Design and development of Microwave tubes including theoretical investigation, processing, and design and development of parts, tools, jigs, fixtures, and techniques. BS in EE—electronics major. Several years of general tube experience preferably on klystron, magnetron or traveling wave tube development.

## VIBRATIONS ENGINEER

We are looking for an engineer with approximately 2 or more years of electronics experience who wants to enter a new field with challenging opportunities. BS in ME, or BS in EE with mechanical leanings. Work involves vibration studies of tubes and electronic devices.

These positions offer an opportunity to contribute to the growth of a steadily expanding company

Address all replies to:

Manager of Personnel

**SYLVANIA**  
ELECTRIC PRODUCTS, INC.

40-22 Lawrence St., Flushing, N. Y.

**SYLVANIA**

# OPPORTUNITIES AT THE BRUSH DEVELOPMENT COMPANY FOR PHYSICISTS & ELECTRICAL ENGINEERS

Leaders in the Fields of:

- Piezo-electric Crystals and Ceramics—
- Electro-acoustics—
- Magnetic Recording—
- Ultrasonics—
- Industrial and Research Instruments—

Increased activities and a highly promising future leads us to add to our highly skilled staff. Conditions are friendly and problems highly stimulating and the field offers opportunity for expansion.

Compensation, pension plans and general personnel policies will make these situations highly attractive to the most able people in the field.

Write Vice President in charge of Engineering;  
3405 Perkins Avenue Cleveland 14, Ohio

## The W. L. MAXSON CORPORATION IS SEEKING Outstanding ENGINEERS AND PHYSICISTS

with AMBITION to FURTHER PRESENT STANDING Immediately

Minimum Requirements are:

1. Five to ten years' experience in advanced electronics or in servomechanism and computer research and development.
2. Outstanding record of ingenuity.
3. Ph. D., M.S. or equivalent.

Those presently employed at their highest skill in defense work need not apply.

Please send resume and salary requirements to:

**The W. L. MAXSON CORPORATION**

460 W. 34th St. New York 1, N. Y.

## WANTED—ENGINEERS

for work on

- Electrical Control Techniques—
- Control Circuit Design—
- Relay Applications

We have several attractive openings for electrical engineers with experience in the application of relays, stepping switches, and similar components to a wide variety of electrical control circuits and apparatus. Special consideration will be given to applicants with experience in designing control circuits or in the determination of relay characteristics to meet conditions of use.

Our organization is a well established leader in the field of electrical control techniques for industrial and military uses and is now embarking on a program of expansion affording unusual opportunities for progress. Applications will be treated in full confidence. Address W. B. Near, Personnel Director.

**AUTOMATIC ELECTRIC COMPANY**

Originators of the Automatic Telephone Makers of Communication and Control Systems and Equipment

1033 West Van Buren Street, Chicago 7, Ill.

## WANTED SALES REPRESENTATIVE

Man or organization experienced in component sales to electronic equipment manufacturers. No jobber selling, exclusive territory available—State of Missouri and surrounding area by Eastern manufacturer of specialty subfractional motors, blowers and alternators.

RW-9757, Electronics  
330 W. 42 St., New York 18, N. Y.

## ELECTRONIC ENGINEER

At least three (3) years post-college experience in development, DC amplifier, digital computers, pulse and servo design. Established Company, New York City.

P-9662, Electronics  
330 W. 42 St., New York 18, N. Y.



# A LEADING SUPPLIER OF ELECTRONIC & AIRCRAFT EQUIPMENT

**IMMEDIATE DELIVERY -- FULLY GUARANTEED**

## A C MOTORS

5071930 DELCO, 115 V., 60 Cy., 7000 RPM. PRICE \$6.50 EA.  
TELECHRON SYNCHRONOUS MOTOR, Type B3, 110 V., 60 Cy., 4 W., 2 RPM. PRICE \$5.00 EA.  
TELECHRON SYNCHRONOUS MOTOR, Type BC, 110 V., 60 Cy., 6 W., 60 RPM. PRICE \$4.00 EA.  
EASTERN AIR DEVICES, Type J33, Synchronous, 115 V., 400 Cy., 3  $\phi$ , 8000 RPM. PRICE \$15.00 EA.

## HAYDON TIMING MOTORS 110 V., 60 CY.

TYPE 1600, 2.2 W., 4/5 RPM. PRICE \$3.00 EA.  
TYPE 1600, 2.2 W., 1/240 RPM. PRICE \$3.00 EA.  
TYPE 1600, 2.3 W., 1 RPM. PRICE \$3.00 EA.  
TYPE 1600, 2.2 W., 1-1/5 RPM. PRICE \$3.00 EA.  
TYPE 1600, 3.5 W., 1 RPM. With shift unit automatic engaging and disengaging shaft. PRICE \$3.75 EA.  
TYPE 1600, 2.2 W., 1/60 RPM. PRICE \$3.00 EA.

## SERVO MOTORS

CK1, PIONEER, 2  $\phi$ , 400 Cy. PRICE \$10.00 EA.  
CK2, PIONEER, 2  $\phi$ , 400 Cy. PRICE \$14.00 EA.  
CK2, PIONEER, 2  $\phi$ , 400 Cy., with 40:1 reduction gear. PRICE \$15.50 EA.  
10047-2-A, PIONEER, 2  $\phi$ , 400 Cy., with 40:1 reduction gear. PRICE \$10.00 EA.  
MINNEAPOLIS HONEYWELL Type B, Part No. G303AY, 115 V., 400 Cy., 2  $\phi$ , built-in reduction gear, 50 lbs. in torque. PRICE \$10.00 EA.  
MINNEAPOLIS HONEYWELL Amplifier Type G403, 115 V., 400 Cy., Used with above motor. PRICE \$10.00 EA, WITH TUBES

## REMOTE INDICATING COMPASSES 26 V., 400 CY.

PIONEER TYPE AN5730-2 Indicator and AN5730-3 Transmitter. PRICE \$40.00 PER SET  
KOLLSMAN TYPE 680K-03 Indicator and 679-01 Transmitter. PRICE \$15.00 PER SET

## D C MOTORS

DELCO TYPE 5069625 Constant Speed, 27 V. D.C., 120 RPM. PRICE \$15.00 EA.  
JOHN OSTER TYPE C-28P-1, 27 V., 0.7 Amp., 7,000 RPM, 1/100 H. P. PRICE \$5.00 EA.  
JAEGER WATCH CO. TYPE 44K-2 Contactor Motor, 3 to 4.5 V. Makes one contact per second. PRICE \$2.50 EA.  
GENERAL ELECTRIC TYPE 5BA10AJ52C, 27 V., 0.65 Amp., 14 oz. in torque, 145 RPM. PRICE \$6.50 EA.  
GENERAL ELECTRIC TYPE 5BA10AJ37, 27 V., 0.5 amps., 8 oz. in. torque, 250 RPM. PRICE \$6.50 EA.  
GENERAL ELECTRIC TYPE 5BA10J18D, 27 V., 0.7 Amps., 110 RPM, 1 oz. ft. torque. PRICE \$6.50 EA.  
BARBER-COLMAN CONTROL MOTOR, Type AYLK 5091, 27 V., 0.7 Amps., 1 RPM. Contains 2 adj. limit switches. 500 in. lbs. torque. PRICE \$6.50 EA.  
WHITE RODGERS ELECTRIC CO., Type 6905 No. 3, 12 V., 1.3 Amps., 1 1/2 RPM, torque 75 in. lbs. PRICE \$10.50 EA.

## RECTIFIER POWER SUPPLY

GENERAL ELECTRIC TYPE 6RC146. Input 230 V., 60 Cy., 3  $\phi$ , adjustable input taps. Output 130 Amps., at 28 V. D.C. Continuous duty. Size 46" high, 28" wide and 17.5" deep. PRICE \$225.00 EA.

## INVERTERS

WINCHARGER CORP. PU-16/AP, MG750. Input 24 V. D.C., 60 Amps. Output 115 V., 400 Cy., 1  $\phi$ , 6.5 Amps. PRICE \$75.00 EA.  
HOLTZER CABOT TYPE 149 H, Input 24 V. D.C. at 44 Amps., Output 26 V. at 250 V.A., 400 Cy., and 115 V., 400 Cy., at 500 V.A., 1  $\phi$ . PRICE \$55.00 EA.  
HOLTZER CABOT TYPE 149F, Input 24 V. D.C. at 36 Amps., Output 26 V. at 250 V.A., 400 Cy., and 115 V., 400 Cy., at 500 V.A., 1  $\phi$ . PRICE \$55.00 EA.  
PIONEER TYPE 12117. Input 12 V. D.C., Output 26 V., 400 Cy. at 6 V.A. PRICE \$30.00 EA.  
PIONEER TYPE 12117. Input 24 V. D.C., Output 26 V., 400 Cy. at 6 V.A. PRICE \$30.00 EA.  
PIONEER TYPE 12116-2-A. Input 24 V. D.C. at 5 Amps. Output 115 V., 400 Cy., 1  $\phi$  at 45 watts. PRICE \$100.00 EA.  
GENERAL ELECTRIC TYPE 5D21NJ3A. Input 24 V. D.C. at 35 Amps. Output 115 V., 400 Cy., 485 V.A., 1  $\phi$ . PRICE \$25.00 EA.  
LELAND PE 218. Input 24 V. D.C. at 90 Amps. Output 115 V., 400 Cy., 1  $\phi$  at 1.5 K.V.A. PRICE \$47.50 EA.

## PIONEER AUTOSYNS

TYPE AY1, 26 V., 400 Cy. PRICE \$8.50 EA.  
TYPE AY5, 26 V., 400 Cy. PRICE \$8.50 EA.  
TYPE AY14G, 26 V., 400 Cy. PRICE \$15.00 EA.  
TYPE AY14D, 26 V., 400 Cy. PRICE \$15.00 EA.  
TYPE AY54D, 26 V., 400 Cy. PRICE \$10.00 EA.  
TYPE AY131D Precision Autosyn. Price \$35.00 EA.

## PIONEER AUTOSYN POSITION INDICATORS & TRANSMITTERS

TYPE 5907-17. Dial graduated 0 to 360°, 26 V., 400 Cy. PRICE \$25.00 EA.  
TYPE 6007-39. Dual Dial graduated 0 to 360°, 26 V., 400 Cy. PRICE \$40.00 EA.  
TYPE 4550-2-A Transmitter, 26 V., 400 Cy., 2:1 gear ratio. PRICE \$20.00 EA.

## VOLTAGE REGULATORS

LELAND ELECTRIC CO. TYPE B, Carbon Pile type. Input 21 to 30 V. D.C. Regulated output 18.25 at 5 amps. PRICE \$6.50 EA.  
WESTERN ELECTRIC TRANSTAT VOLTAGE REGULATOR Spec. No. V-122855, Load K.V.A. 0.5. Input 115 V., 400 Cy. Output adjustable from 92 to 115 V. PRICE \$10.50 EA.

## RATE OR TACHOMETER GENERATORS

EASTERN AIR DEVICES J36A, .02 V. D.C. per RPM. Max. speed 5000 RPM. PRICE \$12.50 EA.  
ELECTRIC INDICATOR CO. TYPE B68 Rotation Indicator, 110 V., 60 Cy., 1  $\phi$ . PRICE \$14.00 EA.  
ELECTRIC INDICATOR CO. TYPE PM-1-M. Same as Type B35, 2 V. D.C. per 100 RPM. Max. speed 5000 RPM. PRICE \$14.00 EA.  
GENERAL ELECTRIC TACHOMETER GENERATOR TYPE AN5531-1. Variable frequency, 3  $\phi$  output. PRICE \$20.00 EA.  
GENERAL ELECTRIC TACHOMETER GENERATOR TYPE AN5531-2. Variable frequency, 3  $\phi$  output. PRICE \$25.00 EA.

ALL PRICES  
F. O. B.  
GREAT NECK  
N. Y.

## SYNCHROS

1F SPECIAL REPEATER, 115 V., 400 Cy. PRICE \$15.00 EA.  
2J1F3 GENERATOR, 115 V., 400 Cy. PRICE \$5.50 EA.  
2J1G1 CONTROL TRANSFORMER, 57.5/57.5 V., 400 Cy. PRICE \$3.50 EA.  
2J1F1 GENERATOR, 115 V., 400 Cy. PRICE \$4.00 EA.  
5SDG DIFFERENTIAL GENERATOR, 90/90 V., 400 Cy. PRICE \$20.00 EA.  
5G GENERATOR, 115 V., 60 Cy. PRICE \$50.00 EA.  
W. E. KS-5950-L2 Size 5G, 115 V., 400 Cy. PRICE \$10.00 EA.

## D C ALNICO FIELD MOTORS

DIEHL TYPE S.S. FD6-23, 27 V., 10,000 RPM. PRICE \$6.50 EA.  
DELCO TYPE 5069466, 27 V., 10,000 RPM. PRICE \$15.00 EA.  
DELCO TYPE 5069370, 27 V., 10,000 RPM. PRICE \$15.00 EA.  
DELCO TYPE 5072400, 27 V., 10,000 RPM. PRICE \$10.00 EA.

## BLOWER ASSEMBLIES

JOHN OSTER TYPE MX215/APG, 28 V. D.C., 7,000 RPM, 1/100 H.P. PRICE \$8.50 EA.  
WESTINGHOUSE TYPE FL, 115 V., 400 Cy., 6,700 RPM, Airflow 17 C.F.M. PRICE \$7.50 EA.  
DELCO TYPE 5068571 Motor and Blower Assembly, P.M. Motor, 27 V., 10,000 RPM. PRICE \$15.00 EA.

## GENERAL ELECTRIC D C SELSYNS

8TJ9-PAB, TRANSMITTER, 24 V. PRICE \$4.00 EA.  
8DJ11-PCY, INDICATOR, 24 V. Dial marked -10° to +65°. PRICE \$6.00 EA.  
8DJ11-PCY, INDICATOR, 24 V. Dial marked 0 to 360°. PRICE \$7.50 EA.

## MISCELLANEOUS

SPERRY A5 AMPLIFIER RACK, Part No. 644890. PRICE \$20.00 EA.  
SPERRY A5 CONTROL UNIT, Part No. 644836. PRICE \$7.50 EA.  
SPERRY A5 AZIMUTH FOLLOW-UP AMPLIFIER, Part No. 656030, with tubes. PRICE \$5.50 EA.  
SPERRY A5 DIRECTIONAL GYRO, Part No. 656029, 115 V., 400 Cy., 3  $\phi$ . PRICE \$25.00 EA.  
PIONEER TYPE 12800-1 GYRO SERVO UNIT, 115 V., 400 Cy., 3  $\phi$ . PRICE \$20.00 EA.  
ALLEN CALCULATOR TYPE C1 TURN & BANK INDICATOR, Part No. 21500 28 V. D.C. PRICE \$15.00 EA.  
TYPE C1 AUTO-PILOT FORMATION STICK, Part No. G1080A3. PRICE \$15.00 EA.  
PIONEER GYRO FLUX GATE AMPLIFIER Type 12076-1-A, 115 V., 400 Cy. PRICE \$40.00 EA.

**INSTRUMENT ASSOCIATES**

Write for Catalog NE100

363 GREAT NECK ROAD, GREAT NECK, N. Y.  
Telephone GREAT Neck 4-1147

U. S. Export License-2140

Western Union address:  
WUX Great Neck, N. Y.



Coaxial relay K-101—SPDT—24v DC.....\$ 6.59  
 Set of 83-1S1 coax-connectors for above..... .89  
 RG59U coaxial cable—75 ohm  
 150' roll.....\$11.95 300' roll..... 22.50  
 300 ohm twin lead. 300' minimum—per ft..... .03  
 Sigma plate relay 8000 ohm—SPDT..... 2.75



100KC crystal BT cut.....\$3.95  
 3"scope shield..... 1.29  
 2 speed dial drive for 1/4" shaft ratios 5:1 1 to 1. .39  
 ATC 100 mfd air trimmer screwdriver shaft..... .29  
 Centralab S50 S 50MMF 5KV button cond..... .39  
 Rotary switch mycalex, 2 deck SPDT..... .39

**TUBES!! BRAND NEW! STANDARD BRANDS! NO SECONDS! COMPARE! TUBES!!**

0A3 VRT5 \$1.69	3C24 ..\$2.25	227A/5C27 \$5.95	812H ..\$6.90	8014 ..\$29.95	0A2 ..\$2.95	5Z4 ..\$1.40	6SN7GT ..\$1.60	12SL7 ..\$1.10
0B3 V/R90 1.29	3C31 C1B. 3.49	249C .. 3.95	813 .. 8.95	8020 .. 1.29	0A4G .. 1.35	6A3 .. 1.35	680Q .. 1.15	12SN7 .. 1.25
0C3 V/R105 1.49	3C45 .. 19.95	250H .. 12.95	815 .. 2.95	8025 .. 2.95	0B2 .. 1.45	6A4 .. 1.45	687GT .. 1.50	12SR7 .. .98
1B22 .. 3.45	3CP1-S1. 2.95	250TL .. 21.50	816 .. 1.30	9002 .. 2.25	0Z4 .. .98	6A7 .. 1.40	68T .. 1.45	12Z3 .. 1.10
1B23 .. 12.50	3DP1 .. 4.95	274A .. 5.50	828 .. 9.95	9003 .. 2.25	1A3 .. 1.32	6AB .. 1.25	68U7GT .. 1.45	14A4 .. 1.20
1B24 .. 3.95	3DP1-S2A. 8.95	276A .. 9.95	829 .. 12.75	9004 .. 7.5	1A4P .. 1.30	6AB7 .. 1.49	68V7 .. 1.45	14A7 .. 1.15
1B27 .. 24.50	3D21A .. 1.98	293A .. 2.98	829B .. 14.95	9005 .. 2.95	1A8GT .. 1.05	6AC5GT .. 1.40	68W7 .. 1.65	14B6 .. 1.15
1B29 .. 2.75	3E29 .. 14.95	300A .. 2.55	830B .. 9.95	9006 .. 9.95	1A8 .. 1.10	6AC6 .. 1.65	68X7 .. 1.65	14B7 .. 1.15
1B32 .. 1.35	3E37 .. 2.75	304B .. 9.95	832 .. 12.95	9007 .. 9.95	1A8GT .. 1.35	6AD7GT .. 1.45	68Y7 .. 1.45	14B8 .. 1.30
1B36 .. 24.96	3G1P1 .. 4.75	304TH .. 27.50	832A .. 12.95	9008 .. 9.95	1AB5 .. .98	6AE6G .. 1.05	68ZGT .. 1.25	14H7 .. 1.20
1B38 .. 32.50	3H1P7 .. 3.95	304TL .. 34.95	832A .. 12.95	9009 .. 9.95	1B3/8016 .. 1.85	6AP6G .. 1.45	68ZGT .. 2.00	14I7 .. 1.30
1N21 .. 2.25	4-125A .. 26.95	307A/RK75 5.95	833A .. 39.50	9010 .. 1.30	1B3/25S .. .98	6AG7 .. 1.65	68ZGT .. 1.50	14Q7 .. 1.15
1N21B .. 4.25	4-250A .. 29.95	310A .. 8.95	834 .. 4.95	CK502AX .. 2.95	1B7GT .. 1.75	6AH6 .. 1.65	68ZGT .. 1.45	14R7 .. 1.20
1N21 .. 1.35	4-300A .. 14.21	310B .. 8.95	838 .. 4.95	CK503AX .. 2.95	1B8GT .. 1.95	6A15 .. 1.95	68ZGT .. 1.05	14S7 .. 1.30
1N23 .. 2.25	4R22/BL5B 9.95	323A/B .. 24.50	843 .. 4.95	CK506AX .. 2.25	1C7G .. 1.05	6AK3 .. 2.25	68ZGT .. 1.05	24A .. 1.20
1N23A .. 3.25	4R25/GC 8.95	327A/5C37 4.95	845 .. 4.95	CK507AX .. 2.25	1D7G .. 1.15	6AK6 .. 1.85	68ZGT .. 1.05	25L8GT .. 1.10
1N23B .. 6.95	4R26/2000 8.95	331A .. 12.95	849 .. 29.50	CK512AX .. 2.25	1D7G .. 1.15	6AQ6 .. 1.20	68ZGT .. 1.55	25Z8GT .. 1.05
1N27 .. 1.69	4B26 .. 4.95	350A .. 8.95	852 .. 29.95	CK517AX .. 8.45	1D8GT .. 1.15	6AQ6 .. 1.20	68ZGT .. 1.20	28 .. .98
1N34 .. 1.40	4B28 .. 4.95	350B .. 4.95	860 .. 6.95	CK1006 .. 2.25	1E7G .. 1.55	6AR5 .. 1.25	68ZGT .. 1.10	27 .. .95
1N34A .. 1.40	4B32 .. 4.95	368AS .. 7.95	861 .. 29.50	E1148 .. .35	1F4 .. .95	6AT5 .. 1.05	68ZGT .. 1.10	28D7 .. .98
1P23 .. 1.79	4C35 .. 34.50	371A .. 1.49	864 .. 1.39	EF50 .. 8.69	1F5G .. 1.10	6AT6 .. 2.35	68ZGT .. 1.10	28E7 .. .89
1P24 .. 2.95	4E27/257B 3.69	371B .. 2.75	866A .. 1.39	FG27A .. 8.75	1G4 .. 1.10	6AV6 .. 1.05	68ZGT .. 1.10	28F7 .. 1.05
1P36 .. 1.95	4E37 .. 3.69	388A .. 6.95	866R .. 1.29	FG27A .. 8.75	1H4G .. .95	6B7 .. 1.25	68ZGT .. 1.10	35W4 .. 1.05
2A1 .. 11.95	5A4 .. 3.69	393A .. 6.95	869B .. 1.29	FG32 .. 7.95	1H4G .. .95	6B8G .. 1.25	68ZGT .. 1.10	35Y7 .. .98
2A5 .. 6.95	5AP4 .. 3.69	394A .. 4.95	872A .. 2.95	FG32 .. 7.95	1H6GT .. 1.48	6BA6 .. 1.05	68ZGT .. 1.10	35Z7 .. 1.05
2C1 RK33 .. 4.95	5CP1 .. 4.95	434A .. 4.95	874 .. 1.49	FG32 .. 7.95	1J6 .. 1.35	6BC5 .. 1.25	68ZGT .. 1.10	35Z8GT .. 1.05
2C22 7/193 .. 4.95	5CP7 .. 4.95	448A .. 4.95	876 .. 1.25	FG32 .. 7.95	1J6 .. 1.35	6BF6 .. 1.15	68ZGT .. 1.10	35Z9GT .. 1.05
2C26A .. 4.95	5D21 .. 24.50	450TH .. 47.50	878 .. 1.25	FG32 .. 7.95	1L4 .. 1.15	6BG6 .. 1.25	68ZGT .. 1.10	35Z9GT .. 1.05
2C26B .. 4.95	5D21 .. 24.50	450TL .. 47.50	884 .. 1.85	FG32 .. 7.95	1L4 .. 1.15	6BG6 .. 1.25	68ZGT .. 1.10	35Z9GT .. 1.05
2C28 .. 24.80	5E1 .. 1.95	457 .. 12.75	885 .. 11.95	FG32 .. 7.95	1L4 .. 1.15	6BG6 .. 1.25	68ZGT .. 1.10	35Z9GT .. 1.05
2C34 .. 14.95	5G1 .. 24.45	559 .. 1.39	905 .. 3.59	FG32 .. 7.95	1L4 .. 1.15	6BG6 .. 1.25	68ZGT .. 1.10	35Z9GT .. 1.05
2C4 .. 2.95	5J2 .. 24.45	562 .. 97.50	908 .. 12.95	FG32 .. 7.95	1L4 .. 1.15	6BG6 .. 1.25	68ZGT .. 1.10	35Z9GT .. 1.05
2C46 .. 7.50	5J2 .. 24.45	562A .. 1.95	918 .. 1.69	FG32 .. 7.95	1L4 .. 1.15	6BG6 .. 1.25	68ZGT .. 1.10	35Z9GT .. 1.05
2C51 .. 6.95	5J4 .. 12.95	701A .. 5.95	919 .. 2.79	FG32 .. 7.95	1L4 .. 1.15	6BG6 .. 1.25	68ZGT .. 1.10	35Z9GT .. 1.05
2C59 .. 2.95	5K1 .. 12.95	702A .. 3.95	922 .. 1.45	FG32 .. 7.95	1L4 .. 1.15	6BG6 .. 1.25	68ZGT .. 1.10	35Z9GT .. 1.05
2E22 .. 1.95	5J29 .. 12.95	703A .. 1.05	927 .. 1.59	FG32 .. 7.95	1L4 .. 1.15	6BG6 .. 1.25	68ZGT .. 1.10	35Z9GT .. 1.05
2E24 .. 4.89	5L30 .. 49.50	703A .. 1.05	930 .. 1.20	FG32 .. 7.95	1L4 .. 1.15	6BG6 .. 1.25	68ZGT .. 1.10	35Z9GT .. 1.05
2E36 .. 2.95	5L30 .. 49.50	703A .. 1.05	930 .. 1.20	FG32 .. 7.95	1L4 .. 1.15	6BG6 .. 1.25	68ZGT .. 1.10	35Z9GT .. 1.05
2E30 .. 2.29	5L30 .. 15.95	705A .. 2.95	930 .. 1.20	FG32 .. 7.95	1L4 .. 1.15	6BG6 .. 1.25	68ZGT .. 1.10	35Z9GT .. 1.05
2J21A .. 9.95	5N1 .. 5.95	708BY .. 39.50	954 .. .49	FG32 .. 7.95	1L4 .. 1.15	6BG6 .. 1.25	68ZGT .. 1.10	35Z9GT .. 1.05
2J22 .. 2.95	5N1 .. 5.95	708BY .. 39.50	954 .. .49	FG32 .. 7.95	1L4 .. 1.15	6BG6 .. 1.25	68ZGT .. 1.10	35Z9GT .. 1.05
2J26 .. 26.50	6C21 .. 24.50	708BY .. 39.50	954 .. .49	FG32 .. 7.95	1L4 .. 1.15	6BG6 .. 1.25	68ZGT .. 1.10	35Z9GT .. 1.05
2J27 .. 29.50	6F4 .. 5.95	708BY .. 39.50	954 .. .49	FG32 .. 7.95	1L4 .. 1.15	6BG6 .. 1.25	68ZGT .. 1.10	35Z9GT .. 1.05
2J30 .. 99.50	6H7 .. 8.95	708BY .. 39.50	954 .. .49	FG32 .. 7.95	1L4 .. 1.15	6BG6 .. 1.25	68ZGT .. 1.10	35Z9GT .. 1.05
2J31 .. 39.50	6H7 .. 8.95	708BY .. 39.50	954 .. .49	FG32 .. 7.95	1L4 .. 1.15	6BG6 .. 1.25	68ZGT .. 1.10	35Z9GT .. 1.05
2J32 .. 39.50	6H7 .. 8.95	708BY .. 39.50	954 .. .49	FG32 .. 7.95	1L4 .. 1.15	6BG6 .. 1.25	68ZGT .. 1.10	35Z9GT .. 1.05
2J33 .. 39.50	6H7 .. 8.95	708BY .. 39.50	954 .. .49	FG32 .. 7.95	1L4 .. 1.15	6BG6 .. 1.25	68ZGT .. 1.10	35Z9GT .. 1.05
2J34 .. 39.50	6H7 .. 8.95	708BY .. 39.50	954 .. .49	FG32 .. 7.95	1L4 .. 1.15	6BG6 .. 1.25	68ZGT .. 1.10	35Z9GT .. 1.05
2J36 .. 97.50	6H7 .. 8.95	708BY .. 39.50	954 .. .49	FG32 .. 7.95	1L4 .. 1.15	6BG6 .. 1.25	68ZGT .. 1.10	35Z9GT .. 1.05
2J37 .. 12.75	6H7 .. 8.95	708BY .. 39.50	954 .. .49	FG32 .. 7.95	1L4 .. 1.15	6BG6 .. 1.25	68ZGT .. 1.10	35Z9GT .. 1.05
2J38 .. 12.75	6H7 .. 8.95	708BY .. 39.50	954 .. .49	FG32 .. 7.95	1L4 .. 1.15	6BG6 .. 1.25	68ZGT .. 1.10	35Z9GT .. 1.05
2J39 .. 39.50	6H7 .. 8.95	708BY .. 39.50	954 .. .49	FG32 .. 7.95	1L4 .. 1.15	6BG6 .. 1.25	68ZGT .. 1.10	35Z9GT .. 1.05
2J40 .. 39.50	6H7 .. 8.95	708BY .. 39.50	954 .. .49	FG32 .. 7.95	1L4 .. 1.15	6BG6 .. 1.25	68ZGT .. 1.10	35Z9GT .. 1.05
2J46 .. 39.50	6H7 .. 8.95	708BY .. 39.50	954 .. .49	FG32 .. 7.95	1L4 .. 1.15	6BG6 .. 1.25	68ZGT .. 1.10	35Z9GT .. 1.05
2J48 .. 29.50	6H7 .. 8.95	708BY .. 39.50	954 .. .49	FG32 .. 7.95	1L4 .. 1.15	6BG6 .. 1.25	68ZGT .. 1.10	35Z9GT .. 1.05
2J49 .. 39.50	6H7 .. 8.95	708BY .. 39.50	954 .. .49	FG32 .. 7.95	1L4 .. 1.15	6BG6 .. 1.25	68ZGT .. 1.10	35Z9GT .. 1.05
2J50 .. 39.50	6H7 .. 8.95	708BY .. 39.50	954 .. .49	FG32 .. 7.95	1L4 .. 1.15	6BG6 .. 1.25	68ZGT .. 1.10	35Z9GT .. 1.05
2J54B .. 39.50	6H7 .. 8.95	708BY .. 39.50	954 .. .49	FG32 .. 7.95	1L4 .. 1.15	6BG6 .. 1.25	68ZGT .. 1.10	35Z9GT .. 1.05
2J55 .. 97.50	6H7 .. 8.95	708BY .. 39.50	954 .. .49	FG32 .. 7.95	1L4 .. 1.15	6BG6 .. 1.25	68ZGT .. 1.10	35Z9GT .. 1.05
2J61 .. 39.50	6H7 .. 8.95	708BY .. 39.50	954 .. .49	FG32 .. 7.95	1L4 .. 1.15	6BG6 .. 1.25	68ZGT .. 1.10	35Z9GT .. 1.05
2J62 .. 49.50	6H7 .. 8.95	708BY .. 39.50	954 .. .49	FG32 .. 7.95	1L4 .. 1.15	6BG6 .. 1.25	68ZGT .. 1.10	35Z9GT .. 1.05
2K25 .. 39.50	6H7 .. 8.95	708BY .. 39.50	954 .. .49	FG32 .. 7.95	1L4 .. 1.15	6BG6 .. 1.25	68ZGT .. 1.10	35Z9GT .. 1.05
2K28 .. 36.25	6H7 .. 8.95	708BY .. 39.50	954 .. .49	FG32 .. 7.95	1L4 .. 1.15	6BG6 .. 1.25	68ZGT .. 1.10	35Z9GT .. 1.05
2K29 .. 24.50	6H7 .. 8.95	708BY .. 39.50	954 .. .49	FG32 .. 7.95	1L4 .. 1.15	6BG6 .. 1.25	68ZGT .. 1.10	35Z9GT .. 1.05
3A1 .. 12.95	6H7 .. 8.95	708BY .. 39.50	954 .. .49	FG32 .. 7.95	1L4 .. 1.15	6BG6 .. 1.25	68ZGT .. 1.10	35Z9GT .. 1.05
3B22 Elic .. 4.95	6H7 .. 8.95	708BY .. 39.50	954 .. .49	FG32 .. 7.95	1L4 .. 1.15	6BG6 .. 1.25	68ZGT .. 1.10	35Z9GT .. 1.05
3B23 RK22 .. 4.85	6H7 .. 8.95	708BY .. 39.50	954 .. .49	FG32 .. 7.95	1L4 .. 1.15	6BG6 .. 1.25	68ZGT .. 1.10	35Z9GT .. 1.05
3B24 .. 5.95	6H7 .. 8.95	708BY .. 39.50	954 .. .49	FG32 .. 7.95	1L4 .. 1.15	6BG6 .. 1.25	68ZGT .. 1.10	35Z9GT .. 1.05
3B24W .. 4.95	6H7 .. 8.95	708BY .. 39.50	954 .. .49	FG32 .. 7.95	1L4 .. 1.15	6BG6 .. 1.25	68ZGT .. 1.10	35Z9GT .. 1.05
3B25 .. 4.65	6H7 .. 8.95	708BY .. 39.50	954 .. .49	FG32 .. 7.95	1L4 .. 1.15	6BG6 .. 1.25	68ZGT .. 1.10	35Z9GT .. 1.05
3B26 .. 3.95	6H7 .. 8.95	708BY .. 39.50	954 .. .49	FG32 .. 7.95	1L4 .. 1.15	6BG6 .. 1.25	68ZGT .. 1.10	35Z9GT .. 1.05
3B27 .. 3.95	6H7 .. 8.95	708BY .. 39.50	954 .. .49	FG32 .. 7.95	1L4 .. 1.15	6BG6 .. 1.25	68ZGT .. 1.10	35Z9GT .. 1.05
3B28 .. 8.95	6H7 .. 8.95	708BY .. 39.50	954 .. .49	FG32 .. 7.95	1L4 .. 1.15	6BG6 .. 1.25	68ZGT .. 1.10	35Z9GT .. 1.05
3B31 .. 8.95	6H7 .. 8.95	708BY .. 39.50	954 .. .49	FG32 .. 7.95	1L4 .. 1.15	6BG6 .. 1.25	68ZGT .. 1.10	35Z9GT .. 1.05
3C22 .. 64.50	6H7 .. 8.95	708BY .. 39.50	954 .. .49	FG32 .. 7.95	1L4 .. 1.15	6BG6 .. 1.25	68ZGT .. 1.10	35Z9GT .. 1.05
3C23 .. 9.95	6H7 .. 8.95	708BY .. 39.50	954 .. .49	FG32 .. 7.95	1L4 .. 1.15	6BG6 .. 1.25	68ZGT .. 1.10	35Z9GT .. 1.05

**FULL-WAVE SELENIUM RECTIFIER STACKS**

Max. A.C. Input RMS	Max. D.C. Output	Cell Size	Temp. Range	Output Continuous	This Number	Price
<b>SINGLE PHASE BRIDGE</b>						
0-18 0-14.5	13 1/2	x13 1/2	1.3	18B4D1S1	\$ 3.95	
" " " "	2-3/16	x2-3/16	6.4	18B4S1	7.95	
" " " "	4 1/2	x5	13.0	18B4K1S1	12.95	
" " " "	4 1/2	x5	17.5	18B4J1S1	15.45	
" " " "	4 1/2	x5	32.0	18B4K1S3	37.	



**WANTED! WANTED!**

ATTENTION colleges, schools, hams, industrials!! Highest prices paid for surplus equipment, parts, and tubes. We are especially looking for test equipment TS-12, 13, 35, 14/AP, 15/AP, 146/UP, 173, 174, 175, 239, 259, 263. Any types with TS prefix. Write, wire or call.



**WANTED! WANTED!**

APR-4, 5, 7 and tuning units. ARC-1, 3, ART-13, ATC, APS-10, microwave equipment in S, K, X-band. APS-15, APQ-13, APS-13, SCR-300, 284, 694, etc. BC-221, 342, 348, BC-1016 tape recorders. Write, wire or call.

**RADAR—COMMUNICATIONS AND TEST EQUIPMENT**

TS-35/AP X-band Signal Generator. Pulsed and C.W. freq. range, 8400-9600 mcs. This unit will measure power and frequency. 115v 60-2600 cyc.

TS-3/AP S-band Frequency and Power Meter. Portable. Battery operated. Complete with all cables.

TS-33/AP X-band Frequency Meter. 8500-9600 mcs. Contains crystal detector and indicating meter. Output to scope will indicate pulse wave shape.

TS-62/AP X-band Echo Box. 8400-9600 mcs. tuned and untuned input. Will indicate resonance on meter. Complete with pick up antenna and cable.

TS-268/UP Crystal Diode Test Set. Used to check 1N21, 1N22, 1N23, etc. Battery operated. Portable. Complete with spurs.

TS-89/AP Voltage Divider. 1:10 and 1:100 ratios. Wide band for true pulse shape. Output to scope.

TS-10/APN Altimeter Test Set. Good condition. Complete with cables and dummy antenna \$35.00

TS-12/AP V.S.W.R. Test Set for X-band. Complete with amplifier, slotted line, termination, adaptors, etc. In 2 carrying cases. Excellent.

TS-23/APN Test Set to check freq. and power output of SCR-718 transmitter. Complete with all cables.

TS-36/AP X-band Power Meter. Consists of power measuring circuit, Horn antenna, co-ax to wave guide adaptor, connecting cable and probe. Will measure either absolute or relative power. Nominal band of usefulness is approx. 8.5-9.7 KMC. Excellent condition.

TS-118/AP R.F. Wattmeter for the range of 20-750 mcs. Will measure power up to 500 watts. Complete.

TS-174/U Freq. Meter. Freq. range is 50-250 mcs. High freq. version of BC-221. Excellent Condition.

1-185 Signal Generator. L-band search. S-band track. Used with SCR-545 and similar sets. Complete with cables. Good condition.

TS-61/AP S-band Echo Box. Using meter provided it is possible to maximize the XMTR adjustment and determine relative power output. Complete with probe and cable. Very good condition.

TS-131/AP Field Strength Meter. Consists of pickup unit, control box C-111/AP, cord CX-149/AP, adaptor M-359 and case. Unit will check output in range 200-1000 mcs. Excellent condition.

TS-226/AP used to measure peak power output of any xmitter in the range of 200-1000 mcs. Has provision for oscilloscopic signal observation and built in calibration. Part of AN/APM-29. Excellent.

TS-108/AP X-band Dummy Load. Consists of a length of X-band guide filled with sand. One end closed other terminates in a coupling choke. Excellent.

TS-14/AP consists of S-band signal generator, freq. meter, wattmeter and cables. Power input is 115v 50-2600 cyc. Used to check various S-band radars and beacons.

TS-170/ARN-5 XTAL controlled test osc. with the following freq. ranges: 332.6, 333.8, 335.0 depending on XTAL in use. This set is used to align glide path receivers. Antenna and antenna are self contained. Excellent condition.

AN/APS-3 Airborne X-band Search and Homing radar. Complete. Contains RF head, modulator, synchronizer, control boxes, plugs, antenna, etc. 115v 400 cyc. Excellent condition. \$875.00

ASB-5 L-band Search and Homing radar. Complete. Contains xmitter, receiver, power unit, control box, plugs, etc. 115v 400 cyc. Excellent condition. \$125.00

SCR-518 Radar Altimeter. 500 mcs. equipment. Complete with xmitter, receiver, control box, power unit, junction box with all cables, racks, etc. Unit will indicate altitude up to 50,000 ft. Power input is 28v. New condition. \$125.00

AN/APS-15 R.F. Head and Modulator. X-band. Complete with all tubes. Good condition. \$125.00

AN/APA-23 Automatic Signal Strength and Time Recorder. Unit will scan a receiver thru its range and record all signals on electro-sensitive paper. Input is 115v 60-2600 cyc. and 28v DC. Excellent condition. \$175.00

AN/CRT-3 Victory Girl. Dual frequency emergency lifeboat xmitter. Complete with xmitter, kite hydrogen generator, etc. New in knapsack, C.A.A. approved. \$129.50

AN/APR-5 Radar Search Receiver. Freq. range 1000-3100 mcs. Will detect signals up to 10,000 mcs. with reduced sensitivity. Contains oscillator and mixer cavity. IF strip, power supply. Input 60-2600 cyc. 115v. Excellent condition. \$375.00

T-50 Radiotelegraph Transmitter complete with power supply and all accessories with spares. Portable. New in cases. \$375.00

AN/APT-5 300-1500 mcs. xmitter cavity oscillator using 3C22 highthouse tube. Power output 30 watts. Noise modulated. Excellent condition. Complete with all tubes. \$149.50

SK-1M Radar Receiver Indicators. Freq. 195 mcs. 2 R.F. stages, 3 IF stages. 1 video, etc. New condition. \$125.00

SCR-183 Airborne Command Equipment. Freq. range 201-39KKC and 2500-7700KCS. Complete. Contains receiver, xmitter, dynamotor, antenna switch, control box, coils, etc. Power input 24-28v. Brand new in original cases. Manufactured by Western Electric. \$125.00

NAVY RU Command Equipment. Similar to SCR-183. \$125.00

DU-1 Direction Finding Equipment for SCR-183 and RU Series Equipment. Can be used with any receiver for direction finding in freq. range 200-1600KC. New. Complete. \$45.00

SCR-515 (BC-645) contains xmitter, receiver, dynamotor PE-101, control box, manual, etc. New. \$18.95

AN/PMP-1 EUREKA! Ground portable, beacon responder. Will work into the AN/APM-2 transponder for purposes of homing. C.W. communication can also be carried on between plane and ground. Unit comes complete with xmitter, receiver, power pack, phones, etc. Brand new in knapsack. AN/APN-2 EQUIPMENT CAN BE SUPPLIED ON ORDER.

SCR-269/G Automatic Radio Compass. Freq. range 200-1750KC. Complete with BC-433-G receiver, BC-434, LP-21, 1-81, 1-82, BK22, etc. Very good condition. \$129.95

SCR-300 Frequency Modulated Transceiver. Freq. range 40-48 mcs. complete with 18 tubes, handset and antenna. Powered from self contained battery pack. Excellent condition. Weight approx. 35 lbs. with battery, each. \$450.00

TCN Marine Radios Telephone and Telegraph Xmitting and Receiving Equipment. Freq. range 1500-12000KC. Consists of xmitter, receiver, antenna loading coil, remote control box, power unit, cables, etc. Power input is 12 or 32v DC. We can supply an 110v AC power supply for stationary use at additional cost. Excellent condition.

SCR-536 Xmitter-Receiver (handy talkie). Freq. range 3885-5500KC. Complete with coils, tubes, crystals. Very good condition. \$59.95

AN/APA-10 Panoramic Adaptor for use with any receiver with following IP's: 455KC, 5 mcs, 30 mcs. Unit will give panoramic presentation (1 mc wide for 455KC input) (100KC for 5MC input) (2MC for 30 mcs input). Power input 115v 400 cyc. but can be changed with the addition of a proper power transformer. Excellent condition. \$175.00

AN/ARN-5 Glide Path Receiver. Freq. range 332.6, 333.8, 335.0 mcs. selected by changing crystals. Complete with receiver, mounting MT-28, AS-27 antenna, BC-732 control box, and indicator 1-101-C. Power input is 28v 1.7 amp. Excellent condition. \$49.95

With B motor receiver. \$59.95

SCR-610 Freq. Modulated Portable Transceiver. Covering range of 20.0-27.9 mcs in 80 channels 100KC apart. Complete equipment consisting of BC-620 transceiver, power supply PE-97A, T-17 mike, handset, AN-45 antenna, battery operated or 6 or 12v input. Excellent condition. \$69.95

SCR-610 similar to SCR-610 except for freq. range which is 27.0-38.9 mcs. Excellent condition. \$79.95

AN/APA-11 Pulse Analyzer to work with Search Receiver for analysis of received pulsed signals. PPS, pulse width, wave shape, can be displayed on an CR tube. Unit can also be used as a standard oscilloscope for general servicing work. Input is 115v-400-2600 cyc. but can be changed with the addition of a 60 cyc. transformer. Very good condition.

SCR-694 Field Radio. Light weight version of SCR-284. Freq. range is 3.8-6.5 mcs. Power output is A1-20, A3-5; comes with transceiver BC-1306, GN-45 or 58 hand generator, antenna system, microphone, headset, etc. In excellent condition.

PE-237 AC Power Supply for stationary use can be supplied at additional cost.

SCR-522 VHF Airborne Command Equipment. Freq. range 100-156 mcs. in 4 channels receiver and transmitter. Crystal controlled. Complete equipment. Consists of trans/rec, control box BC-602, dynamotor PE-94, AN104A antenna, plugs, etc. Power input with PE-94 is 28v. Excellent condition. We can supply PE-98 dynamotor for 12v input at additional cost.

**COMMAND EQUIPMENT**

**ARC-5 274N OTHERS**

**RECEIVERS**

ARA 500-1500KC. New. \$24.95

453B 200-550KC. New. 14.95

455B 6-9 mcs. New. 16.50

433 200-1750KC. Good. 29.95

ARR-2 234-258 mcs. New. 19.95

**TRANSMITTERS**

459-A 7-9.1 mcs. New. \$12.85

696-A 3-4 mcs. New. 29.95

TYPE O 5.3-7 mcs. New. 9.95

AVT-23 3000-13,000KC complete w/control box, manual, etc. C.W. or phone. 14 or 28v input. Brand new. Original cases. 79.50

BC-950A 100-156 mcs. New. 59.95

**ACCESSORIES**

BC-456 Modulator. Good. \$2.25

BC-450 Control Box (3 rec). Used. 1.25

BC-451 Control Box (xmitter). Used. .98

BC-442 Relay Unit (ANT.). Used. 1.95

Flexible Shafting Available

**MISCELLANEOUS SPECIALS!**

Sound Powered Chest and Headsets MI-2451-B type O, mfg. RCA. Brand new in original boxes. Pair. \$ 29.95

Trailing Wire Antenna Feed Tube. New. 5.95

Goniometer for SCR-277 Direction Finder. Excellent. 39.95

RL-7 Interphone Control Box. New. 1.95

FT-154 BC-348 Shock Mounts. 2.98

AN/CRW Receiver for Remote Control. 5.95

BC-1206 Beacon Receiver 200-400KC, 28v in. Excellent. 4.95

MN-26-Y Compass Receiver. Very good. 24.95

BC-438G Compass Receiver. 200-1750KC in 3 bands. Excellent. 39.95

BC-778 Gibson Girl 500KC. Good condition. 3.95

BC-1016 Tape Recorder. Complete. New. 459.50

CFI Unit with 200KC Xtal. New. 14.95

T-17 Carbon Mike. Used. Good. 89.95

BC-329 Transmitter. Excellent. 1.59

QBG-1 Sonar complete with Hydrophone. Excellent. 125.00

BC-1091 RF Head. Very good condition. 69.95

AN/104A Antenna for SCR-522, ax handle. New. 3.50

LP-21 Direction Finding Antenna. Good. 12.95

ASB 500 mcs YAGI Antenna Dual 6 Element Single Element. 14.95

AN/APA-17 Radar Direction Finding Antenna, back to back parabola, freq. range 300-1000 mcs. Horizontally and vertically polarized. Excellent. 59.00

CG-(172/173) CPN-8 10CM Coax Patch Cable. New. 4.95

CX-548/CRD-3 Cable. New. 1.25

CX-546/CRD-3 Cable. New. 1.25

CD-508A with SW 14-U and 2 Cord Attachments with JK-48 Jack and PL-68 Plug. New. .75

CD-307A with PL-55 and JK. New. 1.29

Spares for ARC-5 and 274N. APX-1 ASG-10. We have a large stock of TS-34A/AP Spares.

**COAXIAL CABLE CONNECTORS**

83-1AP	.50	83-1SP	.45	83-168	.15
83-1F	1.30	83-1SPN	.50	83-185	.15
83-1H	.80	83-1T	1.30	UG-27/U	.68
83-1J	.80	83-22AP	1.10	UG-58/U	.63
83-1R	.40	83-22R	.48	UG-85/U	.88

Others in stock. Write for prices.

**CORDS AND PLUGS**

CD 508A Cord Assembly with SW 14-U Switch and 2 cord attachments with JK 48 Jack and PL 68 Plug. Value—\$5.00. Our Special Low Price. Brand New. 59c

CD307A with PL 55 and JK. New. \$1.29

JK 26 Jack only—Brand New. 20c

PL 55 Plug—New. 35c

PL 68 Plug—New. 25c

Jones plug 8 contact male and female. 49c

PL-Q-59. 49c

PL-Q-61. 49c

PL-Q-62. 49c

PL-Q-77. 69c

PL-Q-171. 89c

PL-153-A. 69c

PL-172. 89c

**BC-221 FREQUENCY METER**

This is a Terrific Value! QUANTITY IS LIMITED—so first come first served. They are just like new, with original calibration charts. Range 125-20,000 KC with crystal check points in all ranges. Complete with crystal and tubes. **ONLY \$99.50**

**DYNAMOTORS AND POWER UNITS**

Type	Input Volts	Output Volts	Amps	Price
DM-19	12	500	.200	\$ 6.95
DM-25	12	250	.050	4.95
DM-32	28	250	.060	1.75
DM-33	28	570	.160	2.95
DM-34	12	220	.080	8.95
DY-12	12	275	.110	
		500	.110	
FE-73	28	1000	.350	10.00
FE-94	28	300	.260	
		150	.010	
		14.5	.5	2.25
PE-97	Vibrator	Power Supply		8.95
PE-98	12v	300v		35.00
PE-101	28	400		5.75
		800		35.00
PE-103	6 & 12	500	.160	5.00
EP-18-AR	Vibrapak			15.95
RA-42	(for BC-639 Receiver)			29.95
ATR	Inverter			
	12v	110v AC	125 watts	14.95

PHONE DIGBY 9-0347

WRITE FOR QUANTITY PRICES

Prices subject to change without notice.

F.O.B., NYC minimum order \$10.00.

20% deposit required. All merchandise guaranteed.

**RADIO HAM SHACK Inc.**  
189 GREENWICH STREET . NEW YORK, N. Y.



# WE'VE GOT THE STUFF!

## SEND A WIRE, AIR EXPRESS EVERY DAY

### POWER POTENTIOMETERS

Ohm	Watt	Bush	Shaft	Cat. No.	Price
3-3	25	5/8S	1/8SD	O-H	\$1.04
15	25	1/2	1/2	I	\$1.04
15	25	3/8	1"	C	
15	25	3/8	1 1/8	D-245	
15	25	1/2	1 1/4	D-1	
20	25	1/2	1 1/2	D-245	
25	25	1/2	1 1/2	C	
25	25	3/8	1"	D-245	
25	25	1/2	3/8S	I	
30	25	3/8	1"	C	
50	25	3/8	1 1/8	D-245	
50	25	5/8	1/8SD	O-H	
75	25	1/2	7/16	O-H	
100	25	3/8	1"	D-245	
100	25	1/2	1/2	H	
350	25	3/8	1 1/8	O-H	
500	25	3/8	11/16	D-245	
800	50	3/8	7/16F	O-1	1.24
1K	25	1/2	1/2	O-H	1.17
3K	25	3/8	1 3/16	D-245	1.20
5K	25	1/2	1/8SD	I	1.24
5K	25	3/8	7/8FS	D-245	1.24
20K	25	1/2	1/8SD	D-245	1.40

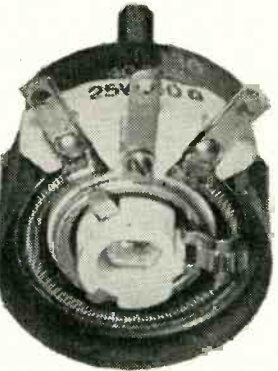

### PRECISION POTENTIOMETERS

Ohm	Watt	Cat. No.	Price
10	6	D-292	\$1.20
2K	6	301AS	1.20
2K	6	314A	1.70
10K	12	M-314A	1.70
20K	6	D-503G-2	1.70
20K	6	D-260	1.70
20K	6	M-314A	1.70
100K	25	433A	6.50

### TOGGLE SWITCHES

Molded Bakelite — 7/16" Bushing  
N.P. Bat Handle

Contact	Current	Stock #	Price
SPST	6A	110B	\$5.39
SPDT	3A	112	.44
DPST	3A	216	.60
DPDT	3A	316	.66
DPDT	Center Off	1A	.60

On All Items Write For  
**QUANTITY PRICES!**

### TURRET

Add letter for corresponding board thickness; A—1/32" B—1/16", C—3/32", D—1/8"

Our Number	Other Number	Price for 100
1200	x1548	\$1.38
1210		1.70
1220	x1143	2.76
1230		3.31
1250		3.05
1260		2.34
1280	X1558	1.38
1290	X1463	1.68
1300	X1724	1.38
1310		2.05
1320	X1579	2.90
1330	X1798	2.02
1340	X1457	1.30
1350	X1245	2.00
1360	X081	1.03
1391	X1578	2.40
2000	X1785	2.90
2010		1.78
2020		3.15
2030		1.95
2040		3.46
2050		3.39
2060	X1604	1.65

POT. LOCK #1510 \$ .23

### TIE POINTS

Our Number	Other	Price
1400B	X1581B	\$ .13
1410B	X1580B	.13
1417		.19
1418		.19
1419		.19
1421		.24
1422		.24

**HIGH VOLTAGE GLASS-METAL SEAL**  
10¢ each, \$7.50 per 100, \$65 per 1000



### GLASS TO METAL SEALS

Only 5¢ Each

Stock No.	Color	Stock No.	Color
199	White	207	green
200	white	208	yellow
201	white	210	clear
202	blue	211	clear
203	green	214	clear
205	brown	215	clear
206	red	216	clear

Widely Known for Fair Dealing and Good Service  
**HAROLD H. POWELL**  
632 Arch Street Philadelphia 6, Pa.  
Market 7-5650

### CONNECTORS

#### 69¢ SPECIALS

31511	RFK-59A-2	PLQ 74
AP-60A-2	RNK-M8-22C-7/8	RFK-59A-2
AP-FD2-23-3/4"	RNK-M8-31SL	RNK-12-22C-7/8
BN	RNK-27-31-SL	RNK-27-31-SL
AP-4-14	RWK-C3-22C-5/8	RWK-C3-22C-5/8
AP-4-CG-11	SK-C16-32S	SK-C16-32S
AP-6-14	SK 4397	SK 4397
AP-6-CG-11	SK 4408	SK 4408
ARC 6967	SO-40	SO-40
CLT 49043	SO-56	SO-56
CLT 49171	SO-239	SO-239
CQA 49547	UG 9/U	UG 9/U
CUF 49042	UG 10/U	UG 10/U
D-16326	UG 12/U	UG 12/U
E-1002-1-20	UG 13/U	UG 13/U
E-1002-4-40	UG 21/U	UG 21/U
E-1002-13-20	UG 25/U	UG 25/U
F 6852-5	UG 28/U	UG 28/U
FK 10-32 S	UG 85/U	UG 85/U
GK-M2-21-3/4B	UG 87/U	UG 87/U
GK-C4-21C-7/16"	UG 167/U	UG 167/U
GK-C4-21-3/4B	UG 342/U	UG 342/U
GK-M5-23 1/2A/C	UG 203/U	UG 203/U
GK-C8-23 1/2"B	WK-1-23-3/8B	WK-1-23-3/8B
GK-9-32S	WK-1-23S	WK-1-23S
GK-12-21C-5/8	WK-M2-23-3/8B	WK-M2-23-3/8B
GK-12-32S	WK-C3-21C-3/8B	WK-C3-21C-3/8B
J201	WK-C3-21C-5/8"	WK-C3-21C-5/8"
LK-R24C-22-7/8T	WK-C3-23	WK-C3-23
M 359	WK-C3-23C-1/2"	WK-C3-23C-1/2"
NAF 47908-1	RWK-C3-31-SL	RWK-C3-31-SL
NAF 68925-1	WK-4-21-1/2"	WK-4-21-1/2"
NAF 68925-2	AC & AN	AC & AN
NAF 68925-3	WK-4-21-1/2B	WK-4-21-1/2B
NK-M8-21C-7/8"	WK-4-21C-3/4	WK-4-21C-3/4
NK-12-21C-5/8"	WK-6-21C-3/8"B	WK-6-21C-3/8"B
NK-12-22C-5/8"	PS-6-24 2415	PS-6-24 2415
NK-12-32S	PL-75429C	PL-75429C
NK-M16-32S	ZA-2816; PM-12	ZA-2816; PM-12
P3-GP 6/7	ZA/US10630 & 31	ZA/US10630 & 31
PL-56	ZA/US10631;	ZA/US10631;
PL-258	ZA/US10630	ZA/US10630
PL-259		
PL-P56		
PLP 60		
PLQ 62		

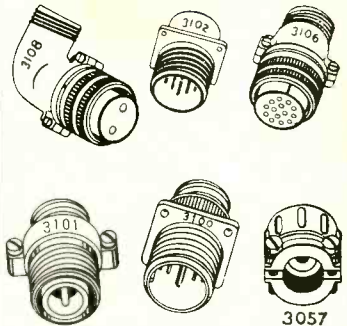

### AN CONNECTORS

COMPLETE LIST NEXT PAGE →

AN	Price	AN	Price
3050-4	.05	3057-10-5/16-2	.35
3050-6	.05	3057-10-1/2-2	.35
3050-8	.05	3057-10-6	.35
3050-10	.06	3057-10-6	.35
3050-16	.08	3057-12	.38
3050-20	.10	3057-12-4	.38
3051-4	.05	3057-12-1/2-2	.38
3051-8	.05	3057-16	.40
3051-10	.06	3057-16	.40
3051-20	.13	11/16-2	.40
3051-26	.12	3057-20	.75
3051-30	.08	3057-22	.80
3054-10	.11	3057-28	.88
3054-16	.15	3057-32	.95
3055-8	.40	3057-40	.95
3055-10-3	.43	3060-6	.33
3055-14-4	.60	3061-4	.50
3055-14-6	.60	3062-6	.40
3055-16-8	.80	3062-12	.55
3055-18-6	.90	3063-3	.50
3055-18-8	.90	3063-16	.60
3055-22-8	1.00	3066-6	.05
3055-28-12	1.10	9760-10	.50
3055-28-16	1.10	9760-14G	.50
3055-40-20	1.40	9760-14	.50
3055-44-24	1.50	9760-16	.50
3057-3	.30	9760-20	.55
3057-4	.30	9760-22	.60
3057-6	.30	9760-28P	.65
3057-8	.35	9769-8	.05
3057-8-5/16-2	.30	9769-8	.05
3057-10	.35	9769-12	.07



**EAGLE ADJUSTABLE TIME DELAY RELAY**, 1.10 volt 60 cy with double throw Micro Switch. Can be set from 1 1/2 to 58 minutes. Includes attractive 3/4 x 4 1/2 x 2 1/2" black cover. Made to sell for \$26. SALE PRICE \$6.95



**PULSE TRANSFORMERS**  
7P26, Westinghouse, 15-F4-91-400-50P, Sprague #S92-5245, H623, 4x5x7 inch oil filled with 3 1/2 inch insulators. 0.91 Microsecond, 15KV. \$9.90

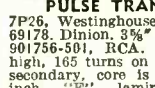

**PULSE FORMING LINE**, Millen flexible type, 23 1/2 inches long, form 2 microsecond pulses, Zo-1000 ohm, our #388 \$3.75

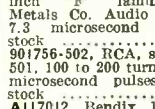

**DELAY LINE** 15-F4-91-400-50P, Sprague #S92-5245, H623, 4x5x7 inch oil filled with 3 1/2 inch insulators. 0.91 Microsecond, 15KV. \$9.90

### TURRET SOCKETS

SAVE TIME BETTER CIRCUIT

Socket	Height	Stock #	Price
Octal	2 1/2"	10-0-9T	\$ .59
Octal	2	8-0-9T	.57
Octal	1 1/2	6-0-9T	.54
Min.	3"	12-MB-12	.73
Min.	2"	8-M-9T	.63
Min.	1 1/2	6-M-9T	.60
Min.	1"	4-M-6T	.59
Noval	3"	12-NB-12	.78
Noval	2"	8-N-9T	.66
Noval	1 1/2	6-N-6T	.65
Noval	1	4-N-6T	.63



### PLUG-IN UNITS

D.C. AMPLIFIERS MULTIVIBRATORS

A—No Can, B—1 3/8" sq. can, C—2" sq. can

Socket	Length	Stock #	Price
Octal	2"	A8-0	\$ .95
Octal	2	B8-0	1.43
Octal	2	C8-0	1.75
Octal	2 1/2	A10-0	.97
Octal	2 1/2	B10-0	1.45
Octal	2 1/2	C10-0	1.78
Octal	3	A12-0	1.00
Octal	3	B12-0	1.47
Octal	3	C12-0	1.81
Min.	2	A8-M	.99
Min.	2	B8-M	1.52
Min.	2	C8-M	1.84
Min.	2 1/2	A10-M	1.01
Min.	2 1/2	B10-M	1.55
Min.	2 1/2	C10-M	1.86
Min.	3	A12-M	1.03
Min.	3	B12-M	1.57
Min.	3	C12-M	1.90
Noval	2	A8-N	.97
Noval	2	B8-N	1.57
Noval	2	C8-N	1.87
Noval	2 1/2	A10-N	1.00
Noval	2 1/2	B10-N	1.60
Noval	2 1/2	C10-N	1.90
Noval	3	A12-N	1.02
Noval	3	B12-N	1.62
Noval	3	C12-N	1.95

Also Dual Socket Units.



## AN CONNECTORS—DISCOUNT: 50% PHENOLIC, 40% MELAMINE

Insert	Shell and 3100 3101	1947 List 3102	Price 3106 3108	Insert	Shell and 3100 3101	1947 List 3102	Price 3106 3108	Insert	Shell and 3100 3101	1947 List 3102	Price 3106 3108	Insert	Shell and 3100 3101	1947 List 3102	Price 3106 3108		
85-1S	\$1.59	1.63	1.19	1.59	2.61	18-25S	\$3.21	2.87	1.73	3.65	3.65	22-24S	\$4.15	4.09	2.72	4.20	5.48
85-1P	1.53	1.59	1.19	1.59	2.61	18-26S	2.72	2.87	1.68	2.96	4.00	22-24P	3.65	3.71	2.23	3.95	4.90
10S-2S	1.48	1.53	1.08	1.39	2.47	18-26P	2.72	2.87	1.73	3.65	4.00	22-25S	4.15	4.20	2.72	5.24	5.48
10S-2P	1.43	1.48	1.08	1.48	2.52	18-27S	2.25	2.92	1.83	3.80	4.44	22-25P	3.80	3.80	2.37	4.40	5.19
10S-3S				1.73	2.67	18-27P	3.25	3.07	2.03	3.21	4.44	22-26S	4.49	4.29	3.11	4.79	5.83
10S-3P	1.73	1.77	1.43			18-28S	2.96	3.07	2.03	3.21	4.44	22-26P	4.20	4.25	2.81	4.75	5.53
10S-4S				1.53	2.76	18-28P	3.25	2.92	1.83	3.80	4.44	22-27S	4.89	5.09	3.71	5.33	6.43
10S-4P	1.59	1.63	1.19			18-29S	3.60	3.25	2.17	4.40	4.79	22-27P	4.29	4.34	3.31	4.75	5.92
12S-1S	1.63	1.73	1.19	1.97	2.72	18-29P	3.80	3.45	2.37	4.59	4.99	22-28S	4.55	4.55	3.16	5.77	5.92
12S-1P	1.68	1.68	1.24	1.97	2.87	18-30S	2.96	3.11	2.08	3.21	4.49	22-28P	3.80	3.85	2.37	4.98	5.19
12S-2S	1.63	1.73	1.19	1.97	2.72	18-30P	3.31	2.92	2.12	3.76	4.99	22-29S	4.79	4.84	3.41	5.39	6.12
12S-2P	1.68	1.68	1.24	1.97	2.87	18-31S	3.71	3.36	2.23	4.25	4.69	22-29P	4.49	4.49	3.11	5.43	5.83
12S-3S	1.63	1.73	1.19	1.97	2.72	18-31P	3.31	2.92	2.12	3.76	4.99	22-30S	5.19	5.91	4.64	5.59	6.81
12S-3P	1.68	1.68	1.24	1.97	2.87	20-1S	4.44	4.69	3.60	4.75	4.84	22-30P	5.88	5.92	4.49	7.10	7.21
12S-4S	1.39	1.53	1.04	1.59	2.72	20-1P	5.63	6.32	3.91	5.92	5.97	22-32S	3.95	4.00	2.61	4.69	5.33
12S-4P	1.39	1.53	1.04	1.59	2.72	20-2S	3.25	3.36	1.92	4.05	4.25	22-32P	3.76	3.76	2.32	4.35	5.04
12-5S	1.59	1.92	1.39	1.97	3.01	20-2P	3.11	3.31	1.83	3.45	4.20	22-33S	3.95	4.20	3.11	4.40	5.77
12-5P	1.53	1.73	1.24	2.67	3.73	20-3S	3.71	3.76	2.23	4.25	4.69	22-33P	4.20	4.25	2.81	5.13	5.53
12S-6S	2.37	2.37	1.84	2.67	3.73	20-3P	3.41	3.56	1.97	3.80	4.84	22-34S	4.15	4.20	2.72	4.89	5.48
12S-6P	3.14	3.49	2.61	3.79	4.58	20-4S	3.36	3.36	2.08	3.76	4.93	22-34P	3.80	3.85	2.52	4.29	2.28
14S-1S	1.77	2.03	1.33	2.37	3.16	20-4P	3.16	3.20	1.92	3.71	4.84	22-35S	4.35	4.35	2.92	5.53	5.63
14S-1P	1.77	2.03	1.33	2.32	3.16	20-5S	3.07	3.16	1.68	3.45	4.40	22-35P	4.00	4.00	2.61	5.24	5.43
14S-2S	1.88	1.97	1.43	2.41	3.25	20-5P	2.87	2.92	1.43	3.56	4.20	22-36S	4.65	4.65	3.26	5.68	6.02
14S-2P	2.08	2.08	1.43	2.37	3.50	20-6S	4.40	4.29	3.01	4.89	5.09	22-36P	4.29	4.29	2.92	5.48	5.83
14-3S	2.03	2.08	1.43	2.37	3.50	20-6P	3.25	3.25	3.11	1.83	3.60	24-1S	4.44	4.35	2.67	5.28	5.59
14-3P	2.08	2.12	1.43	2.37	3.95	20-7S	3.51	4.15	2.87	3.80	5.09	24-1P	3.71	4.00	2.57	4.55	5.48
14S-4S	1.70	1.70	1.43	2.27	3.16	20-7P	4.35	4.69	3.25	4.64	6.59	24-2S	4.89	4.79	3.07	5.63	5.97
14S-4P	1.39	1.48	1.08	1.97	2.87	20-8S	4.40	4.44	3.01	5.33	5.33	24-2P	4.09	4.29	2.57	4.69	5.48
14S-5S	2.12	2.32	1.57	2.47	3.71	20-8P	4.20	4.29	2.81	4.89	5.09	24-3S	4.29	4.29	2.57	4.69	5.48
14S-5P	2.12	2.32	1.57	2.47	3.71	20-9S	4.40	4.29	3.01	4.89	5.09	24-3P	3.80	3.80	2.61	4.49	5.63
14S-6S	2.57	2.47	1.73	4.07	4.20	20-9P	4.15	4.20	2.76	4.64	5.09	24-4S	4.64	4.79	3.07	5.63	5.97
14S-6P	2.61	2.61	2.08	2.96	4.09	20-10S	3.36	3.36	2.08	3.76	4.93	24-4P	4.05	4.26	2.57	4.84	5.48
14S-7S	2.23	2.23	1.63	2.72	3.76	20-10P	3.16	3.20	1.92	3.71	4.84	24-5S	4.69	5.43	4.70	5.39	6.57
14S-7P	1.97	1.97	1.43	2.27	3.16	20-11S	4.44	5.04	3.60	4.75	5.92	24-5P	5.19	5.63	3.91	5.13	6.86
14S-8S	2.08	2.08	1.53	2.37	3.56	20-11P	5.63	6.06	4.55	5.69	6.69	24-6S	5.19	5.63	3.91	5.13	6.86
14S-8P	1.97	1.97	1.43	2.27	3.16	20-12S	3.06	3.06	2.03	3.80	4.35	24-6P	4.35	4.35	2.67	5.04	5.59
14S-10S	2.17	2.17	1.63	2.52	3.65	20-12P	3.65	3.65	2.27	4.84	4.59	24-7S	5.48	6.37	4.69	6.23	7.45
14S-10P	2.52	2.37	1.83	2.72	4.29	20-13P	3.11	3.76	2.27	3.45	4.59	24-7P	5.28	6.03	3.76	6.03	7.21
14S-11S	2.37	2.17	1.63	2.52	3.65	20-14S	4.40	4.44	3.11	5.59	5.39	24-8S	4.93	5.24	4.00	5.77	6.96
14S-11P	2.37	2.37	1.83	2.72	3.85	20-14P	4.40	4.44	3.11	5.59	5.39	24-8P	3.85	4.09	2.47	4.64	5.39
14S-12S	2.08	2.08	1.53	2.37	3.56	20-15S	4.55	4.69	3.21	5.59	5.53	24-9S	4.65	4.99	3.11	5.83	6.17
14S-12P	2.08	2.08	1.53	2.37	3.56	20-15P	4.55	4.69	3.21	5.59	5.53	24-9P	5.28	6.03	3.76	6.23	7.45
14S-13S	2.08	2.08	1.53	2.37	3.56	20-16S	3.76	4.07	2.61	4.89	4.93	24-10S	5.43	5.39	3.65	6.27	6.57
14S-13P	2.08	2.17	1.63	2.37	3.56	20-16P	4.55	4.79	3.31	4.89	5.63	24-10P	6.03	5.92	4.25	6.61	7.16
14S-14S	2.37	2.37	1.83	2.72	3.85	20-17S	4.44	4.49	3.11	4.89	5.43	24-11S	4.89	5.28	3.56	5.68	6.47
14S-14P	2.37	2.37	1.83	2.72	3.85	20-17P	4.44	4.55	3.11	5.33	5.43	24-11P	5.04	5.83	4.75	5.77	7.01
16S-1S	2.61	2.87	2.29	3.21	4.40	20-18S	4.84	4.93	3.41	5.83	5.83	24-12S	4.65	4.79	3.07	5.43	5.97
16S-1P	2.87	2.87	1.88	3.21	4.40	20-18P	4.84	4.29	2.81	4.53	5.24	24-12P	4.65	4.79	3.07	5.43	5.97
16-2S	2.27	2.32	1.68	2.72	3.56	20-19S	4.20	4.25	2.81	5.39	5.19	24-13S	4.69	5.43	4.40	5.39	6.67
16-2P	2.08	2.12	1.48	2.47	3.56	20-19P	3.91	4.25	2.72	4.21	5.04	24-13P	5.69	5.63	3.95	6.37	6.92
16S-3S	1.83	1.92	1.24	2.23	3.41	20-20S	3.91	4.25	2.72	4.21	5.04	24-14S	5.28	5.19	3.45	4.69	5.92
16S-3P	1.83	1.92	1.24	2.23	3.41	20-20P	4.25	4.29	2.81	4.40	5.24	24-14P	5.28	5.19	3.45	4.69	5.92
16S-4S	1.83	1.92	1.24	2.23	3.41	20-21S	4.25	4.29	2.81	4.40	5.24	24-15S	5.28	5.19	3.45	4.69	5.92
16S-4P	1.92	2.03	1.39	2.32	3.56	20-21P	4.25	4.29	2.81	4.40	5.24	24-15P	5.28	5.19	3.45	4.69	5.92
16S-5S	2.17	2.37	1.73	2.76	3.56	20-22S	4.59	4.75	3.25	4.93	5.63	24-16S	5.28	5.19	3.45	4.69	5.92
16S-5P	2.17	2.23	1.59	2.67	3.76	20-22P	4.44	4.44	3.11	5.43	5.43	24-16P	5.28	5.19	3.45	4.69	5.92
16S-6S	2.17	2.37	1.53	2.67	3.91	20-23S	4.44	4.55	3.11	5.43	5.43	24-17S	3.80	4.05	2.52	4.59	5.43
16S-6P	2.12	2.17	1.53	2.52	3.71	20-23P	4.25	4.35	2.87	4.55	5.24	24-17P	4.49	4.44	2.72	5.33	5.63
16S-7S	2.61	2.67	2.08	3.21	4.40	20-24S	3.91	4.00	2.57	5.04	4.89	24-18S	4.49	4.44	2.72	5.33	5.63
16S-7P	2.67	2.67	2.08	3.21	4.40	20-24P	3.71	3.80	2.32	4.35	4.69	24-18P	3.45	3.71	2.17	4.25	5.13
16S-8S	2.37	2.72	2.08	3.07	3.65	20-25S	4.44	5.04	3.60	4.75	5.92	24-19S	5.59	5.53	3.80	5.43	6.72
16S-8P	2.61	2.72	1.92	2.87	3.71	20-25P	4.44	5.04	3.60	4.75	5.92	24-19P	5.59	5.53	3.80	5.43	6.72
16-9S	2.72	2.87	2.12	3.25	4.29	20-26S	4.64	6.03	4.59	5.92	6.92	24-20S	5.63	6.63	3.80	5.92	6.47
16-9P	2.57	2.67	2.03	3.01	4.05	20-26P	4.64	6.03	4.59	5.92	6.92	24-20P	5.63	6.63	3.80	5.92	6.47
16-10S	2.27	2.37	1.73	2.72	3.85	20-27S	4.44	5.04	3.60	4.75	5.92	24-21S	4.84	4.84	3.65	5.68	5.73
16-10P	2.27	2.37	1.73	2.72	3.85	20-27P	4.44	5.04	3.60	4.75	5.92	24-21P	4.59	4.55	3.11	5.04	6.37
16-11S	2.27	2.52	1.83	2.47	3.91	20-28S	5.63	6.03	4.59	5.92	6.92	24-22S	5.73	5.63	3.16	5.68	6.86
16-11P	2.27	2.37	1.59	2.72	3.80	20-28P	5.63	6.03	4.59	5.92	6.92	24-22P	5.73	5.63	3.16	5.68	6.86
16-12S	2.67	2.72	2.08	3.07	4.15	20-29S	5.63	6.03	4.59	5.92	6.92	24-23S	5.73	5.63	3.16	5.68	6.86
16-12P	2.67	2.72	2.08	3.07	4.15	20-29P	5.63	6.03	4.59	5.92	6.92	24-23P	5.73	5.63	3.16</		



METERS

3 MA DC 2 1/2" R.—Simpson black scale.....	\$3.35
500 Microamps, DC—1/4" round—Sun.....	4.30
1 ma. DC Fan type—4" scale (rem. from equipt)	3.95
500 ma. DC 2 1/2" R.—General Electric.....	2.95
2 amp. RF 2 1/2" Sq.—Simpson.....	3.15
5 amp. AC 4 1/2" R.—JBT.....	4.11
50 VAC 3 1/2" R.—General Electric.....	2.95
10 amp. RF 3 1/2" R.—Simpson.....	4.95
50 amp. AC 3 1/2" R.—General Electric.....	4.11
3 amp. RF 3 1/2" R.—Weston.....	6.00

MAGNETRONS

2J21A	2J36	2J61	706CY
2J22	2J37	5J23	706FY
2J26	2J38	5J29	706GY
2J27	2J39	700B	714AY
2J31	2J40	700C	718AY
2J32	2J41	700D	720B/C/DY
2J33	2J48	706AY	725A
2J34	2J49	706BY	730A

KLYSTRONS

2K23	2K33	707A	726A
2K25	2K54	707B	726B
2K26	2K55	723A	5611
2K29	417A	723A/B	

OIL-FILLED HIGH VOLTAGE ISOLATION TRANSFORMERS

Pri. 460V 60 cy. Sec. 115V 200VA Insulated for 50KV DC—G. E. Form EIR—36" x 13"D.....\$125.00  
 Pri. 115V 60 cy. Sec. 115V 250VA Insulated for 35KV DC—G. E. Form EIR—29" H x 12 1/2"D.....\$125.00

VOLTAGE DIVIDER

G. E. Cat. 2428886G-I and 9001934G-1 17,246,400 ohms 35KV 70:1 ratio wire wound shielded oil-filled 40" H x 12"D.....\$77.50

2ϕ LOW INERTIA SERVO MOTORS

KOLLMAN Type 936-0240—85/68V 100 cy 5 watts 2650 RPM—new  
 DIEHL Type FPE-25—75V 60cy 4 watts—new.....\$34.50

OIL FILLED CONDENSERS

MFD	VDC	Price	MFD	VDC	Price
2	600	\$ .45	1	2500	3.85
4	600	1.25	1-1	2500	15.80
4	600 (R'd)	1.25	32	2500	2.95
6	600	1.65	3x2	4000	4.88
6	600 (R'd)	1.39	1	5000	1.65
10	600 (R'd)	1.52	.01-.03	6000	1.79
8-8	600	1.49	1	7000	28.95
1	1000	.62	2	12500	4.70
2	1000	.89	.045	16KV	4.95
4	1000	1.65	.05	16KV	8.95
8	1000	2.45	.075	16KV	18.95
1	1500	.89	.25	20KV	3.95
4	1500	2.95	50	220VAC	4.25
1-1.5	2000	.87	7	660VAC	4.50
1	2000	1.50	8	660VAC	

HIGH VOLTAGE TRANSFORMERS

G. E.—Pri. 115V 60 cy Sec. 2250V 80 MA—12.5 KV Ins.....\$18.50  
 G. E.—Pri. 115V 60 cy. Sec. 6250/3850/2600V 56 MA (12.5 KV Ins.).....\$18.50  
 Raytheon—Pri. 115V 60 cy Sec. 8500/6450V CT 43 MA Hermetically sealed.....\$22.50

CRYSTAL DIODES

1N21	\$1.19	1N23	\$1.49	1N34	\$ .79
1N21A	1.69	1N23A	3.25	1N38	1.66
1N21B	3.75	1N23B	5.25	1N45	.94
1N22	1.09	1N27	1.79	1N52	1.05

ANTENNAS

AT-38A/APT (70 to 400MC).....\$13.70  
 AT-49/APR-4 (300 to 3300MC).....13.70  
 DZ-2 Loop antenna with pedestal.....14.50  
 AN-74B (125 to 150MC).....1.85  
 AN-65A (P/O SCR-521)......95  
 AN-66A (P/O SCR-521).....1.15  
 AIA—3CM conical scan.....125.00  
 ASB Yagi—5 element 450 to 560MC.....7.00  
 ASB Yagi—Double stacked 6 element.....12.70  
 ASA Yagi—Double stacked 370 to 430MC.....29.40

WESTINGHOUSE HYPERSIL TRANSFORMER



PRI-115V. 60CY 3/4 KVA  
 SEC #1 - 240V - 1.56A  
 SEC #2 - 240V - 1.56A  
 WT. 30 LBS.

\$14.50 EACH

Terms 20% cash with order, balance C. O. D. unless rated. All prices F.O.B. our warehouse, Philo., Penna., subject to change without notice.

COAXIAL CONNECTORS



83-1AC	\$ .42	83-1R	\$.45	83-22AP	\$1.10
83-1AP	.30	83-1RTY	.65	83-22R	.68
83-1B	1.30	83-1SP	.45	83-22SP	1.15
83-1H	.80	83-1SPN	.45	83-16R	.15
83-1J	.80	83-1T	1.30	83-185	.15

FULL LINE OF JAN APPROVED COAXIAL CONNECTORS IN STOCK

UHF		N		BN		BNC	
UG-7	UG-23	UG-37	UG-102	UG-175	UG-254		
UG-12	UG-24	UG-57	UG-103	UG-176	UG-255		
UG-18	UG-27	UG-58	UG-104	UG-185	UG-260		
UG-19	UG-27A	UG-59	UG-106	MX-105	UG-284		
UG-21	UG-29	UG-55	UG-108	UG-197	UG-274		
UG-21B	UG-30	UG-86	UG-109	UG-201	UG-275		
UG-22	UG-34	UG-87	UG-167	UG-206	UG-290		
UG-22B		UG-88	UG-171	UG-238	UG-291		
				UG-306			

M-858	MC-277	PL-259A	PL-325
M-859	MC-320	PL-27	SO-239
M-389A	PL-258	PL-284	SO-264
M-360	PL-259	PL-293	TM-201
93-C	49120	D-163950	ES-686696-5
93-M	49121A	D-166132	ES-689172-1

TYPE "J" POTENTIOMETERS

\$1.25 each

Resls.	Shaft	Resls.	Shaft
60	SS	5K	1/4"
60	9/16"	5K	3/8"
100	SS	5K	1/2"
100	1/4"	10K	SS
200	SS	10K	3/8"
200	1/8"	10K	1/2"
500	5/16"	15K	SS
500	1/2"	15K	1/2"
500	5/8"	20K	SS
650	1/2"	25K	SS
1K	SS	25K	1/4"
2K	3/8"	30K	1 1/8"
2500	SS	40K	SS
4K	SS	50K	SS
5K	SS	50K	1/4"
		50K	3/8"

DUAL "JJ" POTENTIOMETERS—\$1.95 each

50	SS	500	SS	1 Meg	SS
100	SS	1K	SS	2.5 Meg	SS
250	SS	2500	SS	5 Meg	SS
330	SS	10K	SS	1K/25K	3/8"

Triple "JJJ" Potentiometers.....\$1.95 each.  
 100K/100K/100K—% 20K/150K/15K—%

SOUND POWERED TELEPHONES

U. S. NAVY TYPE M HEAD AND CHEST SETS  
 U.S.I. A-260 W.B. D-173013  
 A.E. GL832BA  
 ANY TYPE—\$14.88 EACH  
 TS-10 Type Handsets.....\$8.92 ea.

F.W. BRIDGE SELENIUM RECTIFIERS

AC VOLTS INPUT - 18	DC VOLTS OUT - 14.5	AC VOLTS INPUT - 40	DC VOLTS OUT - 34
1.3 Amps.....	\$2.90	0.6 Amps.....	\$3.30
2.4.....	3.85	1.2.....	4.40
6.6.....	5.45	3.2.....	6.55
13.0.....	9.80	6.0.....	11.70
17.5.....	12.50	9.0.....	13.75
26.....	18.80	12.....	21.50
32.....	25.30	18.....	25.50
59.....	33.74	24.....	39.56
70.....	42.26	36.....	45.36

130 VAC 1/2 WAVE STACKS

75MA	\$ .88	150MA	\$1.30	250MA	\$1.75
100MA	1.10	200MA	1.57	400MA	2.60

GENERATORS

Eclipse-Pioneer type 716-3A (Navy Model NEA-3A)  
 Output—AC 115V (0.4A 800 to 1400 cy. 1 ϕ); DC 30  
 Volts 60 Amps. Brand New.....\$38.50  
 Eclipse-Pioneer type 1235-1A. Output—30 Volts  
 DC 15 Amps. Brand New—Original Packing.....\$15.50

THYRATRONS & IGNITRONS

OA4G	FG-41	FG-271	722A
CI1A	FG-57	393	873
IC21	FG-67	394A	884
2A4G	FG-81A	GL-415	885
2B4	91	KU-610	1665
2D21	FG-95	KU-623	1904
3C31	FG-105	KU-628	2050
4C35	FG-166	KU-634	2051
C5B	FG-172	WL-652	5550
C6J	FG-178	WL-672	5551
FG-17	RX-233A	WL-677	5552
FG-33	FG-235A	WL-681	5557
			5560

TEST EQUIPMENT

I-222A Signal Generator.....\$79.50  
 I-72K Signal Generator.....\$48.50  
 Vibrotest Mod. 218 Megger.....\$325.00  
 TS-263/TSP-10—3CM FM Test Set.....\$95.00  
 TS-1B/APR-1 Tuning Unit.....\$95.00  
 C-D Quietone Filter Type IF-16 iio/220 V AC/DC.....\$9.00  
 20 Amps  
 TS-127/U Freq. Meter w/spares.....\$69.50  
 TS-143/CPU Oscilloscope.....\$95.00  
 Dumont 175A Oscilloscope.....\$225.00  
 L M-20 Frequency Meter.....\$48.50  
 Gen. Radio 757-P1 Power Supply.....\$27.00  
 I-130 A Signal Generator.....\$70.00  
 TS-6/AP Frequency Meter.....\$42.00  
 L & N KS-7470 Null Volt Test Set.....\$80.00  
 A.W. Barber Labs. VM-25 VTVM.....\$86.00  
 TS-10A/APN Delay Line Test Set.....\$75.00  
 REL W-1158 Frequency Meter 160-220 Mc. \$32.95  
 CWI-60AAG Range Calibrator for ASB, ASE, ASV and ASVC Radars.....\$39.95  
 CRV-14AAS Phantom Antenna for Transmitters up to 400 MC.....\$11.75  
 TS-19/APQ-5 Calibrator.....\$9.95  
 3 CM. Pickup Horn Antenna.....\$9.95  
 All Items New Except Where Noted (Exc. Used Condition)

MISCELLANEOUS EQUIPMENT

Amperex I98 Gamma Counter.....\$ 9.87  
 Powerstat 1226—115/230V input—0-270V out @ 9 amp.....37.00  
 G.E. 2CV2AI Servo Amplifier.....6.95  
 Sperry A-3 Hydraulic Servos.....3.95  
 EIMAC 35 TG Ionization Gauge.....5.95  
 ATR Inverters 6VDC to 110 VAC 60 cy 75W.....19.95  
 ID-6/APN-4 Indicator.....29.50  
 R-7/APS-2 Receiver.....49.50  
 R-7B/APS-15 Receiver.....49.50  
 SCR-522 Transceiver.....36.95  
 RT-7/APN-1 Transceiver—less tubes.....6.95  
 FL-8 1020 cycle filter.....1.37  
 RM-29 remote control unit.....8.95  
 RM-14 remote control unit.....8.95  
 RTA-1B 12/24 V dynamotor.....40.00  
 BC-1206-OM2 Receiver.....7.95  
 G.E. Type 1P-1 portable current transformer.....575.00  
 G.E. Type 1P-1 Radar Console.....3/8" 5.95  
 ASB—Radar equip. Complete.....69.75  
 AN/APN-13 less tubes.....12.95  
 T-9/APQ-2 less tubes.....16.50  
 BC-645A complete.....18.95  
 RCA AVR-15 Beacon Recvr.....15.50  
 TBY Trans Recvr.....29.95  
 Pioneer Type 800-1B Inverters—28VDC to 120V 800 cy 7 amp AC (used).....22.65  
 G.E. Inverter—28VDC to 120 VAC 800 cy 750VA 1 ϕ.....39.50  
 Navy SD-3 Radar complete.....\$120.00  
 Navy DP-14 Direction Finder complete.....\$385.00

PULSE TRANSFORMERS

UTAH 9262 AN/APN-4 Block Osc.  
 9278 Philco 352-7149  
 9280 Philco 352-7050  
 Philco 352-7071  
 Philco 352-7178  
 Raytheon UX-7350  
 W.E. D-161310  
 W.D. 163247  
 W.E. D-163325  
 W.E. D-164661

AN/APA-23 RECORDER

Sweeps any receiver through its tuning range and permanently records frequency and time of received signals on paper chart. Power input—(motor) 27V DC 1.5A, and (recorder) 80/115V AC 60-2600 cy 135W.  
 Originally designed to record pulse or sine-wave modulated signals received by AN-APR-1, AN/APR-2, AN/APR-4, AN/APR-5, BC-348, S-27, SX-28. Brand New.....\$147.50

SPRAGUE PULSE NETWORKS

7.5 E3-1-200-67P, 7.5 KV, "E" Circuit 1 Microsec. 200 PPS, 67 ohms Imped., 3 sections.....\$4.30  
 7.5 E3-3-200-67P, 7.5 KV, "E" Circuit 3 microsec. 200 PPS, 67 ohms Imped., 3 sections.....\$6.75  
 7.5 E4-16-60-67P, 7.5 KV, "E" Circuit 4 sections 16 microsec. 60 PPS, 67 ohms Imped.....\$8.25  
 15 E4-.91-400-50P, 15KV "E" circuit .91 microsec. 400 PPS, 50 ohms Imped., 4 sections.....\$12.00  
 15-A-1-400-50P, 15KV, "A" Circuit, 1 microsec. 400 PPS, 50 ohms Imped.....\$37.50  
 15 E7-2-200-50P, 15KV "E" Circuit, 2 microsec. 200 PPS, 50 ohms Imped., 7 sections.....\$42.50

SYNCHROS

Size 1, 3, 5, 6, 7 and 8 generators, motors, control transformers, differential generators, and differential motors in stock.  
 1F 6DG X C-78248  
 5B 6G C-78249  
 5CT 7DG C-78410  
 5D 7G C-78411  
 5DG A C-44968-6  
 5F B C-56701  
 5G M C-69405-2  
 5N N C-69406-1  
 C-78254  
 C-78415  
 C-78254  
 C-78670

SEND FOR COMPLETE LISTING

**ELECTRONIC RESEARCH LABORATORIES**  
 1021-A CALLOWHILL ST. PHILA. 23, PA.  
 Telephones - MARKET 7-6590 and 6591



# Reliance Specials

## NEW COAXIAL CABLES

Ohms	Price per 1,000 Ft.	Ohms	Price per 1,000 Ft.
RG-6/U	76	RG-35/U	71
RG-7/U	76.5	RG-37/U	55
RG-16/U	76	RG-39/U	72.5
RG-21/U	93	RG-41/U	67.5
RG-22 1/2/U	95	RG-54/U	58
RG-24/U	126	RG-55/U	53.5
RG-25/U	48	RG-57/U*	95
RG-26/U	48	RG-58/U*	53.5
RG-27/U	48	RG-59/U*	73
RG-29/U*	53.5	RG-77/U	48
RG-34/U	71	RG-78/U	48

\*No minimum order—others 250' minimum  
Add 25% for orders less than 1,000 feet

## COAXIAL CABLE CONNECTORS



15c	\$1.30	Angle	80c	40c	Head
UG 175/U	83-1F	30c	83-1J	83-1R	9c
UG 176/U		M-359			83-1H
		83-1AP			

83-1AC	\$.42	83-22AP	\$1.10	UG 58/U	\$.65
83-1AP	.30	83-22J	1.40	UG 59A/U	2.20
83-1F	1.30	83-22R	.48	UG 60/U	2.48
83-1H	.09	UG 12/U	.63	UG 85/U	.88
83-1J	.80	UG 13/U	.63	UG 87/U	.79
83-1R	.40	UG 19B/U	1.95	UG 88/U	1.25
83-1SPN	.50	UG 21/U	.67	UG 167/U	2.00
83-16S	.15	UG 22/U	1.10	UG 175/U	.15
83-18S	.15	UG 24/U	.67	UG 176/U	.15
83-2AP	2.00	UG 25/U	.60	UG 208/U	.63
83-2H	.25	UG 27/U	.68	UG 281/U	.60
83-2J	1.65	UG 27A/U	2.95	UG 290/U	1.15
83-2R	1.30	UG 29/U	.83	UG 499/U	1.25
83-2ISP	2.10	UG 30/U	2.50		
		UG 57/U	2.30		

## DIFFERENTIAL

115 V., 60 Cyc. \$3.95 ea.

#C78249

3 3/4" dia. x 5 1/2" long

Used between two #C78248's as dampener. Can be converted to 3600 RPM Motor in 10 minutes. Conversion sheet supplied. (Converted) \$4.50  
Mounting Brackets — (Bakelite) for selsyns, and differentials shown above. .35c pair

## 2J1G1 SELSYNS

BRAND NEW

\$1.90

400 Cycle  
Can be used on 60 cycle

## JONES BARRIER STRIPS

Type	Price	Type	Price	Type	Price
2-140Y	\$0.13	4-141W	\$0.30	9-141Y	\$0.64
3-140 1/2 W	.19	5-141	.26	10-141	.50
6-140	.25	5-141 1/2 W	.37	17-141Y	1.17
10-140 1/2 W	.53	7-141	.36	2-142	.15
2-141 1/2 W	.13	7-141 1/2 W	.49	3-142	.21
3-141 1/2 W	.24	8-141 1/2 W	.58	2-150	.39
		9-141	.64	3-150	.54



## PULSE TRANSFORMERS

UTAH—9262, 9278, 9340  
WESTERN ELECTRIC—D161310, KS-9800, D106173, KS-9565, KS-9862, KS-8696, KS-13161, KS-9365  
GENERAL ELECTRIC—80-G-5, K2731  
JEFFERSON ELECTRIC—C-12A-1318  
CROSBY—W-226262-4  
DIXON COIL—TR-1048, TR-1049  
Also 352-7250-2A; 352-7251-2A, T-1229621-60

## Bathtub Condensers

MFD	V.D.C.	Price	MFD	V.D.C.	Price
4	450	.65	25	176	.25
1	1,000	.35	1	600	.20
1	600	.30	1	1,000	.25
2x.5	600	.30	1	600	.22
.5	600	.30	1	500	.20
.25	600	.30	1	200	.15
.25	400	.25	.06	1,000	.30
.2	400	.20	.05	600	.25
3x.1	600	.30	3x.05	300	.15

Neon Glow Lamp NE16..... 30c

## TYPE J POTENTIOMETERS \$1.25 EA.

300	SS	2,500	SS	50K	SS
400	3/8	3K	3/8	80K	SS
500	3/8	5K	3/8	100-K	3/8
1,000	SS	10K	3/8	200-K	SS
1,500	SS	15K	SS	250-K	SS
2,000	SS	25K	1/2	1 meg.	SS

## WATER TIGHT JUNCTION BOX

14 gauge steel, 17"x25"x6 1/2", hinged lid, 2 access panels  
Approx. wt. 50 lb. \$3.50

VARIAC—General Radio, 100 watts, Removed from equipment..... \$18.00

## GEAR ASSORTMENT

100 small assorted gears. Most are stainless steel or brass. Experimenters dream!..... Only \$6.50

## VERNIER DIAL or DRUM (From BC-221)

DIAL—2 3/4" dia. 0-100 in 360°. Black with silver marks. Has thumbblock. DRUM—0.50 in 180°. Black with silver marks..... either. 85c

## BLOWER & MOTOR

Blower #11/2, motor 27 1/2 V.D.C., 1/100 H.P., 8,500 R.P.M. Continuous duty. Has mounting brackets. Navy Inspected..... \$3.50

## ALLEN SET SCREWS

4-40 x 1/8 8-32 x 1/8 8-32 x 5/16  
4-40 x 3/16 8-32 x 3/8  
ALL SIZES \$1.50 per 100

## NEEDLE BEARINGS

B108 1 1/2" wide 5/8" 13/16" 30c

## Wrapped—BALL BEARINGS—New

Mfg	ID	OD	Width	Price
Fafnir 33K5	3/16"	1/2"	5/32"	\$0.25
N.D. 5202C13M	1/2"	1 3/8"	1/8"	1.00
Fafnir 7308W	1 37/64"	3 9/16"	5/18"	2.00
Fafnir 545	2 1 1/8"	2 5/8"	15/32"	1.00
TIMKEN	4 5/16"	6 1/4"	2 9/32"	4.25

## CAPACITORS

### POSTAGE STAMP MICAS

MMF	MMF	MMF	MMF	MMF	MFD
8.2	40	90	240	510	.0011
15	43	100	250	560	.0012
20	47	110	300	580	.0013
30	51	120	330	600	.00136
22	58	125	350	620	.0015
24	60	130	370	680	.001625
25	62	150	390	800	.002
28	68	160	400	820	.0026
30	75	175	430	910	.0027
35	82	200	470	MFD	.003
38	85	220	500	.001	.0033

### Price Schedule

8.2 MMF to .001 MFD..... 5c
.0011 MFD to .001625 MFD..... 7c
.0013 MFD to .002 MFD..... 12c
.01 MFD..... 22c

### SILVER MICAS

MMF	MMF	MMF	MMF	MMF	MFD
18	60	120	270	470	.00282
22	62	150	360	500	.001
23	66	180	370	510	.001625
24	68	200	390	525	.0022
30	75	208	400	560	.0023
38	82	225	410	510	.0023
40	100	240	430	680	.0028
50	110	250	468	700	.006
	115			760	.0082

### Price Schedule

10 MMF to .001 MFD..... 10c
.001625 MFD to .0024 MFD..... 20c
.00282 MFD to .0082 MFD..... 50c

### OIL FILLED

MFD	V.D.C.	Price	MFD	V.D.C.	Price
.125	35,000	\$34.95	.25	2,000	\$1.35
.125	27,000	28.95	.25	2,000	1.05
.5	25,000	34.95	1-1	2,000	.95
.25	20,000	16.75	.02	2,000	0.70
.05	18,000	2.95	6	1,500	2.25
.03	16,000	1.95	2	1,500	1.75
1	12,500	1.95	1	1,500	1.50
1	10,000	9.75	12	1,000	2.45
.15-15	8,000	2.45	6	1,000	1.79
.02	8,000	1.69	4	1,000	1.39
.1	7,500	1.69	3	1,000	.80
.05	7,500	1.50	2	1,000	.65
.03	7,500	1.40	1.02	1,000	.59
1-1	7,000	1.69	1	1,000	.59
.02-.03	7,000	1.35	7	800	1.59
.03-.03	6,000	5.25	8-8	600	2.25
.03	6,000	1.35	8	600	1.60
.01-.03	6,000	1.25	7	600	1.45
2	5,000	6.45	4	600	1.20
.25	5,000	2.25	4x3	600	1.95
3	4,000	4.50	2	600	.45
2	4,000	3.95	1	600	.39
3x.2	4,000	2.35	5	600	.35
.06	4,000	1.55	8	500	1.45
2	4,000	1.35	4	500	.89
.25	3,000	3.65	4	300	.59
2	3,000	1.50	4	200	.39
.1	3,000	1.45			
4	2,500	4.25			
8	2,000	4.25			
6	2,000	4.25			
4	2,000	3.85			
3	2,000	3.50			
2	2,000	2.95			
1	2,000	1.95			
.6	2,000	1.60			

## SPECIAL \$3.95



## TIMING MOTOR 8 RPM

115V., 60 cyc., E. Ingraham Co..... \$1.95

# RELIANCE MERCHANDIZING CO.

Arch St. Cor. Croskey Phila. 3, Pa. Telephone Rittenhouse 6-4927

## WIRE WOUND PRECISION RESISTORS

### 2% OR BETTER

1/4 Watt—30c		1/2 Watt—30c	
2	10.84	13.52	62.54
2.5	11	13.89	79.81
3.5	11.26	14.98	105.8
6	11.74	15.8	129.8
6.68	12.32	16.37	128
10.48	13.02	32	147.5
			220.4
			8,000
			8,500
			4,451
			4,500
			15,000
			15,750
			17,000
			30,000
			37,000
			50,000
			100,000

1 Watt—35c		1 Watt—45c	
.6	15	3,000	9,000
1.01	270	3,300	10,000
2.58	420	7,000	12,000
3.39	1,000	8,250	23,000
5.21	2,000		
100,000	130,000	260,000	320,000
105,000	132,000	270,000	348,000
120,000	200,000	208,000	500,000
128,000			600,000
			700,000

## AN CONNECTORS

IMMEDIATE SERVICE  
PHONE! WIRE! WRITE! YOUR NEEDS

BC 348—H, J, L, O, P, Q—write for prices

## DELAY NETWORK—ALL 1400Ω

T 113—Approx. 1.2 micro sec. delay..... 95c  
T 114—Approx. 2.2 micro sec. delay..... each  
T 115 Similar to T 114 with tap brought out..... 2.50

## CHOKES

30 Henry 80 ma..... \$1.29  
6 Henry 80 ma..... .79

## 3AG FUSES

AMP	Per 100	AMP	Per 100	AMP	Per 100
1/4	\$4.00	1/2	\$4.00	6	\$3.90
1/2	4.00	1	3.00	10	3.00
3/4	4.00	1 1/2	3.00	15	3.00
1	4.00	2	3.00	20	3.00
1 1/2	4.00	3	3.00	25	3.00

## 4AG FUSES

AMP	Per 100	AMP	Per 100	AMP	Per 100
1/4	\$4.00	2	\$2.00	10	\$2.50
1/2	3.50	3	2.00	15	2.50
3/4	3.50	3.2	2.00	20	2.50
1	2.00	5	2.00	25	2.50

Fuse Holder—For 4AG Fuse..... .25c



**MOTOR GENERATORS**

**DYNAMOTORS, INVERTERS, ETC.**

2.5 KVA MG Set. Diehl Elec. Co. 120V D.C. to 120V A.C. 60 cy. 1Ph. .4PF. Complete with Magnetic Controller, 2 Field Rheos and Full Set of Spare Parts including Spare Armatures for Generator and Motor. Full specs. on request. New \$285.00

2 KVA MG SET. O'Keefe and Merritt. 115V DC to 120V AC, 50 cy. Idles at 3 Ph. syncs motor on 208V, 50 cy. New. Export crated \$165.00

1.25 KVA MG SET. Allis-Chalmers. 230 DC To 120 AC, 60 cy. 1 Ph. Fully enclosed. Splashproof Ball Bearings, centrifugal starter. New, complete with kit of Spare Parts....\$150.00

MG Set. Onan MG-215H. Navy type PU/13. Input 115/230, 60 cy. 1 Ph. Output 115, 480 cy. 1 Ph. 1200V and 26V DC at 4 amps. New.....\$295.00

MG SET FOR NAVY TBS TRANSMITTER. Type CG-21302. 440V AC, 60 cy, 3 Ph. 1500 VA to 875 DC and 300V DV. New .....\$69.50

DYNAMOTOR. Navy-Type CAJO-211444. 105/130V-DC to 13V DC at 40A or 26V DC at 20A. Radio filtered. Complete with Line Switch. New. \$69.50

DYNAMOTOR. Elcor. 64V DC to 110V AC, 60 cy. 1 Ph. 2.04 Amps. New.....\$24.50

DYNAMOTOR. Elcor. 32V DC to 110V AC, 60 cy. 1 Ph. 0.43 Amps. New.....\$17.50

DYNAMOTOR — Type PE94C. For use with SCR522 Transmitter-Receiver. Brand new in export cases .....\$9.50

AMPLIDYNE—G. E. Model 5AM21J7. 4600 R.P.M. Motor Compound wound. 150 Watts. Input: 27V. DC. Output: 60V. DC Sig Corps. U. S. Army MG-27-B. New.....\$26.50

AMPLIDYNE—Edison type 5AM31N18A. Input: 27 volts 44 Amps., 8300 RPM. Output: 60V DC at 8.8 amps. 530 Watts. New.....\$22.50

INVERTER—G.E. Model 5D-21N13A. Input: 24V. DC. Output: 115V. 400 cy. 485 Va. New....\$24.50

INVERTER—Leland Elec. Co. Model PE206A. Input: 28V. DC. 38 Amps. Output, 80V., 800 cy. 485 VA. New .....\$17.50

PE 218 INVERTER—G. E. J8169172. Input: 28V. DC. Output: 115, 400 cycles at 1.5 KVA...\$24.50

GENEMOTOR—Carter 6V DC to 400 V DC at 375 mils. New .....\$39.50

D.C. MOTOR—G.E. Model 5BA50LJ2A. Armature 27V D.C. at 8.3A. Field 6V D.C. at 2.3A. RPM 4000. H.P. 0.5. New.....\$22.50

MOTOR GENERATOR M.G. 164. Holtzer-Cabot Motor: 440V, 3PH, 60 cy., .90A, 1/3HP, 1750 RPM. Generator: 70V, 3Ph, 146 Cy., .140KVA Exciter: 115DC, 1A. New.....\$67.50

**BC-348 RECEIVER PARTS**

Dial Mechanism assemblies. 1st, 2nd, 3rd, 4th I.F. transformers. C.W. osc. and xtal filter trans. with xtals. All R.F. colls. Front panels. Shock mounts. Large quantity misc. hardware sub assemblies, etc. Write your requirements.

**MISCELLANEOUS EQUIPMENT**

TS-127/U Lavole Freq. Meter—375 to 725 MC.  
TS-47APR Test Set—40 to 500 MC.  
213-A DuMont C.R. Modulation Monitor.  
BC1203B APN-4 Test Set.  
6255A H.P. Interpolation Osc.  
TS-23/APN Test Set.  
TS-487/U Peak to Peak VTVM.  
BC-221AE Freq. Meter.  
LM-13 Freq. Meter.

**MICROWAVE RECEIVERS**

AN/APR-1 Receivers and tuning units TN-1 (38 to 95 MC) TN-2 (76-300 MC) TN-3 (300-1000 MC).  
AN/APR-4 Receivers and tuning units TN- 16 (38-95 MC) TN-17 (76-300 MC) TN-18 (300-1000 MC)  
AN/APR-5A Receivers. 1000 to 6000 MC Range.

**MODEL AN/APA-10 PANORAMIC ADAPTER**

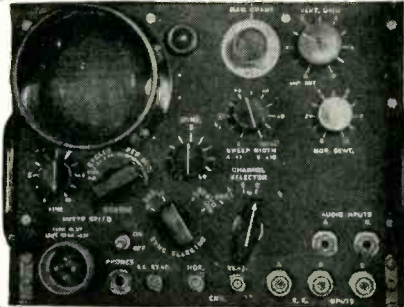

Provides 4 Types of Presentations:  
(1) Panoramic (2) Aural  
(3) Oscillographic (4) Oscilloscopic

Designed for use with receiving equipment AN/ARR-7, AN/ARR-5, AN/APR-4, SCR-587 or any receiver with I. F. of 455kc. 5.2mc, or 30mc.

**SUMMARY OF CHARACTERISTICS:**

**SENSITIVITY:** "A" channel, 400 microvolts or less per 1/4" beam deflection. "B" channel, 400 microvolts or less per 1/4" beam deflection. "C" channel, 1 volt or less per 1/4" beam deflection.  
**RESOLUTION:** 12 kilocycles at 3 db down from peak, sweep control at maximum, using CW signal.  
**PRESENTATION:** Panoramic ("A" and "B" channels); Oscillographic, "C" channel.  
**SWEEP WIDTH:** Channel A, ± 50 kc (100 kc overall) Channel B, ± 500 kc (1 Mc overall) Channel C, ± 1 Mc (2 Mc overall).  
**CATHODE RAY SWEEP:** Oscillatory or non-oscillatory (Servo) Variable Sawtooth Generator, 35 to 40,000 cycles per second.  
**AUDIO OUTPUT:** 50 milliwatts into 600 or 800 ohm load.  
**VERTICAL AMPLIFIER:** Single stage, ± 2db from 30 cycles to 100 kc or higher. Amplifier out position permits direct connection to one vertical plate through coupling capacitor.  
**HORIZONTAL AMPLIFIER:** Single stage, ± 2db from 30 cycles to 100 kc. No provision for direct connection to deflection plates.  
**CATHODE RAY TUBE VOLTAGE:** Cathode to accelerating anode; 1200V DC for 115V A.C. input.  
**SENSITIVITY OF CATHODE RAY OSCILLOSCOPE:** Maximum through Amplifier. Horizontal: 10 volts peak to peak per inch. Vertical: 1.5 volts peak to peak per inch.  
**DIRECT TO VERTICAL PLATE:** 150 volts peak to peak per inch.  
**NOISE:** No disturbance in excess of 25,000 microvolts between 200kc to 200Mc generated by equipment. Overall Dimensions: 19-9/16" x 10 1/4" x 7 3/4". Weight: 40 lbs.  
**Power Requirements:** 115V. A.C. 60 cycles, 1 phase. With 21 tubes including 3" scope tube, for operation on 115 V. 60 cycle source. **PRICE.....\$245.00**

AN/APA-10 80 Page Tech Manual.....\$2.75



**LINEAR SAWTOOTH POTENTIOMETER**

W.E KS-15138  
Has continuous resistance winding to which 24 volts D.C. is fed to two fixed taps 180° apart. Two rotating brushes 180° apart take off linear sawtooth wave voltage at output.  
**Brand New \$5.50**

**G. E. SERVO AMPLIFIER**

Type 2CV1C1 Aircraft Amplidyne control amplifier, 115 volts—400 cycles. Dual channel. Employs 2-6SN7GT and 4-6V6GT tubes. Supplied less tubes. New .....\$22.50

**400 CYCLE TRANSFORMERS**

AUTO. 400 cy. G.E. Cat No 80G184.  
KVA .945S—520P. Volts 460/345/230/115. New. \$4.95  
**FILAMENT.** 400/2600 cy. Input: 0/75/80/85/105/115/125V. Output: 5V3A/5V3A/5V3A/5V3A/5V6A/5V6A/6.3V6A/6.35A. New .....\$2.95  
**THYRATHRON POWER.** 400/1600 cy. Raytheon UX-3876, 400/1800 cy. Pri: 115, Sec: 50-0-50V at 1.5A. 6.3V at 1.2A. Test r.m.s. 1780. New...\$2.75  
**PLATE WECO KS9560.** 400/800 cy. Pri: 115V. Sec: 1350-0-1350 at .057A (2700 V Total). Eleccstat shlded. Wt. 2.3 lbs. New.....\$2.95  
Plate. Thordarson #T46889. 1650 VA. Pri: 105-120V. 500 cy. 1 PH. Sec: 5600V. Center tapped. 1.5KV Insulation. Brand new.....\$49.50  
**SCOPE PL. & FIL. WECO 9558.** 400/2400 cy. Pri: 115. HV Wdg. 1125V at .008A. Fil. Wdgs. 6.4V4/2.5V1.75A/6.4V.6A. Eleccstat shlded. Wt. 1.4 lbs. New .....\$2.75  
**FILAMENT.** 400/2400 cps. WECO KS9558. Pri: 115V. Sec: 8.2V1.25A/6.35V1.5A Eleccstat shlded. Wt. 0.5 lbs. New .....\$1.95  
**PLATE & FIL.** 400/2600 cy. Pri: 0/80/115V. Sec: #1=1200VDC at 1.5MA. Sec. #2=400VDC at 130MA. Fil. Secs: 6.4V4.3A/6.35V0.8A. (Ins. 1500V)/5V2A/5V2A .....\$4.95  
**RETARD.** 400 cy. WECO KS9598. 4 Henry 100MA .....\$1.75

**60 CYCLE TRANSFORMERS**

**FILAMENT.** Raytheon Hypersil Core, Pri: 115V. Sec: 6.3V22A/6.3V2.4A/6.3V2.25A/6.3V0.6A Ins. for 1700V  
High Reactance Trans. G. E. type Y-3502A.—60 cy. Voltage 11200-135. Inductance H.V. Winding 135 Henries. Output: Peak Voltage 22.8KV. Cat. 8318065G1. New .....\$89.50  
High Voltage Trans. Westinghouse Pri: 115, 60 cy. Sec: 15,000 C.T., 60 MA. Good for Hi-Pot test set up .....\$24.50

**PULSE TRANSFORMERS**

**PULSE.** WECO KS-9563. Supplies voltage peaks of 3500 from 807 tube. Tested at 2000 Pulses/sec and 5000V peak. Wdg. 1-2=18 ohms. Wdg. 1-3=72 ohms. L of Wdg. 1-3=073-.082H at 100 cps.\$5.00  
**PULSE.** WECO KS-161310. 50 KC to 4 KC—4MC. 1 3/4" Dia. x 1 1/2" high. 120 to 2350 ohms. New .....\$1.95

**RAYTHEON VOLTAGE REGULATOR**

Adj. input taps 95-130V., 60 cy. 1 Ph. Output: 115V., 60 Watts, 1/2 of 1% Reg. Wt. 20 lbs. 6 1/2" H x 8 1/4" L x 4 1/2" W. Overload protected. Sturdily constructed. Tropicalized. Special.....\$14.75

**HIGH VOLTAGE CAPACITORS**

.25 MFD., 20KV .....\$16.50  
.25 MFD., 15KV .....12.50  
1 MFD., 7.5V .....6.25

**SOUND POWERED PHONES**

Western Electric No. D173312. Type O. Combination headset and chest microphone. Brand new including 20 ft. of rubber covered cable.....\$17.50  
Automatic Elec. Co. No. GL343AO. Similar to above but including throat microphone in addition to chest microphone. Brand new with 20 ft. rubber covered cable .....\$10.00  
U. S. Instrument Co. No. A-260. Complete with 20' cable and plug. Brand new.....\$13.50  
W. E. type TS-10M Handset. New.....\$16.50

**PARABOLOIDS**

Spun Magnesium dishes 1 1/2" dia. 4" deep. Mounting brackets for elevation and azimuth control on rear. 1 1/2 x 1 1/2" opening in center for dipole. Brand new, per pair.....\$8.75

**SWEEP GENERATOR CAPACITOR**

High speed ball bearings. Split star silver plated coaxial type 5/10 mmfd. Brand new.....\$2.50

**WESTERN ELECTRIC CRYSTAL UNITS**

Type CR-1A/AR. Available in quantity—following frequencies—fundamentals.  
5910—6350—6370—6470—6510—6610—6670—6690—6940—7270—7350—7380—7390—7480—7580—9720—Kilocycles.

**\$1.25 each**

All prices indicated are F O B Bronxville, New York. Shipments will be made via Railway Express unless other instructions issued.

**ELECTRONICRAFT INC.**

27 MILBURN ST. BRONXVILLE 8, N. Y.  
PHONE: BRONXVILLE 2-0044

All merchandise guaranteed. Immediate delivery, subject to prior sale.

**All Prices Subject to Change Without Notice**



CRYSTALS Low Freq.

Table listing various crystal models (FT241-A, 370, 372, etc.) with their specifications and prices. Includes a note about fundamental frequencies and fractions omitted.

BATHTUB CAPACITORS

Table listing bathtub capacitor models (MFD Volt Type) and their prices per each.

TEST EQUIPMENT

Frequency Modulated Generator. Type 155A Frequency 38 MC—50 MC. Range 1 MC—10 MC. Boonton Radio. Solar Exameter Capacitor Analyzer. Tube Tester Model 7050. Philco 110/120. AC 60 Cy. 3" scope No. 155A C.R. Oscilloscope R.C.A. Test Set I-180A, Hickok Model 540 Test Equipment Tube checker. Swope Signal Generator Model 909. McMurdo (Silver), Range 2-228 MC. Output 0-5 V Max. 105/125V 50/60 Cy. 35W. Frequency Meter BC221N 125-20000 KC. Precision Series E-400, Sweep Generator FM-TV-AM. Signal Generator Model 702, Radio City Products. Standard Signal Generator Model 78B, Boonton (Measurements Corp.). Television Calibrator WR-39A. R.C.A. Microvoltage Model 20-B Ferris Instrument Boonton. Signal Generator I-216 15-26 MC. CKB 15V/60 Cy. 180-235 MC. Model LU-1, Radar Test Equipment. Frequency meter & Test Oscillator. Industrial Instrument Bridge. LB2-DRI. 10 Watt 115V 60 Cy. Industrial Instrument Bridge RN-1. Hunter charging control analyzer Model 372K2. Hickok Thermo Ammeter Model 147 #1-1270. Weston DC Milliammeter Model #155. Leeds & North Type S Test Set #5300 #5410. RCA Voltmeter Ohmyst. Leeds North Galvanometer #2420A. GR Output Meter #783A. Boonton Q Meter Type 160A & 170A. Industrial Bridge LB1D.

TOP TRANSFORMER BUYS

These XFRMRS are Army Spec. All Underrated.

Table listing transformer models (Comb. Transformers, Filament Transformers, Plate Transformers) with their ratings and prices.

SELSEY TESTER

Magneson Instrument Field Tester AAF 43G2330 Spec. 4072. To test individual mag. Ind. & Xmitters, for isolating faults in magneson systems. Brand new \$99.00

TUNING UNITS

for BC 375 TU7 4500—8200KC. TU8 6200—7700KC. TU9 7700—1000KC. TU26 200—500KC. Price \$2.49 ea.

HEADSETS & MIKES

HS23 Used Good 8000 Imp. \$2.49 HS33 Used Good 600 Imp. \$2.49 HS30B Replugs Elements. 60c ea. Rubber Earplugs for HS30. 10 for 25c Matching XFRMR C410 Less Cords \$1.25 T45 Lip Mikes. 98c T30 Throat Mike \$1.25 CD508T30 Ext. Cords w/Switch Sw141. Complete \$1.25 Gas Mask Mike Elements. 4.99c Cords 3 Cond. Color coded approx. 42¢. 15c ea. Hdband HBI. 25c Hdband EB30. 25c

MOBILES CAP CD

6 V. Trans. Dyn. Supply Ratings Input Volts 6 450 Amps 45 Or Output Volts 6 450 Amps 22 Originally Designed For Use With 14 V Input. Service & Mobile Report Ex. Edited at 6 V. Complete With Mtr. Plate, Filter Box, Starting Relay New \$12.95 Set of 2 Plugs (Sold with Dyn. Only) \$1.00

AN-GSC-T1

CODE TRAINING SET Complete with 10 keys. Consists of a variable pitch audio oscillator powered by universal power supply. DC 6-12-24-115V. AC 115-230 V. Voltage selectable by switch. Has loudspeaker and volume control. Contained in carrying case 17 x 10 1/4 x 1 3/4". Ideal for code training groups, clubs, schools, etc. NEW original boxes. Were \$49.50, now ea. \$24.95.

AUDIO TRANSFORMERS

Table listing audio transformer models (AT666, AT SUB, AT070, etc.) and their specifications.

INSULATORS

Feeder Support IN81-IN82 Porc. Standoff 1-1/2" H x 1-3/16" Dia. 10¢ ea. Feed Thru IN84-XS1 Complete w/ Hdwr. 15¢ ea., 10 for \$1.25 Feed Thru Lapp Bowl Sim to XS3 for 2 3/4" hole. 6% L x 3" dia. \$1.25 ea. ANT Insulators, IN88 3% L x 1 1/8" ea., 10 for \$1.50 Feeder Spreaders 2-11/16" x 7/16" 2" C to C Holes. Price 10¢ Feeder Spreaders 2 1/2" L x 5/8" Sq. 1% C to C Holes. Price 8¢ ea. Locke Suspension Ins Cat # CA1. 81249. 1 1/2" L x 2" D. Price \$1.95 Telephone Knob Insulator Whitehall Tatum #4. Heavy Glass Price \$2.29 Many Others—Write



MICA CAPACITORS SOLAR XMB TAPPED POLES

Table listing mica capacitor models (Mfd. Price) and their prices.

ANTENNA MAST

Are you in a dead spot? If you can't get a good T. V. Picture. Here is a Sig. Corp. Ant. mast 30" high of rugged plywood construction to solve your problem. It telescopes into 3 ten ft. sect. for easy storage. Easy to Mnt. Comp. with stakes & rods. Ea. \$19.95.

1% PRECISION RESISTORS

Table listing precision resistor models (Screen Mod. XFRMR, PP-PP, Paril, etc.) and their prices.

HIGH CURRENT CERAMIC MICAS

Table listing high current ceramic mica models (.0012, .001, .0001, etc.) and their prices.

AMPS—RF

0-4 Amp RF GE Type DW52. 2% Accuracy. Expanded Scale, 2 1/8" dia. Int. Thermocouple. List Price \$19.75. Our Price \$2.95

EE 894 TELEPHONE REPEATER

Used to extend range of field telephones, teleg. & 20 cyc. ringing possible over lines complete w/305 tube & ync. Featherweight. Price \$9.95

OIL CONDENSORS

Table listing oil condenser models (Mfd. Volt. Price) and their prices.

932 PHOTO TUBE

Gas Photo-tube having S1 response, particularly sensitive to Red and Near Infrared Radiation. Can be used with incandescent light source. Price... \$75¢

ARC 5 MODU-LATOR

ARC 5 MODU-LATOR Plate Mod. w/arc tube w/Tube 12-125 2-1825. 1-VR50. Good cond. Price... \$6.95

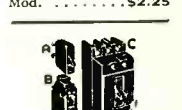

Helmenan Ckt Bkrs for AC-DC operation. AM1510M 7 Amp 1614 80 Amp 1614 50 Amp U90 100 Amp Price ea. \$1.10 P-0322 Dual 10 Amp Price ea. \$2.25

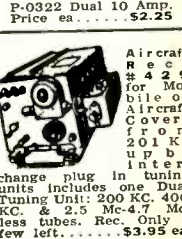

Aircraft Receptacle #429 for Model or Aircraft Covers for 201 Kc up to 400 Kc change plug in tuning units includes one Dual Tuning Unit: 200 Kc. 400 Kc. & 2.5 Mc-4.7 Mc. less tubes. Rec. Only a few left. \$3.95 ea.

All merch. guar. Mail orders promptly filled. All prices F.O.B. N. Y. C. Send MV or Chk. Only shipping chgs. sent C.O.D. Rated concerns send P.O.

COMMUNICATIONS EQUIPMENT CO.

131 Liberty St., New York, N. Y. Dept. E6 Chas. Rosen Phone: Digby 9-4124



SOLVE YOUR

**RADAR**

CALL PAUL J. PLISHNER

**SONAR**

SUPPLY PROBLEMS

**3000 MC BENCH TEST PLUMBING**

**SIGNAL GENERATOR**, using 417A klystron, 2700-3300 mc. Output approx. 50 mw. 115 vac power supply. With tubes, new.....\$425  
**10 CM RF PACKAGE**, using 2J22 magnetron, freq. range 3267-3333 mc. complete with power supply and pulser giving approx. 20 kv @ 30 A, 1 usec. 1000 PPS. Power output 265 kw. 7/8" rigid coax plumbing thru-out. Uses 417A klystron mixer, 6A27 preamp. Pulsor is 715 B hard tube. Complete RF unit, pulser unit, receiver front end, new, with tubes. Requires 115v. 400 cy ac primary source.....\$385.07  
**REGULATED POWER SUPPLY** for GL 446 type light-house tubes (2C40, etc.) 115 vac, 60 cycles. Panel Mounting. Less tubes.....\$32.50  
**10 CM DISH AND DIPOLE ASSY**: approx. 30" paragona, with 360 deg. rotating mechanism, and approx. 10 deg. tilt mechanism, Operating from 24 vdc. With selenium.....\$85  
**10 CM LOW POWER TUNABLE** load with circ. cover 2225 COAX. CRYSTAL MOUNT, type N connectors.....\$17.50  
**RT-39/APG-5** 10 cm. lighthouse RF head c/o Xmir.-Recvr-TR cavity, compl. recvr & 30 MC IF strip using 6AK5, (2C40, 2C43, 1B27 lineups) w/Tubes.  
**721A TR BOX** complete with tube and tuning plungers.....\$57.50  
**MENALLY KLYSTRON CAVITIES** for 707B or 2K28. Three types available.....\$4.00

**F 29/SPR-2 FILTERS**, Type "N" Input and output \$12.50  
**WAVEGUIDE TO 7/8" RIGID COAX "DOORKNOB"** ADAPTER CHOKE FLANGE, SILVER PLATED BROAD BAND.....\$32.5  
**AN/APR5A** 10 cm antenna equipment consisting of two 10 cm waveguide sections, each polarized, 45 degrees.....\$75.00 per set  
**POWER SPLITTER**: 726 Klystron Input dual "N" output.....\$5.00  
**MAGNETRON COUPLING** FOR TYPE 720 MAG, to 1 1/2" x 3" Waveguide.....\$35.00  
**10 CM WAVE METER** VIB type B43549 Transmission type, Type N Fittings Veeder Root Micrometer dial. Gold Plated W/Calib. Chart P/O Freq. Meter X-66404-A. New.....\$99.50  
**AS14A/AP-10 CM** Pick up Dipole with "N" Cables \$4.50  
**LHTR. LIGHTHOUSE ASSEMBLY** Part of RT39 APG 5 & APG 15. Receiver and Trans Cavities w/assoc. Tr. Cavity and Type N C.P.G. To Recv. Uses 2C40, 2C43, 1B27, Tunable APX 2400-2700 MCS. Silver Plated.....\$49.5  
**BEACON LIGHTHOUSE** cavity 10 cm with miniature 28 volt DC PM motor, Mir. Bernard Rice, \$47.50 ea.  
**MAGNETRON TO WAVEGUIDE** Coupler with 721A Duplexer Cavity, gold plated.....\$45.00

**7/8" RIGID COAX—3/8" I.C.**  
**7/8" RIGID COAXIAL TUNING STUBS** with vernier stub adjustment. Gold Plated.....\$17.50  
**7/8" RIGID COAX. ROTARY JOINT**. Pressurized Sperry #10613. Gold Plated.....\$27.50  
**DIPOLE ASSEMBLY**, Part of SCR-581.....\$25.00 ea.  
**ROTARY JOINT**, Part of SCR-581.....\$35.00 ea.  
**RIGHT ANGLE BEND**, with flexible coax. output pickup loop.....\$8.00  
**SHORT RIGHT ANGLE BEND**, with pressurizing nipple.....\$3.00  
**RIGID COAX**, to flex coax. connector.....\$3.50  
**STUB-SUPPORTED RIGID COAX**, gold plated 5' lengths. Per length.....\$5.00  
**RT. ANGLES** for above.....\$2.50  
**RT. ANGLE BEND 15" L. O.A.**.....\$3.50  
**FLEXIBLE SECTION**, 15" L. Male to female.....\$4.25  
**MAGNETRON COUPLINGS** to 7/8" rigid coax, with TR pickup loop, gold plated.....\$7.50  
**FLEX. COAX. SECT.** Approx. 30 ft.....\$16.50  
**CG 54/U—4 foot flexible section** 3/4" IC pressurized.....\$15.00  
**7/8" RIGID COAX**, Bead Supported.....\$12.10  
**SHORT RIGHT ANGLE BEND**.....\$2.50

**8500-9500 MC BENCH TEST PLUMBING**

**1" x 1/2" Waveguide**  
**3 CM SIGNAL GENERATOR** and thermistor bridge, using 723AB oscillator, calibrated variable attenuator, direct reading power meter; reg. 115 vac. 60 cy. power supply. Complete with tubes.....\$425  
**AN/AP5-15A "X"** Band compl. RF head and modulator, incl. 725-A magnetron and magnet, two 723A/B Klystrons (local osc. & beacon), 1B24, TR, recvr-ampl. duplexer, 45 Klystron, blower, pulse xmr, Peak-Pwr. Out: 45 Kw. Input: 115, 400 cy. Modulator pulse duration .5 to 2 micro-sec. approx. 13 KV Pk Pulse. Compl. with all tubes incl. 715-B, 829B, RKR 73, two 72's. Comp'l pkg., new.....\$375  
**COMPLETE 3 CM RADAR SYSTEM EQUIPMENT**  
**40 KW PEAK TRANSMITTER**, pulse modulator, receiver, using 723AB, power supply operating from 115V 800 Cycle, antenna system. Complete radar set neatly packaged in less than 16 cubic feet, less reg. type tubes, but incl. all others, in used but excellent condition—This price for laboratories, schools, and experimental purposes only.....\$350  
**2J42 PULSE MODULATOR**, 14 Kw max. rating 7 kw min. Plate voltage pulsed 5.5 kv, 6.5 amp., .001 duty cycle, 2.5 usec pulse length max. filament 6.3 v. .5 amp. Includes magnetron mtg. and blower. Requires 3C45 and 2-3B24.....\$75.00  
**3 CM SECTOR SCANNING ANTENNA**, 18" dish, cutter feed dipole, 24 vdc drive motor.....\$75.00  
**APS-3 RADAR**, new and complete, using 725A magnetron.....\$950.00  
**TS 36 X** band power meter 1 1/2" x 3/4" waveguide; thermistor bridge with indicating meter, complete.....\$175.00  
**Wavemeter**, 8500 to 9400 Mcs., with calibration. Micrometer adjust head. Reaction type.....\$85.00  
**90 Degree Elbows**, E or H plane, 2 1/2" radius.....\$12.50  
**90 Degree Twist**, 6" long.....\$6.00

**Bulkhead Feed-Thru Assembly**.....\$15.00  
**Pressure Gauge Section** 15 lb. gauge and press nipple.....\$10.00  
**Pressure Gauge**, 15 lbs.....\$2.50  
**Dual Oscillator-Beacon Mount**, P/O APS10 Radar for mounting on 723AB Klystron with crystal units, matching slugs, shields.....\$42.50  
**Dual Oscillator, Mount.** (Back to back) with crystal mount, tunable termination attenuating slugs \$18.50  
**Directional Coupler**, UG-40/U Take off 20 DB, \$17.50  
**Directional Coupler**, APS-6 type "N" take off 20 DB calibrated.....\$17.50  
**Rotary Joint** Choke to Choke.....\$10.00  
**2K25/723 AB** Receiver local oscillator Klystron Mount, complete with crystal mount. Iris coupling and choke coupling to TR.....\$22.50  
**TR-ATR Duplexer** section for above.....\$5  
**CU 105/APS 31** Directional Coupler 25 DB.....\$25.00  
**723AB Mixer—Beacon** dual Osc. Mt. w/xtal holder.....\$12.00  
**TR-ATR Sect** APS 15 for 1B24 w/724 ATR cavity w/1B24 & 724 Tubes, Complete.....\$21.00  
**Stabilizer Cavity** with bellows.....\$21.50  
**3 cm 180° bend**, with pressurizing nipple.....ea. \$6.00  
**3 cm 90° bend**, 14" long 90° twist with pressurizing nipple.....ea. \$6.00  
**3 cm "S" curve 18" long**.....ea. \$5.50  
**3 cm "S" curve 6" long**.....ea. \$3.50  
**3 cm right angle bends**, "P" plane 18" long cover.....ea. \$6.50  
**3 cm. Cutter feed dipole**, 11" from parabola mount to feed back.....ea. \$8.50  
**3 cm. directional coupler**, One way waveguide output.....ea. \$15.00  
**Circular Choke Flanges**, solid brass.....55¢  
**Sq. Flanges**, Flat Brass.....ea. \$5.00  
**APS-10 TR/ATR Duplexer** section with additional iris flange.....\$10.00  
**"X" Band Preamplifier**, consisting of 2-723 A/B local

oscillator-beacon feeding waveguide and TR/ATR Duplex sect, incl. 60 pic. IF amp.....\$47.50  
**15 Deg Bend 10" choke** to cover.....\$1.50  
**5 Ft. Sections** choke to cover. Silver plated.....\$14.50  
**18" Flexible Section**.....\$17.50  
**TR Cavity** for 724 A TR Tube.....\$3.50  
**724 TR Tube (41 TR 1)**.....\$2.50  
**SWR Meas.** Section & L with 2 type "N" output probes MTD full wave apart. Bell size guide. Silver plated.....\$10.00  
**Rotary joint** with slotted section and type "N" output pickup.....\$5.75  
**Waveguide Section 12" long** choke to cover 45 deg. twist & 2 1/2" radius, 90 deg. bend.....\$4.50  
**Twist 90 deg.** 5" choke to cover w/press nipple.....\$6.50  
**Waveguide Sections** 2 1/2 ft. long silver plated with choke flange.....\$5.75  
**Rotary joint** choke to choke with deck mounting \$17.50  
**3 cm mitered elbow "E"** plane unslotted.....\$12.00  
**1 1/4" x 5/8" WAVEGUIDE**  
**Tunable Termination**, Precision adjust.....\$65.00  
**Low Power Termination**.....\$25.00  
**Magic Tee**.....\$45.00  
**90 Degree Elbows**, E or H plane.....\$12.50  
**Waveguide Lengths**, Cut to size and supplied with 1 choke, 1 cover, per length.....\$2.00 per ft.  
**BI Dir-Coupler** WG output calibrated—25 db nominal.....\$17.50  
**Flex sections**, 12" Rubber Coated.....\$14.50  
**Mitred Elbow H Plane** UG51-UG52.....\$12.00  
**6" St. sect. choke** to choke.....\$3.50  
**APQ 13 Constant Z Rotat Jnt.**.....\$22.50  
**CG 98B/APQ 13 12" Flex. Sect.** 1 1/2" x 3/4" OD.....\$10.00  
**Wave Gd Run 1 1/2" x 3/4" Gd.** consists of 4 ft. sect. w/RT angle bend on one end. 2" 45 deg bend on other end.....\$8.00  
**X Band Wave Gd.** 1 1/4" x 3/4" O.D. 1/16" wall aluminum.....\$5.00 per ft.  
**Slug, Tuner Attenuator** W.E. guide. Gold Plated \$6.50

**23,000 to 27,000 Mc BENCH TEST PLUMBING**

**1/2" to 1/4" Waveguide**  
**Low Power Load**.....\$20.00  
**Shunt Tee**.....\$35.00  
**Waveguide Lengths**, 2" to 6" long, gold plated with circular flanges and coupling nuts.....\$2.25 per inch  
**APS-34 Rotating Joint**.....\$49.50  
**Right Angle Bend E or H Plane**, specify combination of couplings (dest.).....\$12.00  
**45° Bend E or H Plane**, Choke to cover.....\$12.00  
**Mitred Elbow**, cover to cover.....\$4.00  
**TR-ATR-Section**, Choke to cover.....\$4.00  
**Flexible Section 1"** choke to choke.....\$5.00  
**"S" Curve Choke** to cover.....\$4.50  
**Adapter**, round to square cover.....\$5.00  
**Feedback to Parabola Horn** with pressurized window.....\$7.00  
**90° Twist**.....\$10.00  
**"K" Band Directional Coupler**.....\$49.50 ea.

**6000 Mc to 8500 Mc BENCH TEST PLUMBING**

**1 1/2" x 3/4" Waveguide**  
**Klystron Mount**, DB356 complete with shield and tunable termination.....\$125.00  
**Flap Attenuator**, DB 361.....\$45.00  
**Variable Stub Tuner**.....\$90.00  
**Wvcd. to Type "N"** Adapter.....\$18.50  
**Wavemeter Tee**, DB352.....\$32.50  
**Magic Tee**.....\$80.00  
**Directional Coupler**, two hole 25DB coupling, Type "N" output.....\$25.00  
**Precision Crystal Mount**, Equipped with tuning slugs and tunable termination.....\$125.00  
**Tunable Termination**, Precision adjust.....\$70.00  
**Low Power Load**.....\$35.00

**4000 to 6000 Mcs BENCH TEST PLUMBING**

**2" x 1" Waveguide**  
**Flap Attenuator**.....\$48.00  
**Variable Stub Tuner and Low Power Termination**.....\$48.00  
**Wavemeter Tee**.....\$48.00  
**Adapters:**  
**Choke to choke**.....\$18.00  
**Cover to cover**.....\$14.00  
**Choke to cover**.....\$16.00  
**Waveguide to Type "N"** Adapter.....\$45.00  
**Directional Coupler**, Two hole type "N" output.....\$48.00  
**Klystron Mount**, Equipped with tunable termination and micrometer adjust. Klystron antenna tuning.....\$110.00  
**Crystal Mount**, Equipped with tunable termination and micrometer adjust. crystal tuning.....\$125.00  
**Tunable Termination**, Precision adjust.....\$90.00

**MAGNETRONS**

Tube	Frg. Range	Pk. Pwr. Output
2J27	2965-2992 mc.	275 KW \$25.00
2J31	2820-2860 mc.	285 KW \$38.50
2J21-A	9345-9405 mc.	50 KW \$12.50
2J22	3267-3333 mc.	265 KW \$25.00
2J26	2992-3019 mc.	275 KW \$37.50
2J32	2780-2820 mc.	285 KW \$37.50
2J38	3249-3233 mc.	5 KW \$39.50
2J39	3267-3333 mc.	87 KW \$39.50
2J49	9000-9160 mc.	58 KW \$75.00
2J61	3000-3100 mc.	35 KW \$75.00
2J62	2914-3010 mc.	35 KW \$75.00
3J31	24,000 mc.	50 KW \$85.00
5I30		
718DY	2720-2890 mc.	250 KW \$35.00
720BY	2800 mc.	1000 KW \$75.00
720CY	2860 mc.	1000 KW \$75.00
725-A	9345-9405 mc.	50 KW \$60.00
730-A	9345-9405 mc.	50 KW \$50.00
709	A, B, C, D	\$35.00
706	AY, BY, DY, EY, FY, GY	\$55.00

**"CW" MAGNETRONS**

QK 62	3150-3375 mc.
QK 59	2675-2900 mc.
QK 61	2975-3200 mc.
QK 60	2800-3025 mc.



New, Guaranteed.....Each \$87.50

**FILAMENT TRANSFORMER**

for above 115V/60 cy Pri: four 6.3V/4A Sec. 5000VIT.....\$27.50  
 Magnetron Kit of four OK'S 2675-3375 inc. w/trans special.....\$250.00



**WAVEGUIDE**

**3/4" x 1 1/4" OD**.....\$1.65 per foot  
**1 1/2" x 1 1/2" OD Aluminum**.....75¢ per foot  
**1 1/2" x 3" OD**.....\$3.00 per foot  
**2 1/2" x 3" OD**.....\$3.50 per foot  
**1" x 1 1/2" OD Flexible**.....\$4.00 per foot  
**7/8" rigid OD 3/4" IC**.....\$1.20 per foot (Available in 10 FT to 15 ft. lengths or smaller).  
 \$8.50 each

All merch. guar. Mail orders promptly filled. All prices, F.O.B. N.Y.C. Send M.O. or Chk. Only shipping chgs. sent C.O.D. Rated concerns send P.O.

MIN. ORDER \$3.00

**COMMUNICATIONS EQUIPMENT CO.**

MIN. ORDER \$3.00

131 Liberty St., New York, N. Y. Dept. E6

P. J. PLISHNER

Phone: Main 4-8373



**MODULATOR UNIT BC 1203-B**

Provides 200-4,000 PPS Sweeptime: 100 to 2,500 microsec. in 4 steps, fixed mod. pulse, suppression pulse, sliding modulating voltage, marker pulse, sweep voltages, calibrations, voltages, fil voltages. Operates 115 vac. 60-60 cy. Provides various types of voltage pulse outputs for the modulation of a single generator such as General Radio #304B or #304C used in depot bench testing of SCR 695, SCR 595, and SCR 535. New .....\$125.00  
 BC 758A Pulse modulator.....\$395.00  
 APS-10 Low voltage power supply less tubes.....\$18.50  
 725A magnetron pulse transformers.....\$18.50 ea.

**PULSE NETWORKS**

Ray-WX4298F .....\$39.50  
 GE-K6824736 .....\$50.00  
 GE-K9216945 .....\$50.00  
 15A-1400-50: 15 KV, "A" CKT. 1 microsec 400 PPS, 50 ohms imp. ....\$42.50  
 G.E. #823-5-2000-50P2T, 6KV "E" circuit, 3 sections 5 microsecond, 2000 PPS, 50 ohms impedance .....\$6.50  
 G.E. #3E (3-84-810) (8-2.24-405) 50P4T: 3KV "E" CKT Dual Unit: Unit 1, 3 sections, .84 Microsec. 810 PPS, 50 ohms imp.: Unit 2, 8 Sections, 2.24 microsec. 405 PPS, 50 ohms imp. ....\$6.50  
 7.5E3-1-200-67P, 7.5 KV, "E" Circuit, 1 microsec 200 PPS, 67 ohms impedance, 3 sections .....\$7.50  
 7.5E4-16-60-67P, 7.5 KV, "E" circuit, 4 sections 16 microsec. 60 PPS, 67 ohms impedance.....\$15.00  
 7.5E33-200-6PT, 7.5 KV, "E" Circuit, 3 microsec 200 PPS, 67 ohms imp. 3 sections.....\$12.50

**PULSE TRANSFORMERS**

G.E.K.-2745 .....\$39.50  
 G.E.K.-2744-A, 11.5 KV High Voltage, 3.2 KV Low Voltage @ 200 KW oper. (270 KW max.) 1 microsec. or 1 microsec. @ 60 PPS .....\$39.50  
 W.E. #166173 Hi-Volt input transformer, W.E. impedance ratio 50 ohms to 900 ohms, Freq. range: 10 kc to 2 mc. 2 sections parallel connected, potted in oil.....\$36.00  
 W.E. KS 9800 Input transformer. Winding ratio between terminals 3-5 and 1-2 is 1.1:1, and between terminals 6-7 and 1-2 is 2:1. Frequency range: 380-520 c.p.s. Perm. alloy core.....\$6.00  
 W.E. #D169271 Hi Volt input pulse Transformer.....\$27.50  
 G.E. K2450A. Will receive 13KV. 4 micro-second pulse on pri. secondary delivers 14KV. Peak power out 100KW  
 G. E. #2756A. Pulse input line to magnetron.....\$34.50  
 G.E. #K276A. Pulse input line to magnetron.....\$36.00

**400 CYCLE TRANSFORMERS  
 115-V 400 CYCLE INPUT**

Ratings	Price Each
6.3V/1.8A P/O APG2	\$1.49
6.4V/2.5, 4.0VCT/35MA, 6.4/150a	3.95
6.4V/7.5, 6.4/3.8, 6.4/2.5a	3.49
780V/27V/4.7, 6.3/2.9, 1.25/2a	2.49
6.4V/8a, 6.4V/1A	1.95
6.3V, 9.1A, 6.3VCT/6.5a, 2 x 2.5/3.5a	2.49
5V/2a, 6.3V/2a, 5V/2a, 6.3/5a	2.99
5V/15A, 5000V Ins	3.95
6.3/2.7, 6.3/66, 6.3VCT/21A	5.95
760V, 6.3V/2.5, 5V, 320V, 6.3V/20A	
6.4/7.5, 6.4/3.8, 6.4/2.5	2.95
592V/118Ma, 6.3/8.1a, 5V/2 W.E.	4.95
6.3V/9.1, 6.3VCT/65a, 2 x 2.5V/3.5A	2.95
6VCT/.00006 KVA	1.49
6.4V/8a, 6.4/7.1a	1.49
1034VCT/111a, 6.9V/10, 2 x 6.3V/1, 5V2, 6.3/2, 63/1	6.49
526VCT/50a, 6.3VCT/2a, 5VCT/29	3.49
400VCT/35MA, 6.4/2.5, 6.4/15a	3.25
2300VCT Large Qty	2.25
600VCT/36A	1.49
2.5V/1.75, 5V/3A, 6.5V/6.5, 6.5/2	3.95
For SCR729	2.95
640V/500Ma, 2.5V/1.75a P/o APS/15B	2.95
360VCT/20MA, 1500V/1MA, 2.5V, 6.3/2.5, 6.3V/6a, P/O	3.95
2 x 2.5V/2.5a, 2.5V/10A, P/O APT 4	4.95
2 x 2.5V/2.5a, 6.3V/2.25a, 1200V Tap 1000V-750V	
P/o AN/APS-15	4.95
745.5V/50MA, 709V, 47MA, 671V/45MA	2.95
600VCT/36MA, 2 3/4 x 2 1/4 x 3 1/4	
1150-1150, 2 3/4 x 2 1/4 x 3 1/4	
640VCT/250MA, 6.3V/9, 6.3V/6, 5V/6A	3.95
6.3V/9.1a, 2.5V/3.5a, 6.3VCT/65a, 2.5V/3.5a	3.25
9800V or 8600V/32MA	12.50
4540VCT/250MA	7.95
5V/3a, 6.3V/2a	1.75
5000V/290MA, 5V/10A	12.50
2200V/350	5.45
2.5V/5, 5200V/2MA	14.95
13.5KV/3.5MA	11.50
734VCT/1.1A, 1710VCT/177a	6.95
6.3V/9A, 7.7V/365A	2.79
2.5/20A	4.85
6.3V/12a, 6.3V/2a, 6.3V/1a, P/o AN/APG-5	5.85
6.4VCT/7.5, 6.4VCT/3.8, 6.4VCT/2.5a	4.35
6.3V/2.7, 6.3V/66a, 6.3VCT/21A	4.95
6.5V/12A, 250V/100MA, 5V/2a, P/o AN/APS-15	3.50
400VCT/35MA, 6.4/15a, 6.4V/2.5a	2.25
650VCT/50MA, 6.3VCT/2A, 5VCT/2A, P/o R58/AR68	2.45
2400CT/5MA, 640V/.5MA, 2.5V/1.75A	3.85
15.35VCT/1A	1.95
6.3/9, 6.3V/.6.5V/6, 640/200MA	4.95
2 x 14CV/00014A, 12QV/00012a, P/o APG2	1.95
3840V/400T, P/o APT4	7.95
23.5V Tapped 22V/47MA	1.95
600VCT/36MA	1.95
780V, 27V/4.3, 6.3V/2.9, 1.25V/20A	3.95
6.4V/11 Amp, P/o APQ7	2.25
2 x 6.3V/1.25a, P/o APQ13	1.95

**VARISTORS**

D-167176	\$ .95
D-172155	\$2.25
D-172307	\$1.75
D-167208E	\$1.85
D-172175	\$1.65
D-168667	\$ .95
D-171812	\$ .95
D-171528	\$ .95
D-165593	\$1.25
D-162356(308A)	\$1.50

**THERMISTORS**

D-166288	\$1.50
D-168392	\$1.75
D-167332 (tube)	\$1.50
D-170396 (bead)	\$1.50
D-167613 (button)	\$1.50
D-164699 for MT in "X" band Guide	\$2.50

APS-2. 10 cm. airborne radar set designed for navigation and high altitude bombing. The antenna rotates through 360 degrees. Presentation is PPI and A Scope. The following units of the set are supplied: Antenna, transmitter-receiver, modulator, indicator, 24VDC input power unit. New with all tubes, incl. 714AY magnetron, 417A klystron.

APS-3. 3 cm. airborne radar set designed for intercept of enemy aircraft and nominal navigation. Antenna is sector scan. Remote as well as master indicator is supplied. 725A magnetron operates the set at 45kw. Complete sets available with all tubes incl. magnetron and 723AB klystrons. Both new and used condition.

APS-4. 3 cm. airborne radar set designed for sector scan surface search, mapping and navigation, weather forecasting, intercepting of enemy aircraft. Entirely enclosed in a streamlined housing for optional mounting on aircraft bomb rack, or on nose of large bombers. Complete sets with indicator equipment, and power unit ready for installation.

APS-6. 3 cm Night Fighter radar with pencil beam antenna. Transmitter-receiver packages and antennas available in equal to new condition.

APS-6A. 3 cm airborne radar RF package, 45kw, using 725A magnetron, IF strip using 6AK5's 723AB beacon and local oscillator.

ASP-10. 3 cm airborne radar using 2I42 magnetron. Modulator decks and low voltage power supply, only, available, less tubes. Beacon local oscillator klystron mounts are available.

APQ-13. 3 cm airborne radar complete RF package in excellent condition including all tubes.

APS-15. 3 cm airborne radar designed for high altitude bombing, navigation, intercept of enemy aircraft weather forecasting. Antenna rotates 360 degrees. Presentation is PPI and A scope. The following units are supplied: Antenna, transmitter-receiver, modulator, indicator, slant-range computer, 24VDC input power unit. New with all tubes including 45kw 725A magnetron, 723AB local oscillator-beacon.

CPN-8. 10cm Navigation Beacon ground station. Complete and partial installations available. High power beacon of long range capability. Complete power, frequency, operation analyzer (5" scope) included.

CXBR. 10cm MIT navigation beacon equipment. Complete, in excellent condition.

FD & Mark IV. 800 mc gunlaying radar mfg and designed by Western Electric for battleships. Complete consoles available with all tubes including 700A magnetron and modulator thyatron.

Mark 10. 10cm gunlaying radar, complete, for automatic firing of guns as antenna tracks target. 250 KW.

SA. 200mc Air Search radar especially designed for shipboard or mobile installation. Ideal for ground intercept and control of aircraft. PPI 7" indicator. Long range.

SD. 200mc radar similar to SA but designed for installation on submarines. New.

SE. 10cm shipboard Surface Search radar, using thyatron modulator. Complete installation available including spare parts. "A" scope presentation. 250 KW.

SF-1. 10cm shipboard Surface Search radar with PPI and A scope. Used for navigation and target range information on naval vessels. 250 KW.

SG. 10cm shipboard Surface Search radar with PPI and A scope. Heavy, rugged equipment designed for large naval and merchant vessels. 250 KW.

SJ-1. 10cm radar designed for installation on Submarines. Equipped with PPI and A scope. Complete installations.

SL. 10cm radar designed for Surface search on shipboard. PPI indicator console.

SN. 10cm portable radar. Lightweight, easily transportable complete radar installation using lighthouse tubes with a 25 mile maximum range. 115 VAC operation.

SO-1. 10cm shipboard radar for navigation on all types of vessels. 4, 20, and 80 mile range. PPI indicator. Large antenna. 115 VDC input.

SO-8. same as SO-1 but with a lightweight antenna.

SO-13. same as SO-1 but with lightweight antenna, 28VDC input. Designed for PT Boat installation.

SCR 518. Radar altimeter using pulse-echo-time principle. 400mc. 28 VDC input, CR tube altitude indication.

SCR 520. Airborne radar RF package, 10cm, complete with pulser, hard tube, 714AY magnetron.

SCR 533. IFF/Air Search trailer. complete, 500mc operation, A scope.

SCR 663. Sperry searchlight training, aircraft tracking ground installation. Used condition.

SQ. 10cm portable radar designed for use on landing barges and beach-heads. PPI, B, A indication on 3" scope. 115 VAC operation.

TPS-2. 1000mc Portable Early Warning System. Bedspring antenna. Complete with portable gasoline generator.

RT73/UPN-2. 10cm Portable Beacon Equipment.

**RADIO SYSTEMS**

White Radio Telephone Model #WRM55. Ship to Ship—Shore to Ship—Small Airports—Mines—Plantations—Inter Island—Ranches. 10 Channel Filt. Tuned Receiver & Transmitter XMTR Pwr Output in excess of 100W unmodulated into antenna of 18Ω & 100 MMF. Freq. Range 2-12 MC. Can be modified to increase range. Xtal controlled. 110V 60 Cy or 220V 60 or 25 Cy. Meas. 24" H x 19" W x 14" D. 125 lbs. Write or phone for data.

TAJ. 500 Watt Low Frequency Transmitter, 150-550 KC. C.W., M.C.W.

TBK. 500 Watt High Frequency Transmitter 2 to 18 MC, A1, A2, A3. Emission. Mfg. by RCA.

**RADAR  
 RADAR  
 RADAR  
 RADAR**

**R  
 A  
 D  
 A  
 R**

**SONAR  
 SONAR  
 SONAR  
 SONAR**

All merchandise guaranteed. Mail orders promptly filled. All prices, F.O.B. N.Y.C. Send M.O. or Chk. Only shipping chgs. sent C.O.D. Rated concerns send P.O.

**COMMUNICATIONS EQUIPMENT CO.**

131 Liberty St., New York, N. Y. Dept. E-12 P. J. PLISHNER Phone: MAIn 4-8373

# RELAYS

## FOR EVERY PURPOSE

### Over a Million in Stock!

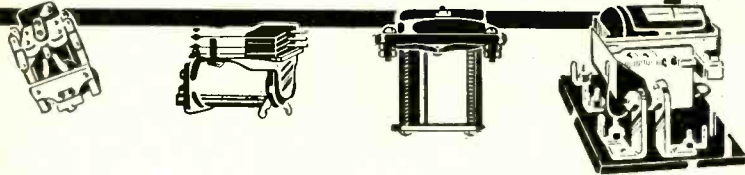

Whether you require large quantities of relays for production runs or single units for laboratory or amateur work, Wells can make immediate delivery and save you a substantial part of the cost.

Our capable engineering staff is prepared to offer assistance in the selection of correct types to suit your exact requirements.

Each relay is brand new, standard make, inspected, individually boxed and fully guaranteed.

The following list represents only a tiny portion of our relay stock. Write or wire us for information on types not shown.

Stk. No.	Volt-age	Ohm-age	Contacts	Unit Price	Stk. No.	Volt-age	Ohm-age	Contacts	Unit Price	Stk. No.	Volt-age	Ohm-age	Contacts	Unit Price
R-714	9/14 VDC.	65	2C/5 Amps.	\$1.55	R-582	120 VAC.	...	1A	2.45	R-137	24 VDC.	300	1C	1.45
R-653	12 VDC.	14	2C	1.55	R-812	115 VAC.	...	1A-D. Break. 15A	2.45	R-142	24 VDC.	400	2C	1.50
R-721	18/21 VDC.	290	2C/5 Amps.	1.55	R-260	115 VAC.	500	3A/15 Amps.	2.80	R-785	24 VDC.	200	2C/10 Amps.	2.00
R-773	24 VDC.	280	3C/10 Amps.	1.60	R-249	100/135 VAC.	600	2A Ceramic	2.80	R-607	24 VDC.	...	1A	1.20
R-694	24 VDC.	300	1A/5 Amps.	1.50	R-665	300	2B/10 Amps.	2.80	R-606	24 VAC.	...	1A & 1B	1.20	
R-704	2/6 VDC.	25	2B/5 Amps.	1.35	R-693	2/6 VDC.	125	1C/3 Amps.	1.10	R-605	25 VAC.	...	3A	1.20
R-297	115 VAC.	...	2C	2.80	R-597	4/12 VDC.	16	1A/25 Amps.	2.45	R-728	6 VDC.	30	1A	1.25
R-173	2/6 VDC.	2	1A	1.55	R-193	5/8 VDC.	11	2C, 1A/10 Amps.	1.30	R-807	6 VDC.	30	2C	1.25
R-280	6/8 VDC.	77	1A Double Break	2.45	R-595	5/8 VDC.	18.5	3C	1.30	R-625	6 VDC.	45	1C/3 Amps.	1.35
R-647	6/12 VDC.	15	2C/20 Amps.	2.20	R-798	6/24 VDC.	1200	1C/3 Amps.	1.45	R-732	24 VDC.	...	1A	1.45
R-273	20 VDC.	160	2A/15 Amps. D. Break	3.55	R-793	12 VDC.	42	2C/10 Amps.	1.55	R-733	12 VDC.	120	2C	1.50
R-169	24 VDC.	200	1A	2.45	R-599	12 VDC.	67	3A/15 Amps.	1.45	R-281	12 VDC.	126	2A	1.25
R-570	24 VDC.	230	1B Double Break	2.70	R-559	24 VDC.	95	1A/10Amps.&1A/20A*	1.30	R-818	18/24 VDC.	300	1B	1.25
R-171	24 VDC.	230	2C/10 Amps.	2.70	R-560	24 VDC.	160	1A	2.80	R-139	24 VDC.	200	4C	1.45
R-529	24/48 VDC.	1020	2C	3.10	R-795	24 VDC.	160	2A/10 Amps.	1.55	R-135	24 VDC.	250	1B	1.45
R-715	24 VAC.	...	2C Ceramic	3.70	R-796	24 VDC.	160	2A/15 Amps.	2.80	R-133	24 VDC.	300	None	.75
R-584	6 VDC.	20	1A Double Break	1.30	R-562	24 VDC.	160	4A/10 Amps.	1.60	R-138	24 VDC.	300	4A	1.45
R-192	12 VDC.	44	3C/10 Amps.	1.70	R-797	24 VDC.	160	8A/8 Amps.	2.80	R-132	24 VDC.	300	2C	1.50
R-204	12 VDC.	66	2A	1.45	R-549	24 VDC.	160	1C/10 Amps.	1.55	R-731	24 VDC.	300	2C	1.55
R-224	12 VDC.	85	1A	1.45	R-758	24 VDC.	160	2C/10 Amps.	1.55	R-730	24 VDC.	300	2C & 1A	1.55
R-734	24 VDC.	280	1A	1.30	R-242	24 VDC.	170	1C/20 Amps.	1.55	R-292	24 VDC.	350	1C	1.25
R-205	24 VDC.	260	2C	1.55	R-775	24 VDC.	180	2A/10 Amps.	1.55	R-626	24 VDC.	400	1A/5 Amps.	1.55
R-536	27 VDC.	230	2C	1.55	R-649	24 VDC.	265	1A	1.30	R-786	60 VDC.	1300	2C	2.00
R-220	75 VDC.	5000	1C	1.50	R-744	24 VDC.	265	1A/20 Amps.	1.50	R-588	90/125 VDC.	6500	4C	2.70
R-627	115 VAC.	...	1A Double Break	3.10	R-745	24 VDC.	265	2A/10 Amps.	1.45	R-755	24 VDC.	300	1A	1.45
R-698	12 VDC.	75	1C	1.20	R-530	24 VDC.	265	2B	1.30	R-150	6 VDC.	30	1A	1.20
R-734	24 VDC.	150	3C/10 Amps.	1.45	R-798	24 VDC.	375	2C/5 Amps.	2.80	R-648	24 VDC.	330	1C/3 Amps.	1.50
R-598	28 VDC.	185	2C	1.45	R-776	28 VDC.	180	2C Ceramic	1.55	R-148	12 VDC.	100	2C & 1B	1.35
R-622	20/30 VDC.	200	3A & 2C/10 Amps.	1.30	R-775	28 VDC.	265	2A	1.55	R-285	12 VDC.	75	3A	1.35
R-274	24 VAC.	...	2A	1.55	R-701	22/28 VDC.	425	2B/10 Amps.	1.70	R-222	12 VDC.	100	2A	1.20
R-270	24 VAC.	...	1A	1.55	R-802	24 VDC.	160	3A D. Break. 15 Amps.	2.80	R-639	6 VDC.	20	3C/3 Amps.	1.45
R-269	24 VAC.	...	1A/15 Amps.	1.55	R-792	24 VDC.	200	1A/15 Amps.	1.30	R-696	24 VDC.	230	1A/8 Amps.	2.00
R-277	12 VDC.	30	2C D. Break. Cera.	2.20	R-791	24 VDC.	200	1C/3 Amps.	1.30	R-743	139 VDC.	5000	3B & 1A	2.05
R-594	12 VDC.	50	2C	2.00	R-695	12 VDC.	70	2C/3 Amps.	1.30	R-783	100 VDC.	6500	1C/Micalex.	2.40
R-668	12 VDC.	50	1C/10 Amps.	1.30	R-288	18/24 VDC.	175	2A Ceramic	2.20	R-782	100 VDC.	6500	4C & 1A	2.45
R-613	12 VDC.	50	1C	1.30	R-558	24 VDC.	280	2C/3 Amps.	1.55					
R-772	12 VDC.	70	1A/15 Amps.	1.45	R-299	6 VDC.	24	2A	1.55					
R-293	12 VDC.	150	1C Double Break	3.10	R-267	12 VDC.	65	2C/5 Amps.	1.55					
R-637	12/24 VDC.	100	1A/10 Amps.	1.45	R-206	24 VDC.	150	2C	1.50					
R-580	12/24 VDC.	150	1C Double Break	2.45	R-207	24 VDC.	210	4A	1.35					
R-276	24 VDC.	100	2C D. Break. Mica.	3.10	R-219	50 VDC.	1500	2A/15 Amps.	1.55					
R-752	24 VDC.	150	2C/3 Amps.	1.45	R-531	12/24 VDC.	83	2A/10 Amps.	1.50					
R-768	24 VDC.	175	2A/5 Amps.	1.45	R-506	24 VDC.	300	2A/6 Amps.	1.20					
R-699	24 VDC.	200	3A/5 Amps.	1.55	R-581	24 VDC.	4500	1A/5 Amps.	1.20					
R-700	24 VDC.	200	2C/8 Amps.	1.55	R-825	115 VAC.	...	1A/6 Amps.	2.45					
R-282	24 VDC.	325	1A Double Break	1.25	R-819	115 VAC.	...	2A/6 Amps.	2.45					
R-286	115 VAC.	950	2C	2.80	R-652	115 VAC.	...	1A D. Break/20 Amps.	2.80					
R-612	2/6 VDC.	1	1A	1.55	R-217	115 VAC.	...	1C	2.80					
R-815	2/6 VDC.	1.5	1A/10 Amps.	1.55	R-824	2 VDC.	...	1C	1.55					
R-263	6 VDC.	12	2C/15 Amps.	1.55	R-500	8/12 VDC.	5000	1C	2.80					
R-279	14 VDC.	250	1A/15 Amps. D. Break	1.55	R-820	10 VDC.	20	1B D. Break/6 Amps.	1.30					
R-278	18/24 VDC.	260	2C, 1A, 1B	1.55	R-821	18 VDC.	2000	1A, 1B/2 Amps.	2.45					
R-706	24 VDC.	150	4C/10 Amps.	2.45	R-871	24 VDC.	160	2C/10 Amps.	1.55					
R-177	24 VDC.	250	4C	2.05	R-739	24 VDC.	200	1A	1.35					
R-609	250 VDC.	5000	1A Double Break	2.45	R-724	75 VDC.	200	2B/3 Amps.	2.40					
R-779	12 VAC.	...	1B/10 Amps.	1.70	R-823	110 VDC.	5000	1B	2.45					
R-272	24 VAC.	...	1A, 1B/5 Amps.	1.55	R-617	12 VDC.	600	1C Double Break	1.30					
R-271	24 VAC.	...	2A, 1B/3 Amps.	1.55	R-729	12 VDC.	80	1A/10 Amps.	1.25					
R-685	115 VAC.	600	1A/6 Amps.	2.50	R-722	24 VDC.	300	1A/10 Amps.	1.30					
R-663	12 VDC.	40	2C/10 Amps.	1.30	R-577	48 VDC.	220	2C	2.45					
R-757	12 VDC.	44	2C, 1A, Ceramic	1.45										
R-152	12 VDC.	50	2C, 1B, Ceramic	1.35										
R-624	12 VDC.	50	1C	1.45										
R-268	12/24 VDC.	260	3A, 1B	1.55										
R-805	18 VDC.	200	1A/10 Amps.	1.30										
R-644	18/24 VDC.	275	1A/25 Amps. & 1A/5A	1.45										
R-687	26.5 VDC.	125	2C/15 Amps. & 3A/10A	2.45										
R-674	24 VDC.	250	1C/5 Amps.	1.45										
R-593	28 VDC.	125	2C/10 Amps.	1.45										
R-191	28 VDC.	125	2C/10 Amps. Ceramic	1.50										
R-248	28 VDC.	150	1A/20 Amps.	1.30										
R-615	32/40VAC.	...	3A/15 Amps.	1.55										

BASIC CONTACT ASSEMBLIES SHOWN IN UNOPERATED NORMAL POSITION

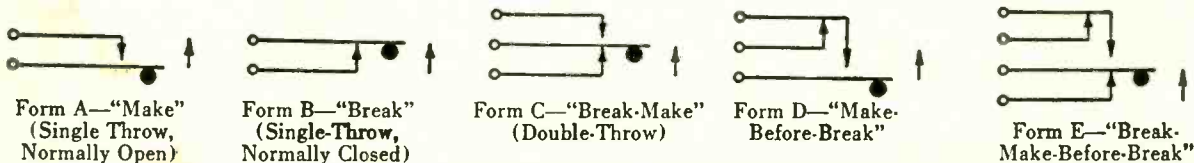

WRITE FOR  
WELLS CATALOG

TELEPHONE  
SEeley 8-4143



833 W. CHICAGO AVE., DEPT. SL, CHICAGO 22, ILL.



UNUSED

# AN PLUGS AN RECEPTACLES

We own and offer all parts listed.

Immediate delivery from our Baltimore Warehouse!

Pieces	Part No.	Insert	Pieces	Part No.	Insert	Pieces	Part No.	Insert
53	AN3100-8S-1P	M	38	-32-7P	M	32	-16S-4S	B
10	-8S-1S	M	62	-32-15P	M	450	-16S-5P	M
15	-10SL-3P	B	34	AN3106-8S-1P	M	65	-16S-5S	M
81	-12S-3S	B	61	-8S-1P	B	158	-16-11S	M
650	-12-5P	B	12	-8S-1S	M	137	-16-11S	B
2098	-12-5S	B	116	-8S-1S	B	2947	-18-4P	B
586	-14S-1S	B	809	-10S-2P	M	12	-18-4S	B
69	-14S4P	B	275	-10S-2P	B	147	-18-4S	M
141	-14S-6P	M	177	-10S-2S	B	1437	-18-5P	B
73	-14S-6S	M	50	-10S-3S	M	11	-18-5S	B
65	-14S-7S	B	466	-10S-3S	B	404	-18-6S	B
96	-14S-7S	B	300	-10SL-3S	B	233	-18-9P	B
328	-16S-4S	B	2737	-10SL4S	B	97	-18-11S	M
41	-18-4S	B	248	-12S3S	B	35	-18-20P	M
99	-18-8S	B	373	-12S-4P	B	38	-22-14S	B
448	-18-12S	B	351	-12S-4P	M	556	-22-19P	B
314	-18-12S	B	13	-12-4S	B	30	-24-2S	B
28	-18-15S	B	22	-12S-4S	B	19	-24-2S	B
70	-18-22P	M	250	-12S-4S	M	15	-24-10P	M
50	-20-81S	M	191	-12-5S	B	25	-24-10S	M
92	-22-2S	M	10	-14S-4P	M	42	-28-1S	M
698	-22-5S	B	68	-14S-7S	B	26	-28-2P	M
16	-22-14P	M	138	-16-2S	B	235	-28-12S	B
32	-22-21P	M	12	-16S-4P	B	106	-28-16P	B
15	-24-2S	M	62	-16S-4S	B	169	-28-17S	M
14	-24-5P	M	200	-16S4P	M	20	-32-1S	M
65	-24-5P	M	45	-16-13S	M	24	-32-6P	M
37	-32-6P	B	200	-18-1S	B	70	-32-7S	B
45	-32-7P	B	269	-18-5P	B	54	-32-13S	M
98	-PR32-7P	M	32	-18-5S	M	40	-32-13P	M
314	-32-7S	M	4711	-18-6S	B	152	-32-14S	B
281	-32-14P	B	278	-18-10S	M	30	-36-6P	B
132	-32-14S	B	20	-20-5P	B			
26	-36-7P	M	828	-20-12S	B			
358	-36-19P	B	12	-20-23S	B			
77	AN3102-8S-1P	M	49	-20-25S	M			
440	-10S-2S	B	56	-20-27S	B			
828	-10S-2S	M	20	-22-3P	B			
31	-10S-8S	M	12	-22-5P	M			
577	-12S-3P	M	510	-22-19P	B			
70	-12S-3S	B	72	-22-27S	B			
172	-12S-3S	M	14	-24-2P	B			
34	-16S-1P	B	78	-24-3P	B			
330	-16S-5P	B	38	-28-12P	B			
32	-16S-8S	M	22	-32-7P	M			
10	-16-11S	B	173	-32-7S	B			
734	-16-13P	B	155	-32-14S	B			
1428	-18-4S	B	43	-32-16S	M			
1607	-18-5S	B	25	-36-10S	M			
38	-18-12S	M	68	-44-1P	B			
25	-18-22P	M	146	AN3108-8S-1S	B			
1122	-20-3P	B	324	-8S-1S	M			
17	-20-5P	B	1013	-10S-2S	M			
16	-20-14P	M	815	-10S-2S	B			
207	-22-1S	B	36	-12S-3S	B			
227	-22-5S	B	72	-12-5P	B			
349	AN3102-24-1S	B	13	-12-5S	M			
82	-PR28-1P	M	102	-14S-2P	M			
20	-28-11P	B	1062	-14S-2S	B			
34	-28-11S	B	12	-14S-7S	M			
70	-32-1P	B	14	-14S-10P	M			
154	-32-1S	B	438	-16S-1S	B			
66	-32-6P	M	411	-16S-4P	B			
20	-32-6S	M	1759	-16S-4P	M			

M—Melamine  
B—Bakelite

UNUSED ELECTRONIC COMPONENTS		
Pieces	Part No.	Description
35	RA-10-DB	Receiver
20	TA12B	Transmitter
150	DA-1F	Dynamotor
162	3611-B	Amplifier
35	MR-9B	Control Box
7	AS27A/ARN-5	Antenna
9000	45	Bulb
11000	1667	Bulb
1000	987	Bulb
300	AN3135-1	Bulb
87	MR16D	Filter
97	FT213	Mount
54	FT293	Mount
80	BX42-7	Dynamotor

WRITE — WIRE — PHONE

## COMMERCIAL SURPLUS SALES CO.

4101 CURTIS AVENUE, BALTIMORE 26, MARYLAND

TELEPHONE: CURTIS 3300

# - THE BEST IN ELECTRONIC SURPLUS -

SF-1 Radar Eqpts. 10 Centimeter, Brand NEW with complete spares to insure over 10 years of continuous operation. Includes motor-generator set in each, all wave-guide plumbing, instruction books, etc. 19 cases per set, export packing.

PRICE, EACH .....\$2,500.00  
 Beachmaster, 250 watt Portable Sound Amplifier Systems, with nine speaker rack, tubes, mike, cables, and spares. Operation from 110 volts, one phase, 60 cycles AC. Excellent and New condition units.

PRICE, EACH .....\$485.00  
 Case of spares for above. PRICE .....\$100.00  
 Western Electric Model HLAS, 500 watt Sound Amplifier Systems, consisting of 40 watt Pre-Amplifier; 500 watt Power Amplifier with built-in power supply, expander-compressor circuit, internal blower-ventilation. 30 kc erasing oscillator circuit for magnetic-tape recording, volume and meter controls; two speaker racks, each with 6-80 watt dynamic horn units. Operation from 115/230-60 AC. New. Unused. Complete with tubes, cables, connectors and instruction manual. EACH .....\$895.00

Wilcox 36A Rectifiers, single cabinet unit containing 4 separate transformer rectifier power supplies, capable of supplying DC voltage to one or more 90C transmitters and one or more Wilcox 50A Modulators (which are designed to modulate a 90C 3 KW RF Output Transmitter). Has terminal connections for 5 90C Transmitters, and for local or remote operation. Measures: 7" high, 29 1/2" wide, and 2 1/2" deep. Operates from 220/3/60 AC. NEW eqpt., complete with control relays, tubes, power transformer (removed for shipment), instruction manual. WRITE FOR PRICE.

RMCA, Model 8010 I.F. Ship Main Radio Transmitter, 325 to 500 KC, types CA & E. Excellent condition. Less motor generators. PRICE, EACH .....\$475.00

RMCA, Model 8019A/H, HF Transmitter, complement to 8010 above, for SHF. Excellent condition. A1 and A2, 200 watts output. Excellent Condition, less tubes and MG (mg with 8010 powers this unit). PRICE, EACH .....\$400.00

RMCA, 8003 Emergency Transmitter, 500 KC, 50 watts output with 12/115 V. DC, motor generator set, and battery charged. Excellent Condition. Complete with tubes. PRICE, EACH .....\$275.00

RMCA, 8707 Direction Finder, (Int. Freq.) consisting of receiver, loop, shaft, rotating wheel. Excellent Condition except shaft housing not available (can be easily improvised). With tubes. PRICE .....\$750.00

Mackay, Model 150-A, I.F. Ship Transmitter, 325 to 500 KC, A1 and A2 sections. Excellent Condition. PRICE with MG, 115 V. DC, EACH .....\$350.00  
 PRICE without MG, EACH .....\$275.00

RC-163 Radio Beacon Ept. 20-40 MC. Converts SCR-508/528/608/628 to directional transmitters and receivers. Ideal for airports or for homing application. NEW and complete eqpt. Export packed. EACH .....\$80.00

SCR-511 "Popo Stick" Walky-Talky. Portable low power AM radiotelephone for 2 to 6 mc operation, with 13 plug-in tuning coils containing crystals for crystal control of both receiver and transmitter. Transmitter-receiver BC-745 of this SCR-511 includes telescopic antenna and "Press-Talk" Switch as well as all cables. Range 5 miles. Plus. With PE-157 Vibrator Power Supply 2-volt battery (less electrovalve). T-17 mike, ready for immediate operation. PRICE, EACH .....\$95.00

RMCA, 8690X Auto Alarm Receivers, 500 KC Automatic SOS (4-second dash actuated) Alarm Unit. Complete with Relay, Control Box, warning light. For 110 V. DC operation. Excellent Condition, with tubes. PRICE, EACH .....\$250.00

TBK-10, 500 watt, 2-18.1 MC. CW Telegraph Transmitter designed for ship installation. Almost new condition, complete with tubes, less MG set and accessories. PRICE, EACH .....\$350.00

Link FM Transmitter-Receiver, 70-110 mc, 50 watts output. Model 1498 DC. Wall style cabinet containing transmitter, receiver and 14 V.D.C. power supply, handset. Dim.: 34" x 21" x 11". New Condition. Complete with tubes, crystals, special telescopic antenna, instruction book. PRICE, EACH .....\$500.00

AN/CRT-1A Sonobuoy Transmitters, for mine and submarine detection. With parachute, tubes, etc., ready for operation (except standard types dry batteries). Operates at 67.7 mc. Excellent to New condition. PRICE EACH .....\$55.00 and up.

R-2/ARR-3 Receivers, FM, 67 to 72 mc, for use with Sonobuoy Transmitters described above, 24 V. DC operation (less dynamotors). Excellent condition. With tubes. EACH .....\$125.00

BC-319-A Transmitter, CW only 300 watts output. Freq. range 4.0 to 13.4 mc. Operates from 110/220 volts, 60 cycles AC. Excellent condition. Less tubes. PRICE, EACH .....\$300.00

Wilcox, 90-200A, 2-KW RF section 115 to 525 KC. Large cabinet with complete RF end containing two VFO, intermediate sections and PA stage. Almost new, but lacks PA inductance. Less tubes. PRICE .....\$500.00

TDE-2, Ship Transmitter, HF and IF bands, for 230V. DC operation. With internal mg supply, and all tubes. NEW, unused condition. PRICE .....\$600.00

### TS-47/APR

Signal Generator, 40 to 115 mc and 115 to 500 megacycles, butterfly condenser tuning with direct precision calibration. Solid construction and shielding, with built-in power supply which operates from 80 to 220 volts AC, 50 to 260 CPS. Complete with instruction sheets, tubes, and connectors. NEW and like new units. EACH .....\$140.00

BC-348 Receivers, like NEW condition, complete with tubes and dynamotor. EACH .....\$140.00

BC-221 Frequency Meters, Excellent to LIKE NEW condition, with calibrated charts, tubes and crystal. EACH \$85.00

### RADIOSONDE AN/AMQ-1, meteorological transmitter with sensitive instruments for measuring pressure, temperature, and humidity and means for modulating transmitter so that this information is transmitted while unit is in flight suspended from a balloon (not supplied). Standard battery powered, NEW, complete in cardboard casing, packed, ready for immediate use after installing batteries. Large Quantity Available. WRITE FOR PRICES.

Sound-powered Head/Chest Sets, RCA Type MI-2154-B, Complete. NEW, packed for export. EACH .....\$8.75

Model ATD Aircraft Transmitter, mfd. by Bendix, 50 Watts A1 & A2, 40 Watts A3, 4-Channel motor tuning 1500 to 9,050 KC. Complete, with tubes, 24 V. Dynamotor, remote control, connectors, spare parts in box, all NEW Equipment. Export Packed. Per Set .....\$175.00

Teletype Co. Wheatstone Perforator, For automatic high-speed transmissions of Int. Morse Telegraph signals on perforated tape, when used with Boehme Keying Head with Keying Head Drive for controlling radio transmitter. Both units available, excellent condition. The Boehme unit includes Pilot Lamp and Transmitting Speed Recorder from 15 to 570 w.p.m. PRICE, both units .....\$490.00

### TEST EQUIPMENT

Model 62 VTVM, Measurement Corp.  
 Model 78-E Standard Signal Generator, Measurement Corp.

Model 65-B Standard Signal Generator, Pre-set Push-Button Control for Frequency, Motor-Driven Tuning, Measurement Corp.

Type 160-A "Q" Meter, with Type 560 L/C Dial Conversion Kit and 141-B Coupling Transformer, Measurement Corp.

Model 200-C Hewlett Packard Audio Oscillator

Model 205-AG Hewlett Packard Audio Signal Generator

Model 330-B Hewlett Packard Distortion Analyzer

Model 154 RCA Beat Frequency Audio Oscillator

CRO-3A, G. E. Oscilloscope  
 General Radio 814-AM VTVM Amplifier  
 Dumort Type 208-B 5" C-R Oscillograph  
 RCA 160-B Oscilloscope

All Excellent Condition Test Equipment. Write for Prices.

### "SNOOPERSCOPE" TUBE

Infra-Red Image Converter Tube (British) to make "Snooperscopes," "Sniperscopes" and other devices that see in the dark. Has many useful industrial applications. Operates with invisible infra-red rays, without scanning or amplifiers. Supplied with technical data and diagrams. Every tube guaranteed! EACH .....\$5.50

6 for .....\$30.00

BAUSCH & LOMB Front-End Lens Assembly, for best images. F2.1, 3.5 in. EF. EACH \$10.00

MOUNTED LENS UNIT, also for front-end, results as good as B & L unit. Speed F1.9 f. 1. 91.4 mm. outside dia. at one end 60 mm. length of mount 64 mm. PRICE, EACH .....\$7.00

### 20-40 MC FIELD STRENGTH AND WAVEMETER

Uses a 0-100 Micro-ammeter with a 184 Pentode, to receive signals in the 20-40 mc range. 1.5 volts battery required. Tuning dial has dial lock, for fixing position, and telescopic Antenna permits adjusting for strong or weak signals. Calibration must be self-performed. With instruction sheet and diagram NEW, unused eqpts. Dim: 6 1/2" x 4 1/4" x 5 1/2". PRICE, EACH .....\$14.95

YJ-1 I.F.F. Ept. Consists of dual transmitters and dual receivers, each working in "A" and "B" bands, 176 and 515 mcs respectively. Includes power supply (115-230 volts, 60 cycles AC) and tubes, all in one metal cased unit. UNUSED eqpt. PRICE, EACH .....\$165.00

32 Volt DC to AC Rotary Converter, mfd. by Kato. For yachts, workboats, or farm installation. Output 110 V., 60 cycles AC, rated 225 watt but good to 300 watts. All NEW Units. PRICE, EACH .....\$39.95

Deck Entrance Insulators, bowl and flange type 8 1/2" dia. with heavy galvanized metal flange and bell. Top bell 6 1/4" dia. x 1 1/2"; brass feed thru. Very high voltage insulation. Individually packed in cartons, all NEW. 12 FOR .....\$24.00

Generator Electric Amplifier, 60. Set, #CG type #V5875077, motor type #73AB58, Navy #CG 21ABU, 115/230 V., 60 cycles, motor rated at 3/4 HP. generator output 250 V. DC at 375 watts. NEW. PRICE, EACH .....\$75.00

T9/APQ2 Radio Transmitters. Noise-modulated Jamming Transmitter, using Electron-Multiplier Photocell. For Jamming certain types radar eqpt. New unused transmitters only, with Electron-Multiplier tube, less other tubes. EACH .....\$32.50

SB-23/GTA-2 & SB-14/GY Switchboards & Power Supply, for operation from 110V, 60 cycles AC (and storage batteries). Each in individual metal cabinet. Price, Each Set .....\$450.00

TS-11 Handsets, for SCR 194 & 195. NEW. EACH .....\$6.95

TS-48AP Echo Boxes. UNUSED. EACH .....\$20.00

SCR-584 Sector Scan Units. UNUSED. EACH .....\$9.00

QBE-3 Control Rectifiers, Type CBM-20223. UNUSED. EACH .....\$27.50

BC-689A Radio Transmitters. Unused. Less tubes. EACH .....\$22.50

### 580-765 MC SUPERHET RECEIVER WITH WAVEMETER

Easily modified for Citizen's Band reception, or for experimental use on VHF Television. Uses a 955 Autodyne detector-oscillator into 3-stage resistance-coupled IF amplifier. Output is for headphones. Includes VR-150 voltage regulator tube, 6E5 tuning-eye, and 5Y3 rectifier. For 115 volts, 60/0 cycles AC. Calibrated Wavemeter, mounted as separate portion, with variable tuning rod and hand-plotted calibration curve for each, permits checking frequency of incoming signal. NEW unused surplus. With instruction sheets and diagram, plus calibration curve, and tubes. PRICE, EACH .....\$75.00

### RADAR TRAINING SET—MARK V

For Student, Schools, Labs, or actual radar application. Operates in the 580 to 765 mc region, designed especially to illustrate how radar eqpt. functions, and permits making numerous experiments to put over radar fundamentals. Uses above described receiver; separate transmitter using 8025 triode with 1.5 watts at antenna, with 400 KC internal modulator using two 811 tubes; External modulator, generating audio frequencies of 16,000, 4,000, and 1,000 cycles, and RF at 750, 350, and 175 KC, with selection switch for modulation frequency and wave form control, using 3 tubes, 807, 6N7, and 6J5; set of Antenna Dipole rods. Supplied with full instruction sheets, diagrams, calibration curves, tubes, NEW unused surplus. PRICE, Per Set .....\$175.00

DZ-2 DIRECTION-FINDING EQUIPMENT, with loop assembly, 28 V. DC operation, 15-70 & 100-1750 Kcs. NEW. PRICE, EACH .....\$150.00

SCR-509/510 and 609/610 Equipments, Vehicular Transmitter-Receiver, FM, 20 to 40 MC. New and Excellent Condition units, with PE-97, or PE-117, or PE-120, 6-12-24 volt Power Supplies available. WRITE FOR QUANTITY PRICES.

SUPREME ship-to-shore transmitter receiver, 110W output, 9 channel, 2-3 mcs., crystal controlled, for 110V., 60c. A.C. Condition N-2. Complete with tubes and microphone. EACH .....\$500.00

MASTER POWER METER PANEL, for measuring voltage, current, and frequency of 2 to 4 50 KW power units of 240 v. 3-phase-3 wire or 3-phase-4 wire, 60 cycles AC. Measures each phase lead. Measures current 0-300 or 0-600 amps, through selection of current transformers. Dim: 22"x34"x20". Has many industrial applications. NEW condition. EACH .....\$150.00

### TUBE SPECIALS

2J27	.....\$24.50	100TH	.....\$ 9.00
707B	.....\$24.50	250TH or TL	.....\$19.50
527	.....\$19.50	450TL	.....\$40.00
721A	.....\$ 2.85	861	.....\$22.75

LIMITED QUANTITIES Following: R-89/ARN-5A Receivers, new; APN-4 Indicators; RBV-2 Portable 28-60 mc Transceivers; TA-12B Transmitters; Model NAA Underwater Ultrasonic Beacon Transmitters; Model ZB-3 Aircraft Homing Adapter Equipment; Portable Test Oscillators for ZB Ept.: RT-3/ARN-1 Altimeter Transmitter-Receiver; Receivers for DP-2 or 13 D.F. Receiving Eqpt.; Radio Receivers BC-733 D; Model ATD Aircraft Transmitters; BD-72 Switchboards; 500 Watt, 110 DC to 110 AC, 60 cps motor-generators. Also, BC-603 Receivers, BC-604 and BC-684 Transmitters, BC-620 and BC-659 FM Transceivers, PE-97, 117, and 120 Power Supplies; Ship-to-Shore Radio Telephone for 32 V. & 110 V.D.C. operation. Large quantities of transformers, power and audio, filter chokes, Radar fittings and accessories.

Immediate Delivery from Stock

All Prices F.O.B. N.Y.C.

All Material Offered Subject to Prior Sale

Cable: Telemarine, N. Y.  
 Tel. LOngacre 4-4490-1

## TELEMARINE COMMUNICATIONS CO.

540 W. 27th St.,  
 N. Y. 1, N. Y.



# SUPERIOR VALUES FROM AMERICA'S LARGEST ELECTRICAL CONVERSION HOUSE

## HIGH FREQUENCY CONVERSION EQUIPMENT

**LELAND-MURRAY MG SET.** Motor: 5 H.P. 220/440 Volts 3 phase, 60 Cy. directly connected to Alternator: 3 KVA. 120/208 Volts, Wye connected. 400 C.P.S. Price ..... \$525.00

**HOLTZER-CABOT MG149F.** Input: 24 VDC. 36 amp. Output: 26 Volts, 400 cycles, 250 VA. Also secondary output of 115 Volts, 400 cycles, 500 VA. Completely rebuilt and guaranteed. Price ..... \$25.50

**Brand New Units, Price.....** \$49.50

**GE MG UNITS.** Motor: 110 Volts, D.C. 31.5 Amperes. In a single compact unit with output of 120 Volts, 20.8 Amp. single ph. 500 cycles. Like New. Price.....\$95.00

**500 CYCLE MG SETS.** British made motor generator, 8 KW, 2 bearing unit, input 180-240 VDC, output 180 volts, 1  $\phi$  weight app. 1000 lbs. Price.....\$425.00

**ELECTRIC SPECIALTY FREQUENCY CHANGERS**  
Type BPS2/3FRS354 Input: 220 Volts, 3 Ph. 60 cy. 3600 RPM. Output: 250 Volts, 20 Amp. single ph. 180 Cye. 5000 VA. 3000 Watts. Brand New. Compact ball bearing units for operation of Hi-cycle equipment. SPECIAL PRICE ..... \$160.00

**ONAN 800 CYCLE MG UNIT.** Employing 5 H.P. Motor operative at 220/440 Volts, 3 $\phi$ , 60 Cy. V belted to self-exc. generator with output of 1.5 KVA, 115 Volts, single ph. 500 CPS, and secondary output of 500 Watts, 28.5 VDC 17.5 amperes. PRICE.....\$289.00

**INVERTER UNIT PE206A.** Input: 27.5 VDC. 38-amp. Output: 80 Volts, single ph. 800 CPS. 500 VA. Price ..... \$19.00

**G. E. HIGH FREQUENCY MG UNITS.** Motor operative at 115 Volts, DC. Generator: 2.5 KW. 24/32 Volts, 78 Amp. D.C. Alternator: 120 VAC, 20.8 amp. .9 PF, single ph. 720 cycles. All three components in a single compact housing. Price..... \$200.00

**800 CYCLE UNIT.** Operate at 440 V. 3 $\phi$ , 60 cy. directly connected to self-exc. alternator with output of 120 Volts, single phase, 6.8 amp. .8 K.W. 800 Cycles. Price ..... \$119.75

**CROCKER-WHEELER 500 CYCLE MG SET.** Compact 2 bearing Unit. Operative at 120 VDC. 7.3 amps. Output: 250 Volts, 5 amp. 500 cycles. Rebuilt. Price ..... \$88.88

**HOLTZER-CABOT HIGH FREQUENCY MG SETS.** Compact 2 bearing units with input of 120 VDC. 7 amps. Output: 120 Volts, 3 $\phi$  320 Cycles. Has shaft extension permitting use as dual generator. Price ..... \$112.90

**WESTINGHOUSE HIGH FREQUENCY UNITS.** Operate with input of 115 VDC to deliver 17 VAC, 1050 to 1650 cycles. An excellent value..... \$25.50

**ESCO DUAL FREQUENCY UNITS.** Motor operates at 120 VDC. 10 amperes. Delivers 70 Volts at 120 Cycles or 200 Volts at 720 Cycles. Price..... \$95.00

**ESCO 500 CYCLE UNITS.** Operate at 100 VDC and deliver 110 VAC 1.38 amp. 150 VA. 500 C.P.S. Price ..... \$25.00

**WESTINGHOUSE 180 CYCLE ALTERNATORS.** 750 V.A. Output: 110 Volts, 3 Phase, 180 C.P.S. 3000 R.P.M. Separately excited at 110 VDC. Price.....\$44.00

Also available with built-in exciter. Price.....\$78.00

**GENERAL ELECTRIC HIGH FREQUENCY UNIT.** Operating at 440-3-60. 75 amp. Output: 70 Volts, 3 ph. 148 cye. 220 Watts, 1.5 amperes. An ideal unit for experimental work or for operation of equipment. SPECIAL PRICE ..... \$34.50

**GE HIGH FREQUENCY MG SETS.** Motor: 250 VDC. 4 amp. Alternator: 600 watts, 125 single ph. 4.8 amp. 500 cycles. Brand new. Price..... \$90.00

**BENDIX-ECLIPSE 800 CYCLE AERO UNIT.** Input: 24-28 VDC. 75 amps. Output: 115 V. 10.5 Amp. 800 C.P.S. Complete filter system mounted thereon. Price ..... \$22.50

**CROCKER-WHEELER 500 CYCLE SET.** Operate at 110 Volts, D.C. 20.8 Ampers. Output: 120 Volts, single ph. 500 cycles 2.5 KW. Price..... \$146.95

**WESTINGHOUSE HIGH FREQUENCY UNITS.** Input: 115 Volts, D.C. 2.7 Amps. Output: 14.4 Volts, 139 Amp. 450-2550 Cycles. Frequency variation is obtained with built-in controller on end of unit. Price ..... \$48.50

**GE DUAL OUTPUT MG SETS.** Consist of Motor rated 3 H.P. 220-440 V. 3 $\phi$ , 60 Cy. directly coupled to 2 generators. Output: 5 KW. 220 Volts, 2.27 Amp. 525 Cycles. Also .5 K.W. 110 Volts, D.C. 4.55 Amp. 3 separate units mounted on common bed plate. Price ..... \$150.00

**ONAN 2 BEARING MG UNITS.** Motor: 115/230 Volts, single phase, 60 cy. Generator: .6 KVA 115 Volts, 5.3 Amps. 480 C.P.S. Price.....\$165.00

**ESCO HV-HF UNITS.** Operative at 11.5 VDC 28 Amp. Output: 575 VDC. .25 Amp. also 55 VAC. .91 Amp. 1 $\phi$ , 500 Cycles. Price..... \$39.75

**ONAN 800 CYCLE ALTERNATORS.** Brand New. Mounted on base with guard for V Belts. Alternator is self-excited. Rated at 1.5 KVA, 115 Volts, single ph. 800 Cye. 2866 RPM. Also output of 28.5 VDC 17.5 Amp. 500 Watts. Price.....\$199.00

**GENERAL ELECTRIC 400 CYCLE UNITS.** Operate at 27 VDC 100 Amp Output: 115 VAC 1 $\phi$ , 400 CPS. 1500 V.A. With filter system built-in. Price..... \$29.50

**HOLTZER-CABOT 500 CYCLE MG SET.** Motor: 110 VDC GENERATOR: 5 KVA. 230 VAC, 1 $\phi$ , 500 Cye. Rebuilt. Price ..... \$271.50

**MARCONI MG UNITS.** Operative at 110 VDC to deliver 500 VAC, 8 Amp. 3 K.W. 240 CYCLES. Extending shaft permits driving complete unit to obtain dual self-excited generator. Price..... \$99.00

**LOUIS ALLIS FREQUENCY CHANGER SETS.** We have 3 sizes in stock, all brand new. (1) Pri: 220/440-3-60; Sec: 30 K.W. 208 Volts, 2 Ph. 500 Cye. .8 P.F. Units are belted on common bed plate. Price ..... \$1250.00

(2) Pri: 25 H.P. 220/440-3-60; Sec: 15/10.8 K.W. 3300/2200 RPM. 306/220 Volts 35/35 Amps. 2 ph. 500/360 C.P.S. Price ..... \$1050.00

(3) Pri: 1 H.P. 220/440-3-60; Sec: 7.5 K.W. 440/220 V. 17/8.5 Amp. 3000/1200 RPM. 360/180 Cycles, 2 ph. Price ..... \$750.00

We can supply these units for 400 cycle output and with transformers to supply 3 phase, wye output. Write for further information.

**ECLIPSE 800 CYCLE GENERATORS.** Flange mounting with spline shaft. Output is 115 VAC 10.4 Amp. 90% P.F. 800 Cycles, 1200 V.A. with secondary output of 28.5 VDC. 60 Amperes. Self excited. Price ..... \$39.00

**BRITISH MADE 500 CYCLE MG SETS.** Motor: 230 Volts, 3 PH.—50 Cycles, XX-Alternator: 5 K.W. 180 Volts. 27.8 Amp. 500 Cycles, Excitation—110 VDC When used at 60 Cycle current. Output is 600 cycles 220 Volts. Price ..... \$353.00

**WINCHARGER PU-7/AP.** Input: 28 VDC, 160 Amps. Output: 115 VAC, single ph. 2500 VA. 400 C.P.S. Frequency and Voltage regulation built-in. Price ..... \$87.00

**HOMELITE 400 CYCLE POWER PLANTS.** PU-6/tps-1 Single cylinder engine, air-cooled governed to operate at 4000 RPM. Generator rated at 1400 Watts, 120 Volts 400 Cycles also secondary output of 27 VDC, 400 watts. Brand new in original cases with instruction book, and complete spare parts. An exceptional unit to procure 400 cycle current or to be used as a lighting plant. Price ..... \$150.00

### HERE IS EXCEPTIONAL VALUE

Robins and Myers Motor Generator Units. Operate at 110 Volts, AC, single phase, 60 cye. and deliver 32/40 Volts, DC. Can be used with field rheostat to supply 24/28 VDC for the operation of aero equipment from lighting line. Rated at 40 watts but will deliver 200 watts for intermittent operation. Gear head built into one end rotates external shaft at 225 RPM. An exceptional value at \$18.75 each. With field rheostat \$20.00. Also available for operation at 115 VDC at \$12.50 and with rheostat at \$13.75 each. Both units have 1/4 HP Motor. Stock up on these sets while they are available. Special price on quantity. Rebuilt.

**CENTURY MOTOR GENERATOR SETS**  
7.5 KVA: 230 Volts, DC to 115 Volts, AC, single phase, 60 Cycles. Complete with automatic controller and push button station ..... \$445.00

**ALLIS-CHALMERS MOTOR GENERATOR**  
Input: 115 VDC at 1 amp. 3600 RPM. Ball Bearings. Output: 1.25 KVA; 80% PF 120 Volts, AC, 1 Ph. 60 cye. 10.4 amp. Centrifugal automatic controller permits line start operation. Fully enclosed. Brand New \$99.95. Also available for 230 VDC operation at the same price.

**GENERAL ELECTRIC DC/AC MG SETS**  
Four Bearing Marine Units: 25 HP 230 Volts, DC coupled to alternator 18.75 KVA; 80% PF; 1800 RPM Output: 115 Volts, AC, Single Ph. 60 cycles. Ball Bearings. 4 bearing set; marine duty. Brand New. \$545.00

**ESCO DC/AC MG SETS.** Motor: 115 Volts, 1 1/2 HP line start; built in voltage regulator, frequency control, filtered; ideal for television, radar or any application requiring constant voltage and frequency. Output: 115 V.A.C. 1 $\phi$ , 60 Cye. 460 V.A. Brand New.....\$120.00

### JANETTE ROTARY CONVERTERS

110 VA. Input: 110 VDC; Output: 110 VAC, single phase, 60 cycles; 3600 speed. With filter for elimination of radio interference. Reliably rebuilt. Special Price ..... \$19.95



**INDUCTION VOLTAGE REGULATOR**  
Type IRT, form M. 1.64 KVA, 3 phase, 60 cycles, cont. duty. Outdoor service. Primary: 208 V., 10.5 load amps. Oil-filled. Wgt. 365 lbs. 33 x 17" x 14".....\$90.00



**G. E. MOTOR CONTROLLED VOLTAGE REGULATOR**  
Cat. #83725, Type "Tirs", Form — 568 KVA, cont. duty, 60 cy., Primary volts 115. Load Amps 16.2 Indoor service. Voltage controlled by mtr. 120/160/140 HP..... \$39.50  
Send for list of other sizes in stock.



Westinghouse Transformer Controller contains 300 watts 120-220 volt transformer with multi-taps. The transformer with tap switch alone is worth more than the special price.....\$7.50



## GEN. ELECTRIC AMPLIDYNES

Model 5AM73AB89: Input: 115 VAC, 1 $\phi$ , 60 cye. 9 amp. Output: 375 K. W. 250 VDC. 1.5 amp ..... \$86.00

Model 5AM65FB2A: Input: 115 VAC, 3 $\phi$ , 60 cye. 5 amp. Output: 500 watts, 250 Volts, 2 Amp.....\$144.00

Model 5AM73AB62: Input: 115/230 VAC 6.2/3.1 Amp. 60 cye. Output: 250 watts, 125 volts, 2 amp..... \$65.00

Model 5AM78AB10: Input 32 VDC, 60 amp 2 H.P. 2200 RPM; Output: 250 Volts, D.C. 3 amperes; 750 Watts ..... \$190.00

## PINCOR ROTARY CONVERTERS

300 VA; Filtered; Brand New. Input: 115 VDC. 4.2 Amp. Output: 220 VAC, 1.36 Amp. SPECIAL PRICE ..... \$38.00

**IDEAL AC/DC M-G UNIT.** 110 V, 1 $\phi$ , 60 cy. unit. 110 VDC 2.28 amp. 25 KW output. 2 bearing unit thoroughly rebuilt and guaranteed. With rheostat. Price ..... \$55.00

**GE DC Generators.** Consists of three separate generators in one unit. 1.300 RPM. Delivers: 1200 V., 450 V., 25 a. and 115 V. 1.3 amp. Price.....\$24.90

**British Alternators.** 1.5 KVA., 230 Volts, 1 $\phi$ , 400 C.P.S. sep. exc. Price ..... \$115.00

**Crompton-Parkinson Alternators.** 3 KVA. .7 PF. 110 VAC, 1 $\phi$ , 60 cy. 1800 RPM. sep. exc. Price.....\$170.00

British made DC/AC MG Sets. Operative at 110 VDC to deliver 220 VAC, 50 cye. 200 watts. Can be used with rheostat to deliver 60 cye. BB. Price.....\$36.75

Normand High Freq. Units. Operative at 220 VDC 8.8 amp. 2 HP. delivers 1200 watts, 1400 to 2800 cycles. Exc. 24 Volts. Price.....\$70.00

Westinghouse Amplidyne Type Units. Consists of Motor rated 1.5 HP operative at 220-3-60 with shunt wound generator having output of 250 VDC. 2 amp. sep. exc. 35 V. and control shunt wound gen. with output of 35 KW., 125 VDC., 2.8 amp. Fields have center tap permitting "amplidyne" operation. Price.....\$183.00

DC Manual Controllers. mfg. by Marconi Co. of England. Enc. type. For starting duty of 24 VDC Motors. rated at .7 HP. A really hard-to-get unit at a giveaway price. SPECIAL ..... \$4.90

Selenium Rectifiers. Full wave bridge type. Input: 15 VAC. Output: 12 VDC, 4 amp. Consists of 4 plates about 4" dia. Price.....\$4.00

GE DC Generators. Type SD. Sh. wdg. .5 KW. 18 VDC, 27.8 amp. 1725 RPM. Price.....\$30.00

Wathour Meters. 110/110 Volt DC operation. Used but in A1 condition. 5 amp. .3-75 10 amp. .4-35 15 amp. .5-50. 25 amp. .5-60. Price.....\$6.00

**G. E. Motor Starting Reactors** Type 11K2840G2: Rated at 440V, 3 Ph. 60 Cy. 16.8 Amp. Only a 3 Pole Double Throw switch is necessary with this unit to make a 15-20 HP compensator starter. Useful for any purpose requiring three phase choke. SPECIAL PRICE ..... \$16.00

Esco AC Motors; built-in magnetic brake for quick reversing. Double shaft, ball bearings. Rated: 3 1/2 HP—30 minutes, marine duty: 410-3-60. Brand new in original cases. SPECIAL PRICE ..... \$34.00

## ESCO DC/DC MG SET

Operate at 220 Volts, DC to deliver 110 Volts, 3.5 amperes. Two of these units, can be used on 220 VDC to obtain 110-0-110 Volts DC. Special Price ..... \$17.50



General Electric Synchronous Motor or Alternator; excitation 2 Volts; operating at or delivering 110 volts, 3 phase, 60 cycles at 1800 speed; no name plate, but lab tests determined specs as above..... \$9.95



**ESCO CONVERTERS**  
Rebuilt like new. Input: 86 VDC 2.85 amp. 3600 R.P.M. Output: 115 VAC, 2.18 amp. .50 P.F. Ball Bearings. Base for table or side mounting. Special ..... \$9.80

IF IT'S FROM ONE FREQUENCY TO ANOTHER; FROM DC TO AC OR AC TO DC,  
IF IT'S FROM ONE VOLTAGE TO ANOTHER, THEN CALL ON US.

**Established in 1922** **WILLIAM I. HORLICK COMPANY** **Tel. HANcock 6-2480**  
**409 ATLANTIC AVE.** **BOSTON 10, MASSACHUSETTS**



# TEST EQUIPMENT

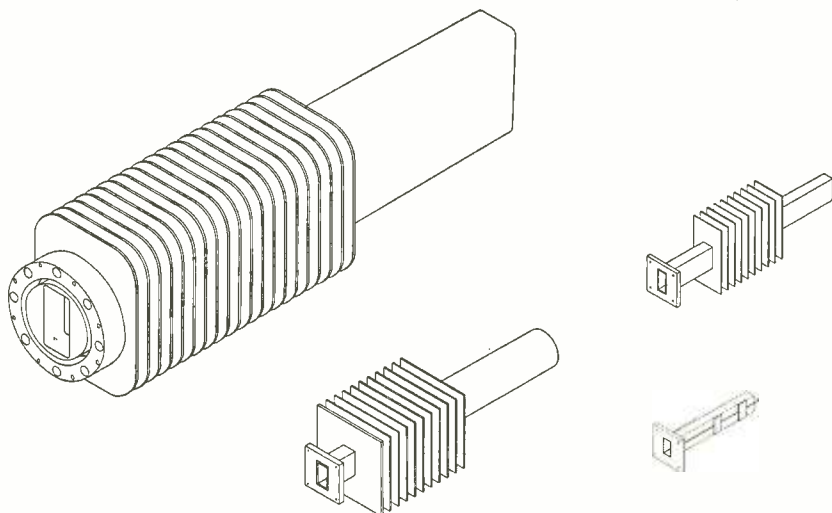

**HI POWER X BAND TEST LOAD**, dissipates 350 watts of average power for  $\frac{5}{8}$ " x  $1\frac{1}{4}$ " waveguide, VSWR less than 1.15 bet. 7 and 10 KMC.....\$150.00

**S Band Test Load TPS-55P/BT**, 50 ohms \$12.00

**HI POWER S BAND TEST LOAD**, dissipates 1000 watts of average power, for  $1\frac{1}{2}$ " x 3" waveguide. Range 2500 to 3700 MC.

**X Band Pick-up Horn, AT-48/UP** with coaxial fitting .....\$10.00

**TS-62 X Band Echo Box** with r.f. cable and pick-up antenna.

**TS-33 X Band Frequency Meter**, 8500-9600 Mcs. Crystal detector and 50 micro-amp. meter. Indicates Resonance. Connection for scope available.

**TS-45A-APM-3 Signal Generator**, 8700-9500 mc., 110 V. 60-800 cps.

**30 MC I.F. STRIP, VIDEO, and AUDIO AMPLIFIER AND 110 Volt 60-2600 cps POWER SUPPLY**. Bandwidth 10 mc; new, part of SPR-2 Receiver.

**AMPLIFIER STRIP AM-SSA/SPR-2** contains I.F. amplifier, detector, video amplifier, pulse stretcher and audio amplifier and Rectifier Power Unit PP-155A/SPR-2 bandwidth 10 mc, center frequency 30 mc, sensitivity 50 microvolts for 10 milliwatts output. Power supply 80/115 V ac, 60-2600 cps 1.3 amps. Send for schematic...\$65.00 less tubes

**S Band Signal Generator Cavity With Cut-Off Attenuator**, 2300-2950 mc., 2C40 tube, with modulator chassis....\$30.00

**UPN-1 S Band Beacon Receiver-Transmitter** .....\$75.00

**TS-155 S BAND SIGNAL GENERATOR and Power Meter**.

**S-Band Mixer**, tunable by means of slider, type N connector for the R.F. and local oscillator input, U.H.F. connector for the I.F. output, variable oscillator injection. \$30.00

**S Band Crystal Mixer**, variable oscillator injection, illustrated .....\$17.50

**TS-110 S Band Echo Box** 2400-2700 mc. portable .....\$110.00

**X Band Thermistor Mounts**, VSWR less than 1.4 8500-9600 MC Fixed triple tuned,  $\frac{1}{2}$ " x 1" waveguide....\$40.00  
Fixed triple tuned  $\frac{5}{8}$ " x  $1\frac{1}{4}$ " waveguide \$50.00

**X Band Crystal Mount**,  $\frac{1}{2}$ "x1" waveguide \$25.00

**UG80/U  $\frac{1}{2}$ "x1" to  $\frac{5}{8}$ "x1 $\frac{1}{4}$ " adapter**, \$5.00

**ESTERLINE Angus recording Milliammeter** 60 cycles, 110V. AC 1 ma full scale. \$160.00

**TS-89 Voltage Divider** for measuring high video pulses, ratios 1:10 and 1:100 transmission flat within 2 db 150 c.p.s. to 5 mc., with cable for attaching to synchroscope .....\$30.00

**Waveguide Below Cut-off Attenuator L 101-A U.H.F. Connectors** at each end calibration 30-100 db .....\$15.00

**HYPERSIL CORE CHOKE**, 1 Henry. Westinghouse L-422031 or L 422-32....\$3.00

**PULSE INPUT TRANSFORMER**, permalloy core, 50 to 4000 kc., WE-161310, impedance ratio 120 to 2350 ohms..\$3.00

**X Band attenuator**,  $1\frac{1}{4}$ "x $\frac{5}{8}$ " guide, single guillotine type, 0-30 db, V.S.W.R. 1.2 maximum, calibrated .....\$85.00

**High Voltage motor operated switch**, 18 KV., 5 Amps peak, Schweitzer-Conrad No. QA-35582 .....\$50.00

## REAL VALUES!

### CABINET CH-118

Olive drab in color, this cabinet has a full length interlock access door on the rear. The front takes the standard 19" panels with 60 inches of height and 20 inches deep. It is shock mounted on a heavy steel platform and has a two-inch protrusion fully covering one side to accommodate wave trap and wiring. Louvered vents allow air circulation top and bottom. Each F.O.B. Chicago \$34.50

### RA 52—RECTIFIER

A transtat controlled rectifier to produce high voltage DC from 110 VAC 60 cycle source. Up to 11,500 volts DC at 50 watts. Metered high voltage (0-15KV) and current (0-20 MA). New \$74.50

### BC 768

Radio Receiver Chassis Complete except for 13 tubes. This chassis with standard 19" panel front contains the receiver for 493.5 MC complete with power supply and an additional low voltage power supply that originally supplied the keyer BC 770 as described below. 110 VAC 60 cycles is the primary voltage.

Five 10 mfd-600 VDC oil filled GE condensers are used as filters. Five stages of 49 MC TF's Two of 10.4 MC, 6.3 VAC Transformer and of course power transformers—chokes and miscellaneous parts. All units are in good condition as removed from new equipment. Even the salvage value is a great deal more than the low price of .....\$9.95

### BC 770 KEYS P/O RC 100 RADAR EQUIPMENT

This unit was used to pulse the transmitter BC 769 as described below. It is in a standard 19" panel chassis and contains many valuable parts such as a 10 Amp, 110 VAC 60 cycle circuit breaker, a 10 mfd 600 VDC oil condenser, a 6.3 Filament transformer, switches, pots, resistors and numerous others. Less tubes.....\$4.95

### BC 769 TRANSMITTER

Originally designed to transmit RF pulses at 470 MC with the use of two 16E tubes. Power was supplied by RA 52 rectifier. Parts consist of 0-150 VAC 60 cycle meter, 6.3 VAC filament transformer, associated circuits for VHF transmission, standard 19" panel chassis, and a .15 Mfd-12000 VTC oil condenser. Less Tubes .....\$6.95

### MISCELLANEOUS SPECIALS!

	Used	New
RA 10 DA Receiver	\$17.50	\$24.95
ET/APN1 Transceiver		14.95
BC 347 Interphone Amplifier		2.95
BC 442 Less Condenser	Used \$1.49	1.95
APS 13 UHF Antenna, Pair		.99
FL 8 Filter		2.95
I-97 Bias Meter	Used \$3.95	4.95
TL 42 Antenna Gearbox Motor and Reel	Used \$4.95	\$7.50
AN ARC-5 VHF Transmitter (T-23/ARC5)		29.95
One Tube Interphone Amplifier—Small compact aluminum case fully enclosed $2\frac{1}{2}$ " x $3\frac{3}{4}$ " x $5\frac{3}{4}$ ". Less Tube		.79
40 Amps Circuit Breaker		.59
220 M.A. Circuit Breaker		.59
Collins VFO Dial—5 calibrated ham bands from 3.2 Mc to 32 Mc; complete with pointer, gears, logging dial and flywheel. Scale 6" on 8" plate, each		.95
C-18 Antenna coil assembly slug tuned used in BC 603 receiver. Frequency range 20-27.9 Mc—fully shielded. New for 10" L 82 F Five Inch 360 degree compass indicator and Selsyn receiver		4.95
A-81 Transmitters Selsyn for 182 indicator		2.45
(Both 182P & Tons. Selsyn for \$7.00)		
T 23/ARC5 Brand new Transmitter for VHF		29.95

### CATHODE RAY TUBES

3FP7	\$1.95	5BP4	3.95	5GP1	3.95
4AP10	1.95	5FP7	1.95		

### SCR 625 FAMOUS ARMY MINE-DETECTOR

for prospectors—miners—oil companies—plumbers—etc.,—etc.,—etc.

This unit is being offered now at a considerable reduction in price. Recently advertised at \$79.50 it is now available in the same brand new wrappings in suitcase style carrying case (less batteries) at \$59.50

WHILE THEY LAST



Shipments FOB warehouse. 20% Deposit on orders. Minimum order \$5.00. Illinois residents, add regular sales tax to remittance. Prices subject to change without notice.

## ARROW SALES, Inc.

Dept 16  
1712-14 S. Michigan Ave., Chicago 16, Ill.  
PHONE: HARRISON 7-9374

## ELECTRO IMPULSE LABORATORY

62 White Street Red Bank 6-0404 Red Bank, N. J.



# TEST EQUIPMENT! Complete Line!

- DUMONT 224-A OSCILLOSCOPE  
 TS-36/AP                      TS-102A/AP  
 TS-108                         TS-184A/AP  
 1-77 HICKOK TUBE CHECKER  
 UPM-1 COMPLETE    TS-250/APN  
 BC-221 FREQUENCY METER  
 RPC MODEL 644 MULTIMETER  
 FERRIS MICROVOLTER MOD. 188  
 TS-111/CP                    I-212  
 TS-117/GP                   TS-5/AP  
 TS-3/AP                      TS-19/APQ-5  
 TS-100/AP                   TS-61/AP  
 TS-170/ARN-5              TS-10B/APN  
 TS-182/UP                   TS-15A/AP  
 TS-127/U                    TS-268/U

## TELEVISION CAMERA

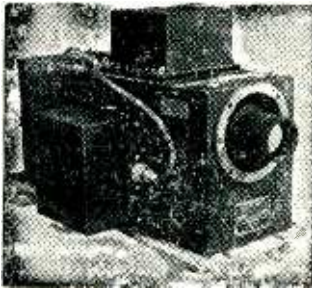

3350 line resolution. Easily converted to present RMA standards. Circuits available with camera. Complete, like new.

JEFFERSON-TRAVIS Model 52  
 5 W. MARINE RADIOTELEPHONE

RC-184 IFF EQUIPMENT  
 BRAND NEW, COMPLETE  
 SCR-584 PARTS

APS-4 RADAR COMPLETE

APS-6 RADAR COMPLETE  
 MARK 16 RADAR COMPLETE

MG19A NEW                    U/16/U PLUGS

MK20A/UP, NEW, INDIVIDUALLY  
 BOXED

BC-1100-A TRANSMITTER  
 WITH REMOTE CONTROL. 125 W.  
 115 VDC OR AC.

WE WANT THIS EQUIPMENT:

- BC-348                         ART-13  
 BC-611                         ARC-1  
 RTA-1B                         ARC-3  
 BC-1000                        R5A/ARN7

## COLUMBIA ELECTRONICS LTD.

524 S. SAN PEDRO ST.  
 LOS ANGELES 13, CALIF.

11816 VENTURA BLVD.  
 N. HOLLYWOOD, CALIF.

Cable Address: COELECT

All items subject to prior sale

# BRAND NEW U. S. GOV'T. SURPLUS GUARANTEED

## POWER RHEOSTATS



Ohms watt	ea.	Ohms watt	ea.
.5	25	1.98	225
.5	50	2.81	250
.5	150	5.93	250
1	50	2.81	300
2	50	2.81	300
2	100	4.68	350
2	225	6.59	350
2	300	8.42	370
3	100	4.67	378
3	225	6.58	400
3x3	300	29.95	400
4	225	6.60	500
5	25	1.97	500
5	100	4.68	500
6	25	2.23	100
6	75	3.90	500
7	25	1.98	585
8	50	2.53	750
10	25	2.23	750
10	100	4.27	1000
12	25	2.23	1000
12	50	2.53	1200
15	25	1.98	1250
15	75	3.90	1250
15	100	4.38	1500
20	50	2.53	1500
25	25	2.23	1500
25	50	2.53	2000
50	50	2.53	2000
60	25	1.98	2250
75	25	1.98	2500
75	100	4.39	2500
80	50	2.53	2500
80	500	12.46	3000
100	25	1.98	3000
100	100	4.39	5000
125	25	2.53	5000
125	500	12.46	7500
150	50	2.53	7500
175	25	2.53	10000
185	25	1.98	10000
200	25	1.98	15000
200	100	4.27	20000

Specify whether shaft required for knob or screwdriver adjust.

## OIL CONDENSERS



Mfd. Voltages Avail.

.1	3-8-20K
.25	2-3-31-4-5K
.5	600-1-3K
1	600-1-11-2-5-6
2	400-600-1-1-1-2
4	600-700-1-1K
6	400-600-1-2K
8	600
10	600-2K
15	600-1K
30	90-vac, 3-ph
100	230-vac, 3-ph
500	
3x8	600
4x3	600
4x8	600
3x10	90-vac

Special Prices on Request

## BATHTUBS



Mfd. Voltages Avail.

.033	400
.1	2-4-600
.15	4-6-1K
.25	2-4-600
.35	400
.75	4-6-1K
1	600
2	1-2-4-6-1K
4	4-600
8	500
25	25-50-75
40	25
50	25
100	15
200	12
300	
2x.01	2-400
2x.02	6-1500
2x.045	600
.046x.055	600
.2x.05	6-1500
.1x.05	200
.1x.5	400x50
2x.1	4-600
2x.16	600
2x.2	600
2x.25	4-600
3x.5	500
2x.5	4-600
1x.05	500
1x.1	300
1x.5	200
2x1	600
2x10	25
2x200	9
3x.001	600
3x.05	600
3x.1	4-600
3x.25	4-600
3x.5	100-600
.015x.03x.045x.06x.12/600	

Also available CHAN-NEl Types. Special Prices on request.

## SELECTOR SWITCHES

Pole	Pos.	Deck	Type	Each
1	11	1	Bak-n/shtg	.60
1	21	3	Bak-n/shtg	.60
2	2	1	Cer-shtg	.50
2	6	2	Bak-n/shtg	.60
2	11	2	Bak-shtg	.75
3	4	2	Bak-n/shtg	.58
5	8	2	Cer-n/shtg	.98
6	11	6	Bak-n/shtg	1.95
10	5	6	Cer-shtg	2.25
16	2	4	Bak-n/shtg	1.35

(Many other types in stock)

## "AN" CONNECTORS



Large Variety Available At Great Savings  
 Send your specs and let us quote

## BIRTCHEr TUBE CLAMPS

#924-A	#928-B22
#924-A1	#928-C
#924-A14	#926-C1
#924-B	#926-C5
#924-B1	#926-C10
#924-B7	#926-C24

35c.



### MICROSWITCHES

A-#Y2-RS13 SPST "S" plunger, metal housing norm. op. .... .59  
 B-#B-RS10 SPDT type "S" plunger, 2-circuits: one op and one cl. .... .59  
 #WZ-RL8 (not illus.) SPST leaf actuator, norm. cl. .... .59  
 #R-RL2T (not illus.) SPST 10x125 vac roller plunger, norm. closed. .... .59  
 C.G.E. SWITCHETTE 10a/115voltsAC  
 #CR1070-C103A3 SPST closed .... .59  
 #CR1070-C103E3 SPST open .... .59  
 #CR1070-C103R3 SPST closed .... .59  
 #CR1070-C123C3 DPST op/cl. .... .59  
 (Many other types in stock)

## SHOCKMOUNTS



100P-1	1 lb.	.15
100P2	2 lb.	.15
100PR-2	2 lb.	.15
100P-3	3 lb.	.15
100P-6	6 lb.	.20
150P-4	4 lb.	.20
150PH-8	8 lb.	.45
150PH-15	15 lb.	.49
150P-6	6 lb.	.25
200PD-15	15 lb.	.59
200PHN-35	35 lb.	.75
204P-112	112 lb.	.98

## TERMINAL BOARDS

5 terminal	.98
8 terminal	1.67
12 terminal	2.49

## HUNDREDS OF OTHER ITEMS AVAILABLE

Open a/c to Rated Concerns. Prices net FOB our wise NYS and subject to change without notice

## POTENTIOMETERS

TYPE "J" \$1.50		TYPE "JJ" \$2.50	
ohms	ohms	ohms	ohms
50*	250*	100K*	500-500*
65*	400*	100K*	600-600*
200†	5000†	125K*	1500-1500†
300†	10K*	200K*	2000-2000*
400*†	15K*	250K*	2000-50K*
500†	20K*	250K*	2200-24K*
600*†	25K*	500K*	20K-2000†
750†	30K*	1meg*	25K-10K†
1000*†	50K*	1meg*	35K-5000†
1500*†	80K*	2meg*	50K-50K*
2000*†		2meg*	100K-100K*

TYPE "JJJ" .4.95

ohms	ohms
20K-200K-20K†	750K-750K-750K†
45K-27K-250†	800K-800K-800K†
700K-700K-700K†	1meg-1meg-1meg†

\* 1/8" screwdriver slotted shaft.  
 † Knob type shaft.

## TRANS-MITTING MICAS

mfd.	wv	type	ea.	mfd.	wv	type	ea.
.00001	600	4	.36	.0015	600	4	.36
.00003	600	4	.36	.00162	600	4	.42
.00005	600	4	.29	.002	600	4	.39
.00005	2500	9	.57	.002	1200	4	.72
.0001	600	4	.29	.0025	600	4	.39
.0001	2500	9	.57	.003	600	4	.45
.00015	600	4	.36	.004	600	4	.45
.0002	600	4	.29	.005	1200	9	.99
.00025	600	4	.29	.0047	600	4	.47
.0005	600	4	.29	.005	2500	9	1.86
.0005	2500	4	.75	.006	600	4	.54
.0005	2500	9	.77	.01	600	4	.65
.0006	2500	9	.85	.01	1200	9	1.41
.0007	600	4	.36	.02	600	4	.92
.00075	600	4	.36	.02	1250	9	2.12
.0008	600	4	.36	.025	600	4	1.08
.0009	600	4	.36	.03	300	4	.99
.001	600	4	.36	.03	600	4	1.34
.001	1200	9	.54	.043	600	4	1.75
.001	1200	9	.57	.05	300	4	1.19

(Many other sizes in stock)

## "UG" and "UHF" CONNECTORS

UG-9/U	UG-25/U	83-1AP
UG-10/U	UG-27/U	83-1RTY
UG-12/U	UG-27/AU	83-1SP
UG-14/U	UG-57/U	83-1R
UG-15/U	UG-58/U	83-1D
UG-16/U	UG-88/U	83-1SPN
UG-18/U	UG-123/U	83-22SP
UG-19/U	UG-124/U	83-2SP
UG-20/U	UG-260/U	83-2R
UG-21/U	UG-290/U	83-2SP
UG-21B/U	83-1AC	
UG-22/U	83-1F	
UG-24/U	83-1J	

PRICES QUOTED ON REQUEST!

## Jones Connectors

P-101-1/4	.25	2-140-Y	.13
P-101-1/2	.30	6-140-Y	.33
S-108-D-MOD	.13	10-140-3/4W	.53
S-304-CCT	.25	10-240	.38
P-306-AB	.16	18-240	.66
P-306-CCT-L	.33	4-141-W	.30
S-306-FHT	.24	4-141-3/4W	.30
S-308-AB	.21	7-141-Y	.49
P-312-AB	.24	12-141-Y	.82
P-312-CCT-L	.42	13-141-Y	.89
P-315-FHT	.40	15-141-Y	1.02
P-315-EB	.30	2-142-Y	.20
P-315-CCE	.40	4-142-Y	.38
S-315-AB	.36	8-142	.48
S-318-AB	.43	3-150	.53
P-324-FHT	.74	4-150-Y	.83
P-324-EB	.58	4-151	1.30
S-330-AB	.84	5-151	1.60
S-404-AB	.33	4-152	1.89
P-406-AB	.33	2002	.04
S-406-CCT	.58	2008	.07
S-408-CCT	.68	8-54	.22
S-2408-SB	.53	8-6	.18
P-2412-SB	.61		
P-2412-CCE	.87		
S-502-D-B	2.55		
P-508-CE	3.04		
P-510-CE	3.52		
P-512-CE			

Many other types in stock

## MALLORY PUSH SWITCH

#2001	S.P., make cont., non-L.	.45
#2003	S.P.D.T., non-lock	.48
#2004	S.P.D.T., non-lock	.48
#2004	D.P., make 2 non-L.	.55
#2004L	D.P., make 2 lock	.55
#2006	D.P.D.T., non-lock	.65

# ALEXANDER MOGULL CO., INC.

161 Washington St., N. Y. 6, N. Y.                      WOrth 4-0865

# BRAND NEW - GUARANTEED - SURPLUS - TYPE N.A.F. AMMETERS & VOLTMETERS

REPLACEMENT AND SPARES FOR EXISTING AIRCRAFT

## N.A.F.-1091 AMMETERS

C-30..... R-17-A-5720	30 Amp are with internal shunt, all higher ranges require external shunt		
C-30..... R-17-A-5720	30 Amp Westinghouse AX	C-120..... C-17-A-5730	120 Amp Weston 606—T224 P
D-30..... R-17-A-5740	30 Amp Weston 606—T202 P	C-120..... R-17-A-5730	120 Amp Westinghouse AX
D-30..... R-17-A-5740	30-0-30 Amp General Electric DW-53	D-120..... R-17-A-5765	120-0-120 Amp Westinghouse AX
C-60..... R-17-A-5725	30-0-30 Amp Weston 606—T203 P	C-240..... R-17-A-5735	240 Amp Weston 606 T223 P
C-60..... R-17-A-5725	60 Amp General Electric DW-53	C-240..... R-17-A-5735	240 Amp General Electric DW-53
C-60..... R-17-A-5725	60 Amp Weston 606—T205 P	C-240..... R-17-A-5735	240 Amp Sutton-Horsley
D-60..... R-17-A-5745	60 Amp Westinghouse AX	C-240..... R-17-A-5735	240 Amp Westinghouse AX
D-60..... R-17-A-5745	60-0-60 Amp Westinghouse AX	D-240..... R-17-A-5735	240-0-240 Amp General Electric DW-53
D-60..... R-17-A-5745	60-0-60 Amp Weston 606—T208 P		

## N.A.F.-1091 VOLT-AMMETERS

all are 30 Volt and require external shunt, \* Requires AN Connector  
A-30..... R-17-V-770 30 Amp Weston 606—T201 P  
B-60..... 60 Amp General Electric DW-53 \*

## N.A.F.-1091 VOLTMETERS

E-30..... R-17-V-880 30 Volt General Electric DW-53  
E-30..... R-17-V-880..... 30 Volt Westinghouse AX

## OTHER AIRCRAFT INSTRUMENTS

D-2 Ammeter R-17-A-6739	20-0-100 Amp Hickok	Voltmeter 400 cycle	40 Volt Weston 517
D-2 Ammeter R-17-A-6739	20-0-100 Amp Weston 506	Voltmeter 400 cycle	40 Volt Westinghouse NA-33
F-1 Ammeter Spec. 94-32284	150 Amp Westinghouse	Fuel Flow Indicator	Breeze per AB-1 270 Degrees Weston 545—81
E-1 Ammeter Spec. 94-32173-A	300 Amp Westinghouse		

**ONLY A PARTIAL LISTING  
OVER 75,000 METERS IN STOCK**  
AMMETERS VOLTMETERS  
MILLIAMMETERS  
MICROAMMETERS  
SPECIAL METERS  
A.C.—D.C.—R.F.

## TYPE N.A.F. AND OTHER SHUNTS

All are 50 M.V. Lightweight Aircraft Type

30 Amp.....	NAF—1091
50 Amp.....	MSA—500
60 Amp.....	NAF—1091
120 Amp.....	NAF—1091
150 Amp.....	Spec. 94-32204 (F-1)
200 Amp.....	MSB—201
240 Amp.....	NAF—1091
300 Amp.....	MSB—301 (E-1)

We specialize in electrical instruments. Over 75,000 meters in stock. Send for our latest circular showing our complete line of Surplus-New Guaranteed meters.

**MARITIME SWITCHBOARD  
INSTRUMENTS—ACCESSORIES**  
338 Canal St., N. Y. 13, N. Y.  
Worth 4-8217

Orders accepted from rated concerns, public institutions and agencies on open account, others please send 25% deposit, balance C.O.D. or check with order. All prices FOB our warehouse, N. Y. C.

# NEW YORK'S RADIO TUBE EXCHANGE

TYPE	PRICE	TYPE	PRICE	TYPE	PRICE	TYPE	PRICE	TYPE	PRICE
OA2.....	\$2.00	3C45.....	13.95	312A.....	3.95	721A.....	3.95	872A.....	3.95
OA3.....	1.50	3DP1/A.....	10.95	323A.....	25.00	722A.....	3.95	876.....	.90
OA4G.....	1.35	3E29.....	15.50	327A.....	3.95	723A/B.....	18.95	878.....	1.95
OB2.....	3.00	3N4.....	5.50	350A.....	7.95	724A.....	4.95	884.....	1.95
OC3.....	1.75	4A1.....	1.75	350B.....	5.95	724B.....	6.95	885.....	1.75
OD3.....	1.50	4C27.....	25.00	357A.....	27.50	725A.....	9.95	889R.....	199.50
OA.....	4.95	4C28.....	35.00	368AS.....	6.95	726A.....	6.95	913.....	12.95
OA.....	6.95	4J25.....	199.00	371B.....	1.95	726B.....	56.00	914.....	75.00
IB21A.....	2.75	4J26.....	199.00	385A.....	4.95	726C.....	69.00	931A.....	8.95
IB22.....	3.95	4J27.....	199.00	388A.....	2.95	728AY.....	27.00	954.....	.25
IB23.....	9.95	4J30.....	395.00	393A.....	8.95	730A.....	8.95	955.....	.55
IB24.....	17.95	4J31.....	99.00	394A.....	8.95	801A.....	1.00	956.....	.69
IB26.....	2.95	4J32.....	99.00	MX408U.....	.75	802.....	3.60	957.....	.19
IB27.....	19.50	4J33.....	99.00	417A.....	17.95	803.....	5.95	958A.....	.49
IB32.....	4.10	4J37.....	99.00	434A.....	6.95	805.....	5.95	959.....	.69
IB38.....	33.00	4J38.....	89.00	446A.....	1.95	807.....	1.69	975A.....	17.95
IB42.....	19.95	4J39.....	99.00	446B.....	2.95	808.....	4.95	991.....	.45
IB56.....	49.95	4J41.....	99.00	450TH.....	45.00	809.....	2.45	1280.....	1.95
IB60.....	69.95	4J52.....	350.00	450TL.....	45.00	810.....	11.00	1611.....	1.95
IN21.....	1.35	5B.....	2.95	464A.....	9.95	813.....	7.95	1613.....	1.08
IN21A.....	1.75	5BP4.....	4.95	471A.....	2.75	814.....	3.95	1616.....	2.95
IN21B.....	4.25	5CP1.....	4.95	527.....	15.00	815.....	5.25	1619.....	.89
IN22.....	1.75	5CP7A.....	15.50	5L50.....	22.50	816.....	1.45	1620.....	5.95
IN23.....	2.00	5D21.....	27.50	WL531.....	7.50	819.....	9.95	1622.....	2.75
IN23A.....	3.75	5J23.....	45.00	700.....	25.00	829A.....	11.95	1624.....	2.00
IN23B.....	7.00	5J29.....	19.95	701A.....	7.50	829B.....	15.95	1625.....	.45
IN27.....	5.00	5J2P1.....	27.50	703A.....	6.95	830B.....	11.50	1629.....	.69
IN48.....	1.00	5J2P2.....	17.50	705A.....	3.95	832.....	5.95	1851.....	1.95
IS21.....	6.95	5J2P4.....	27.50	706AY.....	48.50	832A.....	9.95	2051.....	1.80
2B22.....	4.95	5LP1.....	18.95	706CY.....	48.50	833A.....	49.95	8012.....	4.25
2B26.....	3.75	5R4WGY.....	3.75	707A.....	17.95	834.....	7.95	8013.....	2.95
2C34.....	.35	6C21.....	29.50	707B.....	27.00	836.....	4.95	8013A.....	5.95
2C39.....	32.00	6C6A.....	3.95	714AY.....	5.95	837.....	2.95	8014A.....	29.95
2C40.....	27.00	6G.....	7.95	715A.....	7.95	838.....	4.95	8020.....	3.50
2C43.....	27.00	7BP7.....	7.95	715B.....	15.00	845.....	5.95	8025.....	6.95
2C44.....	.90	7DP4.....	10.00	715C.....	25.00	849.....	52.50	9001.....	1.75
2D21.....	1.75	12AP4.....	55.00	717A.....	1.75	851.....	89.50	9002.....	1.50
2E22.....	3.75	15R.....	.95	718AY/EY.....	48.50	860.....	4.95	9003.....	1.75
2E30.....	2.75	NE16.....	.45	719A.....	29.50	861.....	39.50	9004.....	.75
2J26.....	27.95	FG17.....	6.95	720A/B/C/D/Y.....	95.00	866A.....	1.75	9005.....	1.90
2J27.....	29.95	RX21.....	3.95			869B.....	29.50	9006.....	.35
2J31.....	39.95	35T.....	4.95						
2J32.....	69.95	RK39.....	2.95						
2J36.....	105.00	VT52.....	.35						
2J38.....	17.95	RK72.....	1.95						
2J42.....	150.00	RK73.....	1.75						
2J49.....	109.00	100TH.....	9.00						
2J50.....	69.50	FG105.....	19.00						
2J61.....	75.00	F123A.....	8.95						
2J62.....	75.00	203A.....	8.95						
2K25.....	47.50	211.....	.75						
2K28.....	47.50	217C.....	18.00						
2K29.....	27.50	242C.....	10.00						
2K45.....	299.50	249C.....	4.95						
2V3G.....	2.10	250TL.....	19.95						
3R24.....	5.50	274B.....	3.00						
3C24.....	2.50	304TH.....	15.00						
EL3C.....	5.95	304TL.....	14.50						
3C22.....	72.00	307A.....	4.95						
3C24.....	2.50	310A.....	7.95						

**Test Equipment**  
Microwave K Band 24,000 MC.  
TSK1-SE Spectrum Analyzer  
K Band Flap Attenuator

**X Band**  
4X X Band Spectrum Analyzer  
TS 12 Unit 1 USWR Measuring Amplifier, 2 channel  
TS 12 Unit 2 Plumbing for above  
TS 83 X Band Power and Frequency Meter  
TS 35 X Band Pulsed Signal Generator  
TS 36 X Band Power Meter  
TS 45 Band Signal Generator  
TS 146 X Band Signal Generator  
TS 263 Navy Version of TS 146  
TS 62, TS 102, TS 168  
X Band Magic T Plumbing  
X Band Tunable Crystal Mounts  
TVN #3EV Bridge, Cyl 94

**S Band**  
4S S Band Spectrum Analyzer  
TS 102, TS 270  
TS 125, TS 155, TS 127  
RF 4 Electrically Tuned S Band Echo Box  
BC 1277/60ABQ S Band Pulsed Signal Generator  
PE 102 High Power S Band Signal Generator

**L Band**  
Hazeltine 1030 Signal Generator 145 to 235 Megacycles  
Measurements Corp. type 84 Standard Signal Generator  
TS 47, 40 to 400 MC Signal Generator  
TS 226, AN/UPM1

**Broadcast Wave Bands**  
162C Rider Channelizer  
Short Wave Adapter for 162C  
TS 174 Signal Generator

**Oscilloscopes**  
TS 239A Laviole APA10, APA28  
BC 1287A used in LZ sets TS 34 Oscilloscopes WE  
Supreme 564

**Audio Frequencies**  
RCA Audio Channelizer

**Other Test Equipment and Meters**  
TS 15/A Magnet Flux Meter  
General Radio V T Voltmeter 728A  
Calibrator WE 1-147  
General Radio 1000 cycles type 213  
Limit Bridges  
Boonton Standard Instructions  
Weston Meters types 430, 429, 741  
Model 40 Pyrometer  
Rawson, meters 0-10 Microampere 0-2 Millivolt

**RADAR Sets & Parts**  
APS 3—APS 4—R-111/APR5A

Minimum Order \$25.00

**This Month's Special**  
4C28..... \$35.00

**ATTENTION PURCHASING AGENTS AND BUSINESS MANAGERS**  
WE BUY—WE SELL—WE EXCHANGE—WILL PAY CASH FOR YOUR INVENTORY NO MATTER HOW SMALL OR LARGE.  
—TURN YOUR OVERSTOCKED ITEMS INTO CIRCULATION



PHONE WORTH 4-8262 135 LIBERTY ST., NEW YORK 6, N.Y.



**Hard-To-Get Surplus at Easy-To-Pay Prices**

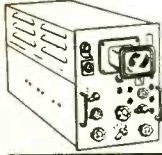

**Aeronauticals, Attention! R-65/APN-9**

Brand New in Original Packaging. First like these in 4 years! Price quotation on request.

**BC-221 FREQ. METERS:** Excellent, checked out with xtal and matching calibration book... \$69.50  
**Best 10-meter receiver:** BC-923. Contains xtal calibrated heterodyne-type freq. meter. Four chans., each adjustable 27.0-38.9 mc. FM, also receives AM. Double conversion. Speaker in front panel. This is the tank and scout car receiver in current tactical use that replaced BC-685 push-button. With schematic, reproduction of theory section of manual, operating instructions and conversion instructions for AM-FM through 150 mc. Like new, with 12 V dynamotor... \$47.50  
**BC-924 Transmitter** for above receiver. FM, 35 W. 27-38.9 mc, 4-channel, VFO tuned with freq. meter in receiver. Both go into P-237 rack. With 12 v dynamotor, schematics, and set-up instructions. Good used... \$24.50  
 We have two complete NEW sets, each containing TWO BC-923, one BC-924, and Rack FT-237. First buyers!... EACH \$150.00  
**BC-659 Mobile Xmtr-Recvr** 27-38.9 mc. FM. 10 meter and new defense net. Xtal controlled 2-channel, good for commercial mobile. With 6 v power supply PE-117. Good condition... \$39.50  
**RF Wattmeter TS-118/AP.** New, with carrying case and manual... \$150.00  
**Field Strength Meter I-95,** for SCR-522, excellent condition... \$50.00  
**TS-100/AP synchroscope,** excellent... \$125.00  
**AM-18/APRT RF output amplifier,** VHF. Excellent... \$37.50  
**T/85-APT-5.** New... \$89.50  
**ID-80/APA-17.** Excellent... \$69.50  
**R-XA-12/ARQ-5 Panoramic receiver** with 5" display, 16-47 mc and 46-77 mc. Excellent... \$125.00  
**RA-88-A power units** for SCR-717. Excellent \$49.50

**CAN YOU USE THIS TRANSFORMER?**

Hermetically sealed, ceramic-insulated lugs, interstage, 2L6191 A/T2. New. We have a good quantity, 3 windings. Voltage rates below based on unit 1 volt between first two terminals of tapped winding; other voltages of this winding, between taps, are in order, 3 v, 1 v, 36 v. Second winding is 148 v CT. Third winding is 100 v... \$2.00  
**Oil-Filled 4 x 8 MFD,** 600 v condenser, in one hermetically sealed case. Common ground. New, with mts. hooks. Used in Army Super-Pro power supply... \$2.89  
**Oil-filled, oil impregnated Condenser,** 0.5 x 1000 v. Aerovox Tubular, metal cased, wax cardboard covered can insulated from foil. A quality component for folks proud of their product. Immersion proofed, sealed against moisture. Rigidly solidly soldered, can't pull loose. 1 1/16" dia, 2 1/4" long 75¢  
**6 v Vibrator,** Mallory 650, Radiart 5321, 4-prong, non-synch. 1 1/2" dia, 3-3/16" over can, 115 cycle, 6 amp. New... \$1.59

**DYNAMOTORS**

For BC-375: PE-73 28 v in, output 1000 v, 350 ma. Filtered. With starting relay. New... \$5.95  
 For BC-191: Same as above except 14 v input. New... \$12.95  
 12 v in, 3 outputs: DM-42-A. 1030 V, 215 ma; plus 615 v, 260 ma; plus 8 v at AF for tone source. New... \$14.50  
**DY-10/ARC-4X.** Choice of 27 or 13.5 v input. Output 360 v, 135 ma cont., 310 v, 355 ma int. Can be used in ARC-1. Excellent... \$12.50  
 For 12 v Transmitter: Output 340 v, 120 ma, cont. With filter and relay base. Used, good... \$7.50  
**DM-64.** 12 v. for receiver BC-923. Output 275 v, 150 ma. With filter in base. Excellent used \$9.50  
**NEW**  
**PE-94-C.** Brand new... \$9.95

**INVERTERS, 1 PHASE**

MG-149-F. 28 v in. Two outputs: 115 v, 400 cy, 500 VA, plus 26 v, 400 cy, 250 VA. Excellent condition... \$7.95  
**PE-218.** 28 v in. Output 115 v, 13 amp (1.5 KVA), 400 cy. NEW \$17.50. Out of original packing \$12.50  
**T-23/ARC-5 Command Xmtr.** 100-156 mc. NEW, with tubes \$34.50. Exc. used... \$24.95. Used, less tubes... \$7.95  
 1-138-A 10 cm signal gen. with voltage regulator. 115 v, 60-2600 cy power supply, rack mounting, in carrying case... \$79.50

**TECH MANUALS, WHILE THEY LAST, \$5.00 EACH**

AN/APN-4 major-portion reprint. AN-TPS-3. AN/TRA-1. TRC-1, 3, 4. RC-312, 314, 342, 344. RC-375. BC-1000. DU-1. MN-26. PE-52. PE-75. RA-10. RA-34-H. RC-34. RC-261. SCR-269-F. SCR-269-G. SCR-300. SCR-500. SCR-508. 525. 538. SCR-510. SCR-536. SCR-578. SCR-593. SCR-608. 625. SCR-609. 610. SCR-625. TA-21. TA-21-24. TC-19. TCS-6. TELETYPE.

**WANTED!**

Your Spare Surplus Equipment and Tubes, Dynamotors, Recvrs., Xmtrs., Test Equipment. Send list, stating condition and rock bottom price.

**G. L. ELECTRONICS**

905 S. Vermont Ave., Los Angeles 6, Calif. Calif. Buyers Add Sales Tax.



**ACORN IMMEDIATE DELIVERY**

**220 V. INPUT TRANSFORMERS**  
 Pri. 200-210-220-230-240 V.—50-60 cy.  
 Sec. #1—5 V. @ 14.5 amp. C. T.  
 #2—8 V. @ 14.5 amp. C. T.  
 Open Frame Fed. Tel. & Tel.— \$6.95  
 Pri. 200-210-220-230-240 V.—50-60 cy.  
 Sec. #1—367-0-367 V. @ 500 ma.  
 Open Frame Fed. Tel. & Tel.— \$5.95  
 Pri. 200-210-220-230-240 V.—50-60 cy.  
 Sec. #1—2.5 V. @ 20 amp. C. T.  
 Insulated for 10 KV— \$5.95  
 Open Frame Fed. Tel. & Tel.— \$4.95  
 Pri. 200-210-220-230-240 V.—50-60 cy.  
 Sec. #1—6.3 V. C. T. @ 6 amp.  
 Open Frame Fed. Tel. & Tel.— \$4.95  
 Pri. 200-210-220-230-240 V.—50-60 cy.  
 Sec. #1—5 V. @ 4 amp. C. T.  
 Open Frame Fed. Tel. & Tel.— \$3.95  
 Pri. 200-210-220-230-240 V.—50-60 cy.  
 Sec. #1—9 V. @ 28 amp. C. T.— \$10.95  
 Open Frame Fed. Tel. & Tel.— \$5.95  
 Pri. 200-210-220-230-240 V.—50-60 cy.  
 Sec. #1—556-0-556 @ 220 ma.— \$5.95  
 Shielded upright mount. Open Frame Fed. Tel. & Tel.— \$5.95  
 Pri. 200-210-220-230-240 V.—50-60 cy. autoformed.— \$8.95  
 Sec. #1—17 V. @ 8 amp.  
 #2—5 V. C. T. @ 10 amp.  
 Open Frame Fed. Tel. & Tel.— \$10.95  
 Pri. 200-210-220-230-240 V.—50-60 cy.  
 Sec. #1—2.5 V. C. T. @ 10 amp.  
 #2—2.5 V. C. T. @ 10 amp.  
 #3—6.3 V. C. T. @ 5.5 amp.  
 #4—6.3 V. C. T. @ .3 amp.  
 Open Frame Fed. Tel. & Tel.— \$6.95

**OUTPUT TRANSFORMERS**

6V6 Push Pull—8000 Ohm Pri. Plate to plate—12 W. output  
 Univ. Sec. 4-8-15-250-500 ohm V.C. Shielded U.M.— \$89.50  
 6L6 Push Pull—6000 ohm. Pri. Plate to plate—25 W. output  
 Univ. Sec. 4-8-15-250-500 ohm V.C. Half Shell Mtg. Shielded— \$2.95

**RCA HIGH FIDELITY OUTPUT TRANSFORMER**

6L6 Push Pull—9000 ohm. Pri. Plate to Plate  
 Sec. 8 ohms—25 W. output— Chicago Trans. Cased— \$4.95

**6V6 HIGH FIDELITY OUTPUT TRANSFORMER**

Pri. 5000 ohms  
 Sec. V.C. 4-8-15-50-200 ohm imp. Frequency response 60-10,000 CY ± ¼ D. B.— Hermetically Sealed— .98

**6L6 SINGLE OUTPUT TRANSFORMERS**

Pri. 2500 ohms  
 Sec. 6-8 ohms. Channel Mtg.— .98

**6V6 SINGLE OUTPUT TRANSFORMER**

Pri. 5000 ohms  
 Sec. 6-8 ohms. Channel Mtg.— .89

**LOW VOLTAGE STEP-DOWN TRANSFORMERS**

Pri. 115 V.—50-60 cy.  
 Sec.—16V. @ 12 amp. G. E.— \$4.95  
 Pri. 115 V.—50-60 cy.  
 Sec.—10 V. @ 12 amp. G. E.— \$4.95  
 Pri. 115 V.—50-60 cy.  
 Sec.—16 V. @ 5 amp.—U. T. C.— \$2.79  
 Pri. 110-147-220 V.  
 Sec.—13 V. @ 8 amp.—U. T. C.— \$3.49  
 Pri. 115 V.—50-60 cy.  
 Sec.—24 V. @ 2 amp.—Ferranti— \$1.49  
 Pri. 0-105-110-115 V.—50-60 cy.  
 Sec. #1—11 V. @ 10 amp. C. T. #2—7 V. @ 1 amp. C. T. #3—7 V. @ 1 amp. C. T. Kenyon Cased— \$4.95

**FILAMENT TRANSFORMERS**

Pri. 105-115 V.—50-60 cy.  
 Sec. #1—6.3 V. C. T. @ 5 amp.— Thord. C. H. T. Case— \$2.79  
 Pri. 105-115-125 V.—50-60 cy.  
 Sec. #1—6.3 V. @ 4.5 amp.  
 #2—6.3 V. @ .6 amp.  
 #3—6.3 V. @ .6 amp. Cased— \$2.95  
 Pri. 115 V.—50-60 cy.  
 Sec. #1—6.3 V. @ 1.2 amp. Channel Mount— .89

**POWER TRANSFORMERS**

Pri. 115 V.—50-60 cy.  
 Sec. #1—7.5 V. C. T. @ 175 ma.  
 #2—6.3 V. @ 6 amp.  
 #3—5 V. @ 3 amp.  
 #4—5 V. @ 2 amp. Half Shell Mount— \$4.79  
 Pri. 115 V.—50-60 cy.  
 Sec. #1—700 V. @ 250 ma. C. T.  
 #2—10 V. @ 6.3 @ 5amp. tapped  
 #3—5 V. @ 3 amp. Half Shell Mount— \$4.79  
 Pri. 115 V.—50-60 cy.  
 Sec. #1—600 V. C. T. @ 100 ma.  
 #2—6.3 V. @ 2 amp.  
 #3—5 V. @ 3 amp. Half Shell Mount— \$2.95  
 Pri. 115 V.—50-60 cy.  
 Sec. #1—750 V. C. T. @ 225 ma.  
 #2—6.3 V. @ 8 amp.  
 #3—6.3 V. @ 1.2 amp.  
 #4—5 V. @ 3 amp. RCA Half Shell Mount— \$6.95

All Merchandise Subject to Prior Sale  
 Phone WOrth 4-3270

**ACORN ELECTRONICS CORP.**

76 Vesey St. Dept. E6 N. Y. 7, N. Y.

Pri. 115 V.—50-60 cy.  
 Sec. #1—650 V. C. T. @ 150 ma.  
 #2—6.3 V. @ 4.5 amp.  
 #3—6.3 V. @ .3 amp.  
 #4—5 V. @ 3 amp. Half Shell Mount— \$3.95  
 Pri. 115 V.—50-60 cy.  
 Sec. #1—300 V. C. T. @ 260 ma.  
 #2—6.3 V. @ 8 amp.  
 #3—6.3 V. @ 2 amp.  
 #4—5 V. @ 3 amp. Half Shell Mount— \$7.95  
 Pri. 115 V.—50-60 cy.  
 Sec. #1—600 V. C. T. @ 40 ma.  
 #2—5 V. @ 2 amp.  
 #3—2.5 V. @ 4.5 amp. Upright Mount— \$1.49

**UTC Cased Interstage Audio Transformer**

Type No. A-19: Single plate to 2 grids 5 ma, pri. impedance 15,000 ohms; sec. impedance 30,000 ohms overall; 2:3 to 1 turn ratio overall; ±2 db 50 — 20,000 cycles. List \$19.00. OUR PRICE \$4.95

**A COMPLETE INSTRUMENT—NOT A KIT! 5" OSCILLOSCOPE**

HIGH GAIN WIDE BAND \$129.50 BRAND NEW LIMITED QUANTITY  
 Reg. Value \$279  
 Made by a Famous Manufacturer  
**FEATURES**

- #1: Vertical Bandwidth 10 Cy to 2 Mc., 3db down
  - #2: Vertical Sensitivity .66 RMS volts/inch
  - #3: Decade Type Frequency Compensated Attenuators
  - #4: Horizontal Bandwidth 2 Cy to 900 KC 6 db down
  - #5: Horizontal Sensitivity .15 RMS volts/inch
  - #6: Push Pull Deflection Amplifiers
  - #7: Direct Connection to Deflection Plates Available
  - #8: Internal Synchronization of Either Polarity
  - #9: Zaxis input (Intensity Modulation)
  - #10: Calibrated 60 Cy Test Signal
- Tube Complement:  
 2-6AG7, 3-6SN7, 1-6AC7, 1-5Y3, 1-2X2, 1-884, 1-5CP1

**CARTER DYNAMOTOR**

Stock No. 4037AS  
 DC input 6VDC; output 400 V @ 375 mils DC. Perfect for mobile communications in car, plane or boat. BRAND NEW. List \$71.40. Our Price \$34.95

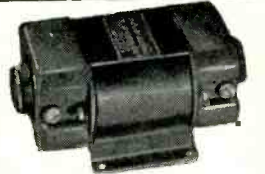

**PIONEER GEN-E MOTOR**

Type E-3: Input 14 VDC @ 8 amps  
 DC. Output 550 V @ 120 mils... \$14.95  
 SP-125: Input 28 VDC @ 2.2 amps  
 DC. Output 270 V @ 120 mils... \$6.95  
 DS-125: Input 28 VDC @ 2 amps  
 DC. Output 260 V @ 60 mils... \$4.95  
 DA-1A: Bendix Dynamotor; Input 28V. @ 1.6 amps.; output 230V. @ 100 mils, \$9.95

**FILTER CHOKES**

Hy.	@ Ma.	Ohms	D. C.	Mounting	Price
10	35	350	D. C.	Channel	5.69
10	60	400	D. C.	Hermetically Sealed	.69
15	70	420	D. C.	Hermetically Sealed	.79
10	75	200	D. C.	Channel	.79
10	85	200	D. C.	Channel	.79
20	100	350	D. C.	Hermetically Sealed	1.89
10	100	480	D. C.	Hermetically Sealed	1.79
15	110	400	D. C.	Upright	1.39
8	150	130	D. C.	Channel	1.19
10	150	200	D. C.	Cased Channel	1.39
3	150	65	D. C.	Channel	1.29
8	150	90	D. C.	Channel	1.29
10	200	60	D. C.	Upright	2.29
2.5	200	60	D. C.	Channel	1.29
15	250	65	D. C.	Upright	2.95
8	250	95	D. C.	Channel	2.59
12	500	95	D. C.	Channel	9.95
32	40	520	D. C.	Hermetically Sealed	1.69

**HANSEN SYNCHRONOUS MOTOR \$2.95**

115 V 60 cy. 1 RPM.

**SELENIUM RECTIFIER \$7.95**

Full wave bridge 0-18V. AC. 10 amp.

TUBES	6BP7	1.69	249B	3.49	
CE2	\$1.65	1853	1.29	708A	4.49
2AP1A	7.95	6X5	1.25	710A	1.49
2C21	2.29	6V7	.98	801	1.49
1642	.32	9GP7	11.95	724B	2.69
2X2	.89	10Y	.79	801/801A	.79
2X2A	1.49	24G6M	.89	838	3.79
3AP1	6.29	CNV6Z26	.79	CR954	.29
3B24	6.29	CRP72	1.29	957	.39
3B24W	7.29	CRP73	1.69	1626	.79
3BP7	2.29	RK73	2.95	VT137	.49
3FP7	3.49	RKP73	2.95	9002	1.49
5BP1	5.98	83V	1.49	XTAL DIODES	
5BP4	5.89	114B	.69	1N51	.89
5CP1	4.39	CEP120	5.00	1N23	1.10

**HEAVY DUTY POWER TRANSFORMER**

Pri. 110-220 V.—50-60 cy.  
 Sec. #1—320 V. C. T. @ 400 ma.  
 #2—6.3 V. @ 3 amp.  
 #3—6.3 V. @ 13.5 amp.  
 #4—5 V. @ 3 amp.— \$7.49  
 #5—2.5 V. @ 1.7 amps.  
 Open Frame—(3 for S21)

**ISOLATION TRANSFORMER**

Pri. 115 V. 50-60 cy.  
 Sec. 150 V. C. T. @ 300 mils. Freed, Cased— \$3.95

**VIBRATOR TRANSFORMER**

Pri. 6 V.  
 Sec. 600 V. C. T. @ 90 ma.— Upright Mount— \$1.99

Terms: 20% cash with order, balance C.O.D. if rated, terms 1% net 10 days. All prices F.O.B. our warehouse in N.Y.C. NOTE: Due to conditions beyond our control, prices are subject to change.



# SURPLUS EQUIPMENT

## BODINE GEAR HEAD MOTORS



10:1 Gear Ratio; Motor operates: 24 VDC, 2 Amps, 1/50th H.P., 5000 RPM.  
New.....\$12.50 ea.

## PIONEER AUTOSYNS

AY-1.....26 volt-400 cycle.....\$4.95  
AY-5.....26 volt-400 cycle.....\$5.95  
(Has hollow shaft)

**NOISE FILTERS.. For 153H Holtzer Cabot Inverters (Mallory & Co.).. LIKE NEW. \$4.50 ea.**

## SERVO MOTOR

10047-2-A-Pioneer; 2 Phase; 400 cyc; with 40:1 Reduction Gear.....\$10.00 ea.

## PE 218 LELAND ELECTRIC

Output: 115 VAC; single phase PF 90; 380/500 cycle; 1500 VA.  
Input: 25-28 VDC; 92 amps; 8000 RPM; Exc. volts 27.5.  
Brand New....\$39.95 ea.

## 12116-2-A PIONEER

Output: 115 VAC; 400 cycle; single phase; 45 amp.  
Input: 24 VDC; 5 amp.....\$90.00

## 12130-1-A PIONEER

Output: 115 VAC; Single phase; 400 cycle; Amps .88; 100 VA. Input: 18-28 VDC; 20 Amps.  
\$80.00 ea.

## 10486 LELAND ELECTRIC

Output: 115 VAC; 400 cycle; 3 phase; 175 VA; .80 PF. Input: 27.5 DC; 12.5 Amp; Cont. Duty.....\$90.00 ea.

5D21N3A GENERAL ELECTRIC; Output: 115 VAC; KVA 485; PF 1; 400 cycle; single phase. Input: 27 VDC; 35 Amps.....\$25.00 ea.

## 5AT121JJ2B GENERAL ELECTRIC

Output: 115VAC; 400 CYC; 750 VA; 3 Phase; and 26 VAC; 400 CYC; 250 VA; Single Phase; Input: 24VDC; 55AMP.....\$195.00 ea.

SEND YOUR REQUEST FOR ALL TYPES OF SYNCHROS

PLEASE ENCLOSE FULL AMOUNT WITH ORDER

ALL PRICES F.O.B. PASADENA UNLESS OTHERWISE SPECIFIED

EQUIPMENT FULLY GUARANTEED

# C and H Sales Company

BOX 356-E EAST PASADENA STATION • PASADENA 8, CALIFORNIA

## RATE GENERATORS

J-36 DC Voltage Generators  
Eastern Air Devices (Mfg.)  
Like New....\$10.00 ea.



## KERMIN SYNCHRONOUS 4 RPM MOTOR

NEW.....\$2.95 ea.



## 400 CYCLE MOTORS

Eastern Air Devices Type JMG6; 200 VAC; 1AMP; 3 Phase; 400 Cyc; 6000 RPM.....\$12.50 ea.

## INVERTERS

5AS131NJ3 GENERAL ELECTRIC (PE-118)  
Output: 115V; 400 CYC; 1 φ at 1500 VA.; PF 0.8; W.E. Spec. KS-5601L1. Input: 26 VDC at 100 Amps.....\$29.50 ea.

## 12130-1-B PIONEER

Output: 122.5 AC; Single phase; 400 cycle; 141 VA  
Input: 20-30 VDC; Amps 12-18.....\$80.00 ea.

## TYPE 778-4 ECLIPSE

Output: 26 VAC; 400 cycle; 60 Va. Output: 115 VAC; 400 cycle; 190 VA. Input: 24 VDC.....\$35.00 ea.

## 10563 LELAND ELECTRIC

Output: 115 VAC; 400 cycle; 3-phase; 115 VA; 75 PF. Input: 28.5 VDC; 12 AMP.....\$80.00 ea.

Output: 115 VAC; 400 cycle; 3 phase; 175 VA; .80 PF. Input: 27.5 DC; 12.5 Amp; Cont. Duty.....\$90.00 ea.

## MOBILE ANTENNA 152-162 Mc

ATTENTION! Cab Co., Police & Fire Depts., Utilities, Govt. & Civilian Defense Agencies. G.E. Model 4BY1C1 Antenna Kit, consists of 1 ea. 18 1/2 Dipole, 12 ft. RG58-U Co-ax Cable, RF Antenna. Conn., PL259 Conn. & Installation hardware. Can be cut for higher freq.  
New. Individually Boxed.....\$4.95  
10 for \$45.00

## CHOKES

6 HY 65 MA.....2 for \$ .99  
10 HY 80 MA 240 OHM.....2.99  
30 HY 100 MA 400 OHM Herm. Seal.....2.99  
7 HY 125 MA, Cased.....\$1.10 ea.; 2/ 2.00  
10 HY 150 MA 140 OHM.....1.69  
7 HY 200MA 100 OHM, Cased.....4.95  
4-16 HY 200 MA 140 OHM Swinging CH.....4.95  
3 HY 250 MA 190 OHM, Cased.....1.25  
15 HY 250 MA 60 OHM, Cased.....6.49  
3-14 HY 300 MA 80 OHM Swinging CH.....6.95  
6 HY 300 MA 65 OHM, Cased.....4.95  
8 HY 300 MA 80 OHM, Cased.....6.95  
6 HY 350 MA 72 OHM, Cased.....5.50  
HY 400 MA 100 OHM, Cased.....5.55  
6 HY 450 MA 80 OHM, Cased.....5.55  
7 HY 750 MA 40 OHM, Cased.....11.50

## 115V FILAMENT TRANSFORMERS 60 CY

2.5 VCT 10 A, 10KV Insulation.....\$4.50  
2.5 V @ 6 Amp, 2.5 V @ 6 Amp.....3.45  
5 VCT 3A, 2.5 KV Insulation.....2.55  
5 V 12 A, 2.5 KV Insulation.....5.95  
5 V 20 A, 2.5 KV Insulation.....6.85  
6.3 V 2 A.....2.45  
6.3 V 3 Amps.....2.45  
6.3 V 12 Amps.....3.95  
6.3 V 4 Amps, 6.3 V 4 Amps.....2.95  
6.3 V 3.5 A, 2 x 2.5 V 3 Amps ea.....3.95  
6.3 V 3A, 2.5 V 6 AMP Herm Seal.....3.49  
6.3 V 8 Amps.....2.85  
10 VCT 10 A, 2.5 KV Insulation.....2.85  
6.3 V 12A, 6.3 V 2A Herm Seal.....5.95

## 115 V POWER TRANSFORMERS 60 CY

435 VCT 145 MA, 6.3V 3A, 5V 3A.....\$ 2.49  
700 VCT 90 MA, 6.3V 4A, 5V 3A.....4.50  
700 VCT 150 MA, 5V 3A.....2.95  
740 VCT 185 MA, 6.3V 4A, 5V 3A.....5.95  
800 VCT 200 MA, 6.3V 4A, 5V 3A.....7.95  
800 VCT 300 MA, 6.3V 10.8A, 5V 6A, 5V 2A.....9.50  
750-600-0-600-750 225 MA.....2.45  
3200 VCT 450 MA.....24.50

## OIL CAPACITORS

7 MF 330 VAC.....\$0.95  
.5 MF 600 VDC......45  
2 MF 600 VDC......79  
4 MF 600 VDC......90  
6 MF 600 VDC.....1.05  
10 MF 600 VDC.....1.95  
2 MF 1000 VDC......95  
5 MF 1000 VDC.....1.90  
10 MF 1KV DC.....3.25  
15 MF 1KV DC.....3.95  
2 MF 1.5 KV DC.....1.75  
4 MF 1.5 KV DC.....2.75  
6 MF 1.5 KV DC.....2.95  
.1 MF 2000 VDC.....1.79

## NEW ITEMS

304TL tubes.....\$ 17.50  
OCTAL PLUG IN 1000 KC XTALS, ideal for BC221 & LM freq meters.....6.95  
OCTAL PLUG IN GERANIUM XTALS, Similar to IN34.....\$1.95. Matched pair plug in units.....2.95  
BC 684 XMTR, w/tubes, used.....14.95  
New LM freq. mtr. calib. book, xtal.....125.00

## METERS

0-100 VA 4" Sq. SP Scale.....\$9.95  
Weston 0-30A DC 2 1/2" Aircraft.....3.49

## ADJUSTABLE ELECTRIC TIMER

1 1/2-15 min., telechron 115V 60 cy motor, micro sw. on-off SW, pilot light, etc. Housed in plastic cabinet. All adjustments front panel. Ideal for Labs, schools etc. New \$5.95 ea. 2 for \$10.00

## COMPONENT BARGAINS

5 Screw Term. Strip (6/32 Screw).....10 for 1.20  
Barrier Strip Yellow Bklt. 6 Term.....10 for 1.50  
5 Way Binding Post, Red or Black.....ea. .40  
Octal Sock., MIP, Mica Filled.....10 for 1.00  
3/8" Fluted Knobs, brass insert.....10 for 1.20  
Dual 10AMP, 115V, 60C, Circuit Breaker.....2.95  
.03MF 400V Metal Cased Oil Tub. Cap.....10/ 1.99  
.1MF 600V Metal Cased Oil Tub. Cap.....10/ 2.49  
.5MF 600V Metal Cased Oil Tub. Cap.....10/ 4.50  
1 x .1MF 600V Bath-Tub St.....10/ 5.00  
5 x .5MF 600V Bath-Tub St.....10/ 9.95  
1MF 600V Bath Tub St......95  
1 x 1MF 200V Bath Tub St......75  
2MF 600V Bath Tub St.....1.25  
4MF 150VAC Oil Cap......95  
4MF 600V Oil Cap TQ Type.....5/ 2.95  
7MF 600V Oil.....1.49  
8 x 8MF 600V Oil.....1.95  
100MF 50V Electrolytic Cap.....5/ 2.25  
20MF 50V Bath Tub Electro. Cap St......49  
1MF 400V Aerovox 484 Tub. Cap.....10/ 2.50  
Muter K53C2 2-3MF Var. Cap.....10/ .99  
601MF 800VW Trans. Mica Cap......80  
601MF 1200VW Trans. Mica Cap......99  
603MF 2500VW Trans. Mica Cap......99  
605MF 2500VW Trans. Mica Cap......99  
602MF 3500VW Trans. Mica Type 9.....1.25  
Four Quadrant Phase Shift Cap.....3.50  
C-H Luminous TTP Bat Handle Aircraft Togg. SW., SPDT, 5A 125 V 10 for.....1.98  
SPST As Above.....10 for 1.95  
SPST As Above, momentary only.....ea. .25  
SPST AS ABOVE, neutral center.....ea. .45  
Cramer Time Delay Relay, 120 Sec 120 VAC.....9.95

TERMS: 25% Deposit with order, balance C.O.D. Rated firms open account

# POLY-TECH N. Y.

919 Dawson St., New York 59, N. Y.  
Tel. MUrray Hill 6-2650

## ASTRO COMPASS

The Astro Compass is a precision instrument measuring 8 1/4" high x 5 1/4". Furnished in Carrying Case. Designed to provide accurately (a) True heading of Aircraft or boat. (b) True bearing of a distant object. (c) The relative bearing of distant objects.

Of special interest to Astronomers & Experimenters.

\$8.75 Each



## TELEPHONE RELAYS—CLARE

1-3300 ohms 2 n.o. 1 n.c.....\$1.35 ea.  
2-4 ohms - n.o.....1.35 ea.  
Double Coil. 12 or 24 volts 240 ohms each coil. Contacts 3 make 2 break.....1.25 ea.

## ADELAKE MERCURY RELAY

110 volt AC 20 AMP N.O. Contacts 30 Sec. to make.....\$6.10 ea.  
Hart Relay #694R5B S.P.S.T. 200 Amp. 24 Volt DC.....\$2.10 ea.

## DIEHL Pilot Motors #802077

SSFDE-14-2 24V DC 1 1/2" Diam. x 3 1/2" long. Shaft 1/2" x 1".....3.95 ea.

## SYNCHRONOUS TIMER

Powered by Hayden Motor

Having a 30 minute on and 30 minute off cycle 10 Amp. capacity. Totally enclosed in metal case, 2 1/2" diam. x 2 1/2" high with 3 1/2" mounting flange. 110V AC 60 Cyc. 5.10 ea.

Minimum order \$2.00.

All prices, net FOB New York—Immediate Delivery

## B & B DISTRIBUTORS

222 Fulton St. New York 7, N. Y.  
Rector—2-0432



# SOLAR MODEL CF Exam-eter

The most complete of all capacitor analyzers, Solar's famous Model CF is a sturdily constructed, reliable instrument designed to simplify electronic servicing.

- Has exclusive patented Quick-Check circuit for qualitative tests and intermittent checks without soldering capacitors
- Capacitance bridge—10 mmf to 2000 mmf in 4 ranges
- Power factor—0 to 50 percent
- Insulation resistance—3 to 10,000 megohms
- Electrolytic leakage current reads directly on 4 1/2" meter
- Built-in d-c power supply continuously adjustable from 0-350 volts for electrolytic tests under rated voltage
- 100 ohms to 7.0 megohm A-C resistance bridge
- 0-600 volt, D-C vacuum-tube voltmeter
- 10-50 volt A-C vacuum-tube voltmeter
- Quality Components for Long, Trouble-free Service, 115 V, 50-60 cycles.
- Complete with test leads & instruction manual

Price: \$69.95

Ready to operate 20% deposit with order. Balance C.O.D. Jobbers write for discounts.

ELECTRONICS CO.  
Dept. D

Arcee

96 WARREN ST., N.Y. 7, N.Y.



# "GIGANTIC" Ceramic CLEARANCE

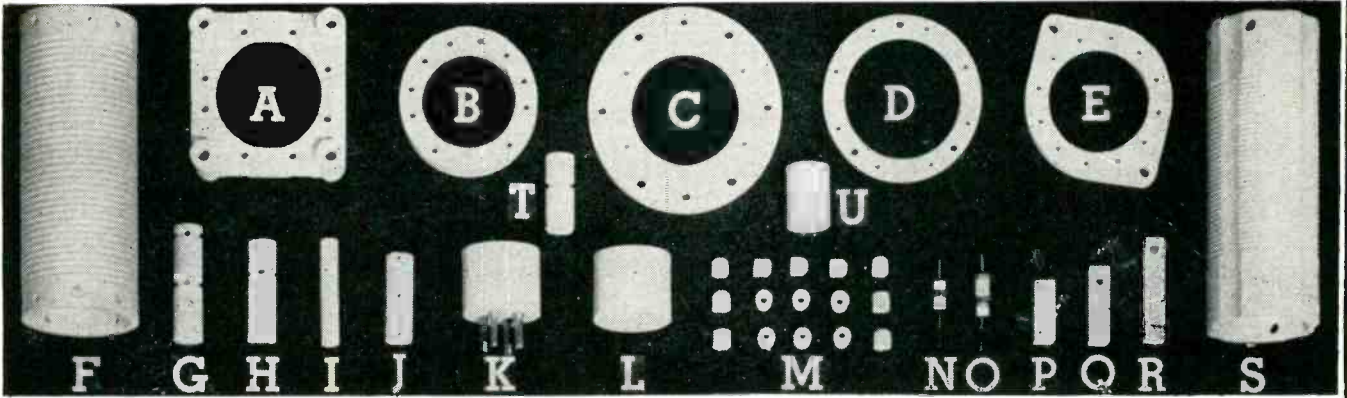

- TYPES A,B,C,D,E BASES FOR VARIOUS TUBE SOCKETS YOUR CHOICE .05
- F - COIL FORMS 2" DIA 4 7/8" LONG. 35 GROOVES - - - - - .10
  - G - STANDOFF INS. 1/2" X 2 7/8" THREADED HOLE ONE END - - - - .02
  - H - STANDOFF INS. 1/2" X 1 5/8" AND 1/2" X 2" THREADED HOLE BOTH ENDS .02
  - I - INSULATED SPACERS 5/16" X 1 3/4" THREADED HOLE BOTH ENDS -.015
  - J - COIL FORMS 1/2" X 1 1/2" 28 GROOVES - HOLLOW - - - - - .02
  - K - 4 PRONG TUBE BASES - STANDARD - - - - - .10
  - L - 4 PRONG TUBE BASES LESS ALL PINS - - - - - .05
  - M - COAXIAL BEADS 5/16" X 3/8" - 1/8" HOLE (PER 1000) - 1.50
  - N - HIGH VOLTAGE FEED THRU INSULATORS 1/2" LONG 1 1/2" OVERALL - .02
  - O - HIGH VOLTAGE FEED THRU INSULATORS 3/4" LONG 1 3/8" OVERALL - .03
  - P - SQUARE INSULATED SPACERS 3/8" X 1" THREADED BOTH ENDS -.02
  - Q - SQUARE INSULATED SPACERS 3/8" X 1 1/4" THREADED ONE END - .02
  - R - SQUARE INSULATED SPACERS 3/8" X 1 3/4" THREADED ONE END - .02

S - THREADED COIL FORMS	Dia.	No. of Ribs	Winding Length	Overall Length
YOUR CHOICE 5¢ EACH	2"	9	1-3/4"	5"
	2"	14	1-3/8"	5"
	2"	6	1"	5"
	2"	34	1-7/8"	5"
	2"	11	1"	5"
	2"	13	2-1/2"	5"
	2"	9	1-5/8"	5"
	2"	15	1-3/4"	6-3/8"
	3"	55	4-1/2"	5-1/4"

SEND FOR OUR LATEST BULLETIN ON CURRENT SPECIALS

T - ROUND INSULATED SPACERS 1/2" X 1 1/4" THREADED BOTH ENDS - .02  
 U - ROUND INSULATED SPACERS 3/4" X 1" THREADED BOTH ENDS - .03  
 SAMPLES SENT TO BONA-FIDE MFG. ONLY  
 MINIMUM ORDER 10.00



**UNIVERSAL RADIO SUPPLY CO.**  
 1729 So. Los Angeles St. Los Angeles 15, Calif.



**TRANSMITTING MICA CONDENSERS**

- 1-01 MFD-1200v. DCW .45 ea.
- 2-003 MFD-2500v. DCW .45 ea.
- 3-0011 MFD-5,000v. . . 2.00 ea.
- 4-005 MFD-5,000v. . . 3.50 ea.

**BATHTUB CONDENSERS**

- 2x.05 MFD 600v. TT .30
- .25 MFD 600v. TT .30
- 2x.25 MFD 600v. TT .30
- .25 MFD 1,000v. ST .40
- 1.0 MFD 600v. TT .40

**UPRIGHT CONDENSERS**

- .1 MFD 600v. TT .25
- 1.0 MFD 600v. TT .30
- 1.5 MFD 330v. AC .40

2x2 Low Loss Tube Sockets .19

**TELEPHONE RELAYS**

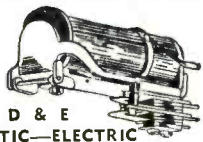

CLARE, TYPES C, D & E  
 COOKE, AUTOMATIC-ELECTRIC  
 ALL TYPES of COILS and PILE-UPS  
 Send Us Your Specifications For Our Quote  
 SEND US YOUR NEEDS FOR OUR QUOTE

**Chase**

Electronic Supply Co.  
 105-07 225th St., Dept. 6  
 Queens Village, N. Y.  
 HOLLIS 4-5033

## -CONNECTORS-

AN  
 "3100"  
 "3101"  
 "3102"  
 "3106"  
 "3108"

Black and Mellomynne Inserts in Stock

101 & 102 A & B Shell Types In Stock

CLAMPS-ALL SIZES

Catalog On Request

QUICK SERVICE OUR SPECIALTY

### WILGREEN

99 Murray St., New York 7, N. Y.

For Immediate Delivery

Write or Phone - WORTH 2-7423-4-5



# COMPASS COMMUNICATIONS CO.

393 Greenwich Street, N. Y. C.

Phone: **BE ekman 3-6510** Cable Address: **COMPRADIO, N. Y.**

## Special Lots of Equipment

- 100—Sets—mobile ground station, model SCR-284
- 100—Switchboards, portable, 12-line, Model BD-72
- 125—Switchboards, portable, 6-line, model BD-71
- 100—Receiver, direction finder, complete, model MN-26
- 12—Shipboard Transmitters, 115 and 230 V dc, model TDE—\$675.00 ea.

## TRANSMITTING STATIONS

- 1 KW—200-500 KCS, complete with 440 volt, 3 ph, 50-60c. power supply  
Price **\$2500.00**
- 800W—(400 watts phone) Western Electric, 10-channel, automatic dial selection, 2.0 20.0 mcs, with 220 volt, 1 ph, **50-60c**, power supply. SAME TRANSMITTER AS USED ON S.S. "QUEEN MARY"—brand new
- 1 KW—FM Broadcast station, complete with monitor, all tubes, antenna and waveguide, Mfr. G. E. **\$1,500.00**—at location, N. Y. C.
- RADAR—SA, SO, SN, SQ, SJ, SF, SL, SK, etc.  
ASB, APS-2, 3, and 4, APN-9, etc.  
AN/CPN-6, AN/CPN-8.
- SONAR—QCD, QBE, QCJ, QBG, WEA, NAA, etc.
- Marine Transmitters—TBK, TAJ, TBL, TBM, TDE, TAQ, and TCS sets for 12, 24, 110 volts dc and 110 volts ac.

### MAGNETRONS & KLYSTRONS

2J21A	2J61	714AY
2J22	4J32	725A
2J26	4J33	718AY
2J27	4J42	718DY
2J28	4J50	730A
2J31	5J23	721A
2J32	5J29	723A/B
2J33	700B	2K28
2J34	700C	2K41
2J36	700D	728A
2J3C	706A-GY	726B
2J50	707B	

### THOUSANDS OF DYNAMOTORS, INVERTORS, CONVERTORS and MOTOR-GENERATORS IN STOCK

6, 12, 24, 28, 32, 115 and 230 dc. input  
This months specials:  
12/24 input, 265/540 at 120/26 ma output  
Brand new—\$8.00

All material guaranteed, offered subject to prior sale.

## YOU NAME IT—WE HAVE THEM

This is only a partial listing of bathtub cased oil capacitors available from our huge stock of 250,000

.01—.05—.1—.25—.5—1.0—2 & 4 MFD  
at 50—100—200—400—600—1000 VDCW

Single—Dual—Triple cased units with top, side and bottom terminals. Most types in very large quantities. Send your requirements to us for quotation.

### MISCELLANEOUS SPECIALS

5CP1 Jan RCA	\$4.45	Compass Indicator I-65	\$5.95
720 EY W.E.	74.50	Tank Set Mark II brand new—complete—1 piece only	79.00
J-38 Keys	.69	Radio Marine 8022 life boat trans-Rec. less case can be used for carrier current	24.75
BC221 Freq. Meter	64.75		
BC 191 Clean Condition	85.00		
25-Prec. W W Resistor kit	2.95		

## ELECTRONIC SPECIALTY SUPPLY CO.

56 LISPENARD STREET

NEW YORK 13, N. Y.



1/2 hr. timer 1/2 min. grads. rings buzzer at end of time interval—Telechron Motor & Micro Switch constr. 115V. AC. 10 Amp. Cap. 10% "L, 5% "H., 3% "W....\$7.50 ea.

AMMETER, 150/300 dual range Triplet 341A 3 1/2" rectangular flush bakelite 5 amp Movement @ \$4.95 with external current transformer for 150 amp. Only \$7.50



DELCO BLOWER — sirocco type D.C. Flange diameter 3 1/2" blade 3-3/16" RPM @ 12 volts 3400 RPM @ 6 volts 1600 .....\$3.95



G. E. Model 6RS 5FB3 full wave 3 plate bridge (12 plates) maximum A.C. input 54 volts maximum D.C. output 40 volt D.C. current 0.150 .....\$1.15 ea.



SILVERPLATED REFLECTOR—Overall Dimensions 4 1/2", Reflecting Surface 4 1/4", Depth 1 1/2", Individually boxed 25¢ ea. \$20.00 per 100.



Miniature lamp T1 1/4, 3 volt .19 amp. Airplane Indicator, Amb. Ctd. 10 for .....\$1.00 100 for .....\$8.50

VOLTMETER Weston 833 130v. A.C. 400 cycles 2 1/4 flush bakelite Aircraft mounting black scale Fluorescent numerals removed from new equipment.....\$3.50

SEND FOR FREE BULLETIN



ALL PRICES F.O.B. N. Y. CITY

## D.C. MICROAMMETERS

- 0-200 ua 3" sq. G.E. DO 50.....\$ 0.00
- 0-100 ua 3" sq. G.E. DO 50..... 10.00
- 0-50 ua 3" sq. G.E. DO 50..... 12.00

## PRECISION PORTABLE INSTRUMENTS

Single or multi-range  
D.C. Microammeters, from 5 ua full scale. Thermo-couple Milliammeters, from 1.5 Ma. Thermo-couple voltmeters.

## Precision Electrical Instrument Co.

146 Grand Street New York 13, N. Y.

## SORRY, NO RETAIL

- 50M Moulded Bushings for Pencil Flashlights.
- 30M Two-prong Sockets (for batteries).
- 1800—Jan 559 RCA Boxed Tubes.
- 1500—371A & 371B Jan Tubes.
- 1500—800 RCA — 2000—1630 RCA Boxed Jan. 75—4P10 CR Tubes—15—5 CPl Tubes CR.
- 50—Dynamotor AD-2—14V.—3A.—220V.—06A.
- 2000—T 4 1/2 Bayonet 6.3 Volt.
- 3000—Rheostats—15 Ohm 3 Watt.
- 5000—Toy Telekeys (cheap).
- Various Large Antennas.
- 400—2-tube Ampl. (Chassis only, no Tubes or Spker).
- 600—3-tube Ampl. Chassis (partly assembled).
- 500—Dual Coil Sets (F & N Ranges) for RU-17 Aircraft.
- 500—Coil Sets CW 47135 (Range 2000-2500 KC).
- 25M Pilot Lights, Screw Base—Six Volt.
- 3000—2650 Mid., 3 VAC. Sprague & Solar FP.
- DM-5004 Input 18V-3.2A output 450V-60MA
- DM-28R Input 28V-1.25A output 220V-70MA
- DM-32 input 28V-1.1A output 250V-60MA
- DM-32A input 28V-1.1A output 250V-60MA
- DM-33 input 28V-1.6A output 575V-160MA
- DM-53A input 24V output 200V
- BD-87C part of BC224—BD-AR-93 P/O SCR-AR-283
- PE-73E & PE-73EM P/O SCR 287
- PE-86 & PE-86E P/O RC36 input 22-32V—250V 80MA
- PE-216A P/O SCR 519A input 25-28V—115V
- PE 218C-D-E P/O SCR 519, 717, 720—25V-115V
- LARGE QUANTITY ANTENNA SURPLUS—MASTS & BASES

### GOULD GREEN

252 Greenwich St. N. Y. C. 7



**CHECK THESE MONEY-SAVING SURPLUS "BUYS"!**

Clearance of Our Entire Stock of

**TECH MANUALS**

Out goes our entire stock of over 10,000 valuable, useful Tech Manuals at these drastically reduced prices—covering every phase of telephone, teletype, power units, transmitters, receivers, remote controls, etc. Check this list carefully—and buy what you need for today and the future! All prices are postpaid and include shipping and handling costs!

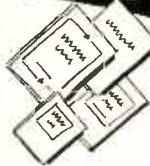

- TRANSMITTERS-RECEIVER MANUALS**
- SCR-536 TM11-235 Handie Talkie \$1
  - SCR-608-628 Tank Set \$2
  - SCR-593 \$1
  - SCR-508, 528, 538 TM-11-600 \$2
  - SCR-506A, TM-11-830 \$2
  - SCR-593A \$1
  - SCR-543 TM-11-850 \$1
  - SCR-300A, TM-11-242 \$1
  - AN/TRC-1, 2, 3, 4, TM-11-2601 \$1
  - AN/TTQ-1, 2 Tools, Gauges, & Maintenance Equipment, \$50
  - TCS Transmitter-Receiver Manual \$3
- TELEPHONE & TELETYPE EQUIPMENT MANUALS**
- Model 14 Type Bar Tape Prints, Parts List & Photos \$1
  - Model 14 Teletype Performer \$1
  - Western Electric Voice Frequency Ringer Packaged Equipment \$1
  - Western Electric Voice Frequency Telephone Repeaters, Packaged Equipment \$1
  - Telephone Central Office Set, TC-2 \$1
  - Telephone Central Office Set, TC-4 \$1
  - Telephone Central Office Set, TC-10 \$2
  - Repeater Set TC-19, TM-11-2005 \$1
  - RC-261 TM-11-2632 Remote Control Equipment \$1
  - BE-77A TM-11-359 Line Unit \$1
  - BD-71 Switchboard \$50
  - AN/TRA-2 Remote Control Equipment \$1
  - TS-26/TSM TM-11-2017 Test Set \$1
- POWER UNITS & RECTIFIERS TECH MANUALS**
- PU-58/12 Generator Set \$1
  - PE-49F Generator Set \$1
  - PE-75 Generator Set \$1
  - RA-34 TM-11-959 Rectifier Unit \$1

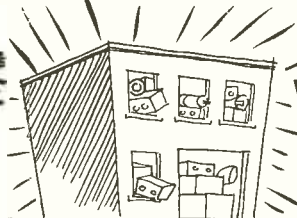

**WAREHOUSE SALE! CLEARANCE SALE!**

Now is the Time to Stock up and Save on all your Equipment! We need the precious warehouse space—and especially the ready cash—and you need the equipment. So take advantage of these drastically slashed prices now, while present quantities last! Thousands of items on sale not listed here—send us your requirements!

- GADGET MOTORS**  
Clearance priced at \$1.99  
Here is a pioneer dynamo motor original specification, 18 volts, in. 450 volts out. With a few minutes work and the simple instructions furnished, it becomes a beautiful motor with 2 open shafts suitable for grinding, polishing, gadget turning. No tools needed. Shipping wt. 10-lbs.
- HI-CAPACITY, LO-VOLTAGE CONDENSORS**  
79¢ ea. 4 for \$3  
This is a really hot bargain! FB for better eliminators, generator filters, etc. 2000 MFD, 25 WV. Brand new. Compare this price anywhere.

- RADIO INTERFERENCE FILTERS**
- 7841, 5 amps. \$3.95
  - 7842, 10 amps. 4.95
  - 7843, 20 amps. 5.95
- Great for shops, labs, factories, etc. Mfgd. by Miller Coil Co., Maximum voltage 220. All enclosed in beautiful black wrinkle case, ready for mounting.

- REPLACEMENT POWER TRANSFORMER**  
for Hallicrafter 5X-28 Receiver  
A Real Buy at \$5.95  
This is really a big baby. Primary 115-230 V., 50-60 cycles. Secondary 700 volts, CT, 200 MA. Plus filament windings.

**Clearance of DYNAMOTORS! Compare These Prices!**

Type	Volts	Volts Amps	Price
PS-225.....	14	375 .150	\$4.50
BD-AR93.....	28	375 .150	3.50
PE-86.....	28	250 .060	2.50
DM-32A.....	28	250 .083	2.50
377.....	14	425 .163	4.95
DY-8/ARC-5.....	28	540 .250	3.95
DM-24.....	13.8	220 .070	7.50
DY-22/ARC-3.....	28	210 .125	9.95
RU.....	14	320 .170	3.95
PU-43A.....	24	115 .800/cycles	17.50

MC-124 246-Inches TUNING SHAFTS, Special! .....\$4.75

WE PAY TOP \$ FOR EQUIPMENT Send us your list and be pleasantly surprised.

- Compare These MOUNTING RACKS Clearance Prices!**
- MT-171/U (Double ATR) \$2.50
  - MT-167/U (Single ATR) 1.50
  - MT-108/APX-1 (BC-966) 2.00
  - MT-137/APQ-13 (Scobe) 3.50
  - MT-14/ARN-1 2.50
  - MT-149A/APS-13 2.75
  - FT-213A (SCR-629 Compass) \$2.50
  - FT-291 (Loran with tilt) 3.00
  - FT-446 (Loran) 2.00
  - FT-409 (BC-929 Scobe) 2.00
  - FT-225A 1.00
  - FT-227A 1.00

**ORDER DIRECT FROM THIS AD**

Prompt shipment of all orders. Cash with order. Minimum order \$3.00. 35% deposit on all C.O.D. orders. Shipments by truck or RR Express collect. California buyers please add state sales tax. All prices subject to change. All merchandise subject to prior sale.

**A Complete FOREIGN DEPARTMENT Fully Staffed For EXPORT ORDERS**  
We maintain a complete staff of Export Specialists to take care of all Foreign Orders. Correspondence and prompt replies in all languages. Address: "Foreign Department, Alvaradio".

**ALVARADIO SUPPLY CO.**

Dept. L-14, 341 S. Vermont Ave., Los Angeles 5, Calif., DUNKIRK 8-2211

**FOR SALE TELEVISION TUNER TEST EQUIPMENT**

Centralized system to provide 12 sound carrier frequencies, amplitude modulated, simultaneously, to multiple test positions for rapid production alignment of TV tuner oscillator circuits.

Consists of two RCA studio type equipment cabinets containing:

- (a) 12 Crystal controlled oscillators, Channels 2 through 13
- (b) 6 Phase shift audio oscillators and 1 interrupter unit to modulate and identify the carriers.
- (c) 2 Electronic mixing units for combining 12 carrier frequencies
- (d) 2 Electronic distribution units with 10 output circuits each.
- (e) 3 RCA Type 580C Regulated "B" power supply units
- (f) Filament supply transformers, power control panels, spare crystals, spare oscillator, etc.

All equipment is custom built, plug-in unitized construction, and designed for continuous production usage.

Accessory equipment for individual test positions includes:

- (g) 8 I.F., discriminator, and audio amplifier units
- (h) 10 Regulated "B" and filament supply units, etc.

Only one complete system available as described. Condition like new. Priced at less than half original cost. Immediate delivery. Phone, write, or wire for complete details.

**ELECTRO ENGINEERING & MFG. CO.**  
627 West Alexandrine, Detroit 1, Michigan Temple 2-2330



**MARKTIME 5 HOUR SWITCH**

A 10 amp. timing device. Pointer moves back to zero after time elapses. Ideal for shutting off radios and TV sets when you go to bed. Limited supply at this special PRICE..... \$4.90

Also available in 15 min.-30 min.-1 hr. at \$5.90  
Steven-Arnold Resonant Relay. Only two types in stock. 442 and 240 CPS either one..... \$4.50  
Both for \$8.00

**ALNICO LUCKY 17% COBALT PURCHASE ENABLES US TO OFFER YOU THESE ACTUAL SIZE MAGNETS! 39¢ EACH 3 FOR \$1.00**

**ISOLATION TRANSFORMER \$1.95**  
Nat. known Mfgs. 50 watt 2 windings, 115 V. to 115 V. 60 cy. Ideal to prevent shocks from small radios and medical and electronic devices.

**ELAPSED TIME METERS \$15.50**



**GONIOMETERS**  
Micro Switch  
Solenoids  
Relays  
Electric Counters

EST. 1923 **BLAN** EST. 1923  
64 Dey St., New York 7, N. Y.

**Genuine TELECHRON Motors**



- 2 RPM ..... \$2.90
- 3.6 RPM ..... 3.15
- 1 RPM ..... 3.95
- 60 RPM ..... 4.30
- One of Each \$12.00

CH 4 pole 35 ampere 115v. AC relay. \$4.90  
GE 3 ampere Mercury Switch 1/2" glass tube... 3 for \$2.50



**ANNUNCIATOR DROP**  
250 ohms, will drop on 12 volts or more \$1.00  
6 for \$5.00

**HOLTZER-CABOT M.G. 218. CONVERTER 400 CYCLE 110V A.C. 1 AMP \$49.50**  
1/4 H.P. D.C., 110V MOTOR

**WESTON Model 528 3 Amp. and 15 Amp. A.C.**  
With test leads in a leather case. Made for U. S. Army for Refrig. \$18.75  
Motor Testing .....

**1951 TV Remote Control Motor Unit**  
Ready to attach to any device that needs turning from remote point. A complete \$30.00 unit made by one of the greatest Video Companies. Sorry, can't name it!... \$13.95

**10 MFD.....600 VOLTS.....75 CENTS**

Although rated at 400V against an operating temperature of 72°C, these nationally famous 5-4-5 MFD capacitors will meet all commercial specifications and operate at 600V provided that the operating temperature does not exceed 40°C. Measuring 3 5/16 x 2 x 3 25/32 and packed 24 to a carton, weighing 42 pounds this item fills the need for an excellent filter and power correction device. Long lasting, extremely low in dielectric leakage and available in sufficient quantity for a large manufacturer. Small quantities—\$.57. Carton quantities—\$.65. Samples upon request.

**WESTON LABORATORIES Weston 93, Massachusetts**

# BRAND NEW STANDARD BRAND TUBES

OB3/VR90 \$1.25	3B7/1291... .49	19Y..... .75	530..... 12.50	802..... 4.49	869B..... 39.50	8011..... .98	CATHODE RAY TUBES
OC3/VR105 1.25	3B22/ELIC. 2.75	12A6..... .79	531..... 10.95	803..... 3.95	872A..... 2.39	8013A..... 4.95	3CP1/S1... 1.95
OD3/VR150 1.05	3B26 3.25	24C..... 1.95	533..... 175.00	804..... 9.95	874..... 1.49	8020..... 1.50	3DP1..... 4.95
1B22..... 3.25	3C24..... 1.95	39/44..... .49	539..... 3.95	805..... 3.95	876..... .59	8021..... 1.49	3FP7..... 1.95
1B26..... 2.75	3C28..... 4.95	45 Spec..... .35	700A..... 27.50	807..... 1.79	879..... 1.43	8025A..... 7.95	4AP10..... 4.95
1B27..... 19.95	3D6/1299... .49	100TH..... 8.75	701A..... 4.95	810..... 10.95	931A..... 5.75	9001..... 1.95	5AP1..... 3.49
1B29..... 4.75	3D23..... 4.95	152TH..... 19.95	702A..... 3.49	811..... 2.95	954..... .35	9002..... 1.49	5FP7..... 3.95
1B36..... 23.75	4A1..... 1.75	205B..... 3.95	703A..... 7.49	812..... 2.95	955..... .55	9003..... 1.25	7BP5..... 18.95
1B56..... 47.50	4B28/S2894 4.75	211..... .75	704A..... 1.00	813..... 7.95	956..... .69	9004..... .45	7BP7..... 6.95
1D8GT..... .89	4E27/257B. 15.95	217C..... 18.00	705A..... 2.89	814..... 3.95	957..... .35	9005..... 1.90	9LP7..... 12.95
114..... .89	4J22..... 149.50	250R..... 18.95	707A..... 12.95	815..... 3.49	958A..... .49	9006..... .35	10BP4..... 18.95
1R4/1294... .69	4J26..... 159.75	250TH..... 23.25	707B..... 17.50	829..... 11.95	959A..... .69	C5B..... 8.95	12LP4..... 21.50
2C22/7193... .35	4J34..... 195.00	250TL..... 19.95	708A..... 4.75	829B..... 14.95	1608..... 4.95	C6A..... 6.95	12LP4A... 22.25
2C26..... .39	4J35..... 195.00	285A..... 10.95	710A/8011... .98	830B..... 3.75	1609..... 4.95	C6J..... 5.95	14BP4..... 26.50
2C34 RK34... 2.95	4J42/700A... 27.50	286A..... 18.95	713A..... 1.25	832A..... 9.95	1613..... .99	CRP72..... 1.98	16DP4A... 34.00
2C40..... 4.99	5D21..... 24.50	304TH..... 13.95	714AY..... 12.95	832B..... 8.95	1616..... .95	E1148..... .35	16RP4..... 37.00
2C44..... 1.49	6AJ5..... 2.25	304TL..... 12.95	715A..... 6.95	836..... 2.95	1619..... .45	FG81A..... 7.69	17BP4A... 37.00
2J22..... 7.95	6B8..... .98	307A..... 5.75	715B..... 12.75	837..... 1.65	1622..... 2.29	FG104..... 19.95	19AP4A... 62.00
2J26..... 24.50	6C8..... .88	310A..... 6.95	715C..... 24.50	838..... 2.95	1624..... 1.75	HY114B... .75	19AP4B... 62.00
2J36..... 89.50	6C21..... 19.95	319A..... 1.50	721A..... 4.95	846..... 8.46	1625..... .75	HY115..... .29	20CP4..... 68.50
2J61..... 44.95	6F4..... 5.75	329A..... 8.95	722A..... 2.49	851..... 49.50	1629..... .35	REL5..... 175.00	
2J62..... 44.95	6J4..... 5.95	331A..... 11.95	722A/B..... 19.95	850..... 5.95	1636..... 3.25	RK34..... .29	
2K25..... 24.95	7A7..... .89	353A..... 4.95	725A..... 3.49	861..... 24.50	1642..... .98	RK72..... 1.65	
2V3G..... .98	7C4..... .49	371B..... .95	725A..... 1.50	864..... .75	1851..... 1.75	RK73..... 1.65	
2X2..... .75	7E5..... .79	388A..... 1.50	725B..... 12.95	864..... 13.95	2051..... 1.39	VT90..... .98	
3A4..... .55	7E6..... .69	450TH... 39.50	730A..... 13.95	865..... .49	866A..... 1.35	VT98..... 175.00	
	7F7..... .95	450TL... 44.50	801A..... .49				

## MARITIME INTERNATIONAL COMPANY

11 State Street, New York 4, N. Y.

Cable Address "Foxcroft"

Phones: Dlgby 4-3192-3



- ★ SMASH INTRODUCTORY SALE!
- ★ Warehousefull of items you've been looking for—
- ★ at right prices! Tell us your needs. Here are some samples.

RCA SOUND POWERED HAND SETS: Type M1-2040-A and TS-10. Brand new. EACH... \$17.95 PAIR for only... \$29.95  
 BC-969A RECEIVER: Frequency range 15 kc-150 kc. in 3 bands. 12 V AC or DC or 250 VDC. Has noise limiter, crystal filter and BFO. Practically new. SPECIAL... \$150.00  
 GENERATOR: 500 W. Type CV47/CN7, 110-120 VAC, 60 cye. Has cye. Brings Stratton Motor. Runs 48 hours on tank of 80 octane gas. Automatic or manual starting. Good cond... \$159.50  
 ART-13 AUTO-TUNE TRANSMITTER: Finest 100 W. transmitter model 813 in final, modulated by 311's. Complete with control box and 24 V. dynamotor. Excellent condition. SPECIAL... \$299.50

### TUBES! ALL BRAND NEW! BOXED!

701-A \$ 4.50 2162..... \$34.50  
 706-BY..... 29.95 304TL..... 9.00  
 706-EY..... 29.95 C5B..... 9.95  
 SIGNAL GENERATOR: I-222A. Freq. 2 bands: 8-15 mcs and 150-230 mcs. Can use up to third harmonic. 110 VAC, 60 cye. Easily made continuous tuning by adding coils. Like new... \$99.50

### METERS! BEST BUYS IN THE BOOK!

WESTINGHOUSE CYCLE METER: 5 1/2 in. square. Type HY. 58-62 cye. per sec. Good cond... \$8.00  
 REDUCED TO: \$6.00  
 PERCENT METER: 2 1/2 in. round in metal desk case. Has 5 mil basic movement. Scale 0-150%. Can be used on P. A. up to 375 W. Like new with plug-in cord. THIS MONTH ONLY... \$7.95

0-12 amp RF 2 1/4 in. rd. Thermocouple-type... \$3.50  
 0-9 amp RF 2 1/4 in. rd. Thermocouple-type... 3.50  
 0-25 mil DC 2 1/2 in. rd..... 3.50  
 0-15 VAC, 600-800 cycles..... 3.50

AZIMUTH CONTROL INDICATOR: C.A.A.T.C.-99, for MN-28 Compass. New. INTRODUCTORY PRICE: \$9.50

BC-221 AK FREQUENCY METER: Modulated model. Like new... \$125.00  
 BC-221Q FREQUENCY METER: Modified to 110 V. 60 cye. operation. Like new... \$100.00

### SPECIAL PURPOSE CONDENSERS

2 x 8 mfd. 600 VDC New..... \$2.25 USED..... \$1.50  
 4 x 6 mfd. 600 VDC New..... \$7.95  
 .1 mfd. 15000VDC..... \$7.95  
 .045 mfd. 16000 VDC..... \$9.50

All items subject to prior sale. 25% deposit required unless company purchase order is forwarded.

### COLUMBIA ELECTRONICS SALES

522 South San Pedro St.  
 Los Angeles 13, Calif.

### ELECTRONIC TUBE-MAKING MACHINERY

For manufacturing radio tubes, electronic tubes, cathode-ray tubes, lamps. New and used. Reasonably priced, satisfaction guaranteed.

AMERICAN ELECTRICAL SALES CO.  
 67 E. 8th St. New York, N. Y.

Ballentine . . . TSL-394 . . . Dumont . . . IE-19 . . . R.C.A. . . . TS-170 . . . Hewlett-Packard . . . TS-3 . . . General

Marion  
 . . . Pennsylvania . . . TSX-4SE . . .  
 . . .

## TEST EQUIPMENT

The largest and most varied stock of Electronic Test Equipment available is performance guaranteed by the unexcelled facilities and competent engineers of

### WESTON LABORATORIES

Weston 93, Massachusetts

Boonton . . . TS-14 . . . Stoddard . . . TS-173 . . . Lavoie . . . TS-27 . . . Precision . . . TS-100 . . . Shallcross . . . BC-787

Radio . . . I-208 . . . Ferris . . . TS-34 . . .

## DEPENDABILITY IN ELECTRONICS

WE ARE NATIONAL DISTRIBUTORS OF PARTS, TUBES AND EQUIPMENT. WE SOLICIT INQUIRIES FROM ORGANIZATIONS WHO APPRECIATE INTELLIGENT SERVICE AND HONEST PRICES, PARTICULARLY AT THESE CRITICAL TIMES.



## SELENIUM RECTIFIERS

F.W.B., FWCT, 3Φ, Volt. DBLR, etc.

Finest materials, workmanship and immediate deliveries.

### Full Wave Bridge Types

	18/14	36/28	54/40
2 amps	\$2.50	\$2.75	\$5.25
4 "	4.00	5.50	
8 "	6.00	7.50	
12 "	8.00	10.00	
24 "	12.00	20.00	

SPECIAL TYPES TO ORDER.

Inquire for quantity prices

### BARRY ELECTRONICS CORP.

136 Liberty St. New York 6, N. Y.  
 Phone: REctor 2-2563

25% deposit with orders—or send full remittance to save C.O.D. charges—rated firms (D&B) net 10 days.

All merchandise fully guaranteed

IF THERE IS

Anything you want

that other readers of this paper can supply

OR—

Something you

don't want

that other readers can use, advertise it in the

SEARCHLIGHT SECTION



# BIG SAVINGS FOR YOU

## COMMAND AND/OR ARC5 TRANSMITTERS and RECEIVERS

BC-442 Antenna Relay, Less Vac. Cond.	USED NEW	
BC-450 3 Receiver Control		1.49
8-6 MC Receiver	5.95	\$11.95
6-8.1 Receiver	6.95	9.95
Triple Receiver Rack		\$1.95
V.H.F. ARC5 Transmitter or Receiver Complete w/tubes		24.95
2.1-8 MC Transmitter w/tubes		14.95
4-5.3 MC Transmitter w/tubes		5.95
5.3-7 MC Transmitter w/tubes		5.95
7-8.1 MC Transmitter w/tubes		19.95
8-4 MC Transmitter w/tubes		18.95
28V Receiver Command Dynamotors		\$0.97
<b>MODULATORS</b>		
BC-456 with Tubes, less dyn.		2.95
MD-7/ARC5 Plate Modulator		7.95
MD-7 Modulator Dynamotor, 28V.		3.95
<b>USED NEW</b>		
BO-433 Receiver—w.o. tubes		\$12.95
with tubes		24.95
MN-26C Compass Receiver		\$39.50
BC-1206 Receiver 200-400 kc.		5.95
BC-357 Marker Beacon Rec. W.O. Tubes		4.95
BC-733D w/o tubes		6.95
w/tubes		19.95

BC-375 Trans. 100 Watt Voice, CW, MCW, freq. range 200 kc to 12 mc, uses Plug-in Tuning units listed complete with tubes, less Tuning Units \$18.95 \$24.95

**TUNING UNITS for BC-375 or 191 Trans:**

TU-7 4500-6200 kc	\$2.49
TU-8 6200-7700 kc	2.49
TU-9 7700-10000 kc	2.49
TU-10 10000-12500 kc	2.49
TU-22 & TU-28 200-500 kc	each 4.50
FT-151 Shock Mounting for BC-375 or 191	2.95
BC-308 Antenna Loading	1.95

GP-7 NAVY TRANSMITTER: 100 watt master os. Can use on any freq. from 350-9050 kc. by using proper plug-in. Comes with 1 tuning unit. **\$13.33**

### LOOP ANTENNAS

DU-1 Has 2 tube amplifier	New	\$25.95
MM-20-E	New	7.95
LP-21 A	New	8.95
FL5 Filters—A's, B's, C's	New	\$1.95
FL5 Filters	New	.79
Hand Keys—J-38	New	.79
TSC TRANSMITTER & RECEIVER with 12V Power Supply and Cables, Good—used		179.50
Heinemann Circuit Breakers, 115 V., 20 amp.		1.39
115 V., 5 amp.		.97
Prop Pitch Motors	New	13.95
Prop Pitch Motors—with Transformer	New	19.95
Prop Pitch Transformer, only	New	6.95
ET-7APN-1 Transceiver, tubes & dyn.	Used	9.95

### TRANSFORMERS

\$200V 300 ma NCT	\$8.95	Pair \$15.95
12V 24V 2am 110V primary		2.95
ARC-4 2 Meter Transceiver, tubes—good, used		\$39.00
522 2 Meter Transceiver with tubes—good, used		59.50
BC-434 Control	Used—\$1.95	New 2.95
Code Practice Tapes for TG-10 15 rolls	New	7.95
BC-908 Absorption Type Freq. Meter. Range 150-225 mc. 0-500 DC Microammeter		\$11.50
Used		14.95
Field Phones E-E 8's	Used \$15.95 pr.	New \$34.50 pr.

### DYNAMOTORS

PE-103 NEW, ORIGINAL CASE	\$29.95
PE-103 NEW, Less Base—Dynamotor	19.95
DM-32A Input 28V. Output 250 DC, .06 amps.	Used 1.95
DA-1A Input 28V @ 1.6 amps. Output 230 DC @ .1 amp.	Used 5.95
PE-73 29V @ 20 amps. output 1000V @ 350 amps	New 5.95
PE-77 14V @ 40 amps output 1000V @ 350 amps	New 15.95
SPECIAL 27V @ 400V @ 7.50 mil 750 V 560 mil	New 12.95
PE-94 or SCR—522 24V Used	\$5.95 New 14.95
DM-34 12V @ 2.8 amps. Output 220V @ 150 amps	New 9.95
SPEC. 9V @ 450V output @ 80 ma.	New 5.95
SPEC. 12V @ 320V output @ 80 ma.	New 4.95
SPEC. 6V @ 250V output @ 80 ma.	New 5.95
SPEC. 12V @ 440V output @ 200 ma.	New 8.95
ARC-1 D-V/ARC-1	Used 11.50
ARC-1 Dy-10-12V	Special 9.50

633 FM Receiver 26 to 39 mc FM Receiver with tubes—used	\$29.95	New \$39.50
EL-42B Antenna Reel Assem. Less wire	New	9.95

### OIL CONDENSERS

Standard Makes—Now			
2 mfd 600V	\$ .49	10 mfd 600V	\$ 1.95
4 mfd 600V	1.39	2 mfd 2500V	2.95
1 mfd 1000V	.69	2 mfd 4000V	5.95
3 mfd 4000V	7.95	2 mfd 6000V	8.95
2 mfd 10000V	24.95	2 mfd 7500V	19.95
T-30 Throat Mikes		\$ for \$0.50	
CD-307 Head Set Extension Cord			.89

### HEAD SETS

HS-30	New—\$1.69
HS-33	New—\$3.95
HS-33	Used—\$1.19
HS-25	Used—\$1.19; New—2.95
Matching Transformers for HS-30	.69
EC-348 Mounting Base	\$2.49
EG-7U Coax Cable, 97.5 ohms	foot .08
MIKE CHEST SET, "F-1" button	New—2.95

CASH WITH ORDER. PRICES SUBJECT TO CHANGE WITHOUT NOTICE. . . . MANY MORE ITEMS.  
California Orders Please include 3 1/4% Sales Tax

## SAM'S SURPLUS

1310 BOND ST., LOS ANGELES 15, CALIF.

# TEST EQUIPMENT

TS-3	TS-59	TS-146	BC-978	OAV-1
TS-6	TS-61	TS-153	BC-1236	W-1158
TS-10	TS-62	TS-155	BC-1277	
TS-14	TS-74	TS-159	CLQ-60	Trans.
TS-15	TS-76	TS-174	D-150637	APQ-2
TS-16	TS-91	TS-203	I-143	APT-1-2-5-5A
TS-19	TS-92	TS-206	I-196	ARQ-8
TS-23	TS-98	TS-218	I-203A	ART-2-7
TS-24	TS-100	TS-226	I-208	AXT-2
TS-26	TS-102	TS-268	I-212	TPS-2
TS-27	TS-111	APA-11	I-223	
TS-33	TS-118	BC-221	LM-8	RECVRS.
TS-35	TS-125	BC-376	LM-15	APN-9
TS-36	TS-126	BC-638	LS-1	APR-5A
TS-45	TS-127	BC-905	LW	ARN-8
TS-47	TS-131	BC-906	OAP-1	ARQ-8

RECEIVERS CPN-3 RA 10 DB TPS-2 RT-48ATPX-1

COMMUNICATIONS, BEACON, LORAN, IFF AND RADAR

SCR-717B; APS-(2)(3)(4)(15); APQ-13

MAGNETRONS POWER UNITS ANTENNAE INDICATORS  
TURBO AMPLIFIERS CONTROL AND JUNCTION BOXES, Etc.

# LERU LABORATORIES, INC.

360 BLEEKER ST.

NEW YORK 14, N. Y.

ORegon 5-3525

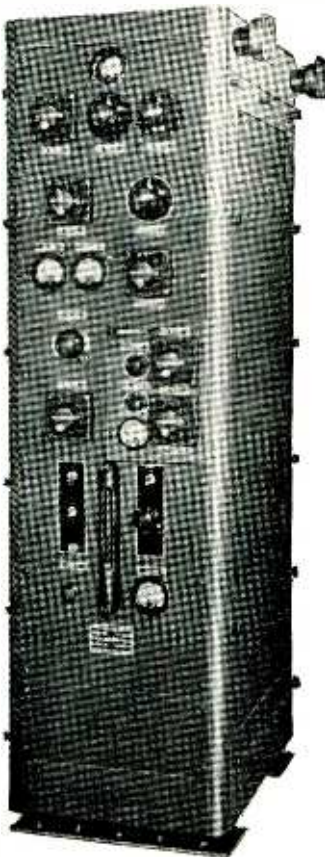

## R.C.A. Model MI-8167

# TRANSMITTERS

Point-to-point communications

Freq. Range: 2000 to 20,000 Kcs.  
Output: 350 Watts C.W.  
250 Watts Radiotelephone  
Input: 190 to 250 Volts AC 50/60 cps.  
Size: 60" high, 17" wide, 27" deep  
Tubes: 807s, 813s, 805s, 866s  
Master Oscillator unit built-in, fully shielded and stable. All self contained including antenna network. Crystal Multiplier units (available) fits in place of M.O. unit. Speech amplifier is only external unit and has 110/220 AC input, four stages, high gain. Total net weight, 625 lbs.

COMPLETE! NEW! QUANTITIES!

Also, Handy-Talkies, Walkie-Talkies, Portable Radars, Search Receivers, etc., Pictorial Listings on Request.

### TRANSMITTER-RECEIVER COMBINATIONS

**BENDIX** 70 watt transmitter and receiver for 24/28 volt DC input. Complete and New, with spares. R.C.A. 10 Watt portable—mobile—aircraft. Receiver and transmitter; phone—CW. 6 or 12 volt input. NEW COMPLETE.

**COLLINS** TCS. 12 Volt DC or 110/220V AC input to transmitter and receiver. Complete with all accessories and remote control — speaker, spares available.

**JEFF.** Travis Radiotelephones for small craft. 6 Volt, 2 channel, compact, complete, 5 watt, NEW.

Other choice selected combinations for all purposes and power outputs.

## COMMUNICATION DEVICES CO.

Cable: COMMUNIDEV

2331 TWELFTH AVE  
N. Y. 27, N. Y.

Tel: AD-4-6174, 5

## SILVER TRIMMERS TYPE TS2A

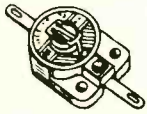

**SINGLE**  
TS2A

Capacity	Price ea.
1.5—7 MMFD	\$ .60
3—13 MMFD	.60
3—30 MMFD	.60
4.5—25 MMFD	.60
4—30 MMFD	.60
7—45 MMFD	.60

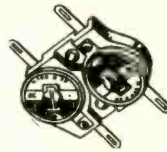

**DUAL**  
TD2A

Capacity	Price ea.
3—12 MMFD	\$1.00
3—17 MMFD	1.00
5—20 MMFD	1.00
7—45 MMFD	1.00

Deduct 10% for Quantities of 1000 or More of Assorted types

Write for FREE Bulletins on Coaxial Cables, AN & UG Type Connectors, Oil Capacitors, Resistors and Pots

## LIFE ELECTRONIC SALES

345 Broadway New York 13, N.Y. Tel. Dlgy 9-4154

### SAVE \$\$ ON BRAND NEW TUBES

1B3GT	\$1.32	4J31	\$89.50	723A/B	\$14.95
1B22	2.95	6AB7/1852	1.39	724B	2.75
1B27	17.95	6AS6	3.19	725A	5.95
1B38	29.95	6B8	1.39	726C	49.50
2C40	9.95	6F4	4.50	832	5.95
2C44	1.44	6K4	3.19	832A	9.95
2C51	4.95	65H7GT	.89	836	3.95
2D21	1.59	12A8	.98	837	1.95
2J21A	14.95	12H6	.89	872A	2.75
2J22	22.95	32L7GT	.79	884	1.75
2J31	34.50	250R	9.95	1616	1.38
2J32	37.50	304TL	12.50	1625	.45
2J33	37.50	446A	1.19	1629	.39
2J34	37.50	446B	1.65	8020	1.98
2I62	38.95	464A	9.95	8025	4.95
3E24	3.50	700A/B/D	16.95	9001	1.75
3E29	14.50	706CY	39.50	9002	1.50
3Q4	.98	706GY	49.50	9003	1.75
354	.98	707B	14.95	9004	.75
4C35	29.95	717A	1.19	9005	1.75

PLUS MANY OTHERS NOW IN STOCK! 25% Deposit with order—Balance C.O.D.  
We Carry a Complete Stock of Radio & TV Tubes & Electronic Parts. Send us your inquiries. Dept. E-1, 7552 Melrose Ave., Los Angeles 46, Calif. **J. S. H. SALES CO.** WE PAY HIGHEST PRICES FOR SURPLUS STOCKS OF TUBES & ELECTRONIC PARTS. Send us your list.

## UTAH 9278



**SCOOP! SCOOP! SCOOP!**  
LUCKY BUY UNCOVERS LAST of the NEW UTAH X124T3 TYPE PULSE TRANSFORMERS

- ★ ORIGINAL UTAH CARTONS OF 70
- ★ NO CRACKED GLASS SEALS
- ★ NO SALVAGED JUNK
- ★ 981 PIECES IN STOCK

Write for prices, giving exact quantity required.

also: UX7350, UX10066, K54J318

See pages 310 & 311 for other listings.

**HAROLD H. POWELL**

632 ARCH STREET

Market 7-5650

Phila. 6, Pa.

## TUBE SPECIALS

1B42	\$7.25	328-A	\$12.50
1L4	.95	807	1.55
1N21	1.25	816	1.10
5D21	20.00	913	10.00
6V6GT	1.25	1619	.55
89	.75	1624	1.65
100TH	9.00	8025	5.00

See last issue for others.

**ARCBY ELECTRONICS**

103 WEST LIBERTY  
LOUISVILLE, KY.

## CONDENSERS

### OUR SPECIALTY

OIL FILLED & TRANSMITTING MICA TYPES

All Values and Voltage Ratings  
We Invite Your Inquiries

**TECHNICAL RADIO PARTS CO.**  
557 McDonald Ave., Brooklyn 18, N. Y.

## FOR SALE

Beryllium Copper Strip  
.0062 (+ - .0005) x 5" x 60"  
No. 1 — B & S Hard  
700# Available

**GLOBE TRADING COMPANY**  
1815 Franklin Street Detroit 7, Michigan

## Quick ANSWERS to your business problems . . .

**H**UNDREDS of miscellaneous business problems can be quickly and easily solved through the use of the Searchlight Section of this or other McGraw-Hill publications.

The Searchlight Section is classified advertising; you can use it at small cost, to announce all kinds of business wants of interest to other men in the fields served by these publications. It is the accepted meeting place of men with business needs and the men who can fill those needs.

When you want additional employees or a position, want to buy or sell used or surplus equipment, want products to manufacture, seek new capital or have other business wants—advertise them in the Searchlight Section for quick, profitable results.

The  
**SEARCHLIGHT** Classified  
**SECTIONS** Advertising  
**OF McGRAW-HILL**  
**PUBLICATIONS**

American Machinist  
Aviation Week  
Business Week  
Bus. Transportation  
Chemical Engineering  
Chemical Industries Week  
Coal Age  
Construction Methods & Equipment  
Electrical Construction & Maintenance  
Electrical Merchandising  
Electrical World  
Electronics  
Engineering and Mining Journal  
E. & M. J. Metal & Mineral Markets  
Engineering News-Record  
Factory Management and Maintenance  
Fleet Owner  
Food Industries  
Power  
Product Engineering  
Textile World  
Welding Engineer

Classified Advertising Division

**McGRAW-HILL PUBLISHING CO., Inc.**

330 West 42nd Street  
NEW YORK 18, N. Y.



**CONNECTORS - CLAMPS**

- WK 1-32
- 4-21
- C.3-23
- GK 9-21
- C.4-21.C
- C.8-32
- SK C.16-23
- C.16-32
- L.3-21
- NK C.23-23
- M.16-21
- S.10-23
- RFK 10-24.C
- B.18-31
- RGK M.5-24
- M.5-31
- RWK 6-24
- 6-31

NOW IN STOCK

Type	Each	Per 100
UG-21/U @	.95	\$87.50
M-359 @	.35	29.50
M-359-A @	.45	39.50
PL-259-A @	.60	54.50
UG-103/U @	.80	74.50
M-358 @	1.45	137.50
PL-274 @	1.45	137.50

**DAVID GREENBERG**

99 Murray St. N. Y. 7, N. Y.

Barclay 7-4862

**IMMEDIATE DELIVERY**

**RADAR**  
SCR 545A Search and Track. Complete trailer, power supply and spare parts. Nearly new. Write for description and price.  
**PORTABLE PUMP ASSEMBLY**  
Leland 110 v. 60 c. 1 ph. 1/3 H.P. motor and D. Roper #2 hydraulic pump. 300 lbs PSI max., 125 lbs. PSI continuous @ 3.25 gallons per min. \$52.00  
**SEARCH LIGHT**  
Signaling, 12" Curtis Lighting, Inc. 115 v. a-c or d-c. 1000 watt. Complete w/ bulb. Comes w/ mounting assembly that gives 360° horizontal rotation and 180° vertical rotation. \$27.50  
**AUTO-DRY AIRE**  
Model 220. 115 v. 60 cy. for pressurizing high altitude electronic equipment. \$160.00

**MOTORS**  
General Electric geared, 27 v. d-c @ 0.7 a., 110 RPM, 1 oz/ft torque. \$4.75  
Electric 1/15 H.P., 115 v. 60 cy. 1 ph. 1800 RPM \$4.75

**GENERATOR**  
Bendix model NEA3. Output 115 v. a-c 10.4 amps, 800 cy. SP. and 28.5 v. d-c, 80 amps @ 2400 RPM. Self excited, splined drive. New. Orig. packing. \$27.50

**BATTERY CHARGER**

**TRANSFORMER:**  
G. E. Cat. #WS-99316. Pri. 105-115-125 v. 80 c. Sec. 105-90-75-60-45-30 v. @ 8 amps. each side of center tap. Voltage reduced 10% and 20% thru tapped primary; two x 5v. 18 amp. C.T. (Tungar filaments) and two x 7 v. 10 amp. 7 1/4" h. x 8-3/4" w. x 5 3/4" d. Wt. 56 lbs. New, orig. packing. G. E. price \$52.00. \$17.50 2 for \$30.00

**POWER SUPPLY COMPONENTS TRANSFORMERS**

Plate, American Transformer Co. Spec. 29108. Pri. 115 v. 60 cy. 10.4 KVA. Sec. 17,800 v., 520 amps., 35 KVA test. \$65.00  
Plate, American Transformer Co. Spec. 29108. Same as above but center-tapped to handle 1 amp @ 8800 v. \$75.00

**NEW!**

- low prices
- values
- equipment
- components

Note: All merchandise not designated as new is guaranteed to be in excellent to new condition.

**EPCO**

1527 E. 7th St.  
Los Angeles 21, Calif.

**CONTACTOR**

Allen-Bradley & Westinghouse, 115 v. 60 cy. coil, DPST, 15 amps. \$4.95

**HIGH VOLTAGE RECTIFIER POWER SUPPLY**  
Variable output 0-15,000 v. d-c @ 500 mils. Input 115 v. 60 cy. SP. Army type RA-38. Size 6 1/2" x 5 3/4" x 5 6/8". Wt. 2040 lbs. Units are new, complete with spare tubes and remote control. Write for detailed information.

Filament, American Transformer Co. Spec. 29108, Type WS, .050 KVA, 50/60 cy. SP., 35 KVA. test, 12 KV d-c operating. Pri. 115 v., Sec. 5 v., 10 amps w/ internal stand-off insulator and socket for #371, 872, etc. rectifier tubes. \$12.50 2 for \$22.50—4 for \$40.00

**CAPACITORS**  
9-12 mfd., 1265 v. 60 c. a-c or 4000 v. d-c power factor correction 5.0 KV. A.R. Cat. #252908. \$17.50  
25-25, 6000 v. d-c or 125 @ 12,000 v. d-c. Past Cat. #A7548, oil. \$3.75  
1.25/1.25 mfd., 7500 v. Cat. #261360 \$12.50  
2x.15 mfd., @ 8000 v. or .075 mfd., @ 16,000 v. Vitamin Q. \$2.90

**RESISTORS**  
Fixed, w.w. 100,000 ohm, 200 w. ferrule ends. \$1.00  
Fixed, w.w. 5,000 ohm, 200 w. ferrule ends. \$1.00

**METERS**  
Meter only, less multiplier. \$4.95  
Ammeter, a-c 3" Westinghouse NA-35 or Weston Model 476, 3 amps, f.s. deflection. Scale calibrated 0-120, includes doughnut type current transformer w/200-5 ratio @ 25-133 cy. \$8.50

**RELAY**  
Magnetic overload, Allen-Bradley #810, 6.3-18.1 amps, 600 v. max. \$7.95

**WIRE**  
Simplex type S, 600 V. (19) conductor #18 A.W.G. Approx. 1000' reels. \$170.00/M

**RECTIFIER:**  
Dry Disc, 6.5 v. a-c FWCT 2.2 v. d-c @ 3 amps. \$7.50 4 for \$29.00

**TRANSTAT:**  
115/230 v. 50/60 c. 0-260 v. 2.5 amp output \$17.50 2 for \$30.00

**FOR SALE**  
**FIELD TELEPHONE EE108**  
IN LEATHER CASES  
SOUND POWERED  
No Batteries Needed  
**BRAND NEW**  
**\$20.00 Each**

**TALLEN CO., INC.**  
562 ATLANTIC AVE.  
BROOKLYN 17, N. Y.

**SURPLUS COMPONENTS FOR SALE**

Bathtubs, oils, micas, xformers, chokes, relays, trimmers, sockets, odd items, etc. Surplus lots purchased.  
**EMPIRE ELECTRONICS**  
Box 41, Midwood Stat., Brooklyn 30, N. Y.  
Phone BRyant 9-1220

**CONDENSERS**

Ceramics, micas, bathtubs, channels, silver micas, molded paper, metal tubular, oils. Large quantities on hand for immediate shipment.

Large stocks of Type "J", "JJ" Pots, Power Rheostats, Coax Connectors and other electronic components on hand.

See our page ad—Page 323, May, 1951, Electronics.

*Inquiries solicited and promptly answered*

**MONMOUTH RADIO LABORATORIES**  
BOX 159 OAKHURST, N. J.

**TEST CHAMBER**

Hot and cold; age 1942; used six months, like new;  
Inside dimensions 30" x 58" x 28" high;  
Temperature control—minus 57° F to plus 125° F;

Electric heating bank 6 KW; Servel Air Compressor, 2-stage; 7 1/2 H.P., 3/60/220 AC

Fans for circulation; inspection in operation

Guaranteed condition; F.O.B. Brooklyn.

**Kings County Machinery Exchange**  
408 Atlantic Ave. Brooklyn 17, N. Y.

**NEW LOCATION**

same big bargains in new equipment

- BC348 dual-section volume control ea \$2.50
- MC215 Tuning Shaft for SCR274N ea \$1.25
- MC124 Tuning Shaft for MN26 306" ea \$6.00
- MC136 Right Angle Drive for MC124 ea \$2.25
- MC211A Right Angle Drive for MC215 ea 85¢
- BC732A Localizer Control Head ea \$2.50
- F10 Fairlead ea \$1.50

Please include sufficient postage

**LONG ISLAND RADIO COMPANY**  
P. O. Box 474 Montrose, Penn.

**ONE OR A THOUSAND PIECES—BRAND NEW—IMMEDIATE DELIVERY**  
**RADIO DEVELOPMENT & SALES CO.**

323 Atlantic Ave. Ulster 5-0488 Brooklyn 2, N. Y.

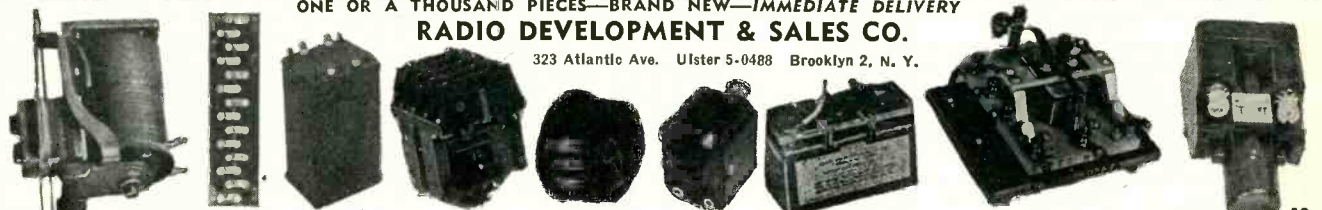

10—WESTERN ELECTRIC RELAY—#D 86672—Single pole n.o. contacts open on 6v. dc. 385 ohm coil operates on 15 ma., releases at 13 ma. Copper Slug provides delay. \$1.95 ea. 11—TERMINAL BOARD—"TM-184". 12-pin base bakelite 1 1/2 x 4 x 3/8". Twenty-eight nickel plated piercing posts for wire to 3/4" d. \$5.95 ea. 12—DOUBLE CHOKE NAVY SPEC RAYTHEON TYPE WX 5146. Sec. #1-1.5 Hys. @ 400ma.; Sec. #2-1.5 Hys. @ 400ma. 21 ohms each sec. 3/4" mtg. studs. Hermetically sealed. 3 1/2 x 4 x 7". Wt. 15 lbs. \$9.95 ea. 13—WARD LEONARD FOUR CIRCUIT CONTACTOR—115v. 60 cys. coil. 15 ampere contacts double make 4 separate circuits. 5 x 5 x 8". \$7.95 ea. 14—LABORATORY POTENTIOMETER—MUTER Type 314A. 2000 ohms, 3" diam. \$2.95 ea. 15—AIRCRAFT CIRCUIT BREAKER—"KLIXON"—Single pole rated 60 amperes @ 28v. dc. Trip-free design. #D-8364 provided with screw terminals. 2 x 2 1/4 x 1 1/2". \$1.95 ea. 16—SIX VOLT STORAGE BATTERY—NT-6 Willard miniature plastic case measures 3 1/2 x 2 x 1 1/4". Spill proof design. Wt. 1 1/4 lbs. \$2.95 ea. 17—ADVANCE TYPE 400-1B ANTENNA RELAY—D.P.D.T. plus S.P.N.O. 3/4" pure silver contacts. Coil is 110v. dc., 4200 ohms res. Your choice with or w/o terminal assy. as shown. \$5.95 ea. 18—PUSH BUTTON CONTROL—Cutler-Hammer—Normally Open makes one circuit, rated 10 amps. 3/8" button diam. \$.75 each. Same unit to make one circuit, break one. \$1.25 ea.





# PHOTOCON SALES

1060-2 N. Allen Ave.  
Pasadena 7, Calif.

SYcamore 4-7156 RYan 1-8271

## WRITE FOR OUR LATEST SURPLUS SALES CATALOGUE

WE WILL BUY YOUR NEW OR CLEAN USED ELECTRONIC SURPLUS: ARC-1, ARC-3, BC-224, BC-348, BC-312, BC-342, ATC, ART-13, APS-13, BC-221, LM's, TS-12, TS-23, TS-34, TS-35, IE-19A, I-222, SCR-522, TS-100, I-100, or any BC, I, IE, TS, APR.

APR4, APR5A, APR7, TS-34, IE-19A, 804CS2, APA-38, BC-348, ART-13, ARC-1.

### WRITE FOR PRICES

APN-1 Altimeter Indicator 0-1MA, shunt, 250° dial .....NEW \$ 1.95  
BC-464 Target Receiver—5 channel control, sensitive relays, battery case, antenna 68-73MC .....NEW 14.95  
National HRO 115V, AC, 7 coils, 100KC-30MC .....EXCELLENT 195.00  
RME-45 with Speaker 115V, AC 550KC-33MC .....EXCELLENT 125.00  
HS-23 Headset .....NEW 3.95  
HS-33 Headset .....NEW 4.95  
BC-1060 Oscillograph, 3 inch—Same as DuMont 224 .....LIKE NEW 150.00  
BC-412 Oscilloscope .....EXCELLENT 60.00

### DIRECTION FINDER BUY OF THE YEAR

MN20E Loop for MN28 Compass, etc. NEW 7.50  
MN52 Azimuth Control for MN28, etc. NEW 7.50  
MC124 Flexible Shaft for MN28, etc. NEW 3.95

BC-221 Frequency Meter with cal. book, crystal, and tubes .....EXCELLENT 89.50  
Weston Model 724C Tachometer Generator FAIR CONDITION 12.95  
EXCELLENT CONDITION 29.50

Weston Model 545 Tachometer meter 0-2000 RPM for use with Model 724C Tachometer Generator .....NEW 14.50

Variac-General Radio Type 50A 0-135V, @ 50 amps. ....EXCELLENT 95.00

One of the largest and most complete electronic surplus stocks in the country. We have thousands of tubes, capacitors, plugs, accessories, transmitters, receivers, test equipment, etc. Send us your requirements.

TERMS: Prices f.o.b. Pasadena, California. 25% on all C.O.D. orders. Californians add 3% Sales Tax. Prices subject to change without notice.



# COMMERCIAL SOUND & TV COMPONENTS

## IMMEDIATE DELIVERY AT SPECIAL LOW PRICES!

We have in stock the following well known RCA "MI" Catalog Numbers:

MI-12799	Program Console (40-Zone)	MI-12294	50-Watt Public Address Amplifier
MI-12298	30-Watt Public Address Amplifier	MI-6203-C	Polydirectional Ribbon Microphones
4117-A	12011	12358	12752
4118-A	12065	12372	12794
4288-L	12098-C	12373	12796
4297-A	12224	12378	12875
4304	12224-Y	12416-99	12878-A
6105	12235-A	12421	13146
6106	12237	12429	13225
6204-B	12239	12444	14702
6207-G	12241	12444-A	14703
6269-A	12251	12448	14704
6294	12268	12448-A	14707
6308	12269	12500	14708
6311	12277	12502	14709
6317-D	12293	12595	14710
6333-C	12295	12596-1	14711
6366	12296	12596-2	14750
12081	12299	12596-4	14800
12081-Z	12385-B	12596-3A	14801
12005-1	12306	12596-2A	14807
12010-1	12308	12596-3A	15306

Also many other miscellaneous MI parts.

### RCA Television Components

201D1	201D77	201T6	204T3
201D5	201E1	202D75	208T8
201D76	201R2	204T1	211T2

Phone, wire or write to our industrial department for quotation on your requirements.

### GE SENSITIVE RELAYS

Type K27J853—SPDT, 2000-ohm coil. Pulls in on 18 milliwatts DC (3 MA). Sealed aluminum case—inert gas filled. Standard five-pin base.

Only \$2.95 each in lots of 100

Lots of 10—\$3.25 each Postpaid sample—\$3.50



## HARRISON RADIO

225 Greenwich Street  
N. Y. C. 7, N. Y.—BARclay 7-7777

2C51	\$ 4.00	9005	\$ 1.50
2E22	1.25	100TH	9.50
2J26	5.00	304TL	13.95
2J36	85.00	304TH	13.95
2J48	13.50	450TH	29.95
2J61	22.50	HK254	7.00
2K45		4-250A	27.50
(WE Boxed)	150.00	RK38	19.95
(3CM. thermal-tuned Klystron)		RK59	1.65
3C33	9.50	RK63	19.95
3DPI-A		RK65	24.95
(RCA Jan.)	3.50	OZ4/OZ4G	.75
3J31	62.50	1A7GT	1.05
5D21	19.95	1B3GT	1.50
5J23	9.95	1X2A	1.60
5JPI	22.50	35A	1.10
6F4	5.95	5U4G	.95
6J4	4.95	5V4G	1.30
CIA	2.00	5X4G	.95
CE25	.75	6A6H	2.00
35TG	3.50	6AK5	1.35
211	.85	6AL5	.90
310A (WE)	4.95	6AS6	2.25
809	2.25	6AU5GT	1.75
812	2.75	6BL7GT	1.95
813	8.95	6BY5G	1.95
832-A (RCA)	9.95	6C4	.90
832	5.95	6J5GT	.50
837	1.50	6J7M	1.40
866-A	1.00	6T8	1.50
872-A	2.95	12A77	1.75
892-R	200.00	12A17	1.25
955	.40	12B8H	1.85
2050	1.75	25L6GT	.95
9002	.90	35L6GT	1.25
		35Z5	.85
		50L6GT	.90

## BARRY ELECTRONICS CORP.

136 Liberty St. New York 6, N. Y.

Phone: REctor 2-2563

25% deposit with orders—or send full remittance to save COD charges—rated firms (D&B) net 10 days.

All merchandise fully guaranteed

### FOR SALE

## ELECTRICAL STEEL

We can offer about 26,000# of Hi-Grade Strip—.005 x 12 1/2" "Hipersil" 3 1/4% Transformer grade — In Coils weighing about 900# each—Material new and prime but outside wrap weather discolored.

### GLOBE TRADING COMPANY

1815 Franklin Detroit 7, Michigan  
Phone—Woodward 1-8277

### WHOLESALE ONLY

## ELECTRONIC COMPONENTS AIRCRAFT EQUIPMENT HYDRAULICS

RADIO & ELECTRONIC SURPLUS  
13933-9 Brush St. Detroit 3, Mich.  
Phone Townsend 9-3403

### RECTIFIER POWER SUPPLY

McColpin Christie Model MH 24-25, input 230 v 60 cy, 3 ph. Output 25 amps. 24-28 v DC. Continuous duty, fan cooled. 13" x 13" x 19". Price \$75.00 each net. New. \$215.00 value.

### LEO SAGAL CO.

860 Glenmont, L. A. 24, Calif.

### FOR SALE

### S-F-1 RADAR

Complete in Original Cases • Price on Request  
WILL BUY ALL TYPES OF RADIO AND ELECTRONIC EQUIPMENT  
Send Details & Price

### SAM'S SURPLUS

1306 Bond St., Los Angeles 15, Calif.

## "AN"

Ferrules	CONNECTORS	Clamps
etc.	3100	3057-3
3050	3101	3057-4
3051	3102	3057-6
3052	3106	3057-8
3053	3108	3057-10
3054		3057-12
3055		3057-16
3056		3057-20
3060		3057-24
3061		3057-28
3062		3057-32
3063		3057-40
3064		97-3057
3066		10-6
3068		

ALL TYPES OF "AN" HARDWARE  
Phone or write  
Immediate Delivery



## GLASS BLOWING IN ALL ITS BRANCHES

Special tubes, Lamps, Vacuum, Rare Gases etc. Developed or made to Specification. Kovar, Tungsten, Copper seals. Vacuum Pumps, Glass or Metal.

### IN STOCK AT VERY LOW PRICES

Tungsten, Moly, Tantalum, Kovar, etc. in Wire, Ribbon, Strips, Mesh, Tubes, etc., also other materials and equipment used in the Vacuum, Radio Tubes, Lamps, in Industry and Laboratories.

### F. ALEXANDER

115 W. 23d St. New York 11, N. Y.

## SHOOT TV TROUBLE FAST!

### With H. G. CISIN'S RADIO "TV TROUBLE SHOOTING METHOD"

ENGINEERS! Don't call in a TV serviceman. Locate TV troubles yourself. Rapid checks enable you to locate all faults in record breaking time regardless of make or model! 160 Picture, Raster, Sound trouble symptoms. Over 100 Rapid Checks including over-all alignment checks, 26 illustrations; simplified step-by-step directions!

H. G. CISIN, well-known to radio men as a recognized electronic engineer, inventor, technical author and educator, has trained thousands of television technicians, many of them now owning their own prosperous TV service organizations. The results of his years of experience are embodied in this remarkable TV TROUBLE SHOOTING METHOD.

INCREASE your TV know-how with the most valuable aid to TV servicing ever written! SEND YOUR NAME AND ADDRESS TODAY FOR YOUR POSTPAID copy with \$1.00 COPY.

### RUSH COUPON NOW!

H. G. CISIN, Consulting Engineer, Dept. EI-1  
200 Clinton Street, Brooklyn 2, N. Y.

Enclosed is \$..... for which please rush..... copies (postpaid) of your TV TROUBLE SHOOTING METHOD.

Name.....

Address.....

City..... Zone..... State.....







# INDEX TO ADVERTISERS

Ace Engineering & Machine Co., Inc.	271	Five Star Co.	300
Acheson Colloids Corp.	153	Freed Transformer Co., Inc.	183
Acme Electric Corporation	264	Furst Electronics	297
Acme Electronics Inc.	283	Gair Company, Inc., Robert	291
Acme Wire Co.	298	Gamewell Company	287
Adams & Westlake Company, The	31	Gates Radio Company	27
Advertising Council	204	General Control Company	266
Aeronautical Communications Equip- ment, Inc.	49	General Electric Company	
Aerovox Corp.	67	Apparatus Dept.	64, 65, 159
Air Associates, Inc.	219	Chemical Dept.	223
Airpax Products Company	174	Electronics Dept.	25, 39, 57, 242
Alden Products Co.	265	General Industries Co.	47
Allegheny Ludlum Steel Corp.	50	General Radio Company	32, 33
Allen Co., Inc., L. B.	300	Gramer Transformer Corporation	163
Allen Manufacturing Company	236	Grant Pulley & Hardware Co.	158
Allied Control Company, Inc.	179	Graphite Metallizing Corp.	158
Allied Radio Corp.	186	Grayhill	287
American Electrical Heater Co.	252	Green Instrument Co.	275
American Gas Accumulator Company	264	Gries Reproducer Corp.	158
American Lava Corp.	227	Guardian Electric Mfg. Co.	217
American Relay & Controls, Inc.	275		
American Smelting & Refining Co.		Hathaway Instrument Co.	277
Federated Metals Division	41	Haydon Company, A. W.	275
American Television & Radio Co.	284	Heiland Research Corporation	266
American Time Products, Inc.	175	Heldor Manufacturing Co.	297
Amperex Electronic Corp.	Third Cover	Heli-Coil Corp.	210
Amperite Company, Inc.	269	Helipot Corporation	55
Amplex Electric Corporation	281	Hewlett-Packard Company	57
Andrew Corporation	184	Hexacon Electric Company	293
Arkwright Finishing Company	196	Hobson Bros.	295
Arnold Engineering Company	229		
Art Wire & Stamping Co.	281	Improved Seamless Wire Company, The	286
Astron Corporation	282	Indiana Steel Products Company	40
Automatic Electric Sales Corporation	18	Industrial Condenser Corp.	262
		Industrial Timer Corporation	34
Bakelite Company, A Division of Union		Instrument Resistors Company	285
Carbide & Carbon Corp.	75	Insuline Corporation of America	266
Ballantyne Laboratories, Inc.	172	International Resistance Co.	4, 5
Barry Corporation	78	Irrington Varnish & Insulator Co.	51, 239
Bead Chain Manufacturing Co.	262	Jelliff Manufacturing Corporation, C. O.	283
Bell Telephone Laboratories	241	Jennings Radio Manufacturing Co.	256
Bendix Aviation Corporation		Jones Div., Howard B. Cinch Mfg. Corp.	277
Eclipse-Pioneer Division	222		
Bentley, Harris Mfg. Co.	191	Kahle Engineering Co.	290
Berkeley Scientific Corporation	270	Karp Metal Products Co., Inc.	63
Bird Electronic Corp.	274	Kartron	300
Birmingham Sound Reproducers, Ltd.	147	Kenyon Transformer Company, Inc.	203
Birtcher Corporation	281	Kester Solder Company	137
Boeing Airplane Company	68	Kings Electronics	259
Boonton Radio Corporation	141	Kings Microwave Co., Inc.	258
Borg Corp., George W.	292, 293	Kinney Manufacturing Company	243
Bowser, Inc.	280	Knights Co., James	182
Bridgeport Brass Co.	247	Kulka Electric Mfg. Co., Inc.	297
British National Radio Show	178		
Bruning Company, Inc., Charles	261	Lambda Electronics Corp.	275
Brush Development Company	182, 235	LaPointe-Plaseomold Corporation	251
Burgess Battery Company	162	Lapp Insulator Co., Inc.	60
Burnell and Company	19	Leach Kelly Company	200
Bussmann Mfg. Co.	29	Leeds & Northrup Co.	10
		Lehnd, Inc. G. H. Co.	190
Cambridge Thermionic Corp.	240	Lenz Electric Manufacturing Co.	44
Cannon Electric Co.	230	Linde Air Products Co.	
Capitol Radio Engineering Institute	262	Unit of Carbide & Carbon Corp.	279
Centralab, Div. Globe-Union, Inc. 13, 14	15	Lockheed Aircraft Corporation	280
Chase Brass & Copper Sub. of Kennecott Copper Corp.	26	Lust, Henry B.	300
Chicago Condenser Corporation	276		
Chicago Telephone Supply Corporation	170, 171	MacDonald Co., Inc., W. S.	281
Chicago Transformer, Div. of Essex Wire Corp.	238	Mack Molding Company, Inc.	272
Cinch Manufacturing Corp.	133	Magnecord, Inc.	168, 205
Clare and Co., C. P.	173	Mahony and Company, Inc., P. R.	80
Cleveland Container Company	157	Manning, Maxwell & Moore, Inc.	165
Clippard Instrument Laboratory, Inc.	214	Marcou Instruments, Ltd.	162
Cohn Corporation, Sigmund	274	Marion Electrical Instrument Co.	2
Collins Radio Company	17	McGraw-Hill Book Co., Inc.	257
Condenser Products Company	7	McIntosh Engineering Laboratories, Inc.	273
Conn, Ltd., C. G.	260	Measurements Corporation	277
Continental-Diamond Fibre Company	161	Merit Transformer Corp.	269
Cornell-Dubilie Electric Corp.	177	Metal Textile Corporation	279
Corning Glass Works	207	Metals & Control Corp., General Plate Division	30
Cornish Wire Company, Inc.	234	Mica Insulator Company	151
Corry-Jamestown Mfg. Corp.	216	Millen Mfg. Co., Inc., James	24
Coto-Coil Co., Inc.	264	Milo Radio & Electronics Corp.	170
Craft Manufacturing Co.	188	Minneapolis-Honeywell Regulator Co., Industrial Division	22
Cramer Co., Inc., R. W.	192	Minnesota Mining & Mfg. Co.	54
Cross Co., H.	300	Mitchell-Rand Insulation Co., Inc.	6
Crowley & Co., Inc., Henry I.	48	Mosinee Paper Mills Company	218
		Motorola	189
Dano Electric Company	295	Muirhead & Co., Ltd.	3
Daven Co., The	231	Multicore Solders Ltd.	11
Dial Light Company of America	186	Mycalex Tube Socket Corp.	40
Doelcam Corp.	283		
Dore, Inc., John L.	162	National Company, Inc.	178
Dow Corning Corporation	300	Neomatt, Inc.	277
Driver-Harris Company	66	Ne-Sil Co., Inc.	9
Dumout Electric Corp.	288	New York Transformer Co., Inc.	25
DuMont Laboratories, Inc., Allen B.	8, 59, 237	North American Aviation, Inc.	174, 260
du Pont de Nemours and Co. (Inc.) E. I. Electrochemicals Dept.	267	North Electric Mfg. Co.	224
Polychemicals Dept.	215	Northern Radio Co., Inc.	289
		Nothelfer Winding Laboratories	273
Eastman Kodak Company		Onan & Sons Inc., D. W.	289
Industrial Photographic Div.	169	O'Neill-Irwin Mfg. Co.	286
Eisler Engineering Company, Inc.	279, 300	Oster Mfg. Co., John	236
Eitel-McCullough, Inc.	71	Owens-Corning Fiberglas Corp.	69
Electrical Industries, Inc.	292		
Electrical Reactance Corp.	42	Panoramic Radio Products, Inc.	298
El-Tronics, Inc.	300	Paramount Paper Tube Corp.	289
Electrons, Inc.	206	Par-Metal Products Corp.	174
Electro Tec Corporation	276	Patten-MacGover Co.	160
Erie Resistor Corp.	61	Plasto Plastics Corporation	268
		Phillips Laboratories, Inc.	233
Fairchild Camera & Instrument Corp.	245	Photocircuits Corporation	279
Federal Telephone & Radio Corporation	253	Pickering & Co., Inc.	287
Federated Purchaser, Inc.	249	Plaskon Division, Libbey-Owens-Ford Glass Co.	20, 21
Ferroxcube Corp. of America	221		

## THE NEW "PRECISION" CR-30 CATHODE RAY TUBE TESTER

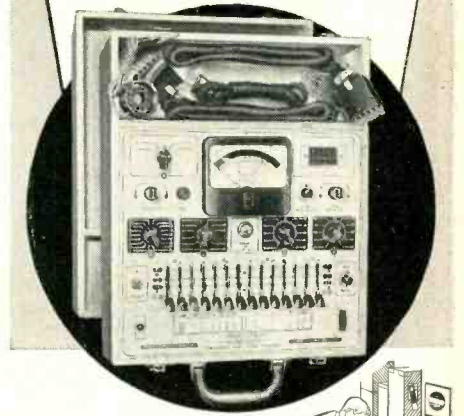

TESTS ALL TV  
PICTURE TUBES  
(Magnetic and Electrostatic)  
'SCOPE TUBES AND  
INDUSTRIAL CR TYPES



A complete and self-contained Electronic Instrument. Incorporates a TRUE BEAM CURRENT Test Circuit. Checks overall electron-gun performance for proportionate picture brightness. Additional tests for accelerating anodes and deflection plate elements.

The Precision CR-30 should not be confused with mere adapters connecting to ordinary receiving tube testers which were never designed to meet the very specialized needs of CR tube checking. Similarly, it is not to be confused with neon-lamp units or similar devices of limited technical merit and which do not check all CR tubes or all tube elements.

### GENERAL AND TECHNICAL SPECIFICATIONS

- ★ Tests All Modern Cathode Ray Tubes. Tests All CR Tube Elements: Not just a limited few.
- ★ Free-Point 14 Lever Element Selection System, independent of multiple base pin and floating element terminations, for Short, Leakage and Quality Tests.
- ★ True Beam Current Test Circuit checks all CR Tubes with Electron-gun in operation. It is the Electron Beam (and NOT total cathode emission) which traces the pattern on the face of the CR tube. The significance of the above rests in the fact that Beam Current (and picture brightness) is primarily associated with the condition of the center of the cathode surface and not the overall cathode area.
- ★ Voltage Regulated, Bridge Type VTVM affords super-sensitive tube quality indications and positive check of low current anodes and deflection plates.
- ★ Micro-Line Voltage Adjustment Meter-monitored at filament supply.
- ★ Accuracy of test circuits closely maintained by use of factory adjusted internal calibrating controls; plastic insulated, telephone type cabled wiring; highest quality, conservatively rated components.
- ★ Built In, High Speed, Roller Tube Chart.
- ★ Test Circuits Transformer Isolated from Power Line.
- ★ 4 1/2" Full Vision Meter with scale-plate especially designed for CR tube testing requirements.

SERIES CR-30-In hardwood, tapered portable case. 17 1/2" x 13 3/4" x 6 3/4". Complete with standard 12 pin tube cable and universal CR Tube Test Cable.

Shipping Weight: 22 lbs. Net Price: \$99.75

See the new CR-30 on display at leading electronic equipment distributors. Place your orders now to assure earliest possible delivery.

**Precision Apparatus Co., Inc.**  
92-27 HORACE HARDING BLVD.  
ELMHURST 10, N. Y.

Export: 458 B'way, N. Y. C., U. S. A. Cables: MORHANEX  
In Canada: Atlas Radio Corp. Ltd., Toronto, Ontario



U.S.E.

U.S.E.

U.S.E.

U.S.E.

U.S.E.

U.S.E.

U.S.E.

U.S.E.

U.S.E.

for quality  
in coils  
it's . . .

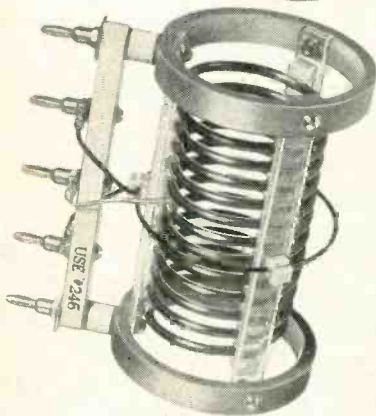

# U. S. ELECTRONICS

- Versatility in engineering
- Adherence to specifications
- Quality production procedures

Cathode Trap Coils • I.F. Transformers • Width Control Coils • Heater Choke Coils • Video Peaking Coils • R.F. Coils • Horizontal Linearity Control Coils • Horizontal Oscillator Coils • Oscillator and Solenoid Coils • Sound Discrimination Transformers • Sound I.F. Transformers • Picture I.F. Transformers. Write today for catalog or samples.

U.S.E.

**United States Electronics Corp.**  
Lyndhurst, New Jersey

Polarad Electronics Corporation	269
Polytechnic Research and Development Company, Inc.	291
Potter & Brumfield	56
Potter Instrument Co., Inc.	299
Precision Apparatus Co., Inc.	339
Precision Paper Tube Co.	273
Prentice-Hall, Inc.	150
Presto Recording Corporation	73
Pyramid Electric Co.	76, 145

Radio Corp. of America	225, 246
Back Cover	
Radio Materials Corporation	197
Radio Receptor Company, Inc.	62
Radio Wire Television, Inc.	278
Rahm Instruments, Inc.	284
Railway Express Agency, Air Express Division	43
Raytheon Manufacturing Co.	143
R-B-M Division, Essex Wire Corp.	156
Rek-O-Kut Co.	294
Remler Company, Ltd.	278
Republic Foil & Metal Mills, Inc.	45
Richardson Company	36
Rider Publisher Inc., John F.	150
Rohden Mfg. Co.	297
Rollin Company	191
Runzel Cord & Wire Co.	285

Samco Products Company	147
Sangamo Electric Company	72
Sarkes Tarzian, Inc.	212
Scientific Electric Div. of "S" Corrugated Quenched Gap Co.	294
Secor Metals Corporation	297
Servo Corporation of America	244, 152
Servomechanisms, Inc.	228
Sessions Clock Company, Timer Div.	23
Shallcross Mfg. Co.	271
Shaw Insulator Co.	79
Sigma Instruments, Inc.	199
Snyder Mfg. Co.	38
Sola Electric Company	28
Sorensen and Company, Inc.	285
Sound Apparatus Company	232
Southwestern Industrial Electronics Co.	178
Specialty Battery Company	209
Speer Resistor Corp.	152
Spincraft, Inc.	201
Sponge Rubber Products Company	139
Sprague Electric Company	164
Stackpole Carbon Co.	293
Standard Piezo Company	295
Standard Pressed Steel Co.	287
Standard Products, Inc.	220
Standard Transformer Corp.	293
Statham Laboratories	285
Staver Company, Incorporated	198
Stevens Mfg. Co., Inc., Geo.	250
Stevens Manufacturing Co., Inc.	289
Steward Manufacturing Co., D. M.	263
Stoddart Aircraft Radio Co.	195
Stokes Machine Co., F. J.	273
Sturtevant Co., P. A.	74
Superior Electric Co.	187
Superior Tube Company	77, 140
Sylvania Electric Products, Inc.	185

Taylor Fibre Co.	160
Taylor Tubes, Inc.	282
Tektronix, Inc.	190
Tel-Instrument Co., Inc.	181
Telephon Laboratories, Inc.	300
Telex, Electro-Acoustic Division	296
Thomas Electronics, Inc.	211
Thomas & Skinner Steel Products Company	260
Transradio, Ltd.	262
Tung-Sol Lamp Works, Inc.	166, 167

Ulanet Company, George	186
Ungar Electric Tools, Inc.	293
Union Carbide & Carbon Corp., Bakelite Company	75
Union Carbide & Carbon Corp., The Lindt Air Products Co., Unit.	279
United States Electronics Corporation	340
United States Gasket Company	202
United Transformer Co.	Second Cover
Universal Winding Company	70

Veeder-Root, Inc.	16
Victoreen Instrument Company	295

Waldes Kohinoor, Inc.	35
Ward Leonard Electric Company	180
Ward Products Corp., The	226
Waterman Products Co., Inc.	291
Weller Electric Corp.	288
Westinghouse Electric Corp.	12, 52, 53, 213
Western Electrical Instrument Corp.	58
White Dental Mfg. Company, S. S.	248, 271
Whitehead Stamping Company	193
Wilcox Electric Company	193
Wilton Tool Mfg. Co.	257
Winchester Electronics Incorporated	257
Workshop Associates, Inc.	208
Zophar Mills, Inc.	182

## PROFESSIONAL SERVICES 299

### SEARCHLIGHT SECTION (Classified Advertising)

EMPLOYMENT	
Positions Vacant	301-306
Selling Opportunities Offered	306
Positions Wanted	300
Selling Opportunities Wanted	300

SPECIAL SERVICES	
Financing	301
Rebuilding	337
EDUCATIONAL	
Books	337
EQUIPMENT	
(Used or Surplus New)	
For Sale	307-338
WANTED	
Equipment	336

## ADVERTISERS INDEX

Acorn Electronics	327
Adelman, Nat.	332
Airborne Instruments Laboratory, Inc.	304
Aircraft Armaments, Inc.	303
Aircraft Radio Industries, Inc.	336
Alexander, F.	337
Alvarado Supply Co.	331
Amber Co.	336
Ampex Electric Corp.	301
American Electrical Sales Co.	332
Arby Electronics	334
Arcee Electronics Co.	328
Arrow Sales, Inc.	324
Automatic Electric Co.	306
B & B Distributors	328
Barry Electronics	332, 337
Bell Aircraft Corp.	304
Bendix Aviation Corp., Pacific Div.	303
Blan	331
Brush Development Co.	306
C & H Sales Co.	328, 336
Chase Electronics Supply Co.	329
Cisin, H. G.	337
Columbia Electronics, Ltd.	325
Columbia Electronics Sales	332
Commercial Surplus Sales Co.	321
Communication Devices Co.	333
Communications Equipment Co.	315, 316, 317
Compass Communications	330
Cornell Aeronautical Laboratory, Inc.	302
Cottone & Co., A.	330
Eastern Air Devices	336
Electro Engineering & Mfg. Co.	331
Electro Impulse Laboratory	324
Electronic Engineering Co. of Calif.	303
Electronic Specialty Supply Co.	330
Electronic Surplus Brokers	336
Electroncraft, Inc.	314
Empire Electronics	335
Engineering & Research Corp.	305
E. P. C. O.	305
Freeland Products Co.	335
G. L. Electronics	327
General Electric Co.	304
General Motors Corp., AC Spark Plug Div.	305
Globe Trading Co.	334, 337
Goodyear Aircraft Corp.	301
Graham, Ross & Co., Inc.	301
Green, Gould	330
Greenberg, David	335
Harrison Radio	337
Horlick Co., William I.	323, 336
Instrument Associates	307
International Business Machine Corp.	305
J. S. H. Sales Co.	334
Kellett Air Craft Corp.	304
Kings County Machinery Exchange	335
Leitron Research Laboratories	312
Leri Laboratories, Inc.	333
Liberty Electronics, Inc.	326
Life Electronic Sales	334
Long Island Radio Co.	335
Maritime International Co.	332
Maritime Switchboard	326
Maxson Corp., The W. L.	306
Mogull Co., Inc., Alexander	325
Monmouth Radio Laboratories	335
National Union Radio Corp.	302
Norman Radio Distributors Inc.	332
Northrop Aircraft, Inc.	305
Phillips Petroleum Co.	301
Photocon Sales	337
Poly-Tech N. Y.	328
Powell, Harold H.	310, 311, 334
Precision Electrical Instrument Co.	330
Radio & Electronic Surplus	337
Radio Development & Sales Co.	335
Radio Ham Shack, Inc.	308, 309
Reliance Merchandizing Co.	313
Sagal Co., Leo	337
Sam's Surplus	333, 337
Sandia Corp.	303
Sanett, Bob	336
Servo-Tek Products Co., Inc.	319
Stevens Aircraft Corp., The	337
Sylvania Electric Products, Inc.	306
Tab	338
Tallen Co., Inc.	335, 336
Taylor Tubes, Inc.	302
Technical Radio Parts Co.	334
Telemarine Communications Co.	322
Universal General Corp.	320
Universal Radio Supply Co.	329
Victoreen Instrument Co., The	302
Wells Sales, Inc.	318
Western Electric Co.	304
Weston Laboratories	331, 332, 336
West Region Electronics	336
Wilgreen	329

This index is published as a convenience to the readers. Every care is taken to make it accurate, but ELECTRONICS assumes no responsibility for errors or omissions.





Another  
**RCA FIRST!**



The new **RCA** **21"** **metal rectangular kinescope**  
**featuring electrostatic focus**

Now . . . RCA electrostatic focusing in a super-large 21" kinescope . . . combining all the advantages of this new RCA technical achievement with the superior constructional features of metal-shell picture tubes. The tube provides television pictures of equal or better quality than magnetically focused types and is a lasting, long-range engineering accomplishment which goes beyond the present program to conserve critical materials.

The new RCA-21DP4 has a maximum over-all length of only 22 $\frac{3}{4}$ ", and a picture area of 18 $\frac{3}{8}$ " x 13 $\frac{3}{16}$ ". The frosted Filter-glass face is made of high-quality glass, provides improved contrast, and minimizes specular reflection. Since the tube utilizes

the structural strength of steel, and weighs substantially less than a comparable all-glass tube, it can be safely shipped in the receiver.

The RCA-21DP4 employs an electron gun of improved design that provides good uniformity of focus over the entire picture area. Focus can be maintained automatically with variation in line voltage and with adjustment of picture brightness. Because the focusing electrode draws very little current, the voltage for the focusing electrode can be provided easily and economically. Design-center maximum voltage rating is 18 kilovolts, diagonal-deflection

angle 70°, and horizontal-deflection angle 66°.

RCA Application Engineers are ready to consult with you on the application of the RCA-21DP4 and its associated components to your specific designs. For further information, write RCA, Commercial Engineering, Section 42FR, Harrison, N. J., or your nearest RCA field office.

FIELD OFFICES: (EAST) Harrison 6-8000, 415 S. 5th St., Harrison, N. J. (MIDWEST) Whitehall 4-2900, 589 E. Illinois St., Chicago, Ill. (WEST) Trinity 5641, 420 S. San Pedro St., Los Angeles, California.

The Fountainhead of Modern Tube Development is RCA



**RADIO CORPORATION of AMERICA**  
ELECTRON TUBES

HARRISON, N. J.