

# Electronic Design. 12

VOL. 24 NO.

FOR ENGINEERS AND ENGINEERING MANAGERS

JUNE 7, 1976

**Computer hardware is changing rapidly and so is the software. A major reason is today's  $\mu$ P revolution. Memories, peripherals, graphic terminals and computers**

**on a board are just a few of the areas being influenced by these tiny chips. For details, plus a preview of the 1976 National Computer Conference, see p. 60.**





# Better trimmer adjustability from a better way to seal . . .

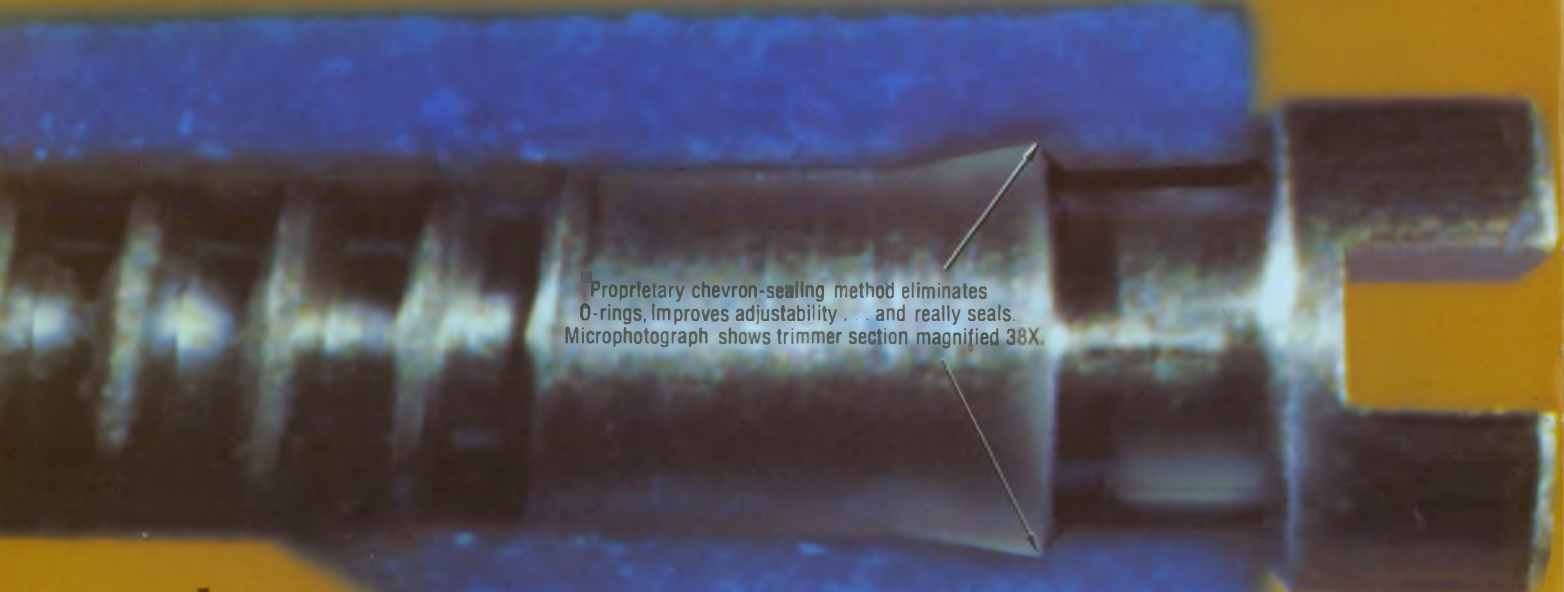

Proprietary chevron-sealing method eliminates O-rings, improves adjustability . . . and really seals. Microphotograph shows trimmer section magnified 38X.

## ... here today at no extra cost in every multi- turn Trimpot® Potentiometer

Bourns multi-turn trimmers adjust quickly, accurately, without the windup and springback problems associated with many trimmers sealed with O-rings . . . because there are no O-rings in the Bourns design.

We use a proprietary, press-fit chevron sealing technique that really works. No need for O-rings . . . therefore faster, more precise trimming without the bothersome rubber-band effect. Our secret is precision molding, closely held machining tolerances . . . and a few other tricks we've picked up since we invented the trimming potentiometer in 1952. Bourns trimmers stay sealed when others fail. We know. We've tested them all. Dip-test one yourself. We'll provide the sample.

### HERE'S PROOF:

Send for a copy of our new engineering report on TRIMMER PERFORMANCE. Tell us about your application, and we will provide any qualification samples that best suit your needs. Bourns quality and reliability are available at ordinary prices . . . off-the-shelf from nearly 100 local distributor inventories, plus our largest-ever factory stock.

TRIMMER PRODUCTS, TRIMPOT PRODUCTS DIVISION,  
BOURNS, INC., 1200 Columbia Avenue, Riverside, California  
92507. Telephone 714 781-5320 — TWX 910 332-1252.

### Swage-Bond™, a revolution in trimmer reliability



Exclusive Swage-Bond process virtually eliminates pin termination failure and provides a marked improvement in tempo consistency. The P.C. pins are secured through the trimmer substrate, with a high-pressure compression swage on top and bottom sides. The pressure locks pins solidly into element, and thoroughly bonds them to the termination material. Compare with less reliable clip-on termination designs.

### Wrap-around wiper for better setting stability



Multi-fingered, wrap-around wiper delivers more consistent, more reliable performance. Unique design significantly reduces CRV fluctuations and open circuit problems due to thermal and mechanical shock by maintaining a constant wiper pressure on the element. Compare the ruggedness of Bourns design with the common "heat-staked" wiper designs. Compare performance. Specify Bourns.



International: European Headquarters — Switzerland 042/23 22 42 • Belgium 02/218 2005 • France 01/75 33 41 3 • Germany 0711/24 29 36  
Italy 02/32 56 88 • Netherlands 070/88 93 18 • United Kingdom 01/572 6531 • Japan 075 92 1121 • Australia 86 9410 • Brazil 257-3535

CIRCLE NUMBER 250



Are you using your \$20,000 mainframe set-up wisely? If you're using it to sweep anywhere in the 1 MHz to 1.4 GHz range, then you know it's only doing a fraction of the job you bought it for.

But think about this: if you used a Wavetek Model 2001 Sweep/Signal Generator instead of a plug-in to work below S-Band, your mainframe would be free for other high frequency testing at the same time.

Besides its range of 1 MHz to 1.4 GHz,

the Model 2001 has an output of 10mW that's flat to within 0.5dB. This solid-state designed unit features excellent linearity and low spurious content. Plus, the 2001 is programmable—with remote control of center frequency, bandwidth

and output level over the 20dB range of its PIN diode attenuator. Not to mention its start/stop mode of operation, (in addition to  $\Delta f$ ), or its flexible birdy by-pass marker system.



Now let's get down to prices. An equivalent low-frequency sweep plug-in will run you at least \$2,200. And it'll tie up your mainframe while you're using it.

On the other hand, you can get a Model 2001 for just \$1,850.\* And untie your mainframe at the same time. It's like having your cake and eating it, too. WAVETEK Indiana, Inc. P.O. Box 190, Beech Grove, Indiana 46107. Phone (317) 783-3221. TWX 810-341-3226

\*US domestic price only.

**WAVETEK®**

CIRCLE NUMBER 2

# Don't tie up your microwave mainframe.





# The largest selection of "OFF-THE-SHELF" POWER SPLITTERS/COMBINERS Available!

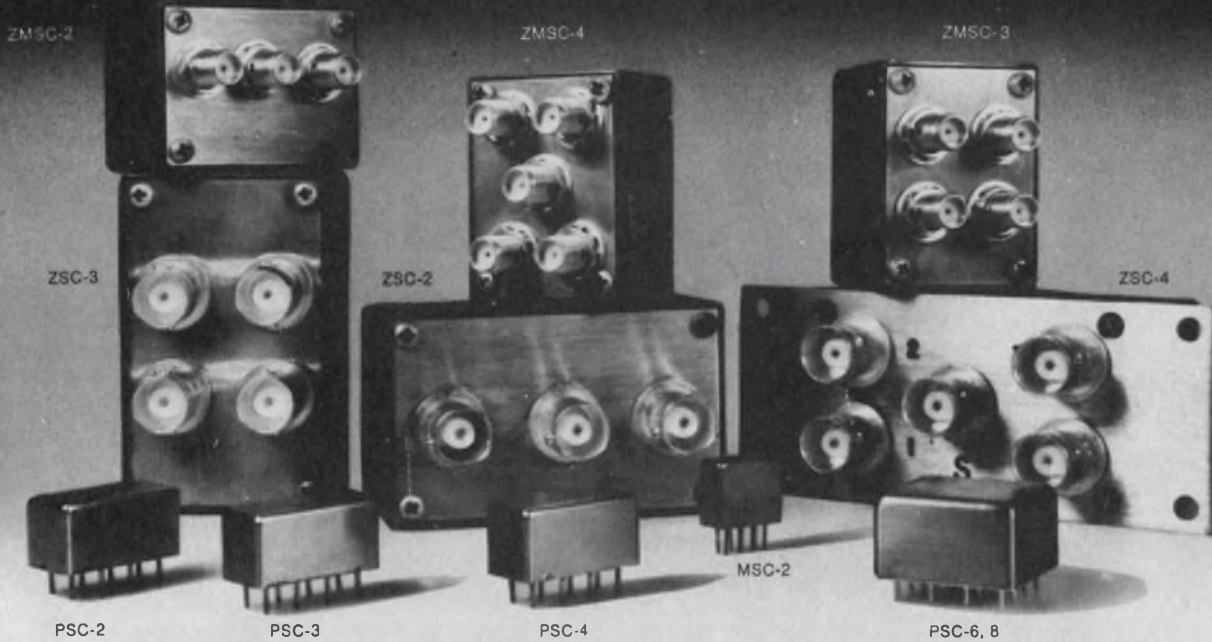

## TWO-WAY, THREE-WAY, FOUR-WAY, SIX-WAY AND EIGHT-WAY POWER SPLITTER/COMBINERS

Model No.	Freq. range (MHz)	Isolation between outputs (dB) typical	Insertion loss (dB) (typical)	Unbalance		Price (Quantity)	Model No.	Freq. range (MHz)	Isolation between outputs (dB) typical	Insertion loss (dB) (typical)	Unbalance		Price (Quantity)
				$\phi$ (deg)	Amp. (dB)						$\phi$ (deg)	Amp. (dB)	
<b>Two-way 0°</b>													
PSC 2-1 ZSC 2-1 ZMSC 2-1	0.1-400	25	0.4 above 3dB split	1	0.1	\$ 9.95 (6-49) \$24.95 (4-24) \$34.95 (4-24)	<b>Three-way 0°</b>						
PSC 2-2 ZSC 2-2 ZMSC 2-2	0.002-60	40	0.3 above 3dB split	1	0.1	\$19.95 (6-49) \$34.95 (4-24) \$44.95 (4-24)	PSC 3-1 ZSC 3-1 ZMSC 3-1	1-200	30	0.4 above 4.8 split	2	0.1	\$19.95 (6-49) \$34.95 (4-24) \$44.95 (4-24)
PSC 2-1W ZSC 2-1W ZMSC 2-1W	1-650	25	0.5 above 3dB split	3	0.20	\$14.95 (6-49) \$29.95 (6-49) \$39.95 (6-49)	PSC 3-2 ZSC 3-2 ZMSC 3-2	0.01-30	40	0.25 above 4.8 split	2	0.1	\$29.95 (6-49) \$44.95 (4-24) \$54.95 (4-24)
PSC 2-1-75*	0.25-300	25	0.4 above 3dB split	1	0.05	\$11.95(6-49)	<b>Four-way 0°</b>						
MSC 2-1	0.1-450	30	0.4 above 3dB split	1	0.1	\$16.95 (6-24)	PSC 4-1 ZSC 4-1 ZMSC 4-1	0.1-200	30	0.5 above 6dB split	2	0.1	\$26.95 (6-49) \$41.95 (4-24) \$51.95 (4-24)
<b>Two-way 180°</b>							ZSC 4-2 ZMSC 4-2	0.002-20	33	0.45 above 6dB split	2	0.1	\$64.95 (4-24) \$74.95 (4-24)
PSCJ 2-1** ZSCJ 2-1	1-200	33	0.6 above 3dB split	2.5	.15	\$19.95 (5-49) \$34.95 (4-24)	PSC 4-3 ZSC 4-3 ZMSC 4-3	0.25-250	30	0.5 above 6dB split	2	0.1	\$23.95 (6-49) \$38.95 (4-24) \$48.95 (4-24)
<b>Two-way 90°</b>							<b>Six-way 0°</b>						
PSCQ 2-90	55-90	30	average of coupled outputs less 3dB 0.3	3	1.0	\$19.95 (5-49)	PSC 6-1	1-175	30	0.75 above 7.8dB split	4	0.2	\$59.95 (1-5)
<b>Two-way 0°</b>							<b>Eight-way 0°</b>						
<b>Two-way 0°</b>							PSC 8-1	0.5-175	30	0.8 above 9dB split	3	0.2	\$59.95 (1-5)

COMMON SPECIFICATIONS FOR ALL MODELS: Impedance all ports, 50 ohms. \*Except 75 suffix denotes 75 ohms VSWR:1.1-1.2 typical Nominal phase difference between output ports, 0° \*\*Except J suffix denotes 180° Q denotes 90° Delivery from stock; One week max.

For complete product specifications and U.S. Rep. listing see MicroWaves' "Product Data Directory," Electronic Designs' "Gold Book" or Electronic Engineers Master "EEM"

World's largest supplier of double balanced mixers

**Mini-Circuits Laboratory**

A Division Scientific Components Corp

837-843 Utica Avenue, Brooklyn, NY 11203

(212) 342-2500 Int'l Telex 620156 Domestic Telex 125460

International Representatives:  AUSTRALIA General Electronic Services, 99 Alexander Street, New South Wales, Australia 2065;  ENGLAND Dale Electronics, Dale House, Wharf Road, Frimley Green, Camberley Surrey;  FRANCE S.C.I.E. - D.I.M.E.S., 31 Rue George - Sand, 91120 Palaiseau, France;  GERMANY, AUSTRIA, SWITZERLAND Industrial Electronics GMBH, Klüberstrasse 14, 6000 Frankfurt/Main, Germany;  ISRAEL Vectronics, Ltd., 69 Gordon Street, Tel-Aviv, Israel;  JAPAN Densho Kaisha, Ltd., Eguchi Building, 8-1-1 Chome Hamamatsucho Minato-ku, Tokyo;  EASTERN CANADA B. D. Hummel, 2224 Maynard Avenue, Utica, NY 13502 (315) 736-7821;  NETHERLANDS, BELGIUM, LUXEMBOURG: Coimex, Veldweg 11, Hattem, Holland;  NORWAY Datamatik AS, Ostensjoveien 62, Oslo 6, Norway

US Distributors:  NORTHERN CALIFORNIA Cain-White & Co., Foothill Office Center, 105 Fremont Avenue, Los Altos, CA 94022 (415) 948-6533;  SOUTHERN CALIFORNIA, ARIZONA Crown Electronics, 11440 Collins Street, No. Hollywood, CA 91601 (213) 877-3550



# Electronic Design 12

VOL. 24 NO.

FOR ENGINEERS AND ENGINEERING MANAGERS

JUNE 7, 1976

---

## NEWS

- 45 **News Scope**
- 51 **Washington Report**
- 60 **Advantages of CCDs and magnetic bubbles cited.**
- 62  **$\mu$ P computers keep bowling scores and analyze weather patterns.**
- 67 **Wanted: a robot that thinks for itself.**
- 76 **Computer 76, special issue, featuring major trends in computer technology.** Topics covered include **semiconductor memories** in which MOS technology continues to replace bipolar devices; **computers-on-a-board**—they're becoming more versatile and a lot less costly to use; **microprocessor benchmark testing**—still popular despite some limitations; **low-cost peripherals**, which are becoming even less expensive as mini and microcomputer prices plunge; **computer graphics** in which the outlook is bright despite some programming bottlenecks; a **profile of Jay Forrester**: A computer pioneer who predicts society's future.
- 

## TECHNOLOGY

- 117 **MICROPROCESSOR DESIGN**
- 126 **A microcomputer needn't take many ICs.** The partitioning of functional elements in the F8 permits a complete  $\mu$ C to be assembled from just two LSI circuits.
- 132 **Multiprocessor control systems** replace a single large processor that has a single memory. Several  $\mu$ Ps linked together can form a powerful combination.
- 138 **Choosing among 4-k MOS RAMs?** A head-to-head comparison of the available package sizes aids in selection of the best memory for your system.
- 144 **Should MOS RAMs be 'TTL-compatible?'** Insistence on tight specs increases costs and compromises speed. And the loading may exceed TTL gate capability.
- 148 **Program erasable PROMs on the board,** after they have been wired in. Besides simplifying development, 'board programming' often reduces costs.
- 152 **Nick Tagaris of Datel** speaks on how to get the most out of a small engineering force.
- 156 **Ideas for Design:**  
Logic probe built from IC timer is compatible with TTL, HTL and CMOS.  
Opto-isolator in fuse monitor keeps indicators at ground potential.  
FETs provide current limiting for protection against shorts.
- 

## PRODUCTS

- 163 **NCC '76 PRODUCTS**
- 172 **Modules & Subassemblies:** Resolver-to-digital converter handles 8 channels under  $\mu$ P control.
- 174 **Modules & Subassemblies:** 12-bit multiplying d/a converter boasts military ratings in 18-pin DIP.
- 176 **Modules & Subassemblies:** Photodiode and control IC come in transparent DIP packages.
- 180 **Instrumentation:** Burn-in system tickles ICs with programmable patterns.
- |                             |                           |
|-----------------------------|---------------------------|
| 170 Power Sources           | 191 Components            |
| 178 Integrated Circuits     | 194 Packaging & Materials |
| 186 Discrete Semiconductors | 196 Microwaves & Lasers   |
- 

## DEPARTMENTS

- |                               |                                |
|-------------------------------|--------------------------------|
| 57 <b>Editorial:</b> The star |                                |
| 7 Across the Desk             | 203 Vendors Report             |
| 198 Design Aids               | 208 Advertisers' Index         |
| 198 Application Notes         | 210 Product Index              |
| 200 New Literature            | 210 Information Retrieval Card |
| 202 Bulletin Board            |                                |

**Cover:** Photo by Moses Almos, courtesy of Texas Instruments Inc.

---

ELECTRONIC DESIGN is published biweekly by Hayden Publishing Company, Inc., 50 Essex St. Rochelle Park, NJ 07662. James S. Mulholland Jr., President. Printed at Brown Printing Co., Waseca, MN. Controlled circulation postage paid at Waseca, MN and New York, NY, postage pending Rochelle Park, NJ. Copyright © 1976. Hayden Publishing Company, Inc. All right reserved. POSTMASTER: Please send form 3579 to ELECTRONIC DESIGN, P.O. Box 13803, Philadelphia, PA 19101.



# Take a close look at the

## SPECIFICATIONS

Range	Accuracy	Input Impedance	Resolution	Max Cont Overload	Resistance	Measuring Current
<b>DC Volts</b>						
1V	0.3% ± 1 Digit	10 Mohm	1 mV	250V	1K 1.0% ± 1 Digit	1 mA
10V	0.5% ± 1 Digit	10 Mohm	10 mV	1000V	10K 1.0% ± 1 Digit	100 μA
100V	0.5% ± 1 Digit	10 Mohm	100 mV	1000V	100K 1.0% ± 1 Digit	10 μA
1000V	0.5% ± 1 Digit	10 Mohm	1 V	1000V	1000K 1.0% ± 1 Digit	1 μA
					10.000K 5.0% ± 1 Digit	1 μA
<b>AC Volts</b>			<b>Frequency Range</b>	<b>Max Overload</b>	<b>OPERATION</b>	
1V	0.7% ± 2 Digits	10 Mohm/40pF	20Hz-1kHz	200V	<b>Power:</b>	
10V	1.0% ± 2 Digits	10 Mohm/40pF	20Hz-1kHz	500V	Internal battery or AC-DC converter. (Converter can charge battery.)	
100V	1.0% ± 2 Digits	10 Mohm/40pF	20Hz-1kHz	500V	<b>Input Terminals:</b>	
1000V	1.0% ± 2 Digits	10 Mohm/40pF	20Hz-1kHz	500V	A positive voltage to the red terminal with respect to the black one will give a positive reading.	
<b>DC Current</b>			<b>Resolution</b>		<b>Function</b>	
1mA	0.5% ± 1 Digit	1 Kohm	1 μA	1A (Fused)	The MM 200 will measure AC and DC volts, AC and DC current and resistance. Ensure correct function selection before connecting input.	
10mA	0.5% ± 1 Digit	100 ohm	10 μA	1A (Fused)		
100mA	0.5% ± 1 Digit	10 ohm	100 μA	1A (Fused)		
1000mA	1.0% ± 1 Digit	1 ohm	1 mA	1A (Fused)		
<b>AC Current</b>			<b>Frequency Range</b>		<b>Range:</b>	
1mA	1.0% ± 2 Digits		20Hz-1kHz	1A (Fused)	The four range multipliers 1, 10, 100 and 1000 are selected by pressing the appropriate button—the decimal point will be automatically positioned. In the 10.000K resistance range, all the range buttons are released.	
10mA	1.0% ± 2 Digits		20Hz-1kHz	1A (Fused)		
100mA	1.0% ± 2 Digits		20Hz-1kHz	1A (Fused)		
1000mA	1.5% ± 2 Digits		20Hz-1kHz	1A (Fused)		





# \$99.95 LSI DMM.

**Readout Height:**  
0.3"

**Reading:**  
2½ per second DC and KΩ

**Temperature Coefficients:**  
DC ranges 0.03% per °C  
AC ranges 0.05% per °C  
Resistance ranges 0.05% per °C

**Operating Temperature Ranges:**  
0° to +50°C

**Power Consumption:**  
100 mA approximately

**Size:**  
Height 3.4" 8.64cm  
Width 10.0" 25.4cm  
Depth 12.0" 30.48cm  
including knobs, feet, and handle  
extended.

**Weight:**  
3.2 lbs. w/battery 1.45Kg  
2.35 lbs. without battery 1.07Kg

When you get all that performance in a reliable, low cost DMM, it's no fluke. It's LSI, the most advanced technology, and the capabilities/cost combination spells doomsday for analog meters and the lesser DMMs. AC/DC converter powers the unit or charges its battery (optional) for more than 8 hours independent operation. Full year free replacement for any reason. And 10 days return option if for any reason you're not completely satisfied. Call or send the coupon for immediate shipment. De Forest Electronics, a subsidiary of DuMont Oscilloscope Laboratories, 40 Fairfield Place, West Caldwell, New Jersey 07006. In New Jersey call (201) 575-8670. Toll free 800-631-1043.

## Let me see it.

If I'm not impressed, I can return it in 10 days for a full refund. My check or authorization to charge to my credit card account is enclosed.

Please send \_\_\_\_\_ MM 200 LSI DMM with AC/DC converter @ \$99.95  
\_\_\_\_\_ rechargeable battery @ \$15.00.

Add \$4.90 per unit for shipping and handling

Name \_\_\_\_\_ Please print

Title/Mail Stop \_\_\_\_\_

Company \_\_\_\_\_

Street \_\_\_\_\_

City \_\_\_\_\_

State \_\_\_\_\_ Zip \_\_\_\_\_

Enclosed is my check or money order for \$ \_\_\_\_\_  
Charge to my credit card account:

American Express  Master Charge

Acct No \_\_\_\_\_

M.C. Bank No \_\_\_\_\_ Expiration date: \_\_\_\_\_

Signature \_\_\_\_\_  
De Forest Electronics, 40 Fairfield Pl., West Caldwell, N.J. 07006

Made in U.S.A.

N.J. residents add sales tax.

CIRCLE NUMBER 4





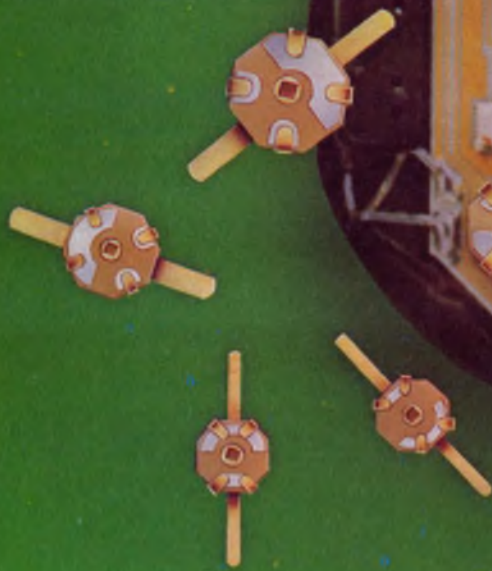

# Thin-Trim<sup>®</sup> capacitors

Tucked in the corner of this Pulsar Watch is a miniature capacitor which is used to trim the crystal. This Thin-Trim capacitor is one of our 9410 series, has an adjustable range of 7 to 45 pf, and is .200" x .200" x .050" thick.

The Thin-Trim concept provides a variable device to replace fixed tuning techniques and cut-and-try methods of adjustment. Thin-Trim capacitors are available in a variety of lead configurations making them easy to mount.

A smaller version of the 9410 is the 9402 series with a maximum capacitance value of 25 pf. These are perfect for applications in sub-miniature circuits such as ladies' electronic wrist watches and phased array MIC's.

The logo for Johanson Manufacturing Corporation, featuring the name "Johanson" in a stylized, cursive script font enclosed within an oval border.

Johanson Manufacturing Corporation  
Rockaway Valley Road  
Boonton, New Jersey 07005  
(201) 334-2676 TWX 710-987-8367

**Sr. Vice President, Publisher**  
Peter Coley

## Editors

Editorial Offices  
50 Essex St.  
Rochelle Park, NJ 07662  
(201) 843-0550  
TWX: 710-990-5071  
Cable: Haydenpubs Rochellepark

**Editor-in-Chief** George Rostky

## Managing Editors:

Ralph Dobriner  
Michael Elphick

## Associate Editors:

Dave Bursky  
Samuel Derman  
Morris Grossman  
John F. Mason  
Stanley Runyon  
Michael Shunfenthal  
Edward A. Torrero

## Contributing Editors:

Peter N. Budzilovich, John Kessler  
Alberto Socolovsky, Nathan Sussman

## Editorial Field Offices

### East

Jim McDermott, Eastern Editor  
P.O. Box 272  
Easthampton, MA 01027  
(413) 527-3632

### West

David N. Kaye, Senior Western Editor  
8939 S. Sepulveda Blvd., Suite 510  
Los Angeles, CA 90045  
(213) 641-6544  
TWX: 1-910-328-7240

Jim Gold, Western Editor  
1537 Shasta Ave.  
San Jose, CA 95128  
(408) 279-8588

## Editorial Production

Marjorie A. Duffy, Production Editor  
Tom Collins, Copy Editor

## Art

Art Director, William Kelly  
Richard Luce, Anthony J. Fischetto

## Production

Manager, Dollie S. Viebig  
Helen De Polo, Anne Molfetas

## Circulation

Manager, Barbara Freundlich  
Trish Edelmann, Gene M. Corrado

## Information Retrieval

Peggy Long

## Advertising Promotion

Paul K. Hogue

## Promotion, Creative Layouts

Manager, Albert B. Stempel  
Maxine Correal, Nancy Gordon



# Across the Desk

## Widespread confusion on role of consultants

Usually I find the ED editorials to be quite good. But I am sorry to say that your Jan. 5 effort ("The Czar's Consultant," ED No. 1, p. 75) displays a considerable misunderstanding of consultants and their use. Unfortunately, these opinions are not just yours alone, but are widespread.

The legend is that consultants, while charging you a bundle:

1. Don't understand your special problems.
2. Don't know what they are doing.
3. When they do give advice, it backfires and puts you in bankruptcy court.
4. The only way to guard against the above is either not to use them or to obtain information from as many sources as possible.

It is my modest suggestion that if the truth were known, Czar Nicholas' problems were probably a result of his not following the advice he was given rather than of the advice being bad. If Rasputin were any politician at all, and he surely must have had some talent to rise as he did, he should have been able to deal with the situation before it got out of hand. When the voice behind the throne says send out bread and troops NOW, and you dilly-dally trying to make up your mind and checking out "other sources," don't blame him for the angry peasants in your sitting room.

It is my observation that consultants come in two types; very good and very bad. If this is true, then by following the ED editorial, and using n sources instead of one, it is obvious even to a mathematical incompetent such as myself that what you have succeeded in doing is increasing your costs n times while

reducing your results to a guaranteed mediocrity. Clearly, the course of action giving the maximum return per dollar is to use a few good sources.

Contrary to popular opinion it is not at all difficult to distinguish the good consultants from the bad. The good have ideas that usually work; the bad have ideas that usually don't. It is important not to be swayed by excuses for failure, since an ability to sling a little "bull" is a consultant's stock-in-trade.

I used to be amazed that corporations would pay thousands for advice which they would then proceed to totally ignore. Now I just regard it as a fact of life and put it to work by sitting back and waiting for trouble to set in and then produce a bail-out by digging out my original report and following my own advice. At times even I'm amazed at how good my original suggestions were!

I won't pursue this self-adulation any further, but for anyone who really wants his advisory money's worth I suggest the study of Robert Townsend's book, *Up the Organization*, to see how he successfully used a consultant (an advertising agency). As he points out, you don't hire a master to paint a picture and then hire a bunch of high school students to give opinions on how he should do it.

*Dr. Benjamin Jacoby  
Professional Engineer*

88 W. Frankfort  
Columbus, OH 43206

## Understanding creativity

Reader Fred Lichtgarn (314 Evonshire St., Santa Barbara, CA 93111) has spent more than 40 years developing a small, 86-page

*(continued on page 25)*

Electronic Design welcomes the opinions of its readers on the issues raised in the magazine's editorial columns. Address letters to Managing Editor, Electronic Design, 50 Essex St. Rochelle Park, N.J. 07662. Try to keep letters under 200 words. Letters must be signed. Names will be withheld on request.

## The finest



## lighted pushbutton



## switches and indicators are

## also the easiest to install



PRESSLITE

## Snap!

- Snap-in instant panel mounting
- Choice of sizes, colors, and lens styles
- Flush or barrier configurations
- Re-lampable from front of panel.

Lighten your decisions  
contact . . .

## ILLUMINATED PRODUCTS INC.

A subsidiary of OAK Industries Inc.  
2620 South Susan St., P.O. Box 11930  
Santa Ana, California 92711  
Tel: (714) 540-9471 • TWX 910-595-1504



COMPONENTS GROUP

CIRCLE NUMBER 6



**EXORciser\***, the first system emulation tool, has always been easy to use, saving design and development time and reducing related costs.

The EXORciser system development tool can be used to emulate exact duplication of the user's final system function and performance, and allows real-time execution of final system capability. It connects with a data terminal for software and firmware program development and enables program evaluation and debugging.

Versatility is inherent in the EXORciser because of its modular design. The basic package includes MPU Module, Debug Module, Baud-rate Module, and power supply. Hardware and software options have been available to expand the capabilities and extend the activity range of the EXORciser . . . I/O Module and flat ribbon interconnects, Static and Dynamic RAM Modules, Wire wrap Module, and an Extender Module for maintenance and trouble shooting. Resident software consists of editor and assembler in 8K of memory.

And now the EXORciser has additional company . . . options to make it even more flexible, even more versatile.



\*Trademark of Motorola





## NEW options expand EXORciser capabilities

**MEX68PP1 PROM Programmer** — Now you can program your own PROMs. The PROM Programmer Module with two EXbug\* firmware compatible programs plugs directly into the EXORciser. This module, with its software, enables the EXORciser to program 2704 and 2708 EPROM devices, to verify EPROM data, and to move data from one memory location to any other including from EPROM to RAM. **MEX68RR EROM/RAM Module** — Just plug in your memories and this module is ready to use. The RAM array takes up to four MCM6810-type 128 x 8 memories, and the ROM section is organized into four arrays of four sockets each. Drop in up to 16 of either 512 or 1K x 8 EROM or ROM units. Each array of four EROM sockets has switch selectable base memory address. The EROM/RAM Module interfaces directly with the EXORciser bus, giving the EXORciser complete control over the module. **M68ASMR020 Resident Macro Assembler and Linkage Editor** — Software power. That's what your EXORciser gets from this new Assembler/Editor option. The macro assembler supplies a super-set of the standard resident assembler features . . . relocation, linking, macros, conditional assembly. The linkage editor combines relocatable object modules to produce an absolute object image, either in resident memory or in external storage. It's available in floppy disk with paper tape and cassette planned. **MEX6850 ACIA Module** — Very simply, the ACIA Module interfaces the EXORciser base system and an asynchronous data terminal. The MC6800 MPU sees this module as an MC6850 ACIA, and addresses it as if it were two memory locations. The MEX6850 is so flexible it can also be set up to appear as a data terminal or MODEM to an external communications device, and it has provisions which allow for the construction of customized circuits. **MEX6816-1 16K Dynamic RAM Module** — Thirty-two MCM6604 16-pin 4K RAMs in harness give the EXORciser 16,384 bytes of RAM in a single memory array. The module has switch selectable base location address for the array, which is refreshed at cycle-stealing 32  $\mu$ s (approx.) intervals. Bus drive capability, TTL voltage compatible high impedance inputs, and parity capability as a factory option round out the portrait of this 16K x 8 dynamic memory block.

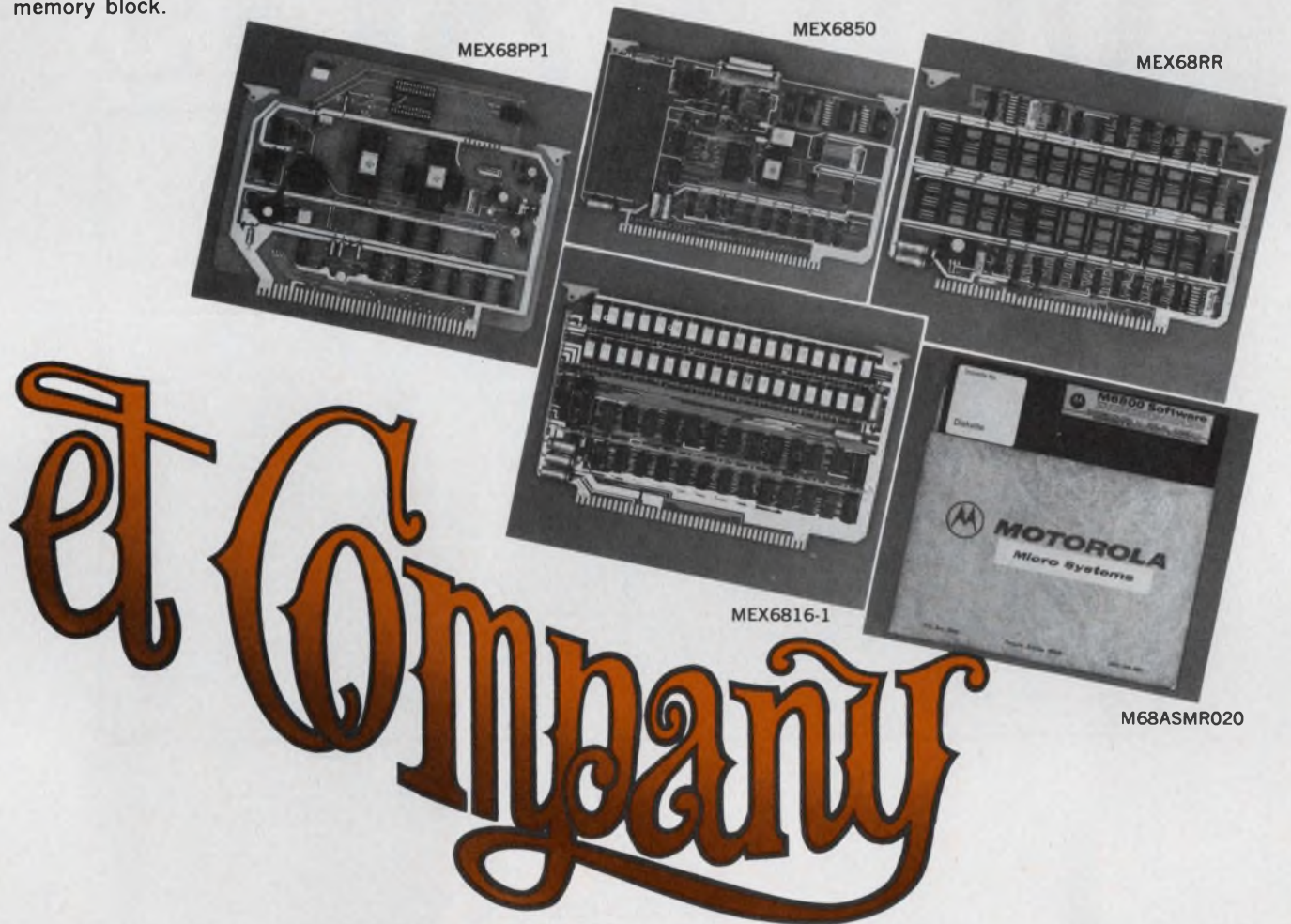

There they are, **EXORciser et Company**, some of the tools so vital to trouble-free M6800 systems development. There are others, of course. M6800 software: from commercial time-sharing, to host computer packages, to the EXORciser resident packages, to the high-level language MPL compiler. The hardware: from the EXORTape\* paper tape reader to the EXORDisk\* floppy disk system. Before you design anything with microprocessors, know all you can about Motorola's total product approach. Write to Motorola Semiconductor Products Inc., P.O. Box 20912, Phoenix, AZ 85036, or circle the reader service number for copies of the latest data. All Motorola data sheets are also now available from VSMF Data Centers.

Contact your Authorized Motorola Distributor or Motorola Sales Office regarding terms of sale.

**MOTOROLA MICROSYSTEMS**  
—making it happen in microcomputers

CIRCLE NUMBER 7



# The Battle of the 80's

Think of your next microcomputer as a weapon against horrendous inefficiencies, outrageous costs and antiquated speeds. We invite you to peruse this chart.

Features:	8080A	Z80-CPU	Features:	8080A	Z80-CPU
Power Supplies	+5,-5,+12	+5	Instructions	78	158*
Clock	2 $\Phi$ , +12 Volt	1 $\Phi$ , 5 Volt	OP Codes	244	696
Standard Clock Speed	500 ns	400 ns	Addressing Modes	7	11
Interface	Requires 8222, 8228 & 8224	Requires no other logic and includes dynamic RAM Refresh	Working Registers	8	17
			Throughput	Up to 5 times greater than the 8080A	
Interrupt	1 mode	3 modes; up to 6X faster	Program Memory Space	Generally 50% less than the 8080A	
Non-maskable Interrupt	No	Yes	*Including all of the 8080A's instructions.		





# Announcing Zilog Z-80 microcomputer products.

With the next generation, the battle is joined.

The Z-80: A new generation LSI component set including CPU and I/O Controllers.

The Z-80: Full software support with emphasis on high-level languages.

The Z-80: A floppy disc-based development system with advanced real-time debug and in-circuit emulation capabilities.

The Z-80: Multiple sourcing available now.

# Your ammunition: A chip off a new block.



A single chip, N-channel processor arms you with a super-set of 158 instructions that include *all* of the 8080A's 78 instructions with *total* software compatibility. The new instructions include 1, 4, 8 and 16-bit operations. And that means less programming time, less paper and less end costs.

And you'll be in command of powerful instructions: Memory-to-memory or memory-to-I/O block transfers and searches, 16-bit arithmetic, 9 types of rotates and shifts, bit manipulation and a legion of addressing modes. Along with this army you'll also get a standard instruction speed of 1.6  $\mu$ s and all Z-80 circuits require only a single 5V power supply and a single phase 5V clock. And you should know that a family of Z-80 programmable circuits allow for direct interface to a wide range of both parallel and serial interface peripherals and even dynamic memories without other external logic.

With these features, the Z80-CPU generally requires approximately 50% less memory space for program storage

yet provides up to 500% more throughput than the 8080A. Powerful ammunition at a surprisingly low cost and ready for immediate shipment.

# Mighty weapons against an entrenched: The Z-80 development system.

You'll be equipped with performance and versatility unmatched by any other microcomputer development system in the field. Thanks to a floppy disc operating system in alliance with a sophisticated Real-Time Debug Module.

The Zilog battalion includes:

- Z80-CPU Card.
- 16K Bytes of RAM Memory, expandable to 60K Bytes.
- 4K Bytes of ROM/RAM Monitor software.
- Real-Time Debug Module and In-Circuit Emulation Module.
- Dual Floppy Disc System.
- Optional I/O Ports for other High Speed Peripherals are also available.
- Complete Software Package including Z-80 Assembler, Editor, Disc Operating System, File Maintenance and Debug.



# On standby: Software support.

All this is supported by a contingent of software including: resident microcomputer software, time sharing programs, libraries and high-level languages such as PL/Z.

# On standby: User support.

Zilog conducts a wide range of strategic meetings and design oriented workshops to provide the know-how required to implement the Z-80 Microcomputer Product line into your design. All hardware, software and the development system are thoroughly explained with "hands-on" experience in the classroom. Your Zilog representative can provide you with further details on our user support program.



# Reinforcements: A reserve of technological innovations.

The Zilog Z-80 brings to the battle-front new levels of performance and ease of programming not available in second generation systems. And while all the others busy themselves with overtaking the Z-80, we're busy on the next generation — continuing to demonstrate our pledge to stay a generation ahead.

The Z-80's troops are the specialists who were directly responsible for the development of the most successful first and second generation microprocessors. Nowhere in the field is there a corps of seasoned veterans with such a distinguished record of victory.

Signal us for help. We'll dispatch appropriate assistance.



**Zilog** MICROCOMPUTERS

170 State Street, Los Altos, California 94022  
(415) 941-5055/TWX 910-370-7955

AN AFFILIATE OF **EXXON** ENTERPRISES INC.

CIRCLE NUMBER 8





# AMS clobbers TI's 4K in Read/Modify/Write.

We give you 80 ns  $t_{mod}$  vs 20 in 22 pins;  
100 vs 20 in 18 pins.

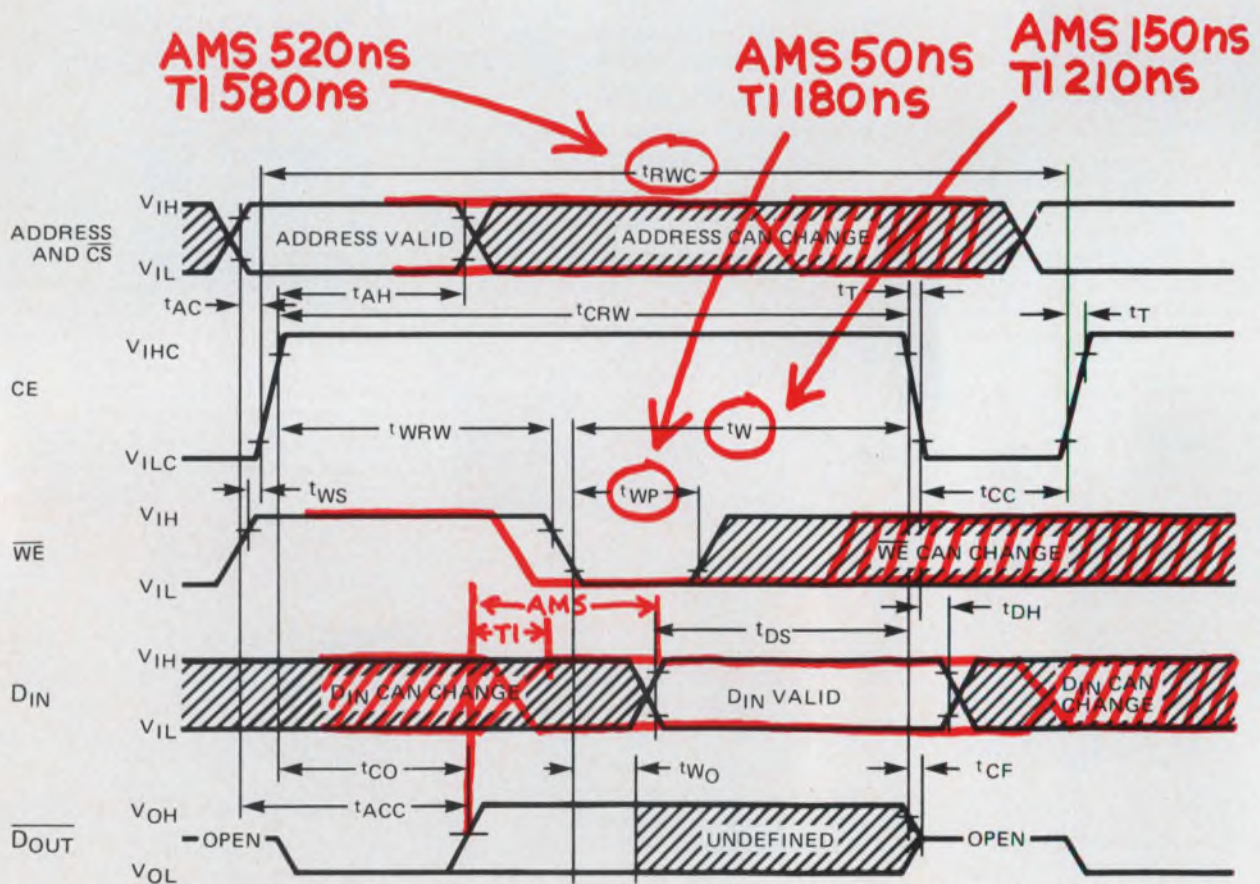

The excessively short system modify time for TI's 4060 stems from the fact that the  $\overline{WE}$  line must go low 60 ns earlier than our 7280. TI's Data In must be stable when  $\overline{WE}$  goes low, while ours only requires that Data In be stable 150 ns prior to CE going low, a clear advantage of 60 ns for the 7280, 80 ns for the 7270.



### No compromises.

If you've built your cards around that minimal modify time, it's time for a whole new shuffle. No trade-offs, no latches, no hitches. Compare the specs, and write or call collect for further information or immediate requirements.

### No lack of sources.

The masks for our 22 pin 7280 and 18 pin 7270 are currently in production at National, too. Not only spec compatible, but mask-for-mask. You'll never be caught in a production/supply bind.

### One of the largest RAM suppliers in the world.

We have shipped more than eleven million RAMs. In ceramic and plastic DIPs, in custom and standard card assemblies; in subsystems with or without power supplies; and in large scale memory systems. We're the largest independent add-on memory supplier in the world; and that RAM experience is ready to work for you.

### Pick a spec.

These are only highlights, but you can readily see how TI ends up in the red.

	22 pins		18 pins	
	AMS 7280	TI 4060-2†	AMS 7270	TI 4050††
$t_{AH}$ Address & CS Hold Time	50	150	50	150
$t_{WP}$ $\overline{WE}$ Pulse Width Time	50	180	50	180
$t_{W}$ $\overline{WE}$ -to-CE OFF Time	150	210	200	210
$t_{DH}$ DIN Hold Time	0	40	0	40
$t_{DS}$ DIN-to-CE OFF Set Up Time	150	210*	150	210*
min RMW cycle	520	580	580	600
$t_{mod}$ @ min cycle	20	20	80	20
$t_{mod}$ @ TI's min cycle (580 ns)	80	20	(600 ns) 100	20

\*data must be valid on  $\overline{WE}$  going low  
†pin-for-pin compatible  
††not pin-for-pin compatible

### Pick a winner.

The 7280 or 7270 from Advanced Memory Systems. With the devices you need, in production quantities, and with the experience to support you in performance, reliability, delivery and pricing.

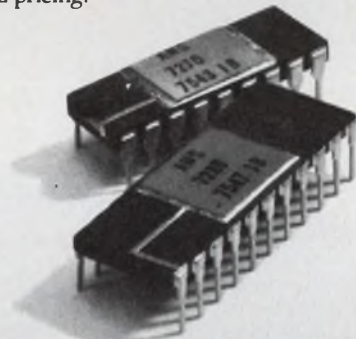

### 4K OK

**AMS 7280 22 pin**  
4096 X 1 NMOS Dynamic RAM  
Max Access 200 ns  
Min Cycle 400 ns  
Single High-Level Chip Enable  
TTL Compatible  
 $P_{diss}$  480mW typ.  
Capacitive inputs  
On-Chip Address Registers  
Pin-for-pin with TI 4060  
Ceramic DIP

**AMS 7270 18 pin**  
Same as 7280 with  
Special Tri-Share Port\*

\*Tri-Share is a registered trademark of National Semiconductor Corporation.

# Intel delivers if you have power to burn and a fistful of capacitors.

Intel's 2107B consumes one third more power during a read or write cycle than our 7280. It's even worse during read/modify/write. Note the chart of  $I_{DD}$  Avg. to your right.

To observe the glitch in the far right graph, hang a probe on an address line of an Intel 2107B board. Watch it shoot above 0.6 Volts. And watch it go away with 7280s.

Supply noise? You can silence Intel with a fistful of capacitors. Or, more simply, you can replace the 2107Bs with our 7280s. No power problem. No clock watching. No trade offs. No kidding.

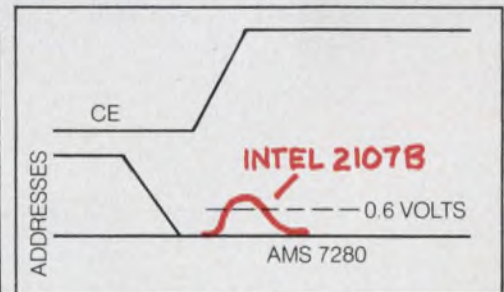
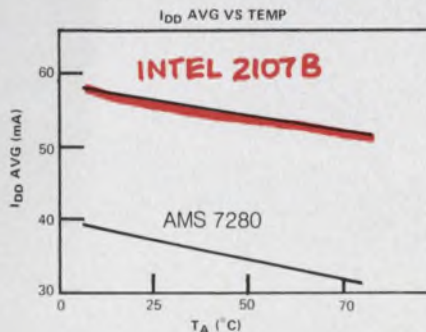

**AMS Advanced Memory Systems.**  
**Memories with a future.**

1275 Hammerwood Avenue, Sunnyvale, California 94086

In stock at Weatherford, all locations.

Sunnyvale, California  
(408) 734-4330

Boston, Massachusetts  
(617) 259-0050

Chicago, Illinois  
(312) 529-1474

London, England  
01 542 4690 Telex: 928139 CANFOR G

CIRCLE NUMBER 9



**KEITHLEY OFFERS:  
A 3½-DIGIT MULTIMETER.  
4 EXCLUSIVE FEATURES.  
\$315.**





The Keithley 168 Digital Multimeter gives you every key performance feature offered by other first-line 3½-digit DMMs.

But only the Keithley 168 gives you 4 extra features—all useful and all at a competitive price. Compare our 3½ with the others and you'll come to an inescapable conclusion: the 168 is the best buy in 3½-digit DMMs.

#### For \$315: a superior DMM

For openers, you get a rugged, reliable, easy-to-read, general-purpose, 5-function DMM with more ranges than you'll normally need. Measure from 100 microvolts to 1000 volts dc, 100 microvolts to 500 volts ac, 100 milliohms to 20 megohms, 100 nanoamps to 1 amp, ac or dc. Basic accuracy is 0.1%. All modes fully overload protected. The 168 brings Keithley quality to general-purpose measurement.



#### 4 extra features, no extra cost.

- *Automatic ranging* gives you the most accurate reading, with decimal in the right place, faster than you could do it with switches. Saves you time every time you make a measurement.
- *HI-LO Ohms* lets you turn on a semiconductor junction to see if it's good or measure an in-circuit resistance without turning on a semiconductor.
- *2-terminal input* for all measurements on all functions. You can't get it wrong. Terminals accept banana plugs, alligator clips, spade lugs or bare wire.
- *Lighted function indicator* so you know precisely what you're measuring, instantly.



#### Surprise: more valuable features.

That's not all. We've packed even more value into the 168. Optional battery pack that you buy now or add later. Patented A-D converter to simplify circuitry. No-nonsense, full-year guarantee on parts, workmanship, and specs—including accuracy. Convenient calibration instructions right inside the cover. Light weight for easy portability.

#### Full complement of accessories.

Use these optional accessories to make your Keithley 168 DMM even more versatile: Wide-range RF probe. Test lead sets. Clamp-on ammeter. 50-amp shunt. High-voltage probe. Carrying case. Rack mount kit.



#### Now the logical choice.

The 168 is out-front in value. And it's backed up by our reputation for quality. Don't you wish all decisions were this easy?

Ordering a 168 is easy, too. Just contact: Keithley Instruments, 28775 Aurora Road, Cleveland, Ohio 44139. (216) 248-0400. Europe: D8000 München 70, Heighhofstrasse 5, West Germany. (089) 7144065.

#### DMMs for all your needs.

We know you have a variety of measurement requirements. So we offer a growing family of DMMs to meet your application and price objectives. Send for our Selector Guide.

180: 4½-digits, 30 nV sensitivity.

190: 5½-digits, high-stability, outstandingly low price.

171: 4½-digits, wide ranging 5-functions.



616: dc, 3½-digits, down to 0.1 picoamp full scale!

160B: dc, 3½-digits, high-sensitivity, low price.

# KEITHLEY

The measurement engineers.



Nothing—not even a scope or a voltmeter or even another logic tester. Because CSC's Logic Monitor™ 2 is the most convenient, efficient way ever developed to monitor circuit activity in digital IC's: it provides instant and continuous display of static and dynamic states of DIP IC's up to 16 pins.

Its built-in power supply, high input impedance and selectable logic thresholds provide the most accurate monitoring of counters, shift registers, gating networks, etc., on big, bright LED's. And because there is no loading of the circuit under test, logic level shifts, false triggering and power sup-

ply loading (that can occur with some equipment) are problems of the past.

LM-2 is a second-generation IC test instrument consisting of two units—a connector/display and a switchable precision voltage reference power supply. In operation, the threshold switch on the power supply is set to the proper logic family (RTL, DTL, TTL, HTL or CMOS). A clip lead is connected to the ground (plus VCC lead, in the case of CMOS), and the connector/display unit simply clipped over the IC under test. That's it.

Each of the 16 pins on the connector/display unit automatically

connects to the corresponding IC pin without any possibility of shorting, and feeds one input of a voltage comparator circuit. The other input is fed from a precision selectable voltage source. When the voltage on a particular pin is more positive than the reference (logic "1"), the corresponding LED lights—at any pulse frequency from DC to 30KHz (50% duty cycle).

If you're looking for an easy way to monitor digital circuits, LM-2 with its 16 channels of automatically-in-sync information and fast, instinctive operation, can't be beat. You won't find anything like it, anywhere near the price.

## CSC'S LOGIC MONITOR 2. AT \$124.95, NOTHING ELSE LETS YOU DO SO MUCH SO FAST AND SO WELL FOR SO LITTLE.

**Fully isolated power supply module**—Constant, bright LED readings without drawing power from circuits under test

**Sturdy, high impact construction throughout**—At CSC, part of making a good thing means making it to last

**Clip module slips easily over IC**—Now, checking static and dynamic states of dual in-line IC's of up to 16 pins is literally a snap

**Non-corrosive nickel-silver contacts**—For maximum reliability and minimum contact resistance

**Selectable threshold level**—Matches characteristics of logic family under test—RTL, DTL, TTL, HTL or CMOS

**Precision plastic guides and flexible web\***—For short-free positive contact with IC under test

**Big, bright 16-LED display**—More information and no more eyestrain—get a picture of everything that's happening *simultaneously*

**High input impedance**—100K impedance for minimum circuit loading

CONTINENTAL SPECIALTIES CORPORATION

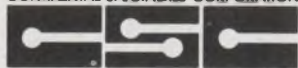

EASY DOES IT

For more information, see your distributor or write for our catalog and distributor list.

44 Kendall St., Box 1942 New Haven, CT 06509 • 203-624-3103 TWX: 710-465-1227 West Coast office: Box 7809, San Francisco, CA 94119 • 415-421-8872 TWX: 910-372-7992 Canada: Len Finkler Ltd., Ontario

CIRCLE NUMBER 11

\*U.S. PAT. NO. 3,914,007 © 1976 Continental Specialties Corp



**we  
did it.**





# We built a better The AMI 6800.

The verdict is in from engineers, scientists, universities and magazine editors. The 6800 has become the most sought-after microprocessor family in the world.

With our new price breaks, it now makes sense to use the AMI 6800 for all applications—from simple, low-cost controllers to high-end microcomputers.

And with our system, you only need one 5-volt power supply. That brings the cost down even more. So for about the same price you'd pay for a 2-chip system, you can get the fast, flexible AMI 6800. The 8080 needs three power supplies. Not to mention at least four TTL devices. That puts it right out of the low-end ballpark.

Even when you move up to a more sophisticated microcomputer, you'll find the same kind of cost advantage in our favor. With the bus-oriented AMI 6800, you can hook up a total of ten memories and peripherals without adding any TTL.

This point underlines the basic reason for the AMI 6800's superiority. It was designed after a thorough study of the early microprocessors, and was patterned after the most successful minicomputers. Whereas the 8080 was designed to be compatible with the 8008. So it's stuck with many of the 8008's weaknesses.

## **You can learn a lot from other people's mistakes.**

A comparison of the 6800 and the 8080 is a classic example of this truism. In virtually every important feature, the 6800 comes out ahead. Often way ahead.

We've already mentioned power supplies (our single +5V versus their three  $\pm 5V$ ,

+12V) and interface (no buffering needed for up to 10 devices our way versus 4 to 6 packages for the 8080). But now take a good look at some other key hardware differences.

We have a simple 5-volt non-overlapping clock which is easily generated from a dual one shot such as a 9602. Theirs is a 0 to 8.5 volt or 0-11 volt non-overlapping asymmetrical waveform with specified delays between phases.

Ours has two levels of external interrupt, one of which is non-maskable. Theirs has only one maskable interrupt.

We save program space with two accumulators instead of one. But even more important in terms of space and cost saving is our interrupt stacking. This automatically stores all registers when the program is interrupted. With the 8080, you need an external subroutine of 4 or 5 instructions every time you hit this condition.

Now look at addressing. They don't have an indexed mode. We do. That can be really important, especially in peripheral applications. We give you a very powerful tool in relative addressing, allowing self-relative code. The 8080 doesn't. And we also have direct addressing, which lets the 6800 use two bytes of code to three for the 8080—a saving of 33 percent.

## **Our instruction set tells you a lot.**

Ours is very flexible and much easier to learn, tailored more like a minicomputer. Take the 6800's branching ability. Besides positive, negative and zero, ours can branch

on equality and all inequality conditions. The 8080 can't test directly for inequalities. So it has to go through two or three additional steps to test for these conditions.

The 6800 can also isolate and test bits in a word much more easily than the 8080.

All this adds up to a 15 to 30 percent more efficient use of memory space. So the 6800 requires less hardware, less interface, less software. And being so much easier to use, the AMI 6800 microprocessor helps you beat the competition to market with a more reliable product.

## **The family plan makes growing easy.**

The AMI 6800 is now a thriving family of nine, with more on the way.

Besides the S6800 MPU, there are the S6810 128 x 8 static RAM; the S6820 Peripheral Interface Adapter; the S6830 8K static ROM; the S6831 16K static ROM; the S6834 512 x 8 EPROM; the S6850 Asynchronous Communications Interface Adapter; the S6860 MODEM; and the S2350 Universal Synchronous Receiver/Transmitter.

For low power or battery backed-up products, our new S5101 256 x 4 CMOS RAM fits right in.

Our S6800 is not only versatile. It can be very tough. It now comes in an industrial temperature range of  $-40^{\circ}\text{C}$  to  $+85^{\circ}\text{C}$ .

The AMI 6800 microprocessor family: you can't do better than that.





# microprocessor.

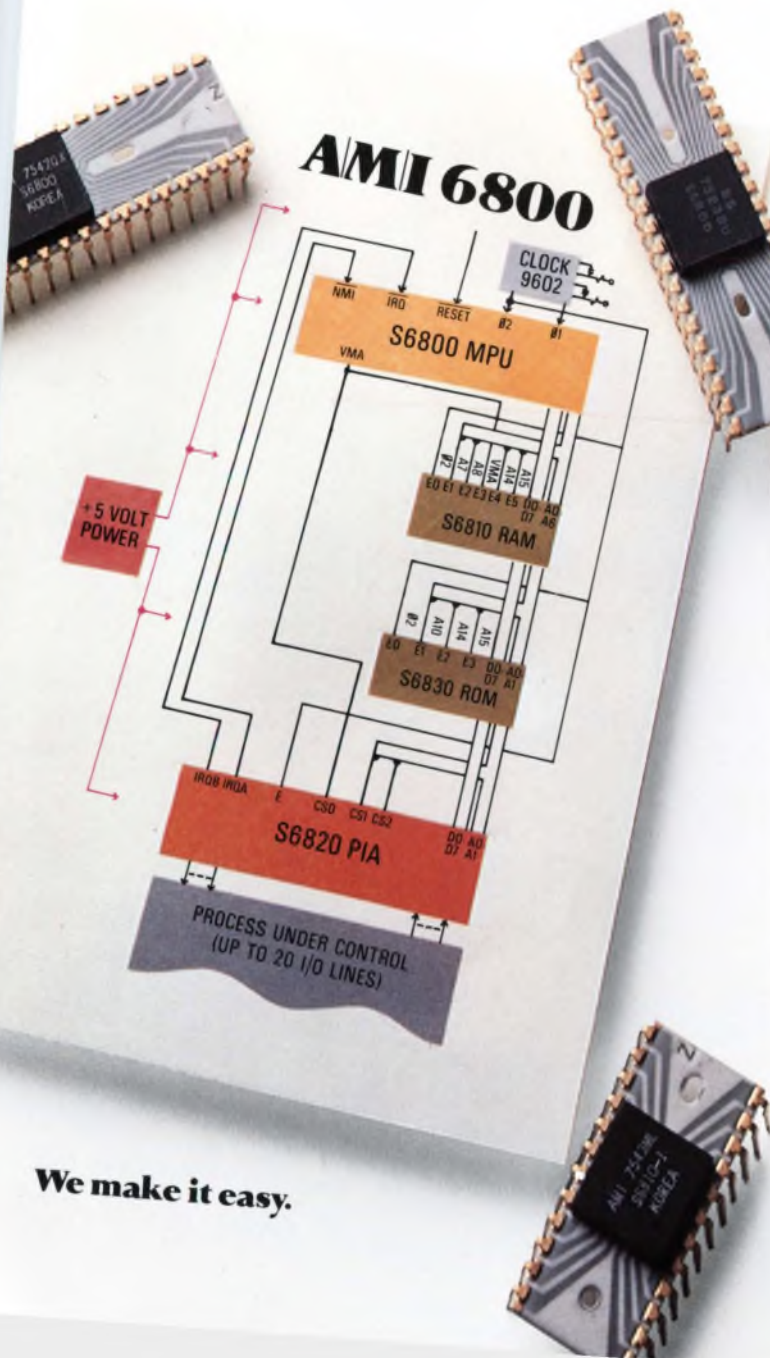

We make it easy.

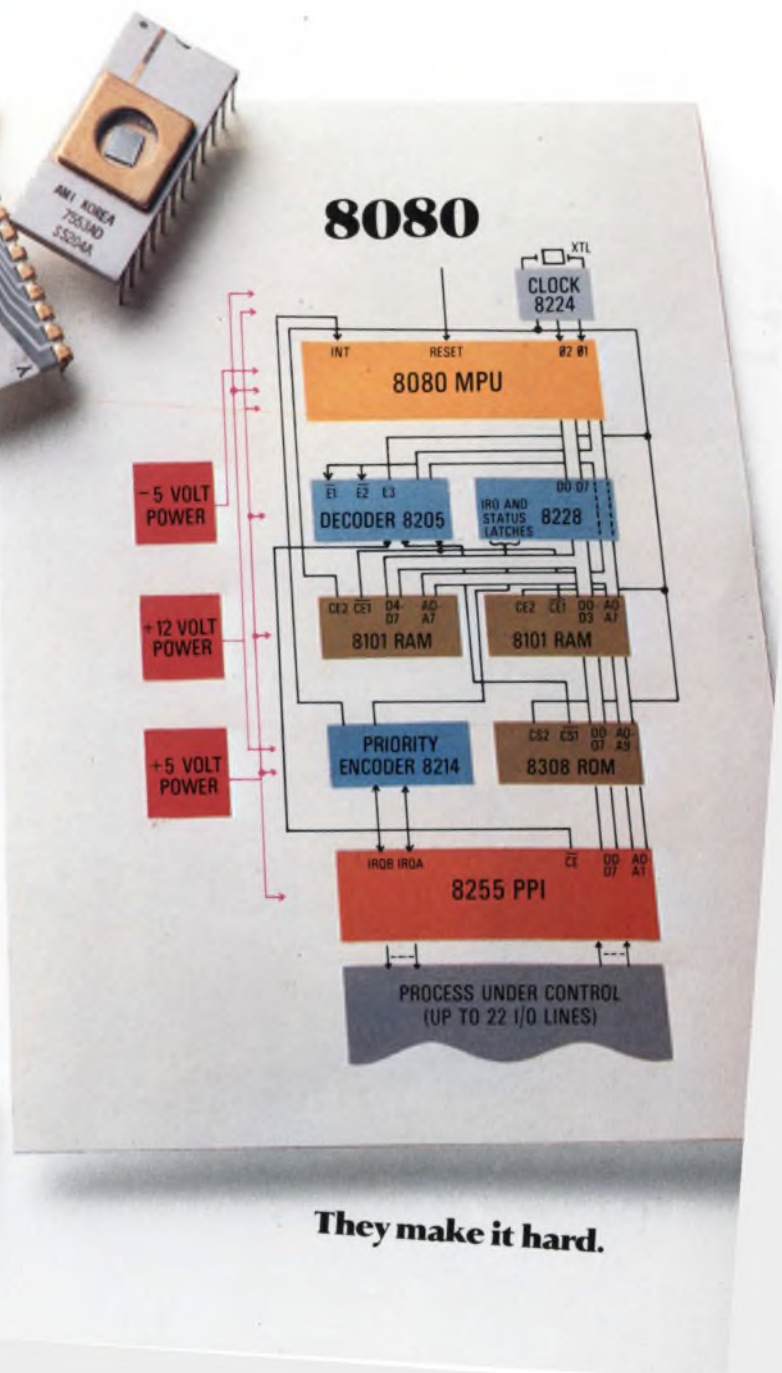

They make it hard.



# We built a better The AMI 6800 Development

It's so much better than the competition, they'll have to change their whole development philosophy to catch up.

The standard AMI 6800 Micro-computer Development Center consists of the 80 character x 25 line CRT, the dual floppy disk with disk operating system, an S6834 EPROM programmer, an RS232 interface, 16K words of RAM memory, a software debug package, editor and assembler.

You will also have options coming out of your ears. The most significant for most people probably are a character printer; EPROM and RAM memory modules; and soon an in-circuit emulator so you can use the CRT like a front panel.

Like everything else about the AMI 6800, our development system is a programmer's dream. We avoided the multiple box approach, with lights and switches, in favor of a very smart CRT with full debug software.

This bypasses all those hassles with paper tape, front panels, teletype or cassettes. In many cases, it cuts programming time from hours to minutes.

With your hands on the keyboard, and your eyes on the

screen, you can modify programs instantaneously. You can interrupt after every instruction, and get a complete snapshot of the state of the machine. Or look at all the registers and change their values, simply by pressing a key. And you never have to translate addresses into binary to get information. In short, our smart CRT helps you make the right decision right away.

## Why learn two processors when one will do?

Strange as it may seem, some development systems have different micro-processors inside than the one you're program-





# support system.

# Microcomputer Center.

ming outside. So you have to learn two instruction sets instead of one.

Naturally, there's an AMI 6800 inside our terminal. And its performance there proves once again how powerful and versatile this micro-computer is.

Among many functions, it edits the screen, controls the communication's interface, and interacts with the disk and keyboard.

Besides high-speed program development (you can complete a typical edit/assembly sequence in a couple of minutes), you can configure our MDC as a test station for incoming 6800 parts. The results are right there on the screen for you to see.

## **There's no such thing as obsolescence.**

With up to one megabyte of storage on-line in the dual floppy disk and a CRT controlled by our versatile 6800, you don't have to worry about this system ever gathering dust.

It converts very easily to a powerful, stand-alone microcomputer for a variety of uses, such as inventory control. Try that with any other development system, and you wind up with a pain in the peripheral. (Ask the competition for even a dumb CRT and they'll send you away to an independent supplier.)

We have another handy development tool, too, called the AMI 6800 Prototyping Board. This helps you debug programs, build 6800 hardware, evaluate parts, and even program our S6834 EPROM in about 40 seconds.

The Board has two 86-pin edge connectors, one for microprocessor bus extension and the other for input/output. Also on-board are 2K bytes ROM; 2K bytes EPROM; EPROM programming; 1K bytes RAM; totally buffered MPU; restart address selection; TTY operating system software; ROM subroutine program library; serial and parallel I/O ports.

In short, there's no better micro-computer than the AMI 6800. And there's no better way of developing it than with the AMI 6800 Micro-computer Development Center.



**It can cut  
programming  
time from hours  
to minutes.  
That's right—minutes!**



# Don't take our Take theirs.



The facts about the AMI 6800 family speak pretty clearly for themselves. But the actions of some pretty big companies say even more.

Companies like Conrac, Hewlett-Packard, Memorex, Tektronix and TRW have selected the AMI 6800 for new products. And the varied uses they're



# word for it.

making of our microcomputer speak volumes for its flexibility, power and organization.

The AMI 6800 turns the Conrac CRT into a highly intelligent terminal that adapts easily to perform a variety of stand-alone and peripheral computer functions. Hewlett-Packard's model 9815 programmable calculator achieves more speed and interface capability with the help of the AMI 6800.

Memorex selected the AMI 6800 for use in their new 1377 high-speed CRT.

In Tektronix' case, it allowed the 4662 Interactive Digital Plotter to include multiple interfaces, resident alphanumeric character generation and digitizing capability in a low-cost package.

TRW's new point-of-sale terminal, through the use of a 6800, offers multiple terminal personalities.

Although everyone recognizes the basic strengths of the AMI 6800, it seems everyone has a different reason for specifying it. Another tribute to its tremendous versatility.

## The AMI 6800 has a great past, present and future.

We've been making MOS longer than any other company in the world. In our ten year history, we've never made a bigger commitment to any program, in terms of money and manpower, than we have to this one.

It marks a turning point for us. Although we're still the leading custom MOS manufacturer (and intend to remain so), the AMI 6800 is spear-heading our rapid advance in standard products.

Much of this effort is dedicated to keeping the AMI 6800 as the Number One microcomputer family. Soon 16K RAMs will be joining our 4K EPROM and other compatible memories. And new communications circuits will extend the 6800's capabilities in that field.

With plants in Santa Clara, California, Pocatello, Idaho and Korea, we're geared to handle any size orders. Very small to very big.

That's another important reason the big companies are coming to us. So why don't you get in touch with your nearest AMI sales office, distributor or representative listed on the next page. Or contact us at AMI, 3800 Homestead Road, Santa Clara, California 95051. Phone: (408) 246-0330. You couldn't make a better decision. Take their word for it.

**AMI**  
AMERICAN MICROSYSTEMS, INC.



*The Conrac 480/25  
CRT Terminal*



*The TRW 2001 Point-of-Sale  
Terminal*



*The HP 9815 Programmable  
Calculator*



*The Memorex 1377  
High-Speed CRT*



*The Tektronix 4662 Interactive  
Digital Plotter*



# How do you get the AMI 6800? It's a snap.

Now it's as easy to get hold of the AMI 6800 as it is to use it.

We've built up our sales and distribution network to give you the products you need as soon as you need them. So snap up some AMI 6800s for your new products. And watch people beat a path to your door.

#### HEAD OFFICE:

AMI  
3800 Homestead Road  
Santa Clara CA 95051

#### SALES OFFICES: UNITED STATES

Long Beach CA (213) 595-4768  
San Jose CA (408) 249-4550  
Altamonte Springs FL  
(305) 830-8889  
Elk Grove Village IL (312) 437-6496  
Norwood MA (617) 762-0726  
Livonia MI (313) 478-9339  
Minneapolis MN (612) 559-9004  
Monsey NY (914) 352-5333  
Cleveland OH (216) 292-6850  
Ambler PA (215) 643-0217  
Richardson TX (214) 231-5721

#### SALES OFFICES: INTERNATIONAL

England—Swindon, Wiltshire  
(0793) 31345  
France—Vincennes (01) 374-0090  
Italy—Milan (02) 29 37 45  
Japan—Tokyo (501) 2241  
West Germany—Munich  
(089) 48 30 81

#### REPRESENTATIVES: UNITED STATES

AMMON & RIZOS  
Oklahoma—Oklahoma City  
(405) 373-2748  
Texas—Dallas (214) 233-5591  
Texas—Houston (713) 781-6240  
BARNHILL FIVE  
Colorado—Denver (303) 426-0222  
Utah—West Bountiful  
(801) 292-8991

#### BENEKE & MCCAUL

Missouri—Grandview  
(816) 765-2998  
Missouri—St. Louis (314) 434-6242  
CAN TEC REPRESENTATIVES, INC.  
Ontario—Ottawa (613) 225-0363

#### COULBOURN DEGREIF, INC.

Maryland—Baltimore  
(301) 247-4646

#### HADDON ASSOCIATES

California—San Diego  
(714) 565-9445

#### HECHT HENSCHEN & ASSOCIATES, INC.

Arizona—Phoenix (602) 275-4411

#### LOWREY & ASSOCIATES

Michigan—Brighton (313) 227-7067

#### NORTHWEST MARKETING ASSOCIATES

Washington—Bellevue  
(206) 455-5846

#### OASIS SALES, INC.

Illinois—Elk Grove Village  
(312) 640-1850

#### PRECISION SALES COMPANY

New York—Syracuse (315) 458-2223

#### REP, INC.

Alabama—Huntsville  
(205) 881-9270

#### Georgia—Tucker (404) 938-4358

North Carolina—Raleigh  
(919) 851-3007

#### TECHNICAL REPRESENTATIVES, INC.

Indiana—Indianapolis  
(317) 849-6454

#### DISTRIBUTORS AND REPRESENTATIVES: INTERNATIONAL

##### ARGENTINA

Arturo E. Vercesi  
Rivadavia 2057 Dept. 11-A  
Buenos Aires  
46-2950

##### AUSTRALIA

CEMA Distributors Pty Ltd  
G.P.O. Box 578  
Crows Nest, N.S.W. 2065  
439-4655

##### Warburton Frank Pty Ltd

199 Parramatta Road  
Auburn, N.S.W. 2144  
648-1771

##### BRAZIL

DATA TRONIX Electronica Ltda  
Av. Pacaembu, 746—CONJ. 11  
Sao Paulo, Brazil  
209-0134

##### DENMARK

GDS—Henckel ApS  
Fyrsvangens 4  
DK-4622 Havdrup  
38 57 16

##### ENGLAND

Adrian Electronics Ltd  
28 High Street  
Winslow, Buckinghamshire  
MK18 3HF  
Winslow 3535

##### APEX Components Ltd

396 Bath Road, Slough  
Berkshire, England  
63741

##### Quarndon Microelectronics Ltd.

Slack Lane  
Derby DE3 3ED  
32-651

##### FINLAND

Atomica AB  
P.O. Box 125  
SF-00121 Helsinki 12  
66 17 99

##### FRANCE

Electronique MS  
89-93, Rue des Alpes  
Cedex L 130  
F-94533 Rungis  
686-7425

##### PEP-Produits Electroniques

Professionnels S.A.R.L.  
2, rue Barthelemy  
F-92120 Montrouge  
735 33 20

##### HONG KONG

Shanklin Co. Ltd  
Rm. 503-5 KAM Chung Bldg.  
54, Jaffe Road  
(05) 281 521-3

##### INDIA

Radiousound  
42 Canady Bridge  
Bombay 400 004  
353997

##### ISRAEL

Tadiran—Semiconductors Division  
P.O. Box 646  
Tel Aviv  
267272

##### ITALY

Celdis Italiana S.p.A.  
via Luigi Barzini, 20  
I-20125, Milano  
68 06 81

##### MEXICO

Semiconductores Calif. S.A.  
Pasaje Reforma, 90-Altos  
Mexico, Baja California  
2-5701-03

##### NETHERLANDS

RITRO Electronics B.V.  
Gelreweg 22/PO. 123  
Barneveld  
50 41

##### NEW ZEALAND

David J. Reid (NZ) Ltd  
P.O. Box 2630  
Auckland 1, New Zealand  
492-189

##### NORWAY

GDS—Henckel A.p.S.  
Heerlokka 14  
N-1440 Drobak  
93 15 97

##### REPUBLIC OF SOUTH AFRICA

Radiokom (1969) (Pty) Ltd.  
P.O. Box 56310  
Pinegowrie 2123  
48-5712

##### SPAIN

Ataio Ingenieros S.A.  
Enrique Larreta, 10 y 12  
Madrid 16  
215-35 43

##### SWEDEN

AB Rifa  
Fack  
S-161 11 Bromma 11  
826-2600

##### SWITZERLAND

GDS (Sales) S.A.  
8 rue de l'Aubépine  
CH-1211 Geneve 9  
21 59 77

##### GDS (Sales) S.A.

Muehlebachstr. 54  
CH-8008 Zurich  
59-434

##### TAIWAN

General Industries (Taiwan) Inc.  
11th Floor, Room D  
Fortune Building  
52 Chang An E. Road, Sec. 2  
Taipei 104  
5221204

##### WEST GERMANY

Omi-Ray GmbH  
D-4054 Nettetal 1  
Ritzbruch 41 (Postfach 3175)  
(02153) 7961

##### MIKROTEC GmbH

D-7000 Stuttgart 1  
Johannesstr. 91  
695-530





# Snap up the AMI 6800 here:

## DISTRIBUTORS: UNITED STATES

ARROW ELECTRONICS:  
Minnesota—Bloomington  
(612) 888-5522

CENTURY ELECTRONICS:  
New Mexico—Albuquerque  
(505) 292-2700  
Utah—Salt Lake City (801) 487-8551

CESCO ELECTRONICS, LTD.:  
Canada—Montreal (514) 735-5511

INTERMARK ELECTRONICS:  
Washington—Seattle (206) 767-3160

SCHWEBER ELECTRONICS:  
California—Costa Mesa (213) 924-5594  
and (714) 556-3880

Connecticut—Danbury (203) 792-3500  
Florida—Hollywood (305) 927-0511  
Georgia—Atlanta (404) 449-9170  
Illinois—Elk Grove Village  
(312) 593-2740

Iowa—Cedar Rapids "Lorenz Sales"  
(319) 393-6912

Maryland—Rockville (301) 881-3300  
Massachusetts—Waltham  
(617) 890-8484

Michigan—Troy (313) 583-9242  
Minnesota—Edina (612) 941-5280  
New Jersey—Somerset (201) 469-6008  
New York—Rochester (716) 461-4000  
Westbury (516) 334-7474

Ohio—Beachwood (216) 464-2970  
Texas—Austin (512) 837-2890  
Dallas (214) 661-5010  
Houston (713) 784-3600  
Canada—Mississauga, Ont.  
(416) 678-9050

SEMICOMP CORP.:  
California—Newport Beach  
(213) 971-5253 and  
(714) 833-3070

STERLING ELECTRONICS:  
Arizona—Phoenix (602) 258-4531  
Louisiana—Metairie (504) 887-7610  
Massachusetts—Watertown  
(617) 926-9720  
New Jersey—Perth Amboy  
(201) 442-8000  
New Mexico—Albuquerque  
(505) 345-6601  
Texas—Dallas (214) 357-9131  
Houston (713) 627-9800  
Virginia—Richmond "Meridian  
Electronics" (804) 359-0221

R. V. WEATHERFORD CO.:  
Arizona—Phoenix (602) 272-7144  
California—Anaheim (714) 547-0891  
Glendale (213) 849-3451  
Palo Alto (415) 493-5373  
Pomona (714) 623-1261  
San Diego (714) 278-7400  
Colorado—Englewood (303) 761-5432  
New Mexico—Albuquerque  
(505) 842-0868  
Texas—Dallas (214) 243-1571  
Houston (713) 688-7406  
Washington—Seattle (206) 243-6340

## ACROSS THE DESK

(continued from page 7)

book, *Basic Components of Creativity*. He feels that creativity is not understood and is neglected, though it is our best national resource. He's offering copies of his book for \$2.50.

## Misplaced Caption Dept.



Now, now. It wasn't such a bad design. Production screwed up.

Sorry. That Rembrandt's "The Reconciliation of David and Absalom," which hangs in the Hermitage in Leningrad.

## Oops right company wrong process

In our April 12, 1976 Communications Special Issue (ED Vol. 24, No. 8, p. 53) Avantek was incorrectly mentioned as a user of silicon-nitride surface passivation for GaAs FETs. Actually Avantek uses a coating of polycrystalline gallium arsenide (PGA) to produce the desired stability of the FETs.

## Specs and data sought for tin-can breakthrough

Concerning the cover photograph of your Communications issue (ED No. 8, April 12, 1976) depicting the voice-actuated, tuned-cavity oscillator, we're interested in obtaining specifications and design documentation for the depicted communica-

tions network. In particular, we are interested in the voice-to-acoustic transceiver transducers, standing-wave propagation characteristics, harmonic attenuation, input and terminating impedances ( $Z_o$ ,  $Z_{in}$ ), and environmental shielding.

We are highly impressed by the cost effectiveness of this network, its potential reliability, maintainability, and availability of spares.

We therefore solicit additional technical data from industry experts and benchmarked performance against other point-to-point networks.

F. Alderete  
F. Sentyrz Jr.

Design Engineers

U. S. Naval Education and Training  
Support Center, Pacific  
1415 Sixth Ave.  
San Diego, CA 92101

## Address corrections for mentioned firms

We most appreciate the editorial coverage accorded our company in your recent fiber-optics article (ED No. 8, April 12, 1976, p. 90). Our address, however, is in Santa Ana, California, not Santa Clara, California.

A. C. Menadier

Poly-Optics Inc.  
1815 E. Carnegie Ave.  
Santa Ana, CA 92705  
Telephone: (714) 546-2250

We were delighted to see the publication of Jim Lipman's Idea for Design (ED No. 9, April 26, 1976, p. 88). Since the idea may generate interest in our Moxie thermal sensors, we are providing a more complete address for Multi-State than that which appeared in the credit.

Stewart Nellis

Vice President, Marketing

Multi-State Devices Ltd.  
2255 Dandurand St.  
Montreal, Quebec  
H2G 1Z6  
Telephone: (514) 279-4507

## Digital-circuit idea

Although I am sure that David Ludington's Idea for Design, "Digi-

(continued on page 31)



# New Intel microcom system costs, increase

Intel has two new LSI components for the MCS-40™ microcomputer system which will help you cut system costs, increase throughput and reduce the number of components you have to stock for I/O interface requirements. The new Intel 4269 Programmable Keyboard Display and the 4265 Programmable General Purpose I/O devices eliminate the large number of discrete SSI/MSI components previously required for keyboard, control panel, indicator array, alphanumeric display, printer, communications and other I/O interfaces. These new LSI parts increase system throughput up to 50%, and make it easy to add standard Intel memory and system peripherals.

The 4269 Keyboard Display can be software programmed to interface to various keyboard and display elements and makes it possible for you to eliminate fifteen or more discrete components.

It significantly increases system throughput since it performs the scan, storage, refresh, and other simultaneous keyboard/display tasks previously required of the 4004 or 4040 CPU.

When programmed as a keyboard or line sensor input interface, the 4269 can scan up to 64 key closures or lines. When a key closure is detected, the 4269 generates a system interrupt and stores up to eight characters in its first-in/first-out buffer before requiring CPU service.

In alphanumeric applications, the 4269 eliminates the need to use the CPU

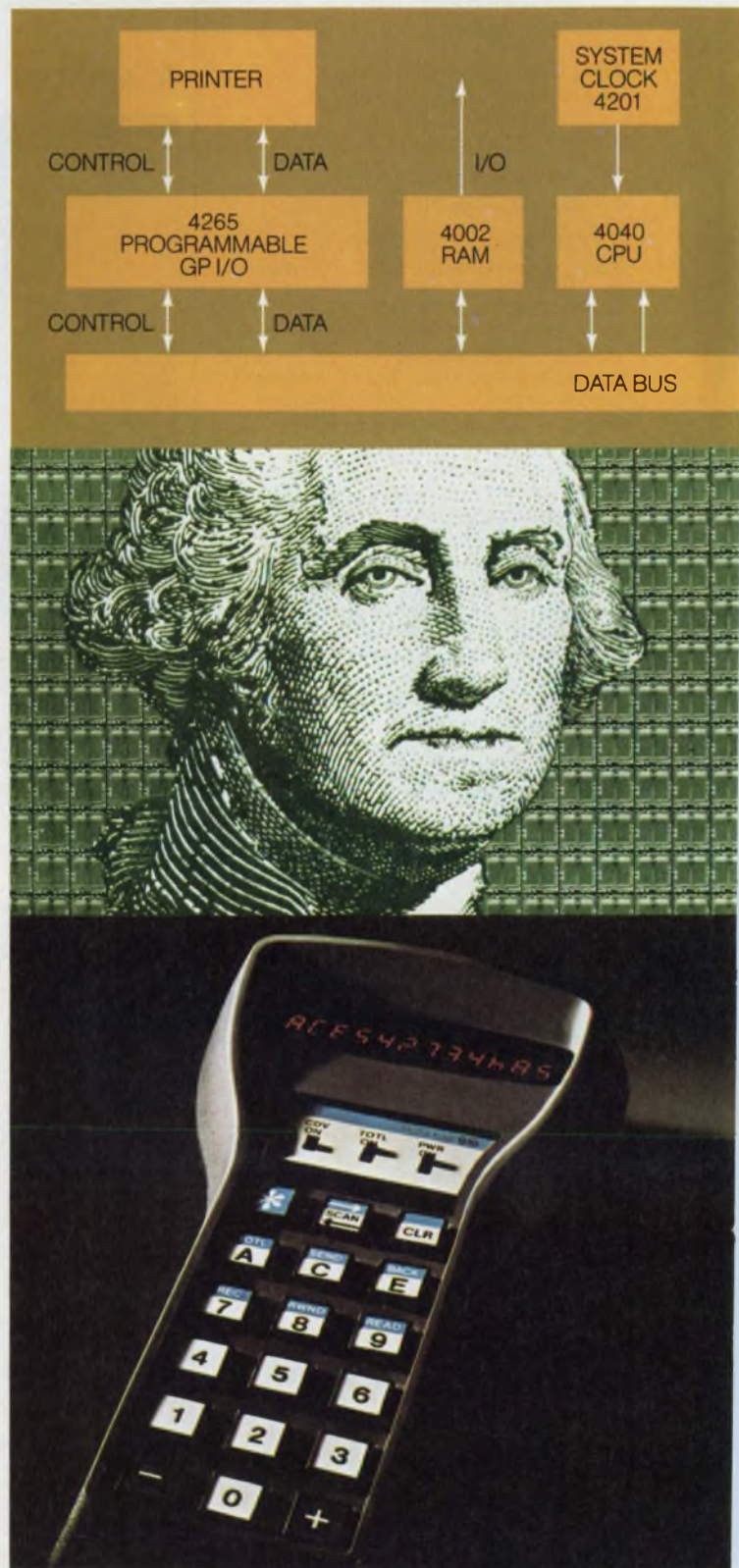

\* Self-Scan is a registered trademark of the Burroughs Corporation.



# puter I/O devices cut throughput up to 50%

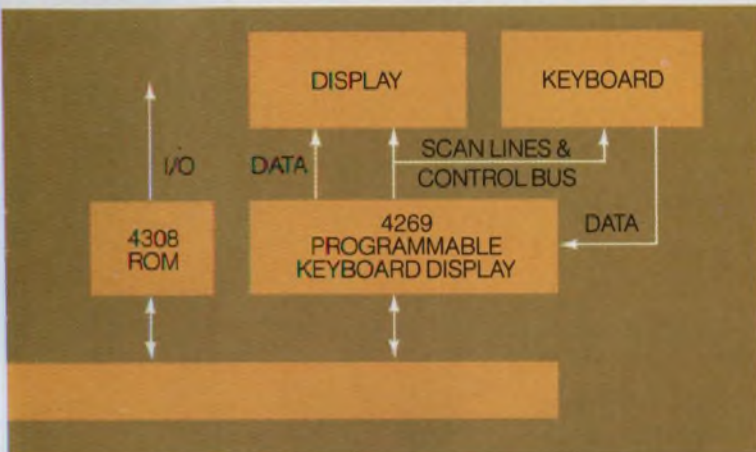

and system memory for display refresh since the necessary memory and control are built in. One 4269 can operate and refresh alphanumeric displays or indicator arrays with up to 32x4 digits, 16x8 characters or any configuration of 128 elements or lights, including a 20-character Burroughs Self-Scan\* Display.

The 4265 General Purpose Programmable I/O is ideally suited to implement custom interface requirements. Up to four devices can be controlled by the CPU. Each 4265 has 16 I/O lines organized into four ports which can be used in 14 different data transfer and control/interface organizations. The 4265 provides synchronous/asynchronous control, buffer inputs and outputs, bit set and bit reset capability on output port lines and byte transfer control. It can be used to add industry standard RAM memory such as Intel's 5101 CMOS RAM. And the 4265 lets you use system peripherals such as the 8251 Programmable Communications Interface (USART), the 8253 Programmable Interval Timer or the 8214 Priority Interrupt Control Unit.

To order, contact our franchised distributors: Almac/Stroum, Components Specialties, Components Plus, Cramer, Elmar, Hamilton/Avnet, Industrial Components, Liberty, Pioneer, Sheridan or L.A. Varah. For your copy of our MCS-40™ System brochure, use the bingo card or write: Intel Corporation, 3065 Bowers Avenue, Santa Clara, California 95051.

**intel**®

Microcomputers. First from the beginning.





Through Omron's 43-year history, each product has been designed and built as we have seen needs and filled them. One by one, year after year, as your needs grew, so did our family. And our family continues to grow—so that today Omron offers some of the broadest lines of control components available.

Omron enjoys a worldwide position of leadership—a position built on excellence in engineering, manufacturing, and marketing. And Omron's

commitment to quality products and service means you'll get *what you need, when you need it.*

So welcome Omron as your component supplier. Tell us your needs. Our applications engineering department will respond to your phone inquiries for key performance data within 48 hours.

**Omron will prove—you're not alone anymore!**



**Welcome  
to the family,  
little fella**





Omron Corporation of America  
Corporate Headquarters  
Sears Tower, Chicago, Illinois

Sales and Service  
1051 State Parkway  
Schaumburg, Illinois 60172  
Phone: (312) 885-9500

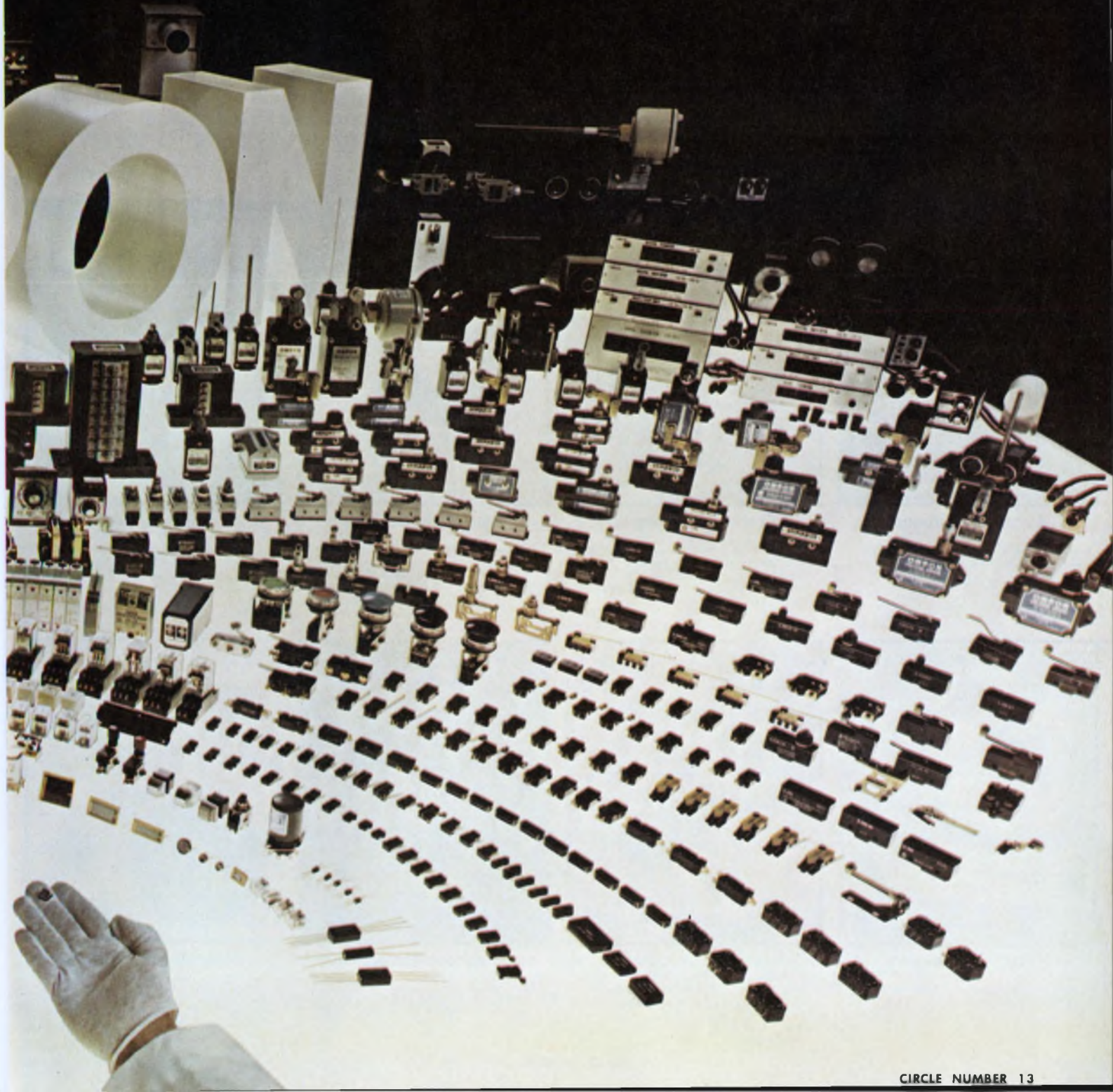



# VACTEC Photodetectors

The Industry's Broadest Line Provides More Semiconductor Detectors for More Design Applications

Vactec serves manufacturers of a wide range of modern electronic products. Pictured are a few examples. All these devices are both made and sold by Vactec, including complete lines of LDR's (photoconductive cells, CdS and CdSe); silicon solar cells, as well as silicon high speed and blue enhanced cells; NPN phototransistors and darlington's; opto-couplers (LED/LDR, lamp/LDR and neon/LDR); selenium photovoltaic cells; silicon photodiodes, blue enhanced and PIN; and custom C-MOS and bi-polar IC's. Write for technical bulletins on the types that suit your requirements. Or send your application, and Vactec will recommend the right cell for the job.

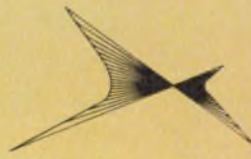

## Vactec, Inc.

2423 Northline Industrial Blvd.  
Maryland Heights, Mo. 63043  
(314) 872-8300



**Electronic Organs**

LED or lamp/LDR Vactrols for audio, and CdS cells for swell pedal controls



**Cameras and Projectors**

CdS or blue enhanced silicon photodiodes for automatic shutter timing, aperture servo systems for automatic projector focus; and slave flash controls.

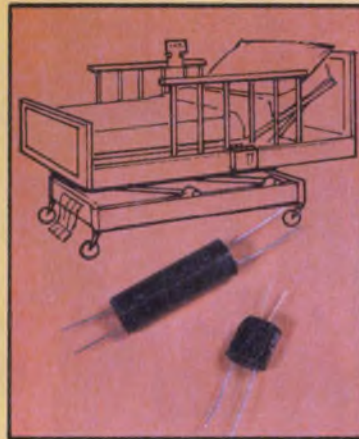

**Triac Motor Controls**

A special Vactrol gates a triac for forward and reverse motor operation as in hospital beds.

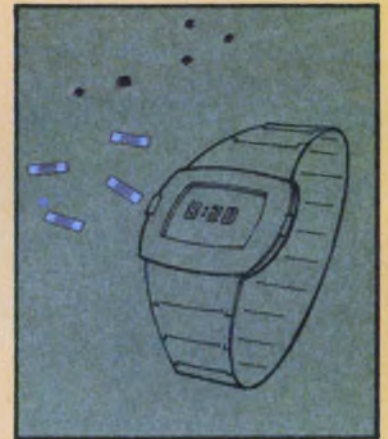

**LED Watches**

Photoconductive or phototransistor chip controls LED brightness.

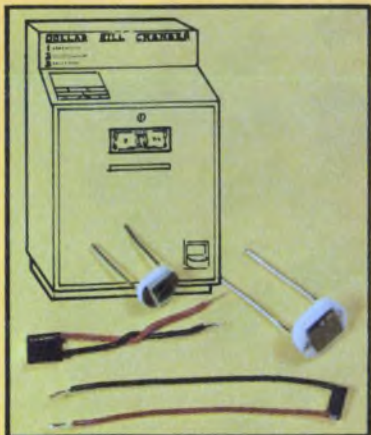

**Dollar Bill Changers**

Silicon photovoltaic cells analyze optical characteristics

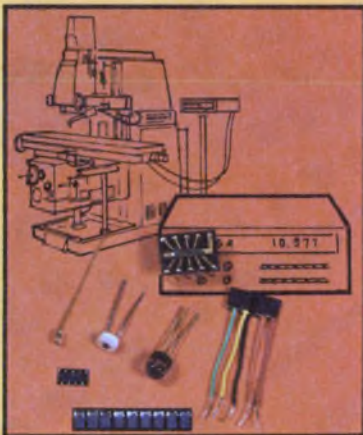

**Machine Tool Controls**

High-speed photovoltaic cells or transistor arrays help computer control repetitive operations, non-contact sensing, and counting and weighing

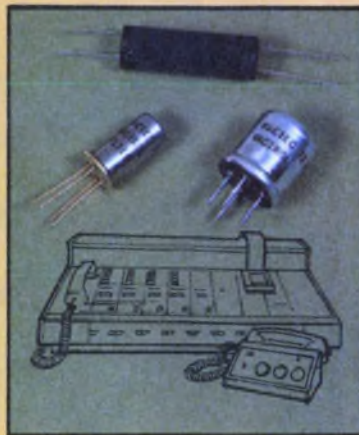

**Telephone Equipment**

Neon/LDR Vactrols sense ringing. Direct a-c coupling, slow LDR response isolates electronics from noise.

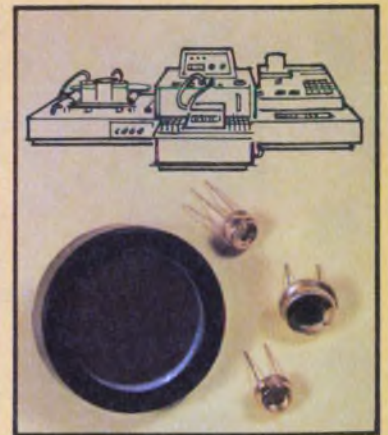

**Scientific Instruments**

Blue enhanced silicon or selenium photovoltaic cells detect solutions densitometrically for precise blood chemistry and other analyses.



## ACROSS THE DESK

(continued from page 25)

tal-Circuit Detects Frequency-Modulated Signals" (ED No. 8, April 12, 1976, p. 126) was independently arrived at, I received a patent for an identical circuit in 1973 (U.S. Patent No. 3778727 Crystal-Controlled Frequency Discriminator). The patent has since been transferred to the Simulation Products Div. of Singer Corp.

Arthur B. Williams  
 Manager, Analog Development  
 Coherent Communications  
 System Corp.  
 85D Hoffman Lane South  
 Central Islip, NY 11722

## Some sweat over capacitor tap impedance

It is quite unfortunate that John Hatchett's "Idea for Design" (ED No. 8, April 12, 1975, p. 82) gives absurd results even with his corrected formula—because his corrected formula was wrong. With his network, the  $R_{in}$  seen at the terminals of the inductor  $L$  is  $2472.1 - j1537.1$  which by no means is matched to  $2500 \Omega$ . Here is a correct design procedure:

To design a network to transform a  $50\text{-}\Omega$  source to a  $2500\text{-}\Omega$  input impedance of an IC to work at  $20\text{ MHz}$ :

1. Choose a suitable  $Q$ . (Generally between 1 and 10.) Let us choose  $Q = 1.4$ .

2. Find  $C_2$ .

$$C_2 = \frac{Q}{\omega R} = \frac{1.4 \times 10^{12}}{2\pi \times 20 \times 10^6 \times 50} \text{ pF} \\ = 222.81 \text{ pF.}$$

3. Find  $C_1$  from  $X_1^2 = R_{in} - R_1$ , where

$$X_1 = \frac{QR}{1 + Q^2} + \frac{1}{\omega C_1}$$

and

$$R_1 = \frac{R}{1 + Q^2},$$

so that

$$R_1 = \frac{50}{1 + 1.4^2} = \frac{50}{2.96} = 16.891$$

$$X_1^2 = (2500 - 16.891) 16.891 \\ = 4.1942 \times 10^4$$

$$X_1 = \frac{1.4 \times 50}{2.96} + \frac{1}{\omega C_1} \\ = 2.048 \times 10^{-2}$$

## What's in a name?

Whenever Naming Day comes to the new Tektronix facility in Wilsonville, OR, folks will be ready.

So far there is only one sign on the beautifully wooded 260-acre site, and it fits in perfectly with the architect's attempt to bring people closer to the outdoors:

"Caution. Low clearance. Over-

hanging branch."

Not content with that, a group of Serious Thinkers considered the possibilities and produced this carefully labeled map. The amateur cartographers include the following engineers: Bruce Baur, Larry Biggs, Tom Cheek, Dan Denham, Joe Hubert, Dick Preiss, Scott Richmond, Harvey Rosener, Larry Shorthill and Jack Sterett.

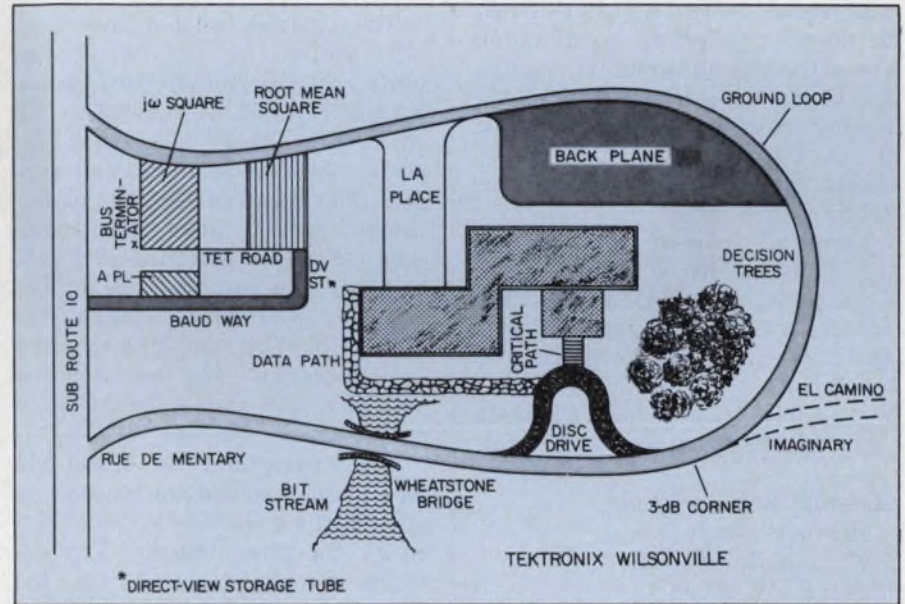

$$\frac{1}{\omega C_1} = 204.8 - 23.648 = 181.15$$

$$C_1 = 43.928 \text{ pF}$$

4. Find  $L$ .

$$\omega L = X_1 + (R^2/X_1)$$

$$= 204.8 + \frac{16.891^2}{204.8} = 206.19$$

$$L = 1.6407 \mu\text{H}$$

This completes the design. We can check the design by working out the  $R_{in}$  from the circuit.

$R$  in parallel with  $C_2$  yields an impedance of  $16.891 - j23.648 \Omega$ . This in series with the reactance of  $C_1$  yields  $16.891 - j204.798 \Omega$ . The admittance appearing across  $L$  is  $4 \times 10^{-4} + j4.8499 \times 10^{-3}$ . The susceptance of the inductance  $L$  is  $-j4.8501 \times 10^{-3}$  and the net admittance looking into the network is  $4 \times 10^{-4}$ , which corresponds to  $R_{in} = 2500 \Omega$ . These equations give the correct results because there are no approximations.

S. Jayasimha Prasad

Senior Research Fellow

Dept. of Electrical Engineering  
 209 Kaveri

Indian Institute of Technology  
 Madras 600 036, India

## The author replies

I would like to thank Mr. Prasad for his interest and concern relating to my "Idea for Design." I feel, however, that my material is correct and that my Eq. 2 does not give "absurd" and "wrong" results as he claims. Mr. Prasad, instead, appears to be drawing incorrect conclusions. I hope the following comments will provide adequate clarification.

The primary criticism appears to be that my published formula

$$R' = \frac{(X_{C1})^2}{R} + R \left( \frac{C_1 + C_2}{C_1} \right)^2, \quad (2)$$

is wrong, or at best, a bad approximation. Mr. Prasad's own results, obtained by his method can be used to help substantiate the correctness of my equation.

For example, he arrives at  $C_1 = 43.928 \text{ pF}$ ,  $C_2 = 222.81 \text{ pF}$  and

(continued on page 32)



## ACROSS THE DESK

(continued from page 31)

$X_{C_1} = 1/\omega C_1 = 181.15 \Omega$  in order to transfer  $R = 50$  to  $R_{in} = R' = 2500$  ohms. Plug his capacitor values into my published Eq. 2 and you get  $R' = 2499.87 \Omega$ . Indeed my formula does not give an "absurd," but a correct result.

I never calculated, nor intended to calculate, values for  $C_1$ ,  $C_2$  by using Eq. 2. The astute engineer will realize, however, that this can be done by selecting a value for one of the two unknowns ( $C_1$  or  $C_2$ ) and then solving for the other. This is similar to Mr. Prasad choosing  $Q = 1.4$ , and then using this chosen value of  $Q$  to solve for  $C_2 = 222.81$  pF.

Using his value of 222.81 pF for  $C_2$  in my published Eq. 2 yields a value for  $C_1$  of 43.91 pF. This agrees with Mr. Prasad's value—again indicating the correctness of my Eq. 2.

*John Hatchett*  
*Communications Application*  
*Engineer*

Motorola Semiconductor  
Products Group  
5705 E. McDowell Rd.  
Phoenix, AZ 85008

## Competition cited for hybrid amplifier

The New Product story "Hybrid Isolation Amplifier Avoids Transformers But Maintains Isolation" (ED No. 2, Jan. 19, 1976, p. 91) contains several important inaccuracies. Although the Burr-Brown 3650 series of isolators uses optocouplers, they do not improve on the performance, size, or price of existing transformer-coupled units.

The Analog Devices' Model 275 (see ED No. 13, June 21, 1975, p. 124) is our lowest-cost isolator at \$79 for quantities of 1 to 9. Our Model 285 is not our least expensive unit as your story says, but rather the highest-performance model in our broad line of single-channel isolators. Nor do we offer a Model 270 or 280, but our line does include the Models 272, 273, 274, 275, 276, 279, 282, 285.

The Model 275 features  $\pm 3000$  V (1 min.,  $\pm 2500$  V continuous) isolation compared with 2000 V (1

min., 1000 V continuous) for the Burr-Brown units, 120-dB vs 90-dB minimum CMR at 60 Hz with a 5-k $\Omega$  source imbalance, isolation impedance of  $10^{11} \Omega$  vs  $50 \times 10^9 \Omega$ ,  $(1 + 25/\text{gain})$  mV vs  $\pm 5$ -mV initial input offset,  $\pm 25 \mu\text{V}/^\circ\text{C}$  maximum vs  $\pm 25$ - $\mu\text{V}/^\circ\text{C}$  offset drift, and  $\pm 0.2\%$  maximum vs  $\pm 0.7\%$  maximum gain nonlinearity. It should be obvious from these comparisons that the Burr-Brown units have sacrificed performance, contrary to what your article states.

The external, isolated power supply required by the Burr-Brown units removes any effective size or price advantage over our 3.5  $\times$  2.5  $\times$  0.89-in. Model 275, which includes the isolated front-end supply. The floating supply recommended for the Burr-Brown units sells for \$33 in quantities of 1 to 9, bringing the cost and size of the resulting isolator up to that of the Model 275. This supply is required for operation of the isolation amplifier, and cannot be found in systems that use the isolator.

The Analog Devices' Model 275 has another advantage because its specifications include errors created by the power supply. The external supply required for the Burr-Brown unit has additional error terms that must be considered.

The reliability of transformer-coupled isolators is an established fact. The reliability of opto-isolators in isolation amplifiers where high voltages are present has yet to be proved. Transformer-coupled isolation amplifiers are nothing to be avoided.

*Fred Pouliot*  
*Marketing Manager for*  
*Analog Modules*

Modular Instrumentation Div.  
Analog Devices  
Route 1 Industrial Park  
P.O. Box 280  
Norwood, MA 02062

I am writing in response to an article on hybrid isolation amplifiers in your New Product section. It was mentioned that the "only head-to-head competition" for the Burr-Brown isolation amplifiers was from Analog Devices.

I would like to point out that Intronics also manufactures a series of isolation amplifiers. A first

glance at the specifications points out that our models, like those units manufactured by Analog Devices, are larger and more costly than the Burr-Brown units. But upon closer examination you will see that our gain nonlinearity spec is 70 times better than the Burr-Brown HG models and 25 times better than the JG models. In addition, our temperature drift is far less than that quoted by Burr-Brown.

*Richard Sakakeeny*  
*Sales Manager*

Intronics  
57 Chapel St.  
Newton, MA 02158

**Editor's Note:** For the product data sheet,

CIRCLE NO. 319

## Where they are now—the past still lives

I read with interest the letter by C. R. Whitlow (ED No. 24, Nov. 22, 1975, p. 10), about old and respected companies now doing business under new names. I can supply information on three of the brands you mentioned and some others.

Gertsch and Stoddart are alive and well and living here at Singer Instrumentation. The introduction of new instruments and accessories continues to expand these product lines. We also offer parts and service for all older instruments still in the field and for Alfred and EMC brands.

Due to the age of the Empire (and Panoramic) product designs, we no longer manufacture new instruments, but we do provide parts and service for both brands.

The Sensitive Research Instrument Corp. product lines have been sold by Singer Instrumentation to Electrical Instrument Service, Inc., Mount Vernon, NY. EIS can supply new instruments as well as parts and service for all older instruments in the field.

We recognize the value of the reputation these fine companies have established in the marketplace and are proud to display their names on the front panel of each instrument.

*James R. Norwood*  
*Public Relations*

Singer Instrumentation  
5340 Alla Rd.  
Los Angeles, CA 90066





# MEASUREMENT COMPUTATION

innovations from Hewlett-Packard

# NEWS

JUNE 1976

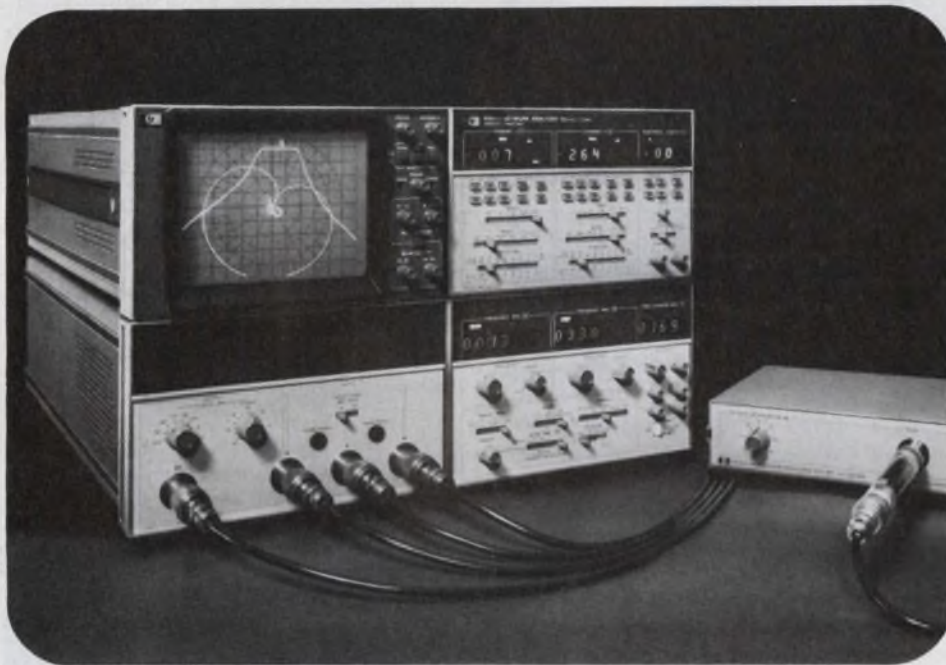

## Advances in network measurements: new 1.3 GHz Network Analyzer measures all major parameters—including delay—over wide ranges with high resolution

The state-of-the-art for RF network measurements has moved significantly ahead with the introduction of the HP 8505A Network Analyzer. Over its extremely wide frequency range, 500 kHz to 1.3 GHz, this new analyzer measures the magnitude and phase of a

network's transmission and reflection characteristics. Important in communications-related applications, the instrument also measures group delay and deviation from linear phase.

But the real story about the new analyzer is *how well* it makes these measurements! Major performance features include:

- Three independent input channels, each with 100 dB displayed dynamic range.
- Dual-channel CRT display of swept-frequency response in rectilinear and polar form.
- High-resolution digital readout of measured parameters at any frequency within sweep range (frequency is counted directly).

## in this issue

Broad line of instruments for the OEM

New HP-27 Scientific/Financial Calculator

Synthesized outputs from 2 to 18 GHz

- Direct measurement of group delay in both broadband and narrowband networks, (no charts or calculations needed).
- Direct measurement of deviation from linear phase using integral electronic line stretcher (with almost 5 wavelengths compensation range).
- Integral high-performance sweep oscillator with seven independent sweep modes and exceptional spectral characteristics.
- Simple yet complete programmability via the HP Interface Bus (HP-IB). Unique "Learn Mode" permits storage of manually-set control positions for later recall.

A wide selection of precision test sets are offered for use with the 8505A Network Analyzer. These include

*(continued on third page)*



# IC Tester brings new economy, versatility and simplicity to testing

Set up this digital IC tester quickly with magnetic program cards. HP's low cost magnetic program cards are the key to lower cost testing—of primary importance with today's proliferation of IC types.

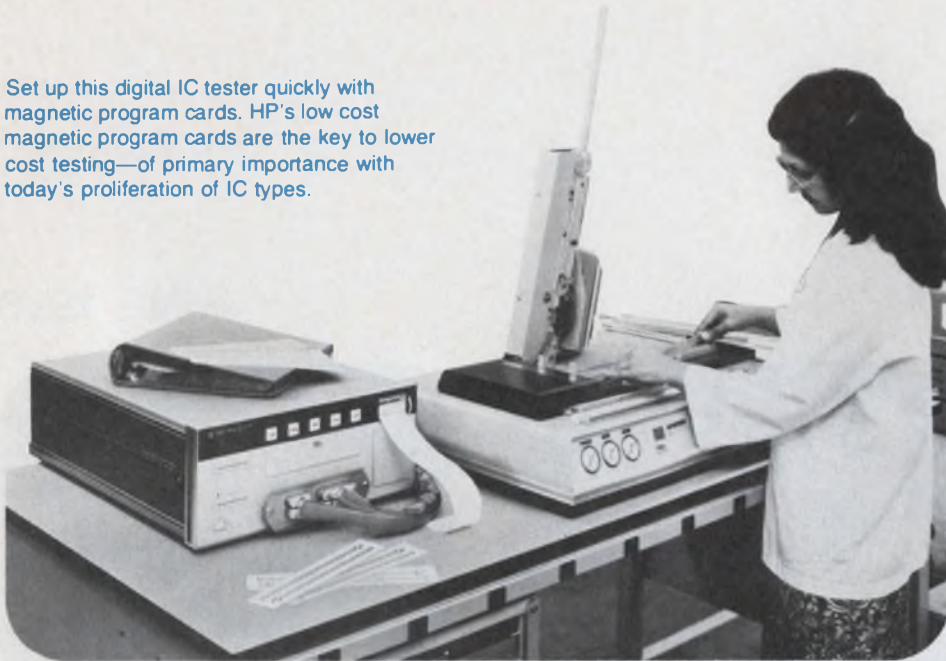

Insert an inexpensive magnetic programming card, and in five seconds this new multi-family Model 5045A digital IC tester is ready for dc parametric and functional testing of digital ICs. It's that simple—absolutely no other set-up or programming is needed. And it'll do some of your RAM and ROM testing too. Programming is so versatile that it can set-up a unique voltage and current level on each pin of the device under test within the limits of  $\pm 200$  mA and 0 to 15V or  $\pm 7.5$ V range.

Flip a switch and the quiet built-in thermal printer prints out failure type, failed pins and the voltage and current on each failed pin. Use this data for diagnostic purposes, to detect failure trends, or to send back with the failed parts so the supplier can understand the reason for your rejecting his product.

We've also made your software problems as simple and inexpensive as we could. When you order a program type, we supply, for a very nominal cost, four cards: a pass/fail test card, diagnostic test card, and a duplicate of each for safekeeping. Our unique program coupon book makes purchasing programs simpler, faster and more economical. Buy a book of ten coupons and just mail

us one whenever you want a program. There are 1000 devices in our standard program catalog right now and we're adding more all the time.

We've also simplified interfacing to a variety of automatic IC handlers. Order one of our standard options and the 5045A comes ready to plug into the handler—mechanical and electrical interfacing have been pre-arranged. All fast rise-time circuits are in a removable test head so they can be placed within inches of the IC tested.

Consider the large and ever growing number of IC types and you can quickly calculate how the low cost of the 5045A's program cards alone saves some users more than the cost of the tester itself....to say nothing of the money saved every day by the 5045A's simple, rapid, error-free operation and ability to handle a multitude of testing assignments. These HP cards are  $\frac{1}{4}$  to  $\frac{1}{2}$  the cost of other available programs.

For additional information, check J on the HP Reply Card.

## Five-function autoranging makes the HP 3476 the right decision

When you need to make measurements of current, voltage, or resistance, the HP 3476A/B will make your job faster and easier through complete autoranging on every function.

All readings are made directly in volts, kilohms, or amps—on an LED display. A rangehold button speeds and simplifies repetitive measurements.

There's no need to worry about polarity or zero...they're both automatic also.

It is *lightweight*: 0.77 kg (1 lb. 11 oz.), *compact*: 5.8 cm (2.3 in.) high, 16.8 cm (6.6 in.) wide and 20.6 cm (8.1 in.) deep.

You have a choice of AC power operation with the 3476A or, in the 3476B, AC power and rechargeable nickel-cadmium battery operation.

The 3476A/B was made possible through the perfection of a new microcircuit process—tantalum nitride on sapphire. All of the precision resistors required for the input attenuator are placed on a single chip. That means greater reliability and better temperature stability.

For more information, check F on the HP Reply Card.



Compact new DMM with advanced circuitry and packaging resulting in high reliability. One circuit board contains all the electronics.



## New network analyzer

(continued from first page)

HP 8502 high-directivity Transmission/Reflection Test Sets and HP 8503A S-Parameter Test Set (has HP-IB option) plus HP 11850 precision 3-way Power Splitters and several types of transistor test fixtures.

Examples of the measurement power of our new 1.3 GHz network analyzer:

### Transmission and Reflection Coefficients

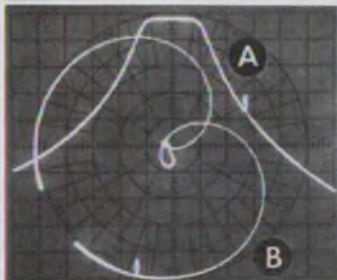

A. Transmission, 10 dB/div.  
B. Reflection, (polar) full radius = 1

### Deviation From Linear Phase and Group Delay

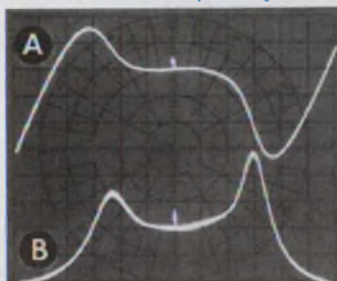

A. Deviation, 10°/div.  
B. Delay, 5 ns/div.

### Automatic Alternate Sweeps to show filter transmission

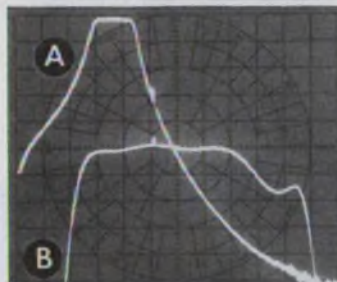

A. Total response, 10 to 500 MHz, 10 dB/div.  
B. Passband response, 145 to 210 MHz, 0.1 dB/div.

For detailed specifications, check L on the HP Reply Card.

## New Interface for Real-Time HP-IB Minicomputer simplifies do-it-yourself assembly of automatic test and measurement systems



Now, system designers can connect HP-IB instruments, like the DVM, scanner, numeric display, thermal printer, timing generator, counter, and digital-analog converter shown above, to the powerful control, data processing, and storage capabilities of Hewlett-Packard Real-Time Minicomputers.

Automatic test and measurement systems using bus-connected instruments can now utilize the full power and flexibility of Hewlett-Packard's Real-Time Minicomputers with the addition of the new HP 59310B Hewlett-Packard Interface Bus (HP-IB) I/O Kit and real-time software Option 422.

The HP 59310B interface can serve up to 14 HP-IB instruments connected via standard bus cables. The Real-Time Minicomputer supports several HP 59310B interfaces at the same time for control of multiple instrument clusters for performing different functions or for optimizing throughput.

Over 35 different HP instruments currently mate with this IEEE Standard 488-1975 Digital Interface for programmable instrumentation. As a corporation, Hewlett-Packard is committed to steady growth in HP-IB capabilities.

With the Real-Time Minicomputer, initial setup requires only connection of instruments to the bus, setting of instrument talk/listen addresses, system generation, and programming. Programs in FORTRAN, HP Real-Time BASIC, or HP Assembly language can be developed on the Real-Time HP-IB Minicomputer at the same time it is controlling HP-IB instrument clusters.

A brochure describing the Real-Time HP-IB Minicomputer will be sent to you if you check G on the HP Reply Card.



## With Hewlett-Packard, your OEM dollar buys more than just hardware

When you purchase OEM equipment from Hewlett-Packard, you are assured of product performance, service and applications assistance from a company that recognizes your reputation and success depend partly on the support you receive from your OEM supplier.

Confidence can be yours when you have HP instruments as part of your

system. Complementing HP's reputation for leadership in new product development utilizing high technology is the knowledge that HP is ready to respond to your needs with over 3,000 sales, service and technical personnel located in 172 offices in 65 countries.

HP offers a highly competitive OEM discount structure across a wide selec-

tion of instruments. Through our purchase agreements, we can coordinate our equipment deliveries with your forecasted customer needs.

In addition, a wide selection of instruments can be custom tailored to meet your specific needs.

## Choose an HP Display when your system needs a bright, sharp image

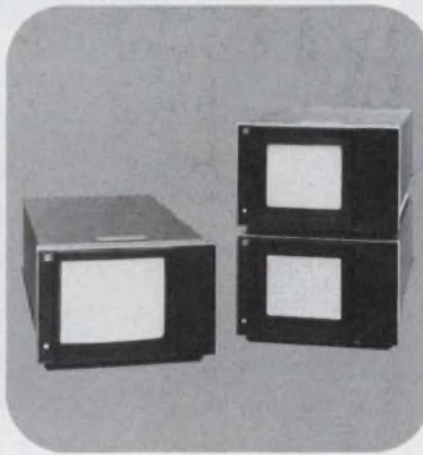
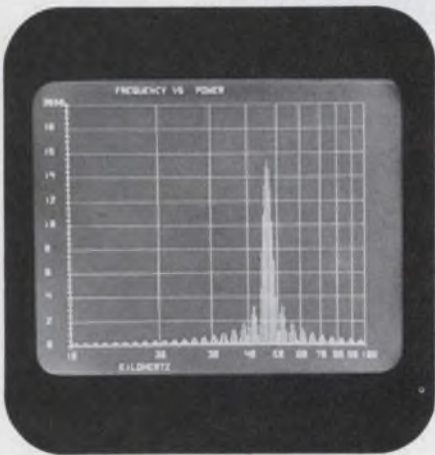

These HP high resolution CRT displays offer OEM users ease in integrating the modules into their packaging. Considerable effort has been taken in developing the structural, thermal and RFI characteristics.

End users of your OEM systems will judge capability by the information they are able to display. HP's 1332A, 1333A, and 1335A CRT displays make excellent choices for all types of systems—from spectrum, network, and chemical analyzers, to automatic test systems.

Each display has a very small spot size that focuses uniformly over the complete viewing area, regardless of writing speeds or intensity level. Fine image detail with excellent contrast and uniformity make them particularly well suited for applications involving complex graphics, especially those with alphanumeric data.

If you need a large viewing area and a brighter image at fast scan rates, consider the 1332A. The 9.6 x 11.9 cm viewing area offers superior performance.

For photographic recording of displayed data, the 1333A offers an extremely small spot size (.20 mm) for

accurate photo evaluation.

The 1335A, a variable-persistence, storage, and non-storage display introduces a totally new CRT design. Erase, store, write, conventional or variable persistence can be selected with manual front-panel controls, remote program inputs, or a combination of both.

For convenience, all frequently used controls have been placed on the front panel for maximum accessibility.

Five large screen graphic displays are also available for OEM computer graphic and instrumentation applications. These models offer a linear writing speed of 25.5 cm/μs for visible writing.

Check C on the HP Reply Card for information on the HP 1310, 1311, 1317, 1321 large screen displays. For the smaller displays, 1332, 1333 and 1335, check D on the HP Reply Card.

## A fine-line of recorders

Hewlett-Packard offers a wide selection of analog recorders and graphic plotters designed to fulfill the needs for recording and displaying data in conjunction with your equipment.

X-Y recorders are available in two basic chart sizes built around a one-piece die-cast aluminum mainframe—a rugged platform for the modular features you select. These recorders are engineered for long, reliable service, even in harsh environments.

Three levels of performance parameters are available depending upon measurement needs. Certain models have high sensitivity and high common mode rejection. Metric and English scales are optional. Two-pen models are also available.

An OEM catalog describing other recorders and printers is available. Models include X-Y, strip chart, oscillographic, and instrumentation tape recorders, plus graphic plotters for computer, timeshare, and calculator use.

For your copy, check O on the HP Reply Card.





## Choose from 89 Models of OEM Modular Power Supplies

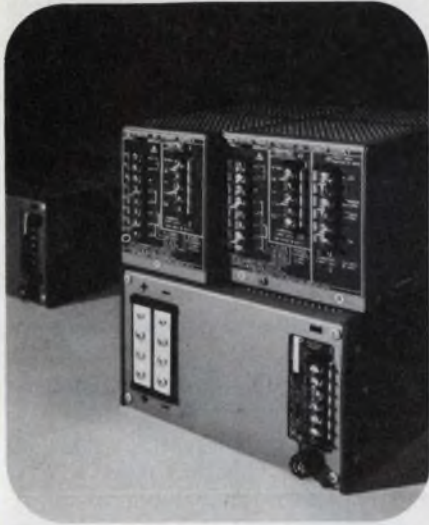

Switching and linear regulated OEM modular power supplies are available with rack mounting and power system accessories. All HP power supplies are UL recognized components.

You can select from five families of switching supplies that give top performance and reliability demanded by today's OEM. Ratings cover the range from 110 to 600 watts, with individual voltages from 4 to 48V in single output models. For smaller systems, there is a compact 110W triple output model with 5V, +12V to  $\pm 15V$ , and -12 to -15V outputs. All offer the benefits of technologically advanced 20 kHz switching regulation: high efficiency, small size, and low heat dissipation—factors that help cut your end-product size and cost.

Single and dual-output, linear regulated power supplies in the 6 to 200W range, with outputs from 3 to 48V are also available—in several different package designs.

A Special Design Group is ready to provide product modifications, assembled power systems, and applications assistance if the standard models do not meet your needs.

Complete specifications are contained in a new 20-page OEM brochure. Check P on the HP Reply Card.

## HP's new microwave synthesized signal generators provide precision signals 2-18 GHz

Two new *fully programmable* microwave synthesizers are now available from Hewlett-Packard. The 8672A Synthesized Signal Generator covers the full 2-18 GHz range in one solid-state package only 5¼" high. With AM/FM and calibrated output usually associated only with signal generators, 8672A also offers the resolution, spectral purity, stability and programmability of a high-quality synthesizer. The complementary Model 8671A, provides 2-6.2 GHz with FM capability only and minimum +9 dBm output.

The broad 2-18 GHz range of the 8672A makes it ideal for use in ECM and broadband component testing. Frequency resolution is 1 KHz in the 2-6.2 GHz range, 2 KHz from 6.2-12.4 GHz, and 3 KHz from 12.4-18 GHz. Frequency stability is  $5 \times 10^{-10}$  per day.

The 8672A's exceptional spectral purity will be important for other applications such as satellite receiver testing. Spurious signals are more than 70 dB below the carrier at 6 GHz, -60 dBc at 18 GHz. SSB noise is more than -78 dBc, 1 KHz away from a 6 GHz carrier, and 109 dBc at 100 KHz offset. True signal generator performance is

achieved with calibrated output from +3 to -120 dBm. Ranges are displayed on a 2½ digit LED readout and internal leveling is flat to  $\pm 1.25$  dB.

Amplitude modulation signals are externally supplied but internally monitored with an AM bandwidth of 500 KHz at 6 GHz and 100 KHz at 18 GHz. Metered and calibrated ranges are 30% per volt and 100% per volt.

Broadband frequency modulation is possible to 10 MHz rates and 10 MHz peak deviation. Six calibrated ranges from 30 KHz per volt to 10 MHz per volt monitor the input signal. Simultaneous AM and FM may be applied.

All front panel functions can be remotely programmed, via the HP Interface Bus, as a standard feature. Frequency will typically switch within 15 ms.

The HP 8671A Microwave Synthesizer (2-6.2 GHz) is ideal for many S and C band local oscillator applications, and offers the same wideband FM features as the 8672A.

For additional technical data, check M on the HP Reply Card.



The new HP 8672A Synthesized Signal Generator with wide dynamic range and exceptional stability provides features important to both broadband testing or to highly stable receiver tests.



## New option adds complete "hands-off" operation to universal counter

Fully programmable front panel of 5328A universal counter facilitates assembling versatile measurement/computation systems. System shown makes ordinary or statistical time interval and frequency measurements. An HP 9800 series programmable calculator is controlling the system and computing statistics to be plotted by the HP 9862A.



Add Option 041 to the Model 5328A Universal Counter for completely automated operation under computer or calculator control *plus* higher performance time interval measurements.

This new option adds full remote programming of all input signal conditioning controls. Trigger slope, trigger level, attenuators, AC-DC coupling, and 50 $\Omega$  or 1M $\Omega$  input impedance can now be set remotely. This is in addition to all the other front panel controls which are remotely set by the Hewlett-Packard Interface Bus (HP-IB) Option 011, a requirement for this total capability.

Option 041 also significantly increases the resolution and versatility of the 5328A counter's time interval

measurements. Included among the many improvements are 10 ns single shot time interval resolution and the HP exclusive jittered clock that can give more accuracy and certainty to averaged time interval measurements.

Combine Option 011 and 041 with the 5328A and you will have a counter that will simplify your automation and measurement tasks.

Other 5328A options available include a 512 MHz channel, choice of two types of built-in DVMs and an ultra-stable time base oscillator.

For more information, check K on the HP Reply Card.

HP has integrated into the NEW HP-27 the most significant functions used by scientists and financiers

The HP-27 Scientific/Plus is the most powerful preprogrammed pocket calculator Hewlett-Packard has ever built.

Five new functions never before offered by HP include variance, correlation coefficient, normal distribution, net present value and internal rate of return.

You will be able to solve difficult scientific and statistical problems with the 28 math and trig functions, 15 statistical functions and 10 financial functions.

You can simplify complex calculations through the use of the 20 memories; store constants in 10 addressable registers; manipulate data in four operational stack memories.

Multiple clearing operations let you preserve data in some registers while preparing others for a new calculation.

For today's engineer solving complicated equations or preparing budgets, cost analyses or forecasts, the HP-27 is an outstanding price/performance tool to assist in technical and resource management decisions.

Check A on the HP Reply Card.



The HP-27 offers all the scientific functions we've preprogrammed into earlier scientifics *plus* new stat and financial functions, new storage capacity, new clearing operations and engineering notation.



# HEWLETT-PACKARD COMPONENT NEWS

## Higher power for microwave impulse train generators



New coaxial step recovery diode modules are of rugged, reliable solid state hybrid integrated design.

Two new step recovery diode modules for comb generation are added to Hewlett-Packard's line. Model 33005C is a complete comb generator with dc return and 3mm connectors; Model 33005D is a cylindrical module with axial leads. Input frequency for both is  $1000 \pm 50$  MHz. Guaranteed output power at 18 GHz is  $-15$  dBm with 0.5 watt drive. Applications include measurement of spectral behavior of linear components such as filters and slow wave structures, frequency and amplitude calibration of receivers and antennas, and reference frequency generation for phase locked systems.

When driven at the appropriate input frequency, the devices generate a train of narrow, high amplitude pulses at a repetition rate equal to the input frequency. The resulting comb spectrum consists of lines at all multiples of the input frequency up to and beyond 18 GHz.

Output pulses are typically 10 volts amplitude and 150 picoseconds wide with 0.5 watt drive at 1000 MHz. Input is matched to 50 ohms.

For technical data, check E on the HP Reply Card.

## Two new hermetic LED displays with on-board decoder/divider

Two new series of LED  $4 \times 7$  dot matrix numeric/hexadecimal displays are hermetically sealed for high reliability. Both displays provide a 7.4 mm (0.29") character height.

Models 5082-7356, -7357 and -7359 are intended for the industrial user who requires the degree of reliability offered by ceramic packages.

Models 5082-7391, -7392 and -7395 are intended for demanding requirements of military, satellite and spacecraft applications, and for industrial users demanding the ultimate in reliability.

These displays are categorized for luminous intensity assuring uniformity of light output from unit to unit within a single category.

For more details on displays for high reliability applications, check H on the HP Reply Card. For less demanding applications, check I on the card.

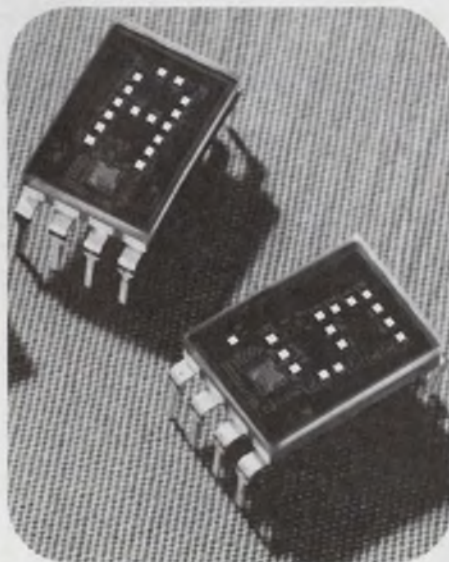

New series solid state numeric and hexadecimal indicators with 5-bit memory designed for use in military and adverse industrial environments.

## New ultra-low noise bipolar transistor with only 2.7 dB NF at 4 GHz

The chip is packaged in the HPAC-70GT, a rugged co-fired metal/ceramic hermetic package.

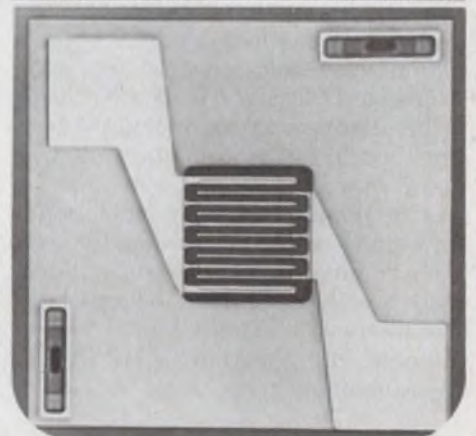
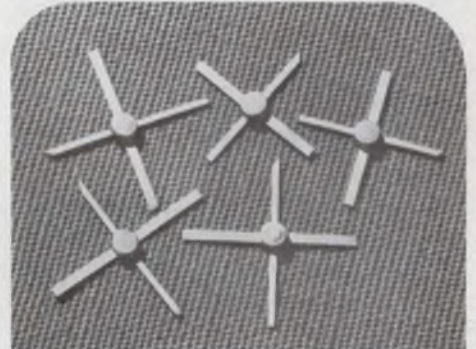

A new NPN bipolar transistor utilizing ion implantation techniques in its manufacture is provided with scratch protection over its active area.

Designers of ultra low-noise amplifiers will find this new microwave bipolar transistor ideal for use from 1 to 4 GHz in applications such as radar preamplifiers, ECM equipment, microwave links, broadband IF amplifiers and satellite systems.

The HXTR-6101 has a specified noise figure of 2.7 dB typical (3 dB max.) at 4 GHz and 1.5 dB typical at 1.5 GHz. Typical associated gain at NF conditions is 9.0 dB at 4 GHz and 15 dB at 1.5 GHz.

For further details, check N on the HP Reply Card.



# We've revolutionized digital troubleshooting again— this time it's a current tracing probe

Put Hewlett-Packard's new Model 547A Current Tracer on or near a misbehaving logic circuit path and look for the light to illuminate at its tip. Now, you're on your way to solving some of digital logic troubleshooting's most difficult problems—you know just where logic current pulses from 1 mA to 1A are flowing...even in multilayer circuit boards...and for all logic families.

You'll be able to perform the following quickly and economically:

#### TROUBLESHOOT:

- Wired - AND/OR busses
- Three-state busses

#### PINPOINT:

- The one bad IC on a stuck node
- Hairline cracks/solder bridges
- Backplane/motherboard shorts

On a shorted node, all points are stuck in one state by the short. Many stuck node troubleshooting problems, particularly in wired-AND/OR configurations, result in wasted time and excessive costs since several ICs have to be removed before finding the bad one, and in the process, the circuit board may be damaged. Now, the 547A exactly pinpoints the one faulty point on a node. How do you determine that your circuit problem is a stuck node? With a voltage-sensitive logic probe like the new, all-family Model 545A announced in the March/April issue of Measurement/Computation News.

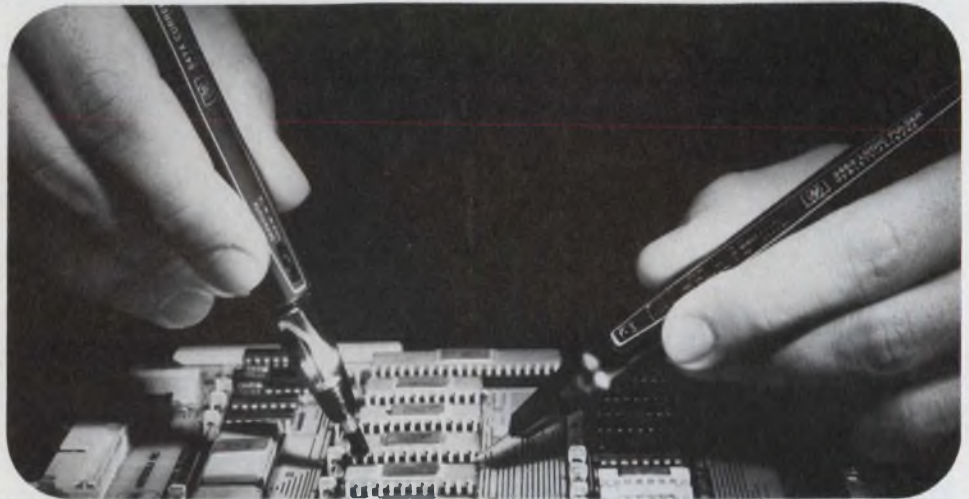

The Current Tracer's highly sensitive, shielded magnetic sensor precisely locates low impedance faults in digital circuits by "sniffing out" current sources or sinks in all logic families. If current pulses are needed, use the new programmable 546A Pulser to supply them.

The lamp in the 547A Tracer's tip indicates single-step current transitions; single pulses  $\leq 50$  ns wide; pulse trains to 10 MHz (typically 20 MHz for pulses  $\leq 10$  mA). Sensitivity is 1 mA for risetimes  $\leq 200$  ns and is adjustable up to 1A via a fingertip control. Power it from 4.5 to 18 Vdc,  $\leq 75$  mA.

If there's no current in the circuit or branch you're testing, you can supply it with our new Model 546A Logic Pulser. It's programmable to give one pulse per command, a 1, 10 or 100 Hz stream, or a burst of exactly 10 or 100 pulses. So now you can set your circuit

into its 852nd clock pulse state if you wish. It'll produce lots of short duration current to drive TTL or CMOS high nodes low or low nodes high—automatically and without harm to the circuit. Use it as pulse source for troubleshooting with logic probes, too. It's an amazingly capable pulse generator—especially for its small size.

Circle B on the HP Reply card and we'll send data on all the above, and on our Logic Clip and Logic Comparator, too.

East-4 Choke Cherry Road, Rockville, MD 20850  
Ph. (301) 948-6370.

South-P.O. Box 10505, Atlanta, GA 30348  
Ph. (404) 434-4000.

Midwest-5500 Howard Street, Skokie, IL 60076,  
Ph. (312) 677-0400.

West-3939 Lankershim Blvd, North Hollywood, CA  
91604, Ph. (213) 877-1282.

Europe-7, rue du Bois-du-lan, P.O. Box, CH-1217, Meyrin-2,  
Geneva, Switzerland, Ph. (022) 41 54 00.

Canada-6877 Coreway Drive, Mississauga, Ontario,  
L4V 1M8, Ph. (416) 678-9430.

Japan-Yokogawa-Hewlett-Packard Ltd., Ohashi  
Bldg., 1-59-1 Yoyogi, Shibuya-ku,  
Tokyo 151, Ph. 03-370-2281/92.

**HEWLETT**  **PACKARD**

Sales and service from 172 offices in 65 countries.

 **MEASUREMENT  
COMPUTATION** **NEWS**  
innovations from Hewlett-Packard

MAY/JUNE 1976

New product information from

**HEWLETT-PACKARD**

Editor: Iona M. Smith

Editorial Offices:

1507 Page Mill Road  
Palo Alto, California, 94304 U.S.A.



**A few of the electronic products now being made in Puerto Rico:**

Electronic precision instruments • Mini-computers • Thermostats • Electric and electronic measuring instruments • Capacitors • Monolithic electronic modules • Potentiometers • TV, Radio and Phono assemblies • Tape recorders • Two-way communications radios for cars and boats • Color TV electron gun mounts • Magnetic core memories • Radial detectors



# A few of the reasons Puerto Rico has attracted so many of your competitors

Electronics is now Puerto Rico's second-largest industry.

In the past five years, shipments of electrical and electronic products from the island are up an average of more than 90%\*.

If you're thinking of opening a new plant, you should know why electronics manufacturing thrives in Puerto Rico. The key reasons are these:

## 1. Unheard-of profits

Unheard of on the mainland, that is. Your competitors in Puerto Rico show an average 29.4% profit-to-sales ratio. That's seven times better than on the U.S. mainland.\*\*

No wonder companies like R.C.A., Digital, Technicon, Bell & Howell, G.E., Westinghouse, GTE Sylvania, Instrument Systems Inc., AMP Inc. and Motorola like the business climate in Puerto Rico.

## 2. No federal income tax

None at all. Puerto Rico is not subject to any federal taxes. So these companies pay no United States income tax, personal or corporate. And neither will you.

## 3. 100% local tax exemption up to 30 years

Companies can be exempt from local taxes of any kind. That means no corporate income tax, no real and personal property tax.

Tax exemption is granted for a minimum of ten years to a maximum of thirty years, depending on where you locate your plant on the island. And there are many

excellent locations available throughout the island.

## 4. Workers who produce

U.S. companies report that the productivity of their Puerto Rican workers is at least equal to—and often surpasses—that of their mainland counterparts.

Over 100,000 such workers are immediately available for employment. A young, eager labor force capable of producing anything from capacitors to the most complex electronics instruments.

And Puerto Rico wages remain reasonable. Companies find they're much lower than those paid in any other industrial area in the U.S. In fact, you can expect to save an average of \$1.84 an hour.

## 5. 2-year wage incentive

Eligible companies can benefit from government reimbursements of up to 25% of production wages paid in their first two years of operations in Puerto Rico.

If you qualify, this incentive would be paid back to you in your third and fourth years on the island.

## 6. In Puerto Rico, U.S. companies are on U.S. soil

Obviously, American companies find this an enormous business advantage over foreign locations. Life is much simpler when you're dealing with the same post office, legal system—and the same money. Imagine what you'll save by avoiding currency fluctuation headaches alone.

## 7. Puerto Rico's great air/sea connections

Fifteen scheduled airlines and thirty ship-

ping lines service the international port of San Juan. Four airlines offer daily airfreight links to the U.S. mainland. Air cargo from Puerto Rico gets to New York in 3¼ hours, to Los Angeles in 8½.

Modern container and roll-on/roll-off ships reach New York in 3½ days; sailing time to Pacific ports is about 12 days. By air or sea, shipments are domestic—no special documentation needed.

## Intrigued? Send for free report

Now you have a general idea of why so many electronics companies are already in Puerto Rico. For the complete, in-depth information you need to make your decision, mail the coupon below.

\*Source: Puerto Rico Planning Board: External Trade Statistics re: shipments to the U.S., the Virgin Islands and foreign countries, 1969-1974.

\*\*Source: Latest available profitability figures (1974). Commonwealth of Puerto Rico, Economic Development Administration, Office of Industrial Economics and Promotional Services.

**Commonwealth of Puerto Rico  
Economic Development Admin.  
Dept. ED-2, 1290 Ave. of the Americas  
New York, N.Y. 10019**

Please send me a "Report on the Electrical and Electronics Industry in Puerto Rico" today, including details on Puerto Rico's irresistible profit incentives. The equipment I am thinking of manufacturing is:

Name \_\_\_\_\_  
Title \_\_\_\_\_  
Company \_\_\_\_\_  
Address \_\_\_\_\_  
City \_\_\_\_\_ State \_\_\_\_\_ Zip \_\_\_\_\_

©1976 Commonwealth of Puerto Rico

**Visit Puerto Rico at Nepcon '76 East June 8-10 Booth 4909**



# Series 9000. They weren't born yesterday.

Being first doesn't happen overnight. The Series 9000 synchronous tape transports are the result of 16 years experience in designing and building digital tape transports. We've learned a few things along the way — the many unique features of Series 9000 prove it. Features such as:

- A position arm anticipatory sensing system. An exclusive Kennedy feature, the linear, non-contact (Mag Pot) position sensor requires no lamp source and assures performance for the life of the machine.
- Interchangeable electronics on all Series 9000 transports, to reduce stocking costs and down time.
- Front-accessible off-line test panel; marginal skew check; threshold scanning which automatically compensates for drop-ins or drop-outs; Read-After-Write shortened skew gate; simplified tape path and quick-release hubs.

- All models are available with either 7 or 9 track, 800 NRZI, 1600 PE or 800/1600 NRZI/PE.
- 7 and 9 track NRZI and PE format/control units to simplify customer electronics. Also, a variety of popular mini-computer mag tape controllers are available.

Series 9000's performance is as impressive as its features, with data transfer rates to 72KHz, and tape speeds from 10 to 45 ips.

Sixteen years is a long time in the digital tape business, but many of the first Kennedy transports are still in the field, and still operating. That's something worth thinking about the next time you have a requirement for digital tape transports.

## **KENNEDY CO.**

540 W. WOODBURY RD., ALTADENA, CALIF. 91001  
(213) 798-0953



**KENNEDY • QUALITY • COUNT ON IT**



JUNE 7, 1976

## Computer updating is needed by domestic ATC System

In the very near future, the computers in the domestic air traffic control system will not be able to handle the expected load. Neither the en route computers in some facilities, nor terminal installations, will be adequate.

That warning is given by Leland F. Page, acting chief of the ATC Systems Branch, Federal Aviation Administration, Washington, DC, at this week's National Computer Conference in New York City.

The crunch will come for two reasons. (1) Traffic loads are expected to increase approximately 4% per year over the next decade. (2) The computer will be given more duties; whenever possible, responsibility will be taken out of fallible, human hands and given to machines.

Keeping the system up to date is a major FAA challenge, and will remain so, Page says. Companies that wish to take part in the project should remember several points:

- New installations must be made without interrupting the system's operation;
- Design commonality must be maintained for hardware and software;
- Expansion of the system must be consistent with other long-range FAA programs, such as the Discrete Address Beacon System, the Flight Service Station Automation, and improved interfacility data communications.

The Discrete Address Beacon System (DABS) will contact individual aircraft from which information is needed. The current system transmits every message to all aircraft.

The Flight Service Station Automation project will computerize the data required by pilots so that ground operators could respond to pilots' queries by pressing a button, and reading the computer-

generated data on CRTs.

Several methods are being developed to improve the performance at the 61 operational air-route traffic centers throughout the United States:

(1) Display-buffer refresh memories will be added to the ATC systems at 30 major terminals, including New York. The memories will provide additional safeguards against loss of data in event of computer outage, and will reduce the display-processing loads on the computer.

(2) A  $\mu$ P-based sensor receiver and processor will perform the initial processing of radar/beacon returns at the radar site and to provide correlated target reports to the air route traffic center. This will reduce the heavy demand on the computers and improve the quality of surveillance data.

(3) An adjunct minicomputer subsystem called the Terminal Information Processing System (TIPS) is planned to transfer more efficiently flight data to and from the en route center computers, and to provide electronic flight-data displays for tower cab-control positions. Since other advanced subsystems such as DABS, the Wake Vortex Advisory System, and Airport Surface Traffic Control are planned, each with its own minicomputers, the potential exists to reduce—rather than add to—the data-processing loads of the host air-traffic systems.

### Quartz xtal oscillator charts urban pollutants

A unique particle detector based on a quartz-crystal oscillator, is one of the more than twenty instruments that will be carried aloft aboard a 15-story high research balloon to be launched this month

near St. Louis, MO.

The balloon will carry four people in addition to equipment for atmospheric tests and monitoring. It is part of the DaVinci II project, sponsored in part by the government's Energy Research and Development Administration (ERDA). During the flight researchers will chart the movement and long-distance effects of air pollutants emanating from a large American city.

Among the items to be measured are the relative sizes and amounts of aerosol particles found in the atmosphere at elevations of 1000 to 3000 ft. The amount of pollutant is determined by having the particles accumulate on the quartz crystal surface, with the crystal connected as an oscillator. The oscillation frequency varies in proportion to the amount of material collected.

Particle size is determined by directing an air stream containing these pollutants to a velocity sorter that separates the incoming material into 12 categories according to size. The amount of accumulated aerosol material in each category is then measured by the quartz-crystal technique.

The DaVinci balloon also carries instruments to monitor the temperature pressure of the atmosphere, and the amounts of ozone, sulfur dioxide and water vapor.

### RCA introduces biMOS op amp to replace 741

A new high-performance, low-cost operational amplifier that plugs into 741 sockets uses RCA's combined MOS/bipolar technology. It also replaces premium op amps like the 107 and LF 356. The new RCA biMOS op amp—the 3140—has a PMOS input and a bipolar output stage. The PMOS input stage, similar to that used in the RCA 3130, has added features of internal compensation and is capable of operating from a 4-to-44-V dual or single supply. Internal compensation eliminates the cost of an external compensation network.

A special input-protection feature makes use of bipolar diodes that can withstand a 1000-V static discharge. These diodes absorb a 0.5-A peak current and clamp the inputs to about 8 V.



RCA's biMOS process has been developed to provide low levels of built-in charge and a low p-channel threshold, according to researchers at the RCA Solid-State Div., Somerville, NJ. Cross-paralled, interdigitated transistors are used to match closely the PMOS pairs and provide a low tempo of offset voltage.

Performance of the CA3140 is substantially better than that of the ubiquitous 741 op amp. The 3140 typically has a high input impedance of 1.5 T $\Omega$ , and a low input current of 10 pA at  $\pm 15$  V. These figures correspond to the 741's input resistance of about 1 M $\Omega$  and its input current of 100 nA.

The input-offset voltage of the 3140 is only 5 mV as contrasted with 600 mV in the 741. Open-loop gain of the 3140 is typically 100,000 V/V as compared to 10,000 to 30,000 of the 741.

The 3140's slew rate is high, typically 9 V/ $\mu$ s. Settling time to 10 mV with a 10-V pk-pk signal is only 1.4  $\mu$ s. Its gain-bandwidth product is 4.5 MHz.

The 3140 output stage is a unit-gain emitter follower. It can supply 20 mA of current and consequently can drive capacitive loads at high slew rates. The output voltages, with a device load of 2-k $\Omega$ , swing to within 2.5 V of the positive supply. The output stage can be strobed, and it can swing to within 2.0 V of the negative supply. As a result, the op amp can directly drive power transistors without the added cost of external level-shifting circuitry.

Prices of 3140s in the general commercial-device category range from 52 to 65 cents in 1000 quantities.

CIRCLE NO. 318

## Very high accuracy scale measures body-weight

A 250-pound electronic scale capable of reading to one part in one-quarter million has been invented by a Massachusetts Institute of Technology researcher. The scale was designed to measure body-weight loss for metabolic research in MIT's Food Science's Instrumentation Laboratory. The weighing system employs sophisticated electronic body-motion filter-

ing to compensate for movements of restless infants while on the scale. Normally, such motion makes accurate scale readings impossible.

The scale, according to inventor James Williams, combines precision strain gauges and low-drift electronics. The scale platform is instrumented with a symmetrical distribution of the gauges that produce linear outputs. These outputs are processed by measuring and filtering circuitry.

Advantages of the scale, Williams points out, include the elimination of human error because the scale requires no calibration or adjustment. Also, it is easy to interface with such auxiliary devices as computers or specialized circuitry.

The Williams scale, which has digital readouts, makes possible precise, measurement of frequent body-weight changes occurring over short periods. It can also measure miniscule losses of body water, such as sweat.

## New satellite antennas boost message capacity

To cope with a steadily increasing demand for the services of communication satellites, engineers are being called upon to squeeze more messages into the crowded frequency spectrum allocated for satellite communications.

One solution is a C-band satellite antenna capable of handling 12 simultaneous wideband signals, all using the same frequency range. The antenna is one of the topics discussed at this month's International Conference on Communications held in Philadelphia, PA.

Such a large message-handling capacity exceeds anything available so far for a single antenna at these frequencies, reports William Scott of Western Development Laboratories, Aeronutronic Ford, Palo Alto, CA.

Known in the industry as "spatial reuse," the multiple-message technique is accomplished by designing the satellite antenna to radiate six separate "pencil beams" to six different spots on earth. The sidelobes of each pencil beam are held to below 33 dB lower than ever achieved with such a design, Scott says. The low level is crucial to the system's successful operation.

An additional antenna design feature, known as "polarization frequency reuse," doubles the message-handling capability of each of the six beams and results in an over-all antenna capacity of 12 simultaneous messages.

Such frequency reuse is accomplished by separating the electromagnetic energy into two spatial polarizations, left handed and right handed. Each polarization can carry a separate message.

## Largest graphite-epoxy antennas set for Mariner

Antennas for the Mariner spacecraft that will fly past Jupiter in 1979 and on to Saturn in 1980 will be the largest spacecraft antennas ever made from graphite-epoxy. They will be 12 feet in diameter and weigh 100 pounds.

The high-gain, dual-frequency S-and-X-band antennas were built by Aeronutronic Ford's Western Development Laboratories Div., Palo Alto, CA, for the Jet Propulsion Laboratory, Pasadena, CA.

Graphite epoxy was chosen for its high-strength-to-weight ratio and for its very precise surface tolerances—better than a hundredth of an inch.

One of the antennas will be flown in each of the two Mariner spacecraft being developed by JPL for NASA. Aeronutronic Ford is building a total of three antennas: one for pre-flight qualification tests, and two for the actual flights.

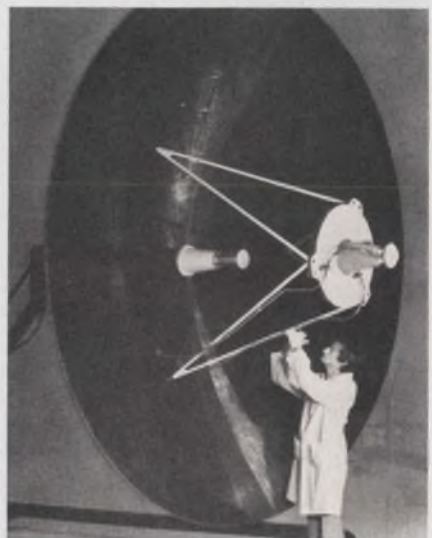

Mariner spacecraft to Jupiter and Saturn will carry this 12-ft diameter, 100-lb antenna made from graphite-epoxy by Aeronutronic Ford.



# Intro- ducing the amaz- ing EECO

machine: in one end you put your raw, un-annotated logic diagram, and out of the other comes your fully wire wrapped socket board frame/drawer system—your choice. Together with a *Final Exception Report*, a *Final String List*,

*an IC Location List*, *lists for IC Type and Socket Size*, a *Wire Loop List*, a *Pin Assignment List*, an *Unused Circuit Elements and Pins List*, a *Pin by Pin Wire List*, and your diagram back, fully annotated.

This machine uses a computer, and people, and hardware all under the same roof, and gives you a chance to correct or change your circuitry before we go to hardware. We deliver in as little as two weeks, including time for you to review. We've been doing this for more than five years, almost in secret. Now we're telling you and the world because it's about time. Write or phone the keeper of the EECO machine, Dick Hunter.



**EEECO**

PACKAGING/SWITCHES/READERS

1441 East Chestnut Avenue, Santa Ana, California 92701  
Phone 714/835-6000



# When you can buy all this for a total of \$701\*

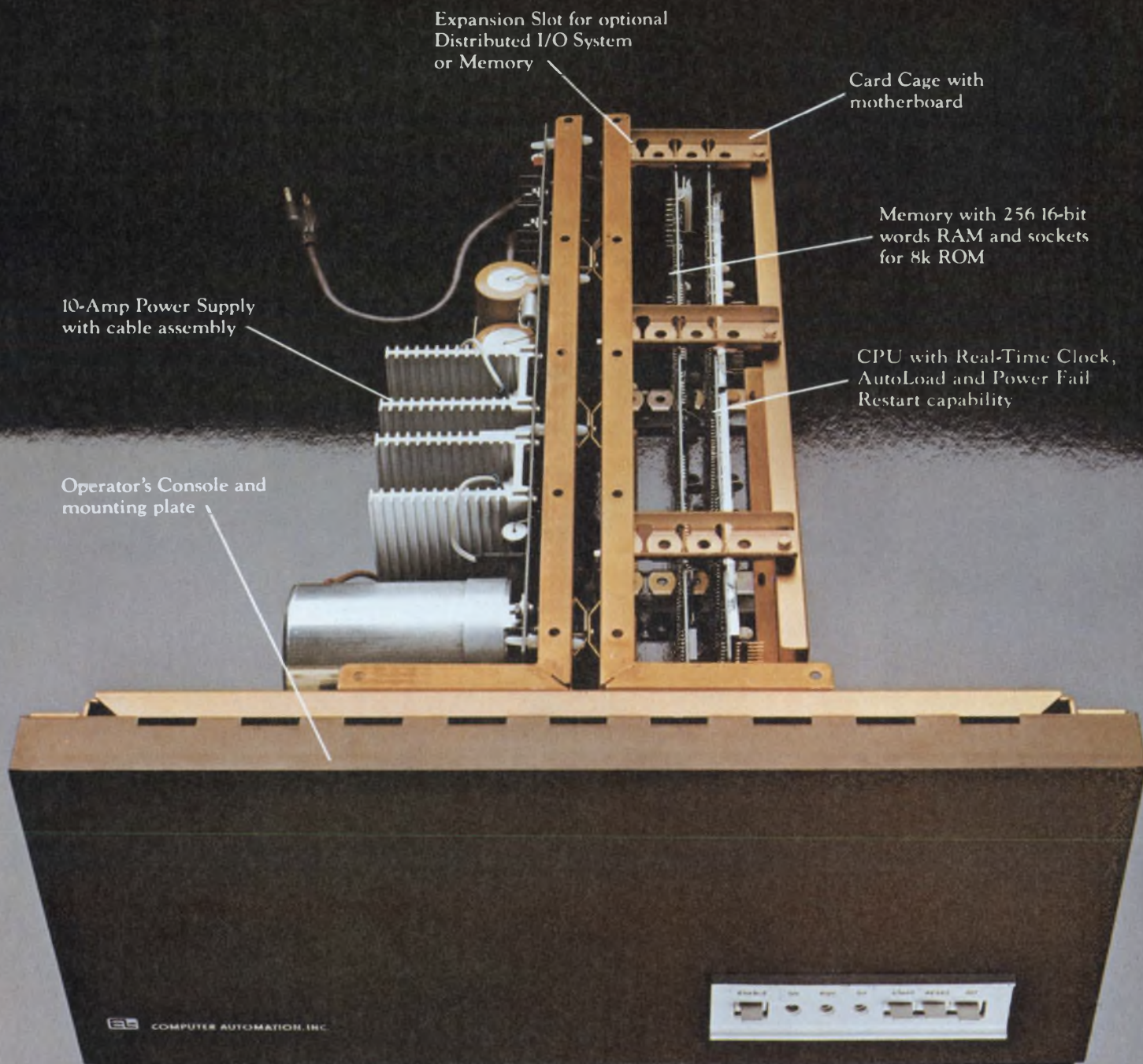

Expansion Slot for optional  
Distributed I/O System  
or Memory

Card Cage with  
motherboard

Memory with 256 16-bit  
words RAM and sockets  
for 8k ROM

CPU with Real-Time Clock,  
AutoLoad and Power Fail  
Restart capability

10-Amp Power Supply  
with cable assembly

Operator's Console and  
mounting plate

CA COMPUTER AUTOMATION, INC.



## The ALPHA™ LSI-3/05 Millicomputer. The lowest priced, 16-bit, full-scale, packaged computer in the world.



# ...building your own just doesn't add up.

Sum and substance. An unbeatable combination even for our competition, so you needn't feel too badly.

Especially when you consider everything we've got going for us.

Specialization, of course. OEM computers — *low-cost* OEM computers — are our only business. The NAKED MINI® people, remember? And when you do only one thing, you do it better.

Experience, too. Over 10,000 up-and-running, field-proven computers successfully integrated into all kinds of sophisticated OEM products.

Also, some things Henry Ford would have appreciated. Buying in volumes most OEM's can't manage. Building the same way.

Where all that gets you is on the down-hill side of the learning curve... where we get our pay-off and you get the lowest-priced, most reliable computers around.

That explains why we can, but not necessarily why you can't. Here's the rest of the rationale:

## The chip shot: a hit or a myth?

The fallacy of the micro-processor is that a chip set isn't a computer. Even if you got your chip sets *free* you still couldn't build a computer equivalent to our ALPHA LSI-3/05 for \$701.

Price out the subassemblies shown in the picture and see what we mean. CPU, memory, card cage, power supply and console. All of that design and development time. Amortized over maybe a few hundred systems?

Heart of the ALPHA LSI-3/05 shown at left is this NAKED™ MILLI central processor and memory for \$395\*

ComputerAutomation will build thousands of ALPHA LSI-3/05 systems.

Then there's the packaging and fabrication. Cable assemblies, too.

Just think about the procurement activity alone. The lead time. Getting our picture?



The ALPHA LSI-3/05 is offered in three series featuring a choice of card cages, consoles, memories and power supplies.

## Computers vs. computerization

How do you talk to a computer?

Mostly with money, it turns out. Interface money. And mostly a lot of it.

Interfacing a computer to one or two peripheral devices can easily cost as much or more than the computer itself.

Which is why we invented the Distributed I/O System. An optional interfacing system that simultaneously interfaces up to 32 peripherals and special devices, serial or parallel in any combination, for less than \$200\* per interface.

## What you see is not exactly what you get

Here's what else you get when you buy an ALPHA LSI-3/05 millicomputer:

- 95 powerful instructions
- Individually vectored interrupts
- Direct Memory Access
- Memory expansion to 32K
- Maxi-Bus interchangeability for easy upward expansion to our full line of compatible minicomputers

Plus full-fledged mini-computer software.

## From the people who brought you the NAKED MINI

The people with the largest line of compatible computers in the world.



Maxi-Bus compatible ALPHA LSI-3/05 achieves unprecedented cost-effectiveness with ComputerAutomation's new Distributed I/O System

The people with the lowest-priced computers in the world.

The people with the first and only Distributed I/O System in the world.

The people who've been simplifying OEM build versus buy decisions for years.

 **ComputerAutomation**  
NAKED MINI Division

U.S.A. 18651 Von Karman, Irvine, CA 92715  
(714) 833-8830  
EUROPE Hertford House, Denham Way, Maple  
Cross, Rickmansworth WD3 2XD, Hertfordshire,  
England; Telephone: Rickmansworth 71211

\*All prices shown are for lots of 100 (U.S.A. only)  
Patent Pending



# LED SUPERSTARS

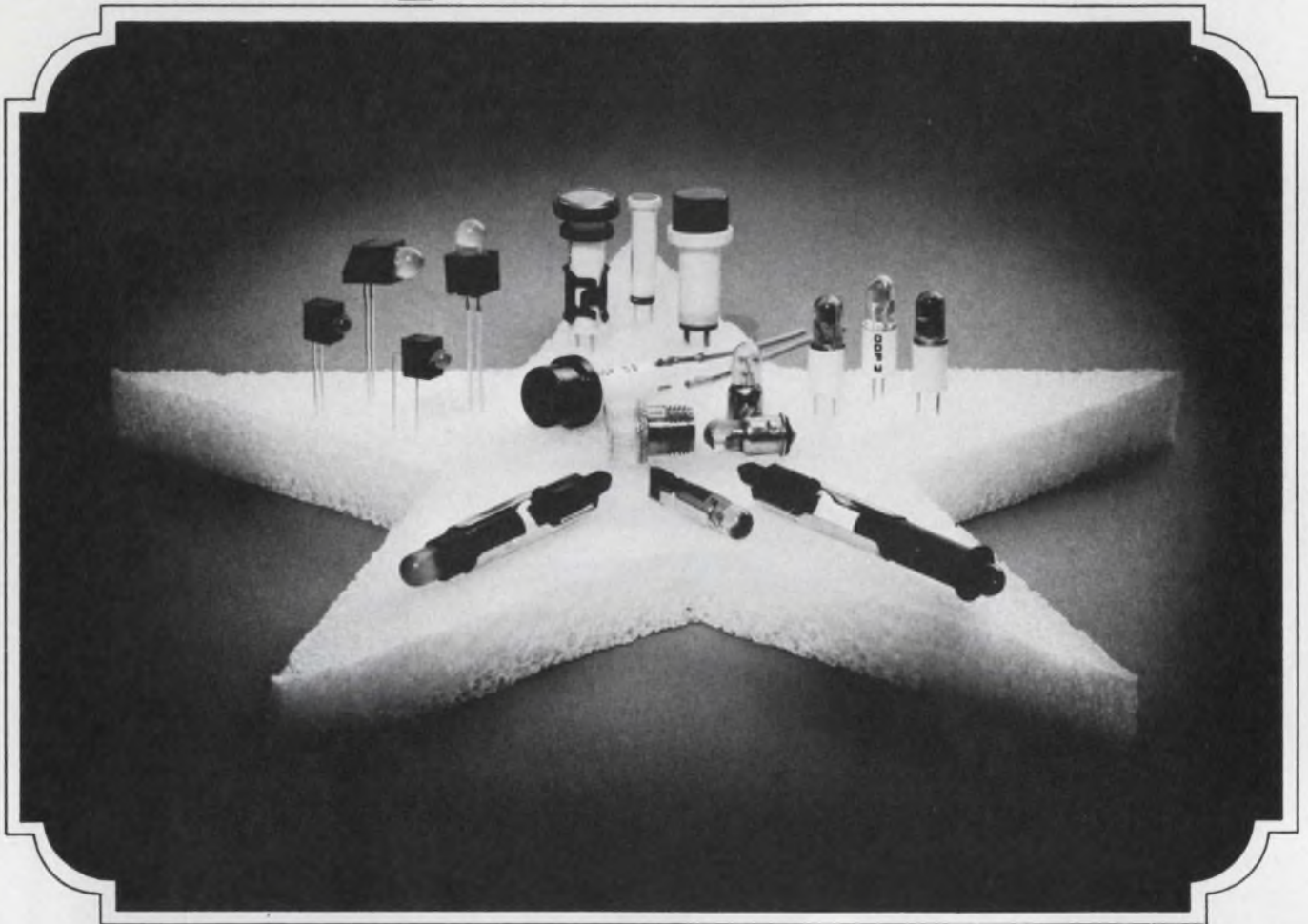

## As bright as many incandescents!

Meet the LED Superstars . . . red, amber and green superbright panel and PCB lights. Their high brightness 50 MCD @ 20 MA (typical clear red) make them the perfect cost and power saving replacements for incandescents. Available with built-in resistors for all popular voltages.

**Subminiature Panel LED's** (also suitable for PCB mounting)—available in hundreds of sizes, shapes and styles.

**PCB LED's**—Horizontal or vertical viewing . . . optional built-in resistor for 5V applications.

**Bi-Pin (T1-3/4) LED's**—Ideal for dead front panel applications, e.g. DEC's PDP Series computers.

**Midget-Flanged (T1-3/4) LED's**—Direct replacements for incandescents in panel light and switch applications.

**Replacement Lenses**—Specifically designed for use with Midget-Flanged LED's.

**Slide Base LED's**—Direct replacements for incandescent types.

There's lots more too, and they're all Superstars! Send for our Catalog today: Data Display Products, 5428 W. 104th Street, Los Angeles, Ca. 90045, (213) 641-1232.

Produced by the original "little light" people.

 **DATA DISPLAY PRODUCTS** ● ● ●



# Washington Report

## **A new science adviser in the White House?**

After a three-year absence, there may soon be a top-level science adviser in the White House. Congress has already passed a bill to create an Office of Science and Technology Policy, and President Ford is expected to fill the adviser position quickly during his Presidential campaign. The position of White House science adviser was abolished by President Nixon in 1973.

The new office, headed by a director and four associate directors, all of whom must gain Senate approval, will advise the nation's Chief Executive on science, engineering and technology issues.

The new chief science adviser will assist in the annual review of the R&D budgets for all Federal agencies, and will prepare a five-year forecast of needs, along with recommendations on how best to focus science and technology to solve national problems. He will be a full time member of the Domestic Council and will advise the National Security Council.

The new office will have an 8 to 14-member Committee on Science and Technology, appointed by the President. Among its other duties, the committee will survey the need for a Cabinet-level department to run all Federal energy and R&D programs.

## **Making it easier to buy minis**

Government agencies favor minicomputers over larger machines and are buying them as fast as they can. The reason they don't buy even more, the General Accounting Office says, is that the buying rules for the small, popular computers are so complicated that it's often easier just to buy a bigger, more expensive machine. To correct this waste, the General Services Administration says it's going to simplify the rules for buying minis.

Presently, government agencies use minicomputers primarily for scientific data processing and machinery control. In the future minis are expected to find greater use in data entry and editing, communications and general data processing.

## **Air Force planning DAIS flight tests in 1979**

The Air Force is planning to hold flight tests in 1979 for its Digital Avionics Information System (DAIS), probably using an A-7D aircraft. A "hot bench" version should be ready by the end of 1977. The Air Force Avionics Laboratory, Wright-Patterson AFB, OH, is investigating how basic avionics functions can be digitized so sensors can be substituted freely in a laboratory environment.



The program goal is to reduce the proliferation of black-box avionics subsystems by reorganizing functions to make them less independent and more adaptable to changes in missions. For example, it should be possible to unplug a TV sensor and plug in an infrared sensor when the aircraft's assignment is changed from day to night operations.

The contractor team consists of Westinghouse on the computers; IBM on the multiplex data bus; Hughes on the multipurpose CRT displays, and Intermetrics of Cambridge, MA, which is supplying the Jovial J73/I higher order language software.

## **GAO finds poor security at Federal computer centers**

Lax security practices for many of the Federal government's 9000 computers in the United States and abroad have been reported by the General Accounting Office. One of the dangers is memory loss due to electrical failures and fluctuations. The computer center at the National Institutes of Health, Bethesda, MD, for example, has lost \$500,000 a year from electrical power fluctuations, the GAO says, adding that the failures resulted in destruction of data for 375 batch-processing jobs and for 2250 remote terminal users. The power fluctuations, also, caused replacement of electronics costing over \$94,000 in various components of the computers.

Many of the installations were also found to be vulnerable to fire, flood, sabotage and theft.

**Capital Capsules:** The Coast Guard is proposing that **vessels grossing over 1600 tons and less than 10,000 tons have a marine radar of some type and that those over 10,000 tons have two radars.** The requirement for anti-collision radar will be studied further. . . . Although President Ford and Secretary of Defense Donald Rumsfeld claim credit for the turnaround in Congressional attitude on defense spending, **Ronald Reagan is privately being given the kudos by the defense industry.** . . . Under a National Aeronautics and Space Administration research program, the Los Alamos Scientific Laboratory has begun testing a model of a **nuclear reactor that will use a gaseous rather than a solid nuclear fuel.** A gaseous reactor could operate at temperatures at which solid fuel elements would melt. . . . **The shipbuilding industry has new cause for concern with the latest Defense Dept. move to allocate a small portion of the Navy's annual shipbuilding program to Government-owned-and-operated shipyards.** Possibly up to 10% of the work will go to Navy shipyards to keep them in operation and provide a surge capability in shipbuilding in times of national emergency. In the past, Congressional reaction has been lukewarm to such proposals, but the big backlog in nuclear submarine construction could prompt a more receptive attitude. . . . **The Naval Research Laboratory is seeking suppliers for a multi-gas laser** that uses hydrogen fluoride or deuterium fluoride and is capable of operating with carbon dioxide, carbon monoxide and nitric oxide gases by changing only the optical components. Specifications include maximum beam divergence of 1 milliradian, repetition rate of a shot every two seconds, and a pulse width of 300 nanoseconds. . . . The Air Force Space and Missile Systems Organization (SAMSO) **plans to flight test a laser communications experiment capable of transmitting at a 1-gigabit rate some time in 1979 or 1980 under its program 4058.** The laser would operate in the visible (green) spectrum using a frequency-doubled neodymium-doped yttrium aluminum garnet (ND/YAG) laser with a 0.53 micron output.



# The Travel Lab



## A New Concept In Portable Test Equipment

The **TEKTRONIX TM 515 Traveler Mainframe** looks like luggage, but it's really a five-compartment mainframe that provides power and interface connections for TM 500 plug-in modular test and measurement instruments. Typically weighing less than 32 pounds (with instruments), it's small enough to fit under an aircraft seat, moisture and dust resistant, and rugged.

With the **TM 515**, you can take the same instruments with you that you use in the lab . . . and maintain the same standards in the field. The case holds five plug-in instruments, and the covers serve as a storage area for your accessories. Now you can concentrate on making mea-

surements instead of the logistics of getting your instruments to the test site.

You can optimize your system by selecting from over 35 general-purpose and specialized TM 500 plug-ins. Plug-ins include DMMs, counters, generators, power supplies, signal processors, logic analyzer, oscilloscopes, monitors, and even blank plug-ins for your custom

circuits. Intended application areas range from digital field service to medical, from audio/communications to on-site industrial control maintenance.

For more information, contact your local Tektronix Field Engineer or write or phone: Tektronix, Inc., P.O. Box 500, Beaverton, Oregon 97077, (503) 644-0161 ext. 5542. In Europe: Tektronix Limited, P.O. Box 36, St. Peter Port, Guernsey, Channel Islands.



**TEKTRONIX®**

committed to  
technical excellence

FOR TECHNICAL DATA CIRCLE # 271  
FOR DEMONSTRATION CIRCLE # 272



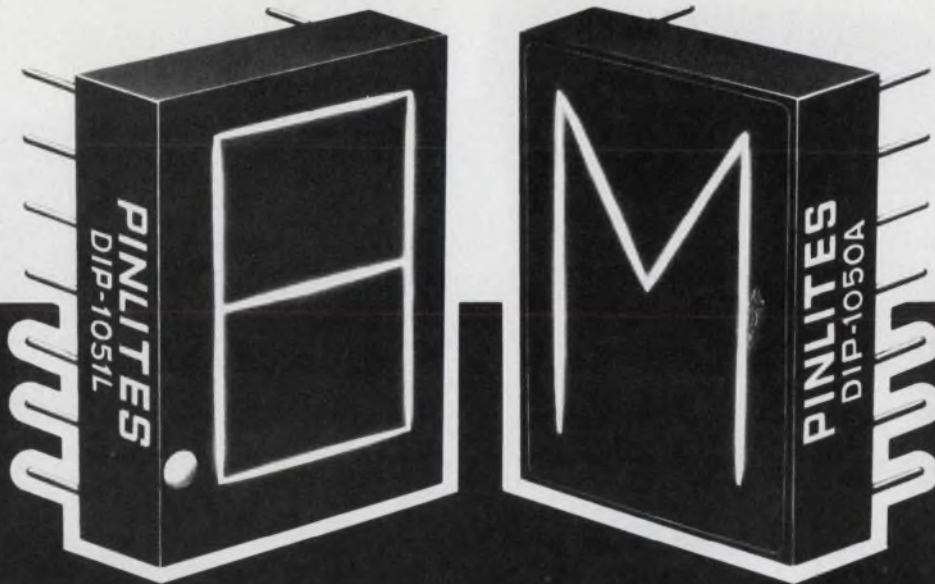

# Pinlites® Displays may be Over-Designed for you.

It's possible. Pinlites incandescent displays are the best in the world. While you may not need every feature we offer, that decision depends on your application. Here are the facts. Now you decide.

## Brightness

Directly-viewed incandescent design makes Pinlites displays ideal for high ambient light situations. Models are available to an incredible 9000 ft. lamberts. And with simple voltage reduction they can easily be dimmed for night use. High contrast ratio insures clear character definition in a 10,000 ft.-candle incident light condition.

## Viewing Angle

120°. Unusually wide because Pinlites are directly-viewed and do not require a magnifying lens.

## Life

Over 100,000 hours per segment.

## Corner Illumination

Pinlites' patented cross-over filament arrangement compensates for the heat sink effect of the filament post. This feature eliminates open corners characteristic of other display types.

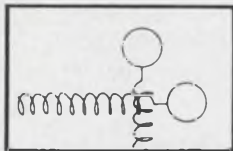

## Electrical Configuration

Pinlites operate on 1.5 to 5 volts and are directly compatible with standard TTL driving networks. They use as little as 8 milliamps per segment and are easily multiplexed. Available in various socket configurations, including 14 pin DIP and 24 pin DIP on the displays shown above. Character heights:  $\frac{3}{8}$ ",  $\frac{1}{4}$ ",  $\frac{3}{16}$ ",  $\frac{1}{2}$ ",  $\frac{5}{16}$ ".

## Filter Requirements

Pinlites produce a bright "white" light. You can filter to a wide range of colors and still maintain excellent readability.

## Applications

Pinlites are particularly desirable for applications requiring brightness and high reliability over a wide range of environmental conditions. Popular uses include aircraft cockpits, marine navigation, computer peripheral equipment, taxi meters and gas pump read-outs.

Call now. We'll have literature in the mail to you today.



**REFAC** electronics corporation

P.O. BOX 809 • WINSTED, CONN. 06098 • 203-379-2731



# Just as you can count on 24 hours in a day,



## you can count on Synchron motors.

We custom-make every Synchron motor. Every one. Because it's almost impossible to stock ready-made synchronous motors exactly right for your needs.

Perhaps the motor you need for your product calls for a little more speed than the motor that's letter perfect for someone else. Or you need a little less torque. Or a threaded output shaft instead of a knurled one.

If we say we'll ship in 5 weeks, we'll do it. At a fair price.



And if we've approved your application we'll stand behind our motor 100%.

Stated simply: You can rely on Synchron motors to be designed and built right, to do the job right. That's the only way we do business.

Call or write for our specification sheets and the name and location of our representative in your area.

Choose from five principal styles of Synchron motors—60 or 50 Hz—from one revolution per week to 900 rpm—from 8 thru 98 oz-in torque at 1 rpm—from hundreds of different outputs.

**MALLORY**



**HANSEN MANUFACTURING CO.**  
a division of P. R. MALLORY & CO. INC.  
Princeton, Indiana 47870

We make every Synchron motor as if our name were on your product



# Coming through...



with wire, cable and cord  
that delivers quality,  
performance, economy...

Belden has it: a total service capability. Extensive design and application know-how. What it takes to deliver complex cable configurations, special harnesses, cords, lead wires, and even special packages to fit your requirements.

Our specialists and engineers will meet with your people at your plant to discuss problems in processing, assembly, installation, ordering, human engineering, color coordination, physical and electrical parameters, opportunities for cost reduction. And when we can't help you using standard products, we'll innovate a solution to your problem.

Talk to a Belden specialist about your new applications, product ideas, processing problems—all your wire, cable and cord needs. He has thousands of standard items to draw from. And standard or special, he'll come through with the best wire buy around. For answers right now, phone:

317-966-6661 Electronic Div. or mark No. 400 on reader service card  
312-986-1600 Electrical Div. or mark No. 401 on reader service card  
312-887-1800 Transportation Div. or mark No. 402 on reader service card,  
or write Belden Corporation, 2000 S. Batavia Ave., Geneva, IL 60134.



**Coming through...**

*with new ideas for moving electrical energy*



## The star

For getting things done, you can't find anybody better than Sam. He's a star performer. When Sam wants a circuit designed, it gets designed—fast. When Sam wants a new data sheet, it gets prepared—fast. When Sam wants some special service for a customer, that customer gets special service—fast.

What bothers him is that nobody else in his company is as effective. The fact that he's president is irrelevant, he says. If anything, Sam will tell you, he's president because he gets things done.

Now that's a matter of some dispute. Many people feel he gets things done because he's president. When Sam asks somebody to do something, that person drops everything else and does what Sam wants. So there are lots of things that don't get done. Those are usually things that somebody else asks for.

The chief engineer might have his people working on a counter, for example, when Sam comes charging in and instructs them to design a DVM. Since Sam controls the purse-strings, they drop the counter project and start working on the DVM.

Months later, Sam challenges his chief engineer. "Where's the counter? You've been working on it forever—and my DVM is almost finished."

Unfortunately, it's hard for the chief engineer to tell Sam that if he had enough people to design counters and DVMs they'd be designing both—not one or the other. Sam can't understand that creative people can't do two things at the same time.

Sam has a good idea of how much work he can get per hour from machines or from people who use their muscles. He doesn't realize that there's a limit to what he can get per hour from people who use their brains.

He feels his strong will power or his managerial talent is what's getting the DVM designed faster than the counter. He still hasn't learned that when the chief executive says: "I want this done right away," he's also saying: "Stop everything else."

Too many of us think we're saying only what we want to say.



RECOGNIZED BY  
AMERICAN REVOLUTION  
BICENTENNIAL  
ADMINISTRATION

ELECTRONIC DESIGN is deeply honored to have received official recognition as a participant in the American Revolution Bicentennial Celebration, with authority to display the Bicentennial Symbol.

A handwritten signature in cursive script, which reads "George Rostky".

Editor-in-Chief  
GEORGE ROSTKY



# The best talents in your business can be bought...

## PRACTICAL DESIGN FOR ELECTROMAGNETIC COMPATABILITY

edited by ROCCO FICCHI

A complete guide to electromagnetic compatibility for electronic systems and equipment. Includes the current techniques for analyzing, predicting, controlling and reducing unwanted signals, along with numerous charts, graphs and nomographs. Recent advances in filtering and shielding, and exhaustive treatment of the special problems encountered in computers, semiconductors and solid-state devices. #5685-0, \$17.20

## PRACTICAL VALUE ANALYSIS METHODS

by JOHN H. FASAL

This step-by-step guide transforms sophisticated VA-VE theory into concrete techniques and methods enabling you to literally take apart and scrutinize every facet of your operation—streamline everything from product costs to worker efficiency. An unlimited planning tool in the hands of today's ambitious executive or manager. #5845-4, \$13.75

## MODERN DATA COMMUNICATION

by WILLIAM P. DAVENPORT

An on-the-job handbook mapping out the latest techniques, systems and services for the most efficient data transmission. Includes simplified coding techniques; ways of dealing with distortion, distraction, interference; efficiency and control techniques; modulating and multiplexing methods; and advice on using today's commercially available services. #5810-1, \$10.30

## BASIC TELEPHONE SWITCHING SYSTEMS

by DAVID TALLEY

Offers the full array of switching techniques—from the early step-by-step type, through the common electro-mechanical group, to today's sophisticated electronic system. Special attention given to the No. 1 ESS type being installed by many companies. Here's a versatile, clearly-written handbook for the engineer, executive, and trainee alike. #5750-4, \$6.60

## RELIABILITY, MAINTAINABILITY AND AVAILABILITY ASSESSMENT

by MITCHELL O. LOCKS

All the techniques and formulas you need for calculating the reliability, maintainability and availability of your repairable and non-repairable systems and components. You'll find sample models using point and interval values, and time-to-failure and time-to-repair data; binomial and other bernoulli-type distributions; simplified goodness-to-fit techniques, and much more. #9204, \$15.95

## VIBRATION AND ACOUSTIC MEASUREMENT HANDBOOK

edited by MICHAEL BLAKE & WILLIAM S. MITCHELL

This giant, field-tested, 680-page manual enables you to master today's vibration equipment and techniques—shows you how to spot up to 90% of equipment problems months in advance and take corrective action before trouble starts. Uses scores of actual industrial problems and solutions in outlining specific procedures and techniques. #9195, \$34.50

# on a 15-day money-back guarantee.

**I'm buying!** Please send me the books listed below to read and use FREE for 15 days. At the end of that time I will send payment, plus postage, or return the book(s) and owe nothing.

Number	Title	Price
_____	_____	_____
_____	_____	_____
_____	_____	_____
_____	_____	_____
		TOTAL _____

Name \_\_\_\_\_

Firm \_\_\_\_\_

Street \_\_\_\_\_

City/State/Zip \_\_\_\_\_

I want to save money! Payment enclosed. Publisher pays postage. Same 15-day guarantee. 75-50



**Hayden Book Company, Inc., 50 Essex St., Rochelle Park, N. J. 07662**



All the people who bought our DUMB TERMINAL (the ADM-3) because of its low \$995\* unit price didn't really expect a lot. But they hadn't counted on the 32 switches. Switches that let you turn the DUMB TERMINAL into a pretty clever animal.

Take the 20 switches under the LSI name plate, for example. Among them, 11 communication rate positive action switches that let you select bauds from 19200 to 75. Also an RS232 interface extension port switch. It allows you to connect the DUMB TERMINAL to all kinds of clever devices — to recorders, printers and smarter terminals. And switches for odd-even parity. Optional upper and lower case (the complete set of 128 USASCII characters) — plus a lot more.

Inside on the PC board, 12 more switches. More positive action types that instruct the DUMB TERMINAL how to behave. And for all those who bought the 24-line optional display, there's a switch to change over from the standard 12-line format. So instead of showing 960 standard characters in 12 rows, you have the option of displaying 1920

The 32 Switches

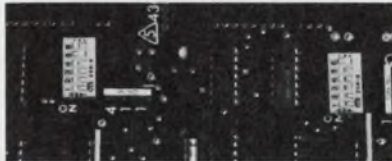

The 12 switches in the rear, on the PC board.



The 20 switches under the front name plate.



characters in 24 rows of 80 letters. And there are still more switches that make your terminal a cinch to operate.

Now people aren't sure what turns them on: the low price, the 32 switches, or the DUMB TERMINAL's standard features. Features like a full 12" diagonal screen. 59 data entry keys, arranged like on a typewriter. Compatibility with all popular computers. Simple, quiet operation. An optional numeric key pad. And fast data throughput. All features that make this terminal a perfect video replacement for the old teletypewriter.

The fact is, people keep finding more and more jobs for our DUMB TERMINAL. Because they can do anything within reason — with just a little switching and training. And that's why the DUMB TERMINAL really turns out to be a smart buy. Which may be the biggest switch of them all.

For full information, write: Lear Siegler, Inc., E. I. D. / Data Products, 714 N. Brookhurst St., Anaheim, CA 92803; Tel. (714) 774-1010.

**DUMB TERMINAL.  
SMART BUY.**



\*U.S. domestic price

**THE \$995 DUMB  
TERMINAL CAN BE TRAINED  
TO DO PRACTICALLY  
ANYTHING.**

CIRCLE NUMBER 25



# Advantages of CCDs and magnetic bubbles cited for main memories

The use of new storage technologies such as charge-coupled devices (CCDs) or magnetic bubbles can provide a large-capacity main memory that is two to four times less costly than a main memory comprised of MOS-RAM technology.

Surprisingly a comparison shows that a three-level CCD storage system has an access time about twice as long as that of a two-level main memory system.

The two-level main memory system consists of a fast bipolar cache memory ahead of a lower cost, slower MOS main memory. The three-level system consists of a cache, page buffer and CCD main memory, all of which use data transfer on demand. Both systems are discussed by Peter Schneider of Siemens AG, Germany, in a paper for the "Storage Systems" session, titled: "Working Set Restoration—A Method to Increase the Performance of Multilevel Storage Hierarchies."

By using a new method of program location, the three-level system's access time can be reduced to that of the two-level cache-buffer system, according to Schneider. This program-relocation method is called "working set restoration." During the execution of the active program it loads into the page buffer the working set of the pages of the next program to be run.

As a result of such loading, the required page-transfer operations are concealed and are not time-critical for the processor. Only the access time to the two-level system is apparent to the three-level machine.

---

**Jim McDermott**  
Eastern Editor

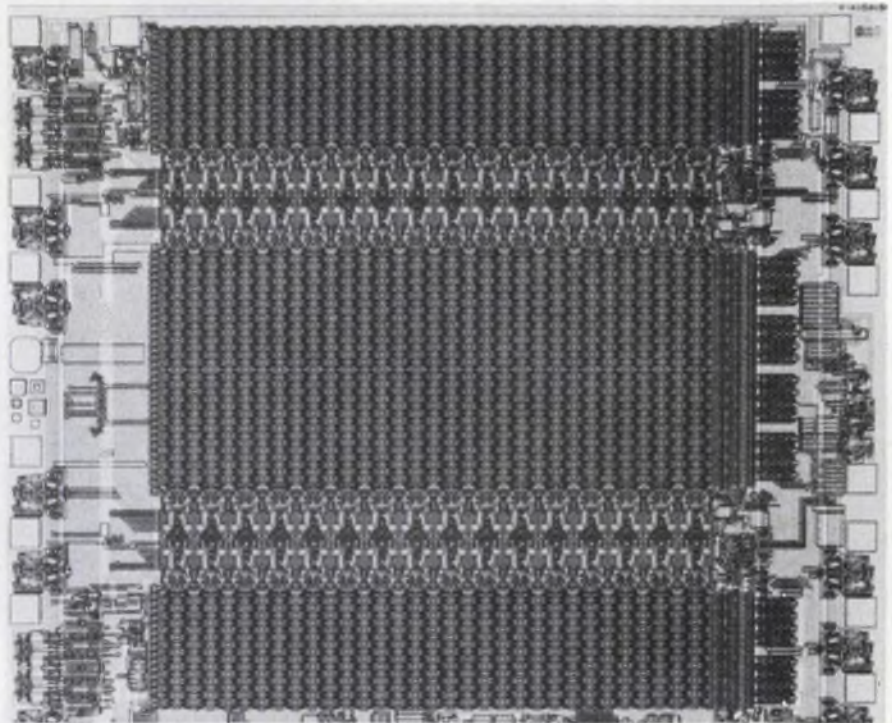

The high circuit density of dynamic CCD and MOS devices, like this National MM-5270 4-k RAM, will create temperature-rise and power cost problems in future super memories. The use of refrigeration systems and 25-C operation will be needed to solve them.

Since it does not make any difference in total time whether all pages are transferred consecutively, or individually upon request, Schneider suggests loading the working set of a program while processing another element—as long as the processing doesn't interfere with the time sequence.

## Power problems

The dramatic rise in the use of dynamic semiconductor memories for large main-memory stores presages the appearance of CCD and MOS memories with capacities of 10-M bytes or more. With these large memories come problems pro-

duced by the power required to drive them.

"There are three factors involved with these super-large semiconductor memories: power, temperature and cost," says Dr. Gilbert Amelio, manager of CCD operations and MOS design engineering at Fairchild Research and Development, Palo Alto.

"In my 'Storage Systems' Session paper I point out that as dynamic memories get larger and larger, it is going to be cheaper, on an over-all system basis, to keep these semiconductor systems at room temperature through the use of refrigeration or other tempera-



## **NOW!** SINGLE IN-LINE RESISTOR NETWORKS WITH IMPROVED PERFORMANCE

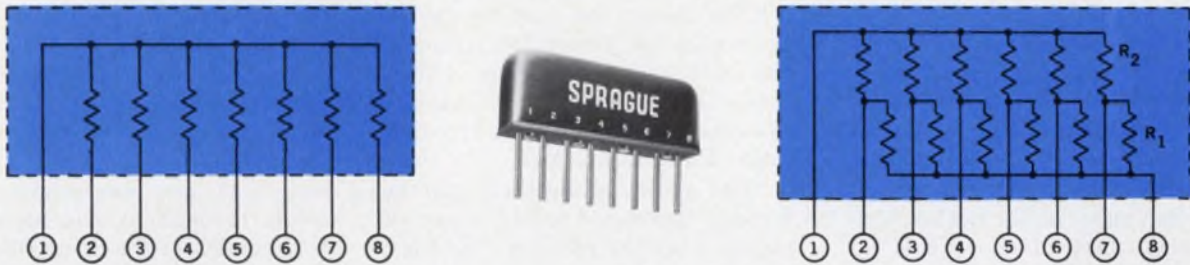

# BOARDABLE AND AFFORDABLE

**Low Cost** and **High Density Configuration** are only two of the features of Sprague Type 216C Metanet® Resistor Networks. Now, you can also enjoy the benefits of improved power dissipation, better temperature coefficient of resistance, and closer standard resistance tolerance.

**Save Board Space.** Single in-line design permits vertical installation, which allows more units to be seated in less space. This mounting style also results in improved high-frequency performance and significant in-place cost reduction.

**Better TCR.** Typical temperature coefficient of resistance is within  $\pm 200$  ppm/°C, cutting previous allowable limit almost in half.

**Up-graded Power Dissipation.** Individual terminating, pull-up/pull-down, and interface networks are capable of dissipating 250 mW per resistor at 70°C, an increase of 100% over previous designs.

**Closer Resistance Tolerance.** Standard resistance tolerance for each resistor is  $\pm 2\%$ , with other tolerances between  $\pm 1\%$  and  $\pm 5\%$  available on special order.

**Proven Product Line.** Sprague has more than fifteen years of experience in the development and manufacture of precision thick-film resistor networks, which include individual terminating, pull-up/pull-down, interface, and dual terminating designs.

For complete technical data, write for Engineering Bulletin 7041A to:  
Technical Literature Service, Sprague Electric Co.,  
347 Marshall Street, North Adams, Mass. 01247.

**THE BROAD-LINE PRODUCER OF ELECTRONIC PARTS**

CIRCLE NUMBER 26





ture-control systems."

Total systems cost, including acquisition and operation, will probably be cut in half over the life of the system by operating systems of 10-M bytes and larger at room temperature (25 C) instead of at temperatures of 70 C or higher, Amelio says.

There are several reasons for the price reduction. First, the cost to manufacture memory to operate at 25 C is much less than the cost of making memory to operate at 70 to 85 C. Yields drop for semiconductors rated at the higher temperatures, particularly yields of higher-density devices such as the 4 k, 16 k and 64 k chips.

Second, with lower operating temperatures it is possible to refresh CCD and MOS memories at substantially slower speeds, since refresh time rises exponentially with temperature.

Another result of low-temperature operation is that reliability increases exponentially with a decrease in temperature. By cooling these very large systems the reliability goes up orders of magnitude, Amelio says. The improvement is reflected in lower costs for downtime and maintenance. An indirect benefit of greater reliability is that more of the memory can be used in system operation than is held inoperative in a standby mode.

Amelio sees these super-large semiconductor memories arriving on the scene by the end of this decade. Because the cost benefits of cooling such systems will be so great, he advises memory system designers to begin thinking today about how to incorporate this feature into future systems.

Amelio's approach to high-density-memory power problems is on a systems level. When you get down

to the CCD device itself, the performance that can be obtained is a tradeoff between its operation speed and its power consumption, according to S. L. Rege, author of another Session paper, "Performance and Power Dissipation Analysis for CCD Memory Systems."

"The faster you run the device, the higher the power dissipation at the CCD level," says Rege, who is senior engineer at the Computer Systems Division of Burroughs Corp., Piscataway, NJ.

"The power dissipation can be directly translated into the cost of maintaining the memory," he adds. "In some cases the power costs for one year can be equal to the device cost, which is highly undesirable."

### New memory architectures

With the mass availability of semiconductor memories, new memory architectures are possible that were not feasible with mixed core-and-semiconductor technology. Some new architectural concepts are discussed in a Session by Dr. Ivan Sutherland, professor of computer science at California Institute of Technology, Pasadena.

"With silicon technology serving both as the principal logic medium and as a major memory medium, many of the older reasons for separating memory and logic are no longer valid today. The combining of logic and memory offers a new kind of architecture that provides several benefits.

"You should be able to improve the bandwidth of the transmission path between the memory and logic elements because you have a lot of parallel paths. The restrictions imposed on bandwidth by the conventional computer architecture are a major limitation to computing speed," Sutherland points out.

Also, you should be able to obtain a higher duty cycle out of both logic and memory. The duty cycle of the various logic elements in a conventionally designed computer seems to be very low.

Most of the memory just sits there remembering, and most of the gates in the processor are not active.

Because of these benefits, he says, the potential of combining logic and memory is very great.

Another new kind of architecture that uses semiconductor elements throughout has been under development at the Sperry Research Center, Sudbury, MA. This architecture is made up of a computer memory formed of circulating serial-storage loops and their associated distributed-processing logic. Called an "Intelligent Memory," the structure is discussed in a paper by Murray Edelberg and L. Robert Schissler, members of the Research Center.

As a component of storage hierarchy, the intelligent memory offers potential gains in performance and speed of 10 to 1000 times that of RAMs, but at the same cost.

In addition to the basic information-storage function, the memory performs off-line sort processing, associative searching, updating and data retrieval, according to Edelberg. An interesting feature is that the memory is capable of dynamically changing its loop size to accommodate varying data requirements.

A number of memory configurations are possible, Edelberg says. The options range from a single-record-per-loop and on-chip logic suited for CCD technology to multiple records per loop and off-chip logic aimed at bubble memories. ■■

## $\mu$ P computers keep bowling scores and analyze weather patterns

Bowlers who enjoy physical activity, but who take no pleasure in the burdensome duties of score-

**Samuel Derman**  
Associate Editor

keeping, may soon find these chores, plus others, taken over by the ever-proliferating microprocessor.

MagicScore, a  $\mu$ P-controlled automatic bowling scorer, recently

developed by AMF Inc., Stamford, CT, is one of the new devices discussed in two sessions devoted to  $\mu$ Ps at the computer conference.

Among the new  $\mu$ P software and hardware discussed is one machine



# Point by point, line by line:

## See why our lowest-cost Graphics package has no competition.

**Our 1024 X by 780 Y viewable points separate Graphics from mere graphing.** The price has never been lower. But Tektronix' new 4006-1 provides the same superior information capacity that has made us the company for all your graphics needs.

We'll throw you a curve. Tektronix will graph circles around the competition. Now, thanks to our new low priced 4006-1, we're in the same ballgame with mere alphanumeric terminals.

Graphics to gain. Nothing to lose. Add the graphics extra at an everyday price: \$2995 or \$150 a month on a two year lease. Alphanumerics? Up to 2590 on screen characters. Plus a spectacular package that includes confirmed compatibility with most mainframes through proven interfaces and time-tested software packages. And expert maintenance that follows you all over the world.

Plug-in peripherals standing by. Like our 4631 Hard Copy Unit for up to four 4006-1's with 8½" x 11" copies, or

4923 Digital Cartridge Tape Recorder for low-cost, off-line storage.

Why wait for graphics? Let graphics wait on you. See what our fine-line, full-line graphics can mean for your applications. Check out the whole story and all the prices right now with your local Tektronix Sales Engineer. Or write:

Tektronix, Inc.  
Information Display Group  
P.O. Box 500  
Beaverton, Oregon 97077



CIRCLE NUMBER 27



# Graphics \$2995



with vast implications for the computer industry. Named the multimicroprocessor, it is a complex array of interconnected  $\mu$ Ps designed to solve—in real time—unusually complex problems based on mathematical models of physical systems. It is still in the development stage.

### Automatic bowling scorers

Automatic bowling scorers are not new: the first one was introduced in 1946. But the technology available then wasn't adequate to make such scorers economically feasible. What was needed was a miniature computer, capable not only of automatically performing the scoring arithmetic, but also of allowing for optional manual scoring and inputting of data—with enough software control to make the entire system tamper proof.

It was the availability of the microprocessor that marked the breakthrough in designing MagicScore, says Dr. Reg Kaenel, AMF's chief engineer for MagicScore, and author of the paper, "MagicScore—A  $\mu$ P Application for Fun and Profit."

When the machine's design work was initiated there was a big problem because an 8-bit  $\mu$ P was not yet on the market, Kaenel says, but work was begun even though 4-bit  $\mu$ Ps would be inadequate. Shortly thereafter Intel and Motorola both introduced 8-bit  $\mu$ Ps.

AMF's MagicScore has completed eight months of field testing, and is just now going into production. It combines the following features, few of which can be found in earlier automatic-scoring machines:

- Keyboard entry. Bowlers can enter their name, specify game-sequencing mode (for example, open or league), make provision for out-of-order players and enter information on any handicaps. It is also possible to key in data on which pins have been knocked down. This information is normally acquired automatically by the machine, but it can be entered manually if desired. The keyboard is also necessary in the event score corrections must be made.
- TV screen readout at each lane, as well as hard-copy printout via thermal printers.
- A console by which the bowling-alley manager can monitor the



**Bowlers' console** of AMF's MagicScore tells players the good news and the bad.



**Players key** in their names and other information on MagicScore's console keyboard.

activity at each lane. The console offers the manager the capability of projecting messages to a TV-display screen at any selected lane.

- Specially "hardened" system. The keyboard is designed to withstand possibly being drenched by liquid refreshments. The  $\mu$ P also has been programmed to compensate for players who may try to outwit the system through illegal keyboard entries.

### $\mu$ Ps join forces

As the cost of the  $\mu$ P steadily declines, it was inevitable that

someone should come up with the idea of linking together large arrays of such elements to duplicate (or exceed) the capabilities of mainframe computers. The idea for such a "multimicroprocessor" system first made its appearance some time ago.

An early computing behemoth, the ILLIAC IV, was actually constructed with 64 semiconductor processors, but it achieved only "partial success," says Justin Rattner of Intel, Santa Clara, CA, at a panel session on strengths and weaknesses of "multimicroprocessors." Since then, no similar machines have been built, but there is now a proposal to construct an improved multimicroprocessor using 32, 162, or even 512  $\mu$ Ps interconnected in an array.

This system, dubbed "Hypercube" by its designers, IMSAI of San Leandro, CA, differs from ILLIAC in that in Hypercube each  $\mu$ P, though interconnected with the entire system, computes independently. In ILLIAC all processors worked together.

The goal of Hypercube designers is to provide a real-time, high-speed capability for solving large problems, especially those involving mathematical modeling. The problems contemplated for Hypercube are in such diverse areas as hydrodynamic modelling of the earth's weather or in nuclear fusion reactions.

Bruce Van Natta of IMSAI reports at the panel session that though many of the subsystems of Hypercube have already been designed and tested, the entire system has yet to be built.

A similar, large-scale system, eventually to comprise as many as 100 processors, is being built at Carnegie-Mellon University, Pittsburgh, PA. At the panel discussion, Daniel Siewiorek, professor of computer science and electrical engineering at Carnegie-Mellon, reports that the first phase of the system, a 10-unit machine, is expected to be completed this fall. Each of the ten units is a DEC LSI-11, a  $\mu$ P-based microcomputer on an 8 x 10 in. board.

Enthusiasm for the future prospects of large-scale  $\mu$ P-arrays is not shared by all experts, however. Skeptics are not hesitant to point out the difficulties, especially in



# Volume. We're big on it.

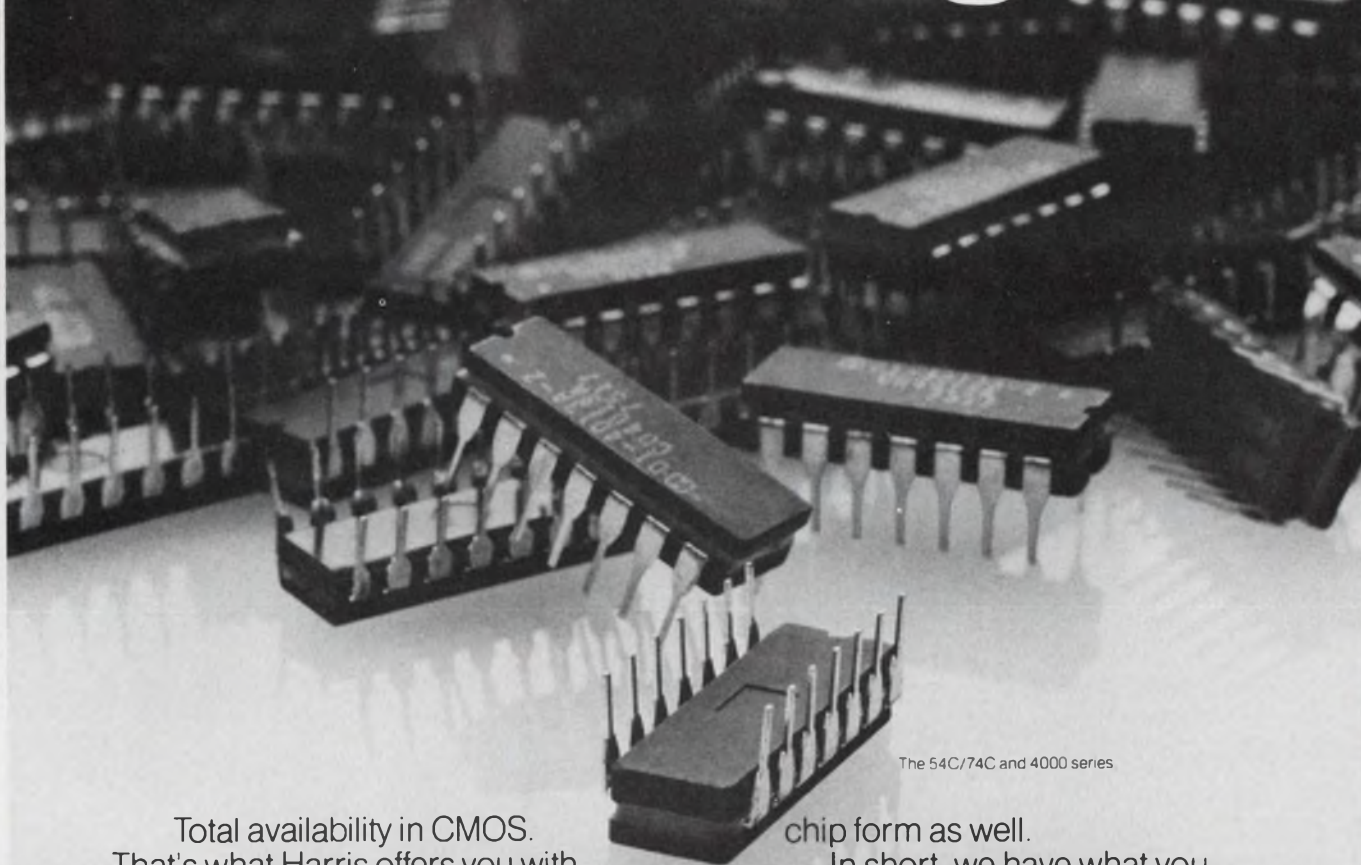

The 54C/74C and 4000 series

Total availability in CMOS. That's what Harris offers you with the 54C/74C and 4000 series logic families. In more than 80 circuit types! And growing every day.

So count on Harris to produce and deliver the CMOS series devices you need, no matter how large your order. And at a price that's always competitive.

You can have commercial devices in both CERDIP and Epoxy 410-B. With a temperature range of  $-40^{\circ}$  to  $85^{\circ}$ C. And high-rel versions, too. In CERDIP and flat-pack with a temperature range of  $-55^{\circ}$  to  $125^{\circ}$ C. All devices are available in

chip form as well.

In short, we have what you need. In the volume you need it.

And you can get immediate delivery of both logic families through the following major electronics distributors: Hamilton/Avnet, The Harvey Group, Inc., Schweber Electronics, R.V. Weatherford. At any of their locations.

For instant applications support, call our CMOS Application Hot Line at 800-327-8934.

Volume. At Harris, we're big on it.



**HARRIS**  
**SEMICONDUCTOR**  
A DIVISION OF HARRIS CORPORATION

P.O. Box 883, Melbourne, Florida 32901 (305) 724-7412

**WHERE TO BUY THEM: OEM SALES OFFICES:** CALIFORNIA: Long Beach (213) 426-7687; Palo Alto (415) 964-6443; FLORIDA: Fort Lauderdale (305) 971-3200; Melbourne (305) 724-7430; ILLINOIS: Hinsdale (312) 325-4242; MASSACHUSETTS: Wellesley Hills (617) 237-5430; MINNESOTA: Minneapolis (612) 835-2505; NEW YORK: Endwell (607) 754-5464; Melville L.I. (516) 249-4500; OHIO: Dayton (513) 226-0636; PENNSYLVANIA: Wayne (215) 687-6680; TEXAS: Richardson (214) 231-9031.

**SALES REPRESENTATIVES:** ARIZONA: Scottsdale (602) 948-5590; CALIFORNIA: Los Angeles (213) 870-9191; Mountain View (415) 961-8121; San Diego (714) 565-9444; COLORADO: Denver (303) 773-0666; CONNECTICUT: East Norwalk (203) 838-1493; FLORIDA: Boca Raton (305) 395-6108; Owiedo (305) 365-3282; Tampa (813) 933-3183; ILLINOIS: Elk Grove Village (312) 640-1850; INDIANA: Indianapolis (317) 849-6454; IOWA: Cedar Rapids (319) 393-5652; KANSAS: Wichita (316) 943-6221; MARYLAND: Randallstown (301) 922-1248; MASSACHUSETTS: Burlington (617) 273-1313; MICHIGAN: Farmington (313) 476-2446; MISSOURI: Hazelwood (314) 731-5799; Kansas City (816) 761-6543; NEW JERSEY: Keasbey (516) 567-5900; West Caldwell (516) 567-5900; NEW MEXICO: Albuquerque (505) 265-5655; NEW YORK: Albany (518) 489-7408 or 4777; Huntington Station (516) 567-5900; OHIO: Cleveland (216) 831-8292; Dayton (513) 890-2150; OREGON: Beaverton (503) 643-1644; PENNSYLVANIA: Allison Park (412) 487-4300; King of Prussia (215) 265-0634; TEXAS: Dallas (214) 691-4592; Houston (713) 661-3007; VIRGINIA: Falls Church (703) 534-7200; Lynchburg (804) 237-4740; WASHINGTON: Bellevue (206) 454-0300; CANADA: Montreal (514) 626-6723; Ottawa (613) 749-0740; Toronto (416) 676-1042.

**NATIONAL DISTRIBUTORS:** Hamilton/Avnet, The Harvey Group, Inc., Schweber Electronics, R.V. Weatherford Company

CIRCLE NUMBER 28



# They're good...no matter how bad

**TW MEETS MIL-S-83731.**  
OFFERS SWITCHING VERSATILITY OF LARGER TOGGLES WITH ADVANTAGE OF SMALL SIZE, PANEL SEALING. IDEAL FOR APPLICATIONS LIKE ON/OFF SWITCH IN THIS MANPACK EQUIPMENT.

**SERIES 1 ROUND LIGHTED PUSHBUTTONS** OFFER FLUSH MOUNTING, PANEL SEALING AND VERSATILE SWITCH CIRCUITRY: INCLUDING SOLID STATE. MIL SPEC QUALITY (MIL-S-22885) AT COMMERCIAL PRICES FOR CONTROL CONSOLES.

**DS SERIES PUSHBUTTONS.** COMPACT .75 INCH SQUARE DESIGN OFFERS PLUG-IN-DESIGN AND 4 LAMP DISPLAY. RFI ATTENUATION. MIL-S-22885.

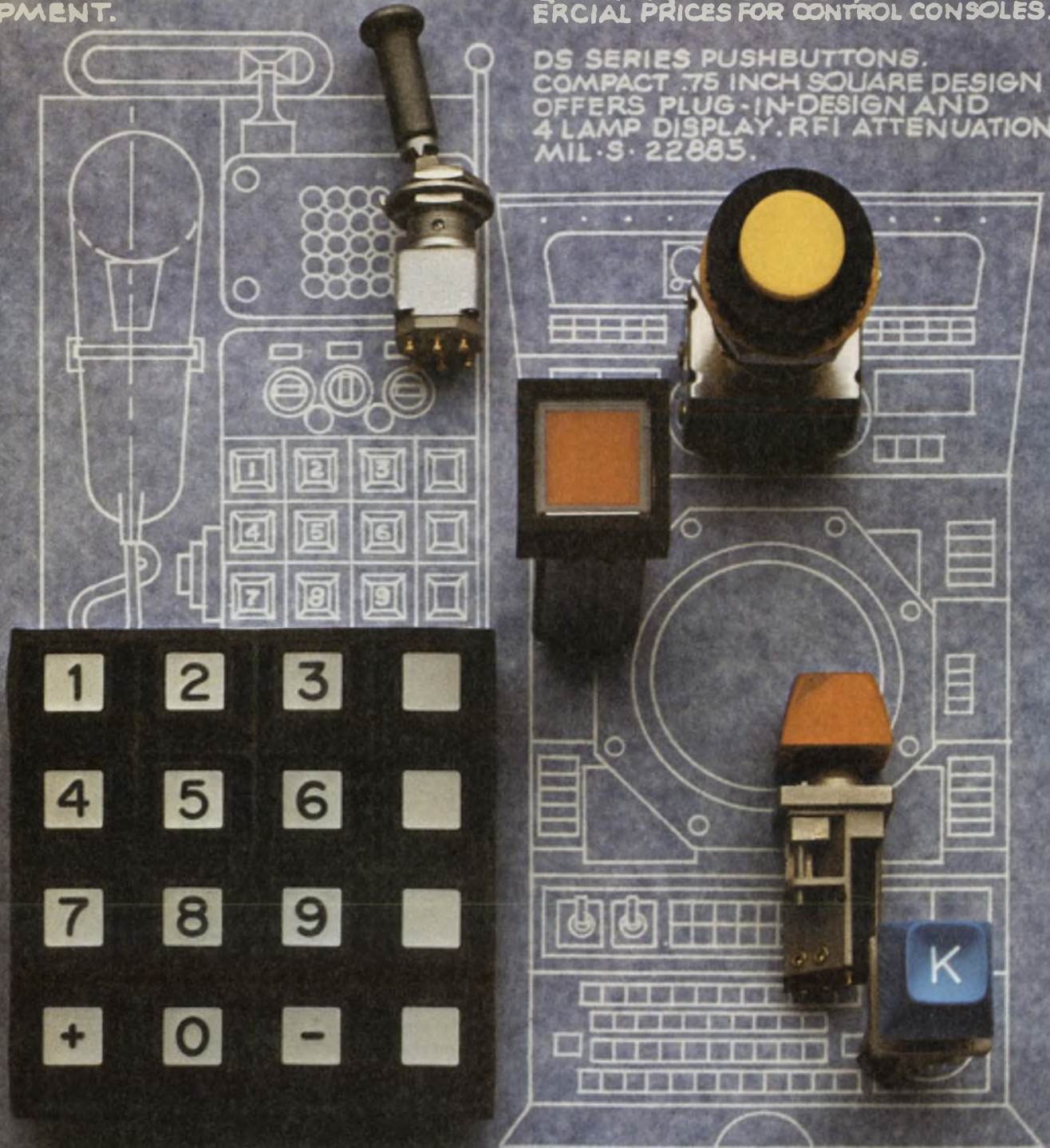

**PX KEYBOARDS.** TOTALLY SEALED WHEN MOUNTED, WITH ZERO DEPTH BEHIND PANEL, PX IS A NATURAL CHOICE FOR MANPACK EQUIPMENT SWITCH MATRICES.

**PANEL SEALED KS KEY SWITCHES.** USE OF SPDT SNAP-ACTION SWITCHES (MIL-S-8805) AND FRONT-OF-PANEL REPLACEMENT, MAKE KS IDEAL FOR RUGGEDIZED CONTROL PANEL KEYBOARD APPLICATIONS.



# things get.

The five switches you see here have all been designed to operate reliably under extremely rugged environmental conditions. Exactly the kinds of environments where Command, Communications & Control Systems are required to work.

But if these switches aren't exactly what you need, you're not out of luck.

Because they're only a sampling of literally thousands of MICRO SWITCH listings available to fill your needs. Including toggle switches. Lighted pushbuttons. Unlighted pushbuttons. Key switches. Sealed keyboards. Plus hermetically and environmentally sealed limit, proximity and basic switches.

All of them available almost anywhere in the world, through over 500 MICRO SWITCH Authorized Distributors and Branch Offices.

And if that still isn't enough, our Application Engineers will work with you to modify an existing MICRO SWITCH product to your needs. Or come up with a new one, through our field and factory engineering staff.

If you'd like more information on the devices you see here, or more information on how we can help, write or call your nearest MICRO SWITCH Branch Office or Authorized Distributor.

## MICRO SWITCH

FREEDPORT, ILLINOIS 61032

A DIVISION OF HONEYWELL

MICRO SWITCH products are available worldwide through Honeywell International.

regard to programming such systems.

Justin Rattner comments, "We have enough trouble programming one  $\mu$ P to do a fairly simple job, and now somebody comes in and says, 'OK—you take hundreds (or thousands) of them and program them to work on the same thing.' The mind boggles at such a problem."

### Support your local $\mu$ P

Support tools for  $\mu$ Ps also receive their share of attention at these sessions.

William Wray of Motorola, Inc., Phoenix, AZ, describes a number of recently-introduced options to Motorola's one-and-a-half-year-old EXORciser, a software development system for the 6800  $\mu$ P.

In his paper, "Support Tools of  $\mu$ P Developments," he describes one of the options, a User System Evaluator (USE), a piece of hardware designed to plug into the EXORciser for directly testing  $\mu$ P systems that are already built.

A second option, a System Analyzer Module that can be used alone or with the USE system, expands the EXORciser's capability by allowing troubleshooting of  $\mu$ P-based equipment in the field. This would allow, for example, a field technician to stop a program at any point to examine either the data stored in memory at that point, or the program instruction itself.

With the current flood of  $\mu$ Ps appearing on the market, engineers may feel that some sort of perspec-

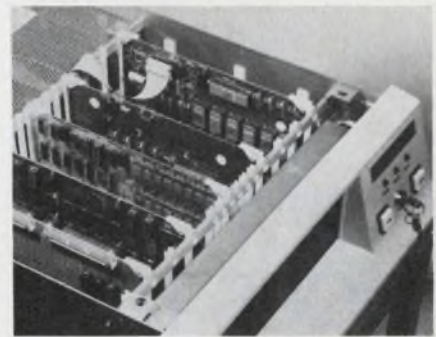

New modules for Motorola's EXORciser enhance its  $\mu$ P-debugging and test capabilities.

tive is needed. Their thoughts have been anticipated.

In a survey paper on  $\mu$ Ps, Jerry Ogdin, president of Microcomputer Techniques, Reston, VA, analyzes present-day  $\mu$ Ps, particularly in terms of generality and efficiency. The more general (less specialized) a  $\mu$ P is, the less efficient it becomes, and conversely.

Ogdin's paper is an updated version of one presented in 1974. It analyzes the 8080, 6800, F-8, 9900, and one of currently-available CMOS  $\mu$ Ps.

One important part of program debugging procedures that Ogdin cites is the single-stepping operation. In that procedure the  $\mu$ P executes an instruction and then waits for a command signal before going on to the next.

"The 8080 needs only one signal to do this," he reports. "In contrast, the F-8 can't be single-stepped at all without using extra chips." ■■

## Wanted: a robot that thinks for itself

How do you get a robot on Mars to find a rock it's just dropped? At that distance from earth the teleoperator approach is too slow. The robot knows the rock has slipped from his grasp because the touch sensors in his fingers tell him so. But it takes 20 minutes for this

news to reach the human operator on earth, and another 20 minutes for the operator to send a message back to Mars telling the robot to look down, just beneath his hand, and pick it up again.

"We have to give a robot the intelligence, or the computer programming, to solve such problems locally, by itself," says Leonard Friedman who chairs a session on "The Present and Future of Mo-

John F. Mason  
Associate Editor



# 1 RCL SWITCH DOES THE JOB OF 12!



- SUBMINIATURE Multi-deck Rotary Switches with ADJUSTABLE STOPS... permitting the user to vary the number of positions instantly.
- Select 2 through 10 positions by moving external plate.
- As many as 4 poles possible per deck!

Send For New '76 Catalog Or  
Call our Hotline For Name  
Of Your Local Representative  
Or Stocking Distributor.  
(201) 374-3311

**AMF**

**RCL Electronics**

General Sales Office:  
700 So. 21st Street  
Irvington, N. J. 07111

ble Robots" and who is in charge of computer programming at the Robotics Research Program at Jet Propulsion Laboratory, Pasadena, CA.

The group's aim at JPL is to develop a robot that can figure out for itself how to perform simple tasks such as picking up objects, seeing and responding to such obstacles as holes and boulders.

"Such a robot would probably go first to Mars," Friedman says, "but could also be used to explore the satellites of Jupiter, Callisto and Io, and Saturn's Titan." Toward this end, some 25 scientists and engineers are pooling their efforts at JPL.

## Robots for the "real world"

The only robots developed for such missions to date have been laboratory models, operated under controlled conditions, Friedman says. "We are trying now to move the robot out into the real world."

Today's robots are "move-and-wait" machines. You make a small move and wait to see the result of the move before making another one. Friedman believes the maximum distance for this approach is probably the moon. The Russians used it with Lunokhod 1, which landed on the moon, and even at this relatively short distance lost control of the roving machine several times.

The solution is to give the robot a sense of touch, a sense of vision and a computer that will enable it to use the data detected for making decisions.

The JPL group's robot, which goes by the unofficial name of Rover, can look for a rock with its two television cameras and analyze what it sees in a computer. If the computer confirms that the object is indeed the rock in question, Rover can also pick it up.

The robot is still only a laboratory model. Its data processing equipment is much too big ever to go too far from Pasadena, let alone Mars. It uses a DEC PDP-10 plus a General Automation Spec 1685 minicomputer.

## μPs are needed for Mars

"We started this program in 1972 assuming that by the time we

were ready to fly, large computers would be miniaturized. To go to the planets we'll have to have microprocessors. We can envision a network of μPs mounted on a robot and having more computational power than a large computer can provide today." Some time during the next few years Friedman plans to start putting μPs into the system.

"We're relying heavily on TV cameras," he says. "At first we were using two vidicons but we have switched to GE cameras built

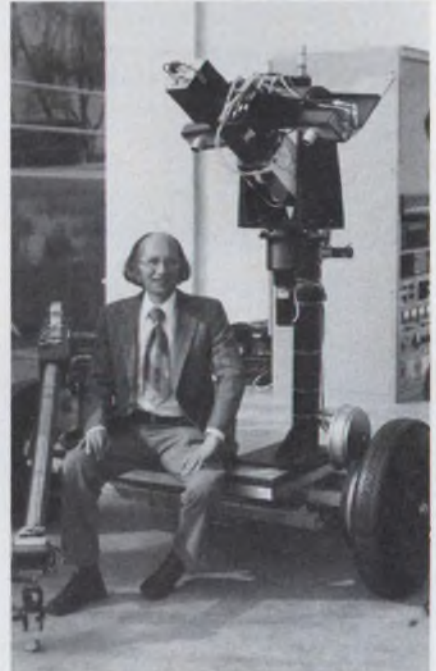

The big computer behind JPL's model of a robot for Mars will be replaced by μPs. Leonard Friedman is in charge of software.

with charge-coupled devices. The result is a smaller and lighter camera, built with light sensitive chips. The image can be focused directly on them."

For redundancy, a laser range finder will check the twin-TV-camera technique. For touch sensors, Rover has used microswitches, which Friedman calls "crude." He says the more refined proximity sensor is being considered. It is a very small LED with two tiny plastic lenses and a receptor that focuses the beam four or five inches away from the sensor. If there's anything there it is reflected back and received by the receptor. "The device actually acts as a sort of optical sense of touch," he says. "We'll use a lot of these for ob-





## TCX...the new aluminum capacitors with the super electrolyte.

TCX'tra! For a lot of extra pluses at extra-competitive prices.

Our new electrolyte system is the key. It provides the properties that make TCX capacitors ideal for even the most demanding commercial duty — such as high frequency, power supply, EDP applications.

Great stability, for instance, over a very broad

temperature range up to 105°C. Which is about 20° higher than with almost every other capacitor of this type.

Along with low leakage, high ripple current, good volumetric efficiency. And a higher voltage/MFD range . . . 3 to 100 V, 10 to 22,000 MFD.

TCX'tra! Read all about it in our TCX literature. Just ask your Mallory representative.

**MALLORY**

**MALLORY CAPACITOR COMPANY**

a division of P. R. MALLORY & CO. INC.  
Box 372, Indianapolis, Indiana 46206; Telephone: 317-636-5353

Electrical and Electronic Components • Timing Devices and Motors • Metallurgical Products • Batteries

CIRCLE NUMBER 30



# AMP leaf-spring contacts...Computer-developed for maximum design confidence.

This unique leaf-spring configuration has proven so successful that it's now used in a range of Economy Wrap, Low-profile and Zero Insertion Force edge connectors manufactured by AMP.

It's the result of a computer-aided development project that considered the many variables in printed circuit edgeboard connectors. Its design features a constant spring characteristic. This unusual characteristic allows compensation for warped pc boards while maintaining good electrical contact.

And if the contacts ever have to be replaced, they snap-in or are removed quickly and easily.

Whether your products require Economy Wrap, Low-profile or Zero Insertion Force connectors, when you specify them with leaf spring contacts, you'll be getting maximum reliability at the lowest cost possible.

For more information on leaf-spring style connectors, write AMP Incorporated, Harrisburg, PA 17105.

Or call (717) 564-0100.

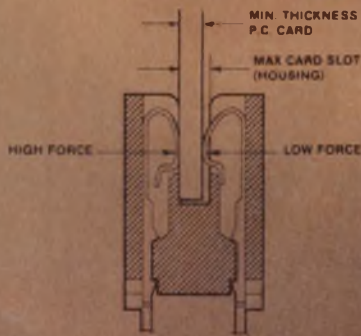

# AMP

INCORPORATED

CIRCLE NUMBER 31

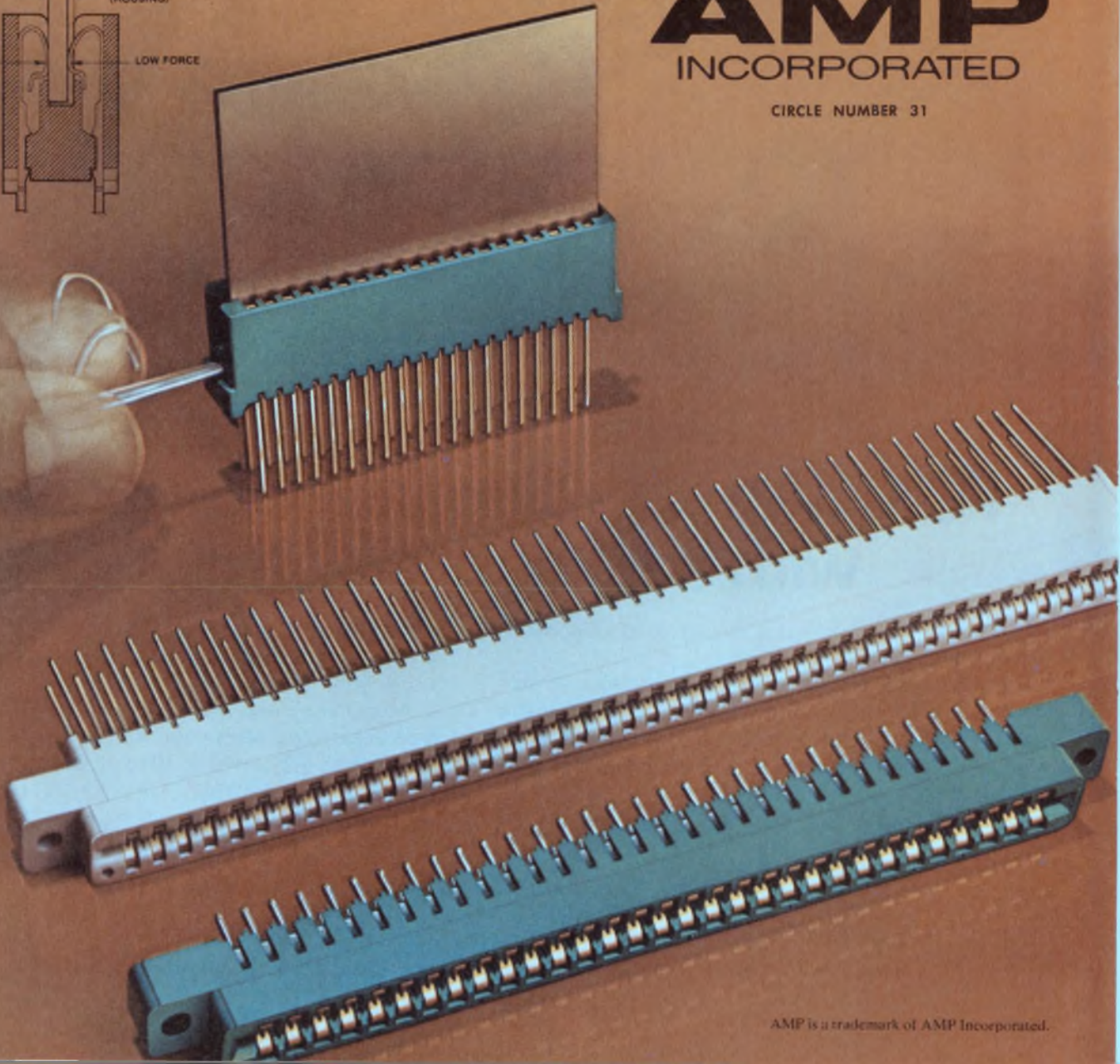





#### EUROPE

**Austria** — AMP Austria, Branch of AMP Deutschland GmbH, Markgraf-Ruediger Str. 4-8, 1150 Vienna. Phone: 924191/92

**Belgium** — AMP Belgium, Branch of AMP-Holland B.V., Rue de Brabant 62-66, Brussels. Phone: 322.17.55.17

**France** — AMP de France, 29 Chaussée Jules-César, Boite Postale No. 39, 95301 Pantaise France. Phone: 030 82 20, 030 92 30

**Germany** — AMP Deutschland GmbH, Ampérstrasse 7-11, 607 Langen, B. FFM., West Germany. Phone: (06103) 7091

**Great Britain** — AMP of Great Britain Limited, Terminal House, Stanmore, Middlesex, England. Phone: 01-954-2356

**Holland** — AMP Holland B.V., Papierstraat 2-4 's-Hertogenbosch, Holland. Phone: (04100) 25221

**Italy** — AMP Italia S.p.A., Via Fratelli Cervi 15, 10093 Collegno (Torino), Italy. Phone: 785-656

**Spain** — AMP Española, S.A., Apartado 5294, Pedro IV, 491, 495, Barcelona 5, Spain. Phone: 307-75-50

**Sweden** — AMP Scandinavia AB, Datavägen 5, 17500 Jakobsberg, Sweden, Mailing Address: Fax S-175 20 JARFALLA 1, Sweden. Phone: 0758/10400

**Switzerland** — AMP AG, Haldenstrasse 11, 6006 Luzern, Switzerland. Phone: (414) 235421, 235422, 235423

#### NORTH AMERICA

**Canada** — AMP OF CANADA LTD., 20 Esna Park Drive, Markham, Ontario, Ph: 416-499-1251

**Mexico** — AMP de Mexico, S.A., Apartado Postal 179, Naucalpan de Juarez, Edo. de Mexico, Phone: Mexico City 576-41-55

**Puerto Rico** — AMP OF CANADA LTD., 677 Calle de Diego, Rio Piedras, Puerto Rico 00924. Phone: (809) 766-2346

**United States** — AMP Incorporated, Harrisburg, Pa. 17105, Phone: 717-564-0100

#### SOUTH AMERICA

**Argentina** — AMP S.A. Argentina 4 de Febrero, 76 Villa Zagla — SAN MARTIN, Buenos Aires, Argentina, Phone: 752-4612

**Brazil** — AMP do Brasil Ltda., AV Comendador Martinelli 185, Lapa, Sao Paulo, Phone: 262-4353

#### PACIFIC

**Australia** — Australian AMP Pty. Limited, 155 Briens Road, Northmead, N.S.W. 2152 Australia, Mailing Address: P.O. Box 194, Baulkham Hills, N.S.W. 2153 Aus. Ph: 630-7377

**Japan** — AMP (Japan), Ltd., No. 15-14, 7-Chome, Roppongi Minato-Ku, Tokyo, Japan, Ph: 404-7171

Products and services for many specialized industries are provided by the AMPLIVERSAL Division. In the United States, this division is known as AMP Special Industries.

For AMP products and services in other countries, write: AMP International Division, Harrisburg, PA 17105, USA.

stacle avoidance.”

A guidance sensor will give the heading of the vehicle and an odometer will help keep track of the robot's location. The installation of meters to detect and measure tilt, slide and slip is also planned.

“Our big goal,” Friedman explains, “is to provide solutions to problems quickly enough to correct and continue the operation without interruption.

#### Robots in the sea

A look at robots for deep-sea use is provided by Herbert A. Johnson, Head of the Ocean Instrumentation Branch of the Ocean Technology Div. of the Naval Research Laboratory, Washington, DC.

The escalating costs of ships and personnel, Johnson says, have made the Navy look to “smart” unmanned “fish” for its deep-ocean search missions and its scientific data-gathering operations.

By 1978 Johnson's group hopes to test the first phase in the evolutionary development of a smart fish.

#### Power is a problem

One of the problems that must be overcome is energy. Power candidates for the fish include fuel cells, lithium inorganic batteries and thermal-energy devices using chemical fuels or nuclear isotopes.

Lithium inorganic batteries have progressed past the research stage, Johnson says. A unit has been developed that can deliver 325 watt-hours of energy. However, a high-endurance submersible similar to one NRL envisions would require an energy source with approximately two orders of magnitude more energy than this to achieve a round trip range of 1000 miles.

Two systems are being considered for navigation: an Omega Dead Reckoning system and an inertial-doppler sonar system.

Omega is useful for an ocean-science data-gathering mission where the vehicle occasionally “pops up” near the surface to obtain a new Omega fix. For deep-ocean work, however, the inertial-doppler sonar is favored because it uses the bottom for obtaining its doppler returns.

Due to future projections on the capability and size of LSI circuits, mass memories and charge-coupled devices, a formidable computing capability can be placed in a small volume of a submersible.

“By use of pattern recognition and artificial intelligence the submersible could recognize man-made objects as it processed data from its sensors. By such techniques it would locate sunken submarines, mines and objects on the ocean floor.”

The incorporation of a manipulator and mechanical hand would be an extension of the artificial intelligence capability. Considerable work in these areas is currently being done for industrial and space applications.

Another smart fish, this one tethered to a surface vessel or a manned submersible, is described by Ronald A. Walrod, Hydro Systems, a Tetra Tech Co., San Diego, CA.

The Model RCV-125 Remote-Controlled Vehicle System sees with a low-light-level television camera tethered to a human operator by a 200-meter cable. It can operate at depths of 2000 meters.

Four oil-filled electric motors give the vehicle three degrees of freedom (forward and reverse, left and right, up and down) and one rotational degree of freedom (heading). The foam hull is a rugged, buoyant envelope that encloses the pressurized housing for the camera and electronics.

The control station provides a complete set of controls and displays so that, by using a joy stick, the operator can position the vehicle relative to the object being inspected. Vehicle's depth and heading, and the pitch angle of the lens are displayed in the television picture and continuously recorded on videotape.

The camera is equipped with a unique lens assembly that enables the operator to pitch the angle of view  $\pm 90^\circ$  from the horizontal. Two 45-W tungsten halogen lamps provide a 7 to 10-m viewing range in clear water.

The low-light-level TV camera uses a silicon intensified target (SIT) tube that has a 300-line resolution, a range of from 8 cm to infinity, and a sensitivity at the image plane of 0.0001 foot-candles or better. ■■



# A lot of microprocessor users wish their analog interface problems would go away.

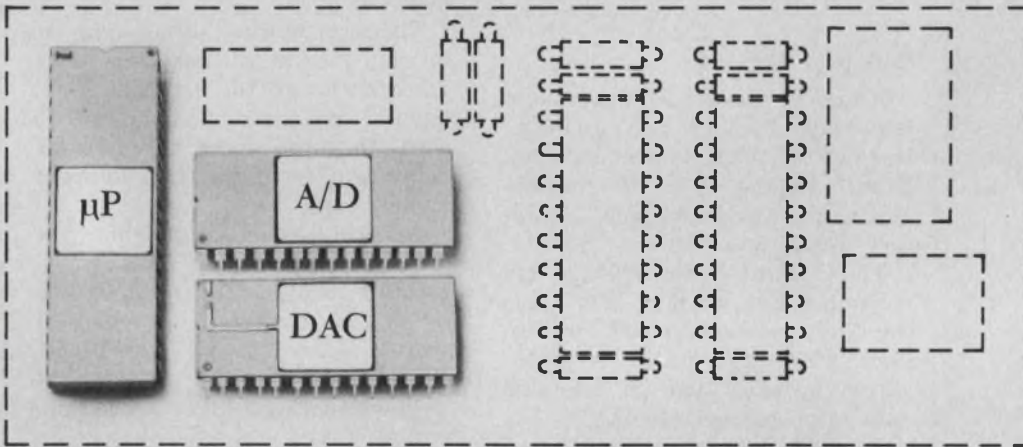

## We made them disappear.

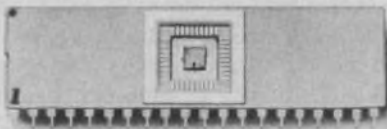

### With our monolithic CMOS converters.

10- and 13-bit A/D converters with tri-state output logic that gets you directly onto the microprocessor data bus. And our 10-bit D/A converter with double-buffered inputs direct from the microprocessor. And each communicates in two bytes: the 8 LSB's, and the remaining MSB's.

Our AD7550, industry's newest and most accurate monolithic CMOS A/D converter, uses a patented (Analog Devices U.S. Patent No. 3872466) "quad slope" conversion technique to provide 13-bit accuracy, 1 ppm/°C offset and gain drifts, and has its own amplifier, comparator, clock and digital logic.

Our AD7570 is a monolithic CMOS 10-bit successive approximation A/D converter with ratio-metric operation and only 20mW of dissipation. Parallel and serial outputs with 20μs conversion time provide excellent application flexibility.

Our AD7522 is a monolithic CMOS multiplying, 10-bit DAC. It's the only such device available with double buffered inputs that can be loaded in parallel or serial mode. Low dissipation, very low feedthrough and drifts of only 1 ppm/°C complement the interface handshaking routine for maximum flexibility and optimum performance.

These I/O peripherals, the AD7550, AD7570

and AD7522 data converters are your only real solutions for interfacing a microprocessor to the analog world.

And these are just three of a complete line of more than 20 IC converters that make a lot of your conversion problems disappear. For more information, write Analog Devices, the real company in precision measurement and control.

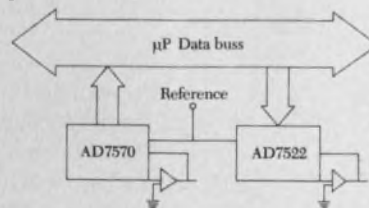

**ANALOG  
DEVICES**

The real IC Converter company.

Analog Devices, Inc., Norwood, Massachusetts 02062

East Coast: (617) 329-4700, Midwest: (312) 894-3300, West Coast: (213) 595-1783, Texas: (214) 231-5094, Belgium: 03 38 27 07, Denmark: 97 95 99, England: 01/94 10 46 6, France: 686-77 60, Germany: 089/53 03 19, Japan: 03/26 36 82 6, Netherlands: 076-122555 and representatives around the world.



BAUSCH & LOMB 

# StereoZoom<sup>®</sup> 5

microscope

## Meet the new MORE and LESS microscope

**MORE in optics . . . MORE in mechanics . . . LESS in price.**

This new StereoZoom 5 completes the royal family of world-leading Bausch & Lomb Stereomicroscopes. Fills the need in electronics for a middle zoom range of 0.8X-4.0X (5:1 ratio) with higher resolving power for accurate inspection and quality control of micro-circuits.

**More in optics.** Higher resolution . . . 200 lines/mm at 4X. Better color correction. Less distortion. Flatter fields . . . no refocusing to see detail at edge of wide field. Zooming is fast with image continuously in focus through full range, while maintaining full working distance of 4". Workers see more, faster, easier, more accurately.

**More in mechanics.** Tighter precision tolerances for better alignment. Smoother operation. Eyepieces can be locked in to prevent theft or tampering, but they are still rotatable. StereoZoom 5 is directly interchangeable with other Bausch & Lomb pods, and can be used with many of the existing StereoZoom modules and accessories. Attractive new modern styling and professional black and white finish.

**Less in price.** Priced lower than other stereomicroscopes with equivalent features.

**More . . .** There's more to the new StereoZoom 5 story. Discover this exciting new instrument by arranging for a free, no-obligation demonstration. Catalog 31-2436 is also available just for the asking.

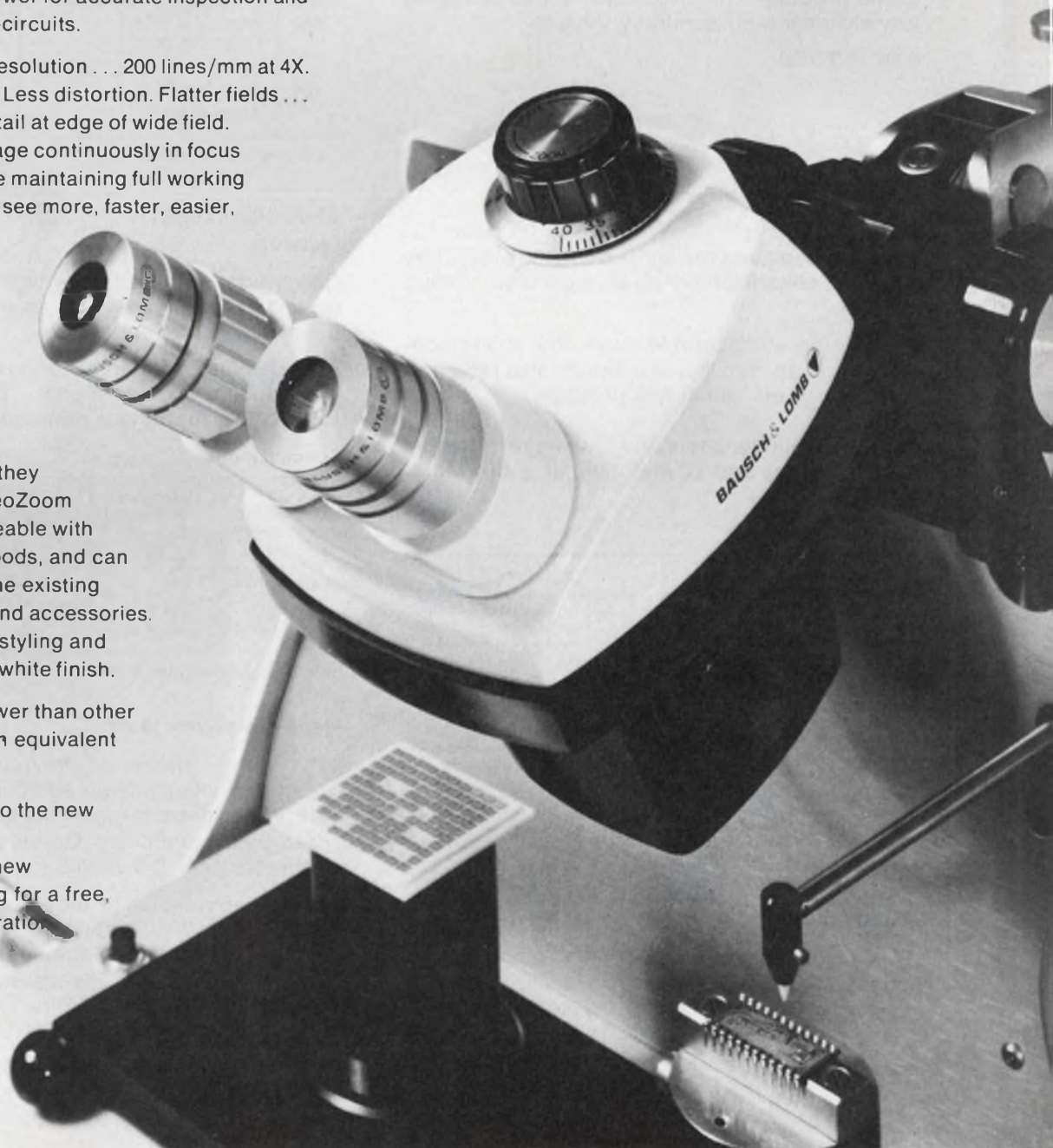



# TRW's MAR™ ultra stable resistors. Performance plus.

Our ultra-precision MAR resistors match the performance of precision wirewound, *plus* they give the inherent advantages of TRW metal film.

Like smaller size, better frequency response, higher resistance values and lower cost.

And MAR's are not "selected" from a lower grade process. The entire facility was *designed* to yield *only* high accuracy devices.

And it *DOES*:



## MAR axial lead family

Tolerances to  $\pm 0.01\%$ . TC's  $\pm 5$  to  $25 \text{ ppm}/^\circ\text{C}$ . Where speed and precision count, the MAR does it all. In a dimensionally clean, axial lead molded package.

With the non-measurable noise, low voltage coefficient, load stability, resistance/size ratio and *reliability* of our metal film process.

*Plus* MAR matched sets and packaged networks have tolerance and TC matching to  $\pm 0.005\%$  and  $1 \text{ ppm}/^\circ\text{C}$ .

## Specifications

IRC Type	Resistance Range* (Ohms)	Temperature Coefficients $-20^\circ\text{C}$ to $+85^\circ\text{C}$ ( $\pm \text{ppm}/^\circ\text{C}$ )	Tolerances ( $\pm \%$ )	Power Rating** @ $85^\circ\text{C}$ (Watts)	Voltage Ratings (Volts)
MAR3	20 - 100K	T10 = 15	1.00, 0.50, 0.25,	$\frac{1}{20}$	200
MAR5	20 - 250K	T13 = 10	0.10, 0.05, 0.02,	$\frac{1}{10}$	250
MAR6	20 - 500K	T16 = 5	0.01	$\frac{1}{4}$	300
MAR7	20 - 1 Meg			$\frac{1}{4}$	500

\*Wider ranges available, contact factory.

\*\*Higher power ratings available. Contact factory.



## AR40 radial lead devices

This plug in configuration offers absolute accuracy and documented reliability. TC's to  $\pm 2 \text{ ppm}/^\circ\text{C}$ , tolerances to  $\pm 0.01\%$  are standard.

*Plus*, AR40 uses only  $.03 \text{ in.}^2$  PCB area including lead attachment, and has the same mechanically rugged terminations used on all MAR resistors.

## Specifications

TCR Class.	Standard Temp. Coeff. ( $^\circ\text{C}$ )	Resistance Range* (Ohms)	Standard Tolerance ( $\pm \%$ )	Wattage $85^\circ\text{C}$
T-18	2 ppm 0 to $60^\circ\text{C}$ 5 ppm $-55$ to $125^\circ\text{C}$	20 to 100K	.01, .02, .05, .10, .25, .50, 1.00	.3 watts
T-16	5 ppm 0 to $60^\circ\text{C}$ 10 ppm $-55$ to $125^\circ\text{C}$			

\*Wider ranges available, contact factory.

## AR90 high range resistors

Designed for applications where you need values up to 10 Meg Ohms—such as precision voltage dividers, input attenuators.

*Plus*, despite its high resistance range, the AR90 has standard TC's to  $\pm 5 \text{ ppm}/^\circ\text{C}$  and tolerances to  $\pm 0.05\%$ . And it is a *real* space saver.

## Specifications

IRC Type	Resistance Range* (ohms)	Temperature Coefficients $-20^\circ\text{C}$ to $+85^\circ\text{C}$ ( $\pm \text{PPM}/^\circ\text{C}$ )	Tolerances	Power Rating	Voltage Rating
AR90	1M - 10M	T10 = 5 T13 = 10 T16 = 15	1.0, 0.5, 0.25, 0.1, 0.05	.5W	1000

\*Wider ranges available. Contact factory.

## Need prototypes fast?

TRW has on stream another *big plus*—a short order production line (in addition to our regular facility) designed to give you quick delivery on bread board quantities. Delivery to satisfy your needs, typically 2-3 weeks.

For more information on ultra-precision resistors, contact TRW/IRC Burlington. TRW/IRC Resistors, an Electronic Components Division of TRW, Inc., 2850 Mt. Pleasant St., Burlington, Iowa 52601. (319) 754-8491.

# TRW IRC RESISTORS

CIRCLE NUMBER 34



# New "Cricket" sub-miniatures: Interchangeability plus full 6 amp rating.

Cutler-Hammer introduces a broad new line of quality sub-miniature switches whose specifications meet industry standards for size, terminal spacing and bushing height. They're rated 6 amps. They're fully interchangeable. They feature high torque bushings. They're competitively priced. And they're available right now. For more information on new, interchangeable sub-miniature switches, call your Cutler-Hammer sales office or Stocking Distributor. Just ask for "Cricket."

**Flat Lever.** Designed for comfortable, finger-tip control. Keyed bushing prevents switch rotation.

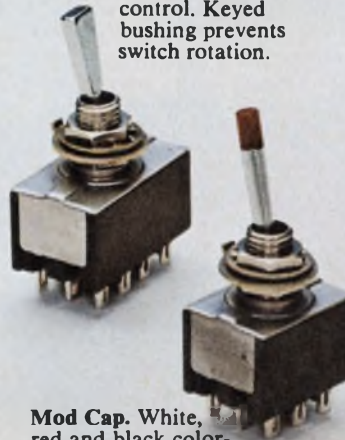

**Lever Lock.** Locks in position to assure precise control of vital or sensitive functions and equipment. No accidental operation.



**Mod Cap.** White, red and black color-tipped caps let you choose and vary your operational coding.



**Watertight.** Toggle or pushbutton. "O" ring seal shuts out dirt and moisture. Keeps switch mechanism dry in adverse environments.

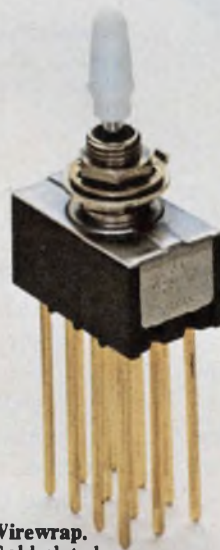

**Wirewrap.** Gold plated terminals in .750 and .964" lengths to satisfy power or dry circuit requirements.



**Rockers.** Sub-panel or snap-in. Variety of paddle or low-profile styles. With decorative bezels. Also with L.E.D. for illuminated functions.

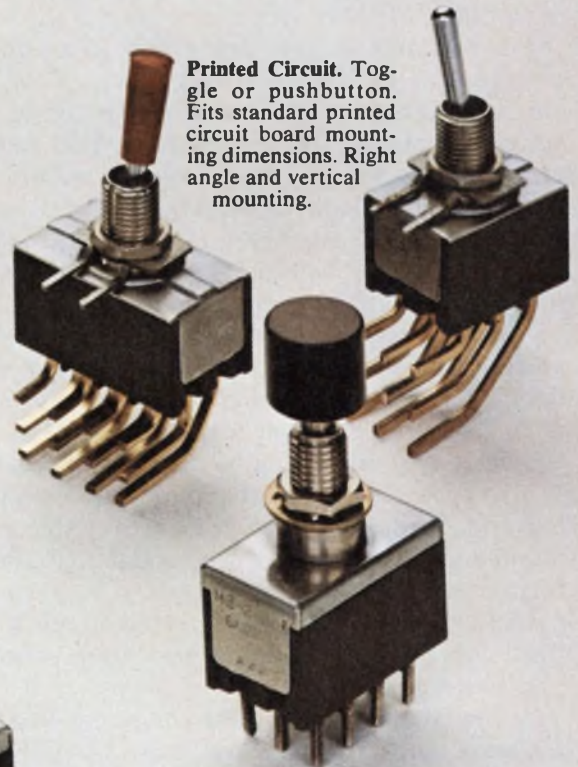

**Printed Circuit.** Toggle or pushbutton. Fits standard printed circuit board mounting dimensions. Right angle and vertical mounting.

**Standard.** Toggle or pushbutton. One to four poles. Eight circuits. Two decorator cap styles in a variety of colors. Dry circuit capability, too.



**CUTLER-HAMMER**  
SPECIALTY PRODUCTS DIVISION, Milwaukee, Wis. 53201





# Computer '76

## Hardware spurred on



Hewlett-Packard's minicomputer-based scientific data system offers multiterminal, on-line data processing. It is shown with a microwave problem on the screen.

Like integrated circuits in the early 1960s, microprocessors have in recent years become so pervasive an influence in the world of computers that they no longer command the headlines they once did.

For example, a few years ago  $\mu$ Ps added intelligence to alphanumeric terminals. Now, without much fanfare, they are appearing in interactive terminals. Tektronix' new 4051 terminal encompasses today's new look in terminals: a built-in  $\mu$ P, built-in tape-cartridge drive, a basic keyboard, RAM storage and other features—all of which make the 4051 look more like a computer than a graphics terminal.

Vector General's brand-new Model 3400 works off line, and a microcoded processor works out the details of perspective, arcs, cubics and the like with a single call from a user's data list. Up to 20,000 short vectors can be displayed at once.

Microprocessors are beginning to creep into low-end printers. Here they are reducing the number of parts, improving reliability and performance and lowering the cost.

In fact,  $\mu$ P prices have tumbled so much lately that associated peripherals have been struggling just to keep pace.

A few years ago the first computer-on-a-board appeared on the scene. Now, more than 20 manufacturers have introduced single-board computers in 4 through 16-bit word sizes. And they are being used in a variety of new applications from TV games to industrial process controllers.

Benchmark tests have long been used in the

industry to evaluate the merits of competing computer systems. They have been adopted for similar service in the microprocessor field. Although the  $\mu$ P can operate as a miniature data processor, it often is used as a dedicated controller—a function so different from the uses of a general-purpose computer that the validity of the benchmark as a test for  $\mu$ Ps has come into question.

Those opposed to benchmark testing note, for instance, that it is difficult to establish a general benchmark that is useful for all  $\mu$ Ps on the market. Also, it is difficult to define a test that is not weighted in favor of a particular type of  $\mu$ P architecture. Finally, it takes quite a bit of time, skill and money to write a benchmark program that is closely related to a specific  $\mu$ P application.

Despite the controversy,  $\mu$ P benchmarks are still widely used. The main reason is that a simple substitute has yet to be found.

The microprocessor has had an effect on semiconductor memory design, and vice versa. Special high-density memories have been designed for  $\mu$ Ps, and many  $\mu$ Ps have been designed around available low-cost semi memories.

Rapid technological advances in semiconductor memories are producing new generations of both bipolar and MOS devices that are faster, have higher packing densities and are compatible with one another.

Some four years after its introduction, the 4-k dynamic RAM has finally obtained sufficient density to give serious competition to mass-core



# and software advances are by microprocessor invasion

Microprogram control circuits, such as this Fairchild 9408, control the sequence in which microinstructions are fetched from a microprogram memory.

## Contents

<b>Semiconductor memories</b> —MOS continues to replace bipolar devices	78
<b>Computers-on-a-board</b> —They're getting more versatile and less costly	86
<b>Microprocessor benchmarks</b> —Still popular despite some limitations	92
<b>Low cost peripherals</b> —They are less expensive as micro prices plunge	98
<b>Computer graphics</b> —Programming bottlenecks limit widespread use	104
<b>Jay Forrester</b> —A computer pioneer predicts society's future	112

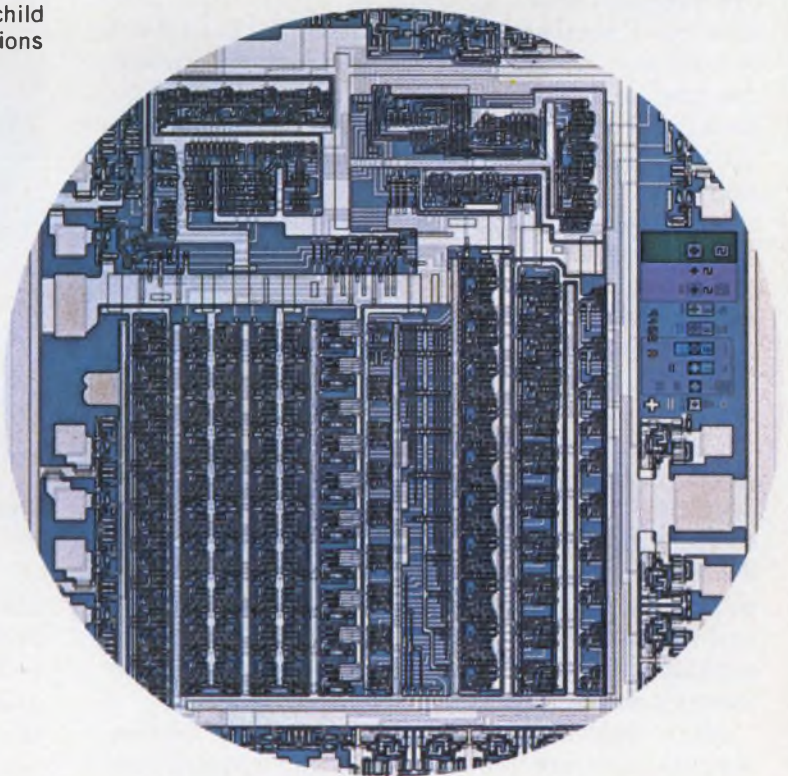

storage. And semiconductor suppliers are already developing or sampling new 8-k, 16-k, 32-k and even 64-k devices.

Major efforts are under way to increase the circuit density on memory chips and to decrease the package size commensurately. This effort has resulted in one important device—the 4-k, 18-pin dynamic MOS RAM, which is only half the size

of its 22-pin predecessor. One sign of the growing interest in this area is that Hewlett-Packard recently announced it plans to buy 1.5 million 18-pin, 4-k RAMs from Texas Instruments for use in HP's 21MX minicomputer.

For an inside look at these and other exciting developments in today's fast growing computer world turn to the pages of this special section.



# Semiconductor memories

## MOS technology continues to replace bipolar devices in most areas

Major semiconductor memory manufacturers are upgrading old products or introducing new ones in a bombardment of publicity guaranteed to keep even the most experienced memory-system designer in a state of confusion. However, significant industry trends have emerged from an ELECTRONIC DESIGN survey of manufacturers and users.

An assessment of the real state of today's semiconductor memories lies somewhere between the semi manufacturer's optimistic claims and the experienced memory user's skepticism. The main action is in semiconductor RAMs, ROMs, PROMs and CCDs, with MOS technology dominating the emergence of new generations of these devices.

The 4-k dynamic RAM has finally established itself in 1976—some four years after its introduction—with sufficient density to give serious competition to mass-core storage. But semiconductor suppliers are already developing or sampling new 8-k, 16-k, 32-k and even 64-k devices, and attention focused on these devices is obscuring substantial progress being made in other memory areas.

MOS technology is displacing bipolar devices because they are lower in cost, and require less power. Their speeds are being pushed upwards to compete with bipolar devices through special processing technology.

For example, Fairchild's standard 93415 1-k static bipolar RAM is challenged by the Intel 2115, a 1-k, pin-for-pin MOS replacement that has speeds in the 70-ns range and requires 30% less power, according to Dave House, product planning and application manager at Intel.

"I expect to see larger 4-k MOS RAMs of equiv-

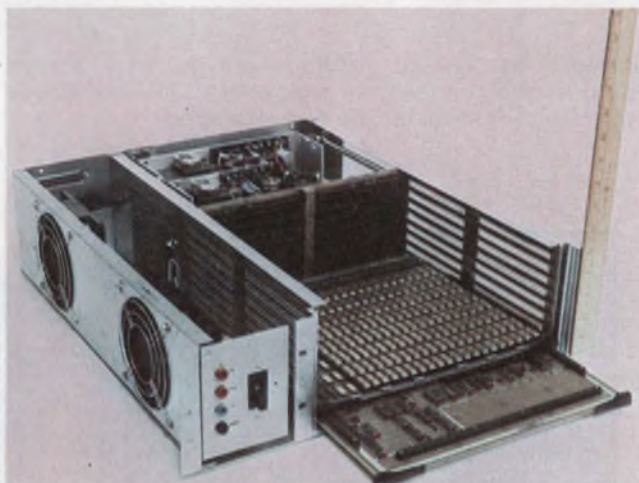

The first million-byte semiconductor memory to fit into a 5-1/2-in. high rack mount is produced by Control Data. It contains eight storage cards organized 64-k by 20, in 10-bit bytes to provide bits for error correction.

alent speed," he says, "and a 70-ns maximum over a temperature and voltage range."

The 70-ns region is an unofficial industry-generated standard, House points out. Many of the first 256-bit bipolar RAMs, and the original 1-k RAM and bipolar PROMs, were produced with 60 to 70-ns speeds, so the industry designed devices to compete at that access speed.

"To achieve faster MOS speed we use n-channel technology, which is superior to the old p-channel," he says. "In addition, by using ion implantation we get an improvement factor of four or five times. Also, we've added a substrate back bias on the chip that allows us to get down to the worst-case 70-ns number."

Fairchild, meanwhile has produced the 93415A, a version that has a 45-ns access speed.

"We anticipate speeding up all our RAMs between now and the end of the year," says Lowell Turriff, manager of marketing at Fairchild.



"We've just redesigned the 93415 into a low-power version, the 931415. We're going to further increase the speed by about 30% without changing the power drain, by adding walled emitters to our existing Isoplanar process. We use Isoplanar I in all the bipolar memory.

"We have an Isoplanar II for our subnanosecond ECL logic. We're taking the walled-emitter portion of the latter processing, and adding it to the Isoplanar I. This shrinks the size of the cell considerably and allows us to get better speed.

"With the walled emitter process we hope to have out by the year's end a 4-k  $\times$  1 static bipolar RAM in an 18-pin package."

### I<sup>3</sup>L used for speed

Fairchild is also using its I<sup>3</sup>L—Isoplanar integrated-injection logic—for a dynamic 4-k  $\times$  1, 16-pin part that currently is being sampled. It is TTL compatible.

"We're using the I<sup>3</sup>L mainly for speed," Turriff says. "The process has a very low power-delay product. Access time is less than 100 ns. Active power is between 300 and 400 mW and standby less than 50 mW. The device will have TTL pinouts and corner power pins that operate from one 5-V supply.

Bipolars will retain a definite niche in the high-performance memory area of 50 ns or lower access time, despite the increasing speed of MOS counterparts, according to a Texas Instruments spokesman. Bipolar will have a strong place in a 4-k memory with speeds in the 50 to 70-ns region within the next 12 months, says TI.

This TI type will have injection-logic storage cells and conventional bipolar or Schottky peripheral circuits. The Schottky circuits will be used for fastest access times.

Signetics is in the process of announcing the industry's largest line of I<sup>2</sup>L devices, but they are LSI random-logic, rather than memories.

"We do not feel that I<sup>2</sup>L is a technology that will compete with either bipolar or MOS," says Ralph Kaplan, Signetics' memory-marketing manager. "The n-channel MOS is so well advanced as far as technology goes that I<sup>2</sup>L will have an almost impossible time catching up."

RCA is in the speed race with its MWS 5501D silicon-on-sapphire, 1024  $\times$  1 CMOS RAM. Typical access time is 90 ns as compared to 400 ns for the competing 6508 CMOS device. Power drain is 20 mW at 1 MHz as compared to 8 mW for the 6508. The 5501D is pin-compatible with the CMOS 6508 and the bipolar 93415.

Major efforts are being expended to increase the circuit density on memory chips and to decrease the package size commensurately. This effort has reached maturity for one important device, the 4-k, 18-pin dynamic MOS RAM, which

is only half the size of its 22-pin predecessor.

Hewlett-Packard became the first major mini-computer manufacturer to use 4-k, 22-pin RAM memories with the introduction of the 21MX series in 1974. HP has recently announced the purchase of 1.5 million 18-pin, 4-k RAMs from Texas Instruments for use in 21MX memory modules.

The 18-pin device gives twice as much memory as the 22-pin RAM, in the same space. That is, 16-k words per module instead of 8 k, according to Bob Frankenberg, R&D section manager of the HP Data Systems Div., Cupertino, CA. HP's new 16-k-word module is priced 30% less than two of the earlier 8-k, 22-pin modules.

Exhaustive testing by HP of the 18-pin RAM was a major factor in choosing them. It involved over 15,000 parts and over 9 million hours of accumulated testing and evaluation time.

"I think the memory technology has pretty much settled down to the 4-k, n-channel silicon gate device," says Frankenberg, who is responsible for the test and evaluation program at HP.

"Its higher density and higher speed have made silicon-gate technology a winner in the 4-k game. While the 18-pin package allows us to upgrade our systems by using it without changing our controller or other circuitry, we are continuing to evaluate 16-pin 4-k parts."

To achieve the densities required for 16-k RAMs the industry, with few exceptions, has adopted the n-channel, double-level polysilicon process. With this, the area required for a mem-

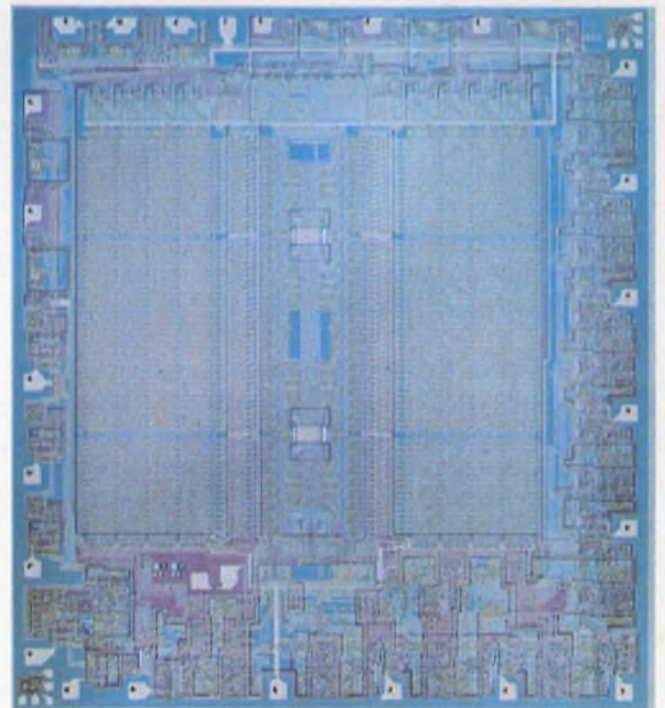

C-L, or closed CMOS logic, is used in the RCA CDP1832 512  $\times$  8 memory for small size and high drive capability. Access speeds are between 200 and 400 ns.



ory cell is essentially halved, thus making it possible to put 16-k bits on a chip that previously held 4 k.

One of the exceptions in the industry is the use of the V-MOS process by American Micro-Systems for a developmental 16-k ROM with a worst-case access of 200 ns, compared to over 500 ns for ROMs using conventional techniques (see ED No. 7, March 29, 1976, p. 27).

"The most significant technological development coming along in the dynamic memory area is the 16-k RAM," says Peter Bagnall, marketing manager of MOS memories, Motorola Semiconductor, Austin, TX. An important advance that has been achieved with the 16-k device is a level of standardization that has never before occurred in the semiconductory-memory industry.

With the 4-k RAM there were many different versions, including 22-pin RAMs from TI and

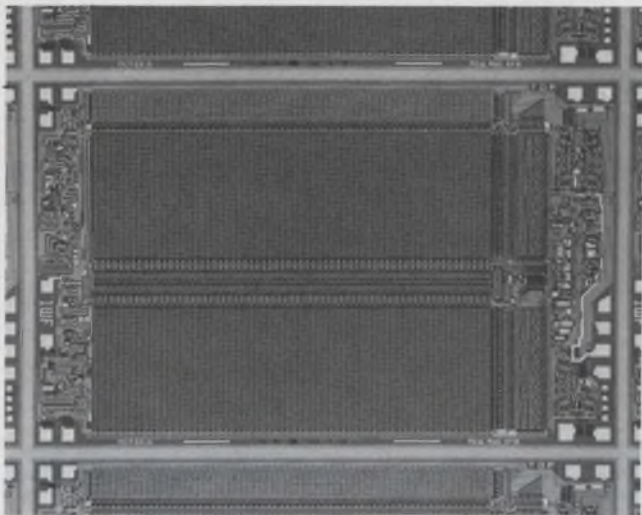

Die size of this 16-pin dynamic RAM, the MCM6616 by Motorola, is only 227 by 145 mils. This unit, like TI's, has a 128-cycle refresh. It is now being sampled.

Intel, a different 22-pin package from Motorola and Intersil, an 18-pin from TI, a different 18-pin device from National, and other 16-pin devices.

For the 16-k RAMs, pinout-standardization has been largely achieved. Intel, Mostek, Motorola and TI have chosen the 16-pin package. There are slight differences resulting from minor options on the device. For example, TI and Motorola have 128-cycle refresh. Intel has 64 but with an option of 128.

Intel's philosophy in the 64-k memory design has been to make it compatible with the 16-pin 4-k RAM pioneered by Mostek.

"Our 16-k RAM, the 2116, is in the 250-ns access range and has the same speed and power as the 16-pin, 4-k's as well as the same pinout," says Intel's Dave House.

"You simply change the chip-select input to be an additional address input (A6) and thereby get a factor-of-four improvement in density in the same package.

"Our part features the 64-cycle refresh and an output latch, just like the 16-pin 4-k. TI is excluding the output latch, which makes it incompatible with the 4-k."

The rush to produce the 16-k RAM is under way; sampling by all vendors will be underway by midyear. But reliable production devices may not be available for a period ranging from 6 to 18 months, depending upon which industry observer you speak to.

The hulabaloo over the 16-k memory has overshadowed other devices under development, including a 64-k dynamic RAM being designed by Signetics and Philips in collaboration. A 32-k n-channel 4-k  $\times$  8 metal-gate ROM by Electronic Arrays will reach the sampling stage in June. The device, in a 28-pin package, will have an access time of 300 ns at 70 C. It has TTL-compatible addresses and outputs and its timing requirements are identical to 4-k RAM clocks.

Static RAMs, which are preferred by some memory-systems designers as a direct substitute for core, are being upgraded. A common characteristic of these RAMs is a single 5-V supply. These memories are organized as 1-k  $\times$  4 and 4-k  $\times$  1 and have access times on the order of 200 to 250 ns, depending on the supplier. National is currently sampling three 250-ns devices, two in 18-pin packages, the other with a 22-pin configuration. American Micro Devices has been shipping 1-k  $\times$  4 and 4-k  $\times$  1 devices with a 200-ns access. Semi, a subsidiary of Electronic Memories and Magnetics has specialized in a high speed 100 ns 4-k  $\times$  1 static RAM using 5 and 12-V supplies. Fairchild is sampling a new 1-k  $\times$  4 static RAM that uses a 5-V supply, is TTL compatible, and comes in an 18-pin package.

Motorola has a series of five n-channel static ROMs that go up to 16 k, organized 2-k  $\times$  8 at the 16-k level.

CCD's have their own unique potential to serve as mass memories in possible future competition with bubbles or electron-beam-scanned semiconductor memories. At present, Mnemonics is developing a 64-k-bit memory. Fairchild and Intel have 16-k devices available, but the general consensus is that the CCDs will not really find a niche until they can be produced in densities of 64-k bits or more.

While the semiconductor manufacturers are busy turning out new products the present and future influence of the new packages is under evaluation by both large and small computer manufacturers.

Fred A. Ordemann, general manager of memory development for Control Data Peripheral



Products Co., Minneapolis, formerly managed development of IBM 360 memories. He sees semiconductor memories at the point of successfully replacing core.

"To date," says Ordemann, "our CDC internal programs have been primarily core, from the standpoint of very large systems. We've also been delivering core memory to minicomputer customers, at the stack or integral-module level.

"But 4-k memory now has the capability of going beyond what core can do. In fact, over the next three years we're projecting a 16-times reduction in the size of the memory we announced last year.

"A year ago CDC announced the 94200 with a  $32 \times 18$  core memory. To do that with 1-k devices on one board was impossible, because it would take 576 of them. Density with 1-k was too low.

"But using 4-k the story is different," Ordemann adds. "Last December we announced the 94500 semiconductor memory using the 4-k, 16-pin MOS module and in that same core enclosure we put one-half million bytes of storage. The 94550, announced in April, has a full megabyte.

"The product has one million bytes in a  $5.5 \times 19$ -in. rack. It is organized in 10-bit bytes, which is hardly usual. It has eight storage cards organized  $64 \times 20$ .

"The additional bits are for error correction, because when you get to the megabyte level you've got to have error correction to obtain better reliability than with core."

Ordemann sees quadrupling that capacity two years from now putting four million bytes in that same enclosure. CDC's scheme for this will take the 16-k chips, because the 16-ks that are being sampled today will fit within the sample package and give us four times the storage capacity.

### Semis replace cores in minis

Semiconductor memories are supplanting core, not only in the large mainframes, but also in minicomputers. For example, Interdata in Oceanport, NJ, who are large users of core memory, will be gradually phasing out most of the core in memories up to 64-k bytes.

A basic reason for the phase-out is to reduce the cost of bit electronics for error-correction purposes. Louis Pezzi, Interdata memory designer, explains why.

"We're heavily committed to the 32-bit minis, which gives us an opening into very large memory systems."

In those memory applications he sees the use of error-correction becoming widespread. As the price of 4-k drops to around \$4, error correction will become inexpensive, compared to the cost of core. "With error correction you can make a

fairly poor device look good."

With core memory his firm could not make such liberal use of very long data words without incurring expensive bit electronics, Pezzi says. "But with semiconductor memories the cost of bit electronics is trivial, so we can increase our data width and transfer more data at a lower cost.

"We're going to see memories, even in the minicomputers, going to longer words. This fits in with the 32-bit trend in minis as well as the trend toward error correction, because error correction becomes more efficient as you add bits to the word.

"If you're error-correcting 16 bits you need six extra bits to do checking and correcting. For 32-bit words you need only seven bits, so for one added bit you've doubled your error-correcting capacity. And for 64 bits you need only eight

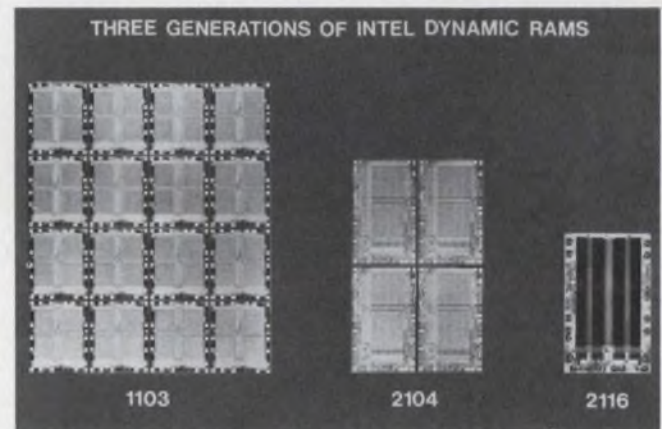

The rapid increase in chip-circuit density over the last few years is illustrated by these Intel RAMs required to produce  $16 \text{ k} \times 1$  storage. The single 16-k chip at right is equivalent to the four chips in the center and 16 chips at the left.

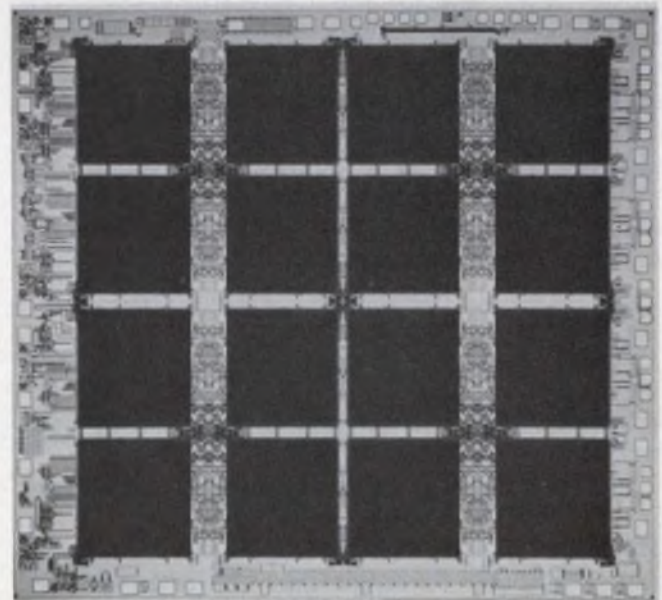

The use of high-density CCDs promises to fill a niche between RAMs and drum or disc memories. Production of this 64-k CCD by Mnemonics is expected by early '77.



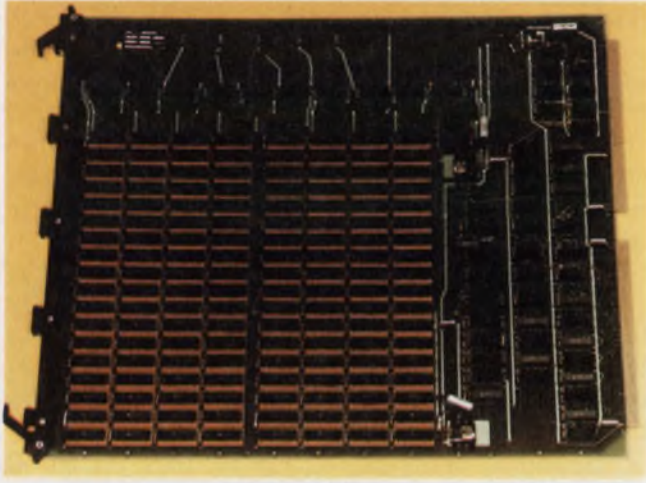

A 32-k-word memory board using TI or Intel 4-k 18-pin RAMs is a basic component of main memory in Prime computers. Up to 400 million words can be supplied.

error-correction bits, so the trend is cast in cement."

Another benefit of semiconductor memories that Pezzi sees is faster throughput, especially in the area of direct-memory-access through multi-ports at high-speed transfer rates.

"Instead of being bound by the core memory cycle time, we'll make extensive use of the page mode available in the 16-pin 4-k chips. This will allow us to triple our DMA transfer rate," he says. "We expect the 4-k chip to be our mainstay even when the 16-k comes on."

In any event, Pezzi doesn't see the 16-k chip becoming mature enough until sometime in late 1977.

But the 4-k device is by no means "out of the woods," Pezzi notes. There are still problems of uniformity. The characteristics change with time, even on different lots from the same vendor. "We do our own testing and characterization, and have even had to make a capital investment in testing equipment," says Pezzi, "which is a new experience for us. Our investment to maintain and use core-memory technology was much smaller.

"I think that the need for the amount of testing required has inhibited the rapid changeover to semiconductor memories to a substantial extent."

Pezzi takes a look into the future use of other kinds of memories.

"I expect to make use of CCDs by late '77 in areas where memories have not been used extensively, such as for smart terminals, like CRT terminals that work with floppy discs.

"I expect to start using the 64-k bit CCD memory from Mnemonics and Fairchild." But the 256-k bit CCD is probably the device that Interdata will need to break into competition with moving memories, Pezzi believes.

Prime Computer, which has been using only semiconductor memories since the company be-

gan building minicomputers a few years ago, sees the emergence of the 4-k RAMs as creating a substantially greater demand for memories than did the older 1-k generation.

"We're using 4-k chips in volume, building 32-k boards with them," says Joe Cashen, director of engineering. "But we're looking forward to the 16-k device. We're staying close to what the vendors are doing in 16-k packages because as soon as we can get what we feel are reliable parts in reasonable volume, we intend to deliver 128-k bits on a board."

Prime's semiconductor memories have traditionally grown faster in size than have other minicomputer manufacturers who also use core.

"We shipped computers with 246-k bytes of memory in the past year, but we see the need for even bigger memories," says Cashen.

The Prime 400, its most recently announced central processor, can support up to eight megabytes of physical memory, if needed.

Another kind of memory element that Prime makes wide use of is PROMs. Cashen explains the philosophy of Prime's application of these devices.

"Our CPUs and many of our device controllers are microprogrammed, so we're constantly looking at PROMs. We're using 2-k now but expect to step into the 4-k kind.

"We see the same thing happening in PROMs as in RAMs—mainly, higher densities, more bits and increased speed. Make 'em bigger and faster. The 16-k PROMs are on their way just like the 16-k RAMs."

While the spotlight has been on the large dynamic RAMs, designers of some of the new large systems will be using static MOS memories. For example, at Goodyear Aerospace, Akron, OH, Charles Blust, head of hardware development for the Staran computer, notes that Goodyear is currently switching to 1000-bit ECL for high speed memories. For added storage capacity, the company will be using the slower 4-k static MOS.

These memories are used in a multidimensional accessed array. In the older version a word was 256 bits long, but with the newer design, word length will go to 64-k bits. The basic word will be one of 9000 bits and will use two 4-k static MOS RAMs and one chip of 1-k ECL. The programmer will select the section he wants.

"The reason for going to static memories is, first, to get more storage capacity for the architecture," says Blust, "and second, we feel the reliability of the dynamic RAMs is not yet good enough. Reliability of the static RAM is presently higher."

So even though the static will be more expensive in the future when static and dynamic are both mature products Goodyear feels the extra cost is justified in terms of reliability. ■■





# A chip off the old block.

As you can see, this chip is housed in ceramic and mounted in a forty pin, dual in-line package.

As you can't see, it's a NOVA® computer.

Inside that packaging sits a full 16-bit, silicon gate, NMOS microNOVA CPU. The mN601.

The mN601 is the first microprocessor designed and manufactured by a minicomputer company. And it's the highest performance NMOS microprocessor on the market. With our 160 nanosecond RAM, it has a memory cycle time of 960 nanoseconds and the fastest instruction times going. Like an Add of 2.4 microseconds. And a Load of 2.9 microseconds.

The mN601 has the 16-bit NOVA instruction set including hardware stack for easy programming. And 16-bit data for efficient memory use.

It also has hardware multiply/divide for fast program execution. Integral data channel logic for easy interfacing to high performance peripherals. Control and timing for high density RAM memories. Integral hidden refresh logic that overlaps instruction execution timing. Plus a unique I/O encoding scheme for efficient easy interface design. Even the real-time clock is included. All of which reduces the chip count.

And all that computer is in a single chip.

And because the mN601 is a NOVA, it uses the most mature, field-proven software you can get with any micro. So you can cut back on development time and cost by using compatible software like our diskette-based Disc Operating System and our Real-Time Operating System.

Also, the mN601 comes with the full documentation support you'd expect from a minicomputer company like Data General.

If you want more than a chip, you can get it. There's a whole chip set, a 4K computer-on-a-board and a fully-packaged 9-slot microNOVA MOS mini. And there's more.

Don't stop here.

Sign up for a technical seminar on the microNOVA. They'll be held in major cities around the country from New York to Los Angeles. They'll last a half-day. And they're free.

For more information call our toll free number, 800-225-9497 (Unless you're in Massachusetts. In which case, call 1-617-485-9100 Ext. 2509.)

**microNOVA:**

A giant reduction in the NOVA line.

# DataGeneral

• Data General, Route 9, Southboro, Mass. 01772 (617) 485-9100. Data General (Canada) Ltd., Ontario. Data General Europe, 15 Rue Le Sueur, Paris 75116, France. Data General Australia, Melbourne (03) 82-1361

NOVA is a registered trademark of Data General Corp.



# Intel Zilch.

1. To be announced.

2. To be announced.

3. To be announced.

4. To be announced.

5. To be announced.

6. To be announced.

7. To be announced.



# National 7.

1. NS3 Bulk Storage Memory System (General Purpose).
2. NS3000-1 Memory Storage Card (General Purpose).
3. NS21 Memory Storage Card (for all HP 21MX Computers).
4. NS32 Memory System (for special graphics terminal used in simulation).
5. MOSRAM 410 (General Purpose).
6. PAC 216 (for Pacer Microprocessor).
7. MOSRAM 6800 (for Motorola 6800 Microprocessor).

While Intel may have terrific memory systems thinking, we've got something considerably more useful: Memory systems.

Standard systems, to replace core memories.

Add-on systems, to increase

existing memory capacity.

Custom systems, for the microprocessor of your choice.

All carefully designed.

All thoroughly tested.

And, most of all, for real.

See us at NCC Booth 3220.

National Semiconductor, Memory Systems Division  
2900 Semiconductor Drive, Santa Clara, CA 95051

Gentlemen:

Off-the-shelf memory systems, eh? Send me your data sheets. And tell me where you've been all my life.

NAME \_\_\_\_\_ TITLE \_\_\_\_\_

COMPANY \_\_\_\_\_

ADDRESS \_\_\_\_\_

CITY \_\_\_\_\_ STATE \_\_\_\_\_ ZIP \_\_\_\_\_

 National Semiconductor Memory Systems



# Computers on a board

## They're becoming more versatile and a lot less costly to use

Computers on a single printed-circuit board are hardly new, but only lately have their real advantages been discovered. They are becoming easier to use and program, and are now being inserted into new kinds of products. Microcomputers are available in 16, 8 and 4-bit sizes, making them more flexible and less expensive than ever.

Microcomputers contain a clock and CPU, with memory and I/O sometimes included. They are classified in terms of data-word size—by the largest number of data bits manipulated by the CPU in one clock period.

### When to consider a computer

Deciding upon where a computer might best be used in your system depends on the system's complexity, the flexibility you will require and cost considerations.

Complexity is measured by the number of digital ICs used. A system using 30 to 50 TTL chips might well be replaced by a  $\mu\text{C}$ , according to A. J. Nichols, manager of  $\mu\text{C}$  applications at Intel, Santa Clara, CA. On the other hand, complex logic decisions might best be handled by programmable logic arrays or by other LSI circuits.

Computers provide much more flexibility in changing the characteristics of the manufactured product than you get with hardwired logic. Changes in the computer program (software modifications) are usually cheaper to implement because at most only a few ROM or PROM chips need to be replaced. Many more chips, and the board layout as well, might have to be changed if the equivalent change in characteristics is re-

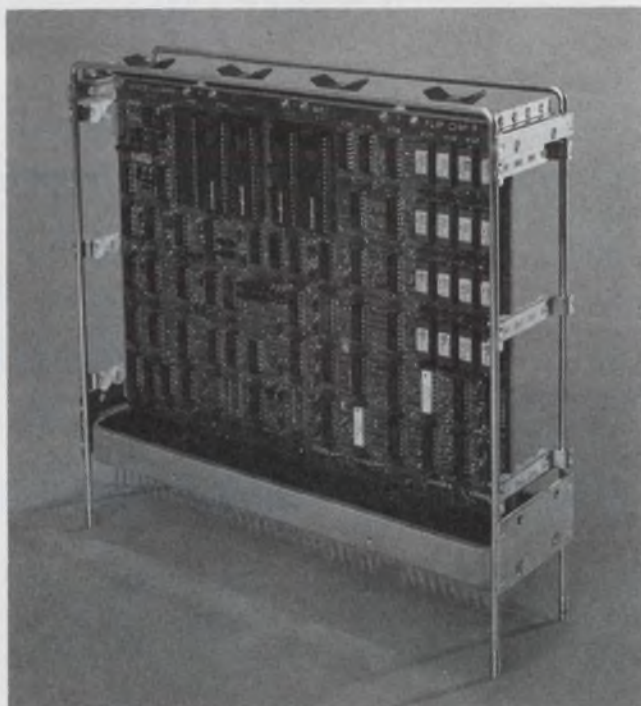

Digital Equipment Corporation's LSI-11 is a 16-bit  $\mu\text{C}$  compatible with the firm's PDP-11 line of computers. I/O and additional memory cards are also available.

quired in a system using hardwired logic. Use of a  $\mu\text{C}$  is recommended, even in simple systems that have fewer than 30 chips, whenever adaptability is important.

Microprocessors and associated support chips are being sold in quantity to people who need to customize computers for their products. Engineers who do not require such large numbers of unique systems have the alternative of buying a board elsewhere and then getting assistance, if necessary, through courses given by manufacturers or independent consultants.



Use of boards is increasing because they are more economical than developing a specific computer for a specific product, especially if fewer than a thousand units per year will be built. Also, since the board comes fully assembled and tested, much less effort needs to be spent on ensuring its quality, and more attention can be devoted to engineering the rest of the product.

Boards must be easy to plug into a system; they must have a buffered output, and universal I/O characteristics, and use standard-power-supply voltages. You also want greater programming ease.

Because so many single-board computers are being designed into products, manufacturers have responded by offering more of them. Boards are commonly available with the following characteristics:

- Standardization of word sizes. Eight and 16 bits are most popular, with 4 and 12 bits also available.
- Standardization of power-supply voltages. Most  $\mu$ C boards use power supplies of +5, +12, -5 and -12 V. The ones that use fewer voltages are gaining in popularity.
- Use of high-current drivers. Digital buffers that can sink 16 mA or more are available to drive external memory and I/O circuitry.
- Standardization of I/O interfacing. Serial lines have RS-232C or current-loop characteristics, and parallel lines feature software programmability.
- Ease of programming. Manufacturers are offering an ever-expanding range of software development systems that reduce programming time in various ways.

The time required to load programs has been reduced from 30 minutes or more, to seconds. Instead of using paper tape to store your application program and debugging and assembling routines, development systems use floppy discs and cassette tape to store the information. Data from these devices can be fed into a computer at a much higher rate than from a standard paper-tape reader.

Higher level, English-like languages are becoming more popular for programming 8 and 4-bit  $\mu$ Cs. These higher level languages can be used to program many different CPUs. Formerly, only assembly-level languages could be used, and each processor had its own.

One problem faced by users is the lack of standardization in board sizes and connector types. The physical characteristics of each board are unique, although some manufacturers offer boards that can be mounted in standard plug-in card cages. Some of National Semiconductor's cards plug into an Augat card cage, for example. Other manufacturers offer card cages with integral backplane assemblies that hold additional

cards for their computers. Machines that have this option include Digital Equipment's LSI-11 and Intel's SBC-80/10.

### Why 16 bits?

There are major differences between 16, 8 and 4-bit units. The 16-bit microcomputers offer the following advantages:

- Machine-language instruction set. The 16-bit  $\mu$ Cs have sets two to three times as long as the 8-bit processors do, and generally have more powerful instructions. As a result, it is often possible to use fewer instructions to solve a given problem.
- Arithmetic capability. The 16-bit units have multiply and divide as single-machine instructions. In many cases floating-point arithmetic is optional, which is not the case with 4 and 8-bit

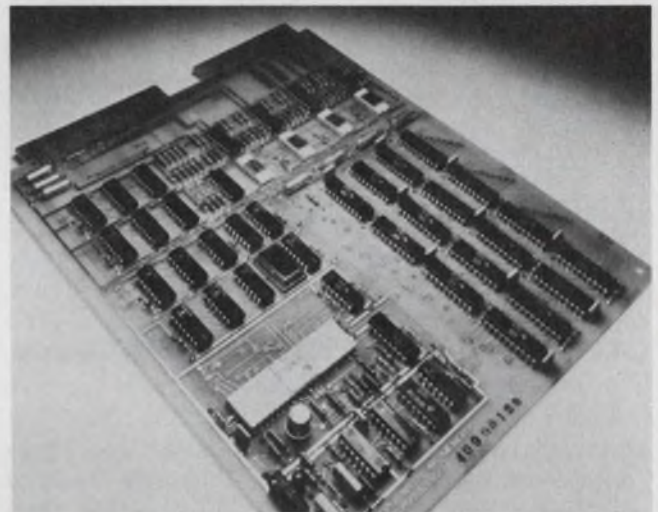

The microNova single-board 16-bit computer from Data General has a 2-bit-wide serial bus and is available with either 2-k or 4-k words of memory.

machines. Multiply and divide routines may be performed by a series of software instructions, but it takes much more time than on 16-bit  $\mu$ Cs.

- Accuracy. Numbers represented by 16 bits inherently have greater accuracy than numbers represented by fewer bits.

Higher level languages, such as Basic and Fortran, that are likely to be known by many programmers, are generally used for 16-bit machines.

Computers-on-a-board have recently been introduced by several minicomputer manufacturers, notably Data General, Southboro, MA, with its microNova series, and Digital Equipment, Maynard, MA, with the LSI-11. Both models have 16-bit data words, and instruction sets that allow programs written for the firm's minicomputers also to be run on its  $\mu$ Cs.

The LSI-11 and the microNova Model 8563



both contain 4-k words of RAM, a real-time clock, interrupt logic, and a DMA channel. The LSI-11 offers floating-point arithmetic as a plug-in chip for the board. The 8563 has a high-speed serial-I/O bus. The LSI-11 costs \$990 in unit quantities.

Other minicomputer manufacturers that have introduced 16-bit  $\mu$ Cs include General Automation, Hollywood, CA, with the GA-16/110 and Computer Automation, Irvine, CA, with its Naked Milli LSI-3/04.

Computer manufacturers are not the only ones supplying boards. Semiconductor makers and others are also competing. For example, National Semiconductor, Santa Clara, CA, offers the IMP-16C/400, composed of MOS bit-slice and support chips on an 8-1/2  $\times$  11-in. board, with 1 k of RAM and sockets for 1 k of ROM. It costs \$795 in unit quantities.

Texas Instruments, Houston, TX, makes a 990/4 board that is compatible with its minicomputer line. The  $\mu$ C comes with 4 k bits of RAM and sockets for an additional 1-k of ROM or PROM. A communications register allows easy I/O control, DMA and an eight-line vectored-interrupt structure. Board size measures 14-1/4  $\times$  11 in. Cost is \$800 in unit quantities.

General Instrument Corp., Microelectronics Div., Hicksville, NY, offers its MC1600 Microcomputer Module, containing its  $\mu$ P, clock and fully buffered address, data and control busses. The unit costs \$495 in single quantities.

Plessey Microsystems, Irvine, CA, makes a special-purpose 16-bit microcomputer for high-speed communications systems. Plessey's machine uses low power Schottky TTL chips rather than the MOS LSI favored by most other  $\mu$ C manufacturers. It features a 350-ns cycle time on a 6.3  $\times$  9.2-in. printed-circuit board. Cost is \$700 in unit quantities.

Another recent addition to the list of bipolar 16-bit machines comes from MMI Systems, Div. of Monolithic Memories, Sunnyvale, CA, with the MMI 304 CPU card. Price is \$625 in unit quantities. It emulates Data General's Nova and additionally can meet applicable military specifications. Support boards are also available.

The considerations involved in choosing among the  $\mu$ Cs depend partly on prior engineering know-how. Suppose you are presently making a large, integrated system that sells for perhaps \$30,000 to \$100,000 and already incorporates a stand-alone mini. If you want to design a cheaper, downgraded version of that product to sell for \$15,000 to \$30,000, then you need a fairly powerful computer-on-a-board, with almost the same capability as the minicomputer.

Your choice of a suitable  $\mu$ C will most likely center around the board-based version manufac-

tured by the supplier of your present mini. The instruction set is familiar, so additional programming skills are not required. The engineering department probably has the necessary development tools and manpower to include the board in your product, so the major considerations will be hardware-interface problems—buffering, physical packaging and the like.

If you are considering a 16-bit machine and have no previous experience with a minicomputer, you could use a unit offered by any of the pre-

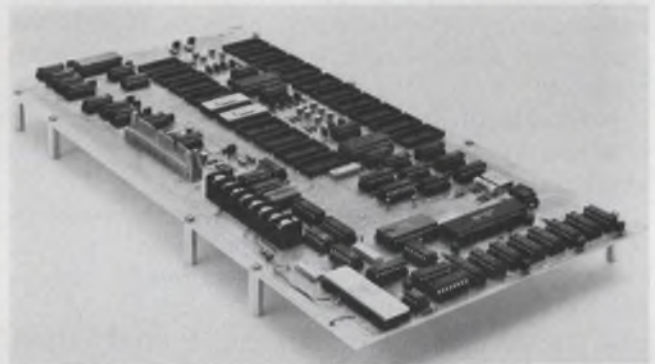

The CCS-1025 from Control Logic is part of the new generation of  $\mu$ Cs incorporating ROM, RAM, serial and parallel I/O and an 8-bit  $\mu$ P.

viously mentioned manufacturers.

Don't overlook the importance of getting a powerful development system to help programmers generate the application program, though. In fact, ease of programming was so important that it was the reason one company chose a 16-bit machine over an 8-bit unit.

"The kind of support software and diagnostics that we needed would have taken us some time to write around the 8080," says Dr. Tom Martin, president of Threshold Technology, Delran, NJ. "So we went to the LSI-11. There definitely is a cost advantage in using the 8-bit architecture, so far as hardware is concerned, but ease of programming was the thing that convinced us."

Nevertheless, 8 bits is catching on and becoming one of the more widely used data-word sizes for microcomputers. According to A. J. Nichols, manager of microcomputer applications at Intel, there are three reasons why use of 8-bit processors is increasing: their prices are dropping, their software development is supported by the manufacturers, and they are becoming more widely known.

### The 8-bit bandwagon

The big news in the 8-bit-microcomputer business is the introduction of production-quality boards from the semiconductor manufacturers.



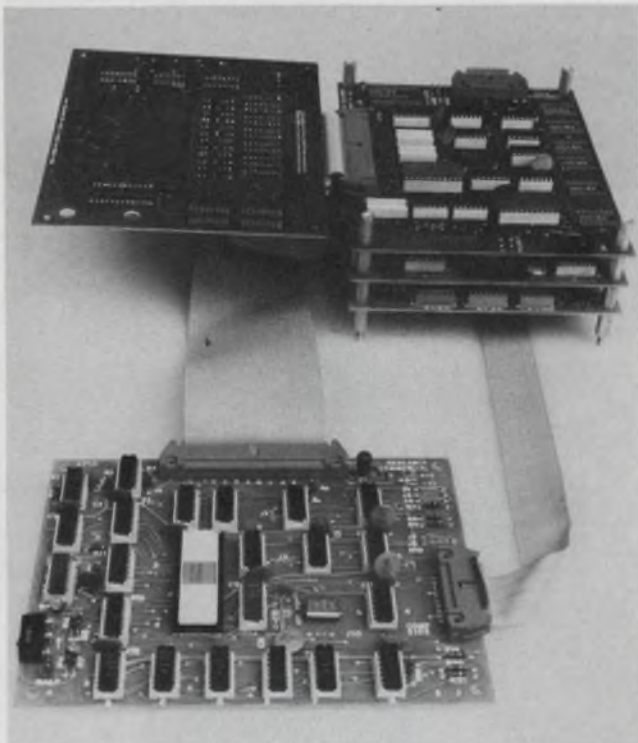

The MIKE-3 system of boards from Martin Research contains  $\mu$ P and clock, keyboard and display, debug, and memory—each on a separate plug-in board that connects with the others (3 boards plus 2 optional).

Previously, these companies sold only evaluation boards not meant for OEM use.

Intel, for example, recently introduced the SBC-80/10. It incorporates serial I/O that allows direct communication connection to a teletypewriter, and has 48 lines of programmable parallel I/O. Size is  $6.75 \times 12$  in. and the cost is \$295 (in 100 quantities). Sockets for 4 k of PROM, and 1-k RAM are on the board.

The CCS-1025 board offered by Control Logic, Natick, MA, is similar, in that it also uses an 8080 for the CPU. It contains 1-k words of RAM and has sockets for 5-k PROM. The unit has a full duplex keyboard, a printer port that uses a current loop, and 32 lines of parallel I/O. The board measures  $8 \times 16$  in. The cost is \$495 in single quantities.

Microcomputers based on the 6800, the 8080, and other CPUs made from TTL chips, are available from many other suppliers. Martin Research, Chicago, IL, makes a board consisting of the 8080 and clock, Model AT471-3, measuring  $5.5 \times 7$  in. It costs \$149 in unit quantities and is part of a system of three boards, called the Mike-3, that has memory, hex keyboard and CPU. The system is supplied with connecting cable.

Signetics, Sunnyvale, CA, offers the PC1001 microcomputer, which contains 1-k words of RAM, sockets for 1 k of PROM and a serial port to a terminal. It uses the Signetics 2650 8-bit

MOS  $\mu$ P and measures  $6.875 \times 8$  in. The cost is \$495 in single quantities.

The S6800 board from American Microsystems, Santa Clara, CA, contains a 1-k RAM and sockets for 4 k PROMs. Cost is \$975 in unit quantities.

The Micro-One from Microdata, Irvine, CA, is a CPU using TTL chips on an  $8 \times 12$ -in. board. It has powerful I/O with vectored interrupts and 32 channels. The price is \$1190 with 1 k of RAM.

Digital Electronics, Electronics Memories and Magnetic Corp., Los Angeles, CA, Monolithic Systems Corp., Englewood, CO, and Pro-Log Corp., Monterey, CA, also offer 8-bit microcomputers.

There are relatively few suppliers of 4-bit  $\mu$ Cs because most engineers specify 8 bits. Nevertheless, you should be sure you don't overlook 4 bits for your applications if 4 bits may fit.

"An awful lot of people use our 8-bit microprocessors where they really ought to use 4-bit units," Nichols says. "Most of the articles they read are about the 8-bit product so they really don't look at 4-bit processors."

#### 4-bit $\mu$ Cs for 4-bit control

Four-bit  $\mu$ Cs are best suited for processing information that is available in 4-bit form. Data such as binary-coded-decimal or hexadecimal numbers can be processed easily, one digit at a time, in programs with looping, limited only by speed. Also, when signals come in four at a time from external sensors, a 4-bit machine is more efficient than an 8-bit machine that requires software instructions to mask unused bits.

Since 4-bit  $\mu$ Cs do problems iteratively, they are too slow for many applications. Sensor information might be changing rapidly, for instance, and so require a response time that could not be achieved by a 4-bit unit.

But memory, support circuitry and the CPU itself are cheaper in 4-bit versions than in 8-bit form. The 4-bit CPUs use 12 memory-address lines, compared with 16 lines in 8-bit machines. Naturally, 4 bits of data memory require fewer and cheaper boards than do 8-bit memories.

Powerful microcomputers are available with 4-bit-wide data paths. Rockwell offers the PPS-4/2 board containing some ROM for debugging, 512 words of RAM and 32 I/O ports. It costs \$350 in single quantities.

Pro-Log sells a 4-bit microcomputer card based on the 4004 (a chip first offered by Intel and now second-sourced by National Semiconductor). The card is called PLS-401 and contains sockets for up to 1-k words of PROM and 320 words of RAM.

Teledyne, Mountain View, CA, offers its Model TDY-52 and Data Architects, Waltham, MA, sells a Model CM101. ■■



# High performance you can really see.

Look to Motorola CRT modules for sharper, brighter displays.

Motorola's 12 and 15 inch CRT modules deliver! 80 sharp characters by 24 lines, with a 7x9 dot matrix display. Video response to 22MHz. Horizontal scan frequency up to 19KHz. TTL separate sync or composite video input. And all at a lower cost than you may now be paying for CRT's with lower performance.

Other screen sizes are 5, 9, 19 and 23 inches. All are optimized for data display applications. All are adaptable for U.S. or European operation. All circuitry is completely solid state. In fact, up to 99% of the module circuitry comes on easily removed printed circuit boards . . . for quick and easy maintenance.

Readable. Economical. Versatile. Serviceable. Why not look us over? Send today for our free Design Kit with complete specs and application notes.



## MOTOROLA Data Products

Domestic 455 East North Avenue  
Carol Stream, Illinois 60187  
312-690-1400 TWX: 910-252-4404

International Airport Center  
4250 Veterans Memorial Hwy.  
Holbrook, L.I., NY 11741 U.S.A.  
516-588-4700 TWX: 510-228-1096

CIRCLE NUMBER 37

# CERBON™ TRIMMER RESISTORS

## Affordable Stability

Centralab's new CERBON trimmers offer you stability approaching cermet at carbon prices. . . As little as 28¢ in distributor 1,000 quantities; as low as 10¢ in high volume orders.

**Look at these performance characteristics:** • TCR less than -400 ppm/°C • CRV less than 2% of maximum resistance • Rotational life exceeds 500 cycles • Adjustability (typical) 0.05% of total voltage • High overload capability—1 watt at 25°C ambient for 1,000 hours exhibits less than 2% cumulative resistance change • Maximum stability in humid environment—resistors exposed to an atmosphere of 40°C at 95% relative humidity for 300 hours return within four hours to +2.5% of their initial readings. Available now for delivery in any quantity. Write for technical data, or call (915) 779-3961 for a free evaluation sample.

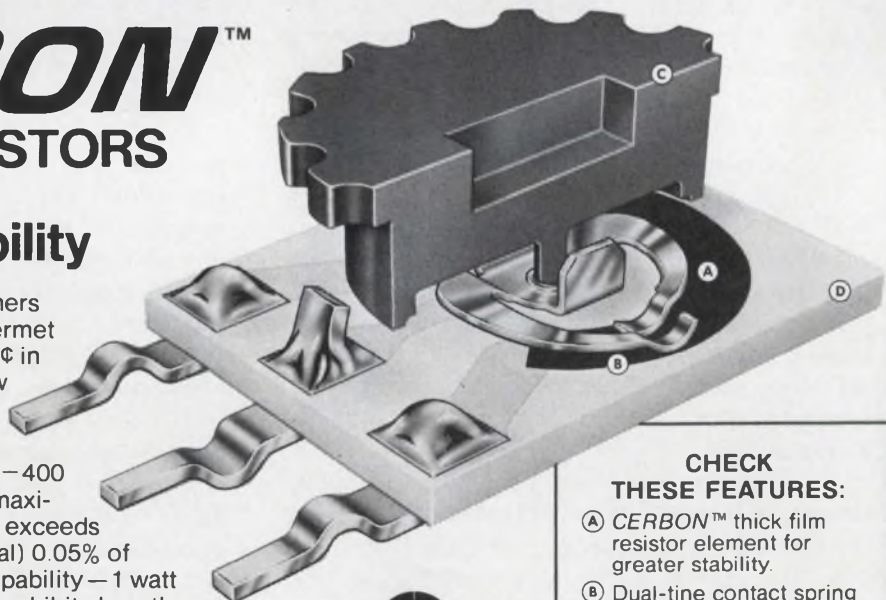

### CHECK THESE FEATURES:

- (A) CERBON™ thick film resistor element for greater stability.
- (B) Dual-tine contact spring for low CRV and set-stability.
- (C) Dust and solder protective thin-profile knob.
- (D) Ceramic substrate resists solder flux; excellent thermal conductivity and dimensional stability.



CENTRALAB  
Electronics Division  
GLOBE UNION INC.  
7158 MERCHANT AVENUE  
EL PASO, TEXAS 79915

CIRCLE NUMBER 38



# MORE PULL in a smaller package?

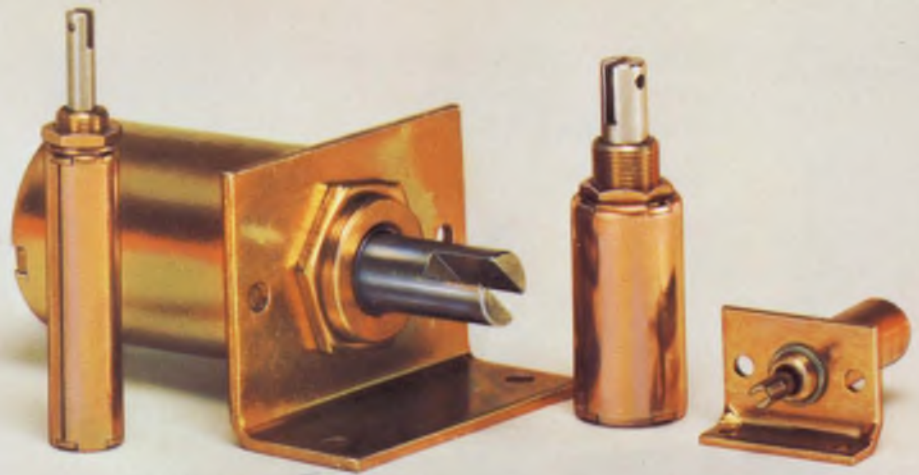
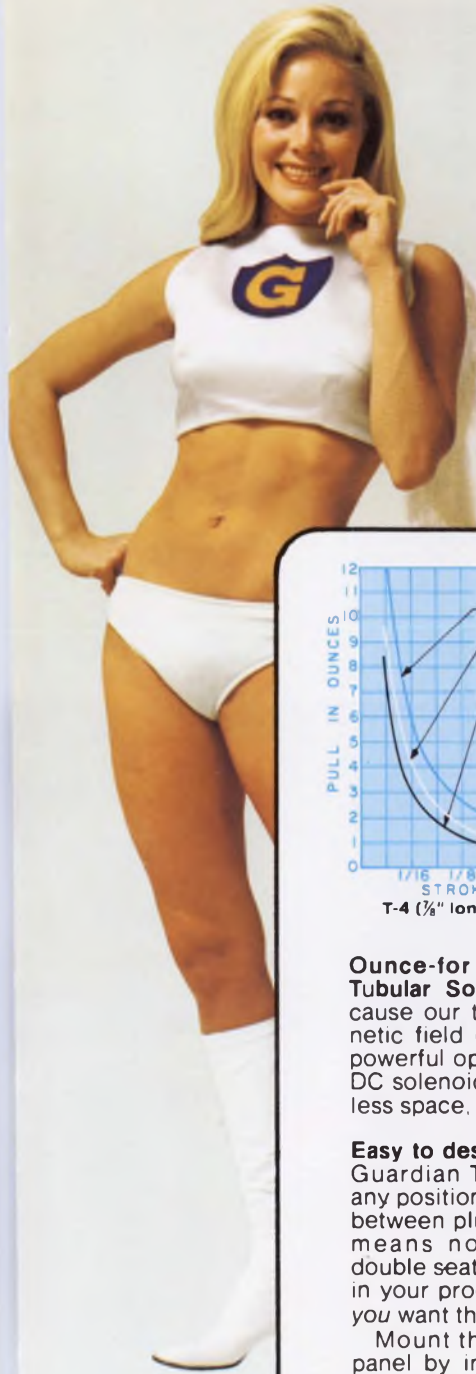

## Check these curves.

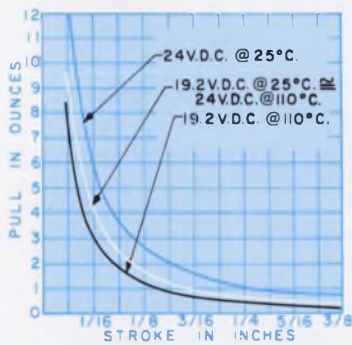

T-4 (1/8" long) Intermittent duty

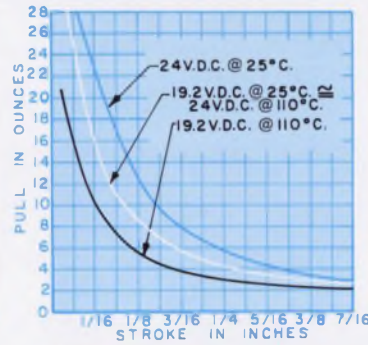

T-8 (1/4" long) Continuous Duty

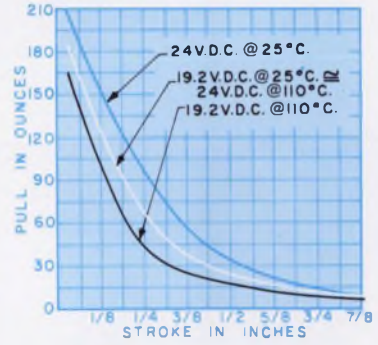

T-12 (1/2" long) Intermittent Duty

**Ounce-for ounce, inch-for-inch Guardian Tubular Solenoids pack more power...** because our tubular designs assure total magnetic field enclosure and result in efficient, powerful operation. More efficient than other DC solenoids. They give you more power in less space, plus UL and CSA recognition.

**Easy to design-in. Easy to install. By design.** Guardian Tubulars work in any position. Close tolerance between plunger and bobbin means no possibility of double seating. So they work in your product just the way you want them to work.

Mount them directly into panel by inserting threaded bushing thru installation hole and tightening nut on lock washer. Or, mount with standard bracket.

Either way, Guardian Tubulars install without damage to the solenoid. Look how the



notched tube-steel shell mates with notched end plate. Result? A stronger assembly that takes more torque when installing... with no chance of damage. The leads emerge thru a notch in the steel shell, so they will not, can not be sheared by rotation during installation.

**Once you put a Guardian Tubular in your product... forget it.** Typical mechanical life is 20 million. That's probably longer than your product's life expectancy... due primarily to the unique Valox® 420 molded bobbin.

**Variations and specials? Guardian's got 'em.** Any DC voltage from 6 to 240. Push type or pull type operation. Return springs, silencers, termination variations, special mountings... you name it and we'll deliver it with the high quality craftsmanship and low prices that have made Guardian Number 1 in Solenoids—and that keeps us here on top.

**Let the Guardian Angel reveal all the pull charts and curves in full size.** Send for your free copy of our 72 page catalog.



This mark indicates recognition under the component program of Underwriters Laboratories Inc.



# GUARDIAN®

GUARDIAN ELECTRIC MANUFACTURING CO. 1572 West Carroll Avenue—Chicago, Illinois 60607 • 312/243-1100



# Hot-molded resistors provide low temperature coefficient and unmatched reliability.

The Resistance Temperature Coefficient of Allen-Bradley hot-molded fixed resistors is typically less than 200 PPM over the entire resistor range shown in the normal equipment operating temperature of +15°C to +75°C. Excellent RTC ratings have always been an Allen-Bradley benefit. And consistency of Allen-Bradley resistors means repeatable results and tight performance patterns. Allen-Bradley resistors offer the **lowest cost—on the board**—where it counts!

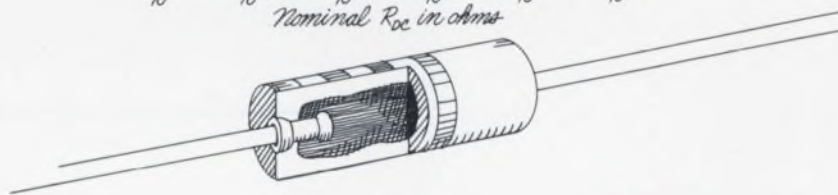
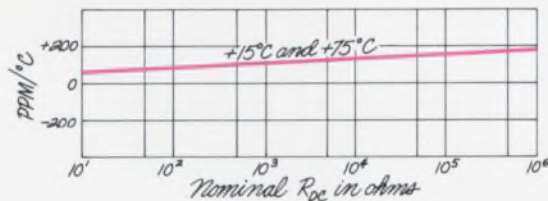

## Reliability

is unsurpassed. Over 700 million unit test hours without a single failure.

## No coatings

Insulation and resistance element integrally molded into one solid structure.

## Pulse handling

characteristics offer outstanding protection against surges and transients.

## Quality in the best tradition.



### ALLEN-BRADLEY

Electronics Division  
Milwaukee, Wisconsin 53204



## Who provides the industry's broadest line of electronic packaging hardware ... including Back Panels?

SAE does! And we offer several styles for your greater design flexibility. You now have the option of discrete connector or pin-in-board assemblies, with either open, closed or universal entries; or metal back planes on .100" or .200" grid, conforming to NAFI MIL specs.

Our PDQ™ pin-in-board back panels feature pairs of pins pressed automatically into a circuit board on .100" x .100" thru .156" x .200" centers, allowing any connector configuration or length desirable. This technique lets you choose the exact number of pins desired with no need for concern as to the availability of standard, off-the-shelf connectors.

Wave-soldering is completely eliminated and all required connections to voltage, ground and signal traces can be accomplished by the gas-tight joint. Available in both short tail and 3-level wrap versions, other features include an extra-large throat opening, polarizing keys, and easy pin replacement. Incidentally, this PDQ concept is particularly well-suited to multilayer panel applications.

Our new 128 page packaging handbook gives complete details, and also describes our entire line of electronic packaging and interconnection hardware.

™ -Stanford Applied Engineering, Inc.

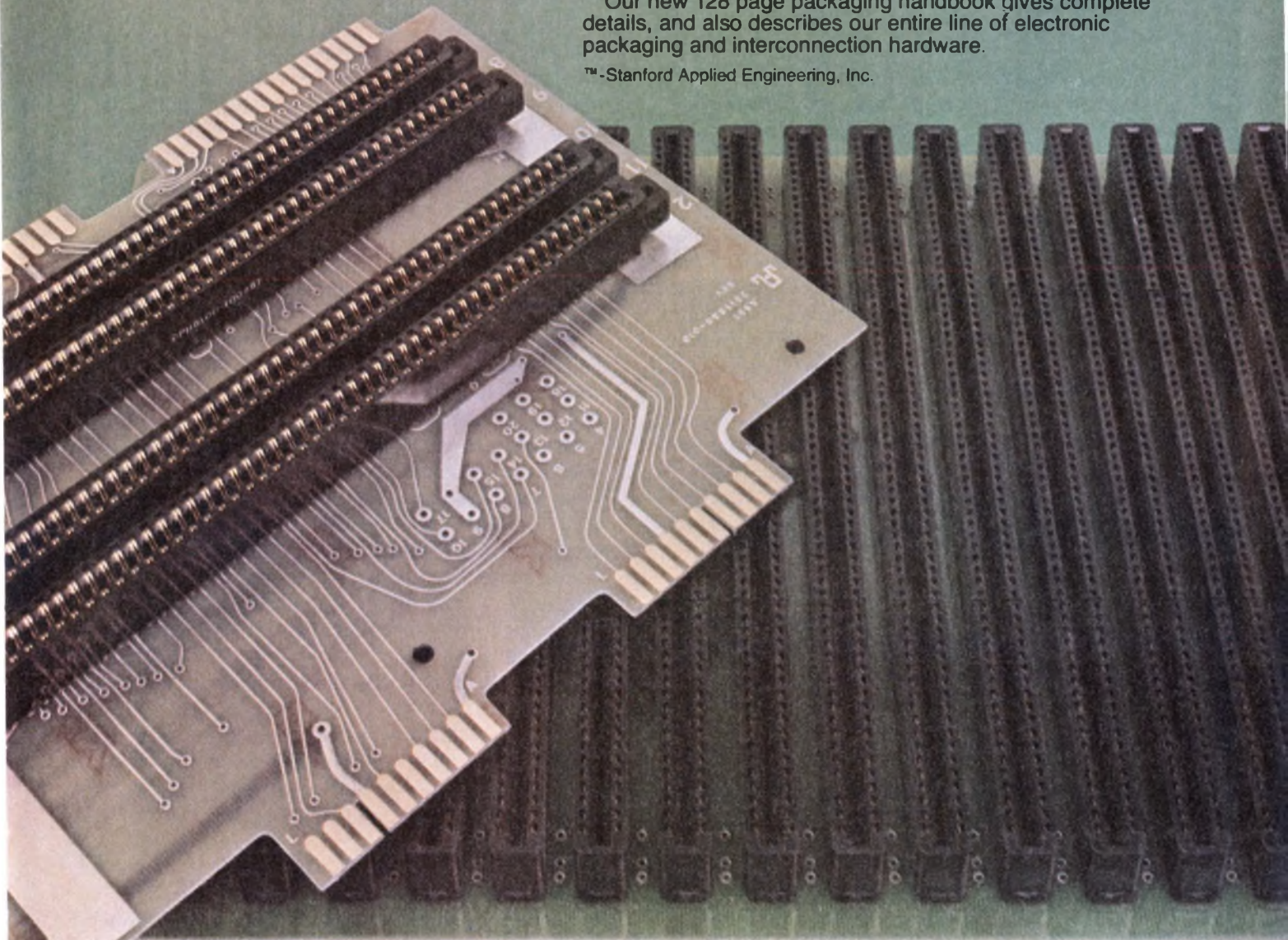

For an immediate reply, call the following toll-free "ZIP QUOTE" number at the factory ... 800-538-6843.

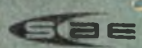

**Stanford Applied Engineering, Inc.**

340 Martin Ave., Santa Clara, CA 95050  
(408) 243-9200 TWX 910-338-0132



# Microprocessor benchmarks

---

## Benchmark testing of $\mu$ P's is still popular despite its limitations

The past few years have seen a proliferation in the variety and the complexity of microprocessors. This has been matched by a corresponding increase in the intensity and frequency of headaches afflicting engineers planning to use these devices. The reasons are not hard to find.

In contrast to the less complicated transistor or integrated circuit, a  $\mu$ P's characteristics cannot be fully described by merely presenting data on a specification sheet. For example, a transistor spec sheet might list the gain-bandwidth product. This figure can then be used in design calculations, no matter what the application.

The characteristics of the  $\mu$ P, however, depend strongly on the application, and even on the skill of the user. In the hands of an experienced programmer a  $\mu$ P might perform a given task in a shorter time than under a less-skilled operator.

### Benchmarks enter the picture

In an effort to try to evaluate and select from among the increasing variety of  $\mu$ P's, engineers seized upon a tool that was already in use in the computer industry: the benchmark test, a short program or group of routines designed to evaluate the computer's data-handling abilities. The test measures the  $\mu$ P's execution speed and the amount of memory required to perform a given task.

The number of bytes of memory required is directly related to the number of instructions. Execution time is obtained by summing the individual  $\mu$ P steps and multiplying each step by the manufacturer-supplied operation time.

Since the earliest  $\mu$ P's were used for data cal-

culations, such tests seemed valid. But within a short time it became apparent that applications for  $\mu$ P's had spread beyond the confines of mere data handling. New fields opened up for dedicated control in such areas as traffic control, intelligent computer terminals, and electronic test equipment.

### Benchmarks called into question

When such applications were considered, the usefulness of the benchmark as a valid  $\mu$ P comparison test began to come into question. One of the reasons cited was that standard benchmark programs are often useless where the  $\mu$ P will be used as a dedicated controller.

In data-manipulation applications, the characteristic speeds are usually measured in microseconds. In contrast, for simple control applications (switches, relays, lights, etc.) the important times are on the order of tenths of a second, so benchmark programs that test only computational speed are irrelevant.

Other disadvantages have emerged. Some of these are:

- It is difficult to establish a general benchmark test useful for all the  $\mu$ P's on the market.
- It is difficult to define a BM test that is not weighted in favor of a particular type of  $\mu$ P architecture.
- For a benchmark to be valid, it must be closely related to the specific  $\mu$ P application. To write such a program takes time, skill, and money.

These problems have not yet been resolved. In fact, the benchmark test has fallen into distinct disfavor over the past year, according to Don Carley,  $\mu$ P-applications engineering manager at RCA, Somerville, NJ. There are even those who question the validity of using the benchmark test altogether.



Those opposed to benchmarking point out yet another problem. They feel that the benchmark test, with its emphasis on speed of processing, may tend to push the  $\mu$ P industry in the wrong direction. Their reasoning is as follows:

One of the big advantages of the  $\mu$ P is that it permits development of a whole class of new, low-cost products. The lower the  $\mu$ P cost, the greater the potential variety of products, and the wider the expected market. In an effort to come up with better benchmark test results,  $\mu$ P manufacturers may tend to pack more performance into their devices than is really required for most applications. The result is an excellent product, but one of limited use and increased cost.

Despite this seemingly formidable array of difficulties,  $\mu$ P benchmarks are still in current use.



Designs of microprocessor software and hardware are discussed by Larry Solomon, Don Carley, and Alexander Young of RCA's Solid-State Division.

There are a number of compelling reasons.

First, and most important, a simple substitute for the benchmark test has yet to be found. Despite its faults, the benchmark does provide a measure of a  $\mu$ P's execution time and memory capability. Based on this data, some preliminary selection can be made from among competing  $\mu$ Ps.

Deene Ogden, manager of systems engineering

at Texas Instruments, Houston, TX, emphasizes another reason: an important indicator of the cost of programming a  $\mu$ P is the number of instructions, and the clarity and ease of preparation of the code.

"The benchmark test helps determine the cost of the software-development effort. One  $\mu$ P may require many fewer instructions than another, even though both  $\mu$ Ps use the same amount of memory. The  $\mu$ P requiring the fewest instructions will usually be easier to program and will contain fewer errors."

Phil Roybal, director of  $\mu$ P marketing at National Semiconductor Corp., Santa Clara, CA, stresses the fact that the benchmarking can provide a fair idea of the end costs of the basic system, such as the memory, or the interfaces.

"You will be in a good position to make trade-offs within the manufacturer's line or among manufacturers. For instance, you can decide to put in an intelligent I/O device to take some of the load off the  $\mu$ P, thus cutting memory and processor costs—but also spending more money on I/O devices."

#### Use benchmarks carefully

Experts agree that no matter how simple or complex the benchmark, it must be used with care.

"Your test has to be applications oriented," stresses Alex Goldberger of Signetics, Sunnyvale, CA. "What you should do is take a typical part of your program, or a critical part, and try that on several competing  $\mu$ Ps and see how they perform."

Some frequently used  $\mu$ P routines that can be benchmarked are:

- Service an interrupt (ability of the  $\mu$ P to stop what it's doing and do something else).
- Move a block of data from one part of memory to another. The block can be anywhere from about 50 to 100 bytes.
- Send data to the outside world; for example, to a teletypewriter.
- Call a subroutine.
- Multiply or divide two numbers.
- Convert D/A or A/D (using appropriate software).

One method of applying benchmark tests that is currently receiving increased attention is to assemble a mix of programs for use as the test. In order for this test to be valid, the mix must span those types of calculations that are ultimately to be performed by the  $\mu$ P. That is, it must have some relation to the intended application.

"If no application is being considered, and a general evaluation is sought, a mix of programs is the only method which can be used for benchmarking," notes Paul Rosenfeld, software prod-



## Programming a simple process

The steps needed to benchmark a microprocessor are illustrated by this sample program, designed to input two bytes of data from two different devices. The signals might be the outputs of two analog-to-digital converters, or they might come from mechanical position resolvers.

The program does the following:

The two digital inputs are compared, and if they are numerically equal, the Q flag is set to "1." If they are unequal, the Q flag is set to "0" and the larger signal is sent on to a third device. The first diagram, an elementary flowchart, gives an overview of the process. The second figure flowcharts the steps in detail.

Once the flowchart is prepared, the next task of the benchmark programmer is to write the actual program, which is shown in the table.

Such a program lists each step executed by the  $\mu P$  in performing its task.

Next, from information supplied by the manufacturer (by means of a spec sheet or otherwise), the  $\mu P$  evaluator obtains the amount of time required for each step, and the number of bytes of memory required. The total memory bytes needed, together with the total time—taking into account any looping (repetitive) operations—represents the benchmark results for this particular program.

Using the RCA COSMAC  $\mu P$ , each instruction takes 16 clock periods. The  $\mu P$  clock runs at a 6.4 MHz rate (for a 10-V supply voltage). The time for each instruction, therefore, is 2.5  $\mu s$ .

The program flowcharts were supplied by RCA's Solid State Division, Somerville, NJ.

### Assembly listing for two-byte processing program

Program counter (Hexadecimal)	Instructions and data (Machine language)	Line number	Assembly language (Mnemonic)	Comments
0000	7A;	0001	REQ	Reset Q to "0"
0001	F800;	0002	LDI A.1 (STORE)	Set storage pointer R(2)
0003	B2;	0003	PHI R2	to point at a free location
0004	F81C;	0004 GO:	LDI A.0 (STORE)	in RAM M(STORE)
0006	A2;	0005	PLO R2	" "
0007	E2;	0006	SEX R2	
0008	69;	0007	INP 1	Read 1st input byte into D
0009	A3;	0008	PLO R3	Save the first input
000A	6A;	0009	INP 2	Read 2nd input byte into
000B	;	0010		memory
000B	83;	0011	GLO R3	Load the 1st input into D
000C	F7;	0012	SM	1st input minus 2nd input
000D	38 18;	0013	BNF RES2	Branch to RES2 if 2nd input
000F	;	0014		is greater than 1st input;
000F	;	0015		otherwise:
000F	83;	0016	GLO R3	Load the 1st input into D
0010	F3;	0017	XOR	M(R(2)) XOR D, to check if the
0011	;	0018		two inputs are equal
0011	3A 16;	0019	BNZ RES1	Branch to RES1 if not equal
0013	;	0020		(1st input is greater than
0013	;	0021		2nd input); Otherwise:
0013	7B;	0022	SEQ	Equal; set Q flag
0014	3004;	0023	BR GO	Go back to beginning
0016	;	0024		
0016	83;	0025 RES1:	GLO R3	Load 1st input into D
0017	52;	0026	STR R2	Store it at M(STORE)
0018	;	0027		
0018	61;	0028 RES2:	OUT 1	Output larger value
0019	7A;	0029	REQ	Reset Q flag
001A	3004;	0030	BR GO	Go back to beginning
001C	;	0031		
001C	;	0032 Store:	ORG *	Storage area
001C	;	0033		
001C	;	0034		
001C	;	0035		
001C	;	0036		
001C	;	0037	END	End of program source
0000				



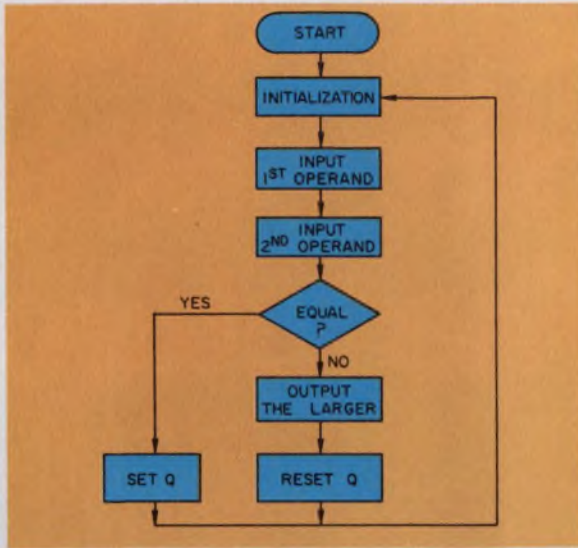

A Basic program flowchart for processing two input bytes, is shown. The program inputs the two bytes, compares them, and outputs the larger. If the bytes are equal, the Q flag is set to "1."

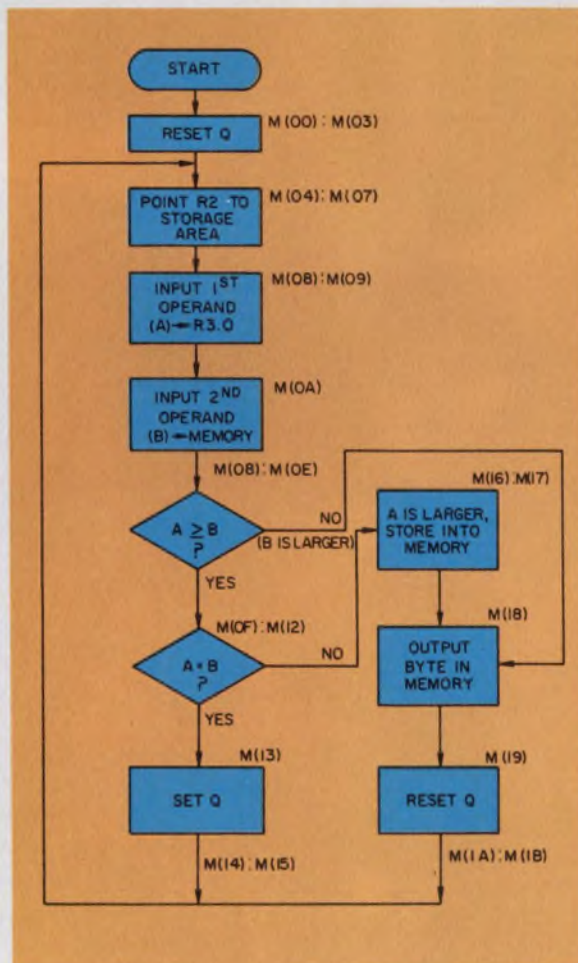

The detailed flowchart for processing two input bytes is used as the basis for writing the micro-processor program.

ucts manager at Intel, Santa Clara, CA.

If there is one area of strong agreement in the industry, it is the fact that the benchmark test should be only one of a number of  $\mu$ P-selection criteria. Some of the others are:

- The number and cost of the power supplies necessary.
- The noise immunity.
- Second sourcing.
- The number of clocks required.
- Compatibility with rest of system.
- Type of vendor support (for example, whether assemblers are available).
- Documentation (for example, are there sufficient application notes).

One important aspect sometimes overlooked in benchmarking, is consideration of the skill of the individual who actually writes the benchmark program. "Programmers of unequal ability are often given the job, with the result that the better programmer generates a more efficient code," notes TI's Ogden.

"If possible, a single programmer, or programmers of equal ability, should prepare benchmark tests. Also, since the bulk of the applications program will be written by programmers of average ability, to ensure validity the benchmark test should also be written by an average programmer rather than by one of unusual skill."

There are a number of sources where potential users of  $\mu$ Ps can obtain benchmarks. Standard benchmark routines are available from data processing consultants. AH Systems, Chatsworth, CA, for example, currently offers five standard benchmark tests, with more in preparation.

A ploy sometimes resorted to by a  $\mu$ P user on the lookout to save money is to ask the vendor to write a benchmark program for his (the user's) intended application. The vendor often complies because he wants to make a sale. In addition, the vendor's program writer gets a chance to emphasize the product's advantages to the potential purchaser.

Such free help often has some disadvantages, however. By having someone else do his benchmarking, or by resorting to "canned" standard routines, the user will never learn how difficult (or how easy) it is to program different  $\mu$ Ps.

"Learning about the processor by actually working on it, is at least as important as those other two 'classic'  $\mu$ P-selection criteria, program length and program time," says RCA's Carley. He says the importance of benchmarks today lies in their ability to show how easy it is to deal with a particular  $\mu$ P.

"The old-time definitions of how long a program is, or how fast it is, are losing ground. In most applications the time doesn't matter, and the cost of the additional memory is so low, that it's not a significant factor." ■■



# More and more major companies The future

More than 200  
deep discharge  
cycles.

Great versatility  
in charging methods.

Wide temperature range  
from  $-40^{\circ}\text{C}$  to  
 $+50^{\circ}\text{C}$ .

More packaging  
flexibility than  
you might  
have thought possible.

Easy  
recharge,  
plus a wide  
range of  
discharge rates.



## IMPORTANT SUBSCRIBER OPERATING INSTRUCTIONS

### BEFORE ANY "CLOSING"

#### 1. PUSH SWITCH TO "TEST"

2. REMAIN MOTIONLESS

#### 3. WALK - TEST

4. STOP AND WAIT

#### 5. REPEAT 3 AND 4

#### 6. PUSH SWITCH TO "ON"

#### 7. RED PILOT LAMP MUST



# use Gates. in energy cells.

Fewer design problems,  
fewer operating problems.

A watt-hour  
per dollar value  
that would warm  
a comptroller's heart.

Thermal  
runaway problems  
are a memory.

Tough,  
sealed construction  
for rugged, safe  
performance.

## FREE!

I would like to know a lot more about Gates energy cells. Please send your **FREE**, no-obligation brochure containing battery features, application information, ratings and specifications. ED-46

Name \_\_\_\_\_

Title \_\_\_\_\_

Company \_\_\_\_\_

Address \_\_\_\_\_

City/State/Zip \_\_\_\_\_

Please mail coupon to: Gates Energy Products, Inc.,  
1050 S. Broadway, Denver, CO 80217.

CIRCLE NUMBER 40



**Energy Products**



# Low-cost peripherals

## They are becoming even less expensive as mini and micro prices plunge

As the cost of micro and minicomputers tumbles into the \$100 to \$600 range, manufacturers of associated peripherals—such as terminals, printers and additional memory—continue to lower their prices too. Small printers are now selling for as low as \$200, floppy-disc drives are available for under \$400 and CRT terminals can be bought for under \$1000.

As one industry spokesman observes: "This is just the beginning; the next 18 months should bring prices lower yet." And ironically, the major technological trend in low-end peripherals is the incorporation of  $\mu$ Ps for parts reduction, increased reliability, greater capability and lower cost.

### Printers are smaller and cheaper

At the lowest end of the printer spectrum are the 6 to 80-column matrix and 7-segment printers. A good example of the lowest cost variety is the Matri-Dot from Practical Automation, Shelton, CT. It sells for only \$140 in quantities of 100 and offers a speed of 138 lines-per-minute, with 18 columns of full alphanumerics. This printer can be bought with either a normal print format or one that is upside-down depending upon the mounting configuration desired.

For \$475 in unit quantities, Datel Systems, Canton, MA, offers the DPP-7 Digital Panel Printer. It mounts like a panel meter and uses a 7-segment thermal print head to print six columns of numeric information with a few letters available as well. The printer is ideal for hardcopy printout from a  $\mu$ C. It can be used for register and memory dumps as well as some debugging operations, and comes in two versions. One ac-

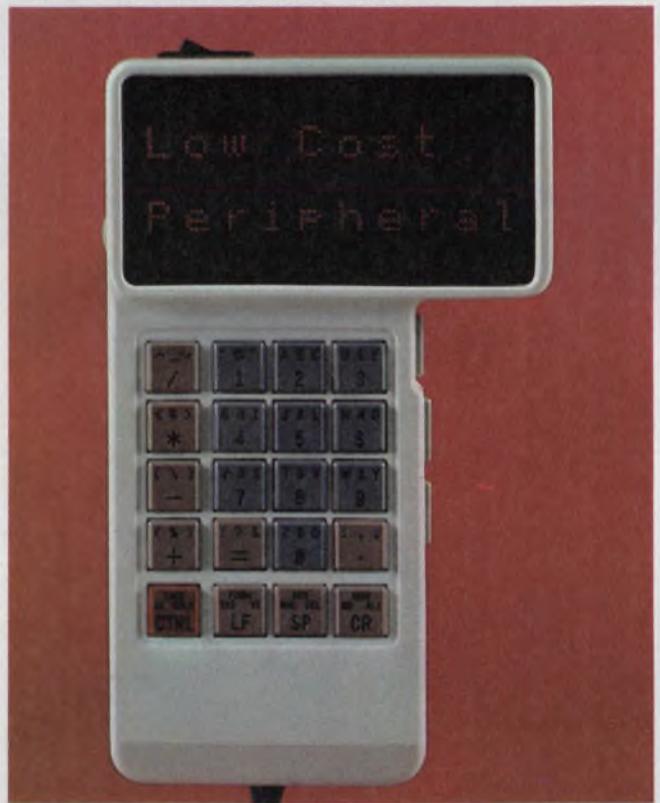

This handheld computer terminal from Termiflex has two lines of 10-character LED display and full ASCII keyboard. It sells in OEM quantities at under \$1000.

cepts BCD and the other takes hexadecimal inputs.

"We'll also be introducing a low-cost full-alphanumeric panel printer in about a year. It, too, will use a thermal print head and have about 20 columns of printout," says Larry Copeland of Datel.

Microprocessors have even crept into these low-end printers. One of the most interesting of the new breed is the EX-800 series from Axiom Corp., Pasadena, CA. This printer sells for \$499 in 200

David N. Kaye  
Senior Western Editor





The VER-iCOM-80 from iCOM is a unique instrument that is a combination card reader, printer and computer terminal. The compact peripheral works with  $\mu$ Cs.

quantities including power supply and interface electronics. It prints 80 columns on electrosensitive paper using a  $5 \times 7$ -dot matrix at a rate of two lines per second with full alphanumerics, on paper 5-in. wide. The heart of the printer electronics is an Intel 4004  $\mu$ P and a FIFO/RAM input buffer that can store up to 160 characters of multi-line information. The unit measures only  $8\text{-}3/4 \times 10\text{-}1/2 \times 4\text{-}1/8$  in., including transformer and a 240-ft roll of paper.

If these small printers won't do the job, the next step up is the 30 to 200-cps serial printers. Here, one of the big decisions is whether to use matrix or full-character printing. Word processing and high quality print applications usually require full-character printers, while just about everyone else is going with matrix or seven-segment printing because of their lower cost.

Dominating the full-character field are the daisy-wheel printers from Diablo Systems, Hayward, CA, and Qume, Hayward, CA. These printers operate at speeds from 30 cps to 55 cps and use a small, interchangeable print wheel that comes both in plastic and metal versions. These printers cost over \$2000, even in large quantities.

Still major forces in the full character field are Selectric printers from IBM and conventional Teletype printers that have firmly established themselves over the years. These printers are significantly cheaper than the daisy-wheel printers at the moment, but they are much slower.

"Printer prices are going down about half every three or four years," says Irving Wieselmann of Dataproducts Corp., Woodland, CA. "And matrix printers are coming down in price fastest of all.

"Reliability and character quality are the main considerations in dot-matrix printers. Distributed-matrix approaches, such as Talley and Printronix have taken with line printers, seem a more reliable way to go than the matrix head approaches



Known as the Dumb Terminal, this 24-line, 80-character CRT terminal is the equivalent of a glass teleprinter. It sells for under \$1000 in single quantities.

taken by many others."

A new medium-speed matrix printer is the Model 700 from Centronics Data Computer Corp., Hudson, NH. It is a 60-cps serial impact unidirectional printer with an effective throughput of 13 to 90 lpm. The standard unit prints 80 columns at 10 channels per in. and an optional tractor feed permits printing of 132 columns. The printer sells for a unit price of \$1520.

Of the serial matrix printers on the market now, one of the most interesting is the Okidata (Moorestown, NJ) 132-column printer at under \$1700 in hundred quantities. It prints at 265 cps in full upper and lower case ASCII, has a choice of 6 or 8 lpi selection, can print double-height or double-width characters and has an operator-controlled self-test feature.

A less expensive relative, also from Okidata, is the CP110, a 110 cps, 80-column printer at under \$900 in hundred quantities.

Low-cost matrix printers also come from Digital Equipment Corp., Maynard, MA, Hydra Corp., Mountain View, CA, and others.

In a class by itself, crossing the boundaries of printers, card readers and terminals is a new kind of peripheral from iCOM, Canoga Park, CA. The company, which specializes in peripherals for  $\mu$ Cs, has just introduced the VER-iCOM-80 Punched/Mark Sense Card Reader and Printer at a price of \$995 (unit quantities) or \$525 (1000 quantities).

You can use the machine as a computer terminal for asking a question and getting a response. The question is asked by marking or punching holes in the standard 80-column card and the response is printed in a single line of type across the top of the card. The printer can type up to 80 characters at a speed of 15 cps.

The peripheral contains a Motorola M6800  $\mu$ P and 512 bytes of RAM that perform all controller





This drive from Emerson takes 1/2-in. tape cartridges and can store up to 153 Mb in a 1000-ft cartridge. Read-write speed is 25 ips.

and read/write functions. A parallel interface is standard and an RS 232C interface is optional. Although this terminal is being marketed by iCOM, it is built for them by Sensor Technology, Chatsworth, CA.

### Floppies still in the formative stage

One of the great disappointments in the peripheral business has been failure of floppy discs to gain market acceptance so far. Now that  $\mu$ Ps are taking off, though, floppy discs are expected to follow on their coattails. The main application for floppies, so far, has been in  $\mu$ C development systems.

Prices of floppies have been plummeting. Almost every company is now offering the drives without control electronics for under \$400 in OEM quantities, and many expect a drop to under \$300 within the next 12 to 18 months.

The leaders in the business at present appear to be Shugart Assoc., Sunnyvale, CA; Control Data, Minneapolis, MN; Calcomp, Anaheim, CA; Pertec, Chatsworth, CA; Memorex, Santa Clara, CA; Remex, Santa Ana, CA, and Orbis Systems, Tustin, CA. Many other companies are now producing drives, but there is bound to be a shake-out soon.

A popular configuration for selling floppies is a dual drive with control electronics and interfacing. Such systems are being marketed by iCOM, Advanced Electronics Design, Sunnyvale, CA, and many others. In OEM quantities, these systems are now selling for under \$3000.

One of the most innovative of the new floppies on the market is from PerSci, Marina Del Rey,

CA. The Model 75 uses voice-coil head positioning for a 100-ms full-stroke seek. A special disc handler automatically inserts and extracts the media.

The Model 75 drive is compactly designed so that a dual drive occupies little more space than do single drives from any other company. A single head positioner is used for both diskettes in the dual drive. Pricing is about the same as the other drives on the market.

New features are creeping into floppies, and almost everyone now offers a double-density drive already.

"Density will move to about 10,000 bpi for additional storage," according to Michael Shebanow of Pertec. "This gives up to 1.5 megabytes with one head and one side. Since IBM has gone to two-sided recording, others will too, and that will double the capacity again."

The trend in low-cost hard-disc drives is toward nonremovable media. Pertec, Diablo Systems and Wangco, Marina Del Rey, CA have all come out recently with 2 to 10-megabyte fixed-disc drives. Although market acceptance has not been overwhelming, it seems to be building. Since these drives cost less than \$2000, they provide an alternative for low-cost computer systems.

Industry sources say the drive that will gain wide acceptance in the micro or low-end mini market will be a 3 to 5 megabyte capacity, fixed-media drive with a flying-head. It will have an average seek time of 60 ms at a cost of \$1200.

Most are also looking for  $\mu$ P-based controllers to find their way into these drives.

### Here comes the mini-3M cartridge

Several companies are developing drives for the new 3M minicartridge that Hewlett-Packard first brought to market. An example is a dual drive aimed at  $\mu$ C development systems being developed by iCOM. Selling for about \$275 in 500 quantities, the drive includes read-write electronics and control electronics, and will search at 90 ips and read-write at 30 ips.

Cartridge capacity has not yet been determined, but the drives can hold 100-k bytes on a single track, phase encoded, or up to 600-k bytes on 2 tracks, MFM encoded. 3M Corp., St. Paul, MN, has also introduced a drive for the minicartridge.

In addition to the mini-3M cartridge, another miniature entry is the MI-50 Mini Data Cassette from Information Terminals, Sunnyvale, CA. This miniature Philips-type cassette measures  $2 \times 1.3 \times 0.3$  in. and holds 50 usable feet of 0.15-in.  $\times$  0.7-mil tape, with a data capacity of 64-k characters at 800 bpi.

The first drive to become available for the new cassette is the Mini-Raycorder from Raymond Engineering, Middletown, CT. The drive consumes less than 1 W and reads and writes at 3



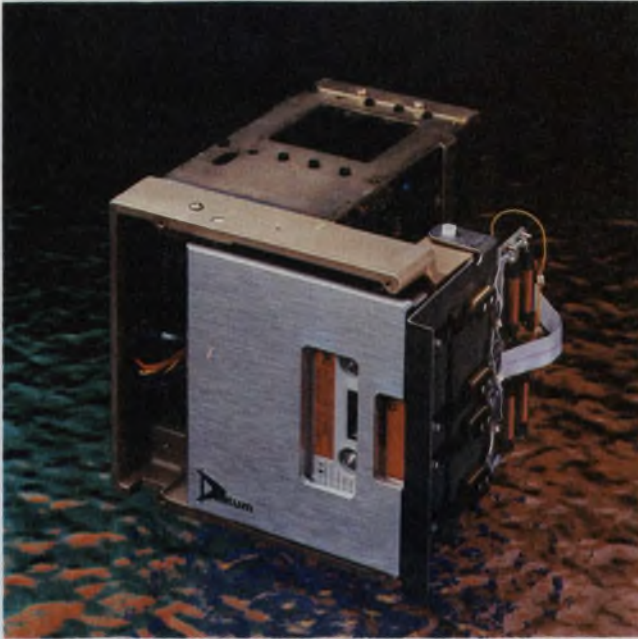

The 4200 cassette transport from Datum is a reel-to-reel recorder that sells for \$2100 in 100 quantities including control and interface electronics, power supplies and buffer memory.

ips. It costs \$175 in OEM quantities. The cassette costs about \$6 in quantity.

Sales of large 3M cartridge drives have been spurred recently by the inclusion of the cartridge in the Model 5100 desk-top computer by IBM. Although no new technology is evident in this area, companies like Kennedy, Altadena, CA; Mohawk Data Sciences, Utica, NY; and Quantex, Plainview, NY, are benefiting.

Emerson has started delivering the Series 2000 Tape Pac cartridge tape system from its Santa Ave., CA, plant. This low-cost cartridge drive provides 7 to 9-track NRZI or 9-track phase-encoded recording at 25 ips with a data-transfer rate of 40-k bytes/s. Using a 1000-ft tape cartridge, 153 Mb of data can be stored. OEM pricing of the drive is under \$2000.

There has been speculation that cartridges and floppies would totally replace cassette drives that use Philips-type cassettes. It hasn't happened. In fact, sales of cassette drives have accelerated.

One that has attracted some big customers recently is the Model 4200 from Datum, Anaheim, CA. It is a high-performance reel-to-reel drive with an ungapped capacity of 5.6 Mb/track at 1600 bpi or 2.8 Mb/track at 800 bpi. Two tracks are available for recording. With controller, interface electronics, power supplies and buffer memory, the drive sells for \$2100 in 100 quantities.

For portable applications involving  $\mu$ Ps, an ideal drive is the ICT from Datel Systems. It requires only 12 V at 83 mA and can run for a year on a single battery. It is an incremental transport using a stepping motor/capstan drive.

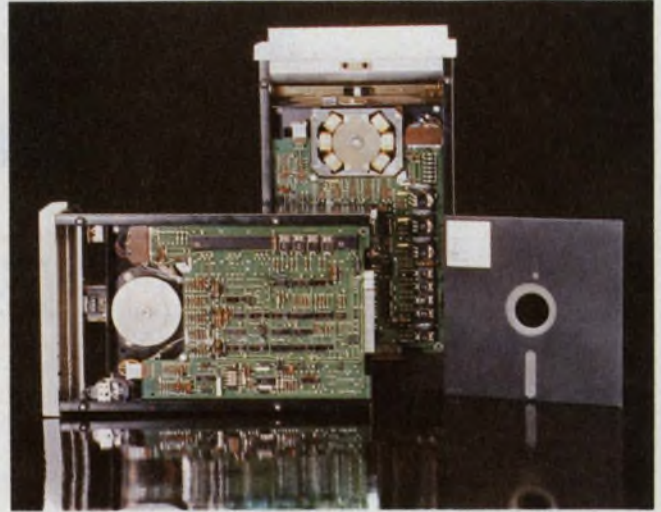

The 2230-line printer from Dataproducts has an unusual drum and hammer-bank design. This 300-lpm printer is ideal for minicomputer applications.

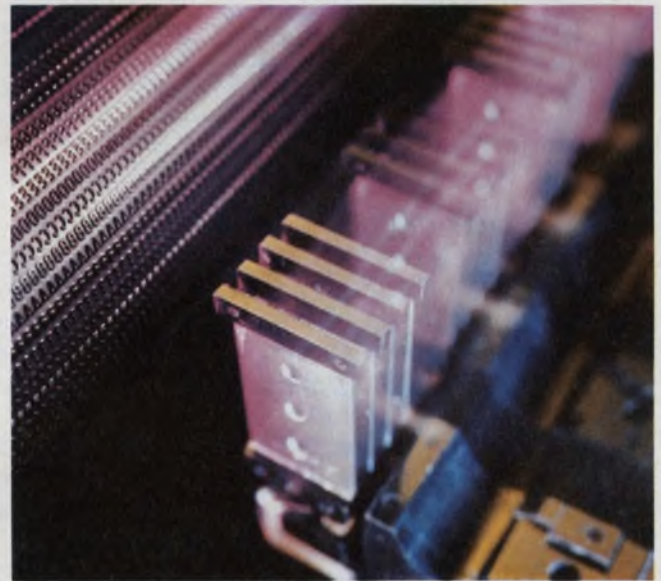

Both ac and dc-drive floppies are available from Pertec. The FD 400 is a direct dc spindle drive and the FD 500 is a belt-driven ac drive.

It costs only \$325 in unit quantities, and stores up to 2.2 Mb.

The ASR 33 terminal from Teletype Corp., Skokie, IL, is no longer alone at under \$1000. CRT terminals are now available from Lear Siegler, Anaheim, CA, and Infoton, Burlington, MA. Both of these terminals are little more than glass teleprinters. The Lear Siegler terminal sells for \$995 in unit quantities and the Infoton terminal sells for \$990 in 25 quantities. They both provide 24 lines of 80 characters.

A hand-held terminal is also available at under \$1000. It is the HT/2 from Termiflex, Nashua, NH. Selling for \$995 (100 units) it provides two lines of LED readouts each 10 characters long. It has a full keyboard and can display the full set of upper and lower case ASCII characters. ■■



# DELCO'S NEW FAS HIGH-GAIN TRANSIS

## MAJOR PARAMETER LIMITS

TYPE	$h_{FE}$ @ 10A	$V_{CBO}$	$V_{CEO}$ (sus)	$V_{CE}$ (sat) @ 7A	$t_f$ (typical @ 5A)
DTS 515	3.5	300V	250V	5.0V	0.25 $\mu$ sec
DTS 516	4	400V	250V	1.9V	0.25 $\mu$ sec
DTS 517	5	500V	250V	1.6V	0.25 $\mu$ sec
DTS 518	5	600V	275V	1.4V	0.25 $\mu$ sec
DTS 519	5	700V	300V	1.4V	0.25 $\mu$ sec
2N6573	5	500V	250V	1.5V	0.25 $\mu$ sec
2N6574	5	600V	275V	1.5V	0.25 $\mu$ sec
2N6575	5	700V	300V	1.5V	0.25 $\mu$ sec

NPN triple diffused silicon transistors. Packaged in solid copper cases conforming to JEDEC TO-3 outline dimensions.



Our newest high-energy silicon power transistors have increased capabilities over our earlier types in current ratings, gain and switching speeds. These improvements were achieved without sacrificing the useful peak power handling capacity that is characteristic of Delco's transistors.

Full time of these transistors is typically 0.25 microseconds. Their biggest advantage, however, is their high current gain as shown on the accompanying beta curves.

A new characterization feature offered with the DTS-515 series is a graph of capabilities for reverse bias clamped inductive switching. Parameter variables, dealt with in the graph, are voltage, collector current, temperature, and forward and reverse base current. As can be seen in the

" $V_{BE}(\text{reverse}) \geq 5V$ " notation, emitter diode avalanche is recommended under certain conditions.

And, of course, these high-energy silicon power transistors come in Delco's solid copper TO-3 packages to ensure low thermal resistance.

The accompanying curves, charts and circuits tell part of the story. Prices, applications literature and electrical data from your nearest Delco sales office or Delco distributor can supply another part.

But the most important part of the story is how well these new transistors function in your applications.

You can order them today; they're in stock at your Delco distributor's.

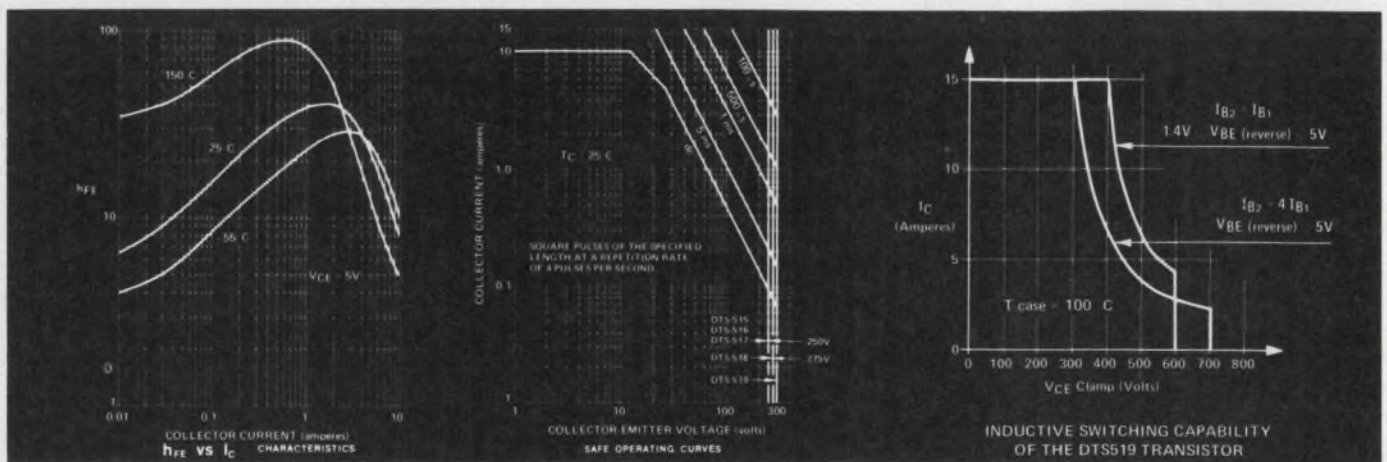



# TER SWITCHING, TORS NOW IN STOCK.

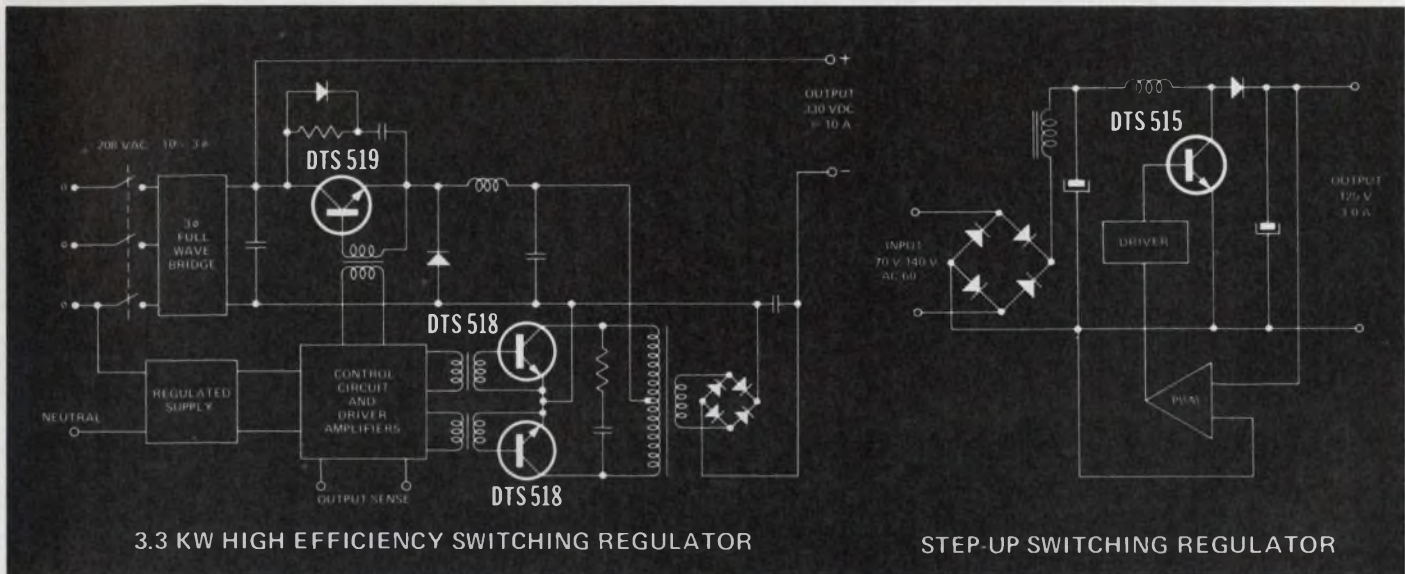

NOW AVAILABLE FROM THESE DISTRIBUTORS IN PRODUCTION QUANTITIES.

**ALABAMA, Birmingham**  
Forbes Distributing Co., Inc.  
(205) 251-4104

**ALABAMA, Huntsville**  
Powell Electronics  
(205) 539-2731

**ARIZONA, Phoenix**  
Sterling Electronics, Inc.  
(602) 258-4531

**CALIFORNIA, Gardena**  
Bell Industries  
Electronics Distributors Div.  
(213) 321-5802

**CALIFORNIA, Goleta**  
R P S Electronics, Inc.  
(805) 964-6823

**CALIFORNIA, Los Angeles**  
Kierulff Electronics, Inc.  
(213) 685-5511

**CALIFORNIA, Los Angeles**  
R P S Electronics, Inc.  
(213) 748-1271

**CALIFORNIA, Palo Alto**  
Kierulff Electronics, Inc.  
(415) 968-6292

**CALIFORNIA, San Diego**  
Kierulff Electronics, Inc.  
(714) 278-2112

**CALIFORNIA, San Diego**  
R P S Electronics, Inc.  
(714) 292-5611

**CALIFORNIA, Sunnyvale**  
Bell Industries  
(408) 734-8570

**COLORADO, Denver**  
Kierulff Electronics, Inc.  
(303) 371-6500

**CONNECTICUT, Norwalk**  
Harvey Electronics  
(203) 853-1515

**FLORIDA, Clearwater**  
Diplomat Southland  
(813) 443-4514

**FLORIDA, Miami Springs**  
Powell Electronics /Florida  
(305) 592-3260

**ILLINOIS, Elk Grove Village**  
Kierulff Electronics, Inc.  
(312) 640-0200

**ILLINOIS, Skokie**  
Bell Industries  
Electronics Distributors Div.  
(312) 282-5400

**INDIANA, Indianapolis**  
Graham Electronics Supply, Inc.  
(317) 634-8202

**MARYLAND, Baltimore**  
RESCO Baltimore  
(301) 823-0070

**MARYLAND, Beltsville**  
RESCO Washington  
(301) 937-5890

**MASSACHUSETTS, Billerica**  
Kierulff Electronics, Inc.  
(617) 935-5134  
(617) 667-8331

**MASSACHUSETTS, Newton**  
The Greene-Shaw Co., Inc.  
(617) 969-8900

**MICHIGAN, Livonia**  
Pioneer /Michigan  
(313) 525-1800

**MINNESOTA, Minneapolis**  
Stark Electronics Supply Co.  
(612) 332-1325

**MISSOURI, Kansas City**  
Walters Radio Supply, Inc.  
(816) 531-7015

**MISSOURI, St. Louis**  
LCOMP-St. Louis  
(314) 647-5505

**NEW JERSEY, Cinnaminson**  
Wilshire Electronics /Philadelphia  
(609) 786-8990 (215) 627-1920

**NEW JERSEY, Clifton**  
Wilshire Electronics /New Jersey  
(201) 340-1900 (212) 244-8930

**NEW MEXICO, Albuquerque**  
Sterling Electronics  
(505) 345-6601

**NEW YORK, Binghamton**  
Harvey Electronics  
(607) 748-8211

**NEW YORK, Buffalo**  
Summit Distributors, Inc.  
(716) 884-3450

**NEW YORK, Farmingdale**  
Wilshire Electronics /Long Island  
(516) 293-5775

**NEW YORK, Freeport**  
Milgray /New York  
(516) 546-6000

**NEW YORK, Woodbury**  
Harvey Electronics  
(516) 921-8700 (212) 895-9260

**OHIO, Cincinnati**  
United Radio, Inc.  
(513) 761-4030

**OHIO, Cleveland**  
Pattison Supply Co.  
Industrial Electronics Division  
(216) 441-3000

**OHIO, Dayton**  
Pioneer /Dayton  
(513) 236-9900

**PENNSYLVANIA, Philadelphia**  
Almo Electronics  
(215) 698-4000

**PENNSYLVANIA, Pittsburgh**  
CAM /RPC Electronics  
(412) 288-2600 (412) 782-3770

**SOUTH CAROLINA, Columbia**  
Dixie Radio Supply Co., Inc.  
(803) 779-5333

**TEXAS, Dallas**  
Sterling Electronics  
(214) 357-9131

**TEXAS, Houston**  
Harrison Equipment Co., Inc.  
(713) 652-4700

**TEXAS, Houston**  
Sterling Electronics  
(713) 627-9800

**WASHINGTON, Seattle**  
Kierulff Electronics, Inc.  
(206) 763-1550

**IN CANADA:**  
Zentronics Ltd.  
Toronto (416) 787-1271  
Ottawa (613) 238-6411  
Montreal (514) 735-5361

**OVERSEAS: EUROPEAN INQUIRIES:**  
European Parts & Accessories  
Marketing Group  
General Motors Continental  
Plant 2, Noorderlaan, Postbus 9  
B-2030 Antwerp, Belgium

**ALL OTHER OVERSEAS INQUIRIES:**  
General Motors Overseas  
Operations  
Parts & Accessories Dept.  
767 Fifth Avenue  
New York, N.Y. 10022  
(212) 486-4412

**Delco Electronics Regional Sales Offices**  
Charlotte, North Carolina 28209  
4600 Park Road  
(704) 527-4444  
Van Nuys, California 91404  
Box 2968  
(213) 988-7550

**General Sales Office**  
700 E. Firmin, Kokomo, Ind. 46901  
(317) 459-2175



Division of General Motors



# Computer graphics

---

## Programming bottlenecks limit widespread use, but the outlook is bright

Like an Olympic diver nervously poised before a plunge, interactive computer graphics remains on the verge of taking off.

Despite steady advances in graphics technology, despite steadily eroding prices, despite the continual appearance of new applications, the big splash in computer graphics has yet to come.

There are perhaps 2000 high-cost (\$50,000 and up) terminals in the United States today—almost double the number of about four years ago.

In low-cost (\$10,000 and under) units, roughly 10 to 15,000 systems are in operation. Al-

though that represents about a twentyfold increase in the last four or five years, it is a far cry from the hundreds of thousands—or even millions—of terminals predicted back then.

The necessary compromise between price and performance may be one factor that has kept graphics back. Until recently, if you needed the utmost performance—dynamic pictures, selective refresh, rotation, zoom, scaling—then you bought a random-vector, refreshed CRT and paid the price, up to \$200,000.

Of course, you could drop your outlay by a factor of 10, or more, by going to a direct-view storage-tube or a TV system, either raster scan or scan conversion. But then you had to give up

---

**Stanley Runyon**  
Associate Editor

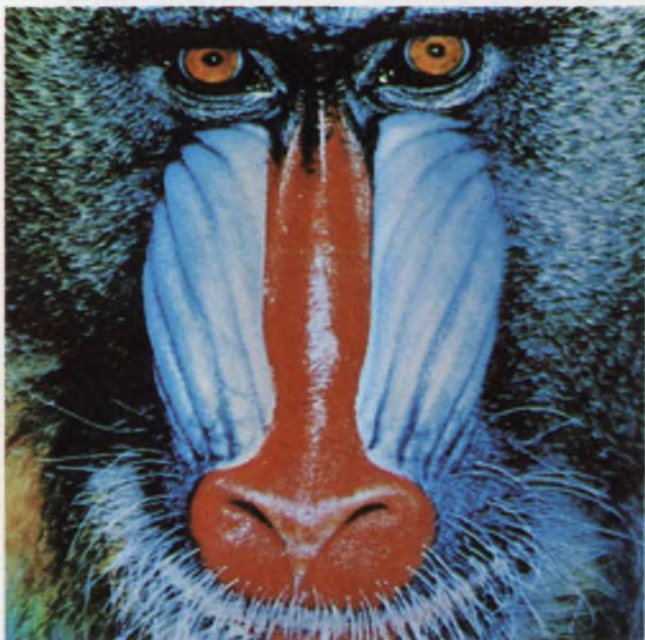

Computer enhancement of images adds fidelity to the space and color characteristics of a display. Note the sharp detail in the Mandrill's whiskers. Contrast can also



be boosted, as in the computer-generated abstract, by pseudo-coloring—the arbitrary juggling of hue, saturation and luminescence (Comtal Corp.).





Two diverse uses of graphics: image modeling (above) and simulation (top right). Equipment from Evans & Sutherland can also show ship's view (right).

something: with the storage tube you sacrificed dynamics or selective refresh; with TV, perhaps you lost contrast, dynamics or other capabilities. For many applications, however, these are acceptable compromises.

[The unwrapping just last month of the Tektronix 4081 graphics system—one that combines refresh and storage-tube features—may radically change the picture.]

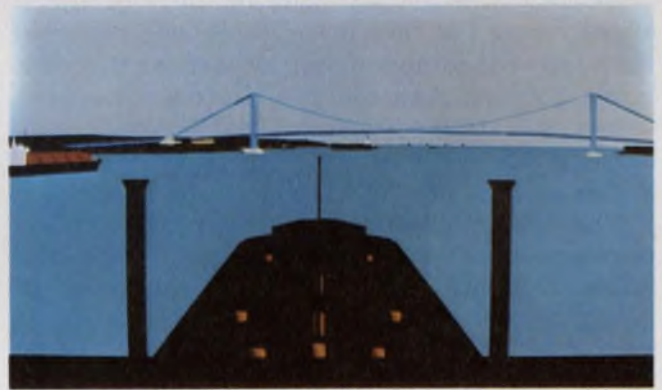

### The software problem: a hard nut

One industry observer sees another reason for the failure of graphics to spread significantly into the office and home. Carl Machover, former vice president of Information Displays (IDI)—a leading graphics vendor—and a man who has grown up with graphics, points to software as the hangup:

“It’s the turn-key problem,” Machover says, “the lack of applications material, that has kept graphics back in the huge, but largely untapped, business world. The scientific, academic and engineering communities, not business, now form the largest area of graphics use.”

What Machover is suggesting is that it may take a skilled, knowledgeable programmer to generate applications software, and perhaps even to operate the system. Such skill isn’t likely to be found in, say, a corporate office.

But things are changing, and more and more vendors are offering operating systems, support packages and other software aids. Hardware is also improving.

Where does computer graphics stand today? In resolution, writing speed, brightness, screen size, and number of flicker-free vectors, among other key areas, there have been few radical performance jumps over the past few years.

Input/output devices haven’t changed much

either. The keyboard, the light pen and the data tablet remain the major man-machine interfaces; the joystick, the trackball and other devices also play a role.

Instead, the major movements have been in the erosion of prices, the march toward more intelligence, the replacement of software functions with hardware and in the drift toward stand-alone terminals or multiple, slaved monitors.

Another trend: with improvements in data communications, remote interactive operation is now feasible, and many systems offer the RS-232C communications interface. With RS-232C, you can hook into a time-sharing service or use the large data base of a central host computer that might be located in the home office.

Low cost in interactive terminals is practically synonymous with the direct-view storage tube and with Tektronix, the company that cracked open the graphic market about ten years ago by introducing bistable tubes.

Today, Tektronix owns an estimated 30% to 40%—about \$50 million worth—of the total graphics market with such products as the 4006-1, a \$2995 terminal offering 1024 × 780 viewable points and 2590 alphanumeric characters. (A few others do compete in storage-tube-based terminals—Comutek, for one. But guess where the storage tubes come from?)



Products like the seven-month-old 4051 and the newborn 4081 practically ensure Tektronix' dominance. The 4051 encompasses much of today's new look in terminals: a built-in  $\mu$ P, built-in tape-cartridge drive, a basic-language keyboard, RAM storage and other features—all of which make the 4051 look like a cross between a graphics terminal and a computer.

Not to be outdone, the 4081 boasts two computers—a general-purpose processor from Interdata, and a display processor. The two “brains” team up to combine dynamic manipulation with flickerless storage graphics—up to 20,000 in. of total image with refresh of up to 800 vectors (or 1600 vector-centimeters, whichever limit comes first).

Although the \$27,000 price of the 4081 tips it slightly over the “low price” category, remember that top-of-the-line refresh systems rarely drop below \$50,000. And the 4081 includes two processors, operating software, a 19-in. display, tape drive, ASCII keyboard, 12 function keys, a joy-switch and an RS-232C interface for the price.

The 4081 represents the storage tube's first counter to a major shortcoming: no selective erase. If a mistake is made or a change is desired, the entire picture must be erased (until now, that is). Rewriting a picture takes up the user's time, may tie up a host computer's time, and can increase communications costs.

Some shortcomings for which the storage tube has been criticized have yet to be corrected. Compared to standard CRTs, the storage tube suffers from low light levels, no gray-scale range and—most important—limited life. How long the tube lasts is subjective, however: it doesn't fail instantly, but gradually deteriorates.

Since refresh directly from a central computer's memory and long picture-manipulation routines in software should be avoided, much work has been done to develop hardware or firmware substitutes.

### Shoving software aside

Vectors and characters have been generated by hardware for some time. More recently, PROMs have been offered to allow users to customize character sets or special symbols. The main emphasis, though, is on complex transformations through hardware and on relieving the host computer of display chores. The result is more and more “stand-alone” terminals.

Adage, Vector General, Evans & Sutherland, Lundy Electronics & Systems and others—companies known for high-quality refresh graphics—now offer systems in which the computer commands, and hardware in the graphics system does the bidding.

For instance, Vector General's brand-new sys-



Structural analysis performed on a Tektronix storage-tube terminal provides geometric previews of a section of a diesel-engine piston.

tem, the Model 3400, works off line, and a micro-coded processor works out the details of perspective, arcs, cubics and the like with a single call from a user's data list. Up to 20,000 short vectors can be displayed at once.

Another fledgling, Lundy's LGD family, features a  $\mu$ P-based dual-memory architecture that allows custom design of graphic instructions, hardware 3-D rotation, windowing, scissoring, scaling and zooming.

A similar emphasis on digital hardware can be found in the Picture System from Evans & Sutherland, a pioneer in graphics. Complex transformations, 3-D perspective views and other functions are all handled by a picture processor that sits between the host computer (PDP-11) and other display electronics.

The Industrial Products Div. of Hughes Aircraft was one of the first to eliminate the dozens of vectors (or hundreds of dots) needed to draw curves with program-controlled line segments. Hughes' Conographic generator draws conic curves with only four parameters—three points and a slope, for example. The result is compression of data by a ratio as great as 14:1.



But complex geometries are also being attacked by new software routines. Calma Co., Reston, VA, offers something it calls "All-angles" software—a program that eliminates sawtooth approximations. With the Calma system, just two digitized points—a center and a circumference point—are needed to generate a circle.

Hughes' C-9 graphics terminal is interesting for more than its curve generator. It's one of only two systems on the market that use scan conversion as the basic display technique.

### Scan conversion, a hybrid technique

Sometimes described as a cross between the direct-view storage tube and the refreshed CRT (which it isn't), scan conversion first captures an image on an internal storage tube, then transfers the information to a standard TV monitor.



Scan-conversion systems, like this one from Princeton Electronic Products, retain data on a silicon storage tube and use a standard CRT for display.

## Computer graphics: a refresher

Interactive graphics is actually a subcategory of computer graphics, a broader classification that includes plotters, printers, hardcopiers, microfilm units, automatic drafting machines and the like. When you think of interactive graphics, most likely you'll think in terms of CRT terminals.

A number of approaches can be used to form the CRT picture, but just two or three techniques dominate in commercial equipment: the random-vector, or stroke-writing, system; the raster; and the storage tube.

Nonstorage CRTs need refreshing to hold the image, and the refresh rate must be fast enough to avoid annoying (and fatiguing) flicker. To paint a scene repeatedly, picture data must be stored somewhere, either locally (as in present practice) or within the host computer (as in early graphics systems).

Storage tubes, of course, don't need refreshing; once an image is drawn on the screen it remains there—for 15 to 30 min in direct-view tubes.

Random-vector systems trace out a picture from point to point. Raster systems use horizontal and vertical sweeps, usually in a standard TV format, and form images by brightening the sweep at appropriate points.

Of the two storage-tube systems found today, the direct-view type is by far the most widespread. The second kind can be termed an electrical storage tube; it holds a picture on a silicon target in the form of a charge distribution.

The latter storage system is called a scan converter, and is actually a combination of the random, raster and store techniques. The image is written in random sequence on the target, and the information is then transferred to a standard (raster) TV monitor for display.

How much data a display can hold is a question often asked. In refresh systems, the more information (vectors or points) you pack in,

the closer you get to the flicker point. Alternately, the more data, the faster the deflection or refresh rate needed.

With direct-view storage, flicker isn't a problem, and resolution is accordingly high. But you can't get animation (dynamics) or selective erase. (A new product may change this situation. See text.)

Scan converters have their own set of limitations, some of which stem from the hybrid nature of the system. That is, the storage medium is essentially analog, while picture data are digital. The required format conversion is performed by the storage tube, so special techniques are required to get selective erase (dynamics aren't possible).

Which system to select depends, of course, on the application. Consider these questions: Must the picture be highly accurate so that parts can be manufactured from hard copy or a plot of the display? Is graphic motion necessary? What about continuous size changes, scaling, complex rotation, perspective—are any of these needed?

Perhaps mostly alphanumeric—with some graphics—are called for. For example, plots, bar graphs, simple line drawings and so on might be all you'll need. Then you won't require an elaborate and expensive system, so an alphanumeric terminal with limited graphic capability will probably do.

Although graphics vendors are offering more extensive software than in the past, you'll probably still have to write your own applications program. You'll also need a number of function keys labelled with the special symbols called for by the application.

To get information into the computer, the keyboard and the light pen are still the most commonly used means. Since storage tubes aren't refreshed, the light pen can't be used and another device—data tablet, mouse, joystick, or tracking ball—must be substituted.





One of the first graphics-display units is this model from IBM. The system is widely used with the company's 360 and 370 large-scale computers.

Both Hughes and Princeton Electronic Products, the other maker of scan-conversion equipment, use a proprietary storage tube as the heart of their terminals, with distinctions in the tube designs.

Advantages of scan conversion? Among other things, it's traditionally less costly (around \$10,000 without computer) than refresh, can be selectively erased and can mix real-time video and computer-generated graphics. Limitations? Among other things, scan conversion costs more than direct-view storage and doesn't allow complex dynamics or light-pen interaction.

Scan converters, along with several other systems, occupy a middle ground between the storage-tube and the full-scale random-refresh system. Some systems hinge on TV techniques, and have refresh from internal RAMs or other memory. Others are stroke-writing (random refresh) displays in which some performance is given up to get the price (\$7000 to \$12,000) down.

And a number of vendors offer systems that are essentially alphanumeric terminals but which offer plotting and other limited graphics. Such firms include Applied Digital Data Systems and Intelligent Systems Corp., with its 8-color terminal.

Areas of compromise include the number of line segments or characters, the number of instructions, the screen size, dynamics and perhaps picture quality—contrast, resolution, gray levels and so on.

Other hard-to-evaluate characteristics that are difficult to pin down even in expensive systems may also be compromised. These include degree



Analysis of structural components is a natural application of graphics (Lundy Electronics & Systems).

of interaction, picture degradation during interaction, speed of response, line-drawing and other functions.

Those active in TV or inexpensive refresh include IDI, Imlac, Megatek, Ramtek and Genisco Computers. Some, like Genisco, are relative newcomers to graphics. Others, like IDI, offer a full line of equipment—drafting systems, full-blown stroke writers and more. Still others, like Ramtek, offer color.

There are two kinds of color systems available today, based on either the color-penetration tube or the color (shadow) mask tube.

The penetration tube—in which colors are changed by varying anode potential—offers the resolution of black-and-white stroke systems, but lacks the color range of the shadow-mask tube and costs a lot more. The color-mask tube, which is used in home TVs, costs less—perhaps \$1000 for a monitor—but can't give the resolution of the penetration tube.

Color in graphics has yet to catch on, probably because of its price. (One estimate puts the number of color-penetration units in operation today at less than 200.)

#### What's around the corner?

There's little doubt, though, that color can enhance images, especially in computer-aided design,





**Automated tire-tread design** is performed interactively in a fraction of the time required with manual methods.

The Sanders Associates graphic system shown can be located miles away from a central IBM 370.

a traditional application for graphics. With color, you can see stress points, distinguish various fluid flows in complex piping layouts, explore multiple-layer PC-board design.

Maurice Stein, executive vice president for Adage, is one who sees a bright future, if not for color, then for black and white TV raster systems.

"Within five years," Stein flatly states, "TV raster graphics will offer substantial competition to the storage tube. Of course, like the storage tube—which is not interactive, it's really a high-speed plotter—the TV system isn't truly interactive."

If the present trend toward the slowing of multiple remote monitors becomes a ground swell, then Stein might be proved right. In any case, future prospects seem bright for a variety of other graphics equipment.

One product that may finally come into its own is the Owens-Illinois Digivue, a plasma panel developed a number of years ago to provide a flickerless display with inherent memory, yet still offer selective erase.

Today, a fair number of companies offer products built around the Digivue (even though the panel is not second-sourced). Among them: Magnavox, Fort Wayne, IN, which works with the University of Illinois to produce the PLATO (programmed logic for automatic teaching operations) system; and AGI, Perrysburg, OH, which

markets a plasma-based terminal for around \$6000.

Others are working on plasma displays—Burroughs, Fujitsu Laboratories, Mitsubishi Electric Corp., to name a few—and on flat-screen liquid crystals, a display yet to be used in a commercial terminal.

Large-screen projection systems—like the consumer system now offered by Advent—are being investigated as an industrial graphics medium; and the future may see increased use of electrostatic plotters—such as those marketed by Varian, Gould and Versatec—to produce complex computer images.

Cathodochromic materials—those that change color when excited by an electron beam—may play a significant role in tomorrow's graphics system. Recently, MIT filed patents on a cathodochromic CRT (CCRT) that is said to overcome previous CCRT shortcomings.

Each day brings new graphics applications. For example, refresh systems from Sanders Associates have recently found homes with manufacturers of tires (tread design), agricultural equipment (parts design, stock handling), and in air-traffic control centers (controller training).

Other applications—motion pictures, art, image processing—show that use of computer graphics is limited only by the imagination, and that graphics may at last take off. ■■



# IT'S FA

We're sti

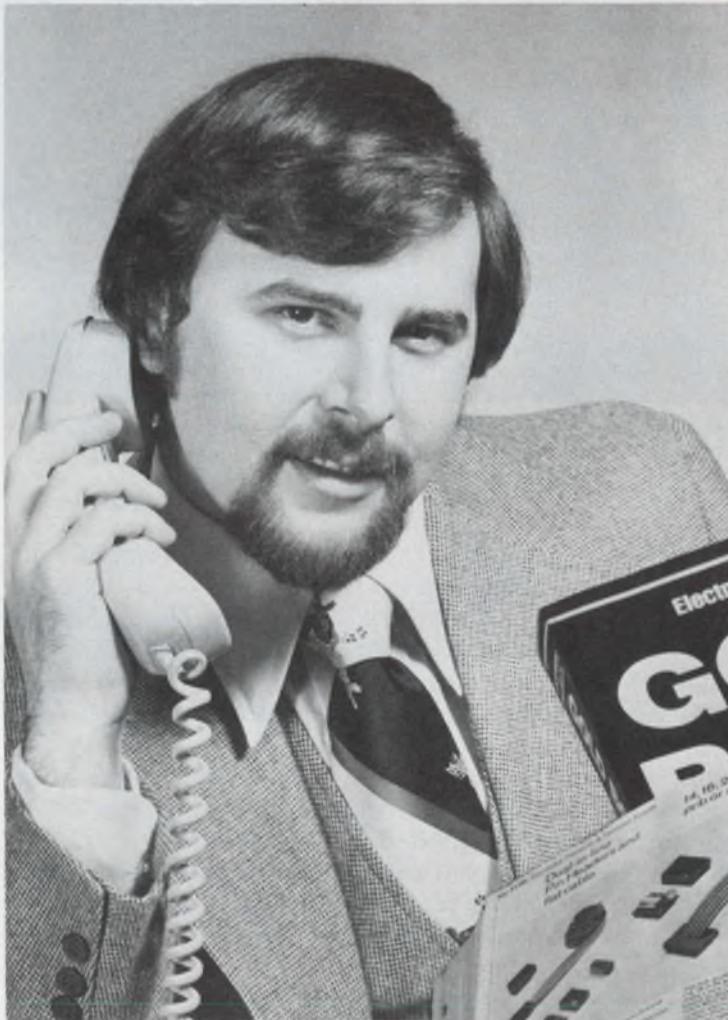

**Stephen J. Scorza**  
General Manager  
NOBEL ELECTRONICS, INC.



Tell us what you think about the GOLD BOOK. (If it's good, we'd like to hear it. If it's bad, we want to improve it.)



# NTASTIC!

## getting business from Jermyn's catalog pages in the **GOLD BOOK**

"We receive numerous calls and letters, both from the U.S.A. and all over the world, which we can readily ascribe to the **GOLD BOOK**," writes Stephen J. Scorza, General Manager, Nobel Electronics, Inc., New City, New York.

In July 1975, Nobel assumed U.S. stocking, marketing, and sales operations for Jermyn, an English company. (Jermyn manufactures semiconductor hardware: IC and transistor sockets, mounting pads, transi-pads, insulators, and heat sinks.)

"Many of the engineers who contact us refer to specific Jermyn products illustrated in the **GOLD BOOK**, requiring either the standard item or a slightly modified version. A brief phone conversation, followed-up with evaluation samples, is frequently all that is needed to produce the initial order. Now, that's cost-effective selling—and all because the catalog pages serve to qualify readers, making them much stronger prospects.

"The **GOLD BOOK** is a good *selling* tool because it is an extremely good *buying* tool. We use it ourselves to locate new sources of old items and to discover new items that may be useful in design and test."

Because the **GOLD BOOK** goes primarily to *Electronic Design's* audience of specifiers, Jermyn (and now Nobel Electronics) gets the benefit of 78,000 engineers, engineering managers, purchasing agents and distributors throughout the U.S.A., not to mention 13,000 overseas. These are the men who are ready to talk business—the men who have the authority to *buy*.

**ELECTRONIC DESIGN'S GOLD BOOK IS WORKING  
...IT'S WORKING FOR READERS...AND IT'S  
WORKING FOR ADVERTISERS, TOO.**



# Jay Forrester: A computer pioneer predicts society's future

Jay W. Forrester, who expanded the frontiers of data computation by inventing the magnetic core memory, has been a pioneer all his life. He guided the design and construction of Whirlwind I, one of the first high-speed digital computers. And, at MIT, he led the planning and technical design of the Air Force SAGE (Semi-Automatic Ground Environment) system for continental air defense.

In 1956 Forrester began to build systems-dynamics models for data-processing machines to examine the socio-economic conditions of cities, nations and the world and to determine where present policies will lead.

"For the past 20 years our group here at MIT has been developing ways to better understand the nature of food problems, pollution, environmental issues and the behavior of cities," Forrester says. Pointing to a bookshelf behind him in his large sun-filled office overlooking the Charles River: "That row of 20 books is the consequence of the work done here over the last 20 years or so on the nature of social systems."

The Systems Dynamics Group's work at MIT has made governments throughout the world aware of the problems, and even dangers, of growth, Forrester continues. One product of the studies, and specifically of Forrester's book, *World Dynamics*, was the world-wide best-seller, *The Limits of Growth*, which sold close to four-million copies in 30 languages.

Forrester's move from technological innovation to socio-economic studies was motivated by the same pioneering spirit that led him to develop the core memory.

"This is a frontier, a new field that I believe will have tremendously more impact than did the

pioneering of electronic computers," he says. One reason is that the issues are crucial—they are nothing less than whether and how civilization will survive.

"It was a pure case of necessity being the mother of invention," Forrester says of his work on the random-access magnetic core memory.

"I was director of a research group developing a computer for real-time control purposes, and we needed high speed and high reliability. Unfortunately, the memories that were available didn't offer either one. So we had to develop a memory as well as other reliable, high-speed components. The project, and our reputations, hinged on it.

"The magnetic core memory, incidentally, was in no sense the only major innovation that came out of this project, though it was the best known development and the most specifically unusual."

The project, which was called Whirlwind I, began with one goal and ended with another. Initially, the Navy wanted a computer that would go a step further than the old Link trainers, which taught pilots to fly during World War II. They wanted a computer that would predict the characteristics of aircraft not yet built. It was to aid the designer.

"We worked for about a year with analog computation," he says, "but decided finally that it was not going to work. Any analog computer that would deal with the equations we needed would be so complex we'd never know whether it was solving the equations or solving its own idiosyncracies and inadequacies. So in 1946, we abandoned analog and went to digital computation."

At that time there had been no discussion of digital computers having real-time or high-speed applications, Forrester says. "So, for about a year we laid out designs around the serial-computer concept in which one might use electronic delay lines or a scanning CRT that would deliver

---

**John F. Mason**  
Associate Editor



stored digits serially, one after the other, rather than in parallel. Finally we decided that a serial computer was too slow."

The group then switched to designing a high-speed parallel computer with synchronous logic. "This did show promise of having a sufficiently high speed to carry out the original objective," Forrester recalls.

But about then the computer's objective was changed. Interest in large bombers was declining and the need for real-time information handling for combat purposes was growing. The computer was to be used in a command-and-control system for an antisubmarine-warfare task force. The system would automatically keep tabs on the positions of all the ships in the task force, on radar and sonar data, and on weapons inventories and target information—all in real time.

"This real-time aspect represented a total



Photo by John F. Mason

change in our objectives and perspective. We no longer wanted to analyze data under static conditions. We wanted to analyze the data for activities that would use it later for active, real-time participation."

But the Navy didn't get its ASW system. Priorities shifted again, and the Air Force got SAGE instead. Called Project Charles, the new direction took the form of a six-month study contract to analyze the command-and-control needs of an air-defense system.

Two important decisions came out of the study, Forrester recalls. "The first was that digital computation would be the way to go in designing complicated command-and-control systems. And second, a research institution was set up. It eventually became MIT's Lincoln Laboratories."

The Whirlwind I computer was initially designed around a CRT storage unit by Forrester's group. It was a barrier-grid CRT in which a flood of low-energy electrons would recharge both the high and low-charged areas of the tube to sustain stored charges in the tube.

### There were two stages

"But the tube was expensive," Forrester recalls, "and it had a short life—about 1000 hours at most. It was impractical in terms of the kind of real-time application we had in mind. Obviously we needed a new memory. So I developed the magnetic core memory in two stages:

"In 1947, I recognized that the existing storage systems were either linear, single-dimensional storage units, or they were two dimensional. The principal single-dimensional type was the mercury delay-line memory that stored data as a sequence of shock waves in a column of mercury.

"The 2-D storage systems were in the form of a rectangular array of storage elements deposited on the face of a CRT. We had one of this type and we had a Williams tube. Many people were experimenting with ways to use 2-D arrays on a CRT."

Why not build a three-dimensional array? Forrester asked himself. Rather than being spread on the surface or lined up in a tube, the storage elements could fill a solid space. The goal for any memory was greater compactness, good reliability and fast access. Without achieving those, the approach would not be practical.

Forrester then considered building a 3-D memory with gas discharge tubes. "In 1947 I began to work out some conceptual structures around the characteristics of gas-discharge tubes—a neon-gas tube, for example, which has a high breakdown voltage and then a low-sustaining voltage. I also used the characteristics of a diode rectifier where one has a high breakdown and then a lower voltage to sustain current once the peak voltage has been overcome."

Forrester worked out a switching sequence that "theoretically allows you to activate any storage cell in a 3-D array and later go back and find out what its state was."

But there were disadvantages to both gas-glow discharges and diode rectifiers: they are both heat-generating devices, and the glow discharge, in particular, involves cathode emission and gas pressure and is subject to contamination.

"So after a small amount of testing, I decided that they didn't have the potential for either the high speed or the reliability that we would require.

"The entire pursuit slowed down," Forrester recalls, "until the spring of 1949, when I was reading the old *Electrical Engineering Magazine*



## Austere days ahead for the 'have' countries

"The developed countries have more severe population problems than the underdeveloped countries, contrary to what most people believe," Forrester says. "The developed countries are going to be less able to sustain their present standard of living from inside their own borders than are the underdeveloped countries."

For the most part, the developed countries are living on energy and resources from other countries and are exporting products in a manner that simply will not be sustainable. Japan, for example, is probably the most vulnerable country in the world. What would Japan be without foreign energy, foreign resources and foreign markets? Yet the day is close at hand when Japan will find all three of these declining.

The countries that have the resources and constitute the markets will soon be manufactur-

ing with their own labor. The need for an industrial country like Japan or for Western Europe or the United States is of limited duration.

"We're in a situation where the fundamental basis for "have" nations and "have-not" nations is reversing. The United States will shift from importing low-priced inputs and exporting high-priced products to a situation where it is importing high-priced inputs and exporting relatively low-priced outputs. It means that the opportunity to sustain a high standard of living through international trade is a declining opportunity.

"The U.S., Western Europe and Japan are overpopulated already in terms of being able to support their present population at its present standard of living if they had to do so entirely within their own boundaries."

of the American Institute of Electrical Engineers and came upon an advertisement for a magnetic material called Deltamex, which showed a highly rectangular hysteresis loop. The material was being sold for use in magnetic amplifiers. It was being used with dc bias to control the saturation, thereby controlling the transmission of ac energy through the transformer. The end point was a nonelectronic amplifier.

Forrester realized at once that the material had certain properties he needed, nonlinearity in electrical behavior and a 3-D storage capability.

"So in the spring of 1949 I set about trying to work that kind of magnetic material into the concepts I had formulated earlier. And in a period of two or three weeks we had the magnetic-core storage."

A number of experimental memories of varying sizes were developed. The first units started as  $2 \times 2$  and then  $4 \times 4$  arrays, with metallic cores. Later, ferrite cores replaced the metallic cores. By 1953 the memory attained access times of 6 ms and the arrays grew to  $32 \times 32$  and then  $64 \times 64$ , at which point they were considered adequate for use in the early Whirlwind computer.

The Whirlwind I was built at MIT by the Digital Computer Laboratory of which Forrester was director at the time.

His change from engineering development work to managerial and social activities was a lot more gradual than it might seem, he explains. After all, managerial as well as technical skills were required to develop a high-speed computer when none of the components existed, and to develop a major computerized air defense system when nothing of the sort had ever been done before.

The project required the coordination of sev-

eral military agencies and a number of contractors. "Our people had to be equally at home in discussing the crystal structure of ferrites, air defense tactics, or budgets and contracts."

Forrester realized when the project was finished in 1956 that "technological successes were more managerial successes than they were scientific. The right kind of managerial environment produces technological success whereas the wrong kind will suppress it."

The project had also given Forrester insight into the nature of managerial processes—into the problems and difficulties encountered by large organizations.

"The work left me feeling that the challenge was to understand the nature of the decision-making system, the nature of the social structure in which technology is set. That was more of a challenge and more important to the future than technology simply for its own sake."

The future is going to be determined more by the dynamics of the social system than by the opportunities in technology, Forrester says.

"On the other hand, some engineers have a better background for dealing with social and economic problems than do people who have been trained in the social sciences," Forrester believes. "In the future, to understand social dynamics, a knowledge of dynamics as taught only in technological fields is vital. Also, that knowledge must be coupled with first hand knowledge of the nature of organizations—knowledge one gets from the practice of management.

"Those people who have a good technical background in dynamics and who are successful in management are the very people who are in the best position to change careers and do something about understanding social systems." ■■



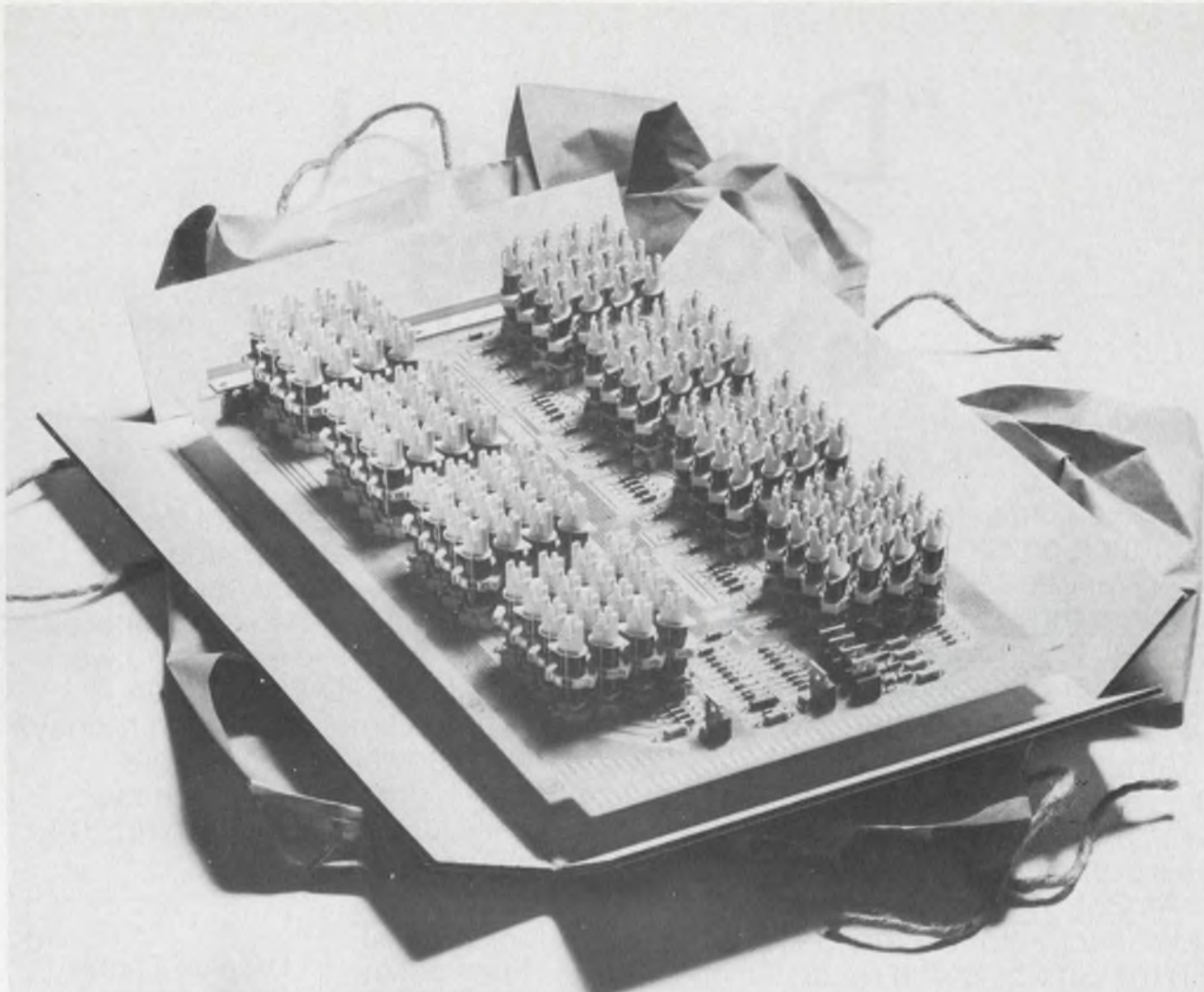

# Hot signal switching to go.

Here's a shortcut to your next state-of-the-art voice and data switching system. Our standard matrices and high-rise Correeds.

They help you design your system without long lead time or a big budget. And because they're standard items, you get the components you need fast.

Many matrix configurations are available, with either magnetically latched or electrically held crosspoints. You can create single- and multi-stage networks of any size by connecting two or more matrices together. Or, just buy our Correed crosspoints and build your own matrices, if you wish.

Correeds make the most of any matrix design. They give you high-density packaging. Millisecond switching speed. Very low insertion loss, noise and crosstalk. And millions of

trouble-free operations.

Why start from scratch? Start at THE SOURCE: GTE Automatic Electric.

For more information on matrices or Correeds, send the coupon below. Or call John Ashby at (312) 562-7100, ext. 250.



(Actual Size)

Please send more information on Correeds and matrices.

on \_\_\_\_\_ of \_\_\_\_\_

(Quantity) (Product)

Name \_\_\_\_\_ Title \_\_\_\_\_

Company \_\_\_\_\_

Address \_\_\_\_\_

City \_\_\_\_\_ State \_\_\_\_\_ Zip \_\_\_\_\_

Telephone \_\_\_\_\_

Mail to: Mr. J.D. Ashby, B-4, GTE Automatic Electric, Northlake, Illinois 60164

**GTE AUTOMATIC ELECTRIC**



# "Digital Signal processing is too much."

"Too much time. Too much money. Too much power." Not anymore.

Advanced Micro Devices announces three easy-to-use, economical, low-power Schottky circuits for high-performance digital signal processing.

Am25LS14. It's an 8-bit by 1-bit serial/parallel LSI multiplier that performs digital multiplication in two's complement notation.

Am25LS15. It's a quad, serial adder/subtractor designed for use with the Am25LS14 in recursive and nonrecursive digital filtering or butterfly networks in Fast Fourier Transforms.

Am25LS22. It's an 8-bit serial/parallel register with sign extend for use with the Am25LS14.

These devices can be used together to implement digital filters, FFT processors, spectrum analyzers

and data compression and transmission systems at rates above 30MHz and at cost and speed/power levels lower than ever before achievable. And, like everything we make, it's MIL-STD-883 for free.

Too much time? Too much money? Too much power? Not anymore.

Digital Signal processing has arrived. Ask for it by name: Am25LS14, Am25LS15 and Am25LS22.

Digital Signal Processing Handbook. 

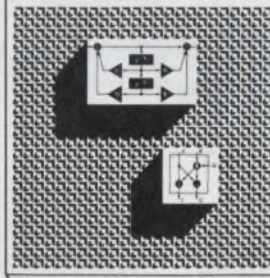

Drop us a note on your company letterhead, and we'll send you the 86-page Digital Signal Processing Handbook. For free.

## Advanced LP/Schottky



Advanced Micro Devices • 901 Thompson Place, Sunnyvale, California 94086 • Telephone (408) 732-2400  
Distributed nationally by Hamilton/Avnet, Cramer and Schweber Electronics.



# Microprocessor Design

## High-level languages, more throughput expected for next generation of $\mu$ Ps

*Federico Faggin, president of Zilog, Los Altos, CA, presents his views here for ELECTRONIC DESIGN readers.*

The next generation of microprocessors will be simpler to use from both the hardware and software points of view. The trend is toward more throughput and high-level languages.

The instruction set will become more suitable for high-level languages, by reflecting the structure of its programs. In effect, a program written in a high-level language will translate directly into machine code—which is very efficient, if we do our job right.

Nobody would program a digital computer using assembly language now; the cost of programming is skyrocketing. With hardware as cheap as it is, the ability to program in a high-level language will increase throughput tremendously and reduce programming time.

The throughput of a  $\mu$ P can be improved in many ways. The most obvious is to increase the speed with which instructions are handled. But you can also increase the number of functions performed by each instruction. Obviously, the more functions of each, the fewer instructions required.

If you write a sentence with a richer



vocabulary, you can do so in fewer words. In the same way, a high-level language uses less storage, and takes less time to read. That translates into greater throughput.

A high-level language also simplifies your software development. The fewer the words you write, the less debugging you have to do and the

*(continued on page 118)*

### Four cards offer choice of different processor systems

A series of four microcomputer cards is sufficiently self-contained to be integrated rapidly into an OEM product. The cards, manufactured by Microcomputer Associates (2589 Scott Blvd., Santa Clara, CA 95050. 408-247-8940), are each based around a different microprocessor: the 8080, 6800, 6502 or the 2650.

In addition to containing the particular  $\mu$ P, each card also holds a crystal-controlled clock, a 1-k  $\times$  8 static RAM, 24 bidirectional I/O lines, buffered address and data lines, DMA capability, interrupts, and 2 k  $\times$  8 PROM sockets. Existing software aids may be used to generate programs. Board size is 4.25  $\times$  7 in., and the cards come fully assembled, tested and guaranteed over the 0-to-70-C temperature range.

Prices start at \$375 in single quantities and \$295 in 100 unit orders. Delivery is 30 to 45 days.

CIRCLE NO. 501



## MICROPROCESSOR DESIGN

(continued from page 117)

faster you get it done. You save money in development and you actually save money in hardware also, because less storage is required to hold a smaller program.

Another benefit we can expect from the next generation of  $\mu$ Ps is greater throughput. A common problem occurs now when a  $\mu$ P is used to service I/O units. A specific I/O device may have a routine that must be performed every so often. But every  $\mu$ P will have its limit, and very often you will find that if there are a couple of I/O devices needing service, the  $\mu$ P throughput becomes a bottleneck.

The normal design reaction is to put some logic

around the I/O and do some of the processing in the hardware. Then the  $\mu$ P will perform only basic control functions. By the time you are through, you have thrown a lot of logic around your I/O.

And that's money—as the user always finds out. The trouble is he finds it out only at the end because at the start he can't tell whether the  $\mu$ P needs additional random logic to do the job.

Adding a  $\mu$ P with a much higher throughput allows you to simplify both your design hardware and your software development. The simpler a system is the easier it is to design and understand.

Usually, having a simpler system automatically translates into fewer problems in the field and fewer components that can go wrong. Eventually that all shows up on the bottom line.

---

## Industrial $\mu$ C shrinks size and boosts performance

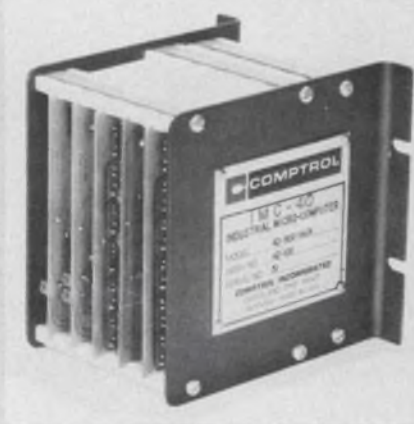

The IMC-40 industrial microcomputer can replace many larger machine and process-control systems. The  $\mu$ C consists of a 4040 CPU and can hold up to an 8-kilobyte control program. Since the I/O circuits use high-noise-immunity logic, the IMC-40 is practically immune to industrial noise.

Other features of the IMC-40 include the following: subroutine nesting of up to seven levels, decimal and binary arithmetic logic modes, 60 instructions, 24 scratch-pad registers, 5120-bit data storage and unlimited I/O expansion capability. The  $\mu$ C, developed by Comptrol (9505 Midwest Ave., Cleveland, OH 44125. 216-659-6126) is directly compatible with most industrial logic card systems, but a complete array of interface modules,

peripheral equipment and software is also available.

Prices for the IMC-40 start at \$495 for a three-card unit with 80 words of data storage, 512 words of program memory and 32 I/O lines. Delivery is from stock.

CIRCLE NO. 502

---

## Magnetic-tape system works with 8080 and 6800

Offering easy interfacing and compatibility with any microprocessor system, the Model 30-002 MicroVox Dual-Magtape Peripheral has two magnetic tape transports, one for writing and the other for reading. The peripheral from Micro Communications Corp. (80 Bacon St., Waltham, MA 02154. 617-899-8111) provides a parallel, eight-bit data bus and requires four handshaking signals for communication control with a microprocessor. The unit's interface is fully compatible with an Intel 8255 programmable peripheral interface or Motorola 6280 peripheral interface adapter.

(continued on page 120)







## UNIVERSAL MODEMS

Making data move is the name of the game in today's switched or dedicated line networks. If you're moving it at any speed up to 2400 BPS, Universal Data Systems has the proper modem for reliability, economy and efficiency in your system.

UDS has more than 20,000 modems in active field service, and that total is growing by more than 1000 units per month. Our product line includes CMOS 201s, plus 103s, 202s and the multiple-modem RM-16 which contains up to 16 units in any configuration mix you desire.

In addition to our products, we're extremely proud of our customer service. Check us out: Call us on the telephone. You'll like what you hear.



See us at NCC;  
Booth #3426



# universal data systems

member of  
IDCMA

4900 Bradford Drive • Huntsville, Alabama 35805 • Telephone (205) 837-8100 • TWX 810-726-2100

Created by Hall & McKeese Advertising, Winter Park, Florida

CIRCLE NUMBER 46



## MICROPROCESSOR DESIGN

*(continued from page 118)*

The company's continuous-loop wafer cartridges are the storage medium in the peripheral. Available with the peripheral are a pair of prewritten wafers containing a monitor, editor and assembler, all in Intel 8080 object code and requiring 4-k of RAM for proper execution. The software support package was developed by Microcomputer Technique, (Reston, VA).

To use the peripheral with an 8080 CPU, the user loads the editor routine into his 8080 RAM and creates a new file (8080 source program) on

a wafer in the MicroVox write transport. The text buffering operation of the editor is completely transparent to the user, allowing him to enter his program without keeping track of current buffer status. After the program is edited, the user loads the MicroVox assembler and uses the information on the edited wafer as the data for the assembler.

The wafer containing the assembled program then can be set aside for future use. The assembler uses the same instructions as the Intel assembler, except for macro generation. But the MicroVox assembler reportedly requires significantly less time than Intel's.

The Model 30-002 sells for \$995. Delivery begins in August.

*Booth No. 1829*

*Circle No. 503*

---

## Keyboard-accessible RAM speeds program development

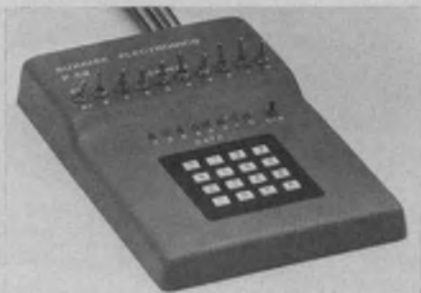

You can cut program development costs for  $\mu$ Pcs by using a random-access memory that can be programmed by a remote keyboard. At least that's what Sunrise Electronics (228 N. El Molino, Pasadena, CA 91101. 213-793-7552) says about its series of KPRAM development tools.

The KPRAM is a RAM coupled with a 16-key keyboard, eight address switches and an eight-bit LED display. Four versions are available: the P-24, with a  $256 \times 4$  memory;

the P-28,  $256 \times 8$  memory (intended as a replacement for the 82S114); the P-54,  $512 \times 4$  memory; and the P-58,  $512 \times 8$  memory. Each unit accepts the hexadecimal data entered on the keyboard and has an access time of 1000 ns (450 ns is optional). Size of the KPRAM is  $8.25 \times 5.25 \times 1.6$  in.

The data bus uses three-state logic and is active only when the data or display-memory button of the KPRAM is depressed. The eight LEDs can display information on the data bus either continuously or on command. The KPRAM requires 5 V at 200 mA and can interface with MOS, CMOS and TTL loads. Prices of the KPRAM start at \$225 for the P-24 and range up to \$525. Delivery is from stock.

**CIRCLE NO. 504**

---

## Board combines in-circuit emulator and programmer for 8080



The two most needed microprocessor hardware-development tools, an in-circuit emulator and PROM programmer module, now come on a single plug-in board. Called the M8-40, the board works in conjunction with the Model 8/16 development system from Microkit (2180 Colorado Ave., Santa Monica, CA 90404. 213-828-8539). The combination emulator and programmer costs \$1100, which includes all software and cables.

The Microkit-8/16 is a complete stand-alone system for developing 8080 hardware and

*(continued on page 122)*



# Berg Quickie Connectors are the logical cable interface for Digital minicomputers

Berg Quickie™ Connectors rapidly, reliably terminate multi-lead, flat, round conductor cable—without pre-stripping. Quickie designs allow for visual inspection before and after assembly.

Digital Equipment Corporation likes the Quickie connector's ease of termination and how its askewed tines strip away insulation to assure positive electrical contact. They like the way Quickie Headers latch to maintain connection integrity through vibration and impact. Digital has found it can rely on Berg . . . to supply the products and the application

machines that precisely meet its demanding interconnection needs.

Berg is experienced. We read interconnection needs like Digital computers read data. We have the products, the background, and the back-up to do the job. Your job. Let's work on it, together. Berg Electronics, Division E. I. du Pont de Nemours & Co., New Cumberland, Pa. 17070—Phone (717) 938-6711.



**BERG ELECTRONICS**

CIRCLE NUMBER 47

**We serve special interests—yours!**

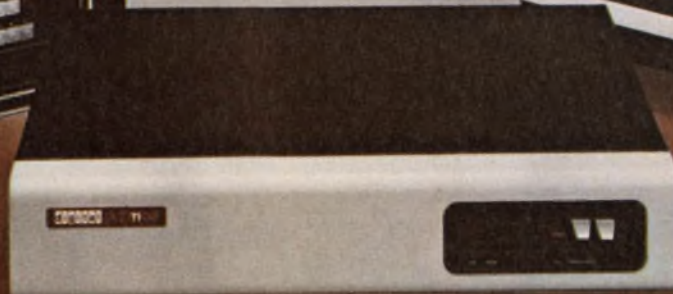
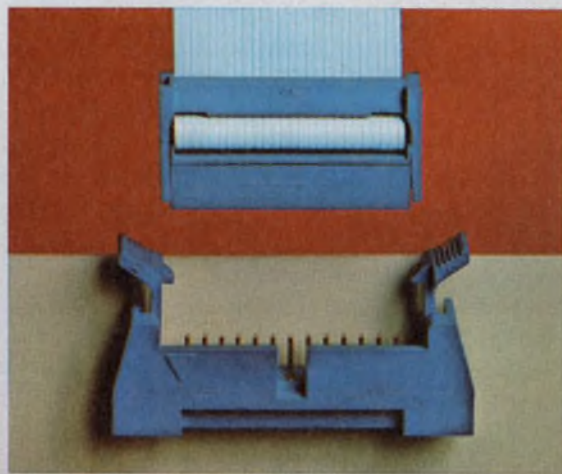



## MICROPROCESSOR DESIGN

(continued from page 120)

software. The in-circuit emulator extends the system's debugging monitor directly into the user's 8080 system. A 40-pin dual-in-line plug is provided to connect into the 8080 socket.

The in-circuit emulator permits hardware and software breakpoints, allowing the user's system to be stopped for examination of system status. Single-step and slow-step modes provide for

program tracing with both register and 168-byte-memory display at each instruction step. Any combination of user and system memory may be used for test programs and data. And the emulator allows DMA within the user's system.

The PROM programmer portion of the M8-40 module provides all of the necessary features to automatically program and verify the 2708/2704 (8708/8704) UV-erasable PROMs. System software allows the PROM images to be stored on cassette tape, floppy disc, or paper tape.

Booth No. 1034

Circle No. 505

## 2 programmable LSI chips extend versatility of 4-bit $\mu$ Cs

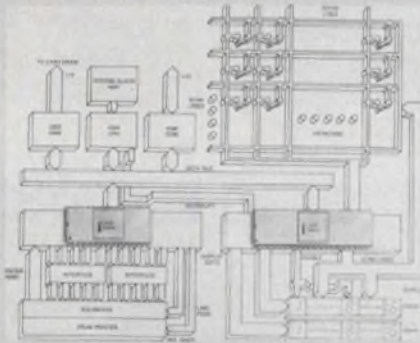

With the availability of two software-programmable devices—the 4269 keyboard/display unit and the 4265 general-purpose I/O unit—users of Intel's MCS-40 family of 4-bit  $\mu$ C systems can reduce the number of components needed to operate an increased number of peripherals. The MCS-40 family is based on the 4004 and 4040  $\mu$ Ps and consists of components that can be used with either  $\mu$ P. All ICs are available from Intel (3065 Bowers Ave., Santa Clara, CA 95051. 408-246-7501).

The new devices have built-in logic functions that simplify program routines and take care of local control functions for the CPU. In addition, the new 4265 I/O

device provides a convenient interface between MCS-40 and MCS-80 systems, which are based on the company's 8-bit 8080  $\mu$ P. With the new I/O unit, a system designer can either add an MCS-80 peripheral component to an MCS-40 system, or he can integrate MCS-40 and MCS-80 systems in multiprocessor applications.

The 4269 keyboard/display unit is a general-purpose interface and control unit for "man-machine" communication devices. As an input, for example, it can interface keyboards up to full teletypewriter size. As an output, it can control and refresh either numeric or alphanumeric displays, including Burroughs Self-Scan displays.

The 4265 I/O unit provides four software-configurable I/O ports (16 I/O lines) and a variety of peripheral control capabilities. The four ports can operate in 14 software-selectable modes, enabling the new unit to interface MCS-40 systems with virtually any kind of peripheral equipment.

Both circuits are available in sample quantities for about \$10 each.

CIRCLE NO. 506

## Multitask executive system works with 6800 processors

A multipurpose operating system has been developed for systems based on Motorola's M6800  $\mu$ P. The MTOS-68 real-time system consists of a 3-kilobyte control program in ROM, a 256-byte scratchpad RAM and an adjustable interrupt clock. The system, offered by Industrial Programming, Inc. (9 Northern Blvd., Greenvale, NY 11548. 516-621-8170), is available as a board that plugs directly into any Motorola Exorciser. Other configurations are also available as required for specific applications.

The MTOS-68 provides four kinds of service: management of tasks; coordination of shared subprograms; management of time; and input and output for console messages. A detailed user's guide for MTOS-68 is available for \$10 and the system, when configured for the Motorola Exorciser, costs \$2000. Delivery is in 30 days.

CIRCLE NO. 507

(continued on page 124)



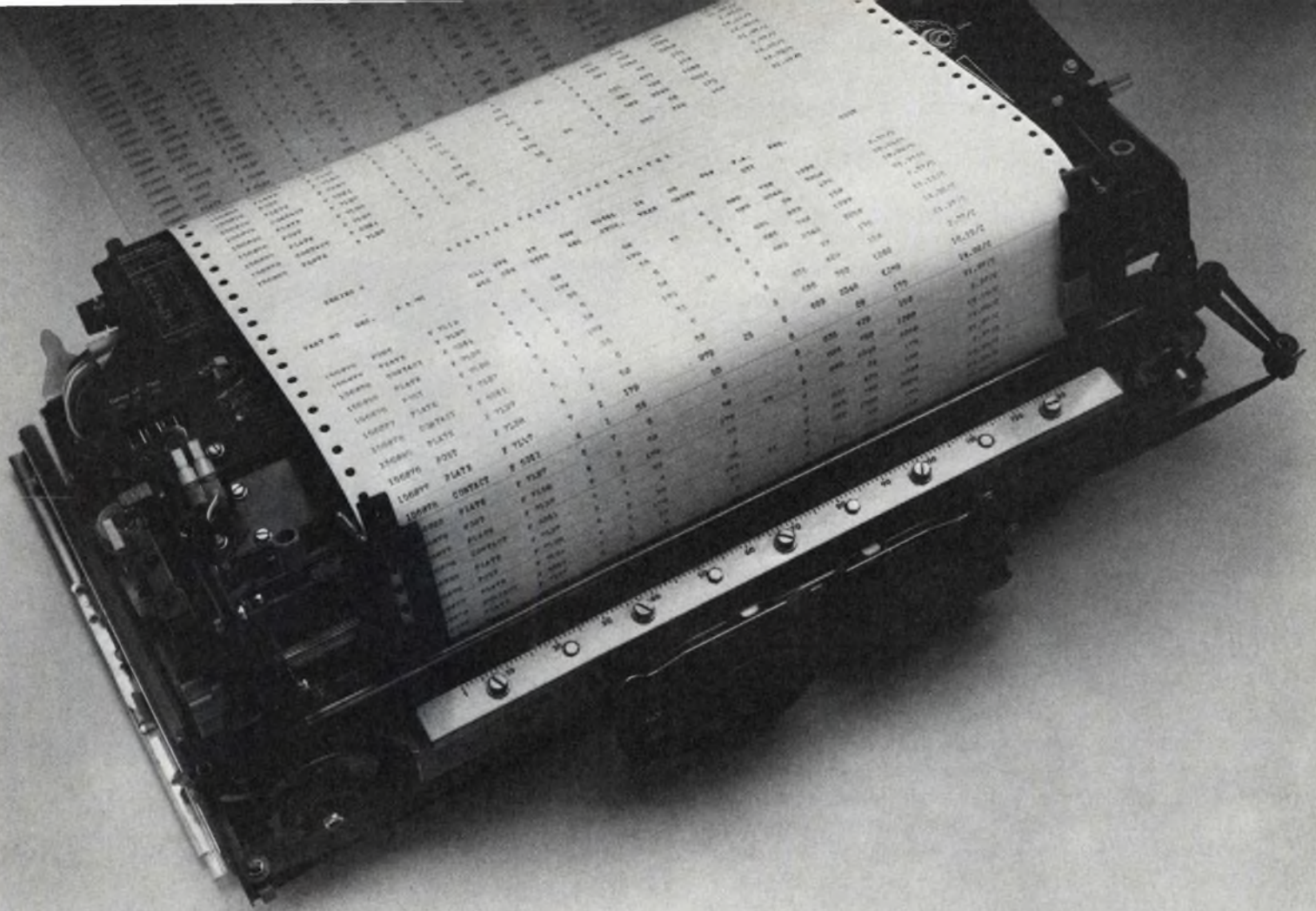

**The Teletype model 40 OEM printer.  
When you look at it from price and performance,  
you'll find it difficult to look at anything else.**

The fact of the matter is simply this:  
We don't think any other printer can even come close to the model 40.

And that's no idle boast. Not when you consider the facts.

Consider: Where else can you get a 132-column, heavy-duty impact printer that delivers over 300 lines per minute for less than \$2000, or an 80-column printer for under \$1400?

The big reason behind the model 40's price/performance advantage is our unique design.

Even though it operates at speeds of more than 300 lpm, wear and tear is less than you'd find in a conventional printer operating at considerably slower speed. Fewer moving parts and solid-state components add up to greater reliability and reduced maintenance.

Here's something else to consider: Where else can you get a printer that delivers the kind of flexibility and reliability the model 40 offers?

For complete information, please contact our Sales Headquarters at: 5555 Touhy Ave., Skokie, Ill. 60076. Or call Terminal Central at: (312) 982-2000.



**The Teletype model 40 OEM printer.  
Nothing even comes close.**



## MICROPROCESSOR DESIGN

(continued from page 122)

### SC/MP-based kit can expand to complete system

The latest  $\mu$ P kit not only takes the pain out of getting a microprocessor system up and running, it can be used as the basis for a complete development system. Called the LCDS (low-cost development system), the kit is based on the 8-bit SC/MP microprocessor. The new kit is due out later this month and is expected to cost less than \$500. Both it and the SC/MP are offered by National Semiconductor (2900 Semiconductor Dr., Santa Clara, CA 95051. 408-732-5000).

Like other assembled kits from  $\mu$ P and other manufacturers, LCDS permits access to the  $\mu$ P's data and control lines. Also it allows simple programs to be entered, in hex code, into the main memory. The new kit is able to manipulate and display the program, and to control program execution in a way that permits bugs to be corrected as they are discovered.

However, unlike assembled kits offered in the same price range from other microprocessor makers, the new unit can be expanded readily to encompass all the memory and I/O that could be required in the final application. Further, it can interface to a terminal for full-keyboard input and hard-copy output. The kit even allows easy interfacing to inexpensive bulk storage—such as cassette and paper tape—for rapid program loading and saving.

The new kit is built around a motherboard, or main board, that functions as both backplane and application-card cage. Holding all control circuitry, the main board provides the following: 16-key pad for program entry, seven control switches, six LED digits for data and status display, and a 20-mA-loop interface. Also included are controlling and debugging firmware.

The motherboard accepts a CPU and memory card that contains the SC/MP microprocessor, support logic, 256 bytes of RAM and a socket for 512 bytes of ROM or PROM. Additional slots can accommodate system-expanding memory and I/O cards. The entire system runs off 5 and -12-V supplies.

A simple control system, like that for a relay, exemplifies how the LCDS can be applied. The controller must activate the relay for a short interval each time a delay is required.

Such an application makes use of a SC/MP instruction that activates a bus line called Delay. It goes High during operation.

The Delay line interfaces to the relay through a rudimentary driver circuit that translates bus signals to those levels needed by the relay's solenoid. The circuit can be placed easily onto an

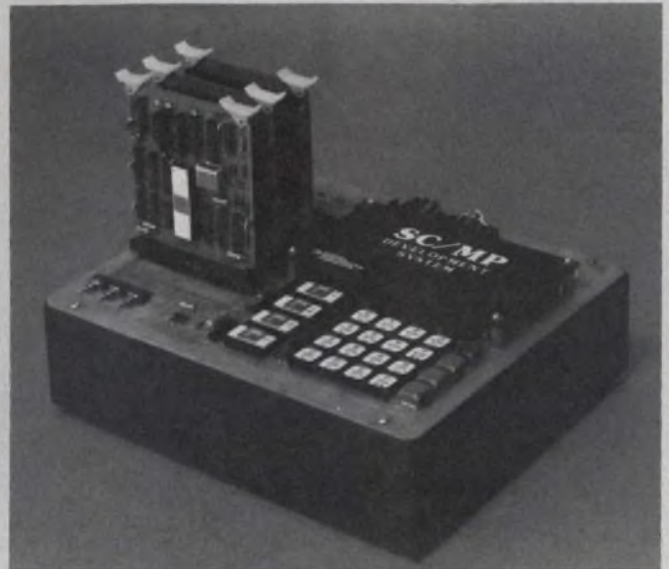

Operation	Code	Comments
LDI 255	C4 FF	Load accumulator with 255 (FF)
DLY 255	8F FF	Delay for 0.263 seconds assuming 2 $\mu$ s cycle time
DLY 255	8F FF	Delay for 0.263 seconds
DLY 255	8F FF	Delay for 0.263 seconds
DLY 255	8F FF	Delay for 0.263 seconds
HALT	00	Halt the processor

A short routine activates a relay for about a second each time the delay is required.

LCDS application card.

The short program shown will turn on the relay for about a second then turn it off. An LCDS user enters the routine into RAM via the keyboard. Since the program doesn't contain labels or branches, it can reside anywhere in memory. The user simply selects a starting location and enters each byte of code consecutively into ascending locations. He executes the program by depressing a Run key.

The delay program can be used as a subroutine for any program that needs it, and can be modified in several ways. For example, you can alter the delay time by putting different values into the second byte of the instruction, or into the  $\mu$ P's accumulator. Or you can build an eight-station timer by putting a 3-to-8 decoder into the Delay line and controlling it with SC/MP flag bits.

CIRCLE NO. 508



*If you buy  
a prom programmer  
before you read this  
you're making a  
big mistake!*

You can spend a lot of money and get practically nothing if you aren't careful.

**Here's what to test for:**

1. Is the programmer universal? Does it equip you for "tomorrow?" Will it program every available PROM type? (At last count there were over 165.)

2. Are programming techniques approved by the semiconductor manufacturers?

3. Can the programmer be calibrated? By you? Can performance be verified to PROM manufacturers' current specifications?

4. Is the programmer supported by direct sales, installation, training and service?

If the programmer is from Data I/O, it passes the test. Today, more than 1500 companies use Data I/O programmers. We build a complete range of machines including the Programmer V which has outsold every other automatic programmer in the



world (including the former world champ, the Data I/O Programmer I).

**Data I/O total three point service.**

1. Every Data I/O customer receives a quarterly update on currently available PROMs.

2. Through our direct (computerized) mailing program, Data I/O customers are kept constantly up-to-date on PROM specification changes and technological innovations.

3. Nine field offices in the U.S.A. and 22 distributors worldwide provide our customers with direct sales support, installations, operator training and service.

**Get the facts** .....

If you would like to know more about our products, or want copies of our quarterly PROM Comparison Chart and PROMBITS (our periodic technical bulletin on PROM applications and innovations), mail this coupon or call one of our offices. Data I/O Corporation, P.O. Box 308, Issaquah, Washington 98027.

Name \_\_\_\_\_

Title \_\_\_\_\_

Company \_\_\_\_\_

Address \_\_\_\_\_

City/State/Zip \_\_\_\_\_



**Data I/O**

CIRCLE NUMBER 49



### A microcomputer needn't take many ICs.

The partitioning of functional elements in the F8 permits a complete  $\mu$ C to be assembled from just two LSI circuits.

Unlike most other microprocessors, the F8 uses two chips rather than one. But because of features not found in other  $\mu$ Ps, the F8 can actually lead to more compact systems than those based on single-chip  $\mu$ Ps.

By a special grouping of functional elements, the F8 eliminates the address bus, equalizes chip size, and reduces pin and parts count (Fig. 1). This partitioning also simplifies and speeds instruction execution.

The result: the two-chip system has sufficient RAM, ROM, interrupt and I/O capability to handle most control applications.

#### System structure allows easy expansion

A minimum F8 system consists of the 3850 central processing unit (CPU) and the 3851 program-storage unit (PSU), both of which come in 40-pin packages. Expanded RAM, ROM, PROM and I/O can be obtained with additional components, as indicated in a cash-register application (Fig. 2).

The F8 relies on two busses. A time-multiplexed 8-bit bus handles all data-addressing functions, and a 7-bit control bus coordinates and synchronizes the activity of the remaining F8-system components.

A significant number of pins for I/O and interrupt operations is available on the primary devices. The CPU and PSU have a total of 38 pins dedicated to these functions, accounting for more than 47% of the pins. Thus, as system requirements increase in complexity, the F8 allows a corresponding increase in the number of I/O lines and interrupt levels.

Each PSU provides 1024 bytes of ROM and 16 lines of TTL and CMOS-compatible, output-latched I/O that operates in a bidirectional manner. The PSU also features a programmable timer.

Additional savings in the number of packages accrue from the inclusion of a system-clock generator and power-on-reset function on the CPU. Also, for a number of applications, the CPU's

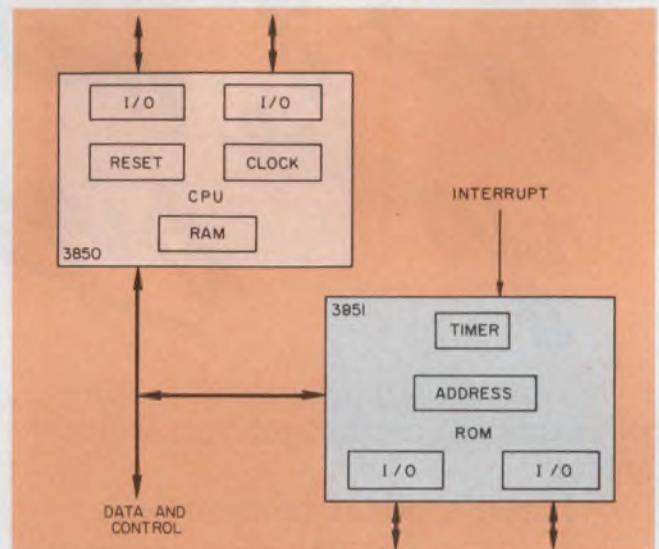

(a)

- 1024  $\times$  8-bit bytes of program-storage ROM
- 64  $\times$  8-bit bytes of RAM
- Vectored interrupt
- Programmable timer with vectored interrupt
- Subroutine stacking
- Internal clock generation
- Power-on reset
- 32 bidirectional TTL-compatible I/O lines with latched outputs
- 4- $\mu$ s I/O cycle time at the CPU ports, 8  $\mu$ s for PSU ports
- 2- $\mu$ s instruction time
- 69 basic instructions
- Memory pointers for RAM and ROM reference

(b)

1. Two LSI chips comprise the minimum F8 system (a). One chip is the 3850 CPU, and the other is the 3851 program-storage unit. The latter performs all addressing functions, eliminating the need for an address bus and permitting the extra pins on both circuits to be used for I/O. The capabilities of the two-chip system can satisfy the bulk of control applications (b).

64-byte scratchpad memory is large enough to avoid the use of external RAM.

In most other microcomputers, the CPU contains the following: program counter, memory pointer, and the logic to save essential registers and to handle interrupts. However, with the F8 set, these are located in the PSU since they nor-

Larry Sullivan, Application Engineer, Mostek, P.O. Box 169, 1215 W. Crosby Rd., Carrollton, TX 75006.



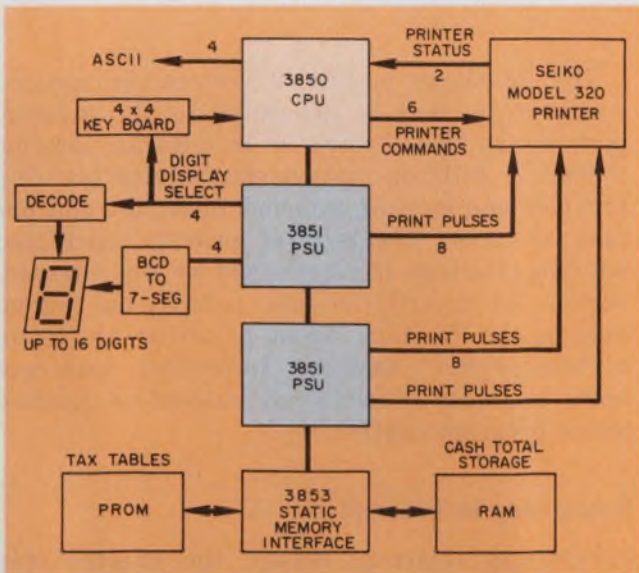

2. A cash-register application uses the F8. Interval timers internal to the PSU permit an orderly scanning of the display, keyboard and printer, without using software timing loops. Cash totals stored in RAM may be polled by a remote data-processing system via the ASCII interface.

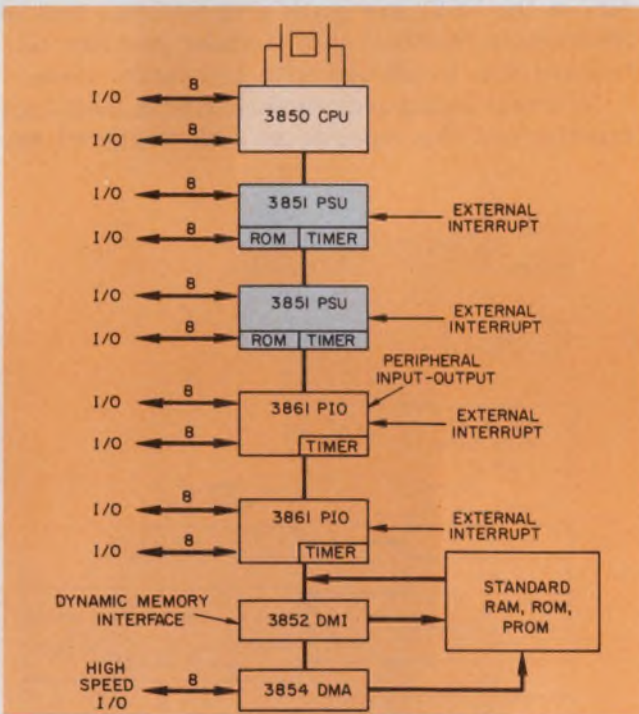

3. The F8 system can be readily expanded beyond the two-chip minimum by adding special support circuits. These may be connected directly together and to peripheral devices, often without interface hardware.

mally operate on the program store and data memory as well as each other. This "all-memory" referencing and addressing frees available pins for I/O.

A system with multiple PSUs has, of course, multiple program counters. However, only one PSU will respond with an 8-bit instruction at the

beginning of any cycle. Page selection within the PSU maintains an orderly flow of instructions.

Applications calling for extensive memory can make use of the 3852 dynamic and 3853 static memory-interface chips (Fig. 3). These devices create a 16-bit address bus that permits the memory-interface chips to range through 64-k words of memory. The devices also incorporate read/write control. As a result, any combination of standard ROM, PROM or RAM may be used for program or data storage when internal memory isn't large enough.

Similarly, for systems requiring extensive I/O, the interface chips allow a mix of PSU and PIO (peripheral input-output) circuits to satisfy system-communications requirements.

For peripheral-to-memory direct-memory access (DMA), the 3854 offers DMA control when used in conjunction with the 3852 memory-interface chip. With the F8, DMA is "transparent" to the CPU, so DMA transfers don't degrade system performance. Once initialized by the CPU, the DMA and memory-interface chips maintain both memory-refresh requirements and transfer control, independent of the processor.

### Internal RAM speeds operation

The 3850 CPU chip contains the usual arithmetic logic unit, 16-bit accumulator, and status registers found on most 8-bit central processing units (Fig. 4). The CPU's 64 × 8-bit scratchpad memory operates 2.5 times faster than external memory would on a bus. The lower 12 of the 64 scratchpad registers are directly addressable, though all 64 registers are indirectly addressable by the 6-bit ISAR (indirect scratchpad address register).

Several scratchpad registers are controlled by specific instructions that link the program counter, stack register, status register, and data counter to the scratchpad. The data paths allowed between elements appear in Fig. 4b.

The CPU's 16 bidirectional I/O lines can be connected directly to standard-TTL devices. All outputs are internally latched. CPU I/O transfers require 4 μs, or half the time needed by other I/O ports in the system. The chip-port addresses are fixed in firmware, and the ports are referenced with In and Out program instructions.

The CPU's clock may be driven by an external source, or controlled by a crystal or RC network. The power-on-reset function gets the system up and running in a "known-state" by initializing the program counter and disabling interrupts. The latter occurs by a resetting of the ICB (interrupt-control bit) in the status register.

The 8-bit bidirectional data bus transmits data and control-port information from the CPU. Special ROM-control lines define 1 of 32 possible



states that the system can have during any instruction-cycle sequence. A decoding of these bits by microcontrollers on other members of the F8 family maintain system synchronization.

### PSU requires mask programming

The MK 3851 PSU is a mask-programmable memory element (Fig. 5). All of its memory-reference pointers—such as program counter and data counter—are 16-bit registers. Inclusion of the pointers for data and program store eliminates the need for a system address bus. Also, their 16-bit length implies that up to 64 PSU or PIO circuits may be used together.

The F8 I/O lines feature electrical compatibility with TTL and CMOS logic families. Output drivers can source 100  $\mu$ A and sink 2.0 mA. The PSU output drivers may also be configured with open drains or as a 1.0-mA source. Outputs are latched without the need for external hardware. The CPU, PSU, and PIO chips each provide 16 lines of I/O arranged as two 8-bit ports.

The CPU ports should be used when I/O speed is most important. The ports are serviced with single-byte instructions requiring only two machine cycles—4  $\mu$ s. Servicing of all other ports requires 8  $\mu$ s.

The F8 allows multilevel vectored interrupts. An interrupt may be generated by the external peripherals, by software, or by internal interval timers. A PSU or static-memory-interface chip provides one level of external interrupt and one interval timer. The level of priority associated with an interrupt is determined by the interconnection of priority-in and priority-out signal lines on the F8 chips. Thus, priorities are set in a “daisy-chain” fashion. Individual interrupt levels also may be selectively enabled or disabled under program control.

### Responding to interrupts

When an interrupt occurs, the affected chip notifies the CPU via an interrupt request. If the interrupt system is armed, and a higher level interrupt is not pending, the affected chip’s interrupt circuitry is enabled. When the CPU acknowledges the interrupt, the program counter vectors to the address specified by the chip receiving the interrupt. Though the interrupt vectors of the PSUs are mask programmed, that of the memory-interface chip is under program control and may be altered with I/O instructions.

Interrupt inputs are compatible with most logic families and they operate as edge-triggered sig-

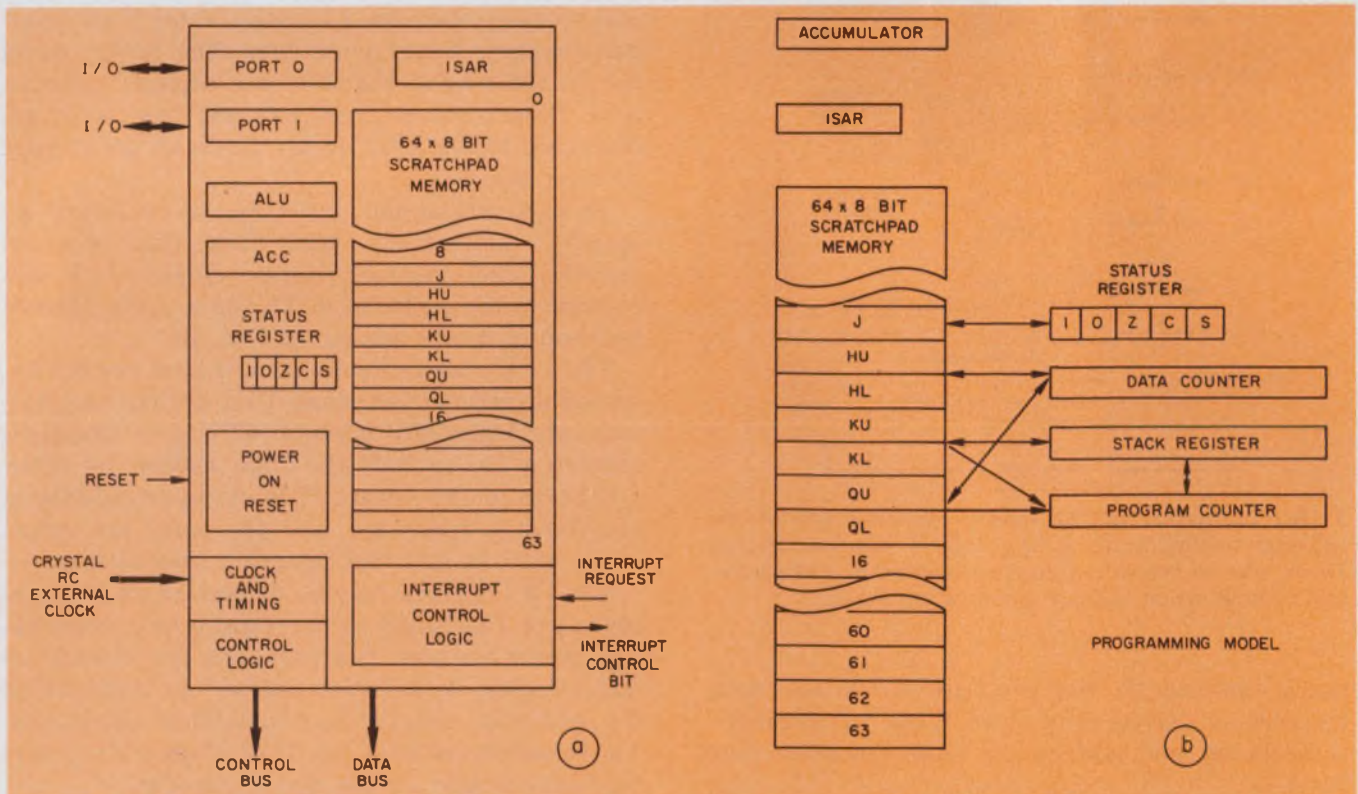

4. The CPU chip contains a 64 × 8-bit RAM, two 8-bit I/O ports and internal clock (a). It also has a power-on reset function and 16 TTL-compatible I/O lines. All 64

registers may be accessed indirectly through ISAR (indirect scratchpad address register), and 12 may be addressed directly (b).



nals. In most cases, these features eliminate the need for additional circuitry.

In other microcomputers, timing intervals are often generated by software timing loops. Only repetitive tasks that can be fitted into the timing loops may be executed.

The F8's programmable timers, however, free the microprocessor from such tasks and allow the processor to solve other problems. In effect, the F8 can perform several tasks simultaneously. In a system with several timers it is possible to have each timer pace a separate peripheral while the main program executes a more complex problem.

If the F8 is implemented with a 2-MHz clock, the timers are programmable in 15.5- $\mu$ s increments up to about 4 ms. When the programmed interval has elapsed, the timer generates a vectored interrupt. The timer counter is viewed by the program as another I/O port; I/O instructions program the timer.

#### Design aids speed development

The F8 Survival Kit offers a quick and easy way to get the microprocessor system up and running. An assembled kit constitutes an evaluation/

development microcomputer with the features indicated in Fig. 6.

To operate the micro, simply attach a 110 or 300-baud ASCII terminal (such as a teletypewriter or CRT monitor system) and 5 and 12-V power supplies. By using DDT-1—designers development tool, the kit's software package—you can load, debug, and modify your own software in the 1-k byte of RAM provided (Fig. 6b). Also included in the kit is a Fortran IV cross-assembler.

An emulator for the PSU can be used to develop and design F8-based systems that employ one or more 3851 circuits. The Emulator is electrically equivalent to the PSU but is field programmable. Thus a user can perform a hardware verification of all PSU programming prior to ordering custom PSU chips.

Also, the Emulator even "plugs in" like a PSU chip (via a male, 40-pin connector on the end of an umbilical cord). Thus prototype systems can be converted to final production status by simply unplugging the Emulator and plugging in the corresponding custom PSU.

The ROM section of the Emulator uses either four 256  $\times$  8-bit ultraviolet-erasable PROMs or a single 1-k  $\times$  8-bit UV-erasable PROM to pro-

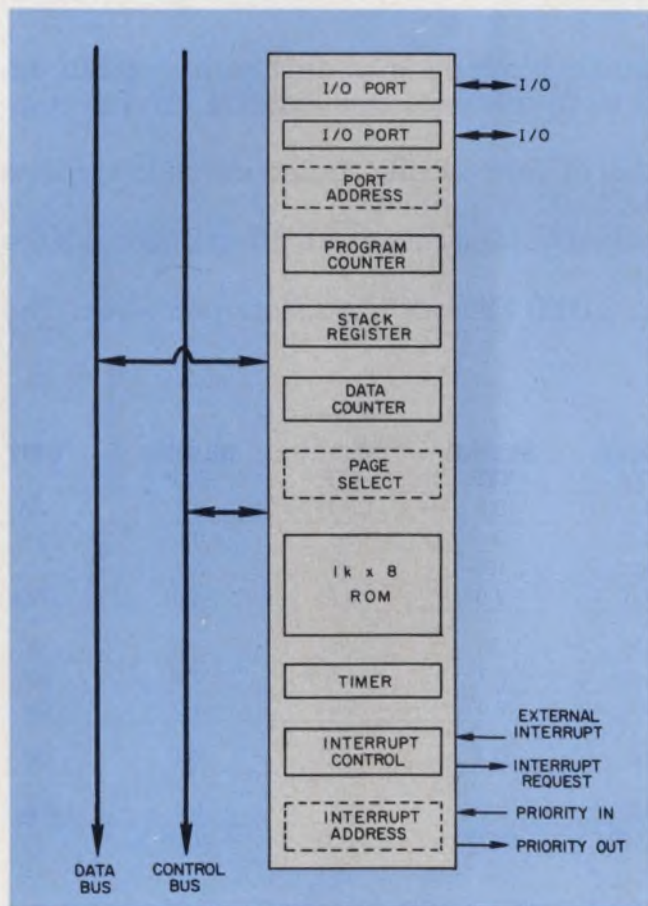

5. The 3851 program-storage unit, a mask-programmable IC, has memory-reference functions.

24-bits of I/O arranged in three 8-bit ports  
 Full duplex TTY interface (20-mA loop)  
 Crystal control clock  
 Automatic power on reset  
 Hardware reset  
 1024 bytes of Random Access Memory  
 Nonvolatile operating system in PSU firmware called Designers Development Tool 1 (DDT-1)

(a)

**Load command**—loads memory from paper tape  
**Dump command**—formats data and output to paper tape punch  
**Type command**—examines blocks of memory from one location to another  
**Copy command**—moves blocks of memory from one location to another.  
**Memory display and Modify Command**—examines and modifies memory one byte at a time  
**Port commands**—displays and modifies the 24 I/O lines  
**Hexadecimal and arithmetic commands**  
**Execute command**—directs program execution to a specific location  
**Breakpoint command**—debugs users software

(b)

6. An assembled Survival Kit forms a compact F8 microcomputer with the features indicated (a). Application software can be written and executed by using commands stored in the PSU (b). The kit comes with a Fortran IV cross-assembler.





**Hard core microwave performance at outrageously low prices!  
 The stripline package they said could never be made!  
 Holds back nothing!  
 A designer's fantasy come true!**

For mature engineers only. Starring the same platinum-silicide/titanium/platinum gold-metalization process used to make devices for hi-rel space applications. And in complementary npn and pnp configurations, too.

The new NEC Micro-X package is a unique line of hermetically-sealed ceramic stripline microwave transistor packages priced as low as \$2.00 in quantity.

This shockingly low price, for a typical  $F_t$  of 5 GHz! Noise figure of 2.6 dB at 2 GHz. It's the real thing!

New automated production yields more than 20,000 Micro-X transistors per week. The kind of transistors designers *really* like!

Check these revealing figures.

Typical Electrical Characteristics ( $T_a = 25^\circ\text{C}$ )		NE 02135	NE 22235	NE 57835	NE 73435	NE 88935	UNIT
Characteristic	Symbol	TYP	TYP	TYP	TYP	TYP	
Collector Cut-off Current	$I_{CBO}$	0.1	0.1	0.1	0.1	0.1	$\mu\text{A}$
Emitter Cut-off Current	$I_{EBO}$	0.1	0.1	0.1	0.1	0.1	$\mu\text{A}$
DC Forward Current Gain	$h_{FE}$	70	80	100	80	80	
Gain Bandwidth Product	$f_T$	5.0	8.0	7.0	3.0	4.0	GHz
Collector to Base Capacitance	$C_{CB}$	0.6	.3	.35	.55	.9	pF
Insertion Power Gain	$ S_{21e} ^2$	6.7	3.5	8.7	14.0	9.0	dB
Noise Figure	NF	2.6	4.0	2.4	2.1	4.0	dB
Maximum Available Power Gain	MAG	11.0	9.0	12.0	17.0	10.0	dB
Frequency for NF, MAG and $ S_{21e} ^2$ Measurement	$f$	2.0	4.0	2.0	0.5	1.0	GHz
Price @ 1K *	=	\$2.50	\$10.00	\$2.75	\$1.35	\$2.10	

\*does not include popcorn; domestic prices only

**CALIFORNIA EASTERN LABORATORIES, INC.**

P.O. Box 915, Burlingame, California 94010 □ (415) 342-7744 □ TELEX 34-9309  
 Sales Agents and Applications Engineers for Nippon Electric Co Ltd U.S.A. □ Canada □ Europe



Set breakpoint address  
 Copy memory arrays  
 Dump memory onto paper tape  
 Execute at specified address  
 Load program (data) into memory  
 Display (and optionally modify) specified memory addresses  
 Display (and optionally modify) specified I/O ports  
 Initiate single-step mode at specified address  
 Type specified memory area

7. A software-development board's supervising system allows debugging commands like these.

vide nonvolatile storage of a user's program. The PROMs should be programmed prior to installation on the Emulator. Six ROM-address select switches can then be used to establish the location of the PROM in the system memory map. I/O ports on the Emulator employ an actual PSU.

A complete development system can be obtained by combining an RS-232 terminal with an F8 software-development board (SDB) and an application-interface module (AIM). The SDB contains an F8 system that can be used in two ways.

As a stand-alone computer system, the SDB offers debugging and assembly software. An engineer designing a microprocessor-based system can begin by developing and debugging his software on the SDB.

Secondly, after his hardware is ready, the SDB (in conjunction with an AIM) can be employed to control the user's target system (the system under development), thus imparting to it the debugging capability of the SDB. It should be noted that the control path is established by replacing the target-system's PSUs with AIMS. In this case, AIMS emulate PSUs but have the added capability of communicating with the SDB supervising system via DDT-2, designers development tool (Fig. 7).

From the control console—teletypewriter or equivalent—the programmer can now perform several tasks associated with system debugging.

Usually the target system is breadboarded in the actual system configuration with empty sockets substituted for each 3851 PSU chip to be used. AIMS are connected to the system through interface cables. The AIMS are then inserted into a standard F8 development system that contains a single SDB for monitoring, controlling and loading each of the ROM boards. Final test and checkout complete the design, and custom masks can be ordered for each PSU. ■■

*The first article in the series appeared in the April 26 issue. Part 2 covered the 8080 and appeared in the May 10 issue. The 6800 will be discussed in the next installment, July 19.*

# One good turn...



# deserves another.

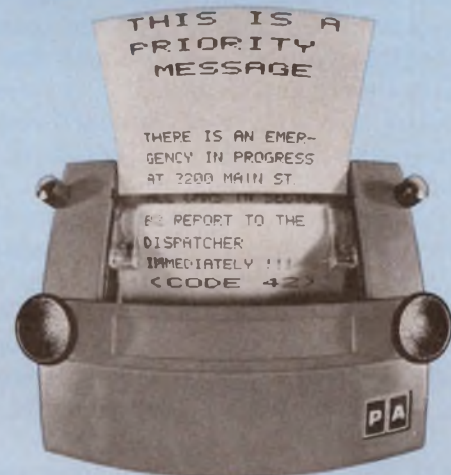

You flipped over our Matri-Dot alphanumeric mini for "first line down" data printing; now we've flipped our design to give you "first line up" text print format, too. So you're ahead, whatever your point of view. Because no one else makes printers as small as 3"H x 3½"W x 7"D. No one else sells them as low as \$140 (in quantities of 100). And no one else offers our features. Instead of a drum, our unique print head purrs along at 138 lines per minute for 18 data columns, even faster for fewer columns. Instead of messy ribbons, our exclusive drop-in ink platen lasts for 75,000 lines and replaces from the front panel. And instead of engraved drum limitations, our 7 x 5 dot matrix characters provide full alphanumeric with a complete ASCII 63 character set. Enhanced characters are also available... 8, 10, 12, or 14 characters per inch. All this, plus multiple-copying capabilities and plug-in panel mounting. No matter how you look at Matri-Dot, it's a turn for the better.

At NCC  
 New York  
 Booth 1631-33  
 35-65-80  
 Characters!



PRACTICAL  
 AUTOMATION,  
 INC.

Trap Falls Road • Shelton, Connecticut 06484  
 Tel: (203) 929-5381



# Multiprocessor control systems

replace a single large processor that has a single memory. When several  $\mu$ Ps are thus linked together, the combination is extremely powerful.

Because of the complexity of microprocessors, their early applications have been the most obvious ones. Mostly they have replaced minicomputers or hardwired logic. But a significant bonus can be realized when several microprocessors are linked together to form an intelligent network.

## Intelligent networks perform many tasks

The concept of multiprocessor networks is well suited for MOS microprocessors ( $\mu$ Ps). First, microprocessors are able to perform many dedicated functions at low cost without the use of supporting electronics or special I/O chips. They can be used as a universal standard component for literally any definable task, particularly data gathering.

Second, the MOS microprocessor, unlike its hardwired predecessor, is capable of generalized data manipulation, information storage and retrieval, and message communications. These attributes allow two or more microprocessors to be teamed to perform tasks requiring cooperation between dedicated and message-handling functions.

Suppose, for example, that microprocessor A is used as a controller for an in-plant telephone switchboard, and microprocessor B is used to control the temperature of the plant. If these two machines are linked we will have the added capability of both transmitting temperature data and controlling the temperature via a telephone line. The added benefits of such a coupled-microprocessor system are derived from the communications link.

A microprocessor network with common memory may perform the same functions as a single large-scale computer. The network provides an efficient information exchange between its constituent microprocessors. For example:

Suppose there are four microprocessors in a

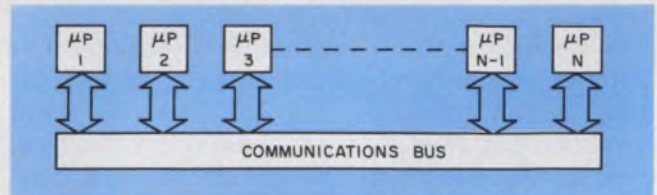

1. Microprocessors linked by a 2-wire bus have the lowest cost communications.

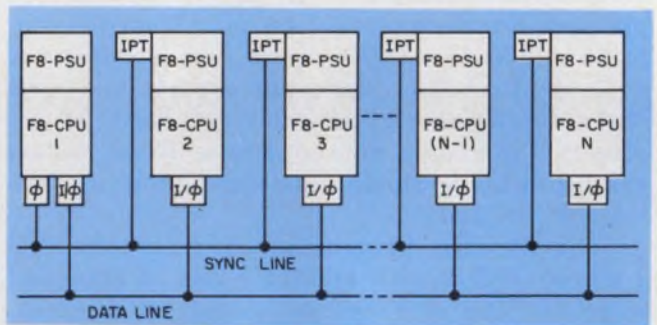

2. With several linked F8  $\mu$ Ps, No. 1 controls data transmission by driving the asynchronous interrupt inputs of the other  $\mu$ Ps.

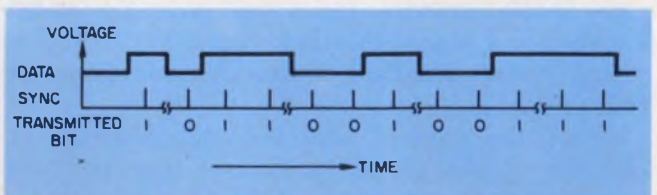

3. A timing diagram illustrates the serial and asynchronous method of transferring data.

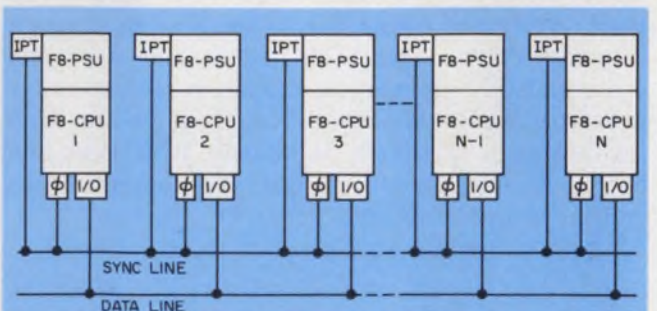

4. Data bus controllers can be dynamically reassigned so that if one device fails another may take over, still allowing the system to function.

**Dr. David Chung**, General Manager, Research and Development, Microsystems Div., Fairchild Camera and Instrument, Mountain View, CA 94042.



certain manufacturing company; A handles the order entry; B controls the manufacturing and inventory; C processes the receivables and payables; and D keeps track of shipping and returned goods. Since each  $\mu\text{P}$  only has access to a portion of the company's total data base, none is capable of compiling a comprehensive month-end profit and loss statement.

But if these  $\mu\text{Ps}$  were arranged to share the same memory, any one of the four would be capable of preparing the statement because each would have immediate access to all relevant data, without human intervention. The network also provides a modular arrangement that eases hardware implementation and software partitioning, and simplifies debugging.

### Supervision by a fixed bus controller

Fig. 1 shows a group of  $\mu\text{Ps}$  linked together via a serial-communications bus, the most inexpensive way possible. Processor-to-processor communications may use any suitable protocol.

Fig. 2 shows an example of such a network, using F8  $\mu\text{Ps}$ . In this case,  $\mu\text{P}$  No. 1 is considered the communications-bus controller. The entire communications bus is made up of only two wires (Fig. 3), one being a bidirectional data line, the other a synchronizing line to strobe the data.

The sync line is also controlled by  $\mu\text{P}$  No. 1, which drives the Interrupt inputs of all the other  $\mu\text{Ps}$  in the network and may be completely asynchronous to CPU operation. All the other  $\mu\text{Ps}$  have access to any transmitted message.

Messages should be formatted to take advantage of the best practices of communications discipline. They should have a header field with the addresses of the transmitter and receiver, a control field, a data field, and a cycle-redundancy check field. In fact, even the synchronous-data-link control (SDLC) protocol can be employed if desired. Since each microprocessor on the network is capable of receiving the check fields and understanding the message format, reliable message transmission and reception is assured.

Periodically,  $\mu\text{P}$  No. 1 will permit one of the

## The trade-offs compared

When MOS microprocessors first became available some three years ago, they were used as if they were inexpensive minicomputers. Then various peripheral controllers were built to supplement the single  $\mu\text{P}$ . That tended to reduce the cost advantage of using the  $\mu\text{P}$  in the first place.

In a single microprocessor system, the CPU has to assume a variety of different tasks, which gives rise to two undesirable consequences: it has neither hardware nor software modularity, and it tends to force the  $\mu\text{P}$  architecture to mimic minicomputer architecture. These trends run counter to the most important advantages offered by LSI technology, namely, low cost and large volume.

The microprocessor possesses two important features that gainfully exploit LSI technology. It takes a minimum number of chips to configure a dedicated function. Also, it permits the easy formation of microprocessor networks.

There are many systems now using a single processor/memory approach that are ripe for a multiprocessor application. Such systems include point-of-sale terminals, electronic automobile control and airborne-warfare control.

If the multiprocessor approach is used, unique controllers, sensors and long wire runs to the CPU for each input could be replaced by a more modular arrangement. The heavy load on a single CPU could be replaced by light loads on multiple CPUs. Software would be simplified in some cases and shorter runs at the lower data-transfer rates used purely for the exchange of processed-data could be substituted.

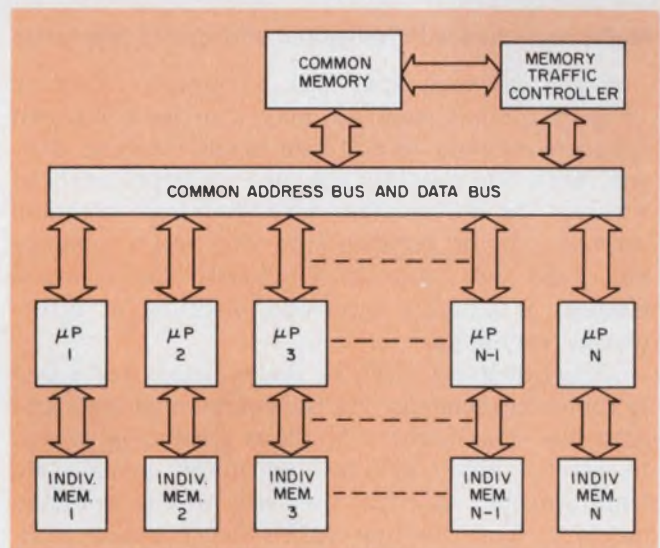

5. Microprocessors may have access to a common memory for general data, and an individual memory for program execution.



other microprocessors to send out a message on the bus. In that case, sync timing is still provided by the bus controller, and the message may address any member of the network.

It would be useful to specify a maximum time interval between two consecutive sync pulses. A period of silence from the bus controller would then mark the beginning of a new message, and spurious pulses at power-on would be disregarded. F8  $\mu$ Ps have no difficulty in determining the time interval between interrupts because they are equipped with on-board timers. There are many possible improvements that can be made to this basic system. The data rate can clearly be increased by increasing the number of data lines, for example.

### Supervision by distributed bus controllers

A more reliable system is shown in Fig. 4. A symmetrically wired system permits the role of the bus controller to be dynamically reassigned. Thus, the failure of one bus controller will not deprive the rest of the network of its ability to communicate, and reliability is improved.

Such a network is especially useful where the individual  $\mu$ Ps are separated from each other by large distances. The two-wire network is ideally suited for controlling a large aircraft. Because of its physical simplicity, a duplicate system forms a practical backup.

A distributed system of the type described above has the following features:

- Simplicity of communication,
- Localized intelligence,
- Modularity,
- High reliability, but is not efficiently organized for multitask operations that must have access to a common memory.

### Multiprocessors with individual and shared memories

A  $\mu$ P network may use a common memory (Fig. 5). Since each  $\mu$ P may also have its own separate memory in addition to the common storage, each one executes its own program without waiting for others. The data that have common interest can be written into the group memory and read out from it. Obviously the common memory is a highly accessible medium for information exchange.

Structurally, all  $\mu$ Ps in the network are wired to the group memory via the common address and data bus. The memory traffic controller is needed to resolve any conflicts that might arise from simultaneous requests for use of the common memory. That function can be incorporated readily into each  $\mu$ P.

The network just described is simple and particularly suited for long-distance communications.

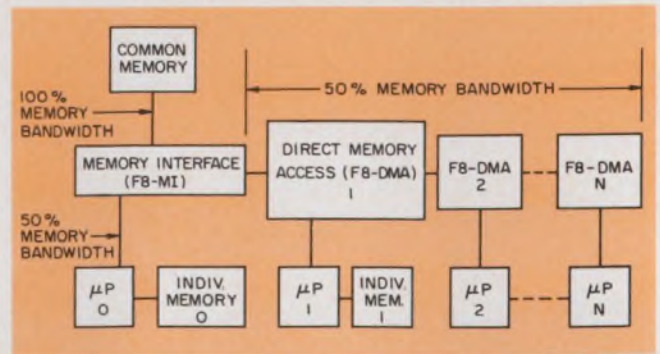

6. A high-speed system may be constructed if individual microprocessors can access common memory through DMA (Direct Memory Access).

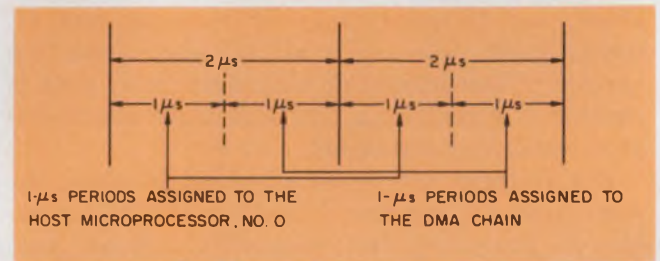

7. Memory time slices are allocated alternately to the host microprocessor and to the remaining processors.

Typically, the common address bus has 16 lines, and the common data bus has eight, so it is clear that the distributed system does not have the simplicity of the two-wire system shown in Fig. 2. Except for the fact that this network is not suited for long distance communications, it is particularly powerful. The system's most outstanding attribute lies in its ability to execute all logically divisible subtasks simultaneously, for subsequent correlation. The ability is especially compatible with low-cost MOS  $\mu$ Ps.

Fig. 6 shows how several F8  $\mu$ Ps gain access to a common memory through the use of a memory-interface chip, the F8-MI, and a direct-memory-access chip, the F8-DMA. Since modern RAM chips are much faster than  $\mu$ Ps, memory also may be accessed by other devices.

Typically, the cycle time of the available RAM chips ranges from 100 to 500 ns, and the shortest execution cycle of the available MOS microprocessors ranges from 1 to 2  $\mu$ s. The memory-interface chip takes advantage of the memory's inherent bandwidth. (If a memory has a cycle time of 1  $\mu$ s, then one million bytes per second may be transferred.)

The F8-MI also splits a 2  $\mu$ s period in two, half for the host  $\mu$ P, No. 0, and half for the DMA chain. The host  $\mu$ P may access the common memory once every 2  $\mu$ s, consuming half the bandwidth or 500-k byte/s.

Since the shortest execution time for most microprocessors, including the F8, is 2  $\mu$ s, the



memory allotment is more than sufficient for the host microprocessor's maximum needs. The remaining 50% of the bandwidth is distributed on the direct-memory-access chain, having also an assigned bandwidth of 500-k byte/s.

Because the  $\mu$ Ps in the network have individual memories, their operations are continuous and independent of the bandwidth assigned to the shared memory.

Each DMA has an assigned task. If  $\mu$ P No. 1 is used as a floppy-disc controller (Fig. 8), DMA No. 1 must be able to accommodate a maximum data-transfer rate of 250-k bit/s or 31.25-k bytes/s. Microprocessor No. 2 might then control a serial-duplex-data link with a transfer rate of 14-k bytes/s. Then, DMA Nos. 3 through N have a worst-case aggregate bandwidth of  $500 - 31.25 - 14$  equals 454.75-k byte/s, a rate that can accommodate many high-speed devices.

The network used in the example, using low-cost F8  $\mu$ Ps, is capable of performing several functions simultaneously. Microprocessor No. 1 specifies locations in the common memory from which data are transferred to or from the floppy disc. These locations in common memory cannot be specified as part of the  $\mu$ P's own instruction memory space.

In other words, the DMA method of accessing the common memory involves an intermediate step of data buffering. That step is quite desirable if a peripheral device such as a floppy disc or a CRT screen is involved, but is extraneous if information fetched from common memory is an instruction executed by the  $\mu$ P. In that case, a network such as the one shown in Fig. 9 is the most suitable.

### Multiprocessors with just common memory

In the network of Fig. 9, all central-processing units share the same common memory. The block designated as the memory interface provides an orderly means for several contending CPUs to use the common memory. The procedure is called a "one-port" memory system, because only one CPU can use the common memory at one time.

The maximum speed is determined by the access time of the common memory. Theoretically, the optimum CPU execution rate should be N times the memory access period, where N is the number of  $\mu$ P chips in the network. The optimum rate provides the perfect match between the memory and the CPU speeds—but if the CPU speed is comparable to the memory speed, a multiport memory system should be constructed (Fig. 10).

In a multiport system, any CPU can have access to any module of the common memory. The block designated as the memory interface is a gigantic cross-bar switch with a built-in conflict

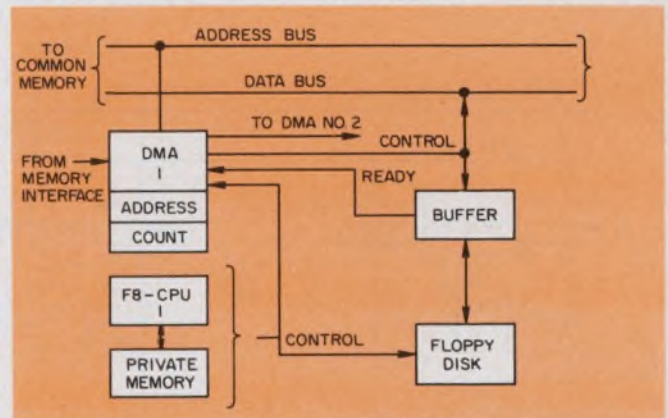

8. A floppy-disc controller requires that data be buffered before use by the microprocessor.

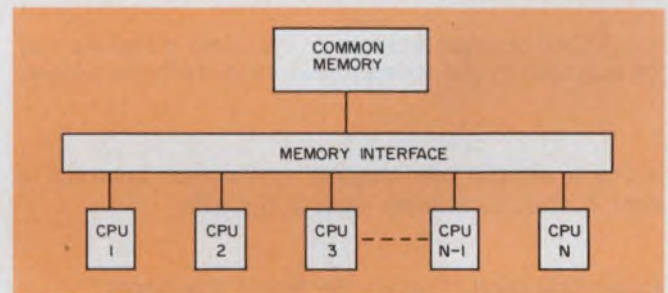

9. Microprocessors sharing a common memory for instructions and data may operate too slowly if CPU speed is comparable to memory speed.

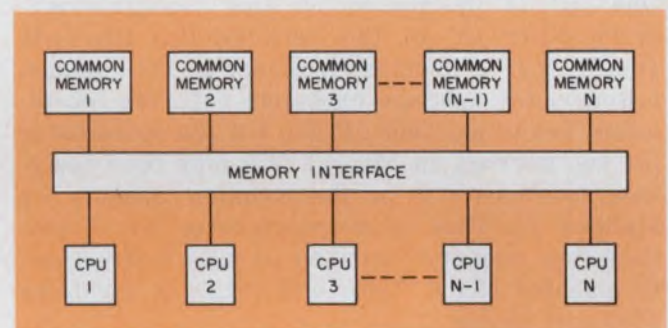

10. Systems that have individual supports of common memory allow fast operation, but require complex memory interface circuitry.

resolver. But this type of switch is rarely used, except in very large computing systems, because it involves a lot of hardware.

A good compromise is available if every  $\mu$ P is autonomous and has its own private memory (Fig. 11). The compromise pre-empts the memory conflict presented in a network that only has a common memory. It nevertheless may have access to a common memory through a pair of isolating buffers controlled by a system-conflict resolver that permits only one  $\mu$ P at a time to use the common memory. Each  $\mu$ P then gains access to the common memory and treats it as a part of its own memory space. Such a system pro-



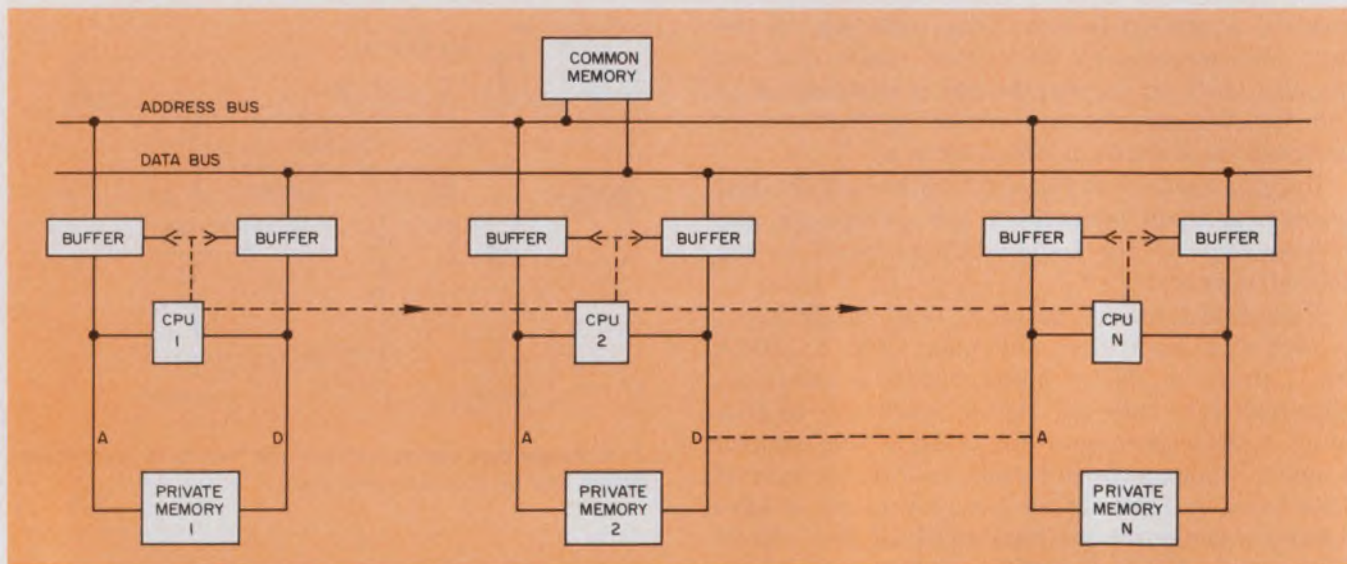

11. Either common memory or dedicated memories may be accessed by the microprocessors in the same address

space. Buffers allow only one CPU to access the common memory in one time period.

vides a simple but elegant synergism between a set of simultaneously operating  $\mu$ Ps.

#### Communication through electronic mailboxes

In a common-memory network, communications between any two microprocessors require no special hardware. Instead, a simple software protocol may be adopted, the "mailbox" system. One  $\mu$ P is designated as the "coordinator;" every other  $\mu$ P in the network has two sets (mailboxes) of memory locations in the common memory, for message exchange with the coordinator. Let us say that  $\mu$ P No. 1 is the coordinator for the network in Fig. 11. We may then designate locations 0-9 in the common memory as Mailbox 12. That is, microprocessor No. 1 uses these ten memory locations to pass instructions to machine No. 2. Data will reside in locations 1000 and higher.

Similarly, we may designate locations, 10-19, as Mailbox 21, which is used by  $\mu$ P No. 2 to deposit messages intended for  $\mu$ P No. 1.

An example may clarify how this mailbox system works. In a certain application of the network shown in Fig. 11,  $\mu$ Ps No. 1, 2 and 3 are respectively the coordinator, the floppy-disc controller, and the data-link controller.

Suppose the coordinator wishes to transmit a record currently stored in floppy-disc 8, track 4, and record 17, to a distant city. It will manipulate the mailboxes in the following way:

1. The coordinator deposits a message in Mailbox 12 saying that  $\mu$ P No. 2 is to fetch the proper record (disc 8, track 4, record 17) to common memory locations 1000-1127.

2. On a periodic scan of its own mailbox (12),  $\mu$ P No. 2 discovers the above message. It promptly

executes the instruction and leaves a message in Mailbox 21 stating that the operation is concluded.

3. In one of its periodic scans of Mailbox 21, the coordinator spots the record in locations 1000-1127. It then issues an order to  $\mu$ P No. 3 (the data-controller) via Mailbox 13. In the order, the coordinator states that the record is presently in locations 1000-1127, and that it is to be sent by a specific coding scheme such as by-sync or SDLC.

4. Microprocessor No. 3, having understood the message in Mailbox 13, transmits the data in locations 1000-1127 with the specified format. It then signals the completion of the data-link operation by leaving an appropriate message for the coordinator in Mailbox 31.

5. The message in Mailbox 31 is read by the coordinator, which marks the end of the transfer.

The entire operation consumes only a few milliseconds. The significant point of the above example is that each microprocessor is almost totally independent except for the simple "Mailbox" convention. The program of each  $\mu$ P can be independently developed and debugged without regard to the programs of the other microprocessors on the same network. This system is an important development in computing technology, especially in view of the high availability and low cost of modern MOS  $\mu$ Ps such as the F8.

As we've seen, there are two basic types of microprocessor networks, communications oriented, and common-memory oriented. Out of these two forms, we can derive many hybrid networks using different combinations and hierarchies. It is safe to predict that many tasks long the private domain of large computers will be handled in the future by microprocessor networks. ■■



# If you spend more than 20 minutes picking a P.C. connector

It's your guide to the broadest line of printed circuit connectors made by any single manufacturer. We have just about everything and in more combinations and more depth than anyone — more types of contact terminations, insulator materials, mounting styles, contact designs, types of plating.

Send for our catalog. Browse through it and you'll discover that picking out the right printed circuit connector for your job is as simple as it should be.

## Quick delivery.

And you can get your hands on our connectors, too — in a hurry if need be. We keep a large inventory; so do our distributors.

## Our "Whatever-you-need-we've-got" department.

As you can guess, we have a lot of tooling filed away. Our production engineers have a unique talent at taking an existing bit of tooling, fiddling with it, and turning out a "custom" connector that's exactly what you need. Your extra cost is only a modest set-up charge... a long way from a full retooling cost.

Use the coupon.

## ...you don't have this catalog.



**Ok. Send me:**  Your latest printed circuit connector catalog.  
 ...and your nearest rep. I want to talk to him about a particular problem I have.

NAME: \_\_\_\_\_

TITLE: \_\_\_\_\_ TELEPHONE: \_\_\_\_\_

COMPANY: \_\_\_\_\_

ADDRESS: \_\_\_\_\_

CITY: \_\_\_\_\_ STATE: \_\_\_\_\_ ZIP: \_\_\_\_\_

 **Viking**  
**CONNECTORS**

Viking Industries, Inc./21001 Nordhoff Street  
Chatsworth, CA 91311 U.S.A./ (213) 341-4330/ **DATACON DIVISION**

CIRCLE NUMBER 52



## Choosing among 4-k MOS RAMs?

A head-to-head comparison of the available package sizes aids in selection of the best memory for your system.

Like most choices, the selection of the optimum 4-k dynamic RAM depends on your system requirements. If low cost or high density is the over-all requirement then the 16-pin version is a natural choice. A high speed system would prefer the 18-pin or 22-pin part. When cost, density and speed are all important, the 18-pin memory usually offers the best compromise.

The 22-pin version is the original device of the 4-k types. The 18-pin and 16-pin versions were derived from the original, giving the user increasing benefits. So let's look first at the organization of the 22-pin version.

### The 22-pin device is simple to understand

The 22-pin 4-k  $\times$  1 dynamic RAM of Fig. 1 uses a straightforward approach to addressing and control functions. That is,

- 12 Address lines ( $A_0$ - $A_{11}$ )
- 1 Read/Write control (R/W)
- 1 Data Input (DI)
- 1 Data Output (DO)
- 1 Chip Select (CS)
- 1 Chip Enable (CE)
- 4 Power Pins

—  
Total 21

The Chip Enable initiates various internal clocks. These internal clocks precharge internal nodes, reduce power consumption and isolate portions of the chip at different times during the cycle. The four power pins are ground, +12 V (required for speed), -5 V (required for substrate reverse bias in a fast dynamic memory) and +5 V (used as a TTL reference level on the output).

Since only 21 pins of the available 22 pins are used, the elimination of just three pins allows the use of the smaller (by nearly 30%) 18-pin package (Fig. 2). The three pin functions:

- Eliminate CS—since most users decode the

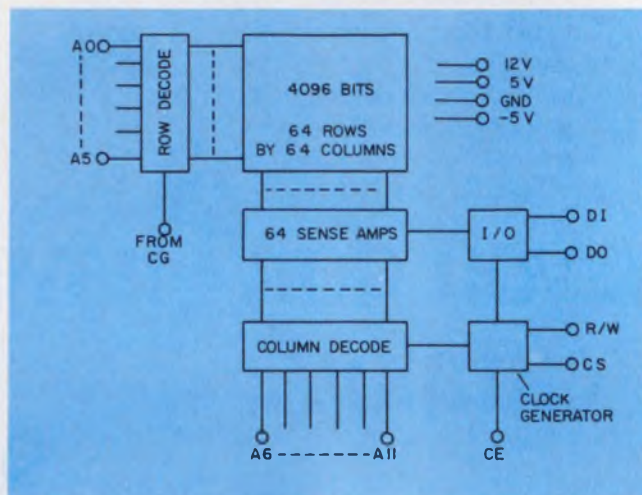

1. A 22-pin dynamic RAM uses a direct approach. Separate address, data, control lines and power pins ensure simple interfacing.

CE to save power, the CS is not absolutely necessary.

- Eliminate the +5 V supply—this is used only as a TTL reference level to reduce power in the output buffer. There are other internal or external methods of providing this reference.

- Combine DI and DO (Data I/O)—most systems do not require simultaneous read and write; a single pin can be shared between the input and the output. When the R/W line is "high," this line is a data output (read); when R/W is "low," then it is a data input (write). Even in systems where read/modify/write is required, there is time to read data, allow the system to operate on it and write in new data in one cycle period.

The 16-pin package uses another approach to reduce pin count (Fig. 3). Borrowing from techniques used in calculators and keyboards, 12 address lines are time-multiplexed onto six pins of the chip. The number of clocks are doubled to give more positive design margins, with a net saving of five pins.

There is only a small speed penalty paid for multiplexing the row and column addresses. The column addresses are not required as soon as the row addresses. First, the six address pins



carry the row addresses ( $A_0$ - $A_5$ ) to select 1 of 64 rows. These are latched by a row address strobe ( $\overline{RAS}$ ). The contents of each of the 64 cells in the selected row are then placed in the sense amplifiers. Now, the six address pins carry the column addresses ( $A_6$ - $A_{11}$ ) to select which of the 64 sense amplifiers is sent to the output or modified by the input. A column address strobe ( $\overline{CAS}$ ) latches these addresses.

While it is possible to multiplex addresses with only one clock, the use of two clocks ensures

faster operation since internal timing margins may be tightened up. Fig. 4 shows the difference between clock and address timing between the 22-pin or 18-pin and the 16-pin RAMs.

### Address driving system requirements

The address driving requirements of the different 4 k's should be considered for the job at hand. The three different systems are:

- Boards having a unique RAM pinout with

### A little history

When talk of the 4-k RAM started back in 1972, it appeared that it would follow in the footsteps of the 1103. The 1103 forecasted the change to a single rather than dual clock and customer comments on 1103 and common usage forecasted the change to TTL compatible inputs and outputs. A straightforward solution to the problem of a 4-k dynamic RAM meant that a package with at least 21 pins be used.

A 22-pin package was selected to house the first 4-k RAMs. This package has a 400-mil spacing between rows. There were at least three different pinouts for 22-pin 4-k RAMs, but these sorted out to just one winner.

The problem for the user started when two separate solutions to the very large 22-pin (500-mil spacing) package appeared. These two solutions were:

- Change to an 18-pin package by eliminating chip select and +5 V and use a common input/output line.
- Change to a 16-pin package with multiplexed addresses.

Overall, there are now at least five different popular versions of 4-k RAMs; two with 22 pins, one with 16 pins and two with 18 pins.

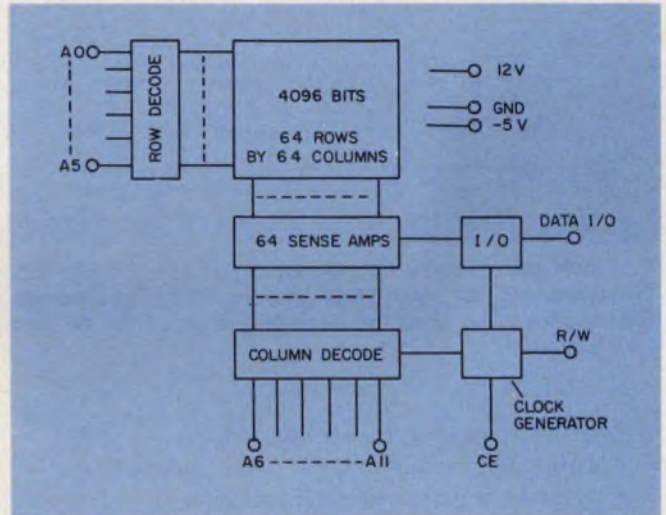
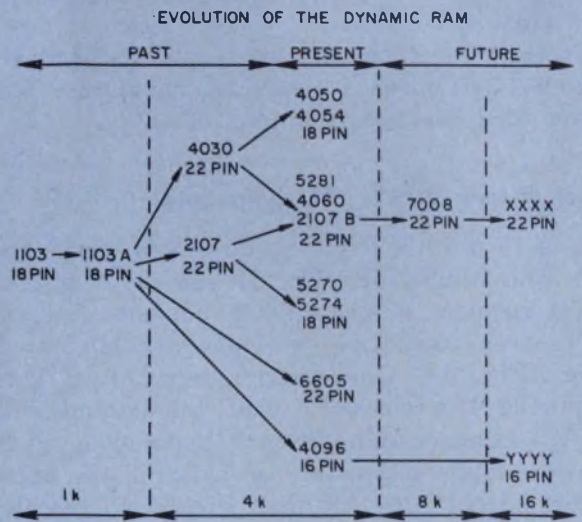

2. An 18-pin dynamic RAM has a single bidirectional data line. It has one fewer power pins than the 22-pin version and no chip-select pin.

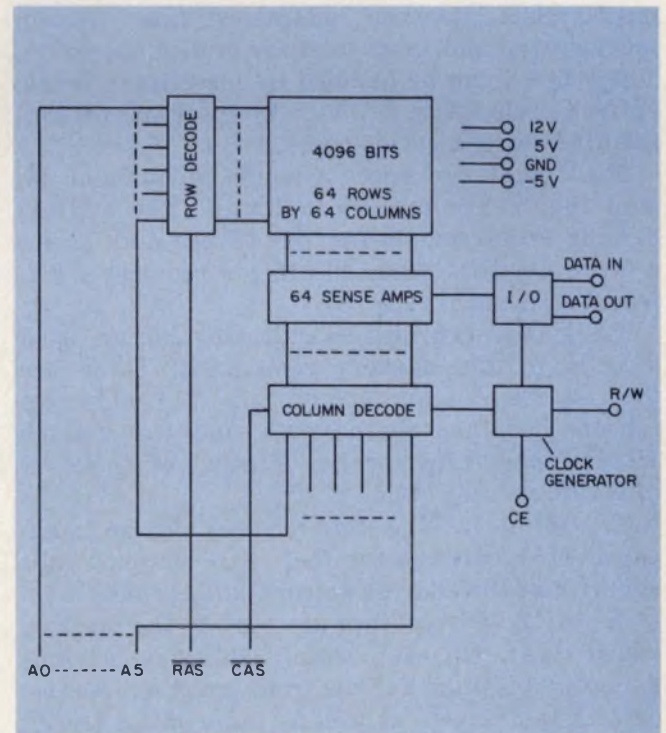

3. The 16-pin dynamic RAM saves a total of five pins by multiplexing address lines. It requires one extra clock line to hold addresses.



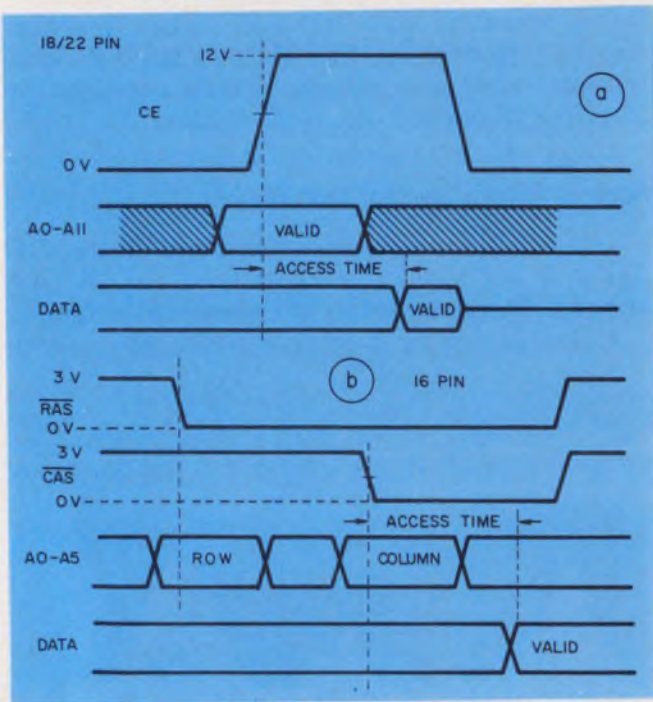

4. Clock and address timing differs for the 18 and 22-pin types (a), and the 16-pin version (b). Data access time is measured from the beginning edge of the CE and CAS signals.

refresh that cannot be exchanged.

- Interchangeable boards with refresh.
- Boards with automatic refresh.

The six row addresses ( $A_0-A_5$ ) on all RAMs are the refresh addresses. The system must ensure that all 64 combinations of these six addresses are accessed within 2 ms. Most systems must select between addresses that refresh memory and addresses used for system operation. The refresh can be handled by inserting a single refresh cycle every 31  $\mu$ s or by inserting 64 consecutive refresh cycles every 2 ms.

Most engineers select a single pinout and design the system around that type. The address driving requirements for the 18 pin and 22-pin 4 k are identical while the 16 pin requires a different approach (Fig. 5).

The system provides 18 addresses that are used directly by the memory component. These are the row ( $A_0-A_5$ ) and column ( $A_6-A_{11}$ ) addresses for the location of the data and the refresh ( $R_0-R_5$ ) addresses for the location of the next interrupt refresh cycle.

The 16-pin RAM system requires only one additional MSI package for the entire system while saving half the address drivers because only 6 instead of 12 address lines are sent to the memory board itself. On each board, additional savings using the 16-pin 4 k come from fewer address receivers and drivers as well as fewer metal traces.

A different approach is used if the designer is building a system compatible with all three types of RAMs. The 18 pin or 22-pin 4-k boards

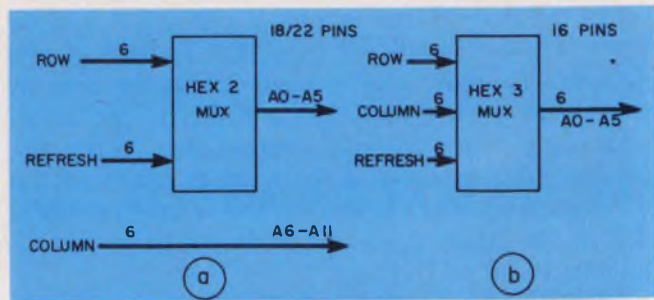

5. Systems may use boards designed for just one or two RAM pinouts: either (a) the 18 and 22 pin types or (b) the 16-pin version.

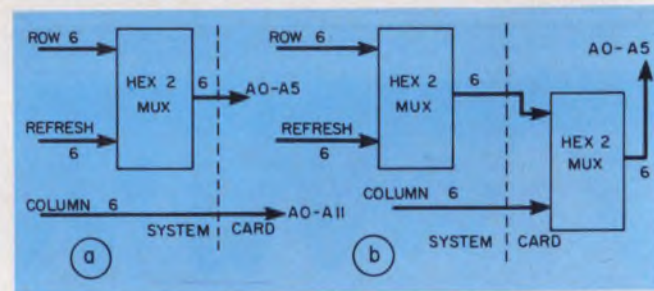

6. To accommodate all of the RAM pinouts you need slightly more address multiplexing on the board. Shown are circuits for (a) 18 and 22 or (b) 16 pins.

take their 12 addresses straight from the system without modification. The 16-pin 4 k requires an additional multiplex level on the card to reduce the system's 12 addresses to 6. The comparison between the parts in board compatible systems is shown in Fig. 6.

Some systems have a predictable pattern of address selection so that refreshing can be automatic. A good example is memory for a video display. If there are at least 64 characters on a line, the column addresses can be used to select the video line and the row (refresh) addresses can be used to select the character on the line (Fig. 7). Each of the 64 refresh addresses would be automatically accessed within 65 microseconds and other provisions for refresh are not necessary. In these types of systems, the 18-pin and 22-pin types have a clear cut advantage with fewer MSI packages required (Fig. 8).

#### Clock drivers: MOS or TTL compatible?

The 16 pin 4-k RAM requires two clocks that are TTL compatible. The 18 pin or 22-pin 4-k RAM requires a single MOS compatible clock; TTL clock compatible versions are also available (Fig. 4). One disadvantage of a RAM requiring two clocks is that the second clock ( $\overline{CAS}$ ) requires an additional time marker in the master timing generator. In addition, the uncertainty of placing  $\overline{CAS}$  with respect to the first clock ( $\overline{RAS}$ ) adds to the access time since it is determined from  $\overline{CAS}$ .



The choice of a TTL or MOS (12 V) compatible clock input requires tradeoffs. TTL compatible clock drivers are usually cheaper and can drive more chips due to lower package input capacitances (7 pF for TTL clock input vs 25 pF for MOS clock input). MOS compatible clock inputs offer the advantage of speed and low power dissipation although higher cost drivers may be necessary. The driver must be relatively stiff to swing the high capacitance MOS clock input rapidly toward either zero or +12 V. The driver should also take the low power while its output is LOW (standby condition); most drivers draw more power when the output is LOW.

In addition, using a RAM that requires a MOS clock input means that the access time is referred to the rising edge of the clock and obtaining maximum performance may require either pnp/npn push-pull drivers or an additional supply above +12 V.

### Using the data I/O function

The 18-pin 4 k is the only RAM type that uses a single pin for input and output data (Data

I/O). But only during a read/modify/write (RMW) cycle does this common function impose any apparent limitation on system timing. The RMW cycle period, as specified for the devices, is 60 ns longer for the 18-pin unit than for the 16 and 22 pin devices.

The 60-ns advantage for the 16 and 22 pin RAMs cannot be used in practice because it assumes only 20 ns for external circuitry to capture the data after it has been read. The system must capture the RAM output data with a strobe, operate on that data, and present it back as input. All this must be done with attendant skews and delays and can easily add up to 80 ns or longer in a real system (Fig. 9).

A real disadvantage of using the 18-pin version is that the DI driver must have a high impedance output (e.g. three-state output) so that the output of the RAM is not overpowered during a read operation (Fig. 10).

Characteristics of a board capable of storing 16-k × 8 words are shown in the table for all three memory categories. The following assumptions have been made: the fastest multiple-sourced components available are used, no RMW

## Characteristics of a 16-k × 8 memory system

No. of RAM pins	# Support pkgs	Board size in. <sup>2</sup>	Fastest component access t <sub>acc</sub> ns	Board access ns	Clock driving	Address driving	R/W logic	I/O logic	Best choice for
16	12	16.0	250	393					Density
18	7	17.6	200	300					Speed density
22	9	25.0	200	300	same as 18	same as 18	same as 16	same as 16	Speed



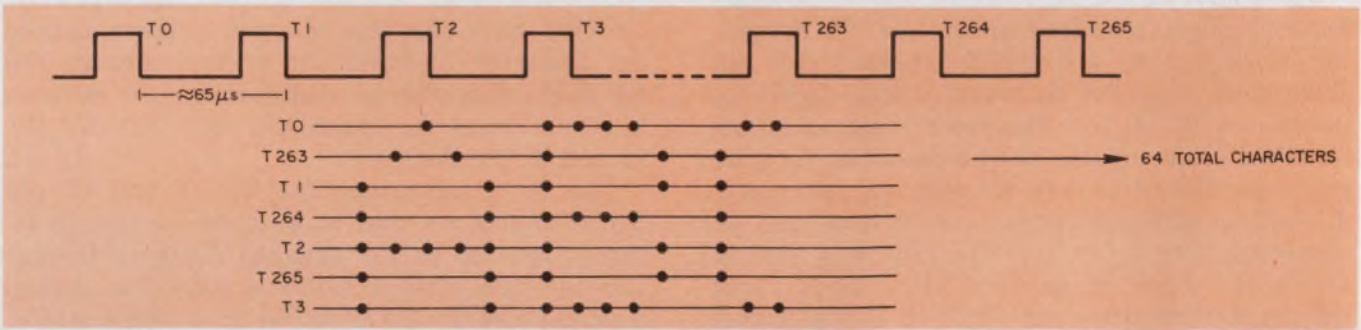

7. RAMs used as display buffers can access the points on a raster-scan display to automatically select 64 columns.

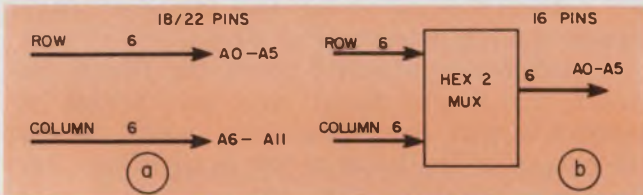

8. A RAM system with automatic refresh requires the simplest address multiplexing on each board, either for (a) 18 and 22 or (b) 16 pins.

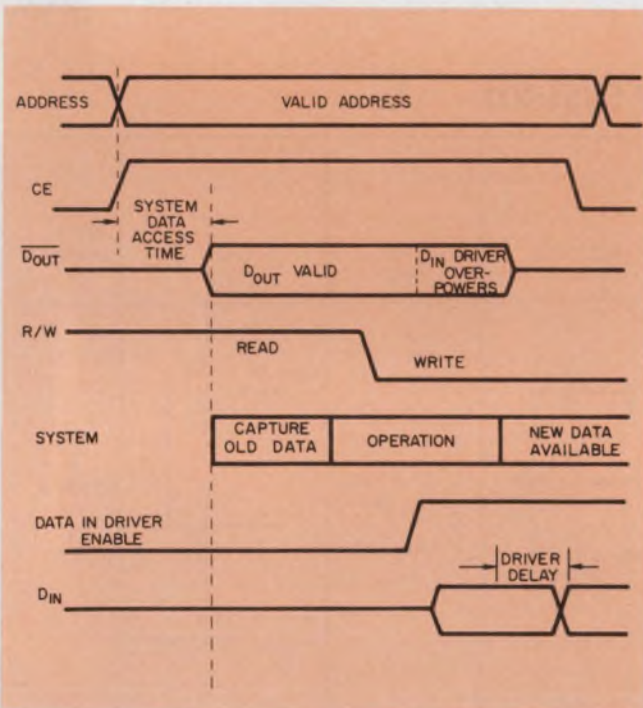

9. Systems that sequentially read, process, then write new data into the same location require at least 80 ns for processing the data.

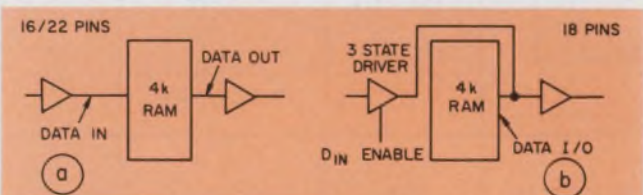

10. Data driver requirements differ for the 16 and 22 pin versions (a) with separate data input and output, and the 18-pin version (b) with a common pin.

cycles are envisioned, no address latches are required and timing generation circuitry is not included.

Board access times are determined by summing RAM access time, clock propagation delay time, any uncertainty time in the clock timing generator, data-line-buffer propagation delay plus an uncertainty in reading board output from the common three-state data bus.

### Future memory expansion

A system designed with 22-pin 4-k RAMs can be expanded to 8 k if you use the 4 k's unused pin (16) as the thirteenth address ( $A_{12}$ ) for an 8-k chip. The AMS 7008, 8-k RAM is designed for just this purpose. If the designer of a 22-pin, 4 k system lays out boards with the extra address wired to pin 16, memory density can be doubled by simply plugging the 7008 into each socket.

The 22 pin device may additionally be expanded to store 64-k bits by using the following methods to bring in extra address lines:

- Eliminate CS—Most systems use a decoded clock (CE) to save power. This serves as the chip select function.

- Use a common DI and DO pin.

- Eliminate the 5 V supply.

The 18 pin cannot be expanded beyond 4 k without multiplexing addresses. Using the 18-pin, 4 k as a basis, however, a 20-pin 16 k could be designed with the 19th and 20th pins used for additional address lines.

The 16-pin approach has the best expansion opportunities since every pin saved can quadruple the memory density instead of just doubling it. A 16-k part already announced,<sup>1</sup> was squeezed into a 16-pin package by eliminating CS. A 16-pin unit could house as many as 256-k bits; the only constraints are die size and yields. In the not too distant future, we may see a megabyte of data in thirty-six, 16-pin, packages, as the next technology advance takes hold. ■■

### Reference

1. "16-k Bit RAM Has the Same Speed and Power Dissipation/bit than 4-k Versions," *Electronic Design* 7, March 29, 1976, pp. 101-102.



# Compare!

CATHODE RAY  
TUBES FOR  
DATA DISPLAY  
TERMINALS

BURROUGHS  
NEW LOW COST  
SELF-SCAN II  
240-CHARACTER PANEL  
FOR DATA DISPLAY  
TERMINALS

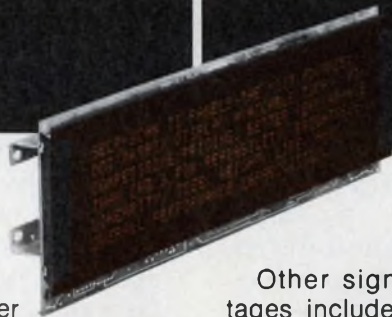

Burroughs' new, low-cost SELF-SCAN II 240-character displays offer many features compared with CRT terminal displays. Contrast and readability are better than ever under all conditions. Characters are jitter- and flicker-free bright neon-orange color, with no fuzziness or loss of linearity at the edges of the display. An all-new manufacturing process has significantly reduced cost, weight, size, and has improved reliability. And, the SELF-SCAN II panel's 40-character line is compatible with popular software. Graphics can also be displayed using additional drivers.

Other significant advantages include easy interface to micro-processors, thin cross-section, small overall size, and rugged construction for long service life under all operating conditions.

Terminal  
space  
saved  
with SS II



Give your data terminals a bright new outlook; call or write for complete information. Burroughs Corporation, Electronic Components Division, P.O. Box 1226, Plainfield, New Jersey 07061. Telephone (201) 757-5000.

You can see the difference

**Burroughs**





## Should MOS RAMs be 'TTL-compatible'?

Insistence on tight specs increases costs and compromises speed. And the loading may exceed TTL gate capability anyway.

Manufacturers of 4-kilobit random-access memories vigorously dispute the relative advantages of their particular designs. But they all seem to agree on one point, the desirability of so-called "TTL compatibility" for MOS RAMs. Unfortunately, the Brownie points won by the marketers tend to come from users who do not understand the issues.

Even though "TTL-compatibility" does not result in the best performance or an optimum interface, suppliers and users are caught up in a numbers game. They've forgotten the real problem: how to get the best possible input buffers and specifications. The insistence on a  $V_{IH\text{MIN}}$  specification of 2.2 or 2.4 V (no one has, as yet, actually been pushed to 2.0 V, the real TTL  $V_{IH\text{MIN}}$ ) exacts cost penalties because of the need for tighter material controls.

And, supreme irony, some input buffers, sweating to make the magic number, put enough peak-current load on the address drivers to preclude the practical use of TTL gates anyway. Yet, if a saner specification of 3 V or so had been accepted, TTL gates could do the job.

### The materials control problems

At first sight, the range from 0.6 V for  $V_{IL}$  to 2.2 V for  $V_{IH}$  allows a reasonable spread for  $V_T$ , the MOS-transistor threshold voltage.  $V_T$  variations with substrate bias for two substrate resistivities are shown in Fig. 1. Calculated values assume 1000 Å of gate oxide, and a surface-state density of  $5 \times 10^{10} \text{ cm}^{-2}$ . The measured  $V_T$  variations show a wider spread than calculated because they include the effects of such other process variations as gate-oxide thickness. Due to short-channel effects, not accounted for in the one-dimensional calculations,  $V_T$  at high bias values is less than calculated.

The  $V_{IL}$  specification sets a nominal  $V_{T\text{MIN}}$  for the process of 0.9 V (at  $V_{BB} = -5 \text{ V}$ ). This specification places an upper limit of about  $8 \Omega\text{-cm}$  on substrate resistivity. The real problem,

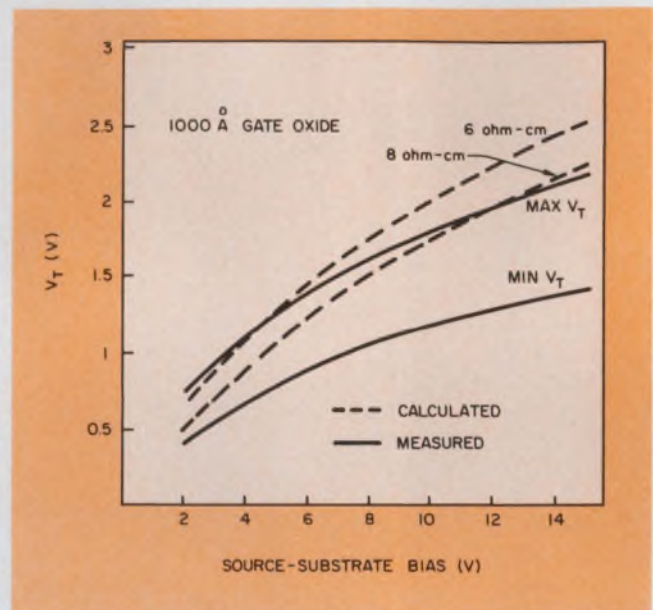

1. MOS-transistor threshold voltage,  $V_T$ , varies with substrate resistivity and source-substrate bias.

however, arises with  $V_{IH}$  and  $V_{T\text{MAX}}$ . The circuit calculations show that  $V_{T\text{MAX}}$  of about 1.3 V is realistic and sets a low limit of about  $6 \Omega\text{-cm}$  to the effective substrate resistivity.

The range of starting resistivities allowed is thus quite narrow. It is also much less than the range for the lowest-cost procurement of starting material. Yet the problem results from a spec limit almost incidental to the main function of the memory.

### Input level affects RAM circuit design

A RAM address-input buffer is required to take the address data and to generate, as fast as possible, true and inverse signals in load capacitances of some 2 to 3 pF. The circuit must draw no dc power, must latch the address state on the rising edge of Chip-Enable, and must have both outputs initially LOW. Principally because people are preoccupied with the magic numbers 2.2 and 2.4 V, no ideal circuit has yet appeared to do all this.

Richard C. Foss and Robert Harland, MOSAID, Inc., Box 11123, Stanton H, Ottawa, K2H 7T8, Canada.



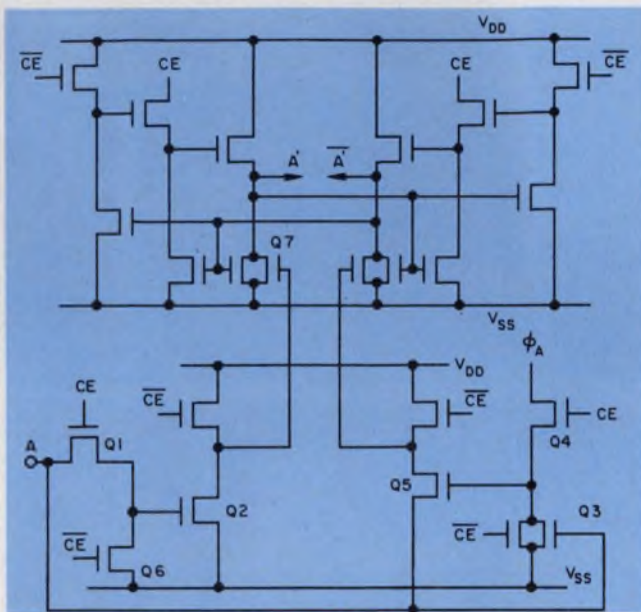

2. In the input-buffer circuitry of a 4-k RAM, Texas Instruments' TMS 4050, design tradeoffs to achieve "TTL compatibility" restrict the performance. Similar problems exist with other high-performance MOS RAMs.

Consider Fig. 2, the circuit used by Texas Instruments in the TMS 4050, 4-k RAM. (The circuit was obtained by analysis of the chip layout.) A ONE-level input signal passes through transmission gate  $Q_1$ , and must turn on the inverter transistor,  $Q_2$ , to discharge the gate capacitance of  $Q_7$ , a large device, steering the output inverters.

The drain current of  $Q_2$  is proportional to the square of  $V_{GS} - V_T$ . With  $V_{GS} = 2.2$  V (actually less, due to the RC time constant of the  $Q_1$  ON-resistance and  $Q_2$  input-capacitance), variations in  $V_T$  from 0.9 to 1.3 V change  $I_{DD}$  in the ratio 1.69:0.81. A further increase in  $V_T$  to 1.5 V reduces the discharge current by the factor  $(0.7)^2$ , or 0.49. Thus the rate of discharge, and hence the delay in the buffer, varies more than three to one as  $V_T$  changes from 0.9 to 1.5 V (see Fig. 3).

On the other side of the steering circuit, the ONE input level holds  $Q_3$  ON. In turn,  $Q_3$  must hold a ZERO at its drain against a narrow load device,  $Q_4$ . Taking the input signal to the source of  $Q_5$  allows this to be a poorer ZERO than would

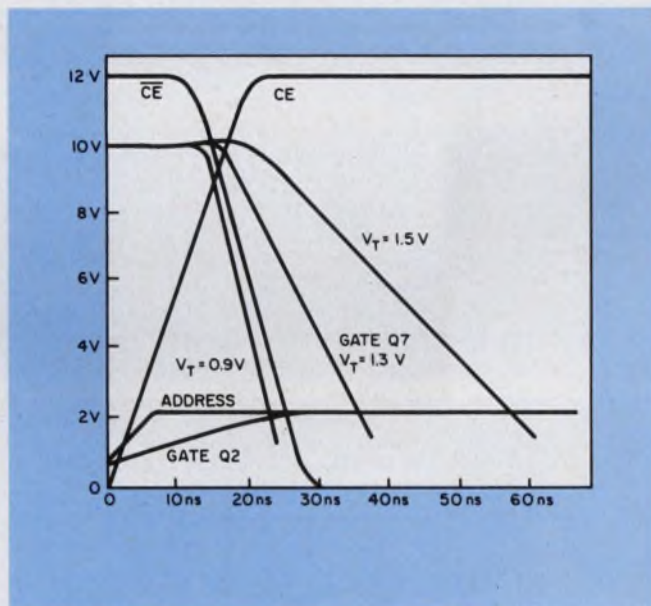

3. RAM input-buffer delay depends on the threshold voltage,  $V_T$ , as shown in these simulated steering waveforms. Speeds can be increased, if unrealistic "TTL-compatibility" specifications are modified.

otherwise be needed, but even so,  $Q_3$  must have a much larger aspect ratio than  $Q_4$ .

The result is that the load,  $Q_4$ , has a high resistance that limits the rate of rise at the  $Q_5$  gate when a ZERO is present on the input. Thus, the small difference between  $V_{TMAX}$  and the TTL ONE level affects both ONE and ZERO input conditions. The best the chip designer can do is try to balance the worst-case effects.

#### Input level affects loading

Unless internal leakage is high, a TTL gate loaded only by capacitance and a few  $\mu A$  of leakage will reach a ONE level of at least 3 V, because the output stage of the gate reaches  $V_{CC} - 2V_{BE}$ , where  $V_{BE}$  is a low-current value (say, 0.6 V). This argument no longer holds if the driven memory chips draw current.

In Fig. 2,  $Q_1$ , fed from Chip Enable,  $CE$ , and  $Q_6$ , fed from  $\overline{CE}$ , are in series to ground.  $\overline{CE}$  is the internally generated inverse of  $CE$  and must therefore overlap it somewhat. Thus, a load is



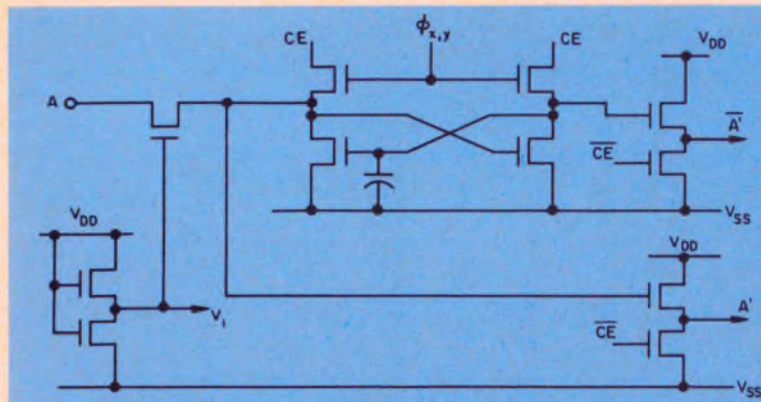

7001

Notes:

- 1) Metal-gate fast 1-k RAM.
- 2) Input threshold  $V_{DD}$  dependent.
- 3) Sources current while  $\phi_{x,y}$  remain high.
- 4) Source input improves gate-protection.
- 5) Relies on capacitance unbalance in flip-flop for sensing  $A = 1$ .
- 6) CE driver problem because sourced I/P current drawn from CE.

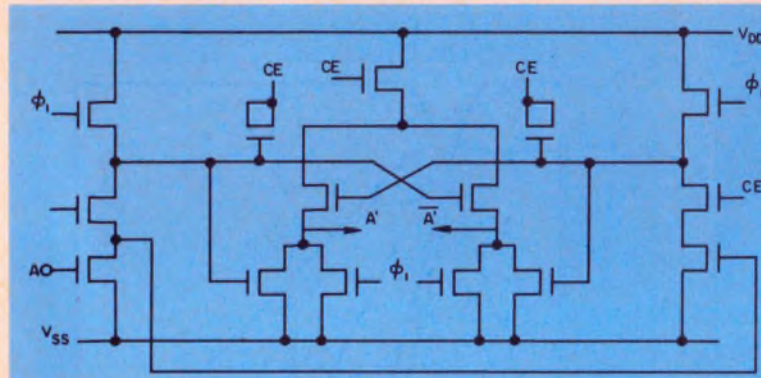

6605

Notes:

- 1) 4-k three-transistor cell RAM.
- 2) No current loading of I/P.
- 3) Heavy C load on CE.
- 4) No flip-flop action.
- 5) Node states not reset between cycles.

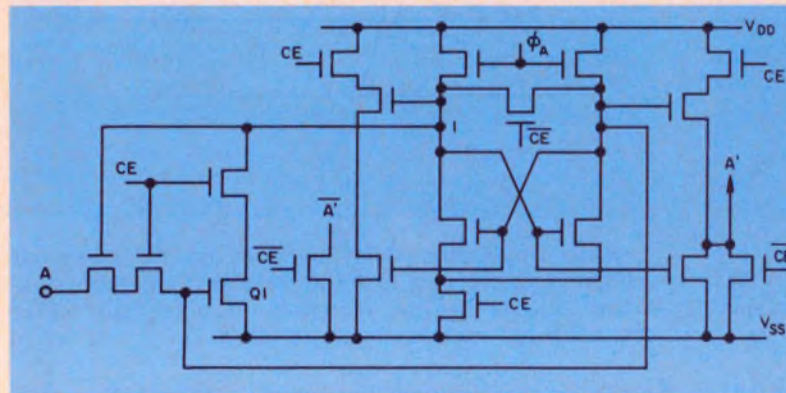

2107B

Notes:

- 1) 4-k single-transistor cell RAM.
- 2) Sinks current if address reset high after initial low. ( $Q_1$  is a small device discharging about 1/2 on node 1.)
- 3) Source input improves gate-protection.

4. The input-buffer circuits of three high-performance MOS RAMs all show compromises in design caused by

the demand for "TTL-compatibility." Specific strengths and weaknesses of each circuit are listed in the notes.

placed on the address bus exactly when the state is being strobed into the buffer with CE going to a clock ONE level.

This load isn't very heavy for a single chip. But with many memory chips on the address bus, the total peak loading may easily exceed the level at which a TTL gate is specified as delivering its worst-case ONE level.

In this typical case, the price to the user of "TTL-compatible inputs" is the likelihood that the RAM isn't usable with TTL gates. Thus the peak current loading may well force the use of a bus driver. Since this device can at least give a good voltage swing, all the chip designer's work to make the 2.2-V spec limit "without pull-up resistors" becomes of dubious value.

Even in an industry noted for problems in defining the optimum form of "components" that

are actually major parts of a system, the "TTL-compatible memory" is a particularly unfortunate distortion. For vertically integrated companies that supply memory components for use in their own systems, acceptance of the constraints of such a number is inconceivable.

Although a TI circuit has been used as an example, every manufacturer of comparable parts has faced similar problems (see Fig. 4 for some examples). Every input buffer found in present high-performance MOS RAMs has some drawbacks.

The problem doesn't result from a real technical requirement. Engineers seem quite happy with today's most popular microprocessor family which uses 3.6 V as its TTL ONE-level specification. Perhaps this article can help start a more rational trend for semiconductor memories. ■■



# Ask CONTROL DATA for the Floppy Disk Drive more major OEM's specify.

## We have it.

One major OEM after another tested our Floppy Disk Drives. Ran them through rigorous evaluations. Compared them with competition. And chose ours. Either our Model 9400; or our Model 9404 with **double-density capability.**

Both have true IBM compatibility, with the write-current switched at track 43. Both offer ceramic heads; and hard and soft-sector capability. The 9400 has a star interface; the 9404 a daisy chain interface plus power reduction, write-protect option, and double-density capability.

Whether large OEM or small, we invite you to make your own tests and comparisons. Let us demonstrate our Floppy Disk Drives, right in your facility. Evaluate them, just as many major OEM's did. We know you'll make the same choice.

Two configurations available. Choose Model 9400 for single; Model 9404 for multiple drive applications. Model 9404 also offers double-density capability.

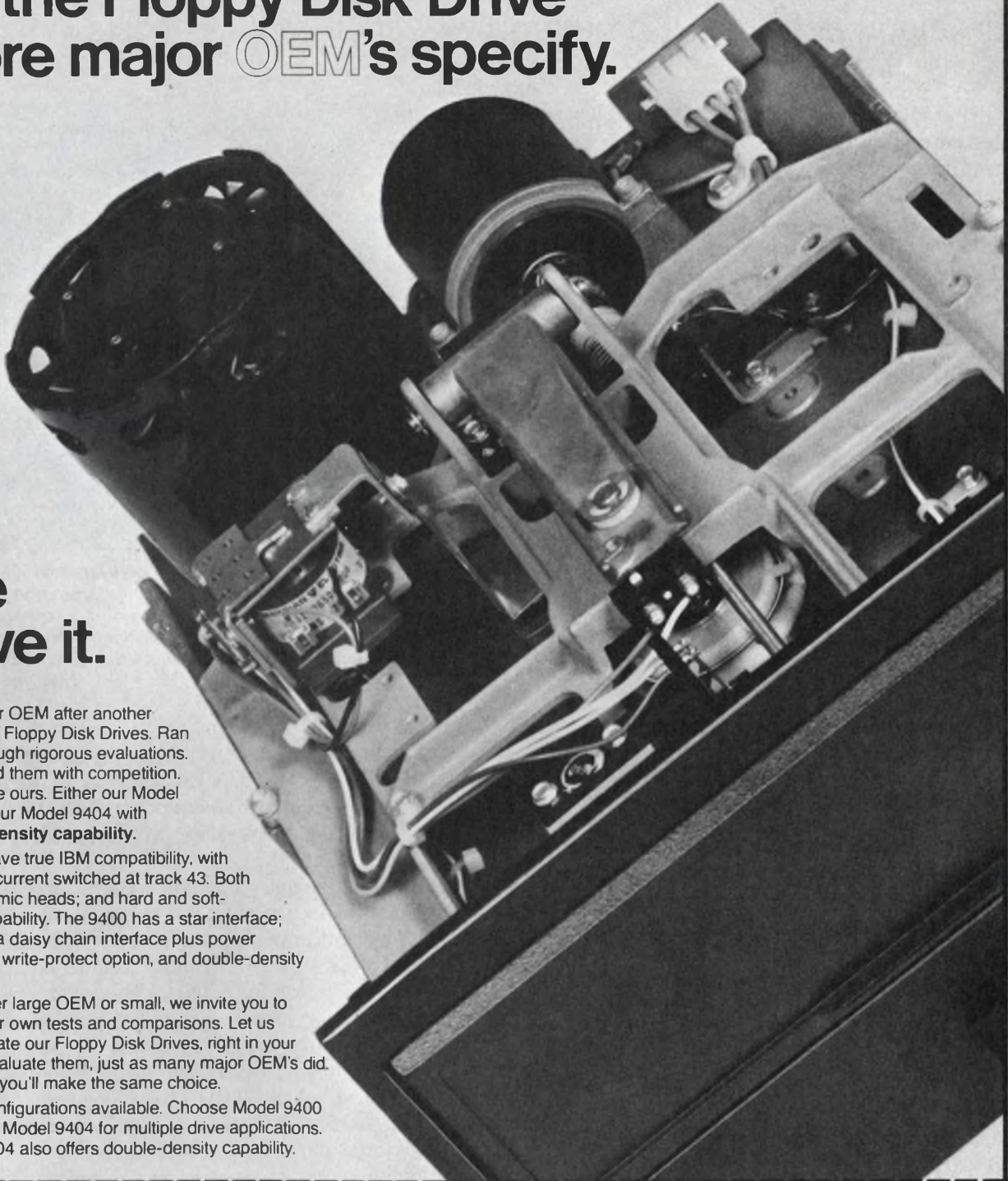

Call (405) 946-5421 or return coupon to: Terry J. Hardie, Control Data Corporation, 4000 NW 39th Street, Oklahoma City, OK 73112.

Please have your salesman bring me a Floppy Disk Drive for evaluation.
  Tell me more about your OEM Floppy Disk Drives

NAME \_\_\_\_\_ TITLE \_\_\_\_\_  
 COMPANY \_\_\_\_\_ ADDRESS \_\_\_\_\_  
 CITY \_\_\_\_\_ STATE \_\_\_\_\_ ZIP \_\_\_\_\_ AREA CODE \_\_\_\_\_ PHONE \_\_\_\_\_

Ask the CDC OEM people

**GD** CONTROL DATA CORPORATION

CIRCLE NUMBER 54



## Program erasable PROMs on the board, after they have been wired in. Besides simplifying development, 'board programming' often reduces costs.

Thanks to a technique known as "board programming," a host of erasable PROMs can be programmed collectively right on a PC board, without special equipment.

The benefits are many. Board programming entails significantly fewer components than does the usual method of programming memories before they are installed on a board.

More important, board programming can slash the discouragingly high costs often associated with the introduction of a new product.

Erasable PROMs are programmed electrically, usually in special equipment. However, they can be erased simply by shining ultraviolet light through a quartz window on top of the packages housing the memories. Once programmed, they behave exactly like mask-programmed ROMs with the same pinouts and functions.

Initially intended as prototyping tools, PROMs reached wide acceptance because they circumvented the constraints of ROMs—minimum quantity requirements, delivery delays and mask charges. Now, however, the prices of PROMs have fallen so low that designers often don't bother to replace the memories with ROM versions.

Erasable PROMs have become especially popular for microprocessor systems, where they are used as main memory.

### Some of the problems

Erasable PROMs, however, have caused problems in documentation, production flow and inventory control. Each PROM must be handled and programmed individually. It must be marked manually with a unique part number, and the stored code must be recorded and documented.

Field-service organizations must then inventory spare, unprogrammed, PROMs that eventually could be programmed to replace failed units. Engineering efforts aimed at debugging the replacements often require additional changes, so that the entire documentation and control cycle may have to be repeated.

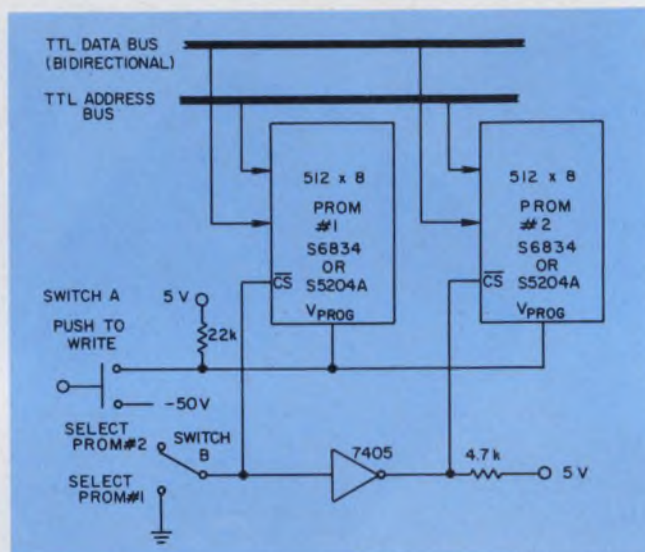

1. Different PROMs can be programmed collectively—a key requirement for board programming. To write (program) data in or read them out, use switch B to select a PROM. For programming, apply address and data, and then depress switch A. For a read operation, simply apply an address; data will then appear on the bus.

Thus the cost of introducing a new component can be very high. Even companies large enough to have computerized document control and extensive field-service organizations reportedly have found that the cost can reach \$25,000. That amount covers documentation, inventory and field-service updates. Costs often run much higher when military applications are intended, since these have more stringent requirements than do commercial or industrial applications.

These problems can be minimized with board programming: a PC board is populated with unprogrammed PROMs and a single part number is assigned to the entire board's stored data. This contrasts with the usual method of assigning individual part numbers to each PROM. The technique relies, of course, on the ability to program units collectively (Fig. 1).

Board programming, of course, can be used with nonerasable bipolar PROMs. But since these circuits aren't erasable, they can't be tested to guarantee programmability. Moreover, if many units are programmed at the same time there is a high probability of error.

---

Joe McDowell, Director of Standard Products Div., American Microsystems, 3800 Homestead Rd., Santa Clara, CA 95051.



Bipolar PROMs are typically 90% programmable, meaning that 9 out of 10 units can be programmed successfully. This fact implies that greater than 10 units on a board will require sockets or additional handling and rework. The MOS units, however, are erasable, so they can be 100% tested and thus soldered directly into the board.

Early MOS PROMs, though, use voltage levels other than TTL at address and other pins during programming. The popular 1702 (256 × 8 bit) PROM, for example, requires -45 V on address and data pins, -47 V on the program pin and -27 V on the normal ground line. Also, the PROM has various timing constraints.

Further, 5-V TTL circuitry (usually address buffers) typically connects to PROM inputs on a board, and output latches or three-state drivers are tied to PROM outputs. The result: board programming has not been possible with this popular PROM.

### TTL compatibility simplifies programming

Newer 1-k × 8-bit PROMs, like the 2708, do allow TTL levels at the address pins. But during programming, they require 12-V on the enable line. Thus, for board programming, this spec requires the enable lines of all rows to be brought to an edge connector. Then they must be jumpered back to the board's TTL row decoder to

physically isolate and avoid damage to the TTL logic.

Another solution employs PROMs that accept TTL levels on all pins during and after programming. These are exemplified by the 512 × 8-bit units shown in Fig. 1. A single program pin not used during normal operation can be bussed together with the same pin on other PROMs, and it is taken to -50 V during programming.

The PROM to be programmed is selected by TTL-addressing signals common to a memory board. A read/write pin (like that for a RAM) is held at a TTL Low level during programming and raised to a TTL High level after programming. The R/W pin, gated by the enable signal, can be bussed together with the same pin on all other units. A disabled device with the program pin at -50 V won't be programmed, just as a disabled TTL RAM with its write pin activated won't write.

Consider the 1024 × 16-bit memory shown in Fig. 2. In the usual practice, programs would be entered individually into the eight PROMs. They would then be manually marked with a part number and a board location. The PROM labelled A-2, for example, would work only in board location A-2 and must be correctly inserted in that location. The board has the part-number list shown in Table 1.

Table 2 shows the new listing with board pro-

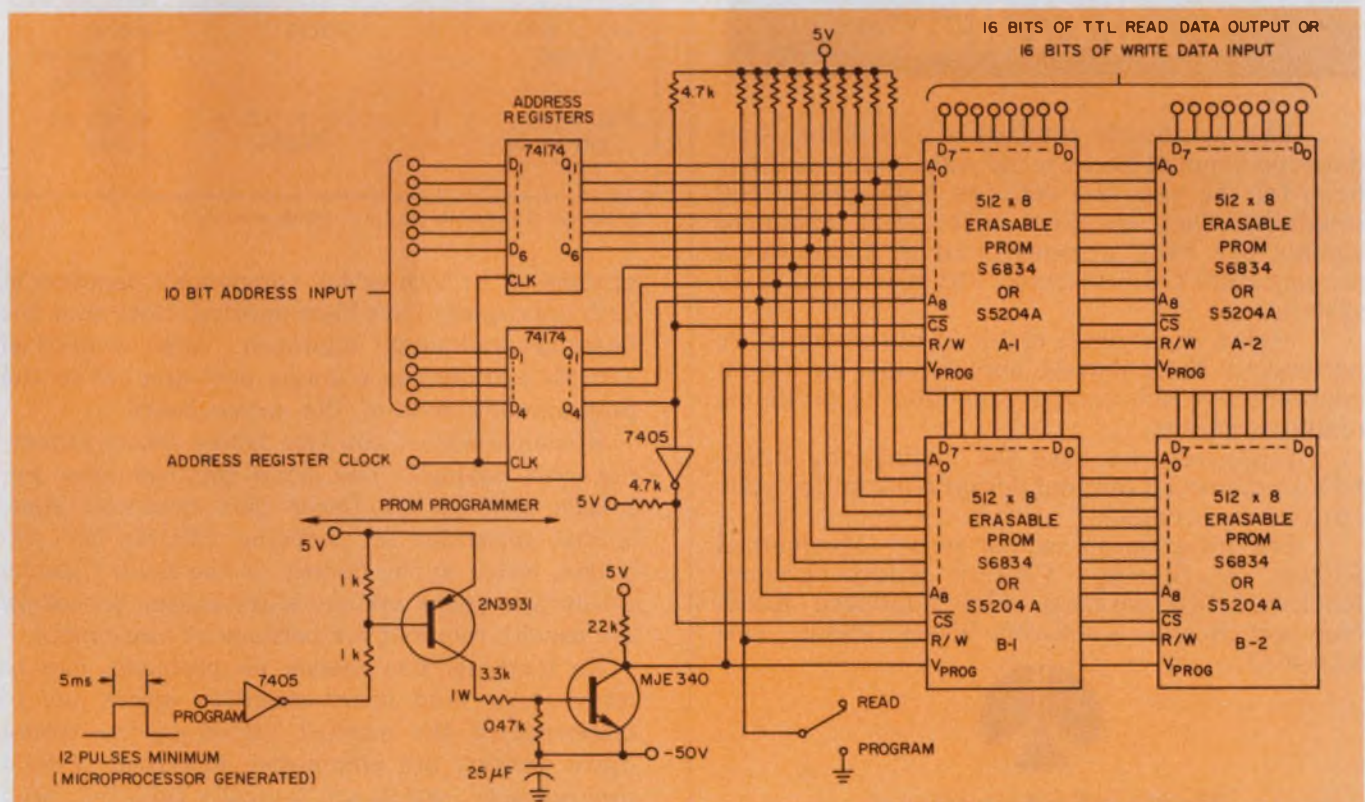

2. A 1024 × 16-bit read-only memory employs erasable PROMs that can be programmed collectively on a board.

Built-in programming circuitry eliminates the need for special equipment.



**If we haven't made  
the mechanical  
filter you need yet,  
we can.**



**Call Collins.**

The worldwide reputation of Collins' standard mechanical filters is the same today as it has been for the past two decades: high quality and reliability. Their excellent rejection of unwanted signals has been demonstrated in applications ranging from CB transceivers to missile guidance systems.

Today, as a direct result of our years of experience in these diverse applications, we have a cost-effective solution to your filtering problems readily available.

Moreover, we have the engineering know-how to create an original design concept for your custom requirements.

For information call or write: Mechanical Filters Marketing, Collins Radio Group, Rockwell International, 4311 Jamboree Road, Newport Beach, California 92663. Phone: 714/833-4632.



**Rockwell International**

...where science gets down to business

CIRCLE NUMBER 55

**Table 1. Conventional approach entails eight part numbers**

Item*	Qty	P/N (Part number)	Comments
512 × 8 MOS PROM	1	S6834-001-A1	S6834 = AMI part number 001 = Custom code A1 = Board location
512 × 8 MOS PROM	1	S6834-002-A2	
512 × 8 MOS PROM	1	S6834-003-B1	
512 × 8 MOS PROM	1	S6834-004-B2	
PROM programming paper tape	1	1-k × 16— S6834-001	2048-bit tape
PROM programming paper tape	1	1-k × 16— S6834-002	
PROM programming paper tape	1	1-k × 16— S6834-003	
PROM programming paper tape	1	1-k × 16— S6834-004	

\*Partial bill of materials for 1-k × 16-bit memory.

**Table 2. Board programming reduces part numbers to two**

Item*	Qty	P/N (Part number)	Comments
512 × 8 MOS PROM	4	S6834	Unprogrammed PROMs
PROM programming tape	1	1-k × 16— S6834	16,384-bit tape

\*Partial bill of materials for 1-k × 16-bit memory.

programming. In both tables, components common to both approaches have been omitted. Note that the board-programming approach uses unmarked PROMs and assigns a single part number to the programming code of the entire board.

A comparison of the two tables shows numerous cost savings. The board-programming approach employs six fewer part numbers. Also, special apparatus for marking PROMs isn't required, either in the factory or the field. (Special set-up jigs, epoxy ink and a dry-baking procedure are usually required for permanent markings.)

No marking also means no problems due to mismarking. And board-assembly errors due to placement of the marked PROM in the wrong board position are eliminated. Moreover, PROM programmers, which are typically tape fed, need to be loaded with only one continuous tape rather than four separate ones. ■■



# ANOTHER DIMENSION

has been added to the world famous family of

# SIMPSON

## 260 VOMS

## the SERIES 6XL



- X** for extra ranges and features
- L** for low power ohms capabilities

- Extra shock and drop-resistant construction, high impact, custom-molded panel and case.
- Extra large viewing area with four-color (Red, Green, Blue and Black) scales, keyed to matching range panel.
- 33 ranges with extra voltage, current, resistance and low-power ohms functions.
- Plus — all the features of the 260-6.

- 260-6XL complete with batteries, test leads and manual.....\$90.00
- 260-6XLM includes mirror scale.....\$93.00
- 260-6XLP overload protected.....\$125.00
- 260-6XLP overloading protected and mirror scale.....\$128.00

ORDER FROM YOUR DISTRIBUTOR

Still the leader...  
the time honored,  
ever popular

**260**<sup>®</sup>  
SERIES 6  
Always available.



### RANGES:

DC Volts .....	0-0.25; 0-1; 0-2.5; 0-10; <u>0-25; 0-100;</u> 0-250; 0-500; 0-1000
AC Volts .....	0-2.5; 0-10; <u>0-25; 0-100;</u> 0-250; 0-500; 0-1000
DC Microamperes .....	0-50 (250 MV Drop)
DC Milliamperes .....	<u>0-0.5; 0-5; 0-50;</u> 0-500
DC Amperes .....	<u>0-5</u> (250 MV Drop)
AC Amperes .....	6 ranges from 0-5 to 0-250 with optional Model 150 Amp-Clamp adapter
DB Scale (1 MW 600 Ω Reference)	-20 to +10; -9 to +21; <u>+1 to +29; +11 to +41;</u> <u>+19 to +49</u>
Resistance (Standard Power)	<u>Rx1</u> (6 Ω center scale), <u>Rx100</u> (600 Ω center scale), <u>Rx1K</u> (6000 Ω center scale), <u>Rx10K</u> (60,000 Ω center scale)
Resistance (Low Power)	<u>Rx1</u> (20 Ω center scale), <u>Rx10</u> (200 Ω center scale), Max. open circuit voltage only 100 mV! Max. measuring power only 0.125 mW!
Size .....	5 1/4 x 7 x 3 1/8" (133 x 178 x 79 mm)
Weight .....	2.5 lbs. (1.14 kg)

### ACCESSORIES

Model 150 Amp-Clamp, Catalog No. 00532 complete with a No. 00533 test lead.....	\$31.00
30 kV DC Probe, Catalog No. 00509.....	\$23.10
Grip-Tip Extension Probe, Catalog No. 00118.....	\$ 5.00
Rigid Case, Catalog No. 00805.....	\$21.50
Sheath Case, Catalog No. 01818.....	\$17.60
5 kV DC Probe, Catalog No. 00506.....	\$ 5.50
5 kV AC Probe, Catalog No. 00505.....	\$ 5.50



**SIMPSON ELECTRIC COMPANY**  
853 Dundee Avenue, Elgin, Illinois 60120 • (312) 697-2260  
CABLE: SIMELCO • Telex: 72-2416  
IN CANADA: Bach-Simpson, Ltd., London, Ontario  
IN ENGLAND: Bach-Simpson (U.K.) Ltd., Wadebridge, Cornwall  
IN INDIA: Ruttonsha-Simpson Private, Ltd., Vikhroli, Bombay

KATY INDUSTRIES



INDUSTRIAL EQUIPMENT GROUP



# Nick Tagaris of Datel Speaks on How To Get The Most Out of A Small Engineering Force

A big company can afford to have a lot of engineers with a variety of specializations. If they aren't always used too effectively, no great harm is done. But a small company can't afford this approach. It has to get the most out of a limited staff or it can't compete.

A variety of management philosophies can be used to achieve this economy, but we've found several specific policies that work well for us:

- We give the engineer total responsibility for his project—womb to tomb;
- We hire only senior engineers—no juniors;
- We don't hire people who are overly specialized;
- And we run a tight ship.

We call our approach a Direct-Management System.

**Every design engineer in the company is a project engineer who takes a new product from the first marketing meeting, where the concept is proposed, to production.**

As a committee of one, the engineer has complete responsibility and authority to meet his own projected design costs and timing goals.

And just as we have no middle managers, we have no engineering technicians. We do have wiremen and draftsmen. But the wireman doesn't work on live circuits. He wires the circuit and hands it to the engineer to debug. The engineer plugs the components in and makes the necessary changes himself.

If he should run into problems he calls me and we go over the design together. Or we might call in another engineer, or even two. But we never have formal meetings where everyone takes part. I think such meetings waste time.

The design engineer takes his project step by step, guiding it himself all the way.



Datel President Nick Tagaris, right, goes over plans with Vice-President and Treasurer Arthur Pappas.

After he's discussed the idea for a new product with marketing he makes a paper design based on the proposed specifications he and the marketing people came up with.

Next, the wireman constructs the breadboard and turns it over to the engineer who makes it a manufacturable circuit.

After the breadboard is working he gets some mechanical design help and packages the product. That is, he tells the packaging engineer how to



do it—exactly the way he thinks it should look.

During the packaging phase the engineer prepares the product for production. I believe a product should be so well designed that a production engineer isn't necessary.

The engineer designs the test equipment and writes the test procedures, keeping in mind that the production people are not engineers. It would cost too much to keep engineers on the production line. The only products that make money are those that are produced easily by people with little technical background.

Then the engineer makes a complete list of materials—including every nut and bolt—and determines whether it's a sole-source or multiple-source product and how much it costs. (I strongly believe an engineer's job includes detail work. A lot of engineers balk at this; they aren't willing to do detail work.)

He makes a complete set of documents—engineering documents and manufacturing documents detailed enough to give the production men complete instructions for their needs.

The designer's responsibility continues even after his creation gets to production because we don't have production engineers on the line.

Regardless of what the original designer is doing he must always be available to drop his new project and go to production to straighten out a problem on his previous project. This interruption could take a few minutes or a couple of days. But whatever the time, it is less than a production engineer, unfamiliar with the initial design, would require. Besides, the very act of "straightening out a problem" could degrade the product's performance if left to someone unfamiliar with the device.

Still another benefit emerges from this approach. A designer doesn't like being taken off his new project, even briefly, so he is motivated to think of producibility during initial design.

Datel's procedure contrasts with that of many companies that transfer a product from the engineer to production and tell production to make the thing work. That arrangement produces the classic engineering vs production conflict, a lot of finger pointing by committees, and no products being shipped.

Finding engineers who function well in our management approach requires careful selection. Everyone must be right because in a relatively small company such as ours each man has to move little mountains. We interview fifty engineers to hire one.

**I know what I want in an engineer: First, he must be a senior engineer. Our most junior man has 10 years of experience.**

With this particular guideline we know that by the time an engineer joins the Datel staff, he

## Who is Nick Tagaris?



It may be prophetic that Nick Tagaris and Alexander the Great were both born in Pella, a small town in northern Greece. They both conquered obstacles as they met them, and they both achieved success. To Tagaris, however, the electronics business is what the world is all about, and he's felt that way since his early teens when he started building single-tube transmitters and receivers as a hobby.

His interest in electronics was sparked by the access he had to his father's lab. His father, a general in the Greek Royal State Police and a specialist in counter-intelligence, made extensive use of communications equipment. During his high school years Tagaris devoted his spare hours to getting a practical education on radio operation and theory from his father's officers, and the die was cast: he would enter electronics.

While waiting to come to the United States Tagaris and two friends built 30 radio receivers, which they bartered for goods to nearby villagers. They then sold the goods for money in the city. "It was a good year," he says. "I learned a lot about operating a business on a shoe string, and we made money."

In 1956, a year after he arrived in the United States, three important events occurred: He was accepted by MIT, he joined Epsco as a part-time tester of high-speed a/d converters, and at Epsco he met his three future partners. In 1969 they founded Datel Systems to manufacture data-conversion products.

"I'm the technical guy," Tagaris says. "Jack Gallagher handles marketing, Arthur Pappas is responsible for finance and Jim Zaros, sales."

From 1971 to 1974 sales grew at an annual rate of 89%. Even during the 1974-1975 recession they climbed 25%. Sales for 1975 hit close to \$10 million.

Tagaris no longer has much time to pack his wife and four children out to the track for a day of sports-car racing. "But I'm still a sports car nut and I like to drive at speed," Tagaris says. "I also like to take the family out on our boat, and once in a while ride my motorcycle."



is already a seasoned and dedicated professional. Engineering maturity is a very fundamental concept with us.

Basically, I want an engineer who can handle himself. I don't need somebody I've got to drag by the nose, telling him to do this and do that. I want him to be self-directed and competent technically. But engineering is more than just technical knowledge; an engineer has got to know what components he should use, how to design a product that works—and makes a profit for the company.

Many engineers are too specialized. To me, too much specialization ties an engineer's hands. Highly specialized engineers fit well in a big corporation but not in ours. I like an engineer to know a little bit of everything. Not only must he know how to design a logic circuit, such as a programmer, but also linear circuits—operational amplifiers or crystal oscillators.

Where do these well-rounded people come from? Not from big companies. Big-company engineers are usually too narrow in their backgrounds. My people come from small companies where they've had an opportunity to work on a variety of things.

Because our designers do work on a wide spectrum of products, they gain experience and they keep interested. One engineer might be a project engineer for an a/d converter; later he may work on a d/a converter, on power supplies, data-acquisition systems, portable data loggers, digital panel meters, panel instruments, clocks or small printers.

The engineer can move from one product to the next. Moving around like that results in his bringing novel ideas to a project.

**Our work schedule is quite uniform—it's 40 hours a week. Everyone comes on time and leaves on time. We have measured coffee breaks—not unlimited breaks as some companies do.**

I don't believe in the "flexible" working hours some companies have. I like everyone to be here at the same time and stay the same length of time. And I don't want anyone working overtime.

I've worked too many 50 and 60-hour weeks and I don't think I produced anything I couldn't have done in 40 hours. My creative juices dried up, my family life suffered and my morale slumped. The mind and body need refreshing or they won't function effectively.

People here are happy with this schedule. They know exactly how many hours they're going to work each week and when those hours are. They can then plan leisure time accordingly.

For two months during the recession—Decem-

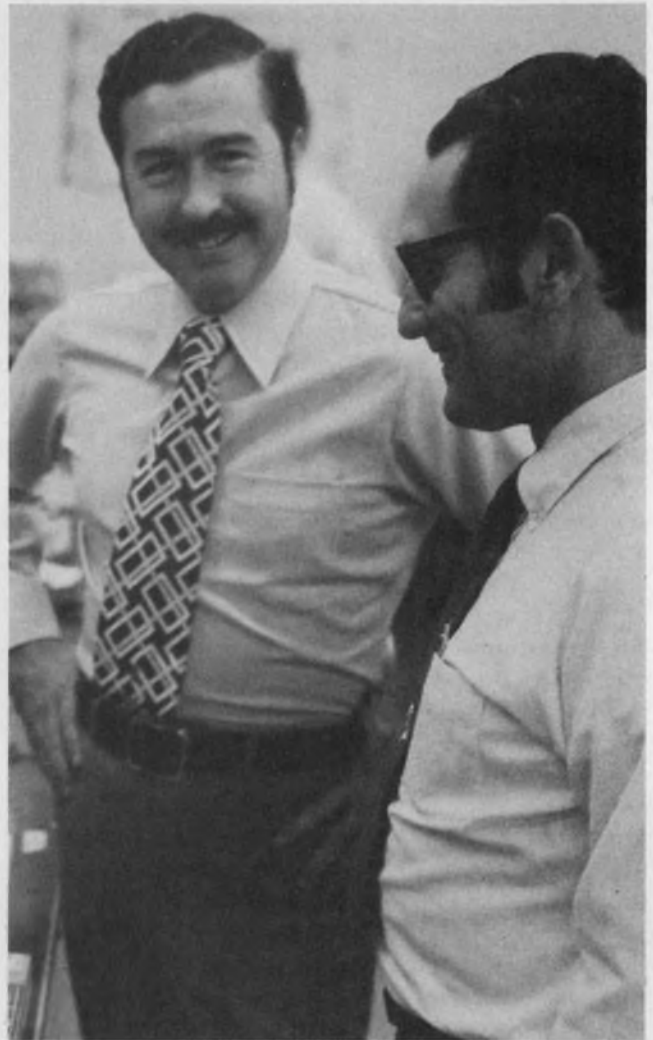

Mel Freedman, right, like all Datel engineers, was a senior designer before joining the company.

ber, 1974 and January, 1975—we cut back to a four-day week, which reduced salaries by 20 percent. I couldn't see laying off people I'd spent so much time and energy selecting. It was also fairer to them to get a temporary salary cut than to be let go. To my surprise, during this period, most of my engineers worked the fifth day, just as if they were being paid. It was unbelievable!

We pay them well, but I don't think that explains their generosity. Professionals are achievers who place a high value on personal identity and quality of performance. That day-a-week loss of time would have made them miss some of their previously committed design deadlines, and that just didn't fit into their scheme of things.

Our approach may rub some people the wrong way, but it works. We like it; our designers like it; and with it we feel we can compete successfully with whoever comes along.

Competition is growing in our marketplace—some of it from the semiconductor giants. But our management approach has been good to us in our first six years, and we have faith in it for the future. ■■



# This complete 16K, 32K, 64K Memory Cycles in just 180 Nsec.

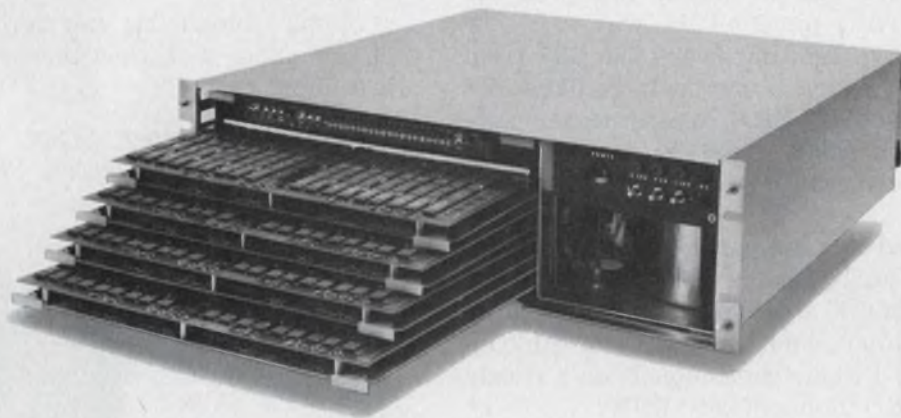

... and it's yours for less than 1¢ per bit!

It's the fastest standard system on the market with large capacity and TTL compatible interface, and it's conveniently packaged at a surprisingly low cost. It's the MICRORAM 3000N-1, a complete random access semiconductor memory system utilizing our own reliable, metal gate NMOS static RAM components.

The MICRORAM 3000N-1 provides a fast 180 nsec. cycle time and accesses at 150 nsec. It is expandable from 16K x 20 to 64K x 20 through the simple addition of plug-in memory cards. The system is completely self-contained, including power supply and cooling fans, in a 5¼" chassis designed for 19" rack mounting. And the entire package is available for less than 1¢ per bit. (If you don't need all that speed, consider the basic MICRORAM 3000N, which cycles at 300 nsec and accesses at 180 nsec.)

High performance. High capacity. Low cost. Immediate availability. We have them all. You can have them too. Call your local EMM office today for all the details.

**EMM** ELECTRONIC  
MEMORIES  
COMMERCIAL MEMORY PRODUCTS

12621 Chadron Ave., Hawthorne, California 90250 • (213) 644-9881

EMM OFFICES: Northern California, (408) 998-2668; Southern California, (213) 644-9881; Chicago Area, (312) 297-7090; New England, (617) 861-9650; New York Area, (516) 423-5800; United Kingdom, 01-751-1213.

CIRCLE NUMBER 57



## Logic probe built from IC timer is compatible with TTL, HTL and CMOS

An inexpensive probe for detecting and indicating logic states can be built with the versatile 555 timer. The probe takes full advantage of the timer's high input impedance and its stable and predictable threshold levels. Its power output is capable of driving indicator lamps directly. The probe automatically becomes compatible with TTL, HTL or CMOS logic simply by the selection of the proper supply voltage.

Input logic signals feed the trigger input (pin 2) of the 555 via two diodes that keep the signals from driving pin 2 all the way to  $V_{cc}$  or ground. This drive limiting keeps the 555 from erratic behavior, which is particularly likely for inputs near ground potential, where negative-going transients as small as 50 ns and reaching only  $-0.3$  V can cause the timer to switch states.

The 555 is used as a comparator, with a threshold of  $1/3 V_{cc}$  set by the device's internal bias. The output (pin 3) assumes an inverted state relative to the input, and can source or sink up to 100 mA. LED-1 lights continuously on a steady HIGH input; LED-2 on a steady LOW.

Capacitors across the series-limiting resistors pass current pulses to the LEDs during signal transitions. These pulses momentarily flash the LEDs to show the presence of short input spikes that would otherwise be undetectable. Series diodes protect the LEDs from excessive inverse voltages when the capacitors discharge.

Resistor values chosen for  $R_1$  and  $R_2$  are a compromise to allow use of widely available 1.6-V, 40-mA LEDs over the full range of the commonly used supply voltages—4.5 to 16 V. For a single supply level, a compromise isn't necessary. With TTL levels, these resistors could be reduced to 120  $\Omega$ ; with CMOS or HTL, they can be raised to 820  $\Omega$ .

For the time constants shown in the circuit, 300 ns pulses, spaced 500- $\mu$ s apart, remain detectable even at  $V_{cc}$  of 5 V. Square-wave inputs light both LEDs equally, which are easily visible

to over 500 kHz. The ratio of brightness is an indication of the duty cycle.

Accurate level detection can be added to the circuit, if the reference terminal (pin 5) is connected to a potentiometer wired between  $V_{cc}$  and ground. In this way, the threshold of the input (pin 2) can be adjusted from about 1 V to  $1/2 V_{cc}$ . Also, hysteresis can be added by omitting the pin-5 bypass capacitor and providing positive feedback with a resistor from the output (pin 3) to pin 5.

Supply voltage  $V_{cc}$  can be borrowed from the circuit under test, thus the probe easily fits into a penlight case.

Arthur R. Klingler, S/Sgt. USAF, Biomedical Equipment Repair Center, Sheppard AFB, TX 76311.

CIRCLE NO. 311

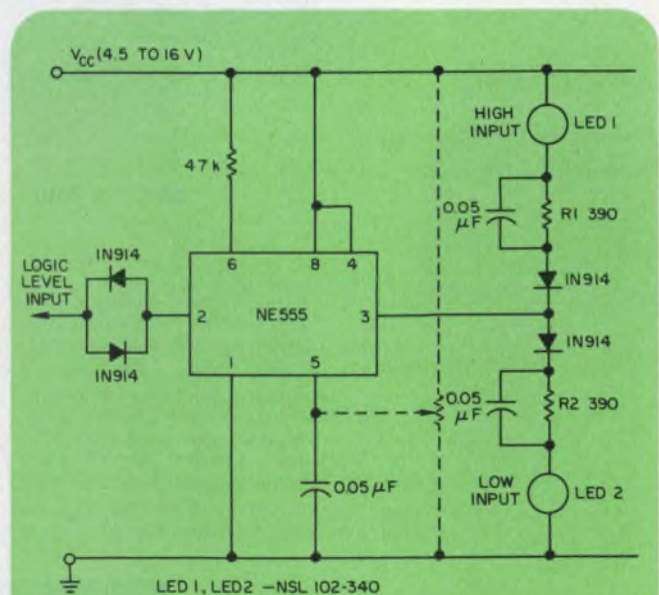

The logic probe can provide accurate level detection if the voltage at pin 5 is adjusted to the desired reference level.



# PMI's Universal DAC.

**The stuff  
dreams are  
made of.**

The DAC-08 is more than the world's fastest monolithic DAC (settling in 85 nsec. typ.); it is a true current output device . . . a *digitally controlled current source*. And it features true 8-bit accuracy:  $\frac{1}{2}$ LSB max. over temp.

It can deliver wide output voltage swings without loss of linearity, since its impedance approaches infinity.

The DAC-08 is universal in its applications because its logic threshold is universal. It accepts TTL, CMOS, P- and N-MOS—any digital input. It's right at home in  $\mu$ P designs. And if you're interested in 4-quadrant multiplication, you'll want to know that you can do it with only two DAC-08's.

## Free Sample

If you just want the data sheet, circle the number below. But if you would like to run some tests on a DAC-08, write us on your letterhead and tell us what your application is. We'll get a sample to you fast, along with appropriate Application Notes.

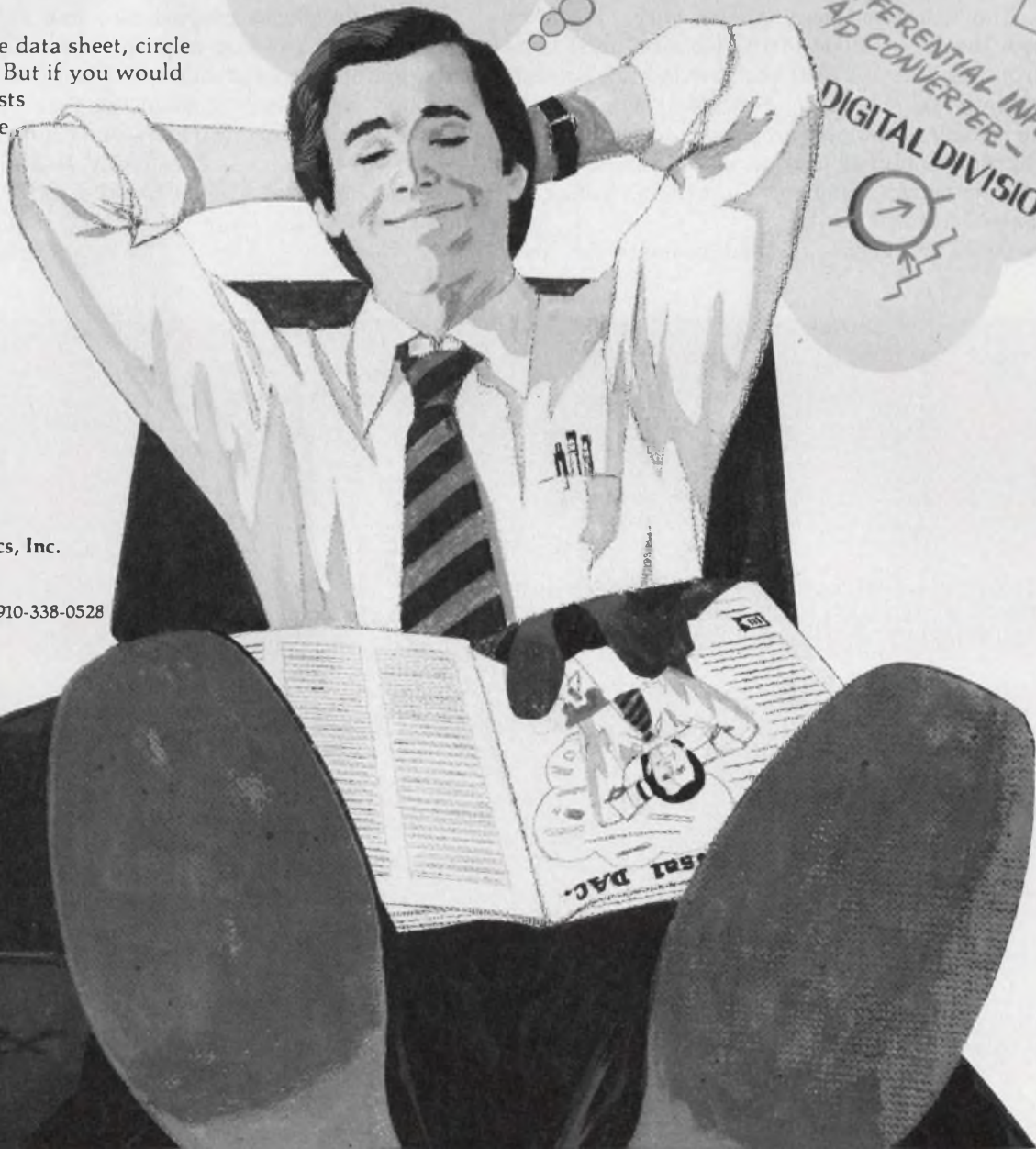
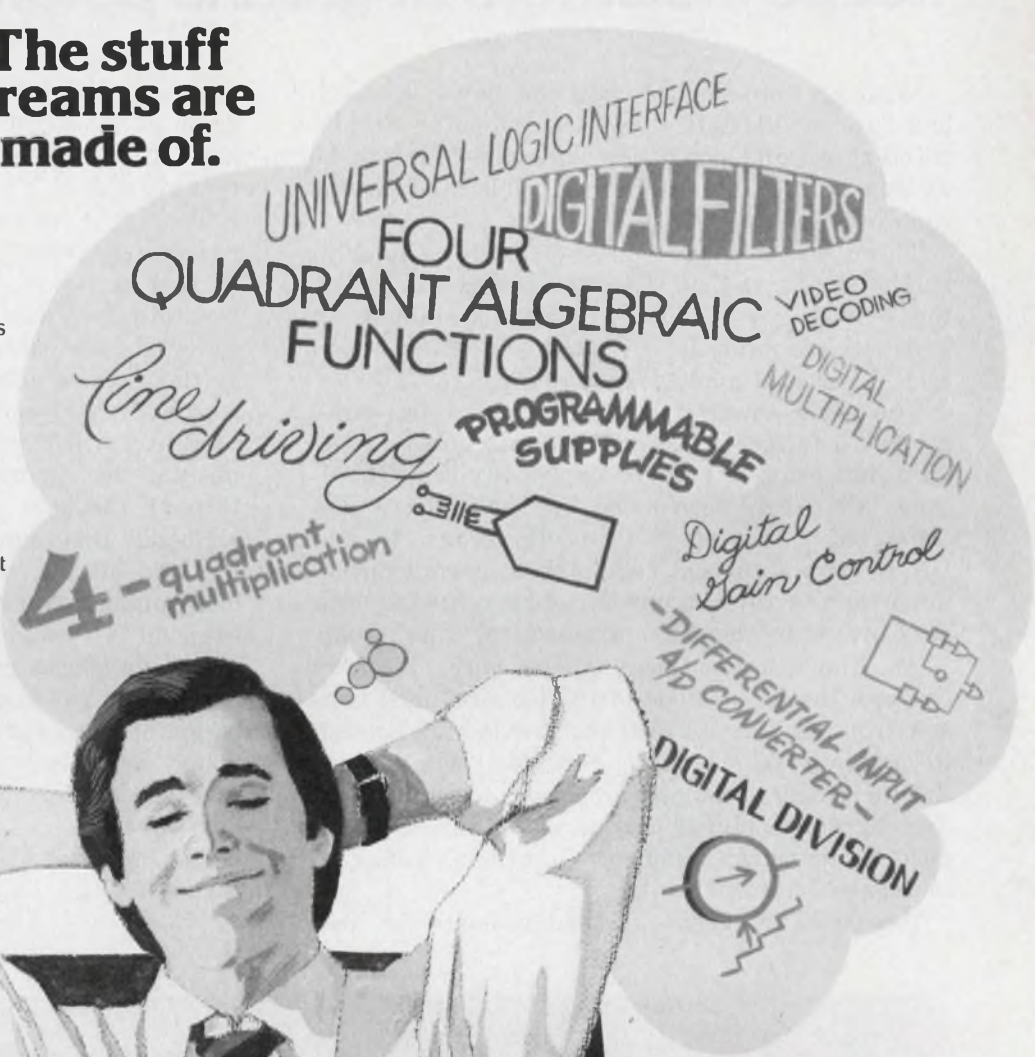

**Precision Monolithics, Inc.**  
1500 Space Park Drive,  
Santa Clara, CA 95050  
(408) 246-9222, TWX: 910-338-0528  
Cable MONO.



# Opto-isolator in fuse monitor keeps indicators at ground potential

With an opto-isolator, you can build an excellent fuse monitor. It allows the indicator circuits to be at ground potential, while the fuse can be at any voltage up to the limit tolerated by the isolator's insulation.

There are two ways to use the opto-isolator: In the series method, the opto-isolator is ON if the fuse is good (Fig. 1); and the shunt, in which the isolator is ON when the fuse is open and  $V_{CC}$  is still applied (Fig. 2).

The series method might be called fail safe, because a failure of the opto-isolator gives a fuse-open indication to warn of improper circuit conditions. Also, if the fuse opens,  $V_{CC}$  is completely disconnected. Series-method circuits (Figs. 1a and 1b) require a current regulator to permit operation over a broader range of load currents than can be tolerated by the usual opto-isolator input diode.

As line current rises above zero, it flows through the input diode of the isolator until voltage drop across the 270- $\Omega$  resistor is high enough to activate  $Q_1$ . As line current rises higher, the increment is largely bypassed by  $Q_1$ . Should line current be higher than  $Q_1$  can manage, an additional transistor such as  $Q_2$  can be added to increase current capacity.

However, the series method reduces the load

terminal voltage by 2.2 V, or more, the load must draw at least 2.5 mA, and the load current is limited by the current capacity of the input current regulator.

The shunt method, on the other hand, neither reduces the terminal voltage, nor is there a load current maximum limit. As shown in Fig. 2a, the isolator input diode and the current-limiting resistor,  $R_S$ , are connected in series across the fuse. If the fuse is good, it shunts current past the input of the isolator. If the fuse is open, this condition will be indicated, but only if about 2.5 mA can flow in the isolator input, and also pass through the load.

Should this input current pose a problem in the load circuit, a second opto-isolator, called a load snubber, can be used as in Fig. 2b to bypass the load.

But the shunt method also has disadvantages. Should the isolator fail, there would be no indication of this condition. Also the load is not completely de-energized when the fuse opens. On the other hand, since the isolator is not in a continuous ON state, it is less likely to fail.

Hans Sorensen, Application Engineer, Hewlett-Packard, 640 Page Mill Rd., Palo Alto, CA 94304. CIRCLE NO. 312

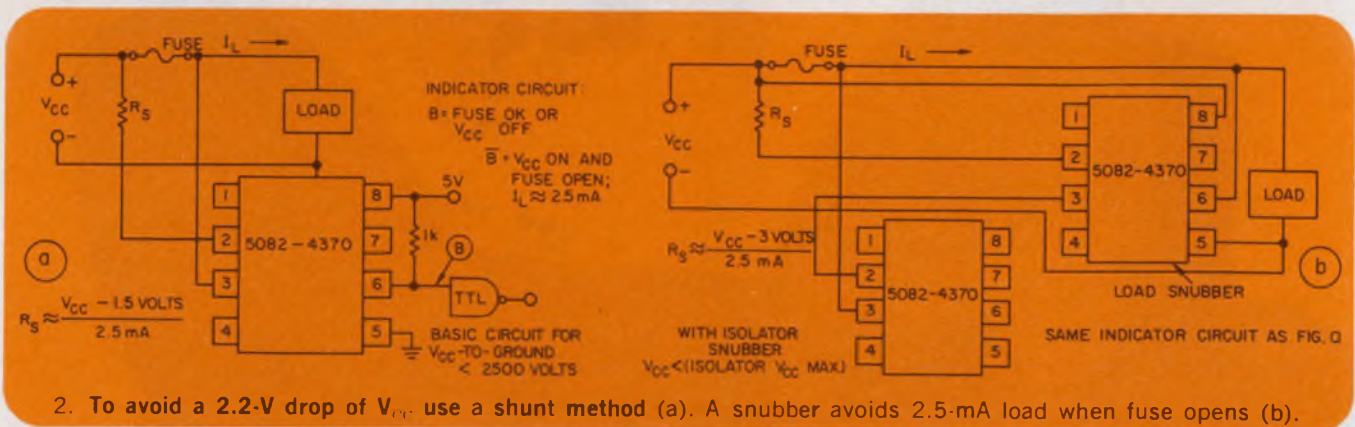
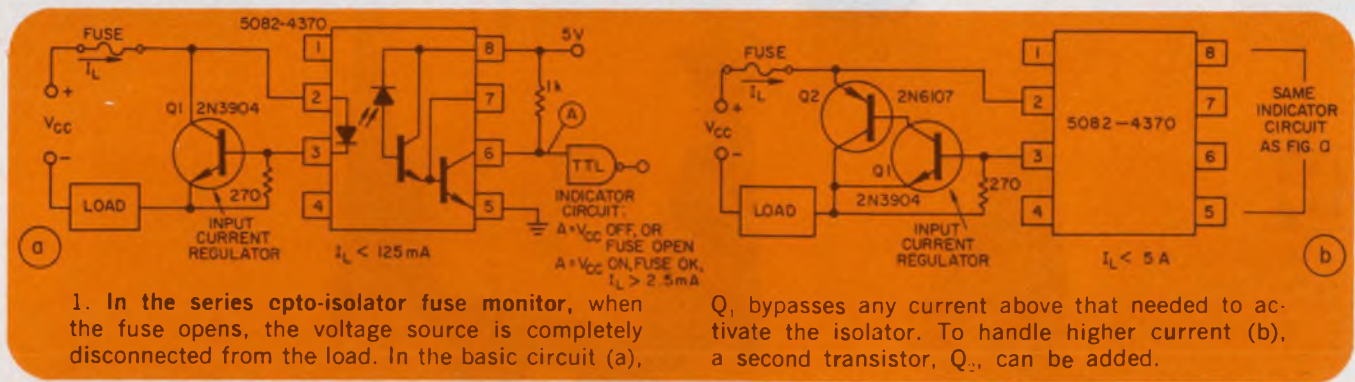



# A lot of people's V/F-F/V Converters are pin compatible.

COMPETITIVE ANALYSIS SUMMARY

For Field Sales Personnel  
J. P. Maxwell - 5/3/76

Competition	ADI Model	Price \$ (1-9) ADI/Brand X	V/F - F/V CONVERTERS			Comments
			Linearity (ppm) ADI/Brand X	Gain Drift (ppm/°C) ADI/Brand X	Offset Drift (uV/°C) ADI/Brand X	
Brand A	456J 10kHz, V/F	29/39, 50	100/1000	120/150	100/100	ADI clear winner! Price and performance.
Brand A	456K 10kHz, V/F	34/53, 50	200/500	80/100	100/100	Brand A has degraded linearity for low level signals.
Brand B	450J 10kHz, V/F	37/55	100/500	30/100	50/100	Brand B has non-standard pin-out. ADI clear winner.
Brand C	450K 10kHz, V/F	45/53	50/100	25/20	20/20	Brand C in large 2" x 2" package vs. ADI 1.5" x 1.5" with superior linearity.
Brand A	452K 100kHz, V/F	49/79	150/250	100/100	30/30	Save 38% with ADI, and get 40% better linearity.
Brand B	452J 100kHz, V/F	39/75	150/150	150/150	30/100	Save 40% with ADI.
Brand D	452K 100kHz, V/F	40/65	150/500	100/100	30/30	Brand D in large 2" x 2" box and costs more.
Brand A	451J 10kHz, F/V	39/53, 50	300/300	100/100	30/50	Brand A price is 37% higher. Upgrade to ADI "K" version for twice the performance at only \$45.
Brand C	451L 10kHz, F/V	55/51	80/100	50/30	30/30	Brand C has better gain drift but needs 78% more real estate.
Brand A	451K 10kHz, F/V	45/79	150/200	50/44	30/50	Brand A has better gain drift. Otherwise ADI is superior and costs 48% less.
Brand C	451L 10kHz, F/V	45/79	80/100	50/30	30/20	Brand C has edge on drift. ADI leads in linearity-price, size.
Brand A	453L 100kHz, F/V	55/61	300/500	100/100	30/30	Unbelievable... Brand D has no signal conditioning circuitry so user must convert signals to pulse... and still pay 77% more.

## How about their price and performance?



All V/F-F/V Converters are not created equal. You shouldn't have to sacrifice performance for price. Or vice versa.

That's why Analog Devices created a family of V/F-F/V Converters that are completely pin compatible with greater performance, higher reliability and lower price than any on the market.

They are more versatile, less susceptible to noise and offer low non-linearity and excellent stability over the temperature range. They're available in three convenient full scale frequency ranges of 10kHz, 20kHz and 100kHz to perform accurate analog measurements while directly interfacing with digital circuits.

For all general purpose applications the Model 450 V/F can achieve 0.01% (13-bit) accuracy over the 1mV to +15V signal range. Model 454 V/F accepts 0 to +20V or 0 to .67 mA inputs and can be operated with bipolar signals up to ±10V. Model 456 V/F

offers the lowest cost for applications requiring 0.1% (10-bit) accuracy. Model 452 V/F is a low cost 100kHz converter that offers resolution of better than 16 bits and low non-linearity error of 0.025% max. over 120 dB signal range.

For low cost interfacing to a wide variety of frequency transducer signals – such as pulse type tachometers, magnetic pick up coils, flow meter outputs – our family of 10kHz F/V converters, Models 451J/K/L, and 100kHz F/V converters, Model 453J/K/L, offer excellent application versatility. Best of all, our V/F-F/V are available at the lowest prices around, starting at just \$25 in 100's.

Find out how the Analog Devices family of V/F-F/V Converters can give you the best of everything. The best performance. The best price. The best answers to your application problems. Write Analog Devices, the real company in precision measurement and control.



The real V/F Converter company.

Analog Devices, Inc., Norwood, Massachusetts 02062  
 East Coast: (617) 329-4700, Midwest: (312) 894-3300, West Coast: (213) 595-1783, Texas: (214) 231-5094, Belgium: 03 38 27 07, Denmark: 97 95 99, England: 01/94 10 46 6, France: 686-77 60, Germany: 089/53 03 19, Japan: 03/26 36 82 6, Netherlands: 076-122555 and representatives around the world.



# FETs provide current limiting for protection against shorts

Only two FETs, without any additional parts, can provide current limiting to protect sensitive circuits (Fig. 1). Removal of the overload condition or short allows immediate return to normal operation.

Connecting the gate to the source of a FET sets the gate-source voltage at zero. The FET can then be used to limit the maximum current in a sensitive circuit to the saturation drain-source current,  $I_{dss}$ , even under short-circuit conditions (Fig. 2).

Two FETs connected back-to-back allow bidirectional current limiting. Depending upon the current directions, one FET acts as the current limiter, and the other behaves as a forward-biased diode. For unidirectional limiting, only one FET is required.

Several restrictions apply to the choice of FETs for use as limiters:

- With two FETs in series, they introduce a resistance of  $2 \cdot R_{ON}$  in series with the protected circuit. Generally, FETs with low  $I_{dss}$  have large  $R_{ON}$ .

- The maximum short-circuit voltage,  $V_{sc}$ , that the circuit can withstand, is limited by the breakdown voltage  $BV_{dss}$  of the FET, where

$$|BV_{dss}| > |V_{sc}| + |V_{out}|.$$

- The product of drain current,  $I_d$ , and the drain-source voltage,  $V_{ds}$ , should not exceed the FET's dissipation capability,  $P_d$ .

The 2N4339 is one of many FETs suitable for use as a current limiter. Its typical characteristics are as follows:

$I_{dss}$	— 5 to 30 mA
$BV_{dss}$	— 40 V
$R_{ON}$	— 100 ohm
$P_d$	— 0.5 W.

*M. Grayeff, Y. Berger, and Y. Scialom, Elta Electronics Industries Ltd., P.O. Box 330, Ashdod, Israel.*

CIRCLE NO. 313

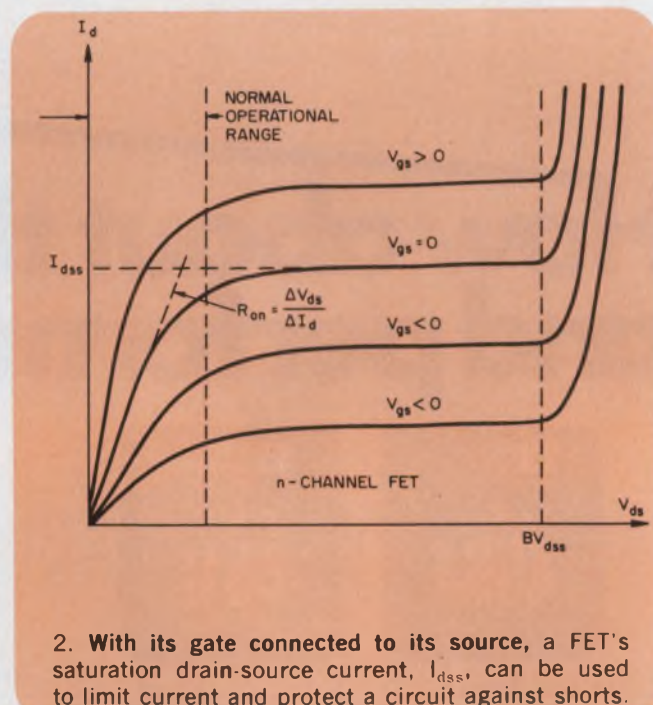
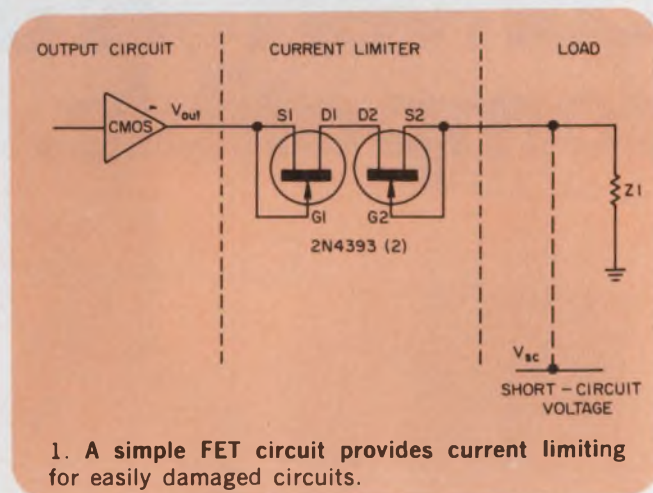

## IFD Winner of February 2, 1976

**Gerald Burma**, National Semiconductor Corp., 2900 Semiconductor Dr., Santa Clara, CA 95051. His idea "Simple Hex VCOs Constructed from CMOS Inverter and Schmitt Trigger" has been voted the Most Valuable Of Issue Award.

**Vote for the best idea in this issue** by circling the number of your selection on the Reader Service Card at the back of this issue.

**SEND US YOUR IDEAS FOR DESIGN.** You may win a grand total of \$1050 (cash)! Here's how. Submit your IFD describing a new or important circuit or design technique, the clever use of a new component or test equipment, packaging tips, cost-saving ideas to our Ideas for Design editor. Ideas can only be considered for publication if they are submitted exclusively to ELECTRONIC DESIGN. You will receive \$20 for each published idea, \$30 more if it is voted best of issue by our readers. The best-of-issue winners become eligible for the Idea of the Year award of \$1000.



# ***Burr-Brown's 8-bit ADC82 gives you a 2.8 $\mu$ sec conversion speed, adjustment free operation, low cost, and much more...***

*Our new ADC82 successive-approximation A/D converter offers both parallel and serial data outputs, output-status signals, and conversion speeds of 2.8 $\mu$ sec, maximum. It's complete and self-contained with its own internal clock, comparator and reference. No external gain or offset adjustments are needed for 0 to +10V or  $\pm$ 10V signal ranges at accuracies of better than  $\pm$ 0.2%,  $\pm$ 1LSB.*

*All this means money saved in production and testing.*

*But we've saved the best for last: The ADC82 uses IC's and laser-trimmed thin-film components to bring you this kind of performance for as little as \$36\*.*

*And the ADC82 is packaged in a metal (ADC82AM) or ceramic (ADC82AG) 24-pin DIP that measures only 1.4" by 0.8" and less than 1/4" high.*

*For details on this or other conversion products, contact Burr-Brown, International Airport Industrial Park, Tucson, Arizona 85734. Telephone (602) 294-1431.*

*\*ADC82AG in orders of 100.*



**BURR-BROWN**  
**BB**

***Fifty-four  
conversion  
choices***

CIRCLE NUMBER 60



# Arrow-M Amber Relays

## An important communication for the telecommunications industry.

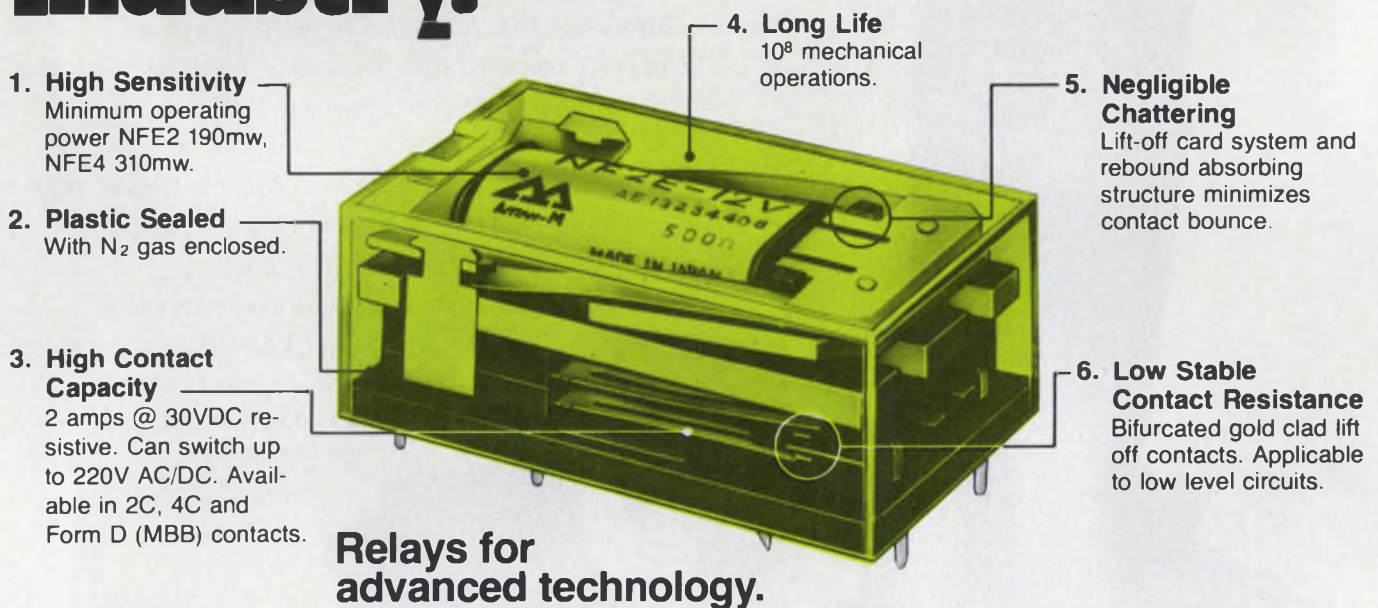

Arrow-M NFE Amber relays give you high sensitivity with half the power drain... N<sub>2</sub> gas-filled plastic sealed for automatic wave soldering and ultrasonic cleaning.

The low power requirements of most telecommunications computer installations demand critical sensitivity and reliability in the relay systems.

Arrow-M Flatpack NFE relays offer maximum reliability and sensitivity using half the power of ordinary relays. The Flatpack design, only .425 inches high, is ideal for high density PC board packaging. The unique automated modular assembly insures extra long life and total reliability. And the gas-filled plastic sealed construction allows for economical automatic wave soldering and ultrasonic cleaning.

For NFE relays providing maximum sensitivity and reliability with minimum power drain, look to Arrow-M, the Company with over 50 years of meeting and advancing needs of modern technology.

For more information on exact specifications, write or call your nearest Arrow-M office.

**Arrow-M Corporation**  
250 Sheffield St.  
Mountainside, N. J. 07092  
(201) 232-4260

*Western Office:*  
22010 South Wilmington Ave.  
Suites 300 & 301  
Carson, California 90745  
(213) 775-3512



**Arrow-M**

Member of Matsushita Group



# Digital plotter talks back to terminal

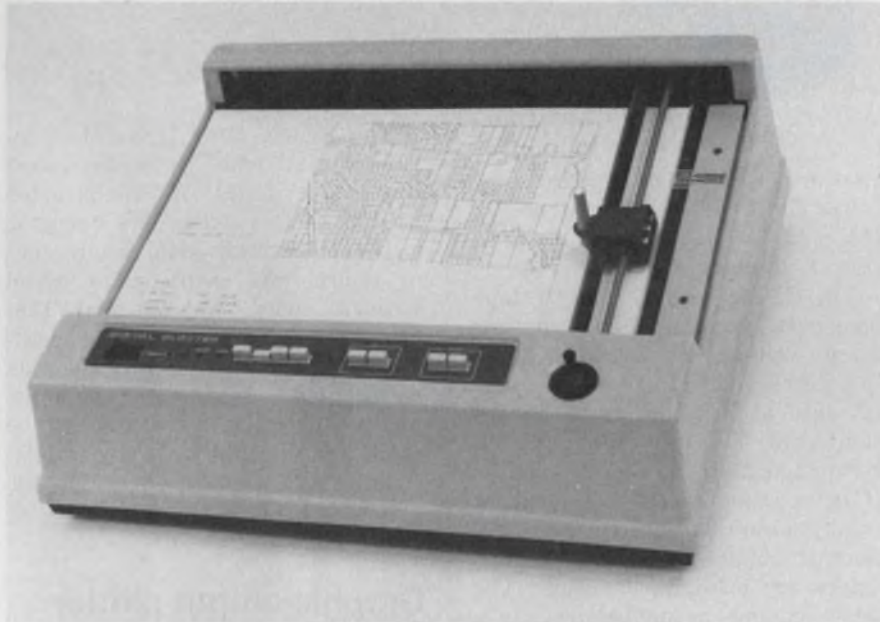

Tektronix Inc., P.O. Box 500, Beaverton, OR 97077. (503) 644-0161. See text.

Hook-up your existing alphanumeric terminal to Tektronix' new interactive digital plotter, the 4662, and enjoy the benefits of computer graphics.

With the 4662's RS-232-C standard interface, all you need to get accurate drawings is a modem—neither a full-blown graphics terminal nor a copying device is necessary. If the IEEE 488 interface is what you need, you've got it—it's also standard on the 4662.

The plotter's \$3995 price gives you 10 × 15-in. images with 0.005-in. accuracy and ±0.0025-in. repeatability. Such performance at that price means you won't have to wait in line any longer to use the single high-cost, high-accuracy plotter that's usually available.

Engineering drawings can be made fairly fast because the 4662's pen zips along at a maximum speed of 22 in./s, and data are transferred at 110, 150, 300, 600 or 1200 baud.

A 1600-byte input buffer optimizes the data transfer, and an

internal  $\mu$ P controls the acceleration and deceleration of stepping motors.

Along with its speed and accuracy, the Tektronix plotter provides a hardware character generator, and digitizing capability. You can print 95 ASCII characters, plus a few others, and you can change character size or rotate characters in 1-degree increments—all from program control.

Digitizing occurs through the 4662's joystick control. Use the stick to move the pen to the desired position, press the call key, and the pen's X-Y location is sent to the host terminal or computer. Also, by use of the joystick, small areas on a plot can be "windowed up" to a full-scale presentation.

Other key specs of the 4662 include a minimum plotting rate of 16 in./s (vector dependent), a pen action rate of 10 points/s maximum and a time to maximum velocity of approximately 120 ms.

Up to four plotters can be hooked-up in series, and each can be individually addressed through its own code. Delivery is 8-12 wks.

Booth No. 2101. Circle No. 301

## Compact digital cassette unit is inexpensive



International Computer Products, Inc., 2925 Merrell Rd., Dallas, TX 75229. (214) 350-6951. \$695; 75 days.

The TermiCette 2020 digital recorder/playback unit uses standard cassettes as the storage medium. It measures 6.75 × 7.75 × 13.5-in. and it transfers data at rates up to 1200 bit/s. The unit weighs 8.5 lb.

Booth No. 1511 Circle No. 307

## 256 kbyte core memory fits single board

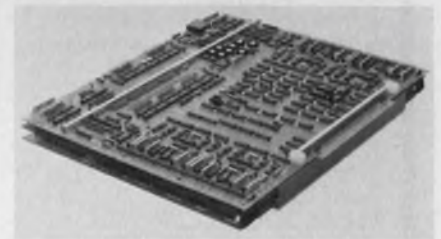

Dataram Corp., Princeton-Hightstown Rd., Cranbury, NJ 08512. (609) 799-0071. \$6500 (unit qty).

The DR-128 single-board 256-kbyte core-memory contains 2.4 Mb, the industry's largest according to Dataram. The system can be addressed as either 256-k × 9 or 128-k × 18 units. A 19-in. chassis also is available, which can contain up to eight DR-128 systems with two megabytes of storage. Cycle time is 1.3  $\mu$ s and access time is 650 ns. Only two dc supply voltages are required.

Booth No. 1117, 1119

Circle No. 308



**RF power**  
 We've made the  
 most of it...  
 You can, too!!

All wrapped up in a neat little package, our Model 510L is an ultra-wideband RF power amplifier whose wide range of frequency coverage and power output provide the user with the ultimate in flexibility and versatility in a laboratory instrument. Easily mated with any signal generator, this completely solid state unit amplifies AM, FM, SSB, TV, pulse and other complex modulations with a minimum of distortion.

Constant forward power is continuously available regardless of the output load impedance match making the 510L ideal for driving highly reactive loads. Unconditional stability and instantaneous fail-safe provisions in the unit provide absolute protection from damage due to transients and overloads.

This outstanding unit covers the frequency range of 1.7 to 500 MHz with a linear power output of more than 9.5 watts and there is no tuning.

For further information or a demonstration, contact ENI, 3000 Winton Road South, Rochester, New York 14623. Call 716-473-6900 or TELEX 97-8283 ENIROC



**ENI**

The world's leader  
 in solid state power amplifiers

SEE  
 Electronic Design's  
**GOLD BOOK**  
 FOR COMPLETE  
 PURCHASING  
 INFORMATION

CIRCLE NUMBER 62

## NCC '76 PRODUCTS

### Digital cassette unit needs one supply voltage

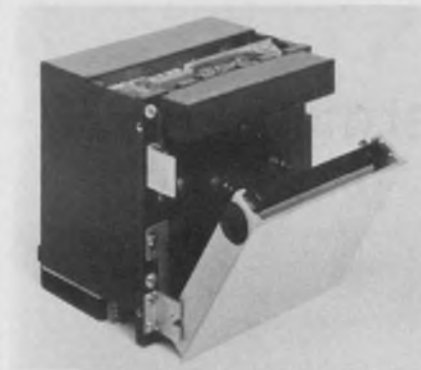

Braemar Computer Devices, Inc.,  
 11950 Twelfth Ave. S., Burnsville,  
 MN 55337. (612) 890-5135. \$460  
 (qty 10); stock.

The CS-400 digital cassette tape transport system requires only one supply voltage of from 14 to 30 V. It accepts and delivers serial digital data at TTL levels at an 8-k baud rate. The unit operates at a nominal density of 800 bits/in. at 10 in./s. Other speeds and densities are optional. The system has two-channel capability and both tape tracks are available for data. The active channel is determined via a TTL command. The system uses the Manchester phase-encoding technique and provides ANSI compatible data.

Booth No. 2745      Circle No. 309

### Portable terminal uses RS232 interface



Informer Inc., 2218 Cotner Ave.,  
 Los Angeles, CA 90064. (213) 477-  
 4216. \$2080 (unit qty); 30 days.

Informer P-series portable video-display computer terminals are small lightweight devices for communicating with a computer. Terminals may be equipped with an RS232 interface for baud rates to 9600 or with a 300-baud acoustic coupler. A pollable, daisy-chain portable unit also is available.

Booth No. 2000, 2002

Circle No. 310

### Serial printer features interchangeable fonts

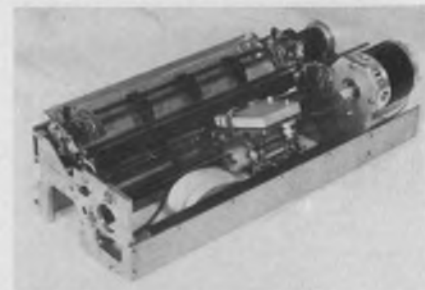

Mitsui and Co., Inc., 200 Park Ave.,  
 New York, NY 10017. (212) 973-  
 4600. \$1400; 30 days.

The Shinko M-60 Helianthus serial printer features easily interchangeable fonts. A 96-character print wheel is used. The operator can replace individual characters or replace the entire print wheel without tools. An optional 128-character print wheel is also available. The M-60 prints 132 columns using pica type, or 158 columns using elite type. Printing can be from left to right or right to left. Paper feeds at 40 ms per line for 6 lines/in.

Booth No. 8463      Circle No. 320

### Graphic-output plotter has built-in $\mu$ P



Glaser Data Co., 225 Forest Ave.,  
 Palo Alto, CA 94301. (415) 321-  
 1348. \$14,000; 60 to 90 days.

Handling 22 x 34-in. drawings with plotting speeds to 800 increments/s is featured by the DP-1600 computer graphic-output plotter. The device attains an accuracy of 0.004 in. A built-in microprocessor simplifies the drawing of straight lines; a slope generator requires only the two end points of the line. In addition, an internal 55-character symbol generator reduces both software and data-transmission needs. Elaborate precision drawings can be made with minimum memory requirements.

Booth No. 2122

Circle No. 321



Good news from Hughes:

## Now you can actually reduce system cost by using our hybrid microcircuit modules.

If you're designing circuits that have to be both cost-effective and high in reliability, it will probably pay you to talk with us.

We've developed a system for condensing circuit requirements into the most efficient hybrid packages possible. And we can help you reduce size and weight as well as manufacturing costs.

**Here's how we do it:** We design the hybrid circuits, develop the prototypes, manufacture custom components, then assemble, test, and guarantee the total hybrid package. We make both thick film and thin film hybrids. We use hermetically-sealed metal and ceramic packages. And we make custom MOS devices and bipolar chips right here in-house.

We produce hybrid modules in volume quantities at competitive prices, as well as small quantities for product development.

**Result:** Now you can work with the one company best equipped and experienced to handle your job from concept through production.

We must be doing a lot of things right, because we're one of the leading producers of custom hybrid circuits.

So when it comes to hybrids, call on Hughes. Especially if quality is as important as price. Write for additional information: 500 Superior Avenue, Newport Beach, CA 92663, Att'n. Hybrid Dept. Or call (714) 548-0671, ext. 204.

**HUGHES**

HUGHES AIRCRAFT COMPANY  
MICROELECTRONIC  
PRODUCTS DIVISION



CIRCLE NUMBER 64



# Thermostatic DELAY RELAYS



by **AMPERITE**

Featuring

**LOW COST · LONG LIFE  
MAXIMUM  
STABILITY**

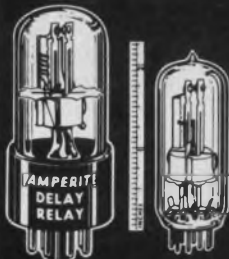

**DELAYS:  
2 to 180  
SECONDS\***

Hermetically sealed — not affected by altitude, moisture, or climate changes. SPST only — normally open or normally closed. Compensated for ambient temperature changes from -55° to +80°C. Rugged, explosion-proof, long-lived. Standard radio octal and 9-pin miniatures.

Price, standard or min., under \$4.00 ea.

\*Miniatures delays: 2 to 120 seconds.

PROBLEM? Send for Bulletin No. TR-81

## New! LONG DELAYS

**240 & 300 Sec.**

Same rugged construction, hermetic sealing and stability as the shorter Delay Relays described above. For delays beyond 300 seconds, these Relays may be used in series.

Price, under \$6.00 ea.

Write for Bulletin No. LD-73.



## DIFFERENTIAL RELAYS

For automatic overload, over-voltage or under-voltage protection. Made only to specifications for 70V, 80V, 90V and 100V.

Price, under \$6.00 ea.

## AMPERITE BALLAST REGULATORS

Automatically keeps current and voltage at a definite value. For AC or DC. Hermetically sealed, rugged, vibration-resistant, compact, most inexpensive.

Price, under \$3.00 ea.

Write for 4-p. Bulletin No. AB-51.



# AMPERITE

600 PALISADE AVE., UNION CITY, N.J. 07087

Telephone: 201 Union 4-9503

In Canada: Atlas Electronics, Ltd.,  
50 Wingold Ave., Toronto 19

OUR COMPLETE PRODUCT LINE CAN BE FOUND  
IN ELECTRONIC DESIGN'S GOLD BOOK.

CIRCLE NUMBER 65

## NCC '76 PRODUCTS

### Data entry system recognizes spoken words



Threshold Technology, Inc., 1829 Underwood Blvd., Delran, NJ 08075. (609) 829-8900. \$10,500.

The Threshold 500 recognizes spoken words, enabling the user to enter data orally. Output is in the same format and code as that of a standard keyboard terminal. A vocabulary of 32 isolated words or phrases can be recognized. In use, the unit is placed in a "train" mode and the user repeats each vocabulary word 10 times to establish reference patterns. In the "recognition" mode the unit displays each recognition decision for operator verification.

Booth No. 1013 Circle No. 322

### Matrix printer can do plotting

Applied Computing Technology Inc., 17961 Sky Park Circle, Irvine, CA 92707. (714) 557-9972. \$1945 (25 up).

Now available is a plotter version of the Series 900 matrix printer that allows a dot to be printed at any position on the paper with a horizontal resolution of 60 dots/in. and a vertical resolution of 72 dots/in. The printer is equipped with a wide range of features either unavailable or at added cost on other printers. Included are bidirectional printing, horizontal and vertical tabulation, forward and reverse 1/6, 1/2 or full-line feed, expanded characters, an internal 320-character buffer and controllable automatic line feed from carriage return. The printer is available as a KSR or RO terminal at data rates of 110, 300 and 1200 baud, switch selectable.

Booth No 3414, 3416

Circle No. 323

### Serial printer uses 7 × 5 matrix

Practical Automation Inc., Trap Falls Rd., Shelton, CT 06481. (201) 929-5381. \$182.50 (100 up); 6 wks.

Designed for panel or base mounting the DMTP-6 printer can record data with the first line visible after printing. In three sizes—35, 60 and 80 columns—the printer uses ordinary paper up to 8-1/2-in. wide and also ribbon or impact-sensitive paper rolls. Over-all height is 5 in., depth 9-5/8 in. and width 7-3/4-in. minimum. Input is serial at 110 c/s and printing is with a proprietary dot-matrix head. Character pitch is normally 12/in., but is variable and character enhancement can be achieved through optional electronic controls. Line pitch is six to the inch, but this is also programmable. Characters are formed with a 7 × 5 matrix to produce a full ASCII set of 64 characters.

Booth No. 1631-1633

Circle No. 324

### Intelligent display uses floppy disc

Delta Data System Corp., Woodhaven Industries Park, Cornwells Heights, PA 19020. (215) 639-9400. \$3100; single drive.

Program load and store, information retrieval and other data entry applications are easily handled by the Delta 4700 system. The system includes a video display terminal and a floppy disc, each of which is under microprocessor control. The display terminal with up to 16 kb of read/write memory is programmable from the keyboard. Standard features include a keyboard with a set of programmable function keys, a display of easily read upper/lower case characters and a variety of special symbols. The disc system, which may contain up to six drives, uses a microprogram to interpret record and file storage and retrieval commands, which may be sent from the display terminal or any other RS232 compatible device. Each drive contains 242,000 characters and may be IBM/3740 formatted.

Booth No. 2631-2633

Circle No. 325



$\mu$ P family compatible  
with mini hard/software



Data General Corp., Southboro, MA 01772. (617) 485-9100. \$950: CPU/4k, single-board  $\mu$ P 4-k word memory (unit qty).

Data General's new 16-bit microprocessor family has the architecture, software and system performance of a Nova minicomputer. Ranging from chip sets to fully packaged computer systems, the microNova family is based on an in-house designed and manufactured 40-pin NMOS microprocessor. The microprocessor features a 16-bit word length. Nova-compatible architecture, a 32-k-word semiconductor main memory and an I/O encoding scheme capable of controlling multiple high-performance peripherals.

Booth No. 1503 Circle No. 326

## Line printer replaces IBM 1403

Potter Instrument Co., Inc., 151 Sunnyside Blvd., Plainview, NY 11803. (516) 681-3200.

Potter Instrument's high-speed line printer, the LP7000, is an exact replacement for the IBM 1403. A chain printer, the LP7000 prints at speeds from 1240 to 1500 lines/min with a 48-character set and 132 columns. Other character sets include 64, 96 or 128 characters with ASCII or EBCDIC codes and include numeric, alphanumeric or symbolic fonts. Character sets may be changed from 48 to 96 or from 64 to 128 characters by simply exchanging chain modules. Sharp printout is obtained for up to six copies.

Booth No. 1333 Circle No. 327

# MEET OUR FAMILY of GRABBERS



**MODEL 4233 MICRO GRABBER**  
Tests high density packaging

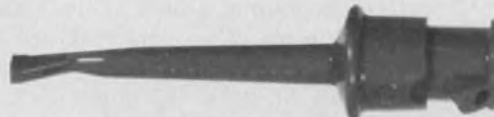

**MODEL 3925 MINI GRABBER**  
Tests conventional packaging

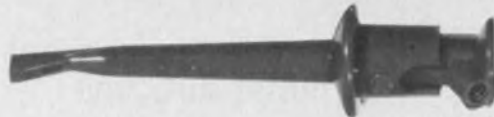

**MODEL 4011 THREADED GRABBER**  
Accepts 6-32 threaded leads

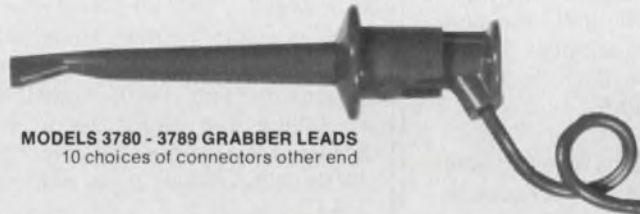

**MODELS 3780 - 3789 GRABBER LEADS**  
10 choices of connectors other end



**MODEL 4225 MAXI GRABBER**  
Tests high rise packaging

All Grabbers shown actual size

Our Grabber family is five years old now, and we're adding new members to keep pace with the complexities of state-of-the-art electronic packaging. Grabber is our name for a series of test clips designed to simplify testing of electronic packages from conventional components to maximum density DIP's. They're rugged, dependable, versatile, and very easy to use. Write for our catalog and get the complete story on the whole family of Grabbers. Find out why they are your best solution to your electronic testing problems.

**AVAILABLE THROUGH YOUR  
FAVORITE ELECTRONIC  
PARTS DISTRIBUTOR**

## ITT POMONA ELECTRONICS

1500 East Ninth St., Pomona, Calif. 91766  
Telephone (714) 623-3463, TWX: 910-581-3822



CIRCLE NUMBER 66



# NEW

## ULTRA WIDEBAND AMPLIFIER



Model 1W1000

## 1 to 1000 MHz 1 Watt Linear

Here's a unique, all-solid-state amplifier that delivers 1 watt of swept power output from 1 to 1000 MHz instantaneously. It's the Model 1W1000 from Amplifier Research. A reliable, unconditionally stable unit, the new Model 1W1000 provides 1 watt of linear power over three decades of bandwidth.

Its performance is matched only by its versatility. For example, Model 1W1000 can be used with high-level sweepers, VSWR measuring systems and network analyzers. It's also used to increase the sensitivity of spectrum analyzers, oscilloscopes and wideband detector systems. It has all the bandwidth you'll ever need. For complete information, write or call:

Amplifier Research  
160 School House Road  
Souderton, PA 18964  
215-723-8181



Your Best source for RF Power  
Amplifiers

### NCC '76 PRODUCTS

#### Complete computer at a calculator's price

*MOS Technology Inc., 950 Rittenhouse Rd., Norristown, PA 19401. (215) 666-7950. \$289 (unit qty).*

The KIM-1 is a complete computer system that retails for the same price as a programmable calculator. The system includes the KIM-1 computer module from MOS Technology, a system power supply and complete software and documentation. This system is not a kit, but a fully assembled micro-computer that includes an 8-bit MPU with a large instruction set, 13 addressing modes, multiple interrupts and a 65-k address range (16 bits). Also included are two MCS 6530 arrays, each with 1024 bytes of ROM, 64 bytes of RAM, 15 I/O pins and an interval timer. *Booth No. 1317 Circle No. 328*

#### Bar-code reader scans in either direction

*Interface Mechanisms Inc., 5503 232nd St. S.W., Mountlake Terrace, WA 98043. (206) 774-3511.*

A bar-code reader, Model 9106, equipped with an ASCII communications output, reads coded tags or labels for input to a data-terminal/computer system. The unit's Ruby Wand light pen reads a two-out-of-five code, and also Intermec's Code 39—a new alphanumeric bar code that features a human-readable text in the area immediately above the code. Intermec also offers its Code 13, which is a new high-density numeric bar code with three special characters. The unit can handle variable-length bar-code messages up to 32 characters; it is switch programmable to read minimum lengths from one to 16 characters. The codes can be bidirectionally scanned at 3 to 25 in/s. An audio signal confirms that a label has been read correctly. The unit's communications interface is compatible with asynchronous bit-serial rates of 110, 150, 300, 600, 1200 or 2400 baud. Parity checking and stop bits are switch programmable. *Booth No. 1022 Circle No. 329*

#### Memory system uses laser recording method

*Precision Instrument Co., 2323 Owen St., Santa Clara, CA 95051. (408) 249-5801. \$415,000.*

The System-190 mass memory records and stores up to one trillion bits of data. It uses laser recording and reading techniques. It can interface to a host computer to provide on-line mass storage or can operate in a stand-alone mode. The recording medium for the System 190 is called the Data Strip. A strip is capable of recording over 1.6 billion bits and has an estimated shelf life in excess of 50 years. Data are recorded by using a precisely focused laser beam to form patterns in the surface of the recording material. The basic System 190 consists of a 191 control unit, a 192 read/write data storage unit, and a 191-4 channel I/O control unit. A single 192 read/write unit contains 80 Data Strips. The Data Strips are removable and replaceable. A single 191 control unit can handle up to eight 192 read/write or 193 read-only units in any combination to provide over one trillion bits of data. *Booth No. 2021-2023*

*Circle No. 330*

#### Impact line printer operates at high speed

*Documation, Box 1240 Melbourne, FL 32901. (305) 724-1111. \$32,500; 30 days.*

The new DOC 2250 impact line printer operates at 2250 lines per minute, single-spaced, using a 48 graphic character set. The free-standing unit contains its own power supply and control logic. Standard features of the DOC 2250 include a fully buffered print line of 132 characters and interchangeable character arrays. The unit also allows format control for page lengths up to 24 in. Paper slews at up to 100 in./s. The cover is acoustically insulated, holding operating noise to 74 dBA. It has resident microdiagnostics and maintenance independent of the host system. *Booth No. 3230 Circle No. 331*



# Ise introduces five new ways to make the competition turn green.

Your competition probably already thinks they're using the perfect display in whatever it is they make. Let them keep thinking it. While you prove them wrong with a new Itron display. They're designed to make the competition turn green. Which also happens to be the color of the segments.

All 17 of them on the 17-digit Itron. All 5 on the FG-512A1. Next comes an Alfa-Numerical Itron. A Linear-Analog Itron. And a Digital Clock Itron. Five ways to be heartless if you put a little heart into it.

## *itron*<sup>®</sup>

*Alfa-Numerical Display*



**FG209M2**

ef = 10V  
ec = eb = 40Vp-p  
ic = 10mA-p-p  
ib = 8mA-p-p  
Wd. 205mm  
Lg. 40mm  
Segment 9mm

*Instruments & Large Calculator Display*



**FG179F2**

ef = 7V  
ec = eb = 35Vp-p  
ic = 7mA-p-p  
ib = 5.5mA-p-p  
Wd. 170mm  
Lg. 40mm  
Segment 9.5mm

*Instruments & Terminal Units Display*



**FG512A1**

ef = 3.5V  
ec = eb = 24Vp-p  
ic = 4mA-p-p  
ib = 3mA-p-p  
Wd. 100mm  
Lg. 40mm  
Segment 12mm

*Digital Clock Display*



**FG425A1**

ef = 5.5V  
ec = eb = 35Vp-p  
ic = 8mA-p-p  
ib = 6.5mA-p-p  
Wd. 140mm  
Lg. 59mm  
Segment 25mm

*Linear Analog Display*

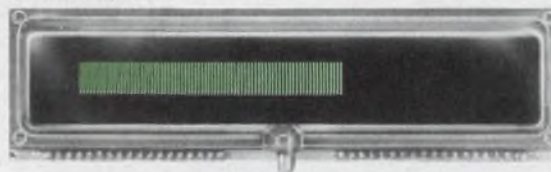

**FG120S1**

ef = 5.5V  
ec = eb = 35Vp-p  
ic = 4mA-p-p  
ib = 0.2mA-p-p  
Wd. 140mm  
Lg. 40mm  
Segment 8mm

### **NORITAKE CO., LTD.**

**Electronics Office (U.S.A.)**  
22410 Hawthorne Blvd. Torrance California 90505  
U.S.A.  
Phone: (213) 373-6704.  
Telex: "230674910"

**Electronics Division**  
1-1, Noritake-Shinmachi, Nishi-ku, Nagoya-City,  
Japan  
Phone: NAGOYA (052) 561-7111.  
Telex: J59738 NORITAKE

### **ISE ELECTRONICS CORP.**

**London Office**  
c/o NORITAKE (U.K.) LTD.  
Noritake House 2, York Street W1H 1 Be, England  
Phone (01) 935 7543 Cable: LUCTUAL LONDON  
**Munachen Office**  
c/o NEUMULLER GmbH 8 Muenchen 2, Karlsruh 55  
West Germany Phone: 592-421 Telex: 522106

**Hong Kong Office**  
Room 1403 Shing Loon Bldg  
24-26 Stanley Street, Hong Kong  
Phone: 5 232420 Telex: HX83151  
**Taipei Office**  
72 9 SEC 2 JEN AI RD, Taipei  
Phone: 351-0293 Telex: 11176



# New case styles!

Bezel, window and surface mounting styles are now included in the expanded line of Beede QA panel meters. There's a variety of meter styles, colors and options to give you complete design flexibility.

Now you can have the best of both... sophisticated appearance *and* high reliability when you specify Beede panel meters. Select from three styles in 1½", 2½", 3½" and 4½" cases. Meter movements available are shielded bar taut-band, Mag B taut-band or pivot-and-jewel, and AC iron vane. Wide choice of options including multi-colored scales, special resistances, different calibration points, tracking accuracies to  $\pm 1/2\%$  and many more.

Each meter has the smart, clean design look. And behind the handsome face of the QA case is the reliable, ruggedized Beede meter you can depend on for long, trouble-free service. Think of Beede as your prime source of reliable, accurate, contemporary-styled panel meters at economical prices.

Write or call for complete information on Beede panel meters, meter relays and pyrometers in the QA case line.

**Beede QA panel meters.**  
**Where appearance is as important as reliability.**

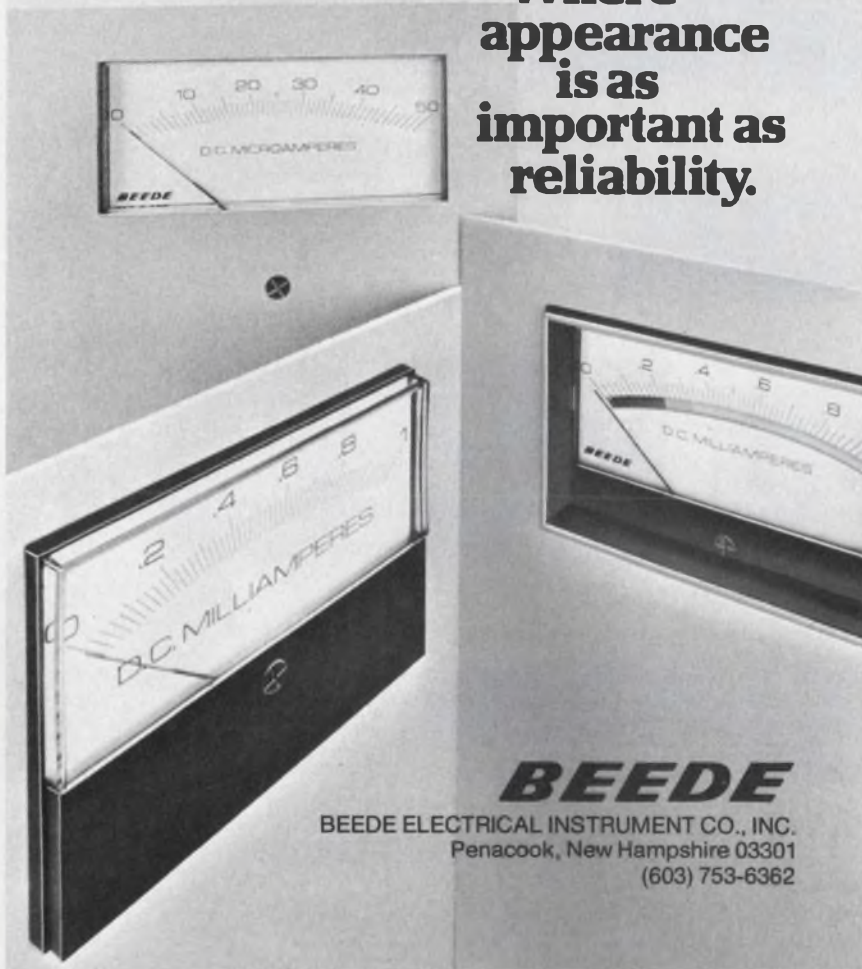

**BEEDE**  
BEEDE ELECTRICAL INSTRUMENT CO., INC.  
Penacook, New Hampshire 03301  
(603) 753-6362

CIRCLE NUMBER 69

## POWER SOURCES

### Three products protect computers

*Topaz Electronics, 3855 Ruffin Rd., San Diego, CA 92123. (714) 279-0111. UPS, start at \$5000; Xformers, \$6000 to \$9000; Regulators, under \$8000 to \$14,000.*

Three new products consist of a line of uninterruptible power systems rated 3 through 15 kVA, single-phase; a line of three-phase ultra-isolation transformers rated 75 through 130 kVA; and a line of three-phase ac line regulators rated 50 through 100 kVA. The line regulators eliminate problems caused by voltage brownouts. The ultra-isolation transformers attenuate ac line noise and the UPS protects the computer from instantaneous and subcycle power losses as well as from longer term power outages.

*Booth No. 1036-1038*

*Circle No. 332*

### Open-frame units deliver three outputs

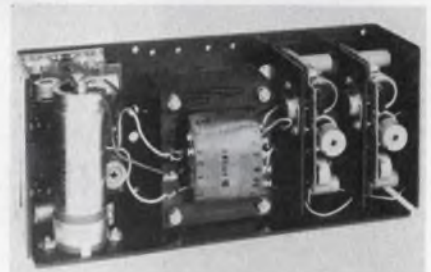

*Power/Mate Corp., 514 S. River St., Hackensack, NJ 07601. (201) 343-6294. \$108.*

Open-frame ETR models provide three different dc output voltages from a single-package/single-transformer power supply. Four models in the series cover an output range of 5 to 24 V, with current from 1 to 6 A. The compact chassis, measuring 11 x 2.87 x 4.88 in., can be mounted on any of three surfaces. All models feature remote sensing and remote programming, self-restoring current limits and convection cooling. Output ripple is less than 1 mV rms. Tempeco is 0.005%/°C maximum. Line regulation is 0.05%, load regulation, 0.1%.

*Circle No. 333*



## Ac source delivers 8.4 kW to 250 kHz

ENI Power Systems, 3000 Winton Rd. S., Rochester, NY 14623. (716) 473-7330. \$11,900; 60 days.

Model EGB 8400 solid-state ac power generator can supply 8.4 kW of ac power and operates over the frequency range of 9 to 250 kHz. The unit uses more than 90 hybrid coupled power transistors in the output stage alone, thus should one transistor fail, the remaining units will supply their output as if nothing had happened. The generator provides maximum power transfer to a 50- $\Omega$  load, however, any load impedance from an open to a short-circuit can be connected without fear of damage or failure. A built-in true-average meter measures the power leaving the EGB 8400 (forward power) and the power absorbed by the load.

CIRCLE NO. 334

## 42 switching supplies comprise two families



Lambda Electronics, 515 Broad Hollow Rd., Melville, NY 11746. (516) 694-4200. LGS-5, \$400; LJS-10, \$180.

Computer and peripheral instrumentation manufacturers now have 42 switching power supplies to meet their needs. The supplies are made up by two series—the LJS and LGS. Together they come in five package sizes, and models range from 10 to 110 A and 5 to 28 V. The LGS series meets MIL SPEC MIL-1-6181D EMI conducted, has 20-kHz switching, efficiency up to 75%, density up to 1.2 W/cu. in, and is guaranteed for five years. LJS series contains 21 models in three package sizes. These provide up to 30 A and voltage ranges up to 28 V.

CIRCLE NO. 335

## Switcher provides three outputs

LH Research, 1821 Langley Ave., Irvine, CA 92714. (714) 546-5279. \$1750; 8-10 wks.

MM Series 930 ECL-PLUS triple-output switching-regulated power supply combines three independent, single-output, regulated power supplies in a single compact

package measuring  $6.1 \times 14 \times 10$  in. and weighing less than 26 lb. Standard outputs of the MM930 are -5.2 V dc at 100 A, -2 V dc at 75 A and 15 V dc at 48 A. Input voltage is  $208 \pm 10\%$  V ac, single phase. Like all Series MM units, the new MM930 is up to 80% efficient, features 1% pk-pk or 50-mV pk-pk ripple and noise.

CIRCLE NO. 336

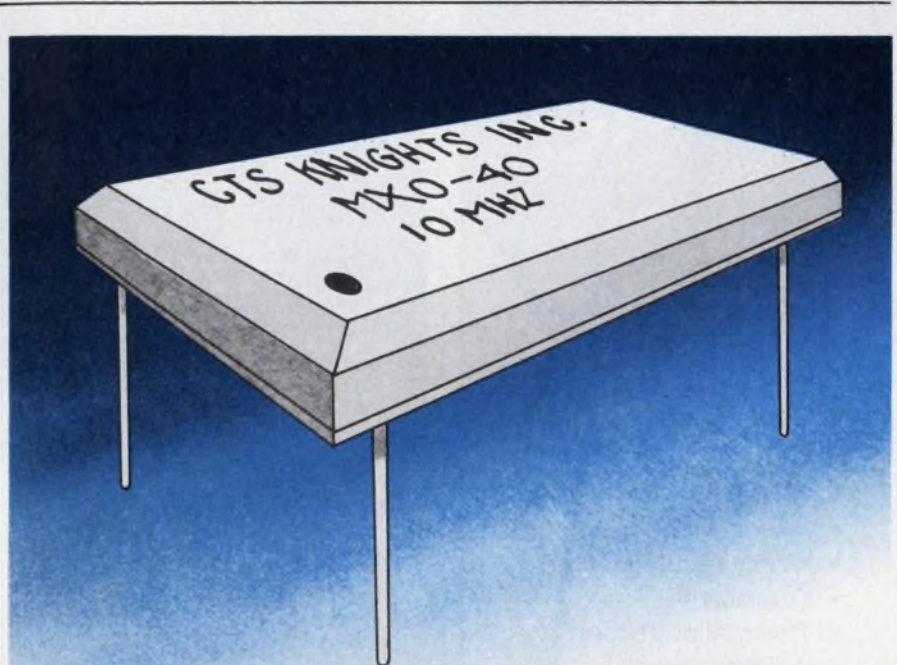

## New low-profile, high-performance crystal oscillator.

Here's a completely new ceramic packaged crystal oscillator that can add more performance per dollar to your time base application.

The new MXO-40 is only .200" high, .800" long and .500" wide. Frequency range: 31.5 KHz to 26 MHz. Frequency stability (calibration, environment and aging for 5 years):  $\pm .01\%$  and  $\pm .1\%$  standard; as low as  $\pm .0025\%$  available upon request. Temperature range: 0° to 70°C. Symmetry: 45/55. TTL Compatible square wave output. Guaranteed startup of 2 msec. assured

by bias feedback circuitry. Input voltage: +5 VDC  $\pm .5$  VDC. 96% alumina ceramic case compatible with 14 pin dual-in-line layouts. Newly developed fully hermetic, epoxy seal. Solder seal available.

A good example of CTS Knights research which produces a continually expanding line of precision frequency control products. Write **CTS Knights, Inc.**, 400 Reimann Ave., Sandwich, IL 60548, phone: (815) 786-8411.

**CTS Knights.**  
The frequency specialists.

**CTS CORPORATION**

Eikhardt, Indiana



CIRCLE NUMBER 70



# 3 WATT DC-DC POWER SOURCES

with improved  
reliability



- 100% Burn-in and test
- Lower price
- Highly regulated
- Low noise
- Thermal protection
- Isolated output
- Copper case
- Most popular pin configuration

Part Number	Output Voltage	Output Current
3W (*) R5	5v	600 ma
3W (*) R12-12	±12v	±125 ma
3W (*) R15-15	±15v	±100 ma

(\*) Input voltage: 5, 12, 24 or 28v  
Example: 3W 12 R12-12

PRICE, ANY UNIT,  
1-9 QUANTITY: \$54.95.  
Substantial quantity discounts  
available.



## Reliability, Inc.

5325 Glenmont/Houston, Texas 77081  
713-666-3261

International: Reliability Nederland, B. V.  
Summerhill, Nenagh, Co. Tipperary, Ireland

\*Trademark, Reliability, Inc.  
Price subject to change without notice

## R/d converter handles 8 channels under $\mu$ P control

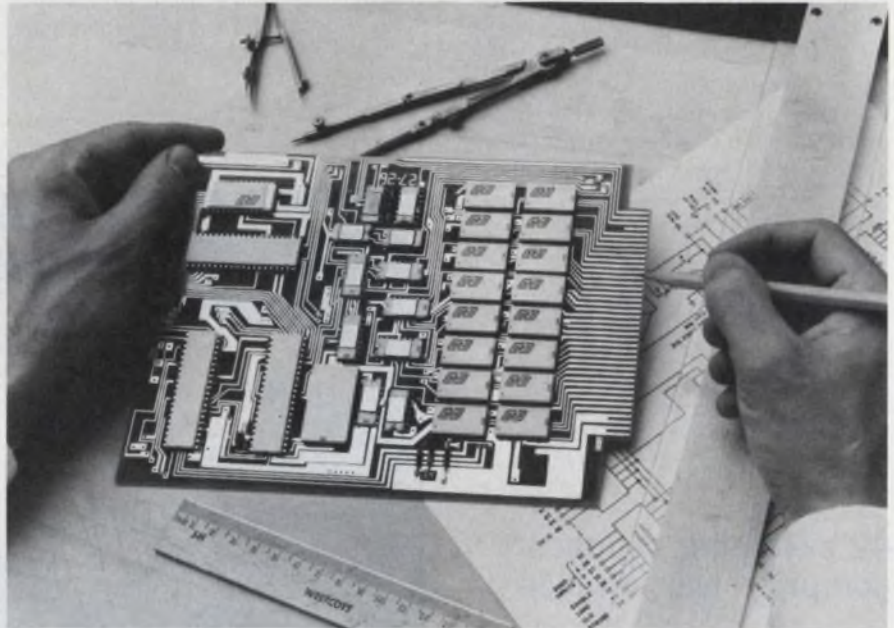

Micro Networks, 324 Clark St., Worcester, MA 01606. (617) 852-5400. See text.

Pack eight channels of analog-resolver data into a single resolver-to-digital converter. The MN7200 multiplexed conversion system developed by Micro Networks accepts up to eight resolver inputs and delivers multiplexed 14-bit data words under microprocessor control to a computer for processing.

The unit requires only 4 ms for each channel conversion and can capture the data in 50  $\mu$ s. The error for an angle phase shift of up to  $\pm 20^\circ$  is only  $\pm 1$  LSB, maximum.

To control the multiplexing and conversion the MN7200 uses an F8 microprocessor. The four-wire resolver outputs feed into ac-to-dc converters and the resultant outputs are then sequentially fed through multiplexers and into a 12-bit a/d converter. The  $\mu$ P initiates each conversion, stores the data in memory and then calculates the angle and reads it out as a 14-bit binary number.

Guaranteed system accuracy over the 0-to-70-C operating range is  $\pm 4$  minutes of arc without any external adjustment. All accuracy

ratings apply for  $\pm 5\%$  power-supply variations,  $\pm 10\%$  reference-frequency changes,  $\pm 10\%$  reference and signal-amplitude variation and 10% signal and reference harmonic distortion. Inputs are standard, two-phase, sine and cosine-resolver signals of 11.8-V rms at 400 Hz. Each channel has an input impedance of about 100 k $\Omega$ , and the reference input is 100 k $\Omega$ .

Channels can be addressed either sequentially or randomly to permit a shorter cycle time than 32 ms if fewer than eight channels are required. Cross-talk between channels is a good -80 dB.

The MN7200 multichannel-conversion system requires  $\pm 12$  and +5-V, nominal power supplies and has a maximum power consumption of 4.637 W. Digital inputs and outputs are TTL compatible. The unit consists of 32 hermetically sealed DIPs mounted on a 6 x 8-in. printed-circuit board. The use of a  $\mu$ P as the controlling element also permits the high system flexibility—just change the program to alter operation.

Price of the MN7200 starts at \$1750 in single lots, and delivery takes three to six weeks.

CIRCLE NO. 302



# semiconductor overload protection... murata's posistors<sup>®</sup> make it simple

Murata's PTH487A Posistors are designed to sense the case temperature of high power semiconductors and appropriately reduce power dissipation when dangerous power and/or current limits are approached. No other components are required, recycling is automatic and reliability is outstanding. Write for complete specifications.

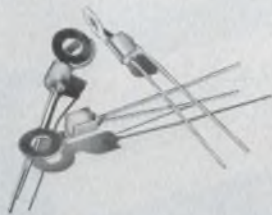

**muRata**  
CORPORATION OF AMERICA  
Rockmart Industrial Park, Rockmart, Georgia 30153  
Phone: 404-684-7821/Telex: 54-2999/TWX: 810-766-1340

CIRCLE NUMBER 72

## PRINTED CIRCUIT SLIDE SWITCHES

Our PC mounted SLIDE switches have 3mm pin centers allowing maximum poles in a limited space. Your choice of one thru 12 poles, 2, 3 or 4 positions in either silver or gold to meet your exacting requirements.

Don't hesitate to ask for more information, prices and samples on this full line of Alco switches.

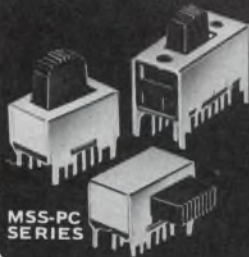

MSS-PC  
SERIES

CIRCLE NUMBER 73

## ROCKER & PADDLE

High quality switches at economy prices. Feature a "snap-in" mount and 10A 125 VAC rating. Unlimited color combinations, lighted or unlighted in single or double pole. All U.L./CSA listed. Ideal for today's panel requirements.

Write or call (617) 685-4371 for our Product Selection Guide, technical information, prices and samples.



X SERIES

CIRCLE NUMBER 74

**ALCO** ELECTRONIC PRODUCTS, INC.  
NO. ANDOVER, MASS. 01845 U.S.A.  
Tel: (617) 685-4371 TWX: 710-342-0052  
A SUBSIDIARY OF AUGAT INC.

# Dialight sees a need:

(Need: The widest choice for your every application.)

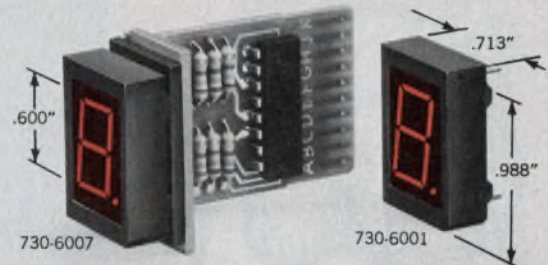

**730 SERIES** A new 0.600" LED character in super bright red, seven-segmented readout . . . low power . . . draws 10mA/segment or less . . . operates with standard IC power supply levels. Very high contrast ratio . . . visible from 40'. Available with or without on-board decoder/driver, plus or minus bar, and with bezel mounting. In 1000-lot quantities each LED  
730-6007 . . . . \$6.05. 730-6001 . . . . \$2.55.

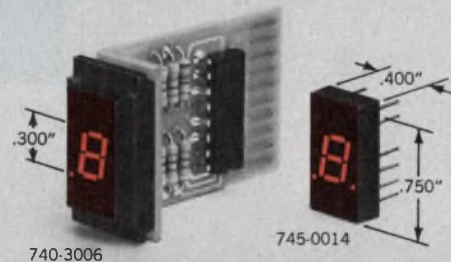

**745 SERIES** A new 0.300" LED character in a very bright red, seven-segmented readout . . . low power requirements. Standard 14-pin DIP . . . available with left and right decimal with  $\pm 1$ , and with and without on-board decoder/driver. Compatible with most TTL and DTL circuits. In 1000-lot quantities each  
740-3006 . . . . \$6.43. 745-0014 . . . . \$2.10.



Dialight, the company with the widest choice in switches, LEDs, indicator lights and readouts, looks for needs . . . your needs . . . and then they develop solutions for your every application. No other company offers you one-stop shopping in all these product areas. And no other company has more experience in the visual display field. Dialight helps you do more with these products than any other company in the business, because we are specialists that have done more with them. Talk to the specialists at Dialight first. You won't have to talk to anyone else. Send for your free new copy of Dialight's current catalog.

**DIALIGHT**

Dialight, A North American Philips Company  
203 Harrison Place, Brooklyn, N. Y. 11237  
(212) 497-7600

# See Dialight.

CIRCLE NUMBER 75



NATIONAL BEWARE!

**We've got  
the bite  
on you!**



**MSK IS ON THE PROWL!**

We're proud to announce the MSK032 . . . the new competition for the LH0032. Its "pin compatible" and competitive in both cost and specifications. Check these specs!

**NATIONAL**

Gain:	70 dB	Typ.
Slew:	500 V/uSec	Typ.
1% Settling:	100 nSec	Typ.
Bandwidth:	70 MHz	Typ.

**MSK**

Gain:	70 dB	Min.!
Slew:	500 V/uSec	Min.!
1% Settling:	100 nSec	Min.!
Bandwidth:	70 MHz	Min.!

\*And there are No Funny Harmonic Distortions Around 3 MHz Either!!

Having any difficulty getting delivery on your LH0063 Buffers? Try an MSK 330. It's pin compatible and delivery is from stock!

# MSK

M.S. Kennedy Corp. Pickard Drive,  
Syracuse, New York 13211  
Tel. 315-455-7077

CIRCLE NUMBER 76

MODULES & SUBASSEMBLIES

## 12-bit MDAC boasts MIL ratings in 18-pin DIP

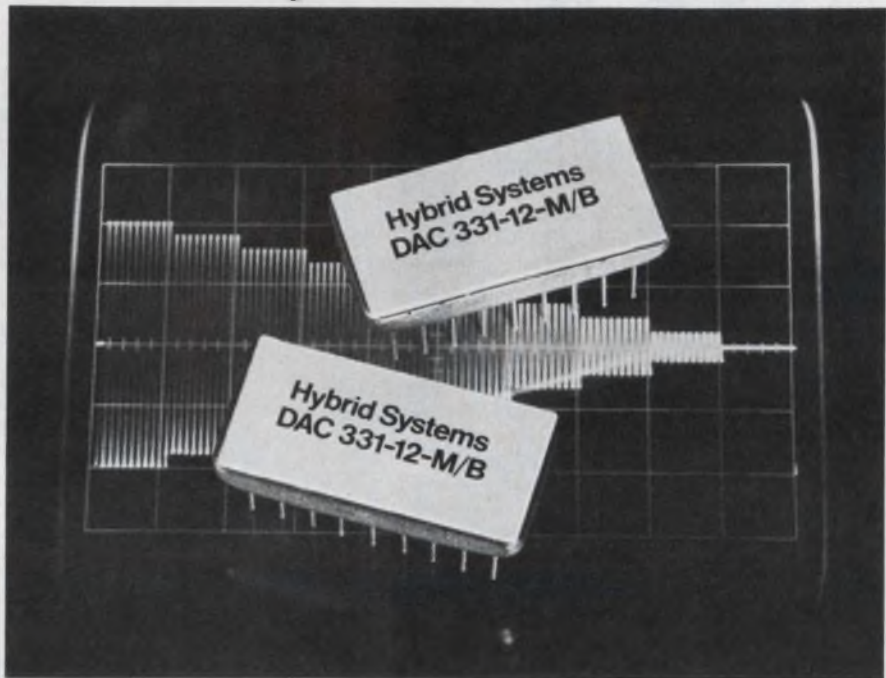

Hybrid Systems, Crosby Dr., Bedford, MA 01730. (617) 275-1570. P&A: See text.

Looking for a 12-bit multiplying d/a converter with full linearity? If you are, check out the Model 331-12-M/B four-quadrant hybrid DAC made by Hybrid Systems. The converter is tested to MIL-STD-883, Level B and won't cost an arm and a leg—only \$75 in single lots. It is housed in a 18-pin hermetic DIP.

Converter linearity—a tight 0.0125% is guaranteed over the -25 to +85 C operating temperature range. Typical drift of the converter's linearity is only 2 ppm/°C. The settling time of the output for worst-case input change is less than 1.5 μs to within 0.05% of its final value.

The converter's reference input accepts signals that range from -20 to +20 V and has a bandwidth of more than 100 kHz. Feedthrough from the input is less than 0.05% at 10 kHz. The output current in milliamps, available from the converter, is equal to the reference voltage divided by 25 kΩ.

To power the converter, all you need is a single +3 to +10-V pow-

er supply—and not much current—the total power consumption is less than 20 mW. Power-supply rejection of the converter is 50 ppm/% of full-scale range. To get a voltage output from the converter, an external op amp must be connected. Inside the converter is a feedback resistor that is pretrimmed for a 0.1% transfer accuracy.

Converter operation can be extended to the full MIL temperature range of -55 to +125 C, but linearity will degrade to ±1 LSB. The 331 is pin-compatible with the Analog Devices (Norwood, MA) Model 7531 12-bit resolution MDAC. The 7531 LD is a monolithic converter but has only 10-bit linearity even though it does offer 12-bit resolution. Price, in single quantities for the 7531, starts at \$29 for the 0-to-70-C version in a plastic DIP and increases to \$39.50 for a hermetic version guaranteed over the -25 to +85 C range.

The 331 from Hybrid Systems is presently only available in the -25 to +85-C version and delivery is stock to four weeks.

Hybrid Systems	CIRCLE NO. 304
Analog Devices	CIRCLE NO. 305



## F/v converters handle input signals of 20 kHz

*Teledyne Philbrick, Allied Dr. at Rte. 128, Dedham, MA 02026. (617) 329-1600. \$29.50 (1 to 9); stock.*

The Model 4722 f/v converter has a input frequency range from dc to 20 kHz. Over a dc-to-10-kHz range the converter will transform the signals into a dc voltage that is accurate to within 0.02%. Wider ranges are possible if 1% errors can be tolerated. Guaranteed specs include: a nonlinearity of 0.03% of FS  $\pm 0.03\%$  of signal, maximum, a full-scale tempo of 300 ppm/ $^{\circ}$ C of a scale factor ( $V_{out}$  for a 10 kHz  $f_{in}$ ) of 9.9 V  $\pm 1\%$ , an initial voltage offset of  $\pm 10$  mV and an offset tempo of 50  $\mu$ V/ $^{\circ}$ C. The converters are housed in 1.125  $\times$  1.125  $\times$  0.4-in. modules and operate from  $\pm 15$ -V power supplies.

CIRCLE NO. 337

## Video output RAMs mate monitors to minis



*Matrox Electronic Systems, P.O. Box 56, Ahuntsic Stn, Montreal, QUE H 3L3N5. (514) 481-6838. \$95 (large qty.); stock to 8 wks.*

The VRAM display modules can directly interface a microcomputer to a TV monitor. On the input side the VRAMs look like ordinary static RAMs. They have access times of less than 1  $\mu$ s (read/write) and can be directly connected to the address (7, 9 or 10 bits) and data (8 bits) bus. The VRAM outputs are video signals that can directly drive a standard TV monitor. The display modules can store 8  $\times$  16, 16  $\times$  32, or 24  $\times$  32 flicker-free alphanumeric characters (ASCII upper, lower case, symbols, Greek letters). No external refresh is required. The VRAMs come in 3  $\times$  4  $\times$  0.6-in. packages, need a single +5-V power supply, and consume less than 1 W.

CIRCLE NO. 338

# We have your High-Rel Hybrids!

At RAYTHEON/QUINCY. And if you want them produced in the most advanced designs and packages available, just tell us your specific needs. We'll custom design your high-rel hybrids just as we do for all our customers.

100% of our business is custom high-rel designs. 98% of that is military and medical electronics. So that means more than just high-rel. It means high performance and high technology, too. And both beam-lead and chip-and-wire packaging.

Of course we have your high-rel hybrids. At Raytheon/Quincy it's a custom. Ask K. Singh. At Raytheon Company, Industrial Components Operation, 465 Centre Street, Quincy, Mass. 02169. (617) 479-5300.

RAYTHEON

CIRCLE NUMBER 77



## New ideas from a new source for flat cable and connectors

The source: Alpha Wire, one of the oldest full-line wire and cable manufacturers.

Our cable is compatible (matches all flat cable connectors designed for 0.050 in. conductor spacing). It has excellent teardown characteristics, is ultra-flexible, and UL listed. Exclusive footage indicator on the reel shows how much cable is left.

Our complete line of connectors (female sockets, headers, DIPs and PCBs) also offer some new ideas:

**Microetched Offset Tines grip conductor securely and prevent conductor damage. (Burs and sharp edges removed.)**

**Eliminates Waste**  
assembler can correct mistakes if he makes a bad crimp.

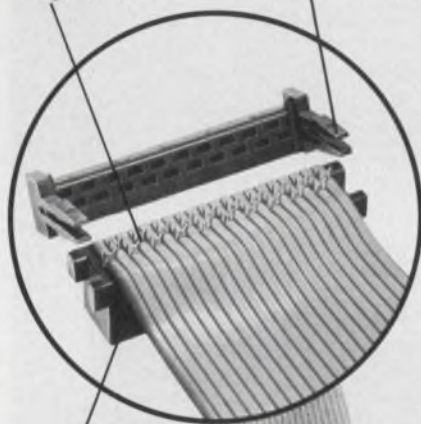

**Positive Contact self-cleaning dual cantilever contacts provide 2 wiping surfaces for reliable, repeatable terminations.**

**Universal Bench Press crimps all connectors. Eliminates need for separate adapters.**

**Allows Denser Wiring** unique design allows cable to remain within profile of the connector.

**alpha**

Alpha Wire Corp.,  
711 Lidgerwood Ave.,  
Elizabeth, N.J. 07207  
(201) 925-8000

CIRCLE NUMBER 78

## MODULES & SUBASSEMBLIES

# Photodiode and control IC come in transparent DIP

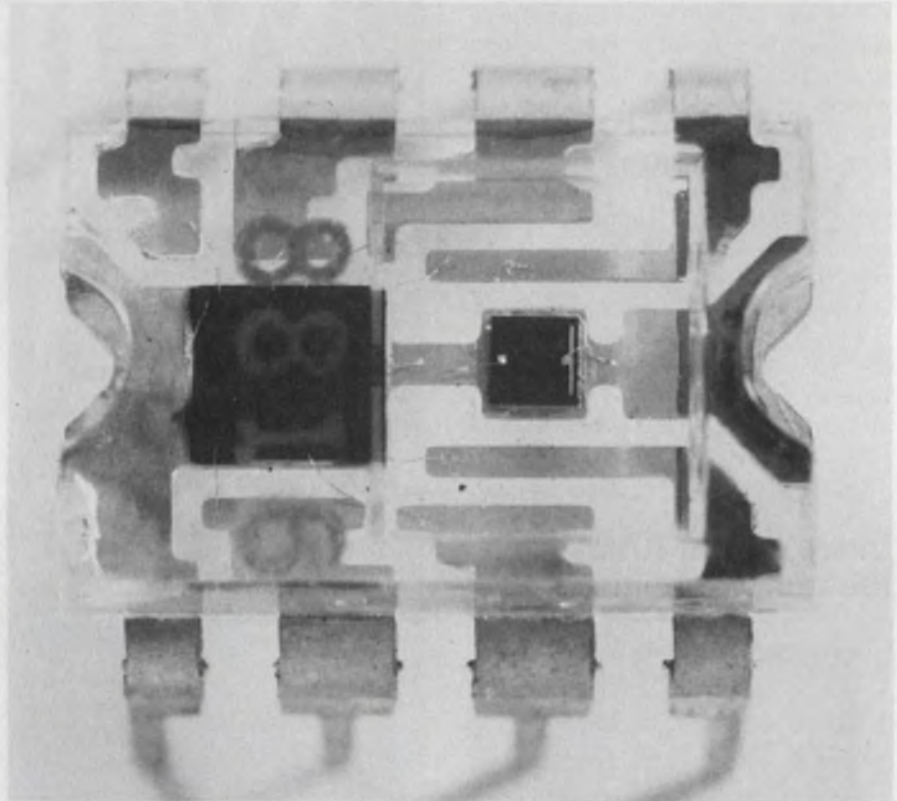

*Micro Components Corp., 99 Bald Hill Rd., Cranston, RI 02920 (401) 463-6000.*

For the first time, an optoelectronic circuit combines a photodetector and monolithic control chip in a compact 8-lead DIP. The package for the new MCC-401 employs a special transparent epoxy through which light can reach the sensing diode.

The bipolar control chip can convert detected illumination into a linear output over the 0.1-to-20- $\mu$ A current range. Or it can provide light-level threshold detection through a TTL-compatible digital output.

For selective responses, optical filters may be incorporated readily into the package. With a popular visible-light filter and a source having a color temperature of 4700 K, typical photocurrent response at the diode output is 0.5  $\mu$ A per foot-candle. Without filtering, a typical current of 2  $\mu$ A can be obtained at a distance of 10 ft from a common,

household 25-W bulb.

The control chip consists of a current amplifier, trigger/comparator, and references.

The current amplifier measures diode-detector output under short-circuit conditions, thereby minimizing external leakage effects and enhancing thermal stability. The amplifier is compensated for both temperature and supply variations, and has a nominal current gain of 80.

The MCC-401 operates from supplies of 3.2 to 6.0 V, and over the temperature range of -25 to 50 C.

Besides offering the 401, the company offers the MCC-402—the control chip itself. Also available are the MCC-403 through 405, ICs designed originally for exposure and aperture-control subsystems, as in cameras.

Typical costs for the components range from \$2.75 to \$4.95 in quantities of 1000. Prices drop to about \$1.50 in 100,000 quantities. Delivery is from stock.

CIRCLE NO. 306



## SMART new data system learns from your finger to do YOUR job



1. Measure up to 248 low level signals accurately, immune from noise—*analog, digital, non linear*. Print them out, tape them, feed your computer (alarms too!).
2. Key program—with one finger—all clock timing, scan intervals, channel gains, I/O, engineering units, powerful subroutines like automatic programming and optional integration. Everything to do your job.

In the new PD-2064, a proven microprocessor, RAMs, and ROMs replace a bushel of expensive circuitry to make a versatile, standardized data acquisition system for general or specific jobs. Get more data *reduced* per dollar. Call about immediate shipment from stocking program. Request Bulletin B110 from Esterline Angus Instrument Corporation, P.O. Box 24000, Indianapolis, IN 46224. 317/244-7611.



CIRCLE NUMBER 79

## STANDARDIZED PLUG-IN HOUSINGS

FROM STOCK

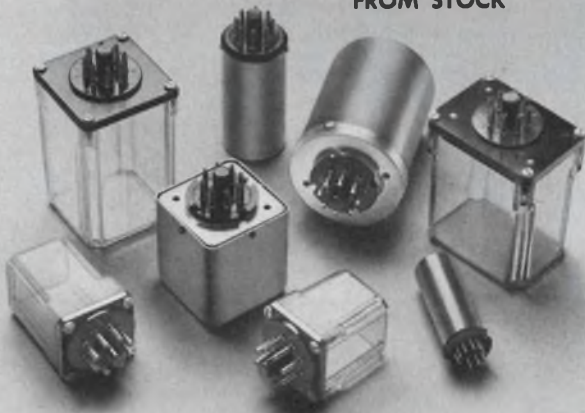

For packaging Relays, Filter Networks, logic circuits, and other assemblies requiring dust, dirt or tamper-proof protection.

**Housings:** A variety of sizes and colors available in Polystyrene, Butyrate, Nylon and Aluminum.

**Headers:** Available in 7, 8, 9, 11 and 20 pin configurations.

NEW FREE CATALOG ON REQUEST

Manufacturers of Standardized Hardware for Electronics



**KEYSTONE**  
ELECTRONICS CORP.

49 Bleecker Street - New York, N.Y. 10012

CIRCLE NUMBER 80

ELECTRONIC DESIGN 12, June 7, 1976

## Reduce ECL system noise with off-board voltage and ground distribution.

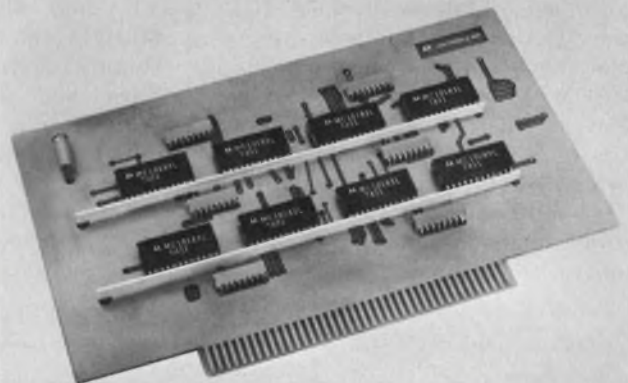

## MINI BUS<sup>®</sup> does it...

Benefits of Rogers Mini/Bus start with design time (lots less for PC boards with ECL circuits) and keep going:

- Eliminate cost of multi-layer boards
- Give higher packaging density
- Reduce system noise

For design data, details of the many versions of Mini/Bus (full card matrix, vertical strips, horizontal strips), and data on why Mini/Bus reduces noise and lowers costs, contact Ray Jodoin at:



**Rogers Corporation**  
Chandler, AZ 85224  
(602) 963-4584

CIRCLE NUMBER 81



## INTEGRATED CIRCUITS

### EPROM accesses in 550 ns

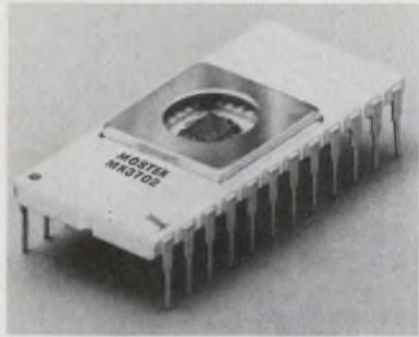

Mostek, 1215 W. Crosby Rd., Carrollton, TX 75006. (214) 242-0444. MK 3702T-3; \$15 (100).

A  $256 \times 8$ -bit electrically programmable and UV-erasable ROM, the MK 3702, is a pin-for-pin replacement for the popular 1702A PROM. Standard access times are 550 ns (dash-1 version), 750 ns (dash 2) and 1  $\mu$ s (dash 3). Programming is typically 30 s for all 2048 bits using standard PROM programmers. The MK 3702 requires no  $V_{GG}$  power supply.

CIRCLE NO. 339

### 5-W audio circuit offers package choice



Fairchild, 464 Ellis St., Mountain View, CA 94042. (415) 962-3816. \$1.60 to \$1.70 (100); stock.

A 5-W audio-amplifier circuit is offered in a molded 12-lead power package. Two versions are available—the TBA800 and 800 A. The two are electrically identical. However, the TBA800 package has a power tab that is bent for easy insertion into a PC board. In the TBA800A, the power tab extends straight out from the package and contains holes for mounting an external heat sink. Both circuits operate over a supply voltage range of 5 to 30 V, and are specifically intended for use with a 24-V supply. The typical output power of 5 W is specified for a 16- $\Omega$  load and 24-V supply.

CIRCLE NO. 340

### Dual op amps have 3-MHz unity-gain BW



Texas Instruments, P.O. Box 5012, M/S 964, Dallas, TX 75222. (214) 238-2481. 58c (100).

Dual op amps—the RM4558 and RC4558—offer improved ac characteristics and slew rates compared with the company's SN72558. The RM version works over the full military temperature range of  $-55$  to 125 C. The RC version has a temperature range from 0 to 70 C. Otherwise, the two are identical, and they are interchangeable to circuits with the same designations from Raytheon Semiconductor. The new units have 3-MHz unity-gain bandwidth, compared with 1 MHz for the SN72558. Their slew rate is 1.5 V/ $\mu$ s, compared with 0.5 for the SN72558.

CIRCLE NO. 341

## SOLID STATE RELAYS WITH SOMETHING EXTRA

From Elec-Trol, a complete line of 3 to 45 Amp, 120 to 480 VAC output, AC or DC input Solid State Relays and custom designs to meet your needs. All feature: **Zero Crossover Switching** to eliminate RF noise and load current or voltage surges. **Photo Isolation between Input & Output.** **Input Current Limiter** on all DC models prevents relay closure by input transients & increases LED life. **Built-in Snubber Network in Output** prevents uncontrolled operation due to load-line transients. **IC Compatibility and Reverse Polarity Protection** on all DC models. Call or write for complete information today.

26477 N. Golden Valley Road • Saugus, Calif. 91350  
(805) 252-8330 • (213) 788-7292 • TWX 910-336-1556

### ELEC-TROL, INC.

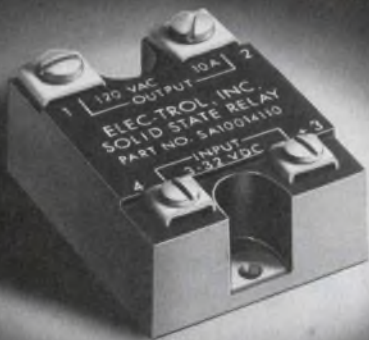

eem

CIRCLE NUMBER 82

## REED RELAYS TO FIT YOUR SPECS... AND BUDGET

**Our Open-Line** reed relays will give you high performance at remarkably low cost if you have no critical environmental factors to worry about.

**Our Encased-Line** is epoxy sealed to meet extreme environmental and handling conditions.

**Both offer** top performance; choice of Form A, B, or C dry reed contacts; Form A mercury wetted reed contacts; up to 6 poles; coil voltages 5 to 48 Vdc; either .1" or .15" terminal spacing; optional electrostatic or magnetic shielding.

Available from distributors. Or contact us today.

26477 North Golden Valley Road • Saugus, Calif. 91350  
(805) 252-8330 • (213) 788-7292 • TWX 910-336-1556

### ELEC-TROL, INC.

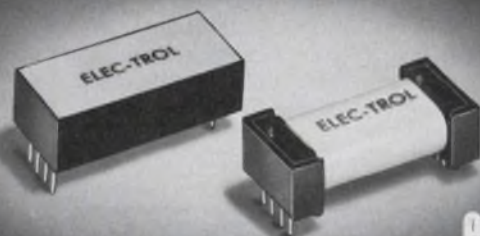

eem

CIRCLE NUMBER 83



## 4-k static MOS RAMs access in 200 ns

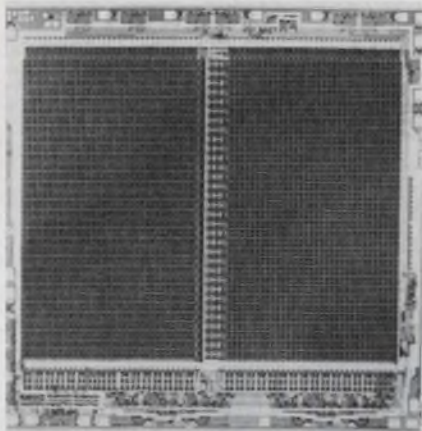

Advanced Micro Devices, 901 Thompson Pl., Sunnyvale, CA 94086. (408) 732-2400. \$24 to \$90 (100).

A pair of 4-k static MOS random-access memories—the Am9130 and Am9140—operates from a single 5-V supply. The memories come in models with speeds to 200 ns and operation over the full MIL-temperature range. Organized 1-k × 4 and 4-k × 1 bits, these low-power circuits (350 mW typical dissipation) have input and output logic levels identical to TTL, thereby offering 400 mW of noise immunity. The static units have an output drive capability of 3.2 mA at 0.4 V and a dc standby mode that reduces power dissipation by 80%. A special memory-status signal incorporated within the circuits indicate when data are valid.

CIRCLE NO. 342

## Pair of amps simplify mag-tape systems

Motorola, P.O. Box 20294, Phoenix, AZ 85036. (602) 244-3465. \$3.75 to \$8.50 (100).

A preamp and Read amplifier can be used to simplify magnetic-tape systems. The Model MC3467 preamp actually contains three independent preamps, each with an electronic gain-control input. The preamps have differential inputs and outputs, allowing operation in balanced systems. Typical preamp bandwidth is 15 MHz, and gain control essentially ranges from zero to about 100 V/V. Optimized for use in nine-track systems, the new circuit comes in an 18-pin plastic DIP.

CIRCLE NO. 343

# This is an echo chamber?



Yes, and much more! It is the first N-channel Bucket Brigade Device designed with the audio engineer in mind. The **SAD-1024 Serial Analog Delay** will provide reverberation, echo, tremolo, vibrato and chorus effects in electronic organs and musical instruments. It will equalize speaker systems in an auditorium, or can be used in speech compression or voice scrambling systems. The SAD-1024, which contains two independent sections of 512 analog storage elements will accomplish all of these with a signal-to-noise ratio in excess of 75 dB. The two sections may be used independently or they may be connected in sequence to provide 1024 clock periods of delay. The delay provided by the device can be continuously varied by the clock rate from less than one millisecond to more than one second.

Other performance characteristics include: Signal bandwidth from 0 to 200 KHz, less than 1% total harmonic distortion, 0 dB insertion loss, and less than 5 mW power requirements from a single 15V power supply.

You get all of these features for less than 1¢ per storage element in OEM quantities.

We also offer a complete circuit card to help you evaluate this exciting new device. Other devices for applications such as time base correction in the video bandwidth are also available.

There are over 70 salesmen and 16 distributors to serve you worldwide.

# RETICON®

910 Benicia Avenue  
Sunnyvale, California 94086  
(408) 738-4266 • TWX: 910-339-9343

CIRCLE NUMBER 84





# LEADER IN IMAGING DEVICES

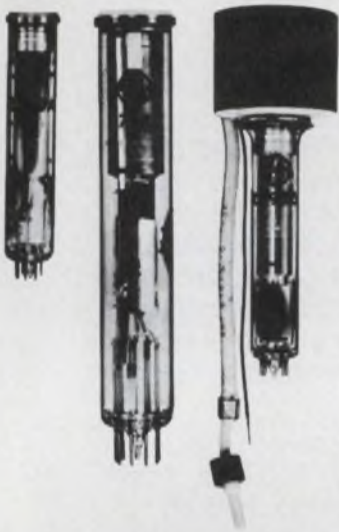

General Electric offers you a wide selection of high-quality imaging devices for a wide variety of surveillance, monitoring and display applications.

These GE imaging devices also offer:

- The right resolution and sensitivity for your specific needs!
- Prices lower than you normally expect!
- Ease of application combined with traditional GE expertise, quality and economy!
- Rugged construction!

For more detailed information, circle the Reader Service Card number below or contact: General Electric Company, Imaging Devices Operation (360-22), Room 301, Building 7, Electronics Park, Syracuse, N. Y. 13201 (phone 315-456-3300).

GENERAL  ELECTRIC

CIRCLE NUMBER 85

## INSTRUMENTATION

# Burn-in system tickles ICs with programmable patterns



*Micro-Test Systems, 743 Pastoria Ave., Sunnyvale, CA 94086. (408) 739-8001. See text.*

Drawing on its experience as an independent test laboratory, Micro-Test Systems has put together a stand-alone, dynamic-burn-in IC tester with hitherto unobtainable features.

System 1000, dubbed Murphy's Oven I by Micro-Test, stresses an LSI circuit with heat and voltage in relative amounts and durations that are user programmable.

Devices handled by the oven include RAMs, ROMs,  $\mu$ Ps and other LSI circuits. Sockets are provided for up to 882 16-pin DIPs. Or you can mix various combinations of 16, 18 and 22-pin devices.

With what Micro-Test calls an ambient test console, you can pre-test loaded burn-in trays for power dissipation, shorts (lows or highs) and the ac characteristics of device addresses and clock phases.

To aid in locating faults or diagnosing problems, each of the System 100's 18 address and clock lines is displayed on the unit's front panel. Each of the clock phases is independently programmable (with

plug-in program boards) for timing and pattern generation.

Also programmable are the five power supplies that come standard on the oven, and which handle the bias and excitation requirements of PMOS, NMOS and CMOS.

Voltage ranges include 3 to 6 V for  $V_{BB}$ , 4 to 7 V for  $V_{CC}$  and 4.5 to 20 V for  $V_{DD}$ . The supplies also include a digital display of both voltage and current, pushbutton sequencing for proper power-up and power-down selection, and protection for overvoltage and excess currents.

The 24 clock drivers of the Micro-Test oven can deliver a 100-ns pulse into a 3000-pF load at 20 V. Pulse widths range from 100 ns to 1.6  $\mu$ s (with an optional programmer) and the system clock zips along at 10 MHz.

The thermal chamber of the System 1000 goes up to 150 C in 1-C increments and is accurate to  $\pm 2$  C. Temperature is displayed digitally.

Price of the Micro-Test oven is \$14,900. Delivery takes four to six weeks.

CIRCLE NO. 303



Rogan knobs  
look better  
and are built better,



and we'll prove it  
with a free sample.

After you receive our catalog, send us a note  
outlining your specific requirement and the  
quantity involved.

Or furnish us with our competitor's part  
number and we will cross-reference it.

Our samples and quotation will be  
returned promptly.



3455 Woodhead Drive, Northbrook, Illinois 60062 (312) 498-2300

CIRCLE NUMBER 86

NOW! MORE APPLICATIONS!

Teflon-FEP  
**SHRINK-FIT**  
Tubing



**PENNTUBE<sup>†</sup> II-SST**

(Super Shrinkable Teflon\*)

**1<sup>2</sup>/<sub>3</sub>:1 SHRINKDOWN**

Now, more applications including encapsulating many  
heat sensitive materials. Insulates, strain relieves,  
moisture proofs, protects. Fewer sizes need be stocked.

Chemically inert with excellent electrical and  
mechanical properties. Will not burn or support flame.

Excellent for: chafe guards—electrical terminal and  
splice insulation—covering over plastic, metal and  
wood—jacketing for cable harness assemblies, etc.

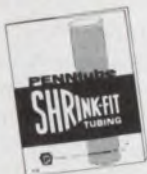

**FREE! SEND FOR FOLDER.**

**PENNTube Plastics Co., Inc.** /  **SUBSIDIARY OF  
DIXON INDUSTRIES**

Madison Ave. & Holley St., Clifton Heights, Pa. 19018 • (215) 622-2300



Export Div. • 5710 Empire State Bldg., N.Y. 10001  
\*Du Pont Reg. TM. † Penntube Plastics Co. Reg. TM.

CIRCLE NUMBER 87

ELECTRONIC DESIGN 12, June 7, 1976

SPEED

POSITION

DISPLACEMENT

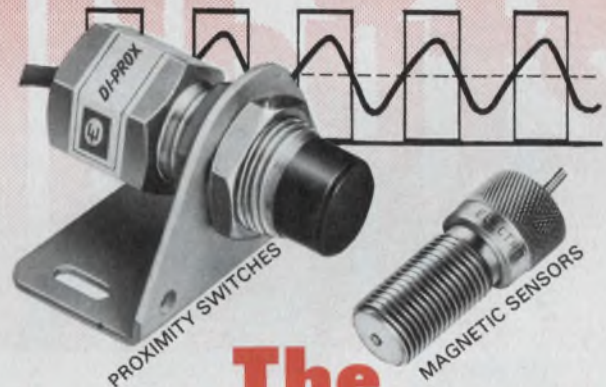

## The "Sensor-Able" Solution!

 The key to effective industrial process control is  
"Sensor-Based" electrical input signals.

Electro's complete line of non-contact magnetic and  
proximity sensing transducers and controls produce  
input responses for the control of speed, position or  
displacement . . . the functions found in today's  
sophisticated process control systems.

Our Standard Analog and Digital DI-MAG<sup>®</sup> Magnetic  
Sensors are designed to sense any ferromagnetic  
material . . . and to convert its motion into control  
inputs suitable for counting, positioning, timing and  
tachometry.

DI-PROX<sup>®</sup> Proximity Switches combine a proximity  
sensor and switch into a single compact unit . . .  
suitable for sensing any metal—producing compatible  
digital signals for control circuits. The LINEAR-PROX  
system permits precise measurement of the distance  
between a metal surface and the sensor . . . ideal for  
monitoring vibration, bearing motion, run-out, or for  
gauging expansion, thickness or distortion.

The design of sensors for unique control applications is  
a specialty at Electro . . . send us your process system  
input specifications . . . or let us send you our  
complete catalog now!



**ELECTRO  
CORPORATION**

1845 57TH STREET

P.O. BOX 3049, SARASOTA, FLORIDA 33578  
AREA CODE (813) 355-8411 • TELEX 5-2683

CIRCLE NUMBER 88



# MODUPERF

## The Ultimate in Design Simplicity

DSI has revolutionized the world of paper tape by perfecting MODUPERF; a tape punch built around four independent, field replaceable MODULES. Equipment down time is a thing of the past because the die block and/or data selector may be replaced in less than a minute, without any adjustments!

The whisper quiet MODUPERF employs design innovations that stress basic simplicity, thereby providing unsurpassed reliability, long life and compact size. No intermediate levers or linkages to adjust, or clutches and ratchets to repair.

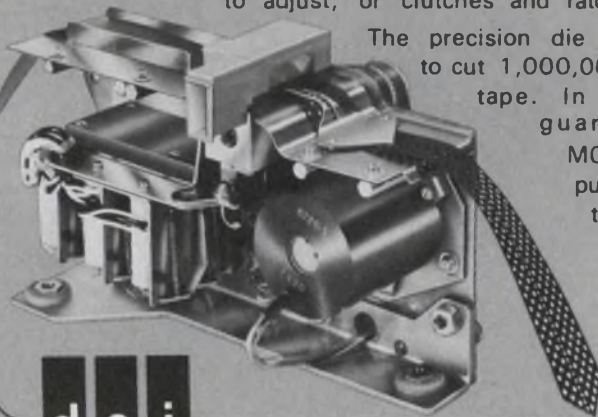

The precision die block is rated to cut 1,000,000 feet of paper tape. In addition, DSI guarantees that MODUPERF will punch all types of tape; i.e. MYLAR or paper, oiled or unoled, folded or rolled.

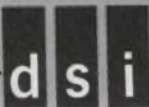

DATA SPECIALTIES, INC. 3455 Commercial Ave., Northbrook, IL 60062 (312) 564-1800

CIRCLE NUMBER 89

# MAGNETIC SHIELDING

- **CO-NETIC** (high permeability) Sheet and Foil
- **NETIC** (high saturation) Sheet and Foil
- CRT, Photomultiplier Tube and Transformer Shields
- Custom Shields — Prototype through Production
- Extensive Standard Tooling
- Engineering, Design and Test Facilities
- Quality Assurance—Certification to MIL Specs
- Broadest Shielding Line in the Industry —

**SEND FOR OUR NEW CATALOG**

**MAGNETIC SHIELD DIV.**



**PERFECTION MICA CO.**  
740 N. Thomas Dr.  
Bensenville, Ill. 60106  
Ph. (312) 766-7800  
TWX (910) 256-4815



**CRT DISPLAY TERMINALS**



**50 Hz Design Assistance**



*Send Shield Print  
For Prompt Quotation*

CIRCLE NUMBER 90

## INSTRUMENTATION

### Data-comm tester offers 15 diagnostic routines



Atlantic Research, 5390 Cherokee Ave., Alexandria, VA 22314. (703) 354-3400. \$9490 (plus options); 3 months.

INTERSHAKE II, a fully programmable data-communications monitor and interactive tester, handles all codes and line disciplines at speeds up to 64 kb/s with internal clock and up to 256 kb/s with external clock. In addition, it provides for all aspects of half and full-duplex testing, including provisions for display and for calculating the block-check character for transmit and receive data of bi-sync, SDLC and others.

Booth No. 1542-1543

Circle No. 344

### Portable kit checks out cassettes



Information Terminals Corp., 323 Soquel Way, Sunnyvale, CA 94086. (408) 245-4400. \$1050.

TK-100 portable cassette test kit can be used to align cassette transports, measure tape tension, measure cassette torque, measure pressure pad force, check wow, flutter and skew, clean the head and pinch roller, and degauss the cassette. The kit can be used with any Philips-compatible cassette of the capstan drive or reel-drive type.

Booth No. 3519, 3521

Circle No. 345



## Logic analyzer plugs into scope

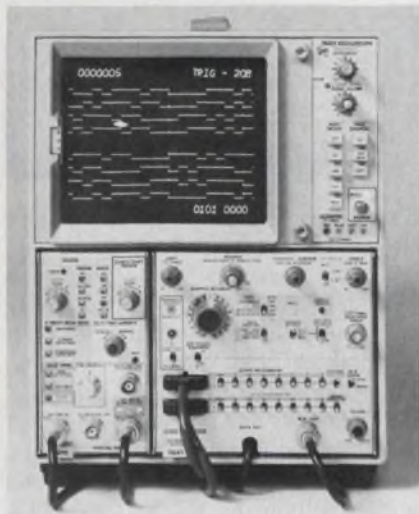

Tektronix, P.O. Box 500, Beaverton, OR 97077. (503) 638-3411.

Model 7D01 is a logic analyzer plug-in for the company's 7000-series oscilloscopes. Up to 16 channels can be acquired and stored simultaneously in the 4-k memory of the 7D01, which offers three storage and display formats: 16 channels  $\times$  256 bits, 8 channels  $\times$  512 bits, or 4 channels  $\times$  1024 bits. In the four-channel mode, asynchronous (internal clock) data sampling rates up to 100 MHz can be selected to perform timing analysis with 15-ns resolution. Synchronous sampling is also possible. Included are data display before, centered around, or after a trigger; a 16-channel word recognizer; two qualifiers; and a movable cursor.

CIRCLE NO. 346

## Line monitor displays data on CRT

Digi-Log Systems, Babylon Rd., Horsham, PA 19044. (215) 672-0800. \$2495.

Model DLM II fault-isolation device includes a CRT display of the upper and lower-case ASCII character set, a half-intensity display to separate transmitted from received data, and a switchable 40-character (double size) or 80-character line length (1280 character display field). All of the features of the company's DLM I have been retained on the new model.

Booth No. 305 Circle No. 347

# Premier Electronic Cabinets and Cases

- ESTHETICS KEYED TO MODERN SYSTEMS
- RUGGED-FUNCTIONAL CONSTRUCTION
- ECONOMICAL PRICING
- PROMPT SERVICE & AVAILABILITY

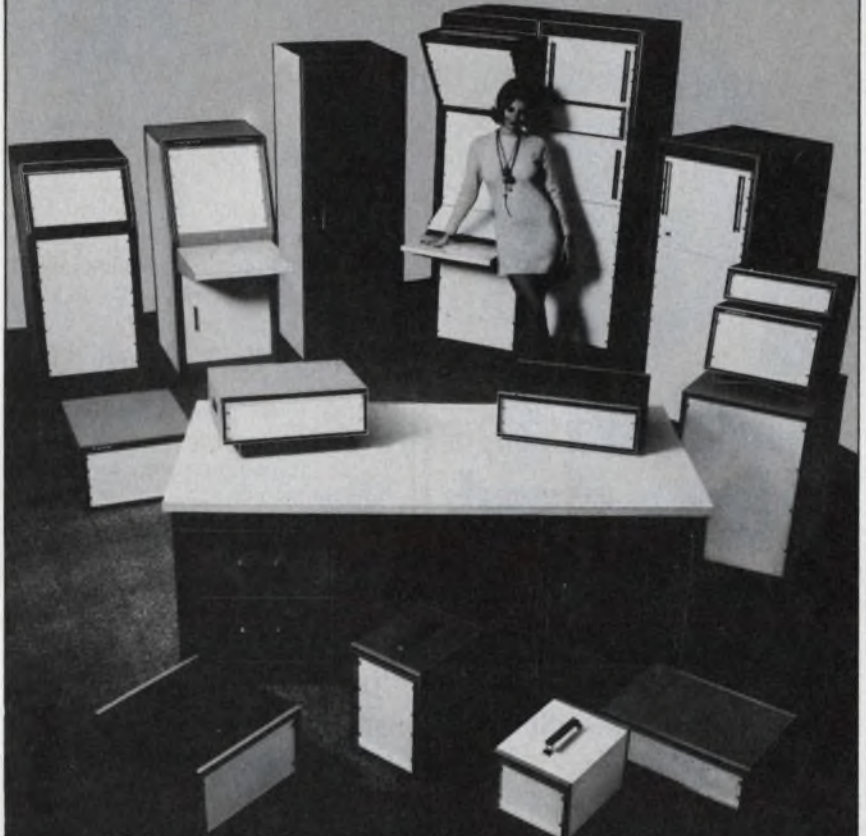

INSTRUMENT CASES - TIC SERIES

TVA Series Vertical Assembly—  
Construction Details  
(1 Frame, 2 End Panels, Rear Door)

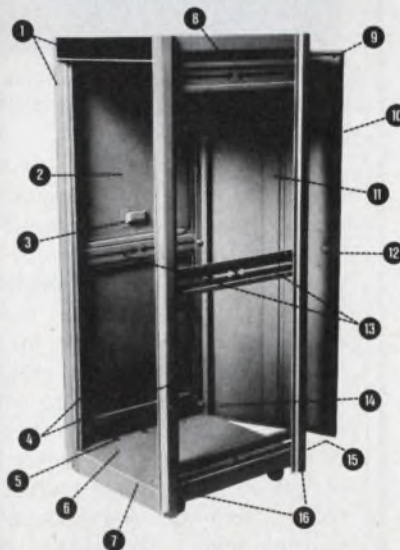

1. Trim: extruded anodized aluminum with textured vinyl inlays
2. Outside removable flush end panels (16 ga.)
3. Recessed hand grip for panel removal
4. 2 pr. panel mounting angles, fully adjustable front to rear with tapped 10-32 holes on EIA & WE Standards spacing (12 ga.)
5. 1" dia. holes for cable entry beneath base
6. Recessed caster mounting holes
7. 1 piece formed steel base provides for heavy equipment mounting area and concealed caster mounting (14 ga.)
8. 1 piece solid top for extra rigidity and squareness (14 ga.)
9. Foam gasketing (3 sides)
10. Magnetic closure gasket
11. Door stiffener channel
12. Keyed latch and brushed aluminum pull handle
13. Horizontal cross-brace and panel mounting angle supports
14. Quick release, spring loaded door hinges (top and bottom)
15. 1 1/8" dia. knock-outs for rear cable entry underneath rear door
16. Formed steel uprights (14 ga.) provide 1/2" recess to panel mounting angles

All features shown are standard in the Trimline TVA Series  
Welded, formed steel construction

Complete catalog and prices on request



**PREMIER METAL PRODUCTS COMPANY**  
381 Canal Place, Bronx, N.Y. 10451/(212) 993-9200

CIRCLE NUMBER 91



another first  
from  
Grayhill

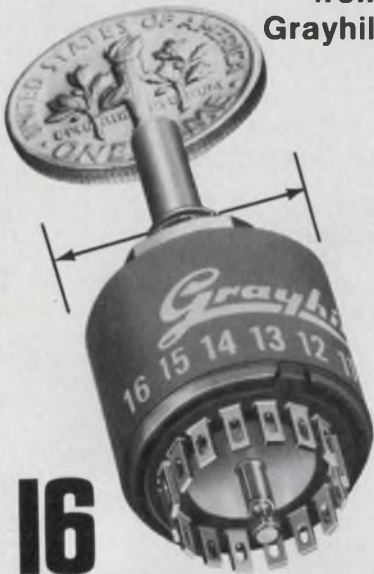

## 16 positions in a dime-sized switch!

Now in demand for octal and hexadecimal applications

- 1/4 amp, 1/2 inch switch single or double-pole with 16 positions in a single deck
- occupies only 1.1 cubic inch behind panel
- contamination-free enclosed construction, molded-in terminals

This new addition to the popular Grayhill Series 51 Rotary Switch family meets the growing number of applications calling for the maximum number of positions in the minimum amount of space. (Previously available 16 position switches had diameters of 1-1/3 inches instead of 1/2 inch!) And you'll be pleased with the performance and price of these switches too...rated for 25,000 cycles of operation, priced about \$6.00 in 100 quantities.

New Product Bulletin #257 contains complete specs and price information...free on request from the leaders in switch miniaturization, Grayhill, Inc. 561 Hillgrove Avenue, La Grange, IL 60525 (312) 354-1040.



CIRCLE NUMBER 92

### INSTRUMENTATION

#### Two compact scopes offer 2-mV sensitivity



Philips Test & Measuring, P.O. Box 523, Eindhoven, the Netherlands.

Two compact, lightweight scopes with 15-MHz bw and 2-mV sensitivity include the single-trace PM 3225 and dual-trace PM 3226. Offered are adjustable level triggering, automatic triggering, line triggering and automatic TV line and frame sync pulse triggering. External triggering is also possible. Input impedance of vertical and horizontal channels is 1 M $\Omega$ /25 pF, and rise time is 25 ns. Dynamic range is 24 divisions for sine-wave signals up to 1 MHz.

CIRCLE NO. 348

#### In-circuit tester offers on-line test generation



Faultfinders Inc., 15 Avis Dr., Latham, NY 12110. (519) 783-7786. \$57,750; 60-90 days.

The FF101C is the first in the company's line of computer-controlled, in-circuit/functional test systems to offer an on-line test-program generation option. Thus an operator unskilled in programming can generate test programs for printed-circuit assemblies by merely entering data into a terminal connected to the FF101C. The in-circuit test system uses a multiple-probe fixture to contact each solder node on the bottom of a printed-wiring assembly. It can thereby test each component, one at a time, using electronic guarding techniques.

CIRCLE NO. 349

#### Synthesizer/funct gen yields pure waveforms



Wavetek, 9045 Balboa Ave., San Diego, CA 92123. (714) 279-2200. \$795; 30 days.

Model 171, a 0.1-Hz-to-2-MHz generator, offers the features of a synthesizer and function generator: frequency accuracy, stability and spectral purity are combined with multiple-output waveforms, dc offset and manual sweep. In the synthesizer mode, the unit provides 0.005% frequency accuracy, with 0.0001%/ $^{\circ}$ C frequency stability from 1.000 Hz to 1.9999 MHz. The unit has 4-1/2-digit resolution in six decade bands, providing resolution of 1 MHz in the low band to 100 Hz in the high band. In the function generator mode, the unit can be manually swept by a front-panel dial or externally by a voltage ramp. The dial has a frequency accuracy of 3% full scale.

CIRCLE NO. 350

#### Memory tester streaks with 10-ns cycle time



Technology Marketing, 3170 Red Hill Ave., Costa Mesa, CA 92626. (714) 979-1100. Starts at \$17,000; 12 wks.

This new semiconductor-memory tester is said to be the first to offer 100-ns cycle time for all test patterns. Designated the TestMaster Series 5000, the unit is designed for high-speed automatic testing of memory systems or devices, as well as other LSI chips and  $\mu$ Ps. The unit features specialized processors with either ROM or optional RAM for program storage.

CIRCLE NO. 351



# NEW DOUBLE BORE Hg LAMPS



- Improved electrode design
- Insulated aluminum handle
- Greater stability
- Longer life
- Value priced
- Optional 10 KHz Power Supply available



WRITE FOR  
DATA SHEET

## HAMAMATSU

Hamamatsu Corporation • 120 Wood Avenue • Middlesex, New Jersey 08846  
(201) 469-6640  
International Offices In Major Countries of Europe and Asia.

CIRCLE NUMBER 93

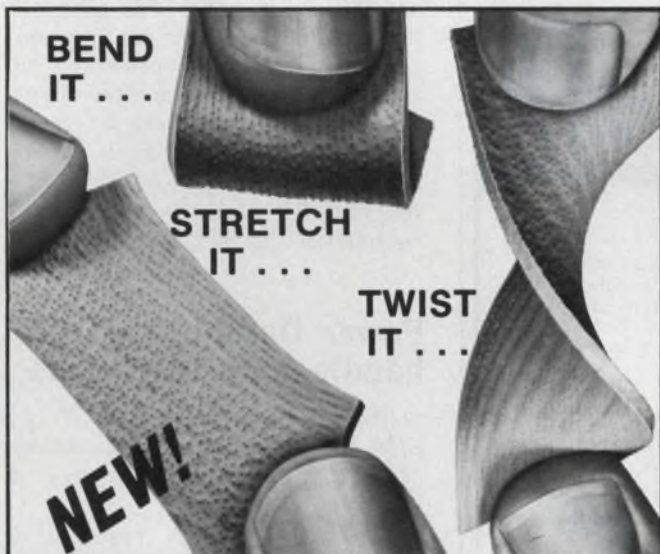

BEND  
IT ...

STRETCH  
IT ...

TWIST  
IT ...

NEW!

## EMI SHIELDING MATERIAL

*Wires Bonded in Silicone  
Prevents Wires From Falling Out*

- ELASTOMET • Contains 700 to 900 individual convoluted wires per square inch • Provides positive environmental seal and shield • High contact force achieved with moderate compression • Free sample available.



Send for  
Data Sheet EMC-820

East Division • 129 Dermody St., Cranford, N.J. 07016, (201) 272-5500  
West Division • 427 Olive St., Santa Barbara, Calif. 93101, (805) 963-1867

CIRCLE NUMBER 94

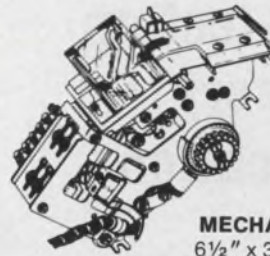

Punched  
Tape

MECHANISM ONLY  
6½" x 3-3/16" x 4½"

# ROYTRON™

ROYTRON Readers, Punches and Combination Reader/Punches are offered in over 20 standard configurations.

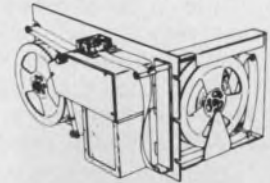

RACK MOUNTED  
12" x 19" x 10½"

Paper Tape/  
Edge Punch Card  
Punches (50-60 cps)

Paper Tape/  
Edge Punch Card  
Readers (50 cps)

Combination Paper Tape  
Reader/Punch  
Reader (50/150/250 cps)  
Punch (60 cps)

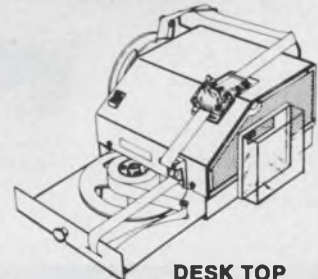

DESK TOP  
14½" x 15" x 9½"

ROYTRON is manufactured in the U.S.A.  
Parts Availability  
Interface Documentation  
Servicing Documentation  
In-Plant Service  
High Reliability  
Cost/Performance

PUNCH COVER  
(Punch Mechanism  
and  
Tape Fault Switch  
Located Below)

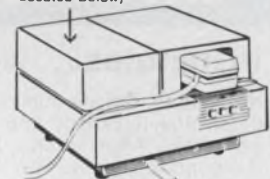

PHOTOELECTRIC  
READER/PUNCH  
16" x 16" x 10½"

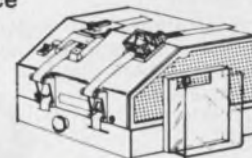

COMBINATION  
READER/PUNCH  
16" x 16" x 10"



Litton OEM Products

for full details, write or call  
**SWEDA INTERNATIONAL**  
34 Maple Avenue, Pine Brook, N.J. 07058/(201) 575-8100  
IN U.K. — ADLER BUS. SYSTEMS/OEM PRODS., Airport House, Purley Way, Croyden, Surrey, England  
IN FRANCE — SWEDA INTERNATIONAL/OEM, 103-107 Rue de Tocqueville, 75017 Paris, France

CIRCLE NUMBER 95



# RF detectors for every application

100 kHz to 18.5 GHz  
Field replaceable diodes

You can get the detector suited to your needs from WILTRON's broad line.

And in all of these high-performance detectors the diodes are field replaceable.

Note, too, the variety of available connectors: BNC, N, APC and SMA (see table).

Discounts to 15% in quantity. Stock delivery.

Call Walt Baxter at WILTRON now for details.



Model	Range	Connectors		Flatness	Price \$
		In	Out		
71B50	100 kHz-3 GHz	BNC Male	BNC Fem.	±0.5 dB	70
73N50	100 kHz-4 GHz	N Male	BNC Fem.	±0.2 dB	75
74N50	10 MHz-12.4 GHz	N Male	BNC Fem.	±0.5 dB	145
74S50	10 MHz-12.4 GHz	SMA Male	BNC Fem.	±0.5 dB	165
75A50	10 MHz-18.5 GHz	APC-7	BNC Fem.	±1 dB	190
75N50	10 MHz-18.5 GHz	N Male	BNC Fem.	±1 dB	170
75S50	10 MHz-18.5 GHz	SMA Male	BNC Fem.	±1 dB	170



930 E. Meadow Drive • Palo Alto, Ca. 94303 • (415) 494-6666 • TWX 910-373-1156

CIRCLE NUMBER 96

# SHAPE FOIL INTO MAGNETIC SHIELDS

in minutes... with scissors... low cost

No waiting. Solves many shielding problems. Use a single formula (ask us) to determine thickness and number of layers. Combine this with practical trial and error. After cutting, hand trim AD-MU foil to the correct outline and fit it around the component to be shielded.

If you need relatively few shields, or are experimenting, that's it. You've eliminated designing, tooling and manufacturing costs for prefabricated shields.

Especially good also for hard-to-get-at places and to make assemblies more compact by placing magnetically reacting components closer together without performance degradation.



Comprehensive 18-page magnetic shielding catalog with 4-page reprint from Electronic Design on request.



## AD-VANCE MAGNETICS, INC.

226 E. SEVENTH ST. ROCHESTER, IND. 46975  
(219) 223-3158 TWX 810 290 0294

Our 3rd Decade of Magnetic Shielding Leadership

CIRCLE NUMBER 97

## DISCRETE SEMICONDUCTORS

### Red, amber & grn LEDs replace incandescents

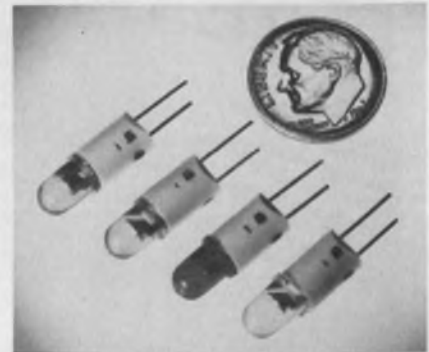

Data Display Products, 5428 W. 104th St., Los Angeles, CA 90045. (213) 641-1232. From \$1.21 (1000-up); stock to 4 wks.

LEDs in Bi-Pin T-1-3/4 packages are designed to replace incandescent lamps. Red lamps are rated at 50 mcd, amber at 35 mcd and green at 16 mcd, all at 20-mA forward current and with clear tinted encapsulation. All devices are available with built-in resistors for various voltages ranging from 3.6 to 28 V dc. Units are also available for ac operation. The terminal posts are offset for polarization and easy insertion in congested areas. The series BP200 lamps have 0.02-in.-diam. terminals, while series BP201 have 0.025-in.-diameter terminals. Both lamps have lengths of 0.68 in. The BP-180 and BP181 units are shorter versions of the BP200 series.

CIRCLE NO. 352

### Power Darlington handle up to 15-A loads

Solitron Devices, 1177 Blue Heron Blvd., Riviera Beach, FL 33404. (305) 848-4311. \$25 (1 to 99); 2 wks.

A series of 15 A npn silicon power transistors is available with voltage ratings of up to 600 V. All units are Darlington and are identified as SDM 6000 (400 V), SDM 6001 (450 V), SDM 6002 (500 V), SDM 6003 (550 V) and SDM 6004 (600 V). The transistors are housed in steel, two-lead TO-3 cases. Typical maximum ratings are as follows:  $I_C$  of 15 A,  $V_{CEP}$  of 400 to 600 V,  $V_{ERO}$  of 8 V,  $I_R$  of 2 A,  $P_t$  of 80 W,  $t_r$  of 0.4  $\mu$ s,  $t_f$  of 1  $\mu$ s and a  $t_s$  of 3  $\mu$ s.

CIRCLE NO. 353



## Darlington arrays handle up to 2 W, total

Silicon General, 7382 Bolsa Ave., Westminster, CA 92683. (714) 892-5531. Single unit prices: \$5 (2001 series), \$8.75 (3851 series); stock.

Two families of medium and high current Darlington arrays are designed to interface with a wide variety of drive signals. Both the SG2001/2/3 series of medium currents to 750 mA. The SG2001 and family of high current arrays consist of seven silicon npn Darlington pairs on common monolithic substrates. The 2001/2/3 group offers peak inrush currents to 600 mA per Darlington and the 3851/2/3 series offers peak inrush currents of 750 mA. The SG2001 and SG3851 are designed to interface with DTL and TTL signals. The SG2002 and SG3852 are PMOS-compatible. The SG2003 and SG3853 are intended for use with either CMOS or TTL drive signals. All devices are available in hermetically sealed ceramic 16-pin DIPs. The arrays have a common-emitter configuration with open collector outputs and integral suppression diodes for inductive loads. Maximum collector output voltage is specified at 50 V for all devices in both series. Collector-emitter saturation voltage is less than 2 V with a 500-mA collector current and a base current of 800  $\mu$ A for the SG3851/2/3 family, and with a collector current of 350 mA for the SG2001/2/3 series. Typical on-off delay times are 100 ns. Total package dissipation limit is 2 W, but each driver individually can handle 1 W.

CIRCLE NO. 354

## Impatt diodes deliver 3 W over 5.9 to 8.4 GHz

Hewlett-Packard, 1501 Page Mill Rd., Palo Alto, CA 94304. (415) 493-1501. 1 to 9 quantities: \$150 (0607), \$250 (0608); stock.

Silicon double-drift Impatt diodes offer power outputs of up to 3 W at frequencies from 5.9 to 8.4 GHz. The type 5082-0607 diode is guaranteed to deliver 1.75 W while the 0608 is guaranteed at 3 W. Diode efficiencies are greater than 10% and power outputs are specified at a 50-C ambient temperature.

CIRCLE NO. 355

# CLINTON PRESENTS THE SUPERTUBES

Clinton Electronics Corporation has for years been regarded as one of the world's leading manufacturers of Monochrome Cathode Ray Tubes in sizes from 3" to 23". These tubes are designed primarily for alpha-numeric data displays, medical electronics, video recording monitors and other applications requiring high resolution with minimum defocusing.

### DATA DISPLAY SUPERTUBES . . .

are conventional rectangular tubes (3:4 aspect ratio) designed for a wide variety of information display applications. These tubes are available with deflection angles ranging from 55° to 114° and neck diameters from 20 mm to 37 mm. All standard JEDEC phosphors are available in addition to Clinton's own phosphors for unique applications.



### SPECIAL PURPOSE SUPERTUBES . . .

are used for unique applications such as flying spot scanners, hard copy printers, radar and projection systems to name just a few. Clinton can custom design a tube to meet your specific requirements.

### LOW PROFILE SUPERTUBES . . .

are available where a combination of high performance and aesthetic appeal is of paramount consideration. We currently supply low profile tubes to companies such as Data Point, Hewlett-Packard, Teletype and Univac. Now we can supply you with similar tubes for your application.

See the supertubes in operation in the Clinton booth (#1107) at the National Computer Conference.



CLINTON...  
the ANSWER people  
IN CAT'S



CLINTON  
ELECTRONICS  
CORPORATION

6701 Clinton Rd. Rockford, Ill 61111 Phone 815-633-1444 Telex 257-484

CIRCLE NUMBER 98



# Autoranging Frequency Counting to 60 MHz with 1 Hz Resolution



B&K-PRECISION MODEL 1801 \$240

- For laboratory, production line or maintenance applications
- Automatic ranging, 20 Hz to 40 MHz is guaranteed...readout to 60 MHz is typical
- TTL circuitry updates the six-digit display five times per second
- Resolution to 1 Hz obtained by suppressing digits above 1 MHz when switching to 1 SEC mode

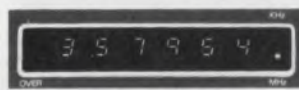

MHz display of  
3.579548 MHz input (AUTO mode)

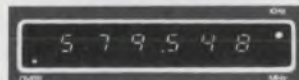

KHz display of overflow of  
3.579548 MHz input (1SEC mode)

- Available for immediate delivery, from local B&K-PRECISION distributors
- 10-day free trial offer

**B&K PRECISION**  
PRODUCTS OF DYNASCAN  
6460 W. Cortland Avenue  
Chicago, IL 60635 312/889-8870  
In Canada: Atlas Electronics, Toronto

FOR PRODUCT INFORMATION, CIRCLE 273  
FOR PRODUCT DEMONSTRATION, CIRCLE 274

## DISCRETE SEMICONDUCTORS Power interface circuits contain all components

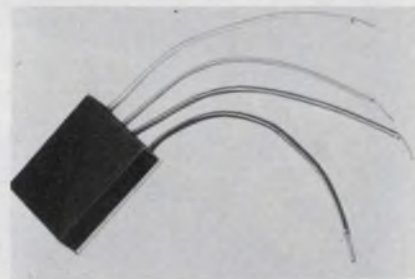

Gentron, 6667 N. Sidney Pl., Milwaukee, WI 53209. (414) 351-1660. See text.

The 440 series of power interface circuits contains power components, snubber circuitry, suppressors, limitors and filters. A ceramic base isolates the circuit electrically. The interface circuits are available with current ratings from 4 to 40 A at voltages to 800 V ac. Prices start at \$6 each when purchased in 100-unit quantities.

CIRCLE NO. 356

## Optical switches have adjustable slot width



HEI, Inc., Jonathan Industrial Center, Chaska, MN 55318. (612) 448-3510. See text.

The Model 112-3 "universal" optical switch is TTL compatible and offers many mounting arrangements. It can be mounted from either side or from its bottom. The air gap can be varied from a 0.062 in. (1.57 mm) minimum to almost any maximum. The switches are available in single or dual-channel versions. Aperture diameters range from 0.005 in. (0.127 mm) to 0.02 in. (0.508 mm) and leads may be either DIP pins or #28 AWG wire. Prices start at \$11.82 each for the single-channel units and increase to \$15.93 for the dual channel models. All units are available from stock.

CIRCLE NO. 357

## Silicon rectifiers made as exact replacements

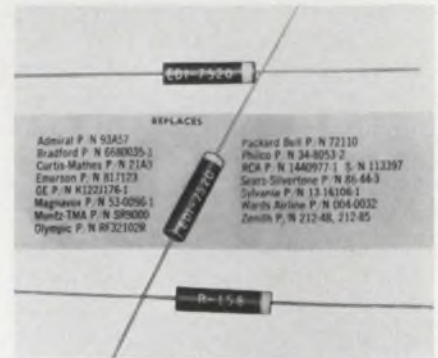

Electronic Devices, 21 Grey Oaks Ave., Yonkers, NY 10701. (914) 965-4400. See text.

A series of multireplacement silicon rectifiers for television focus circuits with 8000 V PIVs and 5 mA forward current ratings is a direct replacement for most selenium OEM rectifiers. The silicon units have greater resistance to high temperature and heat aging than standard selenium types do. The diodes cost about 30¢ each when ordered in production quantities and are available from stock.

CIRCLE NO. 358

## IR detector system fits in TO-99 transistor can

Eltec Instruments, Central Industrial Park, Daytona Beach, FL 32014. (904) 252-0411. \$245; 2 wks.

The Model 404 pyroelectric IR detector has the sensor and the signal-conditioning circuit combined in a TO-99 transistor case. The detector is a thin wafer of lithium tantalate, and has a diameter of 2 mm. The signal conditioner changes the high-impedance signal from the detector into an easily usable low-impedance voltage signal. The detector system can be operated in any one of three modes: The detector only, the detector with a voltage-mode amplifier, or the detector with a high-gain current-mode amplifier. The IR sensor has a  $D^*$  of  $1.4 \times 10^8$  cm  $\sqrt{\text{Hz}}/\text{W}$  (for 10.6  $\mu$ , 10 Hz, 1 Hz BW) and an optical bandwidth of 2 to 15 microns. A germanium window is included in the case but for \$15 more an Irtran 2 window is available.

CIRCLE NO. 359



FOR ELECTRONIC  
EQUIPMENT ENCLOSURES

MACHINE TOOLS,  
COMPUTERS, ELECTRONICS

6000 & 8000 BTU

# McLEAN INDUSTRIAL AIR CONDITIONERS



For "closed loop enclosures". Recirculates and cools internal air. Constant clean air in contact with electronics. Highest quality refrigeration and electrical components. 20,000 hours continuous duty in ambients to 125°F. High velocity cooling for maximum heat removal. Std. cabinet mounting. Quick installation. Factory-installed gaskets seal against induction of ambient, contaminated, or polluted air. 115 or 230 volts.

SEND FOR CATALOG

**McLEAN** ENGINEERING  
LABORATORIES

P.O. BOX 127D PRINCETON JUNCTION, NEW JERSEY 08550  
PHONE 609-799-0100 • TELEX 84-3422

CIRCLE NUMBER 100

# SCRUB

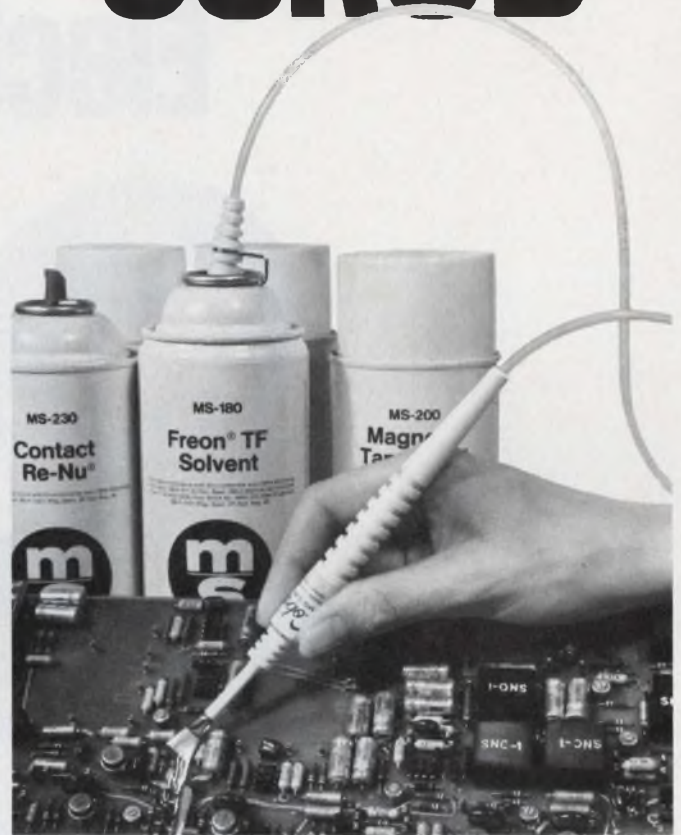

## INCREASE YOUR SOLVENT CLEANING ACTION...NO WASTE

- Brush has finger-tip control for on-the-spot cleaning — eliminates solvent waste.
- Scrubbing action of brush permits use of milder solvents.
- Attaches to all M/S aerosols.
- Sensibly priced.

TRIAL  
OFFER

**miller-stephenson**  
*First In Purity*

MILLER-STEPHENSON CHEMICAL CO., INC.  
Danbury, Connecticut 06810 / (203) 743-4447

ED-6U

- Enclosed is \$2.00, please send my MS-180 Solvent.
- Enclosed is \$5.00, please send my MS-180 Solvent PLUS MS-226 Extension Hose and Brush.
- Please send FREE literature and Military Specs.

Intended Use .....

Name ..... Dept./Title.....

Company .....

Address .....

## SP-G10, H-10 SPEEDEX RECORDER

3 different power supplies available!!

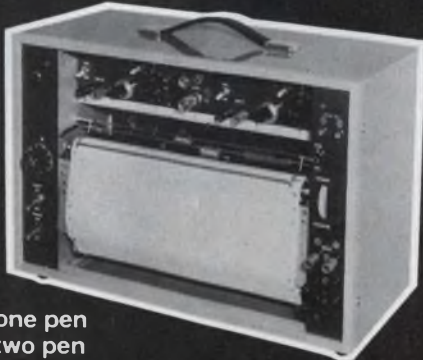

G10...one pen  
H10...two pen

### FEATURES

1. High sensitivity. Switchable from 0.5 mV/250mm full scale to 500V in 12 steps
2. 3 different power supplies
  - a) Internal battery
  - b) AC power line (110, 220V 50/60Hz)
  - c) External 12V power supply
3. Easy to operate
4. Durable plastic potentiometer.
5. All solid-state circuitry
6. Pulse motor chart feed also permits chart feed by external pulse. Chart can be freely wound and un-wound.

● Please write us on your letterhead for detailed information

*Riken Denshi Co., Ltd.*

5-5-2, Yutenji, Meguro-ku, Tokyo, Japan TEL:711-6656 TELEX:0246-8107

CIRCLE NUMBER 101

CIRCLE NUMBER 102







# **GOLD BOOK just two pending orders \$75,000!**

"We're getting a good flow of orders from engineers who tell our salesmen that they have the GOLD BOOK in front of them while they're talking on the phone." writes Mr. James Zaros, Vice President of Sales, Datel Systems, Inc., Canton, Mass.

"I have just confirmed that we have two specific orders pending in our plant, one for \$25,000 and one for \$50,000, that we know are directly traceable to the GOLD BOOK.

"In addition to these phone and mail contacts, we also are receiving a fair number of direct response cards — the ones that are bound in the GOLD BOOK — many of which represent actual or potential business.

"Yes, the GOLD BOOK is definitely working for us."

Datel carries 10 short-form catalog pages in the 1975-76 GOLD BOOK. They feature, among other products, Datel's line of A/D and D/A converters, wideband operational amplifiers and analog multiplexers. The pages are packed with detailed specs, data and price information. Datel makes it easy for engineers to talk business over the phone.

Because the GOLD BOOK is primarily distributed to *Electronic Design's* audience, Datel gets the best of both worlds — 78,000 engineers and engineering managers, purchasing agents and distributors throughout the U.S. *plus* 13,000 in key markets abroad. These are the men who have the authority to specify and buy.

**ELECTRONIC DESIGN'S GOLD BOOK IS WORKING  
...IT'S WORKING FOR READERS...AND IT'S  
WORKING FOR ADVERTISERS, TOO.**



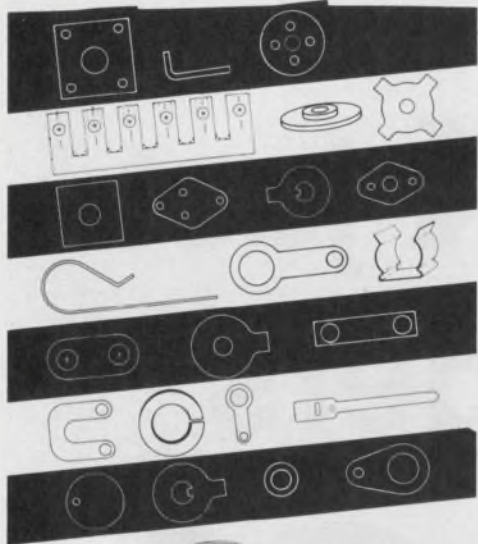

# seastrom wants you!

... to join the thousands of companies relying on Seastrom quality products.

- Washers—all types
- Spring Clips
- Military Standards
- Electronic Hardware

FREE ... Illustrated Catalog. 250 pages with complete description by part number. All stocked for immediate delivery.

Seastrom Manufacturing Co., Inc.  
701 Sonora Avenue Dept. E3  
Glendale, California 91201  
Phone: (213) 245-9121

CIRCLE NUMBER 105

## COMPONENTS

### Photoscanner detects objects up to 5-ft away

*Micro Switch, 11 W. Spring St., Freeport, IL 61032. (815) 232-1122. \$58 (unit qty).*

Though only 1-1/2-in. tall and 1/2-in. thick, the incandescent FE-R6 retroreflective photoelectric scanner can sense up to 5-1/2 ft in a variety of processing and commercial applications. An alignment pin permits adjusting the beam of the scanner from side to side without moving the scanner itself. In addition, a long-life (40,000 h at 5 V ac) lamp can be rotated to narrow the beam so that smaller, more closely packed objects may be detected. The FE-R6 can respond to stationary disc reflectors or carton-identifying reflective tape.

CIRCLE NO. 363

### Carbon trimmer mounts vertically

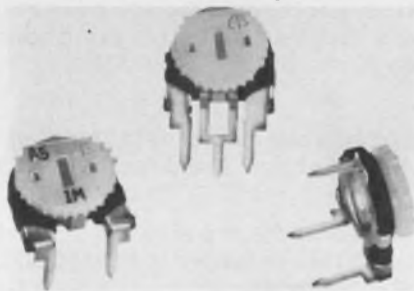

*CTS of Berne, Inc., 406 Parr Rd., Berne, IN 46711. (219) 589-3111. \$0.09 (OEM qty); stock from distributors.*

Two 10-mm composition trimmer potentiometers, the new X260, mount vertically with the knobs perpendicular to the PC board; the older U260-version mounts horizontally. A serrated, slotted knob is standard so adjustment can be made either by hand or with a screwdriver from either the front or rear. Power rating is 0.15 W at 40 C, derated at no load to 100 C; voltage rating across the end terminals is 350 V dc; and the resistance range provided is from 500  $\Omega$  through 1 M $\Omega$  with a tolerance of  $\pm 20\%$ . Standard nonstock resistances are also available through 5 M $\Omega$ .

CIRCLE NO. 364

### Bar-graph controlled from top and bottom



*Burroughs Corp., P.O. Box 1226, Plainfield, NJ 07061. (201) 757-5000. \$29 (1000 up); stock.*

A dual Self-Scan bar-graph display, the BG12203-2, can be independently controlled from the top and bottom of each bar. The dual-bar graph can operate in several modes. One bar can display both upper and lower set points, while the other bar can display actual values. Another mode uses both bars to display the upper and lower values. In a third mode, one bar starts at the top of the display and the other at the bottom. Only 16 connections are required to provide 1/2% resolution in flicker-free, easy-to-read, neon orange. Each bar has 203 segments that are 0.15-in. wide on 0.02-in. spacing.

CIRCLE NO. 365

### 0.5-in. clock display visible to 20 ft

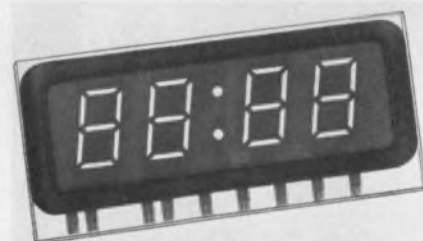

*Cherry Electrical Products Corp., 3600 Sunset Ave., Waukegan, IL 60085. (312) 689-7702. \$5.27 (2000 up).*

A four-digit gas-discharge display, the W04-0003, features 0.5-in.-high numerals in a compact envelope. Over-all the unit measures only 1-1/4-in. high by 2-3/4-in. long and has a colon for minutes and seconds. The uniform brightness of each digit in a neon-orange color allows visibility for distances to 20 ft. The display may be filtered to a deep-red or bright-orange-yellow color. Multiplexed to minimize external connections, the display is available with a unitized connector (W30-0403) that has bifurcated pins for added reliability.

CIRCLE NO. 366



## THE BEST IS NOW #1\*

MFE's 250B Digital Tape Transport  
Offers a 32000BPS Data Transfer Rate



ANSI/ECMA  
COMPATIBLE

- 15,000 Hr. MTBF
  - 1 Year warranty
  - Two moving parts
  - Reel to reel
  - Constant tape tension and constant tape speed - servo controlled
  - ±5VDC operation
  - Guaranteed cassette interchangeability
  - Up to 800 BPI
  - Read after write heads
  - Bi-directional read/write operation
  - Size: 4.39" X 5.46" X 2.42"
  - A few \$525, a hundred \$325
- Call or write Jim Saret

\*Recent survey among leading buyers named MFE number 1.  
Source on request. Over 11,000 in the field.



MFE CORPORATION

Keewaydin Drive  
Salem, N.H. 03079  
Tel. 603-893-1921  
TWX 710-366-1887  
TELEX 94-7477

CIRCLE NUMBER 106

# Free!

## Aluminum Electrolytic Computer Grade Catalog

Here's the 18-page catalog that lists what we feel are the finest quality computer grade capacitors available today. Find out yourself. You'll be glad you did.

### OTHER PRODUCTION ITEMS

INCLUDE: Ceramic capacitors, electrolytic capacitors, film capacitors, oil-filled capacitors—without P.C.B., metallized-paper capacitors, mica capacitors, hybrid IC's and P.T.C. thermistors.



**nichicon** We help keep your world turned on.

NICHICON AMERICA CORPORATION  
Division of NICHICON CAPACITOR LTD., Kyoto, Japan  
6435 N. Proesel, Chicago, Ill. 60645 (312) 679-6530  
40 Orville Dr., Bohemia, N.Y. 11716 (516) 567-2994

CIRCLE NUMBER 107

# INTRODUCING Two New MPU Panels from Excel

because you deserve the very best.

**MPU**  
9045-3BD-60

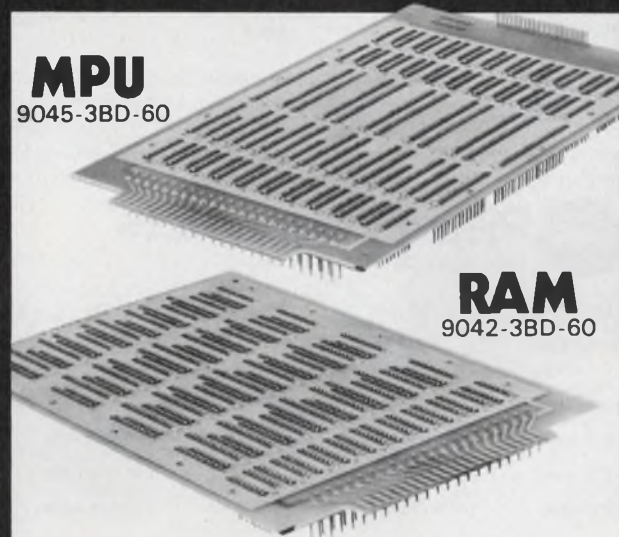

**RAM**  
9042-3BD-60

These New Excel microcomputer panels accommodate Intel, Motorola, Intersil, RCA, Fairchild, Signetics, AMI, National Semiconductor and other current MPU kits.

Memory Panel No. 9042-3BD-60 accepts any 16-18-22 or 28 pin LSI, RAM, ROM, or PROM in 4K increments.

Both panels have all provisions for I/O drivers, receivers, buffers and control lines.

Sizes are 6" X 10" and mate to standard 44 pin edge connectors for ease of system expansion during prototyping, evaluating and programming of MPU devices.

By standardizing pinouts for address and data busses plus control and power lines, you can now interchange processor boards, memory boards and I/O boards, etc., all within the same card cage regardless of whose LSI devices are on any board.

Now for the first time most requirements for processor, memory, I/O boards and the multitude of panel sizes & various MPU kits can be easily handled by these new Excel Quality panels.

AVAILABLE WRAPPED TO YOUR REQUIREMENTS  
OR OFF THE SHELF

Nationally available from Schweber Electronics, Components Center, Milgray, Diplomat/Southland, Southwest Electronics or EXCEL PRODUCTS COMPANY, INC., 401 Joyce Kilmer Avenue, New Brunswick, N.J. 08903 Phone: 201-249-6600  
TWX 710-480-6255

# EXCEL

CIRCLE NUMBER 108



# The Plessey Sampler.

Just \$15.00, and you can sample 18 values between 0.001  $\mu$ F and 1.0  $\mu$ F, 100V to 1,000V, from our broad range of metallized film capacitors manufactured in California. It's just enough to give you a taste for Plessey quality and performance. And show you how the simplicity of our minibox design fits right into your packaging requirements. Compact. Non-burning. With no lead forming or cutting required to simplify PC board assembly. They're ideal for flow soldering. And in production quantities, you'll find that they fit right into your budget as well.



Call the Plessey Distributor nearest you, or contact Plessey Capacitors directly. For only \$15.00, you'll receive our Series 160 Minibox Capacitor Sampler containing over 300 pieces to assist with your design requirements.



## Plessey Capacitors

5334 Sterling Center Drive, Westlake Village, California 91361 (213) 889-4120

**J.V. ELECTRONICS**  
EAST HAVEN  
203-489-2321

**HI-REL**  
LOS ANGELES  
213-774-8200

**CAPACITOR SALES**  
SAN FRANCISCO  
415-964-8880

**ELECTRO SONIC**  
TORONTO  
416-494-1666

### HALL-MARK ELECTRONICS CORP.

ATLANTA  
800-633-2918  
AUSTIN  
512-837-2814  
BALTIMORE  
301-265-8500  
CHICAGO  
312-437-8800

DALLAS  
214-231-6111  
DAYTON  
513-294-0437  
HOUSTON  
713-781-6100  
HUNTSVILLE  
205-837-8700







KANSAS CITY  
913-888-4747  
MIAMI  
305-971-9280  
MILWAUKEE  
414-478-1270  
MINNEAPOLIS  
612-884-9056

NEW YORK  
516-273-0030  
ORLANDO  
305-855-4020  
PHILADELPHIA  
215-355-7300  
RALEIGH  
919-832-4465

ST LOUIS  
314-291-5350  
TULSA  
918-835-8458  
WICHITA  
316-682-2073

CIRCLE NUMBER 109

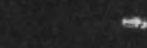
## Get more current at lower light levels

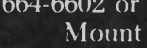
-  highest sensitivity in the industry
-  guaranteed light currents
-  broad line of types
-  glass windows or lenses
-  hermetically sealed
-  three package sizes
-  can be designed to your requirements

Call (914) 664-6602 or write Clairex® 560 South Third Avenue, Mount Vernon, New York 10550

## ...with Clairex photodarlingtons and phototransistors.

### CLAIREX ELECTRONICS

A Division of Clairex Corporation

CIRCLE NUMBER 110

## PACKAGING & MATERIALS

### Acoustical covers muffle noisy machines



Van San Corp., 1180 Centre Dr., City of Industry, CA 91748. (714) 595-7487.

Quietizer Model 1111 for the Teletype 33 ASR and Telex 32 ASR is an effective, low-cost sound-deadening acoustical cover. For installation, the unit requires no machine modifications, fasteners or tools. A clear plexiglass shield provides full visibility of machine operation. The lower section raises to allow operation of the keyboard and the entire shield can be raised for total accessibility. Proper air flow is maintained by an internally mounted whisper fan. Models for more than 200 different models of noisy office machines are available.

Booth No. 1240 Circle No. 367

### PC terminal strip has compact design

Electrovert Inc., 86 Hartford Ave., Mount Vernon, NY 10553. (914) 664-6090. \$34 to \$205 per 100; stock.

A new PC-board terminal strip, compact and molded of unbreakable Polyamid, protects all contacts and terminal screws for dead-front safety. A 12-pole strip measures only 2.39-in. long. The strip is available in any number of poles up to 24 with 0.2-in. pin spacing. Each pole is consecutively numbered. Pin spacings of 5 and 10 mm are also available. Solder pins are hot-tinned electrolytic copper. Connectors are tinned brass, and terminal screws are zinc-plated and di-chromated steel staked to prevent loosening. Rated at 300 V, 10 A, the strip accepts wires up to 14 AWG.

CIRCLE NO. 368



## Display sockets mount at various angles

Garry Manufacturing Inc., 1010 Jersey Ave., New Brunswick, NJ 08902. (201) 545-2424. \$0.50 to \$2.50; 4 to 6 wks.

Alphanumeric display sockets that mount at various angles to wire-wrappable and PC boards mount on 0.4-in. centers and plug into standard 14 or 16-pin positions on IC-packaging panels. The sockets accept either flat leads or 0.016 or 0.02-in.-diameter round leads. Versions of the socket mount at 90, 60, or 45 degrees to the board surface.

CIRCLE NO. 369

## Shrink-tube material shields against rfi/emi



Chomerics, 77 Dragon Court, Woburn, MA 01801. (617) 935-4850.

Cho-Shrink products are alternatives to metal braid and connector backshell braid adapters. They can provide lightweight, flexible emi/rfi shielding and strain relief for cables, connector terminations and coax splices. Inside surfaces of the materials are coated with a proprietary silver-based resin that remains in intimate contact with the polyolefin without cracking, even during shrinking. Typical shielding effectiveness is 50 dB at 100 MHz. It's especially effective above 100 MHz. It can make in-house shielding cable fabrication possible; thus it drastically cuts the required lead time. Tubing, available in diameters of 1/4 to 4 in., can shrink to one-half its original diameter. Molded boots and transitions are available to fit most circular and rectangular connector backshells and typical harness configurations.

CIRCLE NO. 370

## Multicore solder doesn't dissolve copper

Multicore Solders, Westbury, NY 11590. (516) 334-7450. About \$3/lb; stock.

A multicore solder, Savbit, prevents fine-gauge copper wires and thin copper foils, which form the conductive patterns of flexible circuits and PC boards, from dissolving during the soldering operation. This dissolving action, a re-

sult of tin-copper migration has frequently caused a wire or thin foil to weaken during soldering and subsequently break during field use. The new solder is a copper-loaded, tin/lead alloy with five separate cores of a rosin-base flux. The new solder is comparable in joint quality with high-performance 60/40 alloys, but sharply reduces the dissolving of copper as much as 100 times.

CIRCLE NO. 371

**Q:** Is there a recorder just for spectrum analyzers?

**A:**

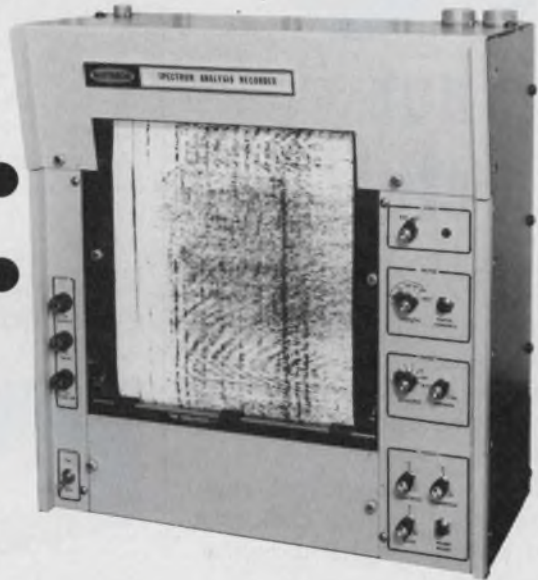

The new 19" rack-mounting SPECTRUM ANALYSIS RECORDER from Raytheon. It's the first dry paper line scanning recorder specifically developed for direct plug-in operation with commercially available spectrum analyzers.

Any new or existing spectrum analyzer equipped with the SAR-097 will have a lot more going for it. Like infinitely variable 100:1 speed range - 5 sec/scan to 50 millisecc/scan... stylus position encoder... automatic recorder synchronization... computer/analyzer compatibility... high resolution and dynamic range... all-electronic drive. And more.

If you design and build - or buy and use - spectrum analyzers, you don't have to settle for multi-purpose recorders any more. The SAR-097 is here. For full details write the Marketing Manager, Raytheon Company, Ocean Systems Center, Portsmouth, Rhode Island, 02871. U.S.A. (401) 847-8000.

**RAYTHEON**

CIRCLE NUMBER 111





## hot stuff

or cold, CHR's family of TEMP-R-TAPE of Kapton provides outstanding endurance. They retain their excellent mechanical and electrical properties over a wide temperature range, -100 to +500F.

Available in thicknesses from .001" to .0045" with a choice of several adhesive systems including two sides.

Find your CHR distributor in the Yellow Pages under "Tapes, Industrial" or in industrial directories. Or write for complete specification kit and sample. The Connecticut Hard Rubber Company, New Haven, Conn. 06509.

**CHR**

an ARMCO company

CIRCLE NUMBER 112

## MICROWAVES & LASERS

### WG filter has only 0.1-dB loss

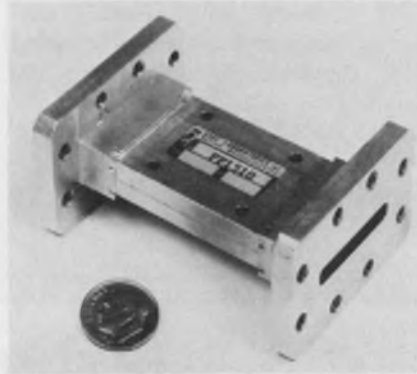

Sage Laboratories, 3 Huron Dr., Natick, MA 01760. (617) 653-0844. \$325; 60 days.

The Model FF1510 waveguide low-pass filter features less than 0.1-dB insertion loss over the 7.23-to-7.45-GHz passband. With some sacrifice in performance, the unit can be operated from 6.4 to 8.0 GHz. Second and third harmonics in the passband are rejected by greater than 60 dB. Over-all rejection is 40 dB minimum from 10 to 24.5 GHz. The unit can transmit 2 kW cw, mates with WR-112 waveguide, and is less than 3-in. long.

CIRCLE NO. 372

### Preamp has 45-dB gain and 3.3-dB NF



Ailtech, 19535 E. Walnut Dr., City of Industry, CA 91748. (213) 965-4911. \$875; 6 wks.

Model 13680 preamplifier features a gain of 45 dB and noise figure of 3.3 dB. When used in conjunction with the company's Type 75 precision noise-figure indicator, the preamp allows for use of a full 65-dB of dynamic range and contributes negligible second-stage noise. The 13680 has a 30-MHz center frequency and a maximum linear output of +17 dBm.

CIRCLE NO. 373

### Coax/WG switch has 100-dB isolation



Sector Motor Industries, 127C Brook Ave., Deer Park, NY 11729. (516) 242-2300. \$1050; stock.

A combination waveguide/coaxial switch, the Model SM2-G3GSP, covers the 3.7-to-4.2-GHz range and has 0.01-dB insertion loss and 100-dB isolation. The new unit employs a special motor that produces switching times of 80 ms. Other features include simple latching and manual override. Models are available for operation from supplies of 15 V dc through 230 V ac.

CIRCLE NO. 374

### Laser copier specs 3-MHz modulation

Coherent Radiation, 3210 Porter Dr., Palo Alto, CA 94304. (415) 493-2111. \$395 (production quantities).

The CR-135 WriteLite helium-neon laser can be used to "write" graphics hardcopy at two seconds per 8-1/2 x 11-in. page. It can be modulated at rates up to 3-MHz or switched on and off within 150 ns. The red-light CR-135 integrates a 2-mW laser, acousto-optic modulation and the necessary drive electronics in a single package. The unit specs a life time of 20,000 hrs.

CIRCLE NO. 375



**Now...Eternacell<sup>®</sup>  
lithium primary batteries  
in 10 off-the-shelf sizes**



There's a lithium primary battery for fast delivery in a cell size for practically every portable-power application — from ½ to 25 ampere-hours capacity. Including "AA", "C", "D" cell sizes and a new 9-volt transistor-size.

Every cell delivers the remarkable performance that has become a new standard for the industry:

- 2.8 volts-per-cell nominal operating voltage, twice that of ordinary cells
- highest energy per unit weight and volume
- greater than 5-year shelf life
- outstanding adaptability to temperature extremes (-65F to +160F)

PCI specializes in the design and manufacture of multi-voltage lithium battery packs for varied industrial, consumer, and military applications.

Write for our catalog or contact our Applications Department to discuss your specific design requirements.



**Power Conversion, Inc.**  
70 MacQuesten Parkway South  
Mt. Vernon, N.Y. 10550  
Telephone: 914-699-7333

CIRCLE NUMBER 113

**SWITCH TO THE  
LICON<sup>®</sup> LPB LINE**

... a spur to your imagination!

Design ideas track better with Licon LPB's! Our vast array of lighted and unlighted model choices give you more options to find the switch you need quickly and save design time, too. Here are just two bright ideas to consider: Our economical **Series 05 LPB** now has a centrally-located LED display. Bifurcated contacts with long wipe. Good tactile feedback. U.L. listed. Ideal for low energy digital electronics switching. **Series 06 LPB's** feature Licon's Ultra-reliable double-break Butterfly<sup>®</sup> switches. Over 200 display options. U.L. listed, C.S.A. certified and meets 3 mm terminal spacing requirements. Wide application range. Both have standard PC or .110 quick-connect terminals. See our brilliant broad line for yourself. Call or write for our Licon Switch Catalog. Licon, 6615 W. Irving Park Rd., Chicago, Illinois 60634. Phone (312) 282-4040. TWX 910-221-0275



**LICON**

A DIVISION OF ILLINOIS TOOL WORKS INC.



© Illinois Tool Works Inc. 1976

CIRCLE NUMBER 114

**Need a mini capacitor  
with full commercial temperature capability?**

**Panasonic L series mini aluminum electrolytics perform from  
-40°C to +85°C with low impedance.**

Panasonic's L series are designed for circuits that require low impedance and low D.F. Units exhibit no mechanical damage or leakage of electrolyte with capacitance and D.F. when within voltage surge limits listed in the table to the right.

Available in radial and axial design. You can order Panasonic L series mini aluminum electrolytics in bulk or on tape and reel. The Panasonic L series provide a complete range of standard miniature electrolytics for commercial, industrial and entertainment applications. For more information, mail this coupon today.

**Panasonic<sup>®</sup>**  
just slightly ahead of our time

WVDC	SVDC
6.3 V	8V
10	13
16	20
25	32
35	44
50	63
63	79
100	125



Available in tape and reel.

ED-6 **I want more information on  
L series mini aluminum electrolytic capacitors.**

Mail to: PANASONIC COMPANY  
One Panasonic Way, Secaucus, New Jersey 07094

Name \_\_\_\_\_  
Company \_\_\_\_\_  
Address \_\_\_\_\_  
City \_\_\_\_\_ State \_\_\_\_\_ Zip \_\_\_\_\_

CIRCLE NUMBER 115



## System soothers... from Wiley-Interscience

### PHASED-LOCKED LOOPS:

Application to Coherent Receiver Design  
**Alain Blanchard**

Here are the answers to all probable questions an engineer may face when designing and upgrading the operation of phase-locked loops. The author presents complete, systematic coverage of PLL and their direct application in communication, radiolocalization, time and frequency control, and instrumentation. Includes many useful graphs, formulas, and diagrams.

0-471-07941-3 1976 \$22.50

### FREQUENCY SYNTHESIZERS:

Theory and Design

**V. Manassewitsch**

Here is a thorough, analytic treatment of system and circuit design information with descriptions of current design tools, recommendations for system design procedures, and an examination of synthesizer design problems. Features coverage of phased noise, spurious outputs analysis, measuring techniques, rf and digital circuits, numerous definitions, and more.

0-471-56635-7 1976 \$27.50

### MICROPROCESSORS & MICROCOMPUTERS

**Branko Souček**

With special focus on detailed descriptions of representative microprocessor families, MICROPROCESSORS & MICROCOMPUTERS describes the application, programming, and interfacing techniques common to all microprocessors. Topics examined range from digital codes, logical systems, organization, and high-level programming to Input/Output transfer modes, 4-, 8-, 12-, 16-bit microprocessors, and addressing modes. Many programming and interfacing examples are also included.

0-471-81391-5 1976 \$23.00

Rush me title(s) indicated.

Mail to:

Customer Information, A5604WI

**WILEY-INTERSCIENCE**

a division of John Wiley & Sons  
605 Third Avenue  
New York, N.Y. 10016



Payment enclosed, plus sales tax. Wiley pays postage/handling. We normally ship within 10 days. If shipment cannot be made within 90 days, payment will be refunded.

Bill me.

NAME \_\_\_\_\_

AFFILIATION \_\_\_\_\_

ADDRESS \_\_\_\_\_

CITY \_\_\_\_\_

STATE \_\_\_\_\_ ZIP \_\_\_\_\_

Prices subject to change without notice.

092-A5604-WI-1

CIRCLE NUMBER 116

## Design Aids

### Heat sinks

More than 250 different extruded semiconductor heat-sink shapes, sizes and variations are displayed in a wall chart. Aavid Eng.

CIRCLE NO. 376

### Solid-state power relays

A designer's manual for the application of solid-state power relays takes the mystery out of SCR capability, performance and calculating safety factors. Opto 22.

CIRCLE NO. 377

### Digital panel instruments

Design parameters, performance requirements and a list of key specs for digital panel instruments can be found in a six-page guide. Analogic.

CIRCLE NO. 378

### Plug-in selector chart

A plug-in selector chart makes it easy for a hybrid microcircuit designer to choose the all-metal package he needs. A wide selection of plug-in packages, covers and lids are illustrated in approximately exact size. The designer can find the package he wants by simply laying the substrate on the outline drawings until he finds the style that fits. Isotronics.

CIRCLE NO. 379

### Bookmarks

Technical formulas and charts pertaining to the use of electronic high voltage dc op amps is given on a 2-1/4 x 11-1/4-in. bookmark. Another bookmark, the same size, gives formulas and charts pertaining to applications of Fabry-Perot interferometry. Burleigh Instruments.

CIRCLE NO. 380

### Insulated tubing

Spelling out the applications and features of 26 different materials used in spiral wound, dielectric tubing, a 14 x 21-in. wall chart aids in selection. Precision Paper Tube.

CIRCLE NO. 381

## Application Notes

### Active filters

"State Variable Active Filter Configuration Handbook" includes such topics as general form of the state-variable element, guide to selecting conventional transfer characteristics and general solution of the transfer function, T(s). Tables and figures are included along with an extensive bibliography. KTI Microelectronics, Div. of Baldwin Electronics, Campbell, CA

CIRCLE NO. 382

### Thermistors

The "Capsule Thermistor Course" booklet is designed to give a brief and technically condensed insight into the What, Where and How's of thermistor sensors and thermistor sensor assemblies for use in temperature measurement, indication and control applications. Fenwal Electronics, Framingham, MA

CIRCLE NO. 383

### Data signal displays

How to achieve stable analog displays of data signals is described in a six-page booklet. Included are descriptions of the HP 1620A pattern analyzer and the HP 7900A disc system (used as the example of a common disc drive). Hewlett-Packard, Palo Alto, CA

CIRCLE NO. 384

### Motor handbook

The third edition of "Dc Motors-Speed Controls-Servo Systems" includes a collection of basic formulas useful in the design of servo motor systems and conversions to metric notation. The 500-page, \$10 book is a basic reference text and includes applications and specifications. Qualified engineers may order the book by writing on their company letterhead and sending only \$1 to cover handling and postage. Electro-Craft Corp., 1600 Second St. S, Hopkins, MN 55343

INQUIRE DIRECT



# MOLON

DESIGNERS and MANUFACTURERS  
of F.H.P. MOTORS and GEAR MOTORS



**MODELS LMO & LMS**  
Synchronous/Stepper motor  
300 rpm. Syn. rpm. @ 60H.  
Torque to 11 in. oz.  
Special versions available  
to 22 in. oz.



**MODEL ZMO**  
Two pole shaded pole  
AC motor.  
Torque to 9 in. oz.  
Also available in  
combination with 8  
standard gearbox designs.



**MODEL QMO**  
2 pole capacitor  
reversible AC motor.  
Torque to 12 in. oz.  
Available in combination  
with 4 standard gearbox  
designs.

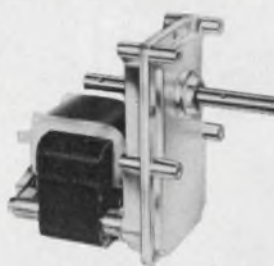

**MODEL ZEM**  
High torque gear motor  
(uni-directional).  
Speed ¼ rpm. to 225 rpm.  
Torque to 200 in. lbs.



**MODEL EM5**  
Compact 1/10 hp. gear  
motor. 8-300 rpm.  
High quality—long life  
gearing.  
Reversible AC motor.  
Torque to 75 in. lbs.

**SPECIALIZING IN HIGH VOLUME F.H.P. MOTORS UP TO 1/10 H.P.**



**MOLON MOTOR & COIL CORPORATION**  
3737 Industrial Avenue, Rolling Meadows, Illinois 60008  
Phone 312/259-8700

**SEE OUR CATALOG IN THOMCAT**

CIRCLE NUMBER 117

**Low cost, high  
performance  
3A SPDT relay  
really saves  
PC board space**

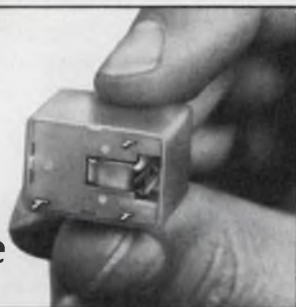

**Mounts on .69" centers...  
satisfies thousands of application needs**

Where size and space are important, the Series 27 relay can be just the low cost answer you've been looking for. It provides 3 amps of switching in a 0.526" cube and mounts on .69" centers, assuring high density PC board mounting. The cost is \$1.05 each in 1,000 piece lots for 3, 6 and 12V dc units ... slightly higher for 24V dc.

You'll find the Series 27 relay suitable for hundreds of control applications. For instance: timing controls; gas pilot light controls; anti-theft devices for CB radios; automotive controls; emergency lighting equipment; and medical equipment, to name a few.

The relay has a 450 mW pick-up sensitivity (180 mW available). Contact rating is 3A res @ 28V dc. 120V ac. Contact resistance is 0.10 ohm.

**Write for information today!**

**NORTH AMERICAN PHILIPS CONTROLS CORP.**

Frederick, Md. 21701 • (301) 663-5141

CIRCLE NUMBER 118

ELECTRONIC DESIGN 12, June 7, 1976

**DAK MULTIDEX®—THE  
ALMOST UNIVERSAL SWITCH**

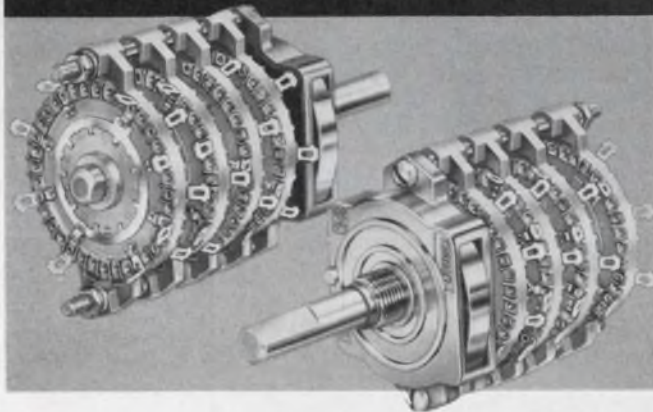

Reduce your design time with this 1½" diameter rotary switch. 8 to 36 positions, depending on detents selected (11 available, from 10° to 45°) allowing thousands of switching variations. Crisp, uniform ball and starwheel Unidex® detent. Double-wiping, self-cleaning, high-pressure contacts. Military types available.

**For additional information call toll-free: 800/435-6106.**

**DAK Industries Inc.**

**SWITCH DIVISION / CRYSTAL LAKE, ILLINOIS 60014**

CIRCLE NUMBER 119

199



# Aerospace Optics make this the only miniature pushbutton switch that is Sunlight Readable

Patents in Process

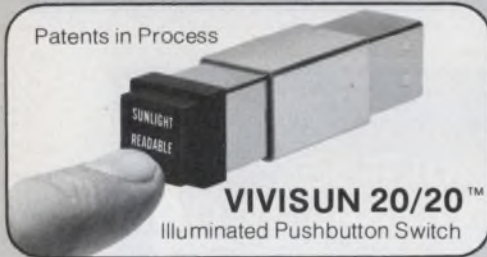

## Tested and Proven

Only Vivisun 20/20 legends are readable in a light ambient of 10,000 foot-candles (sunlight). When the lamps are not energized the hidden legend characters are not discernable in a 10,000 foot-candle ambient (sunlight).

- Switches are designed in accordance with MIL-S-22885
- Single or multi-color legend option
- Individual unit or matrix mounting options
- Momentary or alternate pushbutton action available with SPDT, DPDT, or 3PDT switches
- Companion sunlight readable annunciator available (without switching)
- 1, 2, 3, or 4 separate messages
- Messages available in green, yellow, red, or white
- Designed for low power consumption (5, 12, 14, 18 or 28 volts available)
- Lamps replace from front without tools



**AEROSPACE OPTICS INC.**

7112 Burns Street, Dept. 33,  
Fort Worth, Texas 76118

(817) 284-2293 (Ext 33) Telex 75-8461

Researchers, Designers and Manufacturers  
of Sunlight Readable Lighted Displays

## New Literature



### Sweep generator systems

Descriptions and specifications cover both the mainframe and all plug-ins of the 540A solid-state sweeper system. Systron-Donner, Van Nuys, CA

CIRCLE NO. 385

### Programmable counter

Expanded and revised data for the CD4059A programmable divide-by-N counter can be found in a 12-page brochure. RCA Solid State Div., Somerville, NJ

CIRCLE NO. 386

### Industrial products

Thirteen product categories, ranging from LED displays and low-profile keyboards to communications terminal and test equipment, mechanical displays, servo motors and resolvers and pots are presented in a 24-page brochure. Bowmar Instrument, Phoenix, AZ

CIRCLE NO. 387

### Switches

Detailed specifications, electrical ratings, circuitry and technical diagrams of switches, including PB, lighted PB, snap-action, keyboard/keyswitches and environmental free switches, are given in a 32-page catalog. Licon, Div. Illinois Tool Works, Chicago, IL

CIRCLE NO. 388

### CB radio synthesizer

Still wondering which CB radio synthesizer to use? Is it expensive to assemble? What is the total parts count? These and other questions are discussed in "Nitron CB Radio Products Competitive Analysis." Nitron, Cupertino, CA

CIRCLE NO. 389

### Comm antenna systems

Land-mobile communication antenna systems are described in an 80-page catalog. All products are accompanied by complete specifications for ease in ordering. Prices are included. Phelps Dodge Communications, Marlboro, NJ

CIRCLE NO. 390

### Integrated circuits

Bipolar ROMs, PROMs, RAMs and computer logic devices are the subject of a 24-page catalog. Key specs, applications, pinouts and block diagrams are provided for each IC. MMI, Sunnyvale, CA

CIRCLE NO. 391

### General-purpose op amps

Schematics, pin connections, electrical characteristics and performance curves help describe a general-purpose op amp in an eight-page catalog. Precision Monolithics, Santa Clara, CA

CIRCLE NO. 392

### Analyzer system

The TN-1700 pulse-height analyzer system is detailed in a 24-page brochure. Tracor Northern, Middleton, WI

CIRCLE NO. 393

### Information services

"Datapro Reports on Retail Systems" features over 400 pages of detailed product reports on integrated POS systems, electronic cash registers, EFTS, credit and payment systems, vendors, applications, specialized equipment, software and other retail product areas. The annual subscription price for the book is \$290; however, NCC attendees can order the service at the show for a charter subscription price of \$250. Datapro Research Corp., 1805 Underwood Blvd., Delran, NJ 08075.

INQUIRE DIRECT







# REAL TIME Analog I/O for Intel SBC 80/10 or MDS-800

A single board Analog I/O system for Intel's new single board computer. For laboratory or industrial measurements our DT1751 system can process 16 analog input channels and has 2 analog output channels with power amplifier for driving industrial loads. Drive CRT's directly as well...using the built-in point plot controller.

Real Time measurements are easily done with standard features such as external A/D trigger plus convenient interrupt operation. Optional switch gain amplifier extends dynamic range to 14-bits. CALL US at (617) 879-3595 for a complete set of applications data.

## DATA TRANSLATION

**INC**

109 CONCORD ST., FRAMINGHAM, MA 01701 (617) 879-3595  
TELEX 94 8474 *...the analog I/O company*

CIRCLE NUMBER 124

## MINIATURE FREQUENCY STANDARD

**\$197.00 EACH**  
(10 UNITS)



(5 CUBIC INCHES)  
 $\pm 5 \times 10^{-8}$ /DAY  
CALL OR WRITE



**Greenray  
Industries, Inc.**

840 West Church Rd.  
Mechanicsburg, PA 17055  
Phone 717-766-0223

CIRCLE NUMBER 125

## KEEP

Electronic Design's

## GOLD BOOK HANDY



## When You Call

Save time when you contact suppliers. Check their catalog pages first in *Electronic Design's* GOLD BOOK. Maybe the information you need is right at your fingertips.

# Bulletin Board

Power Physics is offering improved versions of its 2N5038 and 2N5039 power transistors. The transistors use planar construction that allows lower  $I_{CEX(max)}$  leakages from 10 to 1 mA max. Power dissipation at 25-C case temp will increase from 140 to 175 W.

CIRCLE NO. 511

Mohawk Data Sciences is offering the MDS 2405-1 RJE system, consisting of a programmable processor with 16-k memory; a communications controller capable of transmission speeds up to 56 kbits/s; a 400 card-per-minute reader; and a 300 lpm printer, as a special purchase package. The entire configuration, complete with software, costs \$15,000.

CIRCLE NO. 512

Analog Devices slashes prices by more than 26% on its 10-kHz v/f converter modules.

CIRCLE NO. 513

Tycom Systems has dropped the price of the Model 38, an ASCII TTY-compatible terminal, to \$1995 from \$2250.

CIRCLE NO. 514

Telenet Communications has adopted the internationally agreed upon standard, labeled X.25, for connecting computers to its public packet switched network.

CIRCLE NO. 515

Four new options for the Hewlett-Packard 8015A pulse generator speed and simplify the testing of MOS and CMOS circuitry.

CIRCLE NO. 516

General Electric's Information Services Div. has announced the on-line availability of an interactive business graphics package, called PLOT\*\*\*, which provides users with the ability to display data in graphic form without the need for user expertise in special software or sophisticated computer languages.

CIRCLE NO. 517



# Vendors Report

Annual and interim reports can provide much more than financial position information. They often include the first public disclosure of new products, new techniques and new directions of our vendors and customers. Further, they often contain superb analyses of segments of industry that a company serves.

Selected companies with recent reports are listed here with their main electronic products or services. For a copy, circle the indicated number.

Optel. Digital watches.

CIRCLE NO. 518

The Plessey Co. Ltd. Telecommunications and transmission, electronic equipment (including radar and radio), aerospace equipment and industrial hydraulic, electronic and mechanical components.

CIRCLE NO. 519

Sola Basic. Communication systems equipment, power systems equipment, electrical equipment for special environments, electrical construction equipment and electrical production equipment.

CIRCLE NO. 520

Solid State Scientific. Semiconductors and integrated display systems.

CIRCLE NO. 521

LM Ericsson Telephone Co. Public telephone exchanges, subscriber exchanges, instruments and intercom systems, transmission equipment and radio communications systems, military electronics and cable, wire and network equipment.

CIRCLE NO. 522

WUI. Domestic communications, Telex, cablegrams, international carriers and satellite earth stations.

CIRCLE NO. 523

Radiation Dynamics. Accelerators.

CIRCLE NO. 524

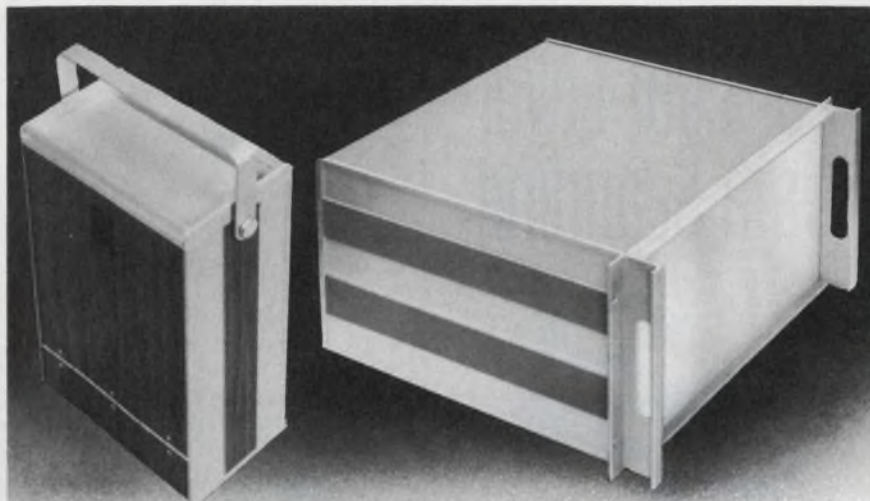

## BUCKEYE designer II CASES

The new look of Designer II is available in six standard heights, four standard depths and widths.

Special features include Rack Adapter Handle with cutout for positive hand grip. Vertical trims with corners beveled. Fluted side extrusions anodized with satin finish and highlighted with vinyl-clad color feature stripes and top panels in blue, black or teakwood. Write today for specs and prices.

the BUCKEYE stamping co.  
555 Marion Rd., Columbus OH 43207 Phone (614) 445-8433

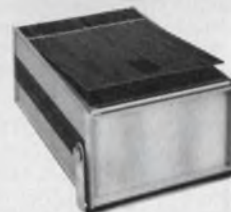

CIRCLE NUMBER 126

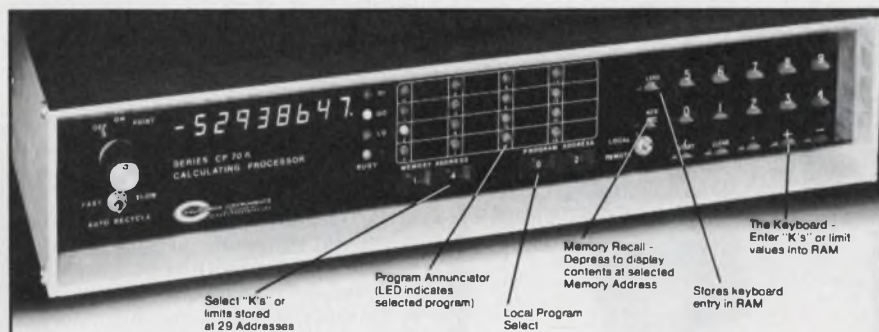

## a digital data processor

NOT A MICROPROCESSOR

NO SOFTWARE REQUIRED

PREPROGRAMMED AT FACTORY

IT CALCULATES:  
WEIGHT  
FLOW  
MASS  
DEVIATION  
RATIOS  
dB  
RPM  
TORQUE  
 $\Delta T$   
AND MORE

The CP 70A closes the gap between individual digital measuring instruments and computer-based digital data acquisition systems. It accepts digital data from up to three separate sources and operates on these data according to equations stored in a plug-in PROM. The basic CP 70A stores from one to eight equations in a single plug-in EPROM, but another may be added to double the equation storage capacity. The plug-in EPROM's let you keep an unlimited number of programs on hand, with a choice of equations ranging from two-term addition to third-order polynomials. If you need only measuring and calculating power don't buy mass memory or expensive software. Save time, trouble, and money with a CP 70A. Call or write for detailed information.

5150 Convoy St.  
San Diego, California 92111  
(714) 279-8620 telex: 695047

**CALIFORNIA INSTRUMENTS**  
a division of  
AIKEN INDUSTRIES INC.

CIRCLE NUMBER 127



# For Low-Level Data Scanning

Ultra Low-Thermal EMF Reed Relays

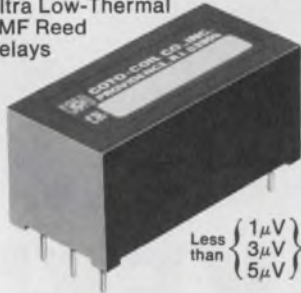

Less than  $\left. \begin{matrix} 1\mu V \\ 3\mu V \\ 5\mu V \end{matrix} \right\}$  Take Your Pick!

Perfect for low-level scanners and multiplexers! Coto's new CR-3250 ultra low-thermal EMF reed relays include 2 low thermal contacts plus a third for guard switching . . . all specially conditioned and tested for reliable low-level switching. Relays are graded and priced according to magnitude of thermal offset; you pay for no more accuracy than you need! Write for new Bulletin MR-10.3.



**COTO-COIL COMPANY, INC.**  
59 Pavilion Avenue  
Providence, R. I. 02905  
Tel: (401) 467-4777

CIRCLE NUMBER 128

# Circuit Savers

**NEW**  
SIGNAL/DATA/TELEPHONE PROTECTION



The SLP protectors were expressly designed to protect signal/data/telephone lines from transient overvoltages caused by lightning, heavy machinery, elevator motors, generators, etc. The SLP interfaces between the signal lines and the sensitive circuit to provide a sophisticated blend of high speed (nanoseconds) voltage limiting and brute force protection. The SLP's recover automatically to standby when the need for protection has passed.

Output Clamp Voltage Level  $\pm 5V$  to  $\pm 200V$   
Input Voltage Level (max) to  $\pm 35KV$  (10 US)  
Energy Handling to 50 joules and higher

**BULLETIN 301**

Full line of protection modules for every hi-lo voltage/current requirement. Write or call for data.

279 Skidmore Rd., Deer Park, N. Y. 11729  
Telephone: 516-586-5125

# MCG Electronics

CIRCLE NUMBER 129

# Electronic Design

ELECTRONIC DESIGN's function is:

- To aid progress in the electronics manufacturing industry by promoting good design.
- To give the electronic design engineer concepts and ideas that make his job easier and more productive.
- To provide a central source of timely electronics information.
- To promote communication among members of the electronics engineering community.

Want a subscription? ELECTRONIC DESIGN is sent free to qualified engineers and engineering managers doing design work, supervising design or setting standards in the United States and Western Europe. For a free subscription, use the application form bound in the magazine. If none is included, write to us direct for an application form.

If you do not qualify, you may take out a paid subscription for \$30 a year in the U.S.A., \$40 a year elsewhere. Single copies are \$1.50 each.

If you change your address, send us an old mailing label and your new address; there is generally a postcard for this bound in the magazine. You will have to requalify to continue receiving ELECTRONIC DESIGN free.

The accuracy policy of ELECTRONIC DESIGN is:

- To make diligent efforts to ensure the accuracy of editorial matter.
- To publish prompt corrections whenever inaccuracies are brought to our attention. Corrections appear in "Across the Desk."
- To encourage our readers as responsible members of our business community to report to us misleading or fraudulent advertising.
- To refuse any advertisement deemed to be misleading or fraudulent.

Microfilm copies are available of complete volumes of ELECTRONIC DESIGN at \$19 per volume, beginning with Volume 1, 1952 through Volume 20. Reprints of individual articles may be obtained for \$3.00 each, prepaid (\$.50 for each additional copy of the same article) no matter how long the article. For further details and to place orders, contact the Customer Services Department, University Microfilms, 300 North Zeeb Road, Ann Arbor, Michigan 48106 telephone (313) 761-4700.

Want to contact us? If you have any comments or wish to submit a manuscript or article outline, address your correspondence to:

Editor  
ELECTRONIC DESIGN  
50 Essex Street  
Rochelle Park, N.J. 07662

classified ad

## CRAMOLIN — Antioxidizing Lubricant

"The Less used — the better it works!"  
For all metal electrical contacts and connections. Reduce contact resistance. Restore electronic system performance. Protect against corrosive atmospheres. Will not harm plastics. Safe. Liquid or aerosol. Tech. data, Engineers Kit Available.

Caig Laboratories, Inc.  
P.O. Box 64, Escondido, Ca., 92025

**Protect Your Heart  
HAVE REGULAR MEDICAL  
CHECK UPS**



Give Heart Fund



# Please Help Children Live

Research is our only weapon against childhood cancer.

St. Jude Children's Research Hospital, which is non-sectarian, is the largest childhood cancer research center in the world.

Please join in the fight against childhood cancer.

Send your special gift now.



**ST. JUDE  
CHILDREN'S  
RESEARCH  
HOSPITAL**

Danny Thomas, Founder

Send contributions to:  
MEMPHIS, TENN. 38101

This space donated by publication



Step-by-step coverage of defense radar system design . . .

# INTRODUCTION TO DEFENSE RADAR SYSTEMS ENGINEERING

James N. Constant

This all-inclusive handbook covers virtually every facet of radar technology that must be mastered in order to design a complete defense radar system. In fact, it concludes with a *step-by-step procedure for specifying and designing a complete radar system for a given application*. Separate chapters cover target characteristics; radar detection; radar receivers; radar system error model; flight of a ballistic missile; ballistic reentry trajectories; trajectory prediction; radar data processing; reflector antennas; and array antennas. Order your 15-day examination copy today! #9194, 344 pages, cloth, illustrated, \$22.95



## 15-DAY FREE EXAMINATION!



Hayden Book Company, Inc.  
50 Essex Street  
Rochelle Park, N.J. 07662

- Please send me my copy of INTRODUCTION TO DEFENSE RADAR SYSTEMS ENGINEERING to read and use for 15 days. At the end of that time, I'll send a check or money order for \$22.95, plus postage and handling, or return the book and owe absolutely nothing.
- I want to save money! I have enclosed full amount. Publisher pays postage and handling. I get a complete 15-day money-back guarantee.

Name \_\_\_\_\_

Firm \_\_\_\_\_

Address \_\_\_\_\_

City/State/Zip \_\_\_\_\_

76-15

# Electronic Design

Advertising Sales Staff  
Tom W. Carr, Sales Director  
Jean Bunfield, Sales Coordinator

## Rochelle Park, NJ 07662

Robert W. Gascoigne  
Daniel J. Rowland  
Thomas P. Barth  
Stan Tessler  
50 Essex St.  
(201) 843-0550  
TWX: 710-990-5071

## Philadelphia

Thomas P. Barth  
(201) 843-0550

## Boston 02178

Gene Pritchard  
P.O. Box 379  
Belmont, MA 02178  
(617) 489-2340

## Chicago 60611

Thomas P. Kavooras  
Berry Connor, Jr.  
200 East Ontario  
(312) 337-0588

## Cleveland

Thomas P. Kavooras  
(312) 337-0588

## Los Angeles 90045

Stanley I. Ehrenclou  
Burt Underwood  
Neil Canavin  
8939 Sepulveda Blvd.  
(213) 641-6544

## Texas

Burt Underwood  
(213) 641-6544

## San Francisco

Robert A. Lukas  
3579 Cambridge Lane  
Mountain View, CA 94040  
(415) 965-2636

## London

Constance McKinley  
50 Essex St.  
Rochelle Park, N.J. 07662  
Phone: (201) 843-0550

## Amsterdam, Tokyo, Seoul

Sanders, B. V.  
Raadhuisstraat 24  
Graft-De Ryp, Holland  
Phone: 02997-1303  
Telegrams: Euradteam-Amsterdam

Haruki Hirayama  
Electronic Media Service  
5th Floor, Lila Bldg.,  
4-9-8 Roppongi  
Minato-ku, Tokyo, Japan  
Phone: 402-4556

Cable: Electronicmedia, Tokyo

Mr. O-kyu Park, President  
Dongbo Intl Corp.—

World Marketing  
C.P.O. Box 4010  
Seoul, Korea  
Tel. 76-3910/3911  
Cable: DONGBO SEOUL  
Telex: EBKOREA K27286



## CURRENT READING OF ANY CONDUCTOR OR ION BEAM

- A Current Transformer used with an Oscilloscope for Fast Pulsed Current (nsec to millisecc)
- Sensitivities from 1 V/A to .01 V/A
- No Physical Connection Required
- Readings without Ground Loops
- BNC or Triax Connector
- Accurate      ■ Fast Delivery
- Low Cost      ■ Specials Upon Request



ION PHYSICS CORPORATION  
A SUBSIDIARY OF HIGH VOLTAGE ENGINEERING CORPORATION

BURLINGTON MASSACHUSETTS 01803 617-272-2800

CIRCLE NUMBER 130

## PROFESSIONAL DISCOUNT PRICES AVAILABLE ON

HEWLETT  PACKARD

## Engineering Calculators

PHONE TOLL FREE  
**800-638-8906**

FOR THE CURRENT LOW DISCOUNT PRICE OF THE LATEST MODEL CALCULATOR OF YOUR CHOICE

### THE GUARANTEE

10 day money back trial. If you are not completely satisfied you may return the Hewlett-Packard calculator you order within 10 days for a cash refund or charge cancellation. In addition Hewlett-Packard and Capital Calculator Co. Inc. warrant each calculator for a period of one year against defective parts and workmanship.

Capital Calculator Company



Maryland residents phone:  
(301) 340-7200

701 East Gude Drive  
Rockville, Maryland 20850

CIRCLE NUMBER 131



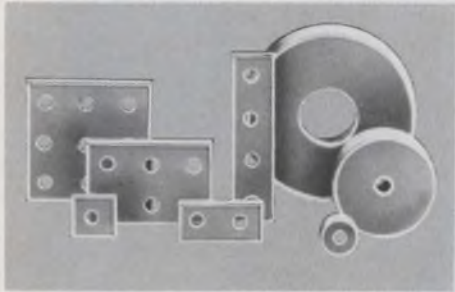

**CIRCLE & MULTI-FEED-THRU CAPACITORS**, available in a wide range of sizes and configurations, with NPO, BX, Z5U and Y5V characteristics. For use as feed-through elements, where volume efficiency of capacitance performance is required. Applications also include filter networks, pulse and logic circuitry, and signal bypass to ground elements in broadband circuits. Available in configurations suited to customer needs. Johanson/Dielectrics, Inc., Box 6456, Burbank, CA 91510 (213) 848-4465.

CIRCLE/MULTI-FEED CAPACITORS 181

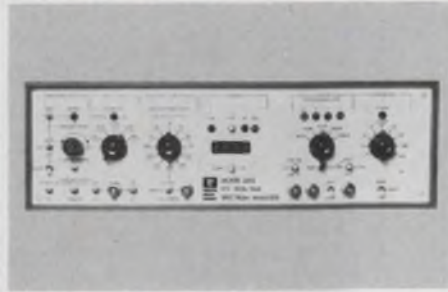

Princeton Applied Research announces the Model 4512 FFT Real Time Spectrum Analyzer. The magnitude spectrum is available with 512 lines of resolution spanning dc-10 Hz to dc-40 kHz, in twelve ranges. The full spectrum can be updated every 35 ms resulting in 16 kHz real time bandwidth. Transient capture and spectrum averaging modes are standard features. Both the temporal signal and spectrum can be displayed simultaneously. Price: \$6,900 F.O.B. Princeton. Applied Research Corp., Box 2565, Princeton, NJ 08540

FFT REAL TIME SPECTRUM ANALYZER 184



**Electrostatic Instrument Tubes**: Shown is a sampling of the broad line of BRIMAR instrument tubes, some with matching TELCON shields. We offer round and rectangular screens, monoaccelerator and spiral or mesh pda types in sizes from 1" round to 7" diagonal short-length rectangular. For detailed information on the tubes and custom-designed magnetic shields, contact The INTER-TECHNICAL Group, Inc., P.O. Box 23, Irvington, NY 10533/(914)591-8822 or our agent in your area.

CATHODE RAY TUBES 187

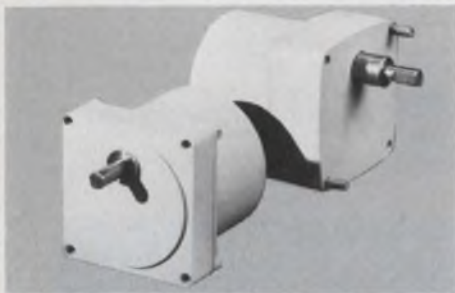

**Dual Speed Unidirectional Synchronous Motor (Series 86000)** offers advantages for instrument drives, especially strip chart recorders and telecopiers. Available torque to 35 oz-in. Choice of square or NEMA 2-11 gear box gives wide range of dual speed combinations. Fast start/stops eliminate need for clutching and prestarts. Available in 24, 120 or 240 VAC, 60 Hz, with CW or CCW rotation. Weight 30 oz. U/L listed. North American Philips Controls Corp. Cheshire, Conn. 06410 (203) 272-0301.

DUAL SPEED SYNCHRONOUS MOTOR 182

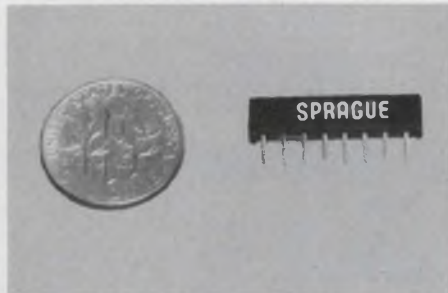

**CERAMIC CAPACITOR NETWORKS SAVE SPACE ON PRINTED BOARDS**. Molded Type 460C Multi-Comp® single in-line package Monolythic® networks . . . for use in signal and data processing equipment where repetitive capacitor values and patterns are required. Mount 2 SIP networks in the same area as 1 standard 16-pin DIP IC! Sprague Electric Co., 347 Marshall St., No. Adams, MA. 01247. (413) 664-4411.

SIP CERAMIC CAPACITOR NETWORKS 185

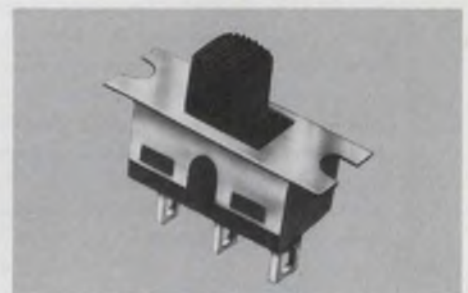

**Model 1101 Slide Switch**, subminiature SPDT in either *Printed Circuit* or *Panel* mount models. Electrical life: 40,000 actuations at full load. Contact rating: 6 amps with resistive load @ 120 VAC or 28 VDC; or 3 amps with resistive load @ 250 VAC. Free engineering sample on request. C&K Components, Inc., 103 Morse St., Watertown, MA 02172 Tel: (617) 926-0800 TWX: 710-327-0460 TELEX: 92 2546

SLIDE SWITCH 188

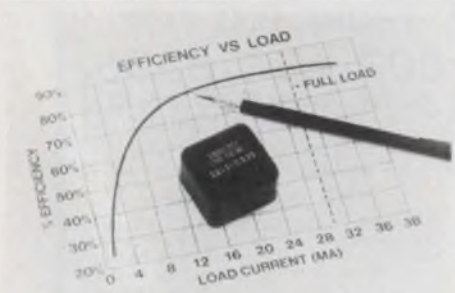

**Activate gas discharge readouts!** DC-to-DC power supplies convert low DC line voltages of 5, 9, 12 or 15 volts to nominal 200 and 250 volt DC levels required to run gas discharge information displays. Ideal for battery powered applications! Both regulated and unregulated. Ask about our custom power supplies, too! Free literature. Endicott Coil Co., Inc., 31 Charlotte Street, Binghamton, N.Y. 13905. (607) 797-1263

POWER SUPPLY 183

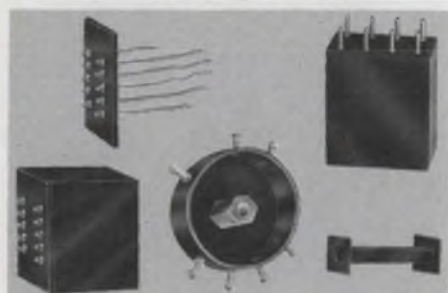

**CUSTOM POTTING SHELLS** made by a unique patented process. Any wanted size; no tool charges; delivery as fast as 24 hours. Epoxy or phenolic material. Holes, slots, terminals, inserts, shielding as needed. Competitively priced in any quantity from 1 to 100,000 pieces. Thousands of satisfied customers since 1963. Epoxy-Cast electronic case co., inc., 222 Lake Avenue, Yonkers, N.Y. 10701. Tel. (914) Y03-5900

EPOXY CASES AND HEADERS 186



**OPTIMA ACTION RACK** is a "building block" rack system that is easy to adapt and modify in the field. Adding units, turning corners and installing accessories is simplified. Designed in steel for 19" EIA panel instruments. Choose any two color combination from eleven colors. Optima Division, Scientific-Atlanta, Inc., 2166 Mtn. Industrial Blvd., Tucker, Ga. 30084, Ph. 404-939-6340.

ELECTRONIC ENCLOSURES 189



**1702A MANUAL  
EPROM PROGRAMMER**  
ASSEMBLED \$299.95  
KIT \$189.95

Features hex keypad, two digit hex address and two digit hex data display. Controls include load, clear, go!(step), key/copy, data in/data out, and counter up/down. Profile card includes high voltage pulse regulator, timing, 8 bit address and 8 bit data drivers/receivers. Two 6 1/2" X 9" stacked cards with spacers. Allows programming in 20 minutes—copying in 5 minutes. Requires +5, -9, and +80 volts. 30 days for delivery. Associated Electronics, 17855 Sky Park Circle, Irvine, CA 92714 (714) 549-3830

1702A PROGRAMMER

190



**CUSTOM PC BOARDS AT LOW COST/FAST DELIVERY.** No minimum order. Specialized service includes computer drilling, plated-through holes, tin or solder re-flow plating. Guaranteed delivery—3 days (single sided), 5 days (double), 1-24 pieces. All artwork services from schematic-to-proto available. Very competitive prices. WESTERN LABORATORIES, 110 South Rosemead Blvd., Pasadena, CA 91107 (213) 793-0148

CUSTOM PC BOARDS

193



**FLEXIBLE CIRCUITS BY ROGERS.** We have the people, experience, plant, equipment—and know-how! Write for information—or call Herman Gordon for action. ROGERS CORPORATION, P.O. Box 700, Chandler, AZ 85224. Phone (602) 963-4584.

FLEXIBLE CIRCUITS

196

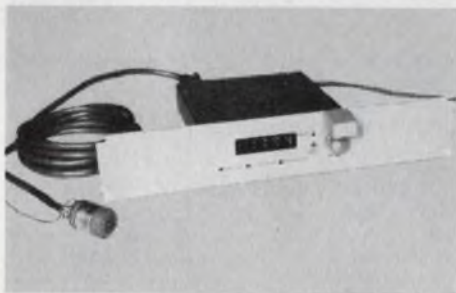

**ABSOLUTE ENCODER**— $\pm 1$  Part in 3600 System Accuracy, Electro-Magnetic Transducer + LED Display + BCD, Binary, and DC Output—Infinitely Adjustable Scale Factor (0 to 9999)—Hi Noise Immunity—Zero Offset—Single and Multi-Channel Units From \$375/Axis (1 pc.) Other CCC products are Synchro to Digital, Synchro to Linear DC, Digital or DC to Synchro Converters, and Solid State C.T.'s or CDX's. Send for Free Catalog & Application Notes. Computer Conversions Corp., East Northport, N.Y. 11731 (516) 261-3300.

ENCODER

191

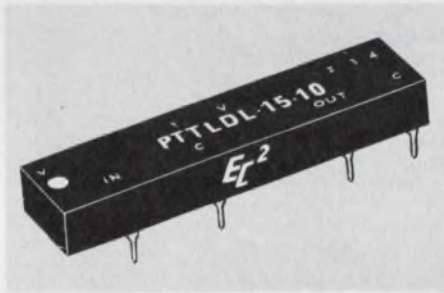

**EC<sup>2</sup>'s new Digitally Programmable T<sup>2</sup>L** Logic Delay lines feature Schottky T<sup>2</sup>L input and output; 15 models with time delays to a max of 255ns; 16 delay steps available with 1ns, 2ns, 3ns, 5 ns, 10 ns or 16ns resolution; propagation delays fully compensated; 32-pin dip package (.250 high); 4ns max rise time on all delays; 10 T-L fanout; programming by remote switching or automatically by computer-generated data. Engineered Components Company, P.O. Box Y, San Luis Obispo, Ca. 93406 (805) 544-3800

LOGIC DELAY LINE

194

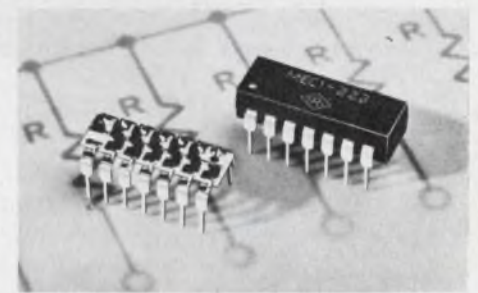

**DUAL-IN-LINE, RESISTOR NETWORKS** for such typical applications as pull-up and pull-down networks or line terminators. • 7 or 13 resistors, 14 pin • 8 or 15 resistors, 16 pin • Resistor values: 100 ohm to 10K ohm. • TCR:  $\pm 200$ ppm/ $^{\circ}$ C • Thick film resistor tolerance:  $\pm 2\%$ . All are available for off-the-shelf delivery from over 200 Centralab Distributors. For the name of your local Distributor call 414-228-2911.

RESISTOR NETWORKS

197



**CMOS DIGITAL TIMERS** by General Time. Low prices enable their use in lieu of both low and high accuracy analog timers and many electromechanical timers.  $\pm 0.5\%$  typical repeat accuracy. On-delay, off-delay, and interval modes available in four different packages; AC and DC. Short reset, recycle and abort times; fast startup. From the industrial control specialists at Industrial Controls Division, General Time, Main Street, Thomaston, CT. 06787. Tel. (203) 283-5881. Telex 96-2445. Helpful literature available on request.

CMOS DIGITAL TIMERS

192



Free 32 Page Catalog

**WINDOWS - PLATES  
DISCS - OPTICS**

Fused quartz, optical glasses, pyrex Ultra-low expansion materials, highly resistant to thermal shock. High UV and IR transmission. Chemically inert to most corrosive materials. Stocking center for lenses, prisms and laser accessories.

Complete fabricating facilities

**ESCO PRODUCTS**

181 Oak Ridge Rd., Oak Ridge, N.J. 07438

(201)697-3700

LENS PRISM CATALOG

195

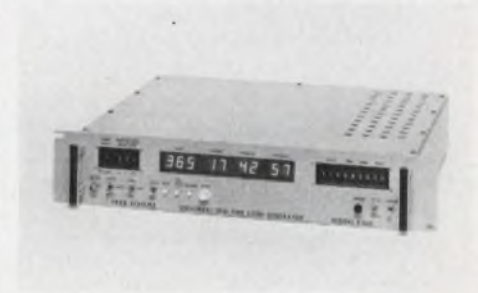

**MODEL 8365 Universal Time Code Generator** has all the features required in a time-code generating instrument. Unit generates all 6 IRIG Codes in DC level-shift form. Modulated output may be ordered with unit or added later by inserting plug-in modules. Unit automatically synchronizes within 2 ms of WWV or within .5  $\mu$ s of an external standard. Has RFI filtered power supply and provision for 12-volt battery backup. TRAK Systems, 4722Q Eisenhower Blvd., Tampa, FL 33614.

UNIVERSAL TIME CODE GENERATOR

198



# Advertiser's Index

Advertiser	Page	Advertiser	Page	Advertiser	Page
AMP, Incorporated	70, 71	Engineered Components Company	207	NEC Microcomputer Division	
Ad-Vance Magnetics, Inc.	186	Epoxy Cast Electronic		of North Electric	74A—F
Advanced Memory Systems	12, 13	Case Co., Inc.	206	National Semiconductor	
Advanced Microwave Devices	116	Esco Products	207	Corporation	84, 85
Aerospace Optics, Inc.	200	Esterline Angus Instrument		Nichicon Corporation	193
Alco Electronic Products, Inc.	173	Corporation	177	North American Philips	
Allen Bradley Co.	90B	Excel Products Company, Inc.	193	Controls Corp.	199, 206
Alpha Wire Corp.	176				
American Microsystems, Inc.	17 thru 25				
Amperite Co., Inc.	166	GTE Automatic Electric	115	Oak Industries, Inc.,	
Amplifier Research Corporation	168	Gates Energy Products, Inc.	96, 97	Switch Division	199
Analog Devices, Inc.	72, 159	General Electric Company,		Omron Corporation of America	28, 29
Arrow-M Corp.	162	Imaging Systems Operation	180		
Associated Electronics	207	General Time, Industrial			
		Controls Division	207		
B & K Products of		*Germanium Power Devices Corp.	115	Panasonic Company	197
Dynascan Corporation	188	Gold Book, The	110, 111, 190, 191, 202	Penntube Plastics Co., Inc.	181
Bausch & Lomb	73	Grayhill, Inc.	184	*Philips Industries	28, 29
Beede Electrical Instrument Co.	170	Greenray Industries	202	Plessey Capacitors	194
Belden Corporation	56	Guardian Electric Manufacturing		Power Conversion, Inc.	197
Berg Electronics, Inc.	121	Company	90A	Practical Automation Inc.	131
Bourns, Inc., Trimpot				Precision Monolithics, Incorporated	157
Products Division	Cover II	Hamamatsu Corp.	185	Premier Metal Products Company	153
Brown Instruments, Inc.	154A-B	Hansen Manufacturing Co., Inc.	55	Princeton Applied Research Corp.	206
Buckeye Stamping Company,		Harris Semiconductor, A Division			
Inc., The	203	of Harris Corporation	65	RCA Solid State	Cover IV
Burr-Brown Research Corporation	161	Hayden Book Company, Inc.	58, 205	RCL Electronics, Inc.	68
Burroughs Corporation	143	Hewlett-Packard	33 thru 42	Raytheon Company, Industrial	
		Hughes Aircraft Company,		Components Operation	175
		Microelectronic Products Division	165	Raytheon Co., Ocean Systems	
				Center	195
				Refac Electronics Corporation	54
				Reliability, Inc.	172
				Reticon	179
				Riken Denshi Co., Ltd.	189
				Rockwell International	150
				Rogan Corporation	181
				Rogers Corporation	177, 207
				Scientific-Atlanta, Optima Division	206
				Seastrom Manufacturing Co., Inc.	192
				Simpson Electric Company	151
				Sprague Electric Company	61, 206
				Stanford Applied Engineering, Inc.	91
				Sweda International OEM	
				Products	185
				TRW/IRC Resistors, an	
				Electronic Components Division	
				of TRW, Inc.	74
				TRW Power Semiconductors	201
				Tecknit	185
				Tektronix, Inc.	53, 63
				Teletype Corporation	123
				Trak Systems	207
				U. S. Capacitor Corporation	Cover III
				Universal Data Systems	119
				Vactec, Inc.	30
				Viking Industries, Inc.	137
				Wavetek Indiana Incorporated	1
				Western Laboratories	207
				Wiley-Interscience	198
				Wiltron Company	186
				Zilog Microcomputers	10, 11

\*Advertisers in non-U.S. edition







# Product Index

Information Retrieval Service. New Products, Evaluation Samples (ES), Design Aids (DA), Application Notes (AN), and New Literature (NL) in this issue are listed here with page and Information Retrieval numbers. Reader requests will be promptly processed by computer and mailed to the manufacturer within three days.

Category	Page	IRN	Category	Page	IRN	Category	Page	IRN
<b>Components</b>			microprocessor	167	<b>326</b>	<b>Microprocessor Design</b>		
bar-graph display	192	<b>365</b>	millicomputer	49	<b>281</b>	controller, industrial	118	<b>502</b>
CRTs	165	<b>63</b>	modems	119	<b>46</b>	development board	120	<b>505</b>
CRTs	187	<b>98</b>	OEM printer	123	<b>236</b>	development system	124	<b>508</b>
capacitors	69	<b>30</b>	paper-tape punch	182	<b>89</b>	executive, multitask	122	<b>507</b>
capacitors	193	<b>107</b>	printer	166	<b>324</b>	Exorciser	9	<b>7</b>
capacitors	194	<b>109</b>	printer, impact	168	<b>331</b>	mag-tape system	118	<b>503</b>
capacitors	III	<b>251</b>	printer, line	167	<b>327</b>	microcomputers	11	<b>8</b>
capacitors, ceramic	191	<b>361</b>	printer/plotter	166	<b>323</b>	microcomputers	117	<b>501</b>
components	29	<b>13</b>	printer, serial	164	<b>320</b>	programmable chips	122	<b>506</b>
display, numerical	192	<b>366</b>	recorder	189	<b>101</b>	system, development	120	<b>504</b>
displays	169	<b>68</b>	recorder, digital tape	163	<b>307</b>	$\mu$ C panels	193	<b>108</b>
displays, 240-char	143	<b>53</b>	tape transport	44	<b>16</b>			
energy cells	97	<b>40</b>	terminal, data	164	<b>310</b>	<b>Microwaves &amp; Lasers</b>		
filters, mechanical	150	<b>55</b>	$\mu$ P system	168	<b>328</b>	filter	196	<b>372</b>
indicators	173	<b>75</b>				laser copier	196	<b>375</b>
lamps	185	<b>91</b>	<b>Discrete Semiconductors</b>			microwave transistors	130	<b>50</b>
motors	55	<b>22</b>	arrays, Darlington	186	<b>354</b>	preamp	196	<b>373</b>
motors, sync	191	<b>362</b>	circuits, power	188	<b>356</b>	switch	196	<b>374</b>
photoscanner	192	<b>363</b>	detector, IR	188	<b>359</b>			
posistors	173	<b>72</b>	diodes, high voltage	188	<b>358</b>	<b>Modules &amp; Subassemblies</b>		
reed-relay matrices	110	<b>42</b>	diodes, Impatt	186	<b>355</b>	converter, f/v	175	<b>337</b>
relay, SPDT	199	<b>115</b>	LEDs	50	<b>19</b>	converter, r/d	172	<b>302</b>
relay, reed	204	<b>126</b>	lamps, LED	186	<b>352</b>	converters, a/d	161	<b>60</b>
relays	162	<b>61</b>	photo-Darlington	194	<b>110</b>	d/a converter	174	<b>304</b>
relays, delay	166	<b>65</b>	photodetectors	63	<b>27</b>	hybrid circuits	175	<b>77</b>
relays, reed	178	<b>83</b>	switch, optical	188	<b>357</b>	module, CRT display	175	<b>338</b>
relays, solid-state	178	<b>82</b>	transistors, high-gain	103	<b>41</b>	opto circuit	176	<b>306</b>
resistor networks	61	<b>26</b>	transistors, power	186	<b>353</b>	power amplifier, rf	164	<b>62</b>
resistors	74	<b>34</b>				rf detectors	186	<b>96</b>
resistors	111	<b>43</b>	<b>Instrumentation</b>					
serial analog delay	179	<b>84</b>	cassette tester	182	<b>345</b>	<b>Packaging &amp; Materials</b>		
solenoids, tubular	115	<b>44</b>	circuit saver	204	<b>127</b>	acoustical covers	194	<b>367</b>
switch	200	<b>120</b>	current reader	205	<b>129</b>	air conditioners	180	<b>100</b>
switches	67	<b>29</b>	DMM, 3-1/2-digit	15	<b>242</b>	bus	177	<b>81</b>
switches and indicators	7	<b>6</b>	data-comm tester	182	<b>344</b>	cabinet and cases	183	<b>91</b>
switches, keyboard	191	<b>360</b>	data-line tester	183	<b>347</b>	cable and connectors	176	<b>78</b>
switches, rocker & paddle	173	<b>74</b>	digital multimeter	5	<b>4</b>	cases	170	<b>69</b>
switches, rotary	68	<b>141</b>	digital plotter	163	<b>301</b>	cases	202	<b>124</b>
switches, slide	173	<b>73</b>	freq. standard	202	<b>125</b>	connectors, PC	137	<b>52</b>
switches, subminiature	75	<b>35</b>	function gen/synth	184	<b>350</b>	electronic hardware	192	<b>105</b>
transducers and controls	181	<b>86</b>	in-circuit tester	184	<b>349</b>	electronic-pack. hardware	91	<b>39</b>
trimmer resistors	165	<b>64</b>	logic analyzer	183	<b>346</b>	knobs	181	<b>84</b>
			logic tester	16	<b>11</b>	magnetic shielding	182	<b>90</b>
			memory tester	184	<b>351</b>	magnetic shields	186	<b>97</b>
			oscillator, crystal	171	<b>70</b>	plug-in housing	177	<b>80</b>
			oven	180	<b>303</b>	readers and punches	185	<b>93</b>
<b>Data Processing</b>			portable test equipment	53	<b>271</b>	shrinkable material	195	<b>370</b>
bar-code reader	168	<b>329</b>	scope	184	<b>348</b>	sockets, display	195	<b>369</b>
calculators	205	<b>128</b>	spectrum analyzer	195	<b>111</b>	solder	195	<b>371</b>
cassette transport	164	<b>309</b>	sweep/signal generator	1	<b>2</b>	solvents	189	<b>102</b>
core-memory system	163	<b>308</b>	VOMs	151	<b>56</b>	tapes, industrial	196	<b>112</b>
data-entry system	166	<b>322</b>				terminal strip, PC	194	<b>368</b>
data processor	203	<b>125</b>				test clips	167	<b>66</b>
data system	177	<b>79</b>				trimmers	II	<b>250</b>
data terminal	59	<b>25</b>				tubing	181	<b>85</b>
data terminal/storage	166	<b>325</b>	<b>Integrated Circuits</b>					
digital tape transport	193	<b>106</b>	amp pair	179	<b>343</b>	<b>Power Sources</b>		
displays	54	<b>21</b>	audio circuit	178	<b>340</b>	ac source	171	<b>334</b>
electronic books	205	<b>130</b>	CMOS	65	<b>28</b>	open-frame	170	<b>333</b>
graphic plotter	164	<b>321</b>	EPROM	178	<b>339</b>	power sources, dc-dc	172	<b>71</b>
imaging devices	180	<b>85</b>	op amp	174	<b>76</b>	switcher	171	<b>336</b>
memory laser	168	<b>330</b>	op amps, dual	178	<b>341</b>	switchers	171	<b>335</b>
memory systems	13	<b>9</b>	PROMs	125	<b>49</b>	UPS	170	<b>332</b>
			RAMs	179	<b>342</b>			



# BME™ Capacitors- Proven Reliability For Automotive Applications

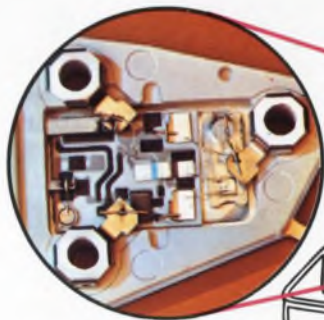

Voltage Regulators

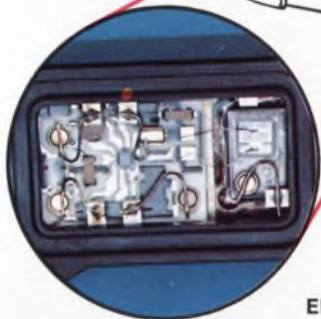
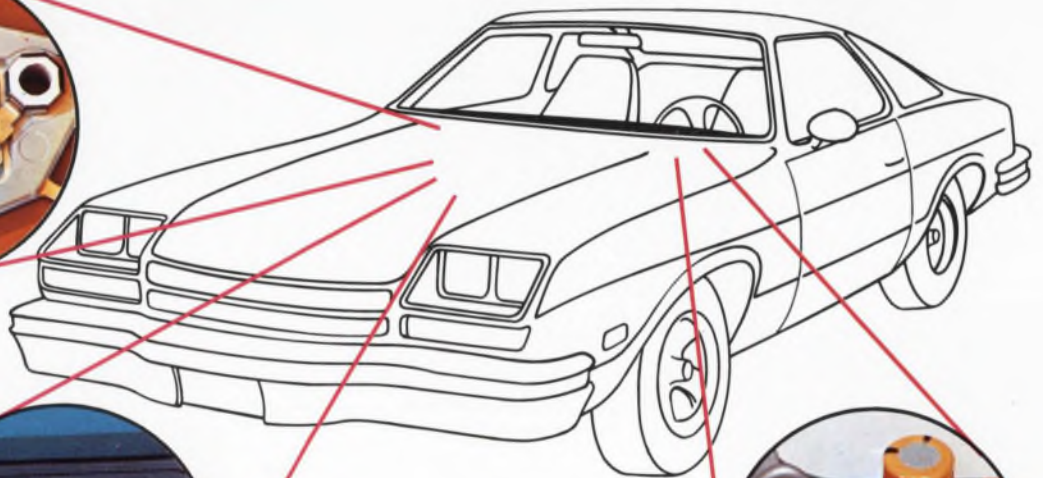

Electronic Ignition Systems



Radios

**USCC/Centralab, the major supplier of monolithic ceramic capacitors to the largest manufacturers of automotive hybrid electronics.** The automotive environment can be considered the ultimate proving ground for component reliability. Under-the-hood systems provide a hostile environment where moisture, temperature extremes, shock and vibration are constant. It is a tremendous challenge to supply a component economical enough for an automotive application which can stand up to their rigorous specifications.

And Centralab is there, providing over 3.9 million BME-Chip™ Capacitors which are in 2.25 million domestic cars and light trucks. Over 11 billion unit life hours in ignition systems, voltage regulators and radios, without a single known failure. That's reliability! Compare your requirements with those of the automotive industry. We're sure you'll choose BME™ Capacitors . . . reliability and availability at a low cost.

Please write on company letterhead for complete technical test reports.



USCC/CENTRALAB Electronics • GLOBE-UNION INC.

4561 Colorado Boulevard • Los Angeles, Ca. 90039 • (213) 240-4880

FOR LITERATURE ONLY CIRCLE 251

FOR FREE SAMPLE, CIRCLE 252



What's new in solid state . . .

# Announcing the 1-chip COSMAC CPU and the 4-chip CMOS system.

Now, a CMOS system that really delivers the promise of the microprocessor. It's the expanded RCA 1800 family with CDP1802, our new one-chip COSMAC CPU. And it gives you an unsurpassed combination of flexibility, performance and cost effectiveness.

This cost effectiveness starts with price: \$23.50 for the CDP1802CD in 100-piece quantities. But there's more to it.

Simple COSMAC architecture lowers memory costs because of 1-byte instructions and internal address pointers. It also reduces I/O costs. Plus design and learning costs.

Then you have the familiar CMOS savings. Single power supply. Single-phase clock. Less cooling and other equipment, thanks to low power and high tolerances.

For all these reasons, we believe no other microprocessor matches the RCA 1800 for system cost effectiveness. What's more, you can get the whole system from us: CPU, ROM, RAM, I/O. Everything you need including complete design support. From the first house in CMOS.

For more information, contact your local RCA Solid State distributor. Or RCA.

Write: RCA Solid State, Box 3200, Somerville, NJ 08876; Ste. Anne de Bellevue H9X 3L3, Canada; Sunbury-on-Thames, U.K.; Fuji Bldg., Tokyo, Japan.

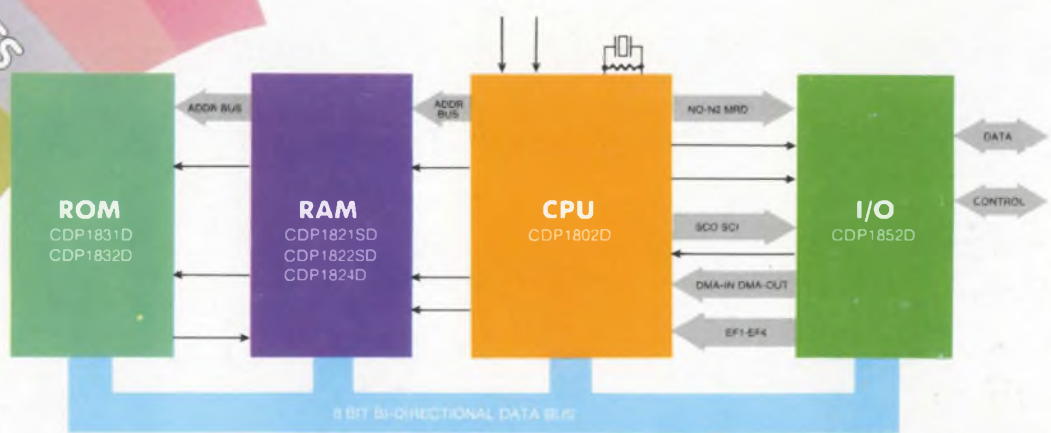
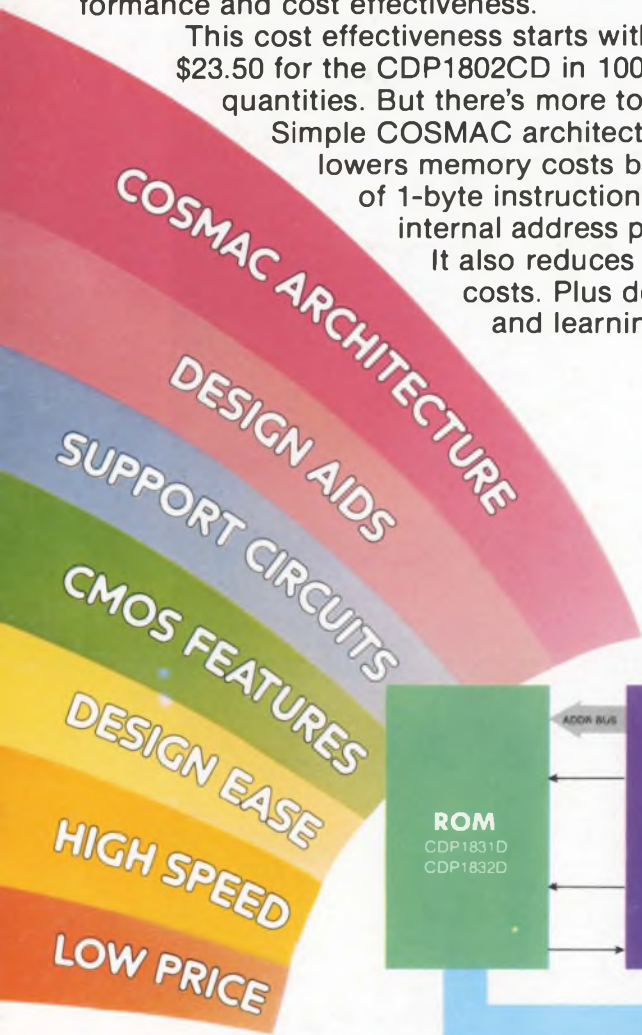

CIRCLE NUMBER 253



RCA 1800. The full spectrum in one low cost system.