

QST

DEVOTED ENTIRELY TO

AMATEUR RADIO

Published by the American Radio Relay League

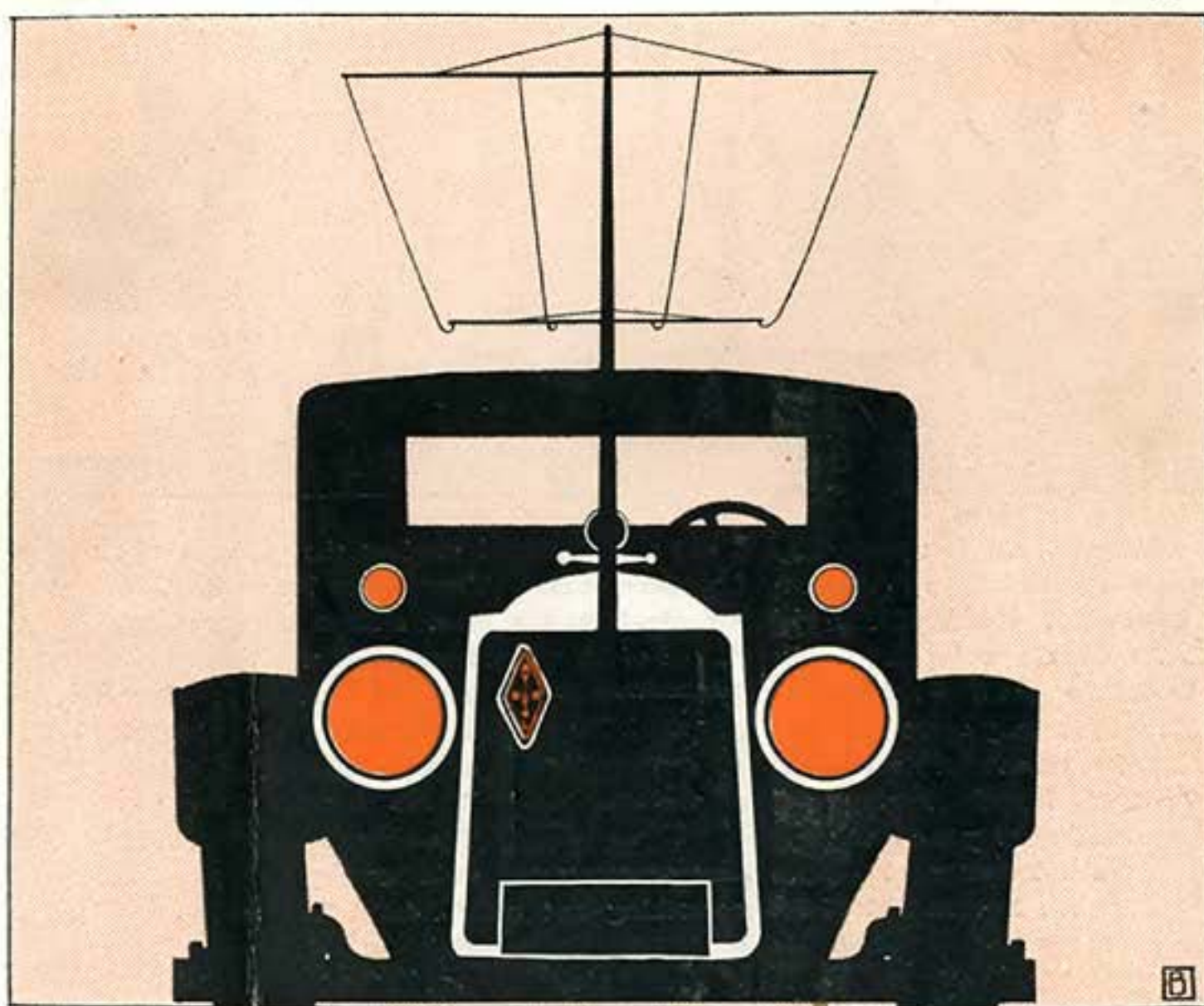

OCTOBER
1925

25¢

Cunningham

RADIO TUBES

Since 1915—Standard for All Sets



TYPES, C-301A · C-299 · C-300 · C-11 · C-12

IN THE ORANGE AND BLUE CARTON

Whenever perfection is approached in any manufactured product, the qualities of that product soon become known to the great American public. Thus it has been with Cunningham Radio Tubes. From Maine to California, from the Florida Keys to Puget Sound, they have made themselves known in millions of American homes. Throughout the nation these tubes are now associated with all that is best in radio. That you may come to know the delight, the charm, of tone is flawlessly recreated, install Cunningham Radio Tubes in every socket of your receiver. Then music becomes like the laughter of clear, swift-flowing water; and the human voice like something not quite human but divine.

Price
\$2.50
 Each

E. J. Cunningham Inc.

Home Office: 182 Second Street

Chicago

San Francisco

New York

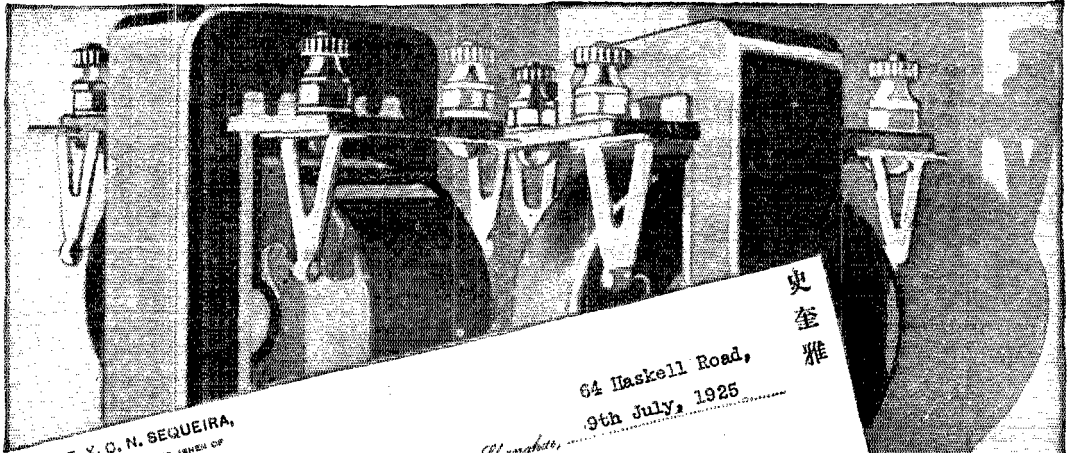

史奎雅

64 Haskell Road,
9th July, 1925

Shanghai,
(China)

F. X. C. N. SEQUEIRA,
COMPILES & PUBLISHES OF
THE FAR EASTERN EXCHANGE TABLES
THE FAR EASTERN INDEX TABLES
THE FAR EASTERN ORDER BOOKS
THE FAR EASTERN FREIGHT CALCULATION
THE UNIVERSAL EXCHANGE TABLES ETC., ETC., ETC.
TELEGRAPHIC ADDRESS FEETABLO
TELEPHONE C. 1250

American Transformer Company,
175 Emmet Street,
Newark, N. J.

Dear Sirs:

I have the very great pleasure to inform you that on April 17 last I ordered some Radio goods from ----- Company of Chicago amongst which was a pair of

The Very Best Obtainable Audio Frequency Transformers
irrespective of price
and they sent me a pair of AmerTrans.

Although I have tried and seen a lot of Audio Frequency Transformers, the pair of AmerTrans is certainly superior to them all.

With these AmerTrans in my 3-tube Double Regenerative set, I can not only get Japan and the Philippine Islands, but the amplification is so very beautiful and clear that when I listen in to a Violin Solo it seems that the player was inside the room, every note clear and distinct.

This letter is written to show you my appreciation of your wonderful Audio Frequency Transformers and you are at liberty to use it or any part of it in any way you like.

With best wishes for your continued success and sincerest thanks to you for being the means of making me the proud possessor of such a pair of beauties,

Yours very truly,

P.S. I need hardly tell you that all my Radio friends envy me the possession of my Transformers.



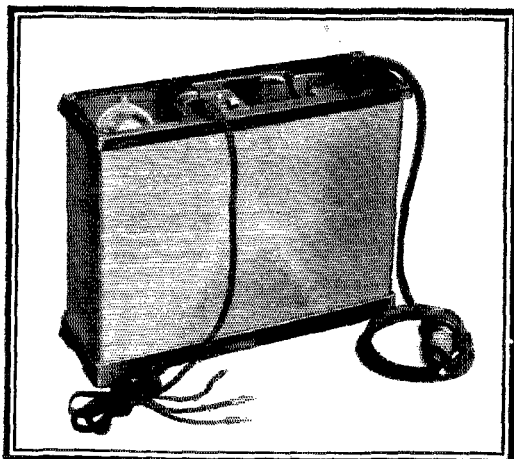

Illustration at left shows Acme B-Eliminator. Made in two types:

- Type E-1
(110 Volts 60 cycle)
\$50
- Type E-2
(110 Volts D. C.)
\$20

For details see text below.

No noise - no hum - no "B" batteries

TO OUR friends and fellow readers of good old QST we take this opportunity to make our first announcement of the successful completion of our efforts to perfect a "B" battery elimination the Acme B-Eliminator.

The problem in making the B-Eliminator has not been to remove the hum. That was easy. The trouble was to overcome the distortion set up by modulation of the plate current.

Now, after two years of experimental and research work we have won. The Acme B-Eliminator has no noise, no hum, no distortion, no filament tube to burn out.

You can guess the result. No "B" batteries to quit cold when you need them most. Nothing to wear out. The first cost is the last.

The current consumed is a trifle. A cent every 6 hours here in Cambridge.

You get permanent reception, better reception, higher voltage that is constant.

The rectifier consists of an Acme transformer and vacuum tube with no filament to burn out. This rectifier (Raytheon) tube handles both sides of the wave and will last indefinitely.

The filter current so successfully smooths out the rectified pulses in current and voltage that a

source of power is delivered of a better nature than batteries.

The full story of not only this new B-Eliminator, but the new MA-2 closed type transformer, the new Acme "double free-edge cone" loud speaker and all other Acme receiving apparatus is contained in the 9th edition of "Amplification without Distortion" which is just coming off the presses.

As old friends of Acme you are probably familiar with former editions over 200,000 of which have been issued. The new one is more complete and interesting than ever. Send for your copy. Ask also for Bulletin T on Acme Transmitting Apparatus.

Claude Hains
President Acme Apparatus Co.
Send for your copy!

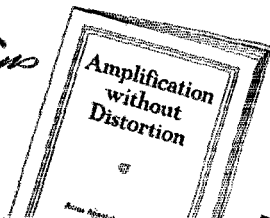

ACME

-for amplification

ACME APPARATUS COMPANY
Dept. E 9 Cambridge, Mass.
Enclosed find ten cents stamps or coin for my copy of the new 9th edition of "Amplification without Distortion". Please also send bulletin T on Acme Transmitting Apparatus.

Name

Street

City..... State.....

Station Call.....

THE TRAFFIC DEPARTMENT, A. R. R. L.

Manager
 A.D.M. D. of C.
 A.D.M. Maryland
 A.D.M. So. N. J.
 A.D.M. West. N. Y.
 A.D.M. East. Pa.
 A.D.M. West. Pa.
 A.D.M. De.aware

3DW
 3AB
 3EB
 3EH
 8P4
 1FM
 82D
 3A1S

Manager
 A.D.M. Michigan
 A.D.M. Ohio
 A.D.M. Illinois
 A.D.M. Wisconsin
 A.D.M. Indiana
 A.D.M. Kentucky

92N
 82Z
 84A
 9CA
 9VD
 9CYQ
 9ET

Manager
 A.D.M. Minnesota
 A.D.M. So. Dak.
 A.D.M. No. Dak.

92T-9XAX
 9EGH
 9CJS
 9CSI

Manager
 A.D.M. Mississippi
 A.D.M. Arkansas
 A.D.M. Tennessee
 A.D.M. Louisiana

5MB
 5AKP
 5XAB
 5CN
 5TK

Manager
 A.D.M. No. N. J.
 A.D.M. N. Y. C.
 A.D.M. East. N. Y.

2BRB
 2WR
 2CWR
 20K-2XAB

Manager
 A.D.M. Iowa
 A.D.M. Mo.
 A.D.M. Kansas
 A.D.M. Nebraska

9DX
 9ARZ
 9RR
 9CCS
 9JT

Manager
 A.D.M. R. I.
 A.D.M. N. H.
 A.D.M. Vt.
 A.D.M. E. Mass.
 A.D.M. W. Mass.
 A.D.M. Conn.
 A.D.M. Maine

1ZE
 1BYB
 1GL
 1BHC
 1KY
 1AWW
 1BM
 1EF

Manager
 A.D.M. Montana
 A.D.M. Wash.
 A.D.M. Oregon
 A.D.M. Idaho
 A.D.M. Alaska

7ABB
 7NT
 7GP
 7JW
 7OB
 7BJ

Mgr. Southern Section
 A.D.M. Dist. 1, 2, 3
 A.D.M. Ariz.
 Mgr. Northern Section
 A.D.M. Dist. 4
 A.D.M. Dist. 5
 A.D.M. Dist. 6
 A.D.M. Nevada
 Mgr. Hawaiian Section

6ANL-6LJ
 6CTO
 6ZZ
 6ZX
 6NX
 6APZ
 6ATN
 6TQ

Manager
 A.D.M. West Va.
 A.D.M. Virginia
 A.D.M. No. Carolina

3BZ
 8AUE
 3CA
 4JR

Manager
 A.D.M. Colo.
 A.D.M. Utah

7ZO
 9CAA
 6ZT

Manager
 A.D.M. S. C.
 A.D.M. Ala.
 A.D.M. Fla.
 A.D.M. Ga.
 A.D.M. Porto Rico

4KU
 4RR
 5AJP
 4EZ
 4RH
 4OT

Manager
 A.D.M. Oklahoma
 A.D.M. So. Texas
 A.D.M. No. Texas

5ZC
 5APG
 5TK
 5AIT

Manager
 A.D.M. P. E. I.
 A.D.M. N. B.

1DD
 1BZ
 1EI

Manager
 A.D.M. Cen. Ont.
 A.D.M. West. Ont.
 A.D.M. East. Ont.

3NI
 9BJ
 3XI
 3AFP

Manager
 A.D.M. Ont.

2CG

Manager
 A.D.M. Sask.

5CG

Manager
 A.D.M. Manitoba

4AO
 4CB-9BX
 4DE

ATLANTIC DIVISION

E. B. Duvall
 A. B. Goodall
 L. Deichmann, Jr.
 H. W. Deinsnam
 C. S. Taylor
 J. F. Rau
 P. E. Wiggin
 H. H. Layton

319 Rhode Island Ave.
 1824 Inglewode Ter.
 6401 Gate Lane
 140 Washington St.
 508 Vasten St.
 2085 E. Kingston St.
 6044 Howe St. E. E.
 305 Washington St.

Mt. Rainier, Md.
 Washington
 Ten Hills, Baltimore
 Collinswood
 Buffalo
 Philadelphia
 Pittsburg
 Wilmington

CENTRAL DIVISION

R. H. G. Mathews
 C. E. Darr
 C. E. Nichols
 G. W. Bergman
 C. N. Crapo
 D. J. Angus
 J. C. Anderson

2747 Hampden Court
 137 Hill Ave., Highland Plk.
 739 Weadock Ave.
 443 Newton Ave.
 210 N. Illinois St.
 Glensary Farm

Chicago, Ill.
 Detroit
 Lima
 Dwight
 Milwaukee
 Indianapolis
 Lexington

DAKOTA DIVISION

D. C. Watcosh
 C. L. Barker
 M. J. Jenkins
 M. L. Monson

54 N. Penn. Ave.
 701
 E. 12th St.

Minneapolis, Minn.
 Hennick
 Bryant
 Grafion

DELTA DIVISION

B. F. Painter
 J. W. Gullett
 Dr. L. M. Hunter
 L. K. Rush
 C. A. Fottag

424 Hamilton Nat. Bank Bldg.
 818-29th Ave.
 207 1/2 Main St.
 4 Second St.
 8520 Forshey St.

Chattanooga, Tenn.
 Meridian
 Little Rock
 Benns, Tenn.
 New Orleans

HUDSON DIVISION

E. M. Glaser
 A. G. Wester, Jr.
 P. H. Matton
 G. Kastenmayer

815 E. 13th St.
 1075 Chancellor St.
 1309 W. Farms Rd.
 417 Paige St.

Brooklyn, N. Y.
 Irvington
 Bronx
 Schenectady

MIDWEST DIVISION

P. H. Quinby
 D. E. Watts
 L. B. Laizuro
 C. M. Lewis
 H. A. Nielsen

Box 134A, Rt. 6
 116 Hyland Ave.
 8020 Mercier St.
 312 E. Rutledge St.
 4708 N. 39th St.

Omaha, Nebr.
 Ames
 Kansas City
 Yates Center
 Omaha

NEW ENGLAND DIVISION

I. Vermilya
 D. H. Fancher
 C. P. Sawyer
 W. S. Finlon St.
 Miss Gladys Hannah
 T. F. Cushing
 H. E. Nichols
 A. E. Wheelton

86 Franklin St.
 11 Stark St.
 201 S. Union St.
 3 Sumner Pl.
 78 Collea St.
 60 Benham Ave.
 165 State St.

Mattapoisett, Mass.
 Westley
 Manchester
 Cambridge
 Springfield
 Bridgewater
 Ellsworth

NORTHWESTERN DIVISION

Everett Kiek
 A. R. Wilson
 L. C. Mayhew
 Paul R. Hoppe
 K. S. Norwest
 Geo. Sturley

3802 Hoyt Ave.
 1321 W. Platinium St.
 110 S. 7th Ave.
 601 1/2 Hill
 Weather Bureau
 206 E. 17th St.

Everett, Wash.
 Butte
 Pasco
 Eugene
 Boise
 Vancouver, Wash.

PACIFIC DIVISION

M. E. McCreery
 E. H. Burgman
 H. L. Gooding
 P. W. Dann
 P. J. Omeient
 W. S. Usson
 St. Clair Adams
 M. E. Smart
 K. A. Coutin

317 Central Ave.
 1200 Tamarind Ave.
 Box 175
 562-35th St.
 51 Pleasant St.
 9230-E St.
 1503 Thokl St.

Los Angeles, Calif.
 Hollywood
 Douglas
 Oakland
 San Jose
 Oakland
 Eureka
 Fallon
 Honolulu, T. H.

ROANOKE DIVISION

W. T. Gravely
 J. L. Bock
 J. F. Wolford
 R. S. Morris

424 Main St., Box 245
 Main St.
 118 Cambridge Ave.
 413 S. Broad St.

Danville, Va.
 Farmington
 Roanoke
 Gastonia, N. C.

ROCKY MOUNTAIN DIVISION

N. R. Hood
 C. R. Stegman
 Art Johnson

1022 S. Ash St.
 1641 Almon St.
 247 E. 7th South St.

Casper, Wyo.
 Denver
 Salt Lake City

SOUTHEASTERN DIVISION

H. L. Reid
 A. Dunro
 A. T. Trum
 C. F. Clark
 P. M. Keith
 Luis Rezac

11 Shadow Lawn Ave.
 290 Watford Campus
 217 Catoma St.
 270 Western Union Tel. Co.
 76 Clement Drive

Atlanta, Ga.
 Spartanburg
 Montgomery
 Jacksonville
 Atlanta
 San Juan

WEST GULF DIVISION

P. M. Corlett
 K. M. Ebert
 E. A. Sahn
 W. B. Forrest, Jr.

2515 Catherine St.
 2304 N. Robinson St.
 Box 569
 502 Royal St.

Dallas, Texas
 Oklahoma City
 New Braunfels
 Waxahatche

MARITIME DIVISION

W. C. Barrett
 W. Hyndman
 T. B. Lacey

14 Sinclair St.
 670 N. B. Power Co.

Dartmouth, N. S.
 Charlottetown
 St. John

ONTARIO DIVISION

Wm. M. Sutton
 W. Y. Sloan
 J. E. Hayno
 P. A. Harrison

355 Dufferin St.
 167 Close Ave.
 303 N. Brock St.
 181 Hopewell Ave.

Port Arthur, Ont.
 Toronto
 Sarnia
 Ottawa

QUEBEC DIVISION

J. V. Arvey

983 Decarie Blvd.

Montreal, Que.

VANCOUVER DIVISION

Wm. T. Rowson

378 Pender St., E.

Vancouver, B. C.

WINNIPEG DIVISION

W. R. Pott'e
 E. L. Mawnard
 P. E. Rutland, Jr.

1164 Willow Ave.
 452 St. John Ave.

Moose Jaw, Sask.
 Morse
 Winnipeg

Absolute freedom from all self-made noises makes Jewett performance a revelation. Due to the Jewett Clarifier (Patent applied for) there is no B-Battery current in the telephone circuit.

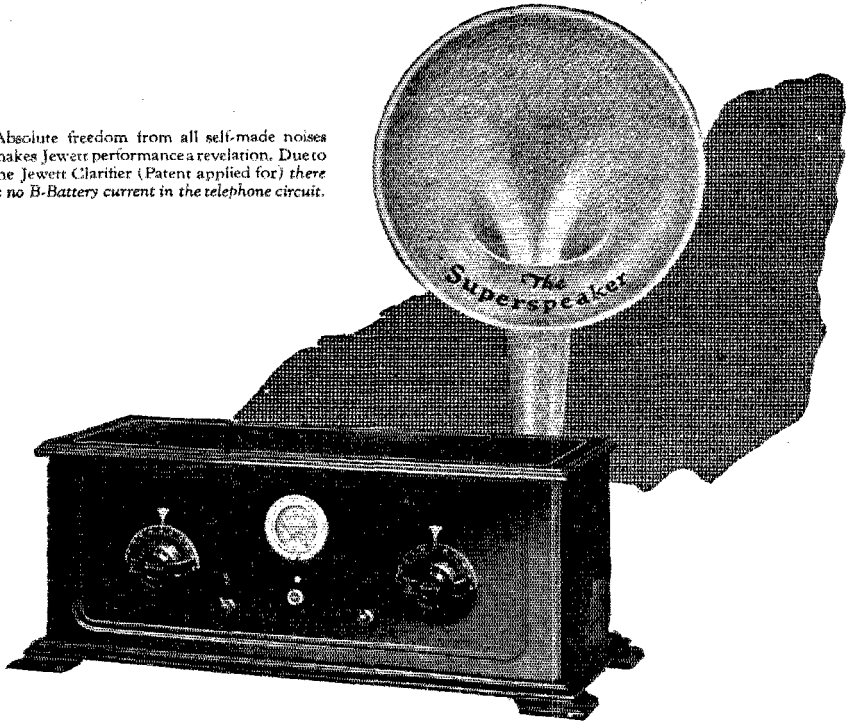

PROCEEDING, step by step, along the path of deliberate and consistent progress, the Jewett Radio & Phonograph Company now offers a Receiver reflecting, in its every detail, that originality and close approach to perfection which you have so thoroughly enjoyed in the Jewett Superspeaker.

Deliveries are being made to pre-arranged schedule. Distribution is through wholesalers and retailers who are under direct contract, with full territorial protection.

JEWETT RADIO & PHONOGRAPH COMPANY

5674 Telegraph Road

Pontiac, Michigan

JEWETT

Copyright 1925 - Jewett Radio & Phonograph Co., Pontiac, Mich.



QST



The Official Organ of the A.R.R.L.

VOLUME IX

OCTOBER, 1925

NUMBER 10

| | | |
|---|---|-----|
| Editorials | | 7 |
| A True Cascade R.F. Amplifier | <i>L. M. Hull</i> | 8 |
| Pacific Division Convention | | 11 |
| Wave Propagation at High Frequencies. | <i>A. Hoyt Taylor and E. O. Hulbert</i> | 12 |
| Jenkins' Awards | | 21 |
| Experimenters' Section Notice | | 21 |
| A.R.R.L. Information Service Rules | | 21 |
| The Army Links Up With The Amateur | | 22 |
| High Frequency Resistance Standards | <i>John M. Clayton</i> | 25 |
| International Intermediates | | 28 |
| The Jewell 1926 Low Power Contest | | 28 |
| Our Third National Convention | | 29 |
| Financial Statement | | 31 |
| Election Notices | | 31 |
| Short Wave Receivers | <i>R. R. Butcher</i> | 33 |
| Transformers and Reactors in Radio Sets Part II | <i>R. H. Chadwick</i> | 37 |
| A Novel Condenser | | 39 |
| Time and Day Conversion Table. | | 39 |
| New R.C.A. Tubes | | 40 |
| T.O.M. Heard From Again | <i>Geo. Sturley</i> | 42 |
| An Input Transformer | | 43 |
| Tools Galore! | | 44 |
| A Simple 200 to 600 Meter Receiver | | 46 |
| A New Tungar Charger | | 47 |
| A New Wavemeter | | 48 |
| I.A.R.U. News | | 49 |
| Amateur Radio Stations LARE, 9CXX, 7NT | | 52 |
| Calls Heard | | 55 |
| Communications | | 59 |
| HAM-ADS | | 105 |
| QST's Directory of Advertisers | | 111 |

Official Organ of the International Amateur Radio Union

QST is published monthly by The American Radio Relay League, Inc., at Hartford, Conn., U. S. A.

Robert S. Kruse,
Technical Editor

Kenneth B. Warner (Secretary, A.R.R.L.),
Editor-in-Chief and Business Manager

Edwin Adams,
Advertising Manager

John M. Clayton,
Asst. Technical Editor

F. C. Beekley,
Managing Editor

David H. Houghton,
Circulation Manager

Subscription rate in United States and Possessions, Canada, and all countries in the American Postal Union, \$2.00 per year, postpaid. Single copies, 25 cents. Foreign countries not in American Postal Union, \$2.50 per year, postpaid. Remittances should be by international postal or express money order or bank draft negotiable in the U. S. and for an equivalent amount in U. S. funds.

Entered as second-class matter May 29, 1919, at the post office at Hartford, Connecticut, under the act of March 3, 1879. Acceptance for mailing at special rate of postage provided for in section 1103, Act of October 3, 1917, authorized September 8, 1922. Additional entry as second-class matter, acceptable at special rate of postage provided for above, at Springfield, Mass., authorized September 17, 1924.

Copyright 1925 by the American Radio Relay League, Inc., Title registered at United States Patent Office.

THE AMERICAN RADIO RELAY LEAGUE

The American Radio Relay League, Inc., is a non-commercial association of radio amateurs, bonded for the promotion of interest in amateur radio communication and experimentation, for the relaying of messages by radio, for the advancement of the radio art and of the public welfare, for the representation of the radio amateur in legislative matters, and for the maintenance of fraternalism and a high standard of conduct.

It is an incorporated association without capital stock, chartered under the laws of Connecticut. Its affairs are governed by a Board of Directors, elected every two years by the general membership. The officers are elected or appointed by the Directors. The League is non-commercial and no one commercially engaged in the manufacture, sale or rental of radio apparatus is eligible to membership on its Board.

"Of, by and for the amateur", it numbers within its ranks practically every worth-while amateur in the world and has a history of glorious achievement as the standard-bearer in amateur affairs.

Inquiries regarding membership are solicited. A bona fide interest in amateur radio is the only essential qualification; ownership of a transmitting station and knowledge of the code are not prerequisites. Correspondence should be addressed to the Secretary.

OFFICERS

President
HIRAM PERCY MAXIM
Hartford, Conn.

Vice-President
CHAS. H. STEWART
St. David's, Pa.

Traffic Manager

F. H. SCHNELL
Hartford, Conn.

Canadian Gen. Manager

A. H. K. RUSSELL
6 Mail Bldg.,
Toronto, Ont.

Treasurer

A. A. HEBERT
Hartford, Conn.

Secretary

K. B. WARNER
Hartford, Conn.

DIRECTORS

Dakota Division

C. M. JANSKY, JR.
Dept. of Elec. Eng., U. of M.,
Minneapolis, Minn.

Delta Division

BENJ. F. PAINTER
424 Hamilton Nat'l Bank Bldg.,
Chattanooga, Tenn.

Hudson Division

DR. LAWRENCE J. DUNN
480 East 19th St.,
Brooklyn, N. Y.

Midwest Division

L. BOYD LAIZURE
30th & Mercier Sts., R. F. D. 1,
Kansas City, Mo.

New England Division

DR. ELLIOT A. WHITE
Apt. K, The Parker, N. Park St.,
Hanover, N. H.

Northwestern Division

K. W. WEINGARTEN
3219 No. 24th St.,
Tacoma, Wash.

Pacific Division

ALLEN H. BABCOCK
65 Market St.,
San Francisco

Roanoke Division

W. TREDWAY GRAVELY
503 Main St.,
Danville, Va.

Rocky Mountain Division

PAUL M. SEGAL
c/o District Attorney,
West Side Court Bldg.,
Denver, Colo.

Southeastern Division

HARRY F. DOBBS
c/o Dobbs & Wey Co.,
Atlanta, Ga.

West Gulf Division

FRANK M. CORLETT
2515 Catherine St.,
Dallas, Tex.

President
HIRAM PERCY MAXIM
Drawer 4,
Hartford, Conn.

Vice-President
CHAS. H. STEWART
St. David's Pa.

Canada
A. H. K. RUSSELL
6 Mail Bldg.,
Toronto, Ont.

Atlantic Division
DR. GEO. L. BIDWELL
1245 Evarts St., N. E.,
Washington, D. C.

Central Division
CLYDE E. DARR
137 Hill Ave., Highland Park,
Detroit, Mich.

Address General Correspondence to Executive Headquarters, Hartford, Conn.

EDITORIALS

Onward!

I N recent months many amateurs have been expressing apprehension about the status of our beloved old game, feeling in a vague sort of way that something has been wrong. Fundamentally nothing is wrong. It is simply that our post-war years have been a period of terrific changes and readjustments and that the readjustment isn't yet completed. We used to be an organization of spark owners, operating on 230 meters and upwards, handling many messages over a distance of a thousand miles or less, undisturbed in our possession of all the short-wave ether. In recent years the outward appearance of the amateur art has changed completely, particularly in matters that affect the practical operation of our stations on the air—our Traffic Department. First C. W. supplanted the spark; then came broadcasting, with millions of the public on the air with us; then short waves supplanted 200 meters, and the short waves were in various narrow bands, dividing us into families; transoceanic and world-wide DX took the place of the old-fashioned 500-mile DX; message-handling no longer was our sole occupation, for the greatest era of experimentation ever known descended upon us. On top of all this the League, like every other part of the radio world, has just gone through the worst financial slump in radio history, a heavy hand being put on our operations. All of these matters have exerted a confusing effect upon us amateurs. It has not been possible to keep pace with changes. Traffic Department organization could not be readjusted quickly enough. We have been in danger of losing touch with each other on our various bands. A brand-new "estimate of the situation" became necessary, and that was the reason for the formidable Traffic Department questionnaire to the Official Relay Stations this past summer. The returns from that questionnaire have been a mine of valuable information, and upon them the changes in our operating system are being based. Many new things are in process; gradually our new operating structure will take form.

The same old spirit of course lives in

Amateur Radio. And in fact just this year, in the midst of all these confusing readjustments, the four biggest things in our history have occurred. Right now, when some of us have been wondering what was the matter with us, our organization has achieved the greatest recognition in its history.

First the U. S. Navy asked us to collaborate with them in short-wave experiments with the Battle Fleet, and they borrowed our Traffic Manager from us for seven months to manage the short-wave apparatus on the "Seattle". Look what Schnell has done! Then the National Geographic Society and MacMillan asked us to provide their polar communication, and we are doing it. Next, the amateurs of the world, at the Paris international amateur congress, offered your officers their 100% allegiance and asked us to do for the amateurs of the world what we American and Canadian amateurs have done for ourselves; they elected your president their president and your secretary their secretary; they named your magazine as their organ and your headquarters as their headquarters—the biggest compliment imaginable! And now the U. S. Army has just asked us to arrange to handle the radiotelegraphic traffic for the National Guard and Organized Reserve units throughout of the nation, and an elaborate plan of co-operation between the Signal Corps and our League is now being worked out, as is announced elsewhere in this issue.

All of our troubles are gradually unravelling. We hope you fellows agree with us that it will pay all of us to keep plugging hard along the way we are headed. Headquarters is a busy place these days, with our many operating problems to solve. We will have to feel our way along, until we find the combination that works best in our new conditions. This League must not falter—we must carry on, shoulder to shoulder, in perfect loyalty and cooperation. All of our difficulties will straighten out some day and then we will be doubly proud of our old League.

—Kenneth Bryant Warner.

A True Cascade R. F. Amplifier

By Dr. L. M. Hull*

THE RFL receiver grew out of a series of laboratory experiments on cascade amplification, which at first involved only an academic investigation of cascade effects at the frequency of the incoming carrier wave. Early in 1924, Harold Snow of the Radio Frequency Laboratories made a detailed experimental study of the superheterodyne method of amplification, the principle results of which were reported in this journal. (See *QST*, p. 12, Jan., 1924). An important conclusion from his work was that the method of reception by frequency conversion is in general very advantageous with respect to one or two "intermediate frequency" stages. But he could find no such thing as true cascade amplification in a medium-frequency amplifier of the

efficiency of the individual stages, as similar stages were added to the first.

Now it is a well-known fact that a higher amplifying efficiency can be provided in a fixed resonant stage designed for thirty or fifty kilocycles than in a resonant stage designed for 600 kilocycles. But the existence of the "tapering-off" effect in the cascaded fifty-kilocycle stages suggested that if a true cascade effect could be obtained in a series of stages resonant to the incoming carrier, of say 600 kilocycles, and the number of cascaded stages increased, a point would be reached at which the high-frequency amplifier, would, for a given number of tubes, surpass the super-heterodyne amplifier. The super-heterodyne would also be handicapped, on a tube-for-tube comparison, by the necessity of providing a heterodyne source and a converting element (first detector).

So the old-fashioned short-wave amplifier was resurrected and made the object of a series of systematic attacks to determine if a true cascade amplification would be possible in the frequency range 500 to 1500 kilocycles, given a reasonably efficient amplifying stage at the beginning. The problem was rather simple, namely: how can we combine a number, n of amplifying stages, each of which yields a voltage gain of A , at some convenient frequency, say 750 kilocycles, so that the overall gain for the combination is A raised to the n th power? At this point let me state that his problem was a real puzzle at the time. The three, four, and five-stage loss-controlled high-frequency amplifier was a familiar animal with most experimenters, but the greatest voltage gain which we were able to produce with *any* number of similar stages of such a nature was of the order 1000.

Interactions in a multi-stage amplifier fall naturally into three general classes: first, interaction through the tube capacities between the input and output circuits of a given stage, commonly called "regeneration", which, by the way, might be either dissipative or sustaining; second, interaction between any one coupling link and any preceding coupling link *not in the same stage* through the capacities of two or more successive tubes; and third, interaction between any two coupling links through incidental magnetic, electric or conductive coupling external to the tubes. It was soon found in the course of the experiments that the elimination of the latter two of these forms of interaction was a sufficient condition for the existence of a true cascade effect in the voltage amplifica-

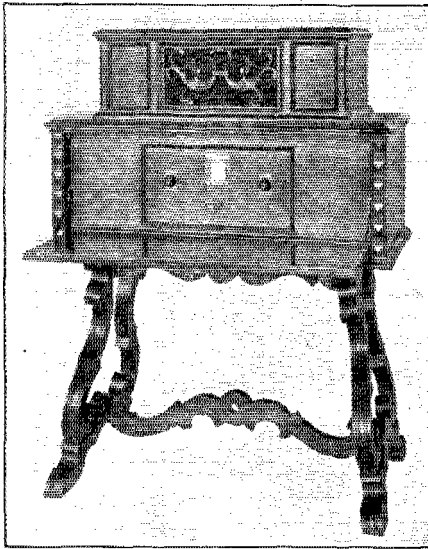

FIG. 1. THE KELLOGG-RFL RECEIVER.

type commonly used in superheterodyne reception. For instance he found that although a single intermediate stage might provide a voltage gain as high as 50 between the two detectors, two such stages in cascade could not be made to furnish an amplification of 2500. On the contrary, the greatest amplification available from two stages was of the order of magnitude 500 while the gain from three similar stages was of the order 800 to 1000. In other words, a conspicuous "tapering-off" effect took place, regardless of the amplifying

*Radio Frequency Laboratories, Boonton, N. J.

tion. How to eliminate the latter two without also wiping out the first is a complicated problem and will not be discussed here. It has, however, been found possible in a practical, reproducible structure to reduce all three forms of interaction to such an extent that the *departures from true cascade amplification are not measurable*.

Interactions of types 1 and 2 were suppressed by cascading strictly one-way stages, while interactions of type 3 were suppressed by the use of closed copper shields around all coils, condensers and tubes, and by the use of 3-way by-passing on the battery terminals of each stage.

An amplifier consisting of one-way shielded stages was finally built, in which each stage, measured separately, gave a voltage gain of 7, in which two stages gave a voltage gain of 49, three stages a voltage gain of 340, four stages a voltage gain of 2400, and five stages a voltage gain of well over 16000. These results occurred at one frequency taken as a standard for the experiments—750 kilocycles. These results were thought to be encouraging, especially in view of the fact that the individual stages of voltage gain seven, were not particularly good to start with.

A description of the structural features of this rather unique amplifier cannot be given in the present article. Externally it simply appeared as a row of oblong copper boxes, faintly suggestive of a string of well-laden Hudson river barges. Each box displayed a small tuning dial on the side and contained a tube, an input circuit for that tube (which constituted the output circuit of the preceding stage), and a portion of the amplifier network. Last, but not least, three microfarads of by-pass capacity were concealed in each enclosure. The whole system was regarded merely as a laboratory experiment until the interesting fact became apparent to the experimenters that they could pick up loudspeaker signals from a 500-watt broadcasting station over 100 miles away, using a coil three inches in diameter as an aerial. Then it appeared that this general scheme was worthy of application in a broadcast receiver.

One interesting fact was brought to light in these experiments, namely, that if a multi-stage cascade amplifier made up of shielded, one-way stages was used as the starting point, and the one-way action in any given intermediate stage of the series was then deliberately disturbed, the increase in signal strength due to plate-grid retroaction in that one stage did not destroy the cascade effect. In other words, if a basic amplification of 3000 was obtained in four one-way stages, the second, third, or fourth stages could be allowed to react through the grid-plate capacity and the overall amplification thereby increased by a factor of about

5. But if this were done to any *two* stages the tendency to oscillation controlled by inserting resistance, the loss in cascade effect due to departure from the condition for cascade amplification more than counter-balanced the gain due to plate-grid reaction in the second stage and the net result was a loss in overall amplification. This provided an additional check on the validity of the condition for cascade amplification. It has been common practice in subsequently developed amplifiers of this type to allow reaction in *one* (the second from the input) of the shielded stages and profit by the grid-plate reaction without destroying the cas-

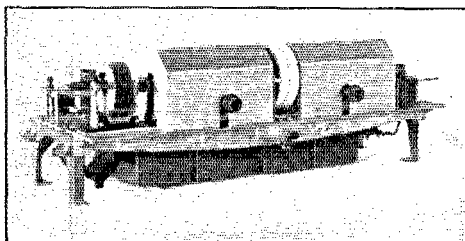

FIG. 2 THE SET REMOVED FROM ITS CABINET.

Underneath the base may be seen the coupling coils. The first (antenna) coupler is seen at the left. Immediately above it is the exposed condenser which tunes the secondary of this coupler. Just back of that is the antenna-series condenser which adjusts the antenna-tuning to agree with the other stages. This condenser is of the "set and forget" variety. The other couplers and their corresponding tuning condensers are contained in the metal shields, each copper box containing one coupler and each aluminum box containing two condensers.

The small panel which is partly seen at the right of the aluminum shields carries the filament rheostat and voltmeter. At the center of the frame is the small knob controlling the filament camswitch. Projecting from the right condenser shield is the tuning control which, by means of a worm gear, operates the shaft carrying the 5 variable condensers. Projecting from the left condenser shield is the volume control knob which operates a variable resistance in the tuned circuit of the second r. f. stage and also has a slight control over the filament current of the detector.

cade effect. This stage is controlled by a series resistance used as a "volume control". There is no question of radiation from this stage as it is preceded in the amplifier by a one-way stage and its coils are, of course, completely shielded.

Continuously tunable coupling units were thought to be the first requisite of an amplifier of this type designed for broadcast reception the second requisite was believed to be a single tuning control for the whole amplifier. A multiplicity of tuning dials—one in each stage—was not even considered, and no compromise in this requirement was ever subsequently made.

The first model of the four-stage cascade single-control amplifier actually worked well over a wavelength band of about 260 to 540 meters. The voltage gain per stage was about 10 at 260 meters, falling off to 6 at 540

meters. I regret to record that certain members of the laboratory staff were so entranced with the novelty of receiving distant stations in the summer on a single-

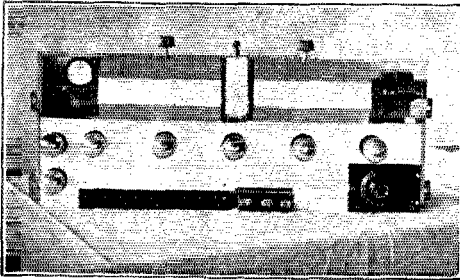

FIG. 3 TOP VIEW OF THE SET.

The two tubes at the right are audio amplifiers, the next tube is the detector and the other 4 are R.F. amplifiers.

This view shows more clearly the antenna-adjusting panel at the left-rear and the filament-adjusting panel at the right-front.

At the rear-center is the C battery for the audio tubes.

knob receiver with a two-foot antenna that they were guilty of several all-night vigils during the month of September, 1924, listening to the strains of far-away jazz, a practice which is usually considered to be justified only by the exigencies of legitimate radio relays.

Passing over a long period of varied but not particularly interesting development, let us consider a more modern receiver which includes the RFL single-control amplifier. Figure 1 shows the exterior of such a set, as it is manufactured at present by the Kellogg Switchboard and Supply Company.

not affect the tuning. Behind the central "window" a white indicator bearing a wavelength scale passes up or down past a fiducial mark as the station selector is rotated. This indicator has a space for the inscription of stations by the user in their proper positions with respect to the fiducial mark. It consists mainly of a strip of translucent celluloid carried on a five-inch hollow drum. Directly behind the indicator a small incandescent lamp is situated, which illuminates by transmitted light the face of the indicator. This indicator is actuated by the amplifier tuning element, and thus its wavelength calibration is independent of the size or form of the collecting structure.

Figure 2 shows the "chassis" of the receiver removed from the cabinet and Figure 3 is a view of the same structure from a different angle. The coupling transformers are closed in the square copper compartments below the frame and the by-pass condensers are concealed under the aluminum sub-panel which covers the main framework and battery cables. It was found unnecessary in this model to shield the upper part of the tubes. The circuit diagram of the receiver is shown in Fig. 4.

The input circuit deserves mention. Coil aeri-als or loops have been consistently and religiously avoided with the RFL receiver, although any model can be made to operate successfully on a loop by properly adapting the input circuit. The reason for the avoidance of this time-honored collector for sensitive receivers is two-fold. First and foremost, it adds another control to the receiver; in spite of the fact that an indoor loop may not be highly directional it must always be swung to some extent, and if it

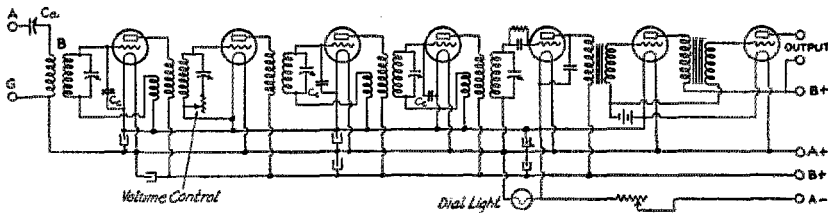

FIG. 4

It is a seven-tube receiver—four radio stages, detector and two audio, employing storage-battery tubes. The control panel is designed to be as far as possible removed from the conventional idea of a radio receiver with dials to twist and instruments to be consulted. It is characterized by a knob at the right which operates the station selector and a second knob at the left which is a volume control. The volume control does

can be rotated it will be rotated in use. Second, the best of loops are no ornament to the drawing room whereas a short length of indoor wire can be readily concealed. A great argument for the use of loops has always been selectivity. But if the selectivity is included in the receiver this is no longer valid. The only legitimate argument for a loop with a receiver of this nature appears to be its directional qualities with respect to

static. This advantage has been deliberately sacrificed, in the interests of simplicity of control. If then, we pin our faith to an indoor wire, which may have a capacity to ground anywhere between 20 and 200 micromicrofarads, some provision must be made for bringing the input circuit, with the collector being on, into tuning alignment with the rest of the system, unless we fall back on the doubtful expedient of an aperiodic input circuit. Accordingly a fixed capacity, say 30 micromicrofarads, is allotted to the input circuit for the collector, when the amplifier is adjusted. This means that the capacity between points B and G must always thereafter have a capacity of 30 micromicrofarads, to preserve tuning alignment. The "antenna compensator" C a is a series condenser inserted for the purpose of adjusting the effective collector capacity to this specified value when a given collector wire is attached to the receiver. In practice, when the receiver is put in service, a wire of any convenient length is attracted to the terminal A. A station is tuned in by the station selector *anywhere within the wavelength range of the set* and the compensator dial is set at the point of maximum signal once and for all. It is *not* moved again unless the length or location of the collector wire is changed. It is not a tuning control and is placed inside the cabinet (see dial in Figure 3) so that the ambitious operator will not be tempted to play with it, in receiving signals.

The resistance of the R.F. transformer secondaries in the *closed copper shields* is approximately 4.8 ohms at 400 meters. They are wound with spaced windings on bakelite forms. A rather low ratio of inductance to capacity is used successfully as regards amplification because of the low resistance and advisedly because the effects upon the tuning of incidental variations in the tube capacities are thereby minimized. The voltage gain in the R.F. stages, with new tubes, is approximately 16 per stage at 200 meters and 9 per stage at 540 meters. The voltage gain in the stage which feeds the detector is considerably less on account of the detector grid current. No apology is made for the falling wavelength amplification characteristic of the stages because the transformers were arbitrarily put in this condition to gain selectivity. The procedure used in designing the transformers was as follows: The secondaries were first determined with regard to the frequency range and their resistance was forced down as low as possible then with the secondary inductance and resistance given, the optimum primaries were determined. Now with a high resistance tube the optimum primary, as a rule, is out of the question on account of selectivity, although it yields a five flat amplification wavelength characteristic. So the primaries were reduced unshielded receivers in the vicinity.

below the optimum value until a certain arbitrary degree of selectivity was reached. If the fortunate time ever arrives when we can use tubes having a plate resistance of 3000 to 4000 ohms in a R.F. amplifier we shall be able to combine the high selectivity with a flat frequency characteristic. Until then, it appears to be a case of choosing one or the other.

Regarding selectivity, it is remarkable what can be done with a four-stage shielded amplifier, properly designed, in which all the radio-frequency energy picked up by the system is forced by the shields to follow the straight and narrow path down the amplifier from the collector to the detector. I dislike to record radio "stunts", but cannot resist mentioning a few facts, which are subject to verification by anyone else sufficiently curious or skeptical. Using a seven-tube receiver similar in every respect to the Kellogg set pictured in Figures 1, 2 and 3, I have worked in Chicago within 600 yards of the antenna of a local 500-watt broadcasting station and received without a "background" a signal from a second 500-watt station approximately 250 miles away in distance and 16 kilocycles away in frequency. With the same receiver I have received in Buffalo, also without a trace of background from a local station, a station in New York City eight kilocycles away from the local station in the frequency spectrum. I have no idea as to the relative field intensities of the local and distant stations at the receiver, but their ratios were undoubtedly tremendous, judging from the behavior of certain unshielded receivers in the vicinity.

Pacific Division Convention

October 2nd, 3rd, 4th. Santa Ana, Calif.

Members of the Pacific Division come to Santa Ana, and at the same time be sure to talk to all the amateurs in your neighborhood and extend a cordial invitation to accompany you to this convention!

St. Ann's Inn will be the headquarters of the convention. Special hotel rates will be given to the delegates; also special railroad rates if railroad certificates are obtained. Don't forget to ask the Ticket Agent about this certificate. Commander Hooper, U. S. N., Lieut. Schnell of the *Seattle*, Dr. Millikan and other prominent speakers will be present. Motor trips to KSE and KOK will be made. There will be a field day and the award of the Wouff Hong trophy will be made.

Five dollars will cover all the events during the three days.

Are we all set? Yes!!! Well, let's go.

—A.A.H.

Wave Propagation at High Frequencies

By Dr. A. Hoyt Taylor* and Dr. E. O. Hulburt†

NO attempt at an explanation of high frequency propagation phenomena can be considered entirely acceptable unless it ties up in some way with already fairly well organized conceptions of the nature of propagation of low frequency waves.¹ I am unable to go into this matter more fully than to say that the most reasonable ideas that have been advanced by way of explaining propagation of low frequencies, assume a more or less gradually increasing state of ionization in the higher level of the earth's atmosphere. Heaviside in England and Kennelly in this country were the first to suggest the existence of an ionized region above the surface of the earth which might have an influence on the mechanism of propagation of radio waves. It can be shown by mathematical calculations that such ionized layers would be able to transmit an electromagnetic wave with higher velocity than it would have when traveling thru un-ionized space. If then we imagine a wave sent out from a vertical antenna, it is evident that many of the rays will strike such an over-head region at a more or less oblique angle, but instead of being sharply reflected, will be gradually bent over because the top of the wave travels more rapidly than the bottom.² Thus they will be bent back towards the earth. The earth itself has (from the reaction of the induced currents in the earth's surface at the base of the wave) an action tending to straighten the waves or keep them nearly perpendicular to the surface of that portion of the earth over which they travel. This gives a tendency for the wave to climb over and around obstacles, rather than to penetrate them or jump over them. Nevertheless, at certain frequencies certainly, pronounced jumping effects or shadows can be observed; in other words, the frequency plays an important part in phenomena of this sort. If any one is interested in getting a more complete summary of low frequency information, it can be found in the Proceedings of the Physical Society of London, volume 37, part 2, February 15, 1925.

Ionization in the Upper Air

A word as to possible causes of ioniza-

*Physicist in charge, Radio Division Naval Research Laboratory, Bellevue, D. C.

† Supt., Heat and Light Division Naval Research Laboratory, Bellevue, D. C.

1.—The author refers to the lower radio frequencies.—Tech. Ed.

2.—This is in accord with our comment on The Reihartz Theory of sharp reflection. See "Editor's Notes" p. 12 of QST for April, 1925. See also "Is There a Heaviside Layer?" page 33 QST for September, 1925.—Tech. Ed.

tion in the earth's atmosphere and the nature of that ionization may not be out of place. Ionization must be thought of as the breaking up of neutral gas molecules into positive and negative constituents, the negative constituent being the light and very mobile electron and the positive constituent being the much heavier and more sluggish ion. Among the causes which produce ionization of the atmosphere, may be mentioned the ultraviolet light from the sun and direct bombardment of the outer layers of the earth's atmosphere by electrons thrown off from the sun—notably from sun spots. Excessive potential gradients produce perhaps violent movements of electrons and ions in connection with lightning strokes. Other electrical phenomena, such as possibly the aurora, could no doubt greatly augment the degree of ionization. This is because an electron under the influence of the strong potential gradients can move with a very high velocity and act upon a neutral ion when it hits it, like an explosive, jolting other electrons loose from the neutral particle.

De-Ionization

Another thing that must be kept in mind with regard to the general process of ionization is that it has a counter part in de-ionization. De-ionization may be thought of as a re-marriage which has taken place between the divorced electron and its positive mate. Of course, it may not re-marry the same mate, but in the social life of the electron that appears to make no essential difference. These positive and negative particles move rapidly about, often accidentally approaching close enough to each other so that their affinity for each other asserts itself and a reunion between the positive ion or at least some positive ion and some one of the electrons, takes place so that de-ionization or re-combination is constantly taking place. Now, if ionization has taken place in regions where the gas molecule population is very sparse, the divorced individuals may move about for a long while before they meet any of the opposite affinities; therefore ionization at very high levels of the earth's atmosphere is persistent and indeed in the very rare high levels, a considerable amount of ionization is probably present all the time. The ionization and conductivity however, probably does not rise indefinitely because this would be limited by the very sparsity of the electron population.

Wave-Energy Losses

For low frequency oscillations, namely, long waves, it would appear that energy can be lost or dissipated in only three ways.

First, some of the high angle rays will not be sufficiently refracted to ever bend down again to the earth but pass on out beyond the earth and their energy is lost in space.

Second, the ions and electrons would constitute a medium capable of absorption as the rays force them to move about and dissipate energy by collision.

Third, that portion of the wave which is earth-bound (and for very long waves, this means probably the major portion of the wave) suffers absorption from currents induced in the earth, owing to the fact that the earth's surface is neither a perfect dielectric nor a perfect conductor.

Absorption

For rarified regions where collisions are infrequent, the absorption must be very low. In order for a wave to exist in free space with its "feet off the earth," it is obvious that it must reach levels which are very high in comparison to the length of the wave. If now we consider the causes which affect ionization, we see that one principal cause, namely, sunlight, is removed at night, and therefore the ions will rapidly recombine after sun-down in the lower levels, but in the very high levels where the mean free paths of the electrons are large, which means that they can wander a long way without possibility of collision, the ionization will still be strong. Some of the wave energy will therefore reach high levels before it is turned over and brought back down to earth and when this happens, long distance signals of great intensity are produced because the region traversed has been mainly a non-absorbing medium. The lower levels have had their ions removed by re-combination and in the upper levels the ions are too far apart to collide readily. Of course, when the wave returns from the high altitude it probably fixes its feet on the earth again but we have sufficient evidence indicating that the night waves are far more complicated in structure when they arrive at the receiving station than those received by daylight.

Fading effects may be due to interference phenomena between earth-bound and reflected rays or to interference between reflected rays coming from different portions of a somewhat complicated upper ionized layer,³ or it may be connected with rotation of the plane of polarization of the wave, which altho starting off essentially vertical from the transmitting antenna, may suffer a rotation somewhere along the route when that route is a high level route.⁴

Evidently the reflecting or refracting layer is not at rest because of the rapidity with which fading effects alter. Moreover, conditions temporarily arise which will concentrate energy in some region at a great distance from the transmitter, thus giving rise to freak transmissions which we know are very common, especially in the 1500-KC. band. It is also well known that if the frequency is lower, the difference between night and day effects becomes less and less.⁵ Freak transmissions are not as common on very low frequencies, also monthly and annual variations of the signal strength are of lesser magni-

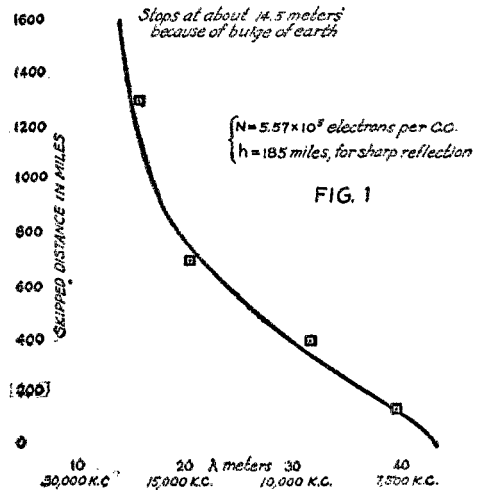

FIG. 1

FIG. 1 THE "SKIPPED DISTANCE" from observation and calculation.

tude. It generally can be said that up to 2000 KC. the daylight range, with a given amount of antenna power, steadily falls off and the opportunities for freak transmissions are most numerous⁵ in the winter nights and are most numerous at the higher frequencies. This, then, is the general situation for frequencies lower than 2000 KC.; that is, for waves longer than 150 meters.

The experimental data and theoretical considerations which have led to this brief outline of the low frequency situation are too well established to be upset readily and any consideration of high frequency wave propagation must not disturb well tested older ideas as to the situation at low frequencies. However, the experiments with high frequency waves, described in the

3—See QST for Sept., 1923, pp. 25 and 26.—Tech. Ed.

4—QST will, within 6 months, present some results of an investigation of wave-front distortion. Preliminary notes will appear in the Experimenter's Section.—Tech. Ed.

5—The very uniform signals of LY and LPZ are perhaps the best illustrations.—Tech. Ed.

following pages, have brought to light new facts which cannot be explained by the low frequency theory in its present form. A new idea must be introduced into the theory in such a way as to leave it untouched in the low frequency range and yet to bring it into agreement with the high frequency facts. This new idea fortunately has already been suggested by Appleton in England and independently by Nichols and Schelling in this country, although they have not used it as we use it. The new idea consists in the recognition of the fact that the magnetic field of the earth influences the motion of the electrons in the atmosphere, and calculation shows that this influence is important for the propagation of high frequency waves and does not affect appreciably the low frequency waves. An appeal to this influence and to the well known laws of the reflection and refraction of waves has resulted in a theory which appears to fit the facts fairly well and which altho by no means complete, will at least, we hope, encourage theoretical and experimental work which will throw light on the subject.

The data upon which the theoretical considerations of this paper are based, has been gathered by the Radio Division of the Naval Research Laboratory with the assistance of the American Radio Relay League, and its co-workers in the foreign countries. Some data have also been collected from commercial companies at home and abroad.

The theoretical work has been very largely carried on by the Superintendent of the Heat and Light Division of the Naval Research Laboratory. A preliminary note bearing on the work has been sent to *Science* and a full treatment of the theory will be published in some scientific magazine, we hope within a few months. In presenting here the salient features of this work, it will be borne in mind that in estimating the data from hundreds of observations we have tried to keep to the method of general averages to which there will be unquestionably a good many individual exceptions¹.

The "Skipped Distance"

Perhaps the most striking fact which has come out of the studies of radio transmission at frequencies in excess of 2,000 KC. and particularly in excess of 4,000 KC., is the evident existence of a "skipped distance" combined with the fact that in many cases the signals at relatively great distances are much stronger than they are at relatively short distances.²

You will all recall how some of the

earlier work in the 15,000 KC. band failed because the observers were not far enough away from the transmitter. Signals could be picked up 40 or 50 miles away, sometimes 100, after which they disappeared, and not until they were sought for at points many hundreds of miles distant, did we realize that we were getting anywhere with our transmissions. What actually happens with the 15,000 KC. wave is that the portion of the wave which follows the earth, is absorbed very rapidly and is so attenuated that it cannot be received at any great distance on the other hand, other components of the radiation with a higher angle upward are either reflected or refracted from the Heaviside layer and returned to the earth at a considerable distance from the transmitter. Mr. Reinartz has shown in his article in *QST* for July, 1925, how this might be possible in the case of reflection and altho we cannot agree with him as to the height of the reflected layer, nor as to the mechanism of reflection, his sketches in that paper will serve well enough to illustrate our points. This reflected or refracted component marks then the beginning of a region of good reception beyond the "skipped distance." In the case of a very high frequency, low powered transmitter, the actual missing region may be definitely determined but at somewhat lower frequencies—say in the neighborhood of 4,000 KC.—the effect is obscured (especially if the transmitter be of high power) by the persistence of the ground wave. Nevertheless by direct measurements and comparisons of signal strength at different distances, one can get a fairly good idea of the extent of what we will still call the skipped distance, even if it is partially filled in with energy from the ground wave.

Conditions even in daylight vary quite materially from summer to winter and indeed the skipped distance in the 15,000 KC. band is scarcely half in the heat of the summer months of what it is in the mid-winter months. We have also confined our calculations for the present to conditions at midday, being fully aware of the fact that they merge gradually over, at either end of the day, into nocturnal conditions. Most reliable observations of the skipped distance were taken by Major J. O. Mauborgne, S. C., U. S. Army, on the U. S. S. ST. MIHIEL, enroute from New York to Panama. These observations, taken day by day, and in the spring of the year when conditions are fairly average, gave quite definitely the skipped distance between 19,000 and 7,500 KC. and permitted us to draw the curves shown in Fig. 1. This curve shows how the skipped distance increases as the frequency is raised, starting with 150 miles for 7500 KC. and increasing to 1400 miles for

6—For a brief general discussion of the Kennelly-Heaviside theory, the Eccles-Larmor theory and the Nichols-Schelling theory, see "Is There a Heaviside Layer?" page 33 *QST* for September, 1925—Tech. Ed.

7—A very important point which almost all amateur experimenters overlook. Much of the material submitted to *QST* is based on too few observations. Tech. Ed.

8—See p. 10 of *QST* for April, 1925.—Tech. Ed.

25,000 KC. It is necessary now to turn to certain theoretical considerations to see why there should be any skipped distance at all, understanding that there will not be an actual skip but only a region of weak signals if the transmitter is very powerful, and the frequency not very high.

The Causes of "Skipped Distance"

We have good reason to say that the change from what we have long been familiar with as normal radio conditions, to what we now recognize as high frequency conditions leading to extraordinary range of communication at low power, occurs at about 130 meters wavelength (2300 K.C.) If we realize that in the upper atmosphere the free electrons will be moving about with great rapidity, there is reason to suspect that they will execute spirals about the lines of the earth's magnetic field. When this phenomenon is considered quantitatively in connection with what is known as total internal reflection, we can derive some interesting results. Total internal reflection may be explained by analyzing what happens when a ray of light passes from a point in a medium of any given wave velocity towards the boundary surface of a second medium in which the ray would have a higher velocity. This occurs for instance, when a ray of light from a source under water becomes incident upon the surface which bounds water and air, as shown in Fig. 3. In general a small part of the ray is reflected and a large part of it emerges into the air, being bent away from the normal to the surface as it emerges, (Fig. 3B) but at a certain angle (known as the angle of total internal reflection), the portion of the ray which emerges falls parallel to the surface of the water (See Fig. 3C) and an infinitesimal increase beyond this angle causes this ray not to emerge at all, but to be refracted completely back into the water as shown at Fig. 3D. This only happens when the upper region is a region of high velocity but the angle at which this happens is related to the refractive index; that is to say it is a function of the ratio of the velocities in the two respective media, therefore if we know the refractive index, we can calculate the angle of total internal reflection, or knowing the angle of total internal reflection, we can work back to the refractive index and can calculate the velocity in the upper region. From that, we can draw conclusions as to the number of electrons per cubic centimeter and say whether our results lead to a reasonable or to an unreasonable number. Here is where the advantage of knowing skipped distances at *different* frequencies

comes in. Using them as base of a triangle, we will be able to construct a figure which represents (we think), what actually happens. Most important of all, we will be able to find out how far up the top of the wave reaches before it is turned back to the earth. We find that such calculations based on the curve of skipped distances, as a function of wavelength, all lead to a very reasonable assumption as to the number of electrons at the point where the wave turns over and we find the number to be 5.57×10^6 per cubic centimeter.

Some information as to the proper value of this number is at hand from other physical sources not connected with radio and this number appears to be entirely reasonable. The question now arises as to how the situation will be changed if instead of being sharply reflected as from a sheet of copper, the ray is gradually bent or refracted. We think we have proved that the effect is substantially the same quantitatively, but the height to which the ray penetrates will, in the case of refraction, depend somewhat upon the disposition of electrons with reference to height.

Reflection or Refraction?

Figure 4 shows the results of our calculations based on sharp reflection giving a height of reflecting layer 185 miles.

If we consider the electrons to increase in number gradually and in proportion to the height above the earth, the ray will

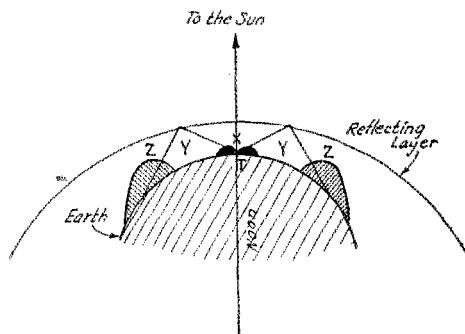

FIG. 4

FIG. 2 THE NATURE OF "SKIPPED DISTANCE" OR "DEAD BELT."

- T—transmitting point.
- R—Receiving point.
- X—Local signal due to earth-bound wave.
- Y—Dead belt or "skipped distance."
- Z—Region of reflected signal.

This figure appears as Fig. 4 on p. 11 of QST for April 1925 where it is discussed in detail.

be bent gradually as shown in Fig. 5 and the maximum height will be $92\frac{1}{2}$ miles.

Figure 6 shows the situation if the electron density varies with the square of the height. Here the top of the wave rises 114 miles. Please remember these observations refer to average conditions. Final-

—A discussion of this subject appears on p. 29 of QST for July, 1925. Our present Fig. 3 appears in that paper as Fig. 1.—Tech. Ed.

ly Fig. 7 shows what may perhaps be more nearly the actual situation, namely; the electron density varying with the logarithm of the height. It will be seen that this height becomes a very near approximation to the height in the case of sharp reflection, the high point in the wave path comes to 183.6 miles. There is of course another way of looking at the thing, and that is to assume that the electrons do not begin to exist in any quantity until 20 or 30 miles up. This will

the layer with such an angle as to be reflected. According to this we are not likely to see very satisfactory communication over great distances on waves shorter than 10 meters we will say—that is, of higher frequencies than 30,000 KC. The only way that we can conceive of communication at higher frequencies being feasible over long ranges would be to have them started preferably in a beam from comparatively high altitude, so that they could come to the reflecting layer at a low angle without being absorbed by the the earth. This point will of course no doubt, be proved or disproved in the not very far distant future.

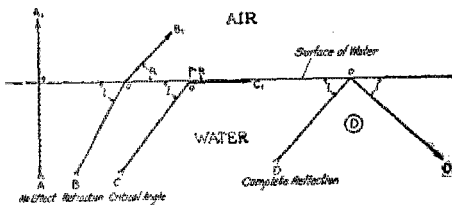

FIG. 1 LIGHT IN WATER AND AIR

FIG. 3 REFRACTION AND REFLECTION.

This figure appears as Fig. 1 on p. 29 of QST for July 1925 where it is discussed in detail.

only raise the base line of the figure and leave the rest substantially the same.

We have not yet calculated the height of the Heaviside layer for nocturnal conditions, partly because we have insufficient data covering night and winter work but roughly speaking, the height of the layer will increase somewhat in proportion to the increase in skipped distance.

To make it clear just what all this has to do with communication on high frequencies, one must realize that all rays striking at an angle higher than the critical angle, will be very slightly reflected and those rays coming out parallel to the earth will be very heavily absorbed by the earth's surface and therefore it is the intermediate rays below the critical angle and yet considerably above the surface of the earth which do the work in long-distance, high frequency communication. If we could have rays reflected with a fair amount of energy from very steep angles, we could not possibly have a skipped distance. Such rays, however, pass out beyond the atmosphere as shown by example A in Fig. 3. It also turns out that the critical angle is a function of the frequency and that the higher the frequency, the flatter the angle; that is, the nearer to the earth's surface will the ray have to go out. This means for instance, that at about 20,700 KC., the ray in order to be properly reflected will have to leave so nearly horizontal that it will be very heavily absorbed by the earth. In addition the curvature of the earth will actually get into the way of it so that it cannot reach

Seasonal Effects

The skipped distance in the summer night time is much greater than it is in the daytime and the skipped distance gradually increases towards midnight. This is what we normally expect. Altho the winter night skipped distance is not accurately known, it is very definitely known that the skipped distance is decidedly greater than it is during summer nights and this again seems reasonable because the ionization should be less in the winter time and therefore should not penetrate to so low a level because the periods of sunlight are shorter and the intensity of sunlight less. It is perhaps only fair to state here that with a single exception, our own observations and those reported to us by reliable observers from other parts of the world, clearly indicate the existence of this skipped distance.

Extreme Distances

The problem becomes a little more difficult to handle for extremely long skips on account of the fact that we have to make allowance for the curvature of the earth in handling the theory. It remains now to consider what happens after the cone of rays included between the horizon and the critical angle starts out from the transmitter. It is our idea that the first few degrees from the horizontal upward are so close to the earth that they are very heavily absorbed and do not get out more than a few miles, the distance depending on the frequency, the higher frequencies being probably more heavily absorbed. There is left then a cone whose angular width is determined by the critical angle and a limiting angle closely horizontal which is probably in the neighborhood of 4 or 5 degrees. Now for very high frequencies, this cone is fairly small but for lower frequencies, say in the neighborhood of 3000 or 4000 KC., the cone is quite wide corresponding to the much shorter skipped distance. In the case of the wide cones, repeated reflection will result in plastering the effective energy for suitable recep-

tion over a wide annular region on the earth's surface in such a way that repeated reflections will mix up considerably with each other and there will be no region beyond the first skip which is entirely without signal energy.

For extremely high frequencies the cone is so narrow that a new possibility is brought out and that is, the possibility of blank spaces beyond the first zone of good reception, the contour of which and extent of which will depend on the height of the Heaviside layer and therefore upon the time of the year at which the observations are made and naturally upon the time of day. If, for instance, the Heaviside layer is very low down as appears to be the case during hot, summer months, and we operate with so high a frequency that only a narrow cone is available, we find, on tracing the path of the cone thru successive reflections from the Heaviside layer and the earth's surface, and making due allowance for the curvature, that it is quite possible to have missing regions occur between the successive reflection points on the surface of the earth.

We are unable to say definitely from our observations whether such additional skipped regions occur at great distance, but we are inclined to think that at high frequencies, they do occur during the summer. This is a point at which the American Radio Relay League can gather a great deal of extremely valuable information.

It is our opinion that in general at extremely distant points fading is neither so rapid nor so violent. It would seem that the rays of radiation can arrive by many different possible routes as the Heaviside layer is no doubt full of convolutions and variations and that these rays summing up at a very distant point tend to average conditions and somewhat reduce fading effects.

There is also no doubt at all, but what a station on the extremely opposite side of the earth from the transmitting station or even approximately on the other side will receive a remarkable concentration of signal. This has been beautifully exemplified in our reports from Johannesburg, South Africa on the transmissions from the USS Seattle. Mr. Sydney Pleass has forwarded voluminous reports on the Seattle when she was at Honolulu. It happens that Honolulu and Johannesburg are on exactly opposite sides of the world. There were two periods of the day when Mr. Pleass could make almost solid copy on signals from NRRL. One period was in the early morning (South African time) and the other period in the early evening (South African time). The moment the Seattle moved on towards Samoa, he found this impossible to do, altho at the same time, signals from our

Naval Station in Honolulu continued to be received. This was in the 7500 KC. band. Mr. Pleass' observations taken in the early morning were no doubt taken on signals which arrived over the shortest route, namely the Atlantic Ocean. On the other hand, late afternoon signals arrived to him over the Indian Ocean. He also demonstrated quite clearly that it was possible to receive signals more than half way around the world. Some of these observations were taken at a time when for the signals to have traversed the short route, namely the Atlantic Ocean, they

Sharp reflection, Ray paths straight lines

FIG. 4

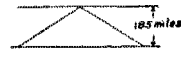

Electron density proportional to height Ray paths arcs of parabolas

FIG. 5

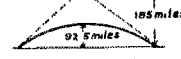

Electron density varies with (height)² Ray paths sine curves

FIG. 6



Electron density varies with e^{-height} Ray paths exponential on logarithmic curves

FIG. 7

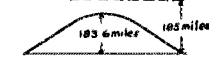

All figures on basis of a maximum electron density of 5.57×10^5 per cubic C.M.

would have had to cover nine hours of daylight which does not seem at all possible at 7500 KC. therefore they must have gone the other way around and arrived to him over the Indian Ocean which made the distance considerably more than one-half way around the world.

The Effect of Frequency

Too little is known of the relative absorption of high frequencies to do much more than speculate as to the role played by absorption but a few general conclusions can be drawn on the assumption that the absorption in the lower levels increases with frequency. We would expect higher absorption in the 15,000 KC. band than in the 7500 KC. band, whereas for daylight work between points separated by a distance greater than the skipped distance, the contrary seems to be the case. This can be understood if one realizes that the 7500 KC. transmission occupies a cone at higher angle so that a good many successive reflections have to be made in the 7500 KC. band before a wave finally arrives at its destination and since each reflec-

tion brings it down to the earth thru an absorbing region, it may lose considerable energy. On the other hand, the 15,000 KC. wave can get away at a low angle and still keep its feet clear of the earth, so to speak. Since it skips a much greater distance, it remains in the higher non-absorbing region for a greater portion of its transit than does the 7500 KC. We admit that we are not completely satisfied with this explanation but it does agree with the fact that for nocturnal transmission where the layer is very high, the 7500 KC. wave (which could then keep away from the earth for a longer distance) shows up very well in comparison with 15,000 KC. One thing, however, is absolutely certain and that is, that the absorption on 15,000 KC. is very much greater in the middle of the summer than it is in spring or fall to say nothing of the winter.

Very little work has been done during summer months from coast to coast in the 15,000 KC. band and we even have difficulty in mid-summer in reaching our station at Balboa, 1800 miles south of us when operating in the 15,000 KC. band. We believe this to be due to the fact that the skipped distance at that time of the year is scarcely half of what it is in the winter midday and therefore the wave has to go up and down several times before it gets across the Continent which very greatly weakens it.

Communication With Greenland

It is very remarkable that 15,000 KC. communication to and from the Navy-MacMillan Arctic Expedition has been a *flat failure* altho the distance from Washing-

Cedar Rapids, Iowa, to Etah on the higher frequencies corresponding to waves of 19 meters and under. At the time of this writing nothing has been tried under 15 meters, and the communication is anything but perfect.

In the Arctic regions at this time of the year there is perpetual sunlight. The Heaviside layer therefore is very low indeed and daylight communication is exceptionally difficult. Communication at any time of the 24 hours with the MacMillan Expedition involves in the summer time the penetration of a considerable distance of daylight and twilight. Signals from WAP on 8240 KC., have been extremely satisfactory in Washington during the month of August, fairly satisfactory during the latter half of July, but extremely unsatisfactory prior to that time. We have consistently tried out during daylight hours at 9 A. M., noon, 2 P. M. and 3 P. M., 14,400 KC., 12,500 KC., and 17,000 KC., and the latter is the only frequency that has met with any marked success during daylight hours in spite of the fact that it is lowest powered of the three transmitters. This lends color to the idea of skipped distances beyond the first one. It is unfortunate that systematic tests on various frequencies cannot be arranged over the entire 24 hours.

It is perhaps interesting to note since the Navy Department started sending time signals for the benefit of the MacMillan Expedition from 2:55 to 3 A. M., followed by a broadcast of official and other messages, the Arctic Expedition has reported practically 100% copy, strength 8. The signals it may be remarked, were sent at the special request of the Peary which stated the expedition was out of the range of all other time signals. This opens up a new and important field of activities for higher frequencies. It readily permits an international checking up of the signals on account of the extreme ranges which it is possible to cover.

Day and Night Effects

The success of the Peary in receiving these signals is interesting theoretically because an examination of the conditions will show that the signals are obliged to traverse 1200 miles of daylight at this time of the year. It has frequently been noticed that when a signal starts in the dark from far western points it can be received at Washington an hour or two after daylight, sometimes more. Such observations have been made on our stations in Samoa and Honolulu, on the U. S. S.

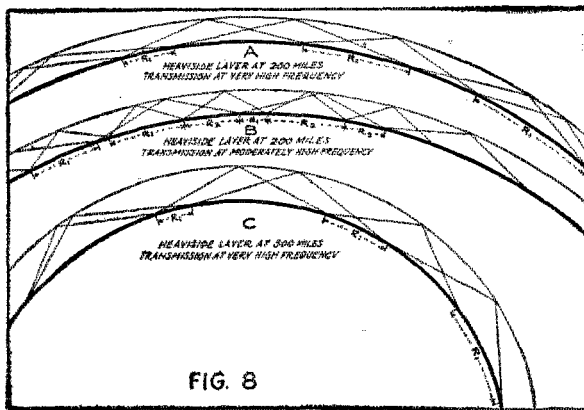

FIG. 8

ton to Etah, Greenland, is only 2700 miles and from Chicago to Etah very nearly the same. Nevertheless communication has repeatedly been had (two-way) from Washington to Etah and from 9CXX at

dark from far western points it can be received at Washington an hour or two after daylight, sometimes more. Such observations have been made on our stations in Samoa and Honolulu, on the U. S. S.

SEATTLE in Australian waters and on Australian and New Zealand amateurs. It is interesting to see that a somewhat similar effect holds for transmission to the northward. It can not be positively stated that this is a reversible condition because in communicating with these other points we have not used exactly the same frequency that they were using, but we have generally used a frequency at least of the same general value so that conditions would appear to be fairly reversible; that is, they would lose our signals at approximately the same time we lost theirs.

This data to my mind indicates that in the early morning hours the Heaviside layer is still fairly high up, permitting the signals in their successive reflections from the earth and from the air spending too much time in the immediate proximity of the air where they would be heavily absorbed.

If the skipped distance on high frequencies is shortened enough due to the Heaviside layer moving downward we have at least a reasonable explanation as to why the 15,000 KC signals in mid-summer are weaker than they are at other times. In line with this is the fact that in the spring when we could do Trans-Continental work in this band the signals were in general, stronger after dark, particularly west coast signals as received on the Atlantic coast. This condition held until after midnight at which time no doubt, the skipped distance became so great that the signals skipped over the east coast. Probably the strongest high frequency signals occur when the skip is extremely long and only one reflection; is necessary to reach the point in question. Nevertheless many other points further on can be reached if sufficient power is used, but the question remains to be definitely settled as to whether or not there are other missing regions further out.

Other Reflections

Considerable evidence crops up from time to time indicating other possible reflections at very low levels indeed. For instance, at points between 5 and 10 miles distant from NKF (Naval Research Laboratory)—very violent fading in the ratio of at least 20 to 1 can be observed at night on the 4200 KC. transmission from NKF. According to the theory herein presented the Heaviside layer at night is fairly high, probably several hundred miles even in mid-summer so that it is very difficult to imagine the reflected waves coming down to a point only 5 miles away and being strong enough to produce almost complete neutralization of the direct or ground wave at such short distances. It is particularly difficult therefore to understand this when we realize

that the rays would have to be sent up almost vertically and could be reflected only with a small percentage of the energy which they have when they are reflected at or below the critical angle; nevertheless, something produces an interference phenomena which may perhaps even play a role in the broadcast band around 800 KC. Attempts have been made to correlate this effect with weather, particularly cloudiness, but without success. Even in the broadcast band¹⁰, there is a small but easily measurable amount of fading even at points 5 or 10 miles distant from the broadcast stations when observations are taken at night, and in all cases this fading is accompanied by a blurring of the minimum and a distortion of the bearing as taken with a radio compass.

We have taken observations at the same points on fading of the 7200 KC. band and we find that the fading is not nearly so marked. Observations at 14,400 KC. show no fading at all either by day or night at such close distances. There may be therefore, some very low level ionization effect that is playing a part and that it also has a critical angle such that the higher frequencies are not reflected at a sufficiently steep angle to return to the earth within a few miles of the station, therefore the only thing that is heard a short distance from the station is the ground wave.

In order to illustrate the possible behavior of very high and moderately high frequencies according to the theory herein presented we have drawn figures (8) which represents three different cases, one for a 200-mile high Heaviside layer with transmission at very high frequencies; one for a 200-mile high layer with transmission at moderately high frequencies, and one for a 500-mile high layer with transmission at very high frequencies. For the sake of simplifying the drawings we have made them for the case of sharp reflection. Introducing the idea of refraction or gradually bending will make very little difference in the appearance of the figure and no difference in the final results, especially if one assumed a logarithmic variation of electron density with altitude.

For rays at very high frequencies, we have assumed the critical angle of 10° and have utilized all rays up to within 5° of the horizon. We have not used rays lower than 5° because we believe they will be absorbed and will be interfered with by the curvature of the earth. Thus a narrow cone going out from the transmitter is available for transmitting signals, radiation going out in other directions is dissipated in space or absorbed by the earth. If we follow the successive reflection of this cone of rays (Fig. 8A) we see that there is the possibility of a second skip or

lesser area than the first one and if we go on out with successive reflection alternatively at the Heaviside layer and the earth, the region of good reception becomes broader and broader and the skipped region diminishes until it finally disappears and regions appear in which there are overlapping rays from the transmitter arriving by very different routes. Now all of these different zones will be subject to some flickering due to movements in the Heaviside layer which are apparently much more violent at night than in the daytime. If we compare this figure with the one for the same very high frequency but for a much higher layer, namely 500

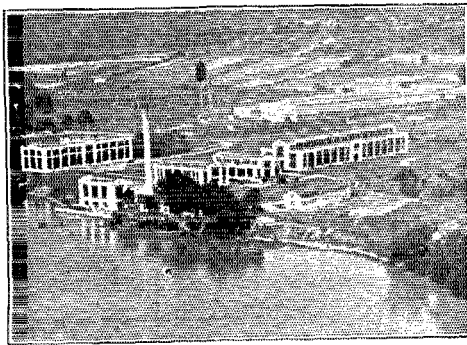

THE NAVAL RESEARCH LABORATORY AT BELLEVUE, D. C.

miles, we see that the same sort of thing is again repeated (Fig. 8C) except that a lesser number of reflections are required to bring about the disappearance of the skipped regions. At the same time the first skip is much longer and the chance of reaching very remote points are greater because the rays spend less time traversing regions close to the earth.

Turning now to the figure for the 200-mile layer, with transmission at a moderately high frequency, (Fig. 8B) we see that we have to deal with a cone which is broader and more steeply inclined upward, the critical angle is nearer the vertical. We do not, however, dare to use rays quite so horizontal because these longer waves would have to rise somewhat more sharply than at very high frequencies in order to get clear of the earth and exist in free space. Nevertheless, the cone is wide on the whole and there is very little trace of even a second skipped distance and beyond the second there is none at all. There are, however, countless places where overlapping rays occur coming by different routes, thus giving ample opportunity for inferences which can produce fading. It is only necessary then to assume a certain amount of flickering and movement

in the Heaviside layer to account for rapid variations in fading. It does not seem surprising that these should be more rapid and more violent at night than in the daytime because the night levels are high and the electrons having greater free paths, may readily vary their disposition and concentration. It is therefore of great importance that additional observations be accumulated which will determine the existence or non-existence of secondary skipped regions beyond the first one. A glance at the figures just presented will show that they must appear considerably beyond the first region. Some evidence of this nature we already have, but it is by no means conclusive. Incidentally it appears owing to the extreme ranges which are plainly possible with very high frequencies, it will be advisable wherever possible to use considerable power in the transmitters upon which these observations are to be made. However, with power of 500 watts and more in the antenna, very satisfactory results should be obtained and doubtless much valuable information will be furnished from records on transmitters having only a small fraction of that power.

In examination of Fig. 8B for the 200-mile layer and a moderately high frequency, shows that there is only a small trace of a skipped distance beyond the first one. A little flickering or irregularity of the layer would reduce the skipped distance to merely a region of very bad fading. We believe this region has been definitely observed. Beyond this point there is no portion of the earth's surface that does not receive at least one set of rays but as one gets further from the transmitter, one finds the region which receives only one set of rays being rapidly diminished in extent and at extreme distances all points will receive 3, 4 and even more sets of rays. This may account for greater steadiness and less fading as observed at very great distances. The diagram readily accounts for the fact that the fading may be materially different at various intermediate range positions. It must also be borne in mind that these diagrams represent a purely ideal case where the layer is of uniform height. Unfortunately we have not yet had time to complete diagrams, which would show the general trend of affairs with a layer of varying height such as one is bound to have on east and west transmission over great distances, part of which lie in sunlight and part in darkness. It seems that the only hope of getting extremely long ranges on frequencies higher than 25,000 KC., would be to take advantage of some peculiar layer formation that

would permit traversing in the upper ranges. Even with north and south transmission there is no doubt considerable variation in the height of the layer as the strength of the ionizing agencies, particularly sunlight, would be a function from the latitude.

The diagrams do show, however, the general nature of the phenomena which we may expect to observe if these theoretical considerations are approximately correct.

Conclusion

In making this attempt to extend the theory of electromagnetic wave propagation to the region of high frequencies, we have tried throughout to avoid making use of erratic or freak observations and to base our ideas on normal and readily reproducible conditions. We have indeed undertaken this work with considerable reluctance because we could wish for still more systematic and more adequate information with respect to certain frequencies but we have been encouraged to put these ideas in the hands of our radio friends in the hope that we will at least have stimulated some speculation along these lines which may help the solution of this very interesting problem. Certainly we shall welcome criticisms and reports of data bearing on this work whether or not it tends to confirm what we have herein set down.

Experimenter's Section Notice

THE Report of the Experimenter's Section is omitted this month, pending consideration of the means for handling the future work of the Section.

Increasing *QST* work is making it more and more difficult for the Technical Staff to take care of the necessary experimental outlines, schedules and correspondence. Fortunately the enrollment records and the like are being kept up to date by our office assistant, Lawrence Flebeau, partly on his own time.

The Editorial Staff and the Executive Committee are studying the problem and hope to be able to report in the next issue of *QST* that it has been possible to gain the necessary time without unduly disturbing other headquarters activities.

Jenkins' Awards

THE judges in Mr. C. Francis Jenkins' contest for ideas for picture-telegraphy have awarded a prize of \$50 to Mr. G. J. Shadick, of Regina, Sask., Canada, for a suggestion made in the first 60-day period. Mr. Shadick's winning suggestion was a very simple one—he proposed that instead of the complicated and messy pen-and-ink arrangement used for reproducing, a piece of carbon paper be wrapped around the white paper and a plain metal stylus be used for writing.

Certainly a very simple suggestion and a very easy way to earn \$50! But no one had thought of it before, and that is the purpose of the contest—to bring forth ideas that have not occurred to the laboratorians working on this development. The contest continues, with prizes of \$100, \$50 and \$25 awarded every sixty days. See page 18, May *QST*. It should be noted that the suggestions must deal with mediums and mechanism for transmission and or reproduction, and that they must be new and original suggestions.

Award of the first and third prizes in the first period has not yet been announced, pending some technical considerations, but Mr. Shadick's suggestion is typical. Mr. Jenkins' position in the matter is that his laboratory is honestly soliciting amateur help and is willing to pay for it. Here is jack for the new bottles, fellows, for a little constructive thinking and experimenting.

A. R. R. L. Information Service Rules

1. Before writing, search your files of *QST*. The answer is probably there.
2. Do not ask for comparisons between advertised products.
3. Be reasonable in the number of questions you ask.
4. Put the questions in the following form:
 - A. Inclose a stamped self-addressed envelope. Envelope without stamp from foreign countries.
 - B. Make diagrams on separate sheets and fasten sheets together.
 - C. Number the questions and make paragraphs of each.
 - D. Print the name and address (NOT merely call letters).
5. Address all questions to Information Service, American Radio Relay League, 1711 Park Street, Hartford, Conn.
6. Keep a copy of your question and diagrams and mention that you did. State whether or not you subscribe to

The Army Links Up With The Amateur

A. R. R. L. Promotes Plan for Cooperation Between the Signal Corps and Transmitting Amateurs

THE Army and the Amateur have joined hands in a cooperative program that will make use of the services of an amateur station for every unit of the National Guard and Organized Reserves throughout the country, with the opportunity to handle Army traffic and get a brand-new fascination out of brasspounding. For several years officers of the A.R.R.L. and of the Signal Corps have been discussing the possibilities of such a plan, and about a year ago it got actually under way. In March of this year a board of army officers appointed by the Chief Signal Officers met with the League's Executive Committee at Hartford, and there the details of the plan were drafted. Now the War Department has authorized our publication of the plan and indicates that the A.R.R.L. will be requested to act as the representative of the amateurs thereunder. The Chief Signal Officer writes President Maxim as follows:

WAR DEPARTMENT

Office of the Chief Signal Officer
Washington

August 7, 1925.

Mr. Hiram Percy Maxim, President,
American Radio Relay League,
Hartford, Conn.

Dear Mr. Maxim:

There is attached hereto a plan for the affiliation of the Signal Corps with the transmitting radio amateurs of the United States. It contains the basic features discussed by your representatives and the representatives of this office at the conference held in March of this year.

The Chief Signal Officer has been authorized by the War Department to communicate this plan to the officials of the American Radio Relay League. It may be published as a plan promoted by the League under the approval of the War Department. Upon notification from the officials of the League that its reception by members justifies placing the plan in operation, the Chief Signal Officer has been directed to submit the entire plan to the War Department for approval and transmission to corps area commanders.

The third paragraph of this plan leaves the selection of the national civilian organization to best represent the interests of the transmitting radio amateurs of the country to the discretion of the Chief Signal Officer of the Army, subject to the approval of the War Department.

The American Radio Relay League is, in

the opinion of this office, fitted to serve as the representative of the transmitting radio amateurs of the country. This opinion seems to be well substantiated by the fact that, in the past, the officials of the League have acted as the representatives of the transmitting amateurs at various conferences held by other departments of the federal Government. The Signal Corps also appreciate the splendid spirit of cooperation shown by the officials of the League in working out the details of this plan.

It is, therefore, with great pleasure that I inform you that the American Radio Relay League will be requested to act as the representatives of the transmitting radio amateurs of the country, provided the response received from the amateurs upon publication of this plan is such as to warrant the final adoption of it by the War Department.

The Signal Corps fully appreciate the magnitude of this undertaking. It cannot be accomplished in a few weeks or months. By careful, considerate, cooperation on the part of the Signal Corps and the amateurs this plan should in a year or so, provide the United States with a vast number of radio operators of potential value to their communities and the nation in an emergency.

It is confidently believed that this plan is beneficial to both the Signal Corps and the transmitting radio amateur. The amateur's participation in it will be concrete and positive answer to those who question his right to continue to exist as such.

You are at liberty to publish this letter with the plan.

Hoping that the response of the amateurs to this plan is such as to warrant its final adoption, I am,

Yours sincerely,
(signed) C. McK. SALTZMAN,
Major General,
Chief Signal Officer of the Army.

The plan of affiliation is published at the end of this article. It is now up to us members of the A.R.R.L. to show sufficiently favorable reception of the plan to justify the War Department in putting it into effect at once. We already know how many of our members feel about the subject, for two general questions about it were included in the recent Traffic Department questionnaire and over 80% of the Official Relay Station operators want such an opportunity and are prepared to keep a weekly schedule when necessary. But this isn't enough: we need a more specific indication for the Signal Corps.

Here is what we want every interested station-owner to do:

Read carefully the plan published at the end of this article. If you are interested in working under this plan, mail one of your regular station cards to A.R.R.L. Headquarters with the statement thereon that you are willing to accept appointment as an "Army Amateur Radio Station".

Mail another similar card, making reference to this QST article, to the commanding General of your Corps Area. If you don't know in what area you are located, address the nearest one. They are located as follows: First Corps Area, Boston; Second Corps Area, New York; Third Corps Area, Baltimore; Fourth, Atlanta; Fifth, Columbus, Ohio; Sixth, Chicago; Seventh, Omaha; Eighth, San Antonio; Ninth, Presidio, San Francisco. Example: an amateur in Ohio would address "Commanding General, Fifth Corps Area, Columbus, Ohio."

Here are all manner of splendid opportunities for us. A chance to serve another branch of our government, another call to answer to organize ourselves to handle emergency communication, a new source of interesting message traffic in large volume, an opportunity to learn all about operating in "tactical nets" which is a new idea in amateur radio organization. It is estimated that when the plan is in full operation some 3,000 amateur stations will be needed. It will take a couple of years of hard work to bring this about. The army is going to appoint an officer just to act as liaison agent between the amateurs and the Signal Corps in this work. He will be located at 2CXL, which will be the control station for the "army" or nation-wide net mentioned in the plan. There will be opportunity in this plan for every kind of amateur transmitter, for there are different kinds of nets, working over different distances, in every part of the country.

If we can put this job over it will be the biggest thing A.R.R.L. has ever done. Certainly it is the biggest opportunity that has ever been offered us. Let us make the most of it. In order for you to do this, mail that acceptance-card today!

And here's the plan.

K. B. W.

AFFILIATION OF THE SIGNAL CORPS, U. S. ARMY, AND THE TRANSMITTING RADIO AMATEURS OF THE UNITED STATES.

1. The Signal Corps, U. S. Army, desires to secure the aid of the transmitting radio amateurs throughout the country for the following purposes:

(a) To secure additional channels of communication throughout the continental limits of

the United States that can be used in time of an emergency such that the land lines, both telephone and telegraph are seriously damaged or destroyed by flood, fire, tornado, earthquake, etc., or from other causes.

(b) To provide channels of communication for the civilian components of the United States Army; the National Guard and the Organized of their business through these channels.

(c) To provide a reservoir of radio operators trained in army methods of procedure and in the basic principles of the army's methods of using radio in the field.

(d) To provide a means of establishing a contact with considerable number of radio operators and popularizing the Signal Corps and its activities with them as well as the exchanging of views on experimental work.

2. The agencies to be employed in this work are the Regular Army, the National Guard, the Organized Reserves and the transmitting radio amateurs. The work will be decentralized and handled under the Corps Area Signal Officers. The Signal Corps will appoint an officer to act as a liaison agent between the representatives of the transmitting radio amateurs and the Corps Area Signal Officers of policy.

3. The Chief Signal Officer of the Army will, subject to the approval of the War Department, appoint a national civilian organization as the representatives of the transmitting amateurs of the country. The organization selected must be one, which, in the opinion of the Chief Signal Officer, best represents the interests of a majority of the transmitting radio amateurs of the country. Since his plan affects the United States as a whole, it is considered essential that the organization selected be one with a national scope and preferably be a mutual cooperative association of a non-commercial character.

4. A general outline of the plan of action is as follows:

(a) There will be organized in each Corps Area the following amateur radio nets, with amateur transmitting stations representing each military unit concerned:

1st A Corps Area Radio Net, comprising the headquarters of each of its Organized Reserve Divisions, the Governor's office in each state within its area, and a Corps Area Headquarters station acting Net Control station.

2nd A Division Radio Net for each of the Organized Reserve Divisions with Brigade, Regimental and such other nets as are necessary to properly provide radio communication for the units of the Organized Reserves.

3rd A radio net for the National Guard of each state to be called the Governor's Radio Net and which will comprise all of the units of the National Guard of that state, grouped in a Brigade, Regimental and such other nets as are necessary to properly provide radio communication for all of the units of the National Guard.

(b) Tactical regulations do not provide for radio stations to be situated at the headquarters of units lower than battalion. Under this plan the Corps Area Signal Officer is authorized to set up such secondary radio nets for the Organized Reserve and the National Guard as he sees fit without regard to tactical regulations regarding the allocation of radio stations or radio nets.

(c) The Corps Area Headquarters will be connected in an Army Amateur Radio Net with an Army Headquarters Station located at The Signal School, Fort Monmouth, New Jersey. The Corps Area Headquarters stations will be either privately owned and operated or government owned and operated so

1. There are nine Corps Areas in the country each containing two National Guard divisions and three Organized Reserve divisions. The size of each area differs with the distribution of population, to include this many troops within its borders.—Ed.

2. Fort Monmouth until recently was known as Camp Alfred Vail. It is the home of 2CXL, operated by Captain Tom C. Rives, S.C., well known on the air.—Ed.

as to provide supervisory stations having direct contact with the amateurs within the Corps Areas and at the same time serving in the Army Amateur Radio Net. In either case the stations must be amateur stations working under amateur calls and complying with the Department of Commerce Regulations regarding amateur stations. The licenses for such stations must be obtained from the Radio Inspector for the Radio District in which the Corps Area is located.

(d) To generate the desired amount of message traffic for the amateur operators to handle it will be desirable for National Guard and Reserve Officers to transmit routine correspondence and reports by amateur radio, sending a confirmation copy by mail. The Corps Area Signal Officers and the Regular Army instructors under them should in turn transmit as much of their correspondence by amateur radio as possible and feasible, sending confirmation copies by mail. *Traffic that would ordinarily go over the commercial land lines will not be sent over amateur radio but will be sent as formerly over commercial land lines.* Amateur radio traffic should be considered as subject to a delay of from twenty-four to forty-eight hours. After the amateurs of a Corps Area have been trained for some length of time, this delay time will be cut down appreciably.

(e) In cases of local emergencies, where the land lines have ceased to function, any and all traffic should be sent by amateur radio. In such cases the local military units should be instructed to protect the radio station of the amateur serving them as this station may be their only means of communication with the outside world.

(f) The Corps Area Signal Officers will arrange for the distribution of such instruction literature as may be available to the cooperating amateurs within their Corps Areas. This literature should be of such a nature as to instruct the amateur in tactical procedure, army codes and ciphers, and army apparatus and methods.

(g) Detailed schedules of operation for the amateur stations should be worked out by the instructors on duty with the National Guard and Organized Reserves. In general it will be desirable for the amateur serving a particular unit to be on duty on the night that unit drills. Corps Area Signal Officers will arrange for periodic tests of the amateur nets under their jurisdiction. Some four to six tests per year should be run with messages starting at subordinate units and coming up through amateur radio channels to the Corps Area Headquarters. Similar tests of a nation-wide character will be organized by the representative of the Chief Signal Officer at Fort Monmouth, N. J., and the representatives of the transmitting radio amateurs.

(h) On Defense Day each year every cooperating amateur should be at his station for the transmission of such messages as are filled with him.

5. The Corps Area Signal Officers will furnish the representatives of the transmitting radio amateurs with a list of the National Guard and Reserve Units for which they wish amateur stations designated. Where an amateur radio station is already working with a military unit, this station should be suggested by the Corps Area Signal Officer as the most likely station for the unit. This requires that the National Guard and Reserve units be consulted before submitting the original list to the representatives of the radio amateurs. The representatives of the transmitting radio amateurs must give due weight to such suggestions. A principal station and at least one alternate will be designated for each unit where feasible. Where only one active amateur station is available it may be designated to serve several units within the same locality.

6. The representatives of the transmitting radio amateurs are responsible for the designation of the amateur radio stations to serve the various units of the National Guard and Organized Reserves. In certain Corps Areas they will undoubtedly find it advisable to allot this work of the designation of amateur radio stations to field or district representatives, in which case they will so notify the Corps Area Signal Officers concerned. All matters of general policy with respect to the transmitting radio

amateurs will be arranged through the representative of the Chief Signal Officer appointed to act as, and to be addressed as, Liaison Agent, The Signal School, Fort Monmouth, N. J.

7. The amateurs designated to serve the various units either as principal or alternate stations should keep their stations open for the transmission of business on at least one night each week, preferably on the night that the unit they serve drills. The tender of their services is purely voluntary and they are at liberty to withdraw their cooperation at any time. No responsibility can attach to them for any "Governing Radio Communication" are bound to pre-radio traffic that fails to reach its destination. They, as radio operators under the "Laws and Regulations serve the secrecy of all radio messages. They are likewise duly obligated to comply with the above laws and such regulations as the Department of Commerce may promulgate, and participation in this plan does not release them from this obligation. In time of local emergency they will be expected to cooperate to the fullest possible extent with the local military organizations. In return, the local military authorities will do everything in their power to protect the amateur's station from injury. The amateur is not expected to enlist or enroll in any manner. His main value to the working out of this plan is that of cooperating with the use of his own transmitting station in the transmission and reception of certain traffic of an official or semi-official nature. He will be expected to handle this traffic by the army methods of tactical radio procedure wherever possible. He will not handle this army radio traffic with stations that have not been designated as army amateur stations in the same way as he has. He will be instructed in the use of certain codes and will in many cases be required to encode his messages before transmitting them. Likewise he will have to decode such messages as come to him in code, before delivery to the local units. He will receive such instruction literature as is available from the Corps Area Signal Officers. When it is impossible for him to be at his station at the prearranged time, he will so notify the organization he serves so that the alternate station may be used at that time.

8. The Army Headquarters Control Station at Fort Monmouth, N. J., will be in charge of Liaison Agent, The Signal School. This station will transmit to the other army net stations such material as will be of value to them. The liaison agent will furnish the Corps Area Signal Officers with copies of such instruction pamphlets as are available in the Signal School. Where this material is not available in large quantities, the Corps Area Signal Officers will be expected to mimeograph such portions of it as necessary for distribution within their Corps Areas. A station of sufficient power to communicate with the army amateur net stations in the middle west will be installed at Fort Monmouth, N. J., and will be kept open under a regular published schedule. All communications with the Corps Area Signal Officers will be carried on by radio insofar as possible.

9. A certificate of appointment will be issued to each of the amateur radio stations accepting an appointment from their representatives to serve a unit of the National Guard or Organized Reserves. These certificates will be signed and sealed by the Corps Area Signal Officers. They will be supplied by the Chief Signal Officer of the Army. These certificates are a confirmation of their appointment and contain the authority for their handling the official traffic of the units they serve. They will be posted in a conspicuous place in the amateur's radio station.

10. Stations designated to serve in this plan will be known as "Army Amateur Radio Stations."

11. The Signal Corps cannot issue any equipment or apparatus to the amateurs for the operation of their stations.

12. No additional funds or personnel can be allotted for this work. Such facilities as are at present available at the Corps Area Headquarters and at Fort Monmouth, N. J., will be utilized to the fullest extent in carrying this project through a successful conclusion.

High Frequency Resistance Standards

By John M. Clayton, Assistant Technical Editor

VERY few A.R.R.L. experimenters have performed any radio frequency resistance measurements at frequencies above 2000 kilocycles. We have not seen any coil measurements at frequencies higher than this nor do we know very much about the shape of a coil resistance curve at very high frequencies. We need a paper similar to Marco's (*QST* for June, 1925) giving coil resistance data at frequencies between 3000 and 15000 kilocycles. The great drawback to high frequency resistance measurements is that resistance units that are sufficiently accurate at these very high frequencies are extremely hard to find and usually quite difficult to construct. There are a number of things that enter into the resistance unit problem. Among these are skin effect, inductance and capacity of the units, and temperature coefficient of the resistance wire.

Skin Effect

With direct current, or alternating current of commercial frequencies, the flow of current through the conductor is uniformly distributed; that is each part of the conductor is carrying just as much current as each other part. As frequency is increased the current no longer distributes uniformly throughout the cross section of the wire but tends to flow only on the outer portion of the conductor. This non-uniformity of current distribution results in an increased R.F. resistance. As the size of the wire is increased or the frequency of the current increased the skin effect will proportionately increase until the resistance at R.F. may be several hundred percent higher than the D.C. resistance. In order to decrease the skin effect it is necessary to use smaller conductors as the frequency is increased if the ratio of A.C. to D.C. resistance is to be kept low. It is generally considered sufficiently low if this ratio does not exceed 1%.

If the conductor is wound into a solenoidal form the current will tend to distribute itself

unevenly, most of it flowing along the surface of the wire in the inner portion of the coil. This also results in a greatly increased R.F. resistance.

Inductance

The ordinary Wheatstone bridge has its resistance units layer-wound on small spools. The higher resistance in such a bridge may contain several hundred feet of resistance wire. Obviously these units have a comparatively large inductance—entirely too large to allow the bridge to be used in any R.F. measurement work. When resistance is inserted in a circuit under measurement

we want to increase the *resistance* of the circuit and we do not want to change any other of its constants. If the resistance units have any appreciable inductance of the total circuit and destroy the accuracy of the measurement.

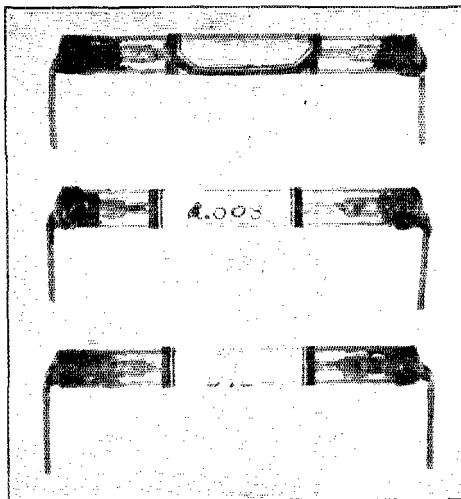

FIG. 1—COMPLETED UNITS.

Capacity

If the resistance unit has any appreciable distributed capacity this capacity will act as by-pass condenser; part of the current which should be flowing through the resistance will flow around it by virtue of this distributed capacity. This results in inaccuracies which are totally out of the question when dealing with frequencies on the order of those found in the amateur band of wavelengths, errors which cannot be compensated for by any re-adjustment in the circuit under measurement. The Ayrton-Perry method results in resistances having the lowest distributed capacity found in commercial use but units constructed in this manner are generally not sufficiently accurate for even ordinary measurements where the frequencies involved are between 5 and 15000 k.c. The distributed capacity will be at a workable minimum in a set of resistances which consist of individual units containing a single straight wire. The wire must be as fine as possible so that the

distributed capacity will be small. We cannot make it too fine, though, for even though the current flowing through the wire will be very small, the wire will heat up very easily and its resistance will change with temperature. We have to compromise between fine wire with small inductance and high change of resistance with temperature and large wire with more inductance and less temperature-resistance change.

This leads us to the consideration of temperature coefficient. The temperature coefficient of resistance of a material is the amount of change in resistance with change in temperature. It is customary to speak of the resistance change in ohms and the temperature change in degrees Centigrade. Annealed copper has a temperature coefficient of .0039 ohm per degree Centigrade above 20 degrees. This means that if a 10 ohm length of copper wire (10 ohms at 20 degrees Centigrade) is heated to a temperature of 40 degrees the resistance of the wire will no longer be 10 ohms but 1078 ohms—a sufficiently large increase to upset many R.F. measurements. Since the resistance units must be short lengths of fine wire, the wire will be so small that it will heat easily enough to change its resistance materially, even if the utmost care is taken when using the unit to see that an excessive amount of current does not flow through them. For this reason the wire must be made of a material whose temperature coefficient of resistance is as small as possible. Copper is out of the question. Commercial manganin or Advance should be used. The temperature coefficients of either of these are so low that almost up to the melting

resistance of the circuit, providing that a 0 ohm copper link of identically the same length as the unit is used in the circuit before the resistance units are inserted.

In order to protect the fine wire from damage while handling, and to exclude moisture which might deteriorate the wire, the units are mounted in small glass tubes. These tubes should be Pyrex glass and should have an approximate length of 8 centimeters, an outside diameter of 9

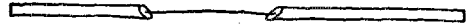

Soldering the fine wires

FIG. 3

millimeters and a wall thickness of 2 millimeters. For the average set of resistances 24 of these tubes will be required.

Referring to Fig. 2 small corks that fit tightly into the glass tubes are drilled with a hole just large enough to pass the lead wires which are of No. 14 copper. The corks should be pushed into the tube until they are a quarter of an inch from the end of the tube and after the units have been made up the end of the tube is filled with sealing wax (Denison's), the lead wires bent sharply at right angles to the glass and a round gob of wax put over the end of the tube and the lead wire.

A handy set of resistances will consist of a 0 unit (No. 14 copper wire), units from .1 to .9 ohm in .1 ohm steps and units from 1 to 30 ohms. The actual length of resistance wire in each unit will vary between one quarter inch and 2½ inches. The following table shows the size of wire to be used for each unit. The wire is manganin:²

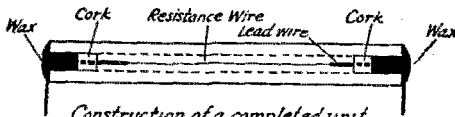

Construction of a completed unit

FIG. 2

point of the wire the resistance will not change enough to effect ordinarily R.F. measurements seriously.

Bustan Type Resistances

Sometime ago the Bureau of Standards proposed the straight wire type of resistance unit. Each unit consists of a uniform length of wire, a portion of which is composed of very fine high resistance material. All of the units are of the same length hence their inductances are practically identical. Their distributed capacities are as small as it is practically possible to make them and for all ordinary measurement work the insertion of one of these links in a measurement circuit changes nothing but the

| |
|--------------------------------|
| 0—No. 14 Copper. |
| .1 to .9 ohms No. 38 manganin. |
| (.1 ohm steps) |
| 1.0 ohms No. 38 |
| 2.0 ohms No. 38 |
| 3.0 ohms No. 40 |
| 4.0 ohms No. 40 |
| 6.0 ohms No. 40 |
| 8.0 ohms No. 44 |
| 10.0 ohms No. 44 |
| 12.0 ohms No. 44 |
| 14.0 ohms No. 44 |
| 16.0 ohms No. 44 |
| 18.0 ohms No. 44 |
| 20.0 ohms No. 44 |
| 25.0 ohms No. 44 |
| 30.0 ohms No. 44 |

It is necessary to calibrate the units by means of some form of Wheatstone bridge.

1—Pyrex tubes of this size can be obtained from the Corning Glass Works, Corning, N. Y.

2—Manganin wire can be purchased from Driver-Harris or Baker & Company both of Newark, N. J., and from the General Radio Company.

The accuracy of the bridge should be known and it should be fairly high. First tin the end of one piece of the resistance wire taking care that the solder does not flow along the wire anywhere except at the very end. *Use nothing but resin cored solder.* Cut off two lengths of No. 14 copper wire and file one end of each piece to a sloping surface as shown in Fig. 3. Carefully tin these surfaces, using just as little solder as possible. Now solder one end of the resistance wire to one of the copper lead wires. This is a two-man job. The copper wire should be clamped in some form of support and the resistance wire should be resting in the center of the filed surface and not near the edges. With a very hot iron solder the wire in place. Be sure that there is no excess solder sticking to either wire. Place the heavy wire in the binding post of the bridge and the other lead wire in the other bridge binding post. Next solder the fine wire temporarily in place, making the length of wire about equal to the length of glass tubing. Measure its resistance. It will be too high but that does not matter. Unsolder

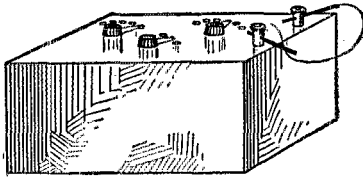

adjusting the resistances
FIG. 4

it and shorten the wire about a quarter of an inch (do not cut the resistance wire until the correct resistance has been found). Keep on soldering, measuring, soldering and shortening the wire until the correct resistance is found. Do not make the wire too short and unsolder and lengthen it for that will leave a tinned place in the middle of the unit. It is impossible to specify the exact length of each unit as the change of resistance caused by a little excess solder at the joint will throw out the resistance sufficiently to make the unit useless. The correct length can be found rather rapidly after the knack of estimating it has been gotten.

The resistances do not have to be absolutely correct to the hundredth of an ohm, providing the correct resistance is known. If you are making the 10 ohm unit and it comes out 10.05 ohms or 9.98 ohms, don't waste a whole day trying to get it soldered correctly. Be sure, however, to paste a paper label on the outside of the glass tube when the units have all been finished and to mark the correct resistance on this label.

After the correct length of wire has been soldered between the two lead wires, clean off any excessive resin with alcohol and take the wires out of the bridge. Slip one of the corks³ over the lead wire, hold the wire vertically and drop the other lead wire and resistance wire through the tube, (Fig. 5) then force the cork down into the tube for about a quarter of an inch. This is a ticklish job (especially with the fine wire units) so go easy. Then push the other cork over the other lead wire and squirm it into place (a quarter of an inch from the end) by means of a heavy wire acting as a "pusher". Now center the wires so that the resistance portion is in the center of the tube and fill up one end of the tube with sealing wax until it is flush with the end of the glass. When that cools turn the tube around and fill up the other end. Let it set until it is thoroughly cooled off and hard, then bend the lead wires at right angles to the tube and close to it. After they have been bent, pile up sealing wax in a small ball over the end of the tube and the lead wire. Great caution must be taken at this stage of the game or the sealing wax will get so hot it will unsolder the resistance wire!

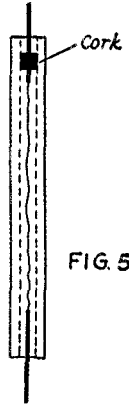

Cut off the lead wires to a uniform length of about one inch and remeasure the resistance of each unit. Be sure that the contact between the lead wires and the binding posts of the bridge is good or the correct resistance will not be secured. After the resistance of each unit has been finally

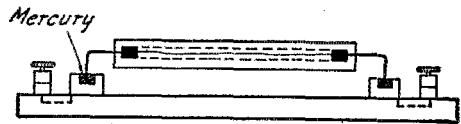

Mounting for units
FIG. 6

measured mark the value on the paper label pasted on the tube.

A satisfactory mounting for the units can be made by mounting two small "cups" made of blocks of copper in which $\frac{1}{4}$ inch holes have been drilled on a piece of bakelite (Fig. 6). They should be spaced so that the resistance units will fit nicely between

³—The smallest standard size cork is too large. Eimer & Amend of New York City make some very small ones. Their smallest size is just right.

them. When using the cups they should be filled with mercury and the end of the lead wires should be amalgamated with mercury before any measurements are made. From time to time this amalgum will have to be renewed but it will last for quite a while.

Great care must be taken when using the units to see that a current not exceeding 100 milliamperes is ever allowed to flow through them. The high resistance units are made of such small wire that it will fuse very easily.

These units should make a most valuable addition to the laboratory equipment of any amateur and it is only with units of this type that accurate resistance measurements can be made at wavelengths below 150 meters.

Much credit should be given to Harold Westman of 2BQH for his kindness in placing the excellent laboratory facilities of 2BQH at the writers disposal and for his assistance in constructing the resistance units described herein.

International Intermediates

- A—Australia
- B—Belgium
- BE—Bermuda
- BZ—Brazil
- C—Canada and Newfoundland
- CH—Chile
- CR—Costa Rica
- D—Denmark
- E—Spain
- F—France
- G—Great Britain
- H—Switzerland (Helvetia)
- HU—Hawaiian Islands
- I—Italy
- J—Japan
- L—Luxembourg
- M—Mexico
- N—Netherlands
- O—South Africa
- P—Portugal
- PI—Philippine Islands
- Q—Cuba
- R—Argentina
- S—Scandinavia (Denmark, Finland, Iceland, Norway, Sweden)
- U—United States
- Y—Uruguay
- Z—New Zealand

The Jewell 1926 Low Power Contest

THROUGH the courtesy of the Jewell Electrical Instrument Company the amateurs of America have a chance to compete for a splendid 21-jewel watch with a solid white gold case and a Lord Elgin movement. The Jewell Company has offered this expensive watch as a trophy for the licensed American amateur who transmits by wireless telegraphy the most miles per watt over a distance of 300 miles or more. The watts input is to be considered as the total power to all of the tubes used in the transmitter (master oscillator, oscillators, or power amplifiers); filament and plate inputs must be measured by means of filament voltage and current and plate voltage and current meters. In order that no freakish work will be considered the average of three records transmissions of separate messages to different points will be taken as the record distance. Proof of reception must be by an affidavit from the receiving operator. The owner of the transmitter must submit an affidavit giving all details of each transmission together with power input readings. These readings must be witnessed by another person who must sign an affidavit and both the owner and the observer swear to the correctness of the affidavit before a notary public. In addition to the affidavit from the transmitting operator a brief description of the transmitting set should be sent. This description should give the size of the various parts, rating of the tubes, transformers, generators, etc. If any instrument readings seem to be in error, the Jewell Company reserves the right of correction by having the instruments checked in their own laboratories.

Low power records are being made and shattered almost every night. Now is the chance gang! In addition to having a good chance at a splendid trophy you have a lot of incentive to make the low power set as efficient as can be and you all have a chance to have a whale of a lot of fun. No matter whether you have a UV-199 or a UV-204-A you have just as much of a chance as the next fellow.

All records and communications regarding the contest should be sent to the Jewell Electrical Instrument Company, 1640 Walnut Street, Chicago, Illinois. The trophy will be awarded on June 1st, 1926. Hop to it!

Strays

One of the dizzy Army calls we have been hearing is M3Y. 7BJ spotted him and got his QRA as Observation Squadron One, U.S. Marine Corps, San Diego, Calif.

Strays

8GZ says that the ORZ who was recently heard by 6BUR is 9RZ.

Our Third National Convention

ANOTHER "red-letter" event has taken place in amateur radio. To the four hundred and fifty amateurs who attended the Third Biennial A. R. R. L. National Convention at the Edgewater Beach Hotel in Chicago on August 18th to 21st, it is now a pleasant memory to be long remembered and to be talked over for many months to come.

Amid welcoming greetings in good old Continental from horns and whistles, delegates from every part of the United States and Canada registered in the grand ballroom of the hotel. Fellows "flived" in from all over the country and the air around the hotel resounded to the call of the amateur at play. Many of the gang "bummed their way" cross-country; one chap even rode a bicycle from Boston! England was represented by a real ham in the person of Mr. W. M. Bakewell, 6GUZ, and when seven stalwart Californians came, headed by Manager McCreery, we thought the whole Pacific Division was marching in.

Promptly at 3:30 on Tuesday afternoon the convention was called to order by the Chairman, Mr. W. E. Schweitzer, who welcomed the visitors in a few words; and from that time on until the closing event Friday night, every minute was made interesting. What glorious accomplishments have been realized by our League in the two years since our last convention! It seems only a few months ago that Don Mix was in the polar regions aboard WNP, and to have him with us at this convention enjoying himself and saying in his quiet way that he was having the time of his life, made us feel that "the world do move." Then we remember Deloy of 7SAB, who was with us two years ago and who upon his return to France startled the amateur world by establishing two-way telegraphic communication with our country, thus leading to our nightly exchange of traffic with the four corners of the world. Our recollection of the little groups of amateurs in different parts of the hotel, reminiscing on these earlier days, almost makes us forget that we are reporting a national convention. But at any rate, it was the friendly little groups everywhere and the good fellowship prevailing everywhere that made this convention stand out in our mind.

The Banquet

A little contrary to the ordinary procedure, the banquet was the first event on the program and served as a splendid opportunity to get acquainted. Promptly on schedule the delegates sat down and partook of a dinner that had such things in

it as A. R. R. L. cocktail, Warner bouillon and C. R. T. A. salad. During the festivities several good songs, prepared especially for the occasion, were sung by the gang. One in particular was so appropriate that we hope all the brass-pounders present took it to heart: "I Wonder What's Become of Traffic," sung to the tune of "I Wonder What's Become of Sally," and written by 9GE.

It was very much regretted that our founder and president, Mr. Maxim, could not be with us, but he sent us a wonderful message which, as usual, made us all feel proud of the League's achievements and determined to push it on to greater successes. Mr. W. R. Dawes, president of the Chicago Association of Commerce, altho not a radio amateur, spoke feelingly of the opportunities which amateur radio offers the American young man. One of the best talks of the evening was that of Mr. Bakewell of 6GUZ, who told us of his impressions in this country and much about the English amateur. Secretary of Commerce Hoover, under whose department the U. S. amateur operates, sent a message of greetings which was delivered by Mr. E. A. Beane, Ninth District Supervisor of Radio. Mr. Beane

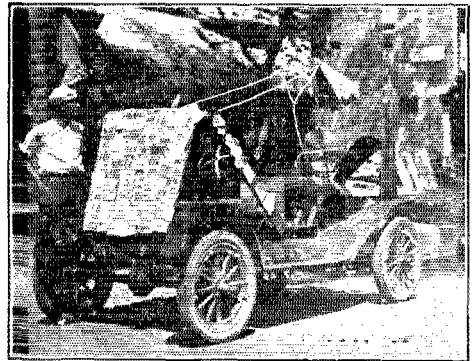

9BWS admitted ownership of this fliv, but insisted that 9TT and 9GT should be held partly responsible.

explained some of the difficulties encountered in radio affairs in the middle west, and told us that of all reports of interference less than three-tenths of 1% were due to amateur operation. Mr. Herbert Frost, president of the Radio Manufacturers Assn., spoke on the relationship of amateur and radio manufacturer. Addresses were also made by K. B. Warner, League Secretary-Editor, and A. A. Herbert, A. R. R. L. Treasurer. Mr. Paul H. Davis, vice-president of the C. R. T. A., was the very able toastmaster.

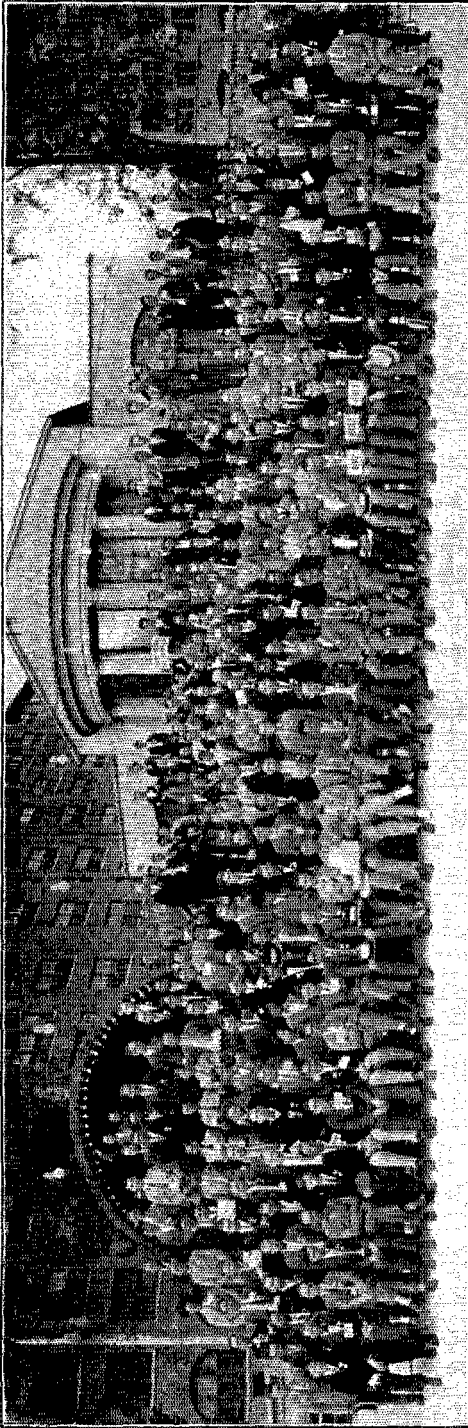

All of the fellows who could be rounded up were herded out on the promenade behind the hotel one noon, and had their picture taken. This is it.

Technical Meetings

We are sure that we can speak for the entire convention attendance when we express our deep gratitude and appreciation to those who delivered technical papers and addresses. The talk of Mr. John C. Warner, of the General Electric Research Laboratories, on the many new models of tubes, since placed upon the market, was extremely interesting. Mr. Karl Hassel of the Zenith Radio laboratory again showed that he knew something about receiving sets and their design, in a most instructive talk. Prof. W. J. Williams, of Rensselaer Polytechnic Institute, who has made a special study of radio interference troubles, gave those present so much information on causes of interference that no doubt a great many of them are now equipped with data that will enable them to solve bad conditions in their home cities. Mr. W. H. Hoffman, old-time amateur and now with the C. F. Burgess Laboratories, interested the brass-pounders in the possibilities of beam transmission. Of prime importance were the two addresses by Dr. A. Hoyt Taylor, head of the radio division of the Bellevue Naval Research Laboratories. His valuable talk on the Piezzo crystal oscillator as used at NK, altho unexpected, at one of the afternoon meetings, was intensely interesting and held the attention of the audience until the very last. But to hold the attention of a radio amateur audience for two hours, one must have something more than ordinary to say, and this was accomplished by Dr. Taylor at the meeting when he contributed his valuable paper on "High Frequency Transmission." It will certainly stimulate thought in amateur circles. Mr. John H. Miller, of the Jewell Electrical Instrument Co. and one of the good friends of the radio amateur, talked on his pet hobby, "Efficiency in Transmission." Of great interest was Mr. Boyd Phelps' paper "Experiments with 5-Meter Transmission," presented by Mr. R. S. Kruse, Technical Editor of *QST*. Don Wallace of 9ZT gave a very interesting and envy provoking talk on "Operation of Vacuum Tubes at 20 and 40 Meters." *QST* hopes to present many of these papers in its pages in the near future.

A. R. R. L. Meetings

Perhaps the most important of the general meetings was the traffic session, presided over by Acting Traffic Manager Handy. Here the operators of the country discussed their problems and many good suggestions were developed. Railroad emergency communication service was discussed at some of the meetings, with several railroad representatives present, amongst whom was Mr. I. C. Forshee, Chief Telegram & Telephone Engineer of the Pennsylvania System, whose address on the communication system of a great railroad was most enlightening. The Managing Editor of *QST*, Mr. F. C. Beekley, presided at a "QST Meeting" which brought forth many constructive suggestions.

Grand Finale

Generally a convention simply "peters out," with fellows leaving ahead of time and things falling a little flat at the tail end. But not this one! It wound up with a wallop, with a good supper at the Rendezvous Cafe on Friday night, where the repressed enthusiasm of the gang was loosed. With good dancing and the staging of the "Loyal Order of the Hams" by the Hudson Division hams and the "Loyal Order of the Derby" by the Milwaukee fellows, it was a fitting climax to one of the best national conventions ever held. With the distribution of the prizes won in the various convention contests, and the singing of the Star Spangled Banner, the convention closed; and with hand-shakes, 73's, and "CU on the air soon," it passed into history.

Acknowledgment

The League wishes to express publicly its deep appreciation and thanks to the Chicago Radio Traffic Association, under whose auspices the convention was held, for the great work it did, and to congratulate them upon its success. Thanks of course are particularly due the convention committee, which consisted of Mr. W. E. Schweitzer, chairman; Mr. F. J. Hinds, advertising manager; Mr. O. Nichols, transportation; Mr. R. Woolsey, athletic events; Mr. R. C. Schweitzer, treasurer; Mr. L. M. E. Clausing, entertainment; and Mr. M. H. Romberg, arrangement.

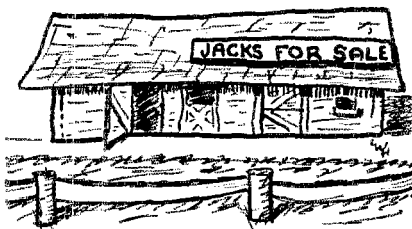

RADIO STORE?

Financial Statement

IN accordance with instructions of the Board of Directors, the following statement of revenue and expenses of the American Radio Relay League for the three months ended June 30, 1925, is published for the information of the membership.

K. B. WARNER, Secretary.

**Statement of Revenue and Expenses
QUARTER ENDED JUNE 30, 1925**

| REVENUE | |
|--|-------------|
| Advertising sales | \$13,857.49 |
| Newsdealer sales | 16,667.41 |
| Newspaper syndicate sales | 3,071.50 |
| Dues and subscriptions | 6,353.18 |
| Back numbers, etc. | 362.91 |
| Emblems | 287.45 |
| Interest on bank deposits | 96.21 |
| Cash discounts earned | 148.95 |
| | \$40,845.10 |
| Deduct: | |
| Returns and allowances | 18,164.37 |
| Exchange and collection charges | 13.50 |
| Discount 2% for cash | 227.17 |
| | 18,405.04 |
| Net Revenue | 22,440.06 |
| EXPENSES | |
| Publication expense .. | 14,660.38 |
| Salaries | 14,285.60 |
| Newspaper syndicate expenses .. | 642.23 |
| Forwarding expenses .. | 494.48 |
| Telegraph, telephone and postage .. | 1,657.25 |
| Office supplies and general expenses | 2,266.57 |
| Repairs and temporary alterations .. | 382.44 |
| Rent, light and heat | 855.78 |
| Traveling expense | 406.76 |
| Depreciation—furniture and equipment | 135.19 |
| Bad debts written off | 260.98 |
| Traffic Dept. field expense | 532.96 |
| Publicity Dept. field expense | 88.98 |
| | 36,669.00 |
| Net Loss from Operations | \$14,229.54 |

ELECTION NOTICES

To all A.R.R.L. Members Residing in the Atlantic, Dakota, Delta, Midwest, Pacific (including Hawaii) and Southeastern (including Cuba, Porto Rico and the Isle of Pines) Divisions:

1. You are hereby notified that an election for an A.R.R.L. Director, for the term 1926-1927, is about to be held in each of the above Divisions, in accordance with the Constitution. Your attention is invited to Sec. 1 of Article IV of the Constitution, providing for the government of A.R.R.L. affairs by a Board of Directors; Sec. 2 of Article IV, defining their eligibility; and By-Laws 12, 13, 14 and 15, providing for their nomination and election.

2. The election will take place during the month of November, on ballots which will be mailed from Headquarters in the first week of that month. The ballots for each Division will list the names of all

eligible candidates nominated for the position by A.R.R.L. members residing in that Division.

3. Nominating petitions are hereby solicited. Ten or more A.R.R.L. members living in any Division have the privilege of nominating any member of the League in their Division as a candidate for Director. The following form for nomination is suggested:

(Place and date)

Executive Committee,
A.R.R.L. Headquarters,
Hartford, Conn.

Gentlemen:

We, the undersigned members of the
A.R.R.L. residing in the
Division, hereby nominate
of as a candidate
for Director from this Division for 1926-
1927.

(Signatures)

The signers must be League members in good standing. The nominee must be a League member in good standing and must be without commercial radio connections. His complete name and address should be given. All such petitions must be filed at the headquarters office of the League in Hartford, Conn., by noon of the first day of November, 1925. There is no limit on the number of petitions that may be filed, but no member shall append his signature to more than one such petition.

4. Present Directors from these Divisions are as follows: Atlantic, Dr. Geo. L. Bidwell, Washington; Dakota, Prof. C. M. Jansky, Jr., Minneapolis; Delta, Benj. F. Painter, Chattanooga; Midwest, L. Boyd Laizure, Kansas City; Pacific, Allen H. Babcock, San Francisco; Southeastern, Harry F. Dobbs, Atlanta.

5. This is your opportunity to put the man of your choice in office as the representative of your Division. Members are urged to take the initiative and file nominating petitions immediately.

For the Board:

K. B. WARNER, Secretary.

Hartford, Conn., 25 July, 1925.

To All A.R.R.L. Members Residing in the Dominion of Canada, Newfoundland, and Labrador:

1. You are hereby notified that an election for an A.R.R.L. Canadian General Manager for the term 1926-1927 is about to be held, in accordance with the Constitution. Your attention is invited to By-Law

26, defining the policy of the League in Canada; Sec. 1, of Article IV of the Constitution, providing for the government of A.R.R.L. affairs by a Board of Directors, of which the Canadian General Manager is a member; Sec. 2, of Article IV, defining the eligibility of Directors; By-Laws 23 and 24, specifying the duties and authority of the Canadian General Manager; and By-Laws 20, 21 and 22, providing for his nomination and election.

2. The election will take place during the month of November on ballots which will be mailed from Headquarters in the first week of that month. The ballot will list the names of all eligible candidates nominated for the position by League members residing in Canada, Newfoundland and Labrador.

3. Nominating petitions are hereby solicited. Ten or more A.R.R.L. members living in the Dominion of Canada, Newfoundland or Labrador, have the privilege of nominating any Canadian member of the League as a candidate for Canadian General Manager. The following form for nomination is suggested:

(Place and date)

Executive Committee,
A.R.R.L. Headquarters,
Hartford, Conn.

Gentlemen:

We, the undersigned members of the
A.R.R.L. residing in the Dominion of Can-
ada, Newfoundland or Labrador, hereby
nominate
of
as a candidate for A.R.R.L. Canadian Gen-
eral Manager for 1926-1927.

(Signatures)

The signers must be League members in good standing. The nominee must be a Canadian member of the League in good standing, and must be without commercial radio connections. His complete name and address should be given. All such petitions must be filed at the headquarters office of the League in Hartford, Conn., by noon of the first day of November, 1925. There is no limit on the number of petitions that may be filed, but no member shall append his signature to more than one such petition.

4. Mr. A. H. K. Russell of Toronto, Ont., is the present Canadian General Manager.

5. This is your opportunity to put the man of your choice in office as the Canadian member of the A.R.R.L. Board. Members are urged to take the initiative and file nominating petitions immediately.

For the Board:

K. B. WARNER, Secretary.

Hartford, Conn., 25 July, 1925.

Short Wave Receivers

By R. R. Batcher*

IT is not hard to design a short-wave receiver. The main difficulty is "how do I know when I have arrived at the right wave?"

In the first place—where is 80 meters, or 40 meters, or 5 meters? Having all sorts of wavemeters available this is not difficult for us but I have included here a chart that should settle this problem once for all—unless someone will persist in using freakish coils. The chart is very similar to those appearing in the book "Prepared Radio Measurement".¹ It is so arranged that any solution can be obtained by laying a straight-edge across the scales. Detailed directions are given with the chart.

The Coils

Now comes the problem—how shall I wind the coil? Should it be wound like the pickle, the pickle bottle or the pickle barrel? Should it be self-supporting or should it be wound on a form?

Just remember these few rules and the problem is not difficult.

A—A circular coil is by nature that most efficient as far as the inductance is concerned. Tubular (i. e. helical) coils are generally more efficient than spiral (i. e. pancake) coils, although the difference is not great where only a few turns are used.² The inductance of a spiral coil is about the same as that of a cylindrical coil with the same length of wire wound on a tube whose diameter is equal to that of a turn half-way in on the pancake.³ A six-sided coil has about 94% the inductance of a circular coil equal to the circumscribed circle. The effect is not very large but in some cases is worth considering.

B—Keep the coil diameter small. The coil will then take less wire for a given inductance and will have less field.⁴ However, don't go to the extreme; a coil having a length of 1 to 1½ diameters will be a good average.

C—The material in the core or winding form, would be inconsequential if there were no distributed capacity. Therefore a coil wound so as to keep this distributed

capacity down (even though it is wound on poor material) may be as good as another coil wound on quartz but having a high distributed capacity.⁵ We have used Pyrex tubes in winding the coils of our short-wave tuner, the Grebe CR-17.

Here is another reason for keeping the diameter small: the distributed capacity of practical coils is equal to the diameter times a constant. If the diameter of a close-wound coil is taken in inches the distributed

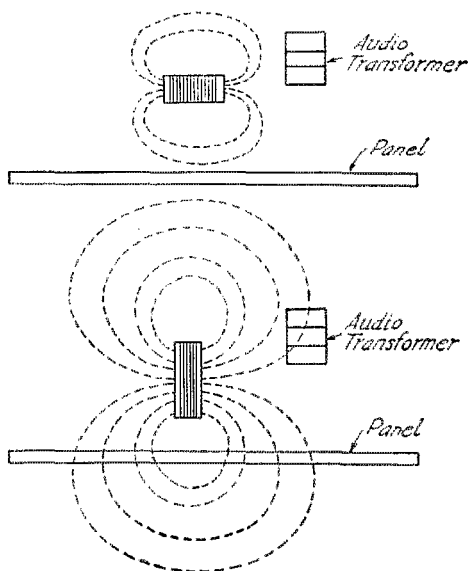

Keep the diameter small. The coil will then..... have less field.

capacity in micromicrofarads may be found roughly by multiplying by 2.75.

D—Basket wound coils look interesting and are easy to wind but are probably no better than close-wound coils. Spacing the turns of a basket-wound coil is generally out of the question and we are firm believers in the spacing of turns on short-wave coils.⁶

E—The material of the winding form affects the distributed capacity but slightly, at all events less than even a small increase in the diameter of the coil⁷

F—The idea of keeping dope, wax etc.

* A. H. Grebe & Co., Richmond Hill, N. Y.

¹ Prepared Radio Measurements by R. R. Batcher. An extremely useful book of design-charts. May be obtained from QST's book department.—Tech. Ed.

² The editor will admit having re-worded the author's statement, and is not sure that he has improved matters. The original wording was, "The inductance is about the same as a tubular coil if the center (i. e., half way out) turn of the spiral is used in figuring diameter and the "turns-times-spacing" factor is used as the length" (of the cylindrical coil).

³ Neither commercial nor amateur designers seem to pay the least attention to this vital point. What is the good of a fine coil when it is half an inch from a bakelite panel?—Tech. Ed.

⁴ But of course the best of all is a good coil on good material.—Tech. Ed.

⁵ Which agrees exactly with what we have said again and again—a circular coil with spaced turns is the best coil. Why does all amateur radio persist in the use of the various "trick" coil?—Tech. Ed.

⁶ This should not be misunderstood. The material does not increase the capacity much but it does increase the losses in the field of the distributed capacities.—Tech. Ed.

off the coils (except maybe a drop here and there) is a good one to remember.

G—The disposition of the end-leads etc. affects the wavelength range because it changes the distributed capacity, but the losses will not be increased *unless* there is a poor dielectric in the space between the leads.

take a 500 micromicrofarad condenser, however, to cover the wave between 17 and 87 meters. With this size of condenser a very accurate vernier is necessary to permit easy tuning over the whole tuning range.

Do not attempt to provide a "vernier" by using a two-plate condenser in parallel with the main condenser, because this doubles

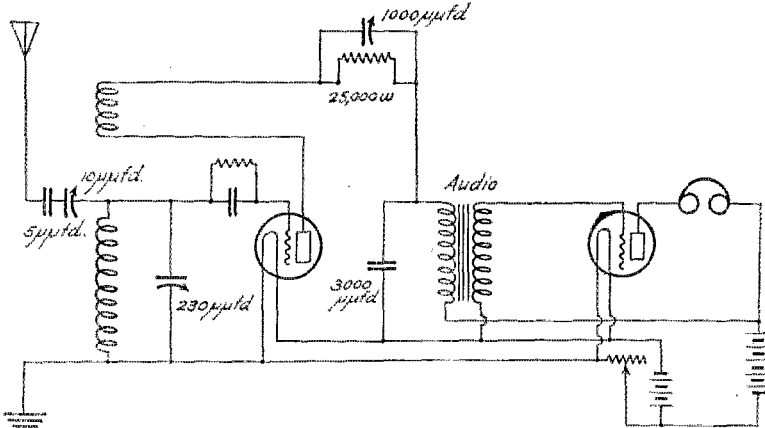

THE GREBE CR-17

The circuit is shown above and rear and top views of the receiver at the right and below.

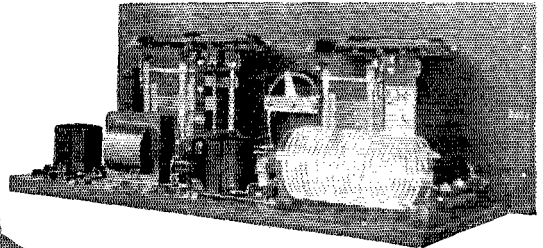
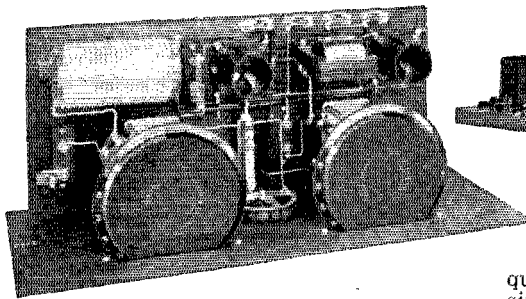

H—Our tests have not progressed far enough to prove or disprove the present practice on wire sizes.

I—Antenna coils and ticklers, if fixed and wound on the same frame with the secondary tuning coil, may be wound with small wire. Nos. 32-36 are convenient and the turns may be wound between the turns of the secondary tuning coil, since the latter are to be spaced.

Condensers

So much for the tuning coils. The condenser comes next. It is not necessary to use a large capacity unless a wide wavelength band is to be covered. The Grebe standard "SLF" condenser,¹ having a maximum capacity of 230 micromicrofarads, will cover a 3-to-1 wavelength band. It will

the minimum capacity in the circuit.

Another point frequently overlooked by the designers of "less loss" tuners is that a small condenser (physically) is required, else the field wanders about in undesired places, causing dielectric losses and uncontrolled feedback. Very small plates, (1/8" radius) and .015" spacing have been used in designing the Grebe "SLF" condenser and the results are very good.²

Tubes and Sockets

Tubes are not very constant lately. Personal experience and trial are necessary. It is ordinarily not necessary to remove the base and throw out the socket on wavelengths above 17 meters.

¹ Just why the condenser was so named isn't clear. The letters stand for "straight line frequency", whereas one would naturally expect to have it called "straight frequency-line". It is a fine condenser and the only one of the type that we know of. It is to be hoped that Grebe will put it on sale. Details appear in the article on p. 13 of our April issue.—Tech. Ed.

² However, if you can't get a compact condenser use some other good one and then keep it 3" away from everything else in the set.—Tech. Ed.

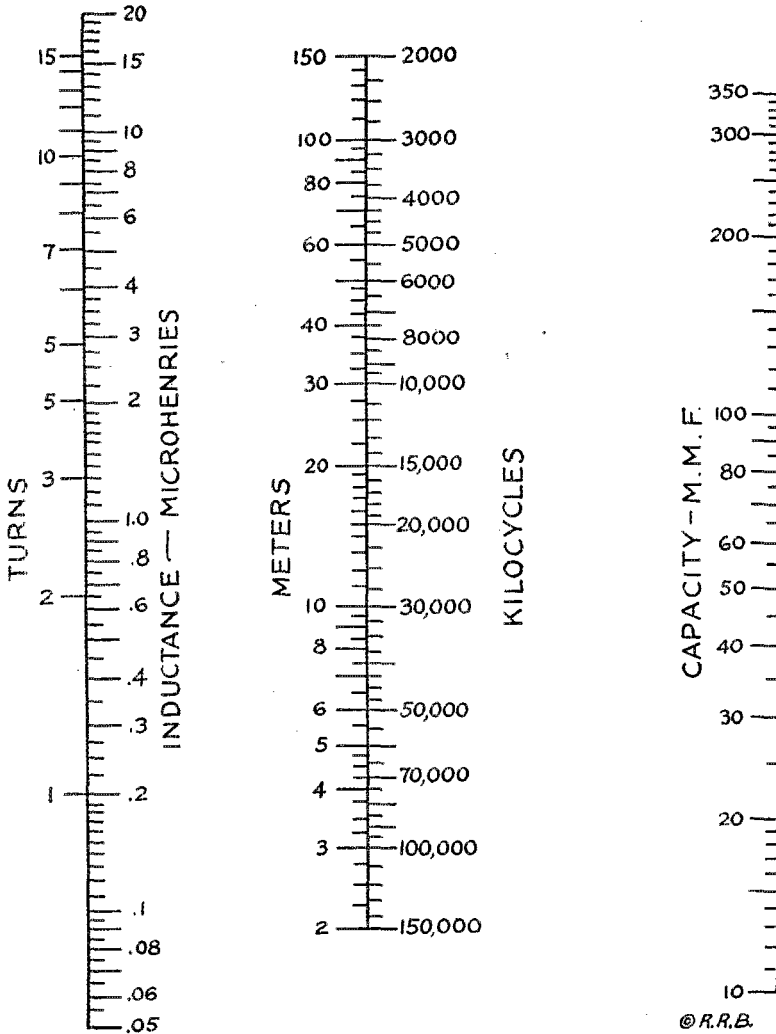

THE SHORT WAVE TUNER CHART

Grid Condenser and Leak

The condenser should be as small as possible, say about 20 micromicrofarads. The grid leak may have any value between 2 and 10 megohms and must be selected by trial.

Audio Amplifiers

Until the amateur C.W. transmitter is built to give a constant frequency it may be just as well not to try to tune up the audio frequency transformers to one frequency. However this is a matter requiring special tests with each type of transformer.⁹

The Grebe CR-17

The Grebe CR-17 is merely a laboratory model and does not as yet take a regular

⁹ It is a very great advantage to use a sharply-peaked audio transformer on even the present signals. As the stations improve we will be able to go to really tuned audio amplifiers. It is very likely that in the end we will have audio amplifiers equipped with regeneration controls, just as our radio amplifiers are now. We only need a few more stations like NKF, 9EK and 9XW to make it worth while.—Tech. Ed.

¹⁰ The "throttle condenser" method of controlling the feedback was used by F. C. Beekley of 1AEL-1KP and described on page 47 of QST for July, 1924. The method of coupling the antenna in thru a small condenser has long been used at various Navy laboratories and is, we believe, due to Dr. L. W. Austin.—Tech. Ed.

place in the Grebe line. In general it embodies all of the ideas which have been given above.

Figure 3 shows the circuit use as developed by Mr. P. D. Lowell.¹⁰ Several

changes can be worked out if desired. For example; if the 24,000 ohm resistance is not available it may be replaced by a choke having 300 turns of small enameled wire (No. 36) on a small open iron core. The antenna may be inductively coupled. In this regard it may be said that the fixed-tune antenna coil gives mainly electrostatic coupling instead of electromagnetic coupling at short waves but the results are the same.

The antenna coupling condenser consists of a fixed condenser having a capacity of about 5 micromicrofarads in series with a 10-micromicrofarad variable condenser. The tickler consists of 6 turns of No. 36 wire wound between the turns of the secondary tuning coil—at the filament end of course. The inner end of the tickler winding passes through a hole in the pyrex tubing.

Results obtained from a large number of experimenters who have used this set indicate that it is an exceptional receiver for the band that it covers, that is 30 to 100 meters. The feedback is very constant and a considerable band can be covered without changing the feedback condenser.

Short-wave Tuner Chart

Short-wave tuners constructed by amateurs, are often designed by the "cut and try" method. A handy chart for avoiding this, is given herewith.

On this chart a number of scales are printed, each bearing a definite relation to the others. Any tuning problem between 2 and 150 meters may be solved by laying a ruler (or other straightedge) across the scales in accordance with the following instructions.

When the capacity and wavelength are known lay the ruler to touch these two

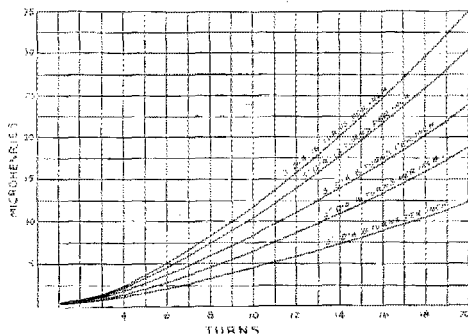

THE INDUCTANCE CHART

values. The value of inductance is then found where the ruler crosses the inductance scale.

When the capacity are known lay the ruler to touch these two values. The value of inductance is then found where the ruler crosses the inductance scale.

Because 3" coils are so common a special

scale has been provided for them. If these coils are wound with No. 16 or 18 wire and the turns spaced 8 to the inch the necessary number of turns may be found directly opposite the inductance scale at the left. Putting it the other way—if the coil has been built it is possible to determine its inductance by referring to this chart.

Inductance Chart

This chart may be used for coils which do not fit the special scale on the left side of the tuner chart.

Strays

E. G. Watts of 4FM makes a very good suggestion regarding an addition to the present R system of stating audibilities. The present "R9" signal only indicates a very loud signal—it may be audible all over the shack but if there is any great amount of QRN or streetcar QRM or induction the readability may be way down. Why not add another figure to the signal strength "R" signal to indicate percent readability, thusly: 9 is 100% readable, 8-80%, 7-70%, 6-60%, and so on. If a fellow tells you R99 it would mean that your signals are extremely strong and 100% readable, there being no interfering noises. You certainly wouldn't QSZ to that fellow. On the other hand if he told you R29 you would know that your signals were R2 (weak) but were 100% readable despite the fact that they were weak. You wouldn't QSZ to that fellow, either. If he told you R65 you would know that your signals were R6 (strong) but only 50 per cent of your transmission could be copied, due to disturbing noises. If you report readability of 5 or less you should also request a QSZ from the other operator. We recommend this system as being very useful and hope the gang adopts it. Useful suggestions which were incorporated into this readability scheme were also received from 8DPL, 8NT, 8NJ and 9TJ.

Through the cooperation of the American Radio Relay League with the Navy Department we are pleased to announce that the following A. R. R. L. members have been commissioned in the U. S. Naval Reserve Forces:

- Lt.-Commander Hiram Percy Maxim,
- Lt.-Commander A. H. Babcock,
- Lieutenant F. H. Schnell,
- Lieutenant W. J. Lee,
- Lieutenant C. A. Service, Jr.,
- Lieutenant F. L. Dewey,
- Lieutenant (j. g.) R. H. G. Mathews,
- Ensign M. H. Pancost,
- Ensign H. F. Pyle,
- Ensign Harry F. Dobbs,
- Ensign H. W. Leighton.

Transformers and Reactors in Radio Sets

Part II.

By R. H. Chadwick*

Audio Frequency Transformers

The best way I know of to comprehend the behavior of audio frequency transformers is to consider the equivalent circuit shown in this diagram.

Fig. 9 has been shown by a long series of experiments to represent accurately the conditions encountered in an audio frequency transformer working between two tubes or between the tube and the line, regardless of whether it is in a receiving set or is a part of the voice transmission or amplification system in a radiophone transmitting station.

E_1 is the alternating voltage generated in the plate circuit of the first tube, that is, it is the voltage applied to the grid of the first tube multiplied by the voltage amplification factor of the tube. R_1 represents the tube impedance in the plate circuit. E_p the voltage across the primary of the transformer. E_2 the voltage across the secondary and R_2 is the impedance of the grid circuit on the second tube.

Now E_1 is whatever we get out of the previous stage of our amplifier.

R_1 is fixed by the characteristics of the tube, and so is R_2 . What we want to get out of the transformer is the maximum value for E_2 for a given value of E_1 and we want this ratio of E_2 over E_1 to be as nearly uniform as possible over all frequencies within the voice range which is at least from 200 to 2000 cycles and preferably from about 60 to 4000 cycles.

Think of the transformer as we would any ordinary commercial frequency transformer. It is seen that the primary circuit may be considered as two impedances in series. The first is R_1 and the second numerically in a perfect transformer is equal to E_2 divided by the square of the ratio of turns in the transformer.² Now E_1 is going to divide itself between R_1 and the primary of the transformer in proportion to the two impedances. If, therefore, we make the ratio of the transformer too high in an attempt to get the maximum voltage out of it, we will get a high ratio of transformation but a very small proportion of E_1 across the primary of the transformer. On the other hand if we make the ratio of the transformer small, for instance one to one, we might hog nearly all of E_1 across the transformer,

but we would not get any step up value, and therefore, not much voltage on the secondary. It will be found that if the transformer were perfect, the maximum voltage could be obtained on the secondary when the ratio was such as to make E_1 divide equally across R_1 and the primary of the transformer, that is, the ratio of transformation would be the square root of the ratio of the grid impedance to the plate impedance.

Why the Amplification Drops at Low Notes

Even the best audio frequency transformer is very far indeed from perfect, and it is the imperfection of the transformer which causes unequal amplification of various frequencies. In the first place, the above statements assume that the primary coil of the transformer considered alone as a choke coil would have infinite

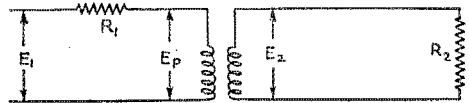

FIG. 9 DIAGRAM TO SHOW ACTION OF TRANSFORMER SUPPLIED BY A VACUUM TUBE
FIG. 9

impedance; that is, no exciting current. This is so far from the truth that in many cases the primary coil alone would have an impedance of lower value than the grid impedance divided by the square of the ratio of turns. Therefore, if we make our transformer have a ratio as stated above equal to the square root of the ratio of grid impedance to plate impedance in the expectation that E_1 would divide equally on the two parts of the circuit, we should be disappointed because the low impedance of the primary coil itself acts just like a shunt on the circuit. It will be seen that this shunt effect is greater at low frequencies. Putting it the other way around, the exciting current is high at low frequencies and low at high frequency.

Why the Amplification Drops at High Notes

The reason for the falling off of amplification at the upper end of the frequency curve is entirely different. It can be seen that if we were to connect a condenser across the secondary of the transformer the output would be much diminished. Actually (and unavoidably) we do just that, not only across the transformer itself but across each two layers, and each two turns. Two layers of fine wire with

*Transformer Department, Fort Wayne Works, General Electric Co. This paper is abstracted from the original talk prepared by Mr. Chadwick for the Hoosier State A.R.R.L. Convention. The paper was read in Mr. Chadwick's absence by Mr. E. A. Wagner, Managing Engineer of the Transformer Dept.

very little insulation on them make a very good condenser. The effect of these miniature condensers, or of the "distributed capacity", as we call it, is negligible at low frequencies, simply because the impedance of any condenser is high at low frequency and low at high frequency.

We therefore, in all practical transformers get an amplification curve which looks more or less like Fig. 10. The amplification ratio is high in the middle, at around 1000 cycles, but falls off on both ends. It falls off at low frequency because of the shunting effect of the low impedance of the primary, and at high frequency because of the shunting effect of the distributed capacity in both coils.

To boost up the low frequency end requires more turns, bigger core, or core material of higher permeability. To boost up the high frequency end of the curve we must reduce the capacity between turns and layers. The most obvious way is to increase the thickness of insulation and in that way reduce the capacity between turns.

I have just tried to point out the considerations governing the design of audio frequency transformers. In practice our designs mostly result from balancing a lot of considerations as to quality needed, size and cost.

Radio Frequency Transformers

About all I want to say on radio frequency transformers is that contrary to the opinion sometimes encountered, it is

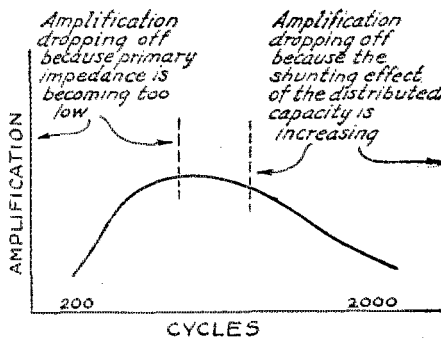

FIG. 10

possible to build transformers that will transmit real power and behave like ordinary transformers when operated at radio frequency. We recently obtained some rather elaborate test data on an iron-core 1 K.W. transformer which we built for 60,000 cycles. These data showed that we

could do a fairly good job of predetermining the behavior of the transformer. We followed the ordinary principles of transformer design.

Filter Reactors or Chokes

I think you all have a pretty thorough comprehension of what a reactor or choke is. Briefly a coil (with or without a core) may be called a reactor. When a current flows through this coil a magnetic flux surrounds each turn of wire and in general the magnetic flux produced by each turn surrounds not only that turn but all other turns. As the current alternates the flux alternates with it and cuts through the wire in the coil and generates an E.M.F. which opposes the flow of the current. The function of the reactor is to introduce this opposition to the flow of the alternating current. The greater the number of turns and the amount of flux surrounding them, the greater will be the opposition. If we want a lot of flux we put in an iron core through which the flux flows more easily than through the air. Reactance might be expressed in terms of voltage generated in the coil for a given amount of current flowing through it, but since this voltage depends also on the frequency, we usually start out with a quantity which we call inductance and which is measured in henries. The inductance is defined as the number of flux linkages per unit of current appearing in the form of an equation,

$$L = \frac{N\phi}{I(10^9)}$$

meaning that the inductance of the coil in henries is proportional to the total amount of flux generated by the coil, times the number of turns.

We then define reactance, which we call "X" as equal to 2π times the frequency, times the inductance,

$$X = 2\pi fL$$

and of course, the counter voltage generated in the coil E is equal to the current times the reactance.

$$E = IX$$

Now the process of designing an ordinary iron core reactor for alternate current would consist of arranging for enough flux and enough turns to produce the desired number of henries when the specified current is flowing. In the filter reactors, however, we have a different condition, and in fact in most reactors used in radio. The wave form of the current output of a two phase rectifier looks something like Fig. 11.

The function of the filter reactor is to

4—These are just the changes that are today being made in the kind of amplifying transformer that is being built for use in broadcast receivers. At the same time new "maximum distortion" transformers are being designed for radio telegraphic reception.

5—Do not make the error of overlooking the absolute need for an air gap if the choke is to be used in a filter. This is explained further along in this paper.

remove as much as possible of the ripple on this uni-directional current. We have a direct current and an alternating current through the reactor, which is required to produce opposition to the A.C. component but to let the D.C. through easily.

We must first supply wire large enough to take care of all the current without too great an IR drop.

Another consideration that must be given to the direct current is the fact that



FIG. 11

this direct current in itself magnetizes the core and keeps it magnetized.

We then have an A.C. magnetic flux superimposed upon a uni-directional flux which is something entirely different from an A.C. flux which has the core all to itself.

We first provide an air gap to make sure the D.C. flux does not saturate the core. This air gap is so chosen with regard to the number of turns as to produce the most A.C. flux for a given A.C. current.

It requires quite a lot of experience as well as a considerable accumulation of data to produce results that are reasonably accurate.

I have merely touched on this subject, not with any hope of giving you a clear method for designing reactors, but in an attempt to bring out for you the general principles and considerations involved.

(The first part of this article appeared in the September issue. This, the second part, concludes the article.—Ed.)

A Novel Condenser

NOTICE the peculiar shape of the plates in this condenser! It gives an approximately straight frequency line curve when used with a coil whose distri-

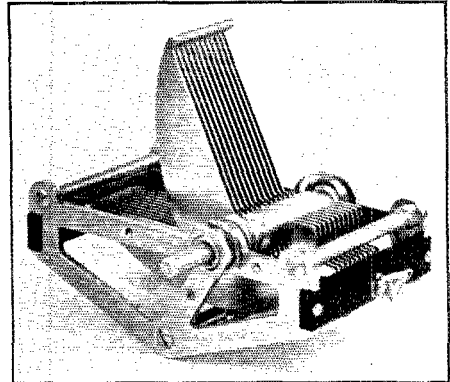

buted capacity is negligible. This means that stations operating on wavelengths that are equally spaced will be tuned in at equidistant points on the tuning dial. The condenser is made entirely of brass and hard rubber. The plates are soldered and a strip of spring metal is used as a pig-tail contact between the rotor and the frame. The insulation is a strip of hard-rubber properly placed. The condensers are made in three capacities: .0005 μfd., .00037 μfd. and .00025 μfd. They are made by the Karas Electric Company of Chicago and are called "orthometric" (straight meter) condensers.

| | | TIME AND DAY CONVERSION TABLE | | | | | | | | | | | | | | | | | | | | | | | |
|-----------|---------------------------------|-------------------------------|----|----|----|----|----|----|----|----|----|----|----|----------|---|---|---|---|---|----|----|----|----|----|----|
| Longitude | Place | TODAY | | | | | | | | | | | | TOMORROW | | | | | | | | | | | |
| | | 12 | 13 | 14 | 15 | 16 | 17 | 18 | 19 | 20 | 21 | 22 | 23 | 1 | 2 | 3 | 4 | 5 | 6 | 7 | 8 | 9 | 10 | 11 | |
| EAST 180 | Fiji Islands | 12 | 13 | 14 | 15 | 16 | 17 | 18 | 19 | 20 | 21 | 22 | 23 | 1 | 2 | 3 | 4 | 5 | 6 | 7 | 8 | 9 | 10 | 11 | |
| 165 | New Zealand (*) | 11 | 12 | 13 | 14 | 15 | 16 | 17 | 18 | 19 | 20 | 21 | 22 | 1 | 2 | 3 | 4 | 5 | 6 | 7 | 8 | 9 | 10 | 11 | |
| 150 | Austral. east | 10 | 11 | 12 | 13 | 14 | 15 | 16 | 17 | 18 | 19 | 20 | 21 | 1 | 2 | 3 | 4 | 5 | 6 | 7 | 8 | 9 | 10 | 11 | |
| 135 | Japan | 9 | 10 | 11 | 12 | 13 | 14 | 15 | 16 | 17 | 18 | 19 | 20 | 1 | 2 | 3 | 4 | 5 | 6 | 7 | 8 | 9 | 10 | 11 | |
| 120 | China, Philippines | 8 | 9 | 10 | 11 | 12 | 13 | 14 | 15 | 16 | 17 | 18 | 19 | 1 | 2 | 3 | 4 | 5 | 6 | 7 | 8 | 9 | 10 | 11 | |
| 105 | Indo China, Straits Settlements | 7 | 8 | 9 | 10 | 11 | 12 | 13 | 14 | 15 | 16 | 17 | 18 | 1 | 2 | 3 | 4 | 5 | 6 | 7 | 8 | 9 | 10 | 11 | |
| 90 | Calcutta (**) | 7 | 8 | 9 | 10 | 11 | 12 | 13 | 14 | 15 | 16 | 17 | 18 | 1 | 2 | 3 | 4 | 5 | 6 | 7 | 8 | 9 | 10 | 11 | |
| 75 | Mauritius, Seychelles | 6 | 7 | 8 | 9 | 10 | 11 | 12 | 13 | 14 | 15 | 16 | 17 | 1 | 2 | 3 | 4 | 5 | 6 | 7 | 8 | 9 | 10 | 11 | |
| 60 | Aden, Somaliland, Madagascar | 5 | 6 | 7 | 8 | 9 | 10 | 11 | 12 | 13 | 14 | 15 | 16 | 1 | 2 | 3 | 4 | 5 | 6 | 7 | 8 | 9 | 10 | 11 | |
| 45 | South Africa | 4 | 5 | 6 | 7 | 8 | 9 | 10 | 11 | 12 | 13 | 14 | 15 | 1 | 2 | 3 | 4 | 5 | 6 | 7 | 8 | 9 | 10 | 11 | |
| 30 | Germany, Italy, Norway, Sweden | 3 | 4 | 5 | 6 | 7 | 8 | 9 | 10 | 11 | 12 | 13 | 14 | 1 | 2 | 3 | 4 | 5 | 6 | 7 | 8 | 9 | 10 | 11 | |
| 15 | England, France, G.M.T. | 2 | 3 | 4 | 5 | 6 | 7 | 8 | 9 | 10 | 11 | 12 | 13 | 1 | 2 | 3 | 4 | 5 | 6 | 7 | 8 | 9 | 10 | 11 | |
| 0 | | 1 | 2 | 3 | 4 | 5 | 6 | 7 | 8 | 9 | 10 | 11 | 12 | 1 | 2 | 3 | 4 | 5 | 6 | 7 | 8 | 9 | 10 | 11 | |
| WEST 15 | | 0 | 1 | 2 | 3 | 4 | 5 | 6 | 7 | 8 | 9 | 10 | 11 | 0 | 1 | 2 | 3 | 4 | 5 | 6 | 7 | 8 | 9 | 10 | 11 |
| 30 | Brazil, east | 23 | 24 | 25 | 26 | 27 | 28 | 29 | 30 | 31 | 1 | 2 | 3 | 4 | 5 | 6 | 7 | 8 | 9 | 10 | 11 | 12 | 13 | 14 | |
| 45 | Argentina, Porto Rico | 22 | 23 | 24 | 25 | 26 | 27 | 28 | 29 | 30 | 31 | 1 | 2 | 3 | 4 | 5 | 6 | 7 | 8 | 9 | 10 | 11 | 12 | 13 | |
| 75 | Washington, D. C., E.S.T. | 20 | 21 | 22 | 23 | 24 | 25 | 26 | 27 | 28 | 29 | 30 | 31 | 1 | 2 | 3 | 4 | 5 | 6 | 7 | 8 | 9 | 10 | 11 | |
| 90 | Chicago, C.S.T. | 19 | 20 | 21 | 22 | 23 | 24 | 25 | 26 | 27 | 28 | 29 | 30 | 1 | 2 | 3 | 4 | 5 | 6 | 7 | 8 | 9 | 10 | 11 | |
| 105 | Denver, M.S.T. | 17 | 18 | 19 | 20 | 21 | 22 | 23 | 24 | 25 | 26 | 27 | 28 | 1 | 2 | 3 | 4 | 5 | 6 | 7 | 8 | 9 | 10 | 11 | |
| 120 | San Francisco, P.S.T. | 16 | 17 | 18 | 19 | 20 | 21 | 22 | 23 | 24 | 25 | 26 | 27 | 1 | 2 | 3 | 4 | 5 | 6 | 7 | 8 | 9 | 10 | 11 | |
| 135 | Alaska | 15 | 16 | 17 | 18 | 19 | 20 | 21 | 22 | 23 | 24 | 25 | 26 | 1 | 2 | 3 | 4 | 5 | 6 | 7 | 8 | 9 | 10 | 11 | |
| 150 | Alaska | 14 | 15 | 16 | 17 | 18 | 19 | 20 | 21 | 22 | 23 | 24 | 25 | 1 | 2 | 3 | 4 | 5 | 6 | 7 | 8 | 9 | 10 | 11 | |
| 165 | Samoa, Hawaii (***) | 13 | 14 | 15 | 16 | 17 | 18 | 19 | 20 | 21 | 22 | 23 | 24 | 1 | 2 | 3 | 4 | 5 | 6 | 7 | 8 | 9 | 10 | 11 | |
| WEST 180 | | 12 | 13 | 14 | 15 | 16 | 17 | 18 | 19 | 20 | 21 | 22 | 23 | 1 | 2 | 3 | 4 | 5 | 6 | 7 | 8 | 9 | 10 | 11 | |

NOTES—(*) Add one-half hour for New Zealand Time.
 (**) Calcutta local time. Subtract one-half hour for India Standard Time.
 (***) Subtract one-half hour for Hawaiian Standard Time.

NOTES—0 is midnight, 1 is 1.00 A.M., etc. 12 is noon, 13 is 1.00 P.M., 16 is 3.00 P.M., etc.
 Read the figure columns vertically, thus:—when it is 12, noon on Monday in New York E.S.T., it is 3.00 A.M. on Tuesday in Melbourne, Australia.
 Or again: 11.00 P.M. on Sunday in San Francisco is 3.30 P.M. on Monday in New Zealand and 5.00 P.M. in Australia.
 The hours of darkness—5 P.M. to 5 A.M. are shaded

THIS IS THE BEST CONVERSION TABLE WE HAVE EVER SEEN. CUT IT OUT AND PASTE IT UP OVER YOUR SET. IT WAS SENT IN TO US BY L. O. DORAN OF THE S.S. WEST JESTER.

New R. C. A. Tubes

ON the 1st of September the R. C. A. placed a number of new receiving tubes on the market. Some of them have been needed for a long time, all of them are interesting.

The UX-120

If you have operated a UV-199 tube set with a two stage amplifier and have had any volume at all available in the last stage you have noted that the last stage should either be a push-pull arrangement with two tubes and two transformers, or that it should contain two UV-199 tubes with their elements in parallel. One tube will not handle the power. The new UX-120 tube immediately eliminates this trouble. The UX-120 is an overgrown UV-199 designed for use in the last stage of an audio frequency amplifier. Its filament terminal voltage is the same as the UV-199 (3 volts) but the current drain is .125 ampere. Plate voltages up to 135 volts can be used. A "C" battery of 22.5 volts is required when the plate voltage is 135.

The UX-112

The corresponding companion tube for use with UV-201A tube sets is the UX112. In the second stage of an audio amplifier when used after a neutrodyne set or a super-heterodyne the UX-112 should immediately replace the usual push-pull amplifier arrangement necessary when a



THE NEW UX-210. A HIGH POWER AMPLIFIER AND A 7.5 WATT OSCILLATOR

great deal of "pep" is secured from the receiver. The UX-112 tube filament draws a current of .5 ampere. Plate voltages between 90 and 157 should be used, with corresponding grid bias voltages varying between 6 and 10.5 volts. The UX-112 tube also can be used as a detector, requiring a grid condenser of 250 μ fd. and a grid leak between 3 and 5 megohms.

Do not get the idea that by merely replacing your existing UV-199 tube with a UX-120 louder signals will be received. Unless there is enough power in the last stage to cause distortion with the smaller tube the UX-120 will actually show a decrease in signal strength. If distortion is due to overloading, because the smaller

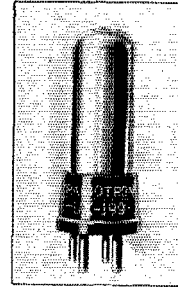

THE UX-199 — A UV-199 DRESSED UP IN THE NEW "STANDARD" BASE.

tube will not handle the energy available, the larger tube should not only eliminate this distortion but should also show a gain in signal strength. The same applies to the UX-112 tube.

The UX-210

A tube designed to handle an enormous amount of power in a power amplifier for receiving purposes is the UX-210. This tube requires a terminal voltage of 6 volts, hence it can be connected directly across the 6 volt battery without a rheostat in series. Plate voltages from 90 to 157 can be used for amplifying purposes, with corresponding C battery voltages varying between 4.5 and 10.5 volts. The UX-210 is an excellent transmitting tube. In fact it is substantially an X-L filament type of UV-202. With a plate voltage of 425 its normal output is 7.5 watts. When used with this plate voltage the filament voltage should be 7.5 volts with a filament current of 1.25 amperes. These 210 tubes should be the berries in the so-called 5-watt transmitting sets.

Special Tubes

The UX-874 is a special voltage regulator tube with a rated voltage of 90 and a starting voltage of 125. It will safely pass a maximum D. C. current of 50 milliamperes. The UV-876 is a special ballast tube with a current rating of 1.7 amperes and a voltage range of 40 to 60 volts. The base of the tube is fitted with a standard Mogul type screw plug. The UV-877 is a protective tube with a double contact bayonet locking type base similar to the

automobile headlight tube bases. A third filament connection which runs to the midpoint of the filament is connected to the shell of the base.

Rectifier Tubes

For use in B battery eliminators two special tubes are now available. The UX-213 is a full wave rectifier having a terminal voltage of 5, a filament current of 2 amperes, a maximum A. C. input voltage per plate of 220, or 440 across both plates and a maximum D. C. load current of 65 milliamperes. The UX-216B is a half wave rectifier requiring a filament voltage of 7.5 and a filament current of 1.25 amperes. The maximum A. C. input voltage is 550 and the maximum D. C. load current 65 milliamperes. Both of these tubes are huskily built and when used in B battery eliminators should have a life

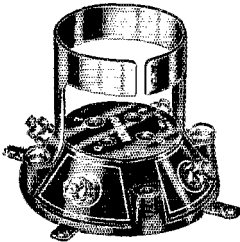

THE RADION SOCKET WHICH FITS BOTH OLD AND NEW STYLE BASES MADE BY AMERICAN HARD RUBBER CO.

vastly greater than that of the present B battery eliminator tubes.

UX Bases

Before you have gone this far you have noted new code letters on these tubes. The "UX" indicates a new type of base which is an effort (feeble as it is) on the part of the R. C. A. to standardize tube bases. We now have two new types to

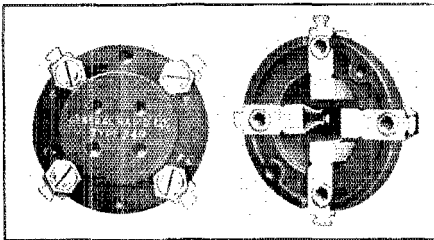

THE GENERAL RADIO "PUSH" SOCKET FOR THE "UX" TYPE TUBES.

go along with the four existing "standards." The UX bases are made in two sizes. The smaller size is used with the UV-199 tube, and the new UX-120. The larger UX base is found on the UX-200 (identical with UV-200 except in the base), UX-201-A (UV-201-A), WX-12

(WD-11-12), the new UX-112, the new UX-210 and the three special tubes. In addition to tubes with the new bases the R. C. A. still sell the old style based tubes.

The UX base has terminal pins quite a bit longer than those on the older tubes. This is so that the tubes can be used in a

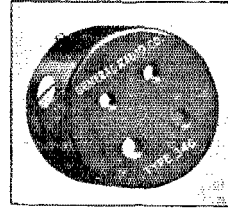

THE GENERAL RADIO ADAPTOR THAT FITS THE SMALL UX BASE IN A STANDARD NAVY SOCKET

new "push" type socket similar to the British and French sockets. The large UX base has, however, a small side pin which allows the tube to be used in the standard Navy type base. The small UX base will not fit the UV-199 type socket as it has no side pin to lock in the bayonet. It can be used with a General Radio adaptor in the large standard Navy socket.

In both small and large UX bases the terminal pin arrangement is identical and the filament pins are larger than the grid and plate pins. This is to prevent incorrect insertion of the tube in the push type sockets.

Strays

"Of the complaints of interference to broadcast reception in this district, those against amateurs are less than three-tenths of one percent. That is so low a percent that it can be due only to the cooperation of the amateur. We know that cooperation pays."—Supervisor of Radio E. A. Beane, in address at banquet of Third National A. R. R. L. Convention.

"As this issue goes to print NRRL is approaching the United States after six months of extremely noteworthy transmission on the short waves. Watch for Schnell's own story of the cruise in an early issue of QST."

Correction

In the Experimenters' Section Report in August QST, an error occurred in the paragraph on Oscillating Crystals. Speaking of crystals not oscillating the sentence *should* have read, "One then has to cut away *one edge* or another"

T. O. M. Heard From Again

By Geo. Sturley, 7BJ

AS I approached T.O.M.'s shack I saw smoke coming out of his chimney. Yep, there was a light inside. He's there I thought and glanced at his new short wave antenna as I came up the walk. T.O.M. was getting up-to-date. A door sign read "Ring Bell" and a small horn above QSL'd with "Who is there?"

"Its BJ", I answered. The door opened and T.O.M. welcomed me in.

"Thought I would drop in and hear what is rotten in radio these days."

"Yew said it, son. Sit down here and you will hear lots."

It was still daylight but just by force of habit T.O.M. handed me a pair of phones. As we talked he tuned around.

Then, "CQ CQ NORTH CQ U 5DUM QTC HR". That seemed to suit T.O.M. OK and he called 5DUM and added a QRV. The 5 came right back and shot a message.

We copied it all OK and T.O.M. signalled back "RR 1 R OK KK". 5DUM came back: "ND QRN???? HR AGN" and he repeated the whole message over again. T.O.M. wallops the table a jolt, kicks everything clear underneath and erupted a string of adjectives describing an awfully punk ham

"Howling Oscillators! Why didn't he find out what I received first? Ye Gawds... Lissen to it!" he continued. Pretty soon the signature was reached and T.O.M. adjusted the spittune for local work and answered 5DU again.

"RR 1 RRRRRRRR OK UR 1 RR OK ALL OK RR HW NWK". He sure ought to get that, I said. And 5DUM comes back "ND sorry OM QRN but w1 QTA HR".

"Yeow! Gangway! Slam!" T.O.M. heaved the phones in the corner and raked his hands through his white hair and blew a big sight of disgust.

Then he said "Huh! Wouldn't that lid do fine out on the sea somewhere and try to tie up a coast station like that...Wow!

then I asked T.O.M. where was his kitty. He didn't speak immediately.

Finally he asked, "Did you ever see that write-up in *QST* about the Braden tuned audio transformer for C.W. reception?"

"Yes", I said.

"Well—I started to make one of the things and, as I was finishing the 50,000th turn on the secondary, the bobbin head broke off and let the whole winding fall apart. Why son, it's just pure luck no hams were present then!"

"Did you finish the job?" I asked.

"Finish! Uh—Why man, I took that mess of wire and heaved it clear through the window out in the berry bushes, and Kitty got so scared she jumped through the broken window and followed the Braden transformer. I expect she'll be back any day now."

"Sure rotten luck", I assured him.

To soothe his ruffled spirits T.O.M. turned on the broadcast tuner and WOC was on. Then all of a sudden some blooper crossed T.O.M.'s bow.

"Weeeee OWWWW oooooick wawp flop ick squee owp." I thought sure T.O.M. was going to crawl right up into the loud speaker and get that birdie—he surely registered impending destruction.

"Who was it?" I asked.

"I dunno," said T.O.M., but he's going to learn some radio Etiquette right tonight. Come on BJ. I know a positive cure for that disease."

"What's that?" I asked.

"C'mon, I'll show ye!" and we left the shack in his "rattler", T.O.M. driving like mad right down through the main "drag" in town.

"I dunno how th' gas is," he says, and swerves the car into a filling station with locked wheels dragging through the gravel. As we stopped so did a uniformed motorcyclist. He put his cycle up on its stand and leisurely dusted off his coat, removed his gloves and headed our way.

"Hello there," he says.

T.O.M. returns, "Good evening".

"What's your name?"

"My name's T.O.M."

"When do you want to appear?"

"Huh? What was I doing?"

"Better'n 30 right on Main Street."

"Uh, well guess you're right."

"Of course, I'm always right."

"Alright, I'll appear in the morning," says T.O.M. and the cop hands him a summons.

"Huh! Blast those two-wheel destroyers," he says as we proceeded. But now he

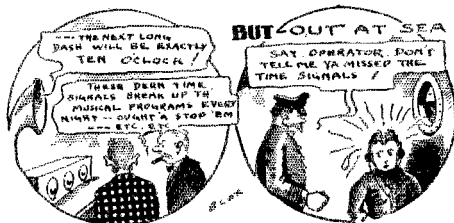

Another operator's ticket folded up in a suitcase".

There was silence for a couple minutes,

watched the speedometer like it was reading milliamps. We stopped at some house, but as it was dark now I couldn't see much. T.O.M. returned with some kind of clock-work under his arm running.

"Oho. An omnigraph, eh?" I says. And I thought to myself, "T.O.M. has brains alright," as I imagined various possible uses that T.O.M. would put this thing to.

Yep, soon as we entered the radio shack again T.O.M. booked up the omnigraph in the antenna circuit on the broadcast tuner. While things were quiet he turned all the omnigraph dials upside down on the shaft and opened the speed regulator wide open. Then we waited for Mr. Blooper. Sure enough, he came back resplendent with all the howls and yowls known to this pestiferous art and T.O.M. released the omnigraph. Big Hi! I never saw the Old Man so happy. We could hear Mr. Blooper wriggling around, twisting, squirming like a snake on hot coals and finally he must have found a combination on adjustments where his set didn't oscillate.

"Fine!" says T.O.M. "Bet he didn't know that before!" Several times during the next hour Mr. Blooper let his jazz-box spill over but we heard him pipe down the oscillating right pronto, like he feared another onslaught of 60-word-per hash.

"He's learning fast!" says T.O.M.

"Not that 60-per hash," I says.

"No, I mean his radio manners have improved!"

Changing the subject I mentioned to T.O.M. the new antenna of his I saw coming in.

"Yes, and say—that reminds me of another rotten thing in radio. You know son, some day I'm going to a Radio Convention and if I ever find that ham present who advocated tin pipe masts...I'll...I'll sure clean him."

"How cum?" I asked.

"Well, I tried it and tried hard. This ham said number 26 gauge rainpipe 2 inches in diameter can be made into a swell strong unsinkable radio mast. Yes sir, I'd jest like to find him now. I had two tackles, six hams, and enough gear, patience and persistence to raise three civilized masts, and after crimping the pipe three times before getting started, we got it half way up when without warning it buckled up in the middle and twisted into six dollars worth of scrap tin. And oh, how all the hams and BCLs gave me the horse laugh! Every time I'd meet any radio hound any place I got an 'I told you so'. Rotten!"

"Sure was," I agreed. "And say OM, how does this new master oscillator kick out?"

"Oh, just fine," says T.O.M. "You know the reason I put that in was to set an example for some of these awful ether warblers and garling QSBs we all hear down on short

waves. Why don't some of those birds ever tune up their receivers on an upper harmonic of their own waves sometimes and catch an earful of it? Boy—I bet if they did they'd go hide in the woods."

And as we flailed rotten QSBs some little noise outside made T.O.M. slip out to see what and who. As the door opened durned if T.O.M.'s Kitty didn't come in. So we spent the rest of the evening feeding up T.O.M.'s cat.

An Input Transformer

SUPERHETERODYNE constructors will be glad to know that there is a factory made Input Transformer designed to replace the cumbersome honeycomb coil transformers which have heretofore been used as input transformers. This new transformer is the product of the General Radio Company, and while it was designed to function in conjunction with their own medium frequency transformers it will operate very satisfactorily with any intermediate frequency transformer having its peak at about 10,000 meters (30 KC). The new GR type 331 transformer is an air core affair having its secondary permanently tuned by a 500 µuf fixed condenser. This condenser is sealed in the bakelite case which holds the transformer. Appropriate terminals are provided for inserting the transformers directly in a superheterodyne

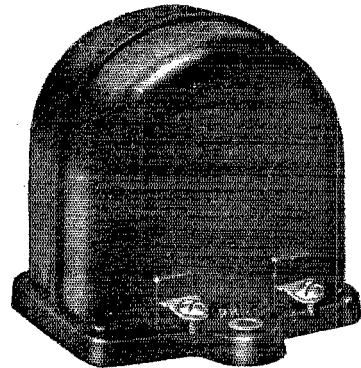

circuit. The transformer requires no external shunt capacity in order to make it resonate at 10,000 meters. The lack of any iron in the magnetic circuit makes it tune very sharply at this wavelength.

Strays

Artgum, obtainable from any 5 and 10 store, makes excellent shock absorber material for your m. g. set.

Tools Galore!

THE worst of the reactionaries who deplore the broadcast craze will have to admit that it has benefited the radio builder. He certainly now has a tremendous variety of good apparatus to pick from, and just look at the tools designed especially for him.

There's the Stevens' line of tools which are illustrated herewith. Sets of wrenches for hexagon or knurled head nuts, extremely handy in assembling parts and making connections. Offset wrenches for getting at nuts a regular wrench won't reach. Three different kinds of reamers for different purposes as shown, and which

are useful for countless things. Scribes (a fellow could make one of these) for laying out panels or for engraving your own indicating lines. Cutters for making peepholes and a bezel beader to finish them off. A drill and countersink in one. An adjustable panel cutter that makes it an easy job to mount any panel type of meter, and even a little clamp to hold screws, which will also smooth out burred threads that would make a screw run hard or not at all. These are manufactured by Stevens & Company of New York.

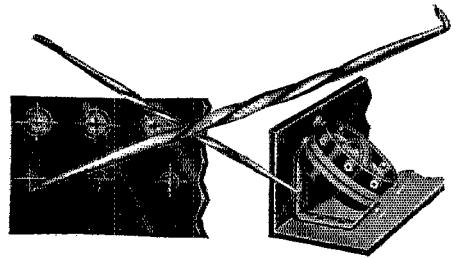
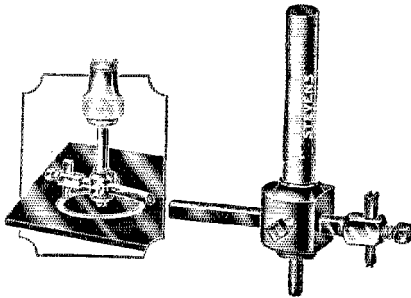

Adroit Jr.

PAT. JUNE 10, 1924

SPECIAL TIPS

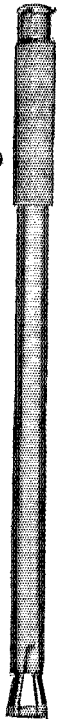
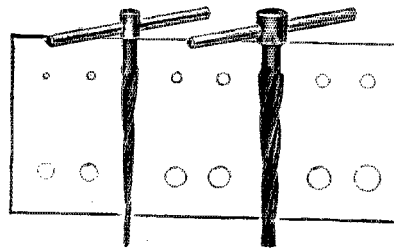
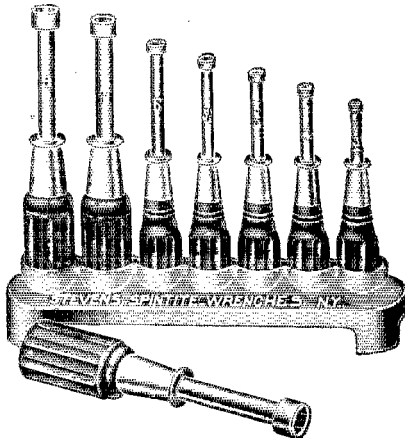
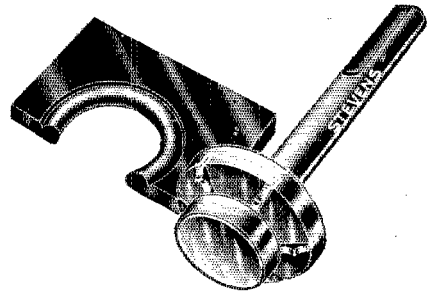
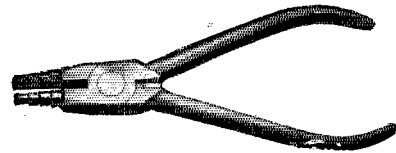
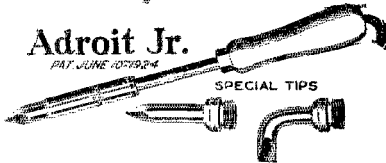

There is an excellent little tool called the "Reachit" which is manufactured by **Caufman & Clough Company of New York**. This will grip round nuts very tightly as we have found, and its jaws are formed to fit the hex nuts. It takes quite a variety of sizes as might be imagined.

The Goyer pliers are oddly useful because one can form a loop to fit the screw over which it must be slipped. And do this without any danger of error, for the plier is marked with the screw sizes. In addition it has a cutter between the handles. This is manufactured by the **Goyer Company, Willimantic, Conn.**

The soldering iron has also undergone a metamorphosis. Many of us can remember when none could be obtained for less than twelve or fifteen dollars. Look at the number of low-priced varieties we

have now. A very handy one is illustrated that has several tips which are interchangeable. The goose-neck tip will be found particularly useful for difficult connections. It is manufactured by the **Adroit Tool Company of New York**.

Most radio and hardware stores are nowadays carrying a full line of tools especially adapted to apparatus; tools designed with the idea that they probably will be used in the parlor rather than in a machine shop.

We have illustrated here a few typical ones. In addition to these there are many types of coil winders, both the cylindrical and spiderweb or basket-weave varieties.

*The Editor is in a pinch,
He needs about half an inch,
To fill.
And so he writes this little verse,*

(Extensive cerebration and investigation has proven conclusively that there exists no suitable word, rhyming with "verse," with which to terminate the next line.)

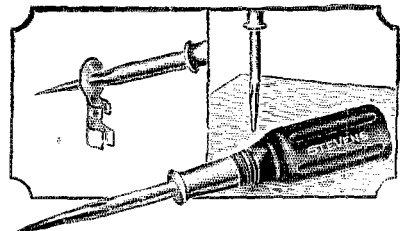
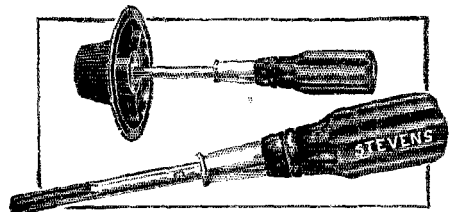
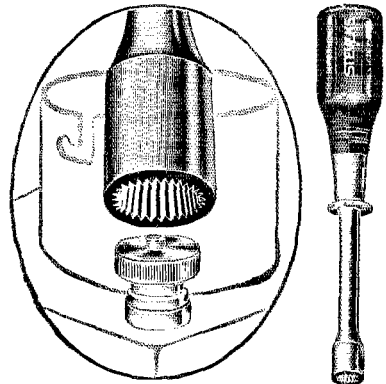
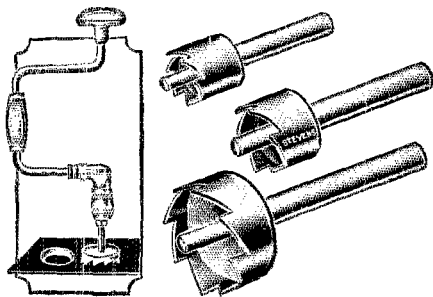
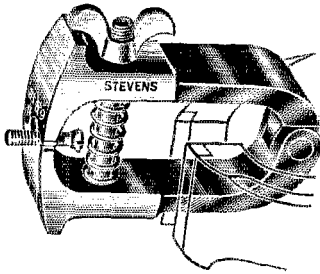
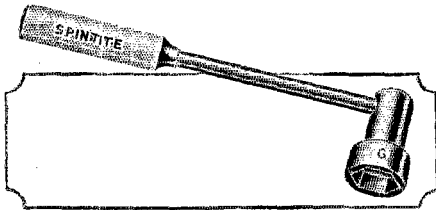

A Simple 200 to 600-Meter Receiver

YEARS ago when radiobroadcasting was new to the general public the Westinghouse people entered the radio business with a receiver that was a single circuit affair. It took with the radio public and its constructional features were copied far and wide. People thought for a long time that for simplicity and ease of construction the single circuit type of

The following parts will be needed. They can be purchased at almost any radio store.

- 1 Breadboard not smaller than 12x18 inches
- 1 500 μ fd (.005 μ fd.) variable condenser with vernier (C1)
- 2 standard tube sockets
- 1 30 ohm rheostat (R1)
- 1 variometer (V)
- 1 2,000 μ fd. (.002 μ fd.) fixed condenser (C2)
- 1 250 μ fd. (.00025 μ fd.) grid condenser (C)
- 1 Audio frequency transformer (T)
- 1 Open circuit jack (J)
- 1 5 megohm grid leak (R)
- 1 General Radio 277-D Coupling Coil (L and LI)
- 1 Hard rubber terminal strip $\frac{1}{4} \times \frac{1}{2} \times 6$ inches
- 5 Binding posts
- 3 2 foot lengths of tinned bus wire
- 10 $\frac{1}{2} \times \frac{1}{2}$ inch brass angles for mounting apparatus
- 20 No. 6 round head brass wood screws $\frac{3}{8}$ inch long

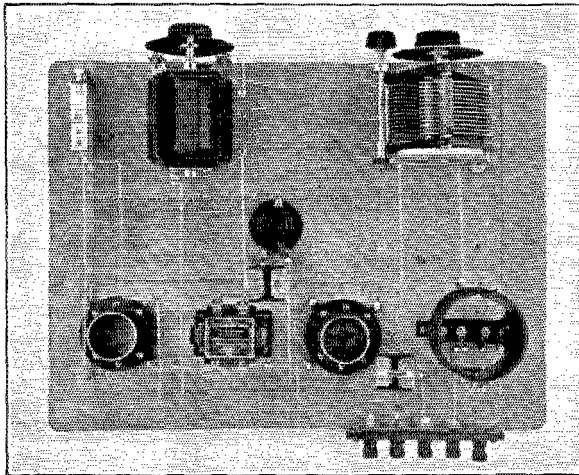

THE COMPLETED RECEIVER

receiver was in a class of its own. Thank goodness that time was years ago. The radiophone public no longer fails to see (and hear) the radiating properties of the single circuit set; no longer believes a single circuit affair the easiest to operate and the best DX-getter. We now have the neutrodyne, the superheterodyne and a whole flock of tuned R. F. sets and many others involving many tubes, much money and a lot of radio knowledge on the part of those who want to assemble a set. We have not seen a description of a *good* simple receiver in a long long time.

With the advent of standardized parts it is really a simple job to assemble a good receiver that is *not* of the single circuit type. The set we are describing can be assembled in several hours and will give excellent results on all wavelengths between 200 and 600 meters. One stage of audio frequency amplification is all that will be required for headset operation. If you *must* use a loud speaker an additional stage of audio frequency amplification can be added easily. Mounting the apparatus on a breadboard not only tends to simplify the assembly but also increases the efficiency of the completed set.

The coupling coil can be purchased readymade or can be constructed by winding 59 turns of No. 26 S.C.C. magnet wire on a $2\frac{3}{4}$ inch hard rubber or cardboard tube. This is the secondary coil LI. A strip of heavy paper $\frac{3}{8}$ inch wide is next wrapped around the secondary as near one end of the

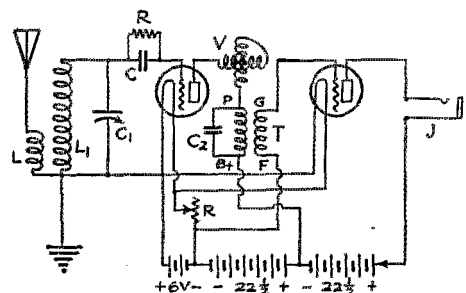

THE CIRCUIT

tube as possible. This strip is held in place by means of a little glue. Over this paper the primary coil L is wound. It consists of 15 turns of No. 26 S.C.C. wire. The end of the primary nearest the end of tube form is connected to the secondary and to the

ground. This allows the "free" end of the secondary (the one away from the primary) to be connected to the grid condenser, as it should be. The rotary plates of the secondary tuning condenser C1 should be connected to the grounded end of the filament circuit.

Regeneration is controlled by means of the variometer in the plate circuit of the detector tube. The General Radio type 269 variometer is particularly recommended on account of the very large variation in wavelength possible with it. Any good variometer, however, can be substituted.

All of the apparatus is mounted by means of the brass angles that are bolted to the various parts by means of appropriate bolts on the apparatus.

When wiring the set take care to connect the "F" terminal of the audio frequency transformer directly to the -6 volt terminal on the binding post strip. The safest thing to do is to wire in the filament circuit first. After it has been completed connect the A battery to its terminal on the set, and see if the tubes light. Then wire in the plate leads and B battery wires and finally the coupling coil and its tuning condenser.

A set of this type will give very satisfactory headset reception over distances between 500 and 1,000 miles under good conditions. At night during the winter months and with a good antenna it is even possible to exceed these distances.

A New Tungar Charger

THE improved type of Tungar charger, while basically the same as previous models, has several added features which add to its value. This type of charger is especially adapted for charging A batteries. As the charger has a two winding transformer, instead of the auto-transformer which was used in the previous

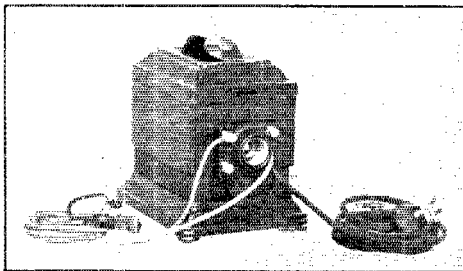

FIG. 1. EXTERNAL VIEW OF NEW TUNGAR CHARGER

sets, it is unnecessary to disconnect battery leads from the radio set when charging the battery. This two-winding transformer also prevents any accidental burnout of either the Tungar tube or the vacuum tubes in the set if a ground is placed on either the

charger or the filament circuit of the battery. Leave the charger connected to the battery; when it is desired to place the battery on charge simply plug in the attachment plug into the nearest socket and the charger starts operating.

There are four binding posts and a lamp socket mounted on the rear of the charger case (Fig. 1). One of these posts (the lower right hand one) is the common nega-

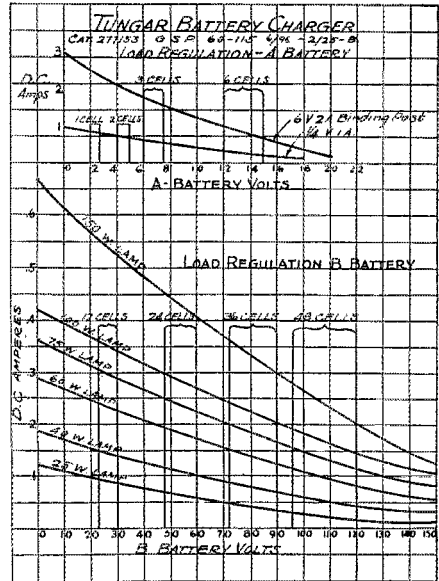

FIG. 2. A AND B BATTERY LOAD REGULATIONS

tive post. The upper left hand post marked 6V is connected to the positive terminal of either a 6 or 12-volt battery. When connected to a 6-volt battery the charging rate is 2 amperes, while on a 12-volt battery the charging rate is 1 ampere. The lower left hand post is for charging either a 2 or 4-volt battery at 1 ampere. This charger may also be used to charge Edison A batteries consisting of 1, 3 or 5 cells.

The improved Type Charger also will charge storage B batteries. When used for this purpose a 25 to 150-watt lamp is inserted in the lamp socket on the outside of the case, the negative terminal of the B battery is connected to the lower right hand binding post on the back of the charger and the positive terminal is connected to the upper right hand post. The correct size of lamp can be determined from the curves shown in Fig. 2. To charge at .1 ampere rate a 25-watt lamp should be used for a 24 to 48-volt battery; a 40-watt lamp for a 72-volt battery and a 60-watt lamp for a 96-volt battery. In no case should the charging rate for storage B batteries exceed .25 ampere. Both the battery and the charger

are very likely to be damaged if the charging rate is too high. To charge at a .25 ampere rate use a 60-watt lamp for a 24 to 48-volt battery; a 100-watt lamp for a 72-volt battery and a 150-watt lamp for a 96-volt battery. As in the case of the A batteries, it is not necessary to disconnect the B batteries from the set when charging. The lamp on the case burns dimly when the battery is charging satisfactorily. If it burns brightly the battery connections are probably incorrect and should be checked.

The new type Tungar tube is electrically identical with the old tube. Mechanically, however, the tube is different. There is no plate connection to be made externally—all leads are properly connected when the tube is screwed in to the socket inside the charger case.

A New Wavemeter

FOR some time there has been quite a consistent need for an intermediate wavemeter; something between the 2 per cent accurate condenser-coil combinations and the precision type suitable for high class laboratory work. The Wireless Manufacturing Company of Canton, Ohio, has made meter available.

In their type A instrument (photographs of which are shown) consists of a condenser across one of the two coils and a

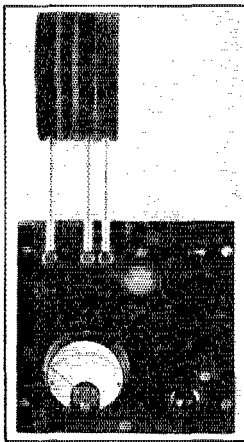

EXTERNAL VIEW OF THE WAVE METER

fixed crystal detector and D. C. milliammeter in series across the terminals of a single turn pick-up coil. Two two coils terminate on three plugs fitting sockets on the ends of the three long rods. The milliammeter is a 0-5 Weston instrument. Since the crystal is in series with the meter there is no danger of the meter being burned out. If the coupling between the

wavemeter and the transmitter is too close the crystal will burn out (and need readjusting) before the milliammeter will be hurt. The parts are mounted on a quarter inch aluminum plate to which a ground post is attached. The inside of the instrument cabinet is lined with sheet copper which makes contact with the alumi-

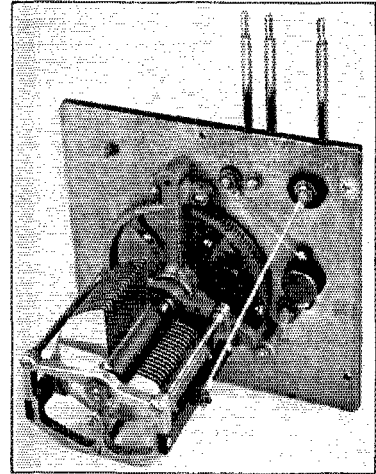

BACK VIEW WITH CASE REMOVED

num plate, shielding the wavemeter thoroughly.

The condenser is fitted with a geared slow motion device which is positive and smooth running. The condenser itself has a vernier scale that allows the condenser setting and wavelength adjustment to be very accurately read. The precision of calibration in the type A meters is .5%. A separate condenser capacity calibration curve is supplied on order, and the condenser terminals are made available by the use of small contact jacks which fit over the two rods to which the condenser is connected.

The type B wavemeter is similar to the type A with a few exceptions. Where accuracy on the order of .5 per cent is not needed the B meter can be used. A condenser of high quality but lower cost is substituted. In place of the crystal and D. C. milliammeter a low resistance lamp has been inserted in the single turn pick-up circuit. This lamp is visible through a peep-hole. The calibration of the type B meter is accurate within 1 per cent.

Four coils are available for use with this meter. They will cover the wave bands from 17 to 550 meters.

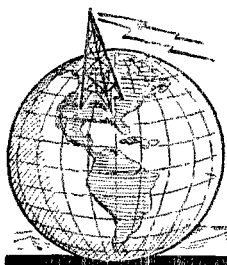

I. A. R. U. NEWS

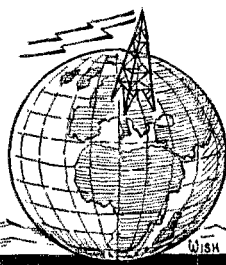

China to Chile!

A very splendid piece of DX work was done in the evening of July 13th when NUQG, the U. S. S. *Pillsbury* at Chefoo, China, worked ch1EG at Vilcun, Chile. A message to the A.R.R.L. Headquarters informing the gang that NUQG is operating daily was sent to ch1EG who promptly QSRred to u6JP. Subsequently NUQG and ch1EG were QSO four consecutive nights and they had little trouble holding each other for an hour or so each night.

The transmitter on the *Pillsbury* was assembled by and is being operated by O. T. Cooper. It consists of a single 50 watt tube fed from the 500 cycle spark transmitter supply generator through a 1100 volt transformer. When operated at 40 meters the *eleventh* harmonic of the very large ship's antenna is used and when operated at 20 meters the *twenty second* harmonic of the antenna's fundamental is used. In both cases an antenna current of two amperes is secured. On 20 meters NUQG has worked 450 miles in daytime; the 40 meter wave being used for night work. (see NUQG's list in Calls Heard).

The Chilean station is the most southerly in the Western Hemisphere we have any record of. It is owned and operated by Mr. Edmundo Guevara and is situated on a farm 11 miles from Vilcun. ch1EG has two transmitters, a 150 to 300 meter outfit and a 20 and 40 meter set. The latter was put in operation about the 1st of July of this year and its first DX work was with NUQG. Power is obtained from a 6.5 K.W. generator driven by a water wheel. The transmitter for 40 meter work uses two 50 watt tubes. ch1EG has been QSO 6JP, 9ZT, 1PL, 5ACL and a few other U. S. stations. He has been heard by a great number of the gang among whom are included 6BUR, NVE off West Coast of the U. S., d7EC, bz1AK, KFUH, S. S. West Jester 11,000 miles away and bB7. Guevara is testing nightly with NUQG on very short wavelengths. They establish communication on 39 meters from 6:40 to 7:40 A.M. Chilean time (E.S.T. one hour later) and gradually QSY until contact is lost. 1EG is anxious to arrange very short wave tests with any of the gang.

In Uruguay there are no government regulations under which the amateurs operate. The hams there have assigned their own call letters and use any wavelengths they desire. At present there are ten transmitters in operation.

A new station in the Canal Zone—the call is 99X—and the station is operated by Wm. Rieger, U. S. Naval Air Station, Coco Solo, Canal Zone. The power is one 50 watt tube and he was first QSO The States when he worked 1PL.

The current issue of the *U. S. Coast Guard Radio and Communication Circular* contains the following: "During the International Ice Patrol just completed by the *Tampa* and *Modoc* both vessels kept a nightly schedule with the amateur station 1BQQ located at 42 Union Street, Mansfield, Mass., owned and operated by Mr. George Howard. The *Modoc* and *Tampa* in carrying on communication with 1BQQ used a Type T1 transmitter and the CGRI (superheterodyne) receiver. Mr. Howard's station uses a 20 watt tube transmitter. The distances over which communication was maintained varied from 1,000 to 1,400 miles. The schedule maintained with 1BQQ was very reliable and enabled the officers and crews of both vessels to send and receive messages to and from their homes, Mr. Howard very kindly forwarding all messages received. This kindness was very much appreciated by the crews of both vessels who take this opportunity to thank Mr. Howard for his untiring effort and kindly courtesy." To which 1BQQ adds that neither of the ships could be copied when using straight C.W. due to their rolling and pitching, but their I.C.W. signals were always good. This work on 1BQQ's part took place on 150 meters. 1BQQ even put a phone signal to the two ships when using two oscillators (5 watts each) and two modulators.

D. Arakawa, Radio Engineer of the Department of Communications. Japanese Government gives us the following data regarding station j1AA located at Saitamaken, Japan: There are two transmitters in operation. One is for the 20-meter band

and uses a single Marconi quarter k.w. tube in a Hartley circuit and the other uses two UV-203 tubes in a Hartley circuit for 40- and 80-meter work. The antenna is a 60-foot vertical cage. Antenna current with either transmitter is one ampere. A Reinartz receiver with one stage of audio frequency amplification is used for reception on all wavelengths. Any communications to J1AA should be addressed to Iwatsuki Radio, Saitamaken, Japan.

6EA reports that his signals were received by o-A4Z in Capetown, South Africa at 3:35 P. M. South African time. If 6EA's sigs travelled over America and the Atlantic they would have encountered daylight all the way and would have travelled a distance of approximately 9,000 miles, while if they went the other way around the distance would have been roughly 14,000 miles, daylight in South Africa and darkness from Los Angeles out.

New regulations in Argentina will allow amateur operations on any wavelength between 0 and 190 meters except during B.C.L. quiet hours that are observed between 1300 and 1600 G.M.T. The maximum wavelength during these hours cannot exceed 125 meters. Amateur fones and I.C.W. transmitters are not silenced during the quiet period.

The Czechoslovakian government will grant a license to operate a short wave transmitter to any person provided they are "self-righteous, reliable and irreproachable" and if they can prove that they intend to establish the transmitting stations for scientific purposes only.

**NOTICE
TO BRAZILIAN AND SWISS MEMBERS
OF THE I. A. R. U.**

The members of the International Amateur Radio Union residing in Belgium, Brazil and Switzerland are hereby advised that the minimum required number of members has been received from these countries, and the Union are hereby declared existent.

In accordance with Article III, Section 3, of the Constitution, a National President is now to be elected in Belgium, in Brazil and in Switzerland, to serve for a term of two years. His powers and duties are outlined in the Constitution. You are invited to nominate a member of the Union from your country to become your National President. Article V, Section 10, specifies that in order to be eligible the nominee must not be commercially identified with the radio industry and that he must be a member of the Union. All nominations must be received by Nov. 15, 1925, immediately after which ballots will be prepared, listing all the eligible names placed in nomination, and mailed to you for the actual voting. Address your nominations to International Amateur Radio Union, 1711 Park St., Hartford, Conn., U. S. A.

K. B. WARNER,
International Secretary-Treas.

Sept. 1, 1925.

The attention of all of the readers of these columns is drawn to the application blank for membership in the International Amateur Radio Union, the *international* organization of radio amateurs interested in two-way telegraphic communication, to be found at the bottom of this page. The organization is growing rapidly. We need you, OM. Fill in the application blank!

APPLICATION BLANK

Executive Committee:1925
International Amateur Radio Union,
1171 Park St., Hartford, Conn., U. S. A.

Sirs:

I am interested in the objects of the International Amateur Radio Union and desire to become a member. I agree, if elected to membership, to abide by the Constitution and regulations of the Union. I attach \$1.00 covering my first year's dues.

.....
(Name)

.....
(Street or Box Address, etc.)

..... (Town) (State)

.....
(Country)

(Remittances should be made payable to The International Amateur Radio Union.)

Mr. W. G. Dixon, Secretary, British section of the I.A.R.U. writes us the following report of British activities:—Several New Zealand and Australian stations have been worked on low power and a series of tests show that it is possible to maintain good communication under favorable conditions with a power input of less than 30 watts. In one instance on July 22nd 2LZ worked z3AL when the latter was using only 2½ watts input, which represents 5,000 miles per watt. NRRL became audible again about the middle of July when the Seattle was approaching New Zealand and a message for Washington was handled by g2NM. g2OD and g2LZ also have worked him on 40 meters. WNP and WAP have been handing out excellent signals most of the month and a number of messages have been taken from WNP by g2KF, g2SZ, g2CC and g2NM on 40 meters.

Most of the British stations are using the 45 meter wave length although in most cases a separate 23 meter wave is available. Daylight work on the lower wave, however, is very unreliable; the 45 meter wave seems to be the most reliable for 24 hour communication except for an hour after midnight when distances up to 500 miles cannot be bridged satisfactorily. North American signals are received best from midnight to 2 A. M. while the South American signals come through from 11 P.M. to 8 A.M. New Zealand stations are heard best from 5 A. M. to 6:30 A. M. and the Australians from 6 A. M. to 7:30 P. M. DX work has been seriously hindered on a number of occasions by QRM in the 35 to 40 meter band from European stations using raw A.C. plate supply. All of the British gang are invited to send in reports of this sort of QRM so that the stations concerned may be communicated with. g2NM has worked a string of A's and Z's and his power fone is now getting out well. g2LZ has done an excellent month's work, having been QSO a number of A's, Z's, two R's and was QSO a new country.

—Y-7XX of Jugo Slovakia. 5SI has been doing some wonderful low power work and has succeeded in lowering his previous record with u1PL. On July 25th they hooked up again and were in communication with an input of only .64 watt. The same day g5SI repeated this feat by working u1CMX on the same input. g2VX of Aberdeen has connected with Palestine BSM on 45 meters. A new contact. g2CC is still going strong, having worked several Z's and having taken 3 messages from WNP. g2KK has logged oA4Z on 48 meters.

M. Robert Audureau, f8CA and Secretary of the French Section of the I.A.R.U. writes the following report on French Progress:—f8BV at Paris with an input of 65 watts is frequently QSO New Zealand and Aus-

tralia. On the 14th of June he worked bz1AB with an input of only 30 watts. f8QQ with an input of 65 watts has been in communication with a2BC at Sidney, Australia on 37 meters and f8SM is working two way with Brazil, Argentina, Australia and New Zealand on both 44 and 21 meters. On June 20th f8CT was in touch with z2AE and z2YI between 0527 and 0657. With an input of only 20 watts f8RDI worked bz 2ST on a wavelength of 37 meters. At the time 2ST's input was 26 watts. f8SM when using a loop transmitter working on a wavelength of 4.5 meters has secured a range of approximately 18 miles and with a loop transmitter operating on a wavelength of .85 meters (85 centimeters) he has worked 17 miles in daylight. With an input of only 30 watts f8ALG has had two way communication with z2AE and z2AC regularly.

On June 7th the first two way communication between Belgium and Brazil was established when bK2 worked bz1AB for an hour and a half. bK2 operated on a wavelength of 75 meters and bz1AB was on 37 meters. bK2 is anxious to arrange 5 meter tests with U. S. hams. He can be addressed care the Reseau Belge.

While there are nearly 30 transmitters in operation in Switzerland only one is "officially" licensed. His call is h9XB and his QRA Marcel Roesgen, Geneva. It will be remembered that Roesgen was one of the pioneer receiving hams during the first trans-Atlantic tests held in 1921.

Amateur transmission has just commenced in Northern Ireland. Eric Megaw of 3, Fortwilliam Drive, Belfast, has been assigned the call 6MU (using "g" as an intermediate, of course) and he is QSO all parts of Europe with a set using four 5-watt tubes.

The call letters of the Manchester (England) Wireless Society which were formerly g2FZ, g5MT and g5MS have been changed to g6MX, the one call taking the place of all three of the old ones. The society is agreeable to arranging tests with any dx hams. A request addressed to the Secretary, 66 Oxford Road, Manchester, will bring an immediate response.

NVE, that wicked signal we all have been hearing just below 37 meters, is The Call of a short wave set on the U.S.S. *Utah*. She has just returned from a trip from Annapolis to the West Coast. The trans-

(Continued from Page 54)

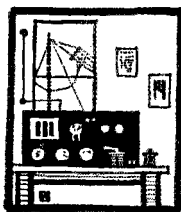

Amateur Radio Stations

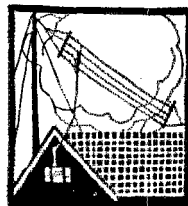

1ARE, Pittsfield, Mass.

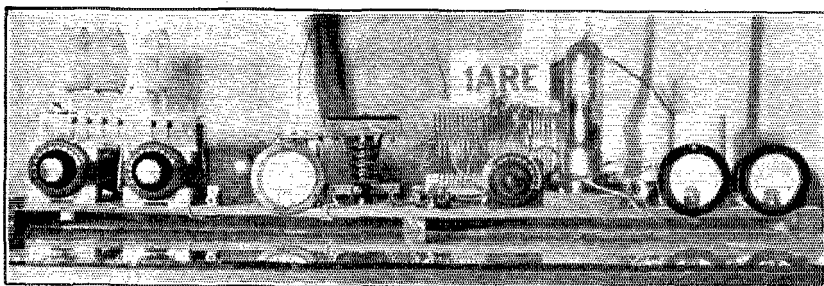

THE major portion of the equipment in use at this station was made by its owner and op A. W. Everest. The transmitter consists of a single 50-watt low-impedance tube working in a coupled Hartley circuit. Plate supply is obtained from a homemade 1100-volt transformer (550 volts on each side of center tap) fed to the plate through a brute force filter consisting of a 30-henry choke and a 2- μ f condenser across the line on either side of the choke. The key click filter consists of an audio frequency plate reactor in the high voltage line with a 1- μ f condenser across the line. The filament transformer is a Christmas tree lamp affair. In lieu of a center tap two Xmas tree lamps (to match the transformer) are connected in series across the transformer's secondary and the grid and plate returns from the tube are connected to the midpoint between the lamps. In order to clean up the note and hold it a 23 plate condenser is connected across one turn in the grid coil.

The receiver is a beautiful job. The coils are mounted way up in the air where they are away from everything. They are wound with No. 16 d.c.c. magnet wire to a diameter of 3 inches. The turns are spaced and held in place by means of three small celluloid strips to which they are cemented with banana oil. A three plate National condenser across the secondary will cover the 40-meter band when there are 9 turns in the secondary coil. Four turns with a three plate condenser will cover the 20-meter band and for the 80-meter band a 21-turn Lorenz coil

is used. The detector tube is mounted upside down so that the grid and plate leads come out on top and near the coil supports. The grid condenser is mounted high above the baseboard and everything else. Regeneration is controlled by means of a 250- μ f variable by-pass condenser across audio frequency transformer and B battery. A. R. F. choke is used in series with a tickler and audio transformer, tho.

The antenna at 1ARE is a single No. 12 enameled wire, semivertical, 100 feet long and 75 feet high at its maximum point. The counterpoise is a 4-wire cage 60 feet long

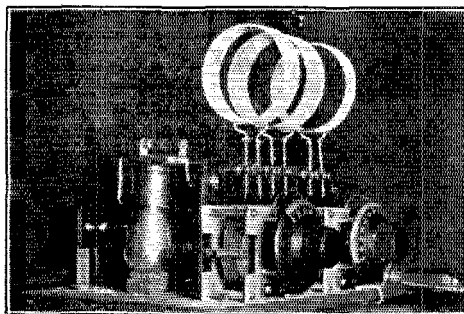

CLOSE-UP OF THE 1ARE RECEIVER

and situated at right angles to the antenna. Everest says that as soon as he gets through tsking Asperin after clearing WAP-WNP he is going to improve the antenna system.

9CXX, Cedar Rapids, Iowa

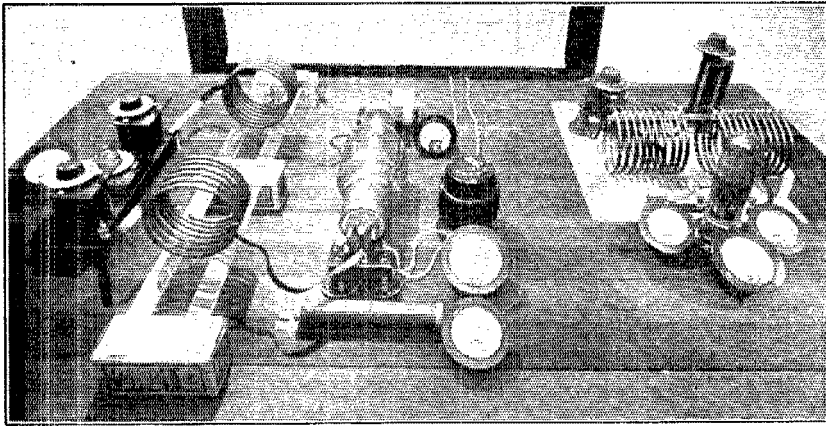

THIS station was the first to be in communication with WNP on 20 meters and has been WNP's mainstay ever since for 20-meter work. Its owner and operator Arthur A. Collins, believes in simplicity for efficiency. Look at the photograph and see how beautifully simple both transmitters shown therein are.

The big tube set has only been used on the 5 and 20-meter bands due to the fact that Collins has not secured a decent plate supply for it for use on the higher wavelengths. The tube is normally worked with an input of close to 1 K. W. in a slightly modified Reinartz circuit. As soon as a mercury arc rectifier is obtained the big tube will probably be used on all wavelengths. The inductances are copper tube helical forms temporarily supported on two long glass bars. For use in the Reinartz circuit these bars are very long allowing great latitude in coupling between the two coils.

The smaller set which has been in use at 9CXX for some time uses a single 203-A tube with a filtered S tube rectifier supply delivering 1,500 volts to the tube. A rather unique arrangement of apparatus is seen in the 50-watt tube set. The tube together with plate blocking condenser C1, grid condenser C6, grid leak and R. F. C. are mounted on a breadboard. The P, F and G terminals from the tube are arranged on a hard rubber terminal strip so that the connections between the tube and different "breadboard" tuning units can be quickly made. The 19-meter breadboard consists of coils and condensers for a 3-coil Meissner circuit. The antenna coil L3 terminates on a terminal strip carrying posts for the antenna and counterpoise. For 38 and 76 meters another breadboard has inductances mounted for a coupled Hartley circuit, with

proper terminals for the tube and antenna circuits. This is a most flexible layout—one that should find much use in combined experimental-traffic stations.

9CXX has never been blessed with a good antenna location. Due to opposition it has been impossible to erect a good antenna. The present system consists of a single

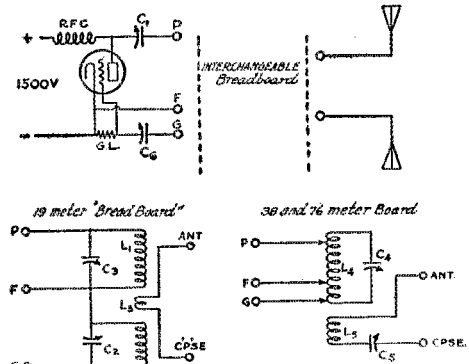

CIRCUIT AT 9CXX

- R.F.C.—150 turns No. 24 D.C.C. 2 1/4 inches diameter.
- C1, C2 and C3—250-ufd. G-R receiving condensers.
- C4—40-plate triple spaced.
- C5—500-ufd receiving condenser.
- C6—250-ufd same.
- L1—3 turns of 1/4-inch copper tubing, 3 inches in diameter.
- L2—2 turns similar to L1.
- L3—1 turn similar to L1.
- L4 and L5—10 turns 1/4-inch tubing, 5 inches in diameter.

wire antenna 50 feet long and a 48 foot counterpoise 20 feet below the antenna.

The receiver is the conventional Reinartz-Weagant arrangement used with one stage of audio frequency amplification.

7NT, Butte, Montana

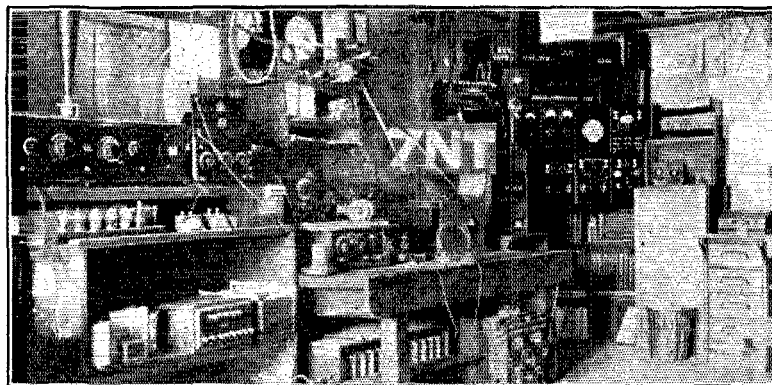

THIS station is owned and operated by Abner R. Wilson, an old time A.R.R.L. man. It was first on the air early in 1923. Since then innumerable changes and additions have been made until the result is the nice looking layout shown in the photograph.

The transmitters are three in number; a 5-meter set using one 50-watt tube, a 20-meter set using another 50-watt tube and a 40-meter outfit using 2 50-watt tubes. Plate supply for the 5-watters is obtained from either a 500 volt M. G. or from the city mains through a transformer and the rectifier and filter shown under the table. The plate supply for the 50-watt tubes comes from the homemade power transformer (filament supply also from this transformer) under the table. The primary of the transformer is tapped for accurate voltage regulation of the filament supply. The chemical rectifier is a very neat job and contains plenty of jars.

There are a number of receivers available. At the extreme left is an Ultradyne B. C. L. superhet with an antenna coupler at the right of it. Next is a three circuit regenerative for B. C. L. and 600-meter work and on the operating table are two regenerative sets for waves below 200 meters. On the shelf above the operating table is a 3-circuit honeycomb coil receiver used for long waves.

7NT is well supplied with laboratory apparatus. There are four calibrated variable condensers, a 2,000-ohm resistance box, two wavemeters, a set of standard coils mounted and ready for use in experimental hook-ups, a good assortment of indicating meters, D.C. and A.C. supply panels, 5-meter wavemeter and other useful and essential laboratory devices. This is our idea of a good traffic and experimental station. When 7NT wants to operate he

doesn't have to rebuild the transmitter or receiver because he has been experimenting. The relay apparatus is kept intact and the laboratory apparatus is entirely separate.

I.A.R.U NEWS

(Continued from Page 51)

mitter consisted of two 50-watt W. E. tubes in a coupled Hartley circuit. The receiver a conventional Reinartz and one stage of audio amplification. The operators were Midshipmen Jordan and Offutt (3BUR of Annapolis) and Chief Radio Electrician Moran.

The U. S. S. Wyoming, NWQ, will be in Southern waters all fall and Ensign S. A. Hammond, jr. of 1UV, will operate a low power short wave set on board. Hammond asks the co-operation of all hams in and around the West Indies and in the Southern States. The call, again, is NWQ.

There are only two active transmitters in Denmark at the present time, d7ZM and d7EC. Of these two d7EC, Eigil Cohrt of Charlottenlund is in operation most frequently. d7EC can be heard almost every night on the East Coast. He started up last winter with a quarter k.w. tube working on 93 meters. In June the dropping down to 45 meters and worked u1CMX right off the reel. Since then he has worked the States almost every night and has had a nightly schedule with u4SA for some time.

There are 26 South African stations engaged in relay work. From this number A4Z, A4L, A4V, A4E, A4M, A3Y, A3T, A3U and A3V are doing the most DX work.

(Continued on Page 58)

Calls Heard



1ABP. Eden Park. R. I.

6awt, 6agk, 6bij, 6bur, 6bwj, 6cgv, 6cig, 6cto, 6ts, 6vc, 7dd, 7lu, 7sf, g2ec, g2dx, g2go, g2fu, g2kf, g2kw, g2kz, g2lz, g2nb, g2nm, g2od, g2rb, g2sh, g2sz, g2tf, g2wj, g5ef, g5ro, g5nn, g5pu, g5pz, g5si, g6ig, g6kk, g6nf, g6td, g6tm, f8ca, f8ct, f8go, f8pl, f8wag, f8ssm, f8wj, f8qg, oonl, ooll, opzl, d7ec, sear2, sear6, sear9, f1af, f1er, lgn, lmt, bzlab, c2lc, c2mk, ber, mib, m1aa, m1af, mbx, n22ac.

1PY. Longmeadow, Mass.

4aae, 4du, 4eg, 4er, 4fl, 4iv, 4jj, 4jr, 4js, 4mi, 4oa, 4oi, 4oy, 4rl, 4rm, 4rz, 4sa, 4si, 4sh, 4ts, 4ux, 4xe, 5ac, 5acl, 5afd, 5agn, 5ail, 5ame, 5aph, 5ax, 5ew, 5hy, 5ams, 5nj, 5oq, 5se, 5uk, 5zai, 5abg, 6agk, 6bgy, 6bni, 6bto, 6cgv, 6csw, 6dah, 6dah, 6dai, 6dn, 6fi, 6kk, 6nx, 6ix, 6vc, 6zad, 6zac-NPI, 9adr, 9akf, 9bpy, 9ccs, 9dbz, 9dde, 9dfh, 9dkv, 9drz, 9ecc, 9hph, a2cm, a2ds, a2ij, a2yi, a3bd, a3bm, a3bq, a3ef, a3da, a4gt, d7ec, f8ag, f8bf, f8ce, f8fm, f8wag, g2kf, g2nm, g2wj, g5lf, g5qv, g6kk, m1aa, mib, m1k, m9a, o2ld, q2mk, rafz, reb8, z2ac, z2ae, z2xa, z4aa, z4ag, z4ak, z4al, z4ar, z4as, chleg, aga, nkf, nrri, f8z, nve, wap, xda.

2ADU. Rutherford, N. J.

4af, 4aj, 4du, 4eg, 4er, 4ft, 4jr, 4jv, 4oy, 4ri, 4rm, 4sa, 4tv, 4vl, 5afd, 5atv, 5ew, 5kce, 5lh, 5uk, 5zai, 6amm, 6aop, 6bbv, 6bhz, 6btu, 6cah, 6cgo, 6cgv, 6dah, 6fa, 6vc, 6zad, 6zac, 9ado, 9aog, 9apx, 9atq, 9acc, 9bhp, 9be, 9bek, 9bov, 9dna, 9cap, 9cbe, 9cca, 9ccs, 9cgv, 9ckl, 9cl, 9dfh, 9dfq, 9dip, 9dka, 9dpx, 9dum, 9awz, 9eas, 9efs, 9hp, 9qd, 9uc, 9xn, 9zb, a2ds, a2yi, a3bd, a3bq, m1aa, m9a, n22ac, n2xa, n24ak, nve, nedl.

2EAR. Red Bank, N. J.

6ae, 6amm, 6awt, 6ban, 6bbv, 6bgy, 6bur, 6bil, 6cah, 6cgo, 6cgv, 6chs, 6csw, 6cto, 6cix, 6dah, 6dai, 6dn, 6ih, 6rp, 6ts, 6sb, 6tx, 7aek, 7dd, 7it, 7no, 7uz, 9fj, 9sn, a2bk, a2cm, a2ds, a2ij, a2lm, a2yg, a2yl, a3bd, a3ef, a3yx, avis, anrri, z1ao, z2ac, z2xa, z4ak, z4al, z4ar, bb9, beber, bzlab, bz2sp, clam, q2by, c2gt, d7ec, dx9, g2kf, g2sz, g5dh, g5lb, 6th, f8ee, hufxl, noba, iter, j1aa, m1aa, m1af, min, m9a, pr4ja, pr4kt, pr4rl, pr4oi, pr4sa, reb8, g2yt.

2CTH. Troy, N. Y.

40 Meter Band

bzlab, bz2sp, q2mk, d7ec, f8ef, g2kf, g2nm, g2od, g2sz, g5bv, g6si, g6lj, g6tm, rfb5, lpz, 4oi, 4sa, 6aij, 6asu, 6bhy, 6ct, 6cgv, 6cto, 6vc, wir, wnp, wap, neck, nfv, nve, 5lh, 5ox, sgc.

2EV. New York City.

40 Meters

1aac, 1aci, 1aiu, 1apz, 1awq, 1axa, 1azw, 1bgc, 1btr, 1cmx, 1ef, 2aa, 3af, 3afw, 3bel, 3bjp, 3cel, 3ckl, 3hd, 4aae, 4ae, 4er, 4fg, 4ij, 4oa, 4oy, 4rz, 4si, 4w, 4xe, 5abi, 5aaw, 5ay, 5nj, 5ph, 5qy, 5uk, 5va, 6agk, 6cgv, 6cs, 6zh, 8aa, 8aap, 8ac, 8aee, 8afd, 8aiv, 8akb, 8apo, 8ao, 8ay, 8bdu, 8bpl, 8bmb, 8bhh, 8bl, 8bny, 8bny, 8bvw, 8ect, 8ekf, 8enl, 8ep, 8dnf, 8dqb, 8dqf, 8eb, 8gi, 8ov, 9oq, 9ado, 9aek, 9akf, 9amx, 9aqt, 9atq, 9azp, 9bbj, 9bcn, 9bcs, 9bcx, 9bcy, 9bet, 9bek, 9bna, 9bpb, 9bvh, 9byw, 9ccn, 9cno, 9dac, 9dex, 9dkv, 9dit, 9dpx, 9dqy, 9dr, 9dui, 9dtk, 9gx, 9oc, 9pb, 9w, 9wu, 9z, nkf, nrri, clam, c2bv, c3aa, c3gg, a2yi, a3ef, ch2re, g4al, m1as, m9a, rfb5.

3LW. Silver Lake Farm, Willow Grove, Pa.

40 Meters

6agk, 6aij, 6amm, 6bbv, 6bgy, 6bil, 6bjx, 6bmw, 6cgv, 6cgo, 6cgv, 6chs, 6cix, 6cix, 6csw, 6cto, 6dah, 6dai, 6zac, 7uz, 7ya, a2bb, a2cm, a2ds, a2ij, a2tm, a2yi, a2yz, a3hd, a3bq, a3ef, a3ju, a3xx, z2ac, z2aq, z2xa, z3br, z4aa, z4ag, z4ak, z4al, z4ar, pr4rl, pr4sa, m1af, m1b, q2mk, beber, g2kf, ilas, rafz, chleg, br7, fxi, ln, kfuh, kfvm, npg, npm, npu, nve, nrri, nedj, numm, pof, sgc, wap.

4UF-4RJ. Santurce, Porto Rico.

1aao, 1af, 1ar, 1acp, 1aw, 1auk, 1arf, 1aaf, 1ahg, 1aap, 1aos, 1ar, 1aj, 1aiw, 1apc, 1anq, 1atv, 1axa,

1aiu, 1bd, 1buo, 1bgc, 1bqk, 1bqt, 1cmf, 1ckp, 1cmx, 1cln, 1ch, 1er, 1eak, 1co, 1cab, 1my, 1no, 1te, 1pl, 1xl, 1rr, 1qm, 1sou, 1uw, 1xu, 1wl, 1vc, 2ag, 2aef, 2afn, 2aky, 2acp, 2amf, 2agq, 2adk, 2air, 2bee, 2bbx, 2bcw, 2beu, 2bmz, 2bui, 2bkr, 2bxj, 2bc, 2bur, 2box, 2buy, 2bq, 2cc, 2ctm, 2cy, 2dy, 2cj, 2ctb, 2cg, 2chm, 2ds, 2dx, 2gb, 2ha, 2lu, 2mu, 2xa, 2xu, 2xi, 2ui, 2pf, 3aew, 3ag, 3auv, 3ava, 3aha 3agm, 3ale, 3anj, 3bz, 3bet, 3bva, 3btq, 3cva, 3cdk, 3cc, 3cdn, 3cin, 3io, 3hg, 3il, 3mv, 3jw, 3fs, 3ly, 3uy, 3qw, 3sf, 3zw, 4ask, 4er, 4by, 4jd, 4eu, 4ua, 4xe, 4tg, 4rr, 4ra, 4rm, 4ff, 4fm, 4xx, 5cas, 5om, 5ot, 5oc, 5uk, 5wi, 5afd, 5ain, 5ajf, 5auh, 5aw, 5awq, 5adm, 5aul, 5bhm, 5bq, 5brc, 5bjr, 5bfe, 5bn, 5bhk, 5bpl, 5apo, 5ccr, 5cic, 5chk, 5cdv, 5ccq, 5cva, 5cnd, 9dka, 5ar, 5dme, 5dfk, 5dae, 5eq, 5lf, 5pl, 5xk, 8iqz, 8ry, 8rv, 8af, 8up, 9ap, 9aek, 9bbj, 8bpb, 9boa, 9bht, 9cxx, 9cel, 9arl, 9ed, 9gr, 9xw, 9onx, 9es, d7ec, g5dh, g2nm, g2sz, opemm, q2by, clar, f8bf, 18dg, pof, pow, wbg, wdbo, aga, ber.

5GE. San Angelo, Texas.

40 Meter Band

1aap, 1abp, 1aci, 1ae, 1aep, 1afp, 1ahl, 1anq, 1bhs, 1bxy, 1cij, 1ckp, 1cmp, 1cmx, 1ere, 1fx, 1ts, 1uj, 1uw, 2aa, 2bee, 2bva, 2cgl, 2cvj, 2dx, 2zy, 2kg, 2wp, 2xaf, 3agw, 3aha, 3bao, 3buu, 3bva, 3cel, 3ot, 4sk, 4ava, 4eu, 4or, 4fl, 4gl, 4gt, 4hk, 4iv, 4ij, 4js, 4iv, 4kw, 4li, 4oa, 4rm, 4si, 4tv, 6abg, 6ae, 6alf, 6agk, 6aiv, 6aop, 6aqp, 6arw, 6aum, 6bbv, 6bdj, 6bix, 6bjj, 6bni, 6cbj, 6cgo, 6cgv, 6clp, 6cmq, 6ers, 6ct, 6csw, 6dah, 6dah, 6ea, 6ebg, 6acs, 6nx, 6rv, 6sb, 6lx, 6ve, 6ws, 7ap, 7ay, 7br, 7uz, 8ac, 8aly, 8axn, 8ay, 8bfk, 8bny, 8bzi, 8caz, 8ced, 8cjd, 8dip, 8drs, 8eg, 8ln, 8pi, 8sf, 8ty, a2bb, a3ef, c3ic, m1aa, m1af, m1b, m1k, min, m9a, pilhr, z4ar, npg, npu, nkf, nrri, nve, wiz, wap.

6AHQ. San Diego, California

1aao, 1ac, 1af, 1ahg, 1aja, 1ajx, 1amd, 1amf, 1ana, 1are, 1asf, 1aws, 1aww, 1arh, 1axa, 1aym, 1azw, 1bcc, 1cc, 1cki, 1ckp, 1cmp, 1cmx, 1dat, 1ef, 1ga, 1hn, 1li, 1oj, 1ow, 1pl, 1py, 1qm, 1rg, 1rr, 1te, 1uw, 1xam, 1xav, 1xq, 1yb, 2adu, 2au, 2cgo, 2agw, 2axf, 2bec, 2bee, 2bgi, 2br, 2bse, 2bur, 2egl, 2cpa, 2csw, 2cyu, 2dc, 2eck, 2kx, 2mu, 2qh, 2qr, 2ud, 2xaf, 3age, 3aih, 3akx, 3apu, 3apy, 3av, 3bmz, 3bnu, 3bvz, 3bwt, 3bz, 3ca, 3kq, 3lg, 3li, 3oe, 3ot, 3sf, 3zv, 3wb, 3zo, 4au, 4eu, 4du, 4fu, 4gw, 4gy, 4jr, 4vw, 4rm, 4ry, 4sa, 4si, 4tn, 4ux, 4xe, 5aa, 5aal, 5aaf, 5acl, 5ado, 5adz, 5ah, 5ajh, 5ajj, 5amh, 5apu, 5aaw, 5asv, 5atv, 5atx, 5ev, 5di, 5eak, 5hi, 5ph, 5ih, 5ka, 5kk, 5lg, 5lr, 5ls, 5nj, 5nq, 5ov, 5ox, 5ph, 5qx, 5sd, 5uk, 5wi, 5wt, 5xy, 5zai, 6asr, 6buc, 6cgo, 6est, 6zac, 7aek, 7afo, 7agz, 7aje, 7ay, 7ahs, 7df, 7dj, 7gb, 7gf, 7hw, 7ij, 7it, 7jm, 7mp, 7ng, 7nj, 7nx, 7pp, 7qd, 7rl, 7w, 7si, 7un, 7uq, 7uz, 7w, 7yu, 7wm, 7ya, 7zw, 8aah, 8ab, 8af, 8ajn, 8aks, 8avy, 8apo, 8aun, 8avo, 8avb, 8bc, 8bem, 8ben, 8bec, 8bf, 8bun, 8bmj, 8bot, 8bpl, 8brc, 8bsc, 8bvw, 8bx, 8byn, 8caz, 8cbi, 8cbp, 8cdg, 8ced, 8cco, 8chk, 8chl, 8co, 8cuz, 8cwp, 8cvi, 8dai, 8dal, 8dae, 8dea, 8dka, 8dnf, 8do, 8doi, 8dok, 8don, 8doo, 8doz, 8dq, 8dte, 8drs, 8drx, 8eq, 8er, 8gc, 8ez, 8ij, 8jq, 8nb, 8nk, 8nx, 8nz, 8oq, 8pq, 8ry, 8sm, 8to, 8zg, 8zk, 8zu, 9aat, 9aav, 9acg, 9adg, 9ado, 9aeg, 9aek, 9afg, 9afr, 9age, 9agl, 9akf, 9ale, 9amb, 9amh, 9amj, 9aod, 9aol, 9aot, 9apm, 9aps, 9apz, 9arc, 9arh, 9atq, 9att, 9ayk, 9ayp, 9azp, 9baa, 9bag, 9bba, 9bbe, 9bbe, 9bbz, 9bdu, 9bdw, 9bdx, 9bcn, 9bet, 9bed, 9bek, 9bec, 9bff, 9bht, 9bjp, 9bkr, 9bml, 9bnd, 9bnf, 9bof, 9boj, 9bnc, 9brt, 9bsg, 9btk, 9bvd, 9bvh, 9bvi, 9caa, 9cbb, 9ccs, 9ccz, 9cfl, 9cfx, 9cgn, 9cld, 9clp, 9cm, 9ep, 9eta, 9eua, 9eud, 9evn, 9ewn, 9exx, 9dac, 9das, 9dat, 9davy, 9dad, 9dbw, 9dct, 9ddi, 9ddp, 9ddz, 9ded, 9dec, 9dfh, 9dga, 9dnc, 9do, 9dpx, 9dqy, 9dti, 9dtt, 9dce, 9dum, 9dwz, 9dzf, 9eak, 9eas, 9ect, 9efv, 9ega, 9eht, 9eic, 9eja, 9ejy, 9eky, 9ek, 9eij, 9ell, 9ff, 9gh, 9hn, 9iz, 9kd, 9rm, 9nl, 9oz, 9co, 9og, 9rt, 9rw, 9rz, 9sr, 9sv, 9xi, 9za, 9ze, 9zt, m1b, m1aa, m1k, m9a, m1x, reb8, z2ac, z2ae, z2xa, z3ar, z4aa, z4ag, z4ak, z4ar.

8er, 8gz, 8hsv, 8ij, 8ry, 8sf, 8uk, 8ze, 9ado, 9akf, 9aug, 9azl, 9bbj, 9bht, 9bnd, 9bpb, 9egn, 9gd, 9ged, 9kda, 9dmj, 9dak, 9dht, 9eij, 9ff, 9hk, 9og, 9ug, 9uq, 9px, 9xw, 9zt, kel, lct, yez. Mexican: 9a, 1aa, nas, npx, 1pu, nst, nki, nrrl, laci, laef, 2agb, 2brb, 2rb, 2xa 2yt, 3bnn, 3co, 4gy, 4ph, 4xc, 5ay, 5adz, 5atv, 5nd, 5ox, 5tg, 5vi, 5bgn, 3bhh, 3bre, 3byn, 3ed, 3er, 3es, 3ry, 3zk, 3hek, 3dac, 3dcw, 3dvw, 3e, 3wo, 3yav, 3zt, wap, wnp, wiz, yeh, kel, piu. Canada: 4gt, 4bv, 4zal, 4nlz. Palippines: 1hr, 1my, nki, npx, nrm, nru, nisv, nuog, nrrl, r1z, a2ds, a2yt, a3vj, a3bd, a3ef, a3ju, nz2ac, nz2xa, nz4ar, pr4sa, pr4rl, mia, mlaf, mva, j1aa, chleg.

99X, U.S. Naval Air Station, Coco Solo, Canal Zone, Panama

1aao, 1aap, 1aay, 1abp, 1aci, 1ack, 1adg, 1aep, 1aha, 1ajg, 1ams, 1aou, 1ap, 1avw, 1azl, 1bgw, 1brt, 1byy, 1caw, 1cu, 1cr, 1ka, 1mk, 1zl, 2ac, 2aep, 2aes, 2aey, 2afn, 2agb, 2agi, 2aof, 2api, 2apm, 2bwc, 2bby, 2bm, 2bo, 2bkr, 2bxj, 2cap, 2cth, 2evj, 2gzw, 2ds, 2gk, 2gy, 2ha, 2kf, 2kn, 2lu, 2mk, 2mu, 2u, 2xg, 3aiq, 3bct, 3bz, 3cel, 3cm, 3hg, 3ot, 3qt, 3qw, 3zw, 4ask, 4cu, 4few, 4fm, 4ci, 4oj, 4rl, 4ry, 4sa, 4tn, 4ts, 4iv, 4xc, 5aac, 5abq, 5afd, 5agn, 5air, 5aiz, 5as, 5amb, 5amh, 5av, 5ax, 5ed, 5ew, 5hi, 5hy, 5oq, 5rg, 5sd, 5tq, 5uk, 5ws, 6akm, 6ij, 7uz, 8abf, 8apw, 8avi, 8bz, 8bfe, 8bhm, 8ccq, 8cdv, 8cni, 8eb, 8om, 8sf, 8sk, 8sj, 8xf, 9adr, 9ali, 9alt, 9apn, 9ato, 9bji, 9bbp, 9bkr, 9bnk, 9bpw, 9dac, 9dfh, 9duj, 9dum, 9ees, 9es, 9ff, 9fu, 9hw, 9mo, 9nl, 9xn, 9xw, 9zt.

J1AA, Tokio, Japan

2bk, 2ef, 2ds, 2mn, 3arl, 3bd, 3bq, 5aci, 5bz, 5lr, 5ox, 5sb, 5add, 6ho, 6akw, 6aif, 6av, 6ar, 6asr, 6aws, 6awt, 6bba, 6bjr, 6bjx, 6bpi, 6bsn, 6bur, 6owd, 6cbi, 6chl, 6chs, 6cte, 6clp, 6cnp, 6cle, 6enx, 6enx, 6ct, 6ea, 6hi, 6hm, 6mg, 6mn, 6oi, 6rn, 6rx, 6ts, 6ua, 6vo, 6xad, 6xz, 6zh, 6bhw, 6ve, 7ay, 7aw, 7el, 7cg, 7es, 7fd, 7fs, 7ml, 7rj, 8pjl, 9ado, 9ato, 9avj, 9axq, 9bnd, 1bdu, 1bpa, 7aci, 9caq, 9car, 9czz, 9daw, 9zt.

CH1EG, Edmundo Guevara, Vilcum, Chile

1aep, 1ckp, 1emp, 1pl, 2akb, 2ayd, 2gk, 2ha, 2xa, 2xaf, 2xi, 3hg, 3ot, 4ask, 4aso, 4cu, 4sa, 4tv, 4xe, 5adz, 5agn, 5aom, 5dn, 5hi, 5ph, 5sd, 5uk, 5va, 5vr, 5wi, 6afg, 6agn, 6avj, 6bel, 6bhm, 6bjm, 6bmw, 6bse, 6bur, 6cdq, 6cft, 6egw, 6ehz, 6ec, 6com, 6ess, 6est, 6esw, 6eto, 6dah, 6def, 6ea, 6eb, 6fa, 6hu, 6ja, 6jp, 6ts, 6xad, 7aci, 7ay, 7it, 7xu, 7scr, 7schu, 8if, 8sf, 9duc, 9ff, 9hk, 9mn, 9oo, 9uq, 9wo, 9xh, 9ku, 9w, npx, nrrl, (nuag*), nve, nas, nrm, nki, xas, ckl, fxl, Brazil: lab, N. Z.: 2ac, 2ae. Argentina: fa3, ba1, a5. Mexico: 1k, 9a, 1af, 1b. Uruguay: octu, Ob2, 2yt, gcs. Pse QSL card.

James Steffensen, Ehlersvej8, Hollerup, Denmark

1aao, 1acb, 1aci, 1ahg, 1ahl, 1air, 1aiw, 1ano, 1apc, 1arf, 1arh, 1bge, 1blu, 1bqt, 1buo, 1byx, 1ccx, 1ckp, 1cmf, 1ka, 1kl, 1mk, 1qm, 1xu, 1za, 2afn, 2aim, 2axf, 2bbx, 2bc, 2bec, 2bxj, 2ctv, 2ha, 2kr, 2lu, 2pf, 2rm, 2te, 2xaf, 2zv, 3ask, 3awh, 3edk, 3ot, 3wo, 4ask, 4aso, 4eg, 4fm, 4kt, 4oa, 4oi, 4qy, 4rl, 4rr, 4sh, 4ta, 5ox, 5aul, 5bfe, 5bgn, 5cau, 5ccq, 5dae, 5dhu, 5ow, 5pk, 5ry, 5bht, 9ff, 9uo, 9xh, 9xn, wap, nrrl, 2cu (ship in European waters). Canada: 2bg, Chile: 1eg, Argentina: f24 (20 m). Mexico: 1aa, Cuba: 2lr, New Zealand: 2ac, 2ae, 4ag, 4ar.

18FJ, John L. Menars, Longfield-Radio, Bordes, B. P. France

1aa, 1aao, 1abf, 1ac, 1aid, 1ajg, 1ajy, 1aim, 1ana, 1arc, 1arp, 1ary, 1asd, 1asy, 1axd, 1axo, 1axz, 1ban, 1bap, 1baq, 1bau, 1bax, 1bbc, 1bbf, 1bbm, 1bbo, 1bed, 1bdg, 1bec, 1bec, 1bdx, 1bfy, 1bg, 1bge, 1bgr, 1bgr, 1bgw, 1bis, 1bjk, 1bjt, 1bk, 1bka, 1bhk, 1lqk, 1lbp, 1hm, 1bmu, 1bad, 1bse, 1bsx, 1bv, 1bvl, 1bvc, 1bz, 1bzu, 1ca, 1cab, 1caf, 1caj, 1cam, 1cao, 1cap, 1ccx, 1eme, 1emp, 1mx, 1emz, 1cr, 1er, 1fr, 1gv, 1hc, 1iv, 1jc, 1lk, 1my, 1ow, 1pl, 1pz, 1qa, 1qm, 1xz, 1yb, 1ym, 1zo, 2arf, 2ay, 2abf, 2abm, 2acf, 2acs, 2ana, 2aqh, 2aa, 2av, 2avu, 2axn, 2bak, 2bge, 2bc, 2bgo, 2bgr, 2bhn, 2biq, 2bka, 2bkh, 2bka, 2b'a, 2b'v, 2b'f, 2b'w, 2bln, 2blp, 2bu, 2bm, 2bmf, 2bmu, 2bn, 2bo, 2bpb, 2brb, 2bse, 2bsd, 2bse, 2by, 2cgl, 2cla, 2cls, 2cta, 2cv, 2cty, 2evj, 2cxw, 2dd, 2fn, 2kx, 2mo, 2pd, 2ns, 2me, 2mo, 2rc, 2w, 2xav, 3ad, 3af, 3ah, 3aoj, 3ats, 3auv, 3bcu, 3bj, 3bl, 3blr, 3bu, 3bn, 3brv, 3bt, 3bt, 3b'q, 3bu, 3bva, 3bwi, 3cv, 3ck, 3cu, 3cfe, 3cgc, 3cgo, 3chg, 3cj, 3cjl, 3cjm, 3co, 3ctk, 3dq, 3he, 3hz, 3g, 3nh, 3pi, 3f, 3xp, 3zm, 3zo, 3zs, 4al, 4al, 4bg, 4do, 4du, 4eq, 4fs, 4fz, 4gw, 4hw, 4io,

4jr, 4je, 4js, 4kl, 4lu, 4mb, 4my, 4oa, 4pd, 4si, 4ti, 4tn, 4tw, 4ua, 4uk, 4v, 4wr, 4xe, 4yz, 5aad, 5aaf, 5abn, 5ac, 5acl, 5am, 5ads, 5adw, 5ack, 5axj, 5agi, 5ags, 5agv, 5ahj, 5aih, 5ail, 5aiu, 5aj, 5ab, 5ajn, 5ajt, 5apq, 5ari, 5asg, 5ash, 5aux, 5aur, 5be, 5ca, 5cv, 5dm, 5ck, 5ew, 5hl, 5if, 5ih, 5jk, 5if, 5lu, 5ov, 5ph, 5qf, 5qk, 5qy, 5qu, 5ry, 5ae, 5ad, 5al, 5uk, 5vm, 5xa, 5zao, 5zas, 6apw, 6akw, 6aif, 6aj, 6aph, 6ano, 6ahq, 6anw, 6agk, 6awt, 6ab, 6ab, 6ahp, 6aan, 6ar, 6ajq, 6aao, 6bel, 6bhw, 6bin, 6bjn, 6bjw, 6bjx, 6bni, 6bur, 6bve, 6ebb, 6cc, 6ccy, 6cdn, 6ccj, 6ege, 6cgv, 6chl, 6chx, 6ckf, 6cmg, 6cni, 6eso, 6ess, 6ett, 6cw, 6cwi, 6ew, 6fy, 6no, 6of, 6pl, 6qn, 6rn, 6vw, 6zh, 7abb, 7adi, 7adm, 7ain, 7afo, 7agi, 7aha, 7ahi, 7aib, 7aip, 7akk, 7ald, 7ao, 7av, 7ey, 7cy, 7di, 7dj, 7fq, 7fm, 7fr, 7gb, 7zj, 7gm, 7gr, 7gv, 7gy, 7ho, 7ij, 7iu, 7jm, 7js, 7ko, 7lg, 7lj, 7lr, 7ly, 7mb, 7nd, 7nh, 7rh, 7rl, 7sy, 7ul, 7uq, 7us, 8acm, 8acx, 8bcp, 8bpl, 8brm, 8bvt, 8bxz, 8cbx, 8chk, 8cnw, 8cz, 8dae, 8deb, 8dia, 8dgp, 8dgv, 8dki, 8dse, 8ab, 8bf, 8ct, 8cu, 8ev, 8fy, 8gz, 8jq, 8kc, 8'b, 8mt, 8sr, 8uu, 8abz, 8sc, 8xt, 9aao, 9abw, 9acd, 9afu, 9afx, 9afy, 9axj, 9axr, 9ahp, 9aif, 9aim, 9aiz, 9apb, 9apq, 9aps, 9av, 9av, 9atu, 9aur, 9avj, 9avs, 9avn, 9azr, 9bar, 9bat, 9bbj, 9bic, 9bji, 9bjo, 9bjz, 9bkn, 9bla, 9blu, 9bku, 9bmc, 9bnk, 9bmo, 9bmu, 9bnf, 9boa, 9boh, 9bpb, 9bpc, 9bpb, 9bpi, 9bpl, 9bqz, 9bqi, 9brn, 9bvz, 9bvf, 9bvw, 9bxb, 9byg, 9byl, 9bzx, 9caa, 9cab, 9cac, 9caf, 9cag, 9cai, 9cal, 9cao, 9cax, 9cbe, 9cbj, 9chk, 9cbm, 9cda, 9edd, 9edi, 9eeb, 9eef, 9eka, 9efm, 9egs, 9eil, 9eja, 9cjc, 9ejo, 9ekj, 9ckn, 9cl, 9cnd, 9cod, 9cof, 9coy, 9cpm, 9epo, 9eqz, 9ctf, 9ctu, 9ctw, 9cu, 9cvf, 9czz, 9dax, 9dat, 9dbj, 9dlj, 9dm, 9dms, 9dpc, 9dpf, 9dpl, 9dps, 9dpx, 9dq, 9dqu, 9day, 9dr, 9dsk, 9dsc, 9dtk, 9dt, 9duc, 9duj, 9duq, 9dwh, 9dwx, 9dwt, 9eas, 9ebt, 9eed, 9eez, 9egg, 9eht, 9ehv, 9ein, 9eji, 9ejy, 9ekx, 9eky, 9elh, 9eli, 9elq, 9esi, 9est, 9ev, 9ex, 9he, 9hp, 9ig, 9iq, 9mc, 9mn, 9mv, 9od, 9af, 9ag, 9sr, 9vc, 9uu, 9zk, 9ct, c2cg, c2bs, c3ly, c3tf, c3vh, c4dq, c4bb, c4fn, c4cf, c5af, c5ef, c5go, c5bf, c5ba, c5hk, mlb, mbx, mci, chste, c2cm, a2yi, a3bd, a3bm, a3bq, a3ju, z1aa, z1ac, z1ao, z2ac, z2af, z3ad, z1aa, z4ab, z4ag, z1ak.

18GX, Neuilly-s/-Seine, France

1ae, 1aad, 1af, 1aaf, 1aao, 1aaz, 1aff, 1amd, 1agi, 1ap, 1ap, 1atu, 1cab, 1ckp, 1pl, 1se, 1uv, 2ab, 2ag, 2ac, 2apc, 2apn, 2af, 2afg, 2bee, 2bec, 2bc, 2brb, 2brc, 2brx, 2bi, 2bu, 2bv, 2bw, 2chz, 2cgr, 2caw, 2cz, 2lu, 2sa, 2cp, 2xu, 2zw, 3ac, 3apv, 3ct, 3ll, 3oc, 3gr, 4cl, 4ua, 4sa, 4xc, 4ar, 4zlab, 4mth, 4frica: 8alg, maroc, octu, br2, bpf, brf, bcy8, dfec, g2iz, g2nm, g2xx, g2gz, g2rb, g2xy, g5ni, g5dh, g5tm, g5id, 6uv, z2nm, 21na, 1ido, 1ias, 1lmt, 1lwb, 1lrg, 1laf, c2agc, smy, smvl, nofp, noqx, npcuu, nogm, Yougoslavia gld, fxx.

g6LJ, London, England

All heard on 35-45 Meters. American: 1aao, 1aap, 1aay, 1aci, 1adg, 1aew, 1ahg, 1ahi, 1ahl, 1ams, 1ana, 1af, 1are 1arh, 1atv, 1axt, 1azl, 1bal, 1bbr, 1bfn, 1cab, 1ccx, 1cme, 1cmf, 1comp, 1cmx, 1cx, 1ka, 1il, 1iv, 1my, 1pl, 1qm, 1uw, 1wl, 1zl, 1zw, 2aes, 2afn, 2agb, 2arx, 2bbx, 2bc, 2bco, 2bee, 2bgi, 2bkh, 2bxj, 2byw, 2cbe, 2cth, 2cty, 2evj, 2exl, 2cy, 2gk, 2gx, 2ha, 2kr, 2lu, 2nf, 2rm, 2vc, 3afg, 3aha, 3ak, 3auv, 3av, 3bmx, 3bta, 3bwi, 3bz, 3ckg, 3jw, 3mv, 3ct, 3ow, 3wb, 4ase, 4ask, 4du, 4fm, 4ja, 4oa, 4oi, 4rl, 4rr, 4sa, 4sb, 4ar, 4iv, 4ox, 5agn, 5ni, 5ok, 5za, 7dk, 8ac, 8av, 8ay, 8ay, 8bnh, 8bz, 8caz, 8ccq, 8es, 8dm, 8don, 8nk, 8rh, 8ry, 8tz, 9dfa, 9dpx, 9dc, 9ek, 9p, nedj, nki, nve, wap, wir, wiy, wnp, wnc. Canadian: 1af, 8aa, Cuba: 2bz, Mexico: 1aa, 1b, 1k, 1na, 1nu, Brazil: 1ab, 1af, 1ap, 2sp, yzt. Argentina: a5, ahl, afl, afd, bal, Chile: 1eg, 2ld, 9tc, Australia: 2em, 2ij, 2ri, 3bq, New Zealand: *2ac*, 2ae, 2za, 4ag, 4ar, 4ar, Japan: 1aa, Java: aue, Mosul: 1dh. Pse QRK G6LJ on 45 meters?

J. C. Wilson, Northwood, Middlesex, England

1aao, 1aay, 1add, 1aep, 1ams, 1atv, 1awb, 1axa, 1ayg, 1bke, 1bus, 1byx, 1cl, 1cl, 1cmp, 1coj, 1il, 1ka, 1oi, 1uc, 1uw, 2axf, 2api, 2bbx, 2bgi, 2bqa, 2bur, 2bvi, 2ch, 2arc, 2cty, 2cub, 2cm, 2lu, 2nf, 3awh, 3bju, 3bwj, 3bz, 3my, 3uy, 3zi, 4ask, 4du, 4ar, 4fm, 4sa, 4sh, 4sl, 4tv, 4ua, 6btu, 8ay, 8ay, 8bf, 8bz, 8bx, 8ccu, 8cl, 9dfk, 8eq, 8ql, 8tx, 9ape, 9azp, 9bmf, 9hw, nki, nve, wiz, wnp, c1el, c3ael.

g5NJ, Whitehead, Ireland

1aep, 1aay, 1iabp, 1iarh, 1iata, 1bke, 1byx, 1btr, 1cmf, 1ckp, 1caw, 1uw, 2by, 2agb, 2box, 4oi, 4tv, 4rl, 4sa, 8bgn, 8lar, a3bd, a3bq, a2cm, bA1, reb8, 1dh, nkf, nrri.

iiER, Milan, Italy

1uhg, 1air, 1anq, 1btr, 1byx, 1cmf, 1fn, 1th, 2afq, 2ai, 2aif, 2api, 2bbx, 2buy, 2caz, 2ha, 2pf, 2tv, 2xaf, 2xaj, 3afq, 3bct, 3cdc, 3ru, 4aso, 4ava, 4oy, 5aom, 5il, 8adm, 8apo, 8avl, 8bce, 8bvy, 8cd, 8clv, 8nt, 8sue, 8aon, 9bcd, 9bdj, 9cjl, 9dbf, 9uk, bz1af, bz2sp, ciAA, ciAm, c3fe, m1af.

bz1AP, Rio De Janeiro, Brazil

1bdh, 1bvl, 1ckp, 1pl, 1py, 1yb, 1xm, 2acp, 2bec, 2xu, 3bva, 3cdk, 3hg, 3jw, 5uj, 8apw, 8aul, 8dae, 8er, 8pl, 8sf, 9bbj, ra8, rafi, rbal, reb8, rdb2, rdb8, rfa8, rfg4, ch2ld, ch2re, yfwx, smyy, f8ct, z2ae, aae, nkf, pox, wir, wiz.

bz1AK, Rio De Janeiro

1ap, 1air, 1alw, 1aos, 1ix, 1bgk, 1ckp, 1cln, 1er, 1il, 1mn, 1my, 1xam, 1xz, 1yb, 2bee, 2apn, 2gk, 2ha, 2mh, 2xg, 2xi, 2xu, 3cdk, 3hg, 3jw, 4sa, 4tw, 5mi, 5nj, 8bgh, 8bre, 8cy, 8gv, 9bht, 9gkh, 9nq, nkf, wgh, wiz. Argentine, a8, afl, af2, ah2, ch8, db2, db8, fa8, lor, lpx, England, 2ih, 2kf, 2lz, 5dh, 6ym, France, 8gq, 8sm, Holland, nsf, Germany, pow, pox, Uruguay, *fwx*, Chile 2ld, Belgium 69, Java, aae.

Livio G. Moreira, Curitiba, South Brazil

1ael, 1aep, 1ahk, 1alw, 1ata, 1azl, 1bdh, 1bqp, 1ca, 1ckp, 1cmp, 1mk, 1my, 1ny, 1zw, 2afn, 2air, 2agb, 2ahg, 2apv, 2bbx, 2bci, 2bee, 2bqi, 2bw, 2cdc, 2cyu, 2ha, 2lu, 2mu, 2xaf, 2xbb, 2xi, 3apn, 3ana, 3aiu, 3aqr, 3awh, 3cdk, 3hg, 4ask, 4oi, 4iv, 5acz, 5he, 5nj, 5ur, 5na, 5tg, 5vg, 6bbz, 8aul, 8lf, 8bgn, 8bhm, 8cd, 8ck, 8ks, 8ry, 8sf, 9at, 9bbj, 9cip, 9ddj, 9ff, 9gbb, 9kxx, 9xn, rA8, rB1, rCB8, rDB3, rDE2, rDE3, rDM9, rFAS, rFG4, bz1AB, bz1AD, ciAL, c2BG, ch1AF, ch2LD, chBQ, q9UQ, qNAS, nAPN, g2SZ, m9AGU, m1AA, sSMYY.

FWX, Montevideo, Uruguay

1acb, 1ael, 1bix, 1cmp, 1il, 1kmx, 2afn, 2agb, 2bg, 2bs, 2gk, 2ha, 2ebx, 2xu, 3hg, 4tv, 5amh, 8sf, 9bck, NRRL, NKF, WIR, WIZ, WGN, WNP, g2SZ, g5DH, z2AC, bz1AB, bz1AK, bz1AP, bz1AS, bz1AT, bz1AV, bz1AX, bz2SI, bzRGT, AGA, POF, POW, POX.

W. and C. de Beaufort, Den Treek, Leusden, Holland

1aao, 1abp, 1ael, 1acp, 1afu, 1ahg, 1akp, 1ams, 1are, 1arh, 1azl, 1bgx, 1bkr, 1bzp, 1caw, 1cmp, 1cmx, 1cm, 1da, 1dm, 1gy, 1mk, 1my, 1pz, 1uc, 1uw, 1wc, 2aey, 2afn, 2agb, 2api, 2awf, 2bbx, 2bee, 2bga, 2bkg, 2cm, 2eah, 2ca, 2eah, 2xli, 2zh, 2gk, 2gy, 2ha, 2hag, 2ky, 2nt, 2lu, 2mw, 2my, 2nf, 2wc, 2xy, 2yrb, 2cpa, 2bw, 3acw, 3afg, 3ccl, 3mg, 3oa, 3auk, 3xm, 4af, 4ask, 4aso, 4zw, 4fm, 4fu, 4oi, 4sa, 4av, 4vl, 5adm, 8bhm, 8bre, 8bn, 8cl, 8don, 8lf, 8sf, 9abk, 9cap, 9ek, ciAR, ciED, m1K, q2BY.

zB7, C. Haumont, Brussels, Belgium

1aap, 1aao, 1abw, 1ajw, 1bmd, 1ams, 1are, 1arh, 1air, 1ata, 1ar, 1awe, 1bo, 1bsa, 1bvl, 1byx, 1ckp, 1cmp, 1cex, 1cab, 1el, 1rd, 1yb, 1kc, 1xmi, 1mk, 1xl, 1uw, 1xr, 1pc, 1rr, 2ac, 2ac, 2afn, 2bcc, 2gk, 2hm, 2rm, 2ld, 2xu, 2cy, 2lf, 2mu, 2tr, 2bbx, 2xaf, 2gst, 2ud, 2ha, 3bbx, 3jw, 3bva, 3ot, 3cc, 4sa, 4al, 4rr, 5nj, 8aur, gBHT, ciAR, c2CG, m1DH, bz2SO, bz1AB, bz1K, bzCB8, bzAF1, ch2LD, ch1EG, chA, ch3BD, ch3EF, ch8GZ(?), z2XA, z2AC, z2AG, z4AG, z3AL, z2AC, NDF, WIR, WGN, WIZ, WGH, CBY, POW, LN.

z2XA, Wellington, N. Z.

Worked on 40 Meters

United States of America: 1aao, 1ana, 1awe, 1cmp, 1cmx, 1il, 1pl, 1uw, 1yb, 1za, 2ago, 2brb, 2buy, 2cty, 2qh, 2rm, 2zv, 3bva, 3bwi, 4rm, 4sa, 5adz, 5av, 5pi, 5uk, 5zai, 6awt, 6ahp, 6agt, 6bh, 6bsn, 6buc, 6bur, 6cbb, 6cej, 6ego, 6gwy, 6chl, 6chs, 6chz, 6cme, 6cto, 6dcf, 6fa, 6fz, 6ij, 6jp, 6lj, 6qi, 6ts, 6uf, 6zcc.

7ay, 7gb, 8bgn, 8cvi, 8do, 8gz, 8pl, 8ry, 8sf, 8zc, 9ado, 9akt, 9bhl, 9cid, 9ced, 9dez, 9ek, 9uc, 9zt, kfuh, nedj, nrri, npu, nve, nuqg, ciAF, c6BA, m1B, bz2SP, beBER, pr4SA, rCB8, g2LZ, g2NM, g2OD, g2SZ, f8BV, i1ER, i1NO, i1RG, sSMYY.

**H. C. St. John, Rockdale, Australia
40 Meters**

1anq, 1cmf, 1cak, 2aim, 2buy, 2cdc, 2sz, 2xaf, 2xap, 3bct, 3bva, 3ot, 4fs, 4oa, 4rr, 4sa, 5akn, 5alj, 5nj, 5ph, 5ox, 5tg, 6asr, 6ahp, 6awo, 6ajl, 6bih, 6bmw, 6bde, 6bwl, 6bur, 6bvy, 6ers, 6esa, 6cgo, 6cix, 6cbb, 6cto, 6dcf, 6ea, 6fa, 6jp, 6iw, 6sb, 6zo, 6zac, 6gd, 7aek, 7ay, 8ayy, 8apw, 8bn, 8caw, 8dme, 8ebe, 8gz, 8sf, 9akf, 9apa, 9ado, 9cwr, 9ded, 9dvw, 9duc, 9cht, 9ek, 9ff, 9oo, 9uc, 9ua, 9xn, 9ya, 9zt, c3aa, c4gt, g5dh, g2am, g2lz, g2od, g2sz, m1b, mix, m9a, p1hr.

a3YX, Victoria, Australia

1aep, 1pl, 1yw, 2bgi, 2lu, 2wc, 2zv, 3bva, 3mu, 4oa, 4rm, 4rr, 4xe, 5acl, 5at, 5avt, 5ame, 5amw, 5hi, 5in, 5lg, 5nj, 5lp, 5cq, 5uk, 5wi, 6aww, 6bhz, 6bur, 6bve, 6cgo, 6cgw, 6chs, 6cmu, 6enc, 6est, 6ct, 6cto, 6cvi, 6dcf, 6ea, 6eb, 6jp, 6km, 6rw, 6vc, 6vr, 6xad, 7ay, 7ya, 8aj, 8aun, 8bgn, 8caz, 8chk, 8cvi, 8don, 8jy, 9ado, *9czz*, 9cma, 9bht, 9ded, 9uc, 9xiv, 9xn, 9xad, 1xi, c4gt.

ch1EG, Valcan, Chile

1aap, 1ahg, 1aki, 1are, 1azi, 1ka, 1my, 1pl, 2agb, 2agw, 2bbx, 2bur, 2buy, 2cty, 2gk, 2xy, 2xa, 2xaf, 3ab, 3awh, 3bwj, 3cel, 3ckg, 3ckw, 4cu, 4fl, 4gt, 4ir, 4ll, 4rm, 4tv, 5abq, 5ac, 5acl, 5adz, 5agn, 5aih, 5akl, 5ame, 5ax, 5ef, 5ew, 5he, 5in, 5lh, 5nj, 5sd, 5uk, 5zai, 6aew, 6agh, 6aib, 6ajj, 6amm, 6awt, 6avj, 6az, 6bbv, 6bcl, 6bev, 6bh, 6bjx, 6bmm, 6bmw, 6buc, 6bur, 6bvy, 6cbb, 6cgo, 6cgw, 6che, 6chs, 6cix, 6cmg, 6cns, 6csw, 6cto, 6dah, 6dcf, 6fa, 6jp, 6js, 6nx, 6rw, 6vc, 6wa, 6zac, 7akf, 7ay, 7ay, 7ct, 7ben, 7br, 7cv, 7er, 7es, 7jq, 7sf, 7sl, 7xas, 9ado, 9amm, 9aad, 9auv, 9av, 9bcd, 9bht, 9bpb, 9cca, 9czz, 9ddp, 9dex, 9dfh, 9dga, 9dku, 9ams, 9do, 9dum, 9dvw, 9eac, 9eht, 9ek, 9eky, 9ff, 9mn, 9oa, 9uc, 9xn, 9zd, 9zt, najd, namg, nas, nedj, negn, nrx, nsv, ukf, app, nrm, nru, nro, nrri, nudg, 8b, nute, wap, wwo, kfuh, g2kf, g2lz, g2am, g2sz, g5bv, g5if, g6rm, g6dh, gGBE f8pr, 1rt, 2lu, 1lab, 12sp, c2be, m1aa, m1af, m1b, m1k, m1n, m1x, m9a, z2ac, z2ae, z2xa, 11af.

I.A.R.U. NEWS

(Continued from Page 54)

The South African stations are using wavelengths between 40 to 60 and 70 to 90 meters and are operating usually between the hours of 3 P.M. to 6 P.M., 9 P.M. to 11 P.M. and Noon to 12:45 P.M. Eastern Standard Time.

5AJH at Abilene, Texas reports reception of signals from ANE, The Laboratory of the Government Radio Services at Bandoeng, Java, Dutch East Indies.

Ward Dorrell of Toledo, Ohio is the first to report reception of signals from the Chelmsford, England 24-meter transmitter. Apparently this is a British Marconi experimental station. Call letters unknown. Know them?

The U. S. S. Paducah, NOG, will have a short wave 500-cycle I.C.W. transmitter in operation soon. Sexton Hedlundof 9AND is the operator.

Communications

The Publishers of QST assume no responsibility for statements made herein by correspondents



Even Harmonic Operation

Detroit, Mich.

Editor, *QST*:

Let me make a few remarks in regard to the foot-note No. 2, page 24, July *QST*, to the effect that amateur stations are not getting good results when exciting their antenna systems at even harmonics of the fundamental frequency of the antenna system. Probably the best explanation of this effect is to be found in Bureau of Standards Scientific Paper No. 326, issued October 23, 1918, entitled "Electric Oscillations in Antennas and Inductance Coils" by John M. Miller.

To summarize this paper an unloaded antenna assumed to have uniformly distributed inductance and capacity is found to have a reactance that varies with frequency according to a cotangent curve, thus: That is, at regularly recurring values of frequency the antenna reactance passes through minus infinity, zero and plus infinity. The lowest frequency at which the reactance is zero is the fundamental frequency of the system. Herein lies the reason for poor operation at even harmonic frequencies, for reference to the curve shows that at even multiples of the fundamental frequency the antenna reactance is infinite. How could it work?

An unloaded antenna, theoretically, can be made to radiate on any of its odd har-

of a capacity. The use of an antenna heavily loaded is not advisable for harmonic radiation. A medium may be struck whereby the desired harmonic may be radiated while the parasitic radiation of other harmonics is minimized.

If an antenna system is shock excited at an odd harmonic frequency of the fundamental, chances are there will be some radiation on the the fundamental frequency. It is possible that a modulated continuous wave, such as is furnished by an oscillator using a.c. plate supply, may cause shock excitation of the antenna system, which, if tuned to an odd frequency will probably radiate to some extent on the fundamental frequency.

—James C. McNary, Asst. U. S. Radio Inspector.

Extending Wavemeter Ranges

3612 Woodbridge Place
Cincinnati, Ohio

Editor, *QST*:

The harmonics of the heterodyne wavemeter can be used to extend its range tremendously provided the particular harmonic which is being used is known. Ordinarily, the only way to do this is to start at the fundamental, and laboriously count each harmonic going down. Where the receiver range does not include the fundamental of the wavemeter this cannot be done. A method of determining the receiver wavelength, when it lies below the range of the wavemeter, is to tune the wavemeter until a harmonic is heard in the receiver, and recording the wavemeter reading W_1 . Then retune the wavemeter, varying the condenser either up or down until the next harmonic is heard, and note the new wavemeter reading, W_2 . The receiver wavelength adjustment, R , is equal to the difference between the two wavemeter readings. Expressed as an equation,

$$R = W_1 - W_2, \text{ or} \\ R = W_2 - W_1,$$

depending on whether W_1 or W_2 is the larger reading. Dividing the wavemeter readings by R gives the harmonics which were used.

If the range of the receiver lies above that of the wavemeter, the latter can still be of use. The wavemeter may be tuned till it beats with a harmonic of the re-

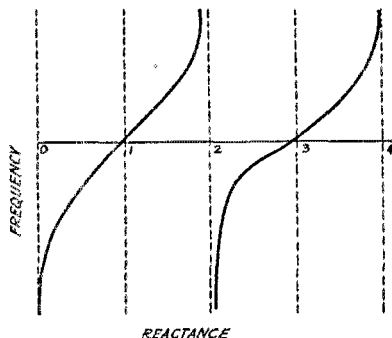

monics. Practically the use of an antenna that is not loaded usually provides a condition that is favorable to the radiation of more than one harmonic. The paper referred to above also furnishes interesting information regarding the use of an antenna system loaded with an inductance

ceiver, at setting W_1 . Retuning either up or down to the next receiver harmonic gives a beat at reading W_2 . The receiver wavelength then is,

$$R \frac{W_1 \times W_2}{W_1 - W_2} \quad \text{or}$$

$$R \frac{W_1 \times W_2}{W_2 - W_1}$$

again depending on which is larger.

Using this method the wavemeter range can be extended immensely. The wavelength of a transmitter can be determined by exactly the same equations, if phones are provided in the plate circuit of the wavemeter. The accuracy of this method is of exactly the same order as that of the original meter calibration. The methods are also applicable to the newest type of wavemeter—the crystal controlled vacuum tube.

—G. F. Lampkin, SCAU-8ALK.

Bouquets

Rockdale, Sydney, Australia

Editor, QST:

I've spent many interesting hours absorbing the contents of the pile of QST's which were sent me some time ago, and I have reaped much valuable information therefrom. I am still of the opinion that as a wireless magazine for amateurs QST stands absolutely on its own, because in it we find that the wireless amateur is consistently catered to, and his problems are solved by sound common-sense articles in simple language, and by information which tells us exactly what we want to know. In short it is, or should be, the hams Bible.

The gang here are looking forward with no small amount of interest to the forthcoming visit of Schnell with the American Fleet. If we can manage to nail him on a platform and get him to hold forth we will, no doubt, hear some very interesting things about the American hams. We have heard quite a lot of NRRL's signals for the past weeks and we are most anxious to meet the guy behind those bumping and pounding signals.

—W. D. Graham.

Wavelength Measurement

Hanover, N. H.

Editor, QST:

Replying to your circular letter on the subject of measuring the length of 1-meter waves, here is a scheme we used to use in the Lab for measuring the length of very short waves from a Hertzian oscillator.

By means of a wooden frame strung with copper wire and suspended on a wall of the Lab, standing waves were set up in

the air (not on the wires) between the frame (from which they were reflected) and the oscillator O. The presence of nodes and antinodes in the electric and magnetic fields could be located by the device D which consisted of a single turn of wire fastened to a handle H with a helium tube (or Spark-C tube) connected

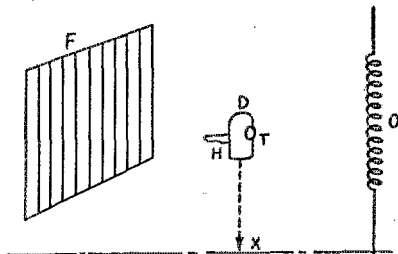

between the open ends of the turn of wire at T. A plumb line dropped to the floor at X where a chalk mark was made, permitted measurement with a yard stick between the located points.

—Elliott White, 1YB-1XAV.

News From Sea

SS "WEST JESTER"
Yokohama, Japan

Editor, QST:

Here's some random notes for the voyage so far between San Francisco and Yokohama. On the 40 meter band, stations from all US Districts came in fine between San Francisco and Longitude 165 East. Between that point and Japan very few stations east of the Rockies were heard. NKF and WIZ continued to come in beyond the "fadeaway" point but signal strength dropped from R7 to R2 over night. The same thing happened all last winter on the 80 meter band and a bird's eye view of the world looking down from the North Pole will show the probable reason. Signals from the States from points east of the Pacific Coast are obliged to travel almost entirely *over land* to reach Oriental points in the vicinity of Japan and beyond, travelling up across Canada and Alaska and down through Siberia!!!!

WAP was heard working 9XN on about 36.5 meters every night between S. F. and a point about 3,000 miles west. He faded out then and hasn't been heard since. Haven't heard WNP at all, but believe he is working on 18.5 meters and I can't hear a thing on that band because of electric fan interference. Every fan on the ship is running full blast and throws out a mean hum all over the 20-meter band.

In and near Japan, Australian and New Zealand stations can be copied at 4 o'clock

in the afternoon, full daylight all the way between, distance approximately 5,000 miles. 6th District stations also begin to come in to Japan at 4 P. M. or about 3½ hours before dark, travelling about half of the 5,000 miles distance in daylight. One of the strongest stations heard out here is Chili 1EG, who rolls in at R7 at a distance of 11,000 mles.

NRRL, KFJH, 6ZAC, NEDJ, NUMM and others 5,000 or more miles to the southward all roll in to Japan at R6 and R7. It may be "lese madjeste" to say so, but NRRL has a rotten note.....VIS Sydney is sending press daily at 4:30 A. M. P. S. T. on 46.2 meters. KWH, KDEL and KDWC were heard on 59 and 61 meters, strength RS, a day or so out of Japan. QR unknown.

Best DX so far:—11,000 miles ch1EG; 7,700 u NKF; 7,000 miles u 4OA; 6,500 miles u 1ARE, 4RM, RTV, 8ER, 9EFY, 9EK; 9JC; 900, 9XN; 6,000 miles m1AA, u5ABZ, 8AYY, 8EB; 5,500 miles u5ATK, 5SD, 5UK, 9BRI, 9DED, 9FF, 9UQ.

Anything under 5,000 miles is more or less local reception so won't include the Pacific Coast, Aust. and N. Z stations till we get further west.

—L. O. Doran.

Receiver Design

El Dorado, Arkansas

Editor, *QST*:

Regarding the article "Giving the Coil and Condenser a Rest" in June *QST*, noisy tubular grid leaks of good make are likely to be bad on account of the label, glue or moisture on the outside of the glass tubing. I have had almost no trouble with leaks from other causes.

I cannot see where the Schnell tuner is much of an advance over tuners of other designs. The Schnell tuner has too many controls on the panel and no control for selectivity. The hook-ups I am showing, although they were published some time ago and are not new, are a distinct improvement over Schnell's arrangement. The hook-up requires that the set have one control for tuning, one control for regeneration and one control for selectivity—three controls on the panel. The regeneration control should not affect the tuning in the least and it should be independent of wavelength adjustments. The selectivity control should not cause any detuning. With a tuner of this type a dozen or more stations can be tuned in in five or ten seconds.

These are nearly automatic regenerative sets in that the tandem condenser and two variometers (Fig. 1) are controlled by one dial. The aerial coupling (selectivity control) should be variable as varying de-

grees of selectivity are often required. The potentiometer is not mounted on the panel, since when it has once been correctly adjusted it is not necessary to change it again. Also an Amperite can be used just as effectively as a variable resistance.

These circuits have a somewhat greater

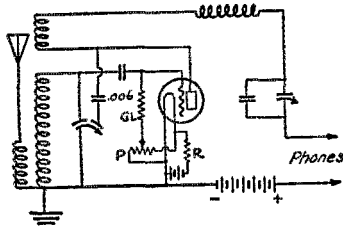
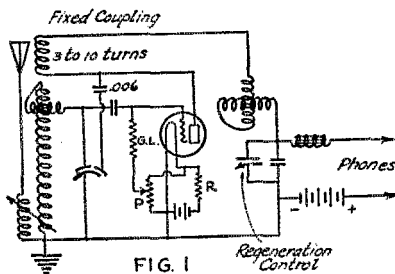

tendency to oscillate at the lower end of the scale at which point the regeneration will not be entirely automatic.

I have preached and argued for years for simpler and better control. Let's have it! The Reinartz and Schnell tuners certainly are NOT the answer. I do not argue that the hook-ups presented herewith are perfect or not capable of great improvement. Certainly they are better than either of the other types. I do argue that only three controls are necessary for tuning, regeneration and selectivity. And I further maintain that these controls must not be interlocking and "geared up" together.

—Dr. Jack Rogers.

The Ham Spirit

Poughkeepsie, N. Y.

Editor, *QST*:

Here I am, a man who will never see 49 again, just getting my feet wet in what may flippantly be called "the ham game." You know how it feels to wade out into a cold stream, how every step out brings the gooseflesh and as the water creeps upward how you wonder if you will get wet all over! Well, I am about ready to plunge into what looks, now, as if it had some of the qualities of Ponce de Leon's fountain of perpetual youth. Already I have had more thrills than I thought possible for one

who has had more thrills out of a long and checkered career than most people can imagine.

I have in my possession a certain impressive document attesting to the fact that I am a licensed Radio operator having passed the required examination with good marks. Listen: at fifty the old bean has already progressed a long way toward complete ossification. It becomes impervious, as it were, to any input. It may have some output, drawing upon reserves laid up in the dim past, but as far as capacity to take on new impressions is concerned and to learn new things, it is not there. So, when it was demonstrated that my mental equipment was still flexible enough to get away with a ten word a minute test, I got a thrill.

I got a thrill also when it was demonstrated that, with a cold start, I was able to get the hang of the theory of the art sufficiently to get by with a hook-up and the functions of the various parts. More evidence of delayed cerebral ossification—more thrill of a kind you can't buy with money.

Then again, when the set which I fabricated was put into commission and *percolated* the moment it was discovered that the center tap of the filament transformer needed to be soldered back into place, which discovery was made after testing every blamed thing in the whole set, more thrill. And when the lamp on the wavemeter blew, more thrill. And when the antenna ammeter showed .8 ampere another hard kick. And again when the first CQ "hooked one" two states away, say, I was about ten years of age by an emotional voltmeter.

And then when with tense muscles and middle-aged hand I pounded the key and muddled through the conventional jargon and heard the OM at the other end tell me I had a gud fist, I was radiating about 200 K. W. of emotion. And then when a young ham friend who had helped me get the set in commission went home to listen to my note and said it was almost d.c. (of course I knew he was kidding me along) I experienced a deep sense of satisfaction like unto which there has never yet been anything like in my experiences.

And when I have found that I have begun to acquire a circle of OM friends, all around 20 years of age, who seem not only to tolerate a literal OM in their midst but actually appear to enjoy palling around with me, I realize this fountain of youth stuff is not an idle fancy.

—A Figurative And Literal OM.

"QSL Card"

Mendoza, Argentina

Editor, *QST*:

Referring to frequent complaints against U. S. amateurs for not acknowledging cards I would like to state that from January to April 1925 I sent 51 cards (only to those repeatedly heard, too expensive

otherwise) and received 41 acknowledgments. I think that 80 per cent replies is good, considering postal errors, wrong addresses in call-books, removals, etc., and hence I come forward to defend the U. S. amateurs against the charge of discourtesy.

—Major R. Raven-Hart, ch9TC.

3 advantages with this 1000 cycle audio built especially for amateurs

Now amateurs can have the transformer they have been waiting for. One that enables you to heterodyne all signals to one frequency and amplify them. Eria offers it to you in a new development which gives 3 distinct advantages.



1. Only one frequency is amplified appreciably. Any static discharges occurring at any frequency except approximately 1000 cycles are not amplified.
2. Harmonics from broadcasting stations picked up by the amateur's short wave set are amplified only at one frequency causing elimination of this interference.
3. Enables differentiation between beat notes of different frequencies by audio tuning effect.

If you want this remarkable new invention send \$6.50 apiece and transformers will be shipped at once.

Electrical Research Laboratories, Dept. 2A
2500 Cottage Grove Avenue, Chicago, Ill.

Note: This instrument is unsuited for broadcast reception.

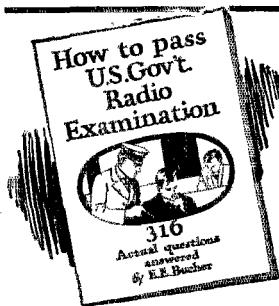

60c

For a Short Time Only

PASS the U.S. Government Commercial or Amateur Radio License examination! This book will help you do it! Send sixty cents in stamps or coin for your copy—postage prepaid to any point in the U. S., Canada or Mexico.

RADIO INSTITUTE OF AMERICA
326A Broadway New York City

BURGESS RADIO BATTERIES

Win Again

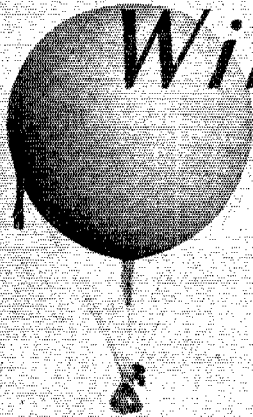

The illustration pictures the take-off of the winning flight and in the insert is the radio equipment carried. (Burgess 'A', 'B' and 'C' Batteries furnished the electrical energy to operate the set.)

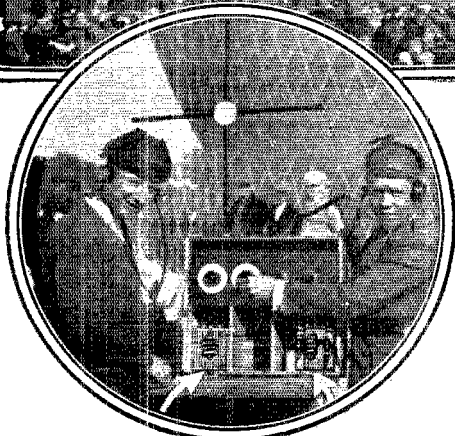

U. & U. Photos

WHEN the Goodyear III won the right to represent the United States at Belgium, Burgess Radio Batteries supplied the electrical energy for the operation of the balloon's radio equipment.

Almost every day from somewhere in the world news comes to us of new Burgess adventures.

And that Burgess Batteries have contributed their bit in so many interesting events of sport, commerce and science reflects the esteem in which they are held.

"Ask Any Radio Engineer"

Your own radio dealer down the street sells Burgess Batteries. He probably sells the famous Burgess Flashlights, too.

BURGESS BATTERY COMPANY
GENERAL SALES OFFICE: CHICAGO

Canadian Factories and Offices:
Niagara Falls and Winnipeg

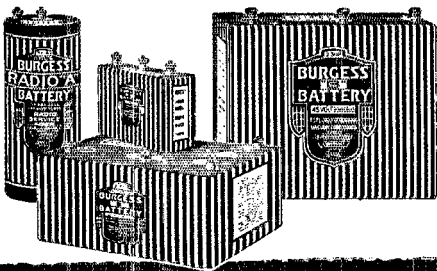



"MORE MILES PER WATT"

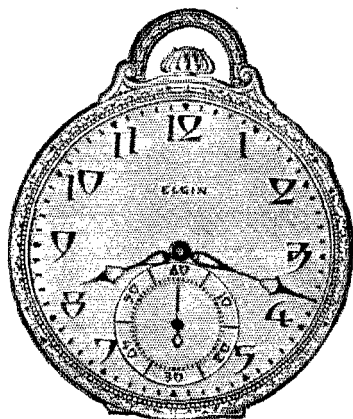

A 21-jewel watch with a solid white gold hand engraved case and a Lord Elgin movement has been selected as the 1926 Jewell trophy for advanced work in radio. This trophy will be awarded on June 1, 1926, to that amateur operator licensed by the United States or Canadian Governments who has submitted documentary proof of having transmitted, by wireless telegraphy, the most miles per watt over a distance of 300 miles or more.

JEWELL

1926 Radio Contest

For

Amateur Operators Licensed
by U. S. and Canadian
Governments

This contest was first announced at the Third National A.R.R.L. Convention held in Chicago in August. It is being held in the interests of efficiency of operation and efficiency in the last analysis is the goal of the amateur.

DX records in the future will probably make careful mention of power input in order to establish a miles per watt basis for discussion.

Miles per watt is an excellent criterion of station efficiency and enables credit to be given to the small station which is operated in accordance with the best engineering principles. It allows such a station to compete on a favorable basis with the more powerful stations, which may reach further by sheer power.

And to measure the input Jewell instruments continue to be found the more reliable, accurate and dependable instruments for the amateur. They are especially adapted to his needs and will prove a necessity for the well-equipped transmitter.

Send for Printed Rules Governing This Contest

Jewell Electrical Instrument Co.

1650 WALNUT STREET
CHICAGO

"MORE MILES PER WATT"

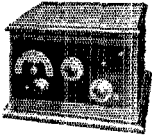

Crosley
2 Tube 51 S. D.
Mahogany finished cabinet holds all batteries



Crosley Pup
A genuine long range receiving set

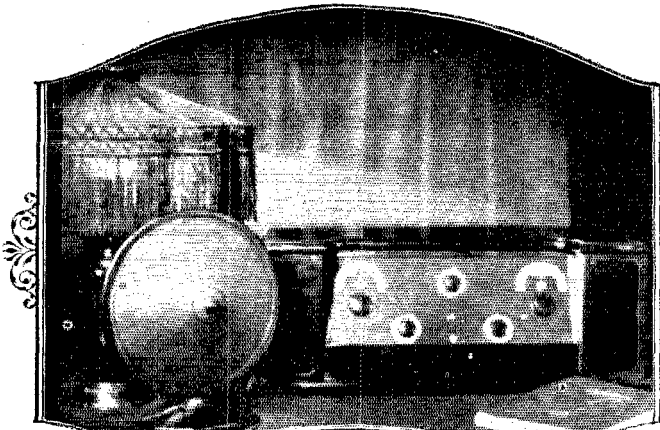

Crosley Super Trirdyn Special \$60.00
Crosley Musicone \$17.50

Crosley
3 Tube 52 S. D.
Highly selective; unusual range; mahogany finished cabinet.

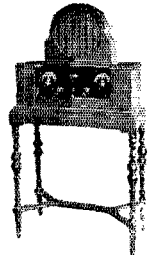

Crosley De Luxe Combination
Musicone De Luxe \$27.50
Super-Trirdyn Special \$60.00
Console Table .. \$25.00
Complete

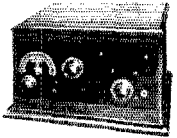

Better Results From 3 Tubes Than From 5

Instead of passing the incoming signal once through each of 5 tubes, Crosley design, in the Super-Trirdyn, passes it through two of the three tubes several times, each time building up its strength and adding to its volume.

Even the technically uninitiated can see the advantages; simplicity instead of complexity; fewer dials to adjust; sharper accuracy in selecting stations; greater clarity; greater volume, greater ease in logging stations.

This simplicity of design combined with the economies of gigantic production makes possible a price of \$60.00 on the Super-Trirdyn Special, the most efficient

and beautiful of all Crosley receiving sets. For Crosley is the world's largest builder of radio sets—owning and operating parts factories, cabinet woodworking and assembly plants.

Listen to a Crosley Super-Trirdyn under the most exacting conditions and you will understand why it represents genuine achievement in radio performance and value which all America was quick to recognize and reward with increasing sales.

Write for an illustrated catalogue of the complete Crosley line or see them at your Crosley dealer's. Authorized sales and service stations everywhere.

Crosley manufactures receiving sets which are licensed under Armstrong U. S. patent No. 1,113,149 and priced from \$9.75 to \$60.00 without accessories.

Add 10% to all prices West of Rocky Mountains. Crosley owns and operates WLW first remote control super-power broadcasting station.

CROSLEY RADIO

B E T T E R · C O S T S L E S S

THE CROSLEY RADIO CORPORATION, - - - CINCINNATI, OHIO
SAY YOU SAW IT IN QST—IT IDENTIFIES YOU AND HELPS QST

The Improved Roberts

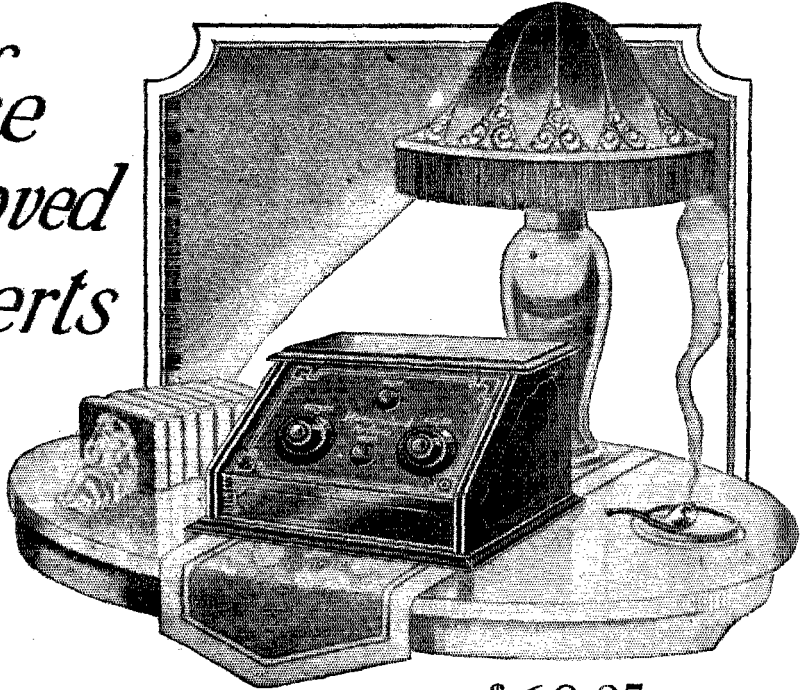

Approved by **\$60.85** Cabinet Extra
Ten leading manufacturers



Send for this most complete book giving full instructions on assembling, wiring, and operating the Hammarlund-Roberts receiver.

25c

The All-American Radio Corp. contribute the Rauland Lyric Transformer to the efficiency of this new receiver.

The new Hammarlund-Roberts receiver is the united achievement of ten leading engineers, endorsed by ten of the best-known radio manufacturers. No one man's or one group's conception of five tube possibilities but the composite of the leaders' convictions.

This concentration of the leaders upon one purpose—the perfection and intense application of tried and proven radio principles—has produced new results. Results so vital and so valuable that they put the Hammarlund-Roberts far beyond your expectations of performance.

In designing this new standard of efficiency, the consulting engineers had at their disposal the finest parts the market affords—regardless of cost. They were not handicapped in building to a price.

These ten leading manufacturers offer to the American public greater value than ever before. A radio receiver constructed throughout of the latest, most efficient part designs at a price within the means of every one. A five tube receiver that equis the Super-Heterodyne in selectivity and volume. A receiver so simple in design that anyone can build it from the instructions in the "Hammarlund-Roberts Construction Book." You will wonder at this new simplicity; this new efficiency; this new saving.

Write for this most complete book

Hammarlund-Roberts, 1182-E Broadway, New York City

Hammarlund-ROBERTS

Associate Manufacturers

All-American Radio Corp., Alden Manufacturing Co., Radial Company, Carter Radio Company, Dubilier Condensers, Union Radio Corp., International Resistance Co., Hammarlund Mfg. Co., Inc.

Na-aid sockets and dials, Carter Rheostats, Jaks and Switches approved for the Hammarlund-Roberts.

The AMSCO ALLOCATING CONDENSER

(STRAIGHT LINE FREQUENCY)

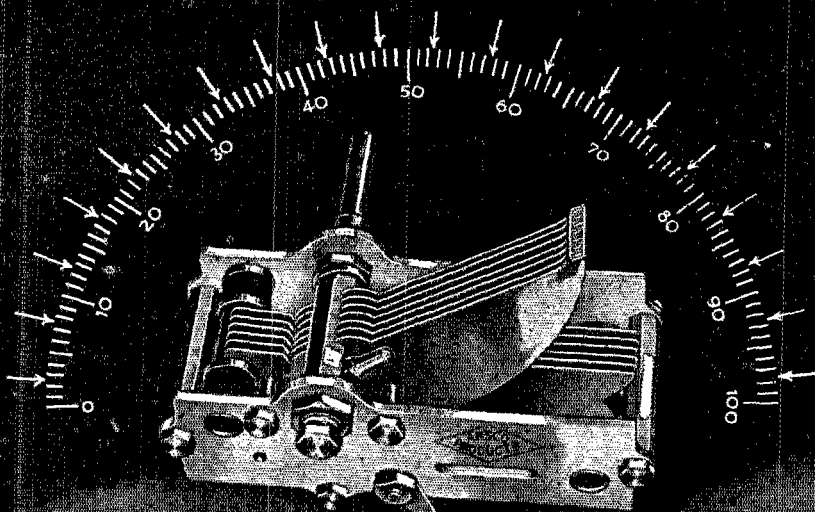

Spreads the Stations Over the Dial

— The new AMSCO Allocating Condenser is the triumphant combination of electrical engineering and mechanical ingenuity. *Electrically efficient* in unscrambling the stations on your dials. Each dial degree from 1 to 100 will be found to represent 10 broadcasting kilocycles accurately over the entire scale—“a station for every degree.” *Mechanically ingenious* in correcting the fault of other S. L. F. Condensers—it conserves space! Scientific low-loss construction. Rigidity with light weight.

Made in three capacities—Single or Siamese. Ask your dealer or write for details of entire AMSCO Line of engineered radio parts.

AMSCO PRODUCTS, INC., Dept. C
Broome and Lafayette Streets, New York City

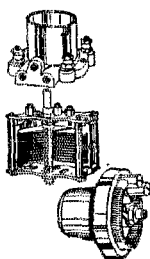

New!—a handsome instrument at a low price. The AMSCO Vernier Dial gives finesse to your fingers. Steps-down 13 to 1, backwards or forwards, fast or slow, without momentum or backlash.

Better reception this season than last !

WOULD you like better reception this fall and winter than last? Better distance? Better volume? Better tone? You will enjoy better results in every way, this season, if you *keep your tubes at full efficiency* with the Jefferson Home Tube Rejuvenator.

All tubes deteriorate rapidly with use. The Jefferson Tube Rejuvenator "brings them back" in 10 minutes! Use it once a month—keep your tubes like new. Completely restores paralyzed or exhausted tubes. Doubles and trebles tube life, quickly paying for itself through this great saving.

Takes large or small tubes—types 201-A, 301-A, UV-199, C-299, 5-VA. Attach to any alternating current electric light socket in your home. The Jefferson Home Rejuvenator for tubes is as essential to satisfactory radio reception as a charger for storage batteries. Get one now; start this season with your tubes in perfect condition. Sold by leading dealers in radio supplies, and fully guaranteed.

Jefferson Electric Manufacturing Co.
501 S. Green St., Chicago, Ill.

Makers of Jefferson Radio, Bell Ringing and Toy Transformers; Jefferson Spark Coils for Automobile, Stationary and Marine Engines; Jefferson Oil Burner Ignition Coils and Transformers.

for
HOME
Use

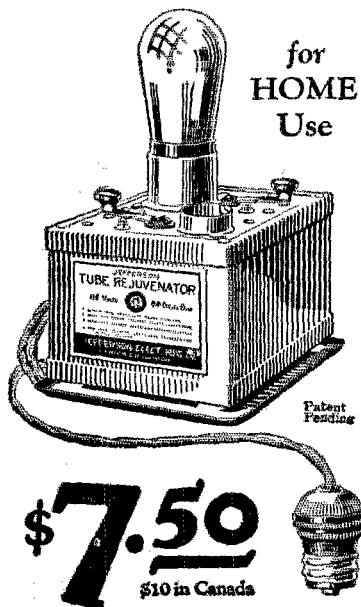

\$7.50
\$10 in Canada

JEFFERSON TUBE REJUVENATOR

Keeps radio tubes like new

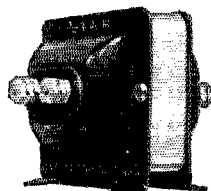

JEFFERSON RADIO TRANSFORMERS

Your radio, no matter how costly, can be no better than its transformers. Our experience as the world's largest manufacturers of small transformers is everywhere recognized by leading radio engineers who carefully specify "Jefferson". If you want amplification without distortion—clear, pure, sweet, natural tones from your radio—make sure it is equipped with Jefferson Transformers. Sold by the better radio dealers, used by leading set manufacturers.



From the Listener's Point of View

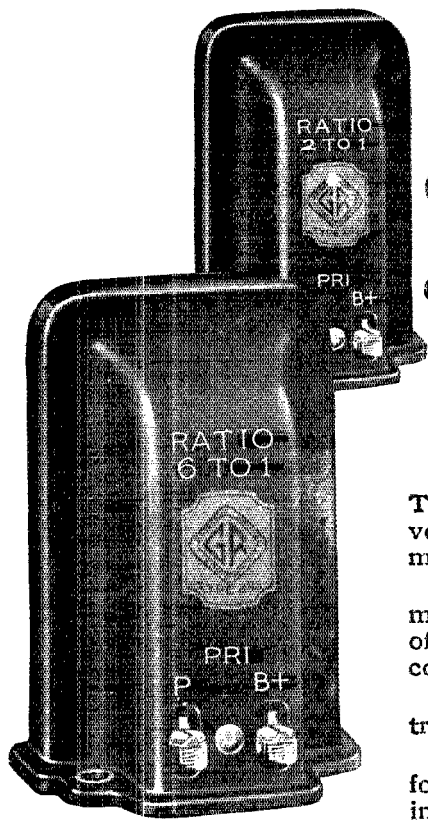

Type 285
Audio Amplifying
Transformers
6 to 1 ratio for first stage
2 to 1 ratio for second stage

\$6 each

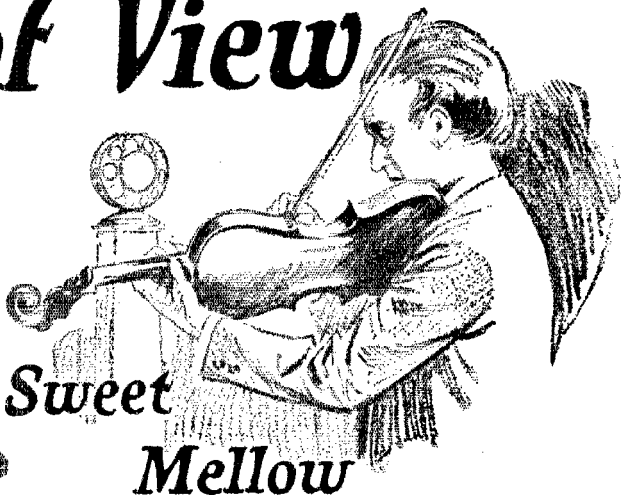

Natural

General Radio transformers are True Mirrors of Tone Quality. They reproduce instrumental and vocal music as pure, full, and natural as it enters the microphone at the studio of the broadcasting station.

Due to the special design of the core and adjustment of the coil turns these transformers are capable of unusually high and even amplification of all tones common to speech and music.

In spite of their recognized superiority over other transformers they sell at a popular price.

Enjoy the programs of radio artists in unmodified form—use a General Radio 6 to 1 ratio transformer in the first stage and a 2 to 1 ratio in the second.

Ask to see them at your local dealers or write for our descriptive folder No. 285-Q showing amplification curves and wiring diagrams.

GENERAL RADIO COMPANY
Cambridge, Mass.

GENERAL RADIO

“Behind the Panels of Better-Built Sets”

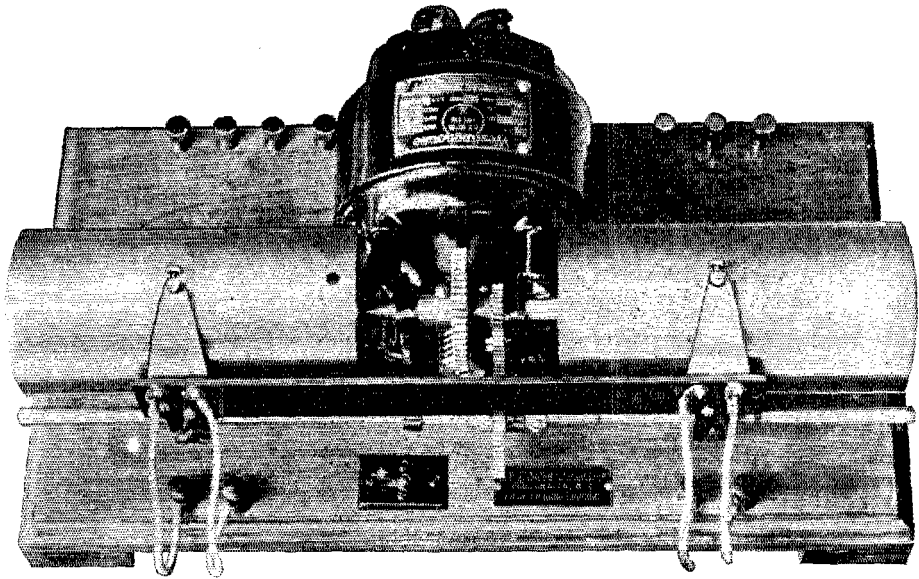

RADIO PICTURES

We are beginning now to find out what you radio experimenters want, and have put your suggestions into the new model machine, shown above. Not only is it complete for both sending and receiving pictures and picture-messages by radio (or by wire), but it is a beautiful piece of workmanship. The price to A.R.R.L. members is but \$45—less than it costs. Why? Because we want your assistance in developing visual radio. But whether you buy a machine or not send for information about prizes for suggestions, for each of which a copy of the book "Radio Vision" is sent, whether you get in the cash prize lists or not. We are after helpful suggestions. Shoot 'em in, and we will do our part.

JENKINS LABORATORIES

1519 Connecticut Avenue

Washington, D. C.

Preliminary Announcement

ALL-AMERICAN RADIO RECEIVERS

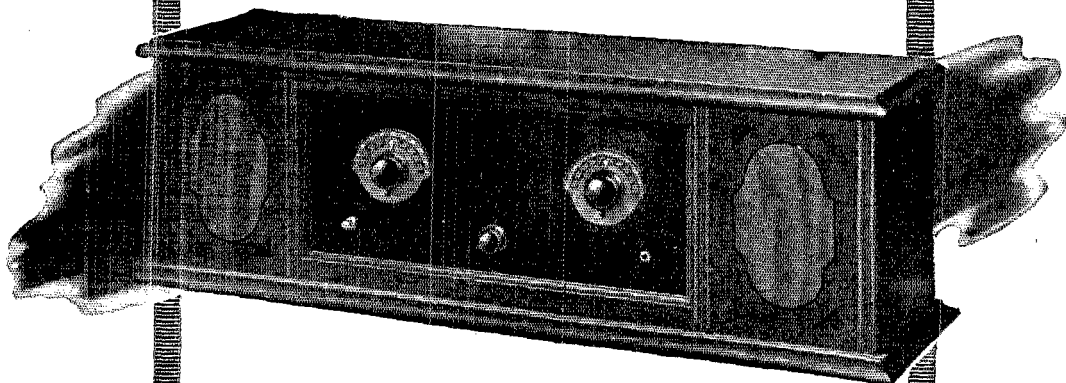

Model R: Price \$90.00

There will be available this fall a limited number of radio receivers, produced and wired complete in the new ALL-AMERICAN factory, and bearing the name ALL-AMERICAN.

Many hundreds of sets have been constructed in the ALL-AMERICAN laboratories. Most of them have performed in a manner which, in less experienced factories, would have caused the most joyful excitement. A few of these sets have shown results truly remarkable even when measured by the ALL-AMERICAN standard; but E. N. Rauland, pioneer in radio and severest critic of ALL-AMERICAN products, shook his head and said "Wait."

And he was wise. If this achievement had not come until next year, it would still have been worth waiting for. But it is on view at the shows.

Last year it was our pleasure to add to the family of the "World's Largest Selling Transformers" an audio amplifying instrument embodying features hitherto considered impractical,

outside the laboratory, on account of their high cost. This transformer, Rauland-Lyric, has in one season revolutionized the tone-amplifying art. And now, in the same spirit, we offer the ALL-AMERICAN Receiver.

ALL-AMERICAN Receivers embody, necessarily, all the genuine improvements of the past year in radio reception—many of them the especial product of the ALL-AMERICAN laboratories. Multistage control through two 360° dials, *without gears*, the elimination of "body capacity," the extreme of beauty in tone through Rauland-Lyric, and of distance, power and selectivity through ALL-AMERICAN Straight-Line-Frequency TUNING—these are combined with the utmost beauty and permanence in external appointments.

And yet, ALL-AMERICAN Receivers are not high-priced. This is due to the fact that, although only a small number will be produced this fall, the price has been set on the basis of next year's extensive production.

Dealers who realize the significance, for future growth, of handling merchandise of this character, are invited to write their jobbers or the factory for full information, or to visit our booth at the Chicago or St. Louis radio shows.



ALL-AMERICAN RADIO CORPORATION, E. N. Rauland, Pres., 4205 Belmont Ave., Chicago, U. S. A.

OWNING AND OPERATING STATION WENR—266 METERS

ALL-AMERICAN
Pioneers in the Radio Industry

Send for this RADIO BOOK FREE

1926 Catalog of RADIO BARGAINS

Save 1/3 to 1/2

The World's Largest Exclusive Radio Mail Order House Will Send You This Wonderful Book FREE



AMERICAN RADYNOLA

5 TUBE SET

64 illustrated pages containing thousands of bargains in radio sets, semi-finished sets and radio kits of all styles, sizes and approved circuits. 5-tube sets as low as \$29.50. Beautiful models of the very latest designs and types. Elaborate console models with loud speakers built right in cabinets of genuine mahogany and walnut. All sets guaranteed. Coast to coast receiving range. Also contains everything in radio supplies, including batteries, charcoal, loud speakers, transformers, condensers, rheostats and any other parts you may want for improving your set or building a new one. Guaranteed saving to you of 1/3 to 1/2.

The Biggest 5-Tube Value on the Market

Positively the world's greatest 5-tube radio bargains. Regular \$75.00 value. Our large quantity production enables us to sell this set for only \$29.50, fully built and wired in beautiful mahogany cabinet of latest design with sloping Bakelite panel of Satin finish, handsomely etched and engraved as illustrated. Constructed of the finest low-loss condensers, coils and sockets, Bakelite baseboard panel and dials. Price for set only. **\$29.50**

Transportation charges extra, shipping weight 25 lbs. This set with all accessories, including the famous American Bell loud speaker with adjustable unit, 2-45 volt "B" batteries, one guaranteed 100 Ampere Hour, rubber case storage "A" battery, cable for battery connection, 8-201A tubes, Aerial and ground equipment, and everything complete ready to set up and operate. Nothing else to buy. Price **\$59.75**



Order Direct from This Page! Save About One-Half!

Order direct from this page. Save 1/3 to 1/2. Our guarantee protects you. Money cheerfully refunded if you are not satisfied. Write your order and prices plainly. Send post office money order or bank draft for full amount to insure safety. Refer to any bank or commercial agency regarding our reliability. All kits described on this page shipped prepaid East of Rockies (except Canada). American Radynola and the 5-tube Radio Frequency receiver shipped charges collect.

SEMI-FINISHED 5-TUBE RADIO FREQUENCY SET

\$18.75

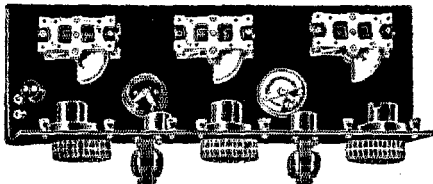

This special offer is astounding the radio world. Coast to coast reception on loud speaker. Low loss condensers and sockets. Highest quality transformer. Bakelite rheostats. All wiring concealed under Bakelite baseboard. 7x18 panel—fits into any standard 7x18 cabinet. Complete instructions for wiring. Guaranteed saving to you of \$30.00. Price: f set all mounted, \$18.75. Cabinet of same model as American Radynola pictured above \$5.66 extra.

You must have our catalog no matter what set or kit you want. Our line is complete and includes all popular sets, such as Superheterodyne, Neutrodyne, Ultradyne, Reinartz, Regenerative, Radio Frequency, Browning-Drake, Super-Heterodyne Reflex and all other latest circuits. Kits, sets and parts manufactured by all well known manufacturers such as Frost, Howard, Baldwin, Brandy, Western Electric, Columbia and others.

Our semi-finished sets come with all parts mounted on panel and baseboard ready for wiring. Do not fail to send for our catalog. Remember—we are the largest exclusive radio mail order dealers in the world and carry the best of everything in radio. We save you 1/3 to 1/2 on the following kits. Detailed descriptions appear in our catalog.

SEMI-FINISHED 8-TUBE SUPER-HETERODYNE

\$43.75



World's Famous 8-tube Superheterodyne.

Fully mounted on panel and baseboard. Comes completely assembled ready to wire and operate. We have testimonials from thousands of builders of this set. Some have received foreign stations on loop aerial. Unsurpassed in volume and tone quality. Low-loss straight line frequency condensers, vernier dials, finest quality rheostats. Matched Remler or Columbia long waved transformers. Requires only three screws for attaching panel and baseboard and set is ready to operate. 7x30 panel. Price of set only \$43.75.

Requires following accessories to complete this set: 7x30 cabinet, 8-201A tubes for storage battery operation or No. 199 tubes for dry cell operation. 100 Ampere hour storage battery, 2-45X "B" batteries, loud speaker, center tapped loop aerial. All these items are listed in our catalog at a tremendous saving.



Catalog includes list of broadcasting stations, general radio information and facts about our free service division. Write for it today.

NEUTRODYNE
Genuine licensed Neutrodyne kit of parts, come fully assembled on the panel and baseboard with complete instructions, \$29.75 ready to wire. Price.

COCKADAY
3-tube Cockaday kit of parts, fully assembled on panel and baseboard, ready to wire \$15.85 Price.

LOW LOSS SHORT WAVE
3-tube set—25 to 10 meters. Fully assembled on panel and baseboard, ready to wire. \$19.80 Price.

ULTRA-AUDION
One-tube Ultra-Audion. Wizard of radio. Fully assembled and ready to wire. \$6.35 with instructions.

RANDOLPH RADIO CORPORATION

159 N. Union Ave. Dept. 22 Chicago, Illinois

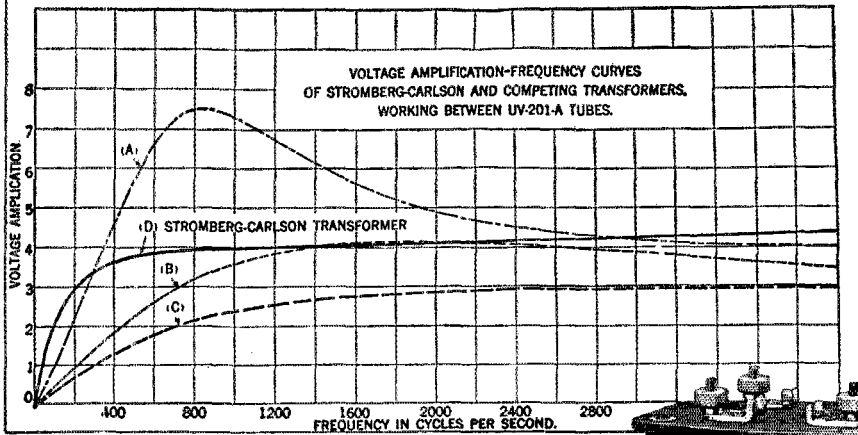

Stromberg-Carlson Transformers

Not only does the charted performance of the Stromberg-Carlson transformer show a comparatively high amplification on low frequencies but it also gives uniform amplification on the intermediate and the higher frequencies. This uniform voltage amplification throughout the widest possible range of musical frequencies is in marked contrast to other makes tested which are efficient over only comparatively narrow bands of frequencies or which produce distortion on the high or low frequencies due to weakness in amplification.

The Stromberg-Carlson Audio frequency transformer makes the nearest practical approach to distortionless performance.

Stromberg-Carlson Head Sets

Transformers and loud speakers have Layer Wound and Layer Insulated coils. These coils are wound one layer at a time with a layer of tough insulation between layers and vacuum impregnated. That is why they stand up indefinitely under present day high plate voltages.

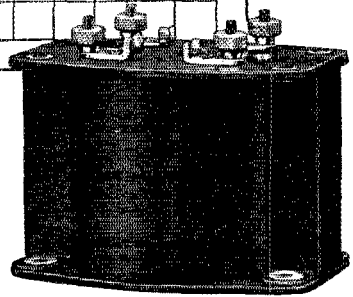

No. 3—A Transformer Ratio 4 to 1 Primary reactance, 125,600 ohms at 1000 cycles. Low core losses, thin laminations. Compact dimensions for sub panel or base board mounting. 2 3/4" long, 1-15/16" wide, 2-3/16" high. Shell type shielding.

PRICE \$4.50



No. 3—A Head Set

No. 3—A Head Set Permanently sensitive. Magnets exert 2 1/2 lbs. pull. Hard Rubber Ear Caps. Die Cast Aluminum Case, Nickeled Head Band with Swivel and Slide Adjustment. 11,000 ohms total impedance.

PRICE \$5.50

Stromberg-Carlson

TEL. MFG. CO.

1060 University Ave.

KANSAS CITY

CHICAGO

Rochester, N. Y.

TORONTO, CANADA

**TELEFUNKEN
AND
MUELLER
Transmitting
Tubes**

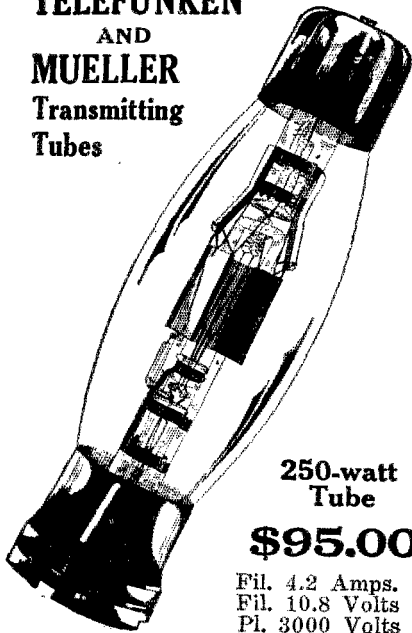

**250-watt
Tube
\$95.00**

Fil. 4.2 Amps.
Fil. 10.8 Volts
Pl. 3000 Volts
Pl. 210 M. A.



Transmitting Filter Condensers
In all sizes

Guaranteed to stand highest potentials
Accurate within 5 per cent.

| | | |
|----------|--------|---------|
| 1 M.F.D. | 1500 v | \$ 1.75 |
| 2 M.F.D. | 1500 v | 2.65 |
| 1 M.F.D. | 2500 v | 4.50 |
| 2 M.F.D. | 2500 v | 7.50 |
| 5 M.F.D. | 2500 v | 13.75 |

TOBE transmitting condensers are distinguished by their silver-finished case.

Telefunken 30-watt tubes . . . \$15.00

Yobe Deutschmann Co.
CORNHILL BOSTON MASS

**The A.R.R.L. Diamond Is the
Emblem of a Real Amateur!**



The League Emblem comes in four different forms. Its use by Members is endorsed and encouraged by the League. Every Member should be proud to display the insignia of his organization in every possible way.

THE PERSONAL EMBLEM. A handsome creation in extra-heavy rolled gold and black enamel, $\frac{3}{8}$ " high, supplied in lapel button or pin-back style. There are still a few fellows who are hiding their light under a bushel. Wear your emblem, OM, and take your proper place in the radio fraternity. Either style emblem, \$1.00, postpaid.

THE AUTOMOBILE EMBLEM. Introduced only this spring, already more than 800 cars are proudly displaying the mark of the "Radio Rolls-Royce." $5 \times 2\frac{1}{2}$ ", heavily enameled in gold and black on sheet metal, holes top and bottom, 50c each, postpaid.

THE EMBLEM CUT. A mounted printing electrotype, the same size as the lapel button, for use by Members in any type of printed matter, letterheads, cards, etc. \$1.00 each, postpaid.

THE "JUMBO" EMBLEM. You've taken care of yourself, your car and your printing. How about the shack wall or that 100-footer? Think of the attention this big gold-and-black enamel metal emblem will get! $19 \times 8\frac{3}{4}$ ", same style as Automobile Emblem. \$1.25 each, postpaid.

Mail your order and remittance NOW to

The American Radio Relay League : : Hartford, Conn.

Build with the *New Models of* **U.S. TOOL CONDENSERS**

Better Condensers Make Better Receivers

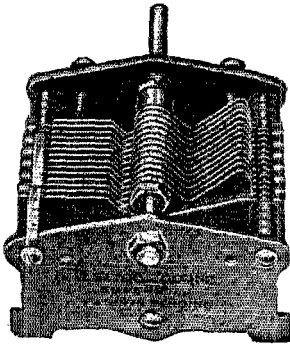

The same superiorities that have induced many reputable manufacturers to adopt U. S. Tool Condensers for their receivers are the points that will greatly improve your set. Chosen by these manufacturers after careful testing; you can use them with the same confidence and satisfaction.

MODEL 8

An efficient condenser made with new and patented one-piece stator, guaranteed to give sharp tuning at the lower broadcasting wave lengths.

| | | | |
|-----------|--------------|----------------|--------|
| Capacity, | Max. .00025, | Min. .0000076, | \$2.70 |
| | Max. .00030, | Min. .000008, | 2.85 |
| | Max. .00035, | Min. .0000086, | 2.95 |
| | Max. .00050, | Min. .000011, | 3.75 |

MODEL 9

Same as Model 8, but with Vernier and Kurz-Kasch Dial.

Capacity.

| | | |
|--------------|----------------|--------|
| Max. .00025, | Min. .0000076, | \$3.75 |
| Max. .00030, | Min. .000008, | 3.85 |
| Max. .00035, | Min. .0000086, | 4.10 |
| Max. .00050, | Min. .000011, | 4.75 |

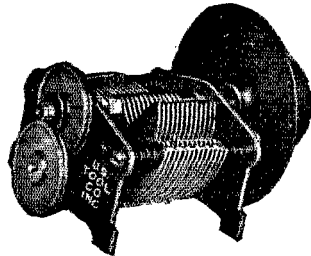

MULTIPLE CONDENSER

*For Single
Control
Receivers*

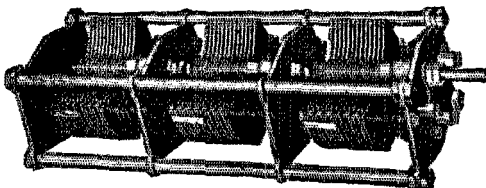

Simplify your receiver by operating two or more U. S. Tool Condenser units with only one dial—the greatest step thus far in radio reception.

Made under Hogan
Patents, Jan. 9, 1912
Pat. No. 1,014,002.

WRITE FOR LITERATURE

See These New Models at Your Dealer's

U.S. TOOL CO., INC. AMPERE, N.J.

Sangamo Mica Condensers

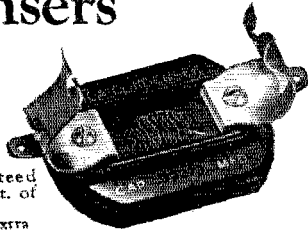

Accuracy guaranteed within 10 per cent. of marked capacity.
Resistor clips 10c extra

In reflexing - - *where accuracy brings results*

BECAUSE of their high accuracy, Sangamo Mica Condensers give perfect results in reflex circuits, where exact capacity is necessary to success. Any receiver, whatever the circuit, is improved by the use of Sangamo Condensers.

They are accurate, and they stay accurate. All nationally recognized radio laboratories have approved Sangamo Condensers.

The accuracy of these condensers is not affected by heat or cold, moisture or acid fumes, soldering or electrical surges. They are solidly molded in smooth brown bakelite which will not chip or crack even if dropped several feet to a hard cement floor. The edges are rounded, and substantial ribs increase their mechanical strength.

All in all, Sangamo Condensers are as fine condensers as money will buy, not only on account of their sustained precision, but because their workmanship and finish is in harmony with the beautiful construction of the highest quality of radio parts on the market. Yet they are not expensive. Quite otherwise, in fact.



All standard capacities. Your dealer should have Sangamo Condensers. If not, insist and he'll get them for you.

Sangamo Electric Company
Springfield, Illinois

RADIO DIVISION, 50 Church Street, New York

SALES OFFICES—PRINCIPAL CITIES

For Canada—Sangamo Electric Co. of Canada, Ltd., Toronto.
For Europe—British Sangamo Co., Fonders End, Middlesex, Eng.
For Far East—Ashida Engineering Co., Osaka, Japan

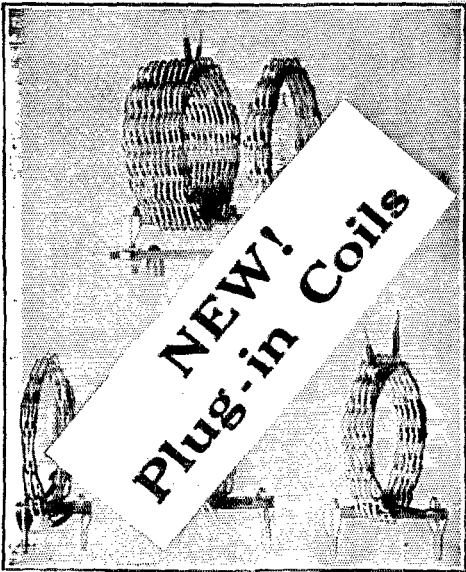

**NEW!
Plug-in Coils**

LOW **REL** LOSS
LOW WAVE COILS

In the Lead Again!—"REL" Basket Weave Coils now equipped with Plug-in Mountings—Quick efficient coil changing—Five interchangeable units in each outfit—Triple cores covered paraffined wire—Chocolate color, won't fail—For any low-loss low wave circuit—Covers 10 to 110 meters—Inexpensive—Rugged—No increase in price!
Price \$4.50, including mounting—
At your dealers', or order direct.

Radio Engineering Laboratories
27 Thames St. New York, N. Y.

Another TOAZ Development

FUSOCKETS

PATENT APP. FOR

Individually Fused Sockets
Insure your Tubes
199 or 200
Single or any multiple
At Your Dealers or
\$1.00 per Socket, P. P.

TOAZ TERMINALUGS
BEST FOR RADIO BUGS

At your Dealers or send \$1.00 for Special Package, including Gripfast Terminalugs, (Pat. App. For.)

TOAZ Engineering & Sales Co.
11703 ROBERTSON AVE., CLEVELAND, O.

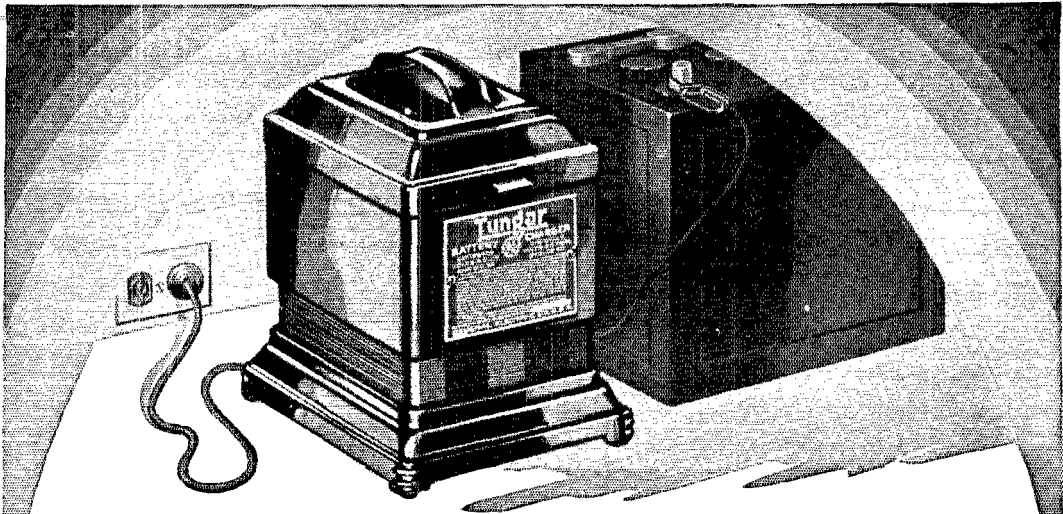

Partners for Power

If you want distance and clear tone from your radio set, your storage battery must have its partner—the Tungar Battery Charger.

Two clips and a plug to connect to the house current. That's all there is to it. Or you can make permanent connection and *just throw a switch.*

The Tungar charges while you sleep—it makes no disturbing noise—keeps your batteries at top notch. For power there is nothing like a good storage battery—with a tungar to keep it good.



The Tungar is a G-E product developed in the great research Laboratories of General Electric.

The new Tungar charges 2, 4, 6 volt "A" batteries, 24 to 96 volt "B" batteries; in series; and auto batteries, too. No extra attachments needed.

Two ampere size (East of the Rockies) . \$18.00
60 cycles—110 volts

Tungar

REG. U.S. PAT. OFF.

BATTERY CHARGER

Tungar—a registered trademark—is found only on the genuine. Look for it on the name plate.

Merchandise Division
General Electric Company, Bridgeport, Conn.

GENERAL ELECTRIC

A Noteworthy Contribution to the Art of Radio Transmission

THIS Weston Model 425 Antennae Ammeter adequately solves the problem of the measurement of antennae current and has made possible remarkable advances in the art of radio transmission. It is compensated against change of temperature, it eliminates the

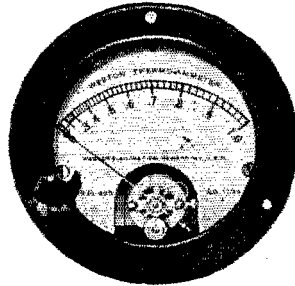

undesirable features found in hot wire expansion types of instruments and it possesses no zero shift—all contributing to making it the accepted standard in government and commercial use. For detailed information write for "Weston Radio Instruments."

WESTON ELECTRICAL INSTRUMENT CORP.
158 Weston Avenue, Newark, N. J.

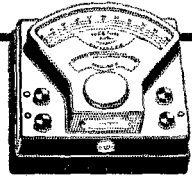

STANDARD THE WORLD OVER
WESTON
Pioneers since 1888

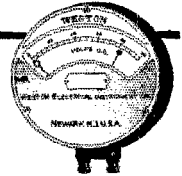

NEW—The Helicon Spiral Variable Condenser

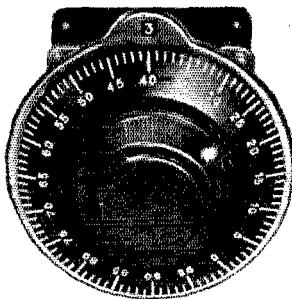

List Prices Complete

| | |
|--------|--------|
| .00025 | \$6.50 |
| .00035 | 6.75 |
| .0005 | 7.00 |

This new condenser has two plates, one fixed, one rotary. Both in spiral form, in operation the rotating spiral is, as it were, screwed into the fixed spiral. The .00035 type requires five complete turns of the rotor shaft to go from minimum to maximum. The turns are recorded by the counter at the window above the dial.

1. Helicon Spiral Condenser has an operating range of 1800°.
2. The one moving plate of the Helicon Spiral gives to its action a flexibility and delicacy far superior to any Vernier, besides having no back lash.
3. The Helicon Spiral is beautifully uniform in action throughout its entire range.
4. It is conspicuously "low-loss." Its grounded rotor eliminates trouble from hand capacity.
5. The oscillation point can be smoothly and gradually reached and maintained.

(Licensed under Oskar Meirowsky Patent)

THE KAPACITON CO., Inc., JERSEY CITY, N. J.

Direct Factory representatives for Massachusetts — **UTILITY MFG. CO., 54 Marlborough St., Springfield, Mass.**

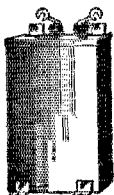

WESTERN ELECTRIC CO. FIXED CONDENSERS

8 mfd. Tested at 350 volts D. C.

These Condensers are just what you want for your "B" Battery Eliminator or experimental work. The condensers are made of the best quality of paper and tin foil and each Condenser is sealed in a metal container. They are compact, accurate and mounting brackets are conveniently located for placing anywhere in the circuit.

Price only \$1.85 ea.

AMERICAN SALES CO., 21 Warren St., N. Y. C.

"Simplify Radio"

says
Daven



Daven Engineers Blaze Another Trail

THE biggest of all the little things in radio is the grid leak. The Daven Grid Leak is known the world over as the grid leak of permanent, constant value. It is standard.

Almost as important is the condenser. But grid condensers change with temperature and humidity. The mica in condensers lacks uniformity or is impure. The tin foil plates melt or change their capacity.

In their constant efforts always to simplify and to improve, Daven engineers have made a remarkably effective combination of grid leak and condenser.

TWO-IN-ONE!

THE DAVEN LEAKANDENSER is so simple, so effective and so sturdy that you will wonder why it was not thought of before.

Similar in size to the Daven Grid Leak, it takes the place of the usual grid condenser which has shunted around it the usual grid leak. Made with five different values of grid leak resistance, 2, 3, 4, 5 and 7 megohms. The grid condenser capacity is fixed and correct for all makes of detector tubes.

With every Leakandenser a pair of new fastener clips that do not permit it to shake out. Precision-built. Price \$1.00 each.

Manufacturers are invited to send for a sample.

THE RESISTOR MANUAL is the handbook of Resistance Coupled Amplification. At your dealer's 25c. By mail postpaid 30c.

! DAVEN PRODUCTS ARE SOLD ONLY BY GOOD DEALERS

The Sine of Merit
DAVEN RADIO CORPORATION
Resistor Specialists

NEWARK Reg. U. S. Pat. Off. NEW JERSEY

CLIP THIS COUPON

DAVEN RADIO CORPORATION G-10-25
158-160 Summit Street, Newark, New Jersey

Please send me the following on Resistance Coupled Amplification:—

- Check one
 Resistor Manual. 30c is enclosed.
 Complete catalogue (free)

Name

Address

For dealers: Send your letterhead or card, or this coupon and we will have our nearest distributor communicate with you.

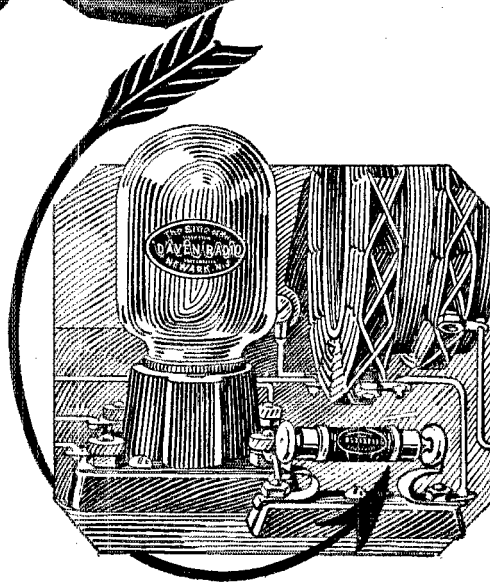

The New Daven Tube

Type MU-20 increases the amplification of the Daven Super-Amplifier to equal or exceed that obtainable with transformer coupling. A one-purpose, three-element tube, 6-volt, ¼ ampere—\$4.00 each. Daven Power Tube Type MU-6 is recommended for last or output stage—\$5.00.

THE BIG LITTLE THINGS OF RADIO



Lullaby

Through the air of the evening, calm and sweet comes a cradle song from a distant city. Then, as never before, we feel the need of radio amplifiers which will bring out, strong and clear, just the pure beauty of music. For such moments is the joy of owning the one amplifying instrument selected by world-famed musical authorities for the purity of its tone: Rauland-Lyric.

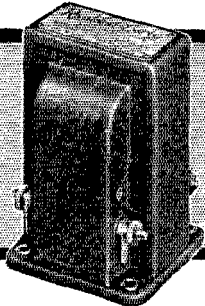

Rauland-Lyric is a laboratory-grade audio transformer designed especially for music lovers. The price is nine dollars. Descriptive circular with amplification curve will be mailed on request. All-American Radio Corporation, 4201 Belmont Ave., Chicago.

Rauland-Lyric
AN

ALL-AMERICAN
TRADE MARK
TRANSFORMER

The Choice of Noted Music Critics

DUPLEX



CONDENSERS

Made according to Bureau Of Standards specifications for lowest losses and best electrical characteristics.

Specially shaped-out stator-plates space the stations over the dial, while keeping the condenser as small as a straight-line capacity model.

Aluminum stator plate, exactly the same as used in the new DUPLEX Straight Line Frequency condenser, sent on request. Write for one today. Learn the secret of DUPLEX superior construction.

DUPLEX CONDENSER & RADIO CORP.

32 Flatbush Avenue Extension
BROOKLYN, N. Y.

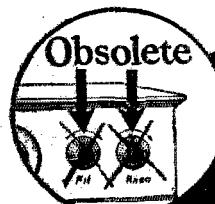

Take
the
"GUESS"
Out of Tube
Control

with

\$ 1.10
Everywhere

Amperite automatically controls tube current, eliminates hand rheostats, filament meters, guessing and all tube worry. Simplifies wiring, tuning and operation. Permits the use of any type of tube or any combination of tubes. Tested and used by more than 50 set manufacturers and in every popular construction set

RADIALL COMPANY
Dept. Q.S.T.-10, 50 Franklin St., New York City

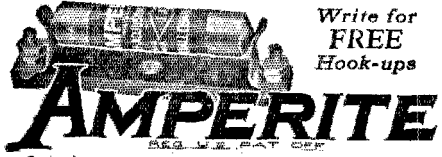

Write for
FREE
Hook-ups

AMPERITE
REG. U.S. PAT. OFF.

The "SELF-ADJUSTING" Rheostat

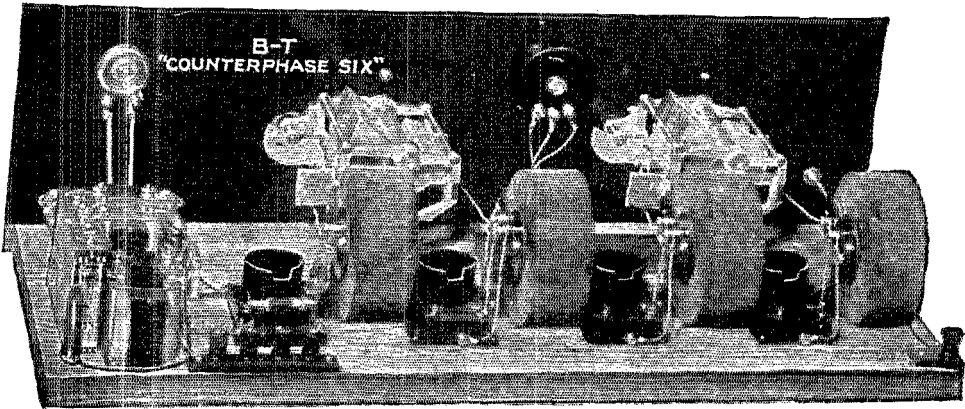

Experience Counts—

Since broadcasting began B-T have designed circuits and apparatus that have been continued successes.

To a long record of achievements is now added the B-T "COUNTERPHASE". The realization of a long cherished ambition,—the sixth tube where it belongs as a third stage of radio frequency. Sensitivity that gives distant reception on only a short indoor antenna. Selectivity to the point where added sharpness would cause distortion by cutting of the side bands. And only two tuning controls.

Nothing short of these improvements would satisfy B-T standards.

Kits containing essential parts for building the "COUNTERPHASE-Six" may be had at all reliable dealers. For those who desire only two stages of "radio frequency" kits may be had for building the "COUNTERPHASE-Five".

Send for Literature.

B-T Variable High Resistances

Smooth, Stepless, noiseless resistance that does not become impaired or change in value by continued service. Does not form a choke for r. f. currents.

Variable High Resistance

Type VHR in four models with maximum resistances of 2000, 50,000, 100,000 and 200,000 ohms.

Price each \$2.00

Non-Inductive Potentiometer

Similar to the above but with three terminals.

No. P-400 400 ohms price \$1.75

No. P-2000 2000 ohms price \$2.00

Volume Control or Modulator

Used in Audio Circuits for noiseless adjustment of volume and improvement of tone quality.

No. VC-500..... 500,000 ohms price \$2.00

Descriptive literature on request.

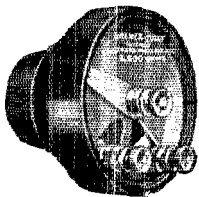

The Trend in Radio

Better Tuning attempts a sane analysis of the Radio trend. Issued bi-monthly. 10c per copy. 50c per year.

BREMER - TULLY MFG. Co.

532 S. CANAL STREET

CHICAGO, ILL.

*No. 10 of a series of 10
"FILTER FACTS"
Follow them thru monthly.*

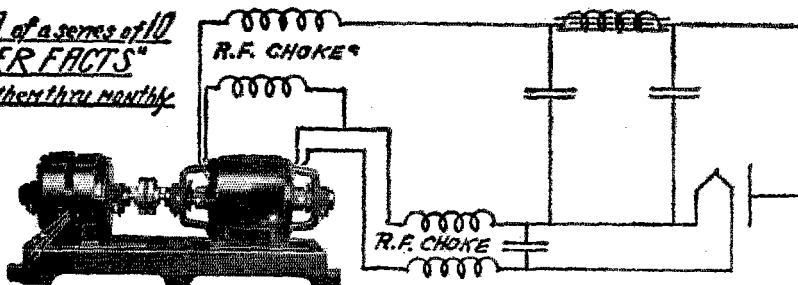

At the longer wave lengths the filters previously discussed have a double purpose. They are both a filter and a protective system against high frequency. At the very low wave lengths it is advisable to insert at the generator terminals R. F. chokes consisting of about 30 turns of large wire about 3 inches in diameter. These tend to impede any high frequency that leaks back thru the small capacity of the windings of large chokes or from stray induction from the set. These should be placed in both the plate and filament supplies. In the filament supply a large condenser, as is shown, should be used.

If you are interested in consistent maximum miles per watt you will be interested in Bulletin No. 237-B on motor-generators.

ELECTRIC SPECIALTY COMPANY

TRADE "ESCO" MARK

225 South Street.

Stamford, Conn.

This complete series with other valuable motor-generator information may be obtained in pamphlet form. Write for your copy.

A. R. R. L. MEMBERS

Fall is here. Amateur operating and League activities will reach their highest point during the coming six months.

The other advertising pages of QST will help you to select the proper receiving and transmitting apparatus to bring your station to top-notch efficiency. This page lists the "A. R. R. L. Apparatus" which you should stock up on so that you can function efficiently as a League Member.

LOG SHEETS. Officially adopted and endorsed by the Traffic Department. Printed on good bond paper, 8½x11", punched for standard 3-ring binder. 125 sheets, \$1.00 postpaid; 500 sheets \$3.50 postpaid.

MESSAGE BLANKS. A new, revised and larger edition of the standard A. R. R. L. form. Printed in "radio green," 75 sheets to a pad. 1 pad 30c, postpaid; 4 pads (300 sheets) \$1.00 postpaid.

MESSAGE DELIVERY CARDS. An attractive and handy card which will help keep your hook clear. 1c apiece for plain cards; 2c each on stamped postcards.

MEMBERS' LETTERHEADS. The authorized form for Members' correspondence. 8½x11", quality white bond paper. Lend dignity and prestige to your letters by using these letterheads. 100 sheets, 75c postpaid; 250 sheets, \$1.70 postpaid.

A complete stock of "A. R. R. L. Apparatus" is as important now as a bin full of coal. Mail your order and remittance NOW.

**The American Radio Relay League
Hartford, Conn.**

MacMillan's *choice* —Dubilier Condensers



ONLY *the best* radio apparatus could satisfy the needs of MacMillan's expedition to the far North. MacMillan and Reinartz—his radio engineer—chose Dubilier condensers. For your set, too, there is a Dubilier condenser that will give you the same unfailing satisfaction.

*Write for specifications
and prices*

4377 Bronx Boulevard
New York City

*Reinartz--MacMillan's
radio operator--with a
Dubilier condenser*

Dubilier condensers for
amateur use:

Type 577
Type 580
Type 663

Absolutely uniform
and constant.

Dubilier

CONDENSER AND RADIO CORPORATION

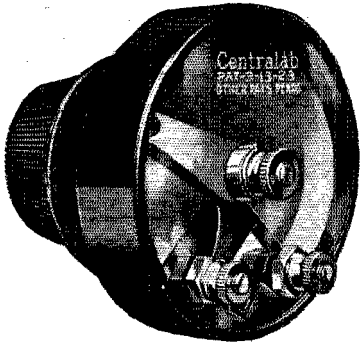

Oscillation, the Boon and Bane of Radio

Controlled oscillation is a boon to receiving sets in that it allows that sensitive regenerative condition which precedes the oscillation point. This condition represents the degree of neutralization of circuit resistance consistent with greatest selectivity and sensitiveness.

Uncontrolled oscillation, however results in distortion and the loss of both selectivity and sensitiveness.

CENTRALAB RADIOHMS give perfect oscillation control and attain the maximum efficiency from your receiver. There is a Centralab Radiohm for every oscillation control problem.

\$2.00 at your dealer, or mailed direct.

Write for literature and circuits describing this and other Centralab controls.

CENTRAL RADIO LABORATORIES

20 Keefe Ave., Milwaukee, Wisconsin

Centralab

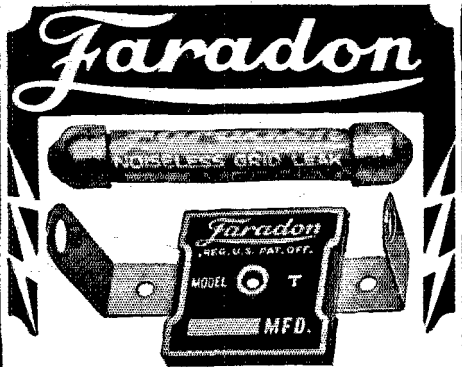

The 'Last Word' in Condenser and Grid Leak Units

FARADON MODEL T All-Metal-Mica fixed condensers are quickly appreciated by radio amateurs. Special construction and treatment secures constant dielectric spacing, permanent accuracy, low energy loss, and quiet operation.

The New Grid Leak—so good we put our famous FARADON trade mark on it—is likewise permanently accurate and noiseless, satisfying those who want the best.

In addition to having superior electrical characteristics they are most pleasing in appearance. We have prepared some interesting descriptive and operating data. It is free for the asking if you mention Q.S.T. Write us now for your copy.

Wireless Specialty Apparatus Co.
JAMAICA PLAIN, BOSTON, MASS., U. S. A.

ELECTROSTATIC CONDENSERS FOR ALL PURPOSES

Greater Power and Range

with the new



AERO COIL SHORT WAVE TUNER

95% Air Dielectric dopeless, air-spaced windings! You know what that means lower high frequency resistance, lower distributed capacity.

This amazing new tuner has a range of 80 to 205 meters with a .00035 condenser, tunes into resonance on a "knife's edge" and actually uses the energy which other types of inductance waste! Has variable primary.

Order an Aero Coil Short Wave Tuner. \$8.00 postpaid anywhere. Order direct.

Henninger Radio Mfg. Co.,
1772 Wilson Ave., Chicago

You and Reichmann

Sales demand or mere popular enthusiasm for something new has never swerved Reichmann Company from building only the kind of radio that *should* be owned by anybody.

You with a passion for the science of radio should know what Reichmann has done in the Thorola Islodyne. There are very exact reasons why it is the positively selective, precise-toned, uniformly produced set with correspondingly superior volume and distance. This is due not merely to the much-acclaimed theories of toroid coils, but to the unique low-loss structural properties exclusive to Thorola Low-Loss Doughnut Coils.

Consider also the indirect effects! By eliminating coil vexations and variables it was possible to attack factors which had been overshadowed by the coils. New control was gained over the elements of reception and of production! You can buy Thorola coils in sets of three, or separately, to test them in any circuits, obtaining your own verification of every point. Opinion is massing behind Thorola Islodyne receivers because they are the advance of the

year in broadcast reception — *and we know to whom we are speaking!* Thorola dealers have information that will satisfy you, or write direct for data on both Thorola receivers and parts.

Thorola Speakers

With vital technical refinements including the self-harmonizing feature, Thorola Loud Speakers increase their margin of leadership. The new Bakelite bell is the largest Bakelite form ever produced. The ingenious throat construction, and identifying gold throat-band lend inspiring grace and rugged strength.

REICHMANN COMPANY, 1725-39 W. 74th St., CHICAGO

Thorola No. 4. \$25

Thorola Islodyne (5-tube) Walnut. \$115

Thorola Islodyne (5 tube) Thorocco. \$85

Thorola Junior. \$15

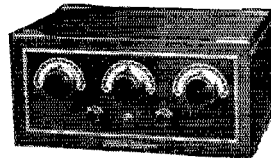
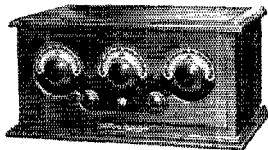
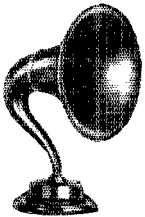

Thorola Low-Loss Doughnut Coils—Set of 3, \$12.....Per Coil \$4
 Thorola Low-Loss Straight Line Frequency Condensers, \$5.50 and \$6
 Thorola Gold Audio Reproducing Transformers \$4.50

Thorola

I S L O D Y N E

SAY YOU SAW IT IN Q S T—IT IDENTIFIES YOU AND HELPS Q S T

HARPER METALOID

The Original Canned Coil

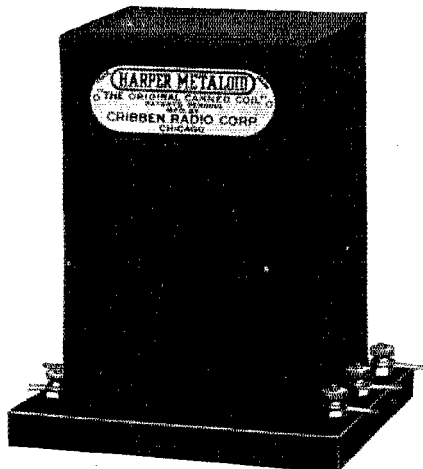

Price **\$5.00** Each

Perfectly Matched Shielded Radio Frequency Transformers

Among the many advantages of the Harper Metaloid is perfect matching—a feature now recognized as vitally important. They are made with mechanical precision, and the bare wire with which the coils are wound is exactly spaced for entire length of coil. Thus each metaloid has consistent electrical characteristics which is seldom the case with other transformers.

The lowest resistance of any shielded radio frequency transformer. Effective Electromagnetic and Electrostatic shielding; reduces interference from strong local signals; permits more compact construction; eliminates interstage coupling, which prevents stray feed-back, thus allowing better control of regeneration. Utilizes the superior space wound solenoid form of inductance. No critical angle for mounting. Mounting base only 3¼ x 4½ inches. Easily installed in your present set. Primary tapped for all tubcs. FREE technical circular especially prepared by W. W. Harper, designer of the Metaloid.

From Your Dealer or Sent Postpaid By

CRIBBEN RADIO CORPORATION

961 Montana Street

Chicago, Ill.

Over 85,000 Operators use the VIBROPLEX

Reg. Trade Marks:
Vibroplex Bug Lightning Bug

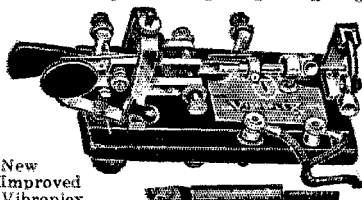

New Improved Vibroplex

Japanned Base,\$17
Nickel-Plated Base, 19

Because it transmits **STRONG** signals at any desired speed with less than **one third** of the labor required in key sending. Easy to learn and operate. Simply press the lever—the Vibroplex does the rest.

Special Vibroplex Requires No Relay

Equipped with 3/16-inch contact points to break high current without use of relay. Radio operators say fills a long felt want \$25

No radio station is complete without a Vibroplex. Radio operators and amateurs on land and sea now sending with a Vibroplex—it's easier.

Sent on Receipt of Price.

THE VIBROPLEX CO., Inc., 825 Broadway, NEW YORK

HERCULES AERIAL MAST

We pay freight

Mail the Coupon

20 Ft.\$10. 40 Ft.\$25. 60 Ft.\$45.

All Steel Construction Complete with guy-wires etc.

MAIL NOW FOR FULL DETAILS
S.W. HULL CO. Dept. D 2045 East 79th St. Cleveland, Ohio
Please send free the full details about the "HERCULES" Aerial Mast.

NAME..... STREET..... CITY.....



BINDING POSTS

Twenty-five Different Engraved Tops



They Don't Lose Their Heads



FIFTEEN CENTS At All Dealers



Your Radio

and

MICARTA

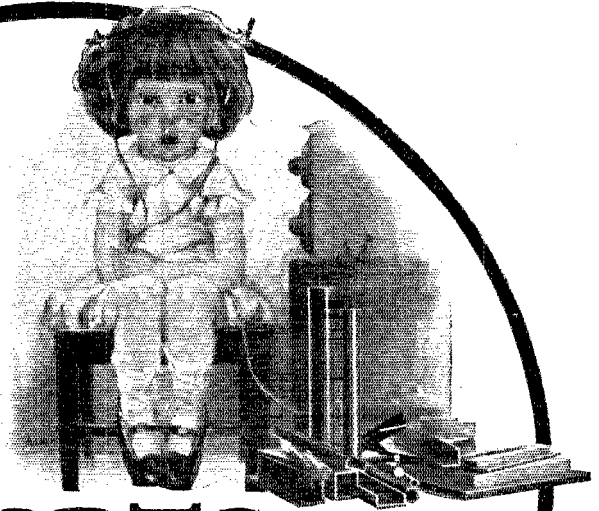

YOUR radio will be built of the best only when a Micarta panel adds efficiency and beauty to careful building.

It is the easiest of materials to engrave and machine. Smooth holes may be drilled without the slightest sign of a chip. It is not affected by temperature, water or oil.

Micarta panel board is now available in the soft, deep gloss of mahogany and walnut as well as in black. You will find it at your dealer's, packed in the orange envelope.

Westinghouse Electric & Manufacturing Company
East Pittsburgh, Pennsylvania
Sales Offices in All Principal Cities of
the United States and Foreign Countries



The Loud Speaker Sensation..!

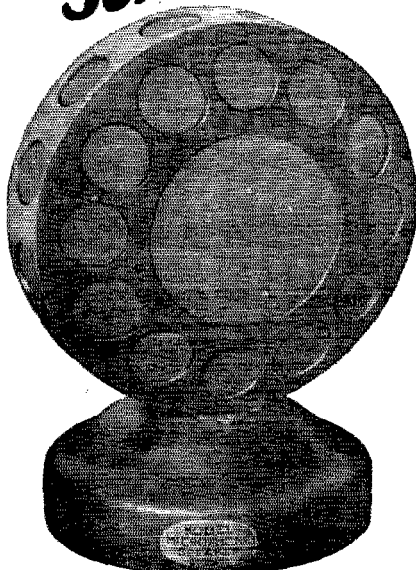

The **KODEL**
MICROPHONE
LOUD SPEAKER.

You can't tell the KODEL MICROPHONE LOUD SPEAKER from the microphone the broadcasting stations use—they are exactly alike in size and appearance.

The efficient Kodel Sound Unit, with a ingenious new snail-shell horn, mounted inside the microphone case, produces a remarkably clear, full-toned volume. Non-vibrating tone chamber absolutely eliminates distortion.

\$15 model incorporates Kodel, Jr. unit; equipped with large Kodel unit \$20

\$15⁰⁰

Radio dealers everywhere have them.

THE KODEL RADIO CORP.
508 E. Pearl St. Cincinnati, O.

RECEIVERS :: SPEAKERS
HOMCHARGERS

WKRC

Owners of Kodel Broadcasting Station WKRC. Send for program

**The New
Precise
Syncrodenser**

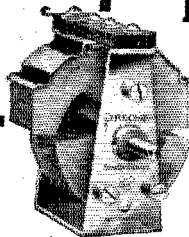

A scientific combination of straight line frequency where it is vital with straight line capacity where that is superior.

The Syncrodenser permits ideal separation of stations on the dial. The lower half of the dial which normally has most broadcast stations has fewer, while the upper half of the dial has more than on ordinary condensers.

The Syncrodenser can be mounted on panel or sub-panel in any position. Prices, .0005 mfd. cap. \$4.50; .00035 mfd. cap. \$4.00. Ask your dealer to show you the Precise line.

PRECISE MFG. CORP.
ROCHESTER, N. Y.

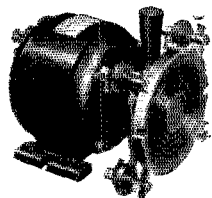

**Improve
your
TRANSMISSION**
WITH THE

ADVANCE "SYNC" RECTIFIER

More Distance—Mellower Tone!

The new improved ADVANCE "SYNC" RECTIFIER will enable you to reach hundreds of distant ears which have never heard of you. Gives both clearer tone and better volume. Rectifies alternating current at 500 to 3600 volts to direct current for the plates of your transmitting tubes. Very efficient on short waves. Requires no attention—always ready. More in use in American Radio Relay League than any other rectifier made.

Revolving disk is moulded bakelite six inches in diameter. Nickel plated brush holders with adjustable gauze copper brushes. Convenient control handle. Disk, aluminum brush support and brush holders perfectly insulated.

Price complete with Westinghouse 1/2 H. P. Synchronous Motor\$40
Rectifying wheel with complete brush assembly and mounting ring to fit your own motor \$15

We Pay All Transportation Charges in U. S. A.
ADVANCE ELECTRIC CO.

1260-1262 West Second St., Los Angeles, California



No Set is Better than its Parts

UNLESS each contributing unit performs its task without flaw, the most perfect results can never be achieved. The amazing excellence of radio performance is due in no small measure to the contributions of the Pacent organization of distinguished engineers, who have provided either first or best, many improvements in radio receiving sets.

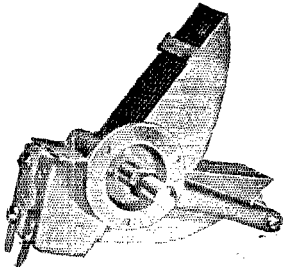

Pacents True Straight-line Frequency Condenser makes possible semi-spacing of stations. Negligible losses. Perfect insulation. Compact and sturdy.

Cat. No. 240 B .00055
Mfd. Max. Price **\$3.50**

Cat. No. 240 C .0005
Mfd. Max. Price, **\$4.50**

Pacents Parts are now used as standard equipment by forty leading set manufacturers. This fact is a clear indication of the prominent place held by Pacents Parts in the radio field. Whether you buy a set or build one, look for the Pacents trade mark on every important unit. It is your assurance of highest quality and performance.

Write for our new illustrated catalog.

PACENT ELECTRIC COMPANY, INC.

You can choose from
forty sets, the manufacturers
of which have selected

Pacents Parts

Charles Freshman Co. F. A. D. Andrea, Inc.
Stewart Warner Speedometer Corp. Patho Phonograph & Radio Corp.
Crosley Radio Corp. Ware Radio Corp.
Ambler-Holman Co. R. E. Thompson Mfg. Co.
Bristol Company Eisemann-Magneto Corp.
Magnavox Company Western Colt & Elec. Co.

Mu-Rad Laboratories

AND TWENTY-SEVEN OTHERS

Executive Offices:
91 Seventh Avenue
New York City

Branches
WASHINGTON
MINNEAPOLIS
BOSTON
SAN FRANCISCO
CHICAGO
BIRMINGHAM

Pacents

RADIO ESSENTIALS

Branches

PHILADELPHIA
ST. LOUIS
BUFFALO
JACKSONVILLE
DETROIT
PITTSBURGH

Canadian Licensees:

White Radio Limited
HAMILTON, ONT.

DON'T IMPROVIZE ~ PACENTIZE

P
Y
R
E
X

*Low Wave-Length Work
Demands the Best Insulation*

THE Navy-MacMillan Arctic Expedition is using PYREX Insulators for the various antennae and leads on the "Bowdoin", "Peary" and the planes.

Radio communication is a vital part of present day Arctic exploration, and the choice of PYREX is a compliment to this unique material.

PYREX is made in a variety of shapes for amateur use.

CORNING GLASS WORKS

Industrial Division
Corning, New York

World's Largest Makers of Technical Glassware

P
Y
R
E
X

**FILTER
CONDENSER**

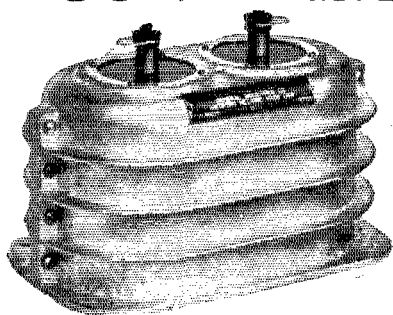

Size: 7 1/4" x 4 1/2" x 5" High.

3000 Volts ——— 2 MFD.

Cast Aluminum Case. 10,000 volt insulators around each terminal. Triple laminated by our special nascent impregnation process, Not a WAX-PAPER product.

GUARANTEED AS RATED

\$5.50 Postpaid

Order from your dealer or direct from
GENERAL INDUSTRIES CO.

MEDFORD HILLSIDE,

MASS.

EAGLE



RECEIVING SETS
MEAN SATISFACTION

Every "Eagle" Receiving Set is individually inspected *eight times* before it leaves the Eagle factory.

95% "Eagle" Built
Durable Balanced
Guaranteed



EAGLE RADIO COMPANY
23 Boyden Place Newark, N. J.

Announcing the *New* radio battery that is always charged

HERE is something that will be welcomed by all radio fans—a compact “A” storage battery and charger, known as the Exide Radio Power Unit.

This unit is assembled in an attractive metal case, and is kept at all times connected to the ordinary house current as well as to the radio set.

Upon raising a small switch on the end of the unit, the receiving set is ready for use; by throwing it down, the battery is automatically placed on charge. Thus battery-charging, in its most convenient form, practically becomes a part of set operation.

The battery, of course, is an Exide, specially designed for the unit, and has ample capacity for any receiving set—whether that set uses one tube or ten. As there are no moving parts to wear or get out of order, maintenance cost is low.

Finished in a rich mahogany color, the Exide Radio Power Unit is furnished in two sizes—one, for sets using 4-volt tubes; the other, for sets using 6-volt tubes; retailing at \$28 and \$38 respectively—slightly higher west of the Rockies.

There are, in addition, Exide “A” and “B” storage batteries for every requirement, and a rectifier for recharging “B” Storage batteries. Inquire of any Exide Dealer or at your favorite radio store.

THE ELECTRIC STORAGE BATTERY CO.
Philadelphia

Exide Batteries of Canada, Limited
153 Dufferin Street, Toronto

Exide

RADIO POWER UNIT

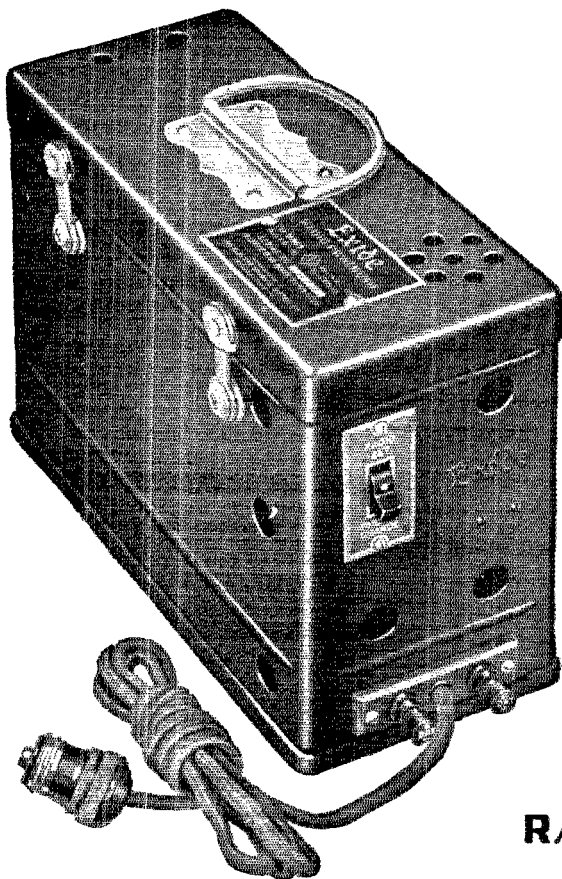

FOR BETTER RADIO RECEPTION, USE STORAGE BATTERIES

SAY YOU SAW IT IN QST—IT IDENTIFIES YOU AND HELPS QST

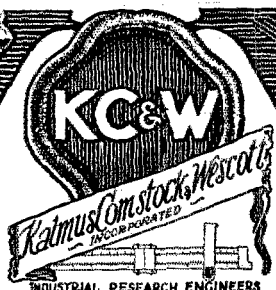

INDUSTRIAL RESEARCH ENGINEERS

Scientific Research for Radio Manufacturers

Radio Manufacturers are constantly faced with scientific problems due to the discovery of new principles and the necessity for keeping their product in the front rank in Radio's rapid advance.

Kalmus, Comstock & Wescott, Inc. offers to the Radio Industry resources, equipment, and trained scientific skill necessary to solve these problems.

We maintain a staff of highly trained scientists and engineers with years of practical experience in the various fields of industrial research. Our Laboratories, personnel and experience are available to Radio Manufacturers for a reasonable compensation. It will pay you to write for complete information.

KALMUS, COMSTOCK & WESCOTT Inc.

110/114 BROOKLINE AVE. Industrial Research Engineers.. BOSTON, MASSACHUSETTS

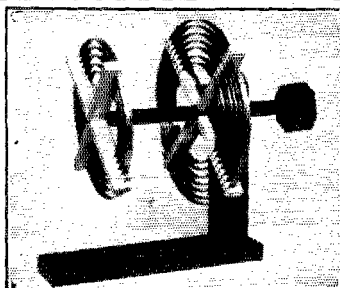

Hardwood Panels and Frames Made to Order. Full Line of Parts and Tubes on Hand. Write for List.

20, 40, 80 Meter Low Loss Coupled Inductances

\$6⁷⁵ postage extra

Very neatly constructed. Wound with heavy brass ribbon. Specially designed for S. W. work, therefore more efficient. Primary and secondary coils all wound ready for use. Stand easily assembled in a few minutes by inserting two screws. This is the regular \$10.50 inductance. Quantity production makes this new low price possible. Coupling Easily Varied.

In Stock, High Grade Panel Mounted Transmitters. Beautifully constructed of finest parts obtainable. 50 watts up. Prices from \$100 to \$250.

J. GROSS & CO.,

Phone Lenox 10199.

323 East 83 Street, New York City

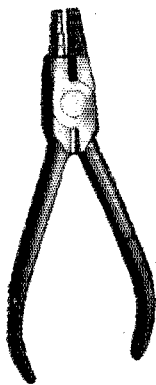

"Windham" Wire Former

(Pat. Pending)

A complete and handy tool for electricians, radio set builders and mechanics. It will accurately form loops or eyes for No. 4, 6, 8 and 10 screws, make easy radii and sharp right angle bends, has flat jaws and wire cutters. This tool is made of the best quality steel, dropped forged and carefully tempered in oil.

We guarantee every tool against defects in workmanship and materials and will promptly replace or refund money on any found defective by purchaser.

Price \$1.25 Each

Ask your dealer

MANUFACTURED BY

THE GOYER COMPANY

Willimantic,

Connecticut

PATENTS

TRADE MARKS · DESIGNS
FOREIGN PATENTS

MUNN & Co.

PATENT ATTORNEYS

Associated since 1846 with the Scientific American

840 Woolworth Building, New York City
521 Scientific American Bldg., Washington, D.C.
410 Tower Building, Chicago, Ill.
365 Hobart Building, San Francisco, Cal.
218 Van Nuys Building, Los Angeles, Cal.

Books and Information on Patents and Trade Marks by Request.

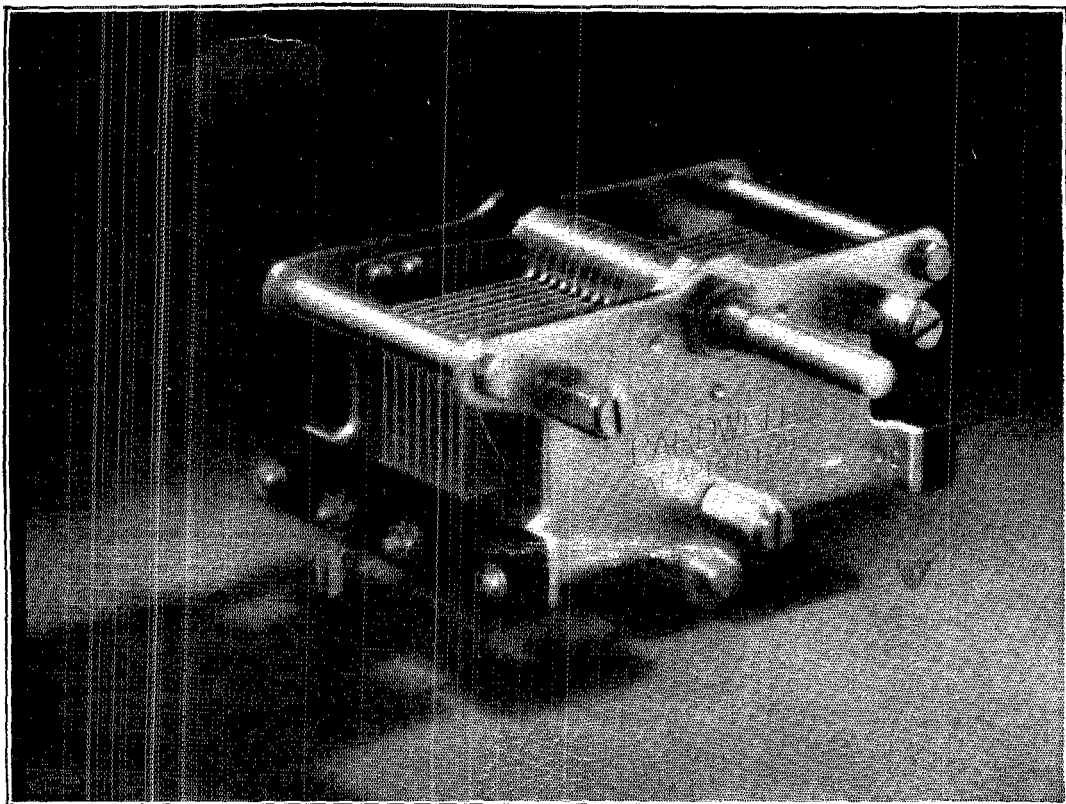

Insist on CARDWELLS

The *first* "low-loss" condensers

CARDWELL invented the original *low-loss* condenser, using metal end plates and a grounded rotor. The phrase "low-loss" was in fact first applied to Cardwell Condensers by engineers to distinguish these highly efficient condensers from the ordinary varieties.

Cardwell Condensers have been universally adopted by radio editors, experts, and professionals. Cardwells have become the standard of comparison.

Performance is the only real test of a condenser. And Cardwell Condensers have proved their superiority because of their scientifically correct

design—small area of contact between insulation and stator supports, rigid three-point frame, permanent alignment, accurate adjustment, etc.

Such details permit exceptional distance records, smooth tuning free from noise, and prevent changes in capacity at given settings.

Use Cardwell Condensers in all receivers. There's a Cardwell Condenser for every requirement—seventy-six different types. A post-card brings you an education on condensers.

Allen D. Cardwell
Manufacturing Corporation
81 Prospect St., Brooklyn, N. Y.

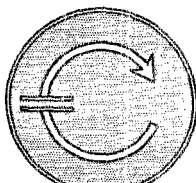

TRADE MARK
 Registered Design

Antenna

Series

Condensers

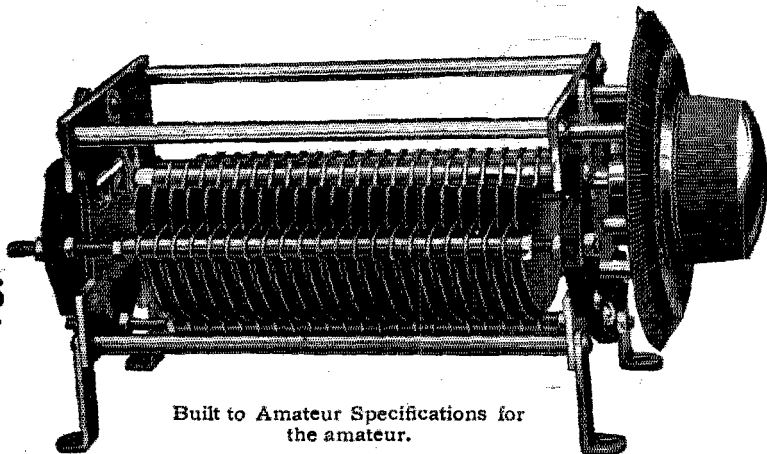

Built to Amateur Specifications for the amateur.

- Type 150 — 3000 150 MMFd. (.00015 MF).
 3/16" spacing (ordinarily known as double spacing), 3000 volt flashover. Fine for 5W and normal 50W sets. Proper size for primary circuits. Price \$7.50
- Type 450 — 3000 450 MMF (.00045MF)
 3/16" spacing, like those NATIONAL supplied to N.R.R.L. Price \$16.50
- Type 100 — 6000 100 MMF (.0001MF)
 3/8" spacing, 6000 volt flashover, for the overloaded "50" and the "250" W. Plenty big enough for the primary, too. All prices include 4" Velvet Vernier Dial. Price \$12.50
- "NATIONAL" can furnish you with 5 or 3 plate Receiving Variables for that short wave receiver. Send for Bulletin 106 Q S T

NATIONAL COMPANY, INC., ENGINEERS AND MANUFACTURERS
 110 Brookline Street, Cambridge, Mass.

This It means
HILCO

Five HILCO Condensers, installed in 18 minutes, will make a 3-tube circuit equal a 5-tube reflex—and then some!

But don't expect it from any other make. It takes the dynamo-tested, watch-built HILCO thus to clear frequency paths, stop battery clack and make low-loss a verity. You never knew a fixed condenser like it—yet HILCO Condensers cost no more than makeshifts.

Reliable dealers and jobbers will get HILCO Condensers for you from

A.E. HILL Mfg. Co. ATLANTA

KIRO
 STORAGE BATTERY

"B" ELIMINATOR SIMPLICITY

PERMANENT ALKALINE STORAGE BATTERY RECEPTION

KIRO MULTI-POWER UNITS operate from your lighting line and eliminate the replacing of dry cell "B" batteries... usually saving their cost in the first six to twelve months of service on Neodyne and Super Heterodyne sets.

Guaranteed Two Years
 Prices
 MULTI-POWER UNITS (Complete)
 90 Volt MX...\$26.50

PERMANENT ECONOMICAL POWER
 Shipped charged and ready to use. No costly bulbs! No acid fumes! Units for 110 volt A. C., D. C. or farm Plants. Write for special offer! Distributors! Everybody!

Kimley Electric Company, Inc.
 2665 Main Street Buffalo, N. Y.

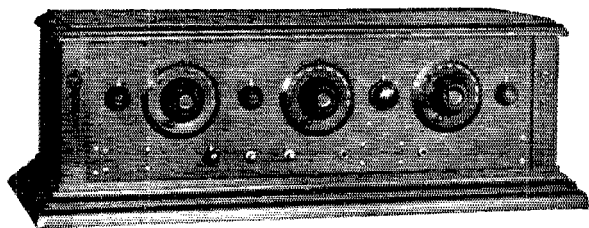
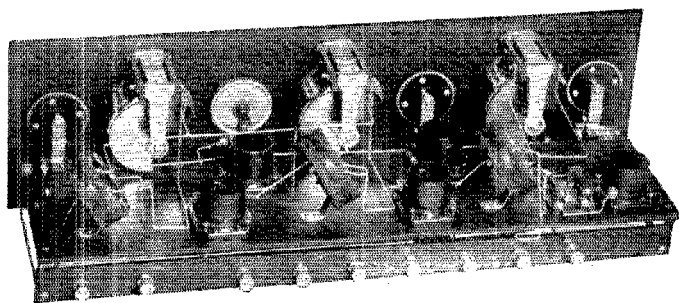

Joseph Calcaterra's Five-Tube, Tuned **Radio Frequency Receiver**

In the past few years scores of loudly heralded "wonder" circuits, with fancy names, have come into the market only to disappear like soap bubbles. And the end is not yet; others will follow, this year and next year.

Meanwhile Joseph Calcaterra's 5-tube tuned Radio Frequency Receiver has grown steadily in the confidence and favor of thousands of "wise" fans. Day by day, under all conditions, it has proved its efficiency, its unflinching selectivity, its

distance-getting ability and its splendid volume.

Two stages of tuned radio frequency, giving the desired qualities of selectivity and ability to bring in distant stations, a vacuum tube detector and two stages of audio frequency amplification to strengthen the signal for loud speaker operation are used in this standard circuit.

You can purchase for only \$55.00 all the parts required to build it, including the handsome 7 x 24 panel cabinet shown above.

Sent FREE Diagram and Complete
Simple Instructions

Fully illustrated with photographs, wiring diagram, layout of parts and full-sized panel-drilling templates. Copyrighted, 1925. Written in easily understood, non-technical language. Don't wait. Get your copy now. A postal brings it free.

Kellogg Switchboard & Supply Company

1035 W. Adams Street

Dept. J.

Chicago, Ill.

Introducing!



The New R.C.A. Ux 210 Transmitting Tube

7½ Watt, 425 Volt, Filament 7.5 Volts, 1.25 Amps.

List, \$9.00. Special Price, \$8.00

A New Line of Troy Transmitting Accessories

WILL BE READY FOR IMMEDIATE SHIPMENT OCTOBER 1ST.

- Troy Short Wave Inductance for 40 or 80 Meters.
 - Troy Lowloss Radio Frequency Chokes.
 - Troy Double Spaced Variable Transmitting Condenser.
- and others will be announced later.

These accessories will be of the best design, workmanship and material. They are the culmination of years of experience in W. Transmission.

AMRAD

- 4000-1 100 Volt "S" Tube Now \$8.00
- 5000-1 500 Volt "S" Tube Now 6.00
- Change-Over Switch Now 6.00

Write for New Detailed List No. 2 for New Specialties Too Numerous to Mention



Troy Radio Company

1254 St. Johns Place Brooklyn, New York



Specialists in Amateur, Experimental and Commercial Radio Apparatus.

NEW!

The Proudfoot 100 to 1 Vernier Dial That Matches All Standard Dials

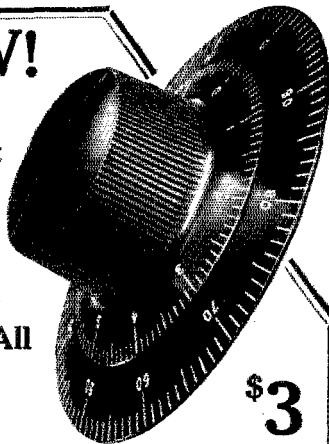

\$3

Improve your reception. Separate your stations more readily by using this efficient dial. 4 in. genuine bakelite. Entire mechanism fitted into a small metal case in the knob. You can't tell it from an ordinary dial. Nothing complicated about it, but extremely fine readings can be obtained. The Proudfoot 100 to 1 Vernier Dial fits all condensers—both screw and locknut mounting types. Easily attached. See one at your dealers. If he cannot supply you, write us at once.

NEED STRAIGHT LINE CONDENSERS?

The Proudfoot Straight Line Low Loss Condenser is theoretically and practically perfect. Equal divisions of the dial give equal changes in wave length. Most compact unit built—less interference with other parts of circuit. Write us for complete literature. Four capacities. At your dealers.

Cruver Manufacturing Co.

2456 W. Jackson Blvd., Dept. M, Chicago, Ill.

NEW LOW WAVE LOW LOSS UNCLE SAM COIL

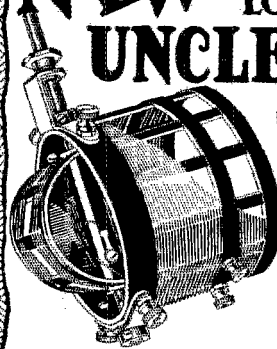

SIZE
2¼ x 2½ In.
Tunes from
35 to 150
meters with
a .0005 Mfd.
Condenser.

Write for Free Four Page Coil Folder and Hook-ups.

UNCLE SAM ELECTRIC CO.
212 E. Sixth St. Plainfield, N. J.

BRASS WIRELESS KEYS

These all brass keys are equipped with 3/16" silver contact points which will break any high current. They are well balanced and fully adjustable and mounted on a wood baseboard.

Price only 95c each

AMERICAN SALES CO., 21 Warren Street, N. Y. C.

Radio drafted Bakelite

so all could listen-in

To make available for everyone, everywhere, the marvel of radio reception, radio engineers required an insulating material possessing a unique combination of properties.

Bakelite alone met the need. It combines high insulation value with strength and light weight. It is easily formed into the many shapes required and will not warp, shrink nor swell. It will not absorb moisture and is unaffected by extremes of heat and cold.

All of these properties and the beautiful color and finish of Bakelite are permanent—unaffected by time, use or climate. So "Radio drafted Bakelite," and today it is used by over 95% of radio set and parts manufacturers.

Make sure that the radio set or parts that you buy are Bakelite insulated, for good insulation is essential to clear reception.

Write for Booklet 27

BAKELITE CORPORATION

247 Park Avenue, New York, N. Y.
Chicago Office: 636 West 22d Street

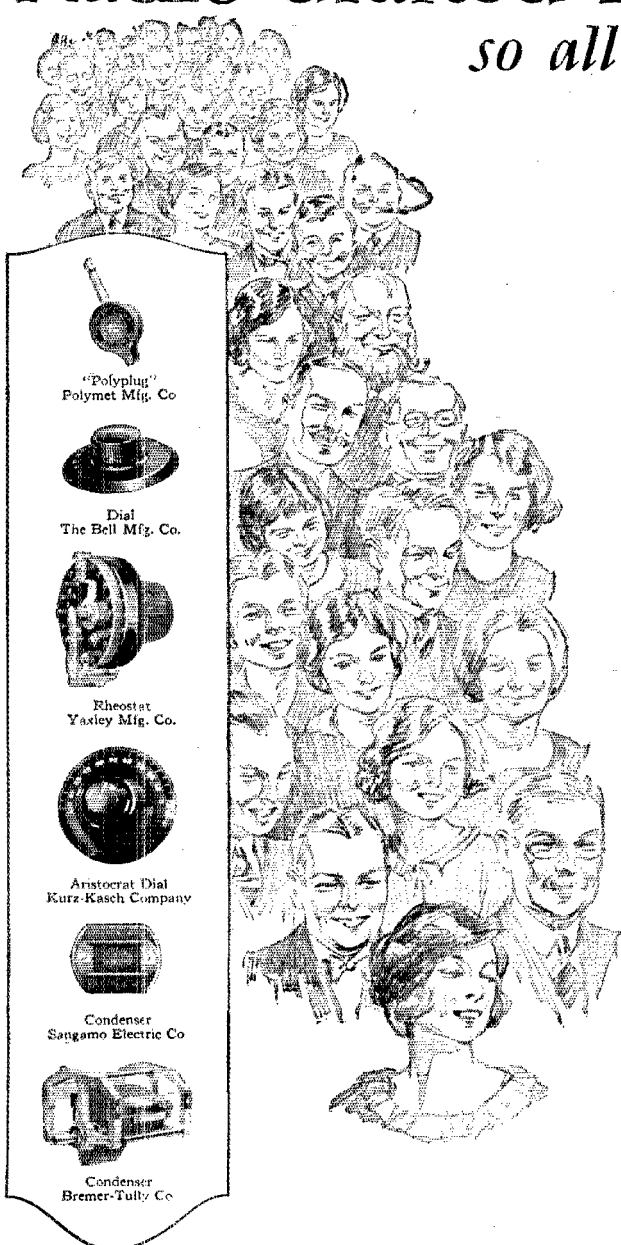

"Polyplug"
Polymet Mfg. Co.



Dial
The Bell Mfg. Co.



Rheostat
Yakley Mfg. Co.



Aristocrat Dial
Kurz-Kasch Company



Condenser
Saugamo Electric Co.



Condenser
Bremer-Tully Co.

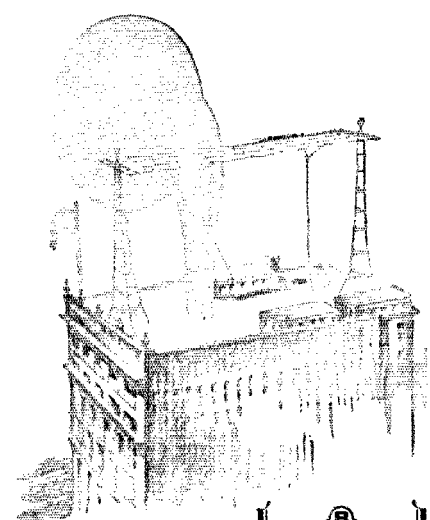

Bakelite is an exclusive trade mark and can be used only on products made from materials manufactured by the Bakelite Corporation. It is the only material which may bear this famous mark of excellence.

BAKELITE

B
BAKELITE
is the registered trade mark for the phenolic resin product manufactured under patents owned by the Bakelite Corporation.

THE MATERIAL OF A THOUSAND USES

THE SUPER-SYNC

The Synchronous Rectifier That Can Be Filtered

The Super-Sync is the only rectifier that delivers a pure D. C. tone and gives 100% rectification at all times. When once adjusted the Super stays put, as all the attention it requires is an occasional oiling of the bearing.

When filtered the Super delivers a tone which is often mistaken for storage battery plate supply. The Super will supply the highest as well as the lowest powered transmitter, as it will easily handle as

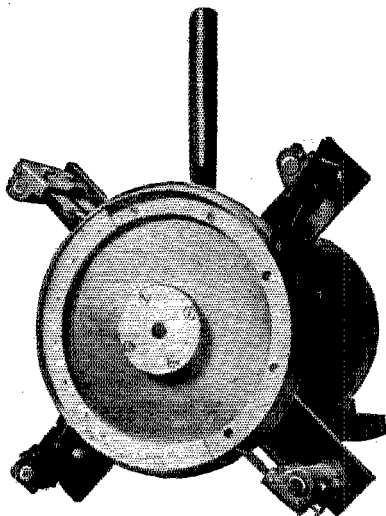

high as 4,000 Volts at 250 M. A. filtered.

The commutator on the Super is driven by a $\frac{1}{4}$ H. P. 1800 R. P. M. 110 or 220 volt 60 cycle General Electric Motor.

The Super does not require a complicated filter but can be filtered with the common type of "brute-force filter." For information write for our descriptive literature. Price on Commutator and brush rig \$45.00.

PRICE COMPLETE \$75.00
PATENT PENDING

MARLO ELECTRIC CO., 5241 Botanical Ave., St. Louis, Mo.

The Wilson "B" Radiopower Unit

Patents
Pending



In Walnut Case

Supplies plate current from light socket. Furnishes constant voltage at all times. Combines all the advantages of wet "B" batteries with none of their disadvantages. Absolutely no hum during operation. No acid to spill. No moving parts to get out of order. Requires no attention after installation. The most dependable, economical and convenient unit for supplying plate current.

In handsome walnut case. Price \$35

PADDLEWHEEL-COIL

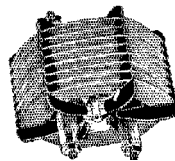

Has exceptionally high ratio of inductance to resistance. Losses are negligible. Increases range, volume and selectivity. Improves tone. Used in high grade receivers such as DERESNADYNE and BUCKINGHAM. Can be used in nearly all standard receivers and circuits. Price \$3.00. Secure constructional blue-prints from your dealer or write to our Technical Department.

We manufacture the famous DUO-SPIRAL Folding Loop in special models for every circuit. If your dealer cannot supply these standard products, write direct.

Radio Units Inc.

1304 First Ave. Maywood, Ill.
Perkins Electric, Ltd., Montreal, Toronto, Winnipeg

Our Type A Wave Meter Is Ready

Send for Literature

Other Real Ham Apparatus Under Way

We are specialists in apparatus for the amateur and want every real ham's name on our permanent mailing list.

THE WIRELESS MFG. CO.

Canton - - - Ohio

BLUEBIRD RADIO TUBES

—are powerful—sensitive for distance, give clear volume and long service.

GUARANTEED

to work in Radio Frequency, Neutrodyne, Super Heterodyne and Reflex.

WITH BAKELITE BASE

Type 200
Type 201A
Type 212
Type 299
Type 299A with standard base

\$2⁰⁰

Type 202 5 watt Transmitter \$3.00
When ordering Mention Types

BLUEBIRD TUBE CO.

230 Broadway Dept. S New York



Shipped Parcel Post C. O. D.



Music Master
Resonant Wood
Insures Natural
Tone Quality

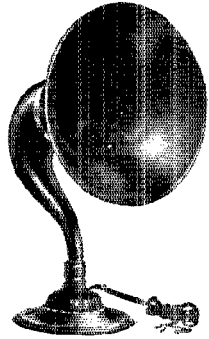

Model VI, \$ 30
14" Wood Bell

Model VII, \$ 35
21" Wood Bell

(Canadian Prices
Slightly Higher)

Ten Models—\$50 to \$460
Guaranteed Unconditionally

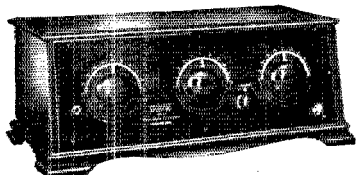

TYPE 60

Five Tubes. Two stages of radio frequency, detector and two stages audio frequency. Selective, good volume and distance. Brown mahogany art finish cabinet. Price \$60

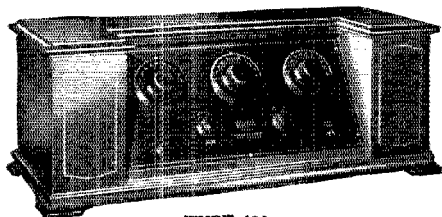

TYPE 100

Five Tubes. New Music Master Circuit, involving special adaptation to radio frequency. Very selective, good volume and distance. Solid mahogany cabinet in \$100 brown mahogany art satin finish. Price \$100

Radio, too, is Now Standardized

PIONEER owners of automobiles had to try out all sorts of accessories to get motoring satisfaction. Pioneer owners of radio receiving sets likewise experimented with tubes, batteries, condensers and "loud speakers" to balance the power of the set with the quality of the amplifier. And they found that Music MASTER Reproducer—the *Musical Instrument of Radio*—made any good set better.

MUSIC MASTER Receivers embody the demonstrated features of standardized radio and assure efficiency of radio reception equal to the world-famous quality of Music MASTER reproduction.

An authorized MUSIC MASTER dealer will demonstrate—in your home—Music MASTER's power of distance, clarity and volume, ease of operation, faithful reproduction and superb musical tone quality.

See MUSIC MASTER—hear—compare—before you buy any radio set.

Music Master Corporation

Makers and Distributors of High-Grade Radio Apparatus
 128-130 N. Tenth Street, Philadelphia
 NEW YORK CHICAGO PITTSBURGH MONTREAL
 Canadian Factory: Kitchener, Ontario

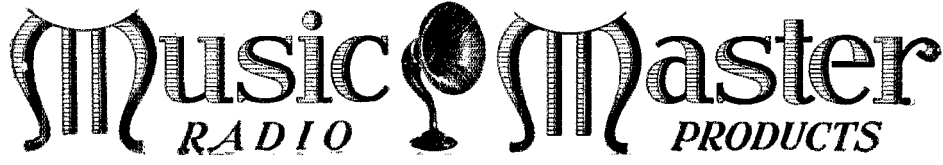

To Our Readers Who Are Not A. R. R. L. Members

Wouldn't you like to become a member of the American Radio Relay League? We need you in this big organization of radio amateurs, the only amateur association that does things. From your reading of *QST* you have gained a knowledge of the nature of the League and what it does, and you have read its purposes as set forth on page 6 of every issue. We would like to have you become a full-fledged member and add your strength to ours in the things we are undertaking for Amateur Radio, and incidentally you will have the membership edition of *QST* delivered at your door each month. A convenient application form is printed below—clip it out and mail it today.

.....1925

American Radio Relay League,
Hartford, Conn.

Being genuinely interested in Amateur Radio, I hereby apply for membership in the American Radio Relay League, and enclose \$2 (\$2.50 in foreign countries) in payment of one year's dues. This entitles me to receive *QST* for the same period. Please begin my subscription with theissue. Mail my Certificate of Membership and send *QST* to the following name and address.

.....
.....
.....

Station call, if any

Grade Operator's license, if any

Radio Clubs of which a member

Do you know a friend who is also interested in Amateur Radio, whose name you might give us so we may write him about the League?

..... Thanks!

Radio "Trouble Shooter" Every Set Builder Should Own One



Actual Size
Easily Slips in Pocket. Generates its Own E.M.F. Fits Any Phone Tip.
ENGINEERS ARE ENTHUSED
Say its wonderful. Lasts practically indefinitely.
Price \$1.25 With complete instructions. Send for one TODAY.
Absolutely simple in Operation. Wonderful time saver
ADBRO MFG. CO.
Garrison Way Pittsburgh, Pa.

The ROYAL

TYPE 201-A TUBE

5 Volts \$1.25
22 Amps.

Detector, Radio or Audio Amplifier

A tube of exceptional quality

FULLY GUARANTEED

Please send money order—no stamps

Magnite Laboratories

P. O. Box 472

Newark, N. J.

The latest developments in low-loss parts

*Built of this special insulation
made to order for radio*

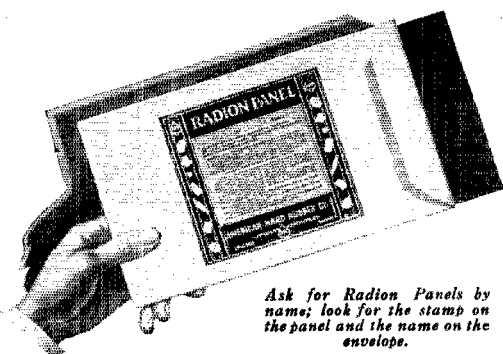

Ask for Radion Panels by name; look for the stamp on the panel and the name on the envelope.

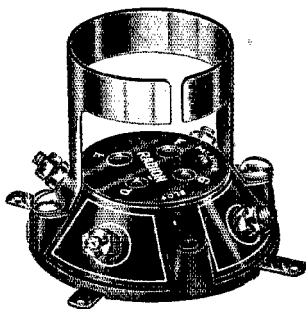

This is the Radion No. 2 Socket, designed for both old and new tubes. Equipped with binding posts.

RADION

The Supreme Insulation

NOW you can get a *complete line* of low-loss parts made of Radion, the special insulation which our engineers created for radio purposes exclusively.

These parts embody the very latest developments in radio. They are as efficient as the well-known Radion Panels and have the same high-resistant characteristics.

Radion Panels, made in black and Mahogany, come cut in 18 standard sizes for whatever set you wish to build. And in addition, you can have Radion Sockets, Radion Loud Speaker Horn, Radion Tubing, Radion Binding Post Strips, Insulators, etc.

New sockets for both new and old tubes

OF PARTICULAR interest are the new Radion Sockets, Nos. 4 and 5 are for the new-style UX tubes exclusively. Nos. 2 and 3 are designed to take *both* new and old style tubes.

All Radion Sockets are highly efficient, due to the principle of their construction and the low-loss characteristics of Radion. Ask your dealer to show them to you.

Send for Booklet

Our booklet "Building Your Own Set" gives clear, complete directions for building the most popular circuits. Mailed for 10 cents (stamps). Send the coupon today.

AMERICAN HARD RUBBER COMPANY
Dept. L7, 11 Mercer St., New York City
Chicago Office: Conway Building
Pacific Coast Agent: Goodyear Rubber Co., San Francisco
Portland

American Hard Rubber Company
Dept. L7, 11 Mercer St., New York City
Please send me your booklet, "Building Your Own Set" for which I enclose 10 cents in stamps.

Name

Address

NOW You Can Build A REAL One Dial Set!

COMPENSATED

MULTIPLE



VARIABLE

CONDENSER

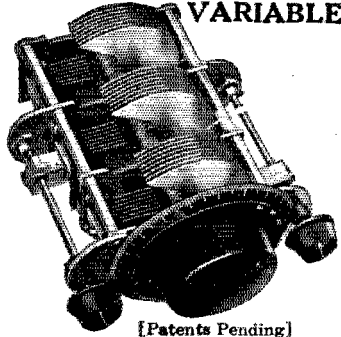

[Patents Pending]

This new U. S. L. Multiple Condenser has been given the most thorough and impartial tests by manufacturers and laboratory experts throughout the country. All agree that it is the

Only Practical One Dial Control Unit

Evenly matched and balanced; 100% perfect electrically and mechanically; can be built into any T. R. F. circuit. It is a straight line, low loss unit making the sharpest tuning quick and easy. Capacity: .00035 mfd. per unit. Order a sample today.

Price \$13.50 including Bakelite dial and two knobs

BRANCH SALES OFFICES

Boston—Philadelphia—Chicago—Minneapolis
St. Louis—Omaha—San Francisco

United Scientific Laboratories 84 FOURTH AVENUE
NEW YORK CITY

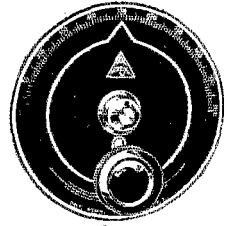

Apex Vernier Dials

are constructed on exhaustively tested and truly scientific principles and are engineered to meet the precise requirements of experts—consequently they more than meet the expectations of the average radio user. They bring in distant stations with alacrity and positiveness seldom encountered and provide control and accuracy essential to full radio enjoyment. They impart a degree of elegance that creates a marked improvement in the appearance of any set. Clockwise or counter clockwise.

- Royal Brass Finish, 4 in. \$2.00; 3 1/4 in. \$1.65
- Satin Silver Finish, 4 in. 2.50; 3 1/4 in. 1.90
- DeLuxe Gold (24K) 4 in. 3.00; 3 1/4 in. 2.50

Apex Rheostat Dials

are little brothers to Apex Vernier Dials. Accurate, handsome—a necessity to satisfactory operation and beauty of appearance.

- Royal Brass Finish 75c
- Satin Silver Finish 85c
- DeLuxe Gold (24K) \$1.00

If your dealer is unable to supply you, order direct from us.

Apex Electric Mfg. Co.

1410 W. 59th St., Dept. 1009, CHICAGO

Big Profits for DEALERS

Make more money. Buy all your stocks from us. Prompt service. Complete line of newest merchandise.

Get Big Free Catalog

of standard parts, sets, kits at big discounts. Write now!



W.C. BRAUN CO.
32-46 S. Clinton St., Chicago

Laboratory Product



CRESCENT LAVITE RESISTANCES

for Distortionless Amplification

12,000, 48,000, 50,000, 100,000 Ohms. List \$1.50 ea. Special Sizes to Order \$2.50 ea.

Dealers write for discounts. When Better Resistances are made they will be Crescents. Crescent Radio Supply Co., 1 Liberty St., Jamaica, N. Y.

ULTRA-LOWLOSS CONDENSER

SPECIAL CUTLASS PLATES DISTRIBUTE THE STRAINS EVENLY OVER THE DIAL SIMPLIFIES TUNING CAPACITY ODDS MEN

\$5.00

PHENIX RADIO CORP., 116-F East 25 St., N.Y.C.

KARAS HARMONIK

AUDIO FREQUENCY

AMPLIFYING TRANSFORMER

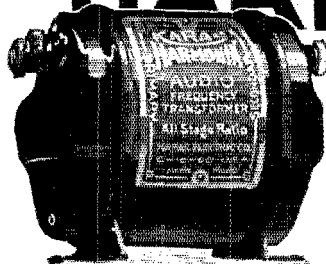

For more than 29 years makers of PRECISION Electrical Apparatus.

The Triumph of a Masterpiece!

— A Marvel of Transformers that Brought Real Musical Quality to Radio Reception

JUST one year ago the Karas Harmonik Audio Frequency Transformer took the radio world by storm.

Nothing like it had ever been known before. For the first time, scientific study had been devoted to perfecting an audio transformer for the reception of broadcast music. The problem of amplifying high, low and medium frequencies to equal degree was finally solved. Bass notes were poured from the speaker in full strength and rich tone quality. The vital harmonics in rich overtones, formerly lost, were brought out in their full beauty by this marvel of audio transformers.

Music critics, who had always condemned radio music as false and distorted, approved the results of Karas Harmonik amplification with great enthusiasm.

Prominent radio engineers subjected Karas Harmoniks to exhaustive laboratory tests—and pronounced it a technical masterpiece. Technical editors who promoted the season's most successful hook-ups specified Karas Harmoniks in their circuits. The triumph of the Karas Harmonik was complete.

But, for all of this, the enjoyment of Karas Harmonik amplification was too greatly confined to one class of radio enthusiasts. Home set builders bought Karas Harmoniks by the tens of thousands. They were free to pick and choose. They were most exacting in their demands for the newest and best developments.

It was the owners of factory-built sets who missed the delightful pleasure of real, true radio music in their homes. Set manufac-

turers were prevented by price from adopting Karas Harmoniks for their sets. So the ready-made set-buyer unless he undertook to switch transformers, had to do without Karas Transformers.

Today there are in use, hundreds of thousands of sets—good sets—which could be vastly improved in musical quality by the simple operation of replacing the old transformers with Karas Harmoniks. Perhaps you own one of these sets. It may be all you desire from the standpoint of selectivity of range, and other tuning qualities. But, if it is not equipped with Karas Harmonik Audio Frequency Transformers, you are NOT getting nearly the musical quality you can just as well enjoy. Are you going to be content with anything short of the best?

You can install Karas Harmoniks yourself. It's a short, easy job. Or, any radio repair man can do it for you. Make up your mind to do it now—at once. Get a pair of Karas Harmoniks TODAY!

In large cities, most good dealers carry Karas Harmoniks—and in many small towns. If your dealer is out of them, order direct from us. Send no money. Just send the coupon now!

Karas Electric Co.,
4056 N. Rockwell St.,
Chicago, Ill.

The Distinctive Features that Elevate Karas Harmonik Transformers to the Highest Pinnacle of Success in the Radio World.

1. Many thousands of turns of wire
2. Low ratio of turns
3. Extra large quantity of special formula iron in core
4. Controlled air gap
5. No core saturation
6. Minimum of Reluctance
7. Least Hysteresis and Eddy Current Loss
8. Low Distributed Capacity
9. Scientifically circular shielding preventing intercoupling of electrostatic and electromagnetic fields.
10. Very High Primary Impedance
11. Extremely High Inductance
12. High and Even Amplification of all Audio Frequencies.

Karas Electric Co.,
4056 N. Rockwell St., Chicago, Ill.

Please send me _____ pairs of Karas Harmonik Audio Frequency Transformers. I will pay the postman \$7 apiece, plus postage, on delivery. It is understood that I am privileged to return the transformers any time within 30 days if they do not prove entirely satisfactory to me, and my money will be refunded at once.

Name.....

Address.....

If you send cash, we'll send transformers postpaid.

SAY YOU SAW IT IN QST—IT IDENTIFIES YOU AND HELPS QST

QSL Cards Radiograms Log Sheets Binders Stationery

"The Better Kind"

The Jack Gray Press
Stationery Specialists
Evanston, Ill.

A. R. R. L. Members -- What about your friends?

You must have a friend or two who ought to be members of our A.R.R.L., but aren't. Will you give us their names, so that we may write to them and tell them about the League and bring them in with the rest of us? The A.R.R.L. needs every eligible radio enthusiast within its ranks, and you will be doing your part to help bring this about by recommending some friends to us. Many thanks.

American Radio Relay League,
Hartford, Conn.

.....1925

I wish to propose

Mr. of

Mr. of
Street & No. Place State

for membership in the A.R.R.L. I believe they would make good members. Please tell them the story.

.....
.....

HAM-ADS

IMPORTANT NOTICE! NEW RATES ADVANCED CLOSING DATE

Effective with May QST, the HAM-AD Advertising Rates are TEN CENTS A WORD. Name and address to be counted, each initial counting as one word. These rates are shown on QST Rate Card No. 6, in force with the May issue.

The closing date for HAM-ADS is now THE TWENTY-FIFTH OF THE SECOND MONTH PRECEDING DATE OF ISSUE. For example, all HAM-ADS for the June issue must be in this office not later than April 25.

Hereafter no HAM-AD will be accorded any particular or special position.

Rates for the QRA Section remain the same; 50c straight. See heading of that section for details.

RECEIVERS built to order. WORK guaranteed. Earl Deakins, Macedonia, Iowa.

MOTORS—New G.E. $\frac{1}{4}$ HP \$12.50, $\frac{1}{2}$ HP \$28.50, 1HP \$45. GENERATORS—Radio Transmission 500V \$28.50. Battery Chargers—Farm Lighting generators all sizes. Lathes, Drill Presses, Air Pumps other Garage and Shop equipment. Wholesale Prices. New Catalog. MOTOR SPECIALTIES CO., Crafton, Penna.

TELEGRAPHY—Morse and Wireless—taught at home in half usual time and at trifling cost. Omnigraph Automatic Transmitter will send on Sounder or Buzzer, unlimited messages, any speed, just as expert operator would. Adopted by U. S. Govt. and used by leading Universities, Colleges, Technical and Telegraph Schools throughout U. S. Catalog free. Omnigraph Mfg. Co., 13M Hudson St., New York.

\$2.95 ——— OUT AT LAST!
"THE Hawley." An alkali un-acid rechargeable "B" storage Battery of 22½ volts. Not an unassembleable battery but ready to use—no extra parts to buy. Uses the largest sized tested Alkaline elements (Edison). Heavy closed top glass cells. Chemical electrolyte included and shipped separate. Any detector or amplifying voltage easily had. Special offer. 4-22½ volts (90 volts) \$10.00; 112½ volts \$12.50; 135 volts \$14.75; 157½ volts \$16.80. For those wishing to put their own together buy the knock-down kits. Put up in all voltages at still greater savings in price. The only battery of its kind sold on a 30 day trial with complete guaranteed satisfaction or your money returned in full without any ifs, ands, or buts. Further guaranteed 2 years. Order direct—send no money. Simply pay expressman its cost plus the small carrying charges. Patent pending. Same day shipments. Write for my guarantee testimonials and literature. It's free and it's interesting. Complete sample cell 35c prepaid. E. Q. Smith, 31 Washington Ave., Danbury, Conn.

REBUILD YOUR NEUT—Use same panel, same parts. No neutralization. 22 feet gold wire, only extra part, circuit and complete, simple instructions—\$5.00 prepaid. Hundreds of Neut owners use this Kit. Details—10c. 48 page catalog parts—10c. Stamps accepted as cash. KLAGAD RADIO LABORATORIES, KENT, OHIO.
SAY YOU SAW IT IN QST—IT IDENTIFIES YOU AND

Send for our FREE CODE LESSONS showing simplicity of learning Radio. Positions secured for graduates paying \$40 to \$50 per week after short course. Fall term begins September 14. Free Scholarships for a few lucky ones. INQUIRE! Catalog free. MASSACHUSETTS RADIO SCHOOL, 18 Boylston St., Boston, Massachusetts.

EDISON ELEMENTS LARGE SIZE WITH CLAMPED ON CONNECTOR 5c PER PAIR. ALL OTHER PARTS CARRIED IN STOCK. 300 AMPERE EDISON A BATTERIES, PERFECT CONDITION \$35.00. GET PRICE LIST. ROMCO STORAGE BATTERY CO., 146 W. 68TH ST., NEW YORK CITY.

MAKE \$120 WEEKLY IN SPARE TIME. Sell what the public wants—long distance radio receiving sets. Two sales weekly pays \$120 profit. No big investment, no canvassing. Sharpe of Colorado made \$955 in one month. Representatives wanted at once. This plan is sweeping the country—write today before your county is gone. OZARKA, 853 Washington Blvd., Chicago.

200-20000 METER RECEIVER including Radiotron \$25.00. Two step amplifier \$15.00. Smith, 4416 Market St., Philadelphia, Penn.

TELEFUNKEN detector tubes with sockets \$1.48. Few Sedgig tubes, .98. Industrial Trading Company, Medina, Ohio.

"EVERYTHING FOR THE HAM THAT KNOWS WHAT AM." GET READY. NOW FOR THE WINTER DX SEASON. No. 12 "DYNEX" SOLID COPPER ENAMELED WIRE 1c FT., 500' \$4.75, 1000' \$9.25. No. 10 (FOR HEAVY DUTY) 1½c FT. PYREX GLASS TRANSMITTING INSULATORS. \$1.50. RECEIVING SIZE 45c. 1/16" ALUMINUM AND LEAD 90c SQ. FT. "DYNEX" KEM RECTIFIER ELEMENTS 1" x 4" 6c, 1" x 6" 7c, 1½ x 6" 8c. PYREX-GAROD GLASS SOCKETS, \$1.50. FLERON LEAD-IN INSULATORS (APPROVED BY THE UNDERWRITERS). \$1.25. ALLEN-BRADLEY RADIO-STATS, \$6.50. TYPE 210 \$1.00. "S" TUBES, HAVE PLENTY ON HAND NOW. \$10.00 WITH BASES. MERSHON CONDENSERS, \$8.00. CARDWELL TRANSMITTING CONDENSERS, \$15.00. No. 16 COTENAMEL, 75c LB. FLOCKS OF OTHER HAM STUFF ON HAND. WHAT'S ON YOUR MIND OM? "DYNEX FOR DX." "THE EIGHT THAT PAYS THE FREIGHT." SBIN, E. J. NICHOLSON, 1407 FIRST NORTH ST., SYRACUSE, N.Y.

FOR SALE—4-50 watt tubes, UV203 slightly used \$12.50 each. Also have a large list of new and used radio receiving and sending apparatus at greatly reduced prices. Write J. Nold, 27 Chestnut St., Schenectady, N. Y.

Radio Sets Built, Rebuilt, Wired, Rewired and overhauled. Any Circuit. Six years' experience and up to date. O.K. Radio Shop, Junction City, Kansas.

DODGE RADIO SHORTKUT KILLS HESITATION. MANY SLOW HAMS..... have increased receiving speed to 25 per by a few hours' practice after memorizing Code our way. MANY BEGINNERS..... have mastered Code and qualified for examination in few days by practice during spare moments. CONCLUSIVE PROOF..... in reports from TWO HUNDRED..... licensed students contained in Honor Roll and mailed on request. In U. S. and Canada \$2.50. Elsewhere \$3.00. Dodge Radio Shortkut, Mamaroneck, New York.

FOR SALE—ESCO 2000 VOLT 500 WATT DC MOTOR GENERATOR. BALL BEARINGS THROUGHOUT. \$140.00 GENERAL RADIO TYPE 174B WAVE-METER 75-1500 METERS \$37.00. BOTH ITEMS UNCONDITIONALLY GUARANTEED IN PERFECT CONDITION. A. H. HARDWICK, ORANGE, N.J., 2PD.

OMNIGRAPHS, Meters, Eliminators, Radio sets. Bought, sold. Ryan Radio Company, Hannibal, Mo.

FOR SALE: 5 to 20 watt transmitter, new. Will work on forty to one hundred twenty meters. R.C.A. parts will sell for Fifty Dollars. L. L. Sutherland, Smithfield, Illinois.

DOLLAR ASSORTMENTS still going BIG. DIDJA GET URS? R.P. Barrows, Columbia Road, Portland, Maine.

GOVERNMENT POSTALS printed the way YOU want HELPS QST

'em. Lots of 100—Black print \$1.90, two color \$2.40. 9DOA.

20 WATT Master Oscillator \$70. Write Arthur Schmitz, Glyndon, Minnesota.

BEST OFFER takes Paragon RA10, DA2. Clifford Hamill, Highland Street, Port Chester, N. Y.

"AMATEUR RADIO EXCLUSIVELY" SERVING ON AMATEUR RADIO EQUIPMENT ON ANY WAVELENGTH. ANY POWER. ANY TYPE OF TRANSMITTER OR RECEIVER. NOT CHEAP BUT THE HIGHEST GRADE AMATEUR EQUIPMENT. SUCH LINES AS CARDWELL, PYREX, THORDARSON, ACME, ESCO MOTOR GENERATORS, "THE KIND THAT SATISFY". WESTERN ELECTRIC, FARADON, GENERAL RADIO, ALL OF THE BEST IN RADIO. ACCURATE READINGS OF ANY CURRENT CAN BE SECURED WITH THE USE OF JEWELL INSTRUMENTS, OR WESTON. WE BUILD EQUIPMENT TO ORDER. SPECIAL EXPERIMENTAL EQUIPMENT. WAVEMETERS. IF YOU HAVE THE PARTS FOR ANY SET SEND THEM IN. WE BUILD ANY EQUIPMENT SHOWN IN QST. INDUCTANCES FOR ANY TRANSMITTING CIRCUIT, OR RECEIVER. OUR STANDARD RECEIVER WORKS FROM 1 TO 200 METERS. PRICES ON ALL EQUIPMENT ON REQUEST. WHEN THAT SUPERHETERODYNE FALLS DOWN ON YOU GIVE IT TO THE EXPRESS COMPANY WITH OUR ADDRESS ON THE BOX. FROM ITALY TO NEW ZEALAND "AMATEUR RADIO EXCLUSIVELY" IS KNOWN IN AMATEUR WORK. FOR RESULTS USE THE BEST. FOR THE BEST IN AMATEUR RADIO EQUIPMENT DROP US A LINE. ESTIMATES GLADLY GIVEN ON ANY WORK. SEND US YOUR INQUIRIES. GET QSO. THOS. ENSALL (ENSALL RADIO LAB.), 1208 GRANDVIEW AVE., WARREN, OHIO. ("Designers of High Grade Amateur Equipment.")

FOR SALE—E.I.S. Type C7 Superheterodyne, well constructed, in excellent condition, complete with panel voltmeter and ammeter. P. H. Chase, St. Asaph Road, Bala, Penna.

COMMERCIAL RADIO TRAFFIC MANUAL—The only publication covering all details of modern radio traffic handling. Improve your ham operation and prepare yourself for a commercial berth. One dollar from Howard S. Pyle, 1922 Transportation Building, Chicago.

THREE 6 ohm rheos \$.75 each, 1 power rheo \$1. Chelsea balanced condenser 23 plate \$2. 2 A.F. Transformers \$1.25. Jewell A.C. voltmeter 0-15, \$4.50 new. 2 workrite variometers—1 coupler, \$1 each. HK ammeter 0-5, \$1. Tube sockets \$.35. Plug—three jacks \$.25 each. Dials \$.50. Good condition. Prepaid. Allan Gower, Tracy, Minnesota.

SELL one Esco Motor Generator 600 volts d.c. 150 watts, 110 volts a.c., \$35. One Jewell 500 volt d.c. meter with resistor, \$7. Both guaranteed perfect condition. William Oldham, Roberts Ave., Santa Rosa, California.

FOR SALE Quartz Crystal cut parallel to the optical axis for use in Piezo electric oscillators. Phillip Apffel Company, 38 Vesey St., New York City.

Sell Amrad Receiver, Jewell Trio, Jewell 1000 Voltmeter, General Radio Laboratory Condenser, Decade Resistance Box, Audibility Meter, Wavemeter, 550 volt Motor-generator, Honeycomb Coils, DL100 to DL1500. Wilcox, 4602A Delmar, St. Louis, Telephone, Main 326.

EDISON B BATTERY ELEMENTS TYPE A. 4c per pair, postpaid. L. Giannini, 561 Brussels St., San Francisco, California.

WANTED—Someone to repair 20 receiving tubes on halves. Charles Coe, Dothan, Alabama.

STORAGE B Battery Parts. Lead Type. Plates .18, Jars .05, covers .08. Write for other prices. K. C. Electric Company, Dubuque, Ia.

ALL the best receiving equipment. A few General Radio 247K Condensers at \$2.00. More Spintites at a quarter a set. Write for complete price list. R. P. Barrows, 4 Columbia Road, Portland, Maine.

DODGE RADIO SHORTKUT AND QUICK SUCCESS. After using this method few days 8DR1 followed with our Intensive Speed Practice and in TWO EVENINGS

.....copied THIRTY FIVE SOLID.....Previous speed about twenty. Ask for his report. Dodge Radio Shortkut, Mamaroneck, New York.

FOR QUICK TRADE, NEW, COMPLETE, UP TO THE MINUTE, PRICE LIST, FOR UR QRA. JUST IN. MOUNTED THORDARSON FILAMENT TRANSFORMERS 150 WATTS 10 VOLT SECONDARY \$10.00. THEY'RE WORTH THE MONEY. IN STOCK. PLENTY CARDWELL 5 PLATE CONDENSERS FOR THE LOW WAVE TUNER. THEY ONLY COST \$4.00. IF YOU'RE THINKING OF BUILDING THAT REINARTZ TRANSMITTER FOR REAL LOW WAVES, WE HAVE THE TRANSMITTING CONDENSERS THAT YOU'LL NEED. CARDWELL .00025 AT \$10.00 AND .00045 AT \$15.00. BOTH SIZES DOUBLE SPACED, TO HOLD HEAVY VOLTAGES. WE ARE WAITING TO SERVE YOU. SHOOT YOUR ORDERS TO THE ONLY HAM STORE IN THE FIFTH DISTRICT. FORT WORTH RADIO SUPPLY CO., FORT WORTH, TEXAS.

ALL GOVERNMENT MATERIAL. General Electric 24/1500 volt 350 watt Dynamotors. Unused \$45.00. Slightly used \$25.00. General Electric 12/350 volt .143 ampere with filter \$18.00. Holtzer-Cabot 12/500 volt .07 ampere \$18.00. Any model for belt drive \$3.00 additional. Crocker-Wheeler 24/1500 volt 450 watt 6500 RPM \$45.00 and \$35.00 used. New 10 volt 20 ampere batteries \$7.50 in case. Navy Flame Proof Key with "Blinker Light" \$2.00 prepaid. 3/16" silver contacts Cost \$16.50. Marconi 50-225 meter receiver. Good set priced right \$75.00. Henry Kienzle, 501 East 84th Street, New York.

EDGEWISE wound copper ribbon, the only really satisfactory antenna inductance .350" wide; 3 1/4" outside diameter 10c turn; 4 1/4" 13c turn; 5 1/4" 15c turn; 6 1/4" 17c turn; 7 1/4" 20c turn, prepaid any number turns in one piece; Geo. Schulz, Calumet, Michigan.

\$30.00 Queen and Company, Portable, Decade Test Set, for resistance measurements, complete, worth \$135.00. Bought \$10,000 worth United States Government Aircraft Department Radio Transmitting, Receiving Sets and Parts. Get our new and latest reduced price list. Send 2c stamp for list. Mail orders answered all over the world. WEIL'S CURIOSITY SHOP, 20 South 2nd St., Philadelphia, Pa.

THORDARSON 5 WATT 650 VOLT POWER-FILAMENT TRANSFORMER \$6.90. CURTIS-GRIFFITH, FORT WORTH, TEXAS.

IF IT'S NEW, and worth while, 9ALD will have it. New RCA tubes, UX-210 7 1/2 watt oscillator or super amplifier, thoriated filament, \$9.00; new 216-B rectifier for transmitting, \$7.50. UX-120 amplifier \$2.50; UX-112 amplifier \$6.50. Fleron porcelain lead-in bushing, see page 20 June QST, \$1.10; General Radio coil forms, see page 11 August QST, 75c. Contact plugs 15c plug and jack complete 25c; Remember we rent and sell omnigraphs. 15 dial \$32.00, 5 dial \$25.00. Send for rental rates at once—and don't forget the free Hamalog, the only real ham catalog. We'll ship C.O.D., but if you send money, please include postage. E. F. Johnson, 9ALD, Waseca, Minn.

FOR SALE: Panel mounted transmitter 100 watts complete \$100. Two W.E. 50s included. Westinghouse 250 watt 1000V M.G. with field rheostat \$100. Grebe "13"—\$45. All above in excellent condition. Write for list. C. E. Prescott, Jr., Havre De Grace, Md.

REAL BARGAINS POST-PAID AT THE FOLLOWING PRICES—7 1/2 watt Tubes, UX-210 Radiotrons, fil. 1.25 amps, 6-7 1/2 volts, a real tube. \$8.00—Twin-R \$10.00 Circuit Breakers, adjustable around 10 amps. \$2.50—Amrad type F \$25.00 Long Wave Tuners, 2000-20,000 meters, \$8.00—Amrad No. 2796 \$8.00 Lightning Switches per reg. \$1.50—R.C.A. \$9.00 UC-1831 Variable Transmitting Condensers, \$1.50—Plenty of "S" Tubes at lowest prices—Amrad No. 2834 \$10.00 Send-receive Switch, \$5.00. Mogul Sockets, 80c. Send for discount sheet and keep in touch with bargains. STATE RADIO CO., 286 Columbia Rd., Dorchester, Mass.

Generators—new—ball bearing—rated at 275v-120 watts and will give output up to 500v—made for Signal Corp for Radiophone sets. \$8. Radiophone set only \$15. Used generators input 30v output 300v \$8. 10v to 300v \$16. UC 1831 variable transmitting condensers \$1.50.

UC1915 \$2. VT2 \$4. VT1 \$3. RCA 202 \$4. No. 12 enameled solid wire any length 75c per hundred. No 14, 50c. Other sizes and magnet wire in stock. 1/4 hp ac motors \$12; used generators in good order 1500v, 5000 speed \$20. 75.v.v. 200 watt \$20. 500v. 500 watt \$15. 500 cycle 200 watt \$10. 1/2 KW \$23, and others. Honeycomb coils 1250 turn \$1, fine for chokes. 1mf 1000v. condensers \$1.25. Coto-coil sockets 39c. 3 coil gearcord mountings \$1.50. Foreign orders shipped promptly. POSTAGE EXTRA. R. Wood, 38 Way Ave., Corona, New York.

ATTENTION!!! GENERAL ELECTRIC TWENTY WATT PHONE AND C.W. TRANSMITTER AND RECTIFIER. EIGHT TUBES, METERS AND MICROPHONE. INDUCTIVELY COUPLED. PHOTO. 40 TO 185 METERS. COST \$430. FIRST \$185 TAKES IT. 3-L J, 1519 NORTH ALLISON ST., PHILADELPHIA, PA.

AMRAD 36 MFD. MERSHON CONDENSERS, \$6.80; No. 400-1 S tubes \$5.00; Thordarson Plate and Filament transformers, 20% off; Cunningham 5 watters, \$3.75. Dealers Supplied. George Voigt Radio Supply Co., Maspeth, N. Y.

JUST because my ELECTRICALLY WELDED Edison elements give satisfaction in "B" batteries don't think that all batteries using Edison elements will give the same results. I use good, large size elements and weld two pure nickel wires on each negative element and one weld on the positive element. Sure, it costs more to do it this way, but it is the only way to keep the battery from becoming noisy. Genuine Edison elements, welded connections, complete with separators 8 cents per pair postpaid. Paul Mills, Woodburn, Oregon.

IMPEDANCE coupled audio transformers, \$1.00 postpaid. W. Cowles, 1292 Linden Ave., Memphis, Tennessee.

BARGAINS: Crystalstat panel mounting detectors 95c. Carborundum fixed detectors 85c. Both wonderful for reflex. Crystalstat mounted crystals 20c. Crystalstat lowloss receiving set \$1.25. Lowloss vario-coupler \$1.25. All prepaid. Breeckenridge Electric, 1923 Lysander, Detroit.

OCTOBER BECKONS. BUT WHY START THE SET WITH A SHORT LIVED B, WHEN AN EDISON STEEL-ALKALINE B LASTS A LIFE-TIME? NO JOINTS, PURE NICKEL CONNECTORS ELECTRICALLY WELDED FOR ABSOLUTE QUIET. GIVE YOUR SET A CHANCE WITH ONE OF THESE. 54 VOLT \$8.25. 100 VOLT \$15.00. OTHER SIZES. OAK CABINET. LARGEST ELEMENTS. REAL EDISON SOLUTION. A BIG 2000 MILIAMP HOUR B FOR THE MULTITUBE SET, 105 VOLTS \$24.00. CELL PARTS 17c. DRILLED 19c. ASSEMBLED CELLS 24c. QUANTITY DISCOUNTS. EDISON A ELEMENTS 5c. WELDED PAIRS 7 1/2c. A NEW SUPERCELL 4000 MILIAMP HOUR, 40c. SAMPLE 50c. ANNEALED TEST TUBES 3/4"-3c, 1"-4. SHOCKPROOF JARS 1 x 6 4c, 1 1/4 x 6 1/2-5c. PUREST SOFT .032 NICKEL 1c ft., .034 (HEAVY) 1 1/2c ft. RUBBER SEPARATORS 1/2c. REAL EDISON ELECTROLYTE (THAT'S NO LYE) LITHIUM COMPOUND \$1.25 MAKES 5 LBS. WIL-LARD COLLOID—A REAL B CHARGER. 50 VOLTS \$2.00. JUMBO \$3.00. 100 VOLT FULLWAVE \$4.00. JUMBO FULLWAVE \$6.00. BRING YOUR AERIAL UP TO QST SPECIFICATIONS WITH NO. 12 SOLID COPPER ENAMELED AERIAL WIRE. 75c 100ft. OB PORCELAIN AND PYREX INSULATORS. A NEW QST LEAD-IN BOWL TYPE PYREX now \$1.50. ANYTHING YOU NEED, NOT PRICED TO SELL BUT TO SERVE. FRANK M. J. MURPHY, 4837 ROCKWOOD ROAD, CLEVELAND, OHIO.

SEND postal card for list of ham parts. Real cheap! Penn Radio, 1220 Pine St., Philadelphia, Pennsylvania.

TEST-TUBES 3c. COMMON CHEMICALS FOR MAKING SOLUTION 55c. PEPP0 \$1.25. PEPP0, 1595 TAYLOR AVENUE, DETROIT, MICHIGAN.

USE G RADIO PONDS to connect your bus bars in that hook-up. No twisting. No sold-ring. Dozen 50 cents. W. T. Wiederhold, R-3, Geneva, N. Y.

SUPERSENSITIVE CALENA CRYSTALS, pound \$1.00 prepaid. ALKEMITE, Allsensitive Crystals 50c. Buskett, Chemist, Joplin, Mo.

SAY YOU SAW IT IN QST—IT IDENTIFIES YOU AND HELPS QST

Hams get my special proposition to you for your receiving and transmitting supplies. It will pay you. Edwin L. Robb, Decker, Indiana.

IVORY RADIO PANEL—Grained white IVORYLITE makes most beautiful set of a.l. 3/16 inches thick. Shipped anywhere prepaid or C.O.D. 3c square inch. FREE SAMPLE. IVORYLITE RADIO PANEL CO., 3222 Ave. F., Dept T, Fort Worth, Texas.

A BIG NEW HAMALOG IS WAITING FOR YOU—NOT JUST THE BEST HAM CATALOG IN EXISTENCE, BUT FULL OF GOOD PRACTICAL DOPE YOU'LL WANT TO HAVE. LET US SEND IT TO YOU FREE. Who first sold No. 13 enameled antenna wire at a reasonable price? Yes it's still \$6.90 per 1000' or 75c per 100' here, and going b'g. No. 14 enameled \$5.00 per 1000' or 55c per 100'; Sure Fire 20" porcelains match the wire in quality, \$1.15 each, \$1.00 each for 4 or more; Edgewise wound copper strip sells fast at 10c per turn for 4" inside diameter coils or 12c for 6", made of strip 1/16"x3/8". Straight strip this size 5c per foot. Our inductance clips positively best available 20c. Flexible flat copper braid 1/2" wide, 4c per foot. NEW FALL CITIZENS CALL BOOKS WITH AMATEUR SECTION, 75c; BALLANTINES RADIO TELEPHONY FOR AMATEURS \$2.00. UC-490 filter condensers \$2.50. 1mf. 1750 volts; UC1014 plate and grid condensers, .002 mfd. 3000 vltg, \$2.50; UC-1866 filament by-pass condensers \$1.35; UC-1015 antenna series condensers, list \$5.00, special \$2.25; UC-1831 variable transmitting condensers, \$9.00 value for only \$1.80; UP-1016 power transformers for two 50s, \$38.50 list, only \$21.00. All Thordarson transformers in stock, also Acme chokes; transformer iron for making your own, 11c per pound plus cutting charge, any size, straight pieces only. BIG NEW STOCK OF 4000-1 S TUBES, \$10.00 EACH. SOCKETS 90c. REGULAR DISCOUNTS TO BONA-FIDE DEALERS. Good rectifier aluminum 1/16" thick, 75c per square foot, lead 90c; 50 watt grid leaks \$1.65, 5 watt \$1.10; Those indispensable No. 260 General Radio insulators for supporting wiring, coils, etc., 25c. We can't tell it all here—be sure you get the free Hamalog. Dealers discounts—use your letterhead. Another ham-ad too, find it and shoot in your orders for quick service. Include postage, please. E. F. Johnson, 9ALD, Waseca, Minnesota.

SILICON Transformer Steel cut to order, .014". 10 lbs. 25 cents, 5 lbs. 30 cents, less than 5 lbs. 35 cents, 4 cubic inches to the lb. .007" for radio frequency transformers, 50c cubic inch, postage extra. Geo. Schulz, Calumet, Michigan.

UV-203 NEW 50 Watt Bottle \$25, 5 watters \$4, 3BOV.

Catalogues get out of date too quick. Order anything in the radio line from us at 20% off list cash with order except power tubes 10%. The only really satisfactory full wave B Eliminator, complete less tubes \$11.00 postpaid. Uses two 201A tubes. Plenty of the new Neon No Filament tubes, 50 mil capacity list \$5.00, 150 mil \$7.50, our price \$4.25 and \$6.00. 300 volt transformer and 50 henry choke for same \$2.95 each. 2 Mfd salvaged tested condensers 75c. Any type receiving tube, fully guaranteed \$1.20. Special 201A bakelite base tubeless tubes 95c, 5,000 ohm resistance 25c, 10,000 ohm General Electric 50c. Finest radio frequency kit you ever saw. Three low loss condensers and coils \$5.50. The Radio Club Inc., LaPorte, Ind.

TRADE—Operadio, complete for transmitter, Rite 66. Essex St., Rahway, N. J.

Bargains—Globe Super-Het Kit \$7.50; Baldwin-Pacific Super Kit \$7.50 Guaranteed. Other bargains write. Wanted transmitting apparatus. Daugherty, P. O. Box 367, Hamilton, Ohio.

1 MFD. WESTERN ELECTRIC CONDENSER for B eliminator. 500 volt new \$1.00, 3 for \$2.50 prepaid. Geo. Schulz, Calumet, Michigan.

"NO LOSS PRICES"—Nr. 4000-1 "S" TUBES \$10.00; Jewell Milliammeters \$9.95; Voltmeters \$6.95; Thermocouple Radiation Ammeters \$11.50; PURE ALUMINUM square foot \$8.85; Pure Lead square foot \$5c; ROICE "5" WATTERS \$2.00; Send 3 cents for "HAM LIST"; CURTIS-GRIFFITH, 1109 Eighth Avenue, FORT WORTH, TEXAS.

LARGEST EDISON ELEMENTS 4c PAIR. 5ADY, 3812 "P," Galveston, Texas.

SELL—Ten watt 80 meter transmitter \$60 with tubes, 80 meter receiver and two step amplifier \$50 (tubes). L. Giannini, 561 Brussels St., San Francisco, California.

HERE'S THE JUNK TO BUILD THAT NEW STATION 900 cycle motor-generator sixty cycle 110 volt ac drive \$55—just substitute output for 110-60 cycle—gives rated transformer output. Honeycomb receiver and onestep—fifteen coils \$30; foto 5c. Fada detector onestep \$5—Transportation extra. John Caleb Phipps, 118 Riverway, Boston, Massachusetts.

KEEP UPKEEP DOWN WITH AN EDISON ELEMENT STORAGE "B" THAT WILL ELIMINATE BUYING DRY "Bs." NEW TYPE BATTERIES WITH GENUINE EDISON ELEMENTS ELECTRICALLY WELDED ON NICKEL STRIP CONNECTORS THAT WON'T COME OFF, OAK RACK AND ENGRAVED HARD RUBBER PANEL WITH CHARGE-RECEIVE SWITCH. CHEMICALS AND SEALING OIL INCLUDED. 100 VOLT TYPE A, 1250 MILLI-AMPERE, \$11.00. SAMPLE CELL 20c. 100 VOLT TYPE 3-G, 1500 MILLI-AMPERE, \$12.50. 140 VOLT, \$18.00. SAMPLE CELL 25c. 100 VOLT TYPE 5-G, 2500 MILLI-AMPERE, \$19.50. 140 VOLT, \$26.00. SAMPLE CELL, 30c. YOUR TUNER OR RECTIGON "A" BATTERY CHARGER CAN EASILY RECHARGE THESE BATTERIES. SEND FOR FREE HOOK-UP. WELDED TYPE A ELEMENTS 5c PER PAIR. 2 POSITIVE & 1 NEGATIVE TYPE G WELDED, 5½c. 3 POSITIVE & 2 NEGATIVE TYPE G WELDED, 9c. NO. 20 PURE NICKEL WIRE, 1c PER FT. NO. 18, 1½c. CHEMICALS FOR 5 LBS. ELECTROLYTE, 85c. EVERYTHING FOR THAT EDISON ELEMENT STORAGE "B." J. ZIED, 530 CALLOWHILL ST., PHILA, PA.

\$5.00 New United States Government Aviators, Automobile, Motorcycle and Racing Leather Helmet with headphones and microphones, cost \$25.00. Postage free. Limited supply; other Government Radio Bargains. Send stamp for list. WEIL'S CURIOSITY SHOP, 20 South 2nd St., Philadelphia, Pa.

MYERS TUBES half internal capacity of other types \$2 each—with subscription to QST \$3.50. 3AFP, 181 Hopewell Avenue, Ottawa, Ont.

MOTOR GENERATOR Bargains. Robbins & Myers 110 V. generator 250 V. 100 W. \$25.00. Robbins & Myers 110 V. generator 350 V. 100 W. \$30.00. Robbins & Myers 110 V. 60 cycle single phase generator 750 V. 250 W. \$55.00. 750 V. 350 W. \$65.00. Esco 220 V. 60 cycle 3 phase 1750 Generator 400 V. 100 W. \$25.00. Esco motor 220 V. 60 cycle single phase Generator 500 V. 200 W. \$40.00. 220 V. Direct current Generator 1000 V. 500 W. \$65.00, 1500 V. 500 W. \$75.00. All above machines are ring oiled and include field rheostat. Also many others. Write us for prices on anything in motors, generators and motor generators stating kind of current voltage, etc. Queen City Electric Co., 1734 Grand Ave., Chicago, Ill.

CW POWER Transformers—Mounted 200 watt; 110v-350v tap-550v-\$8.50. 200 watt; 110v-550v tap-750v-\$10.50. Guaranteed rated voltage 40° cent. temperature rise-97% efficiency at full load. Other standard or special sizes priced accordingly. Write. All postpaid. M. C. Zumpe, 1332 Mishawaka Ave., South Bend, Indiana.

EXCHANGE—What NEW RECEIVING parts do you want? What have you? Can use only perfect, latest model receiving parts, new condition. No sets. RADIO EXCHANGE, KENT, OHIO.

EDISON B BATTERY SUPPLIES. LARGEST SIZE TYPE A ELEMENTS 4c A PAIR, DRILLED 5c A PAIR, WIRED IN PAIRS 8c. PURE NICKEL WIRE 1c A FOOT. PERFORATED RUBBER SEPARATORS FOR BATTERIES 1/3c EACH OR CUT YOUR OWN SEPARATORS FROM SHEETS 5 3/16 x 5 7/8", 3c A SHEET. CHEMICALS FOR 5 LBS. BATTERY SOLUTION, ENOUGH FOR 100 VOLTS. 75c. EDISON 300 AMPERE HOUR A BATTERIES IN PERFECT CONDITION \$58. ALL ARTICLES POSTPAID. SEND REMITTANCE WITH ORDER. BERNARD STOTT, 60 PALLISTER AVENUE, DETROIT, MICH.

For better Edison Elements, write Henry Chapelle, Woodburn, Ore.

FOR SALE: Best quality radio parts at bargain prices. For list, write. Frank F. Foster, Rushville, Illinois.

MOTORS \$2.98; Good, Practical, twentieth horsepower, 115 volt alternating—direct current. Tenth horsepower \$3.98. Order Now. Pay Postman. PERRY TRADING COMPANY, Dept. T10, 815 Lake, Racine, Wis.

WAVEMETERS, 10 to 100 meters, two coils, individually calibrated. Accuracy guaranteed within one percent. Excellent construction and handy size, with flash lamp. \$12.50 Postpaid. **SHORT WAVE COILS,** set of four celluloid supported space-wound plug-in coils with mounting for that new receiver, 18 to 250 meters, \$4.00. We build real amateur equipment and carry the supplies you need. Send for list. Seattle Radio Laboratory, 3335 33d Ave., South, Seattle, Washington.

ACME 200 WATT POWER FILAMENT TRANSFORMERS \$18.00. CURTIS-GRIFFITH, FORT WORTH, TEXAS.

\$100. weekly up. We want experienced Radio men to operate branch assembling plants. Part or whole time. Barfield Radio Co., 13 Tillery Street, Dept. 5, Brooklyn, New York.

PURE ALUMINUM and lead rectifier elements, holes drilled with brass screws and nuts per pair 1/16", 1" x 4", 13c. 1 x 6, 15c. 1 1/2 x 6, 17c. 1 1/2 x 6, 19c. single elements half price. Sheet aluminum 1/16", \$1.09, 3/4", \$1.90. Lead \$1.00 square foot all prepaid. Geo. Schulz, Calumet, Michigan.

BUY THESE! New 2 Acme three Hundred Watt Filament Transformers Mounted \$16; Acme 200 Watt CW Transformer Mounted \$15; Acme three hundred Watt CW transformer Mounted \$19.50; Acme Modulation Transformer \$5; ESCO two hundred Watt five hundred volt Motor Generator slightly used \$75; Roller Smith R. F. Meters 0-3, 0-5, 0-7 General Radio Frequency Meters 0-1½, 0-5 \$5 each; 0-15 AC Voltmeter Roller Smith \$8; Tuska Inductance used \$3; Bremer Tully 43-Plate Vernier Condenser \$3; Kellogg 11P \$2; Murdock 43P \$1.75; Dayfan Coupler \$3.25; Eria Selectorformer \$2; Magnavox 1 Stage Power Amplifier \$15; Radiola II 2 Tube Portable \$35; Mu-Rad MA15 6 tube set slightly used demonstrator works fine. Fine shape \$75; Grebe CR9 3 tube set \$25; Echo-Phone 3 tube dry battery set a beauty \$35; Ferbend wave traps \$4. All the above in A1 condition except where specified. Send Post Office Money Order or we will ship C.O.D. TUNWALL RADIO COMPANY, FORT DODGE, IOWA. A Ham Store.

Listen Hams, I have the following which I would like to dispose of for cash: Esco 450-Watt, 1000 Volt generator with 15 volt filament lighting attachment, including field rheostat—\$125.00; 6 50-watt radiotron bottles at twelve bucks each; five-amp. magnetic material—two bucks; Acme inductance—three bucks; also have Western Electric CW936 complete with tubes and generator—175 bucks; also complete 100-watt transmitter with phone CW attachment, two modulators; one speech amplifier already to use, be yours for 100 bucks; twenty-five Western Electric one-tenth Mfd filter condensers—two bits. Brand new Paragon RA-10 with DA-2 amplifier—\$22.50; A couple of Paragon RB-5's same as RA-10's but one tube—ten bucks; 2-G. E. Navy 50-watt bottles ten bucks; 1-50-watt Kenetron five bucks; A lot of c'okes and filter condensers and meters—name your price; Six-General Radio .00025 247K condensers—\$1.00 each in original boxes. R.C.A. 50-watt rheostats—\$2.50; One Federal Desk Microphone new—\$4.50. Send us certified check, or money order. H. Lubinsky, 89 Lehigh, 2-Cal.

TRANSMITTER TIPS, Construction of Filter Reactors and Transformers, Efficient Antenna Design and other valuable dope in our HAM CATALOG. It's free and belongs in your shack OM. It includes a full line of Standard Transmitting and Receiving equipment at saving prices. JEWELL THERMOCOUPLE Radiation Meters \$10.75. Filament Voltmeters and Plate Milliamps \$6.75 each, HI-VOLTAGE VARIABLE AIR TRANSMITTING CONDENSERS \$7.00. These are FB, we'll ship subject to inspection, 7" wide Hard Rubber Panels 6c inch. LOW PRICES ON TRANSMITTER PANELS, Shielded Audio Transformers 5-1, 3 1/2-1 each \$1.50 FULLY GUARANTEED. We'll ship collect, postage extra. THE HAM SHOP, 5-OI, RUSTON, LOUISIANA.

Q R A SECTION

50c straight, with copy in following form only: **CALL—NAME—ADDRESS.** Any other form takes regular **HAM-AD** rates.

- 2AD—Ellsworth Voigt, 99 Powers St., Brooklyn, N. Y.
- 2JL—W. A. Cohen, 126 Woolsey St., Astoria, Long Island, N. Y.
- 2MS—Paul Hoffman, 23 Lindhurst Place, Rookville Center, N. Y.
- 3PY—Francis Richardson, 507 So. Orange St., Media, Pennsylvania.
- 4FU—Cain & Dewitt, 1812 15th Ave., So., Nashville, Tennessee.
- 6BI—Leroy F. Watson, 2311 Keith Ave., Berkeley, California.
- 7EK (ex7ABB)—Everett Kick, 3802 Hoyt Ave., Everett, Wash.
- 7NS—Dan W. Elam, San Marco Apts., No. 14, Spokane, Washington.
- 9AIG—Hart D. Beebe, Modale, Iowa.
- 9AUG—J. B. Amstutz, 575—40th Street, Milwaukee, Wisconsin.
- G5KO—T. W. Higgs, 107 Park Road, Newcastle-On-Tyne, England.
- IIRG—Radiogiornale, Viale Maino 9, Milano, Italy.

The following stations belong to members of the A.R. R.L. Headquarters gang. Mail for them should be addressed care A.R.R.L., Hartford, Conn.

| | |
|------------------------|-------------------|
| 1BAO R. S. Kruse | 1KP F. C. Beekley |
| 1BHW K. B. Warner | 1OA R. S. Kruse |
| 1DQ John M. Clayton | 1OX L. W. Hatry |
| 1ID C. A. Service, Jr. | 1XAQ R. S. Kruse |

Just Off The Press

"Radio Theory and Operating"

By Mary Texanna Loomis

President, and Lecturer on Radio, Loomis Radio College, Washington, D. C.

850 Pages—670 Illustrations

Size 5½x8 inches, beautifully bound in Flexible Red Kraft Leather stamped in gold.

A thorough text book of value to all interested in radio. Contains much valuable material never published in a text book. Endorsed by a number of the highest authorities in radio. Already purchased by U. S. Signal Corps; Eastern Radio Institute, Boston; Philadelphia School of Wireless; Radio Corp. of America; Government Radio School at Camp Alfred Vail, New Jersey; Tyler Commercial College, Texas, and other schools, libraries, professional and amateur radio men throughout the country.

Price \$3.50

For sale at book stores and radio supply houses, or mailed to any part of the U. S. or Canada, postage paid. Send check or money order.

Loomis Publishing Company

Dept. T.

405 9th St. N. W. Washington, D. C.

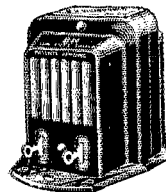

FAMOUS "BH" TRANSFORMERS

BH Vivaphonic (Registered)

A new model of highly scientific design. Wonderfully life-like in amplifying power. Perfectly shielded with minimum loss in shield wall. A personal invention of Benjamin Hughes of the

BENJAMIN HUGHES ELECTRIC CO.

298 Lagachetiere St., W. Montreal, Canada
Transformer Builders Since 1910

Weston Double Range Voltmeters

Model No. 301, 0-7½ and 0-150 volts

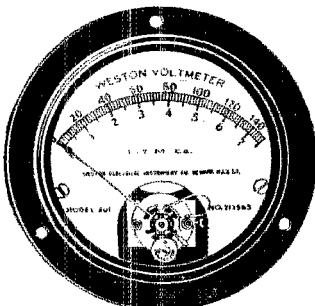

List Price \$10.00 each
Our Price \$4.75 each

In order to get the most in tone, volume and distance out of your set you should always know the true condition of your A & B batteries and what voltage your Tubes are operating.

You can know this accurately by means of one of these beautiful Weston Meters which are complete with external resistor and manufactured by the well known Weston Electrical Instrument Co. of Newark, N. J.

These instruments are designed to be mounted on the panel of the receiving set and are of the flush type in order that they may not protrude in front, and yet add to the appearance of the set.

If a multi-point switch is employed the Voltmeter may be connected at will across A or B batteries or Tubes, depending upon the number of points on the switch.

Every Meter brand new, guaranteed, and packed in original cartons.

OUR EXTRA SPECIAL PRICE \$4.75 EACH
American Sales Co. 21 Warren St., N. Y. C.

**EVEREADY HOUR
EVERY TUESDAY AT 9 P. M.**

Eastern Standard Time

For real radio enjoyment, tune in the "Eveready Group." Broadcast through stations—

| | | | |
|------|--------------|------|-------------|
| WEAF | New York | WCAE | Pittsburgh |
| WJAR | Providence | WSAI | Cincinnati |
| WEEL | Boston | WWJ | Detroit |
| WFI | Philadelphia | WCCO | Minneapolis |
| WGR | Buffalo | WCTS | St. Paul |
| WOC | Davenport | | Worcester |

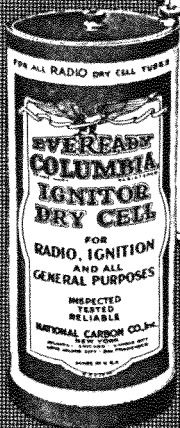

Eveready Columbia Ignitor "A" Battery, the proven dry cell for all radio dry cell tubes 1 1/2 volts

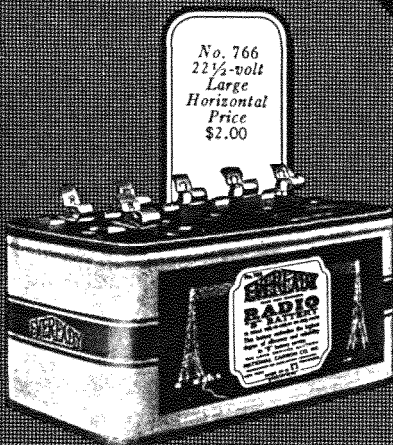

No. 766 22 1/2-volt Large Horizontal Price \$2.00



No. 770 45-volt Extra-Large Vertical Price \$4.75

ECONOMY

No ONE size or type of battery can be economical on every type of receiving set. That's why Eveready Radio Batteries are made in different sizes and types —so that every radio user can enjoy the economy that is to be had by fitting exactly the right Eveready Battery to his receiver. For owners of sets with five, six, eight or more tubes, and power amplifiers, there is the extra-large, powerful and unusually long-lasting Eveready "B" Battery No. 770. There is an Eveready dealer nearby.

Manufactured and guaranteed by
NATIONAL CARBON CO., INC.
 New York San Francisco
 Canadian National Carbon Co., Limited
 Toronto, Ontario

EVEREADY Radio Batteries

-they last longer

—FOR YOUR CONVENIENCE—

QST'S INDEX OF ADVERTISERS IN THIS ISSUE

| | | | |
|-------------------------------------|-----------|---|-----------|
| Acme Apparatus Co., The | 2 | Jack Gray Press, The | 104 |
| Adbro Mfg. Co. | 100 | Jefferson Elec. Mfg. Co. | 68 |
| Advance Electric Co. | 88 | Jenkins Lab., The | 70 |
| All American Radio Corp. | 71-80 | Jewell Electrical Instrument Co. | 64 |
| Allen-Bradley Co., The | 3rd Cover | Jewett Radio & Phonograph Co., The | 4 |
| American Hard Rubber Co. | 101 | | |
| American Transformer Co. | 1 | Kaimus, Comstock & Wescott, Inc. | 92 |
| Amsco Products, Inc. | 67 | Kapaciton Co., Inc., The | 78 |
| American Sales Co. | 78-96-109 | Karas Electric Co. | 103 |
| Apex Electric Mfg. Co. | 102 | Kellogg Switchboard & Supply Co. | 95 |
| "A.R.R.L. Apparatus" | 82 | Kimley Electric Co. | 94 |
| A.R.R.L. Application Blank | 100 | Kodol Radio Corp., The | 88 |
| A.R.R.L. Emblem | 74 | | |
| A.R.R.L. Recommendation Blank | 104 | Loomis Publishing Co. | 109 |
| | | | |
| Bakelite Corp. | 97 | Magnite Labs. | 100 |
| Bluebird Tube Co. | 98 | Mario, Elec. | 98 |
| Bremer-Tully Mfg. Co. | 81 | Munn & Co. | 92 |
| Braun Co., W. C. | 102 | Music Master Corp. | 99 |
| Burgess Battery Co. | 68 | | |
| | | National Carbon Co., Inc. | 110 |
| Cardwell Corp., Allen D. | 93 | National Company | 94 |
| Central Radio Sales | 84 | | |
| Corning Glass Works | 90 | Pacent Electric Co. | 89 |
| Crescent Radio Supply Co. | 102 | Phenix Radio Corp. | 102 |
| Cribben Radio Corp. | 86 | Precise Mfg. Co. | 88 |
| Crosley Mfg. Co. | 85 | | |
| Cruver Mfg. Co. | 96 | Radial Co. | 80 |
| Cunningham, E. T., Inc. | 2nd Cover | Radio Corp. of America | 4th Cover |
| | | Radio Engineering Labs. | 76 |
| Daven Radio Corp. | 79 | Radio Institute of America | 62 |
| Deutschmann, Tobe C. | 74 | Radio Units, Inc. | 98 |
| Dubilier Cond. & Radio Corp. | 83 | Randolph Radio Corp. | 72 |
| Duplex Cond. & Radio Corp. | 80 | Reichmann Co. | 85 |
| | | | |
| H. H. Eby Co. | 85 | Sangamon Elec. Co. | 76 |
| Electric Storage Battery Co. | 91 | Stromberg-Carlson Telephone Mfg. Co. | 73 |
| Electric Research Lab. | 62 | | |
| Eagle Radio Co. | 90 | Toaz Engineering & Sales Co. | 76 |
| Electric Specialty Co. | 82 | Troy Radio Co. | 96 |
| | | | |
| General Electric Co. | 77 | Uncle Sam Electric Co. | 96 |
| General Industries Co. | 90 | United Scientific Labs. | 102 |
| General Radio Co. | 69 | U. S. Tool Co. | 75 |
| Goyer Company, The | 92 | | |
| Grebe & Co., Inc., A. H. | 112 | Vibroplex Co. | 86 |
| Gross & Co., J. | 92 | | |
| | | Westinghouse Elec. Mfg. Co. | 87 |
| HAM ADS | 105-109 | Weston Elec. Inst. Corp. | 78 |
| Hammarlund-Roberts, Inc. | 66 | Wireless Mfg. Co., The | 98 |
| Hanninger Radio Mfg. Co. | 84 | Wireless Specialty Apparatus Co. | 84 |
| Benjamin Hughes Elec. Co. | 109 | | |
| Hill Mfg. Co., A. E. | 94 | | |
| Hull Co., S. W. | 86 | | |

ALWAYS MENTION QST WHEN WRITING TO ADVERTISERS

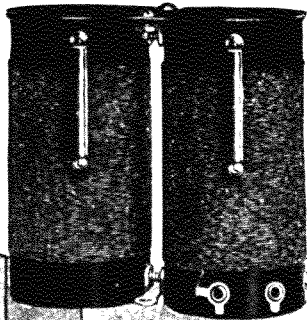

Grebe
Binocular
Coils

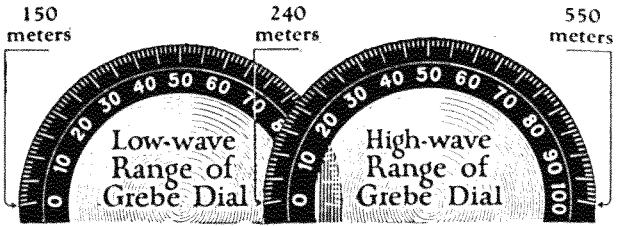

The Synchronphase Now Reaches from 550 Down to 150 Meters

THE Synchronphase, with the new Low-wave Extension Circuits, will receive all present and projected stations. It is really two receivers in one.

This great range is accomplished by means of an *auto-matic* switch which enables *one* dial to cover *two* wave ranges. The first, from 550 meters down to 240, corresponds to the practical tuning range of the usual receiver. The second overlaps this and goes down to 150 meters. Simply move the center dial past the 100 mark for the high range, and beyond the zero mark for the low range.

This low-wave reception opens up over 100 existing stations, broadcasting on less than 240 meters, and not reached by other sets. This will be especially valuable later, when stations generally begin to use lower wave lengths. The Synchronphase is thus equipped for the future.

*Ask your dealer to demonstrate
this new feature; then compare.*

A. H. Grebe & Co., Inc., Steinway Hall, 109 West 57th Street, N. Y. C.
Factory: Van Wyck Blvd., Richmond Hill, New York
Western Branch: 443 S. San Pedro St., Los Angeles, Cal.

The **GREBE** SYNCHROPHASE

TRADE MARK REG. U. S. PAT. OFF.

This Company owns and operates stations WAHG and WBOQ; also low-wave rebroadcasting stations, mobile WGMU, and marine WRMU.



It is written:
"Whoever can see three days ahead will be rich three thousand years."
The purchaser of a Synchronphase now, will not be rendered unhappy by coming changes in broadcasting methods.

Enter 114

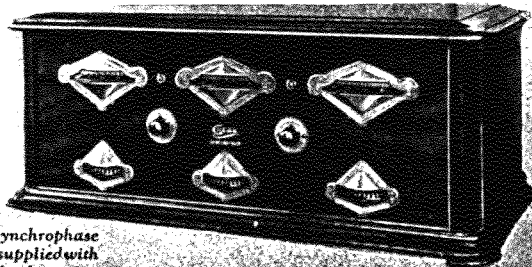

The Synchronphase is also supplied with base for batteries.



All Grebe apparatus is covered by patents granted and pending.

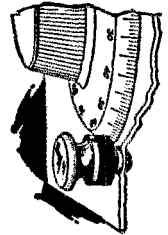
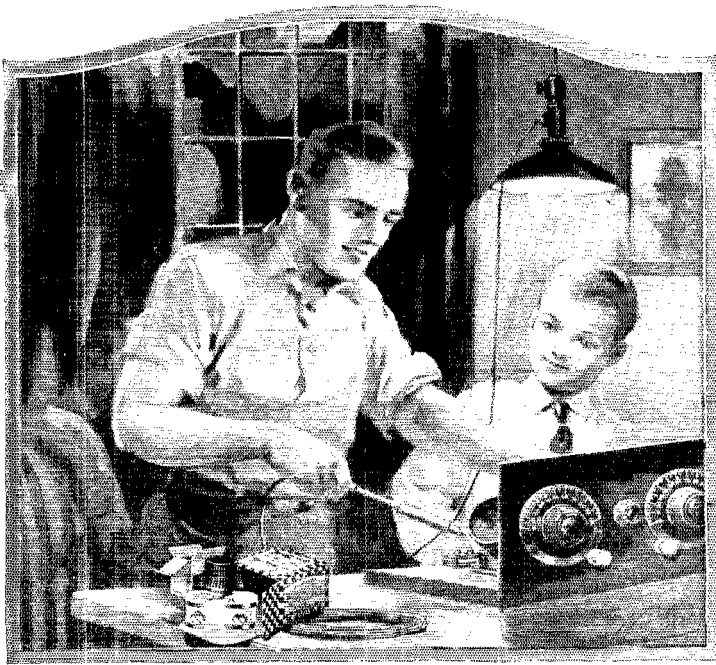

Bradleyner—Perfect Vernier Knob.



Bradleyswitch—Perfect Battery Switch.

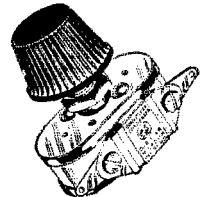

Bradleyleak—Perfect Grid Leak $\frac{1}{2}$ to 10 Megohms.

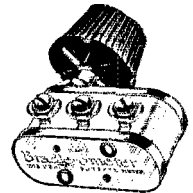

Bradleyometer—Perfect Potentiometer

There's a Real Thrill in trying a New Hook-Up!

EVERYONE in the family is eagerly waiting to hear the new set! After hours and hours of drilling and soldering, the set is nearly ready for its first crucial test. Will it meet with your expectations or will it be a disappointment? That depends upon two things—first your workmanship, and second, the quality of the parts used.

Good workmanship is the result of patience, but good parts are assured only by demanding well-known, guaranteed products, such as Allen-Bradley Perfect Radio Devices. Allen-Bradley Products are known the world over for exceptional performance and fine appearance. They eliminate the hazard and disappointment that follows the use of inferior radio products.

Ask your dealer for Allen-Bradley Perfect Radio Devices if you value your time and labor. *They always work!*

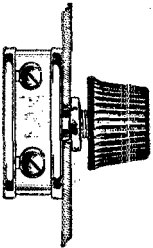

Bradleystat—Perfect Filament Control for All Tubes.



Bradleyohm—Perfect Adjustable Resistor.



Bradleyunit—Perfect Fixed Resistor.

Allen-Bradley Co.
Electric Controling Apparatus

277
Greenfield
Ave.



Milwaukee,
Wisconsin

Mfrs. of Graphite Disc Rheostats for
Over 20 Years

ALLEN-BRADLEY CO.,
277 Greenfield Ave., Milwaukee, Wis.

Please send me your latest literature on the complete Allen-Bradley line of Perfect Radio Devices.

Name

Address

RCA

announces

three new power tubes *for greater volume*

RCA announces three important new Radiotrons. Their contribution to radio progress is *greater power*. They mean greater volume on dry batteries — and greater volume on storage batteries. They mean better tone, because they mean volume of sound *without distortion*.

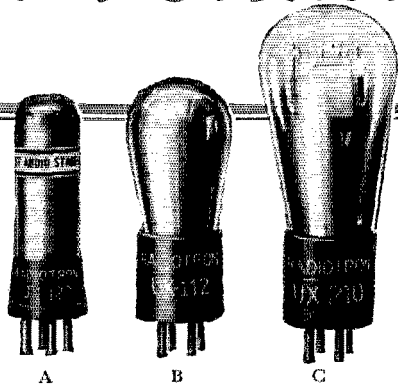

For technical description of the new Radiotrons, write to the nearest RCA office for the illustrated booklet.

- A—New Radiotron UX-120—for great volume on dry batteries \$2.50
 B—New Radiotron UX-112—Similar to Radiotron UV-201-A, but several times as powerful \$6.50
 C—New Radiotron UX-210—A super-power tube several times as powerful as UX-120 \$9.00



Radiotron

AN RCA PRODUCT

The Traffic Department

F. E. Handy, Acting Traffic Manager
1711 Park St., Hartford, Conn.

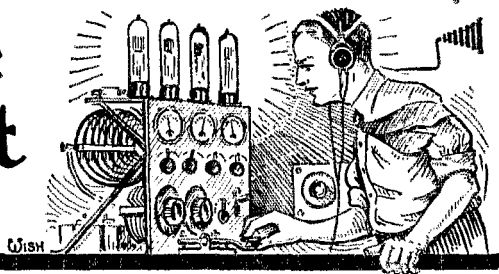

Cooperate For Better Operating

THE League has received many complaints from various sources regarding poor operating on the part of amateur operators. Commercial services have their share of "lid" operators as well, but of course we are not concerned particularly about them. Many newcomers have entered our ranks, and reports have it that they are operating off wavelength, using long drawn-out calls and signing their own calls at infrequent intervals, sending wearisome "CQs", and transmitting what messages they do originate without including the city and office of origin. Often they send "words twice" unnecessarily, and their communication work is done in very slipshod fashion indeed.

Other complaints have come in from League members regarding the interference with our own reception by certain commercial services who cause trouble by transmitting on our wavelength bands. Still others mention the broadcasting station harmonics that are so plentiful on some of our own short wavelengths.

The American Radio Relay League stands for lawful operating, and for good operating, and that organization is expected to represent amateurs to its government in asking for continued privileges in using the valuable shorter wavelengths. Our League is in no position to criticize commercial and broadcast services until it has improved certain things about its own service that we have mentioned in the opening paragraph of this discussion. Before we can ask or expect favors we must show that we are deserving of the things we want and that we have a strong and self-regulating organization.

Our League is a fraternal organization. No large organization is ever entirely free of some radical members; every organization has its problems of supervision; but like most organizations, the League has a big membership of those folks who represent the "best" in the organization. With the American Radio Relay League it is the Official Relay Stations who must stand for the best in operating and the best in station construction. It is these stations and their operators who can be instrumental in bettering the present conditions through their influence and cooperation with their traffic officers. Official Relay Station owners are helping beginners with their problems in building stations and in learning to operate. They are also helping to make operating conditions better by giving new operators the benefit of their friendly criticisms and suggestions. In many cases where they do not have time to write the personal letters that are necessary, they are turning in reports of the improper operating that they hear with their monthly traffic reports so that officials and observers of the League can handle the work of helping the newer stations to keep within our wavelength bands and to improve their operating practices by sending them a friendly line about it.

One of the most powerful agents in improving individual operating is individual, friendly, and constructive criticism. Because it is manifestly impossible for us to write a long, helpful letter to every station owner each time it seems necessary, we have had to look around for some other line of action that would be inexpensive, useful in practice, and productive of the desired results. A form postal card was devised for the purpose. Hartford is already burdened with its share of detailed work, and so this card was placed in the hands of all Division Managers and Assistant Division Managers with instructions that they appoint Official Observers to act in cases where they were unable to give their time.

An improvement in general operating conditions was observed when the new cards were first used. Stations logged for the abuse of CQ and for using

the finish signals improperly were observed to have corrected their practices when they were heard several days after the first reception when time had been allowed for the card to arrive. Many fellows with the right spirit wrote the Official Observers expressing their appreciation of the helpful service. Some suggestions were made for changing the form of the card a bit to make it still more useful.

Every suggestion was followed as far as possible in making up a new and more serviceable card. The present form of the card is shown on this page. As the space on a postal is limited, only the most common faults with our operating are listed. A place for additional improper practices and for more detailed comment is provided.

We have mentioned the purpose of the cards. Observers are instructed to use the postals conscientiously and to make observations carefully. Every one of us is interested in short wave communication. For the fullest enjoyment of our hobby, it is necessary that we have continued short-wave privileges. Our purpose is to keep our League so well-conducted that we can justly expect to receive what is due us and so that we can be proud of our good operators and of our A.R.R.L.

In concluding we ask that all members of the League help us in our efforts to encourage good

AMERICAN RADIO RELAY LEAGUE, INC. TRAFFIC DEPARTMENT

Dear _____ Your signals were R _____ at _____ M _____ ST _____
while (calling) (working) _____ You were noted by _____ the writer
 O. R. S. an official observer as using the following checked undesirable practices:

| | |
|--|---|
| <input type="checkbox"/> Abuse of "CQ" _____ times _____ mins _____ | <input type="checkbox"/> Operating off wavelength on _____ meters |
| <input type="checkbox"/> Long calls without signing _____ | <input type="checkbox"/> Improper numbering of messages |
| <input type="checkbox"/> Sending words twice unnecessarily _____ | <input type="checkbox"/> Failure to give city of origin |
| <input type="checkbox"/> Improper use of "AR" "RST" _____ | <input type="checkbox"/> Failure to give station of origin |
| <input type="checkbox"/> Swinging wave <input type="checkbox"/> QSB <input type="checkbox"/> QSC | <input type="checkbox"/> Omission of date |

Additions and remarks: _____

We know that you will be glad to lend your cooperation in promoting better operating by improving your operating practices now that they have been called to your attention.

Sincerely,

Address

operating and in the adoption of uniform message forms and operating procedure. Be sure that your station keeps on our amateur wavelengths. Adopt the O. R. S. operating rules printed on page 47 of August QST for your station. Use the service message and the uniform message form which were explained in these pages last month. May we have your cooperation OME?

A Challenge

TO those of the gang who play checkers or chess, 8CMG operates on an 80 meter wavelength nightly between 11.00 and 11.30 p. m. E. S. T. He will be glad to play a game with anyone who calls on schedule. Everyone should be sure to have his numbered board ready to use.

8CMG will be glad to have a word from fellows who are interested in forming a "Chess and Checker Club" of League member stations. If enough interest is shown, we can have some interesting contests this fall. Write Mr. E. B. Gerlach, Pearl and Brooklyn Ave., Cleveland, Ohio, if you are interested.

TALK and 9CAA did some worth-while work. A Denver business man made a trip to Portland, Ore. During his stay there, 9CAA and TALK kept him in touch with his business by amateur radio. Incidentally, the Denver business man was 9CAA's father.

Calling Practise

DON WALLACE was responsible for the good suggestion that has now become a part of League operating procedure that we adopt a "three-times-three" CQ. At the National Convention there was some further discussion of operating practices and Don brought out some more suggestions for public approval.

As everyone knows, we have four very useful wavelength bands. The 18.7-to 21.4-meter band is 2000 K.C.'s wide; the 37.5 to 42.8-meter band is 1000 K.C.'s wide; and the 75-to 85.7-meter band and the 150-to 200-meter band are 500 K.C.'s wide. Wallace points out that when trying to raise a station on 200 meters, we usually had to call him for about two minutes so that he could thoroughly cover the band in his search for stations calling him. Because our eighty-meter wavelength band is also a narrow one, it is evident that a two minute call for a station should also suffice here. However, the forty-and twenty-meter wavelength bands are wider, and because there is "more room" down there it is reasonable to conclude that if an operator is hunting for stations calling him with the thorough and systematic methods of a good operator, that a longer period of time must be allowed to enable him to cover the dial with the same care as he observed on the upper wavelength bands. Thus a four-minute call on forty, and an eight-minute call on twenty meters would appear to be justified to give us the same chance of raising our man that we had when only a 200-meter wavelength was used.

These are the facts in the case. It does not necessarily follow that a blanket practice of making long calls should be adopted. We think that a modified practice, adopted with this situation in mind, will produce the best results in raising stations. Assuming that, as Wallace says, it always takes two minutes to cover 500 kilocycles when thoroughly hunting for stations replying to our CQ, we still must observe that if the receiving operator starts from one side of the band changing his tuning at a rate that completely covers the band in two minutes, he will run across the station calling him in something *less* than two minutes unless the most pessimistic condition exists where our transmitting station is on one edge of the band while the receiving "op" is on the other edge when he starts to tune. So it is seldom necessary to call for the full two minutes to raise a station if we use our best judgment and refrain from doing any calling until we know that the receiving operator is "doing his stuff" and that our chances of raising him are best.

The League has never attempted to lay down any rules regarding the length of a call, leaving the problem to the judgment of the individual operators to fit the call to the particular case under consideration. We

believe that the use of a "break-in" system* at most of our stations will do much to obviate the necessity of long calls. We think that in any case where it is imperative that we raise a certain station, a long call is justified. We are of the opinion that a one-minute call with a break in the sending long enough to listen for a reply from the station called, followed by more one-minute calls is much better than a long unbroken call. Such a calling scheme will eliminate much necessary transmission and result in raising a station as quickly as calls of great length. In calling we should always send the call of the station wanted several times (not more than 10 under any circumstances) followed by the intermediate sent carefully and our own station call repeated three times. This combination can be repeated as many times as necessary. Such a procedure allows many stations to log our signals without turning away in disgust at a too-long call. The operators who seem to be most successful in raising the stations they want are not always the ones who use long calls but they are the ones who use the best judgment in selecting the time to call, and in deciding on the number of calls that will give the best results in the calling periods.

—F. E. Handy.

WNP

WITH the MacMillan expedition homeward bound, and rapidly getting further south, the control of communication between the expedition and this country is passing from the midwest stations back to the East Coast amateurs who handled the bulk of the traffic on the north-bound journey. This is in accord with observations that were made on the first radio expedition to the North, when, as many will remember, the East Coast stations handled most of the traffic while the Bowdoin was en route to and from Etah, and the West Coast stations did most of the work while the ship lay at Etah.

Communication during the month has been very good, and many scientific messages, press reports and personal radiograms have been sent and received. IARE seems to be the stations are being worked and logged by many other amateurs all over the United States and Canada.

The Bowdoin and the Perry are scheduled to dock at Wiscasset, Me., about October 1st.

The silver cup offered the station receiving most messages from the MacMillan Expedition, was awarded to Donald C. S. Comstock, 1MY, at New York on Friday, Sept. 18th. 9CXX and IARE were the "runners-up" in contest and handled nearly as many messages. All three stations handled thousands of words and worked the expedition many times during its stay in the North.

Stations handling traffic with WNP and WAP who have reported their work to Headquarters are: c1AR, 1A4O, 1A6P, 1AGI, 1AEP, 1AHG, 1AJG, 1ANA, 1ARE, 1AW, 1CKP, 1MY, 1UW, 2AEX, 2BGG, 2LU-KU, 5AGN, 5EW, 5OQ, 6CUK, 6ZQ, 7LU, 8AXN, 8CCR, 8CID, 8JQ, 8KS, 9ADO, 9BKR, 9CXX, 8DP, 2KF, 2SZ.

* The use of a "break-in" is explained on page III of the Traffic Department section of September QST.

The Traffic Trophy

THIS month three big bundles of messages were sent in from fellows who were interested in winning the Traffic Trophy and in being members of the Brass Pounders' League. We have carefully counted the messages according to the rules that govern the contest and thrown out the messages that had to be discarded because they were delayed more than 48 hours at the station or because the city and station of origin were omitted.

7OY deserves every bit of the space we are giving him this month. His work really means something. He kept a regular schedule with "FC" at Unalaska, Alaska, and the messages he handled were real citizen radio messages that kept several people in the North in contact with civilization. Two of his messages were regulation "service" messages, also. Gleason has been doing some good work right along. We understand that he still has his route to Alaska open, and believe that if he perseveres for two months more he will have the Traffic Trophy for his own. Does he get it, fellows?

Each station listed is putting the broadcast on the air on scheduled time and wavelength to the best of its ability. The operators of the various stations are willingly giving their time to this work. They will appreciate it if you will drop them a postal card saying that you copied the Official Broadcast Message from them on schedule, and we will be pleased to have any suggestions from you regarding ways of making this service through the Official Broadcasting Stations of more value to you.

| Station | Wavelength (Local Standard Time) | | |
|---------|----------------------------------|-----------|----------------|
| | 12.30 p.m. | 7.00 p.m. | 10.30 p.m. |
| 63XI | 41 | | Tues. & Thurs. |
| 1BEP | | | Tues. & Fri. |
| 1CKP | 39 | | Sat. & Wed. |
| 1EF | 40 | | Mon. & Fri. |
| 1GA | 21.3 | | Sun. |
| 1GA | 40.1 | | Tues. |
| 1GA | | 80 | Thurs. |
| 2AFP-ZA | 39.4*** | | Tues. & Thurs. |
| 2CQZ | | | |

(Special schedules on 40, 80 and 185 meters wavelength)

| | | | |
|----------|----------|---------|----------------------------|
| 2WR | 20 | | Sat. & Sun. |
| 2WR | 40 | | Daily during Sept. |
| 2WR | | 80 | Wed. & Fri. |
| 3ALE | 160 | 78 | 75 Mon. & Thurs. |
| 3APV | 19.3 | 37.5 | 75 Sat. |
| 3APV | 19.3 | | 37.5 Sun. |
| 3BWJ | | 40 | Mon. |
| 3BWJ | | 80 | Thurs. |
| 3BWT | | 82 | 82 Fri. & Sat. |
| 3LL | | 39.6 | Tues. |
| 3XAN | | 165 | 5 p.m. Tues. & Fri. |
| WOAX | 240 | | Daily except Sunday |
| 4FM | | 42.5 | 42.5 Tues., Sat. & Sun. |
| 4JE | | 77 | 77 Sat. & Sun. |
| 5ACL | | 40 | 40 Tues., Thurs., Sat. |
| 5ACZ | | 38 | 38 Sun., Tues. & Thurs. |
| 5AGN | | 38 | Daily |
| 5AJP | | 82 | Wed. |
| 5AJT-WBF | | 80 | 80 Wed., Sun. |
| 5GJ | | 83 | Mon. and Thurs. |
| 5UO | | 80 | 40 Mon., Fri. & Sun. |
| 5YR | | 80 | Tues. & Sat. |
| 6BUR | 20 | | 40 Tues. and Thurs. |
| 6CLP | | 41 | Tues. & Fri. |
| 6NX | | 180 | (voice) Mon., Wed. & Fri. |
| 7RJ | | 76 | 76 Sun., Mon. & Fri. |
| 7NT | | 39† | 80† Sat. |
| 7NT | 21 | | Sun. |
| 7OY | | | Wed. & Sat. |
| 8ATP | | 39 | Mon., Fri. & Sun. |
| 8AUL | | 39 | 39 Wed. & Sat. |
| 8AUL | 39 | | Sun. |
| 8BHM | | 40 | 80 Wed. & Sun. |
| 8RSU | | 78 | 78 Mon. & Fri. |
| 8DME | | 41.5 | 81 Tues. |
| 8DME | 21.5 | 41.5 | Sat. |
| 8CEO | | 80 | 80 Sat. & Sun. |
| 8CEO** | | 158 | Mon., Wed. & Fri. |
| 8DOO | 40-80 | | Mon., Wed. & Fri. |
| 8EQ | | 40.3 | 40.3 Tues., Thurs. & Sat. |
| 8GX | 20.7 | | Thurs. |
| 8ZE | 41.5 | | Tues. & Fri. |
| 8ZE | | | 41.5 Wed. |
| 8ZH | | 76 | Mon. & Fri. |
| 9AGL | | 80 | 40 Mon. & Thurs. |
| 9ATO | | 80 | Mon., Wed. & Fri. |
| 9BKR | | 40 | 40 Mon., Fri. & Sat. |
| 9BMX | | 38 | 38 Mon., Thurs. & Sat. |
| 9CAA | | 160 | 40* Wednesday |
| 9CAA | | 80 | Fri. |
| 9CAA | | | 40* Sun. |
| 9CFI | 40 | 40 | Wed. |
| 9CFI | | 40 | 40 Sat. & Sun. |
| 9DXY | 20(noon) | 42.8 | 75 Sun., Wed. & Sat. |
| 9EGU | 20(noon) | 37.5 | Mon., Wed. & Fri. |
| BER | | 36 | 36 Sat. & Sun. |
| c2BE | | 40 | 40 Fri. & Sat. |
| c2CG | | 21 | Wed. |
| c2CG | | 21 | 37 Sat. |
| c3AFP | 120 | | Thurs. |
| c3AFP | | | 85 Thurs., Sat. & Sun. |
| c3AZ | | 39 | Sun., Tues. & Fri. |
| c3XI | | 41 | Tues. & Thurs. |
| c4CR | | 41 | 41 Wed. & Sat. |
| c5CT | | 120 | 120 Mon., Wed. & Fri. |
| c5CT | | 81.5 | Tues., Thurs., Sat. & Sun. |

*Midnight.

** 40. M. Sat. and Sun. 4 p.m. E. S. T.

*** Sun. Wed. Fri. 1.15 a.m. E. S. T.

† 6:30 and 10 p.m.

 R. J. Gleason — 7OY
 Seattle, Washington
 Northwestern Division
 Messages
 Orig: 71 Del'd: 57 Relayed: 26 Total 154

There were not enough contestants for the Brass Pounders' League this month to make it worth while to give it much space. 8EU and 1CJR get honorable mention for sending in their messages.

BACK numbers of QST contain complete information about the Traffic Department Trophy. When you handle over 100 messages in a month be sure to turn in to your local Traffic Officials who will forward them along to the Division Manager. Division Managers will send bundles of messages to Headquarters each month and one man at Headquarters will count the messages and make up a Brass Pounders' League each month after which the message file will be returned promptly direct to you. Only messages containing the CITY and STATION of origin, a SUFFICIENT ADDRESS to insure delivery, the TEXT, and the SIGNATURE shall be counted. The date and number are important as the inclusion of a date speeds up the message and the number makes it possible to easily trace the message. The fundamental parts of a message shall determine whether or not it is counted. All messages must be handled in 48 hours or less. If there is any doubt about your messages, send them in and get the credit that is due you.

OFFICIAL BROADCASTING STATIONS

THE attention of the membership is called to the revision that has been made in the League's broadcasting system. The change that was made makes the system more flexible than before as regards schedules, each broadcaster selecting the days, times and wavelengths when he sends the Official Broadcast most conveniently from a table such as appears below. The stations who now take part in the broadcasting of up-to-the-minute League news and information have told us what wavelengths they will use and any changes that are made from time to time will be mentioned in QST. The new broadcasting system makes it possible for you to select a station, to listen for him at a certain time and on a certain wavelength, and to receive the Official Broadcast. The new system greatly increases your chances of "running across" the weekly broadcast message if you are one of the number of fellows who do not listen just to get the broadcast message, but who do copy it if you happen to hear someone transmitting it.

The latest news and schedules are made into a broadcast which is sent each operator of an Official Broadcasting Station weekly. The broadcast has a release date slightly later than the mailing date so that the material to be sent can be in the hands of each operator at the beginning of the week of release no matter in what part of the country he is located.

NRRL

ABOUT the time this report gets into print, the U. S. fleet will have returned from its Asiatic cruise, and Schnell will be on his way back to Hartford, via the Pacific Division Convention at Santa Ana, California. At the time this report is being written, the first of September, reports on the reception of NRRL are increasing greatly over what they were while the fleet was at Australia. The forty-meter set is still carrying on the bulk of the traffic, apparently, and signals from this outfit are being heard all over the world. It looks as though the Navy has been shown once and for all that the short waves will go farther on a given amount of power, and that the reliability of these signals over long distances is very great. We all await with much interest Schnell's account of the work carried on from the *Seattle*.

STATIONS WORKED AND HEARD — NRRL June 16 to July 20, 1925. Inclusive

WORKED: 1ao, 1comp, 1eg, 1ii, 1ka, 2ac, 2ds, 2lu, 2me, 2nm, 2xaf, 2yg, 2yi, 3bd, 3bq, 3ow, 4ag, 4gt, 4sa, 5ahr, 5fh, 5lg, 5mi, 6aft, 6age, 6agh, 6agn, 6ahg, 6aiv, 6ajl, 6aar, 6asv, 6avi, 6aws, 6awt, 6bgo, 6bhz, 6bih, 6bid, 6bk, 6bmw, 6bur, 6cc, 6cdy, 6cep, 6che, 6cms, 6cmu, 6cnc, 6cst, 6csw, 6dah, 6dcf, 6ea, 6fa, 6jp, 6kw, 6lj, 6mp, 6no, 6nx, 6to, 6tq, 6xad, 6zac, 6zd, 7aek, 7au, 7au, 7ay, 7gj, 7ly, 7rl, 7uz, 7wu, 8apw, 8ave, 8ayv, 8bau, 8bgn, 8dem, 8eq, 8gz, 8pl, 8ry, 8ze, 9aoj, 9apm, 9bht, 9bxq, 9ccs, 9ded, 9dfh, 9ek, 9oo, 9uc, GBE VIS, pilhr, m1B, New Zealand 1ao, 1ax, 2ac, 4ag, Australia 2ds, 2yg, 2yi, 2me, 3bd, 3bq, Canadian 4gt, British 2nm, Chilean 1eg and Alaska QRA WWDO.

HEARD: 1aao, 1aep, 1alw, 1anq, 1axn, 1cmp, 1pl, 1pm, 1sk, 1xu, 2aes, 2aim, 2bbx, 2box, 2brb, 2buy, 2chk, 2enk, 2rj, 2xaf, 2zv, 3dg, 3ef, 3ot, 4au, 4kt, 4oi, 4rr, 4vt, 5ajm, 5ame, 5apu, 5are, 5atv, 5nj, 5oq, 5ox, 5ql, 5vl, 6aak, 6aaq, 6abc, 6afg, 6agh, 6aji, 6ajm, 6aom, 6ari, 6bcw, 6bde, 6bez, 6bzc, 6bvg, 6bbg, 6bjn, 6bvy, 6cal, 6cac, 6cct, 6ccg, 6cbs, 6cix, 6cmi, 6cnb, 6cqa, 6ers, 6ern, 6eso, 6eto, 6cuk, 6dai, 6dca, 6dg, 6eb, 6ex, 6fg, 6jm, 6km, 6kw, 6li, 6np, 6nb, 6nx, 6qd, 6gl, 6rw, 6uf, 6xp, 6zbn, 7aj, 7ao, 7agz, 7ali, 7cw, 7fb, 7gb, 7ij, 7it, 7mf, 7ya, 8bjn, 8chk, 8eyi, 8dem, 8dnf, 8ry, 8sf, 9ado, 9ahf, 9amg, 9apw, 9beq, 9bkr, 9biz, 9buj, 9buz, 9ch, 9ela, 9eld, 9evh, 9exx, 9dmi, 9duh, 9dvw, 9duz, 9eet, 9eli, 9ell, 9wo, 9xa, 9xaj, New Zealand 1ax, 1fq, 2ak, 2bw, 2ev, 2za, 4ak, 4al, Australia 1as, 2ae, 2bc, 2bk, 2cm, 2ij, 2rj, 2yx, French 8ct, 8fu, British 2iz, 2od, Japanese 1aa, Canadian 3eo, 5ba, 5bf, 5ef, KFUH, KFVM, RV, and last but not least WNP.

Traffic Briefs

For several months our stations have been giving a daily service to the people of Wisconsin. 9DTK at Milwaukee secures reports each day on the condition of the butter and egg market in Milwaukee. Information on livestock prices is obtained also. The complete report is then transmitted by amateur radio to 9DKS at Madison, Wisconsin. He turns the material received over to broadcasting station WLBL of the Wisconsin State Department of Markets at Stevens Point. The news is then broadcast to the farmers of the state. This daily and speedy market service is the first of its kind, and it illustrates just one of the ways in which wide-awake station owners are making themselves of service to the people of their communities. Other Official Relay Station owners can find similar ways to do some worth-while traffic handling, if they look for them.

3SK at Princeton, N. J., has a transmitter located at the "Radio Shop". He advertises in the local papers that he will accept messages for transmission to any part of the country via A.R.R.L. Traffic stations. This suggestion for getting traffic is a good one. Knowing that there is plenty of traffic being

originated and that in Milwaukee, Wisconsin, and in Princeton, N. J., everyone is taking the right steps to collect worth-while messages from the public, it is up to each individual station owner to see that such messages as reach him are handled in a manner that reflects credit to him and to the ARRL.

1HQQ arranged a nightly schedule between his station at Mansfield, Mass., and stations on board Coast Guard Cutters *Tampa* and *Modoc* of the iceberg patrol. Operating on a 154 meter wavelength and using four five-watt tubes, he handled traffic reliably to and from the men on the patrol boats and their families until the boats were nearly 1500 miles away. Such communication is but one example of the service which members of the League can give the people of the United States.

WOAX-3XAN broadcasts regular talks concerning the League and its policies on a 240 meter wavelength. Traffic is solicited from the broadcast listeners by this station, also. Using the lower wavelengths, 3XAN handles the traffic received from the broadcast listeners and sends A.R.R.L. broadcasts each week.

WOAX-3XAN Schedules are as follows:

WOAX (voice) Tues. and Fri. 240 meters, 12.30 PM EST.
3XAN (telegraph) Tues. and Fri. 165 meters, 4.45 PM EST.
3XAN (telegraph) Tues. and Fri. 76 meters, 5.00 PM EST.
3XAN (telegraph) Saturday, 76 meters, 11.30 AM EST.

4ASK has been handling friendly messages for the guests of the Princess Martha Hotel at St. Petersburg, Florida. He started a whole bunch of "good" messages and he took pains to check the service on each one of them. 50% of the messages reached their destination. The other messages disappeared somewhere along the line. Bausola wants to know why it is that operators will accept messages if they have no intention of relaying them and delivering them to their destination. There is nothing discourteous in politely refusing to handle a message when it will be impossible to forward it to its destination. If a message cannot be delivered do not fail to start a "service" message back to the office of origin as explained in these columns last month. DO YOUR PART IN IMPROVING RELAYING.

ZZAE writes that every amateur should observe more care in using the international intermediates. With new countries and calls getting on the air with each passing day he points out that unless a station is prominent its identity will often remain in doubt. Intermediates should be sent *slowly* and *distinctly*, especially when one is fishing for foreign "DX". When QRN is bad, the intermediates should be repeated once or twice. Old hands at foreign DX-working often follow this procedure. Be careful in using your intermediates and you will keep many nice records from loss. The receiving operator can't identify the weak station who hurries through his intermediate. Firm, evenly-spaced sending is the best. A "heavier" style of sending makes signals carry through the various forms of interference better than they would otherwise do.

Several fellows have made a practice of collecting messages from tourist camps during the summer season. 8EU, 9VD, and 9DTK have done the best work of this sort. Through the cooperation of the Milwaukee Journal, special message blanks were printed for the use of the Tourists who had messages to send. The Milwaukee gang also place collection boxes in prominent public buildings and hospitals with a little card on each explaining the workings of our A. R. R. L. Traffic organization. Where special routes have been arranged for handling messages accurately and speedily, the names of the cities and a list of the points to which the best service can be given is possible. The public are interested in knowing the days of various schedules, so that their traffic can be handled with the best possible speed. Traffic figures this month show that more messages were originated than last month. Messages can be obtained in a number of ingenious ways. However, there is one thing that we must watch. Our service must be improved, and our messages handled promptly and reliably. It is right that delayed messages should be mailed in 48 hours when they are for points in this country. Starting messages is only one of our jobs. We must see that our messages are handled and delivered *accurately* and *surely*. We are primarily a radio organization, and the bulk of our messages should go by RADIO, not by mail.

Now that more fellows are originating messages, the responsibility of pushing these messages through and delivering them is greater and we must live up to it.

Here is a new "Q" signal that will clarify our understanding of troubles with our signals and that will prevent the waste of a lot of time in useless conversation. 9BBB and 8BBP suggested this addition to our abbreviations. The meaning of the new signal and of the older "QSS" are given to make the distinction clear.

QSSS? Are my signals swinging?
QSSS Your signals are swinging.
QSS Are my signals fading?
QSS Your signals are fading.

Porto Rican stations handle most of their traffic on one of the shorter wavelength bands. They request that traffic for Porto Rico be routed through first or second district amateurs, as they seldom hear the southern stations who are operating on twenty or forty meter wavelengths. However, many stations in the Atlantic, Hudson, and New England Divisions come through regularly in good shape, and they can put the messages right where they belong without delay.

4RL of Santurce, Porto Rico, has some high speed relays to his credit. 2BXJ, 2AFN, 3ZW and 8AJ have all taken messages from him, delivering by telephone and returning answers to Porto Rico in fifteen minutes time (sometimes less). Everyone concerned deserves a lot of credit for his share of the work. 4RL uses a break-in system successfully for most of his traffic handling work. He makes a bid for some of that traffic going to d7EC, with whom his contact has been good. You will find him on a 40 and 20 meter wavelength.

Another nice piece of relay work was pulled off when rCB8 sent a message to WAP via c1AR. The answer was returned the same night, travelling WAP—c1AR—1CB8.

Club Activities

CALIFORNIA—The Orange County Radio Association managed the Pacific Division Convention which was held at Santa Ana, October 2, 3, and 4. This affiliated organization put across a fine convention. A live bunch of workers were responsible.

The Southern California Radio Association, an affiliated A.E.R.L. club, has changed its name to the Radio Club of Los Angeles. A new constitution recently drawn up prevents the handling of any business during open meetings. This plan proved suc-

cessful in increasing the attendance at the meetings. Many valuable talks are given at the meetings, which are held at 8 p.m. the first and third Mondays of each month at the National Automotive School Building, Santa Barbara and Figueroa St., Los Angeles. Visitors are welcome.

IOWA—The Des Moines Club will have a booth at the Iowa State Fair.

MAINE—The Queen City Radio Club of Bangor now has a station handling League traffic on an eighty meter wavelength.

MASSACHUSETTS—The North Adams Radio Club will have its meetings at 1BFE's or 1AMZ's station, when they begin meeting again this fall.

The Eastern Massachusetts Amateur Radio Association held a meeting July 17 at which the Technical Committee was instructed to go ahead with the plans for the exhibit at the Boston Radio Show. 1CPI, 1KZ, 1BZ, 1MP, and 1AAO are the committee members, and they will have a station in operation at the show, accepting messages for transmission. Massachusetts amateurs are invited to visit at one of the meetings at 7 Harcourt Street, Boston, Mass. Meetings take place on the first Tuesday and the third Friday of each month.

NEW YORK—8KS, 8CYI, 8BRD and 8BGN of the Radio Club of Rochester built a transmitter using a dry cell plate supply and a special keying circuit. They operated this transmitter at the recent Rochester Exposition.

OHIO—The Toledo Radio Club staged a big ham-fest August 22 in honor of Messrs. Warner and Hebert, who were on their way home from the National Convention. Fellows from Michigan and Kentucky (9MN) attended. 8IO is the club's Official Relay Station and operates on a 40 meter wavelength.

PENNSYLVANIA—The Lansdowne Radio Club are planning to open a new 500-watt station working on 20, 40 and 80 meters. October 1 is the date set for this event.

The Williamsport Club is having a drive to get new members.

Wiggin is organizing a "Radio Transmitters' Association of Western Pennsylvania." 50 League members in the Pittsburgh district are charter members of the organization. It is hoped that other members from all over Western Pennsylvania will affiliate themselves and form smaller groups in their own localities. Membership is limited to strictly "brass-pounding" amateurs. One of the purposes of the organization is to make Western Pennsylvania the leading section of the Atlantic Division.

WISCONSIN—The Milwaukee Radio Amateurs' Club held its monthly tract meeting in the Milwaukee Journal Building. 9DTK, who had just returned from a visit to 9EK, explained the working of the Beam transmitter and the picture transmitter. 35 hams were present, some coming from as far away as St. Louis and Chicago.

DIVISIONAL REPORTS

ATLANTIC DIVISION E. B. Duvall, Mgr.

THE Atlantic Division is practically in top notch condition and indications show everyone is ready for real traffic handling in the fall and winter. Western Penn. has come up to the top this month. Reports from Western New York show plenty activity but all traffic reports received hereafter must be in the new form to receive attention. New Jersey is coming to life and Eastern Penn. and Maryland are coming forward as traffic officials are returning from summer vacations. The Districts of Columbia is inactive but Delaware is waking up. Results of the Red Cross Emergency tests are not complete at this writing. Many stations that had been crying for traffic were nowhere to be found when this test was held. Reports in general indicate such a test is not welcome by the majority of the stations and it will be a long time before the DM will attempt one again.

OB8 are being appointed as fast as time permits. Each applicant must report in writing to the DM and give his power, waves expected to be used and operating hours.

Radio Clubs are requested to report thru their secretaries direct to the DM, or if more convenient, thru their ADM. The Service Bulletin seems to be appreciated and will be continued thruout the winter. Your cooperation to make this service a success is

necessary. A new district magazine "Radio Graphic," is expected to contain a great deal of real "hammy" stuff of Third District activities. It will probably be the official organ of the Third District Council, Inc.

DISTRICT OF COLUMBIA—ADM 8AB: with the ADM attending the Chicago Convention with 3HS, reports are low. 3BWT will be off the air indefinitely for repairs. 3BSB has two transmitters on the air and has taken some of the Red Cross Messages of 3CKG. 3CKG has a "250" on 40, but has difficulty raising stations within 1000 miles, 3ZW failed to get any of the Red Cross messages on the air and Waddy was forced to turn them over to 3APV. 3KM has been heard, but no antenna is in evidence. 3BPP is active in club affairs. The ADM wants a 100% report next month or there will be some minus certificates.

Traffic: 3BWT, 41; 3BSB, 1; 3ZW, 1.

MARYLAND—ADM 3HG: Jordan and Offett, of 3BUR, operating NVE report that they work everyone they hear. 3AEA visited several hams in New York. 3CGC blew his "fiver" but is using a "201-A." 3OP and 3FR, are among the most active Baltimore stations. 3APT has come down on 80 meters and expects to go lower. 3PH has also forsaken 160 for the lower bands. 3WA reports fine work on 40 and 80. 3ACW is on his vacation. 3AHA, with a new loss-40 meter set has done some remarkable DX. 3RF has had contact with WNP. 3APV got off all his Red Cross Messages in record time and cried for more. He got em! 3HG is being heard in New Zea-

land, England, Australia, New Guinea and South Africa. 3DW found no trouble in getting Red Cross messages off on 80 meters.

Traffic: 3WA, 7; 3HG, 16; 3APV, 115; 3AEA, 8; 3CGG, 4; 3FR, 3; 3APT-3ZD, 17; 3DW, 131.

DELAWARE—ADM 3AIS—Delaware is more active than it has been for some months. 3AEB is a new station with a "fifty." 3AIS has been the only active station on the air as 3WJ has been at sea. 3WJ took along his short receiver and transmitter but reports he has been unable to get the transmitter to perk. 3BSS has a new mast nearing completion.

Traffic: 3AIS, 12; 3AEB, 1.

SOUTHERN NEW JERSEY—ADM 3EH—Dist. No. 6: A good many of the fellows are reconstructing their sets. 3RTQ is the proud owner of a new "fifty" and has been running schedule with the USS Utah on 40 meters. 3SK is on 40 meters and reports much better results with his "fiver." 3ZL's transmitter is now located in the attic and remotely controlled from the first floor. (He must use a periscope to read his meters DM.) 3XAN has been experimenting with antennae. 3CBX will be back this fall. 3BRM stuck to the job all summer, improved his transmitter and is corralling a lot of traffic.

Dist. No. 7: 3ALX had a portable receiver. 3AII is rebuilding. 3BWJ has been working either new Zealand or Australia every morning on his "fifty." 3BO took a flock of Red Cross messages and delivered in person by auto the day received (FB—DM.) 3BEL lost another pole the 15th this year. He recently telephoned a message at a cost of sixty cents but the recipient traced the call and sent him a box of cigars. 3WB is in Canada. 3KJ is a new ORS. Atlantic City will now have at least one station to show to the delegates to the Third District Convention in September. 3OQ has a new 30-watt tube.

Braidwood of the 9th Dist. reports via telegram to his ADM that reports were nil for the District.

Traffic: 3XAN, 11; 3ZL, 5; 3RTQ, 39; 3CBX, 2; 3BRM, 13; 3SK, 1; 3BEL, 6; 3BWJ, 18; 3BO, 9.

EASTERN PENN.—ADM 3FM: The ADM reports from a hospital, where he had an appendicitis operation. 3FM has the valuable assistance of his newly appointed Assistant ADM—his wife. **CONGRATULATIONS.** 3BVU attended the Chicago Convention. 3BNU is doing excellent work on 40 meters. 3BLC is doing splendid DX. 3LK is moving traffic well. 3AVL is using the lower bands, 3CJN handled his share of Red Cross Messages. FB. Operator "B" of 3ZO must be congratulated for the steady and reliable communication handled thru this station during the spring and early summer. 3CHG received his first-class ticket, dropped to 40 meters and worked the first Australian called. 3RT has not had much success on low waves. 3LW went to Chicago. 3ALE, a new ORS, is open for schedules on 75 meters. 3BVZ is going strong on 78 meters. 3BPM is experimenting. 3BQP is working on a new transmitter. 3AWA leaves for college. Sorri OM. 3EU reported for 3BFE who is on vacation. 3EU had a considerable amount of Red Cross traffic and also is chasing up traffic from tourists camps. 3VCK, 3COE, 3CEO, 3AGQ, 3CFT, 3ABA and 3FM, visited the Williamsport gang this month. Williamsport is getting popular. 3CCQ and 3EM visited 2BRB and 2CLA. 3BFE is touring around, visiting hams. 3DB and ex-3AHU are coming back into the game—WELCOME OMS. 3HR now 3AFR, 3ABD and 3BQ, will be on for after midnight work. 3AFR is building a 50 watt set for 40. 3CCQ has been QSO Europe and South America on a "fiver." 3BQ and QSO England with lses than 35 watts.

Philadelphia again seems in the background. No report was received from the CM altho half the Philadelphia stations reported traffic. 3BNU is circulating his district with club organization work. Eastern Penna. stations must be congratulated here for the excellent spirit shown in handling Red Cross traffic. The stations that participated did their work well.

Traffic: 3BVU, 8; 3AEN, 9; 3ZM, 5; 3AWA, 5; 3AHR, 4; 3BTU, 10; 3BQP, 5; 3BPM, 8; 3BVZ, 14; 3ALE, 2; 3LW, 3; 3BFE, 4; 3RTU, 114; 3CFT, 18; 3BQ, 19; 3WH, 4; 3CCQ, 2; 3CHG, 7; 3BNU, 49; 3CDN, 2; 3BLC, 17; 3AVL, 8; 3LK, 14; 3CJN, 52; 3RT, 2.

WESTERN PENN.—ADM 3ZD—Dist. No. 7: 3BOY, the only active station in his districts, has schedules with 2nd and 4th districts. 3DHU, portable station operated by 3CEO and 3AGQ, handled 28 Red Cross messages.

Dist. No. 8: 3DOQ is the only active station in Huntingdon reporting. He is getting out well with

two "fivers." 3AOX is leaving for his vacation and expects to visit a lot of stations and arrange schedules. 3AHK has deserted 200 meters and is rebuilding for 80. 3AKI handled 8 msqs. with a small portable transmitter using 201-A and 100 volts on the plate. He has purchased one of the Jenkins photo transmitters and is going to experiment with Gable, of Altoona, who also has a machine. Stations in the 8th Dist. are now requested to keep in touch with their DS—3AKI at Altoona.

Dist. No. 9: Only a few ORS in this district are failing to report and several who are not ORS are reporting regularly. 3BRB handled 16 Red Cross Messages, and has portable 8KQ on 5 and 20 meters. 3DGL has a new receiver. 3CLX returned from a trip to Canada and New England. 3CES reports but little traffic. 3DBF threatens to rebuild his transmitter. 3BJT has been operating at 3AIM. 3CRK is repairing auto so that he can purchase "fifties." 3DNO has a new transmitter and is arranging schedules on 20 and 40 meters. 3BBL will go to college next month. 3AYH is getting a new 5 watt station. 3CKM is on the job as usual using a "fifty" on 40 meters. 3CHF operated 3AGQ, keeping in touch with the portable station 3DHU that McAuly and Keister had with them on their vacation. A feature of this portable transmitter was the power plant which consisted of one DC generator coupled to two motors—one a 60 cycle A.C. motor equipped to be plugged in the A. C. line by extension cord and the other a motor operated by the storage battery installed on the car. 3DQV has worked 8 districts, Porto Rico and South America.

In the absence of the City Manager for Pittsburgh, the report for Dist. No. 1 was handled by 3CLV. (Many thanks OM, for the help. ADM.) 3OW is experimenting with tubes for short waves. 3CEJ is working out of town. 3RT has a new tuner and added another "250" to the transmitter. 3DIO is operating regularly. 3BHJ expects to carry out 5 and 20 meter tests after returning from a vacation in Canada.

Pittsburgh was represented at the National Convention by 3BIT, 3SE, 3OW, 3AYV, 3VQ, 3CEZ and 3DIO. 3JQ has worked New Zealand, South America, Samoa, and Porto Rico. 3CLV rebuilt but found the transmitter did not work as well on the panel as it did on the bread-board. 3ME moved to Wilkesburg. 3BCM, a new one from the 1st. Dist. is working a "fiver" on 40 meters. 3CUN is collecting material for a super-power station.

Reports for Dist. No. 2 of Pittsburgh are slim. 3BUV enlisted in the U. S. Signal Corps. 3CTE is on the air as usual on 40 meters. 3CUK is visiting stations in the 2nd and 3rd Districts.

Dist. No. 10: Traffic seems to be at a standstill in this District. 3AUD has been away on a motor trip in Maine. 3BYI is QRW heavy work at the store. 3BQ is all set for traffic on 40 meters. 3CMQ threatens to go to 80 meters.

Dist. No. 11: Stations are few and far between. 3DKI is mainly interested in a new YL at the present time. Power leak QRW has been very bad in Warren but the DS has helped locate some of the interference. 3CON has a new vertical antenna.

Dists. Nos. 12 and 13: Activity in these districts has been at a standstill. The DS reports that his station is working on 40 and 80 meters, with fone on 175 meters. 3ABM has been serving as second operator. 3CQL will attend State College. 3GU-3XC will serve as CM at Erie.

Dist. No. 14: The DS sent out a circular letter to all stations in his District and has started things going. 3BJV is now on 40 and 80 meters. 3BKY has been on regularly on 40 meters. It is rumored he will return to Florida this winter. 3DCV is again in operation on 80 meters. 3BRM has been operating consistently all summer, on 40, 80 and 180 meters. 3ABS guarantees prompt delivery of all messages. 3BRP is coal mining to get the cash for new "bottles." 3DBL will attend school out of town. The ADM has 3ZD on 40 meters and will be glad to arrange schedules with any or all of the District Supts. and City Managers for the purpose of holding together the traffic organization of Western Penn.

Traffic: 3DQQ, 10; 3AKI, 8; 3DNF, 6; 3CES, 5; 3DGL, 16; 3BRB, 32; 3CKM, 7; 3DHU, 54; 3DQV, 8; 3BHJ, 4; 3BIT, 8; 3CKV, 37; 3CLV, 9; 3CUK, 10; 3CCK, 2; 3DQ, 3; 3CMQ, 3; 3AXD, 4; 3CON, 6; 3BRC, 26; 3XC, 18; 3CQL, 9; 3BJV, 26; 3BKY, 10; 3ABS, 2; 3BRP, 5.

WESTERN NEW YORK—ADM 3PJ: The ADM returning from his vacation reports for both July and

August. SAVR is overhauling. 8BKQ, 8DHX and 8CNH are all new stations doing good work. 8BKQ uses a "fifty" and has joined the RCC; 8DHX has two "fivers" on 80 meters. 8CCN uses one "fiver" on 80. 8BXP is heard occasionally. 8APU is rebuilding. 8AVJ is pushing out good signals in spite of the warm weather. Kerkhimer rates CM having handled 113 messages.

Dists. Nos. 9 and 10: The Hamfest at Rome was one grand success. 8CNX has a new transmitter working on 40 and 78 meters. 8BZU reports traffic good. 8CCR worked WNP. 8BDF is now at Rochester. 8ADG is on 40 meters. 8DSM is handling traffic on 80 meters. 8CCR FB on 40. Syracuse has 8CTL, 8BIN, 8DKE and 8AVR, a brand new station with a "fifty" feeding a beautiful 80 ft. vertical cage. 8AGM, portable, handled 134 messages.

Dist. No. 13: 8ADM reports a good traffic total. 8DME has a new shack and two transmitters for 20, 40 and 76 meters.

Dist. No. 14: 8VW is off the air with a broken wrist. 8GM is a new League member. 8HJ seems to be the star station for the District. 8SR has been handling traffic on 40 and 80. 8CWH is using a "fifty" on 40 and 80 but has trouble receiving. Nelson resigned as DS. He is moving to California. The Radio Club of Rochester is requested to get in touch with 8CYI who will probably succeed him. Graff will take care of Rochester in place of 8CYI. 8BHM finds a Hertz antenna good for local 40 meter work. 8AYL attended the Convention in Chicago. 8BGN reports traffic much better. 8ALY and 8DRB are rebuilding. 8KS works WNP. 8BGN has been QSO Australia. 8CDR is on again. 8BLP got thru to Belgium on one "fiver."

Dist. No. 15: 8AYB is now an ORS. 8QB works the DM often. 8UL has a good traffic report. 8APO was reported in Sweden. 8BQ handled Red Cross messages. 8WU will be at 2XG after Sept. 20. 8PJ blew two "250s" but has a new one. 8RV expects to be an OBS. 8BSF has a fine transmitter but has been travelling. Buffalo loses Bill Cotin and Ben French who are now with the Bosch Magneto Co. We miss 'em. 8DPL is doing good work. Several of the gang were on board NITZ and 8PJ received messages from her on her westward trip.

Dist. No. 16: Fosberg resigns as he is attending Rensselaer. 8AXN leaves for the fall term at Cornell. 8DGA, 8BGA and 8BZF are the only ones to fill the office of DS. 8CNX reported direct to the DM. Exner of 8XU has been doing a trick for the United Fruit Co.

(Traffic is excellent for Western New York but no one seems to be using the new reporting system. Forms 2 MUST be used by the traffic officials and this is the last time reports will be accepted in the manner they have been—DM.)

Traffic: 8BXG, 25; 8DRJ, 38; 8DHX, 38; 8CNH, 9; 8CFV, 8; 8DDV, 4; 8CNX, 23; 8BZU, 3; 8DSM, 33; 8CCR, 38; 8AGM, 134; 8ADM, 58; 8CWH, 5; 8SR, 5; 8BHM, 58; 8KS, 23; 8CDR, 5; 8BGN, 40; 8CYI, 58; 8DLP, 23; 8DRB, 4; 8UI, 30; 8WU, 30.

CENTRAL DIVISION R. H. G. Mathews, Mgr.

OHIO—ADM 8AA: Dist. No. 1: Seaman, of Findlay, reports he is going to get after the gang to get their reports in and will take this up at the next radio meeting. 8DHS finally has his mast up and will soon be on again. 8DFF has quit the game. 8AOE has difficulty lately with his transmitter.

Dist. No. 2: Traffic is low but DX is good. 8RY worked Ch-1EG in Spanish for over an hour, handling traffic both ways. 8AGS is on 80 meters occasionally. 8BKQ is a new station and has just received his ORS appointment. 8CTG is also a new station, but is having tube trouble. 8WE will be on in November with a "fifty" and pure DC. 8BCE has been off the air with poor rectifiers, and now has an Esco, MG and expects to do some real work.

Dist. No. 3: Who said radio was no good during the summer? The boys are doing just as good DX as last winter and message reports are keeping up well. 8BKM leads the district in traffic. He solicits messages from friends and neighbors. Why not have more of the gang try it? 8DCF handled two Red Cross messages. This month's reports from the ORS show they are finally getting down to brass tacks and starting messages. Let the idea grow.

Dist. No. 4: 8CPQ reports good DX on 150 meters. 8CNI is working England on 40 meters. 8AIB is installing a new set. 8AIW reports difficulty in getting

messages. 8ANB is building a new shack with French windows and doors! 8BON reached England on 150 meters.

Dist. No. 5: Storck, the DS, is spending a couple of weeks in Camp Knox, Ky., and reports were sent direct to the ADM. 8CBP says he will be on soon with a "fifty" on 5, 20 and 40 meters. 8PI reports little traffic on 40 meters, but DX good to Australia and N.Z. 8ZG-8GZ as usual reports DX good, QSOing NZ, Aust S.A. and Europe any time. 8EI took a set to Camp Perry with call 8ZG. 8BBH reports he is still alive and interested.

Dist. No. 6: 8DFO is on nearly every evening, 77 meters, and wants schedules.

Traffic: 8BKM, 46; 8GZ, 31; 8RY, 24; 8DFO, 21; 8EQ, 21; 8PL, 14; 8BPL, 13; 8BOP, 11; 8BN, 10; 8KC, 10; 8BHN, 10; 8CPO, 7; 8BSA, 7; 8CNL, 6; 8ANB, 6; 8DND, 6; 8BON, 5; 8LO, 5; 8AIW, 4; 8AGS, 4; 8DCF, 4; 8ARO, 4; 8ADE, 4; 8EI, 2; 8BKQ, 2; 8UK, 2.

INDIANA—ADM D. J. Angus—Dist. No. 1: In order that the DS would be located nearer the point of greatest activity it was decided to move the office from Marion to Fort Wayne. Tudor is resigning and the work will be taken over by L. B. Wilcox, (9DPJ) 1317 N. Harrison Ave., Fort Wayne, Ind. The CM at Fort Wayne has been acting as DS.

8AVB has moved but will soon be on the air again. 8AFI will either have to marry the poor girl or quit radio. 8AFY is in the same fix, but not so far along. 8BWF is waiting for his new license papers. 8CRH wants traffic. Try him. 8DLW is on again. 8QR is QSO all districts on 40 meters. 8BKJ is going from 40 meters to the 150-200 band for traffic this winter. 8AAI has just come on with four "fivers" and worked all districts the first night. 8DLN has a new 60 foot steel tower. 8DUT lost his 90 foot wooden skyscraper in a storm. 8DBJ also lost his. A horse tangled himself in the guy wires. 8DPL is trying indoor radiating systems. 8II is on with "250." 8AKO got married and flew to California. Red Cross messages to a total of 23 were handled at Fort Wayne between 8CRH, 8DPJ and 8BKJ.

Dist. No. 2: In order to improve conditions in the South Bend district the CM appointment for Elkhart has been cancelled and Elkhart, Michawaka and South Bend all report to the South Bend CM. This made necessary putting Elkhart county in the second district, taking it out of district No. 1.

8BBJ and 8BVL are going to Purdue this fall. 8DYT is rebuilding in order to use the meter he won at the Hoosier Convention. 8DXI is using a break-in system. 8OG is on with a "250." He is putting 1KW tube on 20 meters. 8CBS is in Florida temporarily. 8DHJ is rebuilding. 8DKT is on 20 meters. 8CP is on 20 meters with a Hertz antenna. 8BYI is going regularly on 40 and 80 meters with three "fivers." 8AEB is on 40, with a "50." 8ABP is rebuilding. 8CEM's mast fell and wrecked the house. 8DVE is handling lots of daylight traffic with a "fifty" on 40 meters. 8AM is getting out well with a "fiver" on 80 meters.

Dist. No. 3: Activity in the south end of the state is on the increase as new stations are on the air at Evansville and more coming at other points. 8NG does well with 2 201A's. 8NI is using two "fivers." 8BSC is on with a 203A and "S" tubes and a vertical antenna. He is operating WGBF. 8GSC is rebuilding, putting in a 30 watt tube and a new M.G. 8CKH was heard by A4DO when using two "fivers" on 80 meters. 8BRK is on the air occasionally.

Dist. No. 4: This district has been badly crippled due to most of the gang being at Camp Knox. 8CLO has worked NPL and handled some of their traffic. 8ADK is handling the bulk of the long distance traffic out of Indianapolis. 8BVZ is building a new sync that will insure a pure DC note. Next month's report will prove or disapprove this. 8DTL is rebuilding. 8AUW blew his M.G., "fifty" grid leak, and milliammeter. 8AEG is handling traffic again.

Traffic: 8BBJ, 45; 8CKH, 26; 8TG, 26; 8DIT, 23; 8ADK, 23; 8CYQ, 16; 8NG, 13; 8EAG, 7; 8DHJ, 6; 8BKJ, 6; 8GR, 4; 8DPJ, 3; 8NI, 3; 8AUW, 1.

KENTUCKY—ADM 9EI—9MN has worked Aussies and WAP. 9DYC has completely rebuilt his station. 9HP has moved out in the "sticks" and is adding new countries to his list every night. 9WU has just returned from Europe and is QRV for the winter's work. 9OX, on 40 meters, is doing consistent work. Married life seems to have taken 9ARU and 9DWZ from us. How about it OM's? 9LH blew his plate transformer, but says he will be back soon. 9EP and

WASE have consolidated and will operate under 9EP, using a "fifty" and MG. 9BPE is discarding his 100-watt outfit for a new 500-watter. QCE will be on 40 meters in the near future.

Traffic: None reported.

WISCONSIN—ADM 9VD—Dist. No. 1: This district handled 208 messages, of which 93 were tourist's. We expect this service to the traveling public will grow rapidly. 9BKR is now using a sine rectifier and has changed to the Hartley circuit. (Don't forget to send in your messages to the D.M. for verification OM and get a leg on the Plaque.)

9BBY has been QSO N.Z. and NRRL. 9DTK now has a "250" but can't seem to make the big boy percolate on his Hertz Antenna. 9HW also has one of the big jugs, to the regret of the BCL's. 9ATO is back again with a "fifty" on 20 and 40 meters. 9DDM's rectifier went west, but he will have a new one soon. 9BMV cleared 4 Red Cross messages for Wisconsin cities. 9ELV is now on 40 meters with a "five" and worked 4KY in dalite. 9BEK will be back shortly. 9CCB is doing good work on 40 with "250's."

9DOL is a new station. 9CVI has no A.C. at his new QRA. 9EHM is reconstructing. 9NY is still busy at the Marquette station. 9AFZ is experimenting with antennae. 9DB will be back again in the fall. 9VD will be on soon with a new rectifier and will start emergency work on 39 and 78 meters. 9AEE is experimenting with ice-chamber fone caps, to keep cool. Hi! 9CJV says he wd rather operate at WNP. 9CII is on at times but wants a Ford roadster. Hi!

Dist. No. 2: 9CUO handled a bunch of tourist messages and is receiving QSL's on about 75% of them. 9BME says the threshing machine keeps him busy. 9DUJ is on consistently. 9CWZ is working at Kenosha but trying to get his transmitter going. 9EAN visited many ham stations on a western trip. 9OM will be on in September. 9EAR is having difficulty in making his set "perk" on 40 meters. 9BIB is working on 5 and 20 meters.

Dist. No. 3: 9BVA is remodelling his receiver and antenna. 9ALI has moved into the third district and will be on shortly on the short waves. 9DKA has been QSO Australia. 9EAU is back on the air with two "fivers" on 40 meters and expects to get down to 20 soon. 9BYJ finds it hard to hold down his job on the RR and also operate his station. 9CIU is fixing up for short waves. 9EMD wants a schedule with a Minneapolis station to handle traffic from Chicago at 6 to 7 A.M. 9AGT will be on 40 meters this fall.

Dist. No. 4: 9PJ is still on 1501200 meters hound but gets a good DX and traffic on these waves. 9BKC is building a 70 foot lattice tower. 9AZN is on a vacation. 9AKY was out of town most of the month. (Guess LaCrosse isn't gud enuf for these guys any more.) 9ELL seems to be about the only ham in this district that hasn't been afflicted with the vacation fever. 9DCX is on consistently. 9BFI is on 40 meters.

Dist. No. 5: 9DPR is on 40 meters daily from 6.00 to 8.00 p.m. and wants to arrange schedules west. 9ELI is on a trip through the state and while in Milwaukee called on the ADM.

Traffic: 9BKR, 117; 9CUO, 52; 9XH, 33; 9EIL, 26; 9BBY, 20; 9DTK, 17; 9BVA, 13; 9HW, 12; 9BFI, 11; 9ALL, 10; 9DDM, 9; 9DB, 9; 9DKA, 9; 9DPR, 9; 9DCX, 8; 9ATU, 7; 9BMV, 7; 9EMB, 7; 9ELV, 5; 9BEK, 5; 9CCB, 5; 9DOL, 4; 9DUJ, 3; 9CPX, 3; 9AEV, 3; 9PJ, 2.

MICHIGAN—ADM 8ZZ—Dist. No. 1: Traffic is still down, but the messages that are sent mean more than a year ago. 8CCW is on the job regularly. 8ZT hears NRRL consistently. 8DBO will be QRV when his new receiver is finished. 8BBI has been out of town three months but will be on soon. 8ACU is heard every night on 176 meters.

Some operators are going to lose their ORS for not reporting, so don't be surprised when the notice comes if you have not made a report in five or six months.

Dist. No. 2: Many of the men in this district are putting in new apparatus in new locations, all of which takes time, and there is every evidence of a bumper season this fall.

Stations 8JJ and 8CHK are still in contact with Australia and New Zealand. 8AYY is the only station reporting working WAP. 8AFS is doing wonderful work with his "five". With exactly 10 watts in the antenna he has been reported in New Zealand, and has worked everything on this side of the world. 8EG is the new short wave station of the Reo Motor Car Co., run by the gang at WREO and "boys about town." It is on 20 and 40 meters.

Traffic: 8CHK, 8; 8AFS, 8; 8CCW, 7; 8CED, 6; 8JJ, 5; 8DBO, 3; 8ZT, 2; 8NX, 1.

ILLINOIS—ADM 9CA—Dist. No. 1: The DS reports little activity as nearly everyone was at the Convention. 9AVH will move to Urbana, Illinois, but will be on the air again about Sept. 21st.

Dist. No. 2: West sends in a good report as usual and also attended the convention. 9ELZ, ex-9BCK is using 100 watts plate input on a "Fifty." 9DXL is doing wonderful work on 40. 9ELR is going from 80 to 40 meters. 9BRX was on for a few days on 40. 9BUK was up in Wisc. with 9BRX. 9DLO is building a new house after the fire (New one looks fine—ADM.) 9ELF's YL is away now so he will get a little work done. 9PZ is making application for ORS and is using a "250" on 42 meters. 9DZR is on 80 meters with a 4 coil Meissner. 9CWL is trying to get going on 40. 9ALF is rebuilding and erecting a new mast. 9AQC will be on regularly with a "fifty." 9ARM is rebuilding.

Dist. No. 3: 9AHJ expects to be on 40 meters soon. 9DJG has moved. He and 9CMC will have a 200-watt station this winter. 9CXT will attend the U. of M. this winter. 9TW is using a "fifty" on 40 meters. 9AWQ will be on the air again in Sept. 9CLZ is going to the Case School of Applied Science this winter and would like to hear from nearby eights.

Dist. No. 5: DS Tate was on active duty at Great Lakes in the USNRF and missed his report.

Dist. No. 6: 9DCG handled about 90 msgs this month. 9DVW has gotten fairly settled on 40 meters, and has been heard in Australia and NZ. 9DQR will be on immediately after returning from a vacation including the convention. Six amateurs from Rockford represented that city at the National Convention. 9EHQ is building a tower and getting new antenna installed for 40 and 80 meter work.

Dist. No. 7: Due to the National Convention being held in Chicago many stations were rebuilt and revamped. For this reason the traffic handled in this territory was rather below normal. With the fall season opening and the reorganization of the stations to be done during September traffic should improve.

9BNA has worked every district during the daylight hours on 40 meters. 9GE and 9QD stand to be congratulated on their remarkable showing. We hope they will act as a backbone to improve the conditions in the west-side of the district. 9AFF is now eligible for an ORS. Listen for him and his YL on the high wave band. 9AWW-9ZW has been entirely reconstructed. Transmitters are now working on 40, 80 and on the high waves.

F. J. Hinds, 9APY, has been appointed CM for the Western towns of this district.

Traffic: 9QD, 53; 9GE, 50; 9BNA, 44; 9APY, 19; 9DWH, 19; 9DXG, 17; 9BE, 15; 9CN, 13; 9AFF, 9; 9AAW-9ZW, 7; 9ALJ, 4; 9IX, 4.

DAKOTA DIVISION D. C. Wallace, Mgr.

THE Vigilance Committees which have been appointed by the ADM's throughout the division, have been functioning admirably. Since they have been appointed no complaints have come from the BCL's. This, in spite of the fact that a great deal of publicity has been given through the newspapers and through Radio Associations to the Radio Dealers, concerning the availability of these Vigilance Committees.

Both Minnesota and South Dakota ADM's are issuing monthly mimeographed bulletins. These papers are extremely interesting to read and are issued to all ORS's in the respective states free of charge. ADM Barker and ADM Junkins are to be commended upon their enterprise in this connection.

NORTH DAKOTA—ADM 9CSI—Dist. No. 1: 9EFN is the new D. S. in this district. He recently received a card from 6AJI who stated that he thought "N.D." stood for "Nothing Doing." 9EFN says that he will show 6AJI if it takes a couple of "fifties." 9CZG is a new ORS and is doing good work. 9AAM is rebuilding his set for 5 meter work. 9DLF, 9AMP and 9AUI are temporarily out of commission on account of the recent storm which blew down their aerials but they expect to be on the air by September first. 9DTQ will be on the air when school starts. 9IK-9DFS is a new ORS at the State School of science at Wahpeton. Two operators will work this station in order to maintain a regular schedule. 9DIG is rebuilding for 80 meters.

SOUTH DAKOTA—ADM-9CJS: 9DIY has a five-watt loop transmitter working on 40 and 80 meters

under the call 9AKA. 9DZO is a new station in Sioux Falls. 9BOF worked NRRL. 9DGO is another new one at Canova, and is on 40 and 80. 9CKT has been rebuilt and is going strong. We will have a YL in this district soon, as 9DGO's sister is going to take a trick at that station. 9DWN is doing fine work on 80 meters. 9DXR has a new 70-foot lattice mast. 9DBZ, on 20 meters, was reported dilite by bzLAB. He also heard WAP's fone from Etah. 9CBF has a new 7-pound YL at his place. 9AGL will be regular again after September first. 9DZI works morning schedules to move his traffic. 9BDW has been QSO NRRL and Australian stations, and works 7LU and 8AUB every noon. 9BOW will operate at 9BXP this winter. 9AEO reports a scarcity of traffic. 9BKB had a fire at his home, but is getting fair results on 40 meters. 9BRI has a "fifty" on 40 meters. 9TI rebuilt and broke into NZ in dilite with 225 volts on the plate. 9CKD is pretty well settled in his new quarters and is lining up to work all bands from 20 up. 9CJS has a pair of new lath towers. He is getting rather touchy on the subject of "windmills." 9BBF is still debating whether or not to raise his tower which he built a couple of months ago. 9BBL is selling out.

Traffic: 9DIY, 1; 9CKT, 5.

MINNESOTA—ADM—9EGU: All stations are either undergoing improvement and rebuilding, or are in shape for the winter months. Indications point to the Dakota Division being in line for its usual outstanding work this winter. F. B. We've got GOOD stations, and we've got GOOD operators and we KNOW we're going to put Minnesota in the lead for GOOD WORK. The fellows all seem to be following the Operating Rules for ORS—the nicest thing noticeable on the air. FB, gang, keep up the good work.

Dist. No. 1: 9EGN is great on traffic and does schedule work. 9CWN is installing a "fifty." 9EEP put up a 64 foot lattice tower and works out much better on 42.5 and 20 meters. 9DKR is at the CMTC this month. 9AGO continues his schedule work and is QSO all districts. 9EGF is coming on with B battery plate supply on "10 watts." 9CDV is the "high muck" on traffic and has been doing lots of experimenting with antenna systems. 9AND is chief op on the USS Paducah, but is leaving for Florida soon. 9CKI steps out well with his "fiver" and is doing fine work. 9DFD let 9AND burn out his "fifty" so had to suspend operations. 9EGU was on the USS Paducah cruising in the USNRF.

Dist. No. 2: 9RD has moved to Florida. 9MB has been experimenting with receivers. 9DMA is fighting with 40 meters with poor results. 9BBV can be on only occasionally. 9EGG kicks out fine with his spark coil CW on 20 meters. 9DDP has been experimenting with antennae. 9ANJ signs 9WH on 40 meters. 9AIR is still working on his 3/4 meter set. 9DDB is QRW harvest and threshing. 9JI is QRW with his BC station, but will be relaying soon. 9CPO has 2 new 60-footers and is equipped for operation on all waves.

Dist. No. 3: 9BOL copies WAP consistently, but has not stepped out of the USA as yet. 9DEQ is remodeling his set. 9SE was initiated into RCC and is getting at least one new member each day. FB. His "fifty" is perking FR on 40 meters. 9ZT worked Chilean 1EG for 1 1/2 hours, 25 words per, no QSZ, handled 10 messages, half of them in Spanish, with last half hour of QSO entirely Spanish both ways. FB. 9DPX and 9ZI worked WAP. 9GH is stepping out on 40 meters. (St. Paul seems to be nil on reports this time. What's the trouble? ADM.)

Traffic: 9CDV, 35; 9CWN, 9; 9AOG, 11; 9CKI, 3; 9EGN, 14; 9EGU, 8; 9BMC, 13; 9DYZ, 2; 9DPX, 11; 9RPY, 11; 9APE, 5; 9BVH, 8; 9AXY, 3; 9ABK, 2; 9DEQ, 6; 9ZT, 39; 9BOL, 12; 9GH, 2; 9SE, 62.

DELTA DIVISION

Benj. F. Painter, Mgr.

THE reports from the ADM's for Arkansas and Tennessee are missing this month. No reason is known for the absence of the Arkansas report. We understand the Tenn. ADM went to the National Convention and fear that he was lost in the big city.

MISSISSIPPI—ADM 5AKP: 5ARB is on 40 meters, but is not having much luck there. 5AQU is working dilite schedules with a "fiver" on 40 meters. 5AEV is busy with traffic on 40 meters. 5FQ has generator trouble. 5AUC works all districts with one Roce tube. 5AKP is changing over to 40 meters. The portable transmitter 5AGM is off the air until next summer. 5AGS, the permanent station is being

prepared to take its place. 5QZ reports awful QRN down his way.

Traffic: 5AEV, 37; 5AKP, 6; 5AQV, 12; 5ARB, 14; 5QZ, 16.

LOUISIANA—ADM 5UK: 5KC has returned from sea for a few days and finds time to handle some traffic. 5NJ and the OW went to the Convention. 5MQ is in the radio business, but still gets reports from Australia. 5AU is still trying to make his broadcast set work. 5TQ gave 40 meters a try but went back to 80. 5UK was the connecting link between WSMB and New Zealand during a special test program. 5AEN at last got out of town with his set.

Traffic: 5KC, 4; 5UK, 11.

ARKANSAS—ADM 5KAB: No report from the ADM. 5ANN at Little Rock reports traffic in spite of very bad weather and expects four new stations shortly.

Traffic: 5ANN, 12.

TENNESSEE—ADM 5CN: No report. The ADM attended the Convention 4AJ at Chattanooga is heard regularly, however, and we understand 4MM is on again for fall.

Traffic: 4AJ, 23, 4MM, 2.

HUDSON DIVISION

E. M. Glaser, Mgr.

A GENERAL clean-up is being made by all officials and we are going to see to it that every ORS does its duty. REPORTS MUST BE IN ON TIME OR THEY WILL BE MISSING IN QST. The "Delegates" to the National Convention report a wild time, lots of new dope and plenty of DX.

NEW YORK CITY—ADM 2CWR: 2BEE was away at convention. 2CVL reported he was on vacation. 2CYX did all the Bronx work, and kept the Boro alive. F. B. Marty at Brooklyn showed more than his usual activity. 2BRB is experimenting with a GR, 184 meter crystal with a M. O. set, working on harmonics for low waves. 2CTY is back from Canada. 2ADC is still drawing pictures. 2WC has done good work on 40 meters. 2BO copied WAP for over an hour. Bill Schudt wants photographs and descriptions of prominent stations for publication in the "Telegram". 2AEP has been recommended for an ORS. 2BSL is away in Pennsylvania. 2AHZ is trying for an ORS. 2AVE is arranging schedules on 150 and 80 meters. 2ACZ is rebuilding. 2AFV is stepping in and helping with traffic. 2AKK and 2CEP report little traffic available. 2APJ is a new station, and uses a spark-coil on a 201A. 2BNL was away at the convention.

Traffic: 2CYX, 29; 2BRB, 92; 2CTY, 5; 2ADC, 12; 2WC, 17; 2BO, 20; 2PF, 6; 2AEP, 19; 2AVE, 2; 2AHZ, 1; 2AKK, 5; 2AFV, 17; 2CEP, 4; 2CIS, 1; 2CPG, 1; 2APJ, 9.

MIDWEST DIVISION

P. H. Quinby, Mgr.

IOWA—Dist. No. 1—ADM 9ARZ: The new DS will have a "fifty" on 40 and 20 meters shortly. 9BKV wants east and south schedules. 9BPF and 9DIP are the only active stations in Des Moines. 9BPF has a "fifty" on 79 meters. 9CZC rebuilt his transmitter and has schedules with Eastern Iowan stations. 9EAD works both coasts on 40 meters. 9BOS is at CMTC camp. 9EKK is a new ORS. 9EFS is rebuilding until Sept. 1. 9BEZ handled his share of traffic. 9CGY is the original hard luck station. His latest is a new "A" battery needed. 9DOA reports that traffic has picked up. 9BSX is back with a "fifty" on 40 and 75 meters. 9HK is going on a tour of northern Wisconsin stations in September. 9AXQ will be on September 1st, with two "fifties" on 40 and 80 meters. 9DAU will rebuild entirely. 9BCX reports traffic handled on 40 meters with a "fifty" working off "B" batteries. 9BCD reports traffic fair. 9AXD has his antenna up again and is using two "fivers." The present DS of Dist. No. 1 is G. A. Anderson, 24 Charles St., Council Bluffs. Swamp him with reports, men (DM)

Traffic: 9HK, 46; 9BCX, 35; 9DAU, 1; 9BSX, 2; 9DOA, 16; 9BZE, 16; 9BCD, 6; 9CS, 4; 9BKV, 4; 9DIP, 26; 9BPF, 38; 9CZC, 6; 9AED, 4; 9DEX, 24; 9DMS, 4; 9EFS, 16; 9EKK, 6.

KANSAS—ADM 9CCS: The Lawrence gang are still active and keeping up pep. 9DNG went to the Chicago Convention. 9AOD would have been there also but his Packard was stolen in Kansas City. 9DMX has moved. 9CVL hears WAP daily, even on fone. He has a "fiver" on 40. 9ACQ has been moving.

9CFL has been working but keeps his OBS schedules on 40. 9QW is back from his vacation. 9BRD did some DX and traffic when he was home. 9CYP has a fine new shack. 9CCS did some DX with Australia.

Traffic: 9CVL, 4; 9CFI, 2; 9AOD, 10; 9EHT, 10; 9DNG, 3; 9BXG, 7; 9BRD, 4; 9CCS, 3.

NEBRASKA—Dist. No. 1—ADM 9CJT: Traffic is picking up rapidly and DX is getting more consistent. 9CIM is on 40 and 20 meters. 9AWS, who was deploring the fact that there was no traffic to be had last month, turns in the largest total traffic total. The Citizen Radio Club had quite a representation at the Convention in 9DXY, 9DUH, 9DUP, 9EGA and 9AL.

Dist. No. 2: We are glad to have a report from 9EXT again. 9EAK leads in traffic this month. 9EHW reported in South America. FBI 9AKS is again working with a "fiver." 9OAC represented Lincoln at the Convention. 9DI is at last on 80 and 40.

Traffic: 9CIM, 3; 9AWS, 58; 9BYG, 1; 9EXT, 1; 9EAK, 23; 9PN, 6; 9BRQ, 2; 9BNU, 2.

MISSOURI—ADM 9RR: Reports this month are rather fragmentary due to most of the officers and many ORS being at the National Convention.

Dist. No. 1: The DS is still away on a trip to the west coast. 9ZK collected reports for him. 9DMJ, 9CHX, 9ELY, 9BHL, 9AOT, 9ZK, 9CJC and 9EKY made the convention trip: 9AOT, 9BMM, 9BHL and 9AOT did all the traffic work reported. The CM of K. C. visited in St. Louis on the way home from the convention and reports a good ham fest at 9ZK with 25 present also another at 9EKY a night previous. Better cooperation of the ORS in the matter of reports to the CM or DS is asked. The axe is due for some.

Dist. No. 2: 9DAE is back again with the old reliable. 9DVF is QRT on account of remodeling the house. 9ANG is a new station. 9CUA laid off to help ANG. 9DIX reports ND, too not. 9CYK, the old standby for reporting, is now on 40. 9DNJ is moving. 9CDF is on 40 with two "fivers." 9ARA and 9EBY are heard occasionally. 9ANO says his receiver is FB on 40 meters but the transmitter is not behaving. Another new ham is 9ANI. 9DRQ is at BSA camp where he is counselor. 9LJ and 9CHE hit the convention trail. 9AYF and 9BOC are on 80. 9BWX is heard on 40 meters. 9AQP is on regularly. 9RYN is using a "fiver" on 80 meters. 9ASM is moving. 9CHJ is again heard from after a long absence at school. 9CRM is holding up the publicity department. 9BUE reports some traffic in spite of QRN. 9AOB went to the convention. 9DJI and 9CUU are on consistently.

Dist. No. 3: All of the ORS in the district went to Chicago. 9AYK and 9DAE applied for OBS.

Dist. No. 4: 9ZD, 9ADR, 9BKK, 9ZB and some others we have been unable to remember went to the convention. 9ZB has gone to Philly to work. 9FF has applied for an OBS to replace 9ZB. 9TJ was "all set" to go to the convention and went to the hospital instead. 9NX visited the gang in KC. 9ADR and 9FF handled some traffic. The other ORS are QRW with rebuilding, YL's or business.

Traffic: 9BMM, 27; 9BHL, 7; 9ZK, 37; 9CYK, 12; 9AMB, 5; 9CDF, 5; 9DVF, 3; 9AYF, 11; 9AQP, 6; 9DLH, 20; 9BUE, 9; 9CRM, 2; 9TJ, 43; 9ADR, 5; FF, 6.

NEW ENGLAND DIVISION I. Vermilya, Mgr.

PRIZE TEST MESSAGES—Five "Prize Test Messages" were started by the ADM during the month, and to date, August 24th, only three tracers have been returned. Four messages have been delivered and one lost entirely. No. 51 was released by IKY to IRE, who mailed it to destination! No. 52 sent to IEF for release—mailed to destination! No. 53 sent to IZE, who released it to a Rhode Island Station. 1AAP mailed this one to its destination, but the tracer never got through. 1AAP wrote a letter in accordance with QST's circular ORS letter telling us how to write letters and IARE says he is going "To have it framed". No. 54 sent to IARE for release—evidently lost. No. 55 made some Real time and was good relaying. This message was released by IARE to IARH at 8.00 A.M. on August 9th. The message was addressed to Can. 1BO. IARH gave this message to Can. 1AC at 10.55 A.M. 1AC mailed this message to destination on August 10th and it was received at 1-BO on August 11th at 3.00 P.M. AST. The tracer was forwarded to Head-

quarters, and IARH is the winner. He has the chance of a "fiver" or something else of equal value.

Please remember, it is absolutely necessary to forward tracer. No prize will be given where a message is mailed practically the entire distance. Also that if you make and keep schedules it will be easy to move your traffic. We have several good prizes waiting for some real work.

MAINE—ADM IEF: A good many station owners in this state are beginning to realize that "Ham" radio is just as good in the summertime using the short waves as it formerly was in the winter.

There have been quite a few hams touring this state lately, among them being 1AWW, C2GE, CIAR, 1GA and 9BHT, and 9DXJ. 1ATV, who has applied for an ORS, is high traffic man this month. 1KL wants to know how to get a good note on forty meters. 1PD is expected back from Connecticut about the middle of September. 1AUR is so used to "fifties" that he is having a hard time making some "fivers" work! 1AAV is a member of the Radio Club de France and the R.C.C. now. 1SO has blown two "fivers", and has another one that is doing the work of four. 1AUC was heard in South Africa on a single "fiver". 1HB is heard occasionally. IEF has just built a chemical rectifier and has been appointed City Correspondent for Ellsworth.

Traffic: 1AAV, 3; 1ATV, 52; 1BDB, 1; IEF, 11.

VERMONT—ADM 1AJG: 1AJG is the only one turning in a message report. The Poulney gang had their annual convention at their home town. One or two more stations are getting lined up for ORS certificates. 1ARY will be on in a week or so.

Traffic: 1AJG, 21.

EASTERN MASSACHUSETTS—ADM 1KY—Dist. No. 1: 1AEO is rebuilding. 1CEA reports things dull. 1NV is having difficulty making the set work on 40 meters; he can hit 35 and lower but not on 40. 1APK received a card from Australian 7BP reporting his sister. 1LM is still on 150 meters. 1ZW finds traffic very scarce on 40 meters. 1BZQ is building a new receiver. 1CJR is the first one in this district to make the Brass Pounders League. 1B, OM.

Dist. No. 2: 1EW's "fifty" went west recently, but he is on the air now with two "fivers". 1GA is home again, having spent six weeks in Maine. 1BUO is using a "fiver" on 40 meters. 1BVL has been experimenting on five meters. 1BCN is putting up a new mast. 1NT has been at CMTC this summer. 1SE blew his 203A. 1ACJ is being heard all over the map, but his transmitter seems to be better than his receiver. 1UW has worked Z's and A's, Honolulu, Brazil, NRRL, WAP and WNP, British, French, Italy and Czechoslovakia. 1CTT has also been doing some good DX. 1AYX is QRW with his YL and flivver most of the time. 1AJR was on for six periods of the 40 meter tests. 1AXA is having a three weeks' vacation.

Traffic: 1LM, 1; 1AEO, 14; 1AKP, 4; 1AFC, 14; 1CEA, 2; 1AFS, 20; 1CJR, 108; 1BZQ, 32; 1AVY, 7; 1AVF, 10; 1AXA, 6; 1AJR, 8; 1AHL, 10; 1ACJ, 40; 1BEN, 26; 1BUO, 35; 1BVL, 6; 1CH, 10; 1GA, 26; 1BR, 22; 1UW, 20; 1RF, 8.

WESTERN MASSACHUSETTS—ADM 1AWW—Dist. No. 3: 1ALQ is away at school. 1BFE and 1AMZ just got back from camp, where they have been for the past four weeks.

IARH connected with British East Africa and New Zealand immediately after getting his pure D. C. note. Fine work! 1CLN is trying to get a QSB like 1ARE's. 1AAE operated by Daddy Campbell and Son, is a new ORS for this district. 1VC is experimenting with 20 meters. 1CKE has co-operated greatly by closing his phone station during the static season. 1ARE is one of the principal contacts between the Nat. Geo. Society and the MacMillan Expedition. Great work, OM! 1XU is the proud owner of a 0.75 meter transmitter and it WORKS! The following stations are now members of the D. C. gang: 1AAF, 1ARE, 1ARH, 1ADG, 1OM, 1CLN, 1AMS, 1XU, 1AZW, 1GT, 1AZD, 1CKE, 1ADG is using a combination receiver and transmitter which is a novelty.

Dist. No. 4: 1BSJ is in the Berkshires. 1AAC moved to Chicopee Falls. 1BLU is down near Lowell, Mass. 1BX, a new ORS, is spending his vacation in R. I. 1AWW visited Pittsfield stations and then went to New Brunswick, visiting Canadian 1BO.

Dist. No. 5: 1BIZ-1SZ has installed a M. G., but reports that it is not perking just right.

Dist. No. 6: 1BOM is on another trip aboard ship. 1AOF is installing "S" tubes to replace the motor-generator.

Dist. No. 7: IAAP is running a "five" on 40 meters. IAKZ carries off the honors in message handling for this month. IAQM expects to be on the air around October with a brand new set. IDB has been away on his vacation. IASU was completely wrecked by lightning. IAJK has gone to sea.

Traffic: 1AAL, 16; IAKZ, 46; IASU, 7; IBQK, 2; IAAC, 7; IARE, 51; IVC, 5; IAAE, 31; IAWW, 19.

CONNECTICUT—ADM IBM: Radio activity in the Nutmeg State shows an increase in totals both of reports and stations reporting.

IMY leads the procession in handling traffic. He took a large number of messages from WNP-WAP. Come on, fellows, let's wake up or our old ADM will leave us all behind. IANQ is Chief Engineer of WTIC. IZL is still working England with his famous "five". IAH and IAYT are doing good work even though it is vacation time IADW is coming along fine for a new operator, and we congratulate him on his report. IANE sends in his first report toward an ORS ticket. IAYR, IBHM, and ICTI were not particularly active but did their bit by reporting. IAOX is anxious for traffic. IAXV has a new operator in the family. Congratulations! IQV has gone down to 40 meters but complaints of being unable to raise stations. Try a little Fleischman's. OM1 IAOS operates on all waves from 20 upwards and wants traffic. IBGC, IIVM and IAXZ are keeping their hooks clear and delivering promptly.

Traffic: IANQ, 108; IMY, 170; IAYT, 2; IAH, 3; IANE, 31; IAOX, 17; IAOS, 18; IQV, 15; IAXV, 8; IZL, 2; IBGC, 18; IIV, 10; IADW, 33; IAXZ, 2; ICKP, 19.

RHODE ISLAND—ADM IBVB: IABP is on consistently on 40 meters. IAWV lost his 13th bottle. IBIE on 40 with a new "fifty". IBCC has QSY'd to tennis, saying that "A Racket in the Hand is Worth Two in the Air." IBHN is off till fall. IABC and IAKK are both back from sea voyages. IUC will become an ORS soon. IAWV is doing excellent low-power work. ILL-IZS went to the National Convention. IAD is perking out FB.

Westerly: IAAP finds that DX is great for this time of year. IBVB has at last got his set perking good on 40. Doc Helfrich will be opening up as soon as his ticket arrives.

Traffic: IUC, 25; IABP, 10; IAWV, 5; IAWV, 2; IBCC, 7; IAAP, 6; IBVB, 6.

NORTHWESTERN DIVISION Everett Kick, Mgr.

7 OY, Bob Gleason of Seattle went over the top to the tune of 150 REAL msks. He is the first in the NW Div. to be in the BPL since the new ruling came in effect. Come on gang, let's see more like him. Schedules do the trick. Your DM will be on the air by the time this is in print with the call 7EK instead of 7ABB.

WASHINGTON—ADM 7GE—Following are the new Districts with counties and DS's in charge: Dist. No. 1: No DS at present; ORS's report direct to ADM. Counties of Okanogan, Chelan, Douglas, Ferry, Stevens, Pend Oreille, Spokane and Lincoln Dist. No. 2: William Keay, 3401 Norton Ave., Everett, Washington. Counties of Whatcom, Snohomish, Skagit, Island and San Juan. Dist. No. 3: James Rutledge, 1035 Pacific Ave., Bremerton, Wash. Counties of Clallam, Jefferson, Grays Harbor, Mason and Kitsap. Dist. No. 4: James De Parlee, 710 East Rose St., Walla Walla, Wash. Counties of Adams, Whitman, Franklin, Walla Walla, Columbia, Garfield, and Asotin. Dist. No. 5: Trendall Rowe, 3323 South 9th St., Tacoma, Wash. Counties of King, Pierce, and Thurston. Dist. No. 6: Geo. Sturley, 206 East 17th St., Vancouver, Wash. Counties of Pacific, Wahkiakum, Lewis, Cowlitz, Clarke and Skamania. Dist. No. 7: Kenneth King, RFD No. 2, Grandview, Wash. Counties of Kittitas, Yakima, Klickitat, Benton, and Grant. City Manager Seattle: Otto Johnson, 2621 Commodore Way, Seattle, Wash. All ORS's and interested stations report to the DS or CM your District comes under.

7GB worked recently. 7UZ has handled a lot of WAP's traffic. 7NL, ex7TM is back from Minnesota and starting in right with a nice total. 7KU is off the air until he will be settled in Spokane. 7FD manages to be on occasionally. He has a new plate supply under construction. 7ADQ, 7HO, 7BU, 7AGI, 7AFO, 7OT and 7ABF will be going soon. 7RL, 7AO and 7GI are going to WSC this fall where they hope to have a College station on the air.

Traffic: 7OY, 150; 7RY, 45; 7AIM, 44; 7NI, 25; 7AO, 38; 7DM, 19; 7GI, 15; 7KU, 6; 7OT, 6; 7FD, 5;

7RL, 5; 7DC, 4; 7AIB, 13; 7ABF, 4; 7GB, 4; 7VB, 1.

OREGON—ADM 7IW—Conditions in the state are about the same, with quite a number of stations on the air handling traffic. All clubs closed down for the summer. 7TQ and 7ER are busy handling traffic. 7PP handled the most traffic for the state. 7AIX does well against bad power-line QRM. 7AJB is in San Francisco, but will be back this fall. 7SY, 7UN, and 7UJ are heard occasionally but report little traffic. 7EO is a new ORS and is on consistently. 7EC is heard week-ends only as he is QRW catching fish the rest of the week. 7AV is pounding out well but is burning out tubes and transformers.

Traffic: 7PP, 46; 7AJB, 1; 7AIX, 11; 7AV, 8; 7MF, 7; 7TQ, 2.

IDAHO—ADM 7OB—Activities look bright for fall in this state. 7OB is back again as promised last month. 7MU departed to sunny (?) California and will no doubt be signing a "six" soon. The YL station 7SI will also be signing a six, as she is going to college at Salt Lake. 7GW says he is on 39.5 meters with "nothing doing and no traffic." HW cum OM? 7YA on 40 meters is working all corners of the world. 7QC is now permanently located in Bonners Ferry, Idaho. Ex7LN has been home on a summer vacation. He is 9JK at College.

Traffic: 7SI, 19; 7IU, 13.

MONTANA: Everything looks favorable for Montana's largest fall. The ADM Prize is something to consider and is causing great interest among the gang. Next month we will announce the first lucky winner. 7MX, who has been helping a budding Ham-to-be, led the State for the largest traffic total.

7ACI paid the Butte gang a visit and bought a "Phord." He reports great improvement in his District thru the use of the "Montana CQ" scheme and plans a Hamilton-Butte and State-wide test for the near future. 7NT has duplicate transmitters and receivers with quick QSY arrangement for the 20, 40 or 80 meter bands. 7FL has ORS aspirations and has been on more regularly this month. 7DD blew his "fifty" so has to rely on a "five." 7GK wrote from Annapolis that he got by the physical exam OK but had to go without eating for 48 hours. 7GS will be on soon. 7EV is a new Hamilton station run by M & Lee Bolin. 7TD and 7KZ will be on when school starts. 7MB is still in Forsythe. Summer work prevents any radio work but he will be back when college opens up.

Traffic: 7MX, 41; 7ACL, 9; 7NT, 9; 7FL, 3; 7DD, 2.

ALASKA—FC discontinued as the owner is moving to the States. The following are stations in operation: 7KM and 7KK at Warren. NITF, U. S. C. G. C. Haida; NRA, U. S. S. Algonquin; NPA, U. S. S. Naval; 7KN and 7DE of Cordova. Two more stations will be in operation by this winter, one in Cordova and the other by WWDO, U.S.L.H.T. Cedar, operated by ex7MN. NFA, NITF, and NRA are using standard S. W. coast guard transmitters on 80 meter band for Ham work. 7KM and 7KK (portable) are the commercial operator at KDJU. 7KM is a "250" and 7KX uses two "fivers." 7KN is using a "five" on 80 meters. 7DE is using "fifties" and "fivers" on the 40 and 80 meter bands. All of the above stations are QSO the States. Any QTC for Alaska will be QSR'd with reliability through 7OY of Seattle, who has a nightly schedule on 80 meters. If not QSO 7OY, make message out according to last month's QST, Alaska.

PACIFIC DIVISION M. E. McCreery, Mgr. Southern Section

I WANT to urge all the fellows in districts 1, IA, 2 and 3, and also Arizona, to get together and see if we cannot make this the best year the southern half of the Pacific Division has ever had. We have an excellent start and it should be a wonderful year. I would like to see an increase of activity in Arizona. The Pacific Division Convention will occur October 2, 3 and 4 at St. Ann's Inn, Santa Ana, California. Those fellows who have not placed their entries for the Wouff-hong trophy should do so at once. This will be an ARRL convention with Fred Schnell and many other interesting speakers.

Southern California sent four delegates to the National Convention at Chicago, and everyone had a wonderful time. It is hoped we will be able to have the 1927 Convention in Southern California.

In the future ORS certificates are something that will be hard to get and worth while having in this territory. All those not reporting as they should or

not living up to ORS qualifications will have their certificates canceled.

Recent changes in the Pacific Division have been made with the idea of experimenting as to the best method of procuring close contact between the field and Headquarters. It is hoped that the boys will cooperate to the extent of giving the changes a fair trial and not condemn matters at first glance. Southern California as a whole believes that closer contact should be established for this territory insofar as directors are concerned, but we realize that League expenses may not justify too many directors. The solution may be an assistant director or a director's personal representative.

ARIZONA—ADM 6ZZ: No report this month from the ADM. However, he said we should not expect a report until October. Try and get started a month earlier this year, OM. We are expecting great news from Arizona this year.

SOUTHERN CALIFORNIA—ADM 6PL: Instructing delegates to the National Convention, deciding on ARRL problems, and having a general good time, about 70 hams, mostly from Southern California, participated in a banquet and hamfest, given August 12 at a downtown Los Angeles cafe, under the chairmanship of DM McCreery. Aussie 6AP gave a short talk on conditions in Australia and New Zealand, which was followed by sketches by former ADM Brockway and succeeding ADM Burgman. 6PL received the hearty thanks of all present for his productive efforts in ARRL work.

Five delegates were given plenty to do at Chicago and arguments on all questions flew thick and fast.

Message totals are low this month, due, no doubt, to summer weather, good swimming, and but few stations on the air consistently. Let's see some efforts toward those merit certificates, gang!

Don't forget the Pacific Div. Convention at Santa Ana, Oct. 8, 9 and 10.

Dist. No. 1: Things are picking up and will be going full blast in a short time. Most of the San Diego gang are either taking vacations or rebuilding. 6AHQ uses a lone "fiver" but manages to get in a little DX now and then. 6AJM is a new ORS, and does good work on low power. Another low power station is 6APP who is blowing "fivers" at the rate of 2 a week. 6CGC has been too busy with a job, and 6CGV will be off until school starts. 6ZH can't seem to get the set to percolate on 40 meters. 6HU handles traffic on 20 and 40 meters. 6CHS managed to QSO chIEG and arrange a traffic schedule. 6CGO worked chIEG and attended the Chicago Convention.

Dist. No. 2: 6APG's fist has not been heard for a moon. 6BBV says he works everything he hears—maybe he needs a good receiver. 6BGC got a commercial license. 6BJX may be heard on low power; he won a WD11 at a club raffle. 6HRQ changed his aerial. 6CSW was QSO chIEG. 6OF junked his "250." 6IH and 6CFE combined stations and are using a "fifty." 6RF is still on his vacation. 6CTO blew his "fifty." The net results are about 350 messages, 24 countries, and 1000 hours of lost sleep. 6CTN, a new ORS, uses a "fifty" and plans 3 ops for the winter. 6VC went on a vacation. 6CAH, another new ORS, operates 6COD at a radio store. 6BGV works 1s and 2s better than 6s with his "fiver." 6BJD is getting a "fifty." 6CHEZ is studying to enter CALTek. 6BUR worked J1AA daylight during the 20 meter tests. 6AHP handles traffic with WAP. 6CIX installed a sink which makes the Whittier bunch about 100% sink. 6CGW leads Long Beach in traffic. "WA" of 6CGW and 6CTO discovered that they were classmates in an eastern hick town grammar school years ago. 6AE handled some traffic.

6US is busy remodeling his house. 6BKX is installing a "250" for 40 meters. 6BNU sees more of the YLs than his set. 6AJI shot his "fifty" but gets out just as well on "fiver." 6TS is kept on the air by 6CNC. 6AGK wants to know why everybody quit 20 meters after the tests. (Same here—DS; Ditto—ADM). 6BBQ has sailed away his "fifty" for the winter, but he handles traffic with a "fiver." 6CMQ wants schedules for five meters. 6AKW is building a reflector for his 20 meter aerial. 6CDY is working 12 hours a day so is not on much. He plans a MG this winter.

Dist. No. 3: 6ASV is practically the only station sticking to it. He expects to have a "fifty" perking at the Tulare County Fair. 6JJ plans to QRT for another month. 6AKZ is heard spasmodically. 6CDG is on 40 and 20 meters. "DE" of 6CDG is coming on with his own set, call 6CWF.

Traffic: 6CHS, 103; 6APP, 19; 6HU, 15; 6AIB, 14; 6CGO, 7; 6CNC, 2; 6CDY, 10; 6BBQ, 48; 6BLS, 20; 6CMQ, 7; 6AGK, 17; 6TS, 2; 6AHP, 14; 6CHZ, 4; 6BUR, 33; 6BGC, 13; 6CSW, 39; 6BJX, 7; 6BQR, 2; 6VC, 20; 6AFB, 24; 6BBV, 32; 6BGV, 6; 6CTO, 72; 6KX, 3; 6AJI, 19; 6AKZ, 4.

P. W. Dann, Mgr. Northern Section

Due to the recent organization of the Pacific Division, the report for the month of July will probably not appear as large as in the past, but the Manager wants to personally express his appreciation to those of his Section who endeavored to furnish him with some kind of news, and who are assisting him in re-organizing under the new plan, and remember, fellows, we are still ONE Division and one League, and we can never be anything else and advance. It is up to us to all pull together inter-sectionally, and we will make the Pacific Division one that will be the talk of the League.

Section 4: 6AMM hooked up with WAP and thereby established the furthest worked to date. 6NX installed a new Chemical Rectifier. The last one ran two years without a change. 6CJD has had all kinds of bad luck with his antenna's coming down, due to ropes breaking. 6AME is remodeling. 6CLP is also rebuilding. 6AOI handles traffic with KFUV-NVE and worked KFVM. 6ADB is on with a new W. E. "fifty." 6MP visited a number of the gang during the month—a thing which all of us should do. 6AJZ is still having trouble with the set. 6CKV had a portable set going at Capitola and worked Australia. 6CAI is a new ORS using a "fifty." 6CTV visited 6ZH while on vacation. 6RCL heard WNP's Phone on June 26th working 1CKP. 6BMW enjoyed the best DX this month, clearing Australia, Samoa and NRRL with some real messages. 6BON is QRW with work now.

Section 5: 6RIP, the DS, has returned from his vacation in Nevada, and since returning has worked both N. Z. and Aussies. 6WP, we hear, is soon to join the ranks of the Benedicts. Congrats from the gang, OM. He built the 50-watt transmitter for the ARRL booth at the Radio Show. 6IP will be on the air with a "fifty." 6BAB is working Pone on 180. 6BEZ is still on the rolling deep. 6KR, 6RIP, 6WP, 6IP and several of the gang in Oakland, Berkeley, Alameda, Richmond and San Francisco had their hands full getting the ARRL Booth lined up for the Radio Exposition, held in the Civic Auditorium, August 22-23rd. San Francisco, ORS stations in all localities helped the gang out at the show by QRX'ing for traffic. (Thanks for the co-operation, fellows—Section Manager). 6UR is doing such fine work with a "fifty" that he refuses to install a "250." 6AVH installed "S" tubes and worked Alaska, Canada and other good DX. 6BNU is moving to Berkeley. 6AJF requests his ORS canceled on account of too much work with the telephone company. Sorry to lose you as an ORS, OM. 6CCT reports traffic FB. 6ALX just returned from his vacation. 6CWN is working with Ashe but expects to be on soon. The Manager and Director Babcock spent a very enjoyable evening with 8NB. NRRL was worked and we gave Schnell the gang's 73's.

Dist. No. 5: 6CDP came on during September. 6BFU is still rebuilding. 6CEG can't get his set working. 6GU is coming on with a "fiver" in about two weeks. 6CKC sold out to 6WP. Casey's going East; YL OM? 6AQ and 6IM put in applications for ORS's. Old 9AHU is putting up a station in Berkeley but has no "Six" call yet. 6AQ will be Publicity Manager for Berkeley. 6BFU has charge of the Vigilance Committee.

Section 5: 6ANW, 6AOA, 6EW were away on their vacations so the traffic report for this month is small. 6HP is on occasionally. 6EW has been doing splendid work on 40 meters. 6ANW broke his arm trying to show his dad how to crank the flyver. 6CTX, 6BAB and 6BNU have just returned from a fifteen-day cruise aboard the U.S.S. Hazelwood NRP. We understand that 6BAB got the bath of his life.

Following are the stations that will handle Signal Corps traffic: 6ANW, 6EW, 6AOA and 6CTX.

Section 6: Activities in this section have not as yet shown much signs of life, but several fine prospects have been located, and are promising ORS stations.

Traffic: 6CLP, 15; 6AOI, 8; 6ADB, 31; 6MP, 8; 6AJZ, 1; 6BCL, 5; 6BMW, 36; 6AMM, 12; 6CJD, 3; 6CCT, 8; 6CTX, 26; 6UR, 26; 6AVH, 36.

NEVADA—6ATN: The old ADM of Nevada has re-

signed, due to the fact that he is coming to California to go to school, and the Manager is pleased to announce the appointment of Mr. C. B. Newcomb as Assistant Section Manager for Nevada. He has had 18 years' experience as Railway and W. U. operator and should know Traffic Handling. T. J. Boland, 721 Lander St., is the new DS of Reno.

K. A. Cantin, Mgr. Hawaiian Section

"Old Man QRN" failed this year to check summer DX work.

6CST with his "fivever" worked Ch-1EG and also had his signals reported QSA in South Africa by A-4M.

6ASR is easily QSO with the mainland, but business does not give him much time to pound the key.

6AFF with his "fifty" is reaching out in great shape. He was QSO WWDO, Tahiti-KFVM S. S. Idalia, 6ZAG, A-2YI and J-1AA. He copied a 300 word msg from J-1AA for Hartford, giving data on the Mid-Summer Short Wave Tests.

The 500-watt station of the Radio Club of Hawaii (6BUC) has been moved to a new location—the Territorial Fair Grounds—and will be exhibited and in operation during the Fair. A staff of operators will be on the job and msgs will be accepted and sent to points designated, so as to show the operating of an Amateur Station.

6TQ is on the air again, using 2MU transmitting circuit. He would like to arrange schedules on 40 meters with 6th District Stations.

Traffic: 6CST, 6; 6BUC, 7; 6AFF, 3; 6TQ, 3.

ROANOKE DIVISION W. T. Gravely, Mgr.

NORTH CAROLINA—ADM 4JR: Who leads the fourth district? Florida. Why? Because N. C. hasn't been on the job! We will show them fellows. The Florida good operating campaign seems to be catching as the rules are now in effect in N. C. Give your support to the nationwide good operating campaign that is now on. Quite a few fellows should study up on the proper method of counting messages relayed. A message relayed counts two so how do you get 19 in the relayed column when it must be an even number?

Dist. No. 1: 4LO is on with a "fifty." 4AF is doing great DX with his two "fivevers" on 40 meters. 4OG is sticking to 80 meters. 4RF is raising plenty of racket locally on 40 meters. 4AA has two sets on, one a "B" battery plate supply on 80 meters.

Dist. No. 2: 4RY on 40 meters has been QSO Mexico and reported in Brazil. 4TS has just returned from camp. 4NJ has his new MG now. 4GW is QRW with work at present. So many different antenna systems have been tried at 4MI that he doesn't know which he hasn't tried. Hi!

Dist. No. 3: A daily schedule is maintained by 4BK on 80 with 4RZ in Wilmington. 4JS has worked WAP and M-1AA with 70 watts into his lone "fivever." 4JR handled 15 Red Cross messages.

Dist. No. 4: There are a number of stations on the air who are not ORS and who do not report. Let us have some news fellows. The hot weather is bothering 4MA but he manages to keep both his sets going on 80 meters. A new antenna, poles and counterpoise, were erected at 4UN and had only been completed two days when a young cyclone put the whole works on the ground. (Hard luck, OM, ADM). 4RW moved his station, will be back on the air soon.

Traffic: 4RF, 3; 4OG, 16; 4RY, 36; 4TS, 6; 4NJ, 4; 4MI, 16; 4JS, 10; 4BX, 22; 4JR, 53; 4UN, 3; 4MA-4NT, 13.

WEST VIRGINIA—ADM 8AUE: 8BLI is rebuilding. 8BBM reports nil on 40 meters, but Schnell receiver FE.

Jones, Kisner, and a few other prominent hams of Fairmont have incorporated station "8SP" and are preparing to make it the finest ham station in the country. The station will be situated on the Masonic Temple. 8ASE-AXG is probably going on low waves. 8AUL had a fire and lost most of his equipment. However, he is on again and is getting wonderful DX. 8CDV says he is holding his own. 8BSK is not much interested in relaying experimenting. Oh Boy! 8BSU-8AKZ is experimenting with 8BSK. 8AKZ is a portable operating with a loop antenna mounted on Ford roadster. It gets all over Wheeling FE. 8BSU and 8BSK are probably the first in the State to experiment with 5 meters. 8ZW-8BSY is spending the summer at Omaha.

Traffic: 8BBM-1; 8WZ, 7; 8BJG, 3; 8AUL, 18; 8CDV, 25; 8BSU-8AKZ, 9.

VIRGINIA—Dist. No. 1.—ADM 3CA: 3CEL on 40

meters, worked two sizes the first night. 3SB is away on a trip. 3TI put in glass insulation, and new inducances. 3BS has forgotten all about radio; his middle name is "Tennis." 3AHL is away at Boy Scout Camp. 3CKA has returned from a trip to Florida on one of the Wood Towboats Co's tugs. Says the set is one of those uster-was'1 3CKK is busy with his new business. All hands wish him luck.

Dist. No. 2: 3ATB is away with an orchestra. His ORS is cancelled. 3AUU is temporarily dismantled due to static. 3SG is in Florida for the summer. 3BMN is rebuilding—the first month of inactivity in years.

Dist. No. 3: 3AAL is out for DX with his three "fivevers." 3BFE and 3BGS are opening in September.

Dist. No. 4: 3CKL was at an army camp and visited WUF, NAM, 3CKK, 3MK, 3TI and 3BBT. 3BZ is handling traffic, and has worked F-8YOR and G2KF recently.

The ADM would be very glad to hear from all active stations in the state. A check-up shows that about twenty-five per cent of the stations do not report, and we want to call your attention to the obligation on your ORS.

Traffic: 3CEL, 1; 3SB, 4; 3TI, 6; 3CKA, 1; 3AAL, 7; 3BZ, 10.

ROCKY MOUNTAIN DIVISION N. R. Hood, Mgr.

COLORADO—ADM 9CAA: Several of the Denver gang took in the National Convention at Chicago. 9EAM has been consistent as usual. 9AMB and 9RED spent several weeks in the mountains. 9CDW is working nights, but is on when he can be. 9CJY had to go to Chicago on account of the death of his Uncle, but was unable to stick for the convention. 9WO has DC on 40. 9BXG, 9CAA and 9EEA went to the convention. 9CAW is a new ORS. 9OO has been very consistent.

Dist. No. 1: 9DVL has been on regularly. 9AOI took a fishing trip.

Dist. No. 2: 9PH packs one of the best punches in Colorado. 9EAE does most of his work in the daytime on 40. Judging by clipping that have been coming in to the ADM's office, 9CDE should be the main cheese in the publicity dept. Hi!

Traffic: 9CDE, 6; 9EAE, 19; 9DPH, 21; 9CAA, 58; 9CDW, 3; 9EAM, 15; 9OO, 9; 9WO, 70; 9DVL, 22; 9AOI, 5.

UTAH—ADM 6ZT: Things look brighter in Ogden than they have for some time and will probably continue. 6FM has just returned from the coast. Three stations reported, 6FM, 6SI and 6BUV.

Things in Salt Lake are moving along smoothly and an increase in activity is noticed. Most of the stations are operating on 40 meters. 6ZT has gone to the coast and expects to visit some of the hams. 6BUH is overhauling. 6RM hooked up with WAP. 6RV is not getting much success on 40. 6BTX, who has just applied for ORS, sends in a good traffic total. 6CRR and 6CRS will be on next month.

Dist. No. 1: 6CJB, the one station in this district, is still going, and has been installing some new equipment.

Traffic: 6RM, 31; 6BUH, 4; 6RV, 5; 6BTX, 29; 6CJB, 1.

WYOMING—Cassell, ex 9XQA, worked WNP daylight from 7LU on 20 meters. 7HX is on 20 and 40 meters and works the Twin Cities and Chicago at high noon. 7LU will build a new set at Casper. 7ZO will be back on the air with 20 and 40 meters in a few weeks.

Traffic: 7HX, 6; 7LU, 80.

SOUTHEASTERN DIVISION H. L. Reid, Mgr.

GEOORGIA—ADM 4RH: Activities are on the increase over the entire state. The regular ADM pulls in from Europe this month. The Macon gang are on and blasting their way through all opposition. 4XX and 4BY are doing the most work in Savannah. Atlanta has shown new signs of life; new stations on the air, a nice sized delegation at the National Convention and increased attendance at the club. 4SI on a lone "fivever" is battin' 'em out. 4AAD clicked with his first Aussie. 4OA connected with WAP. 4AU raised WAP. Chile and Australia. 4RM has worked over a dozen Australians, all the New Zealanders he can hear, Chile, France, and several Britishers. Stations like this add to the glory of the state.

ALABAMA—ADM 5AJP—Dist. No. 1: Birmingham stations are the only ones that seem to be active. 5MI has been working Brazil, N. Z., Chile, Argentine, India and NRRL. 5AMH is on most every

night and doing splendid work. 5VV went to summer camp. 5ZAS is still thundering the air with mighty sigs. 5ACM helped swell the message total.

Dist. No. 2. The hams in this district are a mighty fine lot. Supt. Rush leaves us this month to go to college, and it is with sincere regret that we have to lose him. Hope you make a grand success at the Ala. Pol. OM. Newman of 5AOM will succeed Rush as Dist. Supt. 5AOM blew his glorious fifty and has been off the air until his financial condition becomes better. 5QK has been in Louisiana working for the summer. 5AC has been working English and the Philippines. Australia, N. Z., NRRL and WAP. 5LC is a new station on 80 meters.

Dist. No. 3: Most of the hams in this district are back from vacation now. 5ADA, the old reliable, is on 40 and 80 meters, has placed a big placard in front of his house begging for messages, and it seems to bring in results. 5ATP has installed a "fifty" and says that they all come back at him with R12. Hi! 5AJP has been doing consistent work on 40 and 80 meters. 5ASU has his station in good order and is going after traffic soon. 5DI and 5WI have been on the air steadily, but expect to enter Auburn this fall.

Dist. No. 4: Although nothing officially has been done at Auburn, the beginning of the school term is expected to bring results from 5XA.

Traffic: 5AC, 5; 5ACM, 12; 5ADA, 32; 5AMH, 18; 5AJP, 10; 5ATP, 9; 5ASU, 5; 5DI, 87; 5WI, 14; 5VV, 10.

PORTO RICO—ADM 4OI: The gang is practically all on the air at present, with the best DX being done during the summer months. 4SA is in communication with WNP and WAP on schedules. 4KT is working Australia and New Zealand and 4RL is doing very good work handling traffic with Europe. Congrats to you all. 4JE is visiting the United States and 4KT is taking care of the Carolina traffic. 4OI is doing his share on 40 meters and handles traffic with the North. 4JA is back again with us with a "fiver" and has worked all districts. Fine work, OM!

Traffic: 4SA, 27; 4KT, 13; 4RL, 52; 4OI, 22; 4JA, 12.

FLORIDA—ADM 4EZ: The National Guard and Citizen's Military Training Camps have played havoc with Florida activities this month. This is not a "Summer Slump" by any means, however.

The general trend is toward higher power and more dependable communication with single sending. 4FM has a 1KW tube, and 4IZ has just returned from New York with a "250". We are glad to see these big tubes in the hands of those who are so well fitted to use them.

Lightning entered 4TR's shack and did big damage, but he has more pluck than luck, and is going again. 4XE is in Maine for several weeks. 4ASK is doing splendid 40 meter work, and the St. Petersburg papers are full of his accomplishments. 4TV is in Cuba for a "spell".

Florida stations are getting splendid results from the Hertzian Oscillator antennas described in *QST*; try them, fellows.

St. Augustine has come to life again with 4SB on 40 meters. 4SB, 4DU and 4KK are the most active north Florida stations at present.

Traffic: 4IU, 57; 4TR, 19; 4ASK, 68; 4TV, 26; 4EZ, 5; 4UK, 5; 4SB, 8.

SOUTH CAROLINA—ADM 4RR: LOST—QRN, somewhere between 19 and 42 meters. Finder will receive thirteen step audio amplifier to verify reception. Yessir! OM, QRN is having a hard time of it with Mr. IM ONNA SHORT WAVE cutting him full of holes with 20 and 40 meter sigs.

Nothing of special interest happened in the old Palmetto state this month except that several new stations and some of the "ole timers" are getting on the air, a sure promise of increased activity. Active stations are at present on 20 and 40 meters except 4HW and 4SL who are using the 80 meter band.

Traffic: 4HW, 56; 4SH, 9; 4SL, 7; 4RR, 4VL, 38.

WEST GULF DIVISION Frank M. Corlett, Mgr.

WHILE it has been mentioned many times before, it seems necessary to again state that each individual station report goes direct to the ADM in charge of your section. On page 3 of each issue of *QST* will be found a list of the various traffic officers together with their addresses. Reports sent direct to Division Headquarters will not be included in the report that appears in *QST*, unless it gets here in time to be sent back to your ADM before he makes

up the report for his section. The traffic month for this division closes on the 20th; get your station reports in the mail immediately thereafter. A number of applications for ORS appointments are on file. Most of them will be issued, but some of them will NOT. In due time be advised, so be patient and operate your station in such manner that you will not have to be in doubt which class you fall in.

NORTHERN TEXAS: ADM 5AJT: Northern Texas was well represented at the National Convention by 5AKN, 5CV, and 5SD. Some of the rest of the gang perhaps went up also, but, if so, failed to report it.

5AFU is moving to Houston, and will have a station in about a month. 5AKZ worked Australia twice, Chile three times; and one NZ station. 5ACL and 5SD have also been doing some nice DX work. 5ATH, is temporarily located at Fort Sam Houston, as operator of Army DR4.

Traffic: 5AD, 3; 5RG, 20; 5AKZ, 10; 5SD, 2; 5ACL, 5; 5HY, 14.

SOUTHERN TEXAS—ADM 5YK: We are very sorry to report the death of Mrs. Wall, the mother of the District Supt. of West Texas. Every South Texas amateur knew Mrs. Wall and will long remember the hospitality she extended to visiting amateurs. They were always welcome to her table in spite of her failing health. We regarded her as a mother to the "gang" and take this opportunity to express the sympathy of South Texas amateurs to her family in their, and our, loss.

QRN is letting up and everybody is ready for the fall season. Several stations are QSO with practically all quarters of the globe.

5ZU has a beautiful new 100-watt set radiating 2 amperes on 80 meters. 5ALR has been reported from South Africa. Brooks, of Austin, also has a fine set now and will use it presently. The ADM was in Austin during the summer and is very enthusiastic over the spirit of hams there. 5ALR took the ADM to the various Austin stations. A miniature ham convention was held at the home of 5ZU. 5ZAI, the Hall Brothers, have a big message total and a big list of DX. The work of this station should be an inspiration to all of us. 5OX sends in a big DX list and went to the Chicago Convention. 5HS is going with a "fifty." 5UX has his new transmitter almost finished. 5HC is getting out well and has handled some traffic. Ed Conroy will be back from the sea by September.

Serur, of San Marcos, went back to 80 meters as he had trouble on 40. The Wilsons, of Brownsville, are on all night and each night with three good ops. This station is to be congratulated on the fact that they never fail to report.

Traffic: 5ZAI, 35; 5HC, 4; 5EW, 27.

OKLAHOMA—ADM 5APG—This section has been crippled by the number of fellows who have gone on vacations or to the National Guard Camp. In spite of this fact the future holds out rosy promises. New comers are lining up faster than the number of deflections pile up. Those who have perjured themselves to obtain an ORS certificate to adorn their wall had better prepare for the slaughter that will soon start. Boy! The Wouff-Hong QUICK!

The Perry Gang: with 5UJ, have been holding a Fish Camp with disastrous effects on traffic. Cushing is covering the whole gamut of Ham waves. 5ADO worked A-1XA. 5ANL believes in staying on 200 meters. 5APQ decided that it was about time to line up. 5ACD, 5ALU, 5AAI and 5AUD have combined and have sets working on 20, 40, 80 and 200 meters. 5AGN was the first in Oklahoma, to our knowledge, to work WAP. 5ATK was getting out well with a "fiver" until he dropped it on the floor. Hi! In helping 5ATK put up new antenna 5AGN tried a "Steve Brody" off the roof. 5ATV has been QSO N. Z. Australia and the P. I. with his "fifty." 5AAV is having a keen time on a vacation in Wyoming and Montana. 5AHR reports DX very fine business. 5ED worked NVE, Mexico, Canada and N. Z. on his "fiver." Congrats. OM.

5TW is ahead with traffic as usual, but lost four 5-watt bottles trying to get a set to perk on 10 meters. (How cum 10 meters?) 5JU has been sweating with the National Guard. 5VM has a huge idea that will be sprung on the 5th District and particularly on the West Gulf Division. Get set for a REAL WALLOP and have the armonia bottle handy.

Traffic: 5APG, 10; 5ANL, 1; 5ADO, 1; 5AGN, 47; 5ASK, 2; 5ATV, 31; 5ED, 1; 5TW, 67; 5APQ, 5; 5ALU, 6; 5ACD, 5I; 5AUD, 9; 5ATK, 12; 5PU, 13; 5PI, 2.

CANADA

MARITIME DIVISION

W. C. Borrett, Mgr.

A GENERAL clean-up of the deadwood has been made this month and the following are the ORS that are on the job and who have sent in their questionnaires: 1AF, 1AL, 1AK, 1AM, 1AR, 1AW, 1BZ, 1DD, 1DJ, 1EB and 1EL. All other ORS that have failed to answer the questionnaires will please consider their ORS cancelled from this date. If any of the gang are desirous of a new ORS, please get in touch at once with your ADM, DS or DM. We need many more active stations and all are asked to make a special effort to get on 120 meters on Wednesday nights. For the information of all, most of the boys are using the 40 meter band, except for Wednesday nights.

New Brunswick, 1BQ, has come to life and is arranging a schedule with UAWW. 1AF is making schedules with Montreal stations. The following NB stations have been heard on 40: 1AN, 1AM, 1AL, 1AB, 1AK and 1EL. 1EI has worked all districts of the U. S. A. except 6 and 7 on 40 and thinks it is FB. All NB stations please remember that Tom Lucey of St. John must have your monthly report to give your Province credit in QST. The DM would like an application from a New Brunswick station that would send out the official broadcast every week.

Nova Scotia: The boys are still leaving for other parts and Halifax has lost two stations. Young, of 1AO, has gone to Montreal and Binns, of 1EB, is leaving for Toronto to live. It is with pleasure, however, that the DM can report the return to the air of Gordon Wells of 1BV. Gordon is now in business for himself and was heard on 20 and 40 meters. 1AR reports having worked WAP and WNP and has also worked 9CXX on 20 meters at noon. 1DJ has been on engineering road work most of the summer, but expects to get back to the game soon. 1DD is now a Radio Inspector. He can't cause any QRM to BCLs now. Hi! 1AW is getting a new tube and is rebuilding. 1ED is on a pleasure trip to the Canadian west. 1BZ reports that he is now back and ready to work. There are several stations which are heard often on the air which are doing good work and the DM would like a report from them. Come across with the dope, gang, whether you are ORS or not. The DM wants reports of messages originated, messages relayed and messages delivered from every station, every month. Please read the report that appeared in September issue of QST and act accordingly.

Another matter that all members of the Maritime gang must consider in the near future is who you want to have for Division Manager for 1926-1927. The present DM's term will be up in December and now is the time to think about it and to place a man of your choice in that office for the coming term.

Traffic: 1DD, 11; 1AR, 13; 1AF, 2.

ONTARIO DIVISION

W. M. Sutton, Mgr.

EASTERN ONTARIO—ADM 8AFP: 3AEL is the star traffic station this month. (FB OM keep it up, ADM.) u8CWX and c8BR were visitors at some of the Ottawa stations. 8CWX was much impressed with the work of 3EN, our blind op. 3NF is still operating from stations in St. Catherine. 3AFP has redesigned his aerial. 3XM changed his "river" for a "fifty" with dynamotor plate supply.

Traffic: 3AEL, 83; 3EN, 10; 3AFP, 8; 3AF, 1.

CENTRAL ONTARIO—ADM 9BJ: 3GL is experimenting with tube rectifiers. 3FC is on 40 meters. 3AZ is a member of the RCC. 9AL has three reports from N. Z. 3BR is on a motor trip with a portable transmitter. 30H is heard handling traffic in his old-time form. 9BJ has a "250."

Traffic: 9AL, 39; 3AZ, 26; 3FC, 5; 3GL, 3; 3CK, 1; 3KQ, 1.

WESTERN ONTARIO—ADM 3XI: 3NF moved from Kingston and is now running a motorcycle in St. Catherine. 3ZD is enjoying the sea breezes and a BCL receiver. (Also YLs) 3DH will rebuild. 3KA is pounding brass at VGFC. 3AQ has been to the seashore. 3KP has his new set going with two "fifties" and all-glass insulation. 3NF and 3TN have motorcycles and are trying to break their necks on them. 3ZB is rebuilding. 3AA is sporting a new "fifty" and getting out FB, being QSO 3AEF and 4AK on 40 meters. We take our hats off to him.

3AEC is his second op when not running his own "river" on forty meters. 3MS lost his "river." There are three new comers in Galt and 3AEC is teaching them the code (FB). The Fellows in the district are planning a big hamfest in Toronto in the near future. 3AD is bemoaning his "fifty." 3XI is moving his station.

NORTHERN ONTARIO—3HP is rebuilding and planning on a "fifty." 3NI and 3WS are off the air for a while, owing to the Radio Shack being converted into a garage. 3AT is up in Touchwood, Sask. and making inquiries about obtaining apparatus.

Traffic: 3HP, 9.

QUEBEC DIVISION

J. V. Argyle, Mgr.

THINGS in this division are improving generally. Circulars were sent to all ORS stations last month stating that if no report was received at the proper time in August the certificates would be canceled. The following certificates have, therefore, been canceled: 2AM, 2BN and 2AX.

2BE and 2CG are hearing WAP and WNP every night and 2BE has again worked WNP. (Good for you, Alec.—DM). 2BV now has a station on the air steadily on 75 meters and since he is handling traffic honestly and consistently is made an ORS. Two others will be made immediately to fill the places of the non-reporting stations. 2AB is appointed City Manager of Quebec City and his station will be on the air within a few weeks. 2BE is now an OBS. 2BG operates on 40 meters late at night. 2AU has been visiting the States and on return did excellent DX work. He says his fire bottles were as well fixed up by the rest as he was. 2FO was recovered from the shock and is preparing his wire burning MT tube for Anzac hunting this fall. VDM has not been heard by anyone. 2AZ "reste encore comme 2BN, 2AV, 2AL, 2AI, 2AK" but there are signs of awakening with the brothers. 2BS reports that everything is normal and QLC. 2BT and 2CI are rebuilding. The Wednesday night group especially miss 2CI. 2DO continues good work on the higher waves and is noted for pure CW. With the coming of fall the boys are improving sets all around; DX, however, has been equally good this summer as it was last winter. To illustrate the point: in one night the DM heard z2XA, g51f, g2KF, g2NM, m1AA, m9a, mlb, WAP, mXDA, dPOF and dPOY. and this is being duplicated by anyone listening between midnite and 2 o'clock on 40 meters. Get on the air again. 2AX, 2BN, 2IC, 2HG, 2AK, 2AN, 2AZ, 2BT, 2CKI, 2CN, 2CT, 2EK, 2FB, 2FL, 2FT; do your stuff and make this Division look as though it had three provinces instead of but one. Phone your DM if in Montreal and keep in touch personally.

Traffic: 2BG, 6; 2BE, 5; 2CG, 4; 2AU, 9.

VANCOUVER DIVISION

Wm. J. Rowan, Mgr.

GREATER VANCOUVER—It would seem from the reports that everybody is laying off for a rest. That is FB, fellows, but come back to the game with a firm resolve to follow out the ARRL traffic regulations. If a census of all the hams were taken there would be an appalling number who could not write out a correct preamble. (This is true of nearly all Divisions, worse luck.) There will also have to be some improvement shown in the system of calling and CQing.

5AF and 5HP both have "fifties" now and are doing fine traffic handling. 5AH has his set on 40 meters but reports no success so far. 5GF was on a vacation but is designing a 40-meter transmitter motor boat. 5AS reports good traffic but no DX on 40 meters. 5BA is still sending dope to 5AN, who is in the hospital. 5BM says it is harder than the very blazes to keep his five watties in the socket. 5BJ is moving again. 5GO is going to stage a great come back after his holidays. 5HB is a motor mechanic. 5HS has a longer mast up. The DS requests that report cards be in before the 8th of the month. They should show msgs originated, relayed and delivered (look up QST for details).

Traffic: 5AF, 11; 5AS, 17; 5BA, 2; 5BM, 1; 5HS, 4; 5GF, 3.

CALGARY—4AL is a new ORS, and is going strong and will soon be on with more power. 4IC has moved. 4AX has a new receiver. 4GT worked South America, but one of his S tubes wouldn't stand the gaff and went west, so he is back to the sink again. Hi! 4BH has moved to Calgary.

Traffic: 4AL, 14; 4AX, 8; 4GT, 19; 4LO, 2.
VANCOUVER ISLAND-6CT has been having trouble on 40 meters. 6HK has been on a holiday. 90K made a record for himself on August 12th by working a-8YX on 40 meters with an input of 10.1 watts on a UV201a. (Hot Dog, OM; try a 199 next time:DM).

Traffic: 5CT, 1.
 There has been absolutely no word from Edmonton for three months. What is wrong, gang? Someone please drop me a line: DM.

WINNIPEG DIVISION
 W. R. Pottle, Mgr.

A GOOD number of stations are perking away merrily and the reports are coming in FB. Quite a few new stations have sprouted up, but traffic is very low. What's the matter, Gang? Can't we push a bit more traffic through this Dist.? Activity at Winnipeg has been brisk, with preparations being made for the coming Radio Show in September 14-19. The Manitoba gang heartily thank those responsible for their kindness in placing a booth at our disposal, free of cost.

4EA and 4FZ are combining and will use a "fifty" on short waves. 4DW has a "fiver." 4CR worked Australia on 20 meters. 4CO is on the air again now. 4CN and 4AW are rebuilding. 4DY is busy fitting in a "fifty." 4DY reports difficulty in moving traffic West. (The Western gang are on OK. How about some schedules, fellows?—D.M.)

4DY is the new D. S. and 4EA is C. M. 4DE has a "250" and is busy taming her down. 4AV and 4FH are both out of town. 4BO, a new station, will be perking soon. 4BV is home for a few weeks, but will return to the U. S. A. shortly. J. A. Bettin has a new station just about ready to bust in on C. W. (Good stuff, O. M.—DM.) 4GH has a dandy new mast and aerial, and everything rebuilt. 4AA has poked sigs into Australia. 4EG has moved to Kipling. 4CB has nearly completed moving his set into the house and has a new mast and aerial up. 4IX is manufacturing "fifties." His first attempt was on show at the Chicago Convention. 4ER has moved to Regina. He will double up with one of the Gang there or transfer his own set. 4BF is QSO all districts on 40 meters. 4HH and 4AO are rebuilding.

Traffic: 4AW, 11; 4DY, 6; 4EA, 3; 4AO, 6.

TRAFFIC SUMMARY BY STATES

AN increase of nearly 100% in the number of messages originated, and of a little over 3% in the total number of messages is shown in the traffic reports this month. Unfortunately, however, both the "delivered" and "relayed" columns show decreases.

The number of reports that came in on the new Form 1 cards was about the same as last month, but it is hoped that in the next report the system will have become more familiar and that a larger percentage of reporting stations will fill in the columns properly. At this point it is well to remind all D. S., A. D. M.'s and D. M.'s that they must also turn in their reports in the same way as far as possible. What we are aiming for is a report in which the number of messages originated checks fairly well with the number delivered. The comparison of traffic reports by States follows:

ATLANTIC DIVISION

| State or Division | A. D. M. | Originated | Delivered | Relayed | Total |
|-------------------|----------------------|------------|-----------|---------|-------|
| Me. | G. E. Detchmann, Jr. | 224 | 11 | 31 | 306 |
| Del. | H. H. Layton | — | — | — | 13 |
| D. of C. | A. B. Goodall | 30 | 4 | 9 | 43 |
| So. N. J. | H. W. Denham | 21 | 13 | 65 | 104 |
| W. N. Y. | C. S. Taylor | 2 | 3 | — | 897 |
| P. Pa. | J. F. Rau | 65 | 19 | 271 | 375 |
| W. Pa. | P. E. Wiggin | 74 | 27 | 226 | 327 |
| | | 416 | 81 | 602 | 1865 |

CENTRAL DIVISION

| | | | | | |
|-------|----------------|---|---|---|------|
| Ohio | C. E. Nichols | — | — | — | 279 |
| Ind. | D. J. Angus | — | — | — | 202 |
| Mich. | C. E. Darr | 2 | 1 | — | 40 |
| Ill. | G. W. Bergman | — | — | — | 254 |
| Ky. | I. C. Anderson | — | — | — | — |
| Wis. | C. N. Crapo | — | — | — | 406 |
| | | 2 | 1 | — | 1181 |

DELTA DIVISION

| | | | | | |
|-------|---------------------|---|---|---|-----|
| Delta | B. F. Painter, Mgr. | — | — | — | 142 |
|-------|---------------------|---|---|---|-----|

HUDSON DIVISION

| | | | | | |
|------------|--------------|---|----|---|-----|
| N. Y. City | F. H. Marden | — | 49 | — | 240 |
| N. N. Y. | No report | — | — | — | — |
| N. N. J. | No report | — | — | — | — |
| | | — | 49 | — | 240 |

DAKOTA DIVISION

| | | | | | |
|----------|---------------|-----|----|-----|-----|
| So. Dak. | M. J. Jenkins | 2 | 1 | 3 | 6 |
| No. Dak. | M. Atkinson | — | — | — | — |
| Minn. | C. L. Barker | 125 | 61 | 129 | 315 |
| | | 127 | 62 | 132 | 321 |

MIDWEST DIVISION

| | | | | | |
|-------|---------------|----|----|-----|-----|
| Kans. | C. M. Lewis | — | — | — | 32 |
| Iowa | D. E. Watts | — | — | — | 254 |
| Mo. | L. B. Lutzure | 19 | 11 | 188 | 213 |
| Nebr. | H. A. Nielsen | — | — | — | 108 |
| | | 19 | 11 | 188 | 663 |

NEW ENGLAND DIVISION

| | | | | | |
|----------|--------------------|-----|----|-----|------|
| Conn. | C. E. Nichols | — | — | — | 427 |
| Maine | A. F. Wheeler | — | — | — | 6 |
| W. Mass. | T. F. Cushing | — | — | — | 184 |
| E. Mass. | Miss Gladys Hannah | 128 | 71 | 225 | 424 |
| Vermont | W. M. Hall | — | — | — | 21 |
| N. H. | No report | — | — | — | — |
| R. I. | D. B. Fancher | — | — | — | 61 |
| | | 128 | 71 | 225 | 1184 |

NORTHWESTERN DIVISION

| | | | | | |
|---------|----------------|----|----|----|-----|
| Wash. | L. C. Mayo | 67 | 57 | 26 | 384 |
| Oregon | P. R. Hoppe | 7 | — | 30 | 75 |
| Idaho | K. S. Norquest | — | — | — | 32 |
| Montana | A. R. Willson | — | — | — | 64 |
| Alaska | G. Sturley | — | — | — | — |
| | | 74 | 57 | 65 | 555 |

PACIFIC DIVISION

| | | | | | |
|-------------|----------------|-----|----|----|------|
| So. Section | M. E. McCreery | — | — | — | 558 |
| No. Section | P. W. Dann | 125 | 25 | 67 | 493 |
| Nevada | M. E. Smart | — | — | — | — |
| Hawaiian | K. A. Cauth | — | — | — | 19 |
| | | 125 | 25 | 67 | 1068 |

ROANOKE DIVISION

| | | | | | |
|----------|----------------|----|----|-----|-----|
| W. Va. | J. L. Bock | — | — | — | 63 |
| Va. | I. F. Wohlford | 5 | 6 | 18 | 29 |
| No. Car. | R. S. Morris | 50 | 30 | 102 | 182 |
| | | 55 | 36 | 120 | 274 |

ROCKY MOUNTAIN DIVISION

| | | | | | |
|----------|---------------|----|----|----|-----|
| Utah | A. Johnson | 19 | 3 | 62 | 104 |
| Colorado | C. R. Stedman | 15 | 8 | — | 216 |
| Wyoming | — | — | — | — | 56 |
| | | 34 | 16 | 62 | 406 |

SOUTHEASTERN DIVISION

| | | | | | |
|------------|-------------|-----|----|-----|-----|
| Fla. | C. F. Clark | 44 | 24 | 120 | 188 |
| So. Car. | A. Dupre | — | — | — | 110 |
| Alabama | T. T. Trum | 60 | 45 | 157 | 262 |
| Porto Rico | Luis Rexach | — | — | — | 126 |
| Georgia | No report | — | — | — | 126 |
| | | 104 | 69 | 277 | 686 |

WEST GULF DIVISION

| | | | | | |
|-----------|--------------------|----|---|-----|-----|
| No. Texas | W. B. Forrest, Jr. | — | — | — | 34 |
| So. Texas | E. A. Sahm | — | — | — | 66 |
| Oklahoma | K. W. Ehrst | 27 | 8 | 125 | 253 |
| N. Mexico | — | — | — | — | — |
| | | 27 | 8 | 125 | 278 |

MARITIME DIVISION

| | | | | | |
|----------|---------------------|---|---|----|----|
| Maritime | W. C. Borrett, Mgr. | 4 | 1 | 21 | 26 |
|----------|---------------------|---|---|----|----|

ONTARIO DIVISION

| | | | | | |
|------------|-------------------|---|---|---|-----|
| E. Ont. | F. A. C. Harrison | — | — | — | 102 |
| Cent. Ont. | W. Y. Sloan | — | — | — | 75 |
| W. Ont. | J. E. Hayne | — | — | — | — |
| N. Ont. | — | — | — | — | 9 |
| | | — | — | — | 186 |

QUEBEC DIVISION

| | | | | | |
|--------|--------------------|---|---|---|----|
| Quebec | J. V. Argyle, Mgr. | 4 | 2 | 7 | 24 |
|--------|--------------------|---|---|---|----|

WINNIPEG DIVISION

| | | | | | |
|----------|--------------------|---|---|---|----|
| Winnipeg | W. R. Pottle, Mgr. | — | — | — | 26 |
|----------|--------------------|---|---|---|----|

VANCOUVER DIVISION

| | | | | | |
|---------------|-------------|---|---|---|----|
| Vancouver | W. J. Rowan | — | — | — | 38 |
| Vancouver Is. | — | — | — | — | 47 |
| Calgary | — | — | — | — | 1 |
| | | — | — | — | 82 |

| Originated | Delivered | Relayed | Total |
|------------|-----------|---------|-------|
| 1119 | 489 | 1891 | 9307 |