

1977 WRAP-UP / \$1.00

I AM RADIO HORIZONS

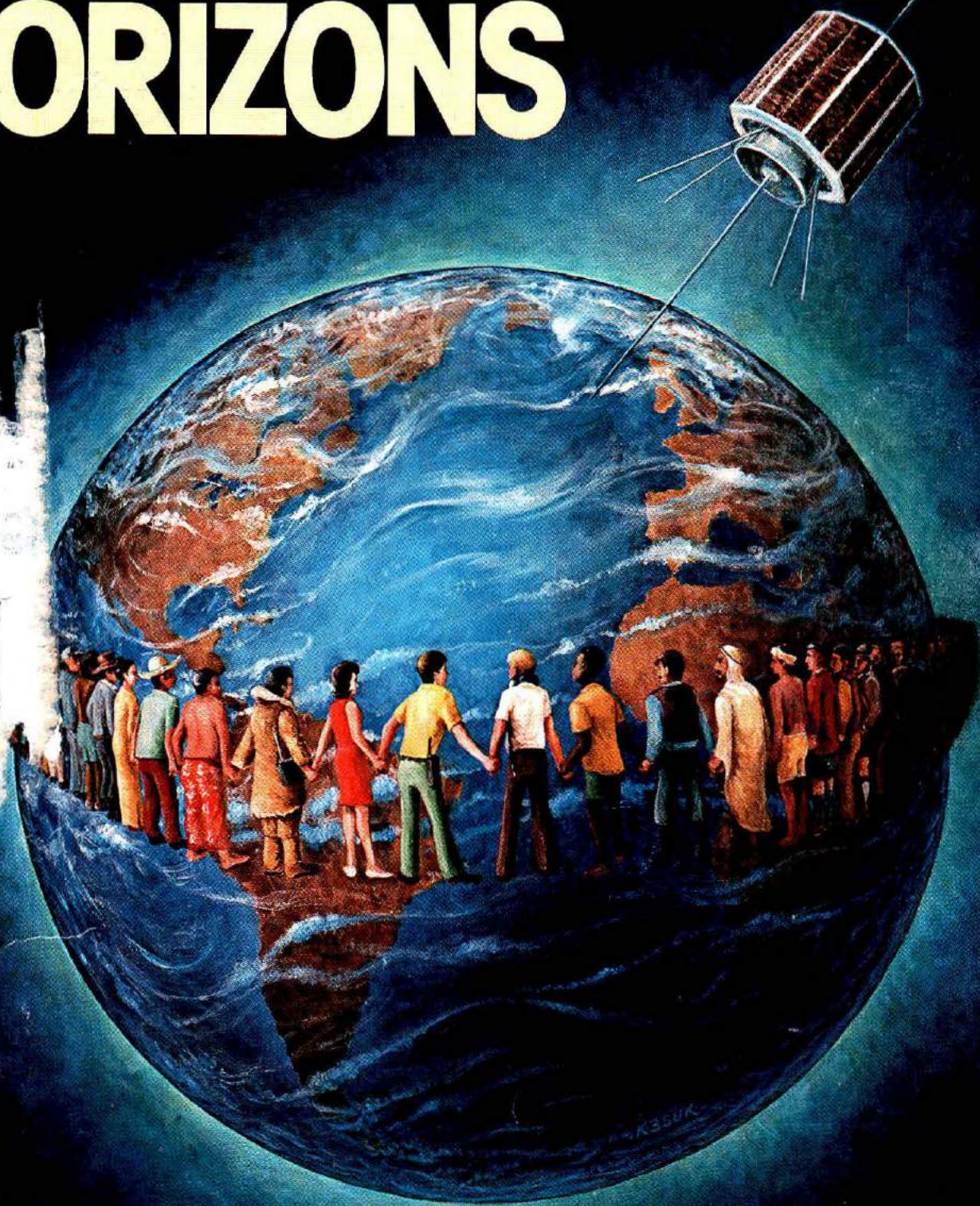

WORLDWIDE FRIENDSHIP THROUGH AMATEUR RADIO

FM SYSTEM SCHOOL

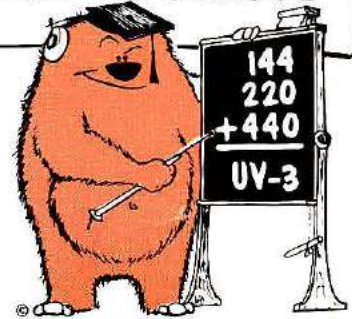

*thoughts to consider
about the new*

DRAKE UV-3



Optional
Drake 1525EM
Encoding Mike

UHF-VHF FM SYSTEM

only \$995 for 3-band UV-3

*How does the cost of the Drake system really compare to
alternative methods of getting on 144-220-440 MHz fm?*

A First of all, there is no direct comparison possible, because the Drake UV-3 is the only rig in the world offering 144-220-440 MHz fm in a single box — and it is fully synthesized on each band.

B The nearest comparison would be to add the suggested list prices of 3 separate units of the most popular fm rigs presently available. It would work out approximately as follows:

2 Meters (Synthesized to 5 kHz)\$ 400.00
220 MHz (12 channels, crystal) 230.00
440 MHz (12 channels, crystal) 300.00
Crystals (Assuming 20 per radio) 200.00
TOTAL	\$1130.00

But wait— even at that price you'd be missing features included in the UV-3:

1. Full synthesis on all three bands
2. Extra diode-programmable fixed channels on each band
3. Priority scan feature on each band
4. Remote, trunk mount operation (optional)
5. Everything in a *single* box!

For your homework, then, ponder the following — at a suggested amateur net of \$995.00, the Drake UV-3 (144-220-440) is, to say the least, an incredible value.

R. L. DRAKE COMPANY



540 Richard St., Miamisburg, Ohio 45342
Phone: (513) 866-2421 • Telex: 288-017

Western Sales and Service Center, 2020 Western Street, Las Vegas, Nevada 89102 • 702/382-9470

Call Toll Free 1-800-633-3410 for accessories



ESI POS-1220Z power supply

This one really works! • 13.8 VDC regulated power supply • Current rating: 20 amps continuous, 30 amps surge • Fuse protected • LED power indicator • ON/OFF switch on front panel. This unit will power a TR-7400A AND a KLM 160 watt 2m amplifier!

69.95 Call for yours today.

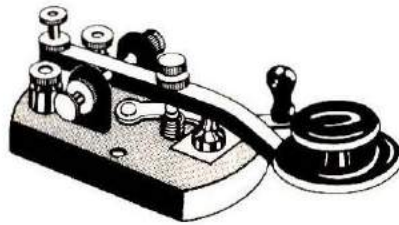

NYE VIKING 114-320-003 key

This heavy-duty key is constructed on a heavy die-cast base. The hardware is nickel-plated. Has smooth adjustable bearings and heavy-duty coin silver contacts. Black wrinkle finished base, switch and Navy knob.

10.60 Call for yours today.

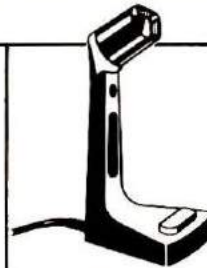

**OVER
50%
OFF**

ELECTRO-VOICE 719 desk microphone

The 719 has two talk switch positions, grip-to-talk & push-to-talk. Features: • 80 to 7000 Hz frequency response • Ceramic generating element • High Z output impedance • Omnidirectional polar pattern. Simple instructions included for change of talk switch position.

19.00 Call for yours today.



NEW!

The NEW DENTRON BIG DUMMY

Now you can tune-up off the air with Dentron's Big Dummy load. A full power dummy load, it has a flat SWR, full frequency coverage from 1.8 to 300 MHz and a high grade industrial cooling oil furnished with the unit. Built to last! Fully assembled and warranted. Help cut out the QRM factor now!

29.50 Call for yours today.



KENWOOD DG-5 LED digital display

The DG-5 gives you a digital readout on your TS-520 or TS-520S. DG-5 connects instantly to any TS-520S. The 520S already has the DK-520 built-in. You can add a DK-520 to your TS-520 for only \$18.00. The DG-5 features: • 100 Hz to 40 MHz measuring range • Frequency counter up to 40 MHz • Input impedance: 5 K ohms • Gate time: 0.1 second • Time base: 10 MHz.

161.10 Call for yours today.



MFJ Super antenna tuner

Features: • 160 thru 10 meter matching • Up to 200 watts RF output • Tune out the SWR on your dipole or whatever antenna you have • Increase the usable band width of your mobile whip • Compact size: 5"x2"x6" • SO-239 coax connectors provided for TX input & coax fed antennas.

69.95 Call for yours today.

Remember, you can call TOLL-FREE: 1-800-633-3410 in U.S.A. or call 1-800-292-8668 in Alabama for our low price quote. Store hours: 9:00 AM til 5:30 PM, Monday thru Friday.



Long's Electronics



MAIL ORDERS: P.O. BOX 11347 BIRMINGHAM, AL 35202 • STREET ADDRESS: 3521 10TH AVENUE NORTH BIRMINGHAM, ALABAMA 35234

THIS MONTHS

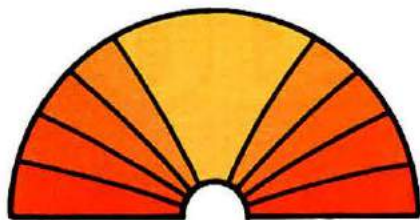

HORIZONS

The Semiconductor Age

Ham Radio Horizons is proud to present an overall sketch of the birth of the semiconductor age by a fellow amateur who was interested enough to do considerable research so that others can benefit. You'll find a wealth of references to this interesting and vital subject in electronics as well as a short course in what makes it all happen.

Satellite Communication

Amateur satellites whirl around the globe several times a day, ready to help amateurs span great distances with their vhf signals. These orbiting repeaters have been planned so that you do not need a large and expensive Earth station to use their services. W1XU talks about the ordinary amateur equipment that you can put together to join the space age.

NN3SI — Smithsonian Institution Calling

Millions of people visit the exhibits at the Smithsonian Institution in our nation's capital every year. They have a chance to examine our history, our technology, our geology, and a multitude of other things that tell what America is all about. It is only natural that there should be an Amateur Radio station as part of the story. The station, NN3SI, is more than an exhibit — it's a

living demonstration of the ability of amateurs to communicate with their fellow man anywhere in the world.

Questions? And Answers!

The end of the Rules and Regulations section is in sight, and a discussion of who is eligible for a license and what to do if you receive a notice of violation just about wraps it up. Operating signals and reporting systems are the next subject brought up under the Operating Practices part of the exam questions and Answers. Much of the information discussed in this part will be helpful when you get on the air, as well as when you take your Novice test.

Those Old Radio Mags

Many of today's amateurs do not remember the *real* old timers, and many have never even heard of them. There were people and products in the past that made radio, particularly Amateur Radio, what it is today. The key to who the people were, what they did, and how they thought, felt, and talked can be found in the old radio magazines. Pick one up, thumb through its pages, and learn what Amateur Radio was like in the old days.

War Surplus

Was war surplus radio gear a blessing or a curse? In some instances it helped put hams back on the air, but did it stifle the growth of ham-oriented business and products too? W6SAI tells us about the days when the magazines were full of advertisements for really low-priced stuff (some of which is still living in flea markets across the land).

Collinear Antenna

The inverted V dipole is well known for its simplicity, low cost, and ease of construction. It performs well as a DX antenna

because of its low-angle radiation characteristics. The antenna described here by Alf Wilson, W6NIF, a modified inverted V, is based on recognized engineering principles.

Future

The year is 1999 and a couple of hams are rag chewing like they did in the good old days. Couldn't be much difference, you say? Well . . . in a way, you're right. Let's tune in and read the mail.

Our Cover

Amateur Radio is perhaps the only type of communications available to the average person on a world-wide basis. Amateurs share a common language, a common desire to communicate, and a great means of developing friendships. Our cover artist, Wayne Pierce, K3SUK, has expressed this bond of friendship through amateur radio by depicting people united through their hobby, encircling the globe as does their own satellite — a symbol of the amateur's ability to advance with technology.

HAM RADIO HORIZONS December 31, 1977, Volume 1, No. 11. Published monthly by Communications Technology, Inc., Greenville, New Hampshire 03048. One-year subscription rate, \$10.00; three-year subscription rate, \$24.00. Second-class postage paid at Greenville, New Hampshire 03048 and additional offices.

About This Issue

We're calling this the Wrap-Up 1977 issue of *Ham Radio Horizons*, and that is just what it will do. You'll notice the cover date is December 31, 1977. Why? Don't miss the complete and important details on page 74.

Call toll-free 800-647-8660 for products by MFJ ENTERPRISES



\$69⁹⁵

MFJ-16010 ST Super Antenna Tuner

This NEW MFJ Super Antenna Tuner matches everything from 160 thru 10 Meters: dipoles, inverted vees, long wires, verticals, mobile whips, beams, balance lines, coax lines. Up to 200 watts RF OUTPUT. Built-in balun, too!

- Operate all bands with one antenna • Works with all solid state and tube rigs • Ultra compact; 5 x 2 x 6 inches • Uses toroid cores



\$39⁹⁵

MFJ-16010 Antenna Tuner

Now you can operate all bands — 160 thru 10 Meters — with a single random wire and run your full transceiver power output — up to 200 watts RF power OUTPUT.

- Small enough to carry in your hip pocket, 2-3/16 x 3-1/4 x 4 inches • Matches low and high impedance by interchanging input and output • SO-239 coaxial connectors • 12 position lapped inductor. Stacked toroid cores • At 1.8 MHz tuner matches 25 to 200 ohms.



\$29⁹⁵

CWF-2BX Super CW Filter

This MFJ Super CW Filter gives you 80 Hz bandwidth, and extremely steep skirts with no ringing for razor sharp selectivity that lets you pull signals out of heavy QRM. Plugs between receiver and phones or connect between audio stage for speaker operation.

- Selectable BW: 80, 110, 180 Hz • 60 dB down one octave from center frequency of 750 Hz for 80 Hz BW • Reduces noises 15 dB • 9 V battery • 2-3/16 x 3-1/4 x 4 inches • CWF-2PC, wired PC board, \$19.95.



\$69⁹⁵

MFJ-8043 IC Deluxe Electronic Keyer

This NEW MFJ Deluxe Keyer gives you more features per dollar than any other keyer available.

- Uses Curtis-8043 keyer chip • Sends iambic, automatic, semi-automatic, manual • Use squeeze, single lever, or straight key • Dot memory, self-completing dots and dashes, jam proof spacing, instant start • RF proof • Solid state keying ± 300 V max • Weight, tone, volume, speed controls • Uses 4 C-cells; external power jack • 6 x 6 x 2 inches • Sidetone and speaker • Optional squeeze key: \$29.95

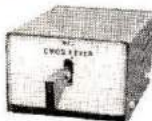

\$54⁹⁵

CMOS-8043 Electronic Keyer

State of the art design uses CURTIS-8043 Keyer-on-a-chip.

- Built-in Key • Dot memory • Iambic operation with external squeeze key • 8 to 50 WPM • Sidetone and speaker • Speed, volume, tone, weight controls • Ultra reliable solid state keying ± 300 volts max. • 4 position switch for TUNE, OFF, ON, SIDETONE OFF • Uses 4 penlight cells • 2-3/16 x 3-1/4 x 4 inches



\$59⁹⁵

LSP-520BX II Log Speech Processor

Up to 400% more RF power. Plugs between your microphone and transmitter.

- Gives your audio punch power to slice through QRM • 30 dB IC log amp and 3 active filters • RF protected • 9 V battery • Two Mic jacks: 1/4" phone jacks, uncommitted 4 pin jack • Output cable • 2-1/8 x 3-5/8 x 5-9/16 inches • LSP-520BX, in standard MFJ enclosure, electronically identical, \$49.95.



\$29⁹⁵

SBF-2BX SSB Filter

Dramatically improves readability.

- Optimizes your audio to reduce sideband splatter, remove low and high pitched QRM, hiss, static crashes, background noise, 60 and 120 Hz hum • Reduces fatigue during contest, DX, and ragchewing • Plugs between phones and receiver or connect between audio stage for speaker operation • Selectable bandwidth IC active audio filter • Uses 9 volt battery • 2-3/16 x 3-1/4 x 4 inches



\$29⁹⁵

MFJ-200BX Frequency Standard

Provides strong, precise markers every 100, 50, or 25 KHz well into VHF region.

- Exclusive circuitry suppresses all unwanted markers • Markers are gated for positive identification. CMOS IC's with transistor output. • No direct connection necessary • Uses 9 volt battery • Adjustable trimmer for zero beating to WWV • Switch selects 100, 50, 25 KHz or OFF • 2-3/16 x 3-1/4 x 4 inches



\$49⁹⁵

MFJ-1030BX Receiver Preselector

Clearly copy weak unreadable signals (increases signal 3 to 5 "S" units).

- More than 20 dB low noise gain • Separate input and output tuning controls give maximum gain and RF selectivity to significantly reject out-of-band signals and reduce image responses • Dual gate MOS FET for low noise, strong signal handling abilities • Completely stable • Optimized for 10 thru 30 MHz • 9 V battery • 2-1/8 x 3-5/8 x 5-9/16 inches

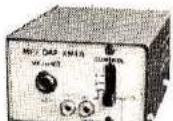

\$29⁹⁵

MFJ-40T QRP Transmitter

Work the world with 5 watts on 40 Meter CW.

- No tuning • Matches 50 ohm load • Clean output with low harmonic content • Power amplifier transistor protected against burnout • Switch selects 3 crystals or VFO input • 12 VDC • 2-3/16 x 3-1/4 x 4 inches

MFJ-40V, Companion VFO \$29.95

MFJ-12DC, IC Regulated Power Supply,

1 amp, 12 VDC \$29.95



\$17⁹⁵

CPO-555 Code Oscillator

For the Newcomer to learn the Morse code.

For the Old Timer to polish his fist.

For the Code Instructor to teach his classes.

- Send crisp clear code with plenty of volume for classroom use • Self contained speaker, volume, tone controls, aluminum cabinet • 9 V battery • Top quality U.S. construction • Uses 555 IC timer • 2-3/16 x 3-1/4 x 4 inches

TK-555, Optional Telegraph Key \$1.95



\$19⁹⁵

C-500 Digital Alarm Clock

This digital alarm clock is also an ID Timer. Assembled, too!

- Gives ID buzz every 9 minutes automatically, or after tapping ID/doze button • Pressing ID/doze button displays seconds • Large .63 inch digits • Easily zeros to WWV • AM and PM LED indicators • Power out indicator • Fast set, slow set buttons • 110 VAC, 60 Hz • 3-1/8 x 3-3/4 x 3-3/8 inches • One year warranty by Fairchild

Order any product from MFJ and try it. If not delighted, return within 30 days for a prompt refund (less shipping).

Order today. Money back if not delighted. One year unconditional guarantee. Add \$2.00 shipping/handling.

Order By Mail or Call TOLL FREE 800-647-8660 and Charge It On



MFJ ENTERPRISES

P. O. BOX 494

MISSISSIPPI STATE, MISSISSIPPI 39762

In Europe contact: ING I. STERN, Lohkoppelstrasse 27, 2000 Hamburg 76, West Germany. Tel.: (040) 299-6110, Telex: 2161808 STEX D

ATB-34

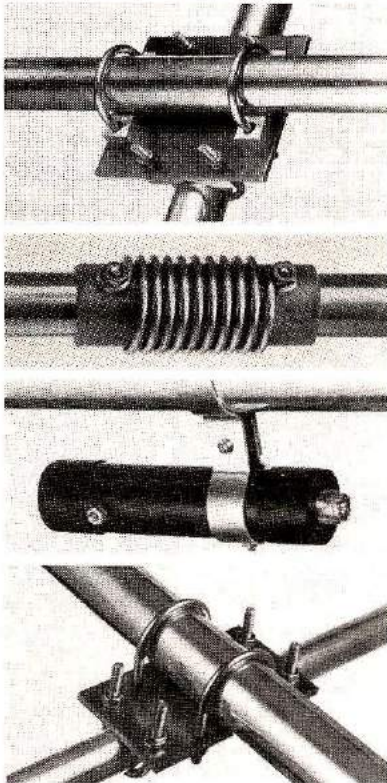
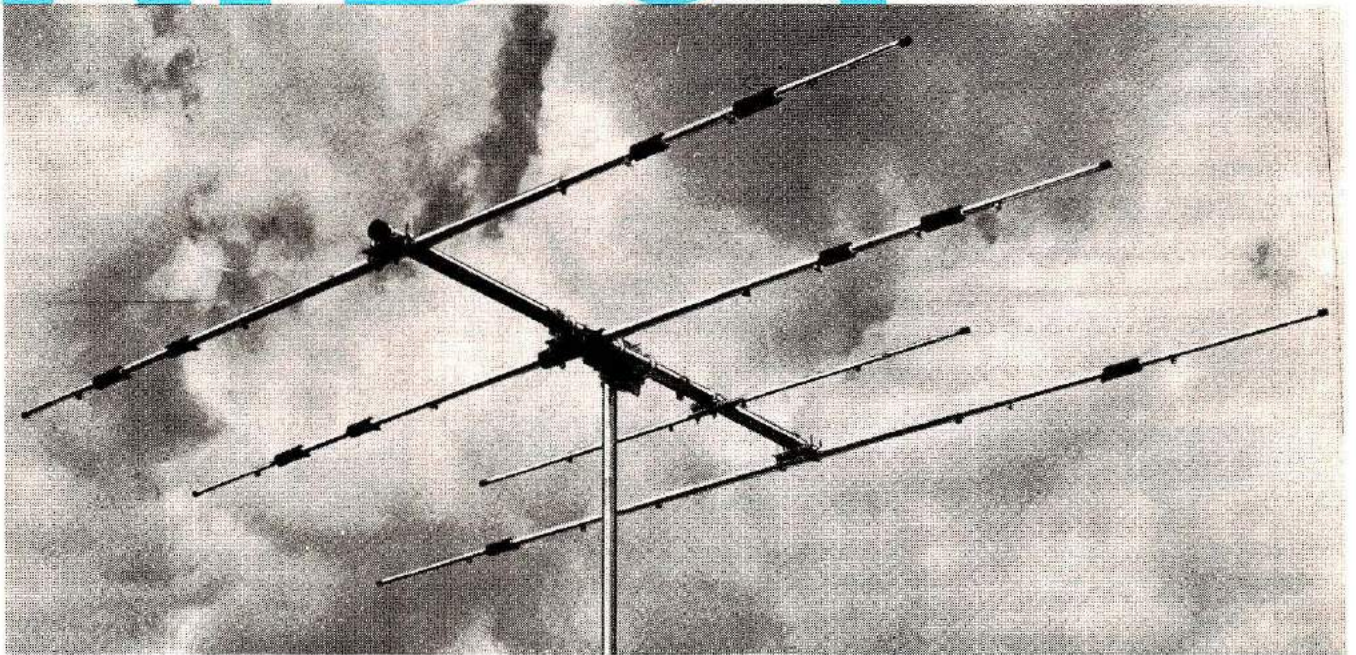

4 ELEMENT-3 BAND 10-15-20 METER BEAM

Cushcraft engineers have incorporated more than 30 years of design experience into the best 3 band HF beam available today. **ATB-34** has superb performance with three active elements on each band, the convenience of easy assembly and modest dimensions. Value through heavy duty all aluminum construction and a price complete with 1-1 balun.

Enjoy a new world of DX communications with ATB-34!

SPECIFICATIONS

FORWARD GAIN -	7.5 dBd	WIND SFC -	5.4 Sq.Ft.
F/B RATIO -	30 dB	WEIGHT -	42 Lbs.
VSWR -	1.5-1	WIND SURVIVAL -	90 MPH.
POWER HANDLING -	2000 WATTS PEP		
BOOM LENGTH/DIA. -	18' x 2 1/8"		
LONGEST ELEMENT -	32'8"		
TURNING RADIUS -	18'9"		

\$239.95

COMPLETE
NO EXTRAS TO BUY

UPS SHIPPABLE

IN STOCK WITH DISTRIBUTORS WORLDWIDE

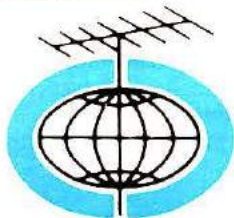

cushcraft

CORPORATION

BOX 4680, MANCHESTER, N.H. 03108

December 31, 1977
Volume 1, Number 11

HAM RADIO HORIZONS

T.H. Tenney, Jr., W1NLB
Publisher

James R. Fisk, W1HR
Editor-in-Chief

Editorial Staff

Thomas F. McMullen, Jr., W1SL
Managing Editor

Patricia A. Hawes, WA1WPM
Executive Editor

Charles J. Carroll, K1XX
Alfred Wilson, W6NIF
Assistant Editors

Publishing Staff

C. Edward Buffington, WB1AMU
Assistant Publisher

Fred D. Moller, Jr., WA1USO
Advertising Manager

James H. Gray, W1XU
Assistant Advertising Manager

Therese R. Bourgault
Circulation Manager

Ham Radio Horizons
is published monthly by
Communications Technology, Inc
Greenville, New Hampshire 03048
Telephone 603-878-1441

Subscription rates are
\$10.00 per year, worldwide

Copyright 1977 by Communications
Technology, Inc. Title registered
at U.S. Patent Office

Microfilm copies
are available from
University Microfilms, International
Ann Arbor, Michigan 48103

Cassette tapes of selected articles
from *Ham Radio Horizons* are available to
the blind and physically handicapped
from Recorded Periodicals
919 Walnut Street, 8th Floor
Philadelphia, Pennsylvania 19107

Dawn of the Semiconductor Age	12	
		Steven E. Komaniecki, WB9SDN
Communicating Through Amateur Satellites	20	
		James H. Gray, W1XU
NN3SI — Smithsonian Institution	28	
		Joseph P. Fincutter, W3IK
Questions? and Answers! Part 5	32	
		Thomas F. McMullen, W1SL
Old Radio Magazines	38	
		John J. Nagle, K4KJ
War Surplus and Radio Amateurs	50	
		William I. Orr, W6SAI
An Inverted-V Collinear Antenna	60	
		Alfred Wilson, W6NIF
QSOs of the Future	66	
		D. B. Smith, KG6JJN
Ad Check	88	Horizons Locator 80
Ad Scan	83	Newsline 11
Advertiser's Index	88	Postbox 70
Annual Index	84	Product Showcase 74
Erratic Errors	76	The View from Here 6
Focus and Comment	8	This Month's Horizons 2

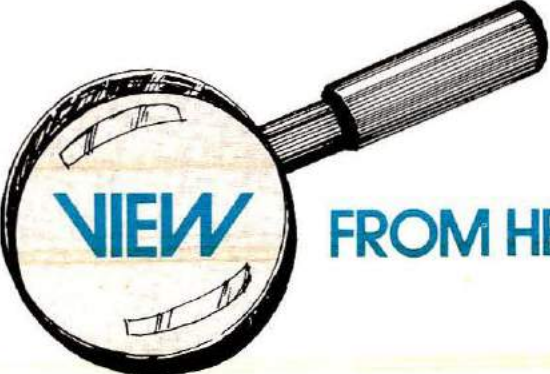

THE VIEW FROM HERE

During the past few months the FCC has been receiving an increasing number of inquiries concerning state and local laws which deal with radio and television. While many of the calls and letters are from CBers, amateurs have raised many of the same questions. Since all radio operations are licensed by the federal government, many amateurs feel that matters which have to do with their station and its operation are "beyond the reach" of local ordinances. When amateurs do run afoul of a local law that seems to infringe upon their radio activities, they often question that law's constitutionality. The FCC doesn't have the time nor the budget to investigate every complaint of this nature, so they have issued a Public Notice which lists some guidelines for amateurs and other FCC licensees who feel they have run into improper regulation of radio communications; some of the important points of that Public Notice are discussed here.

One important facet of the Communications Act passed by Congress in 1934 was the establishment of a Federal Communications Commission with authority to set up a system of regulation for the various radio services. If you read the fine print of the Act you'll see that it leaves little doubt as to the extent of this regulatory scheme — it indicates a clear intention by Congress that radio should be completely regulated by the federal government.

However, this does not necessarily mean that local statutes which deal with radio are illegal or unconstitutional. Under the Supremacy Clause of the United States Constitution, state and local statutes may be pre-empted when (1) a local law conflicts with a law enacted by Congress, or (2) when Congress has adopted pervasive legislation in a particular field with the intent that regulation in that area be conducted exclusively by the federal government. Furthermore, local ordinances which unreasonably burden interstate commerce may be invalidated.

Whether or not a particular local statute has been pre-empted by federal legislation is purely a legal question, and when a conflict between federal and state law arises, the courts are called upon to make the final decision. For proper resolution the specific local law in question must be reviewed, and each case must be carefully judged on its own facts.

In general it may be said that in matters involving purely local concerns, the courts have found that reasonable local statutes are not in conflict with the Communications Act; such things as local zoning ordinances limiting antenna heights, and the right of local authorities to make judgments on the property rights of an FCC licensee's station have all been upheld. On the other hand, when a local law conflicts with the FCC's regulations for radio services, the federal law prevails; state laws involving the censorship of material carried on broadcast stations, for example, and local laws requiring FCC licensees to refrain from activities required by the Communications Act have all been struck down.

Amateurs are usually aware of local legislative proceedings, and when it appears an improper law regarding radio is being brought up for debate, that's the time to make your local representative aware of the potential problems. In general, state legislators have better knowledge of federal authority than do the local county or city authorities, but in either case local lawmakers should be made aware that the FCC has issued extensive regulations governing radio. Therefore, local ordinances designed specifically to regulate amateur (or CB) transmissions may be invalid. If you run afoul of such a law, you have little choice but to seek legal counsel to raise federal pre-emption on your behalf.

Jim Fisk, W1HR
editor-in-chief

ICOM wants you to

Begin with the Best

As you develop your skills, increase your participation in Ham Radio activities, and add hardware for ever-increasing flexibility of operations, you'll come to know ICOM. Just ask any old Ham. ICOM is the quality name in VHF/UHF Amateur Radio equipment because it is simply the best. ICOM is the line you'll want to move up to for unequalled quality and features.

But you needn't wait until you can trade in a truck load of equipment to reach up to ICOM. You can begin building your Amateur Radio operations with reasonably priced ICOM units that have flexible add-on features when you purchase your very first voice transceiver. And when you are installing ICOM's top-of-the-line fixed station unit, the ICOM equipment you began with will probably still be an important integral part of your active hardware.

Don't delay in moving up to ICOM: begin with the best.



Clockwise from lower left: **IC-211** 4MHz, 2 meter, All Mode Transceiver; **IC-245** Mobile 2 meter Transceiver; **IC-225** Mobile VHF FM Transceiver; **IC-502** Portable 50 MHz SSB Transceiver; **IC-215** Portable 2 meter FM Transceiver; **IC-30A** Mobile UHF FM Transceiver.

Ask your dealer for ICOM's complete product line catalog, or mail your request to an address below.

VHF/UHF AMATEUR AND MARINE COMMUNICATION EQUIPMENT

Distributed by:



ICOM

ICOM WEST, INC.
Suite 3
13256 Northrup Way
Bellevue, Wash. 98005
(206) 747-9020

ICOM EAST, INC.
Suite 307
3331 Towerwood Drive
Dallas, Texas 75234
(214) 620-2780

ICOM CANADA
7087 Victoria Drive
Vancouver B.C. V5P 3Y9
Canada
(604) 321-1833



FOCUS & COMMENT

It seems to be traditional to pause at the end of each calendar year and look back at what has happened, to take stock of the situation, or to evaluate your progress; I can't think of a better time to do so. A backwards look at 1977 is very interesting, especially from the viewpoint of someone in the business of putting together a magazine for radio amateurs. In fact, fascinating might be the more accurate term. One thing an editor can depend on is that the readers will let him know how they feel about things, and they do.

But, what a variety of comments! There were letters from those who thoroughly enjoyed the fiction pieces — and in the same mail delivery were some who asked, "Why clutter up the pages with such useless junk?" Other readers reacted strongly to our stories about CB (some see red immediately upon sight of the two letters, never mind what the story has to say), and, fortunately, this reaction was balanced by other readers who applauded our efforts to tell more than one side of the story. Some found our technical material too basic, too simple, and wanted something they could get their teeth into. The other side of that coin was filled by dozens of letters stating that the technical articles filled a need for them — gave them something at a level they found useful. This is a good sign, showing that our readers are involved in amateur radio, not sitting on the sidelines.

There are some other signposts visible as bright spots as you look back at 1977 — indicators that amateur radio is being brought to the attention of the general public in many ways: A recent issue of *Analog* (Science Fiction/Science Fact) magazine had a story that was well done (but too short), about a student who was into amateur radio, and his relationship with his professor. Although the theme was rather "far out," I could find no flaw in the presentation of amateur radio.

Another instance is the publication of the book "*The French Atlantic Affair*," written by Ernest Lehman, K6DXK, in which amateur radio plays a vital role in the lives of the characters portrayed in this contemporary novel.

That's what we need more of — amateur radio told as it is, not inflated by impossible claims, not hidden in undecipherable (to the layman) jargon, but rather spoken of as a great hobby, pursued by everyday people who are just like the rest of the world. I'm glad to see that it is a growing trend. Some of the credentials sent in by many of our *Horizons* authors indicate that they have published articles about amateur radio in women's magazines, local and national newspapers, sporting magazines, and in those time-fillers that you find in the pocket of the seat on your favorite airline. Good stuff!

It's this variety of responses from our readers, the vast amount of territory to be covered, and the possibility of finding more signposts (perhaps even milestones) in the next year, that makes me look forward to 1978 with eagerness; I just know it will be anything but boring.

In the meantime, to all of you who took the time to express your feelings, I send a sincere "Thank You." And I wish each of you the very best for this holiday season, and throughout the coming year.

Tom McMullen, W1SL
Managing Editor

SPECIAL TRIPLE BONUS DEAL on KENWOOD TS-820S

**SERVING
HAMS
BETTER!**

*North ... south ...
east ... west*

All leading brands ...
in-depth stocks ...
new/used gear.



The deal:

- 1)—Send us 1048.00* (in the form of check, M/O, BankAmericard, VISA, Master Charge)
- 2)—We'll ship you immediately, a beautiful brand-spanking-new, peerless performing **KENWOOD TS-820S TRANSCEIVER!**
- 3)—PLUS a **BIRD Model 43 wattmeter** (a 120.00 retail value).
- 4)—PLUS prepaid shipment of both items by **U.P.S. (Brown).**

*Calif. residents add 6% sales tax

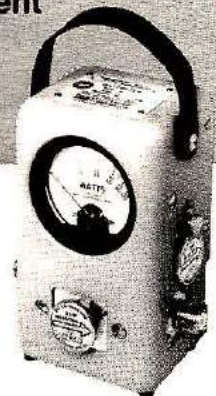

BIRD ELEMENTS
(Not supplied with BIRD wattmeter)
2-30MHz ... 42.00
25-1000MHz ... 36.00

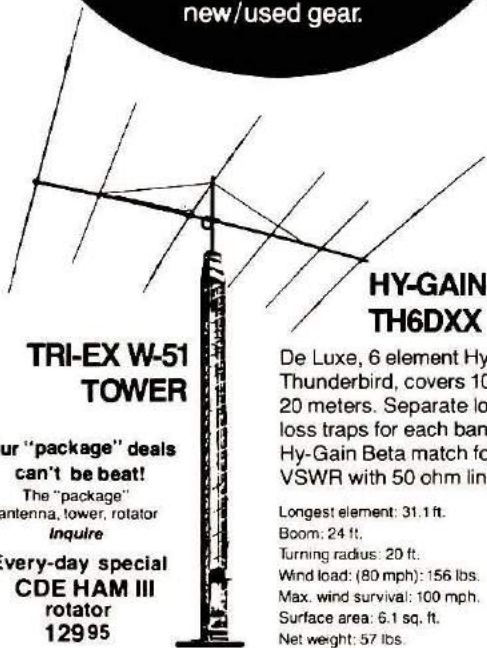

HY-GAIN TH6DXX

De Luxe, 6 element Hy-Gain Thunderbird, covers 10, 15, 20 meters. Separate low loss traps for each band. Hy-Gain Beta match for low VSWR with 50 ohm line.

Longest element: 31.1 ft.
Boom: 24 ft.
Turning radius: 20 ft.
Wind load: (80 mph): 156 lbs.
Max. wind survival: 100 mph.
Surface area: 6.1 sq. ft.
Net weight: 57 lbs.

TRI-EX W-51 TOWER

Our "package" deals can't be beat!

The "package" antenna, tower, rotator
Inquire

Every-day special
**CDE HAM III
rotator
129.95**

SHURE 444 33.95

shipped prepaid,
UPS (Brown).



**OTHER
BIG-VALUE
SPECIALS**

ICOM IC-22S VHF Transceiver plus CUSHCRAFT

**Ringo Ranger
Antenna**

279.00!
shipped
prepaid,
UPS
(Brown).



OVER THE COUNTER (Mon. thru Sat. 10AM to 5:30PM). PHONE, WRITE. SAME DAY SHIPMENT MOST ITEMS.

HAM RADIO OUTLET

SOUTH

Anaheim, Calif. 92801

2620 W. La Palma, (714) 761-3033
1 mile east Knott's Berry Farm. (213) 860-2040

NORTH (Main Office)

Burlingame, Calif. 94010

999 Howard Ave., (415) 342-5757
5 miles south on 101 from S.F. Airport.

SOUTH

Van Nuys, Calif. 91401

13754 Victory Blvd., (213) 988-2212
Dealer inquiries invited.



**Bob Ferrero,
K6AHV/W6RJ.**
Jim Rafferty,
W9UCE/N6RJ.
other well known hams
give you courteous,
personalized service.



• ATLAS • BIRD • CDE • COLLINS • CUSHCRAFT • CURTIS • DENTRON • DRAKE • EIMAC • HUSTLER
• HY-GAIN • ICOM • KENWOOD • KLM • MOSLEY • SWAN • TEMPO • TEN TEC • TRI-EX • YAESU • more.

Wilson's

SYSTEM ONE

TRIBANDER ANTENNA IS HERE...

SYSTEM ONE

FOR 20, 15 and 10 METERS

Monoband performance
with 4 elements on 20 meters
on a 26' boom.

THE SY-1000 TRIBANDER ANTENNA IS SHOWN HERE WITH THE WR 500 ROTOR AND SST-64 CRANK-UP TOWER @ 50 FT. (Guy System not shown)

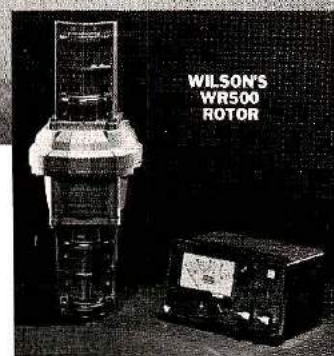

The new standard of performance for Tribanders is the Wilson System One!!! A DX'er's delight operating 20 meters on a full 26' boom with 4 elements, 4 operational elements on 20-15-10, plus separate reflector element on 10 meters for correct monoband spacing. Featured are the large diameter High-Q Traps, Beta matching system, heavy duty Taper Swaged Elements, rugged Boom to Element mounting . . . and value priced at \$259.95. Additional features: • 10 dB Gain • 20-25 dB Front-to-Back Ratio • SWR less than 1.5 to 1 on all bands.

MODEL SY-1 SPECIFICATIONS:

Matching Method:	Beta	F/B Ratio	20-25 dB	Mast Diameter	2" O.D.
Band MHz:	14-21-28	Boom Length	26'	Boom Diameter	2" O.D.
Maximum Power Input:	Legal Limit		(2" O.D.)	Surface Area	7.3 sq. ft.
Gain	10 dB	No. of Elements	5	Windload Area	146 lbs.
VSWR (at Resonance)	1.5 to 1	Longest Element	26' 7"	Shipping Weight	50 lbs.
Impedance	50 ohms	Turning Radius	18' 6"		

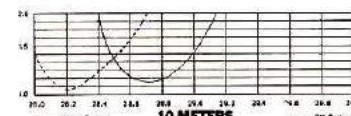
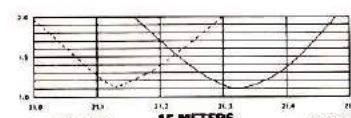
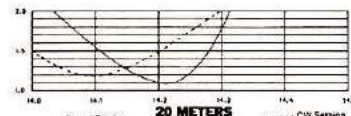

ADVANCED DESIGN LARGE DIAMETER HIGH-Q TRAPS FOR MINIMUM LOSS AND MAXIMUM POWER CAPACITY

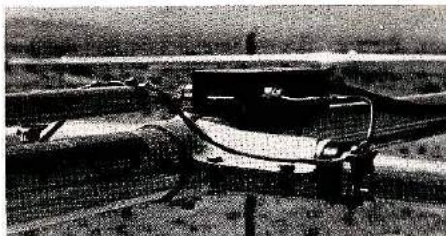

INSULATED DRIVEN ELEMENT WITH PRECISION BETA MATCH AND HEAVY DUTY ELEMENT MOUNTS

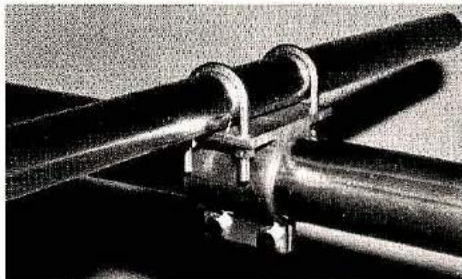

HEAVY DUTY BOOM TO ELEMENT EXTRUSION

AMATEUR PRODUCTS DEALERSHIPS FOR MANY AREAS ARE AVAILABLE!!!
If you are interested in the profits you can make as a Wilson Dealer, contact us.

For complete specifications on the above products or a copy of our new Amateur Products Buyers Guide, write: Consumer Products Division



Wilson Electronics Corp.

P.O. BOX 19000 • LAS VEGAS • NEVADA • 89119 • (702) 739-1931 • TELEX 684-522

NEWSLINE

SEPARATE REPEATER LICENSES will no longer be required and an Amateur operating a repeater will be able to do so simply by signing his regular call with the suffix "/RPT" on CW or "Repeater" on phone when in the repeat mode. This far-reaching deregulatory action came as a Report and Order on Docket 21033. Though agreement was universal throughout the Commission that separate repeater licenses were useful, it was felt they required more Commission investment in time and money than they were worth.

The Repeater Sub-bands were also expanded in the September 21 action, with an additional one MHz — 144.5-145.5 — now opened to repeaters on two meters. Additionally, all amateur frequencies above 220 MHz, with the exception of the 435-438 MHz space-communications slot, are now available for repeater use. The ten- and six-meter repeater limits remain unchanged.

Technicians Will Receive another 500 kHz, down to 144.5 MHz, so they'll be able to use the new two-meter repeater sub-band, which neatly avoids the OSCAR activity just below 146 and also manages to straddle (assuming 600 kHz input-output separation) existing ssb and a-m simplex operation between 145.0 and 145.2.

AMSAT WILL CONSTRUCT a building at the Goddard Space Flight Center to house both Phase III and AOD spacecraft integration and an office, according to an agreement tentatively approved by the Goddard authorities. It will be located next to the visitors' center, with windows permitting them to view the spacecraft construction efforts. Hiring a new full-time administrative assistant from the Washington area was also approved by AMSAT's Board.

OSCAR 7's Mode Schedule will be changed effective January 1 to two days in Mode B for every day in Mode A, and the new schedule will be shown in W6PAJ's orbital calendar coming out in December; see December Newsline. Ample Mode A operations will be provided by the Russian's "RS" spacecraft and AOD, and OSCAR 7 is considerably more sensitive in Mode B than it is in Mode A.

Increasing FM Operations just below 146 MHz are causing problems for OSCAR users. On Mode A 145.85-145.95 fm signals are being repeated to 10 meters, while Mode B users in major urban areas are having contacts broken up by local fm interference. A polite request usually suffices to move the fmers, but universal fm users' avoidance of 145.8 - 146.0 would be the best answer.

5139 Amateurs Throughout the world have used OSCAR 6 and 7, according to a compilation just completed by N3ES and WB2DNN. Just under 40 per cent are U.S. Amateurs, with the rest of the world's 60 per cent demonstrating the international importance of the Amateur space program. Recent word from South Africa has over 100 ZS stations active on Mode A and 20 on Mode B.

FLASHLIGHT "CW" SAVED EIGHT after the 37-foot yacht El Arca ran aground on Round Reef off the Virgin Islands shortly after dusk September 3. With no radio, the owner-captain aimed his flashlight toward shore and blinked a distress message that was spotted by KV4FZ. Herb alerted Civil Defense, Coast Guard, and REACT who immediately mounted a successful rescue effort.

"HAM'S" DETECTION of two policemen engaged in a restaurant burglary, widely reported in the press last summer, has some very unusual implications according to Florida Skip Editor W4IYT. By follow-up investigation, Andy found not only was the scanner-equipped "ham" not a ham, but the two policemen were using handheld units crystallized on 146.52, and neither of them was an Amateur!

Non-Amateur Use of Amateur transmitting equipment, this time for criminal purposes, is another powerful argument for point-of-sale controls — and a reminder that one never knows who is listening when you announce on the air you're leaving your home empty or parking your car in a vulnerable spot at the movie theater.

QUANTITIES OF FCC FORM 610s such as would be required for a large training class should be ordered from the Forms Distribution Center, Room B-10, 1919 M Street NW, Washington, D.C. 20554 rather than a local Field Office. A call or note to the nearest Field Office is quickest if you only need one or two.

KIWANIS MEMBERS may wish to check into a newly formed 20-meter net that meets Saturday mornings at 1700Z on 14275. There is also a Pacific Northwest net on 75 meters Tuesday and Sunday evenings on 3903 at 9:00 PM Pacific time.

HOT-AIR BALLOON ALTITUDE record was set by VS6DA on August 25 in Western Australia. VK6RU and VK6AO both assisted Geoff in the attempt, in which he reached 30,500 feet. Congratulations!

IMPORTANT WARNING TO FIBERGLASS USERS: The catalyst normally used to harden fiberglass resin can destroy eyesight if not washed from the eye within seconds after contamination. Always have a bowl of water at hand when working with resins.

DAWN OF THE SEMICONDUCTOR AGE

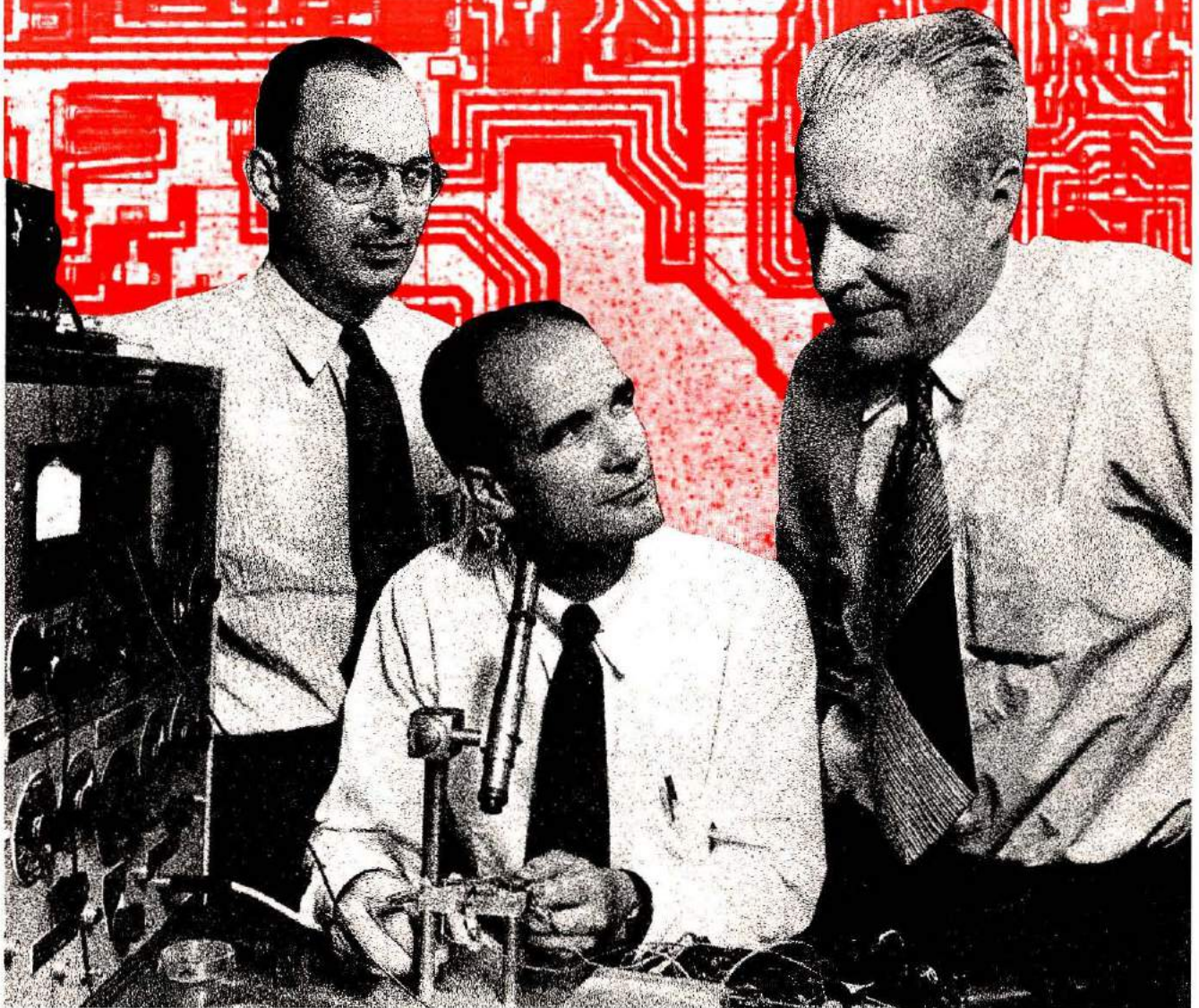

Transistors — how we got them, what we're doing with them, and what they're doing to us

BY STEVEN E. KOMANIECKI, WB9SDN

If a scientist discovers a great revelation or unlocks some secret of the universe, few people notice — unless, of course, he runs throughout the streets like Archimedes, shouting “Eureka! I have found it.” — but then they only stare. But if someone invents a new device that makes life easier for an already indolent society — well, then everyone notices.

This is what happened to semiconductor electronics. Solid-state physics was the foundation for the building of an electronic society. Its first offspring, the transistor, will ultimately change the entire dimension of human existence. Solid-state technology helped send man to the moon, deep into the seas, and into his own body; it flies his aircraft, plays his music and favorite television shows, and may even replace defective bodies. Indeed, it's a rare occasion when there's not some item within sight that's transistor related.

Because these solid-state devices influence all our lives, we should have a general understanding of them. First we should know a little about the transistor's predecessor, the vacuum tube; then we can learn how the transistor was developed, how it works, and the impact it has had on society.

Prelude to the electronic age

The foundation of the transistor was really started well before its official birthday when, in 1883, Thomas Alva Edison was striving to improve his newly invented electric light. The principal flaw in his invention was the way in which the red-hot filament slowly evaporated with sustained use. Edison tried everything possible to slow down the evaporation process. In one test, Edison took a small metal wire and placed it near the filament, thinking perhaps the presence of the wire would affect the life of the filament.

It didn't; but in testing this arrangement, Edison noted an unusual phenomenon: a distinct electric current could be detected in the metal wire, even though the wire was separated from the filament by a vacuum. Somehow current had jumped from the filament to the wire. This phenomenon, though unexplained, soon came to be called the Edison effect. An example is shown in Fig. 1.

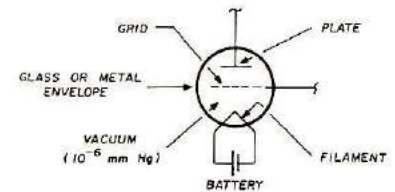
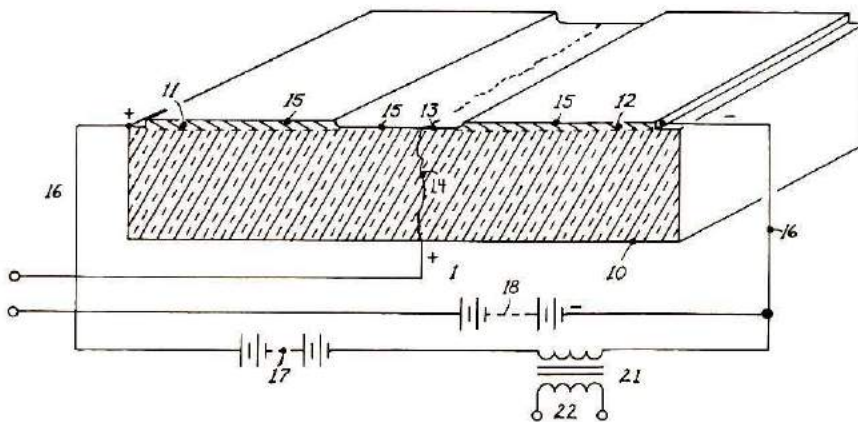

Fig. 1. Example of the Edison effect. Shown is a common triode vacuum tube (3 elements: filament, grid, and plate or anode). Electrons emanating from the heated filament cause an electric current to be induced into the nearby grid wire, even though the wire does not physically touch the filament. The phenomenon is also called “thermionic emission.”

Since its discoverer found no practical use for it, the Edison effect remained unexplained and unused for more than a decade. Near the turn of the century, however, subatomic particles were discovered (Milikin, Rutherford, Chadwicke, *et al*), and the Edison effect quickly ceased to be a mystery.¹ Researchers found that all the atoms that comprise matter contain electrons (negatively charged particles) and protons (positively charged particles).²

An electric current was found to be caused by the flow of electrons from one atom to another throughout the length of a conductor. During this same period the physicist, Owen Williams Richardson, explained that when metal filaments are heated in a vacuum, electrons “boil” out of the filament's atoms; the electrons then leap from the filament to the solitary wire. This subatomic evaporation explained the Edison effect.



Patent drawing of Julius Lilienfeld's “solid apparatus for amplifying oscillating currents,” which was filed with the U.S. Patent Office in 1926. 10 designates “a base member of suitable material, for example, glass.” 11 and 12 are a pair of conducting members such as a coating of platinum or silver, and 13 is an aluminum foil electrode which “is secured in position by providing a transverse fracture (14) in the glass and then re-assembling the two pieces.” Finally, superimposed over 11 and 12 is a thin film of “uni-directional conductivity” (such as copper sulphide, widely used as a rectifier before the availability of silicon or germanium diodes). Lilienfeld's invention is perhaps the first recorded version of the field-effect transistor.

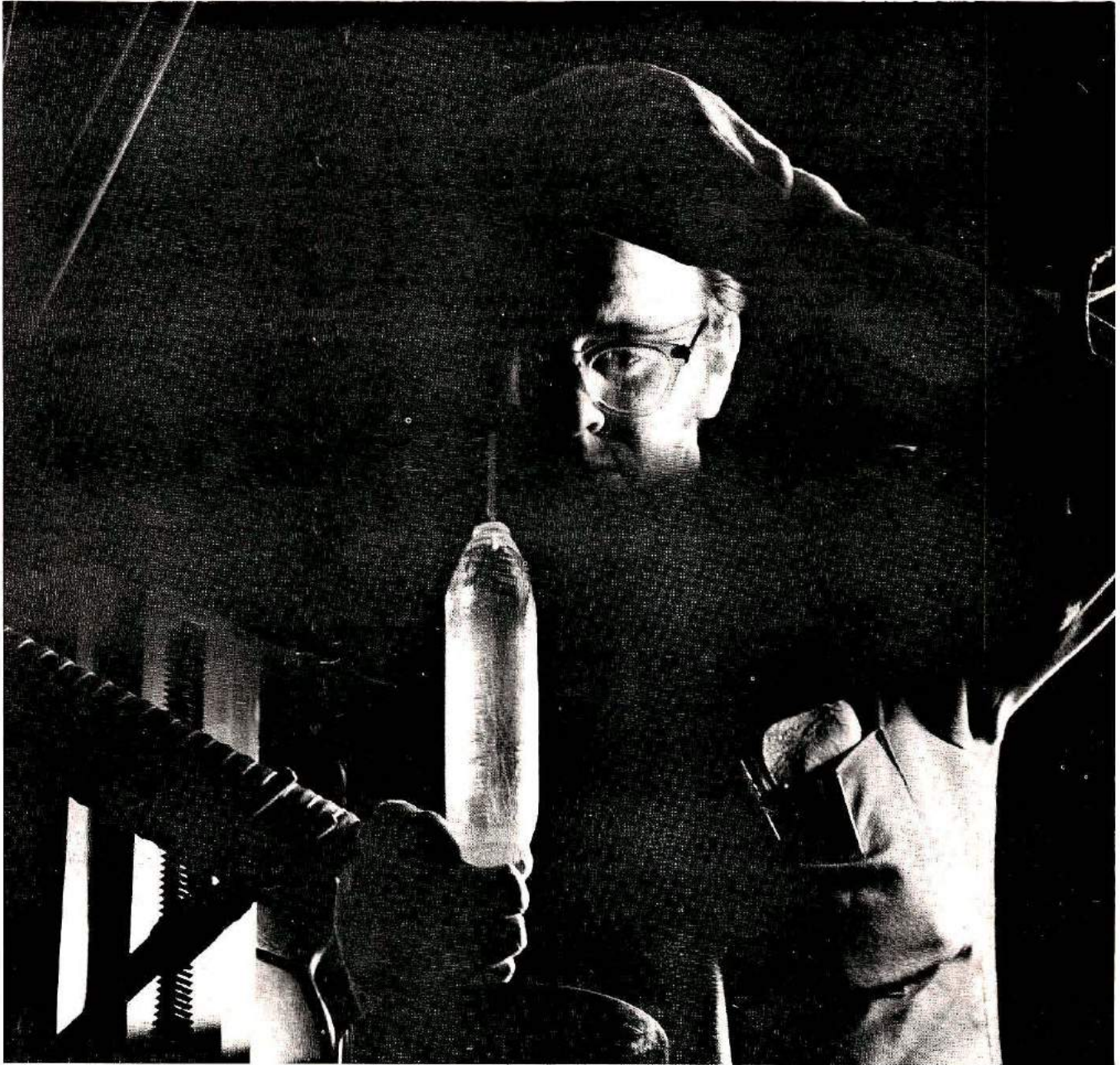

C. David Brandle of Bell Labs in Murray Hill, New Jersey, examines a newly grown single crystal of garnet. Slices of this synthetic crystal are the basis for a new family of semiconductor memories being developed for computers (photo courtesy Bell Labs).

In 1904 the English electrical engineer, John Ambrose Fleming, put the Edison effect to use in an original manner. He placed a small metal cylinder around the filament and encased the entire system in an evacuated bulb. When alternating current (which changes direction many times per second) was applied to the terminals, Fleming found that current flowed mainly from the

filament to the "plate" (or anode), which surrounded it. Fleming called his device a *valve* (the British still do today) because of its ability to turn the electric current on and off much like a water valve. This vacuum tube, which converts two-way motion into one-way motion, is now known as a *rectifier*³ (Fig. 2).

The American inventor, Lee DeForest, carried electronic

control a step further. In 1907, he inserted an element between the original plate and the filament. This added element was called a *grid* because it was perforated with holes; it was given a positive charge in relation to the cathode (an absence of electrons). Because it's positively charged and closer to the filament than the plate, the grid can intercept electrons

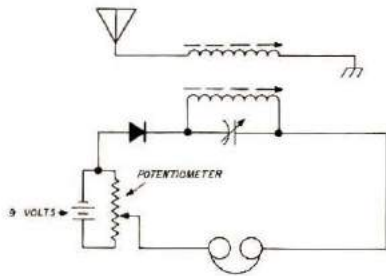

Did you ever hear of Dr. Pickard's oscillating crystal? It's one of the earliest examples of an operating semiconductor circuit, and was published in the March, 1920, issue of *QST*. The circuit was apparently widely duplicated by amateurs, but few, if any, could make it oscillate because their crystal material was not *exactly* the same as Dr. Pickard's!

from the filament, thus speeding the electron flow to the plate.

When the positive charge on the grid is made to increase slightly, the electrons come out of the filament in considerably greater quantities. A small increase or decrease in charge on the grid will impose a correspondingly large increase or decrease in the current passing from filament to plate. Furthermore, the pattern of change in current, or *signal* on the grid will be exactly duplicated by the current passing through the plate. This tube is now much more than a *valve*; it's an amplifier because of its ability to increase the amplitude or power level of a signal. **Fig. 3** shows a triode tube amplifier.

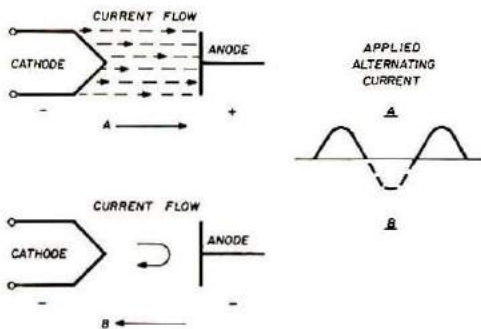

Fig. 2. Typical rectifier. Polarities (- and +) change during each half cycle of alternating current so that current can flow in direction A (sketch A) but not in direction B (sketch B).

In the United States, such amplifiers were commonly known as electron, or vacuum, tubes. Before the transistor, electron tubes were the mainstay of all electronics. Tubes were the only available means to amplify, modulate, and detect radio signals. As with all other man-made creations, the vacuum tube began to show deficiencies. The vacuum tube requires

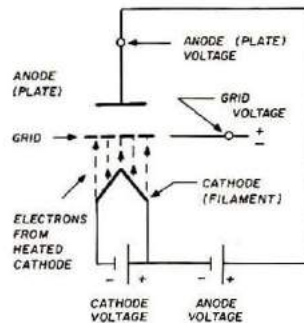

Fig. 3. A thermionic device, called a "triode" (3 elements: cathode, grid and anode) can amplify signals applied to its second element, the *grid*. The grid allows electrons from the cathode to pass through it. Variations in the grid voltage increase or decrease the electron charge from the cathode, which controls the density of the electron stream flowing between cathode (or filament) and anode. Thus, an *amplifier* is formed, which increases the applied signal.

large currents. More heat is developed, and the net effect is loss of efficiency, overheating, and shortened life span. Electron tubes also require a warm-up period. In radio circuits, tubes have an upper frequency limit beyond which they become unstable.⁴ Moreover, electron tubes require a large amount of space.

Finally, because many tubes are made of glass, they lack sufficient strength to survive the rigors of field operation. Engineers and scientists recognized these limitations. They saw that no investment, manpower, or money could make the vacuum tube good enough to meet the future needs of innovations just

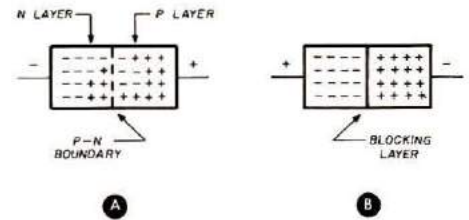

Fig. 4. The phenomenon of a semiconductor, which contains crystals contaminated by controlled addition of impurities. The type of impurity added to the crystal determines positive (P-layer) or negative (N-layer) conduction. In A, negative-charge carriers (N-layer) and positive-charge carriers (P-layer) migrate to the crystal center (dashed line), and current flows. If the applied voltage polarity is reversed (B), negative and positive charge carriers repel and migrate away from the boundary zone (blocking layer), thus no current flows.

beyond the horizon.⁵ Researchers began to look in new directions: to semiconductors.

Birth of the transistor

Semiconductors were not new when transistors were first developed; in fact, they had been around since 1874 when they were first investigated by the Germans. A semiconductor is a substance with electrical properties midway between those of a conductor, such as silver or copper, and an insulator, such as porcelain. Semiconductors in one state may act as conductors, allowing current to flow, while in another state they are insulators, restricting the current flow.

Bell Telephone Laboratories became interested in these

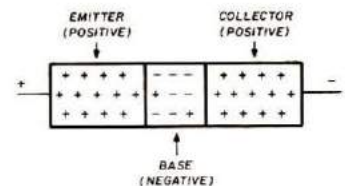
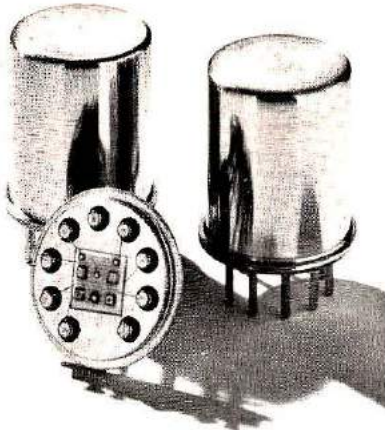
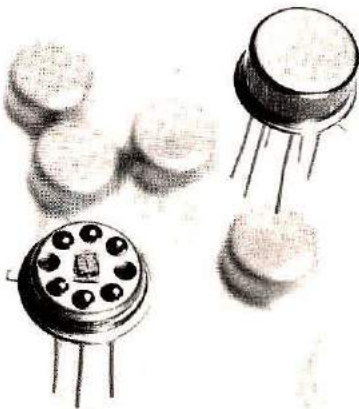

Fig. 5. How a transistor works. The current in the collector circuit is controlled by conduction in the base/emitter circuit. Thus the transistor can be used to amplify signals and to generate oscillations. Compare this action with that of "thermionic valves" or tubes (**Fig. 3**).



Field-effect transistor plug-in replacements for certain vacuum tubes, called Fetrons, are designed for use in electronic instruments (photo courtesy Teledyne Semiconductor).

semiconductors in the early 1930s, when they sought to apply ultrahigh frequency radio waves to Bell-System communications. These frequencies were much higher than had ever been worked with before, and it was soon found that the electron tube, the conventional detector, could not detect such frequencies efficiently. Seeking another solution, the researchers thought back to the old cat-whisker detectors which had



Inside a typical IC. The semiconductor chip is bonded to a metal; fine gold wires are used to connect the active device to the larger leads in the header which go to the outside world. The device is then hermetically sealed with a metal cover (photo courtesy National Semiconductor).

worked so well in Marconi's radio set.* The researchers found some old cat-whisker detectors in second-hand stores. The detectors made of silicon, a semi-conductor, worked best but were much too

researchers accidentally produced an ingot that was not purely one type of silicon; it was *P* in one part of the block and *N* in another.

What intrigued the researchers most was the

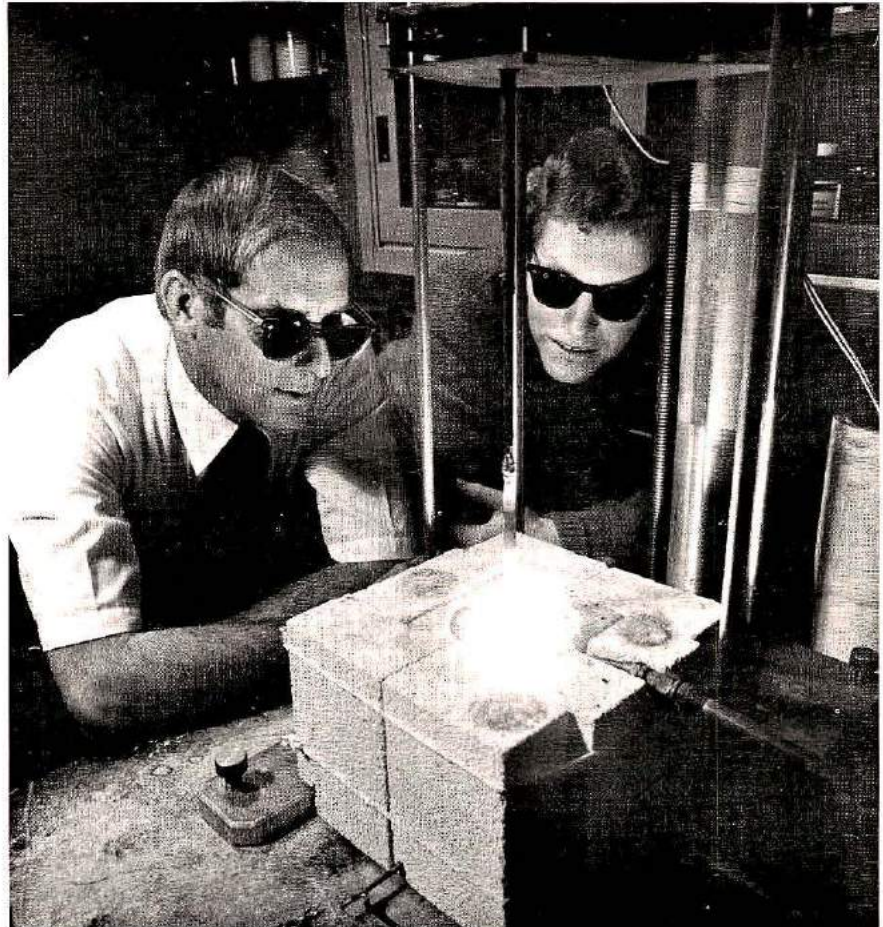

Researchers at Bell Labs watch the growth of lithium tantalate crystals which will be used in a filter for the Data Under Voice (DUV) microwave system produced in cooperation with Western Electric. Compared to quartz filters, the DUV filters have greater bandwidth and fewer components and cost less (photo courtesy Bell Labs).

erratic to provide reliable detection. This erratic behavior later turned out to be a blessing in disguise.

The scientists melted down and pulled ingots from the purest specimens of silicon available and, in studying their behavior, noticed that there were actually two kinds of silicon: *P* and *N*, depending on the positive or negative direction in which current flowed. One day, using a different supply of silicon, the

mysterious action that occurred at the *P-N* interface. Here, the dark silicon displayed an uncanny ability to convert light into electricity. A voltmeter was connected across the crystal, and when a flashlight was directed onto the silicon ingot, a definite potential difference was noted.

*Cat Whisker Detector — An early form of diode detector that consists of a needle point in contact with a base material of some type of semiconductor. Used in vintage radio equipment.

Even more important, the researchers discovered that the interface acted as a rectifier, permitting current to flow in one direction only, as in a vacuum tube rectifier; no wonder the cat whiskers worked so well in Marconi's radio!

Bell Lab scientists had discovered one of the most important phenomena of the electronic age — *P-N junction*. No one knew it at the time, but the *P-N junction* just discovered held the key not only to the transistor but also to the Bell solar cell. Several years passed, though, before these discoveries were put into practice. **Fig. 4** gives a rough idea of how the *P-N junction* works in a semiconductor device.

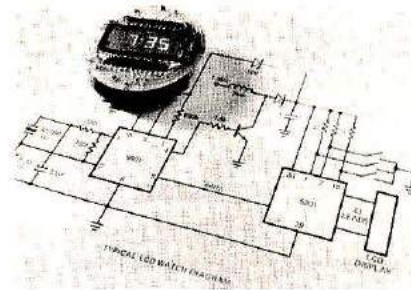

Modern digital watches would not be possible without semiconductors. This Liquid Crystal Display (LCD) watch uses two miniature ICs as well as a crystal and several external components (photo courtesy Motorola Semiconductor).

Meanwhile, during the 1930s, Bell engineers began to look for a substitute amplifier for the vacuum tube. Perhaps the answer could be found in semiconductor crystals. When used as detectors, the crystals

involved only two electrodes, just like the filament and plate of an electron-tube rectifier. Why not introduce a third electrode that would act as a current-controller, as in the grid of a vacuum tube, to make it amplify? The answer was soon to be found.

With a return to peacetime operation after World War II, Bell Labs made an important decision: to begin an organized investigation. So in January, 1946, a research team was formed to investigate the prospect.⁶ Among the many investigators who went to work was a notable trio: William Shockley, Walter H. Brattain, and John A. Bardeen. Shockley and Bardeen were pencil-and-paper physicists — theoreticians — and Brattain

Many electronic circuits require careful transistor matching for best results. The National LM194 pictured here consists of two carefully matched NPN transistors on a single chip. In the background is a microphotograph of the chip; to the left is a thin slice of silicon with hundreds of matched transistor pairs. This is cut up into single small chips which are installed in the metal packages, foreground (photo courtesy National Semiconductor).

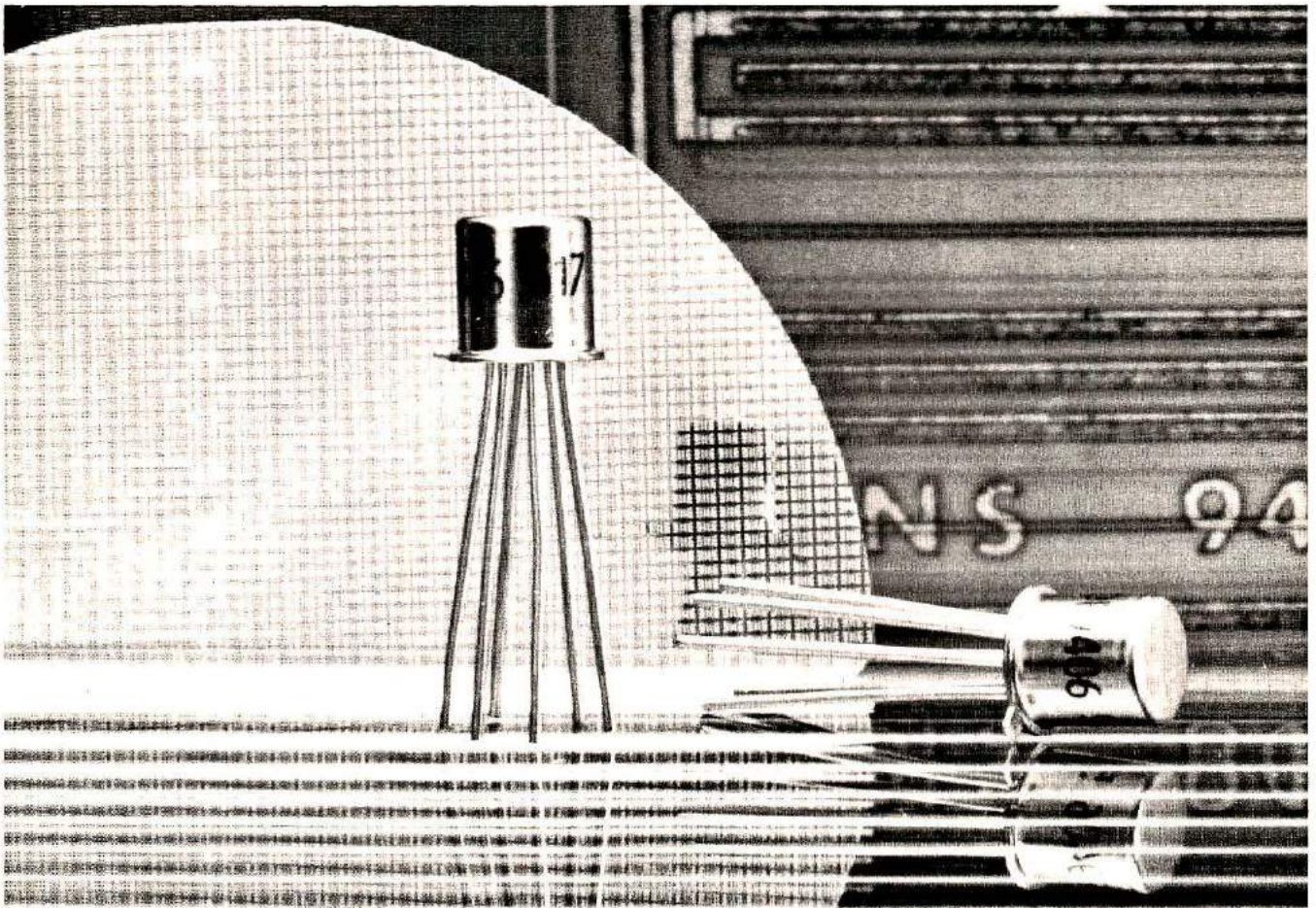

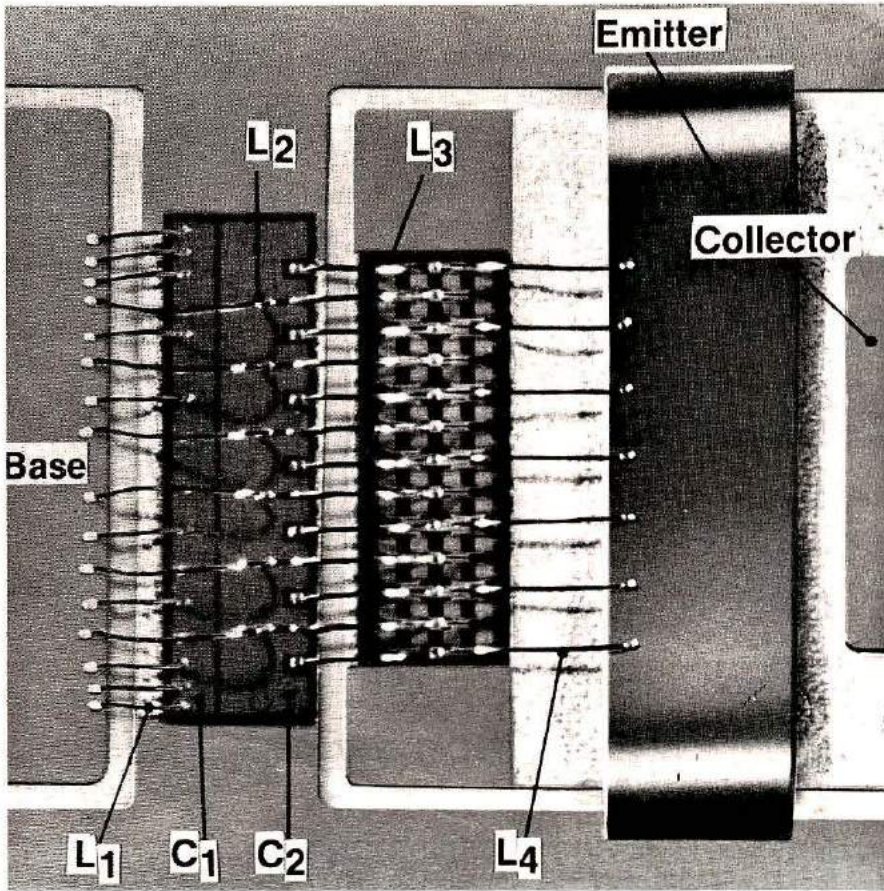

Looking more like a hybrid integrated circuit than a discrete transistor, Motorola's newest line of uhf power amplifier devices features double tuned input matching networks to a multiple transistor to achieve broadband operation from 100 to 500 MHz with power outputs as high as 80 watts (photo courtesy Motorola Semiconductor).

was the lab man or experimenter.

Pooling their creativity, these three men evolved theories and tested them in the lab. From Shockley's calculations, Brattain tried to control the current flowing through a semiconductor crystal; no luck. Then Bardeen modified the theory and Brattain figured out a way to make it work by covering the crystal with an electrolyte. It worked, but feebly. So far, they had been using silicon crystals. Next they tried germanium, which is another semiconductor. Nearly a month later, mid December 1947, they observed that the crystal, which was in contact with two wires two-thousandths of an inch (0.05mm) apart, was behaving in a way never observed before: it was

amplifying; it could in fact amplify a voice 40 times. This phenomenon came to be known as the *transistor effect* (see Fig. 5).

Transistor operation

A transistor is basically a resistor that amplifies electrical signals as they are transferred through it from input to output terminals. The word *transistor* was actually derived from the words *transfer* and *resistor*. It was found that transistor action depends on the activity in the *P-N* barrier.

To understand what happens inside a transistor, we must know a few important things. In a conductor (e.g. a wire), there are really *two* types of current carriers: electrons and something slightly different called holes. The application of

an electric field to a conductor will cause electrons to move to the positive terminal and the holes (which are really vacancies of electrons originally in the metal atom) to move in the opposite direction to the negative terminal. Like charges repel, unlike charges attract.

Next we must know a little about semiconductor chemistry. The semiconductors used in electronics are usually elements that have four valence electrons each. Valence electrons are those which are free to bond with other atoms. *Silicon* and *germanium* are elements of this type. Under laboratory conditions, their crystals can be grown to nearly any desired size and can be made almost perfectly pure. This type of *intrinsic* material is not of much use, though, because it is really only a high value resistor.⁷

Soon after the first transistor creation in 1947, Bell Lab scientists started work on practical models. In 1951, Morgan Sparks created the bipolar transistor. The birth of

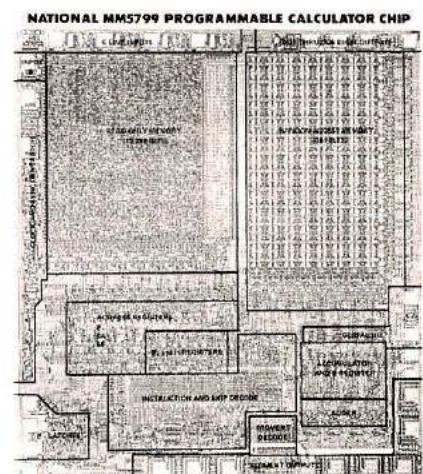

Photomicrograph of the National MM5799 programmable calculator chip, which contains all system timing, arithmetic, and logic, plus memory for more than 12000 bits. A chip such as this is called Very Large Scale Integration or VLSI (photo courtesy National Semiconductor).

the first point-contact transistor was announced in the laboratories' old building opposite the Hudson River docks; in the same building where, twenty-three years before, Davison had discovered electron waves.

The auditorium was jammed with reporters, and on that day — June 30, 1948 — Shockley, Bardeen, and Brattain explained what they had done. They had samples of transistors so small that they could barely be picked up to show the curious onlookers. They also had built a working radio. It had a plastic case so that the public could see there were no tubes at all. For their work, the researchers later received the Nobel Prize in physics.

The impact of the transistor was tremendous. Why? — because Bell Telephone was determined not to keep the invention a secret. This step was radically different, because in most technical industries secrecy is the norm. Morgan Sparks, inventor of the bipolar



Nobel Prize winners Dr. William Shockley, Dr. Walter Brattain, and Dr. John Bardeen (left to right) discuss the crystal structure of semiconductors. The trio received the 1956 Nobel Physics award for their invention of the transistor, which was announced in 1948 (photo courtesy Bell Labs).

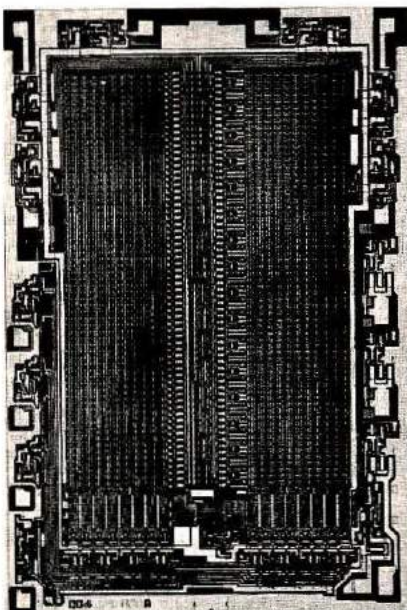

Photomicrograph of a Signetics 4096-bit read-only semiconductor memory. Actual size is approximately 0.1 by 0.16 inch (2.5x4mm); power dissipation is 125 microwatts per bit. This device can replace up to 144 other ICs (photo courtesy Signetics).

transistor, wrote this⁸ for the *Bell Record*: "Bell Lab's first important policy was not to keep transistor information secret. Not only was it not kept a secret, but we actively

expounded the art as well as the science of practicing the technology. Several seminars were held in the early 1950s, where we told all we knew about transistor technology.

References

1. Issac Asimov, "Happy Birthday Transistor," *Saturday Review*, December 23, 1972, page 46.
2. *Understanding Transistors and Transistor Projects*, Allied Radio Corporation, Chicago, Illinois, 1969, page 9.
3. George Grammer, *Understand-Amateur Radio*, American Radio Relay League, Newington, Connecticut, 1971, page 31.
4. M. Surzberg and W. Osterheld, *Essentials of Electricity*, McGraw-Hill, New York, 1965, page 585.
5. Dr. M. Brotherton, *The Magic Crystal*, Bell Telephone, October, 1972.
6. Martin Mann, *Revolution in Electricity*, Viking Press, New York, 1962, page 62.
7. James Kyle, *Electronics Unraveled*, TAB Books, Blue Ridge Summit, Pennsylvania, 1974, page 157.
8. Morgan Sparks, "25 Years of Transistors," *Bell Laboratories Record*, page 342.
9. B. E. Strasser, "Ma Bell Led the Way," *New York Times Magazine*, December 3, 1972, page 110.

HRH

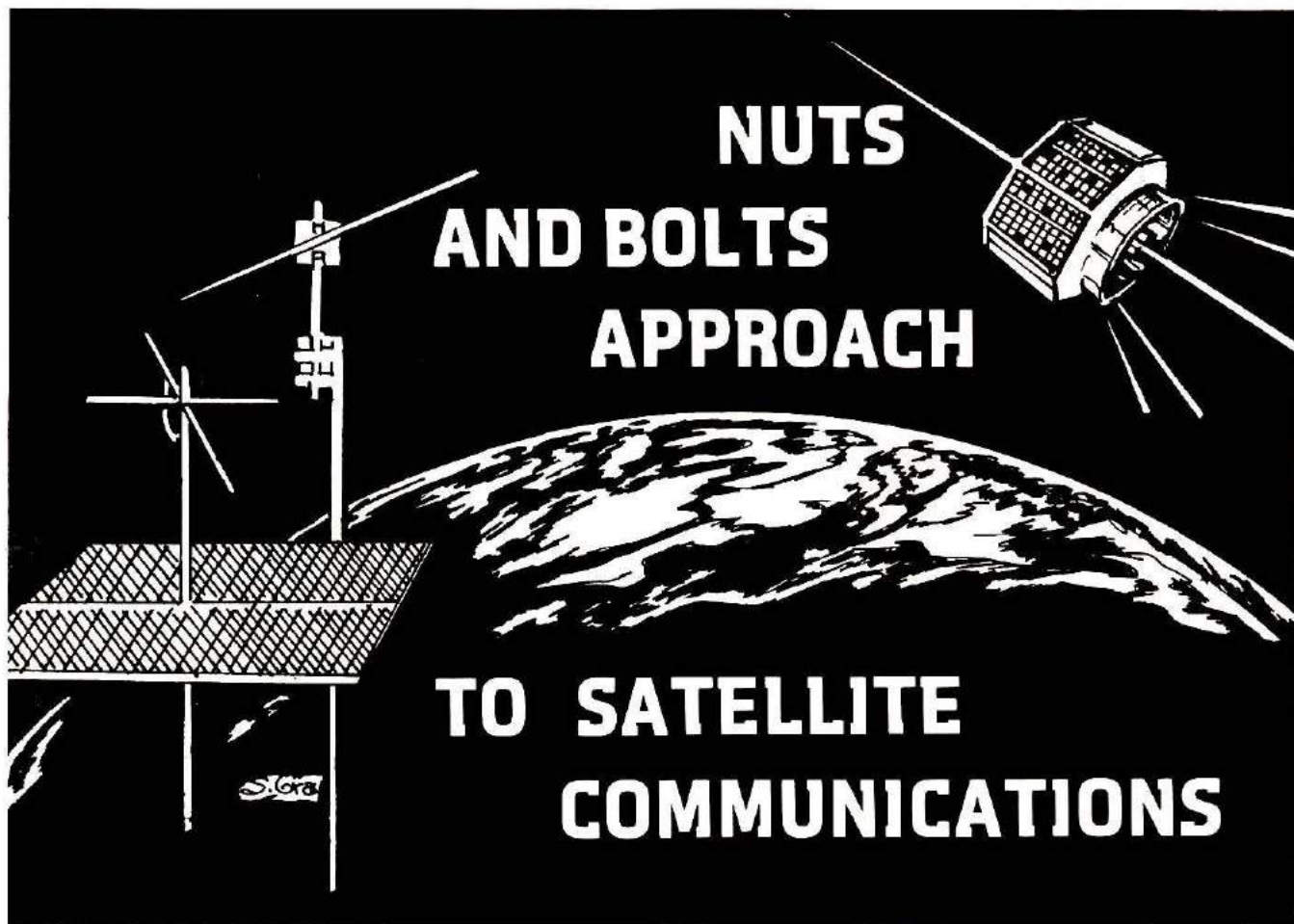

JIM GRAY, W1XU

By now you've probably heard about AMSAT, the Amateur Satellite Corporation, and OSCARs 6 and 7, acronyms that stand for the sixth and seventh Orbital Satellites Carrying Amateur Radio, placed in orbit for the purpose of providing amateurs around the world with an opportunity to communicate with each other by satellite!*

Perhaps you've even heard amateur stations on the high end of the ten-meter band, and wondered if they could be signals relayed by satellite. If so, did you ever ask yourself, "I wonder if I could do that?" Okay, what did you *do* about it?

If you answered "nothing" to that question, you're not alone. Many hams who have never heard signals from the satellites have not done anything about trying to communicate through OSCAR

because "I don't know where to start," or "I don't have the equipment," or "It's too complicated for me" and any one of a variety of similar excuses. Don't believe them! You *can* do it, you *don't* need much equipment and it's *not* at all complicated.

What you'll need

Really, it's very simple to put together a station capable of working through the satellites. You'll need a transmitter, a receiver, and an antenna system. That's right, antenna *system*, but don't be alarmed; two very simple and inexpensive antennas that you can build are all you'll need to start: one for your transmitter, and another for your receiver. In addition to this station equipment, you'll also want

*Anthony R. Curtis, K3RXK, "Riding High With OSCAR Satellites," *Ham Radio Horizons*, March, 1977, page 18.

some data about when and where to look for the satellites — and that's easy to acquire, too. More about these things later.

Some background

December 12, 1976, marked the 15th anniversary of the launching of OSCAR 1, the first non-government satellite to be put into orbit. Four other OSCARs were launched between 1 and 6, but none remain functional — their battery systems were not designed for long life.

OSCAR 6 was launched on October 15, 1972, carrying a repeater, sometimes called a transponder or translator, that could receive amateur signals and retransmit them. The translator picked up signals on the amateur two-meter band (145 MHz) and sent them back in the 10-meter band (29 MHz).

OSCAR 7 was put in orbit on

November 15, 1974, and has two repeaters aboard. One receives signals on two meters, and repeats them on 10 meters, the same as OSCAR 6; the other picks up signals on the 70-cm (420 MHz) band and rebroadcasts them on two meters. Both OSCARS have transmitters that send information about the conditions within the satellite to help the control stations keep things running right. These are called telemetry channels or frequencies (*tele* = distant, *meter* = measure).

When OSCAR 7 is translating from two-to-ten meters, it is operating in Mode A, and when it is repeating from 432 to 145 MHz, it is in Mode B. The satellite alternates between Modes A and B on different days of the week, except for special days or experiments. For our purposes, we'll talk about OSCAR 7 in Mode A, because these are the easiest frequencies to reach with simple equipment.

Uplink and downlink

Signals that go from the ground station up to the satellite are called uplink signals or frequencies; those that return to earth from the satellite are called downlink signals, to borrow some terms

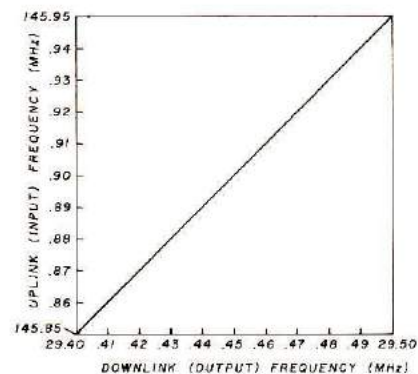

Fig. 1. The frequency translation of OSCAR 7, in Mode A, can be obtained by using this chart. Find your input frequency on the left, follow the line to the diagonal, and then down to the bottom. Read the output frequency between 28.4 and 29.5 MHz.

Table 1. OSCAR 7 operating frequencies.

Input (uplink) Frequency
145.85 to 145.95 MHz
432.125 to 432.175 MHz
Output (downlink) Frequency
29.4 to 29.5 MHz
145.975 to 145.925 MHz
29.502 MHz beacon
435.103 MHz beacon

Note: The uhf translator inverts the signals; USB on 432 MHz becomes LSB on 145 MHz. There is no signal inversion through the vhf translators.

from the space age. To talk through OSCAR 7, you must transmit in the uplink band of 145.85 to 145.95 MHz. The downlink signals will return to you between 29.4 and 29.5 MHz. **Table 1** shows this relationship between the frequencies. The general formula for finding the downlink signal on OSCAR 7 is:

$$F (\text{downlink}) = F (\text{uplink}) \text{ minus } 116.45$$

If I transmit on 145.93 MHz, and subtract 116.45, then I should hear my own signal on 29.58 MHz — and so will anyone else who listens there. You can use the chart of **Fig. 1** to find where your two-meter frequency will come back to you in the downlink for OSCAR 7.

In addition to repeating Amateur transmissions, OSCAR 7 also originates its own *telemetry* transmissions on 29.502 MHz, that tells ground stations all about battery voltages, temperatures, solar-cell charging rates, current consumption, and many other conditions on board the satellite. Ground-command

***Editor's Note:** When this article was written, both OSCAR 6 and 7 were in operation. Since that time, however, OSCAR 6 has had battery problems and was shut down by command stations in an effort to prolong its life. It now refuses to respond to command signals, and must be presumed inoperational.

stations can use this data to determine what, if anything, needs to be changed aboard the satellite, and can actually make changes — such as turning the repeaters on and off, changing power levels, and the like.

The telemetry data is sent in Morse code, and with a bit of practice, plus interpretation tables found in AMSAT's *Orbital Predictions* you can interpret on-board conditions on each pass of the satellite over your area. In fact, both AMSAT and its network of command stations welcome this information from you, and use it to be sure that all is going well. Write to AMSAT, Box 27, Washington, D.C. 20044.

The OSCARS were launched in sun-synchronous orbits; this means that they pass over the same *track* above the earth at about the same time each day. The orbits are roughly circular and at an altitude of about 900 miles (1400km). From this distance, each OSCAR "sees" an area about 5000

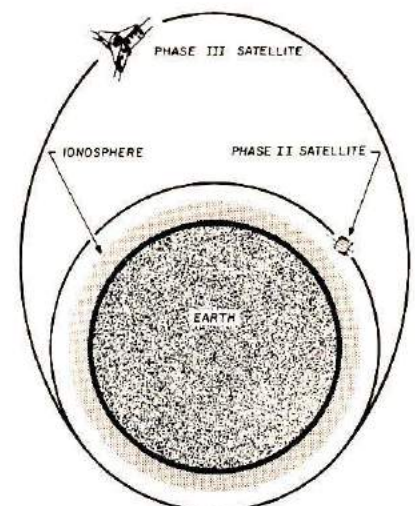

Fig. 2. A new satellite, in the Phase III program of AMSAT, is under construction and may be launched soon. Shown here are the relative orbits of the present (Phase II, or OSCAR 7) satellite and the proposed Phase III type. The new satellite will have a more elliptical orbit, providing amateurs in the northern hemisphere with communications capability nearly 60 per cent of the time.

miles (8000km) in diameter. Their period of revolution about the Earth is approximately 115 minutes; that is, one hour and fifty-five minutes. The orbital paths, however, do not cross the equator perpendicularly, but instead at a slight angle. Each pass is therefore in a generally northwest-southeast direction as it crosses the equator coming north, and is 28 degrees of longitude farther west, representing the distance the earth has turned beneath the orbital path in the last 115 minutes. For example, if one pass is about over Boston, the next one — 115 minutes later — will be approximately over Kansas City.

In the evening hours over the United States, both OSCARS make ascending-node orbits; that is, they head northwestward from the equator. In the morning hours over the United States, both make *descending-node* orbits, passing overhead

in a generally northeast to southwest direction. Because of this, it is a bit easier to work stations in the Carribean and South America in the evening, and in Europe and Africa in the morning, if you happen to live in the eastern part of the United States.

Doppler effect

Because the satellites move so fast (somewhere between 17 and 18 thousand miles (27 to 29 thousand kilometers) per hour,) the signals you will receive from them appear to change in frequency during each pass. Therefore, you'll have to tune your receiver slightly during the time you talk to another station. This effect, known as the Doppler shift, is similar to the change in pitch of a car horn as it approaches and passes you.

The OSCAR satellites tumble slowly in their orbits, so their

antennas are constantly changing angle and perspective as seen from your location. This also means that the signals you receive will not be constant in strength. In addition to this, the signals will also vary in strength due to polarization effects caused by their passing through the ionosphere at an angle. Finally, the signal strength will change according to how close or far away the satellite may be from your station. All of these factors contribute to changing signal strength, but aren't meant to discourage you. They are only mentioned so you won't think you are doing something wrong when you find the signals getting stronger or weaker. Some stations use less power than others, too, and the effect of that variation will be noticeable.

The satellites have only so much transmitter power

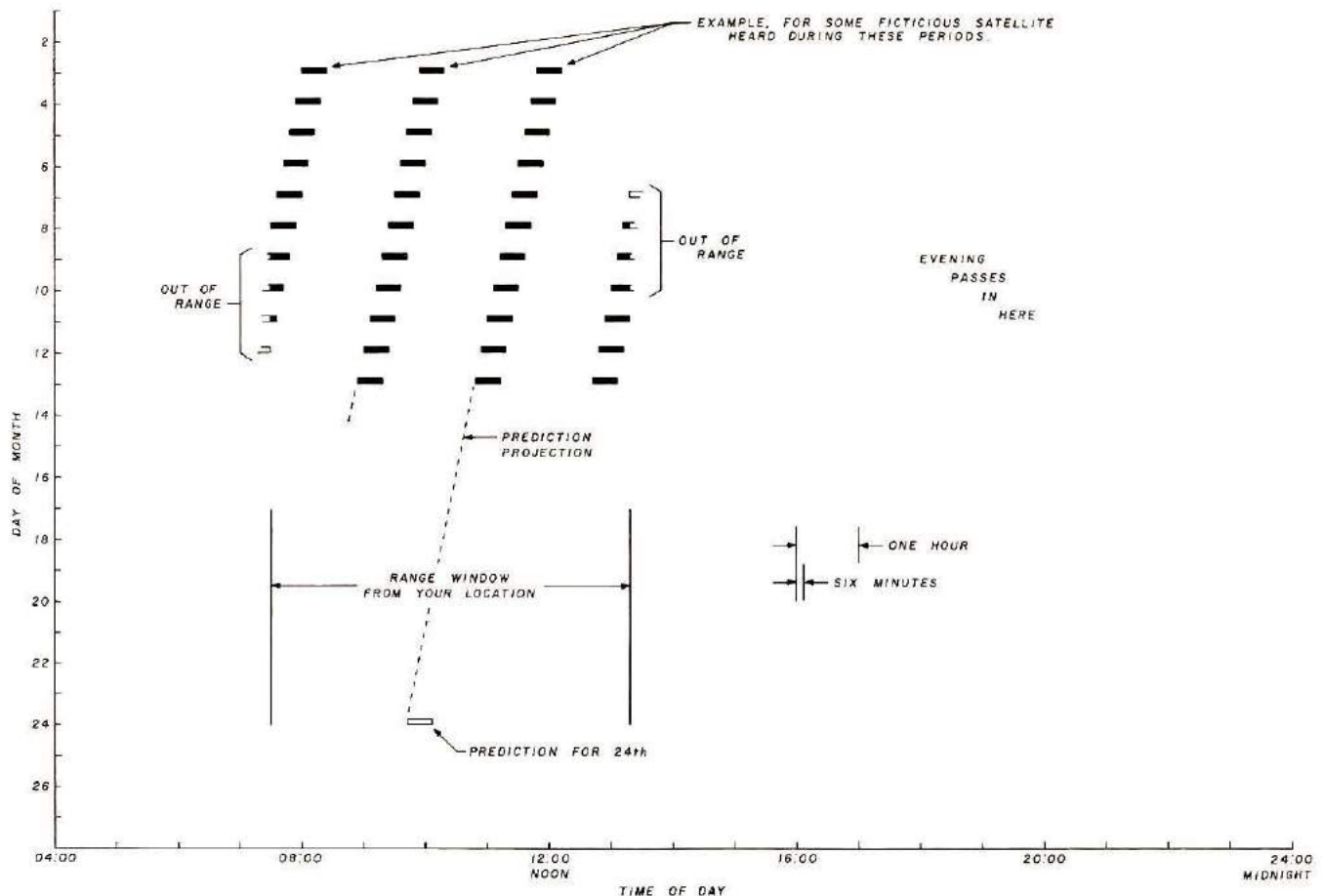

Fig. 3. Here is an example of an orbital prediction chart that you can make for your location if you do some listening and plot the times that you first hear and last hear the satellites. Morning passes are on the left side, evening on the right. Days of the month are designated along the left margin. See text for explanation of how each mark corresponds to a satellite pass.

available; therefore, the amount of power devoted to each repeated signal is proportional to the strength of the received signal. For this reason, it would not be fair for one user to "hit" the satellite with 1000 watts, when another user can only muster 25 watts. OSCAR users are requested to use only about 100 watts effective radiated power. This means the output power of your transmitter multiplied by the gain of your transmitting antenna should be no more than 100 watts.

As an example, suppose your output power is 25 watts and your antenna power gain is 4 (6dB). Four times twenty-five gives you the suggested ERP (Effective Radiated Power).

Finally, you ought to know that OSCAR 7 sometimes reduces its total transmitter power and go into what is known as a low-power, or QRP, mode. For an entire day the signals may seem weaker to you than they should; one explanation might be that a QRP day is in effect. On these days, Earth stations are asked to reduce their power to a maximum of ten watts ERP. It is surprising how little signal it takes to communicate by satellite, and QRP users have been amazed at results.

Where and when

This is one of the questions that you're going to have to answer before you can transmit

signals to, or receive signals from the satellites. Fortunately, the answer is very simple. Some very helpful people have developed satellite locators. One of these is called a *Satellabe*; it is an orbital plotter in the form of a hand-held device having several concentric, movable rings of paper and plastic. The rings contain information about time and longitude, a map or chart, several overlays, and an orbital track. If you know the *beginning* orbit for any day, for either satellite, the calculator-plotter will permit you actually to see the path of that orbit and all other orbits for that day, merely by moving the tracking grid.

You may also want to invest in the publication, *1977 Orbital Predictions for AMSAT OSCAR 6 and AMSAT OSCAR 7*.† This booklet gives all of the data about equatorial crossing times and longitudes for every orbit of the entire year, and is almost indispensable for the serious OSCAR user.

Fig. 3 shows a simple graph developed by G3BVU, that you can construct for your particular location, and it will hold good for a very long time. Best of all, it costs nothing except a little time and effort, plus a fair amount of listening. That's what you plan to do anyway — so it's time well spent.

To make the graph, lay out the days of the month on the

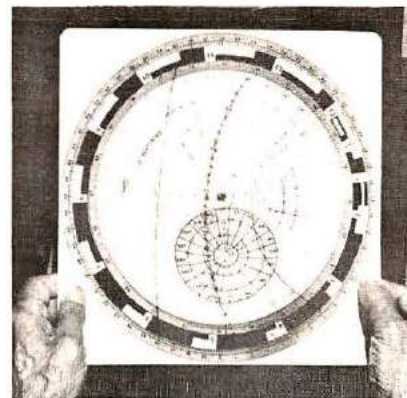

The position and orbital track of OSCAR can be found for each pass near your location by using this *Satellabe*. It is available from *ham radio's* Communications Bookstore, Greenville, New Hampshire 03048, for \$7.95 postpaid.

vertical margin (ordinate) and the time of day on the horizontal margin (abscissa) of your paper. Use the 24-hour clock system. Now, begin listening. Every time you hear one of the satellites, mark in the time of day you first hear signals, and the last time you hear signals on that pass. The result will look like a short, horizontal dashmark. By listening to several successive passes on several different days, you'll begin to develop a plot of times for AOS (Acquisition Of Signal) and LOS (Loss Of Signal). By extending the plots as shown, you can develop a prediction system. The range *window* will begin to make itself apparent, too; that is, the easternmost and westernmost orbits that you can hear from your location.

Transmitters

You don't need a fancy transceiver, capable of doing everything but the dishes, to hear and work OSCAR. At first, you will only need CW, so don't go out and buy a vhf ssb transceiver until you're sure that you want to become a permanent OSCAR user. Many serviceable two-meter CW transmitters are available in the used market for well under

†Available for \$5 from Skip Reymann, W6PAJ, Box 374, San Dimas, California 91773.

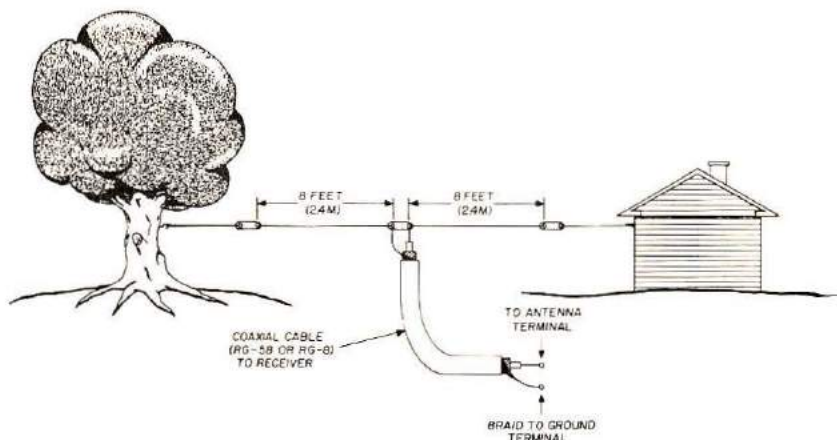

Fig. 4. A simple dipole made for the 10-meter (29-MHz) band will allow you to listen to the OSCAR satellites. Height of the antenna above ground is not particularly critical, but in general the higher you can place it, the better it will receive the satellite signals.

\$100. You might even find one for less than \$50! A very good one is the discontinued Ameco TX-62, with accessory vfo. Another might be the old Johnson 6N2, or one of the older Heathkit rigs that covered two meters. A vfo is desirable, but not absolutely necessary. Just be sure that everything works okay, puts out a decent, stable signal, and has an output power of about 50 watts or so — up to 100 watts, if you don't plan to use a beam antenna. That's it for transmitters.

Receivers

Here is where you may already be in good shape. Almost everyone has a receiver that will cover the entire ten-meter band. If not, many can be made to do so merely by adding a crystal to extend the coverage. Some older receivers covered the whole band, but weren't too sensitive. A good way to check the sensitivity of your receiver is to tune it to the ten-meter band, near 29.5 MHz, with the antenna disconnected. When you connect the antenna you should hear an increase in hiss or background noise. If you do not hear such a change, the receiver needs help in the form of a preamplifier,* they'll do wonders to pep up an old dog. Just make sure that the combination covers 29.4 to 29.55 MHz. That's about it for receivers. I told you that it was simple!

Antennas

You'll need two antennas, as I said before. One can be a simple dipole, sixteen feet (4.9m) in length and fed with coaxial cable, for your receiving antenna (Fig. 4). Put it as high and in the clear as possible, but don't worry if you can't. I've seen excellent OSCAR

*Some suppliers of preamplifiers and converters are: Janel Laboratories, 3312 S.E. Van Buren Blvd., Corvallis, Oregon 97330; Ameco Equipment Company, 275 Hillside Avenue, Williston Park, New York 11596; and Hamtronics, Inc., 182 Belmont Avenue, Rochester, New York 14612. Write for current models available and prices.

receiving antennas inside buildings (although not steel buildings). You may want to try different directions for your dipole, but most users recommend putting it up with the legs running north and south.

The transmitting antenna is somewhat more important. You could use a beam, but that creates still other problems and complications. One of the common antennas for use with OSCAR is a simple *turnstile*, Fig. 5, consisting of crossed dipoles above a reflector screen. Dimensions for both bands

are given in the table with Fig. 5.

What about beams?

As long as you asked, let's just say that it is possible to use multi-element arrays on azimuth and elevation mounts that provide tilt and rotation for your antennas. Usually, the two beams (for 2 and 10 meters) are mounted on the same support and rotate together. A very sophisticated arrangement would include a drive mechanism — perhaps computer-fed — that automatically tracks the satellite for you during its pass. You could

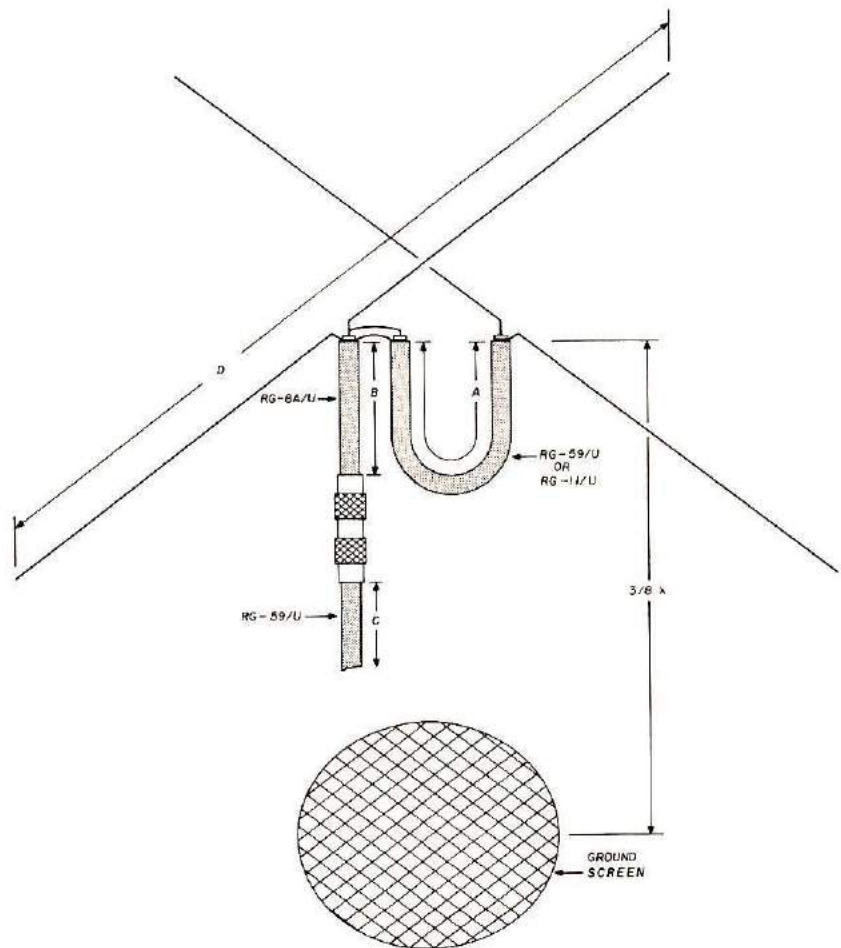

Fig. 5. A turnstile antenna can be made for either 29 MHz or 145 MHz, and is an excellent transmitting and receiving system for use with OSCAR. Dimensions are given for the element length and coaxial cable sections for both bands. For best results the crossed dipoles should be placed over a metal screen that is one wavelength on each side (32 feet, or 10 meters, for receiving; 80 inches, or 2 meters, for transmitting). The distance from the screen to the dipoles in each case should be approximately 3/8 of the wavelength dimension for that band.

DIMENSION	10 METERS	2 METERS
A	56 INCHES (142cm)	13 INCHES (33cm)
B	54 INCHES (137cm)	13 INCHES (33cm)
C	NEEDED LENGTH TO TRANSMITTER	
D	16 FEET (489cm)	39.5 INCHES (100cm)

even have a choice of helical antennas with right- or left-handed polarization, switchable at will. The fact is you don't need them, but if money is no object, go ahead. Remember that with a beam, however, you're going to have to follow OSCAR across the sky; otherwise, it will pass through your narrow beam pattern too quickly.

If you must use a beam, be sure to use only a three- or four-element job. You can tilt it up about 20 or 30 degrees and fix it at that angle. Use two beams, if you must, but don't blame me if your buddy does better with dipoles.

You could use something like a two-meter ssb, CW, and fm transceiver. Lots of good ones are being made in Japan and elsewhere. They will cost you the better part of a \$700 bill before you're through, and

they won't do any better on CW than the Ameco TX-62 with vfo, for example. You might also buy a transverter for your existing CW-ssb transceiver. That's okay, too, and transverters work well. Simplest is best for the beginner — and much less expensive.

Assuming you've built the simple antennas, have acquired the transmitter and receiver, obtained an orbit calendar and plotter, and have done lots of listening, you're ready to access the satellite. Pick an overhead pass for your first try. Let's say you find OSCAR 7, mode A, suitable. Okay, pick a frequency from the chart of **Fig. 1**. You chose 145.93? Good. Now, tune your receiver to 29.49 MHz. Here it comes! Send a series of Vs, or a series of dits, while tuning around your chosen spot. Soon, you should hear them coming back

Επιτόξιο Καταγραμμένο
OSCAR
International Radio Satellites



If you would like to know more about satellites and how they work, what makes them stay up there, and what can be done with them, here is a book that has all the answers. It's an excellent English translation of the original German edition. The price is \$8.50; order RS-O from *ham radio's* Communications Bookstore, Greenville, New Hampshire 03048.

Do you speak OSCAR?

From AMSAT Newsletter,

March 1976

Orbit is the satellite's "highway in the sky", a fixed path in space.

Period is the time taken for the satellite to travel once around the earth.

Equatorial Decrement is the amount that the satellite's orbit moves west or east where it crosses the equator, due to the earth rotating on its axis. The satellite orbit also makes an angle with the equator.

Inclination is the angle of the orbit with respect to the equator.

AOS is the acquisition of signal, as the satellite comes within range of a listening station. AOS time is the time that the signal is first heard.

LOS is the loss of signal, as the satellite moves out of range of a listening station. LOS time is the time that the signal disappears.

Pass is the period of time for each station between AOS and LOS, when the satellite is within range.

Downlink is signals being

transmitted by the satellite toward earth.

Uplink is signals being transmitted by an earth station toward the satellite.

Passband is the range of frequencies available in the satellite for uplinks or downlinks. Example, OSCAR 7; Uplink passband 145.85 to 145.95 MHz; downlink passband 29.4 to 29.5 MHz.

Doppler is the slow frequency drift of signals from the satellite as it completes a pass. Similar to the change in pitch of a siren on a speeding vehicle as it moves away from you or toward you.

Azimuth is the horizontal direction of rotation of your antenna as it follows the satellite during a pass.

Elevation is the vertical rotation of your antenna as it follows the satellite during a pass.

Beacon is the transmitter aboard the satellite sending signals about its condition (spacecraft status).

Telemetry is the status signals from the beacon transmitter.

to you. Now rap out a CQ and listen near your frequency. Be patient, because other stations are going to have to hear you, zero beat, and answer. Also, they may have to follow the signal through its Doppler shift. Got an answer? Great! Now don't rag chew; a simple RST report, name, and location are fine. If you're nervous like I was the first time, it will take you the whole 20-minute pass to get set, have a QSO, and then sit back long enough to let it all sink in and quit shaking. By the way, you'll find that the conversation is fully *duplex*, meaning that you can talk and listen at the same time — like a telephone — and, what's more, hear your own signal.

What a thrill — you've worked through a satellite that was built for and by amateurs, and you've done it with a system that you assembled, and an antenna that you constructed. No wonder you're proud; you have every right to be. Enjoy OSCAR, and look for me.

HRH

above & beyond...

144-220-



Specifications

- Fully synthesized to 5 kHz on all three bands 144, 220, 440 MHz.
- High power output — 25 watts on 144 MHz 10 watts on 220 and 440 MHz. Programmable low power is switch-selected.
- Four diode-programmable fixed channels on each band in addition to the synthesizer.
- Scanner continuously monitors synthesizer frequency when using fixed channels or vice versa.
- Standard offsets or simplex on each band, plus a total of three diode-programmable offsets for special repeaters.
- Remote operation with optional trunk-mount kit.
- Complete 3-band model available or begin with basic configuration and add on other band modules later. Standard band models are:

Designed and manufactured in USA.
Sale subject to FCC Receiver Certification.

Model 1346 Drake UV-3 (144-220-440)	\$995.00
Model 1344 Drake UV-3 (144-440)	\$795.00
Model 1343 Drake UV-3 (144-220)	\$795.00
Model 1345 Drake UV-3 (220-440)	\$795.00
Model 1340 Drake UV-3 (144)	\$595.00

(Prices above include factory installed modules for bands as listed, standard dynamic mike, and mobile mounting bracket.)

*144 Add-on Module	\$250.00
*220 Add-on Module	\$250.00
*440 Add-on Module	\$250.00
Model 1504 Drake PS-3 AC Power Supply	\$ 89.95
Model 1525 Drake 1525 EM Encoding Mike	\$ 49.95
Model 1330 Drake UMK-3	\$ 69.95
Remote Trunk-Mount Kit	\$ 69.95

*Add-on modules expand band coverage of models which may have been purchased in a single band or two band configuration. Prices include factory installation which is necessary to meet FCC Receiver Certification requirements.

For the discerning FM enthusiast who wishes to reach above and beyond 2 meters we are proud to introduce the...

DRAKE UV-3

fully synthesized fm 3-band system

A total system, the UV-3 does not stop with 144 MHz, but can even include full synthesis on the entire 220 and 440 MHz fm bands as well. All of this coverage is now available in a single, bandswitched unit with add-on band capability for your convenience.

In addition to a synthesizer, fixed channels are diode-programmable for quick selection of your favorite frequencies. A built-in scan feature permits continuous scanning of dialed or programmed channels while operating on another channel. The UV-3 even lets you diode-program special offsets for those non-standard repeaters. A standard dynamic mike is included with the UV-3.

An optional remote trunk-mount kit (cable included) adds remote operation and security. The PS-3 AC Power Supply and 1525EM Encoding Mike (Shown in photo) are available as options for further expanding the capabilities of the UV-3 system.

Write for a fully illustrated brochure on the Drake UV-3 System.

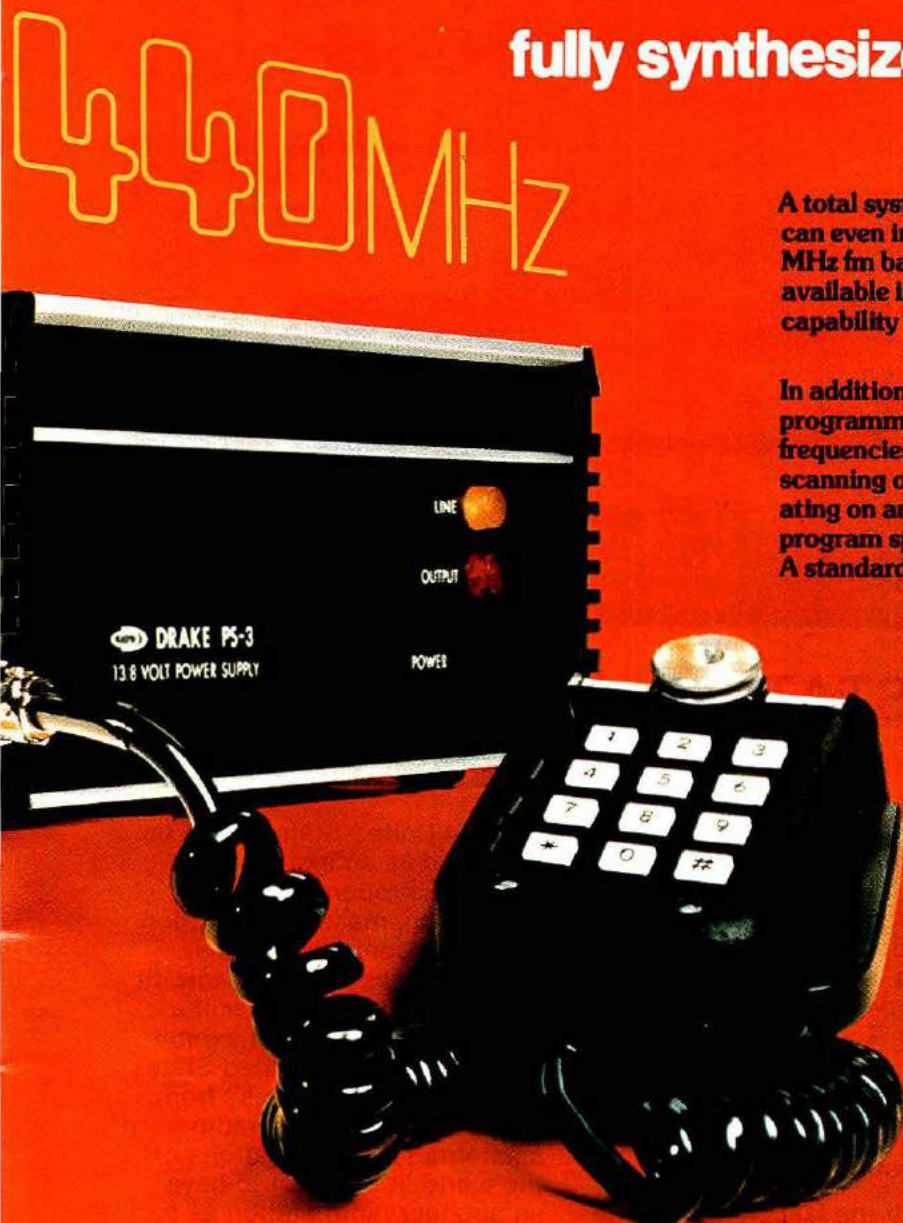

R. L. DRAKE COMPANY



540 Richard St., Miamisburg, Ohio 45342
Phone: (513) 866-2421 • Telex: 288-017

Western Sales and Service Center, 2020 Western Street, Las Vegas, Nevada 89102 • 702/382-9470



AMATEUR RADIO STATION NN3SI CALLING

BY JOE FINCUTTER, W3IK

The Smithsonian Institution's *Nation of Nations* exhibition in its Museum of History and Technology was not only a significant bicentennial display for 1976, but was intended as a sight to see for at least several more years. This exhibition covers the entire west end of the second floor of the building. The main theme of the exhibition is to depict that the United States is a Nation of Peoples who emigrated to North America from the many nations of the world, seeking a new life and a new life style. This new life style is a mixture of the many cultures these

people brought with them and is a distinctive influence on the modern-day world.

The *Nation of Nations* exhibition is divided into four sections, suitably marked as you wander through the displays. These sections are:

1. People for a New Nation.
2. Old Ways in a New World.
3. Shared Experiences.
4. A Nation Among Nations.

Although the last section is the location of amateur station NN3SI, I highly recommend a visit to the Smithsonian and the Nation of Nations exhibit. This last section typifies the

role the United States plays in the world as an exporter and importer through its mass production, mass consumption and mass communications.

Where does amateur radio fit into this exhibit? Well, since the basic theme of the exhibit indicates that the United States is a "Nation of Peoples" from all nations, and since radio amateurs talk to all nations of the world, it's logical to have an amateur radio station as part of the exhibit. The station operators do their best to talk to all nations of the world.

The amateur station has rug-covered stairs directly in front

of the exhibit, which is a fine place for the leg-weary to sit and rest while amateur radio is explained and demonstrated.

Station NN3SI

Let's get down to the real purpose of this article, amateur station NN3SI. The *Nation of Nations* exhibit was opened to the public on the evening of June 8, 1976. The first transmission of NN3SI (which was the special callsign assigned by the FCC to the Smithsonian Amateur Radio Club — Vic Clark, W4KFC, trustee) was made at 2130 (9:30 PM local time).

I was fortunate enough to be the chief operator that evening. The official opening ceremonies consisted of transmissions by Harry Dannals, W2HD, president of ARRL; S. Dillon Ripley, secretary of the Smithsonian Institution; and Vic Clark, W4KFC, first vice president of ARRL.

The first QSO, although in the form of an Official Bulletin, was with VE3JW, W1AW, and W2AN. Vic Clark transmitted a short poem by Walt Whitman that depicted the theme of the exhibit. He used a straight key that was once used by David Sarnoff (RCA) when communicating with the *Carpathia* on April 15, 1915, to obtain detailed information about the survivors of the sunken liner, *Titanic*.

Once the official ceremonies were over and we had loggers ready, it was

QRZ NN3SI? — 3865 kHz

What a pileup! But it was fun! We did our best to work those we heard until sign-off time. I know we missed many callers, but I must say that the decorum of all the operators calling was *excellent*! I'm sure that most of them knew what it must have sounded like at NN3SI and they were compassionate.

Station features

One very nice feature of amateur station NN3SI is that

it's open to the public and not behind a glass enclosure. The flat portion of the display case between the two operating consoles (see photo) is about chest high for the average adult. This allows the public close access to operating equipment and the operators. The display also serves as a storage area for equipment not in use.

Antennas

Nine antennas are installed on top of the building (six floors above ground). The coaxial cables from the station to the antennas are more than 200 feet (61m) long. The antennas include a 20/40 meter beam, two verticals, a log periodic for 10, 15, and 20 meters, and beams for 2-meter and OSCAR communications. Also included are dipoles for 80 and 40, and the 11.7 meter swl band.

Each antenna is terminated on a patch panel in a cabinet under the back display case. Each console can be connected to any antenna by three coaxial patch cables. Normally the 40- and 11.7-meter dipoles and one vertical are used for the shortwave listening post, leaving the other antennas for use in the two consoles

at the operator's discretion.

With the equipment available and the frequencies that can be used, the majority of operation has been on the 20- and 15-meter bands. In keeping with the theme "talking with the nations of the world," DXing has been mostly on 20 and 15 meters.

We've done considerable work on 10, 40, and 75 meters; some on 2-meter fm; and the equipment has been set up several times for OSCAR. RTTY and SSTV will be set up and operated during the summer months. At present there's no set schedule for times and frequencies, but the museum is open from 10 AM to 9 PM in the summer months. For the most part, operators are available during that time.

QSLs

Although the QSL cards displayed on the board above the exhibit indicate some good DX contacts, these cards were already there the night the station first was operated. The displayed QSL cards were donated by ARRL and the Smithsonian's Division of Electricity. The station's own card collection, now representing well over 100 countries, will be added with the addition

One of the two operating consoles of NN3SI showing the amateur radio equipment in use.

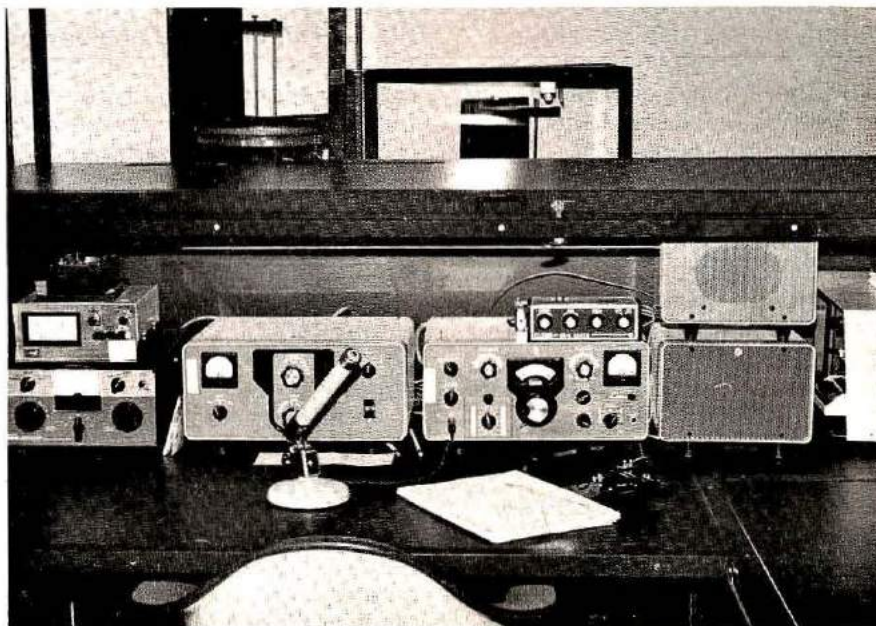

of special drop-down panels.

The NN3SI QSL card is a commemorative card, and with the special prefix, is a collector's item. So, when you work the station the operator will provide you with details for obtaining a card for the contact.

Visiting operators

The station is staffed by operators through the Smithsonian Associates Volunteer Program and the Smithsonian Amateur Radio Club. Duty operators are W4HU, K3BV, W3STG, W3FYJ, W4KFC, K3KWJ, N3DF, WB3BRF, K3NCB, W4ZM, N8II, WB3FTB, and myself, W3IK. Station managers are K3RJA and WA4CLQ from the Smithsonian staff.

Amateurs who would like to operate as a visiting operator should write to: Smithsonian Institution, Division of Electricity, Room 5025, Museum of History and Technology, Washington, D.C. 20560. Indicate when you will be available and your license class. Each of the duty operators is responsible for the proper operation of the station and assists the visiting operators. I have used WAYLARCS W3CDQ, W3RXJ, WA3IWK, WA3GZT, and K4SHE, and these gals have been a big help.

Present practice is to operate within the restrictions of the class of license you hold and with the original of your license in your possession at the time of operating. Additional operators are being added to keep the station in operation during the normal open hours of the museum.

Although one operator can keep the station in operation, it's better to have two, so that one can converse with the people who stop by to ask questions about amateur radio, or who want to know the difference between shortwave radio, amateur radio, and CB radio. So, really, it takes two operators to keep things going, but three is the ideal number.

With three operators, two can keep operating while the third can sit in the middle, so to speak, and field the many questions that come from the visitors. This provides for maximum use of equipment and allows amateurs in the United States and abroad additional opportunities to work NN3SI.

CB and amateur radio

Those of us who have been in amateur radio for some time seem to forget the impact that CB radio has made on the younger people in particular and, to some extent, on older people. It's amazing how many people, when they hear the term "communications" or see a small transceiver, immediately think of CB. Also, they're amazed to find that there's a form of communications *other* than CB. For example: "It sure looks and sounds like CB!" — "Well, that sure looks like the same equipment my friend uses on CB." So we explain amateur radio and the big differences between it and CB radio. How well we've succeeded in explaining both we'll never know, but we deserve an E for effort.

When we ask people if they've ever considered becoming an amateur, a standard answer is, "It costs too much!" or "I can't afford it!" So I've used the analogy of the first car I bought. I didn't order it especially built for me. I bought a used car, worked on it, fixed it, then either sold it or traded up to a better car. I explain that it's the same way with amateur radio: you buy used equipment within the affordable price range, use it within its limitations, and later on trade up to something better.

Another standard answer is, "I could never pass the tests!" So we explain how easy it is to get a Novice license at the present time because of all the training being offered by amateur radio clubs, recreation departments, and schools.

So we stress the beneficial facets of amateur radio and try to show that CB is a means of *communications over short distances*, while amateur radio is a *hobby* with unlimited possibilities for learning about electronics as well as for providing communications around the world.

We pass out literature made available by the ARRL. We have people fill out a small card with their name and address, which we forward to ARRL, so that the good word of amateur radio may be passed onto them.

One question that invariably comes up is, "How far can you talk?" and we always answer, "Around the world!" To prove our point, each operator on each day lists the DX stations worked during the day in a log book, so that we can show the inquirers the book and let them peruse the pages to see the countries we've worked. We also have a log of the amateurs from around the world who have visited the station. These include operators from SM5, G3, G8, F3, OA4, F6, J11, LX1, LU3, DL2, HP1, KV4, JR3, PY2, VK5, HC1, SM6, VE1, VK2, 6W8, JY9, PA0, PJ8, SM7, VE5, G4, YN1, PE0, SM0, and VE3.

Amusing incidents

Each of us has, at one time or another, been involved in trying to separate a signal out of a number of other signals. We have one or two fingers on the dial, and our head is cocked at a precarious angle to make sure that the acoustics are exactly right to hear the proper signal. In this position we're absolutely motionless, with a blank stare in our eyes. Or perhaps we're copying Morse code wearing a pair of headphones — not writing down the message, but just looking straight ahead.

Well, this happened to two of us recently. From out in front of the exhibit came a voice which said, "Those are the two most natural looking dummies I've ever seen!" Since I was not working anyone, but was



The second operation position of NN3SI. Many familiar pieces of amateur gear are evident.

looking for a DX station, I immediately stood up, stating that we were indeed alive, but may be *dummies*. A little girl standing there almost jumped out of her shoes — she was sure we were mannequins!

It wasn't until that little incident occurred that we realized NN3SI was the only exhibit that had "live" people in it.

One evening, as I was searching for DX on 20 meters, I heard YO3AC in Romania and was waiting for him to finish his QSO so I could call him. There were several people standing at the station. Along came a young woman, dressed in the latest fashion, with two lady friends. She immediately tried to show her knowledge of radio communications, and was explaining to her two friends how CB worked, and that the operator was a licensed CB operator.

I was just about to correct her knowledge when she

asked, "Where is that station?" I informed her that this was an amateur station, and that the station being heard was in Bucharest, Romania. She replied, "Fine, you amateurs can hear Romania; why don't you try for someone else?" I explained that I wanted to talk to this particular station. At that, YO3AC finished with his QSO and I gave him a call; he came right back to the special call but wasn't sure he had it correct. As I was talking to him, the young lady departed the scene, telling her friends that I was operating illegally since CBers were limited to 150 miles (240km). Oh well, you can't win them all!

Shortly after New Year's Day, 1977, I was calling CQ on the low end of 20 meters when a station called me and informed me that I was using an illegal call; he told me that bicentennial calls were not to be used after December 31, 1976, and that I could be cited for using

an illegal call. I informed him that NN3SI was a special event call and that it was good for some time to come. I have also been told on several occasions that the call is N3SI because no double-N calls had been issued yet.

Acknowledgements

It's a rewarding experience to operate a special event station such as NN3SI. We've met some wonderful people who are interested in museums and thereby have furthered their education. I've made some new friends and hope I've been able to increase the interests of many in amateur radio as a hobby and to extend friendship through amateur radio.

In particular, I want to acknowledge the help provided to all the operators of NN3SI by Bernard Finn, Elliott Sivowitch, and Ray Hutt — all members of the Smithsonian's Division of Electricity staff. **HRH**



QUESTIONS & ANSWERS

Eligibility, Addresses, and Violation Notices; Q-Signals and RST-Systems

BY THOMAS McMULLEN, W1SL

This is it! We're at the last of the Rules and Regulations segment of the FCC Study Guide material. I'll bet you thought it would never end, didn't you! Well, just go through the following sections about License Eligibility and Notices of Violation and you've earned the right to breathe a sigh of relief.

When it comes to who is eligible for an amateur license, you'll find that there are very few people who cannot obtain one. A *representative* of a foreign government is one category that is denied an amateur operator license, but that's about all. Notice that there are no restrictions about age, sex, religion, or almost anything else. As far as station licenses go, corporations (companies, business organizations, etc.) are not eligible either, and if you'll think about the necessity of keeping amateur radio and commercial radio separated, that makes sense too. It just wouldn't do for XYZ Oil Company to outfit its fleet of delivery trucks with two-meter rigs and use the local repeater to keep in touch with home base. But if the *employees* of that oil company decided that they wanted a club station, and formed a club, elected officers,

and appointed a station trustee that's great. They can have their club amateur station, complete with its own call and everything. They'd just better not try to use that station to shuffle a truckload of oil over to 327 Maple Boulevard, or there will be trouble with a capital T!

Before I get carried away, here is the FCC text regarding Station and Operator License eligibility:

97.9 Eligibility for new operator license.

Anyone except a representative of a foreign government is eligible for an amateur operator license.

97.37 General eligibility for station license.

An amateur radio station license will be issued only to a licensed amateur radio operator, except that a military recreation station license may also be issued to an individual not licensed as an amateur radio operator (other than a representative of a foreign government), who is in charge of a proposed military recreation station not operated by the U.S. Government but which is to be located in approved public quarters.

97.39 Eligibility of corporations or organizations to hold station license.

An amateur station license will not be issued to a school, company, corporation, association, or other organization, except that in case of a bona fide amateur radio organization or society meeting the criteria set forth in Section 97.3, a station license may be issued to a

licensed amateur operator, other than the holder of a Novice Class license, as trustee for such society.

97.42 Mailing address furnished by licensee.

Except for applications submitted by Canadian citizens pursuant to agreement between the United States and Canada (TIAS No. 2508 and No. 6931), each application shall set forth and each licensee shall furnish the Commission with an address in the United States to be used by the Commission in serving documents or directing correspondence to that licensee. Unless any licensee advises the Commission to the contrary, the address contained in the licensee's most recent application will be used by the Commission for this purpose.

97.43 Location of station.

Every amateur station must have one land location, the address of which is designated on the station license. Every amateur radio station must have at least one control point. If the control point location is not the same as the station location, authority to operate the station by remote control is required.

Notice that the restriction is against a *representative* of a foreign government, which is not the same thing as being a non-citizen (alien) of the United States. There are provisions under which an alien can obtain a permit to operate an amateur station, spelled out in sections 97.301 through 97.311. This is often referred to as reciprocal licensing. Many countries do not have an equivalent of the Novice license, however. The new FCC form 610 (application for Individual Amateur Station and/or Operator License) no longer has a Declaration of Citizenship as one of the questions to be completed, so an alien who intends to live in the United States can get his amateur license just the same as anyone else.

I included the section dealing with a station location and mailing address because it ties in with the next part: Notice of Violation. One thing that the FCC takes a very dim view of is failure to respond to a Notice of Violation or other correspondence. It would be a shame to have them take

drastic action (like suspending your license) just because their mail did not reach you for whatever reason. That's why it is a good idea to use a form of traceable mail (Registered, Return-receipt, etc.), whenever you answer a notice, or have other vital communication with the FCC. Here's the text concerning notice of violation:

97.137 Answers to notices of violations.

Any licensee receiving official notice of a violation of the terms of the Communications Act of 1934, as amended, any legislative act, Executive order, treaty to which the United States is a party, or the rules and regulations of the Federal Communications Commission, shall, within 10 days from such receipt, send a written answer direct to the office of the Commission originating the official notice: Provided, however, that if an answer cannot be sent or an acknowledgment made within such 10-day period by reason of illness or other unavoidable circumstances, acknowledgement and answer shall be made at the earliest practicable date with a satisfactory explanation of the delay. The answer to each notice shall be complete in itself and shall not be abbreviated by reference to other communications or answers to other notices. If the notice relates to some violation that may be due to the physical or electrical characteristics of transmitting apparatus, the answer shall state fully what steps, if any, are taken to prevent future violations, and if any new apparatus is to be installed, the date such apparatus was ordered, the name of the manufacturer, and promised date of delivery. If the notice of violation relates to some lack of attention or improper operation of the transmitter, the name of the operator in charge shall be given.

97.49 Commission modification of station license.

(a) Whenever the Commission shall determine that public interest, convenience, and necessity would be served, or any treaty ratified by the United States will be more fully complied with, by the modifications of any radio station license either for a limited time, or for the duration of the term thereof, it shall issue an order for such licensee to show cause why such license should not be modified.

(b) Such order to show cause shall contain a statement of the grounds and reasons for such proposed modification, and shall

specify wherein the said license is required to be modified. It shall require the licensee against whom it is directed to appear at a place and time therein named, in no event to be less than 30 days from the date of receipt of the order, to show cause why the proposed modification should not be made and the order of modification issued.

(c) If the licensee against whom the order to show cause is directed does not appear at the time and place provided in said order, a final order of modification shall issue forthwith.

97.131 Restricted operation.

(a) If the operation of an amateur station causes general interference to the reception of transmissions from stations operating in the domestic broadcast service when receivers of good engineering design including adequate selectivity characteristics are used to receive such transmissions and this fact is made known to the amateur station licensee, the amateur station shall not be operated during the hours from 8 pm to 10:30 pm, local time, and on Sunday for the additional period from 10:30 am until 1 pm, local time, upon the frequency or frequencies used when the interference is created.

(b) In general, such steps as may be necessary to minimize interference to stations operating in other services may be required after investigation by the Commission.

Many amateurs live in dread of receiving that "pink ticket" from the FCC, notifying them that they have violated some part of the Rules. Well, it's a serious business, all right, and not to be taken lightly. But, neither is it reason to take a long walk into the ocean. People make mistakes, equipment malfunctions, and they realize this. That's why they give you a chance to explain what happened.

In almost all cases, if you find out what went wrong, and give the FCC a rational explanation of what happened, along with assurances and a description of what steps are being taken to prevent its happening again, that is all that is necessary. For instance; you just received a notice that you were transmitting a "spurious signal" at 21,315 kHz. You didn't think you had

been on that band (15 meters) at that time, so you checked in your log. Sure enough, you were on 40 meters that night. (There's another good reason for keeping a log.) How come you were transmitting a signal on 15? Well, a moment's thought clears up the mystery; you had been using a 40-meter dipole but on the day in question you changed to the new tri-band antenna that you just put up. This antenna doesn't discriminate against harmonics like the dipole did, so it radiated your third harmonic in great quantities. The cure? Easy! Just place a tuned matching network, or a filter, between your rig and the antenna. This should attenuate your harmonic to such a degree that it will not radiate. All you have to do is tell the FCC all of this, and you are off the hook. What they really want is some assurance that you are a responsible individual and are really trying to run a clean station.

End of a section

Congratulations, you have stayed with me through the Rules and Regulations portion of the series. But, don't file them away and forget them. Keep going back now and then to refresh your memory on a point or two. Sometimes things will seem a bit more clear when you read them a second or third time. If you would like to have your own set of the complete Amateur Rules, you can obtain them from your nearest Government Printing office outlet. Ask for the new edition of the Amateur Radio Rules, (Part 97), stock number



004-000-00338-1. The price is \$1.30 from the Superintendent of Documents, Government Printing Office, Washington, D.C. 20402. Several major cities have GPO outlets, so it may be worthwhile to look in your telephone book to see if they have one near you. Look in the section under United States Government.

Now, let's get back to the operating practices that I started to talk about last

month. The next subject on my list was operating signals, which you'll need to know about when you get on the air the first time; you'll also find some questions about them on the Novice exam. These signals apply to telegraphy (CW) because when you are using voice you should "say it with words," just the same as you speak to each other. The same reasoning applies to the signal-strength reports which I'll talk

about shortly; why say, "Your signal is R-5, S-9," when "Your signal is very clear and strong," sounds more friendly and tells the same story?

Telegraphy

Radiotelegraphy (CW) is the basic language of the radio amateur, and as a beginner it is only natural that you will find the language difficult for a while. You can make life on the air a bit easier, and speed up

Table 1. A list of the most common Q-signals used by amateur radio operators.

QRG Will you tell me my exact frequency (or that of . . .)? Your exact frequency (or that of . . .) is . . . kHz.	Please inform . . . that I am calling on . . . kHz.	communicate with . . . direct (or by relay through . . .)
QRH Does my frequency vary? Your frequency varies.	QRX When will you call me again? I will call you again at . . . hours (on . . . kHz).	QSP Will you relay to . . .? I will relay to . . .
QRI How is the tone of my transmission? The tone of your transmission is . . . (1. Good; 2. Variable; 3. Bad).	QRY What is my turn? Your turn is number . . .	QSU Shall I send or reply on this frequency (or on . . . kHz)? Send or reply on this frequency (or . . . kHz).
QRK What is the intelligibility of my signal (or those of . . .)? The intelligibility of your signal (or those of . . .) is . . . (1. Bad; 2. Poor; 3. Fair; 4. Good; 5. Excellent).	QRZ Who is calling me? You are being called by . . . (on . . . kHz).	QSV Shall I send a series of Vs on this frequency (or . . . kHz)? Send a series of Vs on this frequency (or . . . kHz).
QRL Are you busy? I am busy (or I am busy with . . .) Please do not interfere.	QSA What the strength of my signals (or those of . . .)? The strength of your signals (or those of . . .) is . . . (1. Scarcely perceptible; 2. Weak; 3. Fairly good; 4. Good; 5. Very good).	QSW Will you send on this frequency (or on . . . kHz)? I am going to send on this frequency (or on . . . kHz).
QRM Is my transmission being interfered with? Your transmission is being interfered with . . . (1. Nil; 2. Slightly; 3. Moderately; 4. Severely; 5. Extremely).	QSB Are my signals fading? Your signals are fading.	QSX Will you listen . . . on . . . kHz? I am listening to . . . on . . . kHz).
QRN Are you troubled by static? I am troubled by static . . . (1-5 as under QRM).	QSD Are my signals garbled? Your signals are garbled.	QSY Shall I change to transmission on another frequency? Change to transmission on another frequency (or on . . . kHz).
QRO Shall I increase power? Increase power.	QSG Shall I send . . . messages at a time? Send . . . messages at a time.	QSZ Shall I send each word or group more than once? Send each word or group twice (or . . . times).
QRP Shall I decrease power? Decrease power.	QSK Can you hear me between your signals and if so can I break in on your transmission? I can hear you between my signals; break in on my transmission.	QTA Shall I cancel message number . . .?
QRQ Shall I send faster? Send faster (. . . wpm).	QSL Can you acknowledge receipt? I am acknowledging receipt.	QTB Do you agree with my counting of words? I do not agree with your counting of words. I will repeat the first letter or digit of each word or group.
QRS Shall I send more slowly? Send more slowly (. . . wpm).	QSM Shall I repeat that last message which I sent you, or some previous message? Repeat the last message which you sent me (or message (s) number(s) . . .).	QTC How many messages have you to send? I have . . . messages for you (or for . . .).
QRT Shall I stop sending? Stop sending.	QSN Did you hear me (or . . .) on . . . kHz? I did hear you (or . . .) on . . . kHz.	QTH What is your location? My location is . . .
QRU Have you anything for me? I have nothing for you.	QSO Can you communicate with . . . direct or by relay? I can	QTR What is the correct time? The time is . . .
QRV Are you ready? I am ready.		
QRW Shall I inform . . . that you are calling him on . . . kHz?		

The Q-signal takes the form of a question when it is followed by a question mark: QRV? means "Are you ready?" and the reply, QRV, means "Yes, I am ready."

your contacts, if you learn a few commonly accepted abbreviations and signals to use in your contacts.

A group of signals called "Q-signals" will convey a lot of common information in just a fraction of the time that it would take to spell it all out. You should learn the proper meaning and use. For instance, the signals "QRM" and "QRN" are often mistakenly switched. They should be easy to remember — QRM relates to interference from another station (M = manmade interference), and QRN refers to the static from storms and the like (N = natural interference).

The proper use of Q-signals involves simply placing a question mark after one if you are asking a question. As an example, a very much abused signal is QRZ. If someone just pops up on a frequency and sends QRZ, you don't know whether he was telling you someone was calling you, or what he had in mind. You'll hear this signal misused on both CW and voice operation. Properly used, the signal should have a question mark after it — QRZ? — meaning "Who is calling me on this frequency?" A proper reply would be "QRZ WB7XXX," meaning, "you are being called by WB7XXX," but the signal is so grossly misused that a reply would likely confuse everyone.

If you think about the voice version of that signal, you can see the absurdity of using Q-signals when you are speaking. To use the signal properly, "QRZ question the frequency," or as most operators misuse it, "QRZed question" would sound ridiculous, to say the least!

In spite of their occasional misuse, Q-signals are a handy thing to know and use in your operating. Certainly a snappy "QSY PSE" on CW is much faster than a couple of sentences explaining that the

new station on frequency is interfering with a contact already in progress, and would he please move away. Q-signals were invented by commercial operators for just this purpose — saving time on the air. You'll hear old-timers speak of other codes, such as "Z-codes," Philips codes, and the like.

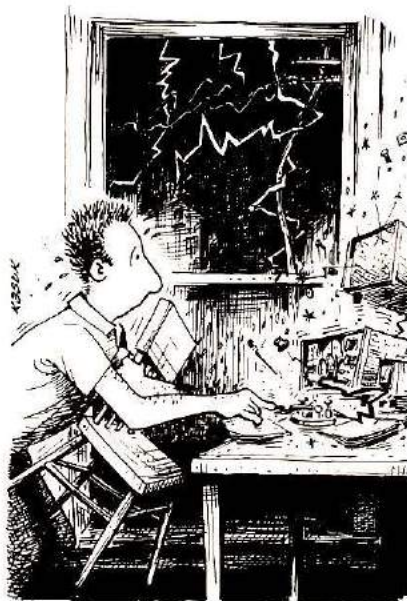

"Must QRT, QRN is getting unbearable."

These also were used to speed up CW transmissions in the early days of radio, but the Q-code that is shown here is universally accepted by amateurs worldwide, and understood by most of them. A list of the most commonly used Q-signals is given in **Table 1**.

Operating abbreviations

The same need for speed and brevity that led to the use of Q-signals also brought about some operating signals or abbreviations. Most of these are to inform the other station of what you intend to do, or what you would like him to do. Two of the most often used are **DE** and **K**; instead of sending "this is," you send the two simple letters **DE**. An invitation to another station to transmit is simply **K**, and the voice equivalent is "go ahead", or, "over." When you are in

contact with a specific station and you do not care to have another station call either of you, you can modify the invitation to transmit by sending **KN**, which means, "Only the station I am in contact with go ahead." **Table 2** has a list of operating signs that you will need to know.

Signal reporting

Radio operators recognized the need for a signal-strength and readability system very early in the history of radio. Without knowing how well your signal was being copied by the operator at the other end, you might send your entire message only to find out that he had missed half of it because of poor conditions, interference, fading, and the like. At first the reporting system that they devised concerned only strength and readability; later, when signal quality became important (because of FCC purity-of-emissions rules), a tone reporting system was added. Thus the system called **RST** means *Readability Strength, and Tone*. Readability means just that — how well can you read (copy) the other guy. It is possible for his signal to be very strong, but not very readable — perhaps because of his sending, or because

Table 2. Some operating signals and abbreviations often used by radio amateurs.

<u>AR</u>	End of message
<u>BT</u>	Pause, or long dash in message text
CL	Closing station, leaving air
CQ	General call, any station please answer
DE	From, this is
<u>DN</u>	Slant bar, often used to indicate that station is portable or mobile
<u>IMI</u>	Question mark, query
K	Go ahead, any station
KN	Go ahead, only the station called

The line above the letters indicates that they are to be sent as one character, with no spacing between the letters.

someone else is on the frequency, or whatever. Strength has to do with your *estimate* of his signal strength. When it was first put into use, a scale of 1 to 9, weakest to strongest, was sufficient, and most operators were realistic in their reporting of signal strength. Later, when receiver manufacturers began to compete with one another for the amateur dollar, someone calibrated a signal-strength meter to indicate dB-levels above the so-called "S9." Then all receivers had to follow suit, with the result that today most meters give readings that are almost unrelated to the original S-scale.

The tone, or purity, report of a signal is a means of letting the other operator know that there may be something wrong with his transmitter. Below 144 MHz all amateur transmitters must have a well filtered power supply. If they do not, the output from the transmitter will have hum, ripple, or a low-frequency tone on it, causing it to take up more room on the band than necessary. In addition, improper tuning, defective parts, or operator error (leaving the microphone turned on while sending CW) can cause the note to be impure. **Table 3** shows the RST system that amateurs use today. Never be afraid to tell another ham that his signal is not T9; you might save him the embarrassment of receiving a notice of violation from the FCC. Some are not gentlemanly enough to accept your report in good grace, but most will thank you for it and start looking for the problem.

Code speed

You can use any code speed you like for your contacts with another station, but you should be sure that you can handle what he sends back to you. Most amateurs can send faster than they receive, and some make the mistake of buzzing off a CQ or an answer to a CQ

at a pretty good rate of speed. The operator at the other end thinks "Oh, boy, this guy is a hot operator," and blasts right back at the same, or higher, speed. Therefore, you should always call at a speed that is comfortable for you because most operators will reply near that same speed. Never be afraid to ask the other amateur to slow down (QRS). It is far less annoying to get it right the first time than to ask for several repeats.

This is a good place for a sample question about this section, and the FCC study guide contains one that is as good as any:

Table 3. Quality and strength of signals associated with the RST reporting system.

Readability

- 1 Unreadable
- 2 Barely readable, occasional words distinguishable.
- 3 Readable with considerable difficulty.
- 4 Readable with practically no difficulty.
- 5 Perfectly readable.

Signal Strength

- 1 Faint signals barely perceptible.
- 2 Very weak signals.
- 3 Weak signals.
- 4 Fair signals.
- 5 Fairly good signals.
- 6 Good signals.
- 7 Moderately strong signals.
- 8 Strong signals.
- 9 Extremely strong signals.

Tone

- 1 Sixty-cycle ac or less, very rough and broad.
- 2 Very rough ac, very harsh and broad.
- 3 Rough ac tone, rectified but not filtered.
- 4 Rough note, some trace of filtering.
- 5 Filtered rectified ac but strongly ripple-modulated.
- 6 Filtered tone, definite trace of ripple modulation.
- 7 Near pure tone, trace of ripple modulation.
- 8 Near perfect tone, slight trace of modulation.
- 9 Perfect tone, no trace of ripple or modulation of any kind.

The Q-signal "QRM" generally means

- (a) a transmission is experiencing interference
- (b) a frequency is varying
- (c) a reply is requested on a certain frequency
- (d) the sending speed is too fast
- (e) the previous message is to be repeated

Your answer should be (a), of course. As a further exercise, look at **Table 1** and see how many of the other choices given can be covered by a Q-signal.

Public Service Operating is the next subject on the list, but I'll let that wait until next month. It's one of the ways that amateurs earn their "place in the sun," but, more than that, a great number of people really enjoy "giving" in this manner.

Meanwhile, here's another sample question to close this segment with:

An amateur station calling CQ should end his transmission with

- (a) KN
- (b) CL
- (c) K
- (d) ARK

I'm tempted to make you wait for the answer in the next issue, but that wouldn't be right. The correct answer is (c).

HRH



HEATHKIT: The name in Amateur radio...and now computers!



SB-104A Amateur Transceiver

The world-famous SB-104 with significant improvements. We've increased the sensitivity to 0.5 μ V on all bands and included a fully assembled and tested receiver front end circuit board for reduced assembly time. The optional 400 Hz filter is independently selectable for CW operation. We've maintained the features that made it famous too — totally broad-banded, all solid-state, digital frequency readout and more. Make the SB-104A the "heart" of your station. Only \$669.95



HW-2036 2-Meter Mobile Transceiver

Our value-standard 2-meter rig offers true digital frequency synthesis in 5 kHz steps and a built-in tone encoder to access most repeaters! Also features built-in simplex, + and - 600 kHz offsets, and an aux. position that lets you add your own crystal for any other offset crystal you may want. The HW-2036 has 0.5 μ V receiver sensitivity and a transmitter that can operate into an infinite VSWR without damage! Come on up to 2-meters with one of the best mobile rigs you can get. Only \$269.95

FREE!

HEATHKIT CATALOG

Nearly 400 kits for you to build! Whatever your interest—hi-fi, television, automotive, marine, home appliances, test gear—it's all in our big new catalog.



Send Today! ▶

Prices are mail order net F.O.B. Benton Harbor, Michigan. Prices and specifications subject to change without notice.



H11
LSI-11
Computer
Kit
\$1295

H8
Computer
Kit
\$375

H10
Paper Tape
Reader/Punch
Kit
\$350

H9
Video
Terminal
Kit
\$530

New The personal computer products you've been waiting for.

And the ones to which all others will be compared. Total computing systems for home, hobby, educational and business applications. Powerful, comprehensive software to get you up and running fast. Unequaled documentation and product support services coupled with low Heath prices make the difference.



LA36
DEC
Writer II
Keyboard Printer
Terminal at Heath's
SPECIAL LOW PRICE:
\$1495 Assembled

New Self-Instruction Course in Microprocessor Operation and Application

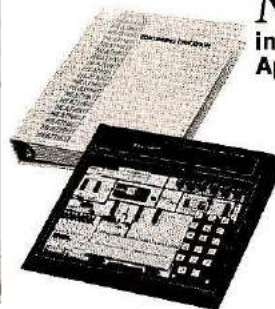

Another addition to Heath's famous Continuing Education Series. Learn microprocessor operation, interfacing and programming. Hardware and software experiments let you get hands-on experience using the ET-3400 Microprocessor Trainer.

HEATH Schlumberger	Heath Company, Dept. 348-370 Benton Harbor, Michigan 49022
Please send me my FREE Heathkit Catalog. I am not on your mailing list.	
Name _____	
Address _____	
City _____ State _____ Zip _____	
AM-356	



those
GOOD OL'
RADIO
magazines

BY JOHN J. NAGLE, K4KJ

*Nostalgia buffs fondly
recall the "Good Old Days"*

WRNY
RADIO NEWS
25 Cents
JANUARY
Edited by PUGG CERNISBACH

RADIO NEWS
and
The **SHORT-WAVE**

RADIO
RECEPTION

MODERN RADIO

MIDWEST RADIO

YE BRASS POUNDER

AMATEUR RADIO
With Which is Combined **RADIO RELAYS**

PRICE 10 CENTS
QST
1910
DECEMBER, 1923

DECEMBER
1924
5

The
TRANSMITTER
America's Amateur Radio Magazine
20¢

RADIO
25

CQ
A Monthly for RT and TRL Commercial Radio Operators
APRIL 1931

WRNY
RADIO NEWS
25 Cents
Edited by PUGG CERNISBACH

AMATEUR RADIO
With Which is Combined **RADIO RELAYS**

15
NOVEMBER
1924

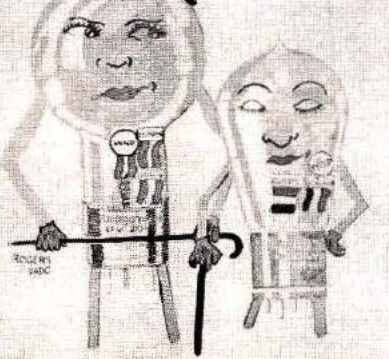

May - 1932
73
15 Cents

AMATEUR RADIO
DEFENSE

FEBRUARY
1941

Official Organ of the U.R.C.A.

Memories . . . memories . . .
 Dusty mountains of surplus
 "one flight up" on radio row;
 once-familiar names: Gonsett,
 Jones, Windom, Reinartz,
 Meissner, Lamb, McMurdo
 Silver; the sights and sounds of
 an HRO, an MB-29, a HQ-120, a
 Super Skyriders; crisp pages in
 the latest copy of *Radio*,
Amateur Radio Review, and *The
 Transmitter*; share these, and

with red covers, some with
 plain covers, and some with
 picture covers; a large
 assortment of *Radio*
 magazines, also known as the
 "West Coast QST;" and all-too-
 few issues of *Amateur Radio
 Defense*. There was a copy of
CQ dated April, 1931 (no
 connection with the present
CQ) published for commercial
 radio operators.

of *Amateur Radio Review* from
 the early 1930s, both with the
 NRA eagle on the front cover:
 "We do our part."

And here were a few *R/9*s.
R/9 was always a first-rate
 technical magazine. When *R/9*
 and *Radio* merged in 1936, the
 result was a really top-notch
 product, and a worthy
 competitor in the field.

There was an swl magazine



In addition to the well-known, nationally distributed amateur magazines like *QST* and *RADIO*, there were numerous publications intended for a local audience. *Amateur Radio* was published in New York in the 1920s; it combined with *Radio Relays*, a Boston magazine, in June, 1924. William Halligan, who later founded Hallicrafters, was the editor of *Radio Relays*. *Ye Brass Pounder* (opposite page) was a four-page newspaper style publication produced in New York around 1930. *Midwest Radio* was published in St. Louis in the 1920s for amateurs in the ninth call area (now the tenth call area). *Modern Radio* was published in Connecticut in the early 1930s; *R/9* was published in Southern California between 1933 and 1936 — both were eventually absorbed by *RADIO*.

more, on a nostalgic ramble
 through the pages of . . . those
 old radio mags.

Last weekend I was
 repainting the family room and
 needed to move the children's
 old train table out of the
 corner. At first I could not
 budge it, but, looking under the
 table, I saw the problem was
 several very heavy boxes.
 "What," I wondered, "has my
 wife stashed away here?" So I
 opened them up and was I
 surprised: they contained *my*
 collection of old radio
 magazines!

I couldn't resist a peek. I
 reached into the nearest box
 and hauled out old *QST*s, some

Did you realize that there
 were two different *73*s, neither
 of which was any relation to
 the present *73*? One issue,
 dated May, 1932, was published
 by the United Radio Operator's
 Association in Portland,
 Oregon; a commercial
 operator's magazine. Another
73 was the official publication
 of the Federation of Radio
 Clubs of the Southwest ARRL.
 Seems kind of strange to read
 an issue of *73* that whole-
 heartedly supports the League,
 like a Hatfield going to bat for
 a McCoy.

I turned up another magazine
 called *The Transmitter* dated
 October, 1926, and two issues

called *RADEX* (stands for
*RA*dio *IN*DEX). In it, my eye fell
 on one item sent in by a reader
 that KNHI, Alcatraz Island,
 tests every morning on 2160 kc
 with the U. S. Coast Guard!
 Verification was signed by the
 Warden. Apparently it was
 easier to get a QSL card out of
 Alcatraz than a weekend pass.

The next box held some early
 handbooks, some pamphlets by
 James Millen and some by
 Frank Jones. I couldn't help
 myself: I forgot the paint brush,
 lit up my pipe, sat down on the
 floor, and, as I leafed through
 these old treasures, returned to
 my boyhood . . .

In skimming through the old

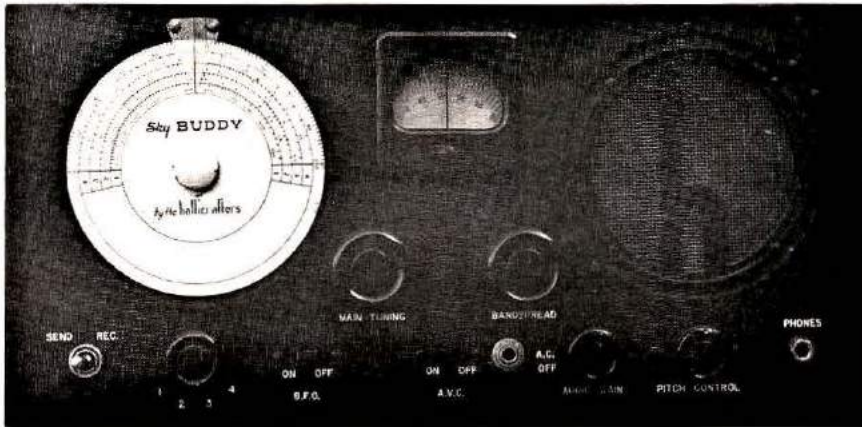

Hallicrafters Sky Buddy receiver from about 1940. This receiver had no rf amplifier, only one stage of i-f, a built-in speaker, and electrical bandspread, but for \$29.50 it was a lot of radio. As a junior high school student K4KJ worked in the school cafeteria almost a full semester to buy one! (photo by K4KJ).

magazines, I gleaned several bits of miscellaneous information that in my 37 years in radio I hadn't known before. I feel the urge to pass these on to the unwary in the form of questions, lest this information become lost to posterity forever.

1. In the late 1920s and early 1930s the National Company made a couple of models of receivers called the MB-29 and the MB-30. What does "MB" stand for?

2. Over the years Hammarlund manufactured a series of receivers known as the HQ-120, HQ-129, HQ-170, HQ-180, etc. What does "HQ" stand for?

3. What is the difference between a heterodyne type receiver and a superheterodyne type receiver? Hint: What is the difference between an autodyne and heterodyne type receiver?

Watch for the answers to these important questions which I will try to work in during the course of the article.

Authors

I was interested to read the tables of contents of these magazines and note the authors: names like W. W. Smith, Ray Dawley, and Frank Jones; John Kraus, also Faust Gonsett (later shortened to

"Gonset"), Herb Becker; E. H. Conklin who, with his wife, Josephine, always seemed to be going somewhere; Charles Perrine, John Griggs, Dawkins Espey, J. N. A. Hawkins (who also wrote as "Jayenay"), and Clayton Bane, F. D. Wells, Robert Kruse, Boyd Phelps, McMurdo Silver, George Grammer, James Lamb, Don Mix, John Reinartz, and Byron Goodman — all these names and many more.

I can't resist philosophizing a little about these names. The tremendous expansion in electronics in the last 30 years or so really began with the intensive use of electronics during World War II. Outside of the telephone and broadcasting

industries, there were very few people trained in electronics except for Amateur Radio operators; and most Amateurs, in those days, learned their electronics by reading these authors. I believe that the electronics industry today owes a lot more to these men than it can ever repay . . . or is even aware of.

In the Small World Department, while this is being written, the May, 1976, issue of *ham radio* arrived with an article by the same E. H. Conklin in which he makes a very flattering comment about a previous article I had written. I can't help but return the compliment, for Conklin's article proves that the early radio writers can also compete in today's market place. They certainly have a wealth of background that would be helpful to the modern generation.

One of the most prolific technical writers of the time was Frank Jones. The earliest article of his of which I am aware appeared in the May, 1929, *Radio* on "Detector Circuit Design Problems," although it may not have been his first article. I visited Frank two or three years ago, and he took me out to his radio room. What a sight! I wish my wife could have seen it; she would appreciate my own modest



Hallicrafters Sky Rider Defiant was also known as the SX-24. It had one rf stage, two i-f stages, a crystal filter, S-meter, and sold for \$69.50 (plus external speaker). One of the features of the receiver was its *Frequency Meter Tuning* system — when the main tuning dial was set to an appropriate index, the bandspread dial was accurately calibrated and could be used as a frequency meter. K4KJ claims that the one he owned was "dead accurate" (photo by K4KJ).

shack. It was a homebrewer's delight. Outside of some commercial test equipment, *everything* was homemade! Gear was spread over the operating table, over a side table, and up the walls. Frank had to rearrange a lot of stuff just to find me an empty chair. I think it should be preserved in its present state in some radio museum. No hurry, though, Frank!

Interestingly, much of his equipment appeared to be transistorized. Apparently, Frank is one of the few oldtimers who has made the transition from vacuum tubes to solid state. I hope we will have some more articles from him, soon.

Goodies For Sale

After reviewing the tables of contents, I moved into an easy chair and turned to the advertisements . . . which proved equally fascinating. The first ad to catch my eye was a small two-inch ad in, the May, 1934 QST that announced that one Robert Henry, W9ARA, of Butler, Missouri, a graduate of the Massachusetts Institute of Technology in electrical engineering, offers to sell the latest factory-made short-wave receivers — on easy terms, too. He was doing business as Henry's Radio Shop then.

I often wondered how a graduate in electrical engineering from MIT could find happiness selling short-wave receivers by mail order on easy terms from a small town in western Missouri. I hope he did, for he's been doing it now for over 40 years, and doing very well at it. In May, 1935, Bob advertised the new Hallicrafters S-9 receiver, which tuned from 550 to 18,000 kcs (they didn't use Hz in those days). It featured a built-in speaker and nine all-metal tubes, the latest thing, then, in the tube business. It was only \$69.50 on easy terms. If you have any left, Bob, I'll pay the full cash price, and not trade-in either!

Another ad that caught my

YOU CAN BUY *with* DOUBLE ASSURANCE

from

Bob Henry

First with assurance before you buy that you will be satisfied. You need send but a \$5.00 deposit to Bob Henry and any receiver will be shipped to you on 10 day trial. Your \$5.00 deposit will be refunded if you return the receiver.

Second with assurance that after you buy you will be kept satisfied. Bob Henry stands back of every receiver. Bob Henry guarantees to service every new set he sells for a year with no cost to you except for parts and transportation. The new receiver will be shipped promptly from the factory or from Henry Radio Shop as you prefer. It will be shipped in factory sealed carton or if you wish Bob Henry will test and OK it before shipment to you.



Bob, W9ARA, tries out a New 1938 SUPER SKYRIDER

Bob Henry must be as good an operator as he is a businessman — he won the DX phone contest in 1937. This photograph was featured extensively in Hallicrafters advertising for their 1938 Super Skyriders in late 1937.

eye was by Bill Harrison, W2AVA, in the December, 1935, issue of *Radio*. Bill was offering genuine Western Electric 211Ds for \$4.90 (regular price, \$17.50) brand new. How many amateurs today use Western Electric tubes in their transmitters? How many even know what a 211D is? If you have any left, Bill, I'll bet you can sell them to the collectors without any trouble at all.

I always enjoyed visiting Harrison Radio, both before the war as a boy and also later on during my annual pilgrimage to New York for the IRE Convention in March. Harrison always had the largest displays of secondhand equipment I have ever seen. It would take me the best part of an hour just to twist all the knobs. That stuff would go like hot cakes at an Antique Wireless Association convention today.

Thinking of Bill Harrison brings back other pleasant memories, too. His old store on West Broadway was just a few

blocks from that "radio heaven" known as Cortlandt Street. On school holidays I would take the Liberty Street ferry from New Jersey, walk down a block, and then walk my way up the east side of Heaven, visiting the stores one by one. By the time I got to the end of radio row, I was usually broke; so I would continue on up to Broadway where my father had his office. I could generally talk the OM out of an advance on the next lawn mowing or car washing job. Then I'd proceed down the west side of Heaven.

Cortlandt Street radio stores were real radio stores, too. A big pile of odds and ends in front of a store advertised as "Today's Special," had probably been Today's Special for the last six months. Some of it looked as if it was also Tonight's Special; (they didn't bother to take it in at night either). Often there'd be several bushel baskets of old glass-type tubes piled in front,

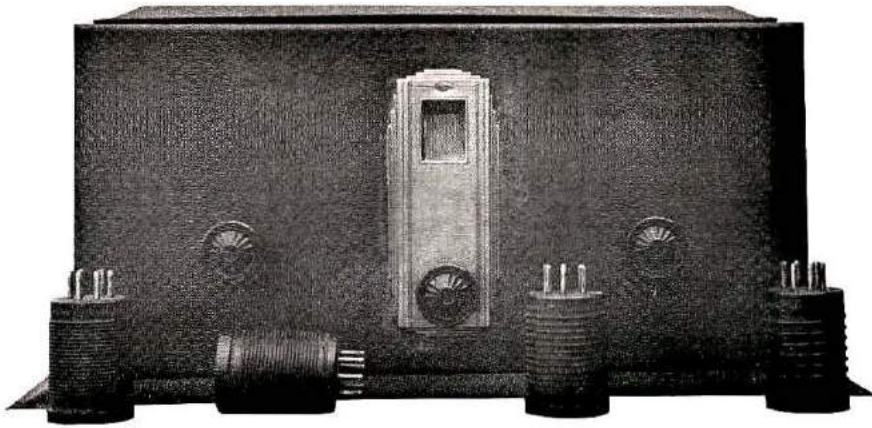

The National SW-5 was one of the first ac powered all-band shortwave receivers. It preceded the famous SW-3 and was designed for shortwave listening, which was very popular in the early 1930s. The SW-5 used plug-in coils and required an external power supply and loudspeaker; the receiver had one stage of rf amplification, a regenerative detector, and three stages of audio with a push-pull output stage to drive the loudspeaker (photo by K4KJ).

“Guaranteed to light, 5 cents each.” No guarantee on the emission capabilities; just guaranteed to light. You wouldn’t have to look very far to find the tube type you needed; the older the type, the easier it was to find. I could really use a store like that today: I’m trying to restore an old National AGS and am having trouble with numbers like 35, 37 and 89 . . . among others.

Inside the store there was inevitably a bargain table right by the front door; around the walls, and in the back of the store, the stuff was piled to the ceiling. There were some stores where it was handy to bring a flashlight. The wooden floor creaked and groaned when you walked, and they hadn’t been swept in months, or maybe even years. Dust was everywhere, but you could usually find whatever you wanted, old or new; and that’s a lot more than you can do today. I wonder if any of those stores relocated, and if so, where?

Some stores were at the tops of stairs one flight up. In many cases the light bulb at the head of the stairs was burned out, so the stairs were dark as well as creaking and rickety. I doubt that I could have gotten my mother inside some of those places, and I think if she had

seen them, she might not have been so willing to let me visit them either.

In spite of the appearance of the stores, or whether they were one flight up or down, you could generally count on a friendly greeting once you got inside. The clerk, who was usually the owner, would say, “Look around, and if you don’t see what you want, call me.” And then he’d go about his business leaving you to browse. I had the contents of

some of the smaller shops memorized and could almost always spot when he had sold something or, perish forbid, gotten in something new.

Theory and Practice

The technical articles of those times are absorbing, too. In late 1933 and early 1934, *R/9* ran a three-part series on single sideband transmission by Robert M. Moore. The series concludes with a schematic diagram of a rig that tunes 3900-4000 kHz. Moore’s rig is almost identical in block diagram-form to that of A. H. Nichols in the January 1948 *QST* at the start of the current sideband activity. Moore uses translation frequencies of 10 kHz, 200 kHz, and 4150 kHz to reach 75 meters. Nichols used 9 kHz, 550 kHz, and 13.665 MHz to reach 20 meters. Both were filter-type rigs with the carrier filter in the high audio region. Moore used type 56 tubes with a 210 output stage; Nichols used mostly 6SN7s with an 807 output stage.

Looking back, I am sorry that ssb was not pushed harder at the time, but a start was made. James Lamb, then Technical

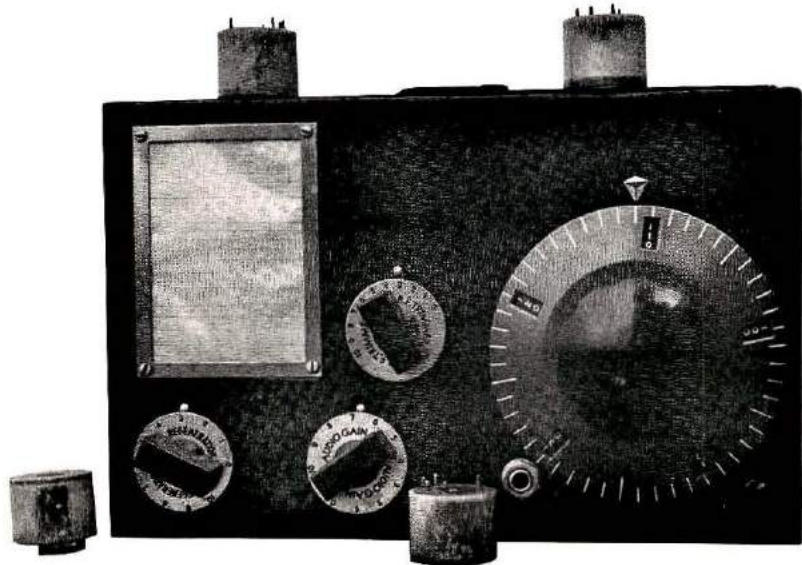

The National 1-10 was introduced in 1936 and was so named because it tuned from 1 to 10 meters (30 to 300 MHz) — this was quite a feat in those days. Note the short pins on the plug-in coils. K4KJ used this receiver in his War Emergency Radio Station (WERS) on the old 2½-meter amateur band during World War II, and reports he had “one of the hottest receivers on the net.” This set had an rf amplifier stage followed by a superregenerative detector (both using acorn tubes), and two stages of audio; the set required an external power supply and speaker (photo by K4KJ).

Editor of *QST*, started what was to have been a series of articles of SSB, but only the first saw the light of day. This article appeared in the October, 1935, issue of *QST*, but was not listed in the magazine index or in the annual index either, so you just have to know where to look (try page 33).

An editorial preface to Lamb's article says, in part, that in 1933 the ARRL Board of Directors instructed the technical staff to investigate the feasibility of single-sideband "carrierless" phone transmission on amateur frequencies. Accordingly, J. J. Lamb investigated both the theoretical and practical aspects and a report was rendered to the Board in 1934. Lamb's October, 1935, article and the articles that were expected to follow were taken from that report. Unfortunately, no articles followed. The October article is mostly an introductory type article. One of his concluding comments was especially interesting.

In explaining the difference between what is now known as ssb and dsb, he states that "With the carrier suppressed and both sidebands transmitted, it is practically impossible to supply a locally generated replacement carrier in the precise phase relationship needed for undistorted reception. For this reason (dsb) is hardly practicable." This information did not appear in *QST* nor the prestigious *Proceedings of the IRE* until the early 1950s, nearly 20 years later.

Lamb also designed an ssb transceiver using an improvement of his original crystal filter and incorporating a crystal oscillator-frequency multiplier chain which provided not only the transmitting carrier but also the receiver heterodyne frequencies from the same source. Remember, this was back in 1935, but it sounds like what is common practice today.

It's fascinating, too, to follow

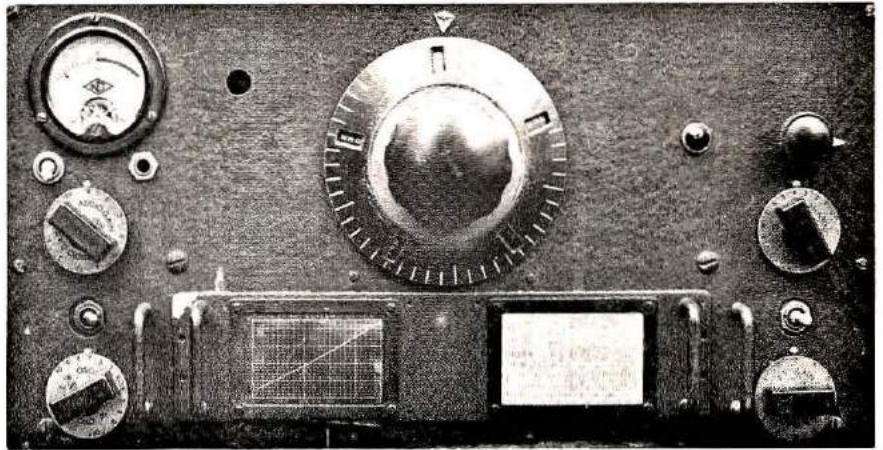

An early National HRO receiver. A previous owner cut a hole in the front panel which considerably reduces its value to collectors of old radio sets (photo by K4KJ).

the development of the single-signal super-heterodyne receiver through James Lamb's articles in *QST*, including the development of the crystal filter and the noise limiter; in fact, several forms of the noise limiter are described. The Dichart, as well as Lamb's, circuits, seem to be still in use today.

The electron-coupled oscillator (eco) and its offspring, the tri-tet oscillator, are both described in an article by Dow and several by Lamb. Both of these circuits were very popular up until the development of transistors.

Speaking of transistors, I'll bet you thought they were a recent development. In the July, 1925, (that's right, 1925) *QST*, an "oscillating crystal" (galena type) is described. That was over 50 years ago. Today the oscillating crystal would be called a point-contact transistor.

Aside from historical interest, many of the early articles have a lot of good, useful technical information that has fallen down through the cracks. Windom's article in the September, 1929, *QST*, describing the single-wire feeder system that bears his name, explains how to adjust the antenna. This information has not appeared in any handbook or antenna manual since that time, to the best of my knowledge. The procedure

is simple and straightforward and required only two rf ammeters. The charts and graphs that are in the books now are fine for a first approximation, but Windom's procedure must be used if a really *good* match is desired. A companion article in *The Proceedings of the IRE*, by Windom's associates, gives more detail on why the antenna works.

As another example, we think of the balun for coupling a balanced antenna to an unbalanced transmission line as a relatively new device. *Radio* for December, 1933, describes a "shielded transformer" to do the same thing. Furthermore, the 1933 article describes some of the problems that one runs into in using such a device; problems that have been generally ignored by all of the recent writers on the subject.

Engineering Practice

Beginning in *QST* for March, 1934, and continuing well into the 1960s, the National Company ran what was probably the most useful and successful series of advertisements in the history of radio publishing. These were one-page articles appearing as the first advertising page in *QST* and were usually written by James Millen (until he left National to form his own company). When I first began

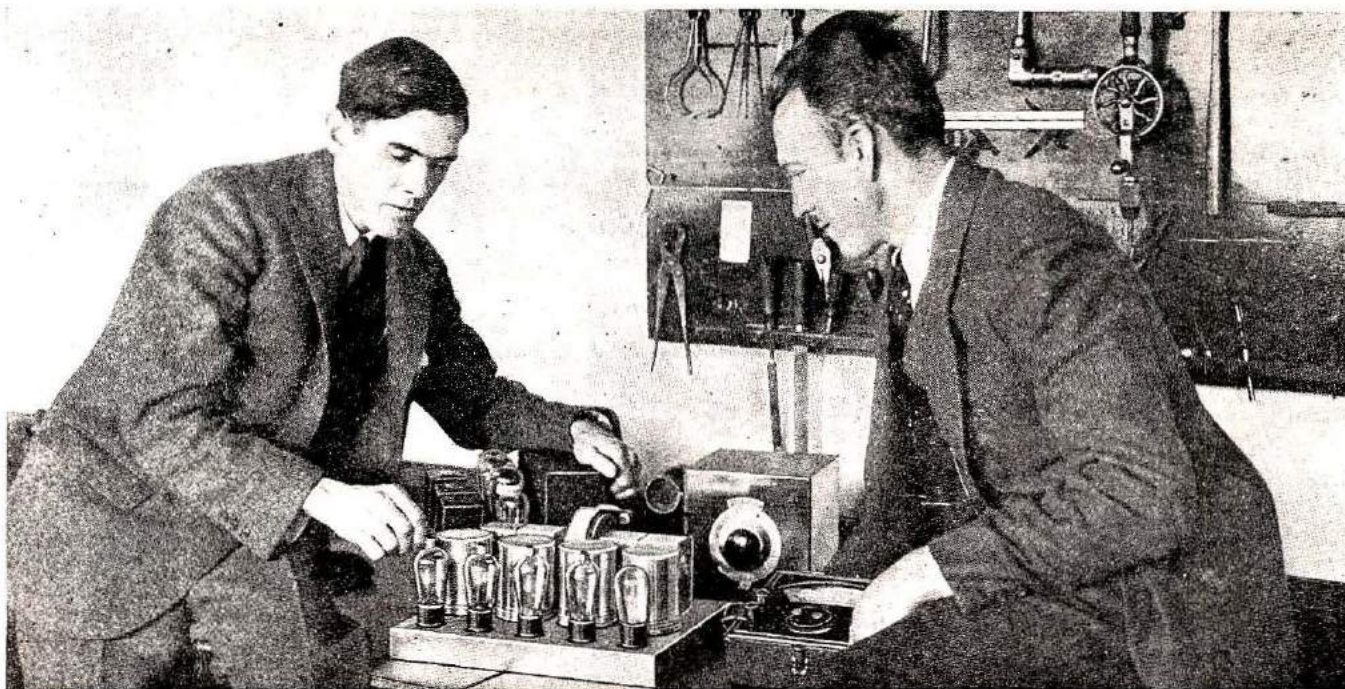

James Millen (left) and Dr. Glenn Browning (right) look over the National Velvetone-29, a five-tube ac screen grid tuner with exceptional signal reception for its day. It was designed for operation with the Velvetone amplifier, the latest thing in high fidelity for 1929. Dr. Browning, who was co-inventor of the famous Browning-Drake circuit used in amateur receivers in the 1920s, went on to form his own company which still manufactures CB equipment. James Millen also formed his own company, and Millen capacitors, inductors, and precision mechanical parts are still used by amateurs who want the very best in their homebrew equipment (*photo courtesy National Radio*).

reading these ads as a boy, I was impressed by the good tips they gave on design problems of a modern receiver and on how to make things work better. As I reread them years later through the eyes of a professional engineer, I find they contain much more than hot tips: they also exemplify an engineering philosophy that is sorely lacking in many of the electronic products on today's market, for professional and consumers as well as amateurs, namely, attention to engineering detail throughout the product. How many times have you bought a product which has a good basic design, but was sloppily assembled? Or assembled using cheap and underrated components? Or how many times have you found a product that is well fabricated, but with sloppy design engineering?

I have long felt that one of the finest examples of attention to engineering detail was the HRO receiver, which appeared first in 1934 and

stayed on the market with the same basic design well into the 1960s, almost 30 years. When it was taken off the market, it was not so much due to technical obsolescence, but to those damnable plug-in coils. Storing the coil set I *am* using isn't any problem because it goes in the receiver, but I have never yet found any good way to store the coil sets I *am not* using. In a field that changes as rapidly as electronics, a design that is accepted by the market place for almost 30 years is truly a good basic design. I have tried to use Millen's "attention to engineering detail" in my own designs, but will probably never be as successful as he was.

A pair of National receivers that were very popular in their day were the MB-29 and MB-30. The MB presumably stands for Millen/Browning. Glenn H. Browning later established Browning Laboratories and made amateur and commercial equipment until relatively recent times.

Early TV

Numerous articles on television appeared in early radio magazines. *Radio News*, in May, 1931, published a list of ten active TV stations along with the number of holes, revolutions of their disks, and their frequencies which were around the present 160 meter band. That's right: mechanical scanning. One of the stations ran 5 kW; a minor headline under the list was: "Television Programs Improving." That was 35 years ago, but you would never know it today!

All-electronic TV systems were also in evidence. One of QST's most popular technical editors, Ross Hull, was accidentally electrocuted while experimenting with amateur TV in the middle 1930s. In 1940 QST published a three-article series describing a camera chain, TV transmitter and a receiver for the 2½-meter band. Amateur TV is just now catching on. Today we have slow-scan television in the hf ham bands. A fast-scan TV

repeater is operating in the Washington, D.C. area on the 450-MHz band.

People

It is interesting, too, to go back and read the early work of some of the people who have become common names in the ham magazines. One always associates longtime *QST* assistant technical editor, Byron Goodman, with ARRL. However, in the February, 1935, *Radio* he wrote the lead article

recognizing them even if they hadn't been signed.

I also suspect that Gil was the originator of the Hashafisti Scratchi cartoon caricature that still appears on and off in *CQ* magazine. Most old-timers remember Scratchi as that mischievous ham from Osockme, Japan. In the 1934 *Radio*, the first drawing of Scratchi appears, which is the same as, but with much more detail than, the present *CQ* cut. (Or maybe *CQ*'s cut is worn out

running newsletter. If true, it is certainly a tribute to Gil's ability to have a symbol still in use after 40 years.

Speaking of Scratchi, do you realize how far back this magazine feature goes? Scratchi has been published on and off in *CQ* since its inception in 1945, and prior to that in *Radio*. Actually Scratchi goes back to at least April, 1922, when "Scratchi Starts Business Career" by David P. Gibbons appeared in *Radio*. I don't know if even this was the first Scratchi or not, but it's the earliest of which I have a record.

The October, 1933, *Radio* has a letter from Osockme, Japan, after a 10-year absence, and promises a letter every month from then on, but gives no indication of the author. April, 1934, *Radio* has a photograph of a person identified as the originator of Scratchi, but gives no name. A box of "assorted Japanese wavelengths" is offered to anyone who can identify him; it says that he started in radio 20 years ago (20 years before 1934, that is).

At the 1975 ARRL Convention at Reston, Virginia, I asked *CQ*'s editor, "Who is writing Scratchi these days?" He changed the subject, and in a way I'm glad he did. It's much more fun to imagine that on the first of each month a special messenger from the Japanese Embassy appears at *CQ*'s editorial office with the latest missive which had just arrived in the diplomatic pouch from Osockme.

I would like to know about Scratchi's early heritage, though, say, prior to World War II. It would also be interesting to learn what happened to David Gibbons, who, I assume, created Scratchi, to the best of my knowledge, the oldest feature in any amateur magazine.

Receivers

The multitude and variety of equipment that was advertised in those old mags was equally



on "The Noise-Free Autodyne." In *Radio*? How could you, Byron?

Another person usually thought of as an ARRL stalwart is the late Phil Gildersleeve, whose cartoons were enjoyed by the amateur community for so many years. "Gil's" cartoons are always associated with *QST*, but the December, 1934, *Radio* has three "Gil" cartoons. Gil had not yet fully developed the quiet, subtle humor that made his "Jeeves" monthly cartoons and his annual Podunk Hollow ARC Field Day *QST* covers such classics, but the lines and style are definitely "Gilean"; you wouldn't have any trouble

after all these years.) The early cut is signed with what appears to be Gil's "signature." The cut was obviously reduced from a much larger original, so I can't be sure and don't want to stick my neck out too far.

However, as I mentioned before, Gil did draw for *Radio* at about that time, and even under a magnifying glass the signature appears to have the same form as Gil's. I don't know when the cut was first used as my collection of *Radio* is not very complete prior to 1934 and I imagine the original drawing is long gone, too! It would be ironic if ARRL's most famous cartoonist originated the trademark for *CQ*'s longest



Rare Hallicrafters Skyrider Diversity receiver, which was marketed in the middle of the depression with a price tag of \$425 — about six months pay for those who were employed. Only about a dozen of these sets were made. The receiver is about 3 feet (1 meter) long. In spite of its impressive size two additional chassis were used which were installed on either side of the receiver (photo by K4KJ).

absorbing — receivers, transmitters, antennas, accessories. At the top of the list were the dream receivers, the Hammarlund Super-Pro and the National HRO, probably the two most wanted receivers of the day. Incidentally, "HQ" stands for "Hi Q," an early trade name used by Hammarlund.

In the affordable price range, the receiver that caught my fancy was the RME 69 or 70. For some reason RME did not put labels on the knobs, so you just had to know what knob did what. As a young teenager, I was very impressed watching a skilled, experienced operator handle a 69 or 70. He would tune in a signal, then tweak a knob here and twiddle another there to make a cluttered signal R-9 just by knowing how, while I couldn't even turn on the ac power without assistance.

In addition to the 69/70, RME made a preselector, the DB-20, available as a separate item. They also made a combined preselector/receiver combination available as a single item. This model, I think, impressed me as a teenager the most. It had more dials and knobs than any other amateur model. I have had my eye open for one since boyhood, but have never seen one. I'm beginning to

wonder if they existed only in the ads.

Of all the receivers, commercial or homemade, past, present, and probably future, the most impressive one of all must be the Hallicrafters Skyrider Diversity (Model DD-1). It looked like a real piece of equipment, for sheer size if nothing else. If you could tune in a signal with one, any layman could not help but be impressed by your skill as a radio operator.

I'll never forget when that receiver hit the street either. Hallicrafters took a two-page spread in *QST*; and it took two pages, too, in order to do justice to the thing. They sure don't build them like that any more, and it's probably just as well: the way they build houses today, the average ham wouldn't have room to keep one. On the other hand, an advantage of today's society is that there are usually one or two pick-up trucks in every neighborhood, so you wouldn't have too much trouble moving one — if you ever had to. This is another item I wonder if they really made, for I have never actually seen one, nor have I ever talked to anyone who has ever seen one.

By way of transmitters,

National sold a rack and panel job; 600 watts, a-m or CW, in an open rack at that. There was no TVI to worry about. The model owned by a local amateur used Taylor TW-150's in the final. Remember those bottles? TW stood for "thin wall." Hallicrafters made the HT-4 for ham use. This equipment did yeoman duty in World War II as the BC-610. Either of those two transmitters was acceptable in my boyhood dreams: I wasn't prejudiced in my youth and would have been happy to have one of each!

For antennas you could have a Mims Signal Squirter on ten or twenty, or both, which was the first commercially available Yagi beam. It featured inductive coupling between feed line and antenna, for continuous rotation in either direction without slip rings, which you don't see any more. I believe the Mims name, trade mark and patents were bought out by Amphenol, but I have never seen them push the product. I don't know what happened, but they certainly had the jump on Telrex.

For the lower frequency bands, you could use EO-1 cable. This was a rubber-insulated 72-ohm impedance balanced line for direct

connection to the antenna. It worked fine in dry weather, but was a dead short after a rain storm. I still have a length of it around someplace for old times' sake. If you wanted all-weather operation, there were Johnson Q-bars to match a 72-ohm antenna to 600-ohm open wire line. Or, why bother to match anyway? Coaxial line was only used by the higher class stations on 5 or 2½ meters, and was always homemade. It was made from copper water pipe; plastic beads, made by Amphenol, separated the inner conductor from the pipe. Since the line was mostly air-insulated, the losses were lower than the commercial flexible cable available today.

October, 1939, *Radio* has an article by F. R. Gonsett entitled "Ten-Meter Auto-Radio Converter." Except for the tube type, this converter appears almost identical to the famous Gonsett Converters of the late 1940s that helped establish mobile operation as a viable means of hamming. An earlier article by Gonsett in October, 1938, *Radio* discusses mobile radio equipment in the 30-41 MHz band. These articles may have laid the ground work for the contribution Gonsett made to mobile communication following World War II.

For operating accessories, my dream station included an Edwin Guthman direct reading frequency meter, a Triplett

model 1639 modulator monitor and a National 1- or 3-inch cathode-ray modulation monitor. After about 1932, you were expected to know what frequency you were on, and after about 1936, your modulation percentage, too.

Here's the answer to my final question: A heterodyne receiver has a separate local oscillator and mixer, as does a super heterodyne, but the output frequency of the mixer is in the audio range for the heterodyne receiver. In a super heterodyne receiver the output frequency of the mixer is at a *supersonic* frequency, usually called "the intermediate frequency."

An interesting series of three articles began in the January, 1935, *Radio* on "How Telegraphers are Made" by Ted McElroy, who at the time was the "world's fastest telegrapher." McElroy gives tips on sending and receiving and on how to run a code speed contest, well worth reading today. His comments on operating conditions at the time would be of interest to the history buffs and maybe to *Playboy* as well. The articles are very interestingly written, for his sense of humor is as good as his ear drums and fist.

While on the subject of code, Walter H. Candler has an article on "Code Technique" in the March, 1934, *R/9* and another in September, 1934. As I recall, the Candler System was still advertising in *QST* up until recently, so he must have had



National 1-inch oscilloscope from the late 1930s. After about 1936 all amateurs were expected to know their modulation percentage. The National CRO used a 913 cathode-ray tube; a trapezoidal pattern was normally used because no linear sweep was provided (photo by K4KJ).

some good advice. Good CW men (and women) seem to be becoming a thing of the past, so that I think his article would be useful reading today.

In the midst of my reverie, the XYL walked in and looked. She didn't say anything, she just looked. Sitting in the easy chair with magazines scattered all around me, while the paint brush had hardened and the paint can had been pushed back in the corner, I had been all too quiet.

From the dreams of my boyhood, a jolt to the realities of the present. Our youngest offspring is bringing her fiance home from college next weekend, so it's back to the woodwork.

The Lamb single-signal supers, the Jones 5-meter transmitters, the Nationals, the Hallicrafters and RMEs, all fade away into the background like DX stations on 20 meters. Never to be built, many of them, but never to be forgotten either. The schematics, the tube lineups, the panel layouts, even the parts lists are as indelibly impressed in my memory as they are on the pages of . . . those old radio mags . . .

HRH

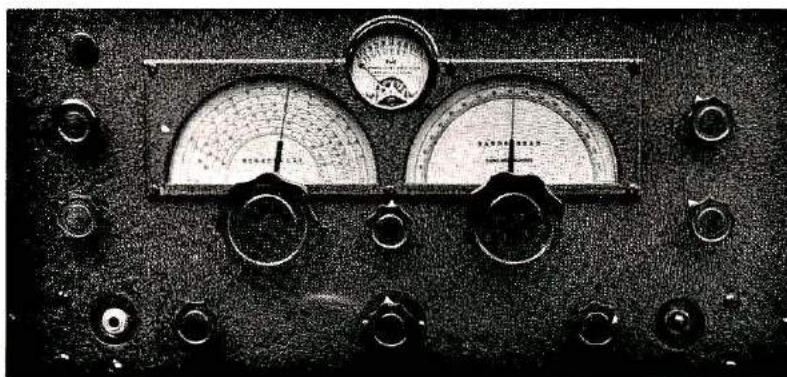

The Radio Manufacturing Engineers' RME-69 was a favorite with many amateurs in the late 1930s. Notice that there are no labels on any of the controls — the operator just had to know which ones were which. Accessories which were available for the RME-69 included a high-frequency preselector and a tunable vhf converter. Amateurs with that lineup on their table had a very impressive looking station (photo by K4KJ).

DenTron Radios... Built by Americans for the whole world.

One of the greatest pleasures ham radio brings is contact with distant lands. What other organization can boast of daily communication among its members throughout the world?

It's a great hobby and we want to make it more fun for you!

DenTron antenna tuners do just that. Our Super Tuners are the only tuners on the market capable of matching everything between 160 and 10 meters, plus handling 1-3 KW PEP.



Professional hams depend

A. The Original Super Tuner 1KW PEP \$129.50.

If you're new at ham radio you'll find it's invaluable.

B. Super Super Tuner 3KW \$229.50.

If you've added more power to your station it's a must. Both the Super Tuner and the Super Super Tuner match balanced feed, coax, random or long wire. Both transfer maximum power from the transmitter to the antenna.

C. NEW! The MT-3000A \$349.50.

The MT-3000A was designed for the serious ham interested in professionalizing his station. It is a rugged antenna tuner that easily handles 3KW PEP. It has built-in dual watt meters, and a built-in dummy load. The antenna selector switch: (a) enables you to by-pass the tuner direct; (b) select the dummy load or 5 other antenna systems.

D. 80-10 Wire Tuner \$59.50.

Our random wire tuner handles 500 watts and is ideal for the ham on the move.

E. W-2 Watt meter \$99.50.

DenTron's dual in-line Wattmeter allows you to read forward and reflected watts simultaneously.

F. SuperAmp \$574.50.

The SuperAmp is one of the best amplifier values currently on the market. It covers 160-10 meters, and features four 572B triodes in grounded grid. With it add 2000 watts PEP SSB and 1KW CW power. No other amplifier delivers so much at such a reasonable price.

G. NEW! MLA-2500 \$799.50.

The MLA-2500 is one of the world's finest high performance military amateur amplifiers. It was designed for the discriminating buyer who knows and appreciates precision plus power. Coast along with a full 2000 watts PEP input on SSB, 1000 watts DC input on CW, RTTY, or SSTV. The heart of the MLA-2500 is a heavy duty, self contained power supply, and it features 2 Eimac 8875's.

H. NEW! MLA-1200 \$399.50,

external AC supply, \$159.50, DC supply \$199.50. The MLA-1200 shares many fine features with its famous big brother, the MLA-2500, but also has a few distinctive features of its own. It employs a single Eimac 8875, running 1200 watts PEP or 1KW DC. It incorporates the same built-in ALC as the 2500. The MLA-1200 is the smallest 1200 watt linear amplifier on the market, great for your mobile home, boat or car!



DenTron
Radio Co., Inc.

2100 Enterprise Parkway
Twinsburg, Ohio 44087
Phone (216) 425-3173



DenTron for Amateur fun!

*The one and only original RADIO SHACK is located in Boston and has no branches or affiliates elsewhere.

"TAB"

That's A Buy

\$39.00

KIT 866A's & XFORMER put 115VAC/50-60cps 2.5VCT/10 Amps 10K tube and sockets JOH TUBES, SPECIAL \$5. GEN72A's & XFRMR instn & sockets SPECIAL WRITE for CATALOG

BUYS in TUBES

872A	\$2.25	304-TH Eimac	\$9.95
807 Westhse	1.05	809	1.79
811	1.95	810	2.59
813	6.75	814	4.50
211 GE	4.95	826	2.25
829B	3.94	832A	4.05
829B socket		931A	

Brother — this is it!

Brand New Surplus U. S. Air Corps Receiver BC-348

One of the Finest Ham Receivers Ever Sold by the Government

AT A FRACTION OF ITS WORTH

WAR SURPLUS STORY

RECTIFIERS BRIDGE
IN OUT AMPS
18V 14 1.35 2.4
15V 11 1.5 2.4
3 1.5
36 1.5
21 1.5 40maC-Cut
WRITE FOR OTHER SIZES
VAR 100B/175Watt/0-130V
VAR 100C/860Watt/0-130V
VAR 100R/115or230V/230or270
1N34 2for 2.10; 10for 9.85; 50 for
WRITE for CATALOG
MAYDON CLOCK MOTORS 10V/60
1RPM @ 89c; 115V/60cy/1RPM @ 2.25;
for \$10. 115V/25cy/1RPM @ 2.79; 4for
0. BRACKET SWITCH & CAM for
attachment to Clock Motors

21 to 115
KIT 144
... 4.95
... 1.98
SETS 4, 5, 6, 7, SP, 25 for 2.49
for 304 tubes each.9
2X2 HV type each.3
"T C IT. WRITE to "TAB"
FREQMTR. WVMTR & CON
TROL Unit BC1162p/RC150, freq
150-210mc's ideal Citizens band
Radio 19 tubes & 115V/60cy pwr
supply NEW SPECIAL. . . \$25.95
SAME less Tubes (LT). . . 19.95
FREQMTR & WVMTR only (LT)
... 13.95
POWER Supply only (LT). . .
BC456 Modulator used (LT).
BC375 & TU & Tubes used.
GIBSON GIRL XMTTR.
TTR BENDIX/40Watts used LN.
STERPHONE & DYN LN.

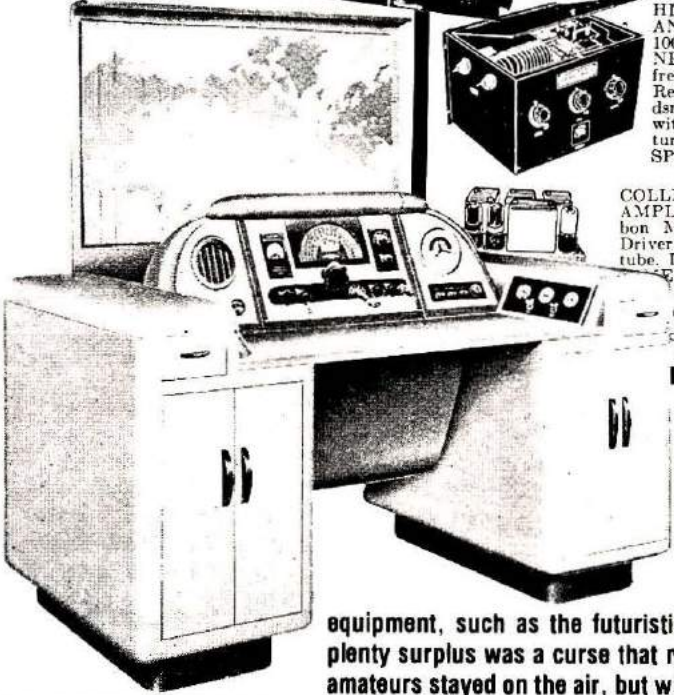

HIPOWER VARIABLE ANTENNA NETWORK 1001A/1KWRF/1.5 to 7mc NEW easily converted to freq use CASED 5'x15' Relay Rack mtg. Coil, dsr. RFMTR etc. NEW with Tech Manual loose Coil turns require cementing SPECIAL. \$9.95
COLLINS ART13 SPEECH AMPLIFIER Dynamic or Carbon Mike or line inpt. Audio Driver to PPG & Monitoring tube. Less Tubes. 4.50
& CLIPPER KIT & Data. NEW. 8.25
GRAM" SPECIALS
d Post. & 25% deposit, back "TAB" Guarantee.



BY BILL ORR, W6SAI

To thousands of equipment-starved amateurs the warehouses full of surplus equipment was a blessing, and the BC-348 series of receivers, left center, and the command sets, upper right, were rulers of the ham shack. To manufacturers of new equipment, such as the futuristic console, left, and the advanced receiver, above, the horn-of-plenty surplus was a curse that marked the end of the road for many of them. Profits were made, amateurs stayed on the air, but what happened to progress?

Two weeks after the end of World War II, one of the largest assembly buildings on earth hummed with purposeful activity. As far as I could see down its half-mile length, the building was filled with just-completed, four engine, heavy bombers. The aircraft, gleaming with Air Force insignia, were surrounded by mechanics and technicians.

One-by-one, the planes were rolled out the door of the building where a tank truck gave each one a few gallons of high-octane fuel. With a cough, then a roar, and belching blue exhaust flames, the engines were started. After a few minutes, the engines were turned off, the remaining gasoline was siphoned from the tanks, and the bomber was officially turned over to the government.

After a pause, a tractor was hooked to the nosewheel of each aircraft and it was towed slowly to the end of an ever-growing line of similar planes. At the front of the line, another tractor pulled a bomber into position under a crane which supported a two-ton lead ball, swinging at the end of a cable. After a second flurry of paper work, the technicians and mechanics moved away from the doomed aircraft.

The lead ball was hoisted high into the air and let fall with a thunderous crash

HARRISON HAS IT!

HARRISON SELECT SURPLUS

Your assurance of good, usable, guaranteed, surplus material at sensationally low prices — TOP VALUE ALWAYS! Come in and browse through our large HSS Department.

BEAM POWER TUBE VALUES
 807 Always popular. New Amateur net. \$2.30
 HSS—\$1.75 each. Three or more at \$1.47
 814 Can give 160 watts output with only 115 watts drive. Net price \$14.00, reduced from \$17.50
 HSS \$7.45

257-B
 Full power up to 150 Mc., 1.4 watts drive
 230 watts output. Net price is \$24.50
 Harrison sells them for **\$6.90** only.

0-1 DC MILLIAMMETERS
 Flush panel mount bakelite case. 1/2 inch diameter. D'Arsonval movement with jewelled bearings. 2% guaranteed accuracy. FB for multi-meter, field strength, etc. Excellent value at only **\$4.75**

.0001 MF 9000 VOLT peak working mica condensers, Sangamo Type F3L, 1/4" x 2/8" x 3/8" body. List price \$29.15. HSS \$6.75	2 METER RF CHOKES Ward-Leonard type Z.O. Per Dozen \$1.00 (\$55 per Thousand)
--	---

COAXIAL CABLE!
 All new, perfect, and at lowest prices!

JAN TYPE	Impedance	O.D.	1-100'	100' and up
RG-11/U	75 Ohms	.405"	10c	7c
RG-13/U	74 Ohms	.420"	14c	10c
RG-39/U	73 Ohms	.315"	11c	8c
RG-58/U	55 Ohms	.195"	8c	5c
RG-22/U	95 Ohms	.405"	25c	25c

TWINAX
 *Double Shield.
 Furnished in one piece within -0% to +20% of length ordered. Full measure.

24G TUBES
 (3C24) An FB tube for VHF. 90 watts rated class C output. Compact size. Ham net was \$9.00, reduced to \$6.00 but Harrison sells them for only \$1.48 ea. Three or more at **\$1.48**

XTALS
 Here is the VALUE in Ham band stals that tops anything you have ever seen. Made for Signal Corps—so they must be good. A fully mounted and sealed crystal for less than the blank alone. 40 METERS in DC-35 and 60 METERS in DC-34 holders. **90c** (Three or more postpaid). Specify frequency range when ordering.

9002 TUBES 9003
 Harrison sells you these popular types at the lowest prices yet! First quality, fully tested. No rejects here! **\$2.49** Five for \$12.49 (Postpaid in USA)

amidships of the bomber. Its spine was broken, the wings collapsed, and the landing gear was crushed. Again and again the lead ball was dropped until the new bomber was a mass of wreckage. A puffing bulldozer then swept the corpse into a huge pile of rubble and the next plane was brought into position under the crane.*

The foreman in charge of demolition, wearing a yellow hard hat, approached me. "You a radio ham?" he yelled above the din. Before I could answer, he said, "Why don't you go down the line and take some of the radio equipment out of the planes? Anything you can remove without a screwdriver is yours. A pity to waste all this surplus radio gear. There's tons

*Similar scrapping of aircraft and radio equipment was reported in the newspapers for Guam, Japan, and England.

of it in the warehouse, too, and the taxpayers will never see it; that's for sure!"

The foreman was wrong

At the end of World War II, amateurs were allowed back on the air, but, for most of them, it was a slow start back to normality. Many hams were still overseas in the armed forces, and those at home had little equipment. In many cases their receivers had been sold to the Government during the war, and several war-production drives for panel meters had stripped the erstwhile hamshacks of indicating devices. Although new receivers were becoming available, they were selling for about twice the price of comparable pre-war receivers. Yes, amateur radio seemed to be getting off to a slow start, indeed.

Unknown to most radio amateurs, a vast fortune in communications equipment belonging to the War Assets Administration and the Defense Supply Corporation, agencies of the United States Government, was stored in bulging supply depots scattered across the United States and abroad. This is the story of some of that equipment, and the impact it had on amateur radio.

It all began quietly enough. In mid-August, 1945, the

SURPLUS PRICES SLASHED!

COMMAND EQUIPMENT
 (274N, ARC-S, ATA)

Receivers New Used

190-550 RC \$12.95
 1.5-0 Mc. 14.95
 3-0 Mc. 5.95 3.95
 G-0 Mc. 0.95 5.95
 3-Rec. Bark .99
 3-Control Head .99

TRANSMITTERS

BC-696, 3-4 Mc. \$14.95
 T-19, ARCS, 3-4 Mc. 12.95
 BC-457, 4-5.3 Mc. 3.95
 T-20, ARCS, 4-5.3 Mc. 5.95 3.95
 BC-458, 5-3.7 Mc. 3.95
 T-22, ARCS, 7-9.1 Mc. 12.95 6.95

MODULATORS

BC-456 \$2.95 \$ 1.95
 MD-7, ARCS, Push-pull 8.95
 SCR-522 \$24.95
 ARC-4 Xmit-Rec. 16.95
 APN-4 Receiver 12.95
 APN-4 Indicator 17.95
 APN-1 Xmit-Rec. 6.95

APS-13 Xmit-Rec. New 17.95
 BC-645 Xmit-Rec. New 12.95
 ATN Receivers 24.95
 BC-375 Transmitter 11.95
 Tuning Units for above 1.95
 BC-223 with 1 TU 49.50
 ASII series Receiver 17.95
 BC-929A Indlc. New 15.95
 BC-929A Indlc. Used 6.95
 ATQ 2 HF Transmitter 19.95
 RAX Receiver 200-1500 kc., 1.5-9 Mc. Each 15.95
 RA-10 Receiver, Models FA, DA, MN 26 C Receiver. 32.50
 New 18.95
 MN-26 Y Receiver 14.95
 BC-431 Receiver 10.95
 MN-20 E-Loop, New 6.95
 D U 1 Loop, New 19.95
 BC-434 Control Box, New 1.49
 AIN-7 Receiver 12.95
 C4ARN-7 Control Box 4.95
 PE-237 Vibra-Park B, 12, 24, V. Input, Output; 525 V. 095 A, 100V. 042A; 0.5 V. 2 A; 0 V. 3 A; 3 V. 450 A. 12.95

ESEGE SALES CO., LTD.

BEST BETS IN HEADSETS!
 HS-38 2,000 ohm. New. \$1.75
 HS-23 4,000 ohm. New. \$2.95

METERS! METERS!
 0-1 amp. R.F. 2" rd. G.E. \$2.99
 0-8 amp. R.F. 2" rd. G.E. 2.98
 0-25 MADC 2" rd. Weston 2.49
 0-50 MADC 2" rd. se. Westinghouse 2.99
 0-15 VAC 2" rd. Westinghouse 2.50

PE103 DYNAMOTOR
 6 & 12 V. input; output, 500 V. @ 160 mhz. Ideal for mobile. Excel. cond. \$15.95

APQ-5 POWER SUPPLY: Electronically controlled power. Embraces 2-5U4G, 4-6Y6, 2VR150, 1-6B17, 1-GX5. Operates from 115 V., 400 cycle. Replacing transformer with 60 cycle. Makes ideal lab or test supply. Excellent cond. Ea. \$6.95

BC375 TRANSMITTER: 100 W. Phone or CW. 2-211 tubes in dual. Complete with all tubes but less tuning unit. \$12.95
HAMS! WE ARE LOOKING FOR TUBES AND ALL TYPES OF CLEAN EQUIPMENT. CONTACT US FOR HIGHEST PRICES! CLEAN UP BY SELLING TO COLUMBIA!

RCBU COAX CABLE
 52 ohm. New. Per 100 ft. \$4.95
 Per ft. 5c
TRANSFORMERS: 115 VAC 60 cy. 5 V. @ 10 amp with 50 W socket mounted on top. Good cond. \$6.95
PARTS KIT FOR 274N & ARC-S COMMAND EQUIPMENT: 1.2 mfd. condenser, C16, 3X.22 condenser, L15 AP choke, 1100-20 ohms output transformer, T-50 Tone Oscillator, T-51 Mike Transformer (20-330 ohms). EACH KIT: 59c

ESSE WILL BUY ANYTHING ELECTRONIC

Attention Factories, Hams, Dealers, Individuals

WE NEED AT ONCE!

We are Especially Interested in Large Quantities

BC-348 Receivers, AC or DC models
BC-312 Receivers
BC-221 Frequency Meters
SCR-522 Transmitters & Receivers
Hallicrafters BC-610 Transmitters
Any factory built transmitters and receivers such as Hallicrafters, National, Temco, Collins, RCA, RME, Hammerlund, Millen, Meck, Harvey-Wells, Meissner, Sonar, McMurdo-Silver, Gonset, Stancor, Bud, etc.
Amateur or commercial sets
Large stocks of tubes
Large stocks of transformers

Large stocks of condensers
Large stocks of resistors
Large stocks of speakers
BC-224 Receivers
BC-342 Receivers
Police type VHF transmitters and receivers for mobile application
Collins ART-13 Transmitters
APS-13's
SCR-269F or G Fairchild or Bendix ADF's
Headphones in quantity lots
Microphones in quantity lots
Field telephones
Sound-powered telephones

wartime system of priority allocations was scrapped, permitting sale of communications equipment to the general public without a "show of necessity."

In the November, 1945, issue of QST, the Hallicrafters Company announced that it was offering "government radio and electronic supplies" for general distribution, under contract SIA-3-24 with the Reconstruction Finance Corporation. A coupon was included with the full-page advertisement, soliciting inquiries about bidding for the various items.

But, the red tape prevailed.

AMATEURS! HAMS! EXPERIMENTERS!

- * NOW—TRANSMITTING TUBES *
* AT SENSATIONALLY LOW PRICES! *
- * 955 ACORN TUBE Detector Amplifier Oscillator Tube—Brand New. 19c ea. *
 - * 1625 Transmitting beam power amplifier same as 807 except 12.0 volt filament medium duty base. 14c ea. *
 - * 003, VR150 Voltage Regulator Tube. 49c ea. *
 - * 836A 3B27 Half Wave High Vacuum Rectifier. Ratings 5000 V max. Heater 2.5 V at 5 amps. 99c ea. *
 - * 829 PUSH PULL Twin Beam Power Amplifier Tube. \$1.49 ea. *

Although large businesses seemed able to buy some choice items, little material appeared in the ham marketplace.* Then, in early 1946, a trickle of war surplus equipment began to show up at the larger radio distributors, such as Harrison Radio in New York. By midsummer, the trickle had become a stream as more and more radio

*In 1946, a letter to the Sales Agency of the Reconstruction Finance Corporation brought a reply to contact the manufacturer of the equipment. A follow-up letter to selected manufacturers brought an answer that told me to contact the RFC Sales Agency! War veterans could apply through the Smaller War Plant Corporation office for a certificate to buy surplus radio equipment directly from the RFC, provided that the applicant was in the radio repair, test, sales, manufacturing, or similar electronics business. The certificate could not be issued to amateurs, or to the public at large. By late 1946, the RFC had been severely cut back, the Smaller War Plant Corporation was defunct, and the military began direct, sealed-bid sales to the public. The system had collapsed of its own red tape!

distributors obtained government surplus radio equipment.

The coming of "Surplus Sam"

I don't think anyone, including the government, was really aware of the great quantity of communications equipment that had been built during the waning years of the war.

By mid-1946, the Reconstruction Finance Corporation had gone out of the surplus business, and the military, frantic to unload their stocks of equipment, began to sell it at closed bid — by the pound — to any and all bidders. Most radio distributors, unwilling to get into the junk business, stood aside while a new breed of entrepreneurs stepped into the picture: The surplus dealers who handled nothing but government surplus equipment.

Within just a few months the price of surplus equipment dropped sharply, and the flood reached full tide. For only pennies on the dollar, a radio amateur could outfit himself with a station that looked like a military communications post! Overnight, unknown surplus dealers sprang up, and the heretofore obscure Esse Radio Company of Indianapolis, Indiana, ran four-page advertisements in CQ magazine, showing their surplus stocks and a photograph of their three-story warehouse! In the same issues

POWER!! POWER!!



EIMAC
304TL
BRAND NEW
JAN. INSPECTED
SUPER VALUE
BETTER ORDER
4 OR MORE
TODAY
90c
EA
WHILE THEY LAST
ANY QUANTITY

SUPER SPECIAL
BRAND NEW \$3.95
EIMAC 304TH \$3.95 ea
JAN. INSPECTED

of CQ, R & M RADIO ran two-page advertisements featuring more war surplus goodies. By February, 1948, as more and more equipment reached the market, some of the ham magazines resembled war surplus catalogs!

The manufacturers

Needless to say, the flood of surplus radio equipment knocked the new-equipment market into a cocked hat! Who

tended to make obsolete the flood of old-style, war-surplus triodes.

Meanwhile, the character of war surplus equipment slowly began to change in a subtle way. Some pieces of equipment, not necessarily the best, had disappeared from the market. The cumbersome and unstable BC-375 aircraft transmitter, bought by hams mostly for parts, became unavailable; and the BC-654A

coded radio messages over point-to-point communications networks on the mainland of China.

The BC-654A transmitter-receiver, and other good items of communications equipment, had been purchased by Israel in the early years of that country. In addition, during the Korean War, the United States Government bought back certain choice items of equipment that it needed, but

NEW WILLARD RECHARGEABLE STORAGE BATTERIES

New 6 volt battery in spill-proof clear plastic case, housed in metal case for easy mounting. Applicable for a wide range of uses where battery power is needed. Shipped dry. Uses standard battery electrolyte available everywhere.

Price, each
Lots of Ten
Without metal case, each
Lots of Ten

BC-348 RECEIVER

Acclaimed the best military receiver for amateur use, this handling six bands

\$49.50

a-c conversion \$4.00
348.....\$6.50

AAF XMTR BC-375-E

For a real bargain, you can't beat these used, but in A-1 shape, BC-375's. Furnished complete with five tubes, seven tuning units covering 200 kc to 12 mc (less BC band); unit BC-306-A antenna tuning PE-73-C with

\$35.00

with variometer and tap switch, dynamotor relay, fuses, and filter. For detailed description of this 200-pound bargain, see our Feb. QST adv.

PE-103 DYNAMOTOR New Lot, only \$9.00

Brand new, in original Signal Corps packing; delivers 160 mils at 500 volts; operates from 6 or 12 volts d-c; shock-mounted assembly includes relays, switches, filters, and

SCOOP: The famous B-19; Mark II; 40 & 80 meter xmtr-revr with tubes; dynamotor power supply, instruction manual, 12 ft. antenna & base, V.H.F. antenna and base, dummy antenna, mounts, 1 headset, microphone, key, junction boxes and interconnecting cables, N-1.....\$29.95

B-19 Mark II complete tank installation with all spares. Packed for export. Instruction manual, etc. N-1.....44.95

would buy a \$275 receiver when it was possible to buy an acceptable war-surplus receiver for only \$49? Why buy a \$45 transmitting tube when you could get the same tube — surplus — for only 49 cents!

Of course, under these circumstances, many manufacturers went out of business. Some of them introduced new products, many of which didn't even get off the ground. TAYLOR TUBE COMPANY closed its doors and EIMAC, one of the largest independent tube manufacturers, survived only because it brought out a new line of high-gain tetrodes that

transmitter-receiver combination that covered the frequency range between 3.7 and 5.8 MHz had disappeared. Where did they go, who bought them, and why?

Looking back on those days, it appears that Nationalist China had bought enormous stocks of surplus radio equipment which eventually fell into the hands of the Chinese Communists. By the mid-1950s, West Coast Amateurs were cursing those old BC-375 transmitters which had showed up on the 80-meter band, chirping and blurring their

were in short supply.

In 1950, a prominent war-surplus junkie confided to me that he had made a quick \$60,000 in two days by buying war-surplus transmitting tubes from the United States Army at *fourteen cents a pound*, and selling them to the United States Navy at *\$35 apiece!*

The deadline

By 1951, the huge stocks of good war-surplus material had been virtually depleted and the equipment left for sale, such as oxygen bottles, tuning boxes, dynamotors, and out-of-band crystals, was mostly junk. The party was over, and on the

VLF CONVERTER

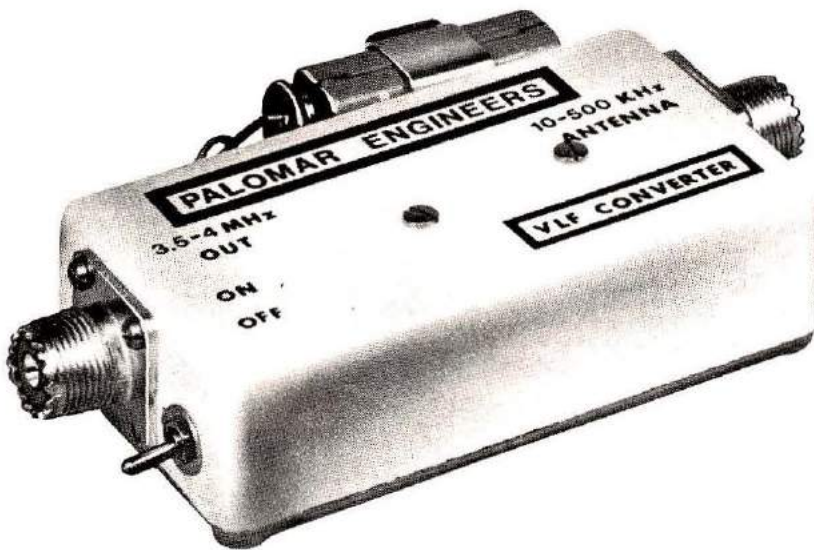

- New device opens up the world of Very Low Frequency radio.
- Gives reception of the 1750 meter band at 160-190 KHz where transmitters of one watt power can be operated without FCC license.
- Also covers the navigation radiobeacon band, standard frequency broadcasts, ship-to-shore communications, and the European low frequency broadcast band.

The converter moves all these signals to the 80 meter amateur band where they can be tuned in on an ordinary shortwave receiver.

The converter is simple to use and has no tuning adjustments. Tuning of VLF signals is done entirely by the receiver which picks up 10 KHz signals at 3510 KHz, 100 KHz signals at 3600 KHz, 500 KHz signals at 4000 KHz.

The VLF converter has crystal control for accurate frequency conversion, a low noise rf amplifier for high sensitivity, and a multipole filter to cut broadcast and 80 meter interference.

All this performance is packed into a small 3" x 1½" x 6" die cast aluminum case with UHF (SO-239) connectors.

The unique Palomar Engineers circuit eliminates the complex bandswitching and tuning adjustments usually found in VLF converters. Free descriptive brochure sent on request.

Order direct. VLF Converter \$55.00 postpaid in U.S. and Canada. California residents add sales tax.

Explore the interesting world of VLF. Order your converter today! Send check or money order to:

PALOMAR ENGINEERS

P.O. Box 455, ESCONDIDO, CA. 92025 — Phone [714] 747-3343

horizon appeared a small cloud — no bigger than a man's hand: television interference, TVI.

Since 1948 the number of television sets had increased sharply and, by 1950, many amateurs were in serious trouble with television interference. The surplus equipment, designed over a decade before and hastily pressed into operation by eager amateurs after the war, was simply not *clean* enough to meet modern operating standards.

To top it all off, ESSE RADIO COMPANY and other surplus stores were running magazine advertisements offering to *buy back* the surplus equipment sold to hams only a short time before! Overseas buyers were looking for good war-surplus radio gear, and many amateurs were at last willing to unload all of the military equipment in favor of communications equipment that better fitted their needs and the changing state of the art.

The popularity of single sideband finally signalled the doom of the surplus market. True, even today, bits and pieces of World War II radio gear are for sale: It looks as if the popular *Command* receivers will go on forever. But, the days when an up-to-date Amateur station boasted a BC-348 communications receiver, a 500-watt BC-610 transmitter, a BC-221 frequency meter, and a modified SCR-522 for two-meter work are probably gone forever.

The grand old radio equipment of World War II, rendered obsolete at last by the combination of age, TVI, ssb, and solid-state devices, is now only a collector's item, bringing back memories to old-time hams who served their country well in the greatest of all wars.

HRH

The photographs of equipment and the advertisements used as illustrations are from *CQ* and *QST* magazines of the war-surplus era, and are reproduced here with their permission.

Get all this transceiver

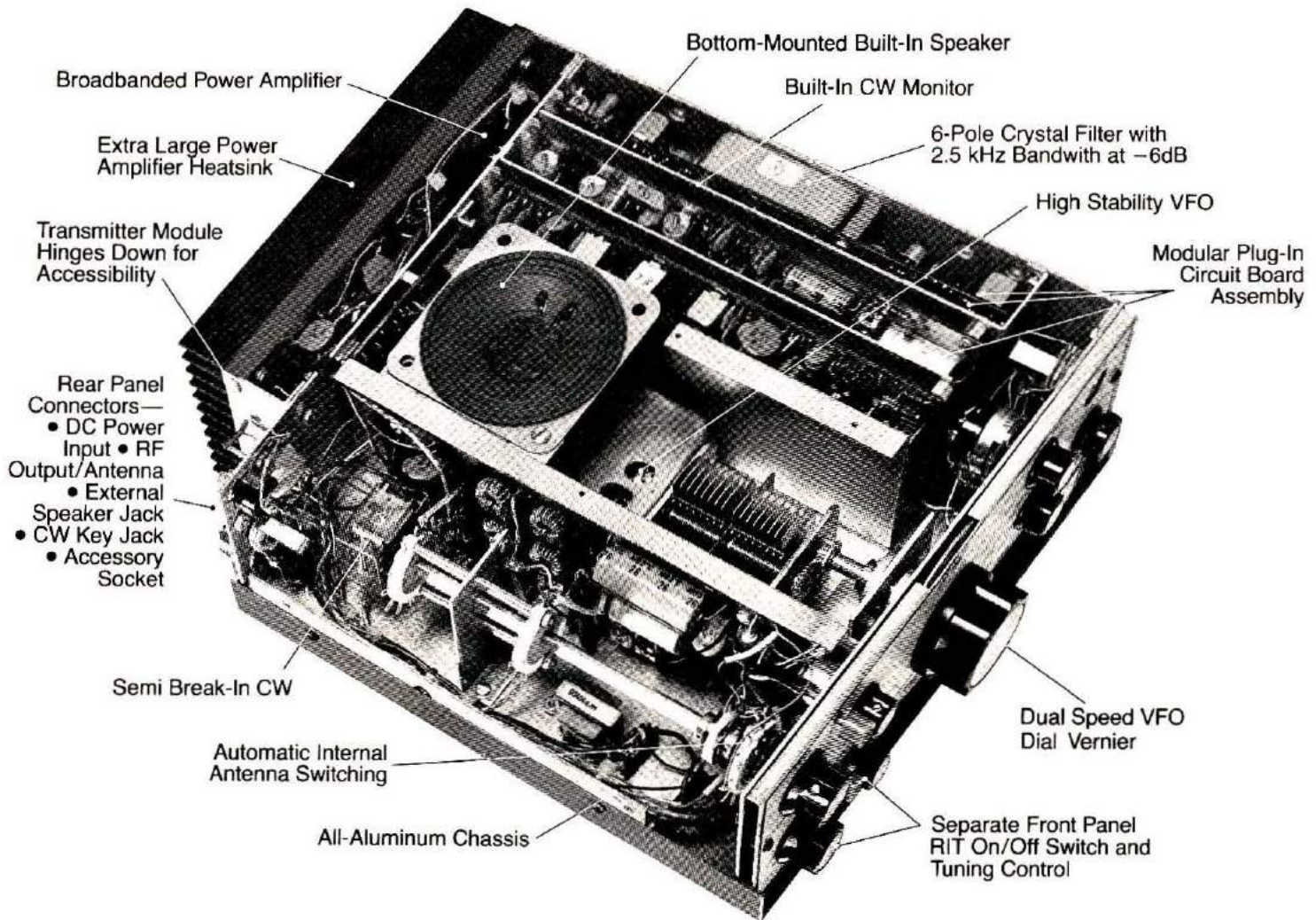

for under \$500.

Available Options Include 100 kHz/10 kHz Dual Crystal Calibrator, Noise Blanker and Portable or Heavy Duty Power Supply

Microphone and mobile mount included.



ALDA 103 is completely manufactured in the U.S.A

alda 103

totally solid state SSB Transceiver • 80 through 20 meters • 250 watts

ALDA Communications Inc., 214 Via El Centro, Oceanside, CA 92054 • (714) 433-6123

Calling
All Hams...



...All Hams
Call Us!

It's Toll Free... So Dial Away!

1-800-325-3636

FOR NEW OR USED AMATEUR RADIO GEAR... we're specialists and carry *in stock* most of the famous-brand lines. Or, we will talk trade.

FOR FAST, DOOR-STEP DELIVERY... give us a call. You'll be amazed; for we guarantee we'll ship your equipment the same day. Plus, most shipments are **PRE-PAID**.

TO SAVE MONEY... join thousands of our satisfied customers who buy from us as easily as from their local supplier. So, remember your call is *Toll Free*.



We welcome your Master Charge or Bank Americard



HAM RADIO CENTER, INC.

8340-42 Olive Blvd. P.O. Box 28271 St. Louis, MO 63132

MORSE CODE COURSES

INCLUDES SPECIAL PREP FOR THE NEW COMPREHENSIVE CODE EXAM

Specially Designed for Beginners

OUR 2 NOVICE COURSES TAKE YOU FROM DAY 1 (NO KNOWLEDGE OF ANY CODE) THRU 6 OR 8 WORDS PER MINUTE

NO CLASSES-LEARN AT HOME

OUR NEW METHOD SUCCESSFULLY USED BY PEOPLE FROM 10 THRU 65 YEARS OLD. PLENTY OF PRACTICE MATERIAL, OUR 6 & 7 CASSETTE METHODS SUCCEED WHERE 1 & 2 FAIL.

INCLUDES EXCLUSIVE NOVICE TRAINING SCHEDULE ALL REFERENCE MATERIALS, CHECKING SHEETS TO VERIFY ACCURACY, INFO ON OTHER HAM LICENSE REQUIREMENTS.

STANDARD 2 TRACK MONAURAL CASSETTES PROVIDE 60 MINUTES EACH OF SCIENTIFICALLY PREPARED CODE PRACTICE (LETTERS, NUMBERS, PUNCTUATION, CODE GROUPS, WORDS) CASSETTES ARE DESIGNED TO MINIMIZE LEARNING PLATEAUS, EMPHASIZE NEW MATERIAL.

SET 1 0-6 WPM (Novice License) 6 CASSETTES \$15.95
 SET 2 0-8 WPM (Novice License) 7 CASSETTES 17.95
 SET 3 7-14 WPM (Gen Cl. License) 3 CASSETTES 8.95
 First class postage and handling required per CASSETTE 0.40

THE HERRMAN CO.
 DEPT J, BOX 1101, LARGO, FLA. 33540

CLUBS - GROUPS ANY 10 OR MORE SETS
 10% OFF + 25 ¢ PER CASSETTE 1st CL. POST & HNDLG.

bind 'em AND find 'em!



Keep those valuable issues of Ham Radio HORIZONS like new! Prevent smears, tears and dog ears — bind 'em in the handsome, 2-color buckram binders now available from Ham Radio's Communications Bookstore.

Each binder comes complete with gold-stamped date labels and is fully washable.

In the future, you'll be happy you did it now!

Ham Radio HORIZON Binders **\$6.95**
 Order HR-HBDL **3 for \$17.95**



ham radio's communications bookstore
 Greenville, N.H. 03048

Here's my payment for the HORIZON binders.
 \$6.95 \$17.95

Name _____

Address _____

City _____

State _____ Zip _____

ME-3 microminiature tone encoder

Compatible with all sub-audible tone systems such as: Private Line, Channel Guard, Quiet Channel, etc.

- Powered by 6-16vdc, unregulated
- Microminiature in size to fit inside all mobile units and most portable units
- Field replaceable, plug-in, frequency determining elements
- Excellent frequency accuracy and temperature stability
- Output level adjustment potentiometer
- Low distortion sinewave output
- Available in all EIA tone frequencies, 67.0 Hz-203.5 Hz
- Complete immunity to RF
- Reverse polarity protection built-in

\$29.95 each

Wired and tested, complete with K-1 element

communications specialists

P. O. BOX 153
BREA, CALIFORNIA 92621
(714) 998-3021

K-1 FIELD REPLACEABLE,
PLUG-IN, FREQUENCY
DETERMINING ELEMENTS

\$3.00 each



We Fill SANTA'S ORDERS



**KENWOOD TR-7400A 2M/FM
Synthesized Xcvr \$399.00**



**KENWOOD TS-700S 2-Meter
All-Mode Digital Xcvr \$679.00**

**KENWOOD TS-520S 160-10M
Transceiver \$649.00**



**DRAKE TR-4CW
Transceiver \$699.00**



**KENWOOD TS-820S DELUXE
Digital Transceiver \$1048.00**



**TEMPO 2020 DIGITAL
Transceiver \$759.00**



"GOOD/CLEAN" TRADE-
INS WELCOMED. Write
TODAY for Quotation!

DEAR OM: Just in the "NICK" of time!! All your favorite "GIFT IDEAS" from Atlas, CIR, DenTron, Drake, Icom, KLM, Kenwood, Swan, Tempo, Ten-Tec, Wilson, Yaesu and MORE . . . PLUS a COMPLETE LINE of operating aids & accessories NOW IN STOCK for IMMEDIATE DELIVERY throughout the coming holiday season. And, remember, at BURGHARDT AMATEUR CENTER, "S-E-R-V-I-C-E" is our MOST IMPORTANT PRODUCT, so that when it comes to FAST DELIVERY, HONEST DEALING and PROMPT/DEPENDABLE SERVICE — we don't just advertise it — WE GIVE IT!! You can "RELY ON US" to give YOU a "GOOD DEAL" plus COMPLETE SATISFACTION and FULL S-E-R-V-I-C-E backup today, tomorrow AND "NEXT YEAR!"

Season's Greetings

WE'RE FOR REAL . . . There's no doubt about it!

73's STAN BURGHARDT WØIT BILL BURGHARDT WBØNBO JIM SMITH WBØMJY ERV HEIMBUCK KØOTZ

**STORE HOURS:
TUESDAY thru SATURDAY
9:00 A.M. to 5:00 P.M.
Closed Sunday & Monday**

**124 First Avenue Northwest
P.O. Box 73
Watertown, South Dakota 57201
Phone 605-886-7314**

Burghardt
INC.
AMATEUR CENTER

Write today for our latest Bulletin/Used Equipment list.

"America's Most Reliable Amateur Radio Dealer"

Your Full-Line Ham Dealer Where S-E-R-V-I-C-E is our most important product.

Bunghardt
AMATEUR CENTER

Straight from...

HEADQUARTERS

NEW YAESU FT-301D "GOLD LINE"



**FP-301D Deluxe
AC Supply \$209.00**

**FT-301D DIGITAL
Transceiver \$935.00**

**FV-301 Remote
VFO \$109.00**

**YO-301 Monitor
Scope \$219.00**



**DENTRON MLA-2500
Linear Amp \$799.50**

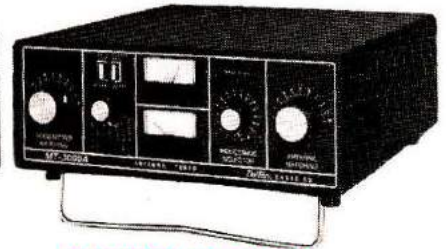

**DENTRON MT-3000A
Monitor Tuner \$349.50**



**ATLAS 350-XL Digital
Transceiver \$995.00**

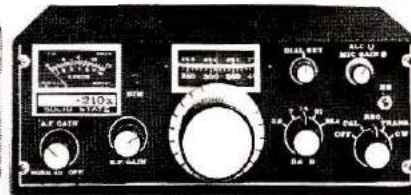

**ATLAS 210/215-X
Mobile Xcvr \$679.00**



**TEN-TEC TRITON IV
Digital Xcvr \$869.00**



**CENTURY 21 CW
Transceiver \$289.00**



**ASTRO 200 Digital
Transceiver \$995.00**



INVERTED



BY ALFRED WILSON, W6NIF

The popular inverted-V dipole can be improved to provide some directivity by adding a little more wire and a couple of home-made phasing stubs

The inverted V, or sloping dipole antenna, which was described in Jim Fisk's article, "Antennas for the High-Frequency Amateur Bands" in the June, 1977 issue of *Ham Radio Horizons*, is one of the simplest arrangements you can use for working DX stations. Only a single support (tree or mast) is needed to hold the antenna above ground. The inverted V is really a dipole antenna with sloping elements, or legs. The angle between the legs isn't too critical; however, it should be somewhere between 90 and 120 degrees. If the angle is much less than 90 degrees, you can expect feed problems and high standing-wave ratio.

The inverted V has characteristics of both horizontal and vertically polarized antennas. The inverted V doesn't perform as a true vertical antenna; nevertheless it seems to have a low radiation angle in the vertical plane. Furthermore, an elaborate ground radial system, which is characteristic of vertical radiators, isn't necessary.

Energy radiated from a half-wave (dipole) antenna oriented

horizontally looks like the pattern of **Fig. 1A**. The radio-frequency energy leaves the antenna in two broad lobes in opposite directions, **A** and **B**. If two dipoles arranged in a straight line are connected so that they operate in the *same phase*, the currents in each element will appear as shown in **Fig. 1B**. Such an

arrangement is known as a *driven array*.

The radiation pattern of the antenna of **Fig. 1B** will be similar to that of **Fig. 1A**. However, because two half-wave elements are used, which are fed in phase, the radiation pattern will be intensified and will look somewhat like that shown in **Fig. 2A**. This radiation pattern is sharper and more directive, which is the same as saying that the antenna producing such a pattern has *gain* along the line of maximum energy propagation. Also, the antenna beamwidth is reduced. This is the same feature provided by expensive Yagi beams, which use aluminum tubing for elements and must be mounted on a tower or other high support for maximum effectiveness.

If all the elements in a driven array are in a straight line, the arrangement is called a *collinear array*. The current in each element must always be in the *same phase*. This phase relationship is maintained by connecting each element with sections of transmission line, called "stubs," of the correct length and impedance.

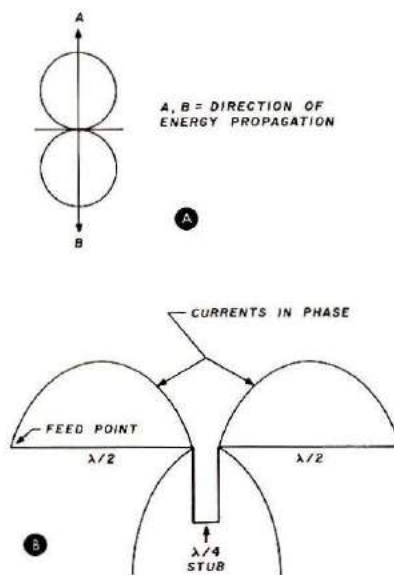

Fig. 1. Radiation pattern for a simple horizontal dipole antenna, **A**, and current distribution of two dipoles driven in phase, **B**.

When two collinear half-wave antenna elements are connected directly, the effect is that of a full-wave antenna, **Fig. 2B**. The current in the first half-wavelength element is exactly 180 degrees out of phase with that in the second half-wavelength element.

When the elements are connected by a quarter-wavelength stub, as in **Fig. 1B**, the current travels down one side of the stub and up the other. The current travels a distance of one-half wavelength in the stub; thus the current travels through *one-half cycle* of change. When the current reaches the next element, it's in the desired phase. Since the current in one side of the stub is equal and opposite to the current on the other side, the fields produced by the stub cancel, and no radiation is produced from the stub. Thus, the two half-wave elements are said to be *driven in phase*.

Let's build one

Enough of the theoretical stuff. Here's how to put up an

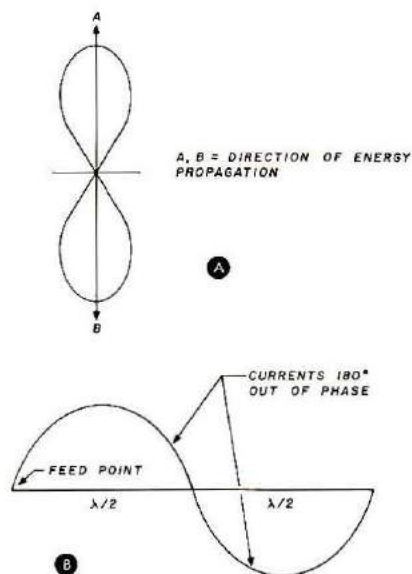

Fig. 2. Radiation pattern of an antenna with two half-wave elements driven in phase, **A**. The pattern is sharper than that of an ordinary dipole and gives increased signal strength in the directions shown. Sketch **B** shows the current distribution in two half-wavelength antenna elements connected directly together; that is, the system operates as a full-wavelength antenna.

inverted V with collinear elements for increased directivity. A sketch of the

modified inverted V is shown in **Fig. 3**. Dimensions are in terms of wavelengths for the radiating elements and the phasing stubs. Also shown are suggested angles for separating the antenna legs (angle α), the angle between the antenna legs and the phasing stubs (angle β), and the angle between the mast and antenna legs when the antenna is looked at from the side (angle γ). The reason for showing angle γ is that I've obtained better results with the inverted V when the plane of the element legs is sloped out of the plane of the supporting structure. See **Reference 1** for further details.

Assuming you're now using the naked inverted V and want to add another half-wavelength section to each leg for improved performance, all you need is a little more wire for the additional elements and a couple pieces of coax cable for the phasing stubs. I've shown type RG-8/U coaxial cable for the stubs and transmission line in **Fig. 3**; however, if you're

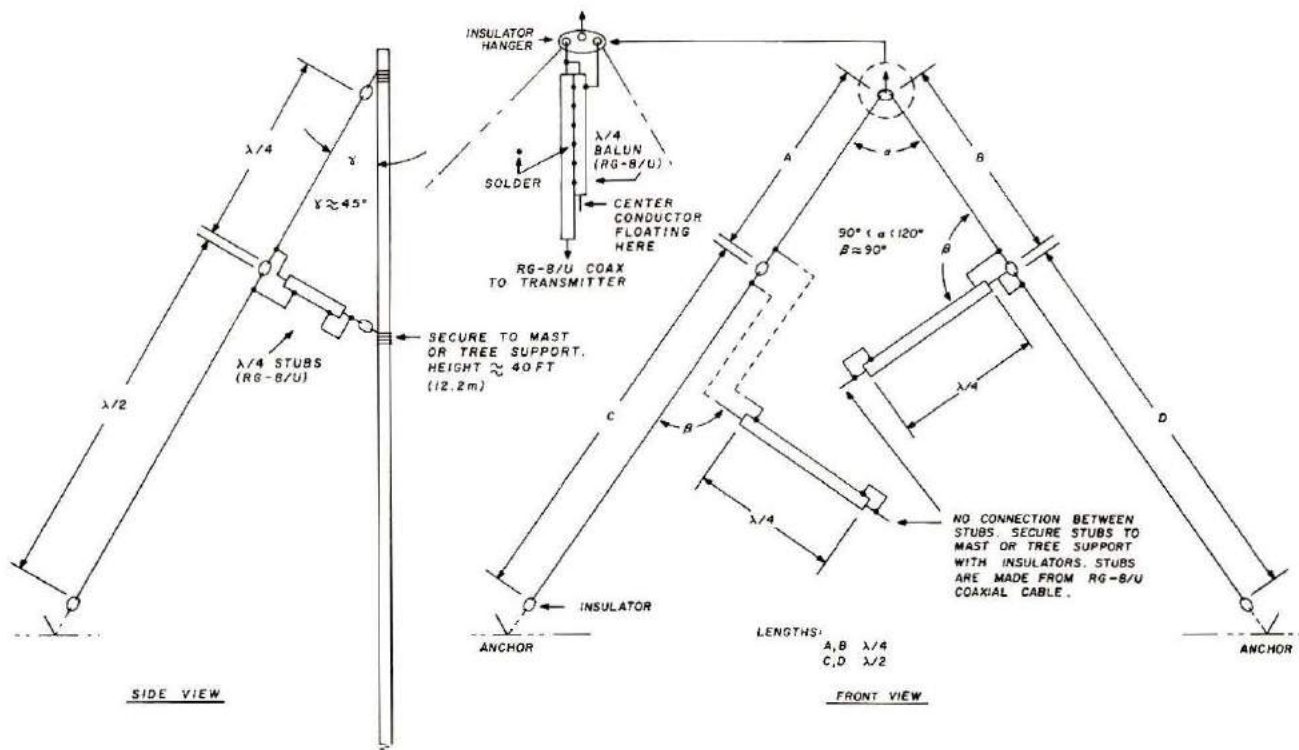
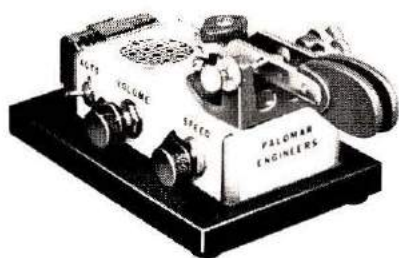

Fig. 3. The modified inverted-V antenna. Two half-wavelength elements are added, which are driven in phase. The angles shown are nominal. The coax cable is shown as RG-8/U, but RG-58/U will work for low-power transmitters. Good solder connections are important for trouble-free operation.

NEW! IC KEYER

The World's Greatest
Sending Device



Adjustable to Any
Desired Speed

Now available from Palomar Engineers — the new Electronic IC KEYER. Highly prized by professional operators because it is EASIER, QUICKER, and MORE ACCURATE.

It transmits with amazing ease CLEAR, CLEAN-CUT signals at any desired speed. Saves the arm. Prevents cramp, and enables anyone to send with the skill of an expert.

SPECIAL RADIO MODEL

Equipped with large specially constructed contact points. Keys any amateur transmitter with ease. Sends Manual, Semi-Automatic, Full Automatic, Dot Memory, Squeeze, and Iambic — MORE FEATURES than any other keyer. Has built-in sidetone, speaker, speed and volume controls, BATTERY OPERATED, heavy shielded die-cast metal case. FULLY ADJUSTABLE contact spacing and paddle tension. The perfect paddle touch will AMAZE you.

Every amateur and licensed operator should know how to send with the IC KEYER. EASY TO LEARN. Sent anywhere on receipt of price. Free brochure sent on request.

Send check or money order. IC KEYER \$97.50 postpaid in U.S. and Canada. IC KEYER LESS PADDLE and non-skid base \$67.50. Add 6% sales tax in California.

Italy write i2VTT, P.O. Box 37, 22063 Cantu.

Fully guaranteed by the world's oldest manufacturer of electronic keys. ORDER YOURS NOW!

PALOMAR ENGINEERS

BOX 455, ESCONDIDO, CA 92025
Phone: (714) 747-3343

using low power (say, under 200 watts input), then type RG-58/U cable will be okay. The main thing to remember is that the added elements must be connected in the *proper phase*; adding the stubs will maintain this relationship.

Here's an example for a collinear inverted V antenna for 15 meters. Dimensions **A** and **B** (Fig. 3) are one-quarter wavelength, which means each of these legs will be 11 feet (3.4m) long. The two phasing stubs, also one-quarter wavelength, will also be the same electrical length. The added elements, **C** and **D**, are one-half wavelength long, which is 22 feet (6.7m). (All these dimensions are nominal for the 15-meter band).

So this means that each antenna leg will be of the order of $11 + 22 = 33$ feet (10m) long. A 40-foot (12.2m) mast would be a good choice as a support. If the antenna apex angle is 90 degrees (angle α in Fig. 3), the insulators at the end of each leg will be about 16 feet (5m) above ground.

When you make the phasing stubs, remember that the coax center conductor is connected to the antenna elements and the coax-cable shield braid is connected with a *good* solder joint as shown. The solder joints should be wrapped with PVC tape then coated with silicone compound to avoid long-term corrosion problems.

The far end of the phasing stubs should be insulated from each other. A low-loss antenna insulator can be used here. The stubs should (ideally) drop at a 90-degree angle from the antenna elements, (angle β) although this doesn't seem to affect antenna performance. Secure the phasing stubs to the mast or other support through insulators. If the coax shields of the stubs are correctly soldered and coated with some kind of protective material, you won't have any problems with corrosion for a long time.

Ordinary "egg" insulators

can be used for the setup shown if low power is used, or you can use pieces of thick plastic salvaged from discarded containers from household detergents. The choice is yours: you can be elegant and use expensive materials for insulators or use materials that would otherwise end up in the trash can. Either way, the antenna won't know the difference. You can save money by using your ingenuity.

Final remarks

During the next few years propagation conditions on the high-frequency amateur bands are expected to improve. The antenna described here won't provide a quantum jump in signal strength over your horizontal dipole or vertical antenna. Also it won't give results that a beam antenna will provide, but you'll find that the improvement obtained in received and transmitted signal strength will be well worth the construction effort.

Acknowledgement

My thanks to Joe Saugier, K6CD, for reviewing the manuscript and for much helpful engineering advice.

Reference

1. A. Wilson, W6NIF, "Dipole Sloping Inverted Vee," *ham radio*, February, 1969, page 48. **HRH**



"This is K9ARF apologizing to the FCC and all other listeners for the comment made when my desk drawer fell on my foot."

TEMPO

VHF / ONE PLUS



MORE POWER / 25 OR 5 WATTS OUTPUT SELECTABLE

REMOTE TUNING / ON MICROPHONE

NEW LOWER PRICE / NOW ONLY \$399.00

SIDEBAND OPERATION WITH SSB/ONE ADAPTER / MARS OPERATION CAPABILITY / 5 KHz NUMERICAL LED

The Tempo VHF / One Plus is a VHF / FM transceiver for dependable communication on the 2 meter amateur band • Full 2 meter coverage, 144 to 148 MHz for both transmit and receive • Full phase lock synthesized (PLL) • Automatic repeater split—selectable up or down • Two built-in programmable channels • All solid state • 800 selectable receive frequencies with simplex and +600 KHz transmit frequencies for each receive channel.

TEMPO FMH-2, FMH-5 & FMH-42 (UHF)

6 channel capability • selectable 1 or 2 - 1 or 5 Watts output • Solid-state • Battery level meter • Earphone jack • Built-in charging terminals and separate charging jack for Ni-cad batteries • Flex antenna • Carrying case standard • Excellent frequency stability allows use with booster amplifier for high power output over 100 Watts • 8 AA batteries or 10 AA Ni-cads.*

*Not furnished.
FCC Type accepted models available.



TEMPO VHF & UHF AMPLIFIERS

VHF (135 to 175 MHz)			
Drive Power	Output	Model No.	Price
2W	130W	130A02	\$199
10W	130W	130A10	\$179
30W	130W	130A30	\$189
2W	80W	80A02	\$169
10W	80W	80A10	\$149
30W	80W	80A30	\$159

UHF (400 to 512 MHz)			
Drive Power	Output	Model No.	Price
2W	70W	70D02	\$270
10W	70W	70D10	\$250
30W	70W	70D30	\$210
2W	40W	40D02	\$180
10W	40W	40D10	\$145
2W	10W	10D02	\$125

FCC Type accepted models available.

TEMPO POCKET RECEIVERS

MS-2, 4 channel scanning receiver for VHF high band, smallest unit on the market. MR-2 same size as MS-2 but has manual selection of 12 channels. VHF high band. MR-3, miniature 2-channel VHF high band monitor or paging receiver. MR-3U, single channel on the 400 to 512 UHF band. All are low priced and dependable.

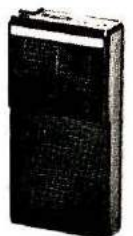

Sold at Tempo dealers throughout the U.S. and abroad. Please call or write for further information.

Prices subject to change without notice

11240 W. Olympic Blvd., Los Angeles, Calif. 90064
931 N. Euclid, Anaheim, Calif. 92801
Butler, Missouri 64730

213/477-6701
714/772-9200
816/679-3127

Henry Radio

YOU... AND AMSAT PHASE III

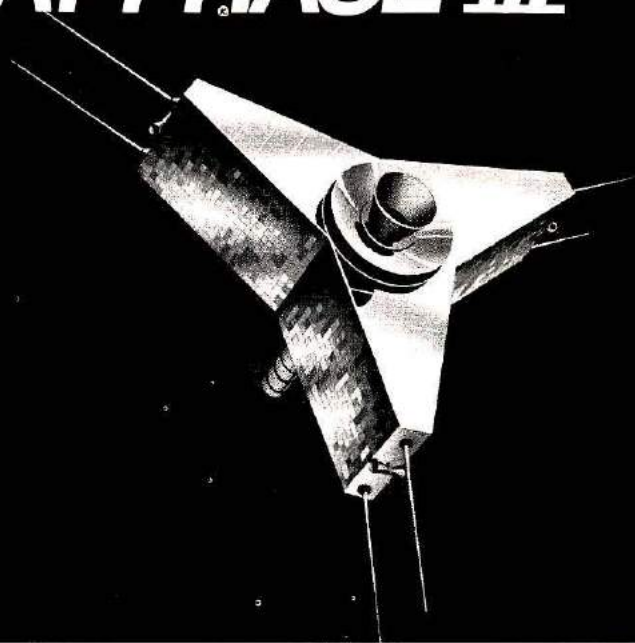

An exciting new era in amateur radio is about to begin... the era of AMSAT PHASE III OSCAR satellites.

Many of you are familiar with the benefits of the AMSAT OSCAR satellites, notably OSCAR 6 and 7. These satellites, with a combined total of over 8 years in orbit, have provided communications between amateurs throughout the world. They have also provided a capability for an educational program in space sciences and many interesting experiments.

AMSAT, with members and contributing groups worldwide, and headquarters in Washington, D. C., has been responsible for our current satellite program. Many people feel that perhaps the greatest value of the amateur satellite program is the dramatic demonstration of amateur resourcefulness and technical capability to radio spectrum policy makers around the world.

The value of this aspect of amateur radio as we prepare for the 1979 World Administrative Radio Conference (WARC) is enormous.

The AMSAT PHASE III satellite program promises a continuing demonstration that amateur radio is at the forefront of modern technology. PHASE III satellites will routinely provide reliable communications over paths of up to 11,000 miles (17,600 km) for 17 hours each day. You can think of them as a resource equivalent to a new band.

The cost of these PHASE III satellites is a projected \$250,000. Commercial satellites of similar performance would cost nearly \$10,000,000.

Your help is needed to put these PHASE III OSCAR satellites in orbit.

Your valued, tax-deductible contribution can be as small as one of the 5000+ solar cells needed. A handsome certificate will acknowledge the numbered cells you sponsor for \$10 each. Larger components of the satellites may also be sponsored with contribution acknowledgements ranging to a plaque carrying your name aboard the satellites. Call or write us for the opportunities available.

Your membership in AMSAT is important to the satellite program, and will give AMSAT a stronger voice in regulatory matters concerned with satellites. At \$10 per year or \$100 for life, you will be making a most significant contribution to the satellite program and the future of amateur radio. You will also receive the quarterly AMSAT newsletter.

Clip the AMSAT PHASE III coupon below and send your support today, or call 202-488-8649 and charge your contribution to your BankAmericard (VISA) or Master Charge card.

	AMSAT PHASE III	HRH
	Radio Amateur Satellite Corporation Box 27, Washington, D.C. 20044 202-488-8649	
YES, I want to support AMSAT PHASE III OSCAR satellites. Enclosed is:		
<input type="checkbox"/> \$_____ in sponsorship of _____ solar cells (@ \$10 each)		
<input type="checkbox"/> \$10 Annual membership <input type="checkbox"/> \$100 Life membership		
<input type="checkbox"/> Send information on sponsoring larger satellite components.		
Name	Call	AMSAT Member?
Street		
City	State	Zip
The publisher has donated this space to AMSAT in support of AMSAT and the PHASE III program.		

RTTY Can Be Easy!

Have You Wondered . . .
What Owning a RTTY Station Would be Like?
Have You Thought . . .
About Finding Out but Didn't Know Who to Ask?



ASK THE GUYS AT HAL!

Our sales and service staff will be happy to assist you in your choice of RTTY equipment, answer questions about RTTY, and provide assistance if problems do arise. In addition, all HAL amateur RTTY equipment manuals can be purchased for \$10.00 each for an advance look (applicable to future purchase of that unit).

Answers to common RTTY questions are featured in the center-fold of our new amateur radio catalog. Such questions as "What do I need?", "How do I hook it up?", and "What frequencies do I use?" are discussed. Technical points concerning RTTY pulses, FSK and AFSK, and high-tones vs low-tones are covered.

Write today for HAL'S new catalog and RTTY guide and discover how much fun RTTY can be.



HAL COMMUNICATIONS CORP.
Box 365
Urbana, Illinois 61801
217-367-7373

For our European customers
see HAL equipment at:

Richter & Co., Hannover
I.E.C. Interelco, Bissone
Primetek Systems, Handen, Sweden
Radio Shack of London

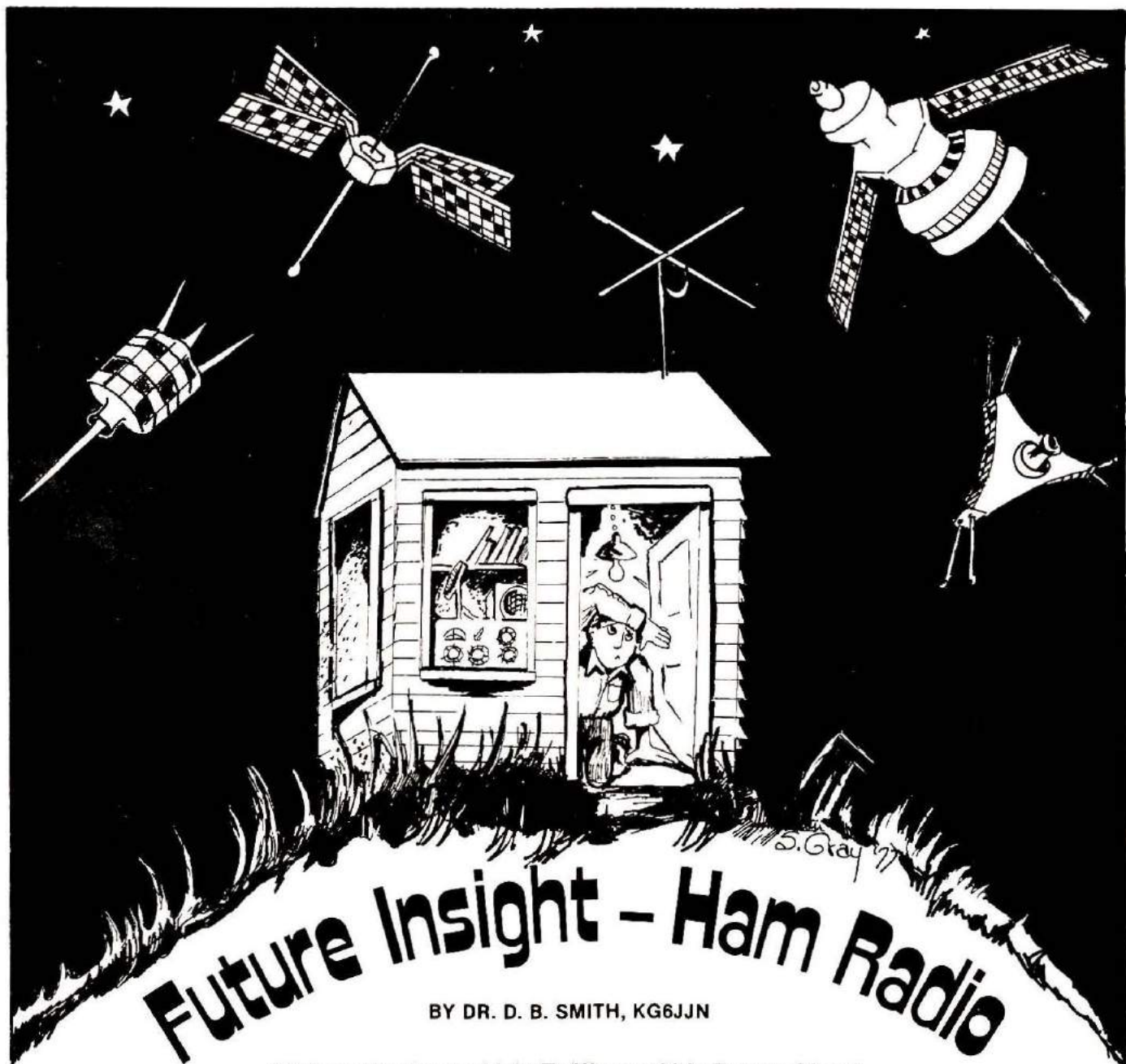

Future Insight - Ham Radio

BY DR. D. B. SMITH, KG6JJN

With apologies to Alvin Toffler and his Future Shock

You say you wonder what ham radio is coming to these days? Repeaters, slow-scan television, all kinds of nets taking up the 75-meter band, programmed DX from exotic places . . . Are these changes getting to you? How about taking a look at what it could grow into many years from now. Come over here and listen to this new converter circuit that I've been haywiring

together; it's a new gadget and I'm not too sure I got it working right, but I heard something the other night. Mind you — the dial calibration is not too good yet, so I'm not sure what year I've tuned in, but here goes . . .

"Breaker — breaker DX, from WZ2ABC . . ."

"WZ2ABC, your call has been sked to me by the SatCom Scan Searcher; this is KG6XYZ."

"Roger dodger; got you on Visual, KG . . . I see we got Channel 8899. I got that channel assigned to me last year and won a bundle on it in the Random Sked Raffle. How about that, Old Person?"

"That's a roger. You're pegging my meter at the 10-4 mark, and you get one little green light, to boot. Nice signal through the bird."

"Thanks good buddy. I notice

we were assigned satellite No. 765; real interesting. You got two green lights at this end, and my processor indicates we have four hours of use before losing it."

That's a big roger dodger. Say, WZ, notice on the soft copy that your handle is Heat Sink."

"Roger dodger . . . like to make up some homebrew from time to time. Got me a new snap-it-together CW simulator kit the other day. All you gotta do is snap ten pieces together, and you can produce good old-fashioned Charlie William right off the processor keyboard!"

"Well . . . can't see the advantage of that over the built-in. What else can it do?"

"Makes CW from 'phone . . . but you have to watch your accent, though; gets most of it spelled okay in NewPhonics. Another few green stamps and you can add a conversion to Old American. Say, KG, how come you aren't using the long wire?"

"Aw . . . got sick of it after the first few years out here; just too easy. Besides, it's only hooked up to about 95 per cent of the licensed hams. Have to hit a bird to get the rest, anyway, so thought I'd do some real hamming tonight by wireless."

"Yeh, know what you mean, but I sure like it, though. Don't know what I did before the cable went in. Used to hear noise and hiss on so many of the signals; takes all of the fun out of the hobby when you hear some noise on a signal, ya know? Some of the signals used to fade out just like they had equipment trouble when I used to work the old terrestrial repeaters."

"Yeh, WZ, I know . . . but seems to me that there's more challenge in it. After all, you have to wait for one of the satellites to be assigned to you by the Scanner, and you can only get ten kW from most of

'em, anyway! Heard there's gonna be a new series up with 100 kW . . . what say, WZ?"

"News to me. Will they let the CB Extras work it, KG?"

"Roger dodger. They get all the Tech privileges when they pass the 60-wpm typing test. Sure was a good thing when The Lobby got incentive licensing for CB, WZ. Know what I mean?"

"Yeh, but as I remember, they took away half of the 500 channels, and then gave 'em back to only those who could pass the typing test. Beats me why they didn't use technical exams, instead."

"Roger dodger that, WZ . . . just like the days before guys started implanting CW converters under their scalps; you had to pass higher-speed CW to use additional 'phone channels."

"Hey, that's right! Think they used to call 'em straps, or bands, or something like that, before everything got channelized, Old Person."

"Roger dodger. With this twenty-step Am-Cit incentive program, I guess a lot of terminology has been changed. Say . . . what did 'break' used to mean in the Old Days? I note by the print-out you have 5 years in, and are a certified *Old Timer*."

"Yeh, KG; and I'm working on my next five to make me an *Ancient*. 'Break' used to mean that you were passing the cable over to the other station. Then it was adopted in place of a Q-call . . . *QRZ*, I think it was."

"Gee, WZ, wonder if they had any way of starting a chat before that?"

"Yeh, KG, my old *Almanac for Ancients* shows something called *CQ* as predating *QRZ*; and a note here states that in rare instances it was used to interrupt a visit, but almost never used to indicate an emergency."

"Roger dodger. Very interesting to get that

background. Say . . . I heard they used to do some 'bare-wire' work back then . . . had some luck, too."

"Right, KG, but haven't tried it lately myself, though; too much hassle. Weak signals, noise, all that. It's done by beaming your raw rf straight at the other station, if you happen to know where one might be that has the same capability."

"Roger dodger, WZ; probably by sked. How did the other station pick up the rf?"

"Had to have his own antenna, rather than use the short wire into the local antenna co-op."

"Roger dodgeroodle, Old Person. Boy, that must have looked like a mess around the ol' high-rise; and I'll bet it was a hassle trying to get SatCom Scan to assign a channel . . . oops, forgot. They would be working direct. Really ancient, eh what?"

"Right, KG, and to make it worse, they used to modulate by amplitude, before it was outlawed. No advantage to it at all. Well, your video is getting a bit hazy on my screen, so I'll sign. Have punched in a 925 to give you a QSL entry into your *pross*; 10-73, Old Buddy."

"10-73, Old Person." . . . Bleep . . .

"Breaker-breaker, WZ2ABC, this is an automatic recording from your friendly Amateur Cable Company. How would you like the hiss-free, loud-signal advantage of world-wide cable communications just for a small monthly billing to your compu-account? Well, all you have to do is punch a \$10-4 into your keyboard, and . . ."

"Bleep; cancel message, de WZ2ABC clear."

"Bleep; WZ2ABC from AmCabCom. Won't you reconsider? Think of the fine signal reports, and . . ."

"Bleep, AmCabCom from WZ2ABC . . . discontinue sales routine #324. This is not a live station you're working, but a

you're carefree

when you know you've got the very best!



Larsen Kūlrod® antennas

Repeater or simplex, home station or mobile, 1 watt or 50 . . . what really counts is the intelligence that gets radiated. Jim Larsen, W7DZL found that out years ago when he was both hamming and running a two-way commercial shop. That's when he started working with mobile antennas . . . gain antennas that didn't waste power in useless heat. Today, thousands and thousands of Larsen Antennas are being used. We call it the Larsen Kūlrod® Antenna. Amateurs using them on 2 meters, on 450 and six call them **the antenna that lets you hear the difference.**

Larsen Kūlrod Antennas are available for every popular type of

Illustrated . . . Larsen JM-150-K Kūlrod Antenna and mount for 2 meter band. Comes complete with coax, plug and all mounting hardware. Easy to follow instructions. Handles full 200 watts.



Dealer Inquiries Invited

Larsen Antennas

11611 N.E. 50th Ave. • P.O. Box 1686 • Vancouver, WA 98663 • Phone: 206/573-2722
In Canada write to: Canadian Larsen Electronics, Ltd.
1340 Clark Drive • Vancouver, B.C. V5L 3K9 • Phone: 604/254-4936

* Kūlrod . . . a registered trademark of Larsen Electronics.

synthesized compu-station."

"AmCabCom here. Say, just wanted to tell you, fella, what a good deal you're missing. How would you like to have a fine business chat with a station just like mine, anytime you want? Well, I'm not a real person, but a computer . . . and it's mighty fine to subscribe to our service so that you can have a chat anytime you want, even when the channel doesn't answer. Think how impressed the other hams will be when they hear you getting all those DX contacts, when they can't even get a clear channel assigned.

And, with our new generation of conversation — Conver IV — they will never know whether you're talking to a real ham, or being answered by your service. Just punch #573 into your pross, and . . ."

"Bleep. Synthetic compu-station clear by command."

"Bleep. This is KG6XYZ closing the SynCompStat. For all interested hams and CB Extras on channel, you, too, can work KG6 by subscribing to the CEEBAM DX Bureau. Your calls will receive guaranteed DX via our fine Radio Buoys and Long Wire Beacons. Just punch a \$\$\$ into your processor for more information." . . . Bleep . . .

"Attention all holders of licenses in the Senior Citizens' Bands: These bands once were issued to another class of license, and if you would like to save these channels for your own use, just punch a 457\$% & into your pross and join the 'Fight to Save 220 Megs, Inc.'" . . . Bleep . . .

"Attention all holders of Youth Band equipment: Say, gang, did you know that six meters once belonged to adults? Well . . . let us tell you what you can do to have some real fun with your 1-kW model-controlled equipment and help save the band, too . . ."

Bleep. Bleep.

HRH

ENERGY CRISIS SOLVED!

Personal energy crisis? Get precious RF on DX target with World Record Breaking antenna that won W6TYP the QRP ARC 1,000,000 miles/watt award.

THE JOYSTICK VFA

(Variable freq. ant) gives low angle, omnidirectional, harmonic free radiation on all bands 160 thru 10 (+ MARS and receive on all BC & SV).

1000's of glowing reports in our files of the VFA in use, often in poor QTH and/or under QRP., contests, etc.

SYSTEM 'A' \$75.00

250W P.E.P. &/or Receiving Only

SYSTEM 'J' \$99.00

500W P.E.P. &/or Improved Q Factor Receive Air Mail cost included. (Each system 3 sections easily assembled to make unit 7' 6" long. Matching ATU). Not only will you save space but you will save \$\$\$ at present low exch. rate and by buying direct UK manuf. Rush your order — Mastercharge or check, or ask for brochure.

PARTRIDGE (HH) ELECTRONICS LTD.

Broadstairs, Kent, England
Tel. Thanet 62535

G3CED

G3VFA

MADISON SUPER STATION BUYS

NEW OMNI-J 2-meter mobile or portable antenna. 3/8" thread, 5-dB gain (1.5-dB gain over conventional 1/2-wave mobile whip antenna). \$29.95; 220-MHz \$27.95. Guaranteed results.

PREMAX 4-foot ground rod plus clamp \$4.50

MIDLAND 23-136 dual meter reads SWR and relative power. Handles 1 kW from 3-150 MHz. \$21.95

YAESU FT-101EE + Hy-Gain 18AVT/WB vertical antenna \$649.00

YAESU FT-101EX + Hy-Gain 18AVT/WB vertical antenna \$589.00

HY GAIN 18AVT/WB + 100 feet RG8 coax \$100.00

HY GAIN 18V vertical \$19.95

Model 214 2m Yagi \$21.50

Hy-Gain 2BDQ Dipole \$39.95

VHF SPECIALS: Kenwood TS700S List... \$679

KLM: Antennas, Linears, Accessories All In Stock

FREE balun w/2 meter base antenna.

JANEL PREAMPS: In Stock. Technical Books (ARRL, Sams, Tab, RCA, T.I., etc.)

HAM X ROTOR (New Model) Turns 28 sq. ft. of antenna List... \$325 Order Now

Your Price \$289

CDE HAM-III \$129.00

BIRD 43 WATTMETERS plus slugs in stock.

SWAN METERS: WM 6200 VHF Wattmeter \$49.95; SWR 1A \$21.95

TELEX HEADSETS: In Stock

CETRON 572B \$24.95 ea.

ADEL nibbling tool, \$6.45; punch \$3.50

CABLE 5/32", 6-strand, soft-drawn guy cable. For mast or light tower, 3c foot.

BELDEN COAX CABLE: 8237 RG8 19c ft.

8214 RG8 foam 23c ft., 8448 8-wire rotor cable 14c ft., 8210 72 ohm kw twinlead \$19/100 ft., 8235 300 ohm kw twinlead \$12/100 ft., Amphenol PL-259 59c, UG175 adapter 19c, PL-258 dbi female \$1.00. BNC female, chassis mount 61c ea; MICRO RG-8/U same size as RG-59, 2 KW PEP @ 30 MHz 16c/ft.

NYLON CORD 5000 ft. + per roll \$15.00

BELDEN 14 gauge copper stranded antenna wire. \$5.00/100 ft.

RG8 foam Xtra-Flex coax, 100% Braid coverage, 23c ft.

22 gauge plastic covered ant. wire for long wire, radials. \$3.50/1000 ft.

KESTER SOLDER 1 lb. 60/40, .062 \$6.50

Leader — Amateur Test Equip. — 10% off list.

Mallory 2.5A/1000PIV epoxy diode 19c ea.

.001 MFD 20KV CAP. \$1.95

CALL FOR QUOTES ON: YAESU FT301D, FT301, KENWOOD TS520S, TS820S, TS600A, TR7400A, TR7500A, FT101E & ETO-ALPHA. ALL IN SEALED CARTONS. CALL FOR QUOTES ON ITEMS NOT LISTED.

CALL FOR FAST QUOTE, OR WRITE AND INCLUDE TELEPHONE NUMBER. IF WE HAVE YOUR BARGAIN, WE'LL CALL YOU PREPAID.

TERMS: All prices FOB Houston. Prices subject to change without notice. All Items Guaranteed. Some items subject to prior sale. Send letterhead for Amateur dealers price list. Texas residents add 5% tax. Please add postage estimate, excess refunded.

MADISON ELECTRONICS SUPPLY, INC.

1508 MCKINNEY HOUSTON, TEXAS 77002
713/658-0268 Nites 713/497-5683

2 METER FM

and HF too...
SATELLITE HEADQUARTERS

See Erickson for all your Amateur Radio needs!



WB9EBP, WB9JKT, WB9VIK serving you with...

- Ameco • ASP • Atlas
- Belden • Bird • CDE
- CES • Collins • Cushcraft
- Dentron • Drake • HAL
- Hy-Gain • Icom • KLM
- Kenwood • Larsen • MFJ
- Midland • Mosley • NPC
- Newtronics • Nye
- Regency • Shure • Swan
- Standard • TPL • Tempo
- Ten-Tec • Wilson • Yaesu



Hours: 9:30-9 Mon. & Thurs,
9:30-5:30 Tues, Wed. & Fri.
9-3 Sat.

E ERICKSON COMMUNICATIONS
5935 N. Milwaukee Ave.
Chicago, IL 60646
(312) 631-5181

STATEMENT OF OWNERSHIP, MANAGEMENT AND CIRCULATION

1. TITLE OF PUBLICATION: COMMUNICATIONS TECHNOLOGY INC.

2. NUMBER OF COPIES: 100,000

3. DATE OF PREPARATION: 1977

4. NAME AND ADDRESS OF PUBLISHER: T.J. JENSEN JR., MAIN ST., GREENSBLE, N.H. 03048

5. NAME AND ADDRESS OF EDITOR: T.J. JENSEN JR., MAIN ST., GREENSBLE, N.H. 03048

6. NAME AND ADDRESS OF BUSINESS MANAGER: T.J. JENSEN JR., MAIN ST., GREENSBLE, N.H. 03048

7. NAME AND ADDRESS OF CIRCULATION MANAGER: T.J. JENSEN JR., MAIN ST., GREENSBLE, N.H. 03048

8. STATEMENT OF CIRCULATION: (Table with columns for Total Copies, Paid Circulation, Free Distribution, Copies Not Distributed, Total Copies, and Total Paid Circulation)

9. SIGNATURE OF PUBLISHER: T.J. JENSEN JR., PUBLISHER

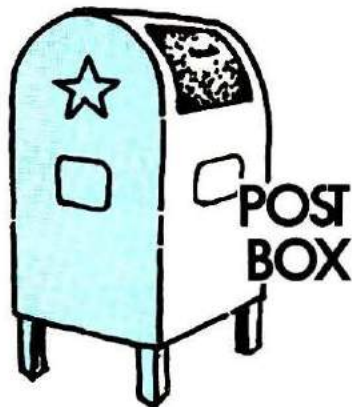

Dear Horizons:

I found your article on CB radio (October, 1977) quite interesting. Although the article was accurate, it totally overlooked the almost total disregard for FCC rules that many CBers seem to exhibit. Forget the INTENT of the service — look what's happening in actual use.

So called "amateur" linears are being manufactured and distributed for the exclusive use of bootleg CBers. Amateur transceivers seem to have a larger market among the CBers than the amateur. CB signals are heard en masse up to 27.65 MHz and occasionally will even get up into the bottom of the 10-meter amateur band. CB operators have been heard operating on 10 meters as hams with fictitious calls. CB DXing is common (forget the 150-mile limit). Overpowered CB stations have been causing tremendous interference on the 10 meter band — I have personally had QSOs cut short by CB splatter. Probably the most frustrating thing is the apparent inability of the FCC to enforce its own rules and bring the CB service back under control. As far as I'm concerned, the 11-meter CB service should be phased out, 11 meters given back to the amateurs, and a new CB service should be established in the uhf spectrum, far away from any other radio service. Maybe then it would in fact be a service, rather than the Citizens Band Dis-service it is now.

Stanley A. Holz, WA1SFN
Whitfield, New Hampshire

Unfortunately, Stan, everything you say about the abuse of CB is true. Equally unfortunate is the fact that I could match you point for point with wrongdoings in the Amateur Service, so we (as a

service) cannot afford a holier-than-thou stance. But neither of these arguments addresses itself to the main point of our publishing articles about CB and Amateur Radio. In order to understand the real point, you have to first face and understand a couple of realities: 1. The Amateur Radio Service must show a need for the space it occupies. We have been given less than subtle warnings about this from the people who will represent us at the World Administrative Radio Conference; 2. Good deeds and technical achievements are no longer enough to warrant the many MHz that we hold exclusive rights to. In today's world, people are what count, therefore we must grow — or die.

Horizons is not here to solve the FCC's problem with CB; we are here to help people become hams. There are millions of individuals who have been exposed to the thrill of communicating within the limited possibilities of CB. If we can instill in a small percentage of them the same pride in Amateur Radio, pride in accomplishment, that most of us have developed, then we have helped a lot of good people. There is indeed a gap of prejudice and stubbornness to be bridged here, but you cannot build a bridge on one shore only — you must have a foundation on the other side too. A foundation based on the "you-guys-are-all-bad-and-I'm-going-to-save-you" theory is set in quicksand. If you would read some of the CB publications of recent date, you'll see that they, too, are becoming increasingly concerned with the actions of their "bad apples," and are casting about for ways to handle the situation. That's a good sign.

The solution that will work for CB is one that they themselves come up with, not one that is imposed by Amateurs. In the meantime, let's not be afraid to show the "good apples" what our good life is all about, and let's make sure that we keep our service worthy of being a goal.
Editor

Dear Horizons:

I am enclosing a check for a subscription to *Horizons*. You are doing a fine job of informing that group of people who are looking past CB toward Ham Radio.

When you get to writing about

Novices or old timers getting into CW traffic handling, please tell them about the "Hit and Bounce Slow Net." It is a young offspring of the very old and respected independent "Hit and Bounce Net." The HBSN meets Friday, Saturday, Sunday, and Monday at 7:30 AM EST on 3714 kHz, and at 8:00 AM EST on 7140 kHz. We try to keep the speed down to 10 wpm, and welcome Novices and newcomers.

This is a chance for a Novice to learn a little about CW traffic handling and work the rare state of Delaware as a bonus.

Dan Bucher, WA3WPY
Wilmington, Delaware

Thanks for writing Dan, and I hope many beginners see this reminder of your Net. We cannot publish a Net Directory here, but if our readers know of other nets that are tailored to the Novice or beginning traffic handler, perhaps we can mention them from time to time. **Editor**

Dear Horizons:

I just wanted to drop you a quick line to let you know that the first issue of your magazine is just great! I hope you manage to keep the quality as high in the future. Most magazines designed with the beginner in mind are cheaply done and boring, but you manage to avoid all that. As a beginner just starting to study for my Novice license I want to get *Horizons* each month.

Edward Hall
Fort Lauderdale, Florida

Dear Horizons:

Spend a tropical isle vacation (April, 1977) talking to Americans? Unthinkable!

Mary M. Steffens, WB7OSH
Pullman, Washington

But you forget, Mary, that some people will do almost anything to escape from New England winter weather! **Editor**

Dear Horizons:

I would like to congratulate you on your great magazine. It lives up to everything you said it would be. I enjoyed my first two issues greatly, and anxiously await the next ones. It is not too complicated, but loaded with information. Keep up the good work.

Daniel Baker, WB3AYC
Hanover, Maryland

Great gift ideas from Ham Radio's Bookstore

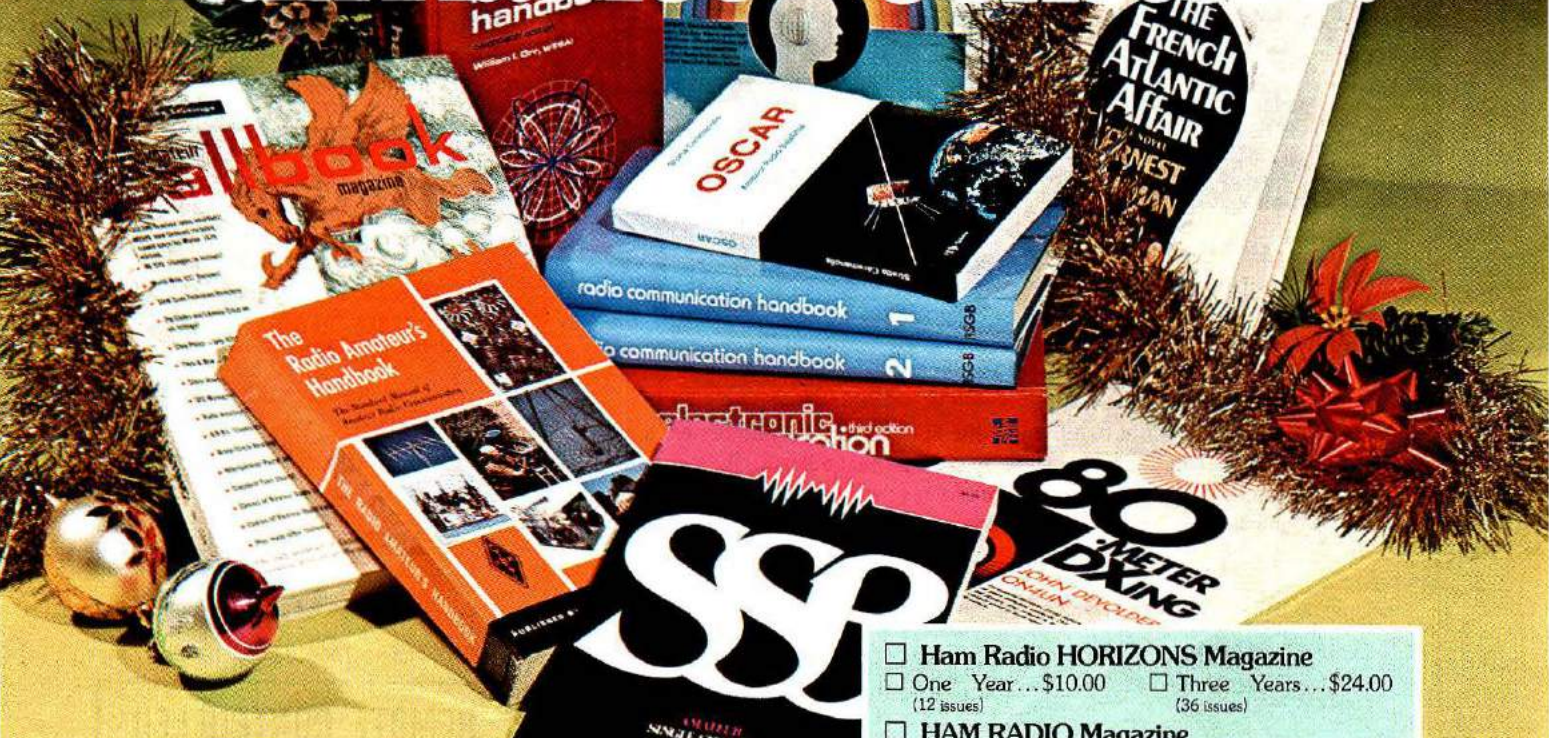

1978 ARRL RADIO AMATEUR'S HANDBOOK

World's best selling technical reference: a standard for every Radio Amateur's bookshelf. Revised and updated with state of the art technology. Guaranteed to please every ham. Softbound.

(AR-HB) \$8.50

AMATEUR SINGLE SIDEBAND

Originally published by Collins Radio Company, reissued by tremendous popular demand. The bible of SSB; a complete intro to SSB and its equipment. Softbound.

(HR-SSB) \$4.95

RADIO HANDBOOK 20th Edition

Famous communications handbook for engineers and Amateurs alike. How to design and build radio communications equipment and accessories.

Holiday Special Save \$2.00
(24032) Only \$17.50

1978 US RADIO AMATEUR CALLBOOK

Brand new format! Calls in new bold-face, large, easy to read type. Over 350,000 entries vs. 303,000 last year. Thousands of new hams and new 1 X 2 calls. Same price as before.

(CB-US) Only \$14.95

(Please include \$1.50 shipping and handling)

Two Volume 5th Edition RADIO COMMUNICATIONS HANDBOOK

Completely revised edition from the RSGB. One of the most thorough and handsome books in Amateur Radio. The perfect gift.

(RS-RCH12) Only \$29.95

3rd Edition ELECTRONIC COMMUNICATION

The most fantastic Amateur and commercial license study guide we know of! Comprehensive, includes questions and answers.

(MH-57138) Only \$18.95

TUNE IN THE WORLD WITH HAM RADIO

Tells you what Amateur Radio is, how to pass the Novice exam and set-up your first station. Includes booklet, code cassette and map.

(AR-HR) \$7.00

OSCAR - AMATEUR RADIO SATELLITES

The comprehensive book on Amateur satellites. Learn the principles, then examine OSCAR from concept to actual use. Softbound.

(RS-O) \$8.50

- Ham Radio HORIZONS Magazine**
 One Year...\$10.00 Three Years...\$24.00
 (12 issues) (36 issues)
- HAM RADIO Magazine**
 1 yr...\$12.00 2 yrs...\$22.00 3 yrs...\$30.00
 (12 issues) (24 issues) (36 issues)



*Please enclose names and addresses on all gift subscriptions.

THE FRENCH ATLANTIC AFFAIR

International suspense and romance in a dynamic novel where Amateur Radio is the hero. A real spellbinder!

(A-FAA) \$10.95

(Much sex and violence; for mature readers only)

80 METER DXing

A must for every DX'er. A foremost authority has compiled many of his secrets into this book. Meet this exciting challenge and get the most from your station.

(HR-80M) \$4.50

Yes! Please enter my order as checked on the boxes by each book on this page.

Number of books checked _____ Total amount \$ _____

Check or money order enclosed

Charge my Mastercharge

Charge my VISA (BAC)

Acct. No. _____ Exp. _____ Interbank No. _____

Name _____

Address _____

City _____ State _____ Zip _____

Send to: **HAM RADIO'S BOOKSTORE**
GREENVILLE, NH 03048

or call **TOLL FREE 800-258-5353**

An invitation to join
The
"Argonaut Club"

Argonaut 509

Tired of push-button QSOs? Then the excitement of Argonauting is for you! A challenge? Of course, The test of an operator? Perhaps. But above all it is the thrill of working the world with five watts. The club is exclusive but if you enjoy the spirit of conquering distance with lower power, you are "in". There are no dues — just \$359.00, the price of an Argonaut. Join more than two thousand fellow members with Argo fun. Your membership awaits you at most ham dealers.

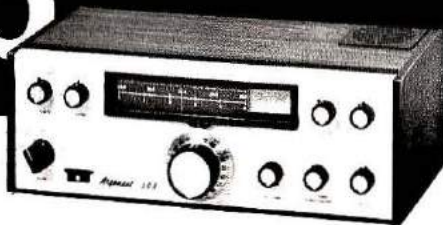

Argonaut 509 \$359.00

SPECIFICATIONS:

Five bands, 3.5-30 MHz.
SSB and CW modes. Fully solid state. Permeability tuning.
Instant break-in. Instant band change. Built-in SWR bridge.
S-Meter. WWV. Internal speaker.
Direct frequency readout.
Receiver offset tuning. Five watts input. Automatic sideband selection. Plug-in circuit boards.
½ uV receiver sensitivity.
12-14 VDC or AC pack power.
Weight 6 pounds. Size HWD:
4½" x 13" x 7".

ACCESSORIES:

Model 206 — 100 kHz Crystal Calibrator..... \$29.00
Model 208 — CW Filter..... \$29.00
Model 210 — One Ampere Power Supply..... \$30.00
Model 215P — Ceramic Microphone..... \$29.50
Model KR5-A — Keyer..... \$39.50

For further information, write:



SEVIERVILLE, TENNESSEE 37862
EXPORT: 5715 LINCOLN AVE.
CHICAGO, ILLINOIS, 60646

All You Want to Know About...

OSCAR

by Stratis Caramanolis

Comprehensive look at satellite communications, specifically the OSCAR series, from basic principles through locating and working the bird. The only book providing the thorough understanding you'll want to really get involved. Send for your copy today.

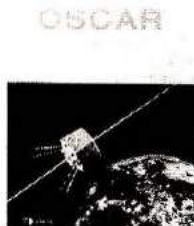

Greenville, NH 03048

Order RS-0

Only \$8.50

FOR THE HAM

A BELT BUCKLE



From The COLORADO SILVER CO
Cast In SOLID BRONZE
ENGRAVED WITH CARE

This fine personalized belt buckle can be yours for only \$12.50, plus \$1.00 for postage and handling.

OR SEND FOR FREE DESCRIPTIVE BROCHURE.

COLORADO SILVER CO

P. O. BOX 1755
ASPEN, COLO. 81611



COLO. RES. INCLUDE 3% SALES TAX

REMOTE CONTROLLED ANTENNA SWITCH

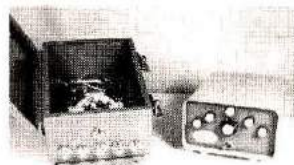

- The SW-5 is a heavy-duty remote controlled RF switch. Handles 4 kW PEP with negligible insertion loss and SWR below 30 MHz. Housed in rugged, weather-proof enclosure.
- Safe, low-voltage operation from 26 VDC supply in control unit.
- Indicator lights show at a glance which antenna is in use.
- Requires six-wire control cable. Ham-M cable satisfactory to 150 feet.
- Models from 3 to 9 positions. Optional connectors and special switching systems are available.
- Five position Model SW-5 \$120.00 (Shipping \$3.00 in USA — IA res. add 3%)

ANTENNA MART

Box 1010 ISU Station
Ames, IA 50010
Phone: 515-292-7114

THE BIG STEAL

★ starring ★

The Touch. by Regency

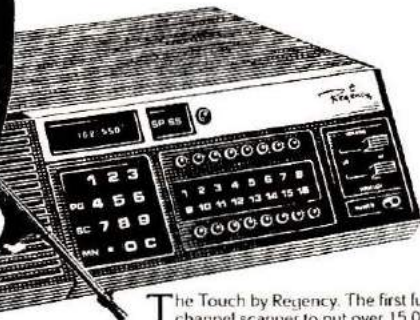

Alan, check out these reviews

"TRULY AMAZING!" The Montrose Gazette
 "MAGNIFICENT!" The Salida Post Tribune
 "...HUH?" The Cotopaxi Chronic Bugler
 "ATSA MY BOY." Mrs. Capone

Frequency Coverage (MHz)

30-50
 146-148
 146-174
 440-450
 450-512

NOW SHOWING AT:

The Touch by Regency. The first fully synthesized 16 channel scanner to put over 15,000 frequencies at the command of a fingertip.

Now that's not just a new scanner. It's a revolution in scanning.

Reg. \$329 Now

\$269

Offer good to licensed hams only.
 Include call with order.



1401 Blake Street
 Denver, Co. 80202



electronics
 303-893-5525



Joy to the World...

And the angel said unto her, Fear not, Mary: for thou hast found favor with God. And, behold, thou shalt conceive in thy womb, and bring forth a son, and shalt call His name Jesus. Luke 1: 30,31 KJV

Then said Mary unto the angel, How shall this be, seeing I know not a man? And the angel answered and said unto her, The Holy Ghost shall come upon thee, and the power of the Highest shall overshadow thee; therefore also that holy thing which shall be born of thee shall be called the Son of God. Luke 1: 34,35 KJV

And she brought forth her firstborn son, and wrapped him in swaddling clothes, and laid him in a manger; because there was no room for them in the inn. Luke 2:7 KJV

For God so loved the world, that he gave his only begotten Son, that whosoever believeth in him should not perish, but have everlasting life. John 3:16 KJV

Nearly 2000 years ago, God reached out and touched the world with his love. He is still reaching out today seeking the lost.

Let his love reach into your heart this Christmas season. Become a member of God's family by turning from your way, and trusting in God's way today.

May you and your family reach out and accept the joy he has for you this Christmas.

Joy to the World...

Lee, Andy, Denny, Don, Bill, Denny, Linda, Lydia, Billie, Kim, Lee, Rick, Jane, Deb, Barb, Les, Merrill, and Paul.



RD 1 • BOX 185A • FRANKLIN, PA 16323

PRODUCT

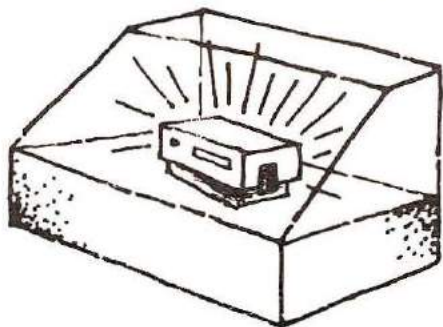

SHOWCASE

Daytronics Iambic Keyer



Daytronics Company, of Selden, New York, has recently announced a new Iambic Electronic Keyer designed to be used by any amateur radio operator, Novice to Extra class. The *IK-1 Iambic Keyer* is a fully automatic keyer which greatly reduces operator fatigue by enabling the operator to send perfect code with little effort. Features included are both DIT and DAH paddle memories, self-completing characters, automatic spacing, automatic weighting, and a built-in side-tone speaker for monitoring. The transistorized keying circuit will accommodate either grid-block (negative grounding) or cathode-keyed (positive grounding) transmitters. The *IK-1* is able to send at speeds from below 5 wpm to over 40 wpm. Sturdy paddles are also available which come mounted on a beautifully finished wood base. The paddles can be set for wide, medium, or narrow grip spacing.

The *IK-1* is attractively priced at \$39.75 for the kit version; \$65.00 with a set of paddles. The factory assembled version is \$56.95; \$80.00 with paddles. Write to Daytronics company,

12 Oakdale Ave., Post Office Box 426, Selden, New York 11784, or use *ad check* page 88.

OSCAR Amateur Radio Satellites

For most amateurs, obtaining information about any of the Oscar satellites has been somewhat of a piecemeal process. Almost every area of interest was covered in a separate publication or source, and some information just did not seem to be available at all.

Author and engineer Stratis Caramanolis has written a very useful book, *OSCAR AMATEUR RADIO SATELLITES*, that ties it all together in one place. The

original was published in German, and now an English-language version is being distributed by the Radio Society of Great Britain, and by Ham Radio's Communications Bookstore.

Almost any question that you may have about amateur radio satellites can be answered by consulting *OSCAR Amateur Radio Satellites*. It shows a high degree of competence in presenting the technical and theoretical facts of satellite operation, but at the same time these facts are covered in language that the non-engineer can understand and work with. The author uses just enough mathematics to prove whatever theory or point is being discussed, but not so much as to scare away

WHY WRAP-UP 1977

A word of explanation

During the past year you've probably wondered at one time or another why the cover date on *Horizons* was so far ahead — why you were receiving the August issue in early June, or the December issue in early October.

The original idea was to give adequate time for newsdealers and retailers to distribute *Horizons* to each of their various locations. However, experience has shown that this is not really necessary; at the same time this postdating has proved difficult to most all of us, including subscribers and advertisers. We are correcting this problem with this *Wrap-Up 1977* issue.

This issue would normally have been dated January, 1978; by calling it *Wrap-Up 1977*, December 31, 1977, we have been able to move future cover dates back one month, thus putting them more in line with customary dating practices.

To provide each subscriber with the proper number of issues we will subtract one month from your expiration date on the label — **you will still receive the appropriate number of issues.** To clarify even more: if your scheduled expiration was 0378 (March 1978) it will now be 0278 (February 1978). As you'll recall, according to our old method of dating, you would have received the March issue in early January but now that issue will be the February issue.

There will be *no* changes in subscription terms, number of issues, or mailing schedules. You will still receive 12 issues per year (one per month).

It may sound mixed up, but it's really very simple. No one's subscription has been changed. The only change has been in the cover-dating procedure. Perhaps it's confusing for now, but it should become much simpler in the future.

any neophyte to amateur radio or satellite communications.

The book starts out with a discussion of the solar system from the first misconceptions that placed the earth at the center of the universe, and brings you right through the changes in scientific thinking into the current period of knowledge, which was started by Johannes Kepler. The first three laws formulated by Kepler are essential in understanding the mechanics of orbiting bodies, no matter what size they are. The book uses this Keplerian foundation to build a subsequent discussion of satellite orbital mechanics starting with a simple explanation of the trajectory of a projectile and then developing this into a trajectory that has no terminus, thus being an orbit.

Once the essential mechanics of orbits and satellite theory are taken care of, the author gets into a good explanation of satellite types, systems, control, power requirements, and structures. This is followed by a chapter on the fundamentals of telecommunications by means of satellites, which includes such areas as free-space loss (of signal strength) and receiver sensitivity — both important considerations if you plan to use a satellite system.

All of this groundwork material takes up a good portion of the book, but it is interesting and essential reading if you are to really understand what makes any satellite behave the way it does. Chapter seven is the first one that is devoted entirely to amateur radio satellites, and it starts with the background of amateur work in planning, building, and launching the first OSCAR. It continues with a history of each amateur satellite right through to the current OSCARs 6 and 7.

This chapter is followed by one that, logically, devotes many pages to detailed descriptions of all the systems that go to make up an OSCAR satellite package — transponders, telemetry, antennas, receivers,

modes, decoding, and much more. It explains how you can calculate orbital information, how you can interpret the telemetry data that indicates the condition of the spacecraft systems, and what you need at your home (ground) station to work with satellites.

The last chapter is devoted to the subject of learning with satellites. It is a section de-

signed to acquaint educators with the possibilities of classroom use of amateur satellite signals and experiments. The author points out some of the uses that have been made of this material, and provides names and addresses where those interested can obtain more information. Some samples of techniques useful in classrooms are given, such as

Don't Buy an Amplifier on Toothpaste Claims



Buy a tube of toothpaste on the basis of outrageous exaggerations as to what it'll do for your social life and it still may clean your teeth.

BUT if you buy a linear amplifier on the basis of toothpaste claims — or ambiguous specifications — you may end up with a real turkey!

Large differences in quality and performance exist among so-called "2 KW PEP" amplifiers. Thinking of buying another model that's "just as good" as an ALPHA? Better thoroughly investigate the manufacturer's reputation and what, exactly, is promised in his specifications and warranty. Unless, of course, you like surprises.

EXAMPLE — Power Output & Efficiency:

An ALPHA 76 running key-down at one kilowatt DC input delivers well over 600 watts of output, averaged over the 160 thru 10 meter amateur bands. Another current model "deluxe" linear managed less than 400 watts average output in identical tests using the same instrumentation. You'd never suspect it from reading the manufacturer's claims

and specs — and the deficiency was largely concealed by gross errors in the internal metering circuits!

EXAMPLE — Duty Cycle:

Ratings are sometimes ambiguous and can be misleading. One prominent amplifier manufacturer rates his desk model for full power in "intermittent amateur service." (Just how intermittent he doesn't say.) Another manufacturer hedges his "continuous" rating with time limits for one model, but not for a second model.

ALPHA specs say clearly, "No Time Limit." And every ALPHA is backed by a factory warranty that extends 18 months — six times as long as other amplifier warranties!

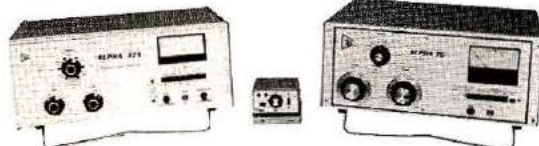

It's understandable why certain of our competitors hedge: the ALPHA 76's forty-five pound transformer alone weighs as much as some of the complete linears for which they claim capability equal to the 76's. And every ALPHA power transformer is efficiently cooled by ETO's exclusive ducted air system. You owe it to yourself, before buying, to check how (if at all) the smaller transformers in those other desk-top linears are cooled.

To get the facts about what an ALPHA linear amplifier can do in your station, call or write your dealer or ETO direct for detailed literature. And ask for a free copy of our newly updated guide to comparing linears.

ALPHA: Sure you can buy a cheaper linear... But is that really what you want?

ETO Ehrhom Technological Operations, Inc.

P.O. Box 708 • Cañon City, Colorado 81212 • (303) 275-1613

measurement and explanation of Doppler effects, orbital data, and transmission of amateur television and weather satellite pictures through the OSCAR spacecraft. Future satellites are discussed, but because of the many variables in timing of launch vehicles, satellite construction, and the like, this coverage can be only tentative

at best.

All-in-all, the book is recommended as an excellent reference for the amateur (or anyone else) who is curious about any phase of satellites, or who is seriously contemplating the use of OSCAR for communication or educational purposes. *OSCAR Amateur Radio Satellites*, by Stratis Caramanolis, is 194

pages, paperback, and is \$8.50 postpaid from Ham Radio's Communications Bookstore, Greenville, New Hampshire 03048; order RS-O.

Radio Shack Mobile Clock Module

Now you can add an electronic digital clock to your car, truck, boat, or other 12 Vdc vehicle, with the New MA1003 Digital Clock Module, available nationwide from *Radio Shack* stores and dealers.

The digital clock module features a four-digit, green fluorescent display with a blinking colon as an activity indicator. Accuracy is said to be ± 0.5 second per day.

Automatic display-control circuitry turns off the display when the ignition is off, and reduces brightness to 33 per cent with parking lights or headlights on. It also follows the dashboard-lamp dimmer-control setting. A lens may be used to filter the display color to blue, blue-green, green, or yellow.

The digital clock module is ready-to-use with the addition of three switches to control the "hours set," "minutes set," and "display on" functions. The "display on" switch is used if you want to display the time when the ignition switch is off.

The MA1003 Digital Clock Module for vehicular or portable applications is priced at \$24.95. If there are no Radio Shack stores near you, write H. L. Siegel, National Publicity and Promotion Manager, 2617 West Seventh Street, Fort Worth, Texas 76017, or Phone (817) 390-3272, or use *ad check* on page 88.

Erratic Errors

Things do go wrong at times when getting an article into print. We are indeed fortunate when a reader calls a mistake to our attention. Then the problem

QUALITY KENWOOD TRANSCEIVERS ... from KLAUS RADIO

The TS-820 is the rig that is the talk of the Ham Bands. Too many built-in features to list here. What a rig and only \$830.00 p.p.d. in U.S.A. Many accessories are also available to increase your operating pleasure and station versatility.

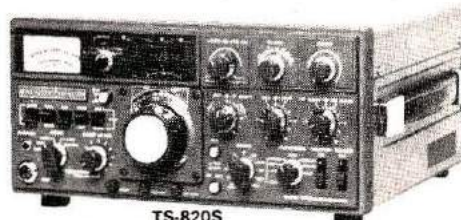

TS-820S
160-10M TRANSCEIVER

Super 2-meter operating capability is yours with this ultimate design. Operates all modes: SSB (upper & lower), FM, AM and CW. 4 MHz coverage (144 to 148 MHz). The combination of this unit's many exciting features with the quality & reliability that is inherent in Kenwood equipment is yours for only \$599.00 p.p.d. in U.S.A.

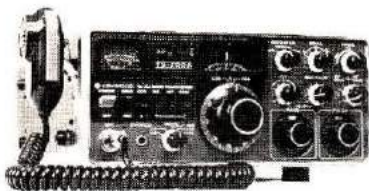

TS-700A
2M TRANSCEIVER

Guess which transceiver has made the Kenwood name near and dear to Amateur operators, probably more than any other piece of equipment? That's right, the TS-520. Reliability is the name of this rig in capital letters. 80 thru 10 meters with many, many built-in features for only \$629.00 p.p.d. in U.S.A.

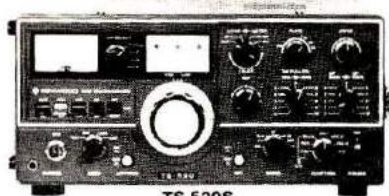

TS-520S
80-10M TRANSCEIVER

This brand new mobile transceiver (TR-7400A) with the astonishing price tag is causing quite a commotion. Two meters with 25W or 10W output (selectable), digital read-out, 144 through 148 MHz and 800 channels are some of the features that make this such a great buy at \$399.00 p.p.d. in U.S.A.



TR-7400A
2M MOBILE TRANSCEIVER

Send SASE NOW for detailed info on these systems as well as on many other fine lines. Or, better still, visit our store Monday thru Friday from 8:00 a.m. thru 5:00 p.m. The Amateurs at Klaus Radio are here to assist you in the selection of the optimum unit to fulfill your needs.

KLAUS RADIO Inc.

8400 N. Pioneer Parkway, Peoria, IL 61614
Jim Plack W9NWE — Phone 309-691-4840

becomes one of advising our readership so they will know too. Take a moment to check the items below; it could clear up something that has been puzzling you.

Happy birthday

A *Newsline* item in the March, 1977, issue of *Horizons*, indicating the age of the earth as 20 billion years, was questioned by several of our readers. We checked with our source for that bit of information, and, to the embarrassment of both of us, found it to be in error. The 20-billion year figure refers to the *Universe*, with the earth still pegged at just over the 4-billion year mark. Either way, that's a lot of birthday candles!

Integrated-circuit keyer

The following should help the builders of the integrated circuit keyer by WA5TRS, in the May, 1977, issue of *Horizons*. The circuit shown in Figs. 2, 4, and 6, when combined, is the recommended keyer. The printed-circuit board is shown twice actual size, but can be purchased for \$3.50 from G. R. Whitehouse, 15 Newbury Dr., Amherst, New Hampshire 03031. Also, a complete kit that includes the PC board, sidetone generator, and electrical components, is available for \$19.95 from Whitehouse.

The reed relay is available for \$2.10 by writing to Electronics Application Co., Attn: Annie Williams, 4918 Santa Anita Ave., El Monte, California 91734.

Sunspots

We regret that the following list of sources of material was inadvertently omitted from the article, "The Strange World of Sunspots," by William I. Orr, W6SAI, in the July, 1977, issue of *Ham Radio Horizons*.

* *Ionospheric Radio Propagation*, Superintendent of Documents, Government Printing Office, Washington, DC 20402.

* G. Jacobs and S. Leinwoll, "Cycle 20: The Declining Years," *CQ*, November, 1969, page 44.

* T. Cohen and G. Jacobs, "Solar Activity Update: The Transition Years," *CQ*, January, 1976, page 18.

* E. Schultz, "Don't Be Afraid of the Big Bad Blackout," *CQ*, November, 1969, page 31.

* E. Tilton, "The DXer's Crystal Ball," *QST*, June, July, August, September, 1975.

* G. Jacobs, "Sunspots and the Solar Influence Upon High Frequen-

cy Radio Communications," unpublished thesis, University of Maryland.

* T. Cohen and P. Lintz, "The Sunspot Cycle Analysis and Prediction," *CQ*, March, 1974, page 24.

* G. Jacobs and E. Martin, "The Dwindling High-Frequency Spectrum," *IRE Transactions of the Professional Group on Communications Systems*, Volume CS-9-4, December, 1961.

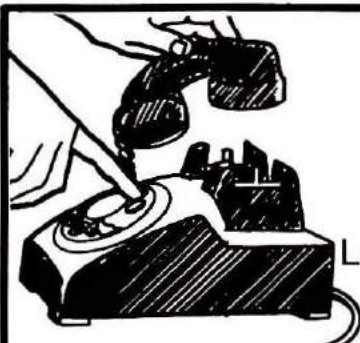

**CALL TOLL FREE
1-800-535-9598**

LA. RESIDENTS CALL COLLECT

AUTHORIZED DEALER FOR...



DRAKE



ICOM

YAESU!



MOTOROLA HOBBY COMPUTERS
**ATLAS • BIRD • CDE • DENTRON
ETO • HUSTLER • HY-GAIN
KLM • LARSEN • MOSLEY
ROHN FOLD OVER TOWERS
SWAN • TEMPO • TEN-TEC
TRI-EX • WILSON • CUSHCRAFT**

- Prompt phone and mail service
- Liberal trade-ins
- Large inventory
- Same day shipment if ordered before noon
- Visa and Master Charge accepted

DIGITAL ELECTRONICS, INC.

1201 ANNUNCIATION ST.
P.O. BOX 30566
NEW ORLEANS, LA. 70190
PHONE 504-568-9879

AMATEUR PRODUCTS GALORE!

YAESU

FT-301D all solid-state transceiver; 160-10 meters; AM, CW, SSB, FSK; 200 watts PEP input on SSB, 200 watts DC input on CW, and 50 watts DC input on AM or FSK; features 100-Hz frequency stability, 6-digit LED frequency display; tailored audio response, 0.25 μ sensitivity, variable selectivity from 0.6 to 12 kHz, requires only 13.5-volts DC power source; matching AC supply and speaker available.

YAESU

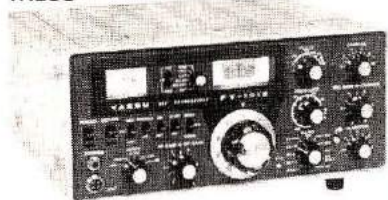

FT-101E TRANSCEIVER

Popular? I guess! Over 200,000 units of this FT-101 series are in service around the world. 10 thru 160M, SSB, CW, AM, built-in WWV reception, solid state, RF speech processor, VOX, AC or DC operation are some of the many reasons for this rig's popularity. We'll be happy to discuss the many fine features of the FT-101E with you today.

Call or visit with us today for assistance in selecting the Amateur product that is the most likely to meet your operating requirements. **Write for our low price today.**

KENWOOD

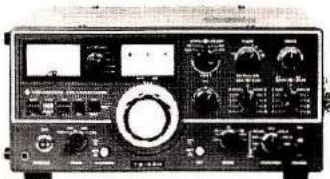

TS-520S
160-10M TRANSCEIVER

Ask around about Kenwood's TS-520. It's in constant use around the globe and has a record of reliability that is universally admired. USB, LSB, CW, operates AC or DC, WWV receiver, RIT, VOX and noise blanker are some features that make the TS-520 a very welcome companion in your shack. Also, come in and ask about the **NEW** Kenwood TS-820 that has all of the great features found in the TS-520 plus so many truly unique operating advantages that it is the Pacesetter of the industry.

KENWOOD

TR-7400A two-meter FM transceiver covers 144-148 MHz in 5-kHz steps, selectable simplex and 600-kHz offset; PLL circuitry with unlock protection; LED digital frequency display; CTCSS encode-decode, plus tone-burst; MOSFET with helical resonators, plus 2-pole 10.7-kHz crystal IF filter for superior sensitivity and selectivity, and much more. Write today for details and price.



RSE HAM SHACK

1207 W. 14 MILE, CLAWSON, MICHIGAN 48017
313-435-5660



G.R. WHITEHOUSE & CO.

15 Newbury Drive, Amherst, N. H. 03031

TRANSMATCH PARTS

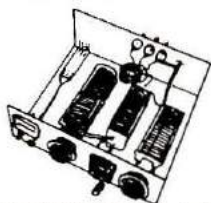

PACKAGE
DEAL \$129.95

LOOK AT THESE PRICES, LOWEST YET:

154-10 Single section 350 pf. transmitting capacitor, 154-507 Dual-section 192 pf. section transmitting capacitor, 229-203 Roller Inductor 28 μ h by Mulltronics, 3902-1 Turns Counter by Barker & Williamson.

SEPARATELY PRICED AT \$163.80 NOW \$129.95

WE ALSO STOCK THE OTHER TRANSMATCH PARTS.

POPULAR TOROID ASSORTMENT

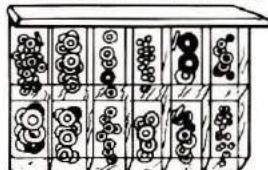

We Stock a Complete Line of Powdered Iron and Ferrite Products.

CONVENIENCE AND LOWER COST \$15.50 Value for \$9.95

INCLUDES: 2 pcs. each, T25-2, T25-6, T37-2, T37-6, T37-10, T37-12, T50-10, T50-12, T68-10, T80-2, T80-6, T94-2. 3 pcs. each, T50-2, T50-3, T50-6, T68-2, T68-3, T68-6

AND CONVENIENT STORAGE BOX AND SPEC SHEETS

TRANSMATCH BALUN SPECIAL 3 T200-2 cores plus 20' #14 Teflon Covered Wire SAVE \$3.45 TBS Kit.....\$9.75

FERRITE BEAD ASSORTMENT

Includes convenient plastic storage box and one dozen each of FB43-101, FB43-801, FB64-101, FB64-801, FB73-101 and FB73-801 plus new spec sheets. Value \$7.50 for \$6.95

Add \$2.00 to each order for shipping and handling. Prices subject to change.



There's
nothing
like it !

RADIO AMATEUR
callbook

Respected worldwide as
the only complete authority
for radio amateur
QSL and QTH information.

The **U. S. Callbook** has nearly 300,000 W & K listings. It lists calls, license classes, names and addresses plus the many valuable back-up charts and references you come to expect from the **Callbook**.

Specialize in DX? Then you're looking for the **Foreign Callbook** with almost 235,000 calls, names and addresses of amateurs outside of the USA.

U.S. Callbook \$14.95

Foreign Callbook \$13.95

Order from your favorite electronics dealer or direct from the publisher. All direct orders add \$1.50 for shipping. Illinois residents add 5% Sales Tax.

RADIO AMATEUR
callbook INC.
Dept. E 925 Sherwood Drive
Lake Bluff, Ill. 60044

TEN-TEC ULTRAMATIC KEYS

MODEL KR50

- SUPERLATIVE "FEEL" 5-50 GRMS PADDLE FORCE
- AUTOMATIC OR MANUAL WEIGHTING
- DIT AND DAH MEMORIES WITH SEPARATE DEFEATS
- "STRAIGHT KEY" OVERRIDE FOR QRS OR TUNE-UP
- GUARANTEED FOR LIFE BEARING PIVOTS

A sparkling new keyer with a host of exciting features. A powerful aid to cleaner, more articulate CW that is relaxing to use and a joy to copy.

The paddle assembly will delight the CW purist as well as the recent graduate from a bug or hand key. The superlative "feel" is attained by a magnetic return force, instantly adjustable to exactly the right touch for you.

Weighting, the ratio of dit and dah (bits) lengths to the spacing between them, is either automatically or manually varied. In the automatic position, it is programmed to lengthen the bits at slow speed for enhanced smoothness and decrease them as you advance the speed, for highest articulation. Or, it can be adjusted to a constant value.

The KR50 is versatile. Dit and dah memories are provided for full iambic (squeeze) keying. Either dit or dah, or both, may be turned off for operation as a conventional type keyer. Self-completing characters at all times.

A convenient "Straight key" is built-in for QRS sending or tune-up. Also an internal side-tone and 115VAC/12VDC operation is provided.

The KR50 is designed to have a permanent place in your shack for the years, perhaps decades, ahead. An investment in the enjoyment of CW.



KR20-A

Paddle has unique principle with excellent feel for rhythmic CW. Characters are self-completing. Bit weighting is optimized for normal speeds. Manual key button conveniently located for hand sending. Side tone signal. Reed relay. Plug-in circuit boards. 115VAC or 6 to 14 VDC. HWD 2 1/2" X 4 1/2" X 8 3/4". Wt. 2 1/2 lbs.

PRICE \$69.50

KR1-A

This is the paddle mechanism used in the KR50. Requires 6-14 VDC for adjustable electromagnetic paddle return force. Adjustable contact spacing. For iambic or conventional keyers. "Straight key" button. Housed in an attractive metal case with cream front panel, walnut vinyl top. Size: 2" X 4" X 6". Wt. 1 1/2 lbs.

PRICE \$35.00

KR5-A

Similar to the KR20A but without monitor signal and AC power supply. A great value. For 6-14 VDC operation. Size HWD 2" X 4" X 6". Weight: 1 1/2 lbs.

PRICE \$39.50

KR2-A

The paddle used in the KR20A. Single paddle for non-iambic keyers. "Straight key" button conveniently located, cream aluminum case with walnut vinyl top. Size: 2" X 4" X 6". Weight: 1 1/2 lb.

PRICE \$17.00

PRICE \$110.00

TEN-TEC, INC.
SEVIERVILLE, TENNESSEE 37862
EXPORT: 5715 LINCOLN AVE., CHICAGO, ILL. 60646

R-X NOISE BRIDGE

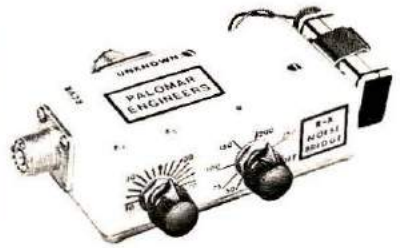

- ✓ Learn the truth about your antenna.
- ✓ Find its resonant frequency.
- ✓ Adjust it to your operating frequency quickly and easily.

If there is one place in your station where you cannot risk uncertain results it is in your antenna.

The Palomar Engineers R-X Noise Bridge tells you if your antenna is resonant or not and, if it is not, whether it is too long or too short. All this in one measurement reading. And it works just as well with ham-band-only receivers as with general coverage equipment because it gives perfect null readings even when the antenna is not resonant. It gives resistance and reactance readings on dipoles, inverted Vees, quads, beams, multiband trap dipoles and verticals. No station is complete without this up-to-date instrument.

Why work in the dark? Your SWR meter or your resistance noise bridge tells only half the story. Get the instrument that really works, the Palomar Engineers R-X Noise Bridge. Use it to check your antennas from 1 to 100 MHz. And use it in your shack to adjust resonant frequencies of both series and parallel tuned circuits. Works better than a dip meter and costs a lot less. Send for our free brochure.

The price is \$49.95 and we deliver postpaid anywhere in U.S. and Canada. California residents add sales tax.

Italy write i2VTT, P.O. Box 37, 22063 Cantu. Elsewhere send \$52.00 (U.S.) for air parcel post delivery worldwide.

Fully guaranteed by the originator of the R-X Noise Bridge. ORDER YOURS NOW!

PALOMAR ENGINEERS
BOX 455, ESCONDIDO, CA 92025
Phone: (714) 747-3343



hallicrafters
IS BACK — BIGGER
and **BETTER THAN EVER — and**
"HAM" BUERGER HAS IT!

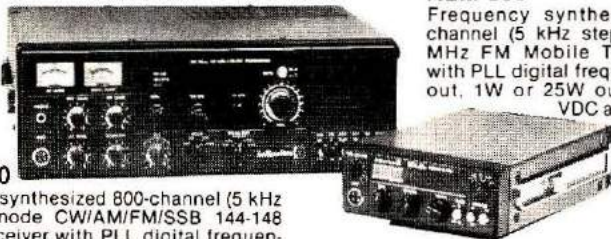

H2M-1000

Frequency synthesized 800-channel (5 kHz steps) all-mode CW/AM/FM/SSB 144-148 MHz Transceiver with PLL digital frequency readout, 12 watts output, 117 VAC, 13.8 VDC and VXO, SSB, VOX noise blanker and repeater offset.

H2M-1000. \$749⁰⁰

H2M-500

Frequency synthesized 800-channel (5 kHz steps) 144-148 MHz FM Mobile Transceiver with PLL digital frequency readout, 1W or 25W output, 13.8 VDC and repeater capability.

H2M-500 \$389⁰⁰

Call or write TODAY for our very best deal on: Antenna Specialists, Astatic, Drake, Hallicrafters, Hy-Gain, Mosley, Regency, Rohn, Telex, Ten-Tec, and Wilson. REMEMBER: We pay shipping charges on all prepaid orders!

"HAM" BUERGER, INC.

ELECTRONIC EQUIPMENT DISTRIBUTOR

WA3ZID-Bob

WB3BPJ-Bob

WB3GXP-Dave

WB3HOF-Jeff

68 NORTH YORK RD.
WILLOW GROVE, PA
19090
(215) 659-5900



HRH LOCATOR

TO HELP YOU FIND YOUR LOCAL AMATEUR RADIO DEALER

Alabama

LONG'S ELECTRONICS
2808 7TH AVENUE SOUTH
BIRMINGHAM, AL 35202
800-633-3410
Call Us Toll-Free
To Place Your Order.

Arizona

POWER COMMUNICATIONS
6012 N. 27 AVENUE
PHOENIX, AZ 85017
602-242-6030
Arizona's #1 "Ham" Store,
Kenwood, Drake, Icom & more.

California

TOWER ELECTRONICS CORP.
24001 ALICIA PARKWAY
MISSION VIEJO, CA 92675
714-768-8900
Authorized Yaesu Sales & Service.
Mail Orders A Specialty.

Florida

LAFAYETTE RADIO ELECTRONICS
(Assoc. Store)
1811 N. HIGHWAY 17-92
MAITLAND, FL 32751
305-831-2271
The Electronics Emporium

Illinois

SPECTRONICS, INC.
1009 GARFIELD STREET
OAK PARK, IL 60304
312-848-6777
Chicagoland's Amateur Radio
leader.

Indiana

HOOSIER ELECTRONICS, INC.
P. O. BOX 2001
(43B Meadows Shopping Center)
TERRE HAUTE, IN 47802
812-238-1456
Communications Headquarters
of the U.S.A.

Iowa

BOB SMITH ELECTRONICS
12 SOUTH 21ST STREET
FORT DODGE, IA 50501
515-576-3886
For an EZ Deal on New
or Used Equipment.

Maryland

THE COMM CENTER, INC.
LAUREL PLAZA - RTE. 198
LAUREL, MD 20810
301-792-0600
Drake, Hy-Gain, Mosley, Tempo,
Ten-Tec, Wilson.

Massachusetts

TUFTS ELECTRONICS
209 MYSTIC AVENUE
MEDFORD, MA 02155
617-395-8280
New England's Friendliest
Ham Store.

Michigan

RSE HAM SHACK
1207 W. 14 MILE
CLAWSON, MI 48017
313-435-5660
Complete Amateur Supplies.

New Hampshire

EVANS RADIO, INC.
BOX 893, RT. 3A BOW JUNCTION
CONCORD, NH 03301
603-224-9961
Icom, Dentron & Yaesu dealer.
We service what we sell.

New York

HAM-BONE RADIO
(Div. Stereo Repair Shop)
3206 ERIE BOULEVARD, EAST
SYRACUSE, NY 13214
315-446-2266
We Deal, We Trade,
We Discount, We Please!

HARRISON RADIO CORP.
20 SMITH STREET
FARMINGDALE, NY 11735
516-293-7990
"Ham Headquarters USA®"
since 1925.
Call toll free 800-645-9187.

Ohio

UNIVERSAL AMATEUR RADIO
1280 AIDA DRIVE
REYNOLDSBURG (Columbus)
OH 43068
614-866-HAMS
Drake, Yaesu, Ten-Tec, KDK, Wilson.
All Lines In Stock.

Pennsylvania

ELECTRONIC EXCHANGE
136 N. MAIN STREET
SOUDERTON, PA 18964
215-723-1200
Personal attention to Newcomer
and Oldtimer.

Amateur Radio Retail Dealers:

Your store belongs in **HORIZONS LOCATOR**, The beginners where-to-buy-it bible. Call toll free 800-258-5353 for complete details — do it today.

Price-Buster.

The **Kantronics Mobile 2 Antenna Kit** offers a reasonable alternative to the high priced VHF antenna! The **Mobile 2** is a high-quality, quarter-wavelength antenna that is quickly assembled. Everything needed for use with your 2 meter rig is included in the kit.

Adjustable whip length and accompanying Allen wrench permit tuning your **Mobile 2** for best SWR, and 18 feet of RG-58/U coax connect to almost any point on your car. Kit also includes a standard PL-259 connector.

All these features . . . for a low, low price!

Write us, or ask your dealer about the **Mobile 2** and other **Kantronics** amateur radio products.



only **\$8.95**

KANTRONICS
The Lightweight Champs.

Telephone 913-842-7745
1202 East 23rd St.

Lawrence, Kansas 66044

NEW VISUAL CODE READER AND ELECTRONIC KEYS

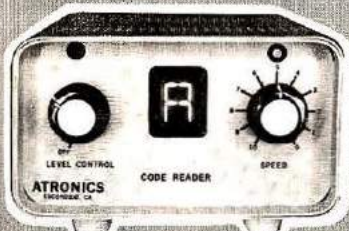

Works with any keyer, including squeeze keyer in speeds from 7 WPM to 40 WPM. Both in a single unit.
Model CR101E
\$249

from **ATRONICS**

- Display letters, numbers, and commonly used punctuation visually as Morse Code signal is received.
- Operating speed 5 to 50 WPM at selected speeds.
- All Solid State.
- Makes code learning faster and easier.
- A single connection to your receiver or transceiver speaker puts it into operation.
- Hard copy read-out of CW available with TU-102 TTY interface Module accessory.

Our popular, lowest priced **CODE READER KIT**
Model KCR101 \$149
Ready made CODE READER... Model CR101 \$225

BUY FACTORY DIRECT & SAVE! SEND FOR FREE LITERATURE.
USE YOUR BANKAMERICARD OR MASTER CHARGE

BOX 2946

LAGUNA HILLS, CA 92653

(714) 830-6428

Atronic

More details? Ad Check page 88.

the famous HAM KEYS

The keys that are easy to put your fingers on!



JUST DIAL
1-800-325-3636
TOLL FREE



Model HK-1

- Dual-lever squeeze paddle
- Use with HK-5 or any electronic keyer
- Heavy base with non-slip rubber feet
- Paddles reversible for wide- or close-finger spacing

\$29⁹⁵

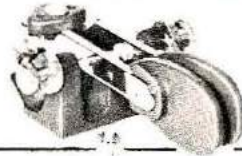

Model HK-2

- Same as HK-1, less base for incorporation in own keyer

\$19⁹⁵



Model HK-3

- Deluxe straight key
- Heavy base - no need to attach to desk
- Velvet smooth action

\$16⁹⁵

Model HK-3A

- Same as above, less base \$9.95

Navy type knob, only \$2.75

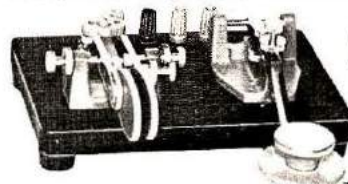

Model HK-4

- Combination of HK-1 and HK-3 on same base

\$44⁹⁵

- Base only with rubber feet \$12.00

Terminals, red or black, \$75 each



NEW AND IMPROVED

Model HK-5A Electronic Keyer

- New Cabinet Colored-Keyed to Match most modern radio equipment
- Iambic Circuit for squeeze keying
- Self-completing dots and dashes
- Dot memory
- Battery operated with provision for external power
- Built-in side-tone monitor
- Grid block or direct keying

- Speed, volume, tone and weight controls all mounted on front panel
- For use with external paddle, such as HK-1 or HK-4
- Can be used as Code practice oscillator with straight-key, such as HK-3

\$69⁹⁵

Same day shipment . . . **PREPAID**

We welcome the use of your



HAM RADIO CENTER, INC.

8340-42 Olive Blvd • P.O. Box 28271 • St. Louis, MO 63132



- Advance Registration \$14.00 per person; with Hotel Sahara Late Show and two drinks \$28.00 per person or with Hotel Sahara Congo Dinner Show (entree Cornish Hen), no drinks \$35.00 per person. Tax and Gratuity included.
- Entertainment in Hotel Sahara's Congo Room has not been selected at press time.
- Advance Registration must be received by **SAROC** on or before December 22, 1977.

The NATION'S ANNUAL LAS VEGAS PRESTIGE CONVENTION



HOTEL SAHARA'S CONVENTION SPACE CENTER

January 5-8, 1978

- **SAROC** Registration includes: registration tickets, admission to technical sessions, Friday cocktail party hosted by TRI-EX Tower Corp.; Saturday cocktail party hosted by Ham Radio Magazine; Hotel Sahara Buffet Brunch on Sunday, Tax and Gratuity.
- Hotel Sahara room rate for **SAROC** registered delegates \$22.00 per night plus room tax, single or double occupancy.
- Hotel Sahara room reservation request card will be sent only to **SAROC** registered delegates and exhibitors only until December 22, 1977.



Send your check or money order to **SAROC**, P. O. Box 945, Boulder City, NV 89005



HORIZONS ad-scan

RATES Regular classified is available at 50¢ per word. Display classified (1 inch deep x 2 1/4 inches wide) is \$50, or at the 12x rate is \$35. All Ad Scan payable in advance. No cash discounts or agency commissions allowed.

HAMFESTS Sponsored by non-profit organizations receive one free regular classified ad (subject to our editing). Repeat insertions of hamfest ads pay the standard rate.

COPY No special layout or arrangements available. Material should be typewritten or clearly printed (not all capitals) and must include full name and address. We reserve the right to reject unsuitable copy. *HORIZONS* cannot check each advertiser and thus cannot be held responsible for claims made. Liability for correctness of material limited to corrected ad in next available issue.

DEADLINE 15th of fourth preceding month.

SEND MATERIAL TO: Ad Scan, Ham Radio Horizons, Greenville, N. H. 03048.

FREE LICENSING CLASSES in Flushing, NY area. Send inquiries to FRATS (Flushing Radio Amateur Technical Society), 62026 Boelsen Crescent, Rego Park, NY 11374.

CUSTOM ENGRAVING for the Ham and Hamshack. 1 x 3" Namebadge with name and call \$2.50. 2 x 8" Nameplate w/acrylic base \$5.25. All colors. Send check or money order to Ed's Engraving, Box 644, Westfield, MA 01085.

SST T-1 RANDOM WIRE ANTENNA TUNER



All band operation (160-10 meters) with most any random length wire. 200 watt output power capability. Ideal for portable or home operation. Tuning indicator for small size. 3 x 4 1/4 x 2 3/8. Built-in neon tune-up indicator. SO 239 coax connector. Guaranteed for 1 yr., 10 day trial. Compact - easy to use. Only \$29.95 postpaid. (Add Sales Tax in Calif.) 12131 376 5887

SST ELECTRONICS, P.O. BOX 1, LAWDALE, CA 90260

STOP THIEVES! Protect your rig with guaranteed slide mount. \$7.95 ppd. Adams H-101, Box 408, Chadron, NE 69337.

QSL's with class! Unbeatable quality, reasonable price. Samples, 25¢. QSL's Unlimited, Box 27553H, Atlanta, GA 30327.

AWARD CERTIFICATES

Award for Public Service or Emergency Communications Award. Send 2.00 each, event, name and address. FREE Information. 49'er RADIO CLUB, Box 1400-HH, Downey, Calif. 90240.

CODE PRACTICE OSCILLATORS, hand keys, electronics keyers, other products. Free catalog. Globalman Products, Box 246, El Toro, CA 92630. 714-533-4400.

STOLEN EQUIPMENT: DRAKE ML-2, SN 11546, with 34/94, 94/94, 16/76, 07/67, 22/82, and 25/85 crystals installed. Stolen from Tom Fraser, WA0QQT, Colorado Springs, Colorado. Call (303) 635-8911, Ext. 3874. Anyone desiring to list stolen Amateur radio equipment please send information to Colorado Council of Amateur Radio Clubs C/O Charles E. Myers W0RNT, 1120 Yosemite Drive, Colorado Springs, CO 80910. Please include as much identification information as possible. Free distribution will be made to all Amateur radio magazines and Colo. Amateur radio clubs. Funds for postage and printing will be greatly appreciated.

NORTH CAROLINA QSO PARTY — from 1900Z Dec. 2 through 0100Z Dec. 4. Suggested frequencies are plus/minus 10 kHz: cw, 3560 7060 14060 21060 28060; Novice, 3720 7120 21120 28120; ssb, 3900 7270 14290 21390 28590. Out-of-state stations transmit RS(T) and state, province or country. NC stations send RS(T) and NC county. Logs must be postmarked no later than Jan. 10, 1978 and sent to: Alamance ARC Inc., 2822 Westchester Dr., Burlington, NC 27215. For additional information write K4EG.

SECOND ANNUAL WELLESLEY AMATEUR RADIO SOCIETY QSO PARTY from 0100Z November 19th to 1900Z November 20th. Exchange RS(T) and ARRL Section or Country with W1TKZ on 3.950, 7.250, 14.310, 21.400, 28.600, and 146.52 (phone) or 3.720, 7.120, 21.120, and 28.120 (CW). QSL and long SASE to W.A.R.S., 324 Washington St., Wellesley, MA 02181.

MOBILE IGNITION SHIELDING provides more range with no noise. Bonding strap sale less than 50¢ each. Literature. Estes Engineering, 930 Marine Drive, Port Angeles, Wash. 98362.

SOCIETY OF WIRELESS PIONEERS second annual membership on-the-air CW QSO Party, December 17th & 18th for the full GMT period. All members with Amateur licenses are encouraged to call CQ SOWP 55 kHz up from the low end of each Amateur band. Information from Bill Wilmot, K4TF, 1630 Venus Street, Merritt Island, FL 32952.

MICROCOMPUTER INTERFACING WORKSHOP, December 8 - 10, 1977. A three-day workshop based on the 8080 and 8085 microprocessors, with over 20 microcomputers available for participant use; and ...

DIGITAL ELECTRONICS FOR AUTOMATION WORKSHOP, December 6 & 7, 1977. A two-day workshop based on small-scale and medium-scale TTL integrated circuits, with in-depth lectures and individual breadboarding stations. For more information on these workshops, write Dr. Norris Bell, V.P.I. and S.U. Continuing Education Center, Blacksburg, VA 24061, or call (703) 951-6328.

WEST COAST BULLETIN edited and transmitted by W6ZF, 9 PM PDT (8 PM PST) (0400 UTC) 3450 kHz, A-1, 22 WPM. **FIRST AND THIRD MONDAYS** each month. Ten to fifteen items of latest current events of interest to Amateurs, with final few minutes at 25 WPM to help build code speed.

THE OAK PARK HIGH SCHOOL Electronics Club presents a Swap and Shop on Thanksgiving Sunday, Nov. 27, 1977 at Oak Park High School, Oak Park, Michigan, 48237. Refreshments and Door Prizes. Donation \$1.00. Table \$1.00.

TOROIDS 88 or 44 mH. Same day shipment, 5 for \$3.50 postpaid. Gull Electronics, 12690 Rt. 30, N. Huntingdon, PA 15642.

UR TRIPOLE MULTI-BAND



Universal Radio Co. Dept. H3
Box 23041 El Paso, TX 79926
Telephone (817) 592-1910

All-band antenna
50 to 5 Meters plus 160' 5 SWL M Bands. Built in
dual — 2 KW PEP rating. No tuning tap or
trap changes. 80 to 120 ft inverted V or horizontal.
Available in kit form or assembled.
Kit T80-K \$54.95 cash PPD in USA

*Does not include 1/2" x 1/2" hole for
SST antenna base for mounting on pole.
*RIGID antenna from separate kit.

Guaranteed



ENGRAVED NAMETAGS—1 1/2" x 2 1/2" — \$3.00. QTH added—\$0.50. Black, blue, red, green, walnut. White letters. Beveled. Locking pin. Other colors available. Tag-It Co., Box 2062, Indianapolis, In. 46206.

LaPORTE ARC'S WINTER HAMFEST, Sunday, February 26, 1978 at the LaPorte Civic Auditorium, 50 miles southeast of Chicago. Plenty of room, free tables, good food. Donation \$2 at gate. Talk in on 01/61 and 52 simplex. LPARC, Box 30, LaPorte, IN 46350.

"THE CADILLAC" of QSL's! — New! Samples: \$1.00 (Refundable) — MAC'S SHACK, Box #1171-G, Garland, Texas 75040.

ELIMINATE QRM AND QRN problems with our superior CW and SSB Filters. Also CW Keyers, speech compressors, power supplies, and multiband antennas assembled or in kits. Dealer discounts. Dynamic Electronics, Box 896, Hartselle, AL 35640. (205) 773-2758.

CASH for your clean ham gear. Beacon Communications — used equipment specialists, 879 Beacon St., Boston, Mass. 02215. 617-267-1975.

HAM RADIO HORIZONS

Index to Volume I — 1977

This index covers all articles published in *Ham Radio Horizons* during 1977. The articles are listed alphabetically under each category along with the author, page number and month. Categories are: Antennas; Construction; Features; Fiction; Fm and Repeaters; License Preparation; Miscellaneous Technical; Operating; Old-Time Radio; Propagation; Receivers; Regulations and FCC; Satellites; and Station Equipment.

ANTENNAS

- Antennas for hams
 - W6SAI p. 34, Aug 77
- Antennas for limited space
 - K4IPV p. 26, Nov 77
- Dummy loads you can build
 - W8YFB p. 60, Oct 77
- High-frequency antennas, all-purpose
 - G5RV p. 36, Jun 77
- High-frequency antennas,
 - Part I, W1HR p. 12, Jun 77
 - Part II, W1HR p. 26, Jul 77
- Inverted antenna
 - W6NIF p. 60, Wrap-Up 77
- Towers
 - K1XX p. 22, Jun 77
- Transmission lines . . . pipeline to the outside world
 - W1HR p. 32, May 77
- Tri-band wire yagi antenna
 - W1HXU p. 26, Dec 77
- VHF antennas
 - W1SL p. 28, Jun 77
- 80-meter vertical
 - Smithson p. 62, May 77

CONSTRUCTION

- A power supply for your projects
 - W1KLK p. 30, Dec 77
- Audio amplifier, inexpensive
 - WA1SNG p. 38, Oct 77
- Audio oscillator, simple
 - W1KLK p. 38, Mar 77
- Build your own enclosures
 - WA2PVV p. 38, Dec 77
- Electronic keyers, simple
 - WA5TRS p. 54, May 77
 - Erratic Error p. 76, Wrap-Up 77
- For that professional look . . .
 - VE3GFN p. 42, Dec 77
- Nicad Battery, how to build
 - W5QNO p. 62, Jul 77
- Novice receiver, two-band
 - Thorpe p. 22, Jul 77
- Power supply for your projects
 - W1KLK p. 20, Nov 77

- Transmitters, low-powered
 - W7OE p. 30, Aug 77
- Wavemeter, high-frequency
 - W1KLK p. 52, Jun 77
- Workbench, how to build
 - W2IMB p. 56, Jul 77

FEATURES

- Amateur radio afloat
 - W6QKI p. 12, Aug 77
- Ham radio and citizen's band as communication services
 - WB2AYA p. 12, Oct 77
 - Letter p. 70, Wrap-Up 77
- Ham radio and hospitals
 - K4IPV p. 30, Oct 77
- Introduce your wife to ham radio
 - WB3AIQ p. 46, Aug 77
- National Radio Astronomy Observatory
 - W1HLV p. 12, May 77
- Radio control of models
 - W2EUQ p. 12, Jul 77
- Youngest ham
 - W2EUQ p. 51, May 77
- Two Watts on the "Island in the Sun"
 - W1KLK p. 15, Apr 77
- 1977 Sweepstakes Winners
 - W1NLB p. 70, Sep 77

FICTION

- Call from Cedro Canyon
 - W7ZC p. 50, Apr 77
- Power paranoia
 - W1HEO p. 51, Aug 77
- They always came back
 - W7ZC p. 47, Oct 77
- Those Days Before Spark . . .
 - WA7YUA p. 66, Jun 77
- Zero bandwidth ssb
 - Karryer p. 48, Apr 77

FM AND REPEATERS

- Public service . . . one ham's answer to the portable problem
 - WA1QLI p. 24, Apr 77

- Repeaters, introduction to
 - WA3VUP p. 12, Sep 77

LICENSE PREPARATION

- Advice for beginners
 - WB9OJA p. 42, Oct 77
- CB to Ham, not-so-rocky road from
 - W2EUQ p. 24, Mar 77
- Morse code, a plan for
 - W5ZPV p. 20, May 77
- Pass your general class exam
 - W1HEO p. 56, Sep 77
- Those exam questions?
 - And answers! — W1SL
 - Part I p. 27, Sep 77
 - Part II p. 52, Oct 77
 - Part III p. 56, Nov 77
 - Part IV p. 60, Dec 77
 - Part V p. 32, Wrap-Up 77

MISCELLANEOUS TECHNICAL

- Dawn of the semiconductor age
 - WB9SDN p. 12, Wrap-Up 77
- Decibels explained
 - James p. 64, Aug 77
- Electronics and mechanics — a comparison
 - W4KOM p. 43, Aug 77
- Oscilloscope uses
 - WB0KTH p. 46, Nov 77
- Slow-scan television
 - W2DD p. 12, Nov 77
- Taking the mystery out of single sideband, W1SL
 - Part I p. 54, Mar 77
 - Part II p. 42, Apr 77
 - Part III p. 42, May 77
- Time signals and stations
 - W2EUQ p. 42, Sep 77
- Understanding resistors, capacitors, and inductors
 - WA1TWT p. 46, Dec 77
- Variable-frequency oscillators
 - W6SAI p. 26, May 77

OLD-TIME RADIO

- Brass pounding on wheels
 - K6QD p. 38, Jul 77
- Early day broadcasting
 - W7CSD p. 34, Sep 77
- Golden Years of Radio
 - W6SAI p. 32, Mar 77
- Those Old Radio Magazines
 - K4KJ p. 38, Wrap-Up 77

OPERATING

- All is not gold that glistens
 - W2EUQ p. 12, Dec 77
- An Evening of DX
 - W9KNI p. 46, Mar 77
- Become a rare station — at home
 - W4NXD p. 36, Oct 77
- Calling NN3SI
 - W3IK p. 28, Wrap-Up 77
- Contest operating
 - W1GQO / K1XX p. 38, Apr 77
- DX at dawn
 - W9KNI p. 56, Aug 77



502-886-4534



YAESU — TEN-TEC — TEMPO — DENTRON

- WE HAVE FULL SERVICE ON WARRANTY AND NON-WARRANTY RADIOS.
- ALL NEW DIGITAL MODELS ARE NOW IN STOCK.
- CALL US SOON FOR PERSONAL SERVICE.

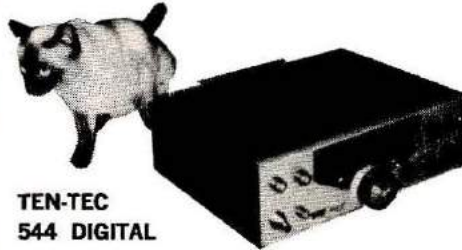
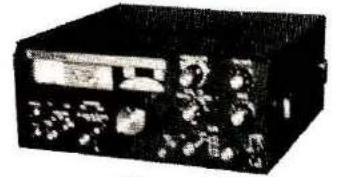

TEN-TEC 544 DIGITAL

TRENTON, KY. 42286

COHOON AMATEUR SUPPLY

Field day operation
K1XX, WA1ABV / K1RX p. 38, Jun 77

Future insight — ham radio
W2SPJ p. 66, Wrap-Up 77

Keep in touch with ham radio
K3RXK p. 24, Aug 77

Long path, short path DX
W9KNI p. 60, Jun 77

Phone patch, instant
W5QNO p. 48, May 77

Safety tips for amateurs
W1HEO p. 34, Nov 77

Starlight DX
W9KNI p. 62, Sep 77

Television DXing
WB2AYA p. 46, Jun 77

That first QSO
WB2AYA p. 21, Dec 77

1750-meter band, exploring the
W2IMB p. 20, Apr 77

PROPAGATION

Introduction to the propagation of radio waves
W9RX p. 68, Apr 77

Ionospheric focusing
W6LFM p. 54, Dec 77

Radio propagation
Aladdin p. 74, Mar 77

Sunspots, strange world of
W6SAI p. 48, Jul 77

Error p. 76, Wrap-Up 77

RECEIVERS

Novice receiver, two band
Thorpe p. 22, Jul 77

Receiver design, a different approach
WA5SNZ p. 42, Jul 77

REGULATIONS AND FCC

HRH Interviews FCC's
John Johnston, K3BNS, W9JUV

Part I p. 14, Mar 77

Part II p. 10, Apr 77

Part III p. 66, May 77

SATELLITES

Nuts and bolts approach to satellite communications
W1XU p. 20, Wrap-Up 77

OSCAR satellites, riding high with
K3RXK p. 18, Mar 77

STATION EQUIPMENT

Cutting the cost of Amateur Radio
W6ROL p. 33, Jul 77

Get on the air... on a budget
W1HR p. 62, Mar 77

Station accessories
W2EUQ p. 38, Nov 77

Voice-controlled relay
W7RXV p. 26, Oct 77

Your hamshack, be proud of it
WB2HJD p. 32, Sep 77

Your station from the ground up
W2EUQ p. 28, Apr 77

This is easy- anyone can solder- WITH KESTER SOLDER

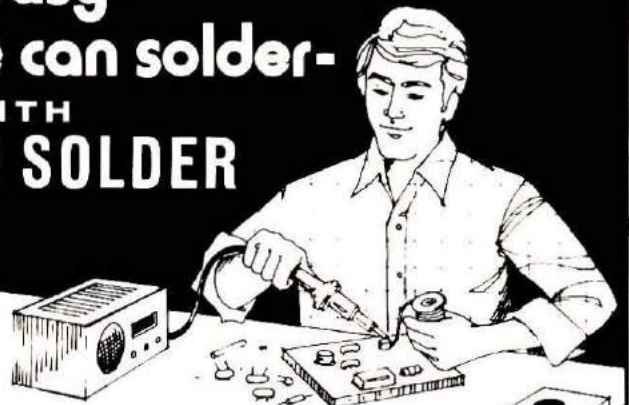

Handymen! Hobbyists! DO-IT-YOURSELFERS!

Let Kester Solder aid you in your home repairs or hobbies. For that household item that needs repairing — a radio, TV, model train, jewelry, appliances, minor electrical repairs, plumbing, etc. — Save money — repair it yourself. Soldering with Kester is a simple, inexpensive way to permanently join two metals.

When you Solder go "First Class" — use Kester Solder.

For valuable soldering information send self-addressed stamped envelope to Kester for a FREE Copy of "Soldering Simplified".



KESTER SOLDER Litton 4201 WRIGHTWOOD AVENUE/CHICAGO, ILLINOIS 60639

ZEN CW?



Battery model - uses 8 "D" cells
less batteries - \$86.00 ppd

Economy AC option - wall transformer
plus regulator in unit - add \$10.00

Hildreth Engineering
Box 60003 Sunnyvale
CA 94088



DRAKE

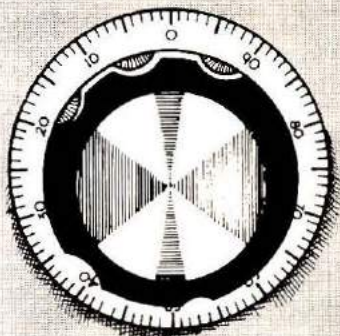

Adirondack has it!

ADIRONDACK Radio
Supply
Amateur Headquarters for the Northeast
185-191 West Main Street • P.O. Box 88
Amsterdam, N.Y. 12010 Tel (518) 842-8350
Just 5 minutes from N.Y. Thruway - Exit 27

RADIO & ELECTRONICS CONSTRUCTOR

Here is an interesting general electronics hobby magazine. It's loaded with lots of interesting simple circuits and ideas, not only about radio, but in all phases of electronics including test gear, audio, remote control and security electronics.

We are sure that you will find a number of worthwhile projects in this British magazine.

1 Year (12 issues) \$11.00

Radio & Electronics
Constructor
Greenville, NH 03048

UNIVERSAL TOWERS

FREE STANDING
ALUMINUM TOWER
10' to 100'
Prices from
\$128.00 (30')

MOST
POPULAR
HAM TOWER

EVER MADE!

REQUEST
NEW CATALOG
OF

TOWERS &
ANTENNAS

Communication Specialists
Midwest Ham Headquarters

For Over 38 Years
HAMS! Write For Free Catalog
and Wholesale Prices!

Electronic Distributors, Inc.
1960 Peck Muskegon, MI 49441
Tel: 616-726-3196 TELEX: 22-8411



77/78 AMATEUR RADIO EQUIPMENT DIRECTORY



Here's everything you want to know about Amateur Radio Equipment. Featuring descriptions, specification, prices and pictures. A one stop buying and reference guide to all your amateur needs. The new 77/78 supplement (32 pages) updates the 1977 Edition and brings the total number of pages to 168 (2 volumes). Almost 100 manufacturers/distributors are included. Only \$3.50 (plus postage and handling) for both volumes! Send for your directory today! (The 77/78 supplement is available for \$1.00 postpaid if you have already purchased the 1977 Edition.)

KENGORE CORPORATION, Dept. A
9 James Avenue
Kendall Park, N. J. 08824

Please send the 1977/78 AMATEUR RADIO EQUIPMENT DIRECTORY (2 volumes). I'm enclosing \$3.75 (\$3.50 plus 25¢ postage and handling—U.S. only.) Canadian orders \$4.00, Foreign orders \$5.00 (air).

Name/Call _____
Address _____
City _____ State _____ Zip _____

AD CHECK

... for literature, in a hurry — we'll rush your name to the companies whose names you check.

Place your check mark in the space between name and number. Example: HRH 150.

ALD ___ 625	Ham Outlet ___ 595
Adirondack Radio ___ 000	Heath ___ 060
Amsat ___ 220	Henry ___ 062
Antenna Mart ___ 009	Herrman ___ 568
Atlas ___ 198	Hildreth Eng. ___ 283
Atronics ___ 382	ICOM ___ 065
Burghardt ___ 530	Kantronics ___ 605
CW Elect. ___ 533	Kengore ___ 538
Cohoon ___ 559	Kenwood *
Colorado Silver ___ 630	Kester Solder *
Comm. Center ___ 534	Klaus ___ 430
Comm. Spec. ___ 330	Larsen ___ 078
Cushcraft ___ 035	Long's ___ 468
Daytronics ___ 612	MFJ ___ 082
Dentron ___ 259	Madison *
Digital Elect. ___ 631	Matric ___ 084
Drake ___ 039	Orlando Hamcation *
E. T. O. *	Palomar ___ 093
Elect. Dist. ___ 044	Partridge ___ 439
Erickson ___ 047	RSE Hamshack ___ 607
HAL ___ 057	Callbook ___ 100
"Ham" Buerger ___ 604	Radio Constructor ___ 586
Ham Center ___ 491	Radio Shack ___ 165
H. R. C. B. ___ 150	SAROC *
	Ten-Tec *
	Whitehouse ___ 378
	Wilson ___ 123

*Please contact this advertiser directly.
Limit 15 inquiries per request.

WRAP-UP, 1977

Please use before January 31, 1978

Tear off and mail to
HAM RADIO HORIZONS — "Ad Check"
Greenville, N. H. 03048

NAME _____

CALL _____

STREET _____

CITY _____

STATE _____ ZIP _____

CALL TOLL FREE 800-228-4097

for prices on Yaesu, Tempo, Swan, Ten-Tec, Icom, MFJ, Nye-Viking, Drake, Hy-Gain, Dentron, Midland, and CDE.

DRAKE

TR4-CW (RIT) 80-10m hf trans. with CW filter	reg. \$699.00	Now \$629.00
34PNB Noise blanker for TR-4C	reg. \$100.00	Now \$90.00
RV-4C Remote VFO/speaker	reg. \$150.00	Now \$134.95
AC-4 AC power supply for TR-4C & T-4XC	reg. \$120.00	Now \$109.00
DC-4 DC power supply	reg. \$135.00	Now \$124.00
L4B Linear amplifier	reg. \$895.00	Now \$789.00
SSR-1 Gen. coverage rcvr. .5-30 MHz	reg. \$350.00	Now \$279.00
R-4C 80-10m receiver	reg. \$599.95	Now \$539.95
4-NB Noise blanker for R-4C	reg. \$70.00	Now \$64.00
T-4XC 80-10m transmitter	reg. \$599.95	Now \$539.95
TV-3300LP Low pass filter	reg. \$26.60	Now \$19.95
MN-2000 Antenna Tuner	reg. \$240.00	Now \$219.95
MN-4 Antenna Tuner	reg. \$120.00	Now \$109.95
1525 Encoder Microphone	reg. \$49.95	Now \$45.95
TR-33C, 2m Portable Xcvr	reg. \$229.95	Now \$209.95

HY-GAIN

TH6DXX 6 element super Thunderbird	reg. \$249.95	Now \$209.95
TH3-MK3 3 element tri-band	reg. \$199.95	Now \$169.95
204BA 4 element 20m beam	reg. \$189.95	Now \$159.95
Hy-Quad, 2 el. Quad, 10-20 meters	reg. \$219.95	Now \$189.95
TH3JR 3 element tri-band	reg. \$144.50	Now \$129.95
TH2MK3, 2 element tri-band	reg. \$139.95	Now \$124.95
402BA 2 element, 40m	reg. \$199.95	Now \$169.95
203BA 3 element 20m	reg. \$129.95	Now \$109.95
153BA 3 element 15m	reg. \$79.95	Now \$69.95
103BA 3 element 10m	reg. \$54.95	Now \$49.95
DB10-15A 3 element 10, 15m	reg. \$149.95	Now \$134.95
18HT Hy-Tower, reg. \$279.95	Now \$239.95	
2BDQ Trap Doublet 40, 80m	reg. \$49.95	Now \$44.95
5BDQ Trap Doublet 10 thru 80m	reg. \$79.95	Now \$69.95
12AVQ 10-20m vertical	reg. \$37.95	Now \$33.95
14AVQ/WB 10-40m vertical	reg. \$67.00	Now \$57.00
18AVT/WB 10-80m vertical	reg. \$97.00	Now \$84.95
LA-1 Lightning Arrestor	reg. \$44.95	Now \$39.95
BN-86 Ferrite Balun	reg. \$15.95	Now \$14.95
203 3 el 2m beam	reg. \$12.95	Now \$12.95
205 5 el 2m beam	reg. \$16.95	Now \$16.95
208 8 el 2m beam	reg. \$19.95	Now \$19.95
214 14 el 2m beam	reg. \$26.95	Now \$26.95
273 4 el J-Pole	reg. \$49.95	Now \$49.95
3806 2m Handheld	reg. \$189.00	Now \$169.00
3750 Transceiver	reg. \$1895.00	Now \$1695.00

CALL FOR DAILY SPECIALS
OPEN 7 DAYS A WEEK

Talk to Bob, WB0RQZ, Joe, WA0WRI, Don, WB0YEZ, Roy, WB0WWA, Bill, WB0YHJ, or Ken WD0EMR.

800-228-4097

Nebr. residents call
402-466-3733 collect

Communications Center

2226 North 48th Street
Lincoln, NE 68504

AD INDEX

ALD Industries	55
Adirondack Radio Supply	87
Amsat	64
Antenna Mart	72
Atlas Radio	Cover IV
Atronics	81
Burghardt Amateur Center	58, 59
CW Electronic Sales Company	73
Cohoon Amateur Supply	85
Colorado Silver Co.	72
Communications Center	88
Communications Specialists	57
Cushcraft	4, 89
Dentron Radio Co.	48, 49
Digital Electronics, Inc.	77
Drake Co., R.L.	Cover II, 26, 27
Ehrhorn Technological Operations	75
Electronic Distributors	87
Erickson Communications	69
HAL Communications Corp.	85
"Ham" Buerger	79
Ham Radio Center	56, 81
Ham Radio's	
Communications Bookstore	56, 71, 74, 80
Ham Radio Outlet	9
Heath Company	37
Henry Radio Stores	63
The Herrman Co.	56
Hildreth Engineering	87
Icom	7
Kantronics	81
Kengore Corporation	87
Trio-Kenwood Communications, Inc.	90-96, Cover III
Kester Solder	85
Klaus Radio, Inc.	76
Larsen Antennas	68
Long's Electronics	1
MFJ Enterprises	3
Madison Electronic Supply	69
Matric	73
Orlando Hamcation	86
Palomar Engineers	54, 62, 79
Partridge Electronics Ltd.	69
RSE Hamshack	78
Radio Amateur Callbook	78
Radio & Electronics Constructor	87
SAROC	82
Ten-Tec	72, 79
G. R. Whitehouse & Co.	78
Wilson Electronics	10

Foreign Subscription Agents for Ham Radio HORIZONS

Ham Radio Austria
Karin Ueber
Postfach 2454
D-7850 Loerrach
West Germany

Ham Radio Holland
MRL Electronics
Postbus 88
NL-2204 Delft
Holland

Ham Radio Belgium
Stereohouse
Brusselsesteenweg 416
B-9218 Gent
Belgium

Ham Radio Italy
S.T.E. Via Maniago 15
I-20134 Milano
Italy

Ham Radio Canada
Box 114, Goderich
Ontario, Canada N7A 3Y5

Ham Radio Switzerland
Karin Ueber
Postfach 2454
D-7850 Loerrach
West Germany

Ham Radio Europe
Box 444
S-194 04 Upplands Vasby
Sweden

Ham Radio France
Christiane Michel
F-89117 Parly
France

Ham Radio UK
P.O. Box 63, Harrow
Middlesex HA3 6HS,
England

Ham Radio Germany
Karin Ueber
Postfach 2454
D-7850 Loerrach
West Germany

Holland Radio
143 Greenway
Greenside, Johannesburg
Republic of South Africa

2 METERS...

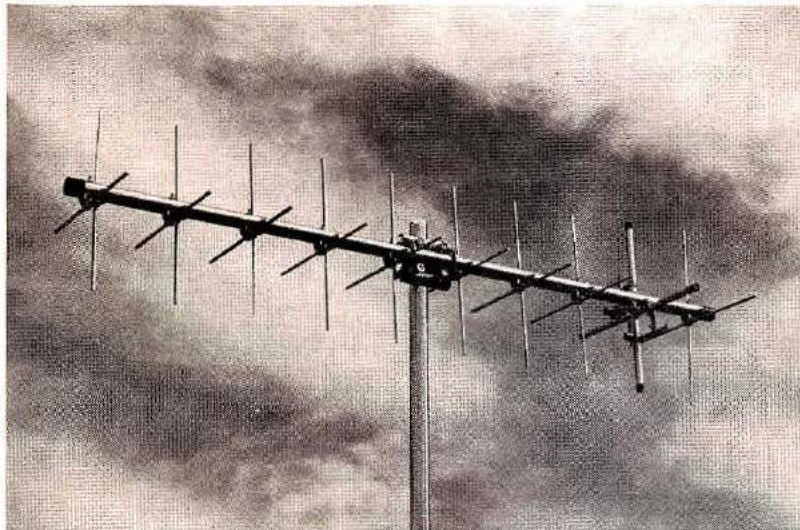

... *Alive* with activity at *both* ends of the band! Be a part of the total 2 Meter picture with the Cush Craft Twist Antenna. Actually two, easily assembled, 10 element yagis in one — the vertical elements are cut for the high end, the horizontal elements for the low end, and separate feed lines are used. The A147-20T is tailored to meet the demands of the operator who enjoys the best of both worlds

— FM and SSB/CW.

A147-20T

\$54.95

CQ OSCAR

... *Extend your horizon* — Explore the exciting new world of amateur satellite communications using low power with our multi-polarized Twist Antennas. All models include phasing harness for selectable linear or right/left circular polarization. Two of these Twists may be mounted on the A14T-MB mounting boom which is complete with a pre-drilled plate for a readily available mast-through rotator. *Face this challenging frontier — Become a Specialist!*

A144-10T \$34.95

A432-20T \$49.95

A144-20T \$54.95

A14T-MB \$15.95

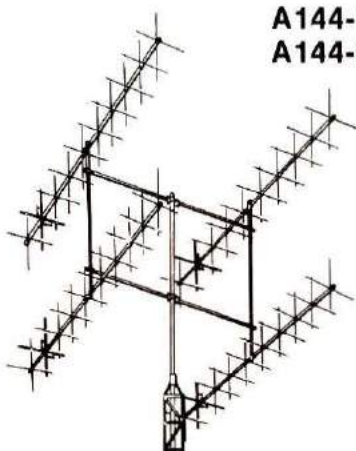
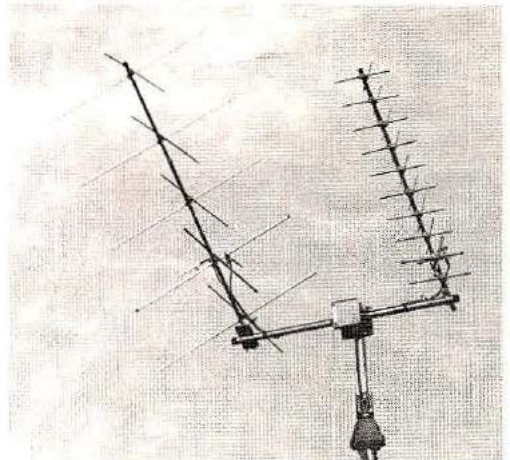

PERFORMANCE ARRAYS . . .

Enjoy fade-free contacts on VHF/UHF with Twist Antennas and Arrays. Excellent for scatter and other long-haul techniques. Double your effective radiated power by stacking two Twists, or quadruple ERP by stacking four Twists. Arrays are easily assembled for your special communications requirement. Write for stacking and phasing harness details concerning amateur and commercial frequencies.

Dependable communications — Now Yours!

	SPECIFICATIONS			
Model	A147-20T	A144-10T	A144-20T	A432-20T
Center Freq. (MHz)	144.5/146.5	145.9	145.9	432
No. Elements	10/10	10	20	20
Weight (lbs.)	6	3.5	6	3.5
Wind Surf. Area (ft. ²)	1.42	.74	1.42	.37
Mounting	Center	Rear	Center	Rear
Dimensions (Inches)	40x40x140	40x40x70	40x40x140	14x14x57

IN STOCK WITH
DISTRIBUTORS WORLDWIDE

cushcraft
THE ANTENNA COMPANY
P. O. BOX 4680, MANCHESTER, N.H. 03108

KENWOOD

...pacesetter in amateur radio

TS-520S

AND DG-5 DIGITAL FREQUENCY DISPLAY



The TS-520S combines all of the fine, field-proven characteristics of the original TS-520 together with many of the ideas and suggestions for improvement from amateurs worldwide.

FULL COVERAGE TRANSCEIVER

The TS-520S provides full coverage on all amateur bands from 1.8 to 29.7 MHz. Kenwood gives you 160 meter capability, WWV on 15.000 MHz., and an auxiliary band position for maximum flexibility. And with the addition of the TV-506 transverter, your TS-520S can cover 160 meters to 6 meters on SSB and CW.

DIGITAL DISPLAY DG-5 (option)

The Kenwood DG-5 provides easy, accurate readout of your operating frequency while transmitting and receiving.

OUTSTANDING RECEIVER SENSITIVITY AND MINIMUM CROSS MODULATION

The TS-520S incorporates a 3SK35 dual gate MOSFET for outstanding cross modulation and spurious response characteristics. The 3SK35 has a low noise figure (3.5 dB typ.) and high gain (18 dB typ.) for excellent sensitivity.

NEW IMPROVED SPEECH PROCESSOR

An audio compression amplifier gives you extra punch in the pile

ups and when the going gets rough.

VERNIER TUNING FOR FINAL PLATE CONTROL

A vernier tuning mechanism allows easy and accurate adjustment of the plate control during tune-up.

FINAL AMPLIFIER

The TS-520S is completely solid state except for the driver (12B-Y7A) and the final tubes. Rather than substitute TV sweep tubes as final amplifier tubes in a state of the art amateur transceiver,

Kenwood has employed two husky S-2001A (equivalent to 6146B) tubes. These rugged, time-proven tubes are known for their long life and superb linearity.

HIGHLY EFFECTIVE NOISE BLANKER

An effective noise blanking circuit developed by Kenwood that virtually eliminates ignition noise is built into the TS-520S.

RF ATTENUATOR

The TS-520S has a built-in 20 dB attenuator that can be activated by a push button switch conveniently located on the front panel.

PROVISION FOR EXTERNAL RECEIVER

A special jack on the rear panel of the TS-520S provides receiver signals to an external receiver for increased station versatility. A switch on the rear panel determines the signal path... the receiver in the TS-820 or any external receiver.

VFO-520 — NEW REMOTE VFO

The VFO-520 remote VFO matches the styling of the TS-520S and provides maximum operating flexibility on the band selected on your TS-520S.

AC POWER SUPPLY

The TS-520S is completely self-contained with a rugged AC power supply built-in. The addition of the DS-1A DC-DC converter (optional) allows for mobile operation of the TS-520S.

EASY PHONE PATCH CONNECTION

The TS-520S has 2 convenient RCA phono jacks on the rear panel for PHONE PATCH IN and PHONE PATCH OUT.

CW-520 — CW FILTER (OPTION)

The CW-520-500 Hz filter can be easily installed and will provide improved operation on CW.

AMPLIFIED TYPE AGC CIRCUIT

The AGC circuit has 3 positions (OFF, FAST, SLOW) to enable the TS-520S to be operated in the optimum condition at all times whether operating CW or SSB.

The TS-520S retains all of the features of the original TS-520 that made it tops in its class: RIT control • 8-pole crystal filter • Built-in 25 KHz calibrator • Front panel carrier level control • Semi-break-in CW with sidetone • VOX/PTT/MOX • TUNE position for low power tune up • Built-in speaker • Built-in Cooling Fan • Provisions for 4 fixed frequency channels • Heater switch.

TS-520 Specifications

Amateur Bands: 160-10 meters plus WWV (receive only)
 Modes: USB, LSB, CW
 Antenna Impedance: 50-75 Ohms
 Frequency Stability: Within ± 1 kHz during one hour after one minute of warm-up, and within 100 Hz during any 30 minute period thereafter
 Tubes & Semiconductors:
 Tubes 3 (S2001A x 2, 12BY7A)
 Transistors 52
 FETs 19
 Diodes 101

Power Requirements: 120/220 V AC, 50/60 Hz, 13.8 V DC (with optional DS-1A)
 Power Consumption: Transmit: 280 Watts Receive: 26 Watts (with heater off)
 Dimension: 333(13 1/4) W x 153 (6-0) H x 335(13 1/8) D mm(inch)
 Weight: 16.0 kg(35.2 lbs)

TRANSMITTER

RF Input Power: SSB: 200 Watts PEP CW: 160 Watts DC
 Carrier Suppression: Better than -40 dB
 Sideband Suppression: Better than -50 dB
 Spurious Radiation: Better than -40 dB
 Microphone Impedance: 50k Ohms
 AF Response: 400 to 2,600 Hz

RECEIVER

Sensitivity: 0.25 μ V for 10 dB (S+N)/N
 Selectivity: SSB: 2.4 kHz/-6 dB, 4.4 kHz/-60 dB
 Selectivity: CW: 0.5 kHz/-6 dB, 1.5 kHz/-60 dB (with optional CW-520 filter)
 Image Ratio: Better than 50 dB
 IF Rejection: Better than 50 dB
 AF Output Power: 1.0 Watt (8 Ohm load, with less than 10% distortion)

AF Output Impedance: 4 to 16 Ohms

DG-5

SPECIFICATIONS

Measuring Range: 100 Hz to 40 MHz
 Input Impedance: 5 k Ohms
 Gate Time: 0.1 Sec.
 Input Sensitivity: 100 Hz to 40 MHz... 200 mV rms or over, 10 kHz to 10 MHz... 50 mV or over
 Measuring Accuracy: Internal time base accuracy ± 0.1 count
 Time Base: 10 MHz
 Operating Temperature: -10° to 50° C/14° to 122° F
 Power Requirement: Supplied from TS-520S or 12 to 16 VDC (nominal 13.8 VDC)
 Dimensions: 167(6-9/16) W x 43(1-11/16) H x 268(10-9/16) D mm(inch)
 Weight: 1.3 kg(2.9 lbs)



DG-5

The luxury of digital readout is available on the TS-520S by connecting the DG-5 readout (option). More than just the average readout circuit, this counter mixes the carrier, VFO, and heterodyne frequencies to give you your exact frequency. This handsomely-styled accessory can be set almost anywhere in your shack for easy-to-read operation... or set it on the dashboard during mobile operation for safety and convenience. Six bold digits display your operating frequency while you transmit and receive. Complete with DH (display hold) switch for frequency memory and 3-position intensity selector. The DG-5 can also be used as a normal frequency counter up to 40 MHz at the touch of a switch. (Input cable provided.)

NOTE: TS-520 owners can use the DG-5 with a DX-520 adapter kit.

KENWOOD

...pacesetter in amateur radio



TS-820S

WITH DIGITAL FREQUENCY DISPLAY

We told you that the TS-820 would be best. In little more than a year our promise has become a fact. Now, in response to hundreds of requests from amateurs, Kenwood offers the TS-820S*... the same superb transceiver, but with the digital readout factory installed. As an owner of this beautiful rig, you will have at your fingertips the combination of controls and features that even under the toughest operating conditions make the TS-820S the Pacesetter that it is.

Following are a few of the TS-820S' many exciting features.

PLL • The TS-820S employs the latest phase lock loop circuitry. The single conversion receiver section performance offers superb protection against unwanted cross-modulation. And now PLL allows the frequency to remain the same when switching sidebands (USB, LSB, CW) and eliminates having to recalibrate each time.

DIGITAL READOUT • The digital counter display is employed as an integral part of the VFO readout system. Counter mixes the carrier VFO, and first heterodyne frequencies to give exact frequency. Figures the frequency down to 10 Hz and digital display

reads out to 100 Hz. Both receive and transmit frequencies are displayed in easy to read, Kenwood Blue digits.

SPEECH PROCESSOR • An RF circuit provides quick time constant compression using a true RF compressor as opposed to an AF clipper. Amount of compression is adjustable to the desired level by a convenient front panel control.

IF SHIFT • The IF SHIFT control varies the IF passband without changing the receive frequency. Enables the operator to eliminate unwanted signals by moving them out of the passband of the receiver. This feature alone makes the TS-820S a pacesetter.

*The TS-820 and DG-1 are still available separately.

TS-600



Experience the excitement of 6 meters. The TS-600 all mode transceiver lets you experience the fun of 6 meter band openings. This 10 watt, solid state rig covers 50.0-54.0 MHz. The VFO tunes the band in 1 MHz segments. It also

has provisions for fixed frequency operation on NETS or to listen for beacons. State of the art features such as an effective noise blanker and the RIT (Receiver Incremental Tuning) circuit make the TS-600 another Kenwood "Pacesetter".



TV-506

An easy way to get on the 6 meter band with your TS-520/520S, TS-820/820S and most other transceivers. Simply plug it in and you're on... full band coverage with 10 watts output on SSB and CW.



TR-8300

Experience the luxury of 450 MHz at an economical price. The TR-8300 offers high quality and superb performance as a result of many years of improving VHF/UHF design techniques. The trans-

ceiver is capable of F₃ emission on 23 crystal-controlled channels (3 supplied). The transmitter output is 10 watts.

The TR-8300 incorporates a 5 section helical resonator and a

two-pole crystal filter in the IF section of the receiver for improved intermodulation characteristics. Receiver sensitivity, spurious response, and temperature characteristics are excellent.

KENWOOD

...pacesetter in amateur radio

TS-700S

WITH DIGITAL FREQUENCY DISPLAY



Check out the new "built-ins": digital readout, receiver pre-amp, VOX, semi-break in, and CW sidetone! Of course, it's still all mode, 144-148 MHz and VFO controlled.

Features: Digital readout with "Kenwood Blue" digits • High gain receiver pre-amp • 1 watt lower power switch • Built in VOX • Semi-break in on CW • CW sidetone • Operates all modes: SSB (upper & lower), FM, AM and CW • Completely solid state circuitry provides stable, long lasting, trouble-free operation • AC and DC capability (operate from your car, boat, or as a base station through its built-in power supply) • 4 MHz band coverage (144 to 148 MHz) • Automatically switches transmit frequency 600 KHz for repeater operation. Simply dial in your receive frequency and the radio does the rest. ... simplex, repeater, reverse • Or accomplish the same by plugging a single crystal into one of the 11 crystal positions for your favorite channel • Transmit/Receive capability on 44 channels with 11 crystals.



VFO-700S

Handsomely styled and a perfect companion to the TS-700S. This unit provides you with the extra versatility and the luxury of having a second VFO in your shack. Great for split frequency operation and for tuning off frequency to check the band. The function switch

on the VFO-700S selects the VFO in use and the appropriate frequency is displayed on the digital readout in the TS-700S. In addition a momentary contact "frequency check" switch allows you to spot check the frequency of the VFO not in use.

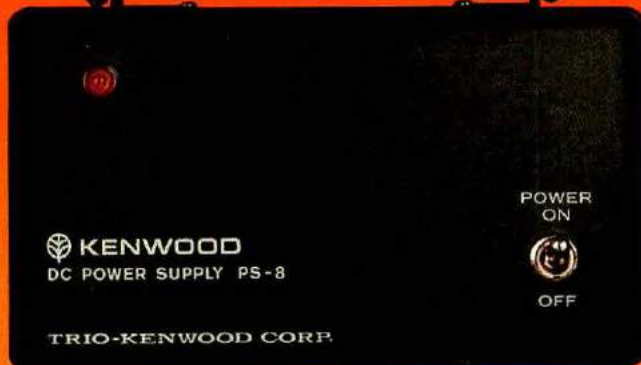

TR-7400A

Features Kenwood's unique Continuous Tone Coded Squelch system, 4 MHz band coverage, 25 watt output and fully synthesized 800 channel operation. This compact package gives you the kind of performance specifications you've always wanted in a 2-meter amateur rig.

Outstanding sensitivity, large-sized helical resonators with High Q to minimize undesirable out-of-band interference, and give a 2-pole 10.7 MHz monolithic crystal filter combine to give your TR-7400A outstanding receiver performance. Intermodulation characteristics (Better than 66dB), spurious (Better than -60dB), image rejection (Better than -70dB), and a versatile squelch system make the TR-7400A tops in its class.

Shown with the PS-8 power supply

(Active filters and Tone Burst Modules optional)

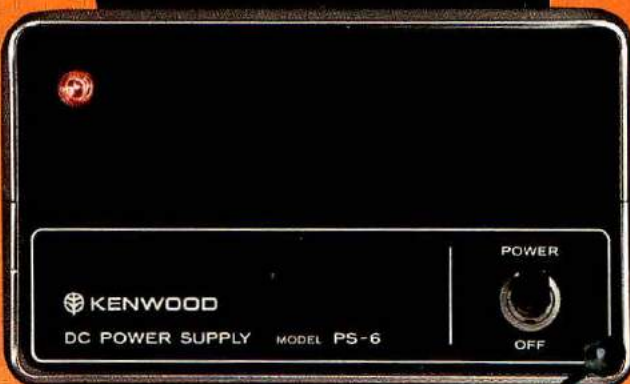

TR-7500

This 100 channel PLL synthesized 146-148 MHz transceiver comes with 88 pre-programmed channels for use on all standard repeater frequencies (as per ARRL Band Plan) and most simplex channels. For added flexibility, there are 6 diode-programmable switch positions. The 15 KHz shift function makes these 6 positions into 12 channels. 10 watt output, ± 600 KHz offset and LED digital frequency display are just a few of the many fine features of the TR-7500. The PS-6 is the handsomely styled, matching power supply for the TR-7500. Its 3.5 amp current capacity and built-in speaker make it the perfect companion for home use of the TR-7500.

TR-2200A

The high performance portable 2-meter FM transceiver. 146-148 MHz, 12 channels (6 supplied), 2 watts or 400 mW RF output. Everything you need is included: Ni-Cad battery pack, charger, carrying case and microphone.



KENWOOD

...pacesetter in amateur radio

Kenwood developed the T-599D transmitter and R-599D receiver for the most discriminating amateur.

The R-599D is the most complete receiver ever offered. It is entirely solid-state, superbly reliable and compact. It covers the full amateur band, 10 through 160 meters, CW, LSB, USB, AM and FM.

The T-599D is solid-state with the exception of only three tubes, has built-in power supply and full metering. It operates CW, LSB, USB and AM and, of course, is a perfect match to the R-599D receiver.

If you have never considered the advantages of operating a receiver/transmitter combination... maybe you should. Because of the larger number of controls and dual VFOs the combination offers flexibility impossible to duplicate with a transceiver.

Compare the specs of the R-599D and the T-599D with any other brand. Remember, the R-599D is all solid state (and includes four filters). Your choice will obviously be the Kenwood.



R-599D

T-599D

R-300

Dependable operation, superior specifications and excellent features make the R-300 an unexcelled value for the shortwave listener. It offers full band coverage with a frequency range of 170 KHz to 30.0 MHz • Receives AM, SSB and CW • Features large, easy to read drum dials with fast smooth dial action • Band spread is calibrated for the 10 foreign broadcast bands, easily tuned with the use of a built-in 500 KHz calibrator • Automatic noise limiter • 3-way power supply system (AC/Batteries/External DC) ... take it anyplace • Automatically switches to battery power in the event of AC power failure.



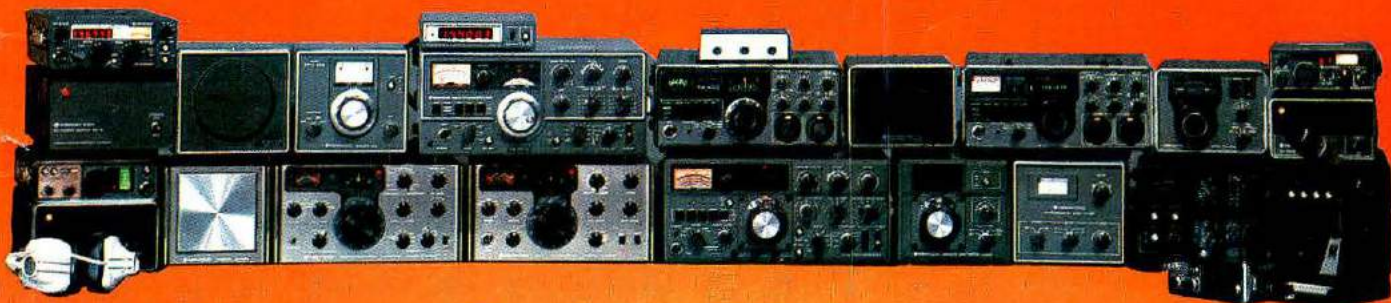

Fine equipment that belongs in every well equipped station

HF LINES

820 Series

- TS-820S... TS-820 with Digital Installed
- TS-820... 10-160 M Deluxe Transceiver
- DG-1... Digital Frequency Display for TS-820
- VFO-820... Deluxe Remote VFO for TS-820/820S
- CW-820... 500 Hz CW Filter for TS-820/820S
- DS-1A... DC-DC Converter for 520/820 Series

520 Series

- TS-520S... 160-10 M Transceiver
- DG-5... Digital Frequency Display for TS-520 Series
- VFO-520... Remote VFO for TS-520 and TS-520S
- SP-520... External Speaker for 520/820 Series
- CW-520... 500 Hz CW Filter for TS-520/520S
- DK-520... Digital Adaptor Kit for TS-520

599D Series

- R-599D... 160-10 M Solid State Receiver
- T-599D... 80-10 M Matching Transmitter
- S-599... External Speaker for 599D Series

- CC-29A... 2 Meter Converter for R-599D
- CC-69... 6 Meter Converter for R-599D
- FM-599A... FM Filter for R-599D

SHORT WAVE LISTENING

- R-300 General Coverage SWL Receiver

VHF LINES

- TS-600... 6 M All Mode Transceiver
- TS-700S... 2 M All Mode Digital Transceiver
- VFO-700S... Remote VFO for TS-700S
- SP-70... Matching Speaker for TS-600/700 Series
- TR-2200A... 2 M Portable FM Transceiver
- TR-7400A... 2 M Synthesized Deluxe FM Transceiver

- TR-7500... 100 Channel Synthesized 2 M FM Transceiver
- TR-8300... 70 CM FM Transceiver (450 MHz)
- TV-506... 6 M Transverter for 520/820/599 Series

POPULAR STATION ACCESSORIES

- HS-4... Headphone Set
- MB-1A... Mounting Bracket for TR-2200A
- MC-50... Desk Microphone
- PS-5... Power Supply for TR-8300
- PS-6... Power Supply for TR-7500
- PS-8... Power Supply for TR-7400A
- VOX-3... VOX for TS-600/700A

Trio-Kenwood stocks a complete line of replacement parts, accessories, and manuals for all Kenwood models.

MORE ACCESSORIES:

Description	Model #	For use with
Rubber Helical Antenna	RA-1	TR-2200A
Telescoping Whip Antenna	T90-0082-05	TR-2200A
Ni-Cad Battery Pack (set)	PB-15	TR-2200A
4 Pin Mic. Connector	E07-0403-05	All Models
Active Filter Elements	See Service Manual	TR-7400A
Tone Burst Modules	See Service Manual	TS-700A; TR-7400A
AC Cables	Specify Model	All Models
DC Cables	Specify Model	All Models



The Kenwood HS-4 headphone set adds versatility to any Kenwood station. For extended periods of wear, the HS-4 is comfortably padded and is completely adjustable. The frequency response of the HS-4 is tailored specifically for amateur communication use. (300 to 3000 Hz, 8 ohms).



The MC-50 dynamic microphone has been designed expressly for amateur radio operation as a splendid addition to any Kenwood shack. Complete with PTT and LOCK switches, and a microphone plug for instant hook-up to any Kenwood rig. Easily converted to high or low impedance. (600 or 50k ohm).

TRIO-KENWOOD COMMUNICATIONS INC.
1111 WEST WALNUT/COMPTON, CA 90220

KENWOOD
...pioneer in amateur radio



THE ALL SOLID STATE **ATLAS 350-XL**

Its face has many interesting features:

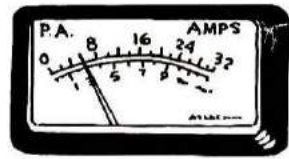

350 WATTS SOLID STATE POWER

P.E.P. and CW input.

SSB/CW TRANSCEIVER

SSB with PTT or VOX operation and full break-in CW operation.

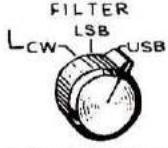

CW-LSB-USB FILTER

Selection of upper or lower side-band with 2700 Hz bandwidth, 1.6 to 1 shape factor, or 500 Hz CW bandwidth with 2.5 to 1 shape factor.

A.F. NOTCH



AF NOTCH FILTER

Provides better than 40 dB rejection of an audio frequency, adjustable from 300 to 3000 Hz.

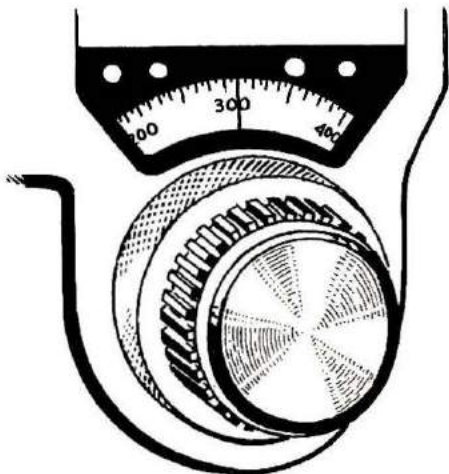

ANALOG DIAL SCALE

0 to 500 kHz dial scale in 5 kHz increments. Velvet smooth dual speed tuning, with 18 kHz per revolution of fine tuning control.

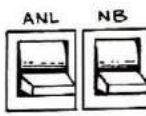

ANL AND NOISE BLANKER

Automatic Noise Limiter reduces hash type noise interference which is not intermittent pulse type. Blanker effectively reduces or eliminates pulse type noises.



RECEIVER INCREMENTAL TUNING

Permits receiving up to 5 kHz above or below your transmitting frequency. Especially useful for CW operation or in a net of SSB stations that are on different frequencies.

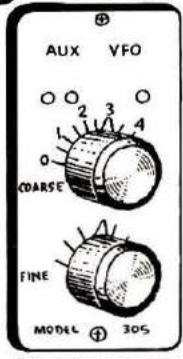

PLUG-IN AUXILIARY VFO (Optional)

Can be either a tunable VFO with the same 500 kHz tuning range as primary VFO or a crystal controlled fixed channel oscillator with choice of up to 11 crystal controlled channels.

10-160 METERS COVERAGE

Provides a full coverage of all amateur bands in 500 kHz segments.

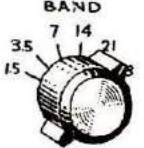

AUXILIARY RANGES

Up to 10 additional 500 kHz ranges between 2 and 23 mHz can be added by plugging in auxiliary crystals. (Will not operate between 23 and 28 mHz.)

- ATLAS 350-XL (less options) \$995.**
- Model DD6-XL Digital Dial Readout . . . \$229.**
- Model 305 Plug-in Auxiliary VFO . . . \$155.**
- Model 311 Plug-in Auxiliary Crystal Oscillator \$135.**
- Model 350-PS Matching Power Supply \$229.**
- Plug-in Mobile Mounting Bracket \$ 65.**



DIGITAL DIAL READOUT (Optional)

Provides precise frequency readout within 50 Hz. All L.E.D. Dot Matrix 6 digit display.



ATLAS RADIO INC.
417 Via Del Monte, Oceanside, CA 92054
Phone (714) 433-1983
Special Customer Service Direct Line (714) 433-9591